

Hobbies

WEEKLY

January 5th. 1944

Price Twopence

Vol. 97. No. 2516

THIS piece of furniture looks rather an elaborate article to build considering the general shortage of timber, but really the amount of wood needed is comparatively small.

For example, the legs can be made from a piece of 1in. thick board, 6ft. long and the frame from another piece of the board, this time 3ft. long.

The top and shelf take 10ft. of board, and with a piece for the doors is all the wood it is imperative to provide. The panels and back are made up of cardboard, with the

A SIMPLE KITCHENETTE

intention of replacing them with plywood panels when that useful material is again to be bought, let us hope in the not too distant future. The whole thing complete measures

2ft. 9ins. high and is 2ft. 6ins. wide, a convenient size for a normal kitchen.

As furniture is hard to get and when got, expensive, readers who can get the required number of feet of 9in. or 11in. board can easily make a useful article for themselves at little cost.

The article represents a kitchen cupboard, which, by adding an interior shelf later and providing receptacles for holding household jars, etc., can make a kitchenette.

Economy in Wood

The construction is very simple and any reader able to do an easy job of woodwork can build it. Fig 1 shows a view of the carcass partly made up.

To save repetition the wood used is 2ins wide and 1in. thick, except where otherwise stated, and the pieces of board should be sawn into suitable strips and planed to that size. Of course, much time and labour is saved where the strips can be bought already cut and planed.

First make up the horizontal frame A to dimensions given, or such other measurements as convenience may dictate, and see that the corners are square. A plain glued and nailed butt joint will suffice.

For the legs, get eight strips of the wood and cut to length. The strips are then glued and nailed together at right angles (L shape) in pairs, to make the four legs. A distance of

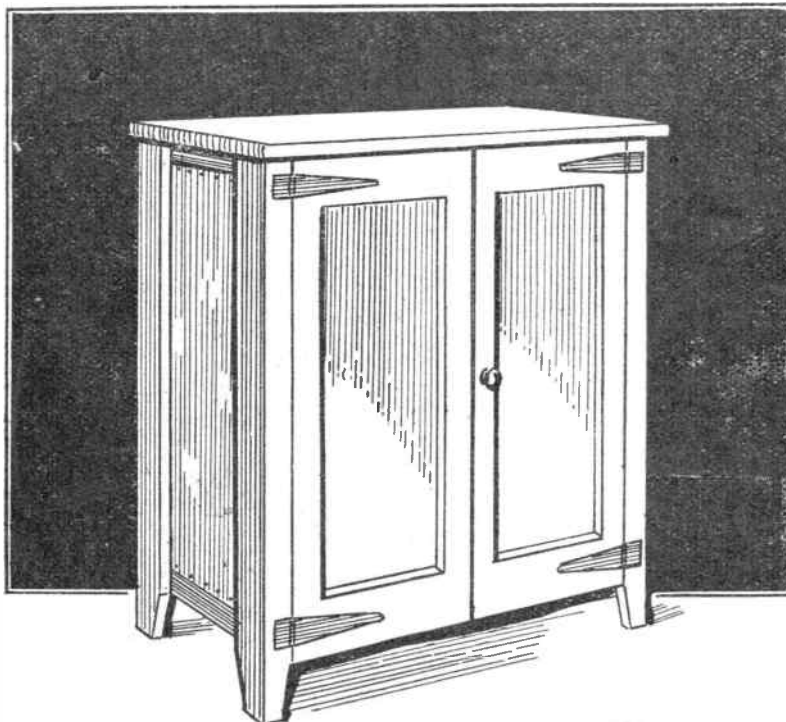

4ins. at the bottom of each leg, is tapered off a little. The legs are then fixed to the frame as at B.

Note here that the narrow side i.e., the 2in. wide one, is fixed to face the front or back, leaving the 3in. side to the ends.

Fix with glue and nails driven through into the frame, and screws driven through the frame into the legs as shown.

Across the ends at 4ins. up from the floor level, nail a rail as at C, Fig. 2. The boards for the bottom of the cupboard are then cut to correct length and nailed across to

result looks very neat and workman-like.

The Top

The boards for the top are now cut to length, and should be when glued together, large enough to overlap the ends and front of the cupboard by 1in. Glue the boards together edge to edge, and clamp up until the glue is hard.

The top is then trimmed up with a plane and is fixed over with screws driven through the blocks from underneath. The sharp corners are best rounded off and the whole

of the cupboard and about 1in. of the top frame, to both of which they are nailed.

The cardboard can be joined together, if not available in large enough pieces with tape glued across the joints as at D, Fig. 4.

When the panels have all been cut to size, cover them with strong paper pasted over both sides. That covering which will be the outside face should be $\frac{1}{4}$ in. larger all round, and be neatly pasted over to the back as in Fig. 4.

Fitting these panels is a simple matter. Just fix them between the

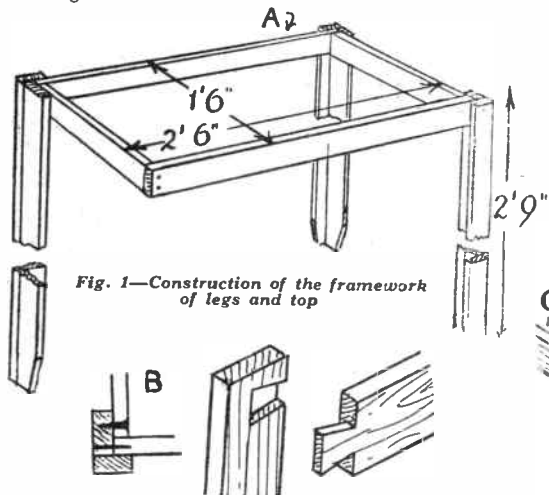

Fig. 1—Construction of the framework of legs and top

Fig. 3—Joint for door rails

these rails. Add a few more nails if necessary through the legs into rails and frame to make the carcass quite firm.

On the inside of the frame glue a few 1in. long blocks of wood, cut from scrap bits left over, to which the top of the kitchenette can afterwards be screwed. These are shown in detail, Fig. 2.

Economical Doors

The doors are made up of strips of the wood, 2ins. wide as usual for the sides but 3ins. wide for the horizontal top and bottom rails. The size of the doors will be measured off from the carcass. They should be long enough to reach from the top to below the bottom of the cupboard.

The doors can be framed up with the usual mortise and tenon joints, or with a dovetail half lap as in Fig. 3, as preferred. The latter joint is the easiest. An ordinary halved joint is not recommended as the sawn edge looks unsightly when the doors are opened.

Fit the doors with T hinges (as in the illustration) or $\frac{1}{2}$ in. butt hinges and add a catch and inside bolt to keep the doors shut. There are some patent fasteners for these kind of cupboards which can, or rather, could be got from hardware stores. It is worth while trying as some may still be in stock and the

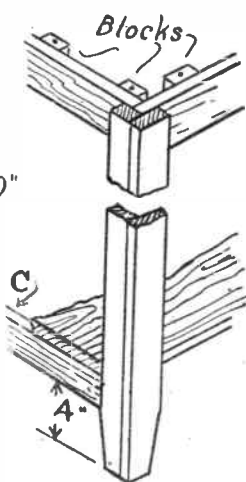

Fig. 2—Detail of legs and rails

glasspapered to smoothness. Now for the panels.

These, being of a temporary nature, can be made up of cardboard any thickness and size available. Their dimensions can be measured off from the carcass. The end and back panels fit between the legs and should be long enough to cover the edges

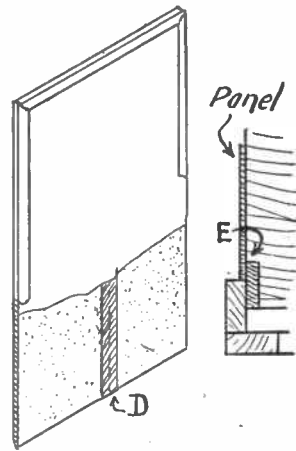

Fig. 4—Panelling the doors with card

legs and nail at top and bottom, using small brass-headed nails for appearance sake. Inside the cupboard a slip of wood is glued each side to which the panels can be also nailed to prevent them bulging out afterwards. This slip is shown at E, a horizontal part section through one end.

Panels for the doors are made similarly and should be $\frac{1}{4}$ in. larger each way than the opening they will fill. Nail them over the inside of the doors.

Suitable Finish

For a finish the top of the cupboard should be left plain for preference so it can be easily cleaned down after use. The rest can be stained and varnished oak colour, enamelled or painted white.

The panels are stained to match and afterwards sized and varnished, unless the wood is painted white, then if white paper is used to cover the panels, sizing and varnishing will be enough.

If or when, sufficient wood is available, a shelf should be added to the inside of the doors and provided with rims of wood, on which the jars, etc., used by the housewife can be lodged.

Narrow shelves can also be fitted to the inside of the doors and provided with rims of wood, on which the jars, etc., used by the housewife can be lodged.

2 CALENDARS



Sufficient painted wood for making these calendars (No. 25'6) is obtainable for 24 from Roberts Bronches, or by post from Roberts Ltd., Dereham, Norfolk, for 2

Specially planned for Hobbies, you will enjoy these GOOD PARTY GAMES

HERE are some excellent games you should introduce into any party. They are easy to arrange, simple to remember and original.

For "Smugglers" one person is the Coastguard Cutter. He is blindfolded, and stands at the middle of the room, in the Harbour Mouth. This consists of two chairs placed sufficiently wide apart that the Cutter can just span the opening with outspread arms. All the rest of the players are Smugglers, trying to get through the harbour entrance without being caught.

The game should proceed as quietly as possible, and goes on without pause until the Cutter has caught a Smuggler—when this happens the two change places.

Initiation

You should also try the game called "Password." Stage this stunt like a solemn initiation ceremony. The Novice is brought into the circle of the Brethren and made to stand before the Master.

"Give the Password," orders the Master.

The Novice is naturally puzzled, and probably says that he doesn't know it. Then the Master steps forward and whispers confidentially: "If you don't know it you had better say, 'Sorry, will some Brother help me out.'"

The novice obeys. And one or two of the Brothers do help—with considerable energy! Then the next victim is brought into the room, from those waiting outside.

The simple game of "Penny Toss" with its trial of skill appeals to everybody. An ordinary cake tin is needed—the sort that has depressions for half-a-dozen small cakes. These "holes" are numbered—gummed scraps of paper can be stuck in the bottoms of them with the numbers written on.

Then the tin is leaned against the wall, at a flat angle, and individuals or teams take it in turn to toss pennies. If the holes are numbered 1 to 6 then 50 should be Game.

Draughts Billiards

For "Draughts Billiards" have an ordinary draughts board, and three men. Use a black for the "red ball" and let each player have a clearly distinguishable white. Every black square counts as a pocket. Strokes are made by flicking one's "ball" with the forefinger shooting off the thumb.

When a white, after hitting a red, goes cleanly inside a pocket, 3 points are gained; going "in off" a white scores 2. A cannon—when a white

glances from either of the other balls and hits the third—scores 2. Observe billiard rules as far as possible.

For Team Work

"Rummage Race" can be an individual race or a team relay: the latter is most exciting providing you have enough players. For each team you have a bag of odds and ends—brush, penny, button, safety pin, shoe lace, piece of string, and so on; and the team is handed a piece of paper with a list of the articles in its own bag. The bag is hung on a chair at the far end of the room.

At the word "Go!" the competing runners dash up to their bags; find the first objects on their lists—by touch, putting the hand in the bag, without looking inside; carry the thing back to their team and hand it on to the second player, who races off with it.

This second runner drops the first thing back into the bag; feels for and secures the second on his team's list; takes this back and passes it to the third runner and so play goes on until every article has been brought down and returned to the bag. Alternatively, articles may remain with the team.

Like Shove-ha'penny

"Draughts Flip" is a kind of shove ha'penny. Have an ordinary draughts board flat on the side of a table, and let each of the two competing players in turn flip a draught—whichever colour he has chosen—up the board with finger and thumb. No scoring is made until eight white and eight black draughts have been sent, all remaining on the board—unless they

go off on to the table. Then scores are reckoned.

There are, of course, eight divisions running right across the board from side to side—a draught cleanly within any of these strips counts 1 point; 2 points are gained by a draught which is inside a square, touching none of the four lines surrounding it.

Remember that draughts can all be displaced by succeeding shots, and it is their "final lie" alone that matters.

Wording

For the game of "Vocabulary" a player points to another person and says a letter. The other must say twenty words beginning with the letter within one minute. A referee can hold a watch, bar x and z, and do not let the same letter be used twice. You can plan this as a team game, every team member competing in turn.

"Rabbits" is good fun if you are in a fairly large room. One person is the "sportsman," he stays wherever he likes, aiming to catch a rabbit which is trying to get into the "hole"—a chalked circle at the middle of the room, or a rug laid on the floor. The sportsman cannot get inside the hole. The rabbits hide themselves about the room, and whenever they see a chance make a dash for the middle hole. If one is touched he changes places with the sportsman.

"Car Parking" is a change from musical chairs, but is equally good. Place chairs, singly, about the room, in irregular order. Each is a "car park." While music plays those taking part follow a leader in single file in and out among the chairs. When the music breaks off all dash for seats. The last to sit is "out."

Somebody's Happy Christmas!



MEN of the sea are adept model makers, and here is Marine J. Lynch of Newport, Mon.,

with fretsaw and tools. Some lucky young lady had a marvellous Xmas, because the house is complete with doll's furniture. The design, of course, is one of ours, published some years' ago.

How to get the best results on your models by using POSTER COLOUR FINISH

MODELMAKERS are frequently instructed to finish off their work in poster colours. Quite a few, not knowing exactly what poster colours are like in appearance nor how to use them, may ignore such a finishing medium.

We think a few lines of advice on the subject, therefore, will be of interest, not only to a minority of readers, but all of you. Indeed, once a model-maker starts using poster colour paint, he will probably always use it, because it is easy to apply, quick to dry and one has all the colours in a rainbow at his disposal.

One can, you see, apply poster colour paint to anything, such as wood, glass, metal, paper, celluloid, linen, etc., in fact, there is no end to the items that can be effectively coloured with it. It "takes" excellently on any surface, no matter how rough or smooth.

The Only Drawback

The only drawback with poster colour paint is that it is not waterproof. Its solvent is water, if you wish, so that a coloured-up model, coming into contact with rain or damp, or wet fingers, is liable to be marked.

The fact that poster colour paint can "come off" easily, however, is often a blessing rather than a fault. Some of you, after painting a model with the paint, may not fancy the finished result. The colours, perhaps, are too bright or too dark, or as is often the case, all wrong.

How easy to get a wet rag and wipe the colours off without harming the model seriously! Such a job this presents if it is oil paint or enamel paint that has to come off. It would take you some hours, in that case, and the surface of the model would be rather impaired and unsightly and even your hands would be in an awful mess.

Poster paint, nevertheless, while soluble, can be "fixed" to remain permanent on a model by the simple expedient of giving the finish a single, thin coat of clear varnish or polish. The varnish, or polish, of course, puts a protective "skin" on the paints.

Like Water Colours

What, you may be wondering, is poster paint like? Is it much the same as water colour paint? In a way, the answer is half and half. Water colours are sold in small square cubes or in tubes, hard in the former case and soft in the latter. Poster colours are usually sold in air-tight jars or vials; the paint itself is (and should be kept) soft.

The main difference between the water colour paint and poster colour stuff is that one paint is transparent and the other has a "base" which renders it much the same as wall distemper. The advantage of this base in the paint is that the user can easily maintain an even, strict colour no matter how many coats are applied.

Water colour paint, on the other hand, will become deeper in shade. It will not remain identical throughout; it will show streaky, unless carefully brushed on (usually in a flowing manner, with the surface held at an incline so the colour blends properly on its own accord). We are thinking chiefly of wash drawings and picture paintings, of course, and not in respect to model surfaces.

Poster Colour Outfit

Thus, you will now appreciate the difference between the two finishing mediums. Water colours for picture painting, poster colours for show-card work—and models. Every serious model-maker enthusiast should obtain a small poster colour outfit.

Ivory-black, chinese white, light green, yellow, cerise, vermilion tint and deep ultramarine-blue are the best colours and from these seven colours, as you know, one can make various other colours and shades.

For example, a touch of black added to white gives you a grey colour. Different shades of green are made by mixing blue and yellow together. A touch of black to cerise, or vermilion tint, gives a brown colour. Yellow and red makes an orange colour. While red and blue gives a purple colour.

Mixing Colours

From the three primary colours of red, yellow and blue, in fact, it is possible to obtain shades ranging from brown and grey to black. Poster paint is opaque and dries flat. Being opaque, that is to say, having a base in it, one needs to add a little white when mixing up a colour so as to keep it of an equal consistency throughout.

If you want to make a colour pale, it is thinned out with water, plus a

touch of chinese white. The following list of colours are worth obtaining if you do not like mixing your own colours:—

YELLOWS—Yellow ochre, lemon or cadmium-yellow. **REDS**—Vermilion, crimson-lake, cerise or Indian red. **BROWNS**—Vandyke and burnt sienna. **BLUES**—Prussian-blue, cobalt-blue and ultramarine-blue. **GREENS**—Emerald or viridian-green, dark green. Other colours—ivory-black, chinese white and grey.

Using the Paint

Seeing that water is the solvent, it is advisable to prepare the surface of the work to be coloured, such as a wooden model. One merely damps the glasspapered wood with a rag, allows it to dry thoroughly, then rub the swollen grain down again with a fine grade of glasspaper. The grain, as a result of this precaution, does not tend to rise again so much, if it rises at all afterwards.

Assuming it is a model aeroplane you are finishing in the camouflage colours of dark green and brown, it is advisable to pencil the "patches" on the wood lightly, then fill in all the brown patches before tackling the green patches. Allow the colour to dry out before applying the other next to it, by the way, or the colours will "mix" badly on you.

Suitable Holders

Avoid overlapping as much as possible, for one poster colour is soluble on the other. A careful, steady hand is wanted. Do not load the brush with too much colour, otherwise the paint will "run" on the work. A little colour at a time is the safest measure.

You should have a water pan and brush for each colour. The writer finds that egg-cups are ideal water pans. Just fill them three-quarters full with clean water. Have a piece of old blotting paper handy to dry the brush when loaded too much with the water or paint, after you have of course, scraped as much excess water, or paint, off the hairs of the brush on the edges of the egg-cup.

Avoid dipping a different-coloured brush into your water pan or paint jar. It will greatly alter the colour of the water and will, in time, do the same to your paint. Just be careful, and patient, and success will crown your efforts.

Wherever possible, try the colour out first to ensure you have got it exactly right for shade. Wait until one colour is dry before adding another, particularly if it is going to run close up to it. A paper mask over it will help.

Y	E	A	R	L	E	A	F
V	E	N	D	E	I		
S	E	N	S	E	S	I	N
R	O	O	T	S	H	I	
B	Y	L	T	O	O	L	S
A	B	O	U	T	N	O	A
G	O	A	T	T	O	D	S
D	E	O	R	T	A		
A	Y	E	H	E	A	T	L
W	A	R	F	A	L		

Solution to Last Week's X-word Puzzle

A weekly "once-over" is worth while now in the CARE OF THE CYCLE

HOW about your bicycle in winter? This is a question that arises in the minds of those who have new, or recently new machines. No one likes the fresh appearance of one's mount to fade or become rusted. But, if we are to preserve the looks of our machines, especially at this season of the year, some little thought must be given to its care.

Why not make a habit of a weekly "once-over". Spend half-an-hour once a week in giving the machine its clean-up; you will find it time well spent. Bicycles are hard to get nowadays, and after the war there will be a great demand for them, so be wise and look after your machine.

It is taken for granted that your cycle is well adjusted. See that there is no undue "play" in the hubs and bearings, no side shake in the bottom bracket, and none in the pedals. The chain should not be quite taut in the tightest place.

Oiling and Greasing

Do not be stingy with oil during winter. In summer when dust is blowing around you require less oil or bearings may be clogged. "Little and often" is the policy then, but in winter you can be more liberal with the oil-can.

These parts call for attention: bottom bracket; pedals; hubs; head bearings; free wheel; chain, and the moving parts of the brake mechanism.

It may well be that the pedals of your cycle are not fitted with oilers or nipples. In that case the pedals should be dismantled, packed with grease and reassembled. The head bearings should be similarly treated if there is no provision for adequate oiling. For that matter, a packing of grease in all the bearings will keep them waterproof and yet free-running.

Always, when oiling in winter, see there is a liberal dose. When lubricating a bearing at one end, and the oil starts to ooze out at the other you know then that the oil has really got to the vital parts of the bearing.

The chain is important. Keep it properly adjusted and well lubricated in winter. Unless protected by a gear-case, give it a coating of graphite grease after cleaning it well. Indeed, a chain should be periodically taken from the machine and allowed to soak in a paraffin bath for a whole day.

Put two pieces of wood at the bottom of the tin or bucket or whatever you may use, and on these rest the chain: the dirt released by the paraffin will then drop to the bottom. After soaking wash chain in clean paraffin. Drain and wipe dry. Then give it a final oiling. At the weekly "once-

over" brush the chain and wipe it with a dry cloth.

When treating a chain with the graphite grease, wipe off all surplus, only a thin film of grease being necessary.

Chromium Plating

Most of us like to see chromium plating on the bike. It requires but a little attention to keep it nice. It does not rust, but it is apt to wear off at the edges and corners exposing the steel underneath. To prevent rust-spotting in these exposed places, smear a little vaseline over them.

Indeed, a thin film of vaseline over all the bright parts of a machine—with the exception of the rims, of

course—will help to protect them from all possibility of rust during bad weather. The protective coating of vaseline can be wiped off when fine weather returns, leaving the bicycle with its appearance as fresh as ever.

A good lamp is a necessity during winter. The best illuminant for night-riding, especially for longish distances, is a dynamo lamp, suitably shaded, of course.

A weekly valeting and your machine will last longer and give you better value all round. And the valeting is much easier if the last wipe over each time is with a slightly oily rag, which gives a film of protection against rust and any caking-on of mud.

The Editor's Notes—

FOR the past 12 years Mr. James Panter, of New Moston, has had a hobby of writing the Lord's Prayer on the reverse side of small coins, but, now at the age of 87, he has added the Gloria, thus making 100 words on one side.

His writing is small but quite distinct through a magnifying glass. He has recently sent samples of his hobby suitably mounted, to the Prime Minister, Generals Eisenhower, Montgomery and Alexander, and President Roosevelt, wishing them all success in the battle for freedom.

* * *

I SAW a photograph the other day of another unusual collection which formed a hobby—small crucifixes and crosses from all parts of the world. The picture came from Reading, Pennsylvania and showed over 120 different kinds, including plain as well as very ornate kinds. One was from the tangled roots of an oak tree over 125 years old. Probably some of our readers in the Forces now serving in the Middle East, and particularly Italy, may get a chance to start such a collection.

* * *

HAVE you ever tried your hand at modelling in putty or Plasticine or plastic wood, Lots of people have a latent talent in this direction which they do not realize until they first try. Actual photographic modelling with correct features is difficult, but a simpler method is

to caricature the subject, much as you see them in cartoons. A former Eighth Army man I know, Mr. B Matthews of Ettingshall, Wolverhampton has made some amusing and realistic models as a hobby including Mussolini with an ice cream barrow, Stalin with the famous steamroller. A spatula and a penknife serve as the tools and the raw materials are Plasticine, oil and water paints and wire.

* * *

AN inspiring poem "England Stand Firm" printed on a card with an overprint outline of the British Isles has been kindly sent me, with a most encouraging letter, by the author, Albert Ralph Korn, of Park Avenue, New York City. He tells how it has been largely distributed by the British War Relief Society of America and, I have no doubt, have done much for the good of our cause.

* * *

IMENTIONED in a recent note how much hobbies can mean to our prisoners of war. Here is an extract from one of the many letters I receive in proof. Mr. G. H. Rush-ton of Netherton, Dudley, Worcs. sends a cutting from a letter from his son who is (or was) a prisoner of war somewhere in Northern Italy. He just says "Don't forget to purchase next year's Hobbies Handbook, as you did last year, as soon as published." Imagine what a host of interest such a book means. Needless to say the Handbook was sent "as soon as published."

The Editor.

Here we deal with scenery and orchestra in making our MODEL THEATRE (Part II)

WE have dealt in last week's issue with the making of the stage and the proscenium and the electric lighting, and now we propose to go a step further and talk on the making of the drop curtains and the scenes. The former should preferably be of some dark material of not too coarse or heavy a nature.

Something of a light tapestry or even silk with a light-weight lining would be more appropriate. The curtains are drawn apart and lifted

of the curtain and then go across the curtains diagonally through small rings stitched to the back as shown. To the proscenium frame on the right, a brass eye is screwed in, while on the left two eyes are fixed a little apart as shown in the diagram.

The cord of the left curtain passes through the lower eye and is then allowed to hang down in a loop. It passes upwards again and through the second eye and is carried across to the single eye of the second curtain—that on the right. From here it is taken down and fixed to the

positions of these scenes and how the "wings" are held in their place through the slots in the sides.

In Fig. 3 two representative scenes are given, and in A—the cottage scene, the wing scenes are distinctly given to show how they are formed and painted to represent distance.

In the second scene "The Quayside" there is one wing scene on the left showing the small roof and window, then at the rear of this there are the two "stone wall" side scenes. The latter stand a little way in front of the back scene.

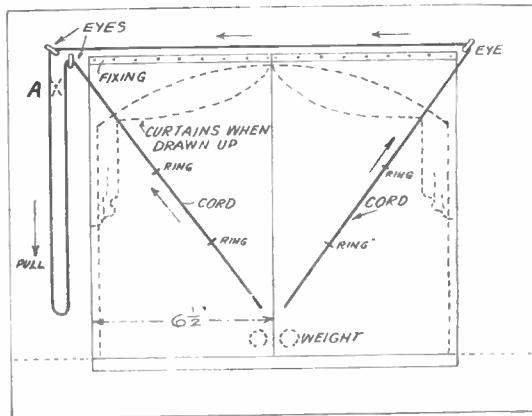

Fig. 1—Cords and rings for curtain raising

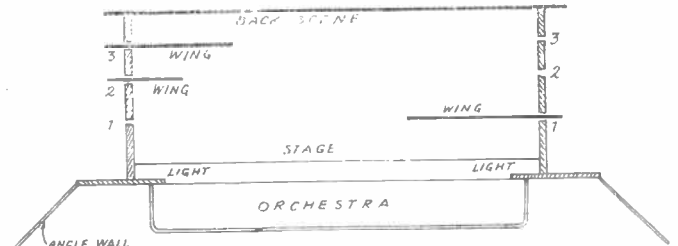

Fig. 2—Plan of stage and orchestra pit



Fig. 4—Draw out the figures of the orchestra in silhouettes

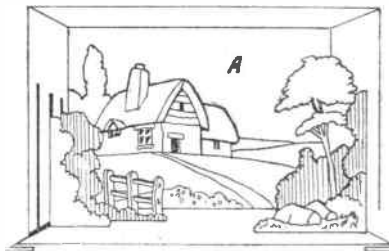
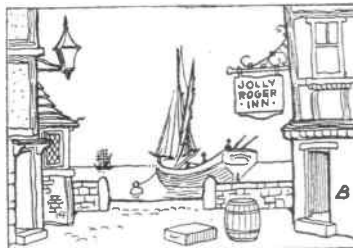

Fig. 3—Two simple scenes to arrange as a back cloth



to the draped effect shown in our sketch. Having decided upon the material for the curtains, they should each measure a full 10½ ins. to 11 ins. long and full 7 ins. wide. These measurements allow for "turnings" in their length measurements and for a lap for nailing securely to a lath or hanging-strip for the top.

Fig. 1 is a rear view of the proscenium with the curtains nailed closely to the strip and hanging loosely. In the lower corner sew in small lead weights to assist in bringing the curtains well together when they are lowered.

The method of drawing the curtains to rise sideways and upwards is shown clearly in the diagram. Two cords are stitched to the lower parts

curtain in a similar manner to the first one.

By knotting the two cords together at point A (Fig. 1) there will be no fear of the curtains rising irregularly when the lower looped end is pulled down.

We pass now to some suggestions for scenery. The main scene or "backcloth" is made on stiff cardboard. Or a cut-out frame of plywood could be made and stoutish paper stretched and pasted over it. The chosen scene is painted direct on this, preferably in water colour after the drawing in has been carefully done in soft pencil.

The wing scenes are those which stand at the sides and complete the scenic effect. In Fig. 2 we see the

To give foreground, two side wing scenes are arranged to stand across the corners at an angle of 45° to the back scene. These "angle" scenes are very suitable where entrance doors are wanted to house or inn near the front of the stage. All such scenes as this should be of stout card.

The figures of actors and actresses may be cut from thin wood and fixed to thin bases to stand up where required.

The orchestra is formed by enlarging the patterns in Fig. 4. The length of wood to contain the pattern should be 12 ins. and to give a really good effect the outline should be carefully studied and followed during cutting.

The Orchestra Figures

The musicians can be painted up naturally or may be coated wholly black to show up well against the lights. The "well" to contain the orchestra can be formed from card to the outline plan in Fig. 2. The exterior of this "well" should be painted crimson-vermilion to represent curtains.

An idea for the simple decoration of the walls and the panels at the sides may be got from the sketch of the finished theatre.

Full patterns for making an excellent miniature MODEL ARMOURED CAR

THIS armoured-car was designed primarily for use by our younger readers in conjunction with model soldiers; it can be easily and quickly made and as a gift to a young friend or brother is certain to please. The diagrams here are full-size which makes measurements and marking quite simple.

First of all a small block of wood (any variety you have available), is used to make the main part of the car and is shown in the drawings as B. These drawings may, of course, be used for a larger model if desired by doubling all dimensions.

A Solid Block

The block of wood should then be cut to the size illustrated and the view shown in the side elevation marked out on each side. The side view is then cut out, including the wood inside the lines E and F. The underside is shown at B and indicates the tapering radiator of the vehicle which is cut to shape.

The car is then thoroughly glass-

paped and the gun-turret made. This is cut from a small wood cube to the shape shown at A and mounts two machine guns which are cut from hard-wood and glued into holes drilled in the turret. The turret is screwed to the car body by the screw L and if a revolving turret is desired a card-board washer is inserted between the turret and arc roof.

The hatch on the top of the turret is of card-board, its actual purpose being to conceal the head of the screw. The turret is completed by the addition of the wireless aerial—a headless pin.

The next step is to make the mud-guards or splashers from tin-plate. The front one is illustrated at E and the rear, over the double wheels at F. These splashers go right across the

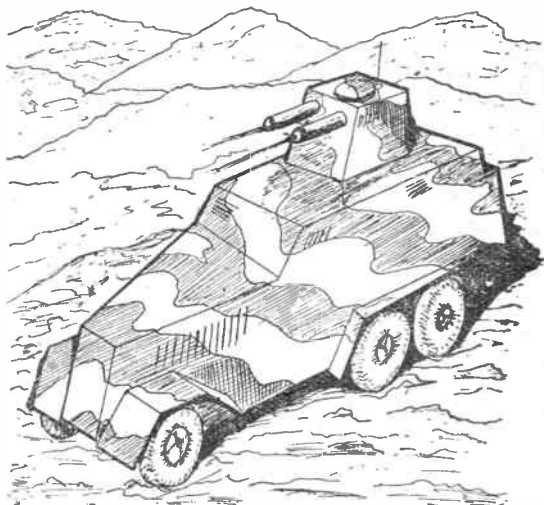

underside of the car, not as separate strips each side, and the dimensions of the tin-plate are clearly shown in the drawings. When these have been cut and bent to fit as indicated the front one may be fitted.

The underside, where it is to fit, is well covered with glue and a hole is punched in the tin-plate to receive the small screw K, which is driven into the body of the car. The rear splasher F is next glued in the same manner and has two holes punched in it for the screws H and J.

The bearers for the axles are next made from tin-plate and are fully illustrated at C and D on the various drawings. They have oval holes punched in them at the places indicated to receive the wheel axles. The idea of oval holes is to pro-

(Continued on next page)

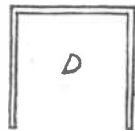
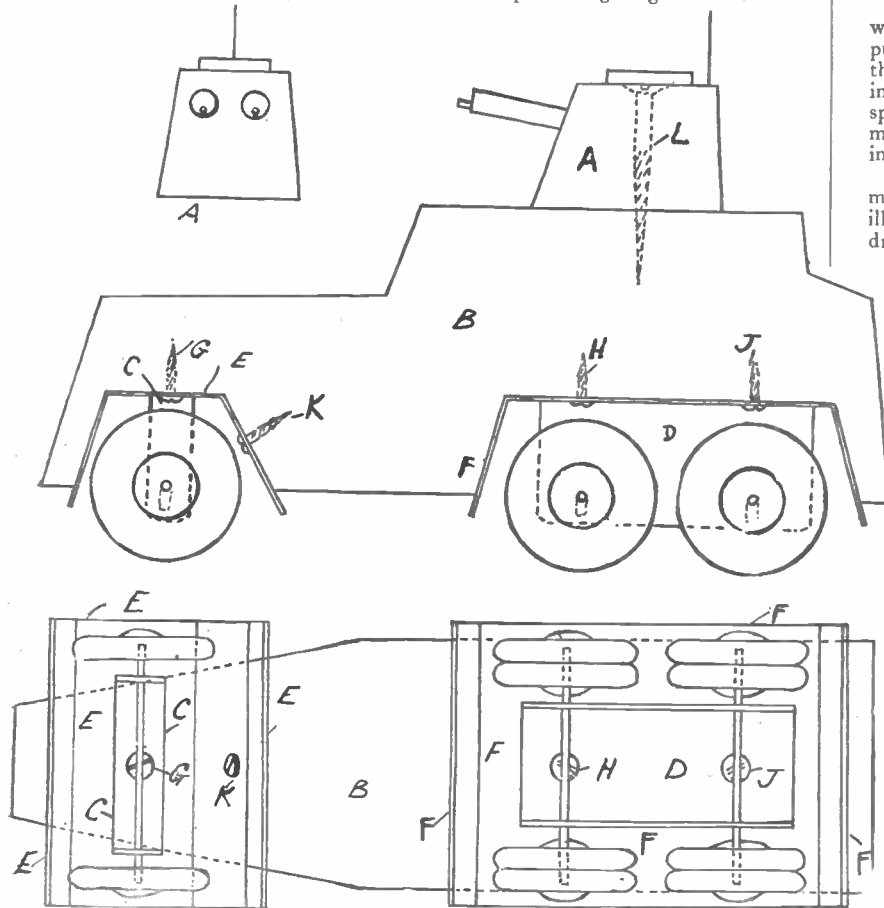

vide a certain amount of flexibility when the car is surmounting rough ground. When these bearers are complete and bent as shown they are screwed to the chassis.

The front wheel bearer (C) is fixed to the car by the screw G which passes through a hole punched in the mud-guard E and up into the body of the vehicle. The larger rear axle-bearer has two holes punched in it corresponding with those in the mud-guard F and through this the two screws H and J secure it to the main body.

All that remains now is to fit the

axles and wheels. The wheels are $\frac{1}{2}$ in. diameter and are normally obtained from any shop supplying model aircraft components. They will usually be found to be properly finished on one side only being flat on the other and are fitted to wire-axles as indicated.

The front pair is shown having the wire glued only part-way into the wheel hubs. This is to avoid spoiling the outer hub of the wheel. The rear wheels are fitted in a similar manner, the flat side of each wheel being glued together and the double unit drilled and glued to the axles as

illustrated, taking care not to pierce the outer hubs.

The armoured-car is now complete except for painting. This may be carried out in a number of different ways. The vehicle in the accompanying sketch is camouflaged khaki and brown, while other effective colours are olive green or battleship grey. The ventilation louvres, etc., on the finished sketch are marked out on the car in black. If readers find difficulty in obtaining paint, dope as sold for model aircraft, is recommended and is usually available in a range of useful colours.

ATLANTIC WAR STAMP FREE!



On November 1st, 1943, the FREE POLISH GOVERNMENT IN LONDON issued a new set of pictorial postage stamps for use by the FREE POLISH FORCES in this country and by POLISH SAILORS at sea. We have been fortunate in obtaining a supply of these historic War Stamps and have pleasure in offering YOU same ABSOLUTELY FREE. The stamp, as illustrated, depicts an actual incident of a Wellington bomber of a Polish Coastal Command Squadron sinking a German Submarine in the Atlantic. It is inscribed in Polish of course, "Polish Air Force in the Battle of the Atlantic"; and the stamp is printed in pink colour. You can get your copy of this most interesting stamp from us ABSOLUTELY FREE by writing to us and asking for our Lists and a selection of our stamps "on approval." This Polish issue can only be supplied FREE with an approval selection and if you send us 3d. in stamps also (to cover cost of List and postage of approvals to you). Do not delay; write immediately for this wonderful FREE OFFER to:— WINDSOR STAMP CO. (Dept. 12), UCKFIELD, SUSSEX.

HOBBIES

is a household word for happy pastimes for the handyman. Now unfortunately it is impossible to fill the great and increasing demands because supplies are short and sometimes unobtainable. To make sure whether your needs for handiwork and home crafts can be supplied you should now enquire before ordering. You may be sure we will help you all we can. Call at a Hobbies Branch or write direct to

HOBBIES LIMITED, DEREHAM, NORFOLK

MISCELLANEOUS ADVERTISEMENTS, etc.

The advertisements are inserted at the rate of 3d. per word or group of letters prepaid. Postal Order and Stamps must accompany the order, and the advertisements will be inserted in the earliest issue. Freework goods or those shown in Hobbies Handbook not accepted. Orders can be sent to Hobbies Weekly, Advertisement Dept., as below.

LONELY? Then write Secretary U.C.C., 5 B.B. Hay St., Braughing, Herts. Genuine. Est. 1905.

BE TALLER. Quickly! Safely! Privately! No Appliances—No Tablets—No Dieting. Details 6d. stamp.—Malcolm Ross, Height Specialist, BM/HYTE, London, W.C.1

YACHT. "Planbook" tells how to make and race Model. New simple time saving method of construction. GAS ENGINE. "Planbook" gives instructions and drawings for working model which runs on air. Made with simple tools and materials. New technique. GAL-LEONS. All the secrets of making lovely models of these old-time ships are in this "Planbook" with working drawings. AIRCRAFT, SHIPS and RAILWAYS. Use "Scaleline" plans. SEND 2d. and addressed envelope for list of over 90 Plans and details of above Modelcraft "Planbooks."—77(H) Grosvenor Road, London, S.W.1.

WANTED. Model Railway, Gauge O or OO, Electric or Clockwork.—Ridgeway, Bois Avenue, Amersham.

METALCRAFT. How to make all kinds of useful and ornamental objects in metalware. 2/- net. Obtainable from booksellers, or Guardian House, Walthamstow, London, E.17.

STAMPS FOR ALL. Illustrations, detailed explanations rare stamps and designs. 2/- net. Obtainable from booksellers, or Guardian House, Walthamstow, London; E.17.

30 STAMPS FREE. Request discount approvals. (Send 2½d.).—C. Stenton (H.W.), 164 White Lane, Gleadless, Sheffield.

LONELY? Join Friendship Circle. Details 6d.—Secretary, 34 Honeywell Rd., London, S.W.11.

TOYS. Send for range of popular designs. Simple to make from scrap materials. For pleasure or profit. 2/6 only Post Free.—Harrod, 10 Beaconsfield Road, Maidstone.

WANTED Meccano. Price about £1.—J. Folds, Hillside, Lyehill, Breachwood Green, Hitchin.

MAKE or recharge Your own Torch Batteries. Great Success. Reduced Price 1/3 post free. Send now. Instructions.—W. H. Tucker, 84 Wiston Road, Brighton, 7.

FREE! 30 Stamps to approval applicants. Postage extra.—A. Cotton, 34 Park Avenue, Kids-grove, Staffs.

GOLDEN JUBILEE! Twenty Unused Stamps Free! To commemorate our Fifty Years of Stamp Dealing (2½d.).—G. H. Barnett, Limington.

APPROVALS on Request.—Warrington, 1, 1erham, Bearsden Glasgow.

SALE—Hornby Clockwork Railway £4.—Bushell, 104 Leighton Rd., Enfield.

MAKE A MODEL FORTRESS (non-flying) from Hobbies Patterns No. 2405, price 4d., (postage 1d.). Or a Boston Bomber (No. 229 Special) price 6d.—From Hobbies Ltd., Dereham, Norfolk, or Branches.

1	2	3	4
5	6	7	8
9	10	11	12
13	14	15	16

NOTE: This design sheet is only presented free with the current issue of Hobbies and Dot with bank numbers. Further copies may be obtained.



No. 2516
3.1.44

PANELS OF WOOD H...
FOR THIS DES...
ONE J3
The price is shown in Weekly, Jan., 5th, 1944 subject to revision. Current edition of Hobbies book, or write for Hobbies Limited, Norfolk.

CUT OUT THE SQUARES AND MOUNT UP ON THIN CARDS. ONE ON FRONT AND ONE ON BACK OF EACH.

FOR SIZE OF CARDS, ETC. SEE ARTICLE ON BACK OF THIS PATTERN SHEET.



17	18
20	21
23	24
26	27
29	30

2	3	4
6	7	8
10	11	12
14	15	16

NOTE: This design sheet is only presented free with the current issue of Hobbies and not with back numbers. Further copies may be obtained.



No. 2516
S.I.44

SUPPLEMENT TO HOBBIES No. 2516.
PERPETUAL CALENDAR
COMPLETE WITH NUMERALS, ETC.

PANELS OF WOOD REQUIRED
FOR THIS DESIGN
ONE J3

The price is shown in Hobbies Weekly, Jan., 5th, 1944, but is subject to revision. See the current edition of Hobbies Handbook, or write for price to Hobbies Limited, Dereham, Norfolk.



JULY	JANUARY
AUGUST	FEBRUARY
SEPTEMBER	MARCH
OCTOBER	APRIL
NOVEMBER	MAY
DECEMBER	JUNE

CUT OUT EACH TO THE LINES AND MOUNT UP ON THIN CARDS, TWO ON FRONT AND TWO ON BACK OF EACH CARD.

FOR SIZE OF CARDS, ETC.
SEE ARTICLE ON
BACK OF THIS
PATTERN
SHEET.



17	18	19
20	21	22
23	24	25
26	27	28

The arrows indicate the direction of grain of wood.



23	24	25
26	27	28
29	30	31

MONDAY	FRIDAY
TUESDAY	SATURDAY
WEDNESDAY	SUNDAY
THURSDAY	

CUT-OUT EACH TO THE LINES AND MOUNT UP ON THIN CARDS, TWO ON FRONT AND TWO ON BACK.

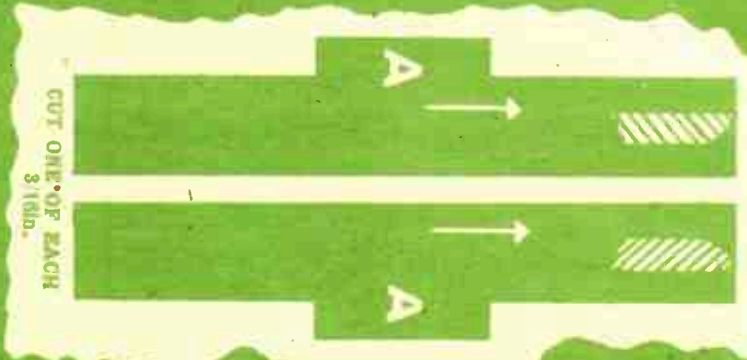
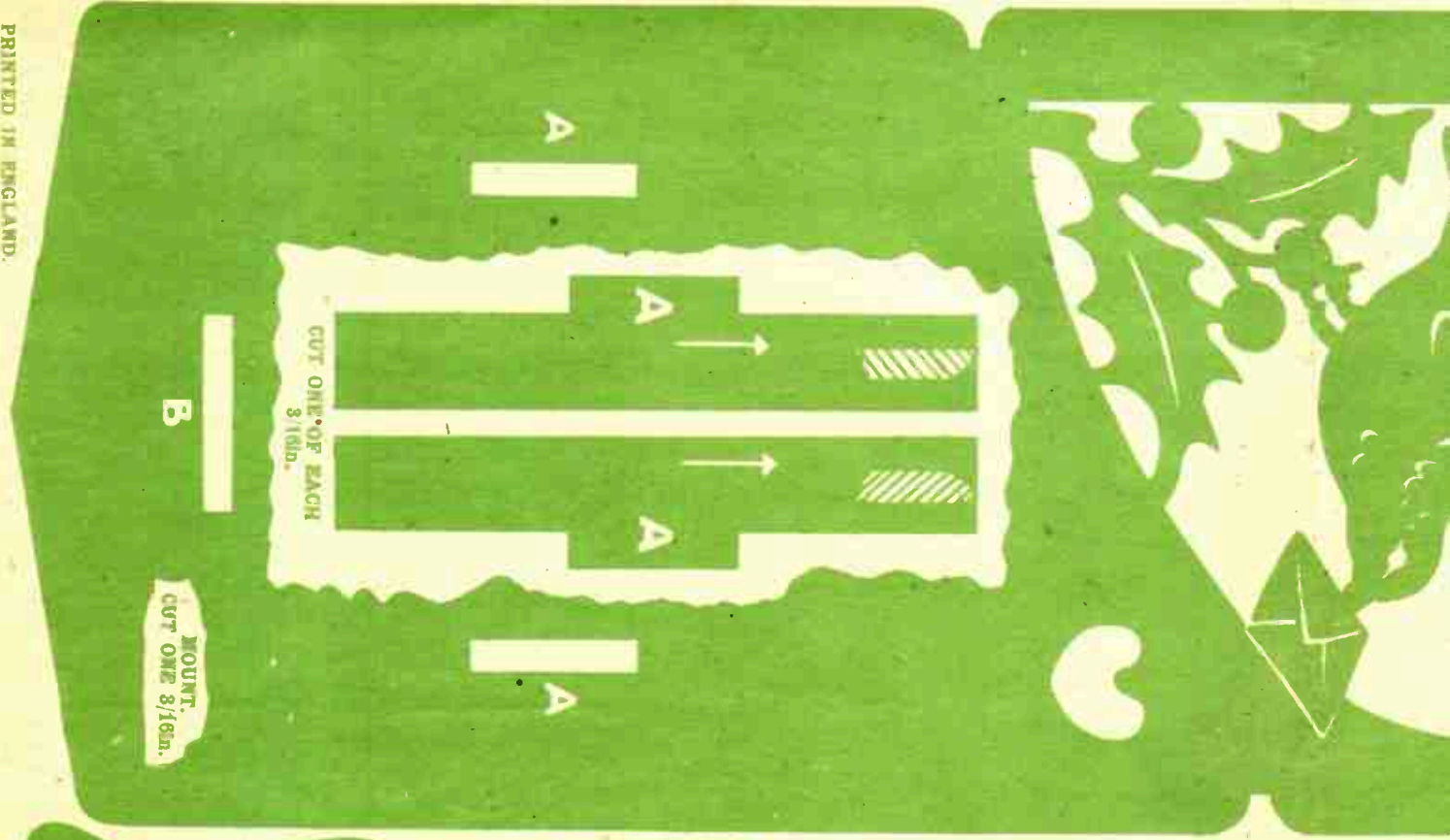

CUT ONE OF EACH 3/16in.

MOUNT, CUT ONE 3/16in.

SIDE

SIDE



FLOOR, CUT TWO 3/16in.

FRONT, CUT TWO 3/16in.

Chamber on face as section

Chamber on face
as section.

TUESDAY	WEDNESDAY	THURSDAY	FRIDAY	SATURDAY	SUNDAY
---------	-----------	----------	--------	----------	--------

CUT OUT EACH TO THE LINES AND MOUNT UP ON THIN CARDS, TWO ON FRONT AND TWO ON BACK.

21	27	24	21
22	28	25	22
30	31		

The arrows indicate direction of grain

SIDE

FRONT.
CUT TWO
3/16in.

FLOOR.
CUT TWO 3/16in.

CUT ONE OF EACH
3/16in.

MOUNT.
CUT ONE 3/16in.

A PERPETUAL CALENDAR

PATTERNS on the other side are provided for cutting from wood with the fretsaw, all the parts necessary for a calendar which will do for any year. It thus forms a suitable gift to a friend if properly made and nicely finished. Details are also provided for a simple method of making the cards, which are interchangeable for the day and month concerned.

A choice of either two calendars is provided, with complete patterns for each, but there are only figures and days and months for one set of calendar indicators. The construction of the calendar holders is the same in both cases.

The Main Back

There is a backboard with a small amount of interesting fretwork to be cut out as the main part. In each of these there are slots at A and B which take the projecting pieces of the calendar holders. These must be cut carefully, of course, in order to make a good joint when the other part is fixed therein.

The bracket piece holding the calendar cards is comprised of two sides, a floor and a front. A back view of it is given in the detail herewith, which makes the construction obvious. The two sides and floor mortise into the back at A and B and should form a strong unit. Over the front of the

whole thing then is glued the openwork front to the pattern shown. Notice that the inside edges of this piece should be chamfered slightly so that the wood does not appear too thick.

The cards are made to stand behind the front and yet be visible for their dates and names. You will want enough card about the thickness of a postcard and preferably white, to form panels of the day, the week and the month. There will be 31 required for the figures for the days, 12 cards will be sufficient for the months as one is pasted at each end. Four will be

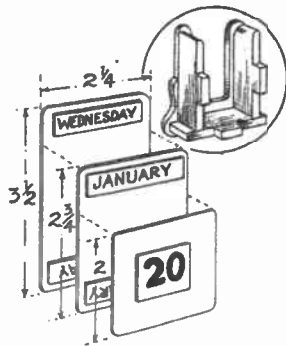

sufficient for the week for the same reason.

All cards are exactly $2\frac{1}{4}$ ins. wide. The height of the weekly card is $3\frac{1}{2}$ ins., that of the month $2\frac{3}{4}$ ins. and

that for the day 2 ins. Cut the cards to these sizes carefully with a sharp knife and ensure that all are the same width and certain of them the same height. It will look ugly if some project above others at the top.

The method of pasting down the figures and the numbers is shown in the detail. Again the figures and names must be cut out very carefully with a penknife, this time from the actual figures and letters given on the sheet. Get a clean, sharp edge to the paper, and then paste down to the card.

The day figures go in the centre of the smallest, the month figures go near the top and bottom of the other card, and the same with the days of the week. Do not forget that those pasted at each end of the card must be reversed in one case so that when the card is turned round the day or month will show the correct way up.

Date Card

If you want a more striking effect you can, of course, paint over the printed figure or letter with poster paint, and those who are good with the brush may even prefer to paint the appropriate figure or name on the card itself.

The calendar is intended for hanging and a small brass wall hook should be fixed to the centre of the top for this purpose. The fretted outlines can be backed up with fancy material if you wish.