

Hobbies

WEEKLY

December 22nd, 1943

Price Twopence

Vol. 97. No. 2514

AN ELECTRIC NIGHTLIGHT

A REMARKABLE type of night-light is shown at Fig. 1. Instead of the usual bright light, we have a soft, mystic and soothing glow; in fact, the glass globe appears to be glowing with an intense, white heat. This delightful effect is obtained by using a small opal-glass jar.

The writer used an opaque mentholatum jar measuring 2ins. long by 1½ins. in diameter. Owing to the nature of the glass (it is a milky colour) the light from the flashlamp bulb is rendered opalescent and pleasing to see.

The items used in making the nightlight is a flashlamp battery, flat 3-cell type, a bulb, holder cup, a couple of roundhead brass nails, some scraps of plain wood and a miniature automatic-action button switch. The latter needs to be pressed to switch on the current and pressed again to switch it off.

Building the Base

Begin work by making the base. The main piece is cut to the size and shape shown at Fig. 2, bottom view. Scribe a 2¾in. radius with the compasses on a piece of ¾in. thick wood to make a 4½in. diam. circle. A 3in. by 2½in. aperture is drawn in centrally for the battery housing, whereas a 1½in. by ¾in. slot is marked on at one side for the base of the switch.

Cut out the apertures first, then go around the radii line. A coarse fretsaw should, of course be used. Deal is the easiest wood to work with, being soft. Other readers might

find it more convenient to mark out the base on a large piece of ¾in. wood, then cut out the apertures by means of a keyhole saw or bow-saw, following which the outside shape is cut and trimmed to line with a spokeshave.

A top for the main base piece is cut from ½in. wood (see Fig. 3). This has a central bolt hole for the bulb holder cup, with an additional ¼in. hole about ½in. away for one of the wires. A third hole, ¾in. diam., is made in line with the other two at a distance of 1½ins. from the central hole.

Glue and pin the top piece to the

main base piece, then proceed by cutting out the jar discs detailed at Fig. 3. The larger disc is cut from ½in. wood and the smaller one from ¼in. stuff. The former is glued centrally on the base top, the latter going on top to build up a ¾in. high "wall" for the jar neck.

The jar neck must be a screw-in fit in the top discs, by the way. So, be sure to measure the diameter of the neck of the jar you obtain and make the aperture in the top discs accordingly.

Battery Contacts.

To provide suitable contacts for

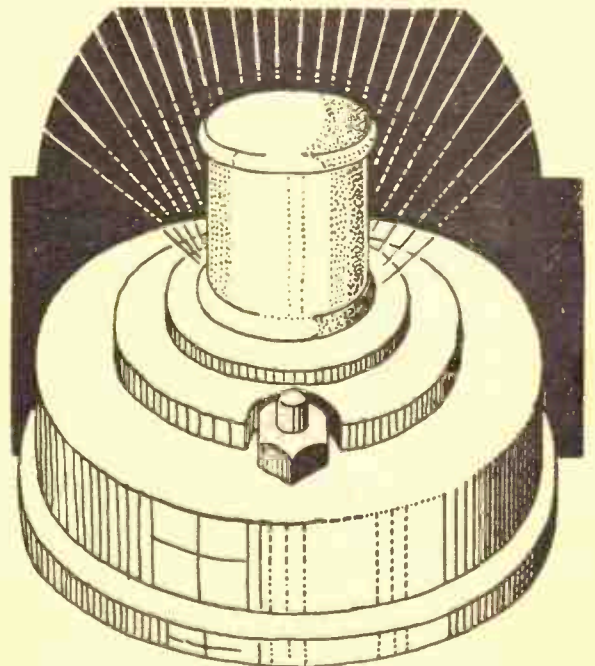

Fig. 1—A nice little glow light with button switch

the arms of the battery, drive two roundhead brass nails into one end of the battery aperture, as shown by the bottom view, Fig. 2. Before finally pushing the heads close against the wood, bare the ends of a couple of lengths of cotton-covered wire (any fine gauge stuff will serve) and wind the exposed ends around the nail shanks.

The switch base could be inserted and fixed on by means of its bakelite

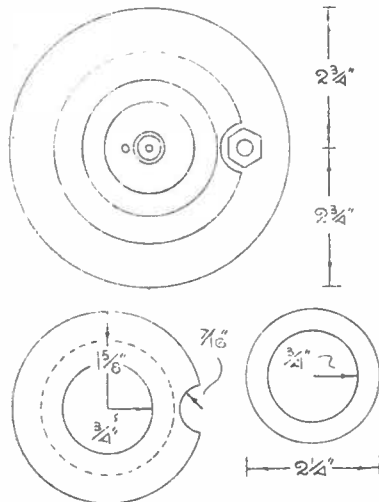

Fig. 3—Top view of work with shape and size of jar discs

nut. The cup of a M.E.S. bulb holder is bolted to the base top. As can be seen by the sectional side view at Fig. 2, one battery contact wire is affixed to the bulb cup set screw, with the second wire running to one of the switch sockets. A third wire is connected to the cup bolt and brought along to the second socket in the switch.

If, of course, a small set screw is not provided on the side of the bulb holder cup, the wire could be twisted around it, or alternatively, a tiny clip could be made from thin brass to fit around the cup and hold the wire firmly against it. Incidentally the lengths of wire used must be sufficiently long so they can be pressed along one of the corners so as not to interfere with the battery.

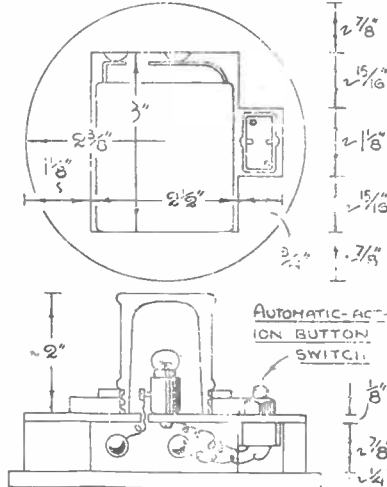

Fig. 2—Bottom view (above) and side section

A Loose Bottom

Now, in order to gain access to the battery aperture, a loose bottom must be made. This is merely a 5 1/4 in. diam. disc of 3/8 in. wood attached by means of four flathead screws.

Another plan is to "dowel" the bottom to the main piece. To do so, simply drill four equidistant holes

about 1/4 in. inwards from the edge of the disc. It is advisable to have the bottom nailed temporarily to the work so the one operation of drilling will serve for making the "receiving" holes in the main piece.

Dowel pins about 1/4 in. thick by 1/2 in. long are glued into the bottom piece to project 1/4 in. The ends should be rounded so they engage more easily with the holes drilled in the main piece. It may be necessary to glasspaper the dowel projections a little to facilitate their entry into the receiving holes.

Now, unless you have the pins accurately spaced, you will not experience any bother no matter what way you fit on the bottom piece. It would be wise, however, to have one pin out of alignment so that the bottom can only be fitted on in one manner.

Finishing Off

As the switch button and nut will likely be finished in white bakelite, the work should be enamelled in some contrasting colour. A very contrasting finish would be ebony black, using french polish.

However, enamel looks attractive, too. Lovely warm colours like vermilion, marine-blue, green, cream, yellow, and so on, are particularly attractive. Enamel paint should be used if you employ spruce in making the base. A couple of light coats, applied alternately, will effectively hide most grain marks and lend a smooth finish.

The first coat should be allowed to dry out thoroughly. The surface is then lightly glasspapered with new pieces of No. 1 1/2 glasspaper, following which the work is dusted down and the second application of enamel brushed lightly on.

THINGS you SHOULD KNOW

THE fine wire-mesh discs in water-tap filters need frequent cleaning. Upon inspection, some of the discs (if not all three of them) may be rusty and broken. If one disc is good, keep it and cut out two discs from a piece of calico or more "open" linen. Fit these, with the wire-mesh disc going beneath to support them. The new filtering discs will filter the water more finely and better than the wire type.

* * *

OWING to the difficulty of purchasing bicycle bells, why not make use of a small high-note buzzer? These sound not unlike miniature Klaxon horns and are better than nothing. The buzzer, for protection, could be mounted on the cross-bar, just beneath the saddle, with the battery housed in a saddle bag.

Flexible wires could run from battery and buzzer along the bar to a

bakelite handle-bar switch fixed where it is most convenient to work with the thumb. It is also possible to use a small electric bell in the same way. The only probable disadvantage with the latter is that sudden jarring may effect the gong hammer or the "set" of the armature.

* * *

AN excellent bicycle bell, incidentally, can be made by using a mechanical door bell, i.e., the large-gong type which winds up. This could be arranged on the head-lamp bracket, with a small button arrangement fixed to the back of the starter so that one has only to press it to start the bell mechanism. Of course, these door bells are as scarce as bicycle bells, but you may have an old one that could be used, without realizing it.

* * *

THE tension of cheap fretsaw handframes is apt to be rather impaired due to using up broken,

short lengths of blades. When a new blade is fitted, it is extremely loose, as a result, and thus easily broken. The only remedy, in such cases, is to pull the top end of the frame as far apart from the handle clamp end as possible. This produces the desired tension, but care must be taken not to throw the frame out of true as a result.

* * *

FRET MACHINE users, unaccustomed to a handframe, might care to try cutting wood with the teeth of the blade turned back to front in the clamps. This means that cutting is done towards the worker, the same as it is done when using a fretmachine. This sounds silly, we know, but in actual practice, the fretmachine user will feel more at home with his handframe, unless he is used to both machine and handframe. At least it is worth trying out.

* * *

ROSEN, or resin, rubbed on fret-machine belts will do much to prevent slipping. This is a more expedient method than trying to tighten up any slackness in the belting.

Simple things an amateur can undertake in MINOR RADIO REPAIRS

WHAT can be the matter with it?" you may say again and again as you fiddle with the knobs and shake the silent wireless set in the hope that it might start working once more.

The main purpose of this article is to show you how you can deal with some of the many minor troubles that arise. One of these faults is the blowing of the fuse in mains-operated sets, this being inserted in the circuit between the supply plug and the set.

This fuse, unlike the one at the mains meter which could blow at the same time, is contained in a small glass tube, with brass cap ends to which the enclosed fuse wire is connected. The fuse is of light capacity and is used for protecting the set only. It is an easy matter to remove and replace these fuses; they are exposed to view and the end caps grip on springy contacts.

A Short-circuit

If, therefore, an accident should happen in the home, causing a short-circuit throughout the wiring system of the house while the receiver is switched on, the fuse at the mains meter and that in the set will undoubtedly blow, i.e., the fuse wire burns up and breaks. The fuse in the set is an extra precaution against damage to the rather costly valves.

Assuming the mains meter fuse has blown, fit a new bit of fuse wire, then turn on the switch of the nearest electric lamp to see if it lights. If so, try the receiver. If it remains silent, disconnect the set from the mains supply, then look at the fuse, taking it out and holding it up to the light.

If doubtful that the wire is broken, test it by means of a flashlamp battery and bulb tester fitted with a bulb. Hold one of the contact legs of the tester against one of the battery arms, then put one brass end of the fuse against the other battery arm and touch the remaining leg of the tester with it. If sound, the bulb should light; if otherwise, the fuse needs replacing.

When obtaining a new one, take the old one with you. There may be markings on it, such as A2, and you should get one exactly the same.

Other Troubles

Amongst other equally simple things that will keep your set silent and useless is a break in the "feed" wires, meaning the twin flex leading from the mains supply plug-in to the wireless set. To find out if this is the case, remove the back from the set and touch the plug pins with the arms of a flashlamp battery, mean-

while getting someone to hold the bulb-tester against the pins of the plug at the opposite end.

More frequently, the break will be found inside the bakelite screw-cap of the mains plug, the set-screws holding the bared wire ends having "cut" the wire strands due to being screwed down rather tightly. Apart from this, a sudden tug on the flex could disconnect one of the wires.

To discover a broken "feed" wire in a battery set, turn the switch on, then twist, bend and kneed the wires in the fingers, gradually working along the wire until all of it has been tested. Push against the wires so that the broken ends will tend to touch each other and cause the set to work. Repair by cutting the wire where broken, baring the wire ends and joining by twisting together and covering with insulation tape or sticking plaster.

Faulty Loudspeaker

If, after trying the aforementioned tests, the set does not work, test the loudspeaker for broken or disconnected wires. In most battery-operated and mains-operated sets there are extension loudspeaker terminal sockets.

Switch the set off and touch these terminal sockets with the arms of the flashlamp. There should be clear, distinct "plopping" sounds from the loudspeaker, proving that the wires are sound, including the latter.

Scratchy, crackling background noises in a receiver denotes particles of dust in and around the magnetic core of the loudspeaker or in the vanes of tuning condensers, etc. The latter are best cleaned with a dry feather or with a few puffs of wind from the mouth or by a vacuum cleaner.

Removing Valves

Remove all removable valves, marking them and their respective positions with corresponding numbers (or letters) in chalk. This is for convenience in getting at the job of dusting the components of the set. Grip the valves at the base firmly with the fingers to remove them, the tips acting as a fulcrum in lifting the pins out of their sockets steadily. Never remove valves by holding the glass bulb, as you are apt to weaken the cement at the base.

Whenever you remove valves or plugs, always make a point of looking at the pins. These, due to dampness, may be slightly corroded, causing slight interference. Furthermore, the "splits" in the pins may be crushed in so that there is poor contact in the sockets.

To remedy the trouble, widen the splits with a penknife. Loose valves are apt to work out of their sockets owing to vibration or constant knocks in lifting and shifting the set about. Corroded sockets are best cleaned with fine emery cloth or by scraping with the penknife, this also applying to the socket pins.

A "Xmasy" Cross Word!

ACROSS.

1. Short for Christmas.
4. Festeoned with lights and gifts.
8. May yours come true this Xmas.
10. One gets excited when postman is this.
11. May be used for home broadcasting.
12. You'll have one on the good things.
14. Short for "limited."
16. For holly sprigs.
19. Can be sure of this rather than snow.
21. Send one to the best girl.
23. A white flower.
25. We skate on it.
26. "Yard" abbreviated.
27. Many expect one at Xmas.
28. A villain's laugh.
29. Drop them for Xmas presents.

DOWN.

2. Xmas party should be this.
3. The Xmas dinner.
4. Playing Santa Claus is pleasant one.
5. All good things must come to this.
6. Do this wisely.
9. Always as good as a mile.
12. On Xmas morn.
13. Bad tidings.

15. Makes an excellent Christmas gift.
17. You won't want . . . Xmas pudding—after the sixth helping at least!
18. Santa Claus (initials).
20. To help one at Xmas.
22. Toys are usually this.
24. Needed to make party a success.
27. At the ends of "ten."



What useful things you can make with those ODDS AND ENDS OF WOOD

READERS are sometimes at a loss to know what to do with the odds and ends of wood and spare pieces of board which are often left over from a job, and if saved, gradually form a formidable accumulation. In these times of scarcity of wood, it is certainly a wise plan to keep all these odd pieces because at various times they will come in useful in some form or other.

They may not be large enough to make a complete piece of work in themselves, but frequently small pieces are required to help to complete an article, to make stiffening blocks, or to fill up some part which would make it waste to cut from a

grained wood, or you can use a fretsaw providing you keep the spill quite thin. $\frac{3}{8}$ in. thick is quite wide enough, and should be thinner if possible.

Matchholders to make

Then some odd pieces of board will frequently make a matchbox-holder, and a suggestion for a standing one and a wall bracket is given here. The base of the standing type should be fairly thick, and can measure about $4\frac{1}{2}$ ins. long by 3 ins. wide. The simple block to hold the match box cover is erected on it towards the back edge.

This allows a shallow sinking to be made in front of it to hold the used matches. A groove can be made with a gouge or probably a chisel if the wood is shaped off nicely after-

can be stained and varnished or even painted.

The actual block for the matchbox case is from $\frac{3}{8}$ in. wood $1\frac{3}{8}$ in. wide and 1 in. long. It is glued firmly to the base, but as it will be the end grain for fixing, it is advisable also to put a long screw through from underneath to give additional strength. Be careful to drill a hole first, in order not to split the wood.

The wall type bracket has a back-board of thin material— $\frac{3}{16}$ in. or $\frac{1}{4}$ in. will be sufficient—to which is added the support shelf for the matchbox holder itself. Any odd pieces of wood will do for this, and a single little corner support can be added under the shelf. The one shown is a straight angular piece, but you can cut it rounded if you wish with the fretsaw on the front edge.

Fix the matchbox holder near the back, and have the recess for used

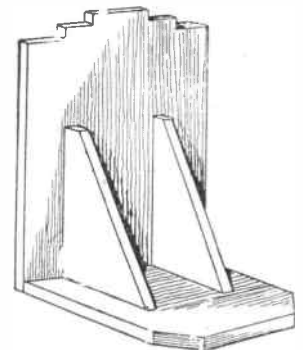
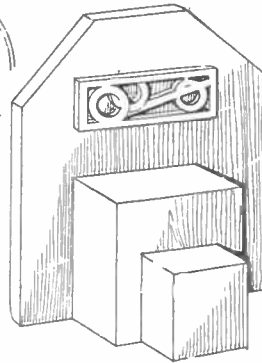
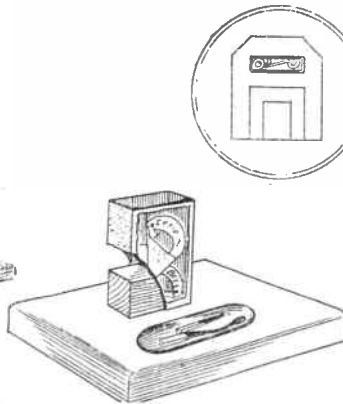
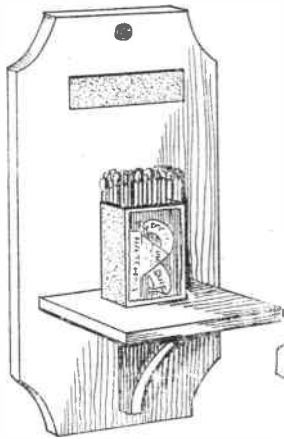

Two simple forms of match box holders

A block book-end

A bracket type book-end

larger board.

These spare pieces should, of course, be kept in a box of some kind, and not left lying all over the place where they cannot be found just when wanted. Of course, there is the likelihood that they will be in a variety of wood, but this can frequently be overcome in the finished job by staining all down to one standard shade.

Spill Making

A few suggestions then as to the use of this spare wood will be helpful. Such jobs will serve to fill in an hour or two between larger work, and will sometimes make a change even in the middle of the construction of an elaborate model or piece of fretwork.

In these days of shortage of matches, spills are always very acceptable, and if you have pieces of wood $\frac{3}{8}$ in. or $\frac{3}{16}$ in. thick and about 8 ins. long you can cut them down for this purpose. A plane iron set very wide is useful for the purpose of soft

wards with glasspaper. Be careful not to go too deep.

This base piece will have to be thick enough to allow for the sinking, and should not therefore be less than $\frac{1}{2}$ in. or $\frac{3}{8}$ in. See that it does not look too thick, and actually the finished base should have its upper edges rounded, and then the whole thing

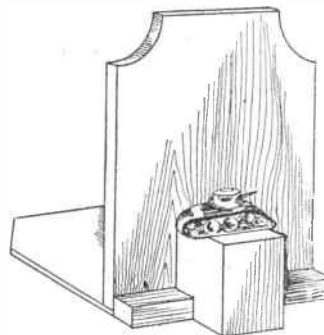

Another type of book-end

matches in the front. Instead of this recess you can, of course, add a small tin or even the matchbox tray itself if glued down and nicely painted.

The cover piece, which stands over the upright block, should fit reasonably tight, as if loose they have a habit of flying off when anyone strikes the match upwards. To overcome this difficulty, too, you can glue a piece of fine emery cloth or even the side of a spare matchbox to the back. This will provide a simple striking surface.

Book-end Suggestions

Another practical method of using odd pieces is in the making of book-ends, although possibly for this you require larger and thicker parts. Two or three suggestions are given here, and their dimensions can be worked out easily from whatever size of book you propose to use the article for.

The main piece which comes against the book should be $\frac{3}{8}$ in. or $\frac{1}{2}$ in. thick,

and the projecting blocks on the outside can be glued against it or on to a base fitted at right angles to the main upright. The shape of them can be plain or fancy, and you can add various decorations to make them more attractive.

Fretted Decoration

Some of the small overlays found on fretwork designs can be quite easily used for decoration, and should be cut in 1/16in. or 1/8in. wood. Do not have them over-elaborate, but select a small simple panel which will just break the flatness of the top of the book-end.

If two angle pieces are put in as shown in one of the illustrations, notice that the top is cut flat. This is better than running the angle right up to the upright because one can get a more precise cut and also have less likelihood of damage. In this illustration, too, you will see the bottom flat portion which is glued and

screwed to the face of the upright, and should extend above the portion shown.

If, however, you do not wish to take up the room needed for this flat portion, then the base piece can be put on the inside of the upright end as shown in one instance. This can be a stiff piece of card glued securely to the underside of the end. It will take the weight of the books and so help to prevent the outer portion slipping away.

The card should be fairly tough, or if you can get a piece of thin stiff leather, so much the better. If the book-end is likely to come in for constant use, the card is not to be recommended as it is apt to be pulled away.

As a change from the plain cutting, you might also like to add a piece of carving as a decoration to stand on the end block. A miniature tank or plane will be particularly appropriate although, of course, the work must be carefully undertaken and realistically

finished. In a tiny carving such as this, there is no need for elaborate detail.

The plain outline of the article can be carved with a penknife and then painted. The actual markings of the prototype can be lightly painted on with indian ink or thin lines of coloured paint.

Suitable Finish

If you have used wood of the same nature and colour throughout, you can easily polish the book-ends. If, however, you have used various kinds of wood, then stain them dark to be all one shade before varnishing or polishing. On the other hand, you may like to get some of the bright colours of enamel, and so cover up the wood entirely and have a nice glazed finish.

In doing this, you should put on a first coat of dull paint and allow it to soak thoroughly into the wood, and to dry, before applying the second.

See Cover iv for these patterns for two simple CALENDAR HOLDERS

WE are able, this week to give full-size patterns for two Calendar Mounts intended to stand on mantelpiece or sideboard. These designs give the fretworker an admirable chance of showing his skill. They are simple in character and should not take long in the cutting and making up.

Almost any variety of wood is suitable, although we suggest a light wood as this looks better with a dark backing canvas or paper behind the frets. Wood 1/2in. or 3/16in. thick will answer, both for the mount and for the struts which go at the back.

Wood Needed

The larger of the two designs, that showing the bird, will require a piece of wood measuring 5 1/2ins. long by 4 1/2ins. wide, while the other designs will take a piece 4 1/2ins. by 3 1/2ins.

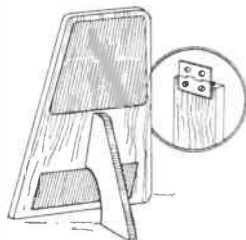

Fig. 1—Back view

Stick the pattern down to the wood, and after drilling the holes for the insertion of the saw, cut all the inter-

ior frets before cutting round the outer edge. Use the finest saw obtainable, and do not, if possible, touch the cut edges with the file unless of course any little irregularities need cleaning off where the drill has entered.

In cutting the mortise A in the small design, take care to cut it to the width of the wood being used, 3/16in. stuff is recommended for the struts in each case.

The overlay bearing the calendar pad on the larger design may be of 1/2in. or 1/16in. wood, and its position on the mount should be lightly pricked on the wood before the paper pattern is removed. Clean the paper from the wood by glasspapering, rubbing always in the direction of the grain of the wood, the reason for this latter precaution being that if the glasspaper is rubbed across the grain, unsightly scratches will appear which will be most difficult to rub down once they are made.

Backing Material

Lightly rub clean the backs of the mounts before sticking on the backing canvas or fancy paper. Fig. 1 shows how the pieces of backing material will be cut and stuck on.

For the larger design the long plain back strut will be used, and it will be hinged to the mount as shown in the

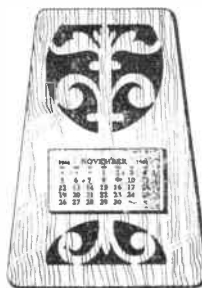

circled diagram in Fig. 1. The hinge—a 1/2in. brass one will be suitable—will be first screwed to the back surface of the strut, and the latter then laid in place on the wood mount and screwed on.

The holes must be drilled for the screws before they are run in otherwise the wood may split. Bookbinders' cloth makes a very suitable backing to the fretted portions of the designs, and this can be got in various colours which will nicely show off the fretworker's art.

Finish

No special finish is suggested for the front surfaces of the mounts, they may be left untouched after being cleaned with fine glasspaper, or they may receive a coat of clear varnish.

The calendar pads are simply glued to the mounts. The pads may be obtained from Hobbies Ltd. price 1d.



FREAKS AND VARIETIES

THE keen stamp collector is always on the look-out for something out of the ordinary, but unusual things may be merely oddities or may be important and valuable. If the variation is peculiar to a single stamp it is a freak or curiosity, but if it is constant, that is, if it recurs in the same place on every sheet printed from a particular plate or cylinder, it is a variety.

The freak is due to a trifling accident in the printing process, like the creasing of the paper or the fall of a speck of dust or a hair on the plate. The important feature of the variety, however, is that the error or flaw is repeated in each successive printing from the same plate.

Varieties fall into five main groups: watermarks, perforations, colours,

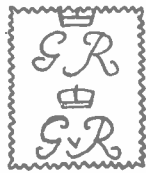

"V" missing

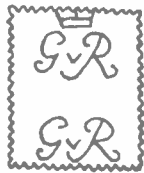

Crown missing

surcharges and plate flaws. They can be dealt with in this order.

There are many watermark varieties, the commonest being the inverted and the sideways. The inverted watermark, for example, appears in all G.B. issues from the 1d. black onwards, though it was far less common in the earlier issues than it is in the modern. Hence a 1d. black with inverted watermark is worth six times the normal and the 1d. red imperforate no less than seventeen times as much.

Inverted Watermarks

Twentieth Century issues with this watermark variety however are worth only a trifle more than those with the ordinary watermark. This is because the majority of modern low value stamps with inverted watermark come from booklets, in which, owing to the method of printing, half the stamps invariably have the watermark inverted.

Stamps with inverted watermark above the value of 1½d. in George V's reign and above 2½d. in George VI's are more expensive, as these come from whole sheets with inverted watermark, which are scarce.

Sideways watermarks, on the other hand, appear only from 1911 onwards,

and are much less common than inverted. A particularly scarce example is the G.B. Dec., 1912 George V 1d. scarlet, with Multiple Cypher watermark, which is catalogued at 30/-.

It is worth remembering that there is a better chance of finding a bargain in watermarks than in any other type of variety, because many collectors are perhaps inclined to be careless about watermarks. Even if they do glance at them they are apt to overlook inverted watermarks and particularly the "part missing" varieties in such an issue as the G.B. George V 1912-22 set.

Very Scarce

The ½d. and 1d. values of this same set, by the way, were issued in August, 1913 with Multiple Cypher watermark. They are very scarce, being originally issued in rolls only. You can imagine how easy it is to overlook the difference between this watermark and the normal.

Of the immense number of perforation varieties only a few of the most outstanding need be mentioned.

The "imperforate between"—which occurs when the perforating machine misses a line—is the most important and should be collected in pairs because it is unfortunately only too easy to clip the side perforations of a wide-margined stamp to make it look imperforate.

A unique perforation variety is provided by several sets of New Zealand. This is the mixed perfora-

tion, and occurs in several stamps between 1901 and 1906.

The sheets were first perforated 14, or 14 and 11 compound, and because the perforation was incomplete or defective strips of paper were pasted over the bad patches and re-perforated 11.

Sometimes a very slight variation in the perforation causes a big change in price (for example the New Zealand King Edward VII 8d.). Slight perforation varieties in modern G.B. issues, however, are due to shrinkage of paper, and are of no importance.

Freak perforations sometimes occur. The writer has seen two, for example, in the current G.B. issue. In the one, the top part of the stamp was severed

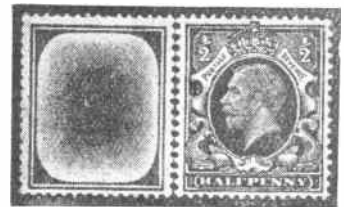

The "Poached-Egg" and what it should be

from the bottom by a regular jagged edge measuring 11 on the perforation gauge. The top left hand corner of the other was in shreds, with the perforation holes all out of line. Of course, these stamps are merely curiosities.

Nor need much be said about colour varieties. Colour changelings, like the G.B. 1887 1½d. and the 1900 ½d. in which the colour is blue instead of green, are classed as freaks.

The "Poached Egg" Blank

The so-called "poached-egg" (an oval of colour in a frame without lettering) which apparently was mistakenly issued for the ½d. of the George V 1934 photogravure set and then withdrawn is a doubtful variety. It has not catalogue status. On the other hand, the G.B. Jubilee 2½d. Prussian blue is a genuine variety and is catalogued at £50.

Surcharge varieties are almost numberless, but, as might be expected almost always take one or other of the following forms: double or inverted, omission of stops, or variation in the lettering or spacing. Illustrations are not necessary.

Varieties found in the design of the stamp are numerous and varied. They are much commoner in the early line-engraved issues than in those printed by modern processes. Consequently there is great competition

DESIGN FOR A SOFT COLLAR BOX

Wood for making this box is supplied by Hobbies Ltd., from their Branches for 7/10, or sent by post from Dereham, Norfolk, for 8/5 post free.



for the few varieties found in G.B. stamps from about 1900 onwards.

A variety which is found in several G.B. surface-printed issues is a stamp printed on the gummed side. All stamps printed on the gummed side are catalogued at several pounds each.

Two other modern G.B. varieties may be mentioned, both in the George V 1912-1932 issue. The first is "PENCF" for "PENCE" in the 1½d. value, the second is "Q" for "O" in the "ONE PENNY" of the 1d. scarlet. This last is not really a "Q" but an "O" with a hair line running across the bottom right hand corner so that it looks like a "Q." This variety is keenly sought after.

There is also at least one other stamp with a similar flaw, a New Zealand 1d. "Universal," but this apparently was a freak.

The error "No Cross on Crown" appears on two values of the G.B. Edward VII issue (the 6d and the 10d.)

and on several of the early George V stamps.

It should be borne in mind that all the plate flaws so far mentioned are easy to fake. All stamps which are said to show these varieties should be carefully examined before being bought. For instance the Crown can easily be scratched off with a pen-knife and at first sight the stamp appears quite genuine.

Extremely rare varieties such as the bisect, inverted centre, tête-bêche (i.e. a pair of stamps, one inverted), and "printed on both sides," are not likely to come the way of many collectors, and need not be dealt with here.

However, there are several minor varieties in the G.B. Coronation stamp which you may quite easily come across. The "colon" variety is hardly likely to be missed, but the "Ray flaw," "Pearl" and "Spur" varieties are more easily overlooked.

The colon variety has a vertical pair of white dots to the right of "12" in the date. The Ray flaw is a thickening of the two right lines of the star in the top left hand corner next to the control.

The Pearl is a tiny light globe in the orb on the left of the stamp, and the Spur is a projecting white line on the right leg of the "A" of "MAY". All these varieties are fairly common and you are quite likely to pick one up cheaply.

Varieties add flavour to a collection and lift it above the commonplace. Indeed, the demand for them nowadays is so keen that every new stamp issued is exhaustively examined for microscopic variations from the normal.

So beware of paying a fancy price for what after all may be a valueless freak. The genuine variety, however, is always worth looking out for.

ATLANTIC WAR STAMP FREE!



On November 1st, 1943, the FREE POLISH GOVERNMENT IN LONDON issued a new set of pictorial postage stamps for use by the FREE POLISH FORCES in this country and by POLISH SAILORS at sea. We have been fortunate in obtaining a supply of these historic War Stamps and have pleasure in offering YOU some ABSOLUTELY FREE. The stamp, as illustrated, depicts an actual incident of a Wellington bomber of a Polish Coastal Command Squadron sinking a German Submarine in the Atlantic. It is inscribed in Polish of course, "Polish Air Force in the Battle of the Atlantic"; and the stamp is printed in pink colour.

You can get your copy of this most interesting stamp from us ABSOLUTELY FREE by writing to us and asking for our Lists and a selection of our stamps "on approval." This Polish issue can only be supplied FREE with an approval selection and if you send us 3d. in stamps also (to cover cost of List and postage of approvals to you). Do not delay; write immediately for this wonderful FREE OFFER to:— WINDSOR STAMP CO. (Dept. 12), UCKFIELD, SUSSEX.



Books of Designs

Simple designs for everyday subjects to cut from small pieces of wood. Brackets, pipe racks, boxes, frames, calendars, etc. All printed full size, ready to paste down.

FOUR BOOKS
A and B Books have 20 Designs each. Books C and D each contain 14 Designs of slightly larger subjects.
1/6 each, postage 1d.

HOBBIES LIMITED, DEREHAM & BRANCHES



MISCELLANEOUS ADVERTISEMENTS, etc.

The advertisements are inserted at the rate of 3d. per word or group of letters prepaid. Postal Order and Stamps must accompany the order, and the advertisements will be inserted in the earliest issue. Freetwork goods or those shown in Hobbies Handbook not accepted. Orders can be sent to Hobbies Weekly, Advertisement Dept., as below.

CRUISER Tank Model, 12ins. long, made from Design Sheet No. 223 Special (Price 9d.) Parcel of wood for making, 10/9, postage 7d.—Hobbies Ltd., Dereham, Norfolk.

BE TALLER. Quickly! Safely! Privately! No Appliances—No Tablets—No Dieting. Details, 6d. stamp.—Malcolm Ross, Height Specialist, BM/HYTE, London, W.C.1

WONDERFUL OPPORTUNITY for boys 14 upwards to receive a training in the manufacture of electric motors, drills and high grade electrical mechanical apparatus covering a wide range. A four-year course will be given free to selected applicants who can pass a simple general knowledge examination. Assured position will then be offered at termination of training. In first instance apply for prospectus without obligation. London area only. Box 64, Hobbies Weekly, Dereham, Norfolk.

GOLDEN JUBILEE! Twenty Unused Stamps. Free to commemorate our Fifty years of Stamp Dealing (2½d.)—G. H. Barnett, Limington, Somerset.

TOYS. Send for range of popular designs. Simple to make from scrap materials. For pleasure or profit. 2/6 only post free.—Harrod, 10 Beaconsfield Road, Maidstone.

10 STAMPS FREE to responsible approval applicants, enclosing 2½d.—W. Reid, 41 King Street, Bathgate, Scotland.

WANTED. Model Railway, Gauge O or OO, Electric or Clockwork. Ridgeway, Bois Avenue, Amersham.

LONELY? Join Friendship Circle. Details 6d.—Secretary, 34 Honeywell Road, London, S.W.11.

30 STAMPS FREE! Request Discount Approvals, (Send 2½d.)—C. Stenton (H.W.) 164, White Lane, Gleadless, Sheffield.

LONELY? Then write Secretary U.C.C., 5 B.B. Hay Street, Braughing, Herts. Genuine. Est. 1905.

WANTED Power Fretsaw Machine.—Stevenson, "Ash Villa," Brookfield Av., Chaddesden, Derby.

MAKE A MODEL FORTRESS (non-flying) from Hobbies Patterns No. 2405, price 4d., (postage 1d.). Or a Boston Bomber (No. 229 Special) price 6d.—From Hobbies Ltd., Dereham, Norfolk, or Branches.

FRETSAWS—Hobbies British made—8d. and 10½d. per dozen. Only one dozen per customer.—From Hobbies Branches or by post (2½d. extra) from—Hobbies Ltd., Dereham.

Two Fretted Calendar Holders

See details on page 93

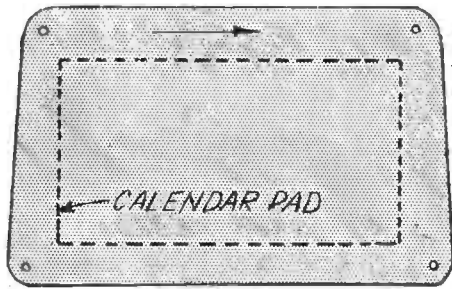

THE ARROWS
SHOW DIREC-
TION OF GRAIN
OF WOOD.

OVERLAY
B

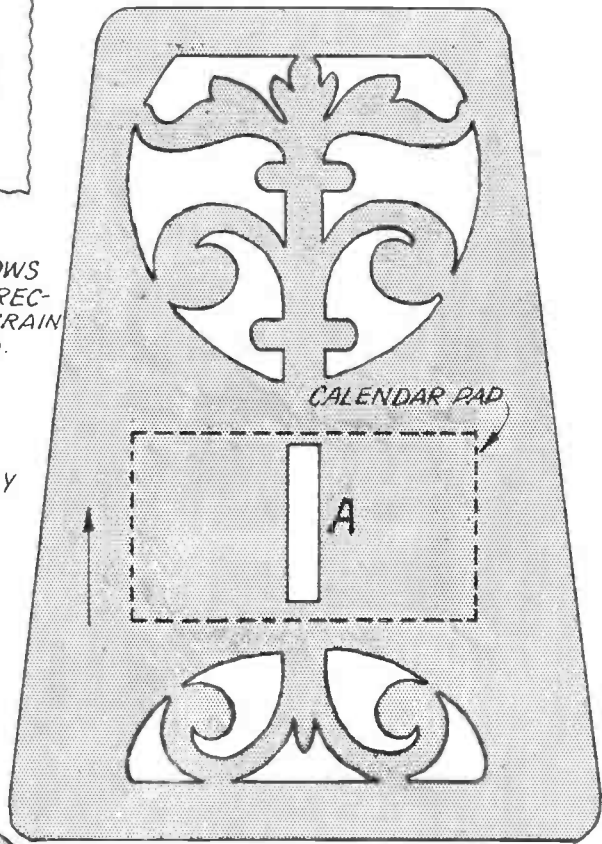

CALENDAR PAD

A

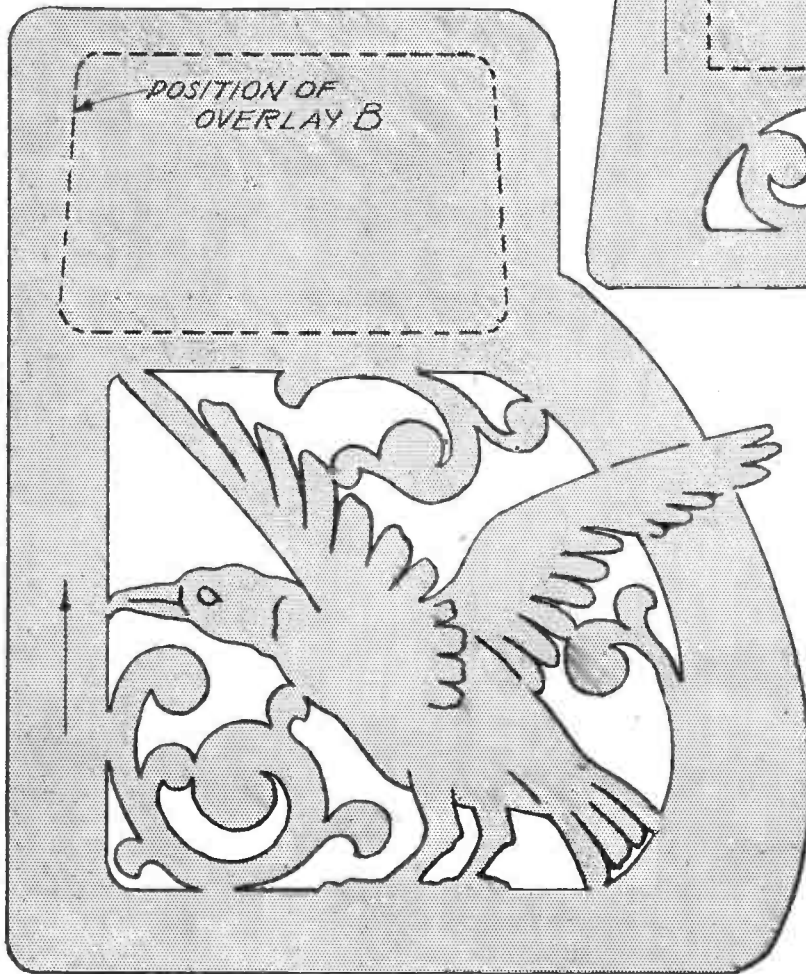

POSITION OF
OVERLAY B



HINGE

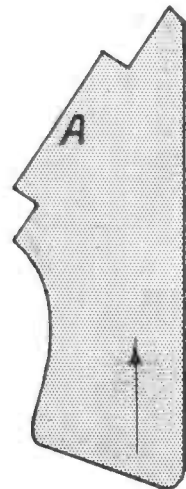

A

BACK STRUTS



OVERLAY ON END,
CUT ONE 2 1/8".

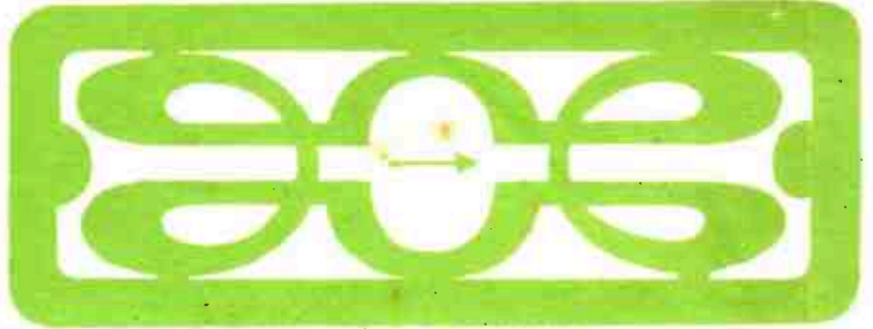

OVERLAY ON END. CUT ONE 2 1/8".

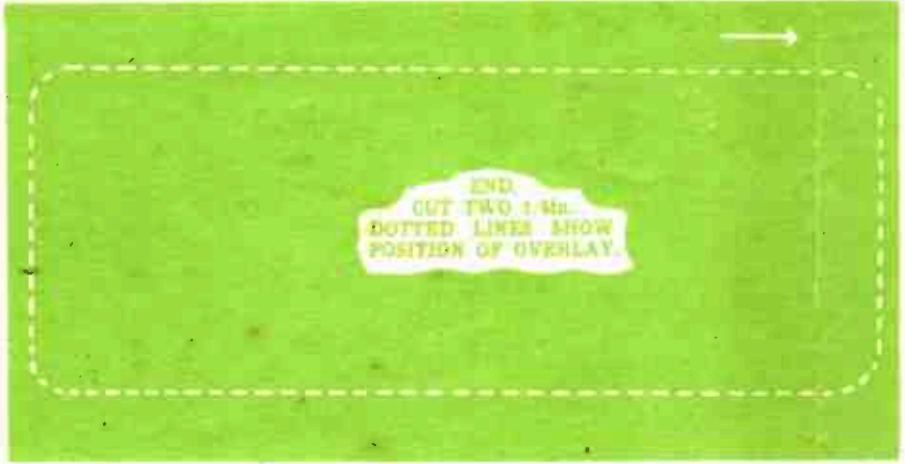

END.
CUT TWO 1 1/4".
DOTTED LINES SHOW
POSITION OF OVERLAY.

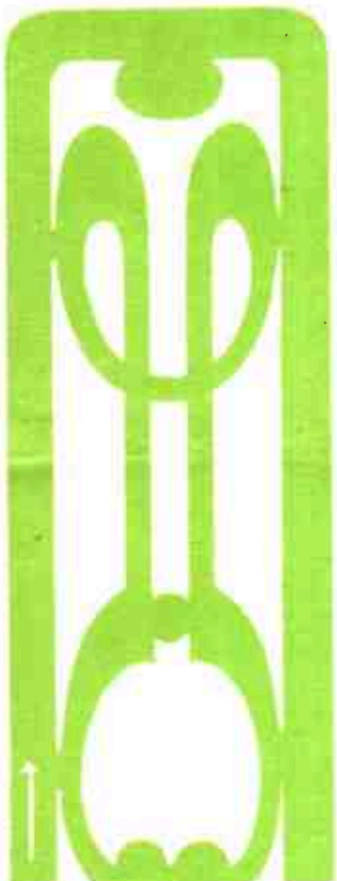

OVERLAY ON
SIDE. CUT ONE
OF EACH 3 1/8".

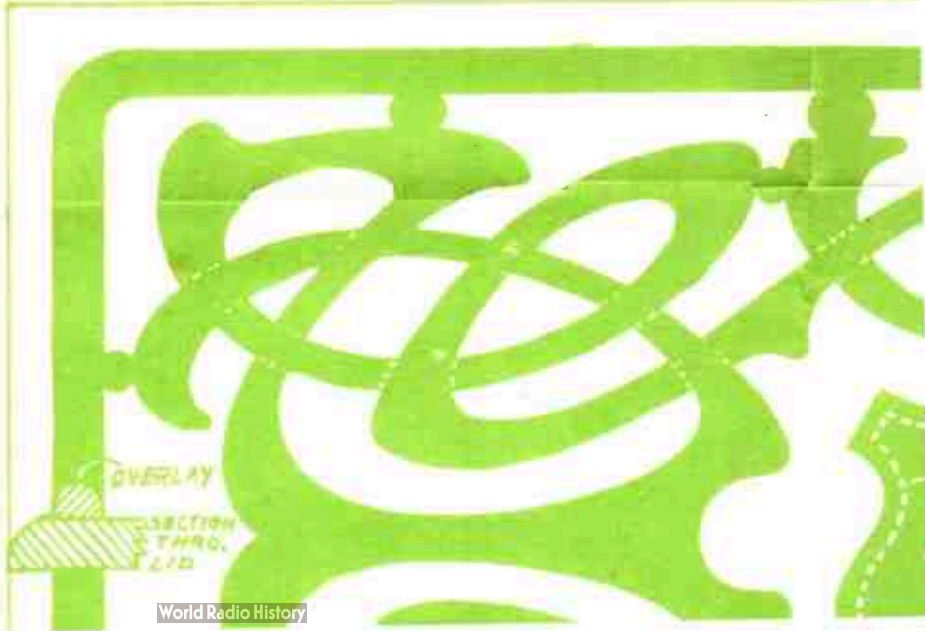
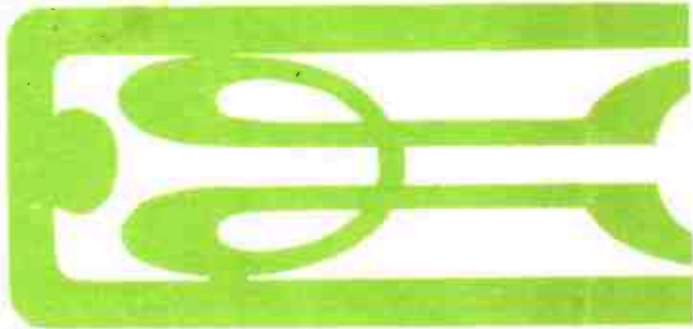

OVERLAY
SECTION
THRO.
2 1/2"



DESIGN

No. 2514
22.12.43

SUPPLEMENT TO HOBBIES No. 2514

BOX FOR SOFT COLLARS

AN ARTICLE USEFUL TO THE GENTLEMAN.



FOOT, CUT FOUR
2 1/8 ins.



PANELS OF WOOD REQUIRED
FOR THIS DESIGN.

TWO J4 TWO H3

The price is shown in Hobbies Weekly, Dec. 22nd, 1943, but is subject to revision. See the current edition of Hobbies Handbook, or write for price to Hobbies Limited, Dereham, Norfolk.



SIZE
10 ins. LONG
5 1/2 ins. WIDE
3 1/2 ins. HIGH.

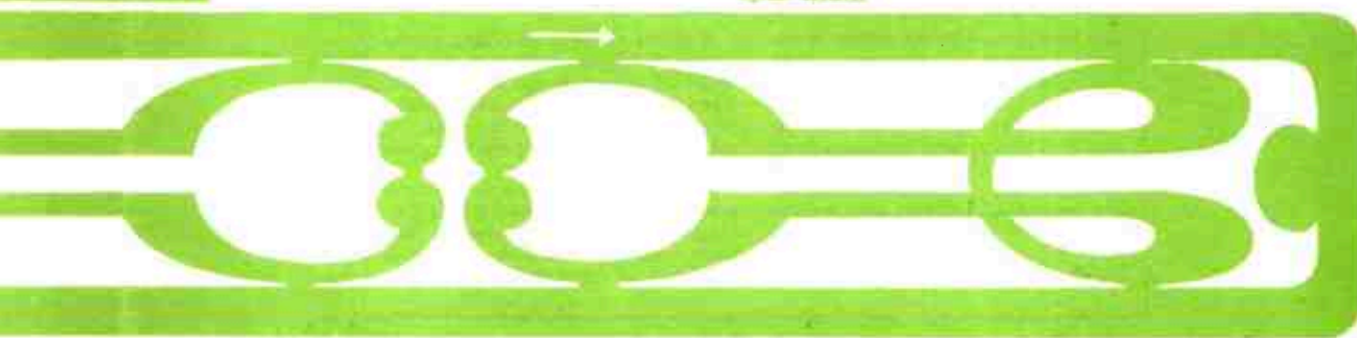

SHIELD
FOR
LID



The arrows indicate the direction of grain of wood.

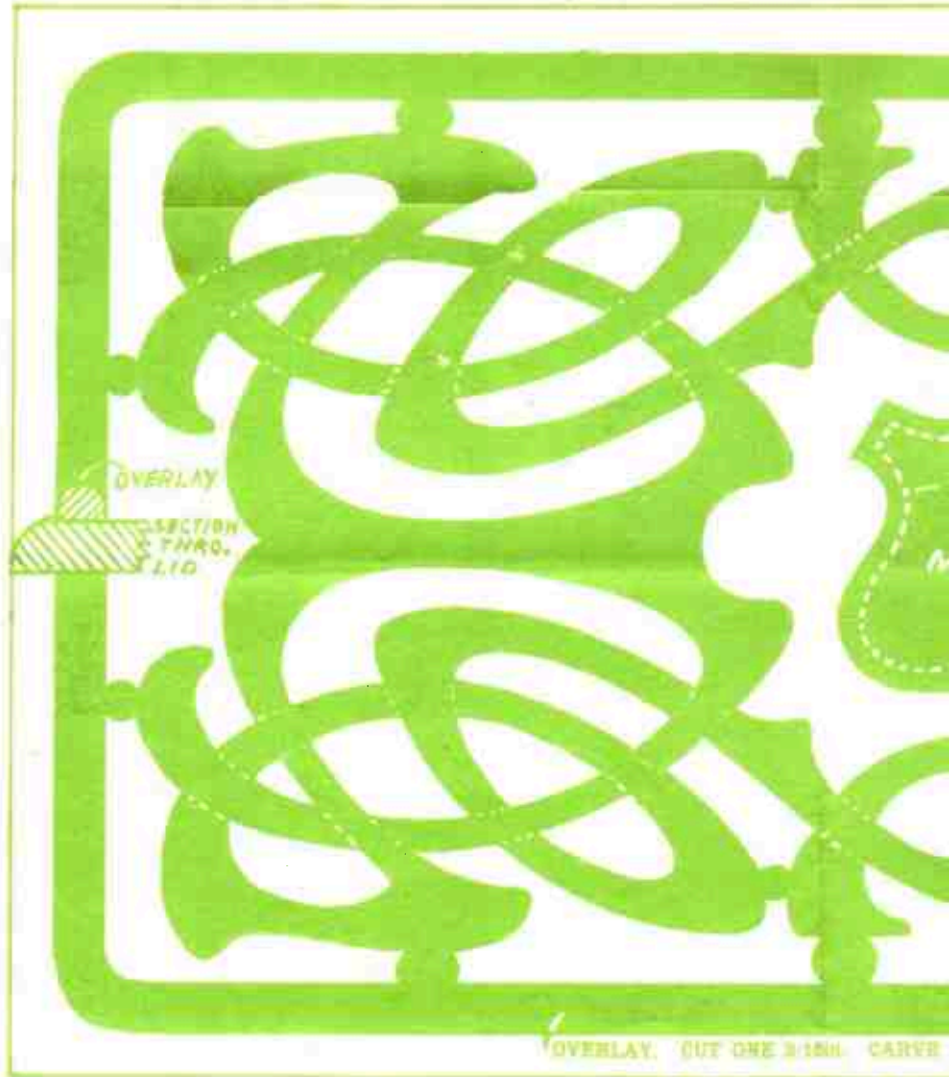

OVERLAY. CUT ONE 3/16-IN. CURVE

FLOOR OF BOX, AND LID OF BOX.



DETAIL SHOWING HOW HINGE IS RECESSED INTO BACK TO ALLOW LID TO LIE FLUSH WITH ENDS AND FRONT.

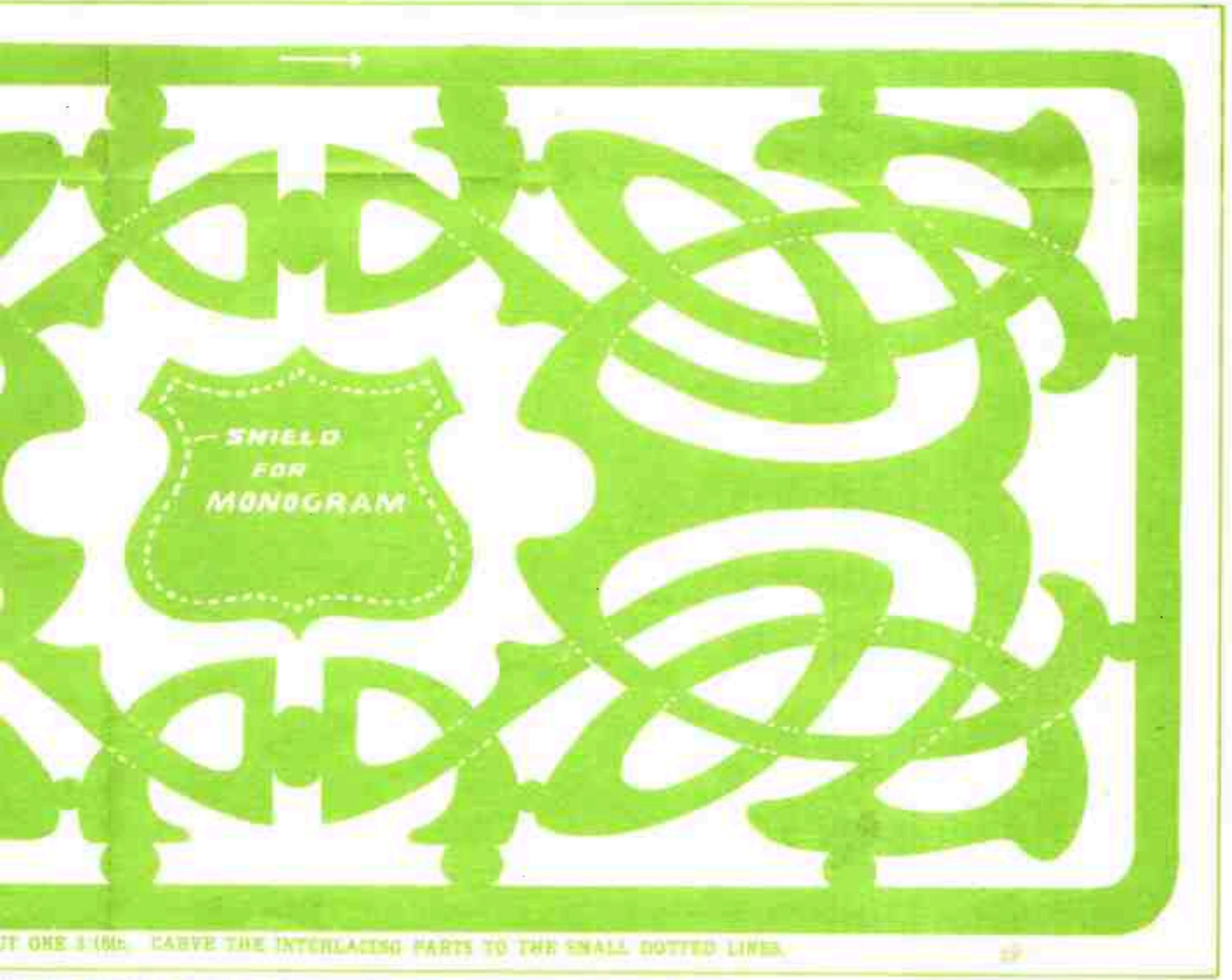

CUT ONE 1/4 IN. CARVE THE INTERLACING PARTS TO THE SMALL DOTTED LINES.

29

OF BOX, AND LID OF BOX—BOTH CUT TO THE OUTLINE GIVEN 1/4 IN. THICK.



DETAIL SHOWING HOW HINGE IS RECEIVED INTO BACK TO ALLOW LID TO BE FLUSH WITH ENDS AND FRONT.

NOTE.—This design sheet is only presented free with the current issue of *Hobbies* and not with each number. Further copies may be obtained.

SIDE CUT TWO 1/4 IN. DOTTED LINES SHOW POSITION OF OVERLAY.

END

SOFT COLLAR BOX

THE patterns are all provided on the reverse side of the sheet, and can either be traced off, or the paper pasted to the wood concerned. The main parts of the box are in $\frac{1}{4}$ in. material, and the overlays are $\frac{3}{16}$ in. The patterns of the side can be marked off carefully direct on to the wood by laying the paper down and pricking through the exact corners.

When the paper is taken away the holes can be linked up with pencil marks to provide cutting lines for the fretsaw. Be sure to keep all the edges straight because they must butt up to each other to make a strong joint and correct rightangle.

Box Frame

See the two ends go between the two sides, and all four are glued down to the piece which extends a little beyond them. The baseboard, you will note, is the same size as the lid, and both are cut to the outline of the pattern shown. They form a plain rectangle of wood $10\frac{1}{2}$ ins. long and $5\frac{1}{2}$ ins. wide.

The overlays are cut with the fretsaw from $\frac{3}{16}$ in. wood and glued down in the positions clearly indicated. The long strips go on the sides, and the rectangular pattern goes on the lid.

As a further suggestion for ornamentation, the interlaced parts of the

overlay on the lid can be slightly carved. This is done with a sharp penknife and the parts which go over and under are indicated by the small dotted lines. You will see by reference to the illustration of the finished lid which go over and which go under.

Cut down about $\frac{1}{16}$ in. along the dotted lines with the penknife. Then slope the wood down from outside this line, gradually recessing the part to make it look as if it disappears under the crossing piece. If this is done carefully a greatly added effect can be given.

The surrounding border of the overlay, too, can be treated in the same way and rounded off carefully with file and glasspaper to give a finished effect. The little lozenges which form link pieces between this outer front and the inner fretted portion, should also be rounded.

Shield Overlay

A shield shape is provided in the centre of the overlay and on this can be added the monogram of the owner. The letters concerned can be painted on to the wood in indian ink, or coloured paint, or can even be carved in.

The whole lid is finally fixed to the box by means of a pair of $\frac{1}{2}$ in. or $\frac{3}{4}$ in. hinges. One plate is recessed into the upper edge of the back as shown in the detail on the other side.