

Hobbies

WEEKLY

December 1st. 1943

Price Twopence

Vol. 97. No. 2511

WORKING MODEL BEAM ENGINE

HERE is another interesting working model that can be made up in wood. It is of an old fashioned Beam Engine of early days when pumping engines were in their infancy. These beam engines are the direct descendants of the first mine pumping engines, and are even still made and used chiefly for pumping stations.

Our model is built upon a substantial base in which the mechanism for working it is hidden, as may be seen from the illustration at Fig. 1.

How it Works

The model stands nearly 9ins. high and the base overall measures 10½ins. by 4ins. On the top of the base there are two standards between which the "beam" is pivoted. At one end of the beam there is a connecting rod which is coupled up direct to a crank working between two shaped brackets.

To this crank is attached the flywheel which gives continuous and even motion to the machine. At the opposite end of the beam there is a somewhat similar type of connecting rod, but this is pivoted to a piston rod which works in the cylinder attached to the top of the base.

The motion to the model is made by means of an outside crank with handle, and an inner spindle to which

a pulley is attached. A corresponding pulley is fixed to the hub of the flywheel and both linked up with an elastic "belt" giving, it will be seen, direct drive.

The base and its construction can be plainly seen in Fig. 2. The top and bottom measure overall 10½ins. by 4ins. by ½in. thick. The bottom is just a plain piece, the top will have openings cut in it according to the measurements shown. The dotted circle is on the right of diagram. Fig. 2 shows where the cylinder will later be placed while the hole here is intended for the extension of the piston rod—see also the scale side view Fig. 3.

Glue up the sides and ends of the base as shown and glue on the feet as almost the last operation. These feet, it should be mentioned, are essential in raising the base well off

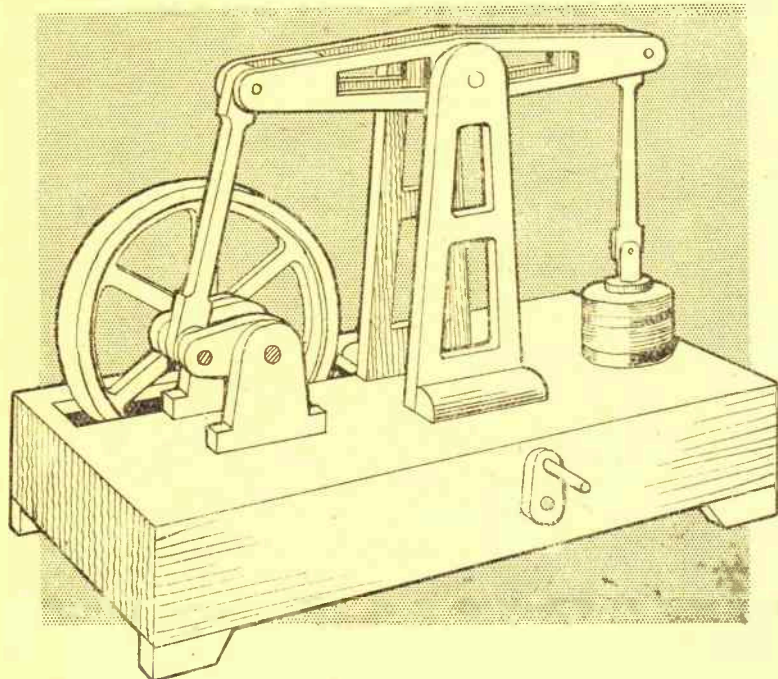

For interest and instruction you should make a SIMPLE RAIN GAUGE

THE rain gauge is a somewhat important meteorological instrument, telling as it does the rainfall in any given period. It is of interest, too, to all having garden or allotment to look after, and as it can be easily made it is worth spending an hour or two of interesting work to own one. It is also a splendid article for schools to make and use in weather report statistics.

The interior of the gauge is simple enough. A vertical section is given in Fig. 1 which shows the inside arrangement. As will be seen the "works" consist solely of a bottle into which the rain can run from a tin cup on top.

The bottle is calibrated to register the amount of rainfall in inches. The case to hold this is shown in Fig. 2. It can be made in wood about $\frac{1}{2}$ in. thick, and should be well put together with glue and screws to stand exposure to weather.

The Box Frame

Cut the sides to length first, then the bottom of box part, A and shelf, B. The bottom is not so wide as the sides, as it must come short of the front by enough to let the door in. For example, if the door is $\frac{1}{2}$ in. thick then the bottom will be $5\frac{1}{2}$ ins. wide.

The shelf, B, is the same length as A, but the width will be estimated by the size of the bottle to be used. A sauce bottle is recommended. This will be about 2 ins. sq., and as it is necessary for it to be fitted exactly central in the box, the shelf must be of a width to allow of this, a piece being cut out in which the bottle will fit. With a 2 in. sq. bottle, part B then should be 4 ins. wide, with a piece 2 ins. by 2 ins. cut out as shown.

Lay the sides on a bench, and at the distance down shown in Fig. 2 square

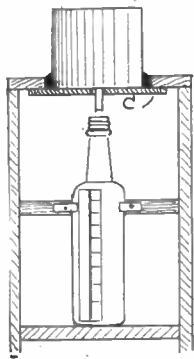

Fig. 1—Sectional view

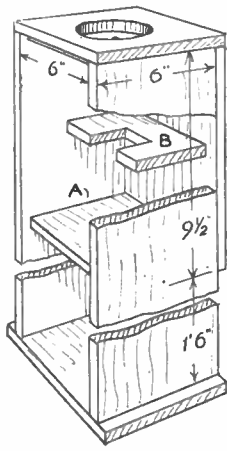

Fig. 2—Construction details

lines across as a guide to fixing the bottom in level. Screw it firmly between the sides, then add the shelf about halfway between it and the top. A piece of board should now be nailed across the bottom of the sides, cutting it long enough to overlap each side about 1 in.

The back, which comes only to the bottom of the box part, is then cut and screwed over. It is as well to glue these joints as well as screw them to prevent wet seeping in between the joints.

The Tin Top

The top of the box is next cut large enough to cover the sides and back. Run a line down the centre of it and at 3 ins. from the front edge strike a circle $\frac{1}{4}$ in. larger all round than the diameter of the tin cup. For this purpose a flat tin about $3\frac{1}{2}$ ins. diam. will serve.

Measure the tin across carefully. Cut the circle out, turn the top over and nail a thinner piece of wood to cover the opening, as shown at C. In the centre of this piece bore a $\frac{1}{2}$ in. hole to let the tube of the tin pass through. The door of the box is a plain piece of wood, cut to fit the opening and hinged to open. Provide a button fastener.

Now take the tin in hand, and before doing anything to it, use it to calibrate the bottle. This job must be carefully done. Proceed in this manner. Get a thin stick of wood and $\frac{1}{2}$ in. from one end mark a line round it.

Having washed out the sauce bottle, prepare a paper strip to gum to it on which the measurements can be marked. This is shown at Fig. 3, cut from smooth white paper. It should be about half the width of the bottle and long enough to reach from the bottom to the neck. Draw a vertical line down it, $\frac{1}{2}$ in. from one edge and stick it to the bottle.

Place the tin on a table, quite level. Put the marked stick in, and holding it upright with one hand, pour water in the tin until the water reaches the $\frac{1}{2}$ in. mark. Do this most carefully.

Now pour the water in the bottle and take care not to spill any. Where the water rises to in the bottle should be marked on the paper strip, and " $\frac{1}{2}$ in." pencilled against it. Repeat this with another $\frac{1}{2}$ in. of water in the tin, and mark the trips " $\frac{1}{2}$ in." Divide the distance between the $\frac{1}{2}$ in. and 1 in. marks into four, or more subdivisions.

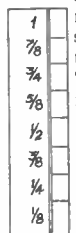
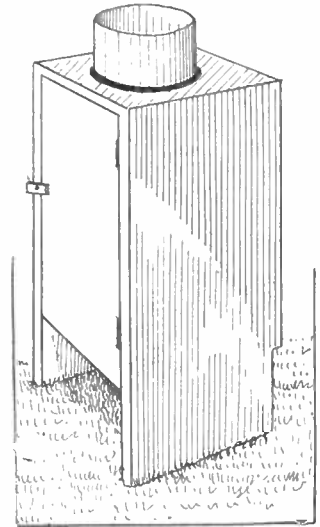

Fig. 3—The gauge

These sub-divisions



should then be measured off and be transferred down from the $\frac{1}{2}$ in. mark to the bottom, thus dividing the whole into eight or more divisions. Ink in these markings on the strip. The bottle can now be replaced in the box, and be secured there by a small wooden button each side.

Fixing the Gauge

Dry the tin, and in the centre punch a hole for the rain to run out. Punch from the inside of the tin so the burr made by the punching will be on the outside.

A small piece of tube should be soldered to the bottom of the tin, over the hole. Any piece of thin tubing will do, or one can be made by pressing a piece of tin round a pencil. The length of the tube must be such as will bring it just above the bottle beneath. This will be seen in Fig. 1.

Now place the tin in position and fill up the space between it and the hole with melted pitch to make the joint watertight. Give the woodwork a coat of creosote all over. The outside of the tin cup looks better if given a coat of enamel.

Ground Level

Dig a hole in the garden, or allotment, where the rain gauge is to stand about 12 ins. deep. Drop it in level and ram earth mixed with small stones well round it to make all firm. The box will then stand about 6 ins. above the ground, a convenient height.

A record should be kept of the readings, with dates, as there is some interest in knowing the rainfall during any particular period.

The days of the week can be named across the top with columns run down. The height is then marked up in the columns.

Every boy would be delighted with these SIMPLE HAND CLAPPERS



THIS is a welcome toy for a boy's band—a kind of relation to the "bones" beloved of nigger minstrels, and the spanish castanets. There is no skill needed to "play" it, just a knack, that's all, and it provides quite a good and effective accompaniment to the music. Single or double clappers (one on each side) can be made but a pair of single clappers is preferable to one double.

The board, Fig. 1 A., is marked out as shown on to a piece of fretwood, say $\frac{1}{2}$ in. thick, or a piece of fairly hard common box wood not more than $\frac{3}{4}$ in. thick. It is then sawn out and the sharp edges smoothed over with glasspaper.

Suitable Finish

The wood can be left plain, but is certainly improved so far as appearance is concerned by a coat of polish or varnish. Most woods can be used for making the board, by the way, but perhaps the best would be a hard wood as it will stand up better to the beating from the disc.

To this board is nailed the clapper. This is a length of thin steel, or other springy metal, with a lead disc at one

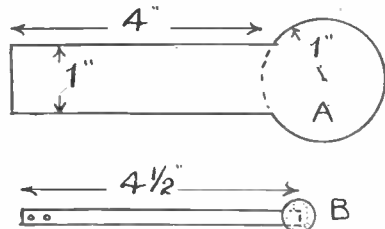

Fig. 1—The two parts of the clapper

end. Perhaps a piece of tinplate would do for the strip, though it has not the springiness of steel. Possibly the steel from an old pair of corsets could be got; it would serve nicely.

Cut it to the length given, and in one end punch two small holes $\frac{1}{4}$ in. apart, for nailing to the board. The lead disc at the opposite end is cast in position.

Making a Mould

For this purpose a mould should be made up. This is shown at Fig. 2. It is quite a simple affair, consisting of a $\frac{1}{2}$ in. hole bored through a thin bit of fretwood, and the fretwood nailed to a second piece, the latter acting as a bottom to the hole, or mould.

Leading into this hole, cut a shallow channel to about half the depth of the hole. Then lay the spring in the channel, ready for the casting. It is well to make the channel a tight fit for the spring so that the latter is less likely to shift while the lead is being poured in.

Get a tin lid and in it melt a few bits of lead over a gas jet, or fire. Then grip the lid with a pair of pliers and pour the molten lead in the mould, as shown.

When the lead is set hard, which will take only a few minutes, lift out

of the mould. Trim up the cast with a file, then nail the completed clapper to the board, near the top.

A pair of these toy clappers could be made so that one can be used in each hand, just like the "bones." Alternatively, one board can be provided with a clapper each side, giving much the same effect.

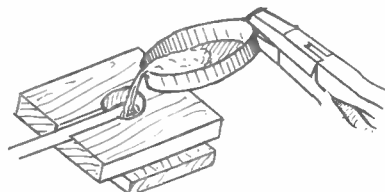

Fig. 2—Pouring the lead weight

In use at first the clappers seem awkward, but a little practice will soon bring proficiency. The movement is really a quick twist of the wrist causing the clapper to throw out and come back on to the board.

In Band Use

Used individually it can offer a definite rhythm effect, but, of course, only as a background to a tune. If incorporated in a band it must not be used too much; merely to give added effect every now and then or to supplement drums.

Some Replies of Interest

Magnet Conversion

I HAVE in my possession a motor cycle magneto and wonder if it is possible to convert it into an A.C. motor for 230 volts A.C.? (G.H.—Trelewis).

IT is quite impracticable to convert a magneto into an A.C. motor. For one thing, the A.C. current would de-magnetize the magneto field magnet, and the general arrangement of the armature is not suited for use as a motor dynamo.

Motor from Dynamo

PLEASE tell me if it is possible to make an electric motor from a cycle dynamo, and how it can be done? (F.T.—Ashford).

FUNDAMENTALLY, to convert a cycle dynamo to an electric motor, it is only necessary to connect the present output leads to a suitable battery—usually a 6 volt accumulator would do.

The motor may or may not be self-starting, so on switching on, if the motor does not run, spin it round by hand. There are several types of cycle dynamo, some have an auto-

matic cut-out in them, and this might have to be removed or altered.

Some cycle dynamos are designed to generate alternating current, and the armature and brush gear would then be unsuitable for using the machine as a motor.

Glass Repairs

I AM looking for an adhesive that will repair a thin glass container (similar to a tumbler) and will remain watertight. (G.L.—Kewton).

"DUROFIX" if used when new is perfectly satisfactory for effecting repairs to broken glassware. Another method (if materials can be obtained) is to shred a piece of clear cellulose acetate and dissolve it in acetone. Brush each joint face with a thin coat of the solution and leave it to dry; then apply a second coat—when "tacky" press the joints firmly together and hold them steady until the adhesive sets. If a pin hole leak is found afterwards, thoroughly dry the surfaces and thin brush each side once only with the solution and leave to dry. Afterwards scrape off any surplus from the surface.

You can choose your own fund in making this COLLECTING BOX

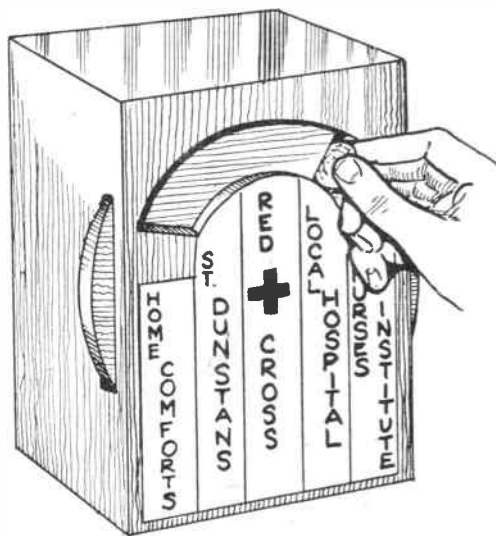

THIS kind of collecting box is just the thing for use in a club, Institution or country inn, in fact, anywhere where people gather together. It has five compartments, each for a different fund, and those donating can choose their particular fund for benefit.

It is only necessary to turn the disc containing the coin slot to the fund chosen before dropping the coin in. There is no mechanism other than a rotating disc to the box, so it is quite easy to make, but it has that touch of novelty about it that draws the cash.

Framework

Fig. 1 shows the sides of the box, A, and the top and bottom, B. Cut these from $\frac{1}{4}$ in. fretwood. The slip, cut away from the front edge of A, which allows the disc to stick out enough for turning is $\frac{1}{4}$ in. wide.

The parts, B, are divided into 5, as shown by the thin double lines, which are $\frac{1}{8}$ in. apart. On these lines chisel out grooves $\frac{1}{8}$ in. deep in which to

receive the vertical divisions that divide the box into separate compartments.

One part B, which will be the bottom of the box, is divided lengthwise, as shown by dotted line, with a saw to allow of the money being afterwards taken out. The part sawn off is not fixed with the bottom, but left loose, being only kept in place by a covering of paper pasted over.

The division pieces, Fig. 2, should be cut from $\frac{1}{8}$ in. fretwood. The cut-outs on the front edges are $\frac{1}{4}$ in. deep, as for the sides. Note the length of these cut-outs differ in divisions 1 and 4 and 2 and 3.

Now nail and glue the parts together and glue the division pieces in their correct order, 1, 2, 3 and 4.

The narrow back piece, cut off the bottom, B, is left out for the time being. The whole thing will now look like Fig. 3, a portion of the back corner being shown cut away to show this loose piece of the bottom.

The Front

Fig. 4 shows the front of the box. Cut two of $\frac{1}{4}$ in. fretwood. One is for the back of the box, so is just a plain rectangle and can be glued in place.

In the front piece of the box draw a line down the middle, and at the centre shown strike the two arcs. The extent of the arcs is 134 degrees, or 23 degrees each side short of a semi-circle.

Mark these points with a protractor and saw out the curved opening. Bore a fine hole in the centre, from which the arcs were struck, turn over, and in this hole drive in a $\frac{1}{8}$ in. or $\frac{3}{16}$ in. brass screw as far as the threaded portion. File off the head leaving a pin not more than $\frac{1}{4}$ in. long.

You will see this pin in Fig. 5, D.

Any threaded part sticking out at the front should be filed off smooth. On this pin the disc can rotate. Now fit the front of the box temporarily with a nail each side only partly driven in.

The Slot Disc

The rotating disc, Fig. 5, C is cut to diameter given from $\frac{1}{4}$ in. fretwood. Where shown cut out a slot $\frac{1}{8}$ in. wide, for the coins to enter. In the exact

MATERIAL REQUIRED

Two panels, G4—9 by 4 ins. by $\frac{1}{4}$ in.
One panel, H4—14 by 7 ins. by $\frac{1}{4}$ in.
One panel, K4—20 by 8 ins. by $\frac{1}{4}$ in.
Four panels, G2—9 by 4 ins. by $\frac{1}{4}$ in.

centre bore a hole to fit over the pin in the front of the box.

Now lift the front off, place the disc on its pin, and replace the front in position. See the disc can rotate smoothly. If this is satisfactory, stain and polish the disc glue the edges of the box, and fix the front permanently in place. Of course, you must take care to get no glue on the disc, or it may stick.

Smooth the outside of the box with glasspaper and stain it, if staining is decided on.

On a piece of glazed notepaper cut a shape to cover practically the front

(Continued foot of page 71)

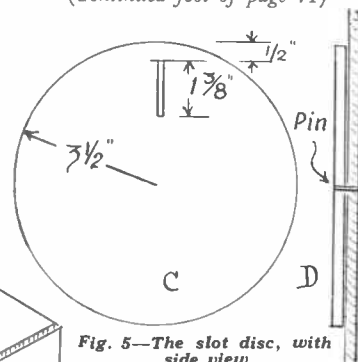

Fig. 5—The slot disc, with side view

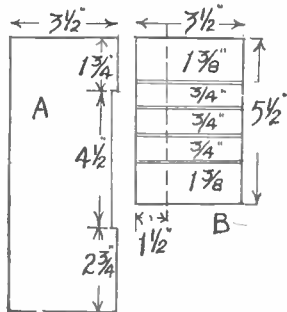

Fig. 1—Sides, top and bottom

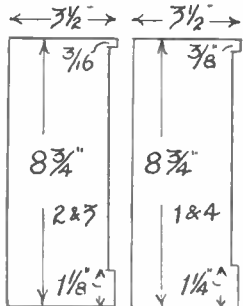

Fig. 2—The division pieces

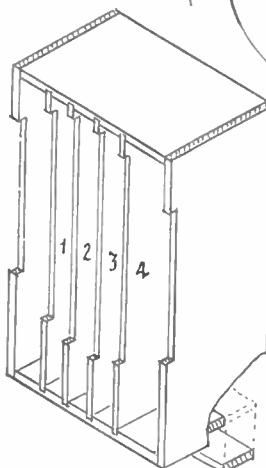

Fig. 3—The partition arrangement

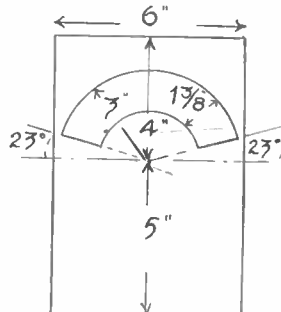
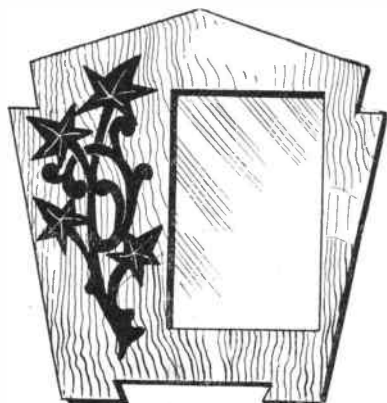

Fig. 4—The front details

Full size pattern overlay on Cover iv for these SIMPLE PHOTO FRAMES



THE time is here when we can think of Christmas presents. As there is so little variety for these in the shops these days, it would be just as well if we tried our hand at making up some.

Most fretworkers have by them a quantity of small pieces of wood and perhaps some ivory or from which they could make up a few simple things. Photo frames, among other articles, are very popular as Xmas presents, in fact they are popular at any time as souvenirs or birthday gifts.

Simple Outlines

It would seem that the plainer the background of the frame, the better

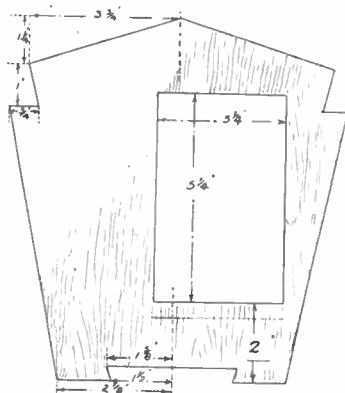

Fig. 1—Outline and dimensions

it is for the decorative overlays to go on it, as it is these overlays which impart a rich effect.

Even plain squares and oblongs of wood, or again just circles or ellipses look very artistic when treated with

decorative overlays well placed and appropriately designed.

Great scope is afforded the fretworker as he can generally think out some simple shape and even experiment on paper before he actually does any cutting of the wood.

We give here on this page two simple outlines for frames to take postcard size pictures, and in the illustrations of the completed articles it is seen how they can be decorated with thin wood overlays, or overlays of ivory or xylonite.

The outline given in Fig. 1 can be cut from a piece of wood measuring 9 ins. by 8 1/2 ins., and that in Fig. 2 from a piece 8 ins. long by 8 1/2 ins. wide. It will be noted from these outlines that the openings for the picture measures 5 3/4 ins. by 5 1/4 ins.

Picture and Glass

The picture and the glass go at the back of the frame and are to be held in place by narrow fillets of wood. These are mitred and glued round with a full margin of 1/4 in. from the actual opening cut in the frame.

Wood either 3/16 in. or 1/4 in. thick may be used for the frames, with 3/16 in. stuff for the fillets at the back. Contrast in colouring between the wood used for the frame and that used for the overlays should be aimed at. If the frame be of mahogany, say, then the overlays should be of white wood or satin wood so that they stand up against the darker background.

Then again, if the frame be of light wood such as oak left in its natural

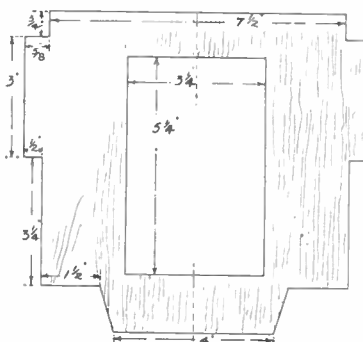
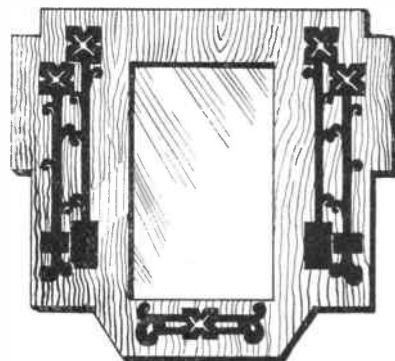

Fig. 2—Details of alternative type

state and not stained, then an overlay of padouk or xylonite would be suitable. Or again, still having the light oak frame, a whitewood overlay stained perhaps dark oak or even finished with a colour stain such as green or vermilion.



Many are the ways of getting a really delightful colour scheme by using stains and wood dyes. On cover iv in this issue we have been able to include a number of suggestions for overlays most of which we have been able to incorporate in the frame designs illustrated in the sketches.

Cutting Thin Pieces

Any of these overlays may be cut from wood or from ivory or xylonite. It should be understood that when cutting these rather delicate designs the material from which they are being cut should be put between two pieces of commoner wood so certain flimsy sections of the design shall not get cracked or broken through.

The fretwork pattern will in this case be stuck down to the top surface of the covering piece and, if possible, a fine grade fretsaw used for the cutting. When gluing on the overlays use the glue very sparingly so that when they are weighted down any superfluous glue will not squeeze out round the edges and spoil the appearance of the work.

Finishing Details

One or two fine headless fretpins may be driven through the overlays to hold them securely in certain places. The holes for these pins must however be carefully drilled beforehand.

After the glass and the picture have been put in from the back, a piece of thin wood should be added as a backing before a square of brown paper is glued over the whole, covering part of the mitred wood fillets also.

If the frames are intended to stand on a shelf or sideboard then a simple strut may be made from odd wood and hinged at the back.

Patterns for Cut-out Animals Free Next Week

You can easily teach yourself to play if you MAKE A RECORDER

THE word recorder is probably new to many readers who may wonder what it can be. It is in fact, a very old musical instrument, and was popular about the time of Queen Elizabeth. In construction it is very similar to the tin whistle or flageolet, to use its proper name. Most of us have, no doubt, either played one or have had a desire to do so, for it is quite an easy instrument to learn and will give endless hours of amusement.

Unlike the whistle which is made of metal, the recorder is made of some

Now, using the same square file, very carefully cut the bevel on the lip, making it slope at an angle of about 30°, and tapering down to the thickness of a postcard. The thin edge of the lip should have a slight curve like the outer part of the pipe. The tone of the instrument depends on how this operation is carried out. A carelessly made lip with a rough edge, or with an uneven taper may make the tone thin or even might not give any sound at all.

The cork is next fitted to the mouthpiece, and it is very important

With the aid of a tuning fork or a piano, blow gently in the mouthpiece and see which note is sounded. It should be lower than what is wanted. All you have to do then is to cut off a little at a time from the small open end until the correct note is obtained.

Drilling the Holes

When you have got the pipe tuned to the correct key there only remains the task of drilling the six holes which must be in a direct line with the lip of the mouthpiece. First measure the open length of the pipe: that is, the distance from the flat end of the cork inside the pipe to the small open end of the pipe.

A quarter of this gives the position for the bottom hole, and also for the top hole, measuring from the small

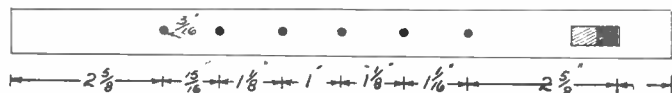

Showing position and distance of holes



A section of the finished pipe

hard wood. It possesses a very pleasing, mellow tone and is quite simple to make. The only materials required are a short length of bamboo and a cork; while the tools needed are of the very simplest and few in number.

Special care should be taken to get all the measurements accurate, and a little extra time and trouble spent in doing this will be amply repaid in the finished article.

For a treble pipe in the key of C, you will need a piece of bamboo about 12ins. long with an inside diameter of about 5/8in. The writer has found a fishing rod just about right for this, and was able to cut a smooth piece about this length between two nodes.

One end of the bamboo will probably be slightly larger than the other—use this end for the mouthpiece, which will be made first. Drill a 3/16in. hole 1 1/2in. from the end and with a small square file cut this until it is nearly 1/4in. square. When filing a square, the correct way is to cut the four corners—the sides, you will find, will look after themselves.

Having cut a perfect square, make sure that there are no rough pieces on the inside of the pipe. A piece of fine glasspaper wrapped round a pencil can be used to smooth this part.

to use one that is free from cracks and holes. It should be about an inch long, so it will project very slightly past the top edge of the square opening.

Place the side of the cork on a piece of fine glasspaper and rub until you have a flat surface just over 1/4in. wide at the smallest end and getting a little wider at the other end. This is for the wing channel. Put the cork in the mouthpiece and test by gently blowing. If the sound is weak or there is no sound at all the channel is not large enough and you must take the cork out and rub it down a little more.

Do not take off too much at a time. The best size for the channel is 1/64in., but this may vary slightly. It is better to make it too small at first and gradually rub it down, testing every now and again until a pleasing tone is produced. Then with a fretsaw cut off the curved portion at the bottom of the mouthpiece opposite to the square wind hole.

Before drilling the six holes along the front of the instrument we must tune it to the key we want. The pipe was purposely made too long, to enable this tuning to be done. A pipe of this length will tune to the key of C or D.



End and side view of mouthpiece

end and flat of the cork respectively. The other holes can then be marked off according to the measurements given in the illustration. These measurements apply only to a pipe having a length of 10 1/2ins. from the cork to the small end. Should the pipe be longer or shorter the distances must be worked out in proportion.

The pipe is now ready for final finishing, and all that needs doing is to remove any rough edges with a piece of fine glasspaper.

It would be very nice to get your friends to make some bamboo pipes to form a band among yourselves. If you do this one or more of the instruments should be made in other sizes—then you would be able to put in alto and tenor parts as well as the treble.

According to the theory of sound, a pipe that will sound an octave below the treble one should be twice the length and of course larger in diameter in proportion. If you decide to have your treble pipe in the key of C, which is the easiest, then the tenor one should be the C below this and the alto the G in between.

Remember always to cut the pipes too long to commence with and gradually shorten them until the right note is obtained.

Collecting Box—(Continued from page 69)

of the box below the curved opening. No pattern is needed for this as the finished view shows what is meant.

Divide this into five vertical divisions with thick black lines and print on, as neatly as possible, the names of the funds chosen, Red Cross,

Hospital, etc. Readers will doubtless have their own choice of funds.

Then paste or glue the paper to the front of the box. As far as possible avoid any creases. Finish off the box with a coat of clear varnish.

The disc can be rotated by twisting

the parts sticking outside the box with the fingers, or by partly inserting a coin and pushing that in the desired directions until the slot allows the coin to enter the chosen compartment.

Marks might be clearly indicated on the edge of the curved opening.



DECORATIVE
OVERLAYS
FOR FRAMES

See
page
70