

1975 HIFI YEAR BOOK

# HIFI YEAR BOOK

## 1975

Pickups/Motors/Tuners/Amplifiers/Microphones  
Recorders/Speakers/Cabinets



**Goodmans**  
One of the founders of high fidelity

# HIFI YEAR BOOK 1975

Editor Basil Lane

Assistant Editor, Wireless World.

**Note: VAT rate change**

Prices where shown as being inclusive of VAT are calculated at the 10 per cent rate. Immediately before going to press the rate was changed to eight per cent. Readers should therefore expect actual retail prices to be lower than quoted.

© IPC Electrical-Electronic Press Limited 1975

*Published by*  
IPC Electrical-Electronic Press Limited  
Dorset House Stamford Street London SE1 9LU 01-261 8000

*Printed in Great Britain by*  
Chapel River Press, Andover, Hants.

# Contents

## Articles

- 6 Understanding and Using Loudspeaker Specifications  
*by Bill Anderton*
- 12 The Surround-Sound Panorama  
*by Geoffrey Shorter*
- 14 Recent Tapes and Discs: A Personal Selection  
*by Donald Aldous*
- 17 Tangling with Tape  
*by V. H. Prior*
- 20 Abbreviations
- 451 Golden Age of Loudspeakers  
*by Basil Lane*

## Directory Sections

- 23 Amplifiers and Control Units
- 71 Cassette Recorders and Decks
- 85 Combination Units
- 97 Complete Audio Systems
- 121 Constructional Kits
- 131 Hi-Fi Cabinets
- 139 Hi-Fi Headphones
- 157 Magnetic Tape
- 163 Microphones
- 189 Pickup Accessories
- 201 Pickups and Arms
- 219 Radio Tuners
- 237 Receivers
- 273 Record Decks
- 297 Speaker Accessories
- 305 Speaker Drive Units
- 321 Speaker Enclosures
- 390 VHF Radio Transmitting Stations
- 393 Surround Sound
- 397 Tape Accessories and Components
- 409 Tape Amplifiers and Mixer Units
- 415 Tape Decks and Recorders
- 434 Test Tapes and Discs
- 439 FM/VHF Aerials
- 445 Stop Press
- 450 Tape Playing Times
- 456 Directory of Manufacturers
- 463 Advertisers' Index
- 465 Directory of Hi-Fi Dealers

# In the confused world of 4 channel stereo JVC offer you this simple solution

Choosing the right 4-channel stereo system can be a difficult business.

From all you've heard, you might think that you need masses of equipment to achieve perfect sound reproduction.

But you don't. And, as the originators of CD-4, JVC know what they're talking about.

All you need is what you see here. Just six component parts that go to make up the most compact and sophisticated 4-channel stereo system available.

It starts with our VL-5 turntable. With a 'sure tracking' tone arm, belt driven 4 pole synchronous motor and 12" aluminium platter, it comes complete with a 4-channel cartridge.

We've matched this to our 4VR-5456 tuner amplifier. Incorporating our CD-4 Demodulator *and* our SEA Sound Effects Amplifier as standard equipment, it has matrix circuits as well as the CD-4 demodulator to allow you to play CD-4 or any matrix recordings. And it has a CD-4 Radar Display to tell you when CD4 is playing.

And - third, fourth, fifth and sixth in line - we offer you our SX-3 speakers. Finished in handsome white spruce or walnut, each one has a 19" woofer with Kurt Müller cone paper and a revolutionary soft dome 2" tweeter.

No matter what anybody else may tell you, that's all you need for perfect 4-channel sound reproduction.

It's a simple solution that cuts right through the confusion.



JVC (U.K.) Ltd, 453 Caledonian Rd, London, N7 9BA. Tel: 01-607 6568

**JVC**

another step closer to reality.

*Essential reading for hi-fi enthusiasts by authors who are well known for their ability to explain technicalities in a readable and easily-understood way.*



### Pickups and Loudspeakers

*John Earl*

The author sets out to guide the reader through the tangle of technical specifications and to show what are the most important features to look for in order to obtain the units best suited for a particular installation and at a suitable price. 203 pages, 156 illustrations. £3.00 net.

price. 203 pages, 156 illustrations. £3.00 net.



### Tuners and Amplifiers

*John Earl*

This book complements Pickups and Loudspeakers in that the two cover the whole of the audio reproducing process. It is based on the author's own practical experience in testing the models in a laboratory and helps would-be buyers in their selection and in getting the best from their equipment. 187 pages, 127 illustrations. £2.10 net.

in their selection and in getting the best from their equipment. 187 pages, 127 illustrations. £2.10 net.



### Tape Recorders

*H. W. Hellyer*

The primary aim of the book is to act as a guide to the purchaser on what to look for in the way of functions, facilities, types, variations and specifications. Also included is an important section on maintenance and upkeep, and for the enthusiast, sections on servicing the mechanical sections of the deck and on making tests and measurements. 239 pages, 254 illustrations. £3.00 net.

sections on servicing the mechanical sections of the deck and on making tests and measurements. 239 pages, 254 illustrations. £3.00 net.



### Creative Tape Recording

*V. Capel*

Almost every household can boast a tape recorder of some kind, but many owners, after the initial novelty, are at a complete loss as to how the equipment can be used to its full advantage. This book will show the way, as the title indicates, and is a mine of information on how to be creative with a tape recorder. 183 pages, 111 illustrations. £3.50 net.

and is a mine of information on how to be creative with a tape recorder. 183 pages, 111 illustrations. £3.50 net.



### Improving Your Hi-fi

*John Earl*

The author details how to connect the units together to obtain top performance and explains the meaning and proper use of the many control knobs and switches found on modern hi-fi gear. There are useful hints on simple performance checks, running repairs and adjustments. Final chapter on surround sound and quadraphony. 176 pages. £3.00 net.

running repairs and adjustments. Final chapter on surround sound and quadraphony. 176 pages. £3.00 net.



### Stereo Sound

*H. W. Hellyer*

The text takes the reader through a description of the nature of sound, discusses audio reproduction and its limitations and investigates the problems of room acoustics. Recording and reproducing techniques are described, as is the multiplex stereo radio broadcasting system. There are also chapters on mixing, phasing and balancing, in addition to an instructive section on how to install stereo equipment in the home. £3.50 net.

There are also chapters on mixing, phasing and balancing, in addition to an instructive section on how to install stereo equipment in the home. £3.50 net.

*Each book is 8½ × 5½ in. and is casebound with coloured dust-jacket. Order from your local bookseller or direct from the publishers.*

**FOUNTAIN PRESS: Argus Books Ltd.**

Station Road, Kings Langley, Hertfordshire, England.

# Introduction

This is my first year as Editor of the Hi-Fi Yearbook and I must, before getting down to describing its contents and general policy, offer a vote of thanks to Colin Sproxtton, my predecessor. He has been largely responsible for making the Year Book what it is, a valuable and reliable source of information on Hi-Fi products and their manufacturers. I hope to be able to maintain his high standards and despite being a "new broom", there has been no real reason for me to make radical changes.

The first noticeable change however, has been to rearrange the sections into alphabetical order. The second change is as a result of a natural trend which has produced an ever increasing number of cassette recorders. For this reason I have introduced a new section called Cassette Recorders and Decks. Quadraphonics has been renamed Surround Sound and the Tuner/Amplifier Section has been renamed, Receivers. These changes are to fall in line with popular usage in most of the audio publications.

Prices have been quoted wherever possible as being inclusive of VAT, this being in line with last year's editorial policy. However, since some of the products described are principally of a professional nature, VAT may be excluded in those instances. Prices are those recommended by the manufacturer and can often be bettered by shopping around. Since going to press with the directory section of this book, the VAT rate has changed from 10 per cent to eight per cent. Since prices in the directory are quoted at the 10 per cent rate, products may well be cheaper than quoted. However with prices changing frequently it is advisable to check carefully before committing yourself to a decision.

Specifications published in the Year Book are those of the manufacturers, since the Year Book publishers have no facilities for verifying the accuracy of the statements or testing equipment.

Every effort is made to ensure the accuracy of the information published in this book, but the publishers regret that they are unable to accept any responsibility for errors or omissions that may have occurred. With an ever increasing range of products it has become more difficult to draw the line, there being only a limited number of pages in the book.

Acknowledgements are given to the valuable assistance given in compilation by Heather G. Preece and Jane Mills and the design of the book by Roger Emmerson.

# Understanding and using loudspeaker specifications

by Bill Anderton

Incredible technical advances have been made over the last 25 years in the development of sound reproduction. Gone are the days when amplifier power output valves were deliberately overloaded in an attempt to produce more volume. To hell with distortion, the novelty was there! But what of today? In our world fanatical for amplifiers with virtually zero distortion characteristics, hi-fi fanatics are cutting their own throats in their search for "mechanical" perfection. But does this not entail the evolution of uniformity in all equipment design? That must be an ideal in art for sure, but the root of complacency in science. Loudspeakers have improved as incredibly as everything else, but seem to be a long long way from perfection. This is mainly due to much disagreement in higher circles as to what are the criterions by which loudspeakers should be judged and also another "spanner in the works," taste and personal preference.

Still, it is acceptable that at present several loudspeaker parameters can be measured to give an indication of the performance limits. It is not acceptable however that these parameters commonly mentioned in manufacturers' literature, are necessarily the most useful or most important. The problem to be overcome is that test signals and test environments are designed with two basic limitations. First, test signals are generally unrealistic (steady state) and second the loudspeaker is tested as an entity separate from its environment, which it is not. Surroundings have as much to do with the sound we hear as the design techniques used in the loudspeakers' construction. This will be explained in more depth, but first how can inadequate parameters be interpreted to be of at least some use.

## Interpreting specs.

a) Frequency response: this is a measure of the way a speaker reacts to signals of constant amplitude but different frequency. A flat re-

sponse indicates that the speaker treats each frequency in exactly the same manner. Resonances show up in the response as peaks and similarly, an inability to radiate a particular frequency as efficiently as lower or higher ones, shows up as a dip in the response. In interpreting the response, remember that a series of *sharp* shallow peaks and dips (often seen) results in a harsh resonant sound. If the peaks and dips are of greater amplitude, but are smooth transitions instead of being "spiky", then this is not so indicative of a bad performance, as illustrated in **Fig. 1**. Similarly, for the limits of the response particularly at the bass end, a gentle roll-off will provide a much smoother more realistic sound than a sudden transition.

So, the frequency response can show up resonances, dips or "suck-outs" and the frequency limits of reproduction. *It can do no more*. The main limitation of conventional response curves is that performance is indicated at discrete frequencies only. Programme material consists of complicated combinations of different frequencies. Examples of continuous test signals, and more useful pulse or transient signals are shown in **Fig. 2**.

In fact, the "frequency response" is not even

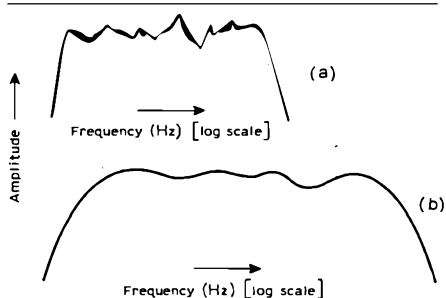

**Figure 1** The amplitude frequency response in (a) will indicate a harsh, resonant type of reproduction compared with the smoother curve in (b).

the frequency response—someone at some time took a diabolical liberty. True frequency response consists of the amplitude response *and* the phase response. Now the amplitude response is the half we are used to calling the “frequency response”. The important bit which shows how the frequencies of a complex signal behave with respect to one another has been left out. Probably because in the past, it has been assumed to be too hard to measure.

A phase response (see Fig. 3) shows how well the correct relationship between the individual frequency components of a complex (real) signal are maintained as the signal is processed by the loudspeaker. The slope of this graph is the important thing, since it represents the time delay of the loudspeaker. If it is constant (not necessarily horizontal) each component of the signal will be subject to the same time delay as it is processed by the speaker. The relationship *between* the signal components has therefore

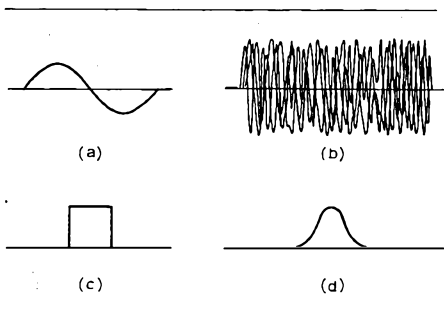

**Figure 2** Examples of test signals for loudspeakers (a) continuous sine wave (b) white noise—all frequencies across the audiobandwidth at constant average power (c) square pulse (d)  $\sin^2$  pulse—little used but very useful.

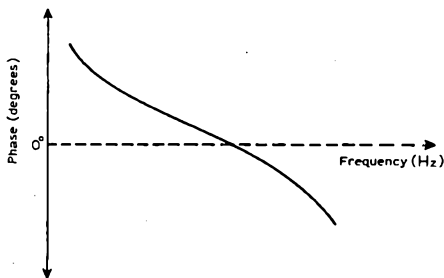

**Figure 3** Ideal phase response of a loudspeaker system. The slope of the curve should be constant. The negative of the slope is the system's time delay.

remained unchanged from start to finish, an indication of accurate reproduction. It is not the flatness of this response that matters then so much as its straightness.

All this might seem rather superfluous as no one seems to recognize its importance although a lot of hot air is wasted on the subject. However, at the time of going to press, at least one manufacturer in this country (KEF) has developed a simple if expensive means of easily measuring the total frequency response. Also, at least one influential American audio journal is taking time delay characteristics into account with published reviews. Perhaps it will not be long before the above information is very relevant.

b) Polar response: the frequency response (as we shall continue to call it) is measured at a point directly in front of the loudspeaker and is not necessarily the same as we move off-axis. High frequencies are especially affected as we move round the speaker i.e. they are more directional than bass frequencies. To demonstrate this effect, the polar response is an indication of the way the response to a particular input frequency varies with the angle it is measured around the loudspeaker's circumference. If the speaker is positioned against a wall, and is designed to radiate in a forward direction only, then we are only interested in the polar response around  $90^\circ$  each side of the on axis position (see Fig. 4).

This response is usually measured at three typical frequencies throughout the range (low, mid and high). The smoother and wider the polar response the better and this partly indicates the consistency and solidity of the stereo image as the listening position is moved.

c) Nominal power rating and efficiency: the nominal power rating is the amount of power measured in watts that the loudspeaker is capable of handling for a long period of time without damage, quite different from the much higher peak power which the speaker is capable of dealing with for short bursts of time. The nominal power rating is useful in matching a loudspeaker to an amplifier but in terms of performance is of no value unless we know the efficiency. From the listeners' points of view the acoustic power output is of more importance than the electrical input power. Loudspeaker efficiency, the ease with which the input is converted into sound is usually very low, around one or two percent. The most efficient type of



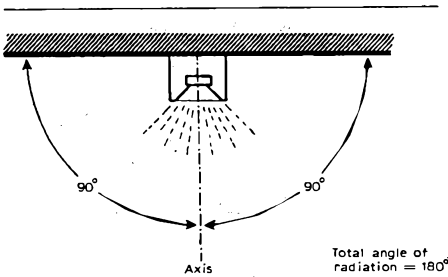

**Figure 4** Angle of radiated sound from a loudspeaker positioned against a wall.

loudspeaker is the horn, as we shall see later, which can have an efficiency as high as 20 or 30 percent.

Efficiency can also be expressed as a sound pressure level at a particular distance from the loudspeaker for a particular input signal e.g. 95dB at 1m at the nominal power rating.

d) Nominal impedance: this parameter is again useful in matching the loudspeaker and amplifier correctly. It should be constant throughout the frequency range. A peak at a low frequency reveals the main resonant frequency of this system and often looks worse than a subjective test indicates. If the peak is not too great then the resonance can be damped by careful cabinet design. More important is that the impedance does not fall to too low a value within the range of transmitted frequencies. This includes subsonic frequencies which could originate with mechanical rumble from a turntable. If this is the case, the amplifier damping factor drops, spoiling transient performance at low frequencies and also introducing the possibility of damage to the amplifier output transistors due to increasing output current. This is why an amplifier should never be matched to a loudspeaker with a lower nominal impedance than that specified.

d) Rooms and acoustics: ideally, the way a loudspeaker is positioned in a room should be specified and although manufacturers have no say in the way buyers furnish their rooms, it's surprising that more do not give information on optimum listening conditions.

I'm not necessarily advocating that furniture and fittings should be bought to provide a pair of loudspeakers with their ideal environment, but that the speakers' position with respect to the rest of their surroundings is important and

often easily variable. Indeed, one or two loudspeaker designs are appearing in this country which defy all performance measurement by accepted means, as they are designed with room acoustics in mind and not anechoic chambers.

It's worth experimenting with a loudspeaker's position. Corner positioning or raising the speaker a foot or so off the floor may improve bass performance. Moving away from heavy curtains or sofas may improve high frequency response. Placing exactly mid-way between floor and ceiling may excite a room resonance. The best results are obtained by experimenting.

All this shows that loudspeaker specifications as they are presented at the moment can—if interpreted with a little background knowledge—reveal the performance limits, but no more. Further than this however, different types of loudspeakers possess properties which are inherent in the design techniques used. So, if we know the type of loudspeaker it is immediately possible to know certain of its reproduction characteristics.

#### Infinite baffle loudspeakers

Low frequency performance and efficiency are

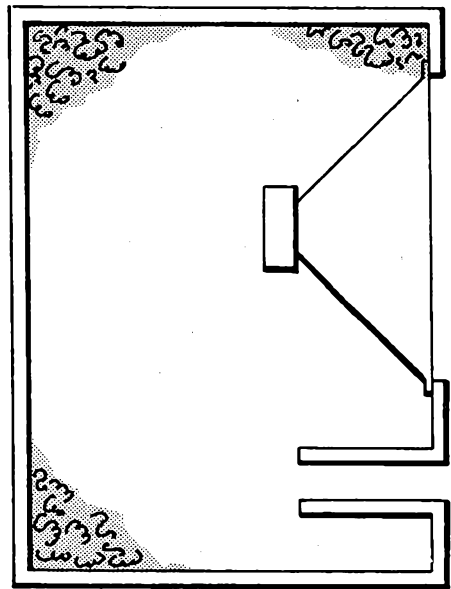

**Figure 5** Reflex or ported enclosure. Useful sound is radiated from the port around the system's resonant frequency.

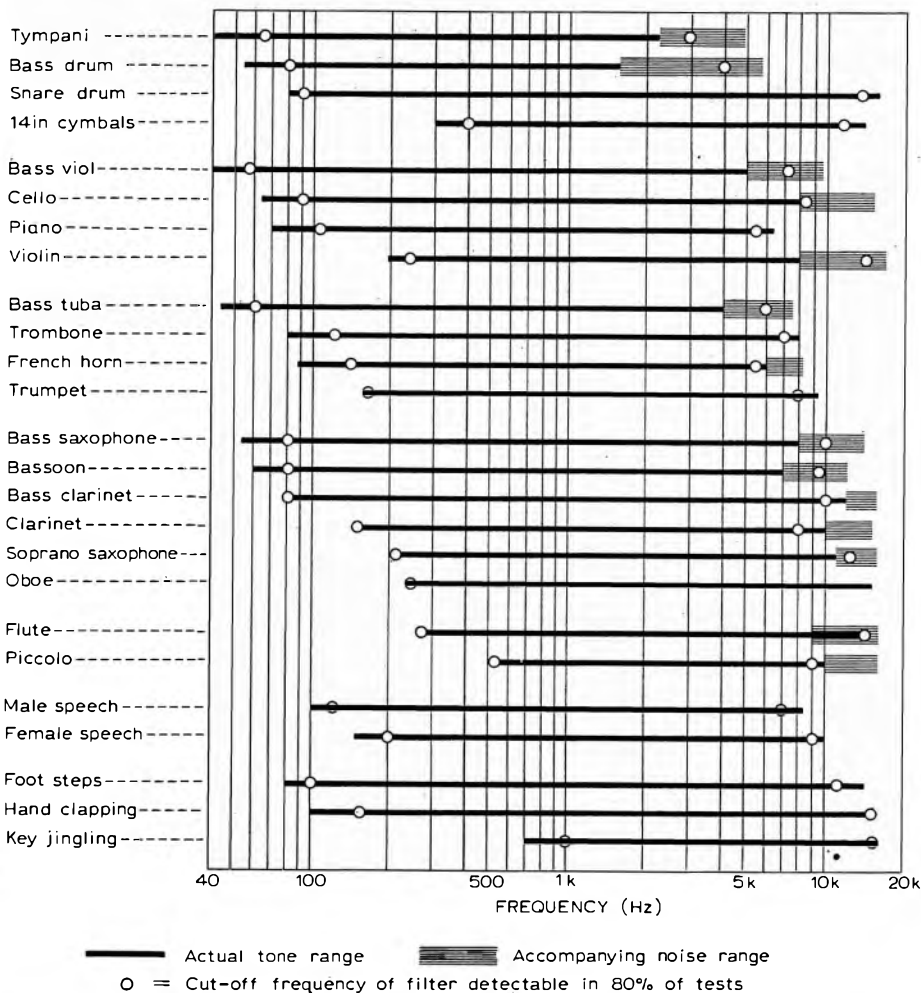

Figure 6 Chart showing audible frequency range (after Moir, "High Quality Sound Reproduction").

controlled largely by the type of cabinet in which the drive unit is loaded. This also applies at mid and high frequencies, but often this performance is determined when high frequency units are manufactured as completely sealed (pressure) units.

If the bass unit is loaded by a completely sealed box or infinite baffle (i.b.), several factors are immediately apparent. Volume of the box determines the relationship between the lower cut-off frequency and the efficiency of the

enclosure i.e. the smaller the box the less bass or less efficiency. A compromise is usually made, but very small bookshelf loudspeakers are invariably inefficient. A way of increasing the effective volume of an enclosure is to pack it with acoustically absorbent material. The effect is to lower the resonant frequency of the enclosure by 10 to 15 per cent. Compressions in internal sound waves decrease from about 344 to 280m/s and efficiency reduces even further by nearly half. The popular belief that a large

value of air stiffness in a small closed box increases speaker damping to produce a smoother response is incorrect. Damping is a function of resistances in the system.

### **Reflex or vented enclosures**

A cabinet with a vent, port or pipe in it (Fig. 5) behaves in exactly the same way as the infinite baffle at frequencies higher than the bass drive unit resonance. However, around the resonant frequency of the driver, the port is designed to emit sound supplementing that from the speaker and also damp its motion. This provides an extended bass response for the same volume of enclosure used in an i.b., plus a higher power handling capability. The latter advantage is a result of the reduced amplitude of the driver around resonance, when the port is radiating. Often, however, it is found that a correct design produces a pipe system of unmanageable proportions. This problem is coped with by the use of a passive radiator which loads the vent—very similar to an unconnected loudspeaker drive unit. This is the basis of the ABR (auxiliary bass radiator) system.

Whichever system, plain reflex or ABR is used, vented enclosure are much more likely to have a very resonant unsatisfactory response if not designed correctly. Ideally, the drive unit should be designed to match the enclosure. Using any old loudspeaker results in far more design compromises than are necessary. Limitations of the ABR are reduction in efficiency of the system and a reduction of the air load presented to the rear of the loudspeaker cone, damping its motion around resonance.

### **Transmission line enclosures**

Unwanted out of phase radiation from the rear of a loudspeaker cone can be led down a long tunnel filled with highly absorbent material which dissipates the unwanted acoustic energy inside the enclosure. This is the transmission line principle. The tunnel is folded to produce an enclosure of dimensions suitable for a domestic environment and is usually fed out via a port to the surrounding atmosphere. The length of the line should be such that at the limits of the loudspeaker response, radiation from the port occurs, which supplements that from the drive unit—in other words it is a form of heavily loaded reflex system.

Some of the best systems now available on the domestic loudspeaker market employ trans-

mission lines, but two disadvantages are inherent in the system. The first can be overcome if plenty of power is available—transmission lines are inefficient. The second can be reduced by careful design and construction. This is the problem of either back pressures reflected onto the cone if the absorbent material is too dense or pipe resonances in the lower bass region if not dense enough. One such excellent system, overcoming these problems was described in *Wireless World*, May 1972 by Dr A. R. Bailey.

### **Horn loudspeakers**

The main inherent property of horn loudspeakers, sound quality apart, is their incredibly high efficiency compared with other types of loading. This is a result of matching the high mechanical impedance of the loudspeakersystem to the low impedance of the surrounding atmosphere. High pressure, low velocity sound waves at the throat of the horn are converted to low pressure high velocity waves at the mouth from which radiation into the air occurs. The dimensions and flare rate of the horn determine the limits of the frequency response.

High efficiency is the advantage, but the large dimensions necessary to produce an extended bass response tend to offset this. However, it is my opinion that low distortion and the high clarity of performance which horn loading can offer are more important than accurate reproduction in the region of 20 to 80Hz i.e. the lowest two octaves of human audibility.

The problem of oversize enclosures is overcome by folding the large bass horn (midrange and high frequency units are usually loaded with short "straight" horns). Smaller sized bass horns have a limited response but this is improved in the corner horn designs which make use of two adjacent walls forming extensions to the horn from the corner in which it is placed.

One further design aspect of multiple horn units is that they may be susceptible to phase cancellation effects between mid and low or mid and high frequency units, as operation crosses from one to the other. Again careful design can eliminate this problem.

In interpreting published reviews, it is as well to remember that the frequency response results of testing a corner horn loudspeaker in an anechoic chamber are meaningless. This applies to any loudspeaker which is designed specially to make use of room acoustics.

### Electrostatic loudspeakers

A problem that has not so far been mentioned with moving coil loudspeakers is that the radiating area of the cone gets smaller as frequency gets higher. This results in the need for multiple driver systems incorporating cross-over networks to avoid cone break-up effects. This is a complication of matters which an electrostatic loudspeaker, designed to cover the full range of audio frequencies can overcome.

The electrostatic loudspeaker usually consists of a sandwich of three metal plates. The inner plate or diaphragm radiates sound while the outer two are fixed. The force which causes the diaphragm to radiate is uniformly spread over its surfaces in the form of an electrostatic charge. In the case of the moving coil loudspeaker, the driving force is not uniformly distributed over the cone but is applied only at its centre.

The result of this type of electrostatic sound production is a unit providing very accurate results, but again often sensitive to room position and lacking in power handling capacity at low frequencies.

### Bookshelf loudspeakers

It's interesting to see how advances in the standard of top quality loudspeakers have been reflected in the performance of smaller, more convenient bookshelf loudspeakers. Incidentally, I mean "bookshelf" size—some loudspeaker P. R. men must have enormous shelves in their living rooms to accommodate their idea of the size of a bookshelf.

New materials in magnets, voice coils, cones and acoustic absorbents plus more accurate methods of driver assembly can now provide excellent performance from small loudspeakers. A glance through the specifications for several bookshelf models revealed the following best combined specification:—

Frequency amplitude response: 70Hz to 20kHz  $\pm 3$ dB.

Impedance: 15 $\Omega$  (+1 $\Omega$  -2 $\Omega$  from 20Hz to 20kHz).

Power handling: 20W continuous.

Sensitivity: 5W for 90dBA at 1m on axis.

Harmonic distortion: less than 2 per cent at 50Hz and 1W.

An extremely useful (but outdated) guide to specifications for loudspeakers—measurement methods and minimum requirements—is provided by the German DIN45 500 standards.

### Appendix

#### Use of decibels

A decibel (dB) is a means of expressing a ratio between a known standard quantity and a variable. If the variable is say power, decibels are expressed as  $10 \log_{10} \frac{W_2}{W_1}$  where  $W_1$  is a

reference level and  $W_2$  is a variable quantity.

From this, if  $W_2 = W_1$ , then the expression results in 0dB. If  $W_2 = 2W_1$  the expression is 3dB.

If the variable is a voltage, decibels are expressed as  $20 \log_{10} \frac{V_2}{V_1}$  where  $V_1$  is a reference level and  $V_2$  is a variable quantity.

#### Sound pressure levels

The following table is a guide to relating dBs of sound pressure levels to loudness. The reference level is 0.0002 dyne/sq. cm., the lower threshold of hearing.

dB	loudness
30	Quiet room.
40	Whispered speech.
60	Normal speech.
95	Heavy lorry at kerbside.
110	Chchestra at conductor's rostrum, fortissimo.
120	Jet aircraft taking off at close quarters—threshold of pain.

# The surround-sound panorama

by Geoffrey Shorter

British buyers on the whole have adopted a cautious, wait-and-see, attitude to surround sound. There is no doubt a complex of reasons for this—not least a lack of agreement about the best way of going about it—but two are prevalent.

One must be the mere existence of a variety of techniques, with precious few people willing to stick their neck out to help potential buyers decide what to do. Decisions about which is best are, we are told, being left to the market place (a little unfair to UD-4, not yet available in Europe), so it is not surprising that more manufacturers are including facilities for all current systems into equipment.

This coexistence could possibly be taken to imply that no one system is sufficiently outstanding over the others and therefore enthusiasts, at least, might be tempted into thinking that an ultimate technique has yet to arrive. Such an attitude is no doubt reinforced by the fact that some important record companies remain uncommitted to any of the proposals made so far.

Then there is the relative lack of “software”, even though new releases continue to be announced through 1974, which might be taken to indicate a less than whole-hearted conviction on the part of record companies.

As well, there is the difficulty in making value-judgements about how much the extra whatever-it-is you get over ordinary stereo is worth in terms of cash.

The caution is perhaps exemplified by the rapidly expanding range of speaker matrix boxes, whose virtue is that they require only a conventional stereo amplifier, the signals for additional rear speakers being derived *after* the power amplifier. They rely largely on antiphase signals being fed to the rear speakers and, because they do not contain 90° phase difference circuits, will not give “solid” rear images.

Such boxes are available from Arnold Elec-

tronics, B & O, Beyer Dynamic, Dynaco, Eagle, Howland-West, Kai (brand name Palm), Neal, Pye, QED, and Scan-Dyna. In addition, many stereo amplifiers have terminals for connection to rear speakers and EMI market speakers in which matrixing is achieved by suitably wiring voice coil tapings. In general, these are less flexible than the boxes, with no independent control of rear levels or of degree of blend.

But there's no reason not to try out the various systems if you can afford it. If a system is eventually adopted that is not compatible with some existing decoders, adding a new decoder would not present undue difficulties. Whatever surround system is adopted it is almost certain that four amplifiers and four loudspeakers will be needed anyway. (Incidentally if you are starting from scratch make all four speakers identical.)

**CD-4 System.** Following hard on the heels of National's announcement of an integrated circuit demodulator for CD-4 records designed in conjunction with Lou Dorren's Quadracast Systems Inc (who are advocating a four-channel broadcast system), were the Victor Company of Japan with another i.c. made by Signetics. Designated CD4-392, two of these i.c.s are used on demodulator circuit boards, now available on an o.e.m. basis. Two boards are made, one for compact systems (TDM-18A) measuring 11 × 8cm and another (TDM-19A) for higher-quality systems. The i.c. includes a limiter, phase-locked loop demodulator, automatic noise reduction circuits, voltage regulator and matrix circuit.

Unlike earlier discrete-component demodulators it has automatic carrier level adjustment to cater for the various pickup cartridges. Suitable cartridges are now available from a number of makers, including ADC, Audio Technica, Empire, National, Ortofon, Pickering, Micro Seiki, Toshiba, Jelco, Excel, Grace, Grado, Elac

and Stanton. No bad thing as many of the early ones didn't show up well on tracking tests.

The i.c. works from a 12-V supply, gives a gain of 22dB and is claimed to give low distortion (0.05 per cent but measurement conditions are not clear) and good signal-to-noise ratio for the carrier channels (70dB for 6kHz deviation and 20mV input).

Victor Company say that CD-4 demodulators based on this i.c. will be simpler and cheaper than matrix decoders for other systems. By the time 1974 is out quite a few European makers will be using CD-4 demodulators.

**QS System.** Sansui now have Variomatrix circuits in integrated form—made by, and available from, Hitachi—and should be announcing some European licensees through 1974. (M. Ishikawa manager of Sansui's new London showroom, announced that another two record labels have recently bought Sansui encoders.)

There are three i.c.s; two (HA1327, HD3103P) would be used in "middle" market equipment providing around -12 or -14dB crosstalk capability, and four for -20dB capability (HA1328, HD3103P and two HA1327). Using them a decoder can be built for £5 and components reduced by a half.

The Variomatrix technique relies on what Sansui call directional masking. According to Sansui, masking of directionality can occur when sounds come from different directions. "Backward" direction masking can occur with level differences of 10 to 20dB, and "forward" direction masking can occur with no level differences—within certain constraints, which



*Signetics/JVC CD-4 demodulator chip features automatic carrier level adjustment to cater for various pickups.*

include a limit on time of arrival differences of 10ms. The technique takes advantage of this in detecting in which direction sound is dominant in the encoded signals and reduces crosstalk "leakage" for this direction, increasing crosstalk of lower-level sounds in such a way that overall energy is constant. It has the property that it can be applied to four-speaker playback of ordinary programme material, as well as to SQ records. The method can be applied on a bandwidth-split basis too, as it is in the Sansui professional encoder/decoder.

**SQ System.** This yearbook went to press before full details of the latest refinements to decoders for the SQ system were available, but Tate, who make SQ decoders in the UK, are claiming all-round -35dB crosstalk for their latest

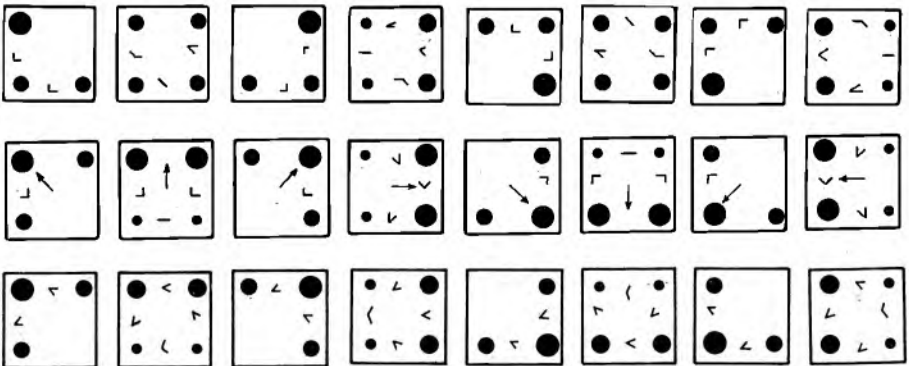

*Phase and amplitude outputs in three commercial two-channel matrix systems for eight source positions. Top SQ; middle QS; bottom BMX, used on UD-4 system.*

development! CBS have announced that Fairchild are making i.cs as well as Sony and Motorola.

CBS and Ben Bauer now have a separate US patent covering the SQ system; evidently the Scheiber matrix patent has not been interpreted as covering systems involving 90° phase difference circuits.

**UD-4 System.** The fourth major system—UMX, invented by Duane Cooper of the University of Illinois and developed by Takeo Shiga of Nippon Columbia—has been launched in Japan in its UD-4 format (previously known under its other name of QMX).

This is a phasor system, independently thought of by Michael Gerzon and Peter Fellgett, in which information is encoded by giving signals a phase shift equal to the “source” direction. In UD-4 records the baseband channels have surround-sound encodings (BMX) and FM carrier channels can be optionally demodulated to provide a “discrete” effect. The additional (carrier) channels are band-limited, made possible because of the way the phase-encoded directional information is derived—making life easier for the cartridge, as top frequency is 40kHz as opposed to 45kHz for CD-4, and giving a better signal-to-noise ratio, with the result that a noise reduction system, as used in CD-4, becomes unnecessary.

While any four-channel (so-called discrete) system could have its baseband channels encoded to a two-channel surround system, UD-4 is unique in actually doing this. It thus gives the user the option of whether to use the carrier channels. The baseband encoding is claimed to be superior to the other two-channel formats, one feature being that phase differences between channels is in lots of 45° (see **Figure**).

As well as being compatible with stereo players, UD-4 records will play in mono without any directional anomalies (important for broadcasters), a feature that neither SQ nor QS can claim.

# Recent tapes and discs: A personal selection

by Donald Aldous

A compilation of this kind, like a preferred choice of books, must be arbitrary and personal. However, this individual judgement is based on a lot of listening to the ‘good sound’, and so whilst the choice of performances may not be definitive or please every purchaser, the technical quality is never unworthy of the best reproducing equipment.

To get this sound picture into perspective, it might be useful to recognize the growth of packaged tape media in recent years. Certainly, compact cassettes and the hardware for playing them have made significant strides forward in technical quality in the past couple of years. So far as repertoire available in the UK is concerned, more than 9·8 millions of pre-recorded cassettes were sold in 1973, and slightly less than 5·75 millions cartridges—a not unimpressive collection of software.

The trend towards cassettes as against tape cartridges remains fairly stable, with perhaps a slight drop off in cartridge sales. Apart from special cassette/cartridge centres springing up around the country, pre-recorded Musicassettes have been better handled in good record and hi-fi stores for some time, compared with the marketing of cartridges through outlets in garages and the motor trade, which has been under stress in the last six months or so.

However, it seems likely that both packaged tape formats will co-exist for a long time, with the Dolby treated cassettes played on the best Dolby cassette machines representing a serious challenge to the disc medium, when every link is set up to the optimum. This might be a good moment to offer a few pet points of mine about the pre-recorded cassette format, rather than commenting on the technique and problems of

copying, at high quality, master tapes to cassettes in quantity.

For instance, the presentation and information provided with most cassettes is inadequate and does not compare with that offered on good disc sleeves. Odd changeover points on Q8 cartridges are well known, and even ill-timed break points on cassettes can be annoying. Decca are to be congratulated for listing run-off times at playback speed when the cassette has unrecorded tape ends. Finally referring to technical criticisms, one can mention the occasional reversal of channels and tape distortion, particularly the effects of tape saturation. The annoying 'drop-out' effect at the beginning and end of many pre-recorded cassettes could be avoided by having about 10 or 15 seconds blank tape at the start and finish of each cassette, thus avoiding fold-over snags on the first and last revolutions of the spindle. This wear factor resembles the scratches and dirt that can be seen at the end of a cinema film reel, just before changeover.

#### Tapes (Cassettes)

Lovers of Verdi operas will find the overall quality, balance and dynamics of two DG sets highly acceptable: *La Traviata*, with soloists, La Scala Milan Chorus and Orchestra, under Antonio Votto, on DG 3371004, and *Rigoletto*, with soloists, La Scala Milan Chorus and Orchestra, conducted by Rafael Kubelik (DG 3371001). These sets of three cassettes are packaged in a flat cardboard container, and the *Traviata* set is Dolby B processed, but *Rigoletto* is non-Dolby, with consequent higher hiss level.

The Bruch and Mendelssohn Violin Concertos (Op.26 and 64 respectively) on a Supraphon cassette 045546 first appeared on disc about eight years ago, well performed by Josef Suk. This Dolby treated version is very pleasing.

Decca KSXC6136 is a Dolby version of Kodaly's *Hary Janos* Suite, with two arias as a fill-up. Kertesz conducts the LSO on this exciting tape. A spacious transfer of Weber's *Der Freischutz* (Leipzig Radio Chorus, Dresden State Orchestra, under Carlos Kleiber) on another DG three cassette set, DG3371008, is another winner.

G. & S. admirers will want to possess Decca KSKC158-59 two cassette package of *The Mikado*, superbly presented by the RPO, under Royston Nash. It has distortion-free quality and low noise level. HMV issued an excellent Dolby

transfer of the *Cello Concertos* by Shostakovich and Walton, played by the distinguished French cellist Paul Tortelier, on TC.ASD2924, with his customary conviction and brilliance.

Of considerable technical interest is the Decca cassette of the great contralto Kathleen Ferrier (KSDC286). Although recorded back in 1952 in mono, this programme of Bach and Handel arias, with Miss Ferrier supported by the LPO, with Boult, appears in a stereo version. No, not electronically processed stereo, but a new recording in full stereo by the orchestra, conductor, etc. of accompaniments to back the voice re-recording from the original tape. Miss Ferrier died, of course, in 1953.

In the light music and 'pop' areas, the catalogues are so large and growing monthly that no one reviewer can have heard all the material, but I liked the A & M. Dolby cassette ZCAM 63527 of the music of Burt Bacharach, also available on cartridge Y8AM63527. As a buying guide, Decca's best sellers for ten full price 'pop' tapes were—a few months ago—two Gilbert O'Sullivan cassettes of his songs, KMAMC502 and 505; two Rolling Stones tapes, *Through the Past Darkly* and *Big Hits (High Tide and Green Grass)*, KSKC5019 and KTXC101; a couple of Mantovani's cassettes of his *Golden Hits*, etc. KSKC4818 and KSKC5172, are among the top cassettes, plus another Mantovani of *Music from the Films*, KSKC4014; the Moody Blues' versions of *Days of Future Passed* (KSCM707) and *Seventh Sojourn*





(KTHC7), with Tom Jones's *Greatest Hits*, KSKC5176 completing the list.

Finally, as an index to this expanding 'packaged tape' market, a check of the latest cassette/cartridge issuing companies produced a total of 25 firms in the UK, many of whom releasing a series of tapes of differing lengths and types and over a wide range of prices. So if you seek a particular composition or performer, the brand names outside the familiar CBS, Decca, EMI, Liberty, Pickwick, Polydor, Philips, Precision, RCA and Rediffusion, should be consulted at your local specialist supplier. Alas, technical quality will be found to be variable, and so reviews in the magazines will have to be studied, as few dealers will permit the time and trouble of a demonstration.

### Discs

The long familiar gramophone record repertoire is vast and many superlative discs are in the catalogues. For example, Neville Marriner, and the Academy of St Martin-in-the-Fields, have a number of issues of exceptionally high standard to their credit. Arzo ZRG657 of Bartok's *Music for Strings, Percussion and Celeste* can be highly commended.

Arthur Grumiaux's performance of Brahms' *Violin Concerto in D Major*, op. 77, is outstanding and reflects great credit on the Philips' technicians. The soloist is accompanied by the NPO under Colin Davis (Ph6500 299).

Getting away for once from the big name pianists, I have been greatly impressed with Robert Szidon playing some Liszt piano music (*Hungarian Rhapsodies* 1 to 19, and *Spanish Rhapsody*) on Deutsche Grammophon 2720 072 (3). A titanic performance, superbly engineered. Daniel Adni plays *Favourite Chopin* on HMV. HQS 1251 is a well balanced recording and will test your equipment. The recording level is low, introducing some hiss, but clean. Another HMV pianoforte record of note is HQS1290, on which Ronald Smith interprets in his own fashion some neglected Chopin piano music.

Rightly described by some critics as a profound musical experience, Decca's SET550-4 of Wagner's *Parsifal* has a superlative recording quality to match. Of course, this boxed set includes a handsome booklet and libretto. With the current upsurge of interest in Mahler's life and work, much of his greatest output is preserved on records. One outstanding issue is the two-set HMV.SLS785 of Janet Baker singing



his *Five Ruckert Songs*, and a stirring performance of the *Fifth Symphony*, by the New Philharmonia Orchestra, under Barbirolli.

Although the 'King of Instruments' is not universally liked by music-lovers, I find the sound of baroque and other rare organs fascinating. One recent issue can be specially recommended; Marie-Claire Alain's playing of Guilan's *Magnificats* on the organ of St Christopher's Basilica at Belfort in France. Erato EDO254.

Sherrill Milnes's recital disc of scenes from Italian opera is most impressive, Decca SXL 6609, with the lusty support of the Wandsworth School Boys' Choir, the Ambrosian Opera Chorus, and the LPO, under Silvio Varviso. Margaret Price sings *Mozart Opera Arias* on RCA.SER 5675 with sensitivity and a rich cantabile tone. The English Chamber Orchestra is conducted by James Lockhart.

Given an exemplary sound, John McCabe's *Notturmi ed Alba* and *Symphony No. 2* is a smooth, demonstration standard recording on HMV.ASD2904, performed by the City of Birmingham Orchestra, under Louis Fremaux. Colin Davis conducts an admirable performance of Berlioz's *La Damnation de Faust* on Philips 6500.649-651, with Gedda and Veasey and Bastin as the principal singers, supported by the LSO. Debussy's *Pelleas et Melisande* is enshrined on a three record CBS set, 77324 and captures this opera record magnificently. Boulez conducts the Chorus and Orchestra of the Royal Opera House, Covent Garden.

The spectacular sound of Decca's Phase 4

recordings is not to everyone's aural tastes, but it certainly can be impressive and startling on occasion. A recent issue includes some rare pieces of baroque brass music by such composers as Scheidt, Pezel, Bach, Bull and Locke. The performers are the London Festival Brass Ensemble, directed by Elgar Howarth and Alan Civil, playing with panache. Phase Four PFS 4290. If the Spanish guitar is your instrument, try John Williams' favourites on CBS72950. You will not be disappointed with this selection.

Coming now to the 'popular' field, Walter Carlos' score for the film *Clockwork Orange* on CBS73059 is a powerful piece of electronically produced sound, and must be judged as such, as no natural 'live' sound can be used for reference. One of the world's biggest sellers in the 'pop' world has been Simon and Garfunkel's *Bridge over Troubled Water*. Some 10 million copies were pressed, and I think it still combines exceptional musical and technical attributes, CBS63699.

Sheffield Records (PO. Box 5332, Santa Barbara, California 93108, USA) is a small company engaged in direct-to-disc recording, that is, 'live' cutting to the master lacquer, thus avoiding any losses in the tape interface. Two LPs, called *The Missing Link*, from the arranger Lincoln Mayorga, have been released so far in America, and a few copies were imported into this country, at a price. The music ranges from Chopin *Preludes* to Burt Bacharach and *Limehouse Blues*. Another incomparable Burt Bacharach album is on A&M, AMLS938, entitled *Make it Easy on Yourself*. Full of pleasing musical sounds, the instrumentation includes flugelhorn and ocarinas.

As a longtime collector of recorded humour and curiosia, in closing, I must include a couple of examples of this difficult genre to store in permanent form: for me the 1961 Parlophone PMC1145 mono LP of the revue *Beyond the Fringe* is an unbeatable classic, but this can hardly be termed of recent origin. However, I cannot refrain from including Flanders and Swann's second Parlophone LP, PCS3052, *At the Drop of Another Hat* and the incomparable Joyce Grenfell's *Joyce*, on Columbia SCX6362.

# Tangling with tape

by V. H. Prior

Magnetic tape has become one of the most important recording materials for domestic audio, ever since Philips first introduced the cassette recorder eleven years ago. If I feel sure that they did not, for many years, know exactly what future the cassette had in store. At that time it was designed solely for popular entertainment as it was a mono machine and all the pre-recorded cassettes were produced in a mono format only.

However, as we all know, things have changed considerably since then and there is a plethora of cassette recorders available on the British market, many of which are described, in specification form in this book.

This article is intended as a short guide to buying a tape or a cassette recorder and also to offer some assistance in the decision of whether to go for a reel-to-reel machine, or a cassette or, for that matter a cartridge machine. Perhaps I can best start by attempting to describe the principal functions of these various types and then go on to provide more detailed information on their potential.

## Music or Recording?

The first stage of the choice is really a very simple one, since it is determined largely by the use you intend putting your machine to. For instance, the cassette recorder has technical limitations which make its ability to produce the highest of quality recordings somewhat doubtful. On the other hand, the reel-to-reel machine has such a potential, but unfortunately does not always achieve it. Cartridge machines are rarely made with a recording function, although again, a few of them are to be found described in the pages of this book. The real and very big advantage of the cassette recorder, apart from its small size, is that there is a wealth of recorded material available in any record shop, and a good many other places, making this medium almost as good as a record player. In fact, for many people, this is exactly what the cassette

recorder has become. Precisely for this reason, the record companies have now started issuing all of the important pop and popular records on cassette and record at the same time.

There has been speculation from time to time as to whether the cassette recorder will ever overtake the record player and the sale of cassettes exceed that of disc. This depends in some measure on the recorded quality of the cassette versus that of the disc and although the disc can, on technical merits, beat the cassette every time, the standard of discs arriving in the record shops still leaves an awful lot to be desired. It is this which could well sound the death knell for the record, since with the cassette, once the production master has been made and the duplicating machinery loaded and adjusted, the quality should be uniform throughout the production run.

When high quality cassette recorders first appeared, they seemed to earn themselves a bad name since the cassettes often jammed or were reduced to a nasty, tangled mess of tape. There were many reasons for this, some attributable to the machine and some to the cassette. However, as in most new products, there was a rapid turn in the learning curve of the principal manufacturers and these days, there is no real excuse for this sort of thing to happen. If it does, and I do know of some instances, then it is almost always due to the cassette and not the machine—if the machine is a new one. Unfortunately, the white box tape of a number of years ago has become the cheap offer “unknown-brand” named cassette of the seventies. However, I digress a little. The choice of machine type therefore depends upon its eventual use. The reel-to-reel machine is principally useful as a *recording* machine, whereas the cassette machine is best as a source of home entertainment, playing pre-recorded cassettes or making recordings of limited quality from such sources as the radio. The cartridge is one on its own, since it is an American invention which started and developed primarily as a vehicle for in-car entertainment. In America it has undoubted popularity for this purpose and the sales of cartridges far outstrip that of cassettes. Some machines have also been developed for use in the home, on the basis that the cartridges bought for use in the car can also be used for home entertainment. However, in Europe, the strength of the Philips organisation has told, and the cassette machine is more popular for use both in the car and in the home.

What perhaps, is more important from our point of view, is that the cassette and the cassette recorder have been developed to a much more refined state than the cartridge and despite the starting disadvantage of low tape speed and narrow tracks, it tends to produce a better performance, at least in the upper end of the market. In the UK the cartridge machine seems to be almost exclusively used by car owners who have a player in the car and have bought a mains machine for use in the home as well. It is nowhere as popular as cassettes and although there are a few machines capable of making recordings, these can almost be numbered on the fingers of one hand.

Because of the popularity of cassette recorders, one might have expected a decline in the sales of reel-to-reel machines and this is indeed the case. There are now fewer mid-price machines on the market and there seems to be a polarization towards the very much more expensive machine that attains almost professional standards. Examples of such machines are the Revox and the Teac machines, both of which take large reel sizes and are available in versions that operate at the professional tape speed of 38cm/s. Since there are no professional produced pre-recorded reel-to-reel tapes available in the UK, these machines are really intended for the serious recordist rather than for the occasional recording made from the radio.

Summarising then, the reel-to-reel machine is best bought by those who also intend buying microphones and doing serious recordings, the cassette recorder by those who need a source of home entertainment that also has a recording facility, and the cartridge machine by those who already have one in the car and want to play their favourite cartridge recordings via their hi-fi systems.

#### **Choosing on the basis of technical data**

As in almost any other part of the hi-fi system, choosing the recorder of your dreams using just data sheets and performance figures, can be a hazardous experience. For a start, the technical terminology is enough to put one off for life! So, here is a brief guide to help you over this hurdle.

Wow and flutter is almost always quoted as one of the parameters describing quality of performance. It is a number which tells you how good the machine is at maintaining a constant speed. Wow is best described as being a low speed variation producing a sort of tremulo

effect to the recordings being played back. Flutter is, as one would suspect from the name, a much faster cyclic variation in speed and produces a sort of vibrato effect to the recording. These are clearly very objectionable characteristics and the measurements should show low figures for a machine to prove satisfactory. There are several ways of measuring wow and flutter, the two most popular being based on American and DIN standards. The first of these can be readily recognised since the figure will be expressed just as a percentage, sometimes accompanied by the abbreviation WRMS (Weighted Root Mean Square). A good figure to be obtained is about 0.08% WRMS for reel-to-reel machines and 0.1% WRMS for cassette machines of medium price. If the DIN standard has been used, the figures are usually described as being plus or minus a certain number and are often accompanied by the letters DIN. Good figures for a reel-to-reel machine are about  $\pm 0.18\%$  DIN or for a cassette about  $\pm 0.2\%$  DIN. Obviously in the better machines, better figures are obtained, but any worse than these cannot be tolerated if the machine is to have any pretensions to being hi-fi.

A parameter that seems to be regarded with great importance, is frequency response. It is also one of the most meaningless of the figures quoted—particularly when referring to cassette recorders. A good frequency response for a cassette recorder is about 50Hz to 13kHz using standard tape and about 14kHz using the high performance or Chromium dioxide tapes. Although better performances are claimed by many machine manufacturers this is often obtained at the expense of distortion. In reel-to-reel machines, a better performance should be obtained at the higher speeds, since the response is dependent upon the speed of the tape. One most important qualification in quoting frequency response is the cut off points. Here in the UK we are accustomed to quote the cut off as being  $-3\text{dB}$ , but since it is possible that the response of a recorder could have some bumps in it, a better qualification would be  $\pm 3\text{dB}$  which defines an envelope of tolerance about the mean level. The DIN method is slightly different, since it defines an envelope of tolerance of  $\pm 1.5\text{dB}$  in the mid band and  $+1.5, -3.5\text{dB}$  at the extremes of the frequency range. One should, therefore, look for either of these two qualifications when using frequency response as a basis for selection and at least be a little

suspicious where this is left out.

Signal-to-noise ratio is also a bit arbitrary and most machines tend, anyway to produce figures that are much of a muchness. There is no doubt that for four track stereo reel-to-reel machines and cassette recorders, the addition of a good noise reduction system such as the Dolby B, produces a distinct advantage. However, this is not a golden rule and should depend upon the standards of the rest of your audio equipment. In general, for the lower priced audio system, the Philips DNL noise reduction system represents a quite satisfactory compromise, but if the very best standards of performance are sought, the Dolby is a must.

There are a host of other parameters which are used from time to time by manufacturers and each of them describe some aspect of performance. Nevertheless, those mentioned so far can be regarded as being the first line to examine. One word of caution, the machine recording performance is dictated, to a large degree by the tape that is used. Some manufacturers make a point of specifying the brand and type of tape to be used on their machine and the advice is certainly worth following.

Since these notes represent a very brief introduction to the pitfalls of selecting tape recorders I can only emphasise that it is well worth studying reviews and articles in some of the hi-fi magazines before committing yourself. Shopping around can also pay and now that the interests of the consumer are so well looked after by the new Trading Acts that have appeared in recent years, even the much maligned discount warehouse has something to offer.

Before leaving that point, I should mention that manufacturers have been developing a policy of marketing that takes into account the problems of competition between discounters and the smaller, specialist dealer. The latter has much to offer in the way of advice, demonstration facilities and the like, and this is recognised by many of the big manufacturing companies who now are marketing some of their models both through discounters and dealers, but reserving some of their best models for the dealers alone. This may explain why some makes or models do not appear in the lists of the discount warehouses.

In conclusion, there has been an explosion of interest in magnetic tape machines and I feel sure that this will continue and that standards will continue to rise.

# Abbreviations

A	- - ampere	m	- - metres	VAT	- - Value added tax
A-B	- - comparison test	M	- - megohms (millions of ohms)	VHF	- - very high frequency (VHF radio approx 88-108MHz, VHF TV approx 174-216MHz)
AC	- - alternating current	mA	- - milliamps (0001A)	V	- - volts or voltage
AFC	- - automatic frequency control	mag	- - magnetic	VA	- - volt/ampere
AGC	- - automatic gain control	ME	- - magic eye	vci	- - voice coil impedance
AM	- - amplitude modulation	MC	- - moving coil	VU	- - volume units
ASA	- - Acoustical Society of America	mg	- - milligram		
aux	- - auxiliary	MHz	- - megahertz (see Hz)		
		mic	- - microphone		
BAF	- - bonded acetate fibre	MOS	- - metal oxide semiconductor		
		mpx	- - multiplex	W	- - watts
CCIR	- - International Radio Consultative Committee	mV	- - millivolts (0001V)	W and F	- - wow and flutter
char	- - characteristic	MW	- - medium waves (approx 185-570m)		
cm	- - centimetre			xll	- - crystal (pickup or microphone)
c/o	- - cut-off frequency	N	- - newton (SI unit of force).		
coax	- - coaxial	NAB	- - National Association of Broadcasters (see also NARTB)	Z	- - impedance
		NARTB	- - National Association of Radio and Television Broadcasters (USA)		
dB	- - decibel	NL	- - noise level	<b>Miscellaneous</b>	
dBm	- - decibel/milli watt	Pat	- - power available for tuner	%	- - per cent
DC	- - direct current	pF	- - picofarad ( $10^{-12}$ farad)	>	- - greater than
deg	- - degrees	PPM	- - peak programme meter	>=	- - less than
det	- - detector	PSn	- - power supply needed	±	- - plus or minus
DIN	- - Deutscher Industrie Normen (German audio standards)	PU	- - pickup cartridge	≅	- - equal to or greater than
disc	- - discriminator	Pw	- - playing weight	≅	- - equal to or less than
		Q	- - Q-factor (quality of tuned circuit)	μ	- - mu (micro or millionth)
FET	- - field effect transistor			μA	- - microamp
fss	- - full frequency stereo sound (Decca)	rcf	- - recommended crossover frequency	μV	- - microvolt
fl oz	- - fluid oz	rec load	- - recommended load	μBar	- - microbar (air pressure equal to 1 dyne/cm <sup>2</sup> )
FM	- - frequency modulation	Replay			
FR	- - frequency response	char	- - replay characteristic		
		RIAA	- - Record Industry Association of America		
gm	- - gramme	RMS	- - root mean square (0.707 peak value of AC)		
HC	- - handling capacity	rpm	- - revolutions per minute		
HD	- - harmonic distortion	sec	- - second (time)		
HF	- - high frequency	sel	- - selector switch		
H & N	- - hum and noise	S/N	- - signal-to-noise ratio		
Hz	- - hertz (cycles per second)	SW	- - short waves (approx 10-60m)		
IC	- - integrated circuit	THD	- - total harmonic distortion		
IEC	- - International Electro-technical Commission	thou	- - thousandths of an inch (0.001 in)		
IF	- - intermediate frequency	tpi	- - turns per inch (screw threads)		
IHF	- - Institute of High Fidelity (USA)				
imp	- - impedance	UHF	- - ultra high frequency (approx 470-854MHz)		
in	- - inches				
ind	- - inductor				
i/s	- - inches per second				
K	- - kilohms (thousands of ohms)				
kHz	- - kilohertz (see Hz)				
lb	- - pound (weight)				
L/C	- - inductance/capacitance				
LP	- - long play (records or tape)				
LW	- - long waves (approx 1100-2000m)				

# The three stages of man.

Remember the faithful old record player? At some time in their lives most people have owned one.

In the days when 'mono' meant everything, and singles cost 6/8d - record players were the next best thing to a juke box.

That was ten years ago.

Now 'mono' is almost a forgotten word. Music has changed - and so has the sound.

Today we call it stereo. In effect this means two perfectly balanced channels of sound, as opposed to one.

Of course there are 101 different ways of achieving this. Most people choose the easiest, when it comes to price. Which is why hundred quid hi-fi systems sell like hot cakes.

But even though the price is appealing, these systems do have their disadvantages. Anyone who's particular about stereo will spot them.

They are quite simply the facilities - or lack of them.

If you're after more than just a standard amp, turntable and speakers, the graduation from record player to mid-range audio units just isn't enough.

Which is why Trio systems are designed to take you one stage further.

Trio offer all the power and facilities you could ever want for. At prices that won't break the bank. Because with as many as 13 different hi-fi systems (including two quadraphonic) to choose from - it's up to you how much you spend.

If you're after a massive output, and scores of professional features like - noise filters, muting switches, a four channel decoder, and eight different out-connectors, plus a perfect VHF tuner section, turntable, and four drive unit monitor speakers - Trio can fit the bill, though we have to admit it's not going to be peanuts.

On the other hand Trio still offer a wide range of specialist facilities in their much lower priced systems too:

Taken by and large, Trio equipment does cost a little more than your average hi-fi.

But then Trio doesn't make average hi-fi. They make it second to none.

Which might explain why Trio are proud to be third, in the three stages of man.

Maybe it's time you found out what you've been missing. Fill in the coupon and we'll send you a full colour brochure with all the details of Trio hi-fi.

## Trio-Hear the sound not the system.

I'm interested. Please send me the new Trio brochure with full details on Trio systems.  
B. H. Morris & Co. (Radio) Ltd.  
Trio House, The Hyde, London NW9 6JP.

Name \_\_\_\_\_

Address \_\_\_\_\_

\_\_\_\_\_

\_\_\_\_\_



 **TRIO**

# Again and again and again

Given the time, the patience, and the money, one can connect\* fifty 303 amplifiers nose to tail so that the programme goes through one after the other gradually deteriorating along the way.

Deteriorating? The fact is, that apart from a very slight background hiss - akin to a good tape recording - the programme will sound exactly

the same at the end as when it started.

\*Of course one must fit an attenuator to reduce the signal back to its original level between each amplifier.

Send postcard for illustrated leaflet to Dept. HN Acoustical Manufacturing Co. Ltd., Huntingdon PE18 7DB. Telephone (0480) 52561.

## QUAD

Products of The Acoustical Manufacturing Co. Ltd.  
for the closest approach to the original sound

QUAD is a Registered Trade Mark



# Directory of Amplifiers and Control Units

★ Indicates entry is illustrated

Abbreviations used in this section are given on page 20.

## ■ ACOUSTICAL MANUFACTURING See Quad.

## ■ ADASTRA

Adastra Electronics Ltd, Unit N22, Cricklewood Trading Estate, Claremont Road, London, NW2 1TU. Tel: 01-452 6288.

### H67/61320

Headphone amplifier. Output: sufficient to drive two pairs of stereo headphones, 8-16 ohms impedance. Inputs: phono 5mV, radio, 100mV. Wood cased, free standing. Power supply, one 9V battery. Price: £14.40 (including VAT).

## ■ AKAI

Rank Audio Visual Ltd, PO Box 70, Great West Road, Brentford, Middlesex, TW8 9HR. Tel: 01-568 9222.

### AA5200

Integrated stereo amplifier. Inputs: mag PU 3mV, aux 150mV, line 775mV, tape 150mV. Output: 20W RMS per channel into 8 ohms. HD: <0.1% at 10W. FR: 20Hz-50kHz -3dB. H and N: (PU input) -65dB, (other inputs) -70dB. Tone controls: ±10dB at 100Hz, treble ±10dB at 10kHz, loudness +7dB at 100Hz ±4dB at 10kHz, high filter -7dB at 10kHz, low filter -12dB at 50Hz. 15 transistors, four ICs, 8 diodes. Mains: 100-240V 50-60Hz. Size: 17¼ × 5¾ × 13¼in. Weight: 19.8lb. Price: £104.90 (including VAT).

### AA5500 ★

Integrated stereo amplifier. Inputs: mag PU 3mV, aux 150mV, line 775mV, tape 150mV, mic 3mV. Output: 30W RMS per channel into 8 ohms. HD: <0.05% at 20W. FR: 20Hz-50kHz -3dB. H and N: (mag PU) -65dB, (other inputs) -80dB. Tone controls: bass ±10dB at 100Hz, treble ±10dB at 10kHz, loudness +7dB at 100Hz +4dB at 10kHz, high filter -7dB at 10kHz, low filter -12dB at 50Hz, 19 transistors, 10 diodes, five ICs. Mains: 100-240V 50-60Hz.

Size: 17¼ × 5¾ × 13¼in. Weight: 21¾lb. Price: £136.50 (including VAT).

### AA5800 ★

Integrated stereo amplifier. Inputs: mag PU 3mV, aux 150mV, line 775mV, tape 180mV, mic 3mV. Output: 45W RMS per channel into 8 ohms. HD: <0.05% at 20W. FR: 10Hz-50kHz -3dB. H and N: (PU input) -65dB, (other inputs) -80dB. Tone controls: bass ±10dB at 100Hz, treble ±10dB at 10kHz, loudness +7dB at 100Hz +4dB at 10kHz, high filter -7dB at 100Hz, low filter -12dB at 50Hz. 42 transistors, two ICs, 10 diodes. Mains: 100-240V AC. Size: 17¼ × 5¾ × 13¼in. Weight: 25¼lb. Price: £199.50 (including VAT).

## ■ ALBA (RADIO & TELEVISION) LTD

Bull Lane, Edmonton, London, N18 1RA. Tel: 01-803 4451.

### UA700 ★

Integrated stereo amplifier. Inputs: mic 2.3mV 50K, aux (1) 2V 3M, aux (2) 375mV at 500K, radio 100mV 150K, magnetic PU 5mV 50K, ceramic PU 60mV. Controls: volume, bass ±15dB at 60Hz, treble ±15dB at 14kHz, loud-



Akai AA5500



Akai AA5800



Alba UA700



★ Indicates entry is illustrated

ness, balance, input selector pushbuttons. Output: 15W per channel (20W per channel IHF rating). HD: <0.1% up to rated output. FR: 30Hz-18kHz  $\pm$  1dB. Noise level: (magnetic PU) -55dB (aux and radio) -63dB. Crosstalk: better than -38dB. Output impedance: 8.15 ohms. AC mains 240V 50-60Hz. Size: 16 $\frac{1}{2}$   $\times$  4  $\times$  7 $\frac{3}{8}$ in. Finish: teak end pieces, black leathercloth top and brushed aluminium front panel. Price: £49.53 (including VAT).

#### UA900

Stereo integrated amplifier. Inputs: phono 2.7mV 47K, tuner, tape, quad adaptor 150mV/1M ohm. S/N: phono 77dB, all others 82dB referred to full power. Output: 40W/channel into 4 ohms. Damping factor better than 200 at 50Hz. THD: 0.02% at 1kHz at 40W. FR: 20Hz-20kHz at 40W. Mains: 110V, 127V, 220V, 240V. Size: 18  $\times$  4  $\times$  9 $\frac{1}{2}$ in. Price: to be announced.

#### ■ ALPHA

Highgate Acoustics, 38 Jamestown Road, London, NW1 7EJ. Tel: 01 267 4937/8.

#### FA200 ★

Integrated stereo amplifier. 18 transistors. Inputs: mag PU 3mV 50K, crystal PU 250mV 1M, aux 200mV 22K, radio 200mV 22K, tape 200mV 22K. Noise level: (mag PU) 60dB, (other inputs) 70dB. Output: 10W RMS per channel. Output impedance: 8 ohms. Tone controls: bass slider +14dB -12dB at 50Hz, treble slider +12dB -14dB at 10kHz. HF filter switch -8dB at 10kHz. HD: <0.4% at 8W output. FR: 20Hz-25kHz  $\pm$  3dB. Finish: teak with brushed aluminium. Size: 13 $\frac{1}{2}$   $\times$  5  $\times$  9 $\frac{3}{4}$ in. Mains: 110, 240V AC. Price: £37.95 (including VAT).

#### FA300 ★

Integrated stereo amplifier. 18 transistors. Inputs: mag PU 3mV 50K, crystal PU 250mV 1M, aux 200mV 22K, radio 200mV 22K, tape 200mV 22K. Noise level: (mag PU) 60dB, (other inputs)

70dB. Output: 15W RMS per channel. Tone controls: bass slider +14dB -12dB at 50Hz, treble slider +12dB -14dB at 10kHz, loudness switch +12dB at 50Hz +3dB at 10kHz. HD: <0.5% at 12W. Output impedance: 8 ohms. FR: 20Hz-25kHz  $\pm$  3dB at 12W. Finish: teak and brushed aluminium. Size: 13 $\frac{3}{8}$   $\times$  5  $\times$  9 $\frac{3}{8}$ in. Mains: 110, 240V AC. Price: £46.75 (including VAT).

#### FA400 ★

Integrated stereo amplifier incorporating 17 transistors and two ICs. Inputs: mag PU 3mV 50K, crystal PU 250mV 1M, aux 200mV 22K, radio 200mV 22K, tape 200mV 22K. Noise level: (mag PU) 60dB, (other inputs) 70dB. Output: 20W RMS per channel. Output impedance: 8 ohms. Tone controls: bass slider +14dB -12dB at 50Hz, treble slider +12dB -14dB at 10kHz, loudness switch +12dB at 50Hz and +3dB at 10kHz. Low filter -10dB at 50Hz. High filter -12dB at 10kHz. HD: 0.5% at 15W. FR: 20Hz-30kHz  $\pm$  3dB at 15W. Finish: teak and brushed aluminium. Size: 14 $\frac{3}{8}$   $\times$  5  $\times$  9 $\frac{3}{8}$ in. Mains: 110, 240V AC. Price: £54.45 (including VAT).

#### Executive 0030

Integrated stereo amplifier. Inputs: mag PU 5mV 47K, radio 150mV 47K, tape 300mV 47K. Overload capability: 26dB on all inputs. Output: 15W RMS per channel. Output impedance: 8 ohms. Controls: volume, balance +6dB -infinity, bass  $\pm$  12dB at 50Hz, treble  $\pm$  12dB at 15kHz, scratch filter -8dB at 15kHz, loudness +8dB at 50Hz and +6dB at 15kHz. HD: better than 0.5% at full power, better than 0.1% at 75 per cent power. FR: 20Hz-20kHz  $\pm$  1dB. Size: 16 $\frac{3}{4}$   $\times$  6  $\times$  3 $\frac{1}{2}$ in. Finish: teak veneer. Output for tape recorder: 150mV 47K. Headphone socket: 1W into 8 ohms. Hum and noise: (mag PU) -60dB, (other inputs) -70dB. Mains: 110 or 240V 50-60Hz. Fully protected output circuits. Price: £46.75 (including VAT).



Alpha FA200

Alpha FA300

Alpha FA400



Amcron D60



Amcron IC-150

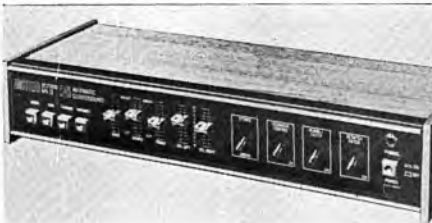

Amstrad IC2000 Mk II

**Executive 0050**

Integrated stereo amplifier. Specification and size identical to the 0030 except more powerful output stages. Output: 25W RMS per channel. Price: £54.45 (including VAT).

■ **AMCRON**

Macinnes Laboratories Ltd, Macinnes House, Carlton Park Industrial Estate, Saxmundham, Suffolk, IP17 2NL. Tel: Saxmundham (0728) 2262/2615.

**D60 ★**

Stereo power amplifier. Output: 62W RMS per channel into 4 ohms, 42W RMS per channel into 8 ohms, 100W RMS into 8 ohms mono. HD: <0.05%. Intermodulation distortion: <0.05% from 10mW to 30W. FR: 5Hz-30kHz±1dB at 30W. Damping factor: >200 from 0-1kHz. H and N: -106dB at 30W. Input: 0.775V for 30W into 8 ohms. Mains: 117, 234V 50Hz. Size: 17×8½×1¼in. Weight: 10lb. Fully protected against short circuit or mismatch. Outlet socket for headphones on front panel. Price: £140 (plus VAT).

**D150**

Stereo power amplifier. Output: 140W RMS per channel into 4 ohms, 100W RMS per channel into 8 ohms, 330W RMS into 8 ohms mono. HD: <0.05% at 75W. Intermodulation distortion: <0.05% from 10mW to 75W. FR: 5Hz-

20kHz±1dB at 75W. Damping factor: >200 from 0-1kHz. H and N: -110dB at 75W. Input: 1.19V for full output. Mains: 117, 234V 50Hz. Size: 17×5¼×9in. Weight: 22lb. Price: on application.

**DC300A**

Stereo power amplifier. Output: 500W RMS per channel into 2.5 ohms, 350W RMS per channel into 4 ohms, 200W RMS per channel into 8 ohms, 650W RMS into 8 ohms or 4 ohms mono. HD: <0.05% from 0-20kHz. Intermodulation distortion: <0.05% 10mW to 150W into 8 ohms. FR: DC to 20kHz±0.1dB. Damping factor: >200 from DC to 1kHz. H and N: -110dB at 150W. Input: 1.75V for 150W output. Mains: 117, 234V 50Hz. Size: 19×7×9¾in. Price: on application.

**IC-150 ★**

Stereo preamplifier and tone control unit incorporating IC circuitry. Inputs: 2 phono, 1 tuner, 2 aux, 2 tape. Output: rated 2.5V, max 10V into 600 ohms. H and N: 90dB below rated output. FR: high-level onto high impedance load, 3Hz-100kHz±0.6dB; into IHF load, 10Hz-20kHz±0.1dB. Volume, loudness, stereo panorama, bass and treble controls. Rumble and scratch filters. Mains: 120, 240V 50-400Hz AC. Size: 17×5¼×8½in. Price: £178 (plus VAT).

■ **AMSTRAD**

AMS Trading (Amstrad) Ltd, 89 Ridley Road, London, E8. Tel: 01-249 5237.

**8000 Mk III**

Stereo transistor amplifier. Inputs: magnetic PU 4mV 47K, ceramic PU 80mV, crystal PU 350mV, radio 100mV, tape 100mV. Noise level: -55dB on all inputs. Overload capability: 25dB on all inputs. Output: 8W RMS per channel. Controls: bass, treble, volume, scratch filter, mono/stereo. HD: 0.5% at 5W. Output impedance: 8 ohms. FR: 25Hz-20kHz±3dB. Mains: 220-240V 50 Hz. Size: 13×3×7in. Finish: teak cabinet with black trim. Price: £33 (including VAT).

**IC2000 Mk II ★**

Stereo amplifier incorporating integrated circuits. Inputs: magnetic PU 3mV 47K, ceramic PU 60mV, tape 100mV, radio 100mV. Noise level: magnetic PU -55dB, other inputs -60dB. Overload capability 33dB on all inputs. Output: 20W RMS per channel. Controls: volume, bass, middle treble, loudness, scratch filter, rumble filter, mono/stereo. HD: 0.5% at 18W. Output impedance: 8 ohms. FR: 20Hz-25kHz±3dB. Mains: 220-240V 50Hz. Size: 17×3×7in. Finish: teak cabinet with black facia and silver trim. Price: £60 (including VAT).

**Integra 4000 Mk II**

Integrated stereo amplifier. Two integrated cir-

★ Indicates entry is illustrated

cuits, 12 transistors and two diodes. Inputs: mag PU 2.5mV, ceramic PU velocity loaded, radio 50mV, tape 70mV. Noise level: (mag PU input) -54dB, (other inputs) -60dB. Overload capability: 30dB all inputs. Output: 15W RMS per channel. Controls: bass, treble, middle, scratch filter, rumble filter, loudness control, mono/stereo mode, Headphone input. HD: better than 0.5% at rated output. Output impedance: 8 ohms. FR: 20Hz-25kHz  $\pm$  2dB. Mains: 220-240V AC. Size: 13 $\frac{1}{4}$   $\times$  2 $\frac{3}{4}$   $\times$  9in. Finish: teak cabinet with brushed aluminium panel. Price: £47 (including VAT).

#### ■ A/R/D

Audio Research and Development Ltd,  
PO Box 73, Hounslow, Middlesex, TW3 1RD.  
Tel: 01-570 0471.

#### 2000 Series 2

Solid state stereo amplifier. Power output 15W RMS into 8 ohms. HD: 0.25% at 15W RMS. FR: 20Hz-20kHz  $\pm$  0.5dB. Controls: bass  $\pm$  12dB at 50Hz; treble  $\pm$  12dB at 10kHz; volume, balance. Pushbuttons for on/off, radio, tape, record. Inputs: PU socket with DIN duplicates for tape and radio: tape record, tape play, radio tuner, ceramic pickup, magnetic pickup, with RIAA equalisation. Psn: 190/225V 50Hz or 110-120V 60Hz. Dimensions: 7  $\times$  4 $\frac{1}{2}$   $\times$  12in. Price: (grey case) £54 (plus VAT); (teak veneered case) £58 (plus VAT).

#### ■ ARMSTRONG

Armstrong Audio Ltd Warlters Road,  
Holloway, London, N7 0RZ. Tel: 01-607 3213.

#### Model 621 ★

Integrated stereo amplifier. 24 transistors, 19 diodes. Inputs: mag PU 2.7mV and 10mV switchable 47K, tape 250mV 68K, radio 120mV 68K, aux 120mV 68K. Noise level: (all inputs) better than -65dB. Overload capability: (mag PU inputs) 70mV and 300mV, (tape input) 7V, (other inputs) 3V. Output: 40W RMS per channel into 8 ohms, 50W RMS per channel into 4 ohms. Controls: bass  $\pm$  15dB at 70Hz, treble  $\pm$  13dB at 14 kHz, electronic gate input selector, switches for two pairs of speakers, loudness, tape monitor, mono/stereo, two high filters and slope control, low filter. HD: < 0.08%. Output impedance: 4-16 ohms. FR: 25Hz-25kHz  $\pm$  1dB at 1W. Mains: 105-135V, 215-250V AC. Size: 12 $\frac{1}{2}$   $\times$  3 $\frac{1}{2}$   $\times$  11 $\frac{1}{4}$  in. Finish: zinc diecast front panel, case in teak or rosewood. All sockets DIN type. Outlet socket for AC mains. Price: £81.95 (including VAT).

#### ■ BANG & OLUFSEN UK LTD

Eastbrook Road, Gloucester, GL4 7DE.  
Tel: Gloucester (0452) 21591.



Armstrong 621



Bang & Olufsen Beolab 1700

#### Beolab 1700 ★

Integrated stereo amplifier with ambiophonic facility. Output: 20W RMS into 4 ohms. Distortion: < 0.5% at 20W. FR: 20Hz - 30kHz  $\pm$  1.5dB. S/N ratio: mag PU > 55dB, > 65dB other inputs. Inputs: magnetic PU 2.4mV 47K, tape 150mV 1M, tuner 150mV 350K. Controls: volume, bass, treble, balance, pushbuttons for sound sources, mono, loudness, speakers, ambio filter and power. Outputs: 4 ohms, headphones 100 ohms minimum. Mains: 110-130 and 220-240V AC 50-60Hz. Size: 19.7  $\times$  9.1  $\times$  2.9in. Finish: teak or rosewood. Price: (teak) £75.90 (including VAT); (rosewood) £76.90 (including VAT).

#### ■ BOSE

Acoustico Enterprises Ltd, Unit 7,  
Space Way, North Feltham Trading Estate,  
Feltham, Middlesex. Tel: 01-751 0141.

#### Power Amp

Stereo power-amplifier. Input: 1.5V > 50K. S/N: > 100dB ref 250W output. Output: 250W into 8 ohms, 400W into 4 ohms. Damping factor: 40. THD: 0.5% up to 5kHz, < 1% up to 10kHz at 250W. Mains: 240V AC. Size: 18  $\times$  7 $\frac{3}{8}$   $\times$  18 $\frac{1}{2}$  in. Price: £547.80 (including VAT).

#### ■ BRADMATIC LTD

338 Aldridge Road, Streetly, Sutton Coldfield,  
West Midlands. Tel: 021-353 3171.

Manufacturers of solid state mono and stereo power amplifiers. Enquiries welcomed and full details of service offered provided on request.

#### ■ BRAHMS

Brahms Manufacturing and Development Co,  
Unit E, Rochester Airport, Maidstone Road,  
Rochester, Kent, ME1 3QJ.  
Tel: Medway (0634) 48816.

**SA80U ★**

Integrated stereo amplifier. 18 transistors, 6 diodes. Inputs: mag PU 3.5mV, ceramic PU 65mV, tape 130mV, radio 60mV. Noise level: -54dB on PU inputs, -60dB on other inputs. Overload capability: (PU inputs) 26dB, (other inputs) 20dB. Output: 20W RMS per channel (both channels driven). Controls: volume, bass, treble, balance, scratch filter, rumble filter. HD: 0.2%. Output impedance: 8 ohms. FR: 30Hz-30kHz-2dB at full power. Mains: 230-250V AC. Size: 16 × 3½ × 7½ in. Finish: restyled low profile housing with brushed aluminium fascia and teak veneered sides. Price: £46.14 (including VAT).

**SA9100**

Stereo integrated amplifier. Inputs: phono (1) 2.5mV 50K, phono (2) 2.5mV 25K or 50K or 100K switched, mic 2mV 50K, tuner 150mV 100K Aux(1) 150mV 100K, Aux(2) 150mV 1V 50K, tape mon (1 & 2) 150mV 100K. S/N: phono (1 & 2) 80dB, mic 70dB All others 90dB; all referred to signal to produce full output. Output: 75W/channel into 8 ohms or 100W/channel into 4 ohms. Damping factor: 70 at 1kHz into 8 ohms. THD: at 1kHz, less than 0.4%. Mains inputs: 110V, 120V, 130V, 220V, 240V, switchable; 50 or 60Hz. Size: 16½ × 5¾ × 13¾ in. Price: on application.

**SA1800**

Stereo integrated amplifier. Inputs: phono (1) 2.5mV 50K, phono (2) 2.4-5mV 50K, mic 2mV 50K, tuner 150mV 100K, Aux (1) 150mV 100K, Aux (2) 150mV-15V 50K, tape (1 & 2) 150mV 100K. S/N: phono and mic 80dB, tuner 70dB, all others 90dB, referred to full output. Output: 50W/channel into 8 ohms, 60W/channel into 4 ohms at 1kHz. Damping factor: 60 at 1kHz into 8 ohms. THD: at 1kHz into 8 ohms 0.3%, FR: 10Hz-70kHz+0dB -1dB. Mains: 110V, 120V, 130V, 220V, 240V, 50 or 60Hz. Size: 16½ × 5¾ × 13¾ in. Price: on application.

**SA7100**

Stereo integrated amplifier. Inputs: phono (1 & 2) 2.5mV 50K, mic 2mV 50K, tuner 150mV 100K, aux (1 & 2) 150mV 100K, tape (1 & 2) 150mV 100K S/N: phono and mic 80dB, tuner 70dB, all others 90dB, referred to full output. Output: 25W/channel into 8 ohms, 36W/channel into 4 ohms. Damping factor: 40 at 1kHz into 8 ohms. THD: 0.5% at full power, 0.05% at half power. FR: 15Hz-30kHz+0dB -1dB Mains: 110V, 120V, 130V, 220V, 240V, 50 or 60Hz. Size: 16½ × 5¾ × 13¾ in. Price: on application.

**SA6200**

Stereo integrated amplifier. Inputs: phono (1 & 2) 2.5mV 50K, mic 7.5mV 50K, tuner 150mV 100K, aux (1 & 2) 150mV 100K, tape



Brahms SA80U

(1 & 2) 150mV 100K. S/N: phono and mic 80dB, tuner 70dB, all others 90dB, ref full output. Output: 22W/channel into 8 ohms, 27W/channel into 4 ohms. Damping factor: 30 at 1kHz into 8 ohms. THD: 0.5% at full power, 0.1% at half power. FR: 15Hz-30kHz ± 1dB. Mains: 110V, 120V, 130V, 220V, 240V, 50Hz or 60Hz. Size: 16½ × 5¾ × 12¾ in. Price: on application.

**SA500A**

Stereo integrated amplifier. Inputs: phono (1 & 2) 2.5mV 50K, tuner 200mV 100K, aux (1 & 2) 200mV 100K, tape (1 & 2) 200mV 100K. S/N: phono 80dB, tuner 70dB, all others 90dB, ref full output. Output: 13W/channel into 8 ohms, 16W/channel into 4 ohms. Damping factor: 40 at 1kHz into 8 ohms. THD: 0.5% at full power, 0.1% at half power. FR: 30Hz-50kHz +1dB -2dB. Mains: 110V, 120V, 130V, 220V, 240V, 50Hz or 60Hz. Size: 13 × 4½ × 12¾ in. Price: on application.

**■ BRYAN AMPLIFIERS LTD**

18 Greenacres Road, Oldham, Lancs, OL4 1HA. Tel: 061-624 4074.

**The Leader LE720**

Integrated stereo amplifier 45 transistors and 14 diodes. Inputs: mag PU 3mV 50K, tape 100mV 50K, radio (1) 100mV 50K, radio (2) 500mV 250K, aux (1) 100mV 50K, aux (2) 1V 500K. Noise level: -70dB Overload capability: mag PU input 30dB Output: at least 35W RMS per channel. Controls: balance (zero to max each channel), treble ± 12dB at 10kHz, bass ± 15dB at 50Hz, filter 3dB roll-off at 5.8-11kHz (8dB in first octave, 20dB in second octave), quiet listening +10dB at 50Hz and +5dB at 10kHz. HD: <0.1%. Output impedance: 4-15 ohms. FR: 20Hz-50kHz ± 3dB. Mains: 100, 110, 220, 240V AC. Size: 18 × 3 × 10½ in. Finish: teak cabinet with extruded aluminium front and rear. Full protection against DC offset on both speaker systems. Price: on application.

**■ BUSH-ARENA**

Rank Radio International Ltd, PO Box 596, Power Road, Chiswick, London, W4 5PW. Tel: 01-994 6491.

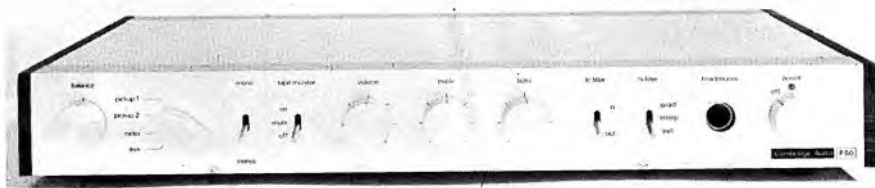

Cambridge Audio P50

**A220**

Integrated stereo amplifier. Inputs: mag PU 2·25mV 47K, ceramic PU 42mV 500K, tape 90mV 200K, radio 70mV 150K. FR: 25Hz-20kHz-3dB. HD: <1%. Controls: volume on/off, bass +12dB -15dB at 100Hz, treble +11dB -13dB at 10kHz, balance, mono/stereo, input selection. Output: 10W RMS per channel into 4 ohms. Output impedance: 4-15 ohms. Outlets for tape recorder (38mV 47K) and stereo headphones (4 ohms). Mains: 220, 240V 50Hz. Size: 13¼ × 3½ × 8¼ in. Price: £44·71 (including VAT).

■ **BUSH NELSON LTD**

Bush House, 6 Yattendon Road, Horley, Surrey.  
Tel: Horley (029 34) 5983.

**Integrated transistor stereo amplifier**

Controls: on/off, mono/stereo, volume, balance, bass, treble. Output: 35W music (total). FR: 15Hz-30kHz ± 1dB at 1W. Size: 12 × 6 × 2 in. Price: on application.

■ **CAMBRIDGE AUDIO**

Cambridge Audio Ltd, The River Mill,  
St Ives, Huntingdon, PE17 4EP.  
Tel: St Ives (0480) 62901.

**P50 ★**

Stereo integrated amplifier. Output: 25W per channel into 8 ohms, 15W into 15 ohms (both at 1kHz). FR: 25Hz-25kHz ± 0·5dB. HD: <0·05% at all levels up to rated output. Intermodulation distortion: <0·1% at all levels up to rated output. S/N: >60dB on pickup input, >70dB on tuner input (both figures unweighted and unaffected by volume setting). Inputs: PU 3mV 47K, PU 100mV 100K (both RIAA equalised), radio 25mV 180K flat, aux 150mV 100K flat. Tape monitor: 500mV. Tape output: 250mV. Crosstalk: better than 50dB at 1kHz. Size: 16½ × 9½ × 2 in. Price: £89·95 (plus VAT).

**P60**

Stereo integrated amplifier. Inputs: phono 3mV 47K. Radio 250mV 180K, cassette 150mV 100K, aux 150mV 100K, tape (1 & 2) 400mV. Outputs: tape (1 & 2) 400mV, cassette 400mV. S/N: phono 60dB, tuner <70dB, unaffected by volume setting. FR: 25Hz-25kHz ± 0·5dB. Power

output: 30W channel into 8 ohms. THD: <0·05% at 1kHz. Damping factor: >80 into 8 ohms. Size: 16½ × 9·6 × 2 in. Mains: 110-120V, 220-240V AC. Price: £112 (plus VAT).

**P110**

Integrated stereo amplifier. Inputs: phono (1) 3mV 47K, phono (2) 100mV 47K, radio 250mV 180K, aux 200mV 100K, tape 400mV. Outputs: tape 250mV, speakers 50W channel into 8 ohms, 36W channel into 15 ohms. Power bandwidth: 25Hz-25kHz ± 0·5dB at 50W 8 ohms. THD: 0·05% at 1kHz at any power up to rated power. S/N: phono >60dB, tuner >70dB. Damping factor: 80 into 8 ohms. Size: 16½ × 9·6 × 2 in. Mains: 110-120V, 220-240V AC. Price: £145 (plus VAT).

■ **CANTERBURY AUDIO**

4 Station Road West, Canterbury, Kent.  
Tel: Canterbury (0227) 60431.

**Stereo 80 Series**

Modular construction integrated stereo amplifier. Inputs: pickup, tape and radio with individual preset gain controls. Tone controls: bass ± 15dB at 100Hz, treble ± 15dB at 10kHz. Scratch filter: -12dB/octave from 5kHz. Rumble filter: -12dB/octave from 100Hz. Output: 35W RMS per channel. Output impedance: 4 ohms (also suitable for 8 and 15 ohm speakers but will supply reduced power). S/N ratio: better than 65dB. FR: 25Hz-25kHz ± 1dB. HD: 0·2% at 1kHz. Mk I with integral input selector module. Mk II with separate input selector module adaptable to different inputs. Price: (Mk I) £31·95; (Mk II) £33·45; (regulated modular power supply) £6·95; (Mk I in cabinet with power supply) £38; (Mk II in cabinet with power supply) £39·75. All prices exclude VAT.

■ **DARBY INDUSTRIES**

38-42 Chestnut Grove, New Malden, Surrey,  
KT3 3JW. Tel: 01-942 1596.

**Elegance**

Integrated stereo amplifier. Inputs: mag PU, radio, tape. Controls: bass, treble, balance, volume. Pushbuttons for mains on/off, input selector, mono/stereo. Output: 5W RMS per

Some Hi-Fi manufacturers  
give you a lot of pretty pictures.

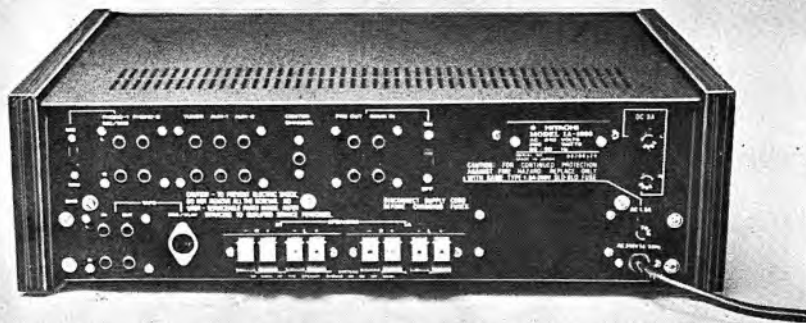

**Hitachi give you the works.**

### **Gold Seal Hi-Fi**

-the Hi-Fi with the Hi-Fi guarantee  
1 year covering parts and labour.  
8760 hours of non-stop satisfaction.

Stereo Turntables · Stereo Amplifiers · Stereo Tuners  
Tuner Amplifiers · Speaker Systems



 **HITACHI**

Hitachi Sales (UK) Ltd., New Century House,  
Coronation Road, Park Royal, London NW10 7QN.

SAE

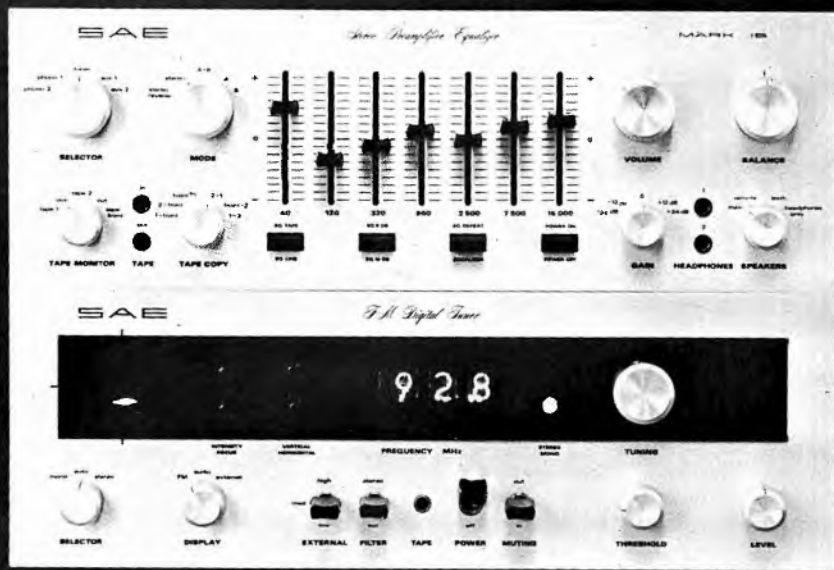

SAE Audio Equipment is made in very small numbers and will be available from only a handful of Franchised Dealers.

For further information write to Sole UK Distributor:

**Gale Electronics & Design Limited**  
**39 Upper Brook Street London W1Y 1PE**

channel. Neon indicator light. Output impedance: 8 ohms. Finish: eggshell black or white. Supplied in mail order pack. Price: £22.50 (plus VAT).

#### Symphony

Similar specification to the Elegance but with rotary input selector instead of pushbuttons. Supplied in mail order pack. Price: £20 (plus VAT).

#### Amplifier (Disco)

Integrated stereo amplifier. Inputs: mag PU 2.7mV 47K, mic 2.5mV 47K, aux 75mV 100K, tape 75mV 100K. Overload capability: 32dB. S/N ratio: 60dB. Controls: treble  $\pm 14$ dB at 10kHz, bass  $\pm 14$ dB at 100Hz. HD: 0.1% at all powers into 8 ohms, 0.25% at all powers into 4 ohms. Output impedance: 4-16 ohms. FR: 20Hz-30kHz-1dB. Output suitable for one 4 ohm speaker per channel, or one or two 8 ohm or 15 ohm speakers per channel. Socket for headphones (mono or stereo 8-2000 ohms). 27 silicon transistors. Robust desk-type cabinet with slider controls. Price: £85 (plus VAT).

#### DECCA

Neachells Lane, Willenhall, Staffs.  
Tel: Willenhall (0902) 67367.

#### Model AA 3000T

Integrated stereo amplifier available as a separate, but forming part of the Decca 30W complete audiosystem. Details to be found under the Audio Systems section. Price when sold as a separate: £76.46 (including VAT).

#### DUAL

Audiodecks Ltd, Farnell House, 81 Kirkstall Road, Leeds, LS3 1HR. Tel: Leeds (0532) 35111.

#### CV120

Integrated stereo amplifier. 30 transistors, 14 diodes. Inputs: mic 2mV 47K, mag PU 2.5mV 47K, radio 300mV 470K, tape 300mV 470K, aux 300mV 470K. Noise level: (mic input) -50dB, (mag PU input) -62dB, (other inputs) -78dB. Output: 40W RMS per channel. Six slider controls for volume, bass, treble, balance, rumble, noise. HD: 0.2%. Output impedance: 4-16 ohms. FR: 20Hz-30kHz  $\pm 0.5$ dB; 15Hz-60kHz  $\pm 1.5$ dB. Mains: 110, 117, 220, 240V AC. Size:  $16\frac{1}{2} \times 4\frac{1}{2} \times 13\frac{1}{2}$  in. Finish: walnut or white with matt black panel. Overload circuit with visual indicator. Price: (walnut) £142.13 (including VAT); (white) £143.36 (including VAT).

#### EAGLE INTERNATIONAL

Heather Park Drive, Wembley, HA0 1SU  
Tel: 01-903 0144

#### TSA.149 ★

Integrated stereo amplifier. Output: 7W RMS

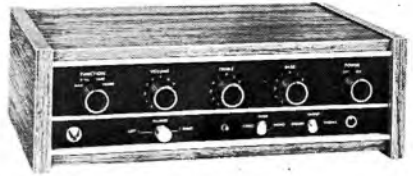

Eagle TSA149

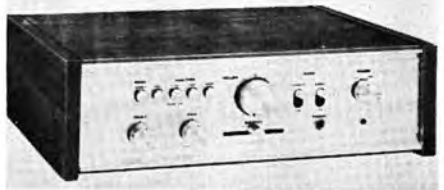

Eagle AA4

per channel. FR: 25Hz-18kHz. Inputs: magnetic PU 3mV, ceramic PU 80mV, tape 180mV, radio 180mV. S/N: better than 50dB. All silicon transistors. Wood cabinet. Size:  $11\frac{1}{2} \times 3\frac{3}{8} \times 7\frac{1}{2}$  in. Price: £34.70 (including VAT).

#### TSA.151

Integrated stereo amplifier. Output: 15W RMS per channel. FR: 20Hz-32kHz. Inputs: magnetic PU 3mV, ceramic PU 100mV, tape 200mV, radio 200mV. S/N: better than 50dB. Silicon transistors. Wood cabinet. Size:  $13 \times 4 \times 8\frac{3}{4}$  in. Price: £50.60 (including VAT).

#### AA2

Integrated stereo amplifier. Output: 10W RMS per channel. FR: 25Hz-20kHz  $\pm 2$ dB. Inputs: magnetic PU 3mV 47K, ceramic PU 80mV 100K, radio 180mV 100K, tape 180mV 100K. Noise level: magnetic PU 64dB, ceramic PU 66dB, other inputs 68dB. Controls: bass, treble, volume, balance, on/off, rumble filter, scratch filter. HD: 0.5%. Output impedance: 8-16 ohms. Mains: 240V AC. Size:  $10\frac{1}{8} \times 8\frac{3}{4} \times 3\frac{3}{8}$  in. Finish: teak cabinet with metal fascia. Price: £46.20 (including VAT).

#### AA4 ★

Integrated stereo amplifier. Output: 20W RMS per channel. FR: 15Hz-36kHz  $\pm 2$ dB. Inputs: magnetic PU 3mV 47K, ceramic PU 80mV 100K, radio 180mV 100K, tape 180mV 100K. Noise level: magnetic PU 66dB, ceramic PU 68dB, other inputs 70dB. Controls: bass, treble, volume, balance, on/off, rumble filter, scratch filter. HD: 0.2%. Output impedance: 8-16 ohms. Mains: 240V AC. Size:  $13 \times 10\frac{1}{2} \times 3\frac{3}{8}$  in. Finish: teak cabinet with metal fascia. Price: £63.80 (including VAT).

#### AA6

Integrated stereo amplifier. Output: 20W RMS



★ Indicates entry is illustrated

per channel. FR: 15Hz-36kHz $\pm$ 2dB. Inputs: magnetic PU 34mV 47K, ceramic PU 80mV 100K, radio 180mV 100K, tape 180mV 100K. Noise level: magnetic PU 63dB, ceramic PU 65dB, other inputs 70dB. Controls: bass, treble, volume, balance, on/off, pushbutton input selectors, five sound effect controllers giving  $\pm$ 10dB over five channels in the audio spectrum. Finish: teak cabinet with metal fascia. Price: £74-80 (including VAT).

#### AA10 and AA26

See Surround Sound Section for details of the Eagle AA10 and AA26 four-channel quadraphonic synthesiser.

#### FF2 ★

Stereo frequency controller and preamplifier. Eight transistors. Inputs: mag PU 3mV 50K (RIAA), tape 200mV 100K, aux 200mV 100K. Tape outlet: 200mV 100K. Main output: 200mV at more than 50K per channel. Controls:  $\pm$ 10dB at 40Hz,  $\pm$ 10dB at 200Hz,  $\pm$ 10dB at 1-2kHz,  $\pm$ 10dB at 6kHz,  $\pm$ 10dB at 15kHz. Power supply: two PP3 batteries. Size:  $9\frac{7}{8} \times 7\frac{1}{2} \times 1\frac{7}{8}$  in (sloping down to  $1\frac{1}{8}$  in). Finish: black crackle. Price: £37-40 (including VAT).

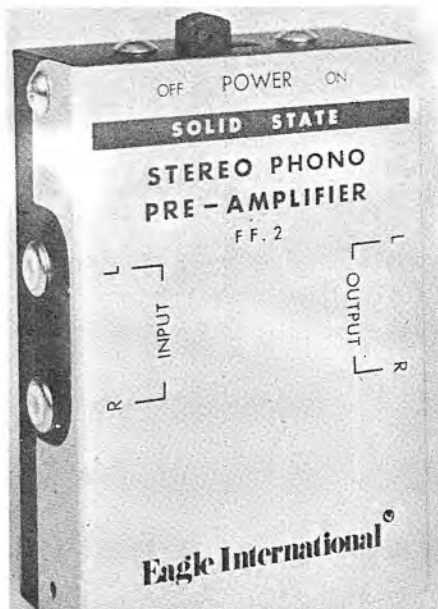

Eagle FF2

#### ■ ELGAR

English Audio (1970) Ltd,  
North Station Road, Colchester, Essex.  
Tel: Colchester (0206) 73467.

#### Elgar

Integrated stereo amplifier. Inputs: mag PU 3-5mV 56K, ceramic PU 20mV 33K, radio 100mV 100K, tape 100mV 100K. Noise level: -65dB on all inputs. Output: 18W per channel. HD: <0.5% at all levels up to rated output. FR: 20Hz-20kHz  $\pm$ 3dB. Overload capacity: 29dB on all inputs. Independent outlet for tape provides 200mV irrespective of volume setting. Controls: (rotary) bass, treble, volume, balance and input selector, (slide switches) mono/stereo, HF filter, loudness, phones/speaker. Indicator light. Output impedance: 8-16 ohms. Connections by DIN plugs. Finish: teak case. Price: approximately £60 (plus VAT).



EMI 1515 amplifier

#### ■ EMI SOUND & VISION

EMI Pathé Division, 252 Blyth Road, Hayes,  
Middlesex, UB3 1HW.  
Tel: 01-573 3888. Telex: 22417.

#### 1515 ★

Integrated stereo amplifier. Output: 15W RMS per channel. HD: <0.2% at 1kHz at rated output. FR: 25Hz-25kHz $\pm$ 1dB. Signal-to-noise level: better than -50dB on all inputs. Inputs: mag PU, radio, tape, microphone, aux. Low pass filter. Two switched mains outlet sockets incorporated. Price: £46-50 (including VAT).



FAL Phase 25

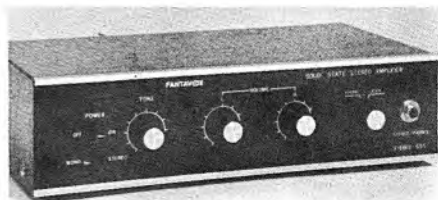

Fantavox Stereo-505

### ■ ESS

Distributed by: Impo Hi-Fi, 22 Buckingham Palace Road, London, SW1.  
Tel: 01-834 0050.

#### ESS Preamplifier

Stereo preamplifier designed primarily for use with the ESS 500M and the ESS 200. Inputs: phono, 10mV 47K. High level inputs: £00mV 75K. Noise level: High level section, -100dB at rated output. Tone control section, -96dB at rated output. Phono, -80dB ref 10mV at 1kHz input. Distortion: 0.0075% from 20Hz to 20kHz at any level up to rated output. Output: rated at 2.5V into 10K or greater. Two tape record outlets, two sets of power amp outlets. Size: 16 $\frac{3}{8}$  × 6 × 9in. Price £255.20 (including VAT).

#### ESS 500M

Stereo power amplifier. Output: 250W per channel, 20Hz-20kHz into 8 ohms. Power bandwidth: 1Hz-100kHz ±3dB. Distortion: Less than 0.1%, 20Hz-20kHz at any power up to rated power. H and N: -100dB ref rated output. Damping factor: 1,000 at 20Hz. Sensitivity: 1.75V input for rated output. Input impedance: 16K. Size: 16 $\frac{3}{8}$  × 6 × 15in. Price: £424.60 (including VAT).

#### ESS 200

Power amplifier. Output: 100W/channel into 8 ohms, 20Hz-20kHz. FR: 22Hz-41kHz ±0.25 dB. THD and Intermodulation Distortion: 0.2%, 20Hz-20kHz at rated output, typically 0.025% at normal operating levels. S/N: -100dB. Damping factor: 100 at 20Hz. Input: 1.5V 47K. Finish: brushed gold facia with ebony plexiglass accent strip, black anodized case or extra oiled walnut case. Price: £242 (including VAT).

### ■ FAL

Futuristic Aids Ltd, 104 Henconner Lane, Leeds, LS13 4LQ. Tel: Pudsey (097 35) 5478.

#### Phase 44

Stereo transistorised integrated amplifier. Inputs: PU 2.5mV 47K (magnetic), PU 35mV 47K (ceramic), radio 175mV 68K, tape 175mV 68K. Noise level: -65dB all inputs. Outlet for tape 200mV. Controls: treble ±15dB at 14kHz, bass ±15dB at 40Hz, volume, balance, filter -6dB at 9kHz, 12dB/octave roll-off. Output: 30W per channel into 4 ohms, 20W per channel into 8 ohms, 10W per channel into 15 ohms. HD: 0.05% at 10W RMS 1kHz. FR: 10Hz-70kHz at 3dB points. Output impedance: 8 or 15 ohms. Mains: 230-240V AC. Consumption: 50W. Size: 15 × 9 $\frac{1}{2}$  × 4 $\frac{1}{2}$ in. Finish: teak veneered cabinet with satin aluminium panel. Price: £47.85 (including VAT).

### Phase 25 'Class A' ★

Stereo transistorised integrated amplifier. Inputs: PU (magnetic) 2.5mV 47K, radio 175mV 68K, tape 175mV 68K. Noise level -70dB all inputs. Outlets for tape recorder 200mV. Controls: treble ±15dB at 14kHz, bass ±15dB at 40Hz, volume, balance +1dB -zero, filter 9kHz, 12dB/octave roll-off. Output: 12W per channel into 8 ohms, 10W per channel into 15 ohms. HD: 0.02% at rated output. FR: 15Hz-68Hz at 3dB points at -10dB full power. Output impedance 8 or 15 ohms. Mains: 230-240V AC. Size: 14 $\frac{3}{4}$  × 11 × 4 $\frac{1}{4}$ in. Finish: teak veneered cabinet with satin aluminium panel. Price: £59.40 (including VAT).

### ■ FANTAVOX

Distributor: Aadastra Electronics Ltd, Unit N22, Cricklewood Trading Estate, Clarendon Road, London, NW2 1TU.  
Tel: 01-452 6288.

#### A11-505 ★

Stereo integrated amplifier. Power output: 5W channel into 8 ohms. FR: 40Hz-18kHz. Inputs: phono 150mV, aux/tuner 150mV. S/N: -50dB. Mains: 200-240V AC. Size: 260 × 70 × 175mm. Price: on application.

#### A12 A3550

Integrated stereo amplifier. 14 transistors and two diodes. Inputs: mag PU 3mV 50K, ceramic PU 300mV 50K, radio 200mV 50K, aux 200mV 50K. Noise level: mag PU input -50dB, other inputs -60dB. Output: 20W RMS per channel. Tone controls: bass ±10dB at 70Hz, treble ±10dB at 15kHz. Loudness control. HD: <1% at 1kHz at rated output. Output impedance: 4-16 ohms. Mains: 240V AC. Socket for AC outlet. Size: 12 × 4 $\frac{1}{2}$  × 9 $\frac{3}{4}$ in. Finish: Metal case with simulated wood grain finish, brushed gold facia. Price: £74 (including VAT).

#### A13 A3525

Integrated stereo amplifier. 12 transistors and two silicon diodes. Inputs: mag PU 3mV 50K, ceramic PU 300mV 50K, radio 250mV, 50K, aux 250mV 50K. Noise level: mag PU input -50dB, other inputs -60dB. Output: 9W RMS per channel. HD: <1% at 1kHz at rated output. Output impedance: 4-16 ohms. FR: 30Hz-30kHz ±2dB. Mains: 240V AC. Unswitched socket for AC outlet. Size: 10 × 4 $\frac{1}{4}$  × 7 $\frac{3}{4}$ in. Finish: metal case with simulated wood grain finish, brushed gold facia. Price £50.50 (including VAT).

### ■ FERGUSON

Thorn Consumer Electronics Ltd, 284 Southbury Road, Enfield Middx. Tel: 01-366 1155.

#### Model 3490

Stereo/quadrasonic amplifier with SQ de-

★ Indicates entry is illustrated

coder. Inputs: phono 3.5mV 50K (mag), phono (ceramic) 140mV 660K, tuner 140mV 660K. S/N: -60dB. (DIN 45 500). Output: 20W/ four channels into 4 ohms. Damping factor: 20. THD: 0.1% at 20W. FR: 30Hz-20kHz, +0dB, -3dB. Mains: 117V, 127V, 220V, 240V 50-60Hz. Price: £132 (including VAT).

## ■ FERROGRAPH

The Ferrograph Company Ltd, Auriema House, 442 Bath Road, Cippenham, Slough, Bucks, SL1 6BB.

Tel: Burnham (06286) 62511. Telex: 847297.

### F208

Integrated stereo amplifier. Output per channel: 20W into 8 ohms or 15W into 15 ohms. Total HD: less than 0.25% at 1kHz all levels. FR: ( $\pm 1$ dB) 20Hz-25kHz, (+1dB -3dB) 15Hz-30kHz. Inputs: ceramic PU, tuner and aux, 100mV-5V at 2M; magnetic PU(RIAA), 3mV at 100K, 68K or 47K; tape 150mV at 50K. Outputs: speaker 8-16 ohms, phones 8 ohms or greater; tape 50K or greater. H and N: less than -65dB (except magnetic PU which is less than -60dB). Bass control  $\pm 17$ dB at 50Hz, treble control  $\pm 13$ dB at 15kHz. Pushbutton low-pass filters -3dB at 10, 7 and 5kHz. Mains: 117, 220, 240V AC 50-60Hz. Size:  $18 \times 5 \times 8\frac{1}{2}$ in. Finish: Teak, Walnut or White. Price: £78 (plus VAT).

### F608 (60 + 60) ★

Integrated stereo amplifier. Inputs: radio and aux, 100mV into 2M or 400K; phono, 2.5mV into 47K. Outputs: 60W per channel. Load: 4-8 ohms or 8-16 ohms switchable. Damping factor: 24 at 8 ohms, 48 at 16 ohms. THD: 0.5% at full rated power. FR: 25Hz-20kHz  $\pm 1$ dB. Mains: 110-120V, 220-250V. Size:  $17\frac{1}{2} \times 5\frac{3}{4} \times 13\frac{3}{4}$ in. Price: £148.50.

## ■ FIDELITY RADIO LTD

6 Olaf Street, London, W11.

Tel: 01-727 0131.

### 20/20 Amplifier

Integrated stereo amplifier. Inputs: mag PU 3mV 50K, ceramic PU 70mV 50K, tape monitor 250mV 25K, aux 250mV 25K, radio 250mV 25K. Output: 20W RMS per channel into 8 ohms. HD: (overall)  $< 0.2\%$ , (power amplifier only)  $< 0.1\%$ , at 20W output. FR: 20Hz-26kHz  $\pm 2$ dB, 30Hz-16kHz  $\pm 1$ dB. Noise level: (mag PU input) -65dB, (other inputs) -70dB. Controls: bass +16dB -18dB at 50Hz, treble +16dB -15dB at 10kHz, scratch filter -3dB at 6kHz 12dB/octave, rumble filter -3dB at 100Hz 10dB/octave, contour +16dB at 50Hz and +9dB at 10kHz. Outlet for tape recorder. Stereo headphone jack (not less than 8 ohms). Socket for connection to external quadraphonic

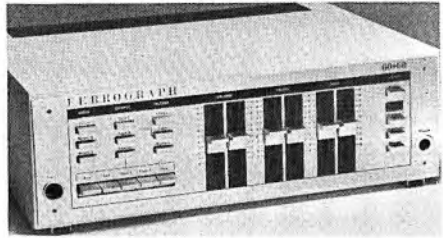

Ferrograph 60+60

equipment. Automatic overload protection circuit. Size:  $18 \times 3 \times 8\frac{1}{2}$ in. Weight:  $7\frac{1}{4}$ lb. Finish: satin black with wood grain end pieces. Price: £52 (including VAT).

## ■ FISHER

ICP Ideal Computer Processors Ltd, Breamish House, Bilton Road, Erith, Kent.

Tel: Erith (38) 41327.

No product details obtainable at the time this edition of the Year Book went to press.

## ■ GALACTRON

Distributed by: Goodmans Loudspeakers Ltd, Downley Road, Havant, Hants, PO9 2NL.

Tel: Havant (07012) 6344.

### Model 10 Mk10

Stereo integrated amplifier. Inputs: phono/mic 1mV 47K, aux 150mV 100K. S/N: phono/mic 76dB, aux 82dB ref. max output. Outputs: 90W channel into 8 ohms. Damping factor: 100 into 8 ohms. THD:  $< 1.0\%$  between 1W and rated power output. FR: 16Hz-70kHz -3dB. Mains: 110-240V AC. Size:  $18\frac{1}{4} \times 5\frac{3}{4} \times 12\frac{1}{4}$ in. Price: to be announced.

### Mk16

Stereo/Quad pre-amplifier. Inputs: Plug-in matching modules available for phono, mic and aux feeding into a line input at 0.775V. S/N: phono/mic 78dB, aux 82dB. Max. output: 8V RMS into 600 ohms. THD:  $< 0.1\%$  at rated output. FR: 20Hz-20kHz  $\pm 0.5$ dB. Mains: 110-240V AC. Size:  $18\frac{1}{4} \times 9\frac{1}{2} \times 5\frac{3}{4}$ in. Price: to be announced.

### Mk100

Stereo power amplifier. Input: 750mV. S/N: 95dB. Max. output 100W channel into 8 ohms. Damping factor: high 100, med 30, low 10. THD: 1% at rated output. FR: 16Hz-70kHz -3dB. Mains 117-240V AC. Size:  $18\frac{1}{4} \times 5\frac{3}{4} \times 12\frac{1}{4}$ in. Price: to be announced.

## ■ GOLDRING LTD

10 Bayford Street, Hackney, London, E8 3SE.

Tel: 01-985 1152.

**VV7 Equaliser**

Equaliser pre-amplifier designed to fit beneath record decks. Includes power supply. Amplifiers output from low output cartridges and equalises to RIAA characteristic. Price: £12.21 (including VAT).

**GOODMANS**

Goodmans Loudspeakers Ltd, Downley Road, Havant, Hants, P09 2NL.  
Tel: Havant (07012) 6344.

**Model Forty-forty**

Stereo integrated amplifier. Inputs: phono 2mV 50K, aux/ceramic 60mV 600K, tuner 60mV 600K, tape 320mV 50K. S/N: phono 60dB, all others 75dB; all ref. to rated power. Outputs: 35W channel into 4 ohms. Damping factor: 40 into 4 ohms. THD: < 0.1%, both channels driven 60W. FR: 30Hz-20kHz  $\pm$  1.5dB. Mains: 120, 220, 245V AC. Size: 22  $\times$  11  $\frac{1}{2}$   $\times$  3  $\frac{3}{4}$  in. Price: £78.41 (including VAT).

**GRAMPIAN REPRODUCERS LTD**

19 Hanworth Trading Estate, Hampton Road West, Feltham, Middx., TW1B 6EJ.  
Tel: 01-894 9141.

**743**

Solid-state mono power amplifier. Input: balanced or unbalanced 600 ohms (to match 10K input) at 800mV for rated output. Output: 50W RMS. Output impedance: 4-8 ohms, 100V line. FR: 100Hz-10kHz +0dB, -1dB; 50Hz-15kHz +0dB, -3dB. HD: < 1% 100Hz-10kHz at rated output. S/N: greater than 70dB. Controls: on/off switch, single gain control giving zero to rated output. Mains: plug-in voltage selection giving 100-125V in 5V steps, 200-250V in 10V steps. Size: 19  $\times$  5  $\frac{1}{4}$   $\times$  12  $\frac{1}{2}$  in. Weight: 32lb. Full specification leaflet on request. Price: to be announced.

**7431**

Specification as for the 743 but is fitted with 1  $\frac{1}{4}$  in peak reading output meter. Price: to be announced.

**744**

Specification as for the 743 but with 100W RMS output. Weight: 40lb. Price: to be announced.

**7441**

Specification as for the 744 but with cover over output control and no supply on/off switch. Price: to be announced.

**HANIMEX (UK) LTD**

Hanimex House, Dorcan, Swindon, Wilts, SN3 5HW. Tel: Swindon (0793) 26211.

New range of hi-fi stereo amplifiers to be introduced under the Hanimex brand name. No

details of models available as this edition of the Year Book closed for press.

**HARMAN-KARDON**

Highgate Acoustics,  
38 Jamestown Road, London, NW1 7EJ.  
Tel: 01-267 4937/8.

**Citation 11**

Stereo preamplifier. 13 transistors. Inputs: mag PU (2) 1.5mV 47K, aux (2) 150mV 20K, aux 300mV 20K. Noise level: mag PU input 66dB, other inputs 80dB. Output: 6V RMS per channel at 500 ohms. Tone controls: bass  $\pm$  12dB at 60Hz,  $\pm$  12dB at 320Hz,  $\pm$  12dB at 1kHz,  $\pm$  12dB at 12kHz, high-cut filter -8dB (6dB/octave) at 10kHz, sub-sonic filter -12dB (6dB/octave) at 15Hz. Two low impedance headphone outlets. HD: 0.05% at 6V. Output impedance: 500 ohms. FR: 2Hz-250kHz  $\pm$  1dB at 6V output. Mains: 110-240V AC. Audio equaliser control. Size: 16  $\frac{1}{8}$   $\times$  4  $\frac{3}{4}$   $\times$  12 in. Price: £207.90 (including VAT).

**Citation 12**

Stereo power amplifier designed for use with Harman-Kardon Citation 13 speakers or other similar high quality systems. Input: 1.6V 47K. Noise level: 100dB. Output: 60W RMS per channel. HD: 0.06% at 60W. Output impedance: 8 ohms. Separate power supply unit for left and right channels. FR: 1Hz-100kHz  $\pm$  1dB. Mains: 110-240V AC. Size: 12  $\frac{3}{8}$   $\times$  5  $\frac{1}{2}$   $\times$  12  $\frac{3}{8}$  in. Finish: black case with brushed aluminium panel. Price: £207.90 (including VAT).

**HARRISON**

Distributed by: Gimar Ltd, 10 Museum Street, London, WC1. Tel: 01-836 3222.

**S200**

Wholly British stereo integrated amplifier. Incorporates touch sense function switching, an LED output level meter and full output protection which is self restoring. Inputs: mic 110mV into 68K, phono 2.5mV into 47K, two aux and radio adjustable 100mV into 50K. Noise level: mic and phono 60dB ref 100W, aux and radio 70dB ref 100W. Output: 100W into 4 ohms, 75W into 7.5 ohms. Damping factor: 100. THD: 0.05% at 100W, 1kHz. FR: 20Hz-20kHz  $\pm$  0.5dB at 50W. Mains: 110-240V preset internally. Size: 17  $\times$  10  $\frac{1}{2}$   $\times$  3  $\frac{3}{8}$  in. Price: £185.90 (including VAT).

**HEATHKIT**

See Constructional Kits Section.

**P. F. & A. R. HELME**

Summerbridge, Harrogate, Yorks, HG3 4DR.  
Tel: Darley (042 372) 279.

**Atlantis 100**

Integrated stereo amplifier. Inputs: mag PU

★ Indicates entry is illustrated

2mV, mic 0.5mV, tape play 150mV, radio 150mV, aux 150mV. Overload capability: better than 30dB. Noise level: mic input -45dB, mag PU input -60dB, other inputs -70dB. Output: 55W RMS per channel into 8 ohms, 50W RMS per channel into 4 ohms, 28W per channel into 16 ohms. Tone controls: bass  $\pm 15$ dB at 40Hz, treble  $\pm 10$ dB at 20kHz. Rumble filter: 6dB/octave at 20Hz. HF filter: 20dB/octave at 7kHz. HD: <0.3% at full output (55W). FR: 20Hz-20kHz. Size:  $14\frac{3}{4} \times 4 \times 10\frac{3}{4}$ in. Channel balance:  $\pm 1$ -6dB. Crosstalk: -45dB at 1kHz. Nine pushbutton selectors. Outlet for tape recorder: 200mV 1K. Jack socket for stereo headphones. Dynamic matching control (DMC) to match amplifier to characteristics of speakers. Price: £119 (plus VAT).

### ■ H/H ELECTRONIC

Industrial Site, Cambridge Road, Milton, Cambridge, CB4 4AZ.  
Tel: Cambridge (0223) 65945.

#### IC-100S

Professional power amplifier with two input channels and mono power output. Transistors and ICs. Inputs: (two) 25mV 100K. Noise level: -70dB all inputs. Overload capability: 35dB. Output: 100W RMS into 8 ohms. Bass control: +18dB -9dB at 30Hz. Treble control: +8dB -10dB at 15kHz. Presence control: +10dB at 2kHz. FR: 20Hz-20kHz  $\pm 0.5$ dB. HD: <0.2% at 80W 20Hz-20kHz (typically 0.05% at 1kHz). Slave output at 500mV 50 ohms. Mains: 115, 210, 220, 230 and 240V AC. Size:  $26\frac{3}{8} \times 4\frac{1}{4} \times 11\frac{1}{2}$ in. Finish: top and bottom ABS plastic with bison grain, bright aluminium front panel. Price: £96 (plus VAT).

#### IC-100

Professional power amplifier with two input channels and mono power output. Designed for use with musical instruments. Input: (two) 25mV 100K. Noise level: (power amplifier) -90dB. Bass control: +18dB -20dB at 20Hz. Treble control +16dB -18dB at 15kHz. Presence control: +12dB at 1kHz. Brilliance control: +10dB at 2kHz. Output: 100W RMS into 7.5 ohms, 120W RMS into 4 ohms. Output impedance: 4-15 ohms. Output protected against short-circuit and open-circuit operation. Mains: 115, 210, 220, 230 and 240V AC. Size:  $26\frac{3}{8} \times 4\frac{1}{4} \times 11\frac{1}{2}$ in. Finish: top and bottom ABS plastic with bison grain, bright aluminium front panel. Price: £129 (plus VAT).

#### 1PA Series D

Professional power amplifiers with outputs from 50W-200W RMS. Modular construction. Bench or rack mounting. Full range of accessories. Full details and specifications on request.



Howland-West DA1000

### ■ HITACHI

Hitachi Sales (UK) Ltd, New Century House, Coronation Road, Park Royal, London, NW10 7QN.  
Tel: 01-965 9861.

#### IA1000

Integrated stereo amplifier. Inputs: mag PU (1) 2mV 50K, mag PU (2) 5mV 50K, aux (1) 140mV 100K, aux (2) 140mV 100K, radio 140mV 100K, mic 2mV 35K. 37 transistors, 18 diodes, two ICs. Output: 50W RMS per channel into 4 ohms (both channels driven). HD: <0.1%. FR: 10Hz-100kHz. Damping factor: 50 at 8 ohms. Tone controls: bass  $\pm 12$ dB at 100Hz, treble  $\pm 12$ dB at 10kHz, high filter -10dB at 10kHz, low filter -8dB at 50Hz. Size:  $17\frac{3}{8} \times 5\frac{3}{8} \times 13$ in. Weight: 27 $\frac{1}{2}$ lb. Two VU meters. Microphone input mixing. Two-system speaker connections. Finish: rosewood sidepanels and drawn aluminium control panel. Price: £148 (including VAT).

#### IA600

Integrated stereo amplifier. Inputs: mag PU (low) 2.5mV 50K, mag PU (high) 6mV 50K, aux (1) 220mV 100K, aux (2) 220mV 100K, mic 2.5mV 25K, tape 220mV. 19 transistors, 13 diodes, two ICs. Output: 27W RMS per channel into 4 ohms (both channels driven). HD: <0.1%. FR: 10Hz-100kHz. Damping factor: 50 at 8 ohms. Tone controls: bass  $\pm 12$ dB at 100Hz, treble  $\pm 12$ dB at 10kHz, high filter -8dB at 10kHz. Size:  $16\frac{1}{4} \times 4\frac{1}{4} \times 12\frac{3}{8}$ in. Weight: 19 $\frac{1}{4}$ lb. Solid wood end pieces, drawn aluminium panel. Price: £99 (including VAT).

### ■ HOWLAND-WEST LTD

3-5 Eden Grove, London, N7 8EQ.  
Tel: 01-609 0293.

#### DA1000 ★

Integrated stereo amplifier. Inputs: mag PU 3.5mV, ceramic PU 100mV, radio 100mV, tape 100mV. Noise level: (mag PU input) 50dB, (other inputs) 60dB. Output: 10W RMS per channel. Controls: bass, treble, volume, input selector, mono/stereo, remote/main speaker, phones/speakers, on-off. Output impedance: 8 ohms. FR: 30Hz-18kHz. Mains: 240V AC. Size:  $14\frac{3}{4} \times 4\frac{1}{4} \times 7\frac{7}{8}$ in. Finish: wood cabinet with metal control panel and trim. Price: £29.70 (including VAT).

### ■ IMPEX

F. I. R. McArdle Ltd, 15 Queen Street,  
Newcastle upon Tyne, NE1 3UG.

#### MS7 and MS24

Stereo pickup amplifiers. See Pickup Accessories  
Section for full specification and prices.

### ■ JVC

JVC (UK) Ltd, 453 Caledonian Road, London,  
N7 9BA. Tel: 01-607 6568.

#### VN300

Integrated stereo amplifier. Inputs: crystal PU,  
mag PU, radio, tape, mic, aux. Output: 18W  
RMS per channel. FR: 20Hz-40kHz. Price:  
£74.80 (including VAT).

#### VN700

Integrated stereo amplifier. Inputs: crystal PU,  
mag Pu, radio, tape, mic, aux. Treble and bass  
controls. Rumble and scratch filters. Five-stage  
sound effect amplifier (SEA) tone system. Out-  
put: 40W RMS per channel. FR: 20Hz-50kHz.  
Price: £150.70 (including VAT).

#### VN900

Integrated stereo amplifier. Inputs: crystal PU,  
mag PU, radio, tape, mic, aux. Controls: treble,  
bass, rumble filter, scratch filter. Seven-stage  
sound effect amplifier (SEA) tone system. Out-  
put: 60W RMS per channel. FR: 20Hz-50kHz.  
Price: £180.40 (including VAT).

#### 4VN550

Integrated four-channel amplifier. Inputs: mag  
PU, radio, tape, mic, aux. Tone controls: treble,  
bass, rumble filter, scratch filter. Output: 12.5W  
RMS per channel (four channels). FR: 20Hz-  
50kHz. Price: £109.45 (including VAT).

#### 4VN880

Integrated four-channel amplifier. Inputs: mag  
PU, radio, tape, mic, aux. Tone controls: treble,  
bass, rumble filter, scratch filter. Facilities for  
four-channel synthesised sound. Output: 28W  
RMS per channel (four channels). FR: 10Hz-  
50kHz. Price: £170.50 (including VAT).

#### 4VN990

Integrated four-channel amplifier. Inputs: mag  
PU, radio, tape, mic, aux. Tone controls: treble,  
bass, rumble filter, scratch filter. Facilities for  
four-channel synthesised sound. Sound effect  
amplifier (SEA) tone system. FR: 10Hz-50kHz.  
Output: 38W RMS per channel (four channels).  
Price: £236.50 (including VAT).

### ■ KLEFTRON

K & K Electronics Ltd,  
60 St Mark's Rise London, E8 2NR.  
Tel: 01-254 9941.

#### KSA1500 Mk II

Integrated stereo amplifier. Output 30W music

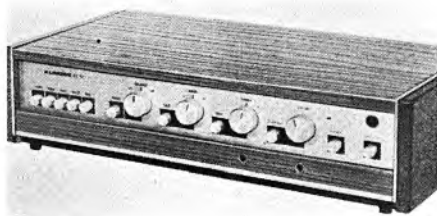

Klinger KC92

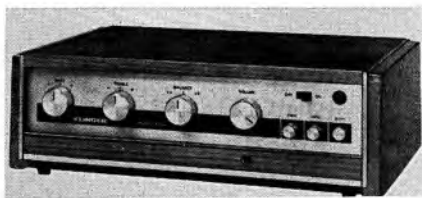

Klinger KC93

power per channel. No further details available  
at time of going to press. Price: £45.10 (plus  
VAT).

#### KSA700 Mk II

Integrated stereo amplifier. Output 14W music  
power per channel. No further details available  
at time of going to press. Price: £34.10 (plus  
VAT).

### ■ KLINGER

Klinger Controls Ltd, Spencer Court,  
7 Chalcot Road, London, NW1 8LU.  
Tel: 01-586 2922.

#### KC92 ★

Integrated stereo amplifier. 28 transistor circuit.  
Inputs: mag PU 2mV 47K, radio 50mV 220K,  
tape 50mV 220K, ceramic PU 100mV 470K,  
aux (mic) 0.15mV 30 ohms. Noise level: (mag  
PU) 66dB, (other inputs) 70dB. Overload  
capability: 30dB. Tone controls: bass  $\pm 15$ dB,  
treble  $\pm 15$ dB, scratch filter 18dB/octave from  
8kHz, rumble filter 12dB/octave from 80Hz.  
Full-range balance control. HD: 0.1% at 20W.  
Output: 25W RMS per channel. Output im-  
pedance: 8 ohms. Tape outlet: 100mV. FR:  
25Hz-35kHz  $\pm 2$ dB at 20W. Stabilised power  
supply. Two stereo headphone sockets. Switch-  
ing for two pairs of speakers. Switched mains  
outlet socket. Finish: teak with diecast enamelled  
sides. Size:  $17\frac{1}{4} \times 4\frac{1}{4} \times 8\frac{1}{2}$  in. Price: £58.50 (in-  
cluding VAT).

#### KC93 ★

Integrated stereo amplifier. 18 transistor circuit.  
Inputs: mag PU 3mV 47K, ceramic PU 40mV  
470K, radio 50mV 470K, tape 50mV 470K.  
Noise level: (mag PU) 60dB, (other inputs)

★ Indicates entry is illustrated

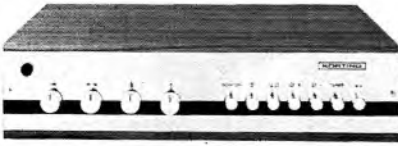

Korting A500

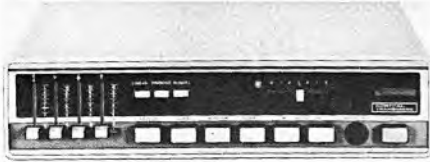

Korting A710 Type 33836



Leak 2200

66dB. Overload capability: 30dB. Output: 10W RMS per channel. Output impedance: 8 ohms. Tape outlet: 100mV. Tone controls: bass  $\pm 15$  dB, treble  $\pm 15$ dB. HD: better than 0.5% at 10W. FR: 40Hz-18kHz  $\pm 2$ dB at 10W. Stereo headphone socket. Switched and direct mains outlet sockets. Finish: teak with enamelled sides. Size:  $13 \times 4\frac{1}{4} \times 8\frac{1}{2}$ in. Mains: 120-240V AC. Price: £39.20 (including VAT).

#### ■ KORTING

Europa Electronics Ltd, Howard Place, Shelton, Stoke-on-Trent, ST1 4NW. Tel: Stoke-on-Trent 29316.

##### A500, Type 29833 ★

Stereo amplifier. 21 transistors. Push buttons for stereo, scratch, tape, pickup 1 and 2, tuner and on/off. Controls: treble, bass, balance and volume, with indicator lamp. Sockets: diode output for tuner; crystal, ceramic or magnetic pickup; tape recorder; speakers. Output: 10W per channel. Drift power transistors and triple negative feedback. Cabinet in natural walnut colour, satin finish. Size:  $3\frac{1}{2} \times 14 \times 9$ in. Price: £42.35 (including VAT).

##### A710, Type 33836 ★

Integrated stereo amplifier. 25 transistors, one diode. Ten pushbutton controls. Sliders for volume, balance, treble and bass. Tone controls:

bass  $\pm 15$ dB, treble  $\pm 15$ dB. Inputs: mag PU, radio, tape, ceramic PU. Output: 20W RMS per channel (DIN). Finish: walnut, satin finish or white. Full specification on request. Price: £74.25 (including VAT).

#### Multisound 600

Four-channel integrated amplifier. 21 transistors, one IC, two diodes, two rectifiers. Inputs: stereo radio, tape, quadrasonic unit. Seven pushbutton controls for phase inversion, reverse, reverberation, duplex stereo, quadrasonic, mono and on-off. Slider controls for balance, bass, treble. Rotary control for volume. Tone control: bass  $\pm 15$ dB, treble  $\pm 15$ dB. Output: 6W RMS per channel. Output impedance: 4 ohms. Finish: walnut or satin finish. Price on request.

#### ■ LEAK

Rank Radio International Ltd, PO Box 596, Power Road, Chiswick, London, W4 5PW. Tel: 01-994 6491.

##### 2100

Stereo integrated amplifier. Inputs: phono 2.2mV or 6mV 47K switchable, tape 140mV 100K, cassette 140mV 100K, tuner 140mV 100K, all at 1kHz for 35W output. Outputs: tape/cassette 140mV, DIN 1.4mV/K. Speakers 30W channel into 8 ohms, 35W channel into 6 ohms, 40W channel into 4 ohms. Both channels sine wave driven at 1kHz. High power single channel mode 80W. Damping factor: 40 at 80Hz. THD: 0.1% at rated power. Power bandwidth: 10Hz-40kHz at 35W -2dB. Mains: 240V AC 50-60Hz. Size:  $16.3 \times 12\frac{1}{2} \times 5\frac{1}{4}$ in. Price: £107 (including VAT).

##### 2200 ★

Stereo integrated amplifier. Inputs: phono 2.5mV or 6.5mV 47K switchable, tape 150mV 100K, cassette 150mV 100K, tuner 150mV 100K, mic 2.4mV 47K, main amp 1V 47K; all at 1kHz for 50W output. S/N: phono 65dB, tape/cassette/tuner 80dB, main amp 90dB. Outputs: tape/cassette 150mV, DIN 1.5mV/K, speakers 45W channel into 8 ohms, 50W channel into 6 ohms, 60W channel into 4 ohms. Both channels sine wave driven at 1kHz. High power single channel mode 120W. Damping factor: 40 at 80Hz. THD: 0.1% at 45W. Power bandwidth: 10Hz-40kHz at 50W -2dB. Mains: 240V AC 50-60Hz. Size:  $16.3 \times 12\frac{1}{2} \times 5\frac{1}{4}$ in. Price: £135 (including VAT).

#### ■ LECSON

Lecson Audio Ltd, Burrell Road, St Ives, Hunts, PE17 4LE.

Tel: St Ives (Hunts) 64124 (STD code 0480).

##### AC1 ★

Stereo preamplifier control unit. 65 transistors,

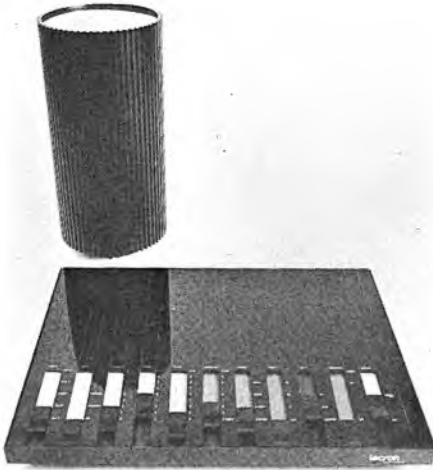

Lecson AC1 and API units



Lowther LL26 amplifier

12 diodes. Inputs: mag PU 2.5mV 47K, radio 125mV 68K, aux 1 125mV 68K, aux 2 125mV 68K. Noise level: mag PU input 70dB, other inputs 80dB. Overload capability: mag PU input 50dB, other inputs 25dB. Output: 500mV or 1-2V to main amplifier, 100mV to tape recorder, 2W max to headphones. Controls: treble  $\pm 10$ dB at 10kHz, bass  $\pm 12$ dB at 100Hz, high frequency filter (Bessell characteristic) -3dB at 5, 8 and 13kHz  $\pm 10\%$  (slope 18dB/octave), low frequency filter (Bessell characteristic) -3dB at 35Hz (slope 12dB/octave). HD:  $< 0.05\%$  at 1kHz. Output impedance: 100 ohms. FR: 10Hz-20kHz  $\pm 1$ dB. Mains: 120-240V AC. Size:  $14\frac{3}{4} \times 1\frac{3}{4} \times 10\frac{1}{2}$  in. Finish: black anodised frame with glass top. Facilities for addition of four-channel decoding matrices and remote control unit. Design Council Award 1974. Price: £110 (including VAT).

**API ★**

Stereo power amplifier. 26 transistors, 11 diodes.

Input: 500mV 10K. Noise level: better than 90dB. Output: 35W RMS per channel into 8 ohms with distortion below 0.05%, 55W RMS per channel into 8 ohms with distortion below 0.1%. HD: typically 0.005% at 35W at 1kHz. Output load: 8 ohms (output impedance less than 0.2 ohms). FR: 10Hz-20kHz  $\pm 1$ dB. Mains: 100-130V, 200-260V AC. Size:  $5\frac{3}{8}$  in diameter,  $11\frac{1}{2}$  in high. Finish: anodised aluminium (black). Patented circuitry designed to eliminate transient distortion effects. Design Council Award 1974. Price: £82.50 (including VAT).

**AP2**

Stereo power amplifier. Similar specification to the model API except for power rating. Output: 70W RMS per channel into 8 ohms with distortion below 0.05%, 100W RMS per channel into 8 ohms with distortion below 0.1%. Price: £104.50 (including VAT).

■ **LEEVEERS-RICH**

Leeevers-Rich Equipment Ltd, 319 Trinity Road, Wandsworth, London, SW18 3SL. Tel: 01-874 9054. Telex: 923455. Cables: Leemag, London, SW18.

**7 Band Audio Equaliser Model LR720 ★**

Wide range equaliser covering spectrum in 7 separately adjustable and overlapping bands, suitable for use in transcription to match widely differing recordings to a common quality standard. Price: £235 (plus VAT).

■ **LOFWF OPTA**

Distributors: SED Television Ltd, Salisbury, Wilts. Tel: Salisbury (0722) 4201.

Hokushin Audio Visual Ltd, 2 Ambleside Avenue, London, SW16. Tel: 01-677 9919.

No details of models available as this edition of the Year Book closed for press.

■ **LOWTHER**

Lowther Acoustics Ltd, Lowther House, St Mark's Road, Bromley, Kent, BR2 9HQ. Tel: 01-460 5225. Cables: Lowther, Bromley.

**IL18 amplifier**

18W. Distortion  $< 0.1\%$ . Input for specified output 0.75V. Response 20Hz-40kHz  $\pm 1$ dB. Feedback 20dB. Noise level -85dB. Output impedance: 16 ohms with adjustment. Output: EL506 distributed load circuitry. Pat. Size:  $12 \times 6 \times 6$  in. To operate with SCU/T control unit. Price: £27 (plus VAT).

**IL26 Mk II amplifier ★**

26W. Dist  $< 0.1\%$ . Input for spec output 0.75V. Response 20Hz-70kHz  $\pm 1$ dB. Feedback 22dB. NL -90dB. Output imp 16 ohms with adjust-



★ Indicates entry is illustrated



Lowther I.A.20

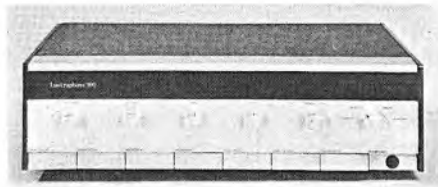

Lustraphone LP100



Lux 507X



Lux SQ707

ment. Output: EL34s. Lowther linear. Size:  $11 \times 12 \times 7\frac{1}{2}$  in. Weight: 33lb. To operate with SCU/T control unit. Price: £47 (plus VAT).

#### L18S stereo amplifier

18W output on each channel. Distortion 0.1%. Input for specified output 0.75V. Response 20 Hz-40kHz  $\pm 1$ dB. Noise level -85dB. Output imp 8.4 or 16 ohms. Output EL596 ultra linear. Size:  $11 \times 12 \times 7\frac{1}{2}$  in. To operate with SCU/T control unit. Price: £47 (plus VAT).

#### I.A.20 ★

Integrated stereo amplifier with Class A output. Inputs: magnetic PU 1-10mV (switched 47K RIAA); radio 100mV, aux 100mV, tape record and replay. Output: 10W RMS per channel into 15 ohms. HD: 0.1%. H and N: >65dB RIAA. Controls: bass  $\pm 16$ dB at 50Hz, treble  $\pm 16$ dB at 15kHz. Low filters: (switched) 40Hz, 80Hz, 160Hz, 270Hz. High filters: (switched) 3.2kHz, 4.5kHz, 9kHz and 11kHz. Balance control: zero to maximum each channel. Switch for main speaker, auxiliary speaker and phones. DIN correction. AC outlet sockets. Mains: 110, 220, 240V 40-60Hz. Finish: teak or walnut cabinet with satin chrome panel (or black Perspex with rear lighting). Size:  $15 \times 5\frac{1}{2} \times 12\frac{3}{8}$  in. Price: £82 (plus VAT).

#### SCU/T

Stereo control unit. Output: 0-750mV RMS per channel at 5K. Specifications as I.A.20. Price: £47 (plus VAT).

### ■ LUSTRAPHONE

Lustraphone Hi-Fi Ltd, Unit 2, Browells Lane, Feltham, Middlesex, TW13 7EL.  
Tel: 01-890 0887.

#### LP100 ★

Integrated stereo amplifier. Inputs: mag PU (1) 2mV 47K, mag PU (2) 2mV 47K, radio 100mV 100K, aux 100mV 100K. Controls: bass, treble, balance, volume, on/off, main/remote speakers, hi/lo gain switch, rumble filter, treble filter. Headphone socket. Output: 50W RMS per channel into 8 ohms. HD: 0.03% at all levels and frequency. H and N: better than -70dB. Mains: 110-250V 50-60Hz. Size:  $16\frac{1}{2} \times 13 \times 4\frac{1}{2}$  in. Price: £118 (plus VAT).

### ■ LUX

Holland-West Ltd, 3-5 Eden Grove, London, N7 8EQ. Tel: 01-609 0293/4/5.

#### SQ707 ★

Integrated stereo transistor amplifier. Inputs: PU 2mV 50K, radio 120mV 50K, tape recorder 120mV 50K, aux 120mV 50K. Noise level: -60dB on magnetic PU, -65dB all other inputs. Controls: two bass, two treble, mild/intense tone operation, function selector, volume, mono/stereo, balance, A/B speaker switch for two systems. Output: 17W RMS per channel into 8 ohms, 20W RMS per channel into 4 ohms. HD: <1% at maximum output. FR: 30Hz-30kHz  $\pm 1$ dB. Output impedance: 8 ohms. Mains: 240V AC. Size:  $14\frac{3}{4} \times 5 \times 9$  in. Polished wood veneered case. Price: £72 (plus £7.20 VAT).

#### SQ700X

Integrated stereo amplifier. Inputs: phono (1 & 2) 2mV 50K, aux (1 & 2) 120mV 50K. Output: 20W RMS per channel into 8 ohms. FR: 10Hz-50kHz -1dB. Size:  $373 \times 227 \times 125$ mm. Finish: rosewood. Price: £121 (including VAT).

#### L308

Integrated stereo amplifier. Inputs: phono (1 &

2) 2.5mV, aux (1 & 2) 100mV, 100mV tuner input (level adjustable). Output: 55W RMS per channel into 8 ohms, both channels driven. FR: 10Hz-50kHz within 1dB. Size: 485 × 300 × 165mm. Finish: rosewood. Price: £256.30 (including VAT).

#### I.309

Integrated stereo amplifier. Inputs: phono (1 & 2) 2.5mV, aux (1 & 2) 100mV, 100mV tuner input (level adjustable). Output: 75W RMS per channel into 8 ohms, both channels driven. FR: 10Hz-50kHz. Size: 485 × 300 × 165mm. Finish: rosewood. Price: £305.80 (including VAT).

#### CL350

Preamplifier. Input impedance: phono (1 & 2) 2mV, three aux inputs 110mV, mic 2-3mV, two tape inputs 110mV. Size: 476 × 244 × 182mm. Finish: rosewood. Price: £209 (including VAT).

#### M150

Main amplifier. Output: 75W RMS per channel into 8 ohms, both channels driven. FR: 10Hz-90kHz to within 1dB. Size: 476 × 244 × 182mm. Finish: rosewood. Matches the CL350 pre-amplifier. Price: £253 (including VAT).

#### 507X ★

Integrated stereo amplifier. 39 transistors. Inputs: PU (1) 2mV 30K/50K/100K switched, PU (2) 2mV 50K, aux (1) 90mV 50K, aux (2) 90mV 200K. Noise level: PU inputs -63dB, aux inputs -80dB. Output: 50W RMS per channel. Output impedance: 8 ohms. Tone controls: bass defeat 150, 300, 600Hz; treble defeat 6kHz, 3kHz, 1.5kHz; bass cut -6dB/octave from 70Hz, treble cut -6dB/octave from 6kHz. HD: 0.04%. FR: 10Hz-60kHz -1dB. Size: 17½ × 10⅝ × 6⅜ in. Finish: rosewood cabinet with white/gold metal facia. Price: £180 (plus £18 VAT).

#### SQ505X

Integrated stereo amplifier. 37 transistors. Inputs: mag PU (2) 2mV at 30K, 50K or 100K selectable, aux (3) 80mV 30K. Noise level: (PU) 63dB, (aux) 80dB. Output: 35W RMS per channel. Controls: bass defeat (150, 300, 600Hz), treble defeat (1.5, 3, 6kHz), bass filter -6dB at 70Hz, treble filter -6dB at 6kHz. HD: <0.04% at 1kHz at 1V. Output impedance: 8 ohms. FR: 10Hz-60kHz-1dB. Mains: 120, 240V. Size: 17½ × 6⅝ × 10⅝ in. Finish: rosewood cabinet with champagne panel. Price: £165 (including VAT).

#### MAJOR

Impo Hi-Fi, 22 Buckingham Palace Road, London, SW1. Tel: 01-834 0050.

#### AS 2000

Stereo integrated amplifier. Inputs: phono (mag) 3.5mV 47K, phono (ceramic) 130mV, tuner 320mV, aux 200mV, tape play 350mV. S/N: aux

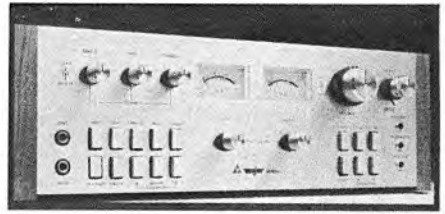

Major AS 8000

and tuner -70dB, phono -60dB, tape play -75dB. Outputs: 15W/channel into 4 ohms, 10W/channel into 8 ohms. Tape output voltage (high level) 350mV, (DIN) 30mV. THD: at 1kHz, 0.07% at 1W, 1% at rated output. FR: 20Hz-20kHz at 1W, ±1.5dB. Mains: 110, 130, 220, 240V 50-60Hz. Price: £57.50 (including VAT).

#### AS 4000

Integrated stereo amplifier. Inputs: phono (mag) 3.2mV, phono (ceramic) 120mV, aux 190mV, tape play 330mV, mic 5mV 47K, tuner 320mV. S/N: aux and tuner -73dB, phono (mag) -62dB, phono (ceramic) -60dB, tape play -75dB, mic -65dB. Outputs: 25W/channel at 1kHz into 4 ohms, 20W/channel into 8 ohms. FR: 20Hz-20kHz at 1W, +1.5dB. Tape output voltage: (high level) 350mV, (low DIN) 30mV. Mains: 110, 130, 220, 240V 50-60Hz. Price: £105 (including VAT).

#### AS 8000 ★

No details available at the time of going to press. Price: £145 (including VAT).

#### MARANTZ

Pyser Ltd, Fircroft Way, Edenbridge, Kent. Tel: Edenbridge (073 271) 4111.

#### Model 1030

Integrated stereo amplifier: 22 transistors and 14 diodes. Inputs: mag PU 2.1mV 47K, mic 2.1mV 47K, aux 150mV 100K. Noise level: (PU input) -93dB. Overload capability: (PU input) 100mV. Output: 15W RMS per channel, both channels driven. Output impedance: 8 ohms. Tone controls: bass ±12dB at 50Hz, treble ±12dB at 15kHz, high filter 16dB/octave from 5kHz, low filter 16dB/octave from 100Hz. HD: 0.5% from 40Hz-20kHz. FR: 20Hz-20kHz ±1dB at 1W. Output circuits automatically protected. Mic input on front panel. Main and remote speakers and headphones. Size: 14½ × 4¼ × 12in. Finish: gold anodised front panel. Price: £75 (plus £7.50 VAT).

#### Model 1060

Integrated stereo amplifier. 35 transistors and 14 diodes. Inputs: mag PU 1.8mV 47K, mic

★ Indicates entry is illustrated

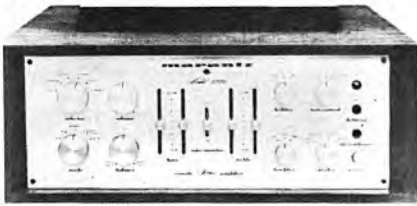

Marantz 1200



Metrosound ST20 Mk II



Marantz 4060

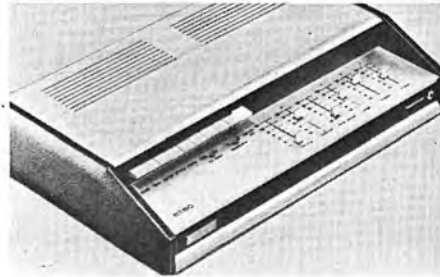

Metrosound ST60

1.8mV 47K, aux 180mV 100K. Noise level: (PU input) -96dB. Overload capability: (PU input) 100mV. Output: 30W RMS per channel, both channels driven. Output impedance: 8 ohms. Tone controls: bass  $\pm 15$ dB at 50Hz, treble  $\pm 12$ dB at 15kHz, high filter 16dB/octave from 5kHz, low filter 16dB/octave from 100Hz, middle control  $\pm 6$ dB at 700Hz. HD: 0.5% 20Hz-20kHz. FR: 20Hz-20kHz  $\pm 0.5$ dB at 1W. Automatic protection of output circuits. Three-zone tone controls. Front panel sockets for mic and aux. Size:  $14\frac{1}{4} \times 4\frac{3}{4} \times 14$ in. Finish: gold anodised front panel. Price: £110 (plus £11 VAT).

#### Model 1120

Integrated stereo amplifier. Inputs: mag PU 1.38mV 47K, mic 1.38mV 47K, aux 138mV 125K. Overload capability: (low level inputs) 100mV. Output: 60W RMS per channel from 20Hz-20kHz at 0.08% distortion. Controls: six-position input selector, high filter 9kHz slope 12dB/octave, low filter 50Hz slope 12dB/octave, four slider type graphic tone controls (one for each channel), tape monitor pushbuttons, loudness switch, muting switch, main remote speaker switch. Tape dubbing jacks. HD: 0.08% 20Hz-20kHz. Output impedance: 8 ohms. FR: 5Hz-50kHz  $+0.5$ dB -3dB at 1W, 20Hz-20kHz  $\pm 0.3$ dB at 1W. Mains: 120, 220, 240V AC. Size:  $15\frac{3}{8} \times 5\frac{3}{4} \times 14$ in. Finish: simulated walnut with gold anodised front panel. Automatic overload protection for circuit and speakers. Price: £220 (plus £22 VAT).

#### Model 1200 ★

Integrated stereo amplifier. 63 transistors and 23 diodes. Inputs: mag PU 1.35mV 47K, aux 134mV 100K. Output: 100W per channel RMS, both channels driven. Output impedance: 8 ohms. High filter: 5kHz, 9kHz. Low filter: 50Hz, 100Hz. HD: 0.15% 20Hz-20kHz. FR: 20Hz-20kHz  $\pm 0.1$ dB at 1W. Centre channel output facility. Fully protected output circuits. Slider type graphic tone controls. Tape dubbing jack sockets on front panel. Size:  $15\frac{3}{8} \times 5\frac{3}{4} \times 14$ in. Finish: gold anodised front panel. Price: £375 (plus £37.50 VAT).

#### Model 3300

Stereo preamplifier control unit. 22 transistors and 10 diodes. Inputs: mag PU 1.35mV 47K, mic 1.35mV 47K, aux 135mV 50K. Outputs: (main) 3V into 47K, (tape) 3V into 47K, (centre channel) 3V into 47K, (headphones) 3V into 8 ohms. Tone controls: treble  $\pm 10$ dB at 10kHz, bass  $\pm 10$ dB at 100Hz, high filter 5kHz and 9kHz switchable, low filter 50Hz and 100Hz switchable. HD:  $< 0.02$ % at 3V 20Hz-20kHz. FR: 6Hz-80kHz  $\pm 0.3$ dB, 20Hz-20kHz  $\pm 0.25$ dB. Tape dubbing jack sockets on front panel. Centre channel output. Slider type graphic tone controls. Tape monitoring facility for two or three head decks. Size:  $15\frac{3}{8} \times 5\frac{3}{4} \times 8\frac{3}{4}$ in. Finish: gold anodised front panel. Price: £235 (plus £23.50 VAT).

#### Model 250

Stereo power amplifier. 45 transistors and 18 diodes. Input sensitivity: 1.35V for rated power.

Input impedance: 100K. Noise level: better than 106dB below rated power into 8 ohms. Output: 125W per channel RMS, both channels driven. HD: <0.1% 20Hz-20kHz. Output impedance: 8 ohms. FR: 20Hz-20kHz + 0.1dB, 2Hz-100Hz  $\pm$ 1.5dB at 1W. VU meters. Relay-operated overload protection. Direct-coupled output circuitry. Size:  $15\frac{3}{8} \times 6\frac{1}{8} \times 9\frac{1}{2}$ in. Gold anodised front panel. Price: £305 (plus £30.50 VAT).

#### Model 2440

Four-channel 'Quadradial' adaptor/amplifier. Synthesises four-channel sound from any stereo source, decodes any matrix encoded record or FM broadcast and has provision for future quadraphonic developments. Inputs: matrix, tape front, tape rear, aux. Output: 20W per channel (four) 20Hz-20kHz. Controls: treble  $\pm$ 12dB at 15kHz, bass  $\pm$ 14dB at 50Hz, variable dimension, mode. HD: 0.18% 20Hz-20kHz. Output impedance: 8 ohms. FR: 15Hz-80kHz  $\pm$ 2dB, 20Hz-20kHz  $\pm$ 0.5dB at 1W output. Mains: 110, 120, 220, 240V AC. Size:  $16\frac{7}{8} \times 5 \times 14$ in. Finish: simulated walnut metal chassis with gold-anodised front panel. Price: £165 (including VAT).

#### Model 4060 ★

Integrated four-channel amplifier. Inputs: mag PU 1.8mV 47K, high level 180mV, radio, aux. Overload capability: 100mV. Output: 60W RMS total into 8 ohms (15W RMS per channel). Controls: five-position mode switch, slider vari-matrix control, slider for balance (left, right, front, rear), separate sliders for bass and treble (front and rear). Pushbuttons for main/remote speakers and headphones, tape monitor, remote control, loudness. HD: 0.25% 20Hz-20kHz. Output impedance: 8 ohms. FR: 20Hz-20kHz  $\pm$ 1dB at 1W. Size:  $14\frac{1}{4} \times 4\frac{3}{4} \times 12$ in. Finish: simulated walnut metal chassis with gold-anodised front panel. Pocket in base for plug-in SQ decoder. Price: £176 (including VAT).

#### Model 4100

Integrated four-channel amplifier. Synthesises four-channel sound from any stereo source, decodes any matrix encoded record or FM broadcast and has provision for future quadraphonic developments. Inputs: mag PU 1.8mV 47K, high level 180mV 120K, radio, aux. Overload capability: 100mV. Output: (four channels) 25W per channel into 8 ohms, (two channels) 60W RMS per channel into 8 ohms. Controls: treble  $\pm$ 12dB at 15kHz,  $\pm$ 14dB at 50Hz, high filter 6dB/octave at 9kHz, slider type balance controls for left, right, front and rear. Four level meters. Mode switch for vari-matrix mono, stereo, discrete and SQ. HD: 0.3% 20Hz-20kHz. Output impedance: 4-8 ohms. FR: 20Hz-20kHz 0.5dB at 1W. Mains: 110, 120, 220, 240V

AC. Size:  $15\frac{3}{8} \times 5\frac{3}{4} \times 14\frac{1}{2}$ in. Finish: walnut (cabinet optional), simulated walnut metal chassis with gold-anodised front panel. Under chassis pocket for plug-in decoder. Price: £286 (including VAT).

#### ■ McIntOSH

Wilmex Ltd, 24-26 Ensign Street, London, E1 8JD. Tel: 01-949 2545.

Range of high quality audio amplifiers being introduced and distributed but no product details obtainable as this edition of the Year Book closed for press.

#### ■ METROSOUND

Metrosound Audio Products Ltd, Audio Works, Carters Road, Waltham Abbey, Essex, EN9 1JF. Tel: Waltham Cross (97) 31933.

#### ST20 Mk II ★

Transistorised stereo amplifier. Output: 10W RMS per channel. HD: less than 1% at rated output. FR: 30Hz-30kHz  $\pm$ 2dB at rated output. Noise level: -70dB. Inputs: mag PU 2.5mV, ceramic PU 150mV, radio 150mV. Noise level: mag PU input -65dB, other inputs -70dB. Overload capability: mag PU input >30dB. Output impedance: 8 ohms. Mains: 200-250V AC (100-120V to special order). 20 transistors, 2 diodes. Controls: pushbutton controls for mains on/off, mono/stereo, tape, tuner, mag PU, ceramic PU. Rotary controls for treble, bass, balance and volume. Bass control:  $\pm$ 12dB at 40Hz. Treble control:  $\pm$ 12dB at 14Hz. Tape outlet: 300mV per channel at 5K. Automatically switchable headphonesocket, 4-16 ohms. Finish: anodised brushed silver facia with polished trim and knobs, teak veneer cabinet. Size:  $3\frac{1}{2} \times 15\frac{1}{4} \times 10$ in. Price: £48.40 (including VAT).

#### ST40

Integrated stereo amplifier. 26 transistors, 10 diodes. Inputs: mag PU 2.5mV 50K, crystal PU 100mV 1.5M, radio 100mV 1.5M, tape 100mV 1.5M. Output: 20W RMS per channel. Controls: volume, bass  $\pm$ 12dB at 40Hz, treble  $\pm$ 12dB at 14kHz, balance. HD: <0.1% at rated output. Output impedance: 8 ohms. FR: 20Hz-30kHz +0dB -1dB at full power. Mains: 200-250V AC (100-120V AC to special order). Size:  $14\frac{7}{8} \times 3\frac{1}{4} \times 10\frac{1}{2}$ in. Finish: anodised aluminium wrap-round panel with teak grained end panels. Outlets for tape recorder and headphones. Price: £62.15 (including VAT).

#### ST60 ★

Integrated stereo amplifier. Output: 30W RMS per channel. Output impedance: 8 ohms. FR: 20Hz-50kHz  $\pm$ 2dB. HD: 0.08%. H and N: (mag PU) 65dB. (other inputs) 70dB. Tone controls: bass  $\pm$ 14dB at 40Hz, middle  $\pm$ 10dB

★ Indicates entry is illustrated



Nikko TRM-300



Nikko TRM-500



Nikko TRM-400



Onkyo 733

at 800Hz, treble  $\pm 14$ dB at 14kHz. Inputs: mag PU 3mV or 10mV at 47K, radio 5mV 120K, tape 5mV 120K, aux 5mV 120K. Filter: switched at 10kHz, 7kHz, 4kHz, variable from 0-20dB per octave. Outlets: two pairs of separately switched speaker sockets. Mains: 200-250V AC (100-120V AC to special order). Two switched mains outlet sockets. Tape outlet: 250mV. Piano style keys, slider controls. Finish: aluminium fascia, teak cabinet, padded ends. Size:  $20\frac{1}{8} \times 3\frac{3}{8} \times 12\frac{1}{2}$ in. Weight: 20lb. Price: £85.80 (including VAT).

#### ■ MILLBANK

Millbank Electronics Group, Bellbrook Estate, Uckfield, Sussex, TN22 1PS.

Tel: Uckfield (0825) 4166.

#### MEX-1001C

Mono power amplifier. 12 transistors, 13 diodes. Input: 775mV at 10K. Noise level: -80dB. Output: (nominal) 100W. HD: typically 0.1% at 1kHz at rated power. Output impedance: 8 ohms. FR: 30Hz-20kHz - 3dB at half rated output. Mains: 220, 235, 250V 50-60Hz. Size:  $19 \times 3\frac{1}{2} \times 15$ in. Price: £145 (plus VAT).

#### ■ NATIONAL PANASONIC (UK) LTD

Whitby Road, Trading Estate, Slough, Bucks.

Tel: Slough 34522. Telex: 847652.

#### SU3000

Integrated stereo amplifier. Full specification on request. Price: £69.95 (including VAT).

#### SU3400

Integrated stereo amplifier. Full specification on request. Price: £124.95 (including VAT).

#### SU3600

Integrated stereo amplifier. Full specification on request. Price: £159.95 (including VAT).

#### ■ NIKKO

Distributors: Howland-West Ltd

3-5 Eden Grove, London, N7 8EQ.

Tel: 01-609 0293.

#### TRM-1200

Integrated transistor stereo amplifier. Inputs: mic 2mV 50K, tape 220mV 100K, PU 1.2mV 50K, radio 220mV 100K, aux 220mV 100K. Signal to noise: tape, tuner and aux inputs 85dB; mic and PU 70dB. Controls: function, volume, balance, tone controls in/out, low filter, high filter, speaker switching, mode, tape monitor on/off, base right, base left, treble right, treble left, on/off, meter level control, loudness. Output: 40W RMS into 8 ohms. HD: 0.9% at rated output. FR: 13Hz-50kHz  $\pm 1$ dB at 30W. Output impedance: 4-16 ohms. Mains: 117-240V 50-60 Hz. Size:  $15\frac{1}{2} \times 12\frac{1}{2} \times 4\frac{1}{2}$ in. Price: £120 (plus £12 VAT).

#### TRM-210

Integrated stereo amplifier. Output power: 16W channel into 8 ohms. Inputs: phono 1.8mV 50K, tuner 200mV 100K, tape and aux 200mV 100K. Price: £59.40 (including VAT).

#### TRM-230

Integrated stereo amplifier. Output power: 20W

channel into 8 ohms. Inputs: phono (1 & 2) 1.8mV 50K, tuner 200mV 100K, tape and aux 200mV 100K. Main in 850mV 150K. Price: £69.30 (including VAT).

#### TRM-300 ★

Integrated stereo amplifier. 26 transistors. Inputs: mag PU 1.8mV 70K, PU (2) 120mV 50K, radio 200mV 100K, aux 150mV 100K, tape monitor 190mV 50K. Noise level: PU (2) input 60dB, other inputs > -70dB. Output: 12W RMS per channel. Output impedance: 8 ohms. Controls: bass, treble, balance, volume, input selector, loudness, tape monitor, mono/stereo. HD: 1%. FR: 30Hz-20kHz ±1dB at rated output. Size: 12 × 8½ × 3¾ in. Price: £44.50 (plus £4.45 VAT).

#### TRM-400 ★

Integrated stereo amplifier. 22 transistors, two ICs. Inputs: mag PU 1.8mV 35K, tape head 1.8mV 200K, PU (2) 120mV 35K, radio 200mV 220K, aux 150mV 220K, tape monitor 190mV. Noise level: tape head and PU inputs -60dB, other inputs -70dB. Output: 16W RMS per channel. Output impedance: 8 ohms. Controls: bass, treble, balance, volume, A+B speakers, low filter, high filter, loudness, tape monitor. HD: 1%. FR: 30Hz-20kHz. Size: 12 × 8½ × 3¾ in. Price: £56 (plus £5.60 VAT).

#### TRM-500 ★

Integrated stereo amplifier. 29 transistors, 9 diodes. Inputs: mag PU 2mV 47K, tape 150mV 50K, aux 150mV 50K, radio 150mV 50K. Noise level: (mag PU input) -60dB, (other inputs) -80dB. Output: 26W RMS per channel. Controls: bass ±10dB at 70Hz, treble ±10dB at 10kHz, loudness +11dB at 70Hz+7dB at 10kHz, low filter -8dB at 70Hz, high filter -7dB at 10kHz, speaker switch (A, A+B, B), tape dubbing. HD: 0.2% at 1W, 0.8% at rated output. Output impedance: 8 ohms. FR: 20Hz-30kHz ±2dB. Mains: 100, 120, 220, 240V 50-60 Hz. Size: 15 × 8¾ × 11¾ in. Finish: wood cabinet with metal trim. Price: £87.45 (including VAT).

#### TRM-600

Full technical specification not available as this edition of the Year Book closed for press. Integrated stereo amplifier. Finish: wood cabinet with metal control panel. Price £103.95 (including VAT)

### ■ ONKYO

J. Parkar & Co (London) Ltd, Parkar House, Beresford Avenue, Wembley, Middlesex, HA0 1YX. Tel: 01-903 5211

#### Integra 725 ★

Integrated stereo amplifier. Inputs: PU (1) 2.4mV 50-100K, PU (2) 2.4mV 50-100K, tuner 100mV 100K. H and N: (PU input) better than 75dB, (tuner input) better than 90dB. Overload

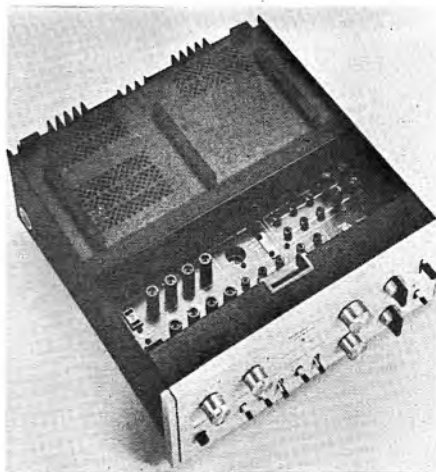

Onkyo Integra 725

capability: PU input 200mV. Tone controls: bass ±10dB at 100Hz, treble ±10dB at 10kHz, low filter -6dB/octave at 70Hz, high filter -6dB/octave at 8kHz. Output: 22W RMS per channel into 8 ohms. HD: <0.1% at rated output. FR: 15Hz-70kHz at rated output. Output impedance: 4-16 ohms. Loudness control. Headphone and mains outlets. Mains: 100-120V or 220-240V AC 50-60Hz. Size: 12¾ × 5¾ × 13½ in. Weight: 17½ lb. Price £130.54 (including VAT).

#### Model 732

Stereo integrated amplifier. Inputs: phono (1) 2mV 50 or 30K, phono (2) 2mV 50K, phono (moving coil) 83µV 80 ohms, mic 1.8mV 50K, tuner, aux (1 & 2) tape 100mV 100K. Outputs: Pre-out (1 & 2) 1V 100K, speakers 56W channel into 8 ohms, 68W channel into 4 ohms. THD: <0.1% at rated output, 1kHz. FR: 10Hz-80kHz -1dB. Power bandwidth: 10Hz-100kHz (IHF -3dB, THD 0.2%). S/N: >110 dB (IHF-A). Damping factor: 100 (DC -20 kHz). Mains: 100, 120, 220, 240V AC 50-60Hz. Size: 437 × 355 × 136mm. Price: on application.

#### 733 ★

Stereo control unit. 50 transistors, 19 diodes. Inputs: mag PU (1) 2.4mV 30-50K, mag PU (2) 2.5mV 50K, mic 1.8mV 50K. Noise level: mag PU inputs -75dB, mic input -55dB. Output: rated 1V, maximum 4V. Controls: tone defeat, high filter 12dB/octave from 10kHz, low filter 12dB/octave from 70Hz, loudness, muting, volume. HD: <0.05% at 1V at 1kHz output. Output impedance: 2-2K. FR: 10Hz-70kHz +0dB -1dB at 1V. Mains: 100, 120, 220, 240V AC. Size: 17½ × 14 × 5½ in. Finish: brushed aluminium. Top entry terminals for easy accessibility. Price: £176.24 (including VAT).

★ Indicates entry is illustrated

## ■ PHILIPS

Philips Electrical Ltd, Century House,  
Shaftesbury Avenue, London, WC2H 8AS.  
Tel: 01-437 7777.

### RH520 ★

Integrated stereo amplifier. 26 transistors, 11 diodes. Inputs: mag PU 2mV 50K, ceramic PU 50mV 100K, tape 250mV 100K, radio 100mV 100K. Noise level: -60dB. Overload capability: (mag PU input) 35dB, (other inputs) 33dB. Output: 15W RMS per channel ± 1dB. Controls: balance, bass ± 14dB at 50Hz, treble ± 13dB at 10kHz, volume, contour, rumble, scratch, mono/stereo, input selector, headphones. HD: < 1%. Output impedance: 4 ohms. FR: 20Hz-20kHz ± 1dB at 50mW. Mains: 110, 127, 220, 240V 50-60Hz. Size: 16½ × 11¾ × 4¾ in. Finish: walnut and brushed aluminium. Separate illuminated output meters. Four channel surround sound facilities. Price: £87.50 (including VAT).

### RH521

Integrated stereo amplifier. 32 transistors. Inputs: mag PU 2mV 50K, radio 100mV 100K, tape 250mV 100K, aux 100mV 1M, microphone 1mV 2K. Noise level: -90dB. Output: 30W RMS per channel ± 1dB. Controls: volume, balance, bass ± 14dB, treble ± 15dB, presence ± 6dB at 2kHz, loudness (three positions) scratch filter, rumble filter, monitor. Output impedance: 4 ohms. HD: < 0.1% at 20W per channel. FR: 20Hz-20kHz ± 1dB at 50mW. Mains: 110, 127, 220, 240V AC. Size: 18½ × 4¾ × 11¾ in. Microphone input. Two sets of speaker outlets. Headphone socket. Finish: walnut veneer cabinet with brushed aluminium fascia. Price: £135 (including VAT).

## ■ PHOENIX

H. L. Audio Ltd, 9B Garman Road,  
Tottenham, London, N17. Tel: 01-808 6127.

### Phoenix 77

Integrated stereo amplifier. Inputs: mag PU, ceramic PU, radio, tape. Output: 10W RMS per channel. FR: 40Hz-20kHz. Controls: bass, treble, balance, volume, scratch filter. Switched headphone socket. Finish: black and brushed aluminium fascia. Price: £29 (plus VAT).

## ■ PHOTAX-CONCERTONE

Photax (London) Ltd,  
Hampden Park, Eastbourne, Sussex.

### Model 420

Integrated stereo amplifier. Inputs: phono (1) 2.5mV, phono (2) 2.5mV, aux or phono (3) 150mV, tuner 150mV, tape 150mV. Outputs: tape, main speakers, remote speakers, unswitched mains: FR: 20Hz-50kHz ± 1dB. Output: 12W per channel (one driven) into 8 ohms.



Philips RH520

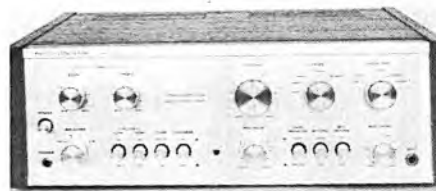

Photax-Concertone 800B

THD: less than 0.6% hum and noise: phono -60dB, tuner and aux -70dB. Mains: 100, 117, 220 or 240V. Price: £66.95 (including VAT).

### Model 620

Integrated stereo amplifier. Inputs: phono (1) 2.5mV, phono (2) 2.5mV, aux or phono (3) 150mV, tuner 150mV, tape (1) 150mV, tape (2) 150mV. Outputs: two tape, main speakers, remote speakers, unswitched mains. FR: 20Hz-40kHz, ± 1dB. Output: 18W RMS. both channels driven, per channel into 8 ohms. THD: less than 0.4% at rated output. Hum and noise: phono -65dB, tuner and aux -75dB. Mains: 100, 117, 220 or 240V. Price: £79.65 (including VAT).

### Model 800B ★

Integrated stereo amplifier. Inputs: phono (1) 2.5mV 30 or 50 switched, phono (2) 2.5mV 50K, tuner 150mV 50K, aux (1) 150mV 50K, aux (2) 50mV 50K. Mic 2.2mV 22K, tape 150mV 50K. FR: 5Hz-70kHz. Output: 34W per channel into 8 ohms. THD: less than 0.4% at rated output. Hum and noise: phono and mic -65dB, tuner and aux -75dB. Mains: 100, 117, 220 or 240V. Price: £107 (including VAT).

## ■ PIONEER

Distributors: Shriro (UK) Ltd,  
Shriro House, The Ridgeway, Iver, Bucks,  
SL0 9JL. Tel: Cedarwood (075 38) 2222.

### SA 500A ★

Stereo integrated amplifier. Inputs: phono (1) 2.5mV 50K, phono (2) 2.5mV 50K, tuner 200mV 100K, aux (1 & 2) 200mV 100K, tape (1 & 2) 200



\* Toshiba SB-300  
Pre / Main Power Amplifier  
17w RMS per channel.  
Sugg. retail (inc. V.A.T.) £78.50

Toshiba ST-500  
FM / AM Stereo Tuner  
Sugg. retail (inc. V.A.T.)  
£107.50

Toshiba SA-300L  
Stereo FM / AM Tuner  
Amplifier 14w RMS per channel  
Sugg. retail (inc. V.A.T.) £117.35

\* Toshiba SB-500  
Pre / Main Power Amplifier  
35w RMS per channel  
Sugg. retail (inc. V.A.T.) £137.40

\* Toshiba SA-500  
Stereo FM / AM Tuner  
Amplifier 35w RMS per  
channel Sugg. retail  
(inc. V.A.T.) £172.30

# For further amplification of foolproof equipment see your Toshiba dealer

Or contact Derek Perriam at Toshiba (UK) Ltd.,  
Toshiba House, Great South West Road,  
Feltham, Middlesex. (Tel: 01-751 1281).



# TOSHIBA





\*Dolby is a trade mark of Dolby Laboratories, Inc.

\*Yamaha wind instruments by courtesy of Bill Lewington Ltd.,  
144, Shaftesbury Avenue, London WC2.

**Every musical instrument on this page  
is made by Yamaha.**



**CR 600** Stereo AM/FM Tuner Amplifier 30 watts r.m.s. per channel  
**TB 700** Stereo Cassette Deck with Dolby<sup>®</sup> Noise Reduction.\*

**YP 700** Two speed, semi-automatic belt drive turntable, with magnetic cartridge  
**NS 625** Speakers. Two-way systems with power handling of 40 watts r.m.s.

# Every musical instrument on this page is made by Yamaha.

Yamaha make musical instruments.

We make French horns and oboes, flutes and clarinets, guitars and drums, concert grands and organs, trumpets and stereo systems.

To us, a stereo system is a musical instrument.

Above, one of the systems we make. And we make it with as much care and love as any of our other instruments.

If that sounds as if we're blowing our own trumpet, we'd like to suggest you try an experiment.

Go to a good hi-fi store. Ask to hear anybody's trumpet—whether it belongs to The Who, The Hallé or Mister Miles Davis—blown through a Yamaha system.

That's when you'll begin to understand how good a musical instrument can sound.



**YAMAHA**

MAKERS OF FINE MUSICAL INSTRUMENTS SINCE 1887

TO: Yamaha Natural Sound (UK), Strathcona Road, Wembley, Middx HA9 8QL 01-904 0141

I would like to read more about Yamaha Systems, in particular:

- Music Centres
- Tuners and tuner amps
- Turntables
- Amplifiers
- Cassette Decks
- Speakers

Name \_\_\_\_\_

Address \_\_\_\_\_

\_\_\_\_\_

\_\_\_\_\_

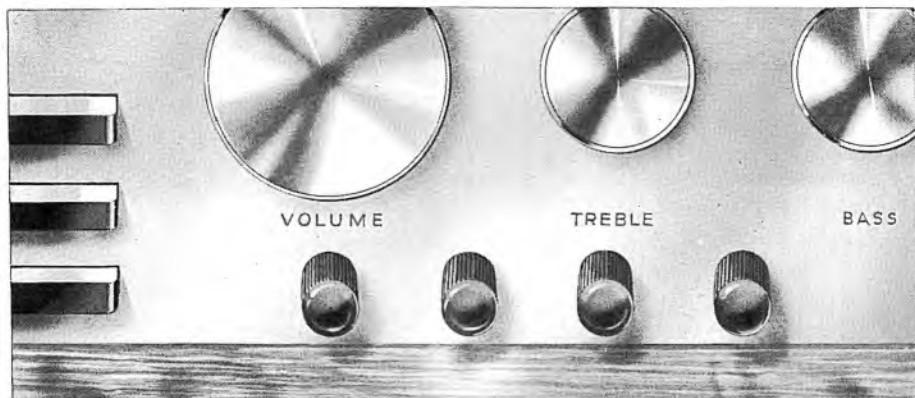

# As well as the record shop **E.M.G.** have an exceptionally well appointed equipment department

It contains a most attractive array of products acknowledged to be the best of their kind available, and selected for their excellent performance, quality and reliability. What you will find there covers a usefully wide price range. More important, however, is the extent to which E.M.G. will willingly go to ensure customer satisfaction. Make your requirements known to E.M.G. and you can depend on receiving thorough and impartial advice. This might mean substituting a single item in an existing installation, a conversion and modern-

isation of what you have already, or a complete new installation. When you become a customer of E.M.G., you will find that service can go on long past the time of your purchase and that the Company identifies itself with your interests completely. There is no better way to ensure good listening. For a start, might we suggest, without obligation, a demonstration in our showroom? You will find our approach to high fidelity very much what you have always wanted.

There is also the record shop for records of classical and serious modern works and the E.M.G. Monthly Letter (£2.00 post free for twelve months) to inform and advise on current releases. A well organised records-by-post department serves those unable to call in person.

**E.M.G.** HANDMADE GRAMOPHONES LIMITED  
26, SOHO SQUARE, LONDON, W1V 6BB

Telephone 01-734 4311

Nearest Underground Tottenham Court Road

mV 100K. S/N: phono 80dB, tuner 70dB, all others 90dB; all ref rated output. Outputs: 13W channel into 8 ohms, 16W channel into 4 ohms. THD: 0.5% at full power, 0.1% at half power. Damping factor: 40 at 1kHz into 8 ohms. FR: 30Hz-50kHz+1dB -2dB. Mains: 110, 120, 130, 220, 240V AC. Size: 13×4.6×12½ in. Price: £68.31 (including VAT).

#### SA 6200 ★

Stereo integrated amplifier. Inputs: phono (1 & 2) 2.5mV 50K, mic 7.5mV 50K, tuner 150mV 100K, aux (1 & 2) 150mV 100K, tape (1 & 2) 150mV 100K. Outputs: speakers 22W channel into 8 ohms, 27W channel into 4 ohms. Damping factor: 30 at 1kHz, 8 ohms. THD: 0.5% at full power, 0.1% at half power. FR: 15Hz-30kHz ±1dB. Mains: 110, 120, 130, 220, 240V AC. Size: 16½×5¾×12¾ in. Price: £119.48 (including VAT).

#### SA 7100

Stereo integrated amplifier. Inputs: phono (1 & 2) 2.5mV 50K, mic 2mV 50K, tuner 150mV 100K, aux (1 & 2) 150mV 100K, tape (1 & 2) 150mV 100K. S/N: phono and mic 80dB, tuner 70dB, all others 90dB; all ref full output. Outputs: speakers 25W channel into 8 ohms, 36W channel into 4 ohms. Damping factor: 40 at 1kHz, 8 ohms. THD: 0.5% at full power, 0.05% at half power, at 1kHz. FR: 15Hz-30kHz-1dB. Mains: 110, 120, 130, 220, 240V AC. Size: 16½×5¾×13 in. Price: £159.28 (including VAT).

#### SA 8100

Stereo integrated amplifier. Inputs: phono (1) 2.5mV 50K, phono (2) 2.5-5mV 50K, mic 2mV 50K, tuner 150mV 100K, aux (1 & 2) 150mV 100K, tape (1 & 2). S/N: phono and mic 80dB, tuner 70dB, all others 90dB; all ref to full output. Outputs: speakers 50W channel into 8 ohms, 60W channel into 4 ohms, at 1kHz. Damping factor: 60 at 1kHz, 8 ohms. THD: 0.3% at full power, 0.05% at half power at 1kHz. FR: 10Hz-70kHz-1dB. Mains: 110, 120, 130, 220, 240V AC. Size: 16½×5¾×13 in. Price: £228.99 (including VAT).

#### SA 9100

Stereo integrated amplifier. Inputs: phono (1) 2.5mV 50K, phono (2) 2.5mV 25 or 50 or 100K, mic 2mV 50K, tuner 150mV 100K, aux (1) 150mV 100K, aux (2) 150mV 50K, tape mon (1 & 2) 150mV 100K. S/N: phono and mic 80dB, tuner 70dB, all others 90dB at full output. Outputs: 50W channel into 8 ohms, 60W channel into 4 ohms. Damping factor: 60 at 1kHz, 8 ohms. THD: 0.3% at full power, 0.05% at half power at 1kHz. FR: 10Hz-70kHz-1dB. Mains: 110, 120, 130, 220, 240V AC. Size: 16½×5¾×13 in. Price: £228.99 (including VAT).



Pioneer SA 500A

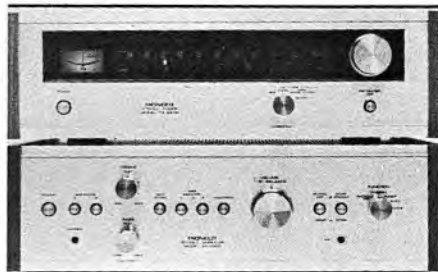

Pioneer SA 6200 with TX 6200 tuner

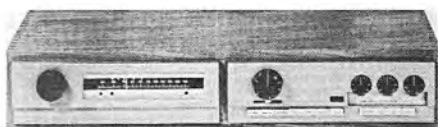

Quad 33 and FM3 in wood sleeve

#### ■ QUAD

Acoustical Manufacturing Co Ltd,  
St Peter's Road, Huntingdon, PE18 7DB.  
Tel: Huntingdon (0480) 52561.  
Cables: Acoustical.

#### Quad 33 control unit ★

Transistorised mono/stereo control unit. Inputs: PU from 2mV, radio (1) 100mV 100K, radio (2) 100mV 100K, tape from 100mV 40K. Signal-to-noise level: -70dB on PU, -85dB on all other inputs. Output: 0.5V. Controls: volume, balance, bass, treble, filter slope, filter frequency. Mains powered. Designed for use with Quad 303 amplifier but suitable for operation with other high quality equipment. Size: 10¼×3⅝×6½ in. Price: £63.80 (including VAT).

#### Quad 50/E

High quality transistor power amplifier primarily intended for professional and industrial use. Input: 500mV RMS into 14 to 50K according to gain control setting for 50W output, or standard 600-ohm line bridging input. Output: 50W. Output transformer secondaries linked by output connector to provide for 4 to 300 ohm loads. Damping factor 10. Total harmonic distortion: 0.1% at 1kHz at any level up to 50W output.



Quad 303 power amplifier

Hum better than 80dB. Consumption: 24-150W depending on power output: Mains: 100-127V or 200-250V 50-60Hz. Size:  $12\frac{3}{4} \times 6\frac{1}{2} \times 4\frac{3}{8}$  in. Weight: 24lb. Price on application.

**Quad 303 power amplifier ★**

Transistorised stereo power amplifier. Output: 45W into 8 ohms. HD: 0.03% at 70Hz and 700 Hz, 0.1% at 10kHz. FR: -1dB 30Hz-35kHz into 8 ohms, -1dB 20Hz-35kHz into 16 ohms. Noise level: -100dB. Sensitivity: 0.5V. Output impedance: 4-16 ohms. Output transistors: High voltage 2N3055. Mains. Designed for use with Quad 33 control unit but can be used with other high quality equipment. Size:  $4\frac{3}{8} \times 6\frac{1}{4} \times 12\frac{3}{8}$  in. Price: £74-80 (including VAT).

**■ RADFORD AUDIO LTD**

Ashton Vale Road, Bristol, BS3 2HZ.  
Tel: Bristol (0272) 652301.

**HD 22**

Stereo preamplifier. Inputs: phono, tuner, two tape machines. Distn: zero at rated output. Noise -83dB ref. 5mV phono input -85dB, line input. Output: Rated 1V, 17V clipping level. Size:  $17 \times 4\frac{3}{8} \times 9$  in. Price: £100 (including VAT).

**HD 250**

Stereo power amplifier designed for use with HD22 preamplifier. Output: 50W continuous into loads from 4-8 ohms. Max. power, 90W into 5 ohms. THD: less than 0.2% typically 0.1% at rated power. Size:  $17 \times 4\frac{3}{8} \times 11$  in. Price: £185 (including VAT).

**HD224 (SQ)**

Quadraphonic preamplifier based on HD22 with



Revox A78



Richardson Electronics SIA.100

a matrix SQ decoder and a derived synthetic system permitting from two to five channel in-line reproduction. Outputs available: left, right, inside left, inside right and centre (mono). Blend control on the two inside channels permits a graded adjustment of sound stage from stereo sources. Size:  $7 \times 4\frac{3}{8} \times 9$  in. Price: on application.

**HD 502 and HD 504**

The HD 502 is a stereo power amplifier, the 504 being identical but for the provision of four channels for quadraphonic reproduction. Output: 50W per channel into 4-8 ohms. THD: virtually zero at and below rated power output. Size: (HD 502)  $17 \times 4\frac{3}{8} \times 11$  in. Price: (HD 502) £110 (including VAT); (HD 504) £185 (including VAT).

**■ REVOX**

Distributors: C. E. Hammond & Co Ltd, Lamb House, Church Street London. W4 2PB. Tel: 01-995 4551. Telex: 934047.

**Revox A78 ★**

Stereo amplifier. Output: 40W RMS per channel into 4-8 ohms, 25W RMS per channel into 16 ohms. HD: less than 0.1% at 1kHz, 0.3% 40Hz-15kHz. FR: 20Hz-20kHz  $\pm$  1dB. Inputs: mag PU 3mV, ceramic PU 230mV, tape 100mV, aux 100mV, radio 100mV, tape monitor 250mV. Treble control:  $\pm$  12dB at 12kHz. Bass control:  $\pm$  12dB at 60Hz. Mains: 110, 130, 150, 220, 240, 250V 50-60Hz. 30 silicon transistors, 3 rectifiers, 14 diodes. Size:  $6\frac{1}{8} \times 16\frac{3}{8} \times 9\frac{3}{8}$  in. Weight: 18lb. Price: £179-30 (including VAT).

**A 722**

Stereo power amplifier. Inputs: 0.75mV 20K

(for 60W/4 ohms). Outputs: speakers 60W channel into 4 ohms, 45W channel into 8 ohms, 30W channel into 16 ohms. THD: <0.1% at rated power into 4 ohms, 1kHz. FR: 20Hz-20kHz -1dB, into 4 ohms. Power bandwidth: 10Hz-50kHz (DIN) into 4 ohms. S/N: >90dB (ref 60W/4 ohms). Price: £185.90 (including VAT).

**A 724**

Quadraphonic power-amplifier and decoder. Decodes SQ and RM/QS. Inputs for four discrete channels, quadraphonic pan balance control, two headphone jacks, four volume meters with switchable sensitivity. Power output: 4 x 30W. Price: £273.90 (including VAT).

**SGE 520**

Five-band stereo graphic equaliser. Output: 1V 10 ohms (source impedance). Inputs: 1V 75K. FR: 5Hz-100kHz ±1dB. Control range: ±12 dB. Filters centred on 60Hz, 240Hz, 1kHz, 3.5 kHz and 10kHz. THD: 0.05% (2V output, controls centred). Unity gain (controls at centre). Size: 8 5/8 x 4 7/8 x 4 1/4 in. Price: on application.

**■ RICHARDSON ELECTRONICS LTD**

57 Jamestown Road, London, NW1 7EJ.  
Tel: 01-267 0723/4874.

**SCP.2P**

Stereo self-powered control unit. Modular construction with pluggable circuits. FET high Z input. Silicon semi-conductors. Stabilised power supply. Low noise and distortion 0.01% for 1V output. Bass ±20dB. Treble ±16dB. Rumble filter on disc. Quiet listening tape monitor. Mag pickup 2mV inputs (two); high Z 2Mohms 50 mV; aux 250mV (two). Size: 14 3/8 x 14 3/8 x 10 1/2 in. Psn 200-250V 50 or 60Hz. Price: on application.

**SIA.100 ★**

Stereo integrated amplifier and control unit. Pre-amplifier specification as for 2CP.2P. Power amplifier incorporates advance design complementary push-pull output to reduce crossover distortion. Output: 30W RMS per channel into 8 ohms. HD: 0.04%. Output protected against short circuit. Stable at all loads. Mains: 200-250V AC 50-60Hz. Price: on application.

**STA.200**

Stereo transistor amplifier. Output: 100W RMS per channel into 8 ohms. 175W RMS per channel into 4 ohms. Mono version available giving balanced output of 50V into 8 ohms. Price: on application.

**STA.100**

Stereo transistor amplifier. Output: 50W RMS per channel into 8 ohms. 85W RMS per channel into 4 ohms. Price: on application.

**SA170 Mk 2 and MA135 Mk 2**

Valve power amplifiers. Full specification and prices on application.



Rogers Ravensbourne



Rogers Ravensbrook

**■ ROGERS**

Rogers Developments (Electronics) Ltd,  
4-14 Barmeston Road, London, SE6 3BN.  
Tel: 01-698 7424/4340.

Cables: Rodevco, London, SE6.

**Ravensbourne ★**

Solid state stereo amplifier and control unit. Power output: 4, 8 and 16 ohms; 35W per channel RMS. HD: 0.1% average (0.06% at 15W). FR: 25Hz-25kHz ±1dB at 25W. Feedback: 36 dB. N/L: -80dB. Output transistors: 2N3055. Power consumption: quiescent 40W; at 25W +25W into 15 ohms 110W. Inputs: disc, sensitivity 2, 4, 50, 100mV impedance 50K, noise level -60-65dB; aux, radio and tape, sensitivity 200mV, impedance 100K. N/L: -75dB. Controls: pushbutton input selector, volume, bass and treble, balance, low pass filter and slope, function, headphone. Dimensions: case 14 3/4 x 10 1/4 x 5 1/2 in; chassis 13 3/4 x 10 1/8 x 4 in. Price: (chassis) £77.50 (including VAT); (in cabinet) £82.50 (including VAT).

**Ravensbrook Mk III ★**

Solid state stereo amplifier and control unit. Power output: 13W per channel into 15 ohms. 20W per channel into 8 ohms. HD: less than 0.3% at 18W into 8 ohms, less than 0.15% at 13W into 15 ohms. FR: 20Hz-50kHz -3dB. Noise level: disc -53dB, radio -8dB. Power consumption: quiescent 22W; 10W/15 ohms 50W. Inputs: disc, sensitivity 2, 4, 25, 50mV, impedance 47K. Noise level: -53dB. Controls:

★ Indicates entry is illustrated

pushbutton input selector, function, bass and treble, balance, high pass filter switch, low pass filter/slope. Output facility for headphones. Output matching: 4-8 ohms and 8-16 ohms. Dimensions: cabinet  $14\frac{3}{8} \times 9\frac{7}{8} \times 5$ in; chassis  $13 \times 9\frac{3}{4} \times 3\frac{3}{4}$ in. Price: (chassis) £57.75 (including VAT); (in cabinet) £63.25 (including VAT).

#### ROTEL

Rank Audio Visual Ltd, Great West Road, Brentford, Middlesex, TW8 9HR.  
Tel: 01-568 9222. Telex: 24408.

#### RA810 ★

Integrated stereo amplifier. Inputs: mag PU (1) 2mV 100K, mag PU (2) 2-8mV 30-100K, radio 200mV 45K, aux (2) 200mV 45K, tape 330mV 100K. H and N: (PU inputs) -65dB, (other inputs) -75dB. Output: 60W RMS per channel into 4 ohms, 40W per channel into 8 ohms. Tone controls: loudness +10dB at 50Hz and +6dB at 10kHz, high filter -10dB at 10kHz, low filter -10dB at 50Hz, bass  $\pm 10$ dB at 50Hz, treble  $\pm 10$ dB at 10kHz. HD: <0.3% 20Hz-20kHz at 40W output. Output impedance: 4-16 ohms. FR: 4Hz-75kHz+0dB-3dB. Mains: 100, 117, 220, 240V 50-60Hz. Size:  $16\frac{1}{2} \times 12 \times 5\frac{1}{2}$ in. Weight: 22lb. Price: £134.30 (including VAT).

#### RA1210 ★

Integrated stereo amplifier. Inputs: mag PU (1) 1mV 100K, PU (2) 1-4mV 30-100K, radio 200mV 45K, aux 200mV 45K, tape 200mV 45K, tape (DIN) 330mV 100K. Output: 80W RMS per channel into 4 ohms, 60W per channel into 8 ohms. Controls: loudness +10dB at 50Hz and +6dB at 10kHz, low filter -10dB at 50Hz, bass  $\pm 10$ dB at 50Hz, treble  $\pm 10$ dB at 10kHz. HD: <0.1% at rated output. Output impedance: 4-16ohms. FR: 3Hz-50kHz+0dB-3dB. Mains: 100, 117, 220, 240V 50-60Hz. Size:  $16\frac{1}{2} \times 12 \times 5\frac{1}{2}$ in. Weight: 30lb. Price: £165.30 (including VAT).

#### RA211

Integrated stereo amplifier. Inputs: phono (1) 2.7mV 45K; phono (2) 140mV/170mV 100K; aux (1) 150mV 50K; aux (2) 330mV 100K. Noise level: 63dB phono inputs, 70dB aux inputs. Outputs: 12W into 8 ohms. Damping factor: 35 at 8 ohms. Size:  $13 \times 6\frac{1}{4} \times 4$ in. Price: £51.50 (including VAT).

#### RA311 ★

Integrated stereo amplifier. Inputs: phono (1) 2.5mV 40K, phono (2) 140mV 94K; tuner 170mV 46K; aux 170mV 46K; tape mon in 1 and 2 150mV 46K; tape (DIN) 330mV 100K. Noise level: phono 65dB, aux 73dB, tuner and tape in 73dB. Outputs: 24W per channel into 8 ohms. Damping factor: 50 at 8 ohms. Size:  $14 \times 7\frac{1}{2} \times 4\frac{1}{2}$ in. Mains: 100, 117, 220, 240V 50-60Hz. Price: £72.50 (including VAT).

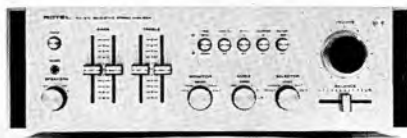

Rotel RA810

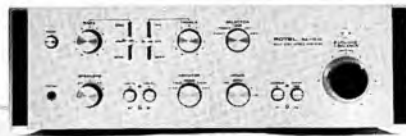

Rotel RA1210



Rotel RA311



Rotel RA611

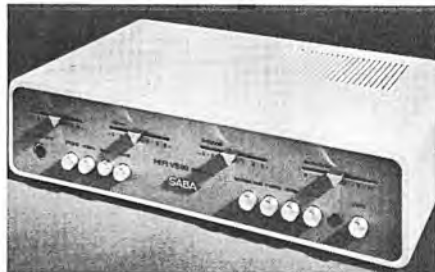

Saba VS80

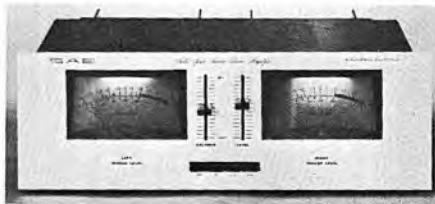

SAE Mark IVCM

**RA611 ★**

Integrated stereo amplifier. Inputs: phono (1) 2.5mV 47K, phono (2) 2.5mV 47K, tuner 150 mV 40K, aux 1 and 2 150mV 40K. tape mon in 230mV 47K, main amp in 800mV 33K, tape (DIN) 330mV 100K. Noise level: phono 65dB, tuner/aux 70dB, tape 70dB. Outputs: 35W RMS per channel into 8 ohms. Damping factor: 35 at 8 ohms. Size:  $16 \times 9\frac{1}{2} \times 5$ in. Price: £103.50 (including VAT).

**■ SABA**

Saba Television Ltd, 6-12 Cornbrook Park Road, Manchester, M15 4EE. Tel: 061-872 7661.

**VS80 ★**

Integrated stereo amplifier. Output: 45W music power per channel. Inputs for mag PU, crystal PU, radio and tape. Full overload protection. Headphone socket on front panel. Slider controls for volume, bass, treble and balance. 29 transistors, 5 diodes. Output impedance: 4-16 ohms. Size:  $16\frac{3}{8} \times 4\frac{1}{2} \times 11$ in. Finish: light walnut or white. Price: £94.95 (including VAT).

**■ SAE**

Distributor: Gale Electronics & Design Ltd, 39 Upper Brook Street, London, W1Y 1PE. Tel: 01-499 9966.

**Mark 1B**

Stereo preamp-equaliser. Seven-band graphic equaliser with a dual range of  $\pm 8$ dB or  $\pm 16$ dB. Inputs: phono 2.5mV 47K, high level 250mV 100K. S/N: phono -8dB, ref 10mV, high level -100dB ref 250mV input. Outputs: line 14V max into 600 ohms. THD:  $< 0.02\%$  at any frequency 20Hz-20kHz. FR: 10Hz-100kHz  $\pm 0.25$ dB. Mains: 120-240V AC 50-60Hz. Size:  $17 \times 5\frac{3}{4} \times 10\frac{1}{2}$ in. Price: £435 (plus VAT).

**Mark 1X**

Stereo preamp-equaliser. Five-band graphic equaliser with a dual range of  $\pm 8$ dB or  $\pm 16$ dB. Inputs: phono 2.5mV 47K, high level 250mV 100K. S/N: phono -75dB ref 10mV, high level -90 at 250mV. Outputs: max 14V into 600 ohms. THD:  $< 0.02\%$  at any frequency 20Hz-20kHz. FR: 10Hz-100kHz  $\pm 0.025$ dB. Mains: 120-240V AC 50-60 Hz. Size:  $17 \times 5\frac{3}{4} \times 7$ in. Price: £280 (plus VAT).

**Mark 111 CM**

Stereo power amplifier. Inputs: 1.2V 50K for 200W RMS. S/N: -100dB below 200W RMS. Power output: 200W RMS 8 ohms, 300W RMS 4 ohms. Damping factor:  $> 150$ . THD:  $< 0.05\%$  at any frequency 20Hz-20kHz. FR: 20Hz-20kHz at 200W RMS  $\pm 0.25$ dB. Mains: 120-240V AC 50-60Hz. Size:  $17 \times 5\frac{3}{4} \times 14\frac{1}{2}$ in. Two illuminated power meters. Relay protection of loads. Unconditionally stable into any type of

reactive load. Five years parts and labour guarantee. Price: £625 (plus VAT).

**Mark 1VCM ★**

Stereo power amplifier. Inputs: 1V 100K for 100W RMS. S/N: -100dB below 100W RMS. Power output: 100W 8 ohms. Damping factor:  $> 150$ . THD:  $< 0.1\%$  at any frequency 20Hz-20kHz, at 100W. FR: 20Hz-20kHz  $\pm 0.1$ dB at 100W RMS. Mains: 120-240V AC 50-60Hz. Size:  $17 \times 5\frac{3}{4} \times 15$ in. Two illuminated VU power meters. Unconditionally stable into any load. Five years parts and labour guarantee. Price: £380 (plus VAT).

**Mark XXV11**

Stereo octave-equaliser. Eleven level controls in each channel, with a dual range of  $\pm 8$ dB or  $\pm 16$ dB. Filters centred at 40Hz, 80Hz, 160Hz, 320Hz, 640Hz, 1280Hz, 2.5kHz, 5kHz, 10kHz, 15kHz, 20kHz. Input: 100K. S/N: -90dB below rated output. Outputs: 2.5V—max of 7V. THD:  $< 0.05\%$ . 20Hz-20kHz at 2.5V. FR: 20Hz-20kHz  $\pm 0.25$ dB. Mains: 120-240V AC 50-60Hz. Size:  $17 \times 8\frac{3}{8} \times 7$ in. Price: £350 (plus VAT).

**Mark XXX**

Stereo preamplifier. Inputs: phono 2.5mV 47K, high level 280mV 100K. S/N: phono -72dB ref 10mV, high level -85dB ref 280mV. Outputs: line 9V max/600 ohms. THD:  $< 0.03\%$ . 20Hz-20kHz. FR: 10Hz-100kHz  $\pm 0.25$ dB. Mains: 120-240V AC 50-60Hz. Size:  $15 \times 4\frac{3}{4} \times 8$ in. Price: £165 (plus VAT).

**Mark XXX 1B**

Stereo power amplifier. Inputs: 1V 50K for 50W RMS. S/N: -100dB ref 50W RMS. Outputs: 50W channel into 8 ohms. Damping factor:  $> 400$ . THD: 0.1%, 20Hz-20kHz at 50W RMS. FR: 20Hz-20kHz  $\pm 0.25$ dB. Mains: 120-240V AC 50-60Hz. Size:  $15 \times 4\frac{3}{4} \times 8$ in. Price: £195 (plus VAT).

**■ SANSUI**

Vernitron Ltd, Thornhill, Southampton, SO9 5QF. Tel: Southampton (0703) 444811.

**AU101**

Integrated stereo amplifier. Input: PU 3mV 50K, mic 4mV 50K, aux 200mV 50K, tape (2) 200mV 50K. Noise level: PU and mic inputs  $> 65$ dB, other inputs  $> 75$ dB. Output: 15W RMS per channel. Output impedance: 4-8 ohms. Tone controls: bass  $\pm 13$ dB at 50Hz, treble  $\pm 10$ dB at 6kHz. Loudness control: +8dB at 50Hz, +3dB at 10kHz. HD:  $< 0.8\%$  at rated output. FR: 20Hz-60kHz  $\pm 2$ dB. Mains: 100, 117, 220, 240V AC. Finish: black front panel with light walnut ends. Size:  $16 \times 4\frac{8}{8} \times 11$ in. Two AC outlet sockets. Two year guarantee. Price: £45.24 (plus VAT).





Sansui RA500



Sansui AU505

### RA500 ★

Stereo reverberation amplifier. Controls: mains on/off, reverberation on/off record, tape mode. FR: 20Hz-30kHz. Reverb time: 1.9 to 3.2 seconds. Rainbow reverberation indicator. Mains: 100, 117, 220, 240V AC. Size:  $11\frac{7}{8} \times 6\frac{3}{8} \times 10\frac{7}{8}$  in. Finish: light walnut cabinet with black acrylic top panel and silver control panel. Two years guarantee. Price: £58.08 (plus VAT).

### AU505 ★

Integrated stereo amplifier. 23 transistors, 2 diodes. Inputs: mag PU 3mV 50K, mic 4mV 50K, radio 200mV 50K, aux 200mV 50K, tape 200mV 50K. Noise level: (PU and mic inputs) better than 70dB, (other inputs) better than 75dB. Output: 25W RMS per channel. Output impedance: 4-16 ohms. Controls: bass  $\pm 15$ dB at 50Hz, treble  $\pm 10$ dB at 10kHz, loudness +10dB at 50Hz +8dB at 10kHz, low filter -10dB at 50Hz, high filter -10dB at 10kHz. HD: <0.5%. FR: 20Hz-60kHz at normal levels. Mains: 100, 117, 220, 240V 50-60Hz. Finish: walnut sides, matt black cabinet and front panel, chrome trim. A, B and A+B speaker switch. Tuner selector switch separate from main selector switch. Price: £101.01 (including VAT).

### AU6500

Integrated stereo amplifier. 36 transistors, 16 diodes. Inputs: mag PU (2) 2.5mV 50K, radio 100mV 50K, aux 100mV 50K, tape (2) 100mV 50K, four-channel adaptor 100mV 50K. Noise level: (PU inputs) better than 70dB, (other inputs) better than 80dB. Overload capability: (mag PU inputs) 30mV. Output: 32W RMS per



Sansui AU7500

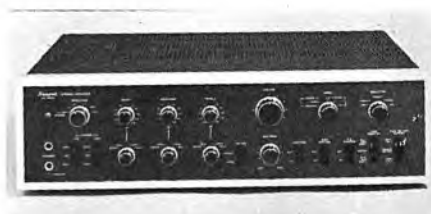

Sansui AU9500

channel. Controls: bass  $\pm 15$ dB at 50Hz, treble  $\pm 15$ dB at 15kHz, loudness +10dB at 50Hz +8dB at 10kHz, low filter -12dB at 50Hz, high filter -12dB at 10kHz. HD: <0.1%. Output impedance: 4-16 ohms. FR: 10Hz-30kHz  $\pm 1$ dB at 1W. Mains: 100, 117, 220, 240V 50-60Hz. Size:  $17\frac{3}{8} \times 5\frac{5}{8} \times 12\frac{3}{4}$  in. Finish: matt black cabinet and front panel with chrome trim. Facilities for four-channel adaptor. Price: £162.45 (including VAT).

### AU7500 ★

Integrated stereo amplifier. 38 transistors, 16 diodes. Inputs: mag PU (2) 2.5mV 50K, mic 2.5mV 50K, radio 100mV 50K, aux 100mV 50K, tape (3) 100mV 50K, four-channel adaptor 100mV 50K, power amplifier-only 800mV 40K. Noise level: (PU and mic input) better than 75dB, (other inputs) better than 80dB. Overload capability: (PU input) 300mV. Output: 43W RMS per channel. Controls: bass  $\pm 15$ dB at 50Hz, mid-range  $\pm 5$ dB at 1.5kHz, treble  $\pm 15$ dB at 15kHz, loudness +10dB at 50Hz +10dB at 15kHz, low filter -12dB at 50Hz, high filter -11dB at 10kHz. HD: <0.1%. Output impedance: 4-16 ohms. FR: 10Hz-30kHz  $\pm 1$ dB. Mains: 100, 117, 127, 220, 230, 240, 250V 50-60Hz. Size:  $17\frac{3}{8} \times 5\frac{5}{8} \times 12\frac{3}{4}$  in. Finish: matt black cabinet and front panel with satin chrome trim. Price: £197.65 (including VAT).

### AU9500 ★

Integrated stereo amplifier. 58 transistors, 37 diodes. Inputs: mag PU (2) 2.5mV 50K, mic 2.5mV 50K, radio 100mV 50K, aux 100mV 50K, tape (3) 100mV 50K, four-channel adaptor 100mV 50K, noise reduction unit 100mV 50K,

power amplifier 800mV 50K. Noise level: (mic) better than 65dB, (PU inputs) better than 75dB, (other inputs) better than 85dB. Overload capability: (PU inputs) 300mV. Output: 80W RMS per channel. Controls: bass  $\pm 15$ dB at 20Hz (3dB steps), mid-range  $\pm 5$ dB at 1.5kHz (1 dB steps), treble  $\pm 15$ dB at 20kHz (3dB steps), bass selector defeat -150Hz, 300Hz, 600Hz, mid-range selector defeat -750Hz, 1.5kHz, 3kHz, treble selector defeat -2kHz, 3.5kHz, 6kHz, loudness +10dB at 50Hz +8dB at 10kHz, low filter -3dB at 50Hz -3dB at 100Hz, high filter -3dB at 12kHz -3dB at 6 kHz. HD:  $<0.1\%$ . Output impedance: 4-16 ohms. FR: 15Hz-40kHz+0dB -1dB at 1W. Mains: 100, 117, 127, 220, 240, 250V 50-60Hz. Finish: matt black cabinet and front panel with satin chrome trim. Four AC outlets. Two headphone jacks. Two microphone jacks. Size:  $19\frac{3}{4} \times 5\frac{1}{8} \times 13\frac{3}{4}$  in. Price: £316.56 (including VAT).

■ **SANYO**

Sanyo Marubeni (UK) Ltd, Sanyo House, Bushey Mill Lane, Watford, Herts, WD2 4UQ. Tel: Watford (92) 30421.

**DCA 1400**

Integrated stereo amplifier. Inputs: PU (1) 2.5mV 50K, PU (2) 2.5mV 50K, aux (1) 100mV 100K, aux (2) 100mV 100K, radio 100mV 100K. H and N: PU inputs -70dB, other inputs -75dB. Output: 20W sine into 8 ohms, 17W sine into 8 ohms (both channels driven). HD:  $<0.8\%$  at rated output. FR: 10Hz-100kHz  $\pm 2$ dB. Controls: bass  $\pm 12$ dB at 100Hz, treble  $\pm 12$ dB at 10kHz, loudness +10dB at 100Hz, +3dB at 10kHz. Connections for two speaker systems, stereo headphones. Slider control for balance. Output impedance: 4-8 ohms. Mains: 120-240V AC. Price: £64.95 (including VAT).

**DCA1700X**

Quadrasonic stereo synthesiser. Output: 20W RMS per channel. Inputs: two PU, two aux, radio, tape. Rotary controls for volume, bass and treble. Slider control for balance. Switches for two-channel and four-channel tape recorder. Loudness control. Quadrasonic effect selector. Mains: 120-240V AC. Price: £73.95 (including VAT).

■ **SERVO-SOUND**

Servo-sound (Cybernetic Hi-Fi), Lamb House, Church Street, London, W4 2PB. Tel: 01-995 4551.

**PR4**

Stereo pre-amplifier designed to drive SL20 loudspeakers which incorporate their own 15W amplifiers. (See Speaker Enclosure Section). Inputs: phono 1.5mV 47k with h.f. radio filter, tape 300mV 40K, aux (1 & 2) 300mV 40K.



Sharp SM-510-H

Power Supply is connected to two of the DIN socket pins: 30V, 15mA pin 4 pos, pin 1 neg. FR: 30Hz-35kHz  $\pm 1$ dB. S/N: phono better than 60dB. THD: less than 0.25% at 1kHz. Outputs: tape 600mV 10K, phones 1.2V 400 ohms. Power reproducer 1.2V 400 ohms (max. of 35 reproducers per channel). Tone controls: treble, bass, low pass filter, loudness control on volume. Price: £71.39 (including VAT).

**RC4-SQ preamplifier/decoder**

Stereophonic preamplifier for the two rear channels in a quadrasonic system. Incorporates SQ decoder and remote control for adjustment of volume levels. Controls: master gain, bass, treble, balance, volume. Pushbuttons for blend, tape monitor, ambio, SQ, stereo front, four-channel tape, mains on/off. Price: £85.90 (plus VAT).

■ **SHARP**

Sharp Electronics (UK) Ltd, Sharp House, 1-7 Hulme Hall Lane, Manchester, M18 8HL. Tel: 061-205 7321.

**SM-510-H ★**

Integrated stereo amplifier using integrated circuits. Output: 15W per channel. Meets DIN Hi-Fi Standard 45 500. FR: 30Hz-20kHz  $\pm 1.5$ dB. Price: £69.22 (including VAT).

■ **SHERWOOD**

Acoustico Enterprises Ltd, Unit 7, Space Waye, North Feltham Trading Estate, Feltham, Middx. Tel: 01-751 0141.

**Model S-9400**

Stereo integrated amplifier. Output: 50W/channel into 8 ohms at 1kHz, 40W/channel into 8 ohms, 20Hz-20kHz. THD: 0.8% at rated output, 0.1% at 10W. Intermodulation Distn: 0.6% into 8 ohms at rated output. 0.25% at 10W. Rec load: 4, 8 or 16 ohms. Headphones: high or low impedance. Inputs: phono 1.8mV, aux 200mV, mic 60mV. S/N: phono -60dB, aux -85dB, vol control min -90dB. Mains: 220-240V 50Hz. Size:  $5\frac{1}{2} \times 17\frac{1}{2} \times 14$  in. Price: £162.80 (including VAT).

★ Indicates entry is illustrated

## ■ SHURE ELECTRONICS LTD

Eccleston Road, Maidstone, Kent, ME15 6AU.  
Tel: Maidstone (0622) 59881.

### Solophone SA-2E ★

Provides personal stereo listening for one or two people. Gives sufficient amplification to accept output from any high quality cartridge (for example Shure Stereo Dynetic range), tape deck or FM tuner. There are input selector switch, separate volume controls for each channel and two headphone jacks mounted on the front panel. Size:  $10\frac{1}{4} \times 3\frac{1}{2} \times 3$  in. Weight: 2lb. Mains: 240V 50Hz. Price: £27.06 (including VAT).

### M64-2E ★

Stereo preamplifier designed to furnish voltage gain and equalisation to enable amplifiers not equipped with necessary input facilities to be used with magnetic pickup cartridges and tape heads. Can also be used for microphones and as buffer amplifiers. FR: 20Hz-20kHz  $\pm$  2dB. Input impedance: 50K at 1kHz. Load impedance: (high) 22K minimum; (low) 600 ohms optimum. Separation: 50dB at 1kHz. H and N: 71dB minimum below 10mV input from 20Hz-20kHz. Price: £21.12 (including VAT). Optional battery power unit. Price: £9.90 (including VAT).

## ■ SINCLAIR

Sinclair Radionics Ltd, London Road, St Ives, Huntingdonshire, PE17 4HJ.  
Tel: St Ives (0480) 4311.

### 2000

Integrated stereo amplifier. 22 transistors, 7 diodes. Inputs: mag PU 3mV 47K, ceramic PU 30mV 220K, aux 100mV 100K, tape 125mV 1K. Noise level: -65dB. Overload capability: 20dB. Output: 8W RMS per channel into 4 ohms. THD: 0.06% at 8W. Controls: volume, bass ( $\pm$ 13dB at 100Hz), treble ( $\pm$ 13dB at 10kHz), balance, filter. HD:  $<$  0.1% at all levels. Output impedance: 4-8 ohms. FR: 25Hz-35kHz  $\pm$  3dB. Mains: 200-240V, 100-120V AC. Size:  $12 \times 6 \times 2$  in. Finish: natural aluminium. Price: £39.95 (including VAT).

### 4000

Stereo amplifier. Inputs: phono (mag) 3mV 47K, phono (ceramic) 30mV 220K, aux (1) 100mV 100K, aux (2) 100mV 100K. Outputs: speakers 17W channel into 8 ohms. S/N: 65dB. Damping factor: 50. THD: better than 0.04% at 17W. FR: 20Hz-25kHz  $\pm$  3dB. Mains: 110, 120, 220, 240V AC. Size:  $12 \times 6 \times 2$  in. Price: £72.05 (including VAT).

### Stereo 80

Stereo pre-amplifier. Inputs: phono 3mV, phono (ceramic) 30mV, aux (1) 300mV, aux (2) 300mV. S/N: 60dB. Outputs: line 100mV. FR: 10Hz-25kHz  $\pm$  3dB. Price: £13.14 (including VAT).



Shure Solophone SA-2E



Shure M64-2E

## Project 80 AFU

Stereo active filter. THD: 0.03% at 1kHz. Rumble and scratch filters. Price: £7.64 (including VAT).

## Z 40

Mono power amplifier. Input: line 100mV. S/N: 64dB. Outputs: speakers 15W 8 ohms. THD: 0.1% at 10W. FR: 10Hz-100kHz  $\pm$  1dB. Price: £6.08 (including VAT).

## Z 60

Mono power amplifier. Input: 100-250mV. S/N: 70dB. Outputs: 25W 8 ohms. THD: 0.03%. FR: 10Hz-200kHz  $\pm$  1dB. Price: £7.64 (including VAT).

## ■ SONAB LTD

PO Box 4, Oldfield Road, Hampton, Middlesex, TW12 2HN. Tel: 01-979 0134.

### P4000

Integrated stereo amplifier. Inputs: mag PU (2) 2mV 68K RIAA, mic 2-1mV 68K flat, aux 100mV 100K, tape 100mV 100K, line 500mV 47K. Output: 70W RMS per channel into 4 ohms, 50W RMS per channel into 8 ohms, 55W per channel into 4 ohms with both channels driven, 40W per channel into 8 ohms with both channels driven. Controls: input selector, mono/stereo, tape monitor, loudness, high filter, volume, balance, bass  $\pm$  12dB at 50Hz, treble  $\pm$  8dB at 10kHz. HD:  $<$  0.1% at 1kHz with both channels operating and up to 35W into 8 ohm load. Output impedance: 4-16 ohms. FR: 15Hz-25kHz  $\pm$  1.5dB. Mains: 110, 130, 220, 240V 50-60Hz. Size:  $18\frac{3}{4} \times 9\frac{3}{8} \times 4\frac{3}{8}$  in. Weight: 18 $\frac{1}{2}$  lb. Provision for two pairs of stereo headphones with impedance 8-600 ohms. Price: £139.95 (plus VAT).

# In 1975 you'll put our business back 3 years.

Three years ago we were the brand leaders in amplifiers. It was your confidence in our products that put us there.

We'd like to say thanks.

Then the competition warmed up a bit and in a way we were pleased. It gave us a chance to have a good look at our range and see what we could do to produce better products.

That's exactly what we've done.

The new range of Teleton products, some of which are shown here, and your confidence in them will again put us in the position of number one.

And that's how in 1975 you're going to put our business back three years.

Who'd ever thought that to go forward we'd have to go back.

Oh by the way, if you're not a Teleton dealer already and would like to join in our success give us a ring at Chelmsford 62442.

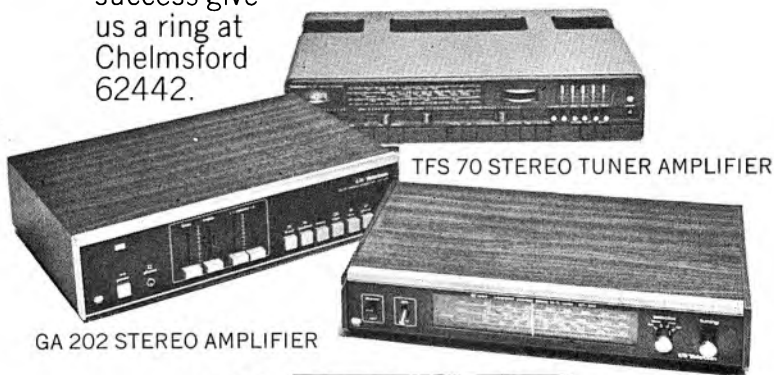

GA 202 STEREO AMPLIFIER

TFS 70 STEREO TUNER AMPLIFIER

GT 202 STEREO TUNER

 **Teleton**

Teleton Electro (U.K.) Company Limited, Teleton House, Waterhouse Lane,  
Chelmsford, Essex CM1 3DW Chelmsford 62442 Telex 99338

# AMCRON

## STATE OF THE ART



AMCRON amplifiers are acknowledged as leading the world in terms of audio reproduction, and reliability. They are to be found in the Studios of CBS, EMI, Philips, De Lane Lea as well as in Sadlers Wells, and the Royal Opera House. Most of the world's leading equipment manufacturers use them as a reference standard, and they are available to you if you want the finest equipment in the world for your own Hi-Fi system.

Detailed Brochures are available on request, and the equipment can be seen, and heard at

**REW (AUDIO VISUAL) LTD.,**  
CENTRE POINT, LONDON, W.C.2

and

**KJ LEISURE SOUND**  
101 ST. ALBANS RD., WATFORD, HERTS.



**MACINNES LABORATORIES LTD.**

MACINNES HOUSE, CARLTON PARK INDUSTRIAL ESTATE,  
SAXMUNDHAM, SUFFOLK IP17 2NL  
TEL: (0728) 2262 2615

**■ SONY (UK) LTD**

Pyrene House, Sunbury Cross,  
Sunbury-on-Thames, Middlesex.  
Tel: Sunbury (76) 87644. Telex: 266371.

**TA-70**

Integrated stereo amplifier. Inputs: mag PU 3.5mV 50K, radio 250mV 100K, tape 440mV 100K. Output: 10W RMS per channel. Output impedance: 8 ohms. Mains: 220, 240V AC. Size:  $13 \times 3\frac{1}{2} \times 9\frac{3}{8}$  in. Finish: wood cabinet with anodised aluminium panel. High filter. Main/remote filter switch. Price: £44.95 (including VAT).

**TA-88**

Integrated stereo amplifier. Inputs: mag PU, radio, aux. Output: 10W RMS per channel. Output impedance: 8 ohms. HD: < 1% at rated output. Mains: 110, 117, 220, 240V AC. Size:  $5\frac{1}{8} \times 9\frac{1}{8} \times 6\frac{1}{2}$  in. Finish: walnut cabinet with brushed aluminium front panel. Input source indicator lamps. Front panel headphone jack. Designed to match ST80F tuner. Price: £54.95 (including VAT).

**TA-1055**

Integrated stereo amplifier. Inputs: mag PU, mic, radio, aux. Output: 20W RMS per channel. Output impedance: 4, 8 ohms. HD: < 0.5% at rated output, < 0.2% at 1W. Mains: 110, 117, 220, 240V AC. Size:  $16\frac{1}{8} \times 4\frac{5}{8} \times 11\frac{1}{4}$  in. Finish: walnut cabinet with brushed aluminium front panel. Mic and aux input jacks on front panel. Inputs and outputs for two tape recorders. Price: £84.95 (including VAT).

**TA-1130**

Integrated stereo amplifier. Inputs: mag PU 1.5mV 47K, radio 130mV 100K, aux 130mV 100K, tape 130mV 100K. Noise level: mag PU 60dB, other inputs 70dB. Output: 75W RMS per channel. Tone filters: (high) 6dB/octave from 7kHz, (low) 6dB/octave from 100Hz. Loudness control: +8dB at 50Hz. HD: < 0.5% at 1W. Output impedance: 4-16 ohms. FR: 10Hz-200kHz+0dB-2dB. Mains: 100, 117, 220, 240V AC. Size:  $15\frac{3}{4} \times 5\frac{7}{8} \times 12\frac{7}{8}$  in. Finish: anodised front panel, cabinet optional extra. Price: £179.95 (including VAT).

**TA-3140F**

Stereo power amplifier. 22 transistors. Inputs: 0.85mV per channel. Output: 35W RMS per channel. Output impedance: 4-16 ohms. HD: 0.05% at 1W. FR: 10Hz-200kHz+0dB-2dB at 1W. Controls: left level, right level, power on/off. Mains: 100, 120, 220, 240V AC. Size:  $7\frac{1}{8} \times 5\frac{7}{8} \times 12\frac{3}{8}$  in. Finish: anodised front panel, metal cabinet. Price: £97.95 (including VAT).

**TA-3130F**

Stereo power amplifier. Input: 1mV. Output: 50W RMS per channel. Output impedance: 4-16 ohms. HD: 0.05% at 1W. FR: 20Hz-

200kHz+0dB-2dB at 1W. Controls: left volume, right volume, mains on/off. Mains: 100, 117, 220, 240V AC. Size:  $7\frac{7}{8} \times 5\frac{7}{8} \times 12\frac{3}{8}$  in. Finish: metal cabinet with anodised front panel. Price: £107.95 (including VAT).

**TA-1066**

Stereo amplifier. 17.5W per channel RMS into 8 ohms at 1kHz. Harmonic distortion: 0.8% rated output. S/N ratio: 65dB. Input and output facilities for 2 tape recorders, slider volume and balance controls, all push-button function selector. Brushed aluminium control panel, wood finish cabinet. Price: £69.65 (including VAT).

**TA-1150**

Stereo amplifier. Outputs: 35W per channel RMS into 8 ohms at 1kHz (both channels driven). Harmonic distortion: 0.2% at rated output. SN ratio: PU 70dB, other inputs 90dB. Inputs: mag PU 2mV 47K, tuner 140mV 50K. Rec/Pb: (input) 140mV 50K. Outputs: Rec out (1) 140mV (Max 5V) 10K, Rec out (2) 0.8V (Max 5V) 2-7K. Centre out 0.8V 680 ohms. Headphone: 8 ohms-10K. Rec/Pb output 24mV 82K. Size:  $15\frac{3}{4} \times 5\frac{1}{8} \times 12\frac{1}{16}$  in. Weight: 18lb 5oz. Mains: 240V AC 50Hz. Function selector. Slider volume and balance controls, treble and bass controls. Mode switch, loudness switch, high and low filter switch, tape monitor, speaker switch. Price: £117.95 (including VAT).

**SQA200**

Combined four-channel decoder/amplifier (SQ). Inputs: two channel tape 440mV 180K, four-channel tape 440mV 50K, aux 250mV 100K. Output: 8W RMS per channel into 8 ohms. Controls: mains on/off, volume, balance, bass  $\pm 10$ dB at 100Hz, treble  $\pm 10$ dB at 10kHz, input selector, monitor, HD: < 0.2%. FR: 30Hz-40kHz+0dB-2dB. Mains: 110, 130, 220, 240V AC. Size:  $13 \times 2\frac{7}{8} \times 11\frac{1}{8}$  in. Finish: wood cabinet with anodised front panel. Four-channel sound with right/left and front/back separation. Decodes SQ records and radio signals into quadraphonic sound. Price: £66.95 (including VAT).

**SQA100**

Combined four-channel decoder/amplifier (SQ). Inputs: two-channel tape 440mV 100K, four-channel input: 440mV 100K, aux 250mV 100K, 25mV 250K. Output: 6W RMS per channel (8 ohms). Controls: mains on/off, volume, balance, bass  $\pm 10$ dB at 100Hz, treble +10dB-6dB at 10kHz, input selector, tape monitor. FR: 20Hz-50kHz+1dB-2dB. Mains: 110, 127, 220 or 240V AC. 2 ICs, 21 transistors, 3 diodes. Size:  $5\frac{1}{16} \times 9\frac{1}{8} \times 7\frac{3}{8}$  in. Finish: walnut cabinet with black and silver front panel. Converts stereo and SQ signals to quadraphonic sound. Price: £44.95 (including VAT).

★ Indicates entry is illustrated

## ■ SOUNDCRAFTSMEN

Gale Electronics & Design Ltd.  
39 Upper Brook Street, London, W1Y 1PE.  
Tel: 01-499 9966.

### Model 20-12 ★

Stereo octave equaliser. Two channels each with ten level controls which give a maximum of 12dB of boost or 12dB of cut for each octave-wide band. Filters centred at 30Hz, 60Hz, 120Hz, 240Hz, 480Hz, 960Hz, 1920Hz, 3840Hz, 7680Hz and 15360Hz. Frequency-spectrum-level controls continuously variable over 18dB range for unity gain. Equaliser includes walnut-grained wood case. Two year parts and labour guarantee. Inputs: 100K. S/N: 90dB ref rated output. Max output: 2V > 3K. THD: 0.05% at 1V RMS. FR: 20Hz-20kHz ± 0.5dB. Mains: 120-240V AC 50-60Hz. Size: 18 × 5¼ × 11in. Price: £165 (plus VAT).

### PE 2217

Pre-amplifier/equaliser, each channel incorporates at ten octave-band graphic equaliser similar to the Model 20-12. Interlocked push-button patching. LED overload warning indicators in each channel. Tape dubbing between two machines with simultaneous equalising and monitoring. Separate system selection enables full use of other functions during tape dubbing.

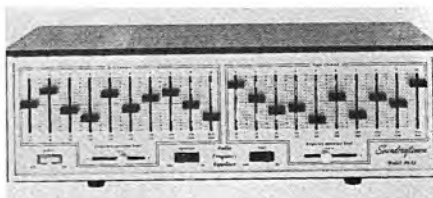

Soundcraftsmen 20-12

Two stereo headphone jacks, six AC accessory outlets. Preamp includes walnut-grained wood case. Two years parts and labour guarantee. Inputs: phono 47K, high level 100K. S/N: phono -84dB ref 10mV, high level -90dB, ref 1V RMS. Output: max 5V RMS into 600 ohms. THD: <0.05% at 1V RMS. FR: 5Hz-100kHz ± 0.25dB. Mains: 120-240V AC 50-60Hz. Size: 18 × 5¼ × 11in. Price: £350 (plus VAT).

## ■ J. E. SUGDEN

J. E. Sugden & Co Ltd, Carr Street, Cleckheaton, Yorks, BD19 5LA.  
Tel: Cleckheaton (097 62) 2501.

### C51 control unit ★

Transistorised stereo control unit designed for use with P51 power amplifier. Inputs: radio, tape and aux, each 150mV into 250K for flat

# Alba Hi-Fi Sounds realistic... the prices are realistic, too!

The ALBA UA700 Amplifier and the matching ALBA UA800 AM/FM Tuner are popular with Hi-Fi enthusiasts everywhere. Solid state circuitry, 15 watts per channel, decoder, push button switching, AFC, QT and a novel directional FM tuner are some of the features which have impressed the fans... and the experts.



ALBA UA700  
Amplifier

Recommended Price **£43.53**



ALBA UA800  
Stereo Tuner

Recommended Price **£46.74**

Write for full descriptive literature of complete Alba Unit Audio Range to

# ALBA

ALBA (Radio & Television) Limited, Dept. HF.YB, Bull Lane, Edmonton, London N18 1RA

response. PU (1) 2.5mV 47K RIAA. PU (2) same as PU (1) or any characteristic to choice with basic sensitivity 0.25mV. Plug-in adaptors available for various cartridges, microphones, etc. Controls: bass  $\pm 14$ dB at 40Hz, treble  $\pm 14$ dB at 10kHz, volume  $\pm 1$ dB per channel, balance  $\pm 6$ dB for 180° rotation fade out at full rotation. Rumble filter: 12dB/octave below 30Hz. Treble filter: 4kHz, 7kHz and 10kHz. Treble filters slope: gradual 6dB/octave, steep 18dB/octave. HD: better than 0.1% at rated output. S/N: better than 85dB on 150mV inputs, better than 75dB on PU inputs. Pushbutton selection of inputs and operating mode. Power: obtained from P51 amplifier. Size: 11  $\times$  3 $\frac{1}{2}$   $\times$  7in. Weight: 6 $\frac{1}{2}$ lb. Price: £60.50 (including VAT).

#### A21 Series Three

Integrated stereo amplifier. 28 transistors, 13 diodes. Inputs: mag PU 2.5mV 47K, radio 100mV 200K, aux 100mV 200K, tape 100mV 200K. Noise level: (PU input) -73dB, (other inputs) -85 dB. Overload capability: (PU input) 130mV, (other inputs) infinite. Output: 20W RMS per channel into 8 ohms, 25W per channel into 4 ohms. Controls: bass  $\pm 14$ dB at 40Hz, treble  $\pm 14$ dB at 10kHz, balance  $\pm 6$ dB for 180° rotation, fade out at full rotation, volume, input selectors, HF filter 7kHz at 12dB/octave, stereo/mono, left/right outputs. HD: <0.1%. FR: 30Hz-20kHz  $\pm 1$ dB at all power levels. Mains: 110, 120, 220, 240V 50-60Hz. Size: 16  $\times$  5 $\frac{3}{4}$   $\times$  11 $\frac{1}{8}$ in. Finish: teak with anodised front panel. Special class AB output stage. Price: £88 (including VAT).

#### A48 ★

Integrated stereo amplifier. 34 transistors, 17 diodes. Inputs: mag PU 2.5mV 47K, radio 100mV 200K, tape 100mV 200K, aux 100mV 200K. Noise level: (PU input) -70dB, (other inputs) -82dB. Overload capability: (PU input) 100mV, (other inputs) infinite. Output: 40W RMS into 8 ohms. Controls: bass  $\pm 14$ dB at 40Hz, treble  $\pm 14$ dB at 10kHz, balance  $\pm 6$ dB at 180° rotation, fade out at full rotation, volume, input selectors, LF filter 18dB/octave from 70Hz, HF filter at 4, 7 or 10Hz, pushbutton selection of slope (steep 18dB/octave, gradual 6dB/octave), quiet button (-16dB loudness compensated), mono/stereo, left or right output. HD: <0.1%. FR: 30Hz-20kHz  $\pm 1$ dB at all output levels. Mains: 110, 120, 220, 240V 50-60Hz. Size: 16  $\times$  5 $\frac{3}{4}$   $\times$  11 $\frac{1}{8}$ in. Finish: teak with anodised aluminium panel. Special output stage. Price: £99 (including VAT).

#### P51

Mono or stereo power amplifier. 21 transistors, 20 diodes. Input: 500mV 300K. Noise level: -90dB. Output: 45W RMS per channel into 8 ohms, 50W per channel into 4 ohms, or with



J.E. Sugden C51

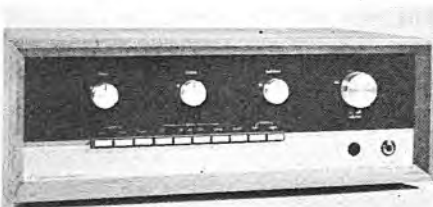

J.E. Sugden Stereo Amplifier A48

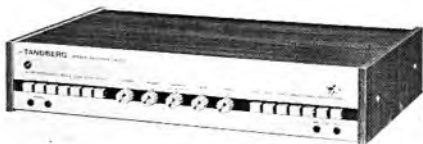

Tandberg TA300

mono connection 100W into 8 ohms. Mono/stereo switch. HD: 0.05% at 8 ohms, 0.1% at 4 ohms. FR: 30Hz-20kHz  $\pm 0.75$ dB at all power levels. Mains: 110, 120, 220, 230, 240V 50-60Hz. Finish: case finished in embossed PVC with matt PVC facing on aluminium panel. Price: £88 (including VAT).

#### ■ TANDBERG

Farnell-Tandberg Ltd, Farnell House, 81 Kirkstall Road, Leeds, LS3 1HR. Tel: Leeds (0532) 35111.

#### TA300 ★

Integrated stereo amplifier. 33 transistors, 13 diodes. Inputs: mag PU (2) 2.5mV 48K, tape (2) 200mV 100K. Noise level: (PU inputs) 60dB, (other inputs) 83dB. Overload capability: 25dB. Output: 35W RMS per channel. Controls: treble  $\pm 17$ dB, high filter -3dB at 7kHz, bass  $\pm 15$ dB, loudness +7dB at 10kHz, low filter -3dB. HD: 0.2% at 1dB below rated output. Output impedance: 4-8 ohms FR: 15Hz-50kHz -1.5dB. Mains: 115, 220, 240V AC 50-60Hz. Size: 16 $\frac{7}{8}$   $\times$  3 $\frac{1}{2}$   $\times$  9 $\frac{3}{8}$ in. Finish: teak or rosewood. Headphones jacks on front. Input mixing capability. Price: (teak or rosewood) £89.62 (including VAT).



★ Indicates entry is illustrated

### ■ TEAC

Acoustico Enterprises Ltd, Unit 7, Space Way, North Feltham, Trading Estate, Feltham, Middx, TW14 0TZ. Tel: 01-751 0141.

#### AS-100 ★

Integrated stereo amplifier. 26 transistors. Inputs: mag PU (2) 2mV 50K, radio 150mV 50K, aux 150mV 50K, tape 150mV 50K. Noise level: mag PU -70dB, other inputs -80dB. Tone controls: bass  $\pm 10$ dB at 100Hz, treble  $\pm 10$ dB at 10kHz, loudness  $\pm 7$ dB at 50Hz,  $\pm 4$ dB at 10kHz, low filter -6dB/octave from 100Hz, high filter -6dB/octave from 8kHz. HD:  $< 0.2\%$ . FR: 5Hz-20kHz  $+ 0$ dB -2dB. Output: 40W RMS per channel. Mains: 100, 117, 220, 240V AC. Size:  $16\frac{1}{8} \times 5\frac{3}{8} \times 13$ in. Finish: matt black. Price: £137 (plus VAT).

### ■ TELEFI

Sound take-off adaptor for feeding hi-fi system from TV. See Tape Recorder Accessories and Radio Tuner Sections.

### ■ TELETON

Teleton Electro (UK) Co Ltd, Teleton House, Waterhouse Lane, Chelmsford, Essex, CM1 1BD. Tel: Chelmsford (0245) 62442. Telex: 99338.

#### SAQ206B

Integrated stereo amplifier. Inputs: mag PU 3mV 50K, crystal PU 130mV 600K, aux 200mV 100K, tape 230mV 100K. Controls: loudness 13dB at 50Hz, 3dB at 10kHz; scratch filter -6dB at 10kHz; bass  $+ 13$ dB -18dB at 100Hz; treble  $\pm 10$ dB at 10kHz; volume and balance. Output: 6W RMS per channel. HD: 1% at rated output. Intermodulation distortion:  $< 1\%$  250Hz-8kHz. FR: 20Hz-20kHz. Output impedance: 8 ohms. Mains: 115, 230V AC. Size:  $15\frac{1}{2} \times 9 \times 3\frac{1}{2}$ in. Price: £39.95 (including VAT).

#### SAQ307

Integrated stereo amplifier. Inputs: mag PU 3mV, crystal PU 130mV, aux 200mV, tape 235mV. Output: 8W RMS per channel. HD: 1% at rated output. FR: 20Hz-20kHz. Controls: input selector, mains on/off, loudness, mode, balance, scratch filter, volume, bass, treble. Mains: 105-125, 210-250V AC. 18 transistors, four diodes, four rectifiers. Headphone and tape sockets. Slider controls. Finish: oiled walnut with black and aluminium facia. Sizes:  $15\frac{1}{4} \times 8\frac{3}{8} \times 3\frac{1}{8}$ in. Price: £39.95 (including VAT).

#### GA202

Integrated stereo amplifier. 20 transistors, two diodes. Inputs: mag PU 2mV 50K, crystal PU 200mV, aux 150mV 100K, tape 130mV 50K. Noise level: (mag PU input) -55dB, (other in-



Teac AS-100



Trio KA-2000A

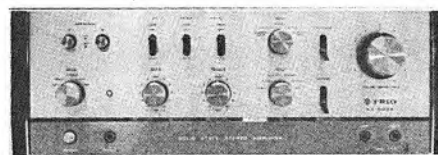

Trio KA-6004

puts) -59dB. Overload capability: (mag PU input) 15dB, (aux input) 18dB, (tape input) 22dB. Output: 16W RMS per channel (both channels driven). Controls: separate slider volume controls for each channel, slider bass, slider treble. Pushbuttons for tape monitor, mono/stereo, loudness, high cut, and input selector. HD: 1%. Output impedance: 8 ohms. FR: 30Hz-30kHz -3dB. Mains: 110-117, 220-240V AC. Size:  $15\frac{1}{4} \times 3\frac{3}{4} \times 10\frac{1}{2}$ in. Finish: wood grain with black facia. Price: £49.95 (including VAT).

### A300

Stereo integrated amplifier. Inputs: phono 3mV 37K, phono (ceramic) 150mV 700K, tape 250mV 120K, aux 200mV 120K. Outputs: tape 45mV 47K, phones 500mV 8 ohms, speakers 10W 8 ohms. S/N: 30mV, all controls max. Power bandwidth: 20Hz-30kHz. FR:  $< 30$ Hz-25kHz  $\pm 1.5$ dB. THD: 0.5% at 6W, 1kHz. Size:  $80 \times 388 \times 230$ mm. Price: £79.95 (including VAT).

### ■ TRIO

Distributors: B. H. Morris & Co (Radio) Ltd, Trio House, The Hyde, London, NW9 6JP. Tel: 01-205 6441.

#### KA-2000A ★

Integrated stereo amplifier. Inputs: magnetic

PU 2mV 50K, aux (1) 130mV 50K, aux (2) 130mV 50K, radio 130mV 50K, tape 130mV 50K. Noise level: mag PU input -60dB, all other inputs -70dB. Controls: volume, bass, treble, input selector, loudness, tape monitor. Output: 16W RMS per channel. HD: <0.8% at rated output. FR: 20Hz-30kHz $\pm$ 2dB. Output impedance: 4-16 ohms. Mains: 110-120V and 220-240V 50-60Hz. Size: 10 $\frac{1}{2}$   $\times$  4 $\frac{3}{8}$   $\times$  9 $\frac{3}{8}$ in. Price: £39 (plus VAT).

#### KA-2002

Integrated stereo amplifier. Inputs: magnetic PU (1) 2mV 50K, magnetic PU (2) 2mV 50K, radio 150mV 50K, aux 150mV 50K, tape 150mV 50K. Noise level: PU and radio inputs -60dB, aux and tape inputs -70dB. Controls: volume, bass, treble, balance, input selector, loudness. Output: 17W per channel RMS. HD: 0.8% at rated output. FR: 20Hz-30kHz $\pm$ 2dB. Output impedance: 4-16 ohms. Mains: 110-120V and 220-240V 50-60Hz. Size: 13  $\times$  4 $\frac{3}{8}$   $\times$  9 $\frac{1}{2}$ in. Price: £47 (plus VAT).

#### KA-4002A

Integrated stereo amplifier. Inputs: magnetic PU (1) 2.5mV 50K, magnetic PU (2) 2.5mV 50K, aux (1) 150mV 100K, aux (2) 150mV 100K, radio 150mV 100K, tape 150mV 100K. Noise level: magnetic PU input -60dB, all other inputs -70dB. Controls: volume, balance, treble, bass, input selector, loudness, filters, output switching. Output: 20W/channel, 8 ohms. HD: <0.02% at rated output. FR: 20Hz-40kHz  $\pm$ 1.5dB. Output impedance: 4-16 ohms. Mains: 110-120V and 220-240V 50-60Hz. Size: 13  $\times$  4 $\frac{3}{8}$   $\times$  9 $\frac{1}{2}$ in. Price: £62 (plus VAT).

#### KA-6004 ★

Integrated stereo amplifier. Inputs: mag PU (2) 2.5mV 50K, mic 3mV 50K, radio 200mV 100K, tape play 200mV 100K, aux (2) 200mV 100K. Input to main amplifier: 1V 50K. Output: 55W RMS per channel. Output impedance: 4-16 ohms. Tone controls: bass  $\pm$ 10dB at 100Hz in 2dB steps, treble  $\pm$ 10dB at 10kHz in 2dB steps, low filter 40Hz cut-off and 80Hz cut-off (both 12dB per octave), high filter 7kHz cut-off (6dB per octave). Loudness: +8dB at 100Hz and +3dB at 10kHz. Speaker switch for A, B, and A+B. Tape-to-tape dubbing switch. HD: <0.5% 20Hz-20kHz (<0.05% -3dB). FR: 20Hz-50kHz. Mains: 110, 230V AC. Size: 17 $\frac{1}{8}$   $\times$  6 $\frac{1}{8}$   $\times$  11 $\frac{1}{8}$ in. Finish: wood sides with satin aluminium panel. Price £115 (plus VAT).

#### KA-8004

Integrated stereo amplifier. Inputs: mag PU (2) 2.5mV 30K/50K, mic 2.5mV 50K, radio 150mV 100K, tape (2) 150mV 100K, aux (2) 150mV 100K. Output: 70W RMS per channel. Output impedance: 4-16 ohms. Controls: bass  $\pm$ 10dB at 100Hz in 2dB steps, treble  $\pm$ 10dB at 10kHz

in 2dB steps, low filter 20Hz or 40Hz cut-off (both 18dB/octave), loudness +8dB at 100Hz and +3dB at 10kHz. Speaker switching (A+B+C, A+B, A+C, B+C). FR: 10Hz-50kHz. Tape-to-tape dubbing switch. Mains: 110, 230V AC. Four mains outlet sockets (three switched, one non-switched). Size: 17 $\frac{3}{8}$   $\times$  6 $\frac{1}{8}$   $\times$  11 $\frac{1}{8}$ in. Weight: 28 $\frac{1}{2}$ lb. Finish: wood grain sides with two-tone aluminium control panel. Price: £150 (plus VAT).

#### KSQ-400

Rear channel amplifier for use in quadraphonic system. Suitable for use with receivers having only two power amplifiers, the KSQ400 includes a decoder for SQ and RM matrix systems. All phono and other connections are made to existing unit, but a feed from a four channel tape deck can be accepted. Inputs: 200mV 50K, tape play 200mV 50K, tape rec/replay 250mV 100K. Outputs: 200mV 50K, tape 200mV 50K, tape rec/replay 50mV 100K, to loudspeakers 10W/channel into 8 ohms, 50Hz-20kHz. FR: 20Hz-20kHz  $\pm$ 1dB. Phase shift: 90 $\pm$ 10% 25Hz-18kHz. Mains: 110-120, 220-240V. Price: £76.45 (including VAT).

#### KA-4004

Stereo integrated amplifier. Inputs: phono (1 & 2) 2.5mV 50K, tuner, aux (1 & 2), tape play 160mV 30K. Main amp input: 1V 50K. S/N: phono 65dB, all others 75dB. Damping factor: 32 at 8 ohms, 64 at 16 ohms. Output: 18W/channel into 8 ohms, 20Hz-20kHz. THD: less than 0.5% at rated power, 20Hz-20kHz. Less than 0.05% at half power. Controls: Bass, treble tone, low filter, high filter, loudness. Size: 17 $\frac{1}{8}$   $\times$  6 $\frac{1}{2}$   $\times$  11 $\frac{1}{2}$ in. Mains: 110-120, 220-240V. Price:

#### ■ TRIPLETONE

K & K Electronics Ltd,  
60 St Mark's Rise, London, E8 2NR.  
Tel: 01-254 9941.

#### Hi-Fi 77

Integrated stereo amplifier. Output 20W music per channel. No other details available as this edition of the Year Book closed for press. Price: £42.35 (plus VAT).

#### Hi-Fi 1818 Mk II

Integrated stereo amplifier. Output 40W music per channel. No other details available as this edition of the Year Book closed for press. Price: £53.35 (plus VAT).

#### ■ T.T.C.

Precision Centre, Heather Park Drive, Wembley, HA0 1SU.

#### G1320

Stereo headphone amplifier. 10 silicon tran-

★ Indicates entry is illustrated

sisters. Output: sufficient to operate two pairs of stereo headphones. Output impedance: 8-16 ohms. Inputs: mag PU 5mV, ceramic PU 100 mV, radio tuner 100mV. Wood cased, free-standing. Power supply: one 9V battery. Price: £13.75 (including VAT).

#### 101C

Integrated stereo amplifier. Phono input: 150mV into 100K. Noise level: -50dB. Output: 3W RMS per channel. FR: 30Hz-15kHz. Size:  $8\frac{3}{4} \times 2\frac{1}{2} \times 5\frac{1}{2}$ in. Mains: 240V. Price: £21.78 (including VAT).

#### 505

Integrated stereo amplifier. Inputs: phono 150mV into 100K, tuner 150mV into 100K. Noise level: -50dB. Output: 5W RMS into 8 ohms. FR: 40Hz-18kHz. Mains: 240V. Size:  $10\frac{1}{2} \times 2\frac{3}{4} \times 6\frac{1}{2}$ in. Price: £19.80.

#### UHER

Uher (UK) Ltd, 15 Broomhills Estate, Braintree, Essex, CM7 7RQ.  
Tel: Braintree 23192.

#### Uher CV140 ★

Integrated power amplifier. Stereo transistorised. Inputs for radio, tape, PU, mic. Output: 35W RMS per channel into 4 ohms. FR: 20Hz-20kHz  $\pm$  1dB. Bass control:  $\pm$  20dB at 20Hz. Treble control:  $\pm$  20dB at 20kHz. Presence control: +20dB at 7kHz. Scratch filter: 12dB per octave from 6.5kHz. Rumble filter: 6dB per octave from 100Hz. HD: better than 0.2% at 1kHz. Input impedance: all 100K. Main chassis pressure casting with printed boards well supported. Easily accessible. Presets on front panel permit all inputs to be adjusted to a common level (indicated on meter on panel) before being passed to main amplifier. Six DIN input sockets provided, three have facilities for plug-in pre-amplifier modules for low impedance mic, magnetic or ceramic PUs or stereo mixer. Mains: 100-130V or 200-240V, 50 or 60Hz. Consumption: 160W at full output: Price: approximately £150 (plus VAT). Plug-in preamplifier modules available extra. Price: £6 (plus VAT).

#### VORTEXION LTD

257-263 The Broadway, Wimbledon, London, SW19 1SF. Tel: 01-542 6242.  
Cables: Vortexion, London, SW19 1SF.

#### CP50 Amplifier

AC mains and 12V. The CP50 is an all silicon transistor amplifier for mains and 12V battery use, with 8 $\Omega$ -15 $\Omega$  and 100V line output. The amplifier itself has overload or short circuit protection and all inputs have reasonable overload protection. Very large heat sinks are used with good ventilation and it is quite cool running on speech or music peaking 50W and even with



Uher CV140

over 40W of continuous sine wave the temperature conditions are not exceeded. The reservoir capacitor has been divided into 4 parts, each fused. The frequency response is within 3dB from 25Hz to 20kHz and bass and treble controls are fitted, of 26dB sweep each. This is housed in our durable steel case. Size: 18 x 6 x 11 $\frac{1}{2}$ in. Battery consumption 3A. Weight: 35lb. 1PU and 3 low Mic inputs. Price: £146.41 (including VAT).

#### All Silicon Mixer Amplifier 20/30 Watt

This is a high fidelity 'minimised' distortion transistor amplifier made possible by the latest types of silicon transistors. Since it gives 20W at 0.1% harmonic and 0.2% intermodulation distortion and less than 3 times this at 30W on 7 $\frac{1}{2}\Omega$  it is suitable for high quality P.A. or High Fidelity use. No output transformer is fitted in this instance, but full overload protection is provided for this cool running amplifier which is suitable for continuous night and day operation and has a quiescent consumption of less than 4W from the mains. In the event of overload the output is instantly switched off until it ceases without blowing any fuses, the circuit operates far faster than any fuse. The response is within 1dB from 20Hz-20kHz and feedback bass and treble controls have a total range of 24-26dB each. It can be supplied for balanced line low impedance microphone (or high impedance at reduced prices) and the normal aux or gram at 50mV into 100K. Price: £246.58 (including VAT).

#### 100 Watt All Silicon Amplifier

This is a high-fidelity amplifier for audio frequencies featuring a new principle protection circuit, which is automatic on output overload, far faster than any fuse, and of course resetting when the signal is reduced. In addition a thermal cut-out is fitted which automatically switches off should it be possible for any reason to take the heat sinks beyond the safe limits. The large heat sinks are funnel cooled to aid efficiency, and when supplying 100W power at low to medium frequencies the output transistors only have to dissipate some 18W each and they are capable of over 100W each. These transistors also have a voltage rating double that required. Large output transistors are not satisfactory above 20kHz, and since it is not required for audio purposes,

the overload limits the power capacity to the safe power available at high frequencies. The response is level from 20Hz to 15kHz and 3dB maximum down at 20kHz. Outputs are for 8-15 ohms and 100V line. Harmonic distortion does not tell the whole story with transistor amplifiers, so in this case only the intermodulation distortion is given which is less than 0.5%. The input required is less than 0.5V on 100K $\Omega$ . Price: £106.20 (including VAT).

**200 Watt Amplifier**

Can deliver its full audio power at any frequency in the range of 30Hz-20kHz  $\pm$  1dB. Less than 0.2% distortion at 1kHz. Can be used to drive mechanical devices for which power is over 120W on continuous sine wave. Input 1mW 600 $\Omega$ . Psn: 100-120V or 200-240V. Additional matching transformers for other impedances are available. Price: £179.68 (including VAT).

**4C/FET/100W**

Mono mains amplifier with four input channels. Inputs: 30-60 ohms balanced line standard, 200 ohms and 600 ohms to order. Controls: separate gain control for each input, common bass and treble. Tone controls give approximately 12dB lift and 12dB cut. All silicon transistors with FET input stages. Output: 100W RMS. FR: level 30Hz-15kHz - 3dB (maximum) at 20kHz. Output impedance: 100V at 100 ohms (other impedances to order). Stove enamelled case. Size: 18 x 6 x 11 1/2 in. Weight: 37lb. Price: £153.06 (including VAT).

See Tape Amplifier and Mixer Units section for details of Vortexion mixer/amplifiers.

**WHARFEDALE**

Rank Radio International Ltd, PO Box 596, Power Road, Chiswick, London, W4 5PW. Tel: 01-994 6491.

**Denton 1 ★**

Stereo integrated amplifier. Inputs: phono 2.5mV or 5mV 47K, tape/tuner/aux 150mV 47K. S/N: phono 60dB, tape/tuner/aux 65dB; all referred to rated power output. Outputs: 12W channel into 6 ohms. Damping factor: 25 at 1kHz. THD: 0.4% at all powers up to 12W. Power bandwidth: 30Hz-35kHz. Mains: 240V AC. Size: 15 1/2 x 10 1/4 x 4 1/4 in. Price: £52.80 (including VAT).

**Linton Mk 2 ★**

Stereo integrated amplifier. Inputs: phono 2.5mV 47K, tape/tuner/aux 150mV 47K; all referred to rated power output. Outputs: 20W channel into 6 ohms. Damping factor: 25 at 1kHz. THD: 0.4% at all levels between 30mV and rated output for 1kHz. Power bandwidth: 30Hz-35kHz. Mains: 240V AC 50Hz. Size: 15 1/2 x 10 1/4 x 4 1/4 in. Price: £69.30 (including VAT).



Wharfedale Denton



Wharfedale Linton

**WILKINSON/FORM**

Wilkinson/Form Electronics, 1-2 Low Quay, Blyth, Northumberland, NE24 3AL. Tel: Blyth (067 06) 3575.

**Stereo Amplifier**

Integrated stereo amplifier. 20 transistors, 5 diodes. Inputs: mag PU 2.8mV 47K, radio 150mV 470K, tape 300mV 470K. Noise level: better than -60dB. Overload capability: not less than 80mV. Output: 55W RMS per channel into 8 ohms, both channels driven. Outlet for tape recorder: 5mV 10K. Controls: treble +15dB -13dB at 15kHz, bass +17dB -15dB at 40Hz, high pass filter 12dB/octave at 40Hz, low pass filter 10dB/octave at 4kHz, 5.5kHz and 10kHz, balance, volume, input selector. HD: <0.5% (typically 0.15%) under all conditions. Output impedance: 4-8 ohms. FR: 10Hz-35kHz -1dB. Mains: 240V AC. Size: 20 x 3 x 10 1/2 in. Finish: satin black and teak. Price: £110 (plus VAT).

**WYE ELECTRONICS LTD**

Queen Street North, Whittington Moor, Chesterfield, Derbyshire. Tel: Chesterfield (0246) 51116.

**Stereo 525 ★**

Transistorised integrated stereo amplifier. Inputs: PU 50mV 1M, radio 30mV 1M, tape 30mV 1M. Controls: treble +11dB. -16dB at 10kHz, bass +8dB -12dB at 100Hz, volume, balance, function selector. Output: 10W RMS per chan-

★ Indicates entry is illustrated

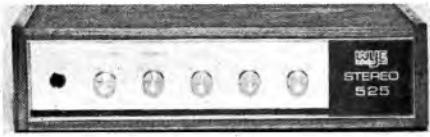

Wye Electronics Stereo 525



Yamaha CA-700

nel into 4 ohms. HD: 1.5% at 1kHz 10W into 4 ohms. FR: 40Hz-18kHz $\pm$ 3dB. Finish: veneered shelf-mounting cabinet with satin metal panel. Price: £33 (including VAT).

#### ■ YAMAHA

Natural Sound Systems Ltd, Strathcona Road, North Wembley, London, HA9 8QL. Tel: 01-904 0141.

#### CA-500

Integrated stereo amplifier. Inputs: mag PU (2) 4mV 50K (noise level 95dB); aux (2) 100mV 100K (noise level 90dB); radio 100mV 50K (noise level 90dB). Overload capability: PU inputs 90mV. Output: 22W RMS per channel. Output impedance: 8 ohms. Tone controls: bass  $\pm$ 10dB, treble  $\pm$ 10dB. Loudness control. High-pass and low-pass filters. HD: 0.05% at 20W. FR: 18Hz-46kHz $\pm$ 2dB at 20W. Pre-amplifier outlet, input to main amplifier and mono output. Finish: steel grey cabinet with satin chrome facia. Size: 16 $\times$ 6 $\times$ 12in. Wooden sleeve available extra. Price: £105.27 (including VAT).

#### CA-700 ★

Integrated stereo amplifier. Inputs: mag PU (1) 4mV 50K, mag PU (2) 0.1mV 100K, radio 100mV 100K, aux (2) 100mV 50K. Noise level: (mag PU) 95dB, (other inputs) 90dB. Overload capability: mag input 90mV. Output: 60W RMS per channel. Output impedance: 8 ohms. Tone controls: bass  $\pm$ 10dB, treble  $\pm$ 10dB. Tape A and Tape B monitor. Tape A to Tape B dubbing. Loudness control. HD: 0.05%. FR: 10Hz-56kHz+0dB -2dB at 50W RMS. Pre-amplifier outlet, main amplifier input. Will cater for two three-head tape units simultaneously. Volume control for mic input. Mains: 110-240V

AC. Finish: walnut cabinet with satin chrome facia. Size 16 $\times$ 6 $\times$ 12in. Price: £156.84 (including VAT).

#### CA400

Integrated stereo amplifier. Inputs: phono 3mV 47K. Noise level: 75dB. Output: 20W RMS into 8 ohms. Load impedance: 4-16 ohms. Damping factor: 50. THD: 0.02% at rated power. FR: 10Hz-100kHz+0-1dB. Dimensions: 17 $\frac{1}{4}$  $\times$ 5 $\frac{3}{4}$  $\times$ 12 $\frac{3}{4}$ in. Mains: 110-240V. Price: £89 (including VAT).

#### CA600

Integrated stereo amplifier. Phono input: 3mV into 47K. Noise level: 80dB. Output: 30W per channel into 8 ohms. Load: 4-16 ohms. Damping factor: 70. THD: 0.02% at rated power. FR: 10Hz-100kHz+0dB -1dB. Size: 17 $\frac{1}{4}$  $\times$ 5 $\frac{3}{4}$  $\times$ 12 $\frac{3}{4}$ in. Mains: 110-240V. Price: £144.35 (including VAT).

#### CA800

Integrated stereo amplifier. Phono input: 3mV into 47K. Noise level: 80dB. Output: 45W per channel into 8 ohms. Load: 4-16 ohms. Damping factor: 70. THD: 0.02% at rated power. FR: 10Hz-100kHz. Mains: 110-240V. Size: 17 $\frac{1}{4}$  $\times$ 5 $\frac{3}{4}$  $\times$ 12 $\frac{3}{4}$ in. Price: £214.10 (including VAT).

#### CA1000

Integrated stereo amplifier. Phono input: 3mV into 47K. Noise level: 80dB. Output: 70W from 20Hz-20kHz into 8 ohms. Load: 4-16 ohms. Damping factor: 70. THD: 0.016% (Class B) not measurable in Class A. Distortion measured at 10W. FR: 10Hz-100kHz+0dB $\pm$ 1dB. Mains: 110-240V. Size: 17 $\frac{1}{4}$  $\times$ 5 $\frac{3}{4}$  $\times$ 12 $\frac{3}{4}$ in. Output stage can be switched from Class B to Class A. Price: £274.26 (including VAT).



*Soundcraftsmen* presents . . .

the new component that is a "must" with every fine stereo system . . .

## the new **Audio Frequency Equalizer**

guaranteed to improve any stereo system and

guaranteed to improve any listening area environment!

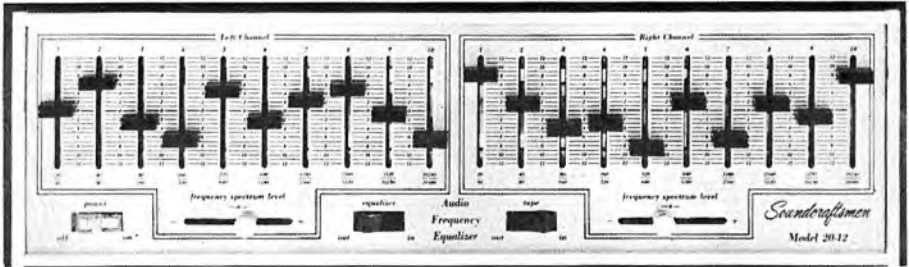

### ROOM EQUALIZATION, SPECIAL EFFECTS, PLAYBACK and RECORDING

**EQUALIZING FOR ROOM CHANGES:** For example, here are some factors that would call for definite changes in your Equalizer settings: (1) Draperies open or closed (2) Sliding glass door open or closed (3) Room full of people (4) Seating arrangements changed (5) Major changes in furniture arrangement (6) Relocation of speakers . . . **EQUALIZATION OF RECORDS:** You can compensate for old 78 record deficiencies (surface noise, absence of highs or lows, etc.) or favorite recordings that have never sounded quite the way you felt they should sound. . . **COMPENSATING FOR RADIO STATIONS:** Some stations are noted for excesses in either low or high frequencies. Make out a Computation Chart for each of your favorite stations so that you can easily achieve the ideal tonal response each time you change stations. . . **EQUALIZING TAPES:** Compensating for pre-recorded, or home recorded, tapes that are under or overemphasized in certain frequency areas. . . **CHANGING OVERALL BALANCE:** You can make up for any deficiencies in recordings to more

accurately duplicate the sounds of the original performance, or shape each curve to your own listening interests to greatly enhance your enjoyment of your recordings. . . **SPECIAL EFFECTS:** You can boost or cut the loudness of a specific instrument or groups of instruments to obtain more pleasing instrumental balance or to add presence to a solo. . . **IMPROVING RECORDING OF TAPES:** Use the Equalizer for tape dubbing, to create a near perfect tape out of one that may have serious deficiencies (Make your own corrected recording of records, station programming, or other tapes, and no further adjustment of the Equalizer will be needed for playback.) (See Operating Instructions) . . .

**COMPUTION CHARTS:** After you have achieved the equalization of sound that you prefer use the Computation Charts, supplied with each Equalizer, to mark the settings, so that you can duplicate the settings easily.

### SPECIFICATIONS and SPECIAL FEATURES

**TOROIDAL** and ferrite core inductors, ten octave-bands per channel.  
**FREQUENCY** response:  $-1/2$  db from 20, 480 Hz at zero setting  
**HARMONIC DISTORTION:** Less than 1% THD @ 2 v, Typ: 0.5% @ 1 v.  
**IMBALANCE:** Less than 1% @ 2 v, Typ: 0.5% @ 1 v.  
**SIGNAL TO NOISE RATIO:** Better than 90 db @ 2 v input.  
**INPUT IMPEDANCE:** Operable from any source 100K ohms or less . . .  
 (any Hi-Fi Pre-amp, Receiver or Tape Recorder)  
**OUTPUT IMPEDANCE:** Operable into 3K ohms or greater  
 (any Hi-Fi Amp, Receiver or Tape Recorder)  
**CIRCUIT BOARDS:** Military grade G-10 glass epoxy  
**RESISTORS:** Low noise selected carbon film

**RANGE:** 12 db boost and 12 db cut, each octave  
**MASTER OUTPUT LEVEL:** "Frequency spectrum level" controls for left and right channels continuously variable 18 db range, for unity gain compensation from minus 12 db to plus 6 db  
**MAXIMUM OUTPUT SIGNAL:** variable Master "frequency spectrum level" controls allow adjustment of optimum output voltage for each channel, to exactly match amplifier capability, up to 7 v.  
**SIZE:** designed to coordinate with receivers, comes installed in handsome walnut grained wood receiver size case, 5" x 18 x 11" or rack mount  
**WARRANTY:** 2 year parts and labor

Send for **FREE BOOKLET: "Why's and How's of Equalization"**  
 Plus list of Franchised Dealers to Sole UK Distributor:

**Gale Electronics & Design Limited**

39 Upper Brook Street London W1Y 1PE

# DISCOUNT AUDIO

## Where discount really counts

- \* Enormous savings on top quality famous names in hi fi systems and tapes.
- \* Huge range of accessories always in stock – whatever you're looking for, try us first.
- \* Quantity discounts on all top name cassettes.
- \* All items covered by full guarantee plus a year's FREE after sales service.
- \* Easy terms available to all callers.



Telephone orders accepted  
on Barclay or Access cards,  
Ring 01-637 1601 ask for  
Mr. C. Kimm.

---

### **Discount Audio Ltd.,**

231 Tottenham Court Road, London W1. 01-636 6682  
245 Tottenham Court Road, London W1. 01-323 4949  
299-301 Edgware Road, London W2. 01-262 2251

---

**Britain's No. 1 Part Exchange Specialists.**

# Cassette Recorders and Decks

★ Indicates entry is illustrated  
Abbreviations used in this section are given on  
page 20.

## ■ AKAI

Rank Audio Visual Ltd,  
PO Box 70, Great West Road, Brentford,  
Middlesex, TW8 9HR.  
Tel: 01-568 9222. Telex: 24408.

### CS30D

Stereo cassette deck. W and F: 0.15% WRMS. S/N: better than 46dB (ferric oxide tapes). FR: 40Hz-13kHz (ferric oxide tapes), 40Hz-15kHz (CrO<sub>2</sub> tapes) ±3dB. CrO<sub>2</sub> switch alters record amplifier characteristics only. Twin VU meters. Inputs: mic 0.5mV 4.7K, line 50mV 200K. Outputs: line 0.78V 20K, phones 8 ohms. One synchronous motor. Mains: 250V AC. Size: 410 × 126 × 220mm. Deck has auto-stop and a tape-run indicator lamp. Price: £88.50 (including VAT).

### CS33D

Stereo cassette deck. W and F: 0.15% WRMS. Fitted with Dolby B noise reduction. S/N: (Dolby out, Ferric oxide tape) better than 46dB. FR: 40Hz-14kHz (Ferric oxide tape), 40Hz-15kHz (CrO<sub>2</sub> tape). CrO<sub>2</sub> switch alters record amplifier characteristics only. Replay char: 120µs. Twin VU meters. Inputs: mic 0.5mV 4.7K, line 50mV 200K. Outputs: line 0.78V 20K, phones 8 ohms. One synchronous motor. Mains: 250V. Size: 410 × 126 × 220mm. Deck has auto stop and a tape run indicator. Price: £107.75 (including VAT).

### GXC36

Stereo cassette recorder. W and F: less than 0.27%. S/N: (Ferric oxide tape) less than 43dB. FR: 50Hz-14kHz (Ferric oxide tape), 50Hz-15kHz (CrO<sub>2</sub> tape). CrO<sub>2</sub> switch alters record characteristics only. Replay char: 120µs. Twin VU meters. Inputs: mic 0.5mV 4.7K, line 80mV 200K, DIN 5mV. Outputs: line 0.775V, DIN 0.5V, speakers 7W 8 ohms. One synchronous motor. Mains: 100-240V 50-60Hz. Size: 410 × 123 × 295mm. Price: £125.50 (including VAT).

### GXC36D ★

Stereo cassette deck. W and F: less than 0.27%. S/N: better than 43dB. FR: 50Hz-13kHz (Ferric

oxide tape), 50Hz-14kHz (CrO<sub>2</sub> tape). CrO<sub>2</sub> switch alters record amplifier characteristic only. Replay char: 120µs. Twin VU meters. Inputs: mic 0.5mV 4.7K, line 80mV 200K, DIN 5mV. Outputs: line 0.775V, DIN 0.5V. Motor: 4-pole induction inner-rotor. Mains: 100-240V AC 50-60Hz. Size: 410 × 115 × 223mm. Price: £112.75 (including VAT).

### GXC38

Stereo cassette recorder. W and F: less than 0.27%. Fitted with Dolby B noise reduction. S/N: better than 43dB (Dolby out, Ferric oxide tape). FR: 50Hz-13kHz (Ferric oxide tape), 50Hz-15kHz (CrO<sub>2</sub> tape) ±3dB. CrO<sub>2</sub> switch alters record amplifier characteristics only. Replay char: 120µs. Twin VU meters. Inputs: mic 0.5mV 4.7K, line 80mV 200K, DIN 5mV. Outputs: line 0.775V, DIN 0.5V, speakers 6W 8 ohms. Motor: 4-pole induction inner-rotor. Mains: 100-240V AC 50-60Hz. Size: 410 × 123 × 295mm. Price: £149.90 (including VAT).

### GXC38D

Stereo cassette deck. W and F: less than 0.27%. Fitted with Dolby B noise reduction. S/N: (Dolby out, Ferric oxide tape) better than 43dB. FR: 50Hz-13kHz (Ferric oxide tape), 50Hz-14kHz (CrO<sub>2</sub> tape). CrO<sub>2</sub> switch alters record amplifier characteristics only. Replay char: 120µs. Twin VU meters. Inputs: mic 0.5mV 4.7K, line 80mV 200K, DIN 5mV. Outputs: line 0.775V, DIN 0.5V. Motor: 4-pole induction inner-rotor. Mains: 100-240V AC 50-60Hz. Size: 410 × 123 × 295mm. Price: £139.90 (including VAT).

### GXC40T

Stereo cassette recorder with tuner and phono input. W and F: 0.21%. S/N: less than 41dB (Ferric oxide tape). FR: 50Hz-14kHz (Ferric oxide tape), 50Hz-15kHz (CrO<sub>2</sub> tape), ±3dB. CrO<sub>2</sub> switch alters record amplifier characteristics only. Replay char: 120µs. Twin VU meters. Inputs: mic 0.1mV 4.7K, line 25mV 200K, DIN 3mV 22K. Outputs: line 1.2V, DIN 0.4V, speaker 5W 8 ohms. Motors: Hysteresis

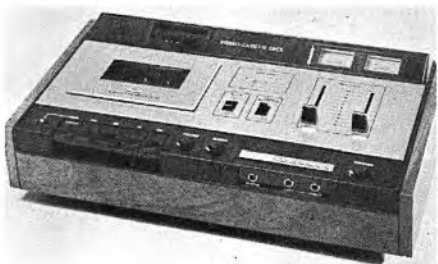

Akai GXC 36D



★ Indicates entry is illustrated

synchronous outer rotor. Mains: 100-240V AC 50-60Hz. Size: 413 × 138 × 320mm. Price: £189.50 (including VAT).

**GXC46D ★**

Stereo cassette tape deck with Dolby noise reduction system.  $\frac{1}{4}$ -track two-channel stereo. Speed:  $1\frac{7}{8}$ i/s. W and F: <0.12%. FR: 30Hz-18kHz using CrO<sub>2</sub> tape, 30Hz-16kHz using low-noise tape. Signal-to-noise: better than 58dB with Dolby system, better than 50dB standard. Bias frequency: 60kHz. Two heads. One motor. Fast rewind: 55-65 seconds for C60 cassette. Output: line (2) 0.775V 20K, phones 30mV 8 ohms. Inputs: mic (2) line (2) 50mV 200K. 39 transistors, two FETs, 34 diodes, two ICs. Mains: 100-240V AC 50-50Hz. Size:  $16\frac{3}{8} \times 5\frac{3}{8} \times 12$ in. Weight: 15 $\frac{3}{4}$ lb. Price: £131.09 (including VAT).



Akai GXC46D

**GXC65D ★**

Stereo cassette tape deck with Dolby noise reduction system.  $\frac{1}{4}$ -track two-channel stereo. Speed:  $1\frac{7}{8}$ i/s. W and F: <0.12%. FR: 30Hz-18kHz using CrO<sub>2</sub> tape, 30Hz-16kHz using low-noise tape. Signal-to-noise: better than 58dB with Dolby system, better than 50dB without Dolby. Two heads. One motor. Fast rewind: 60-65 seconds for C60 cassette. Output: 0.775V 20K, phones 30mV 8 ohms. Inputs: mic 0.2mV 4.7K, line 50mV 200K. 36 transistors, two FETs, 35 diodes, two ICs. Mains: 100-240V AC 50-60 Hz. Size:  $16\frac{3}{8} \times 7\frac{1}{2} \times 11\frac{5}{8}$ in. Weight: 22lb. Price: £145.18 (including VAT).



Akai Model GXC 65D

**AMEREX (UK) LTD**

96 Piccadilly, London, W1V 9HA.

Tel: 01-499 3537/8.

**ACD800 ★**

Stereo cassette tape deck. Speed:  $1\frac{7}{8}$ i/s. Compact cassettes. Twin VU meters. Digital tape counter with pushbutton reset. Headphone jacks for monitoring. Separate left and right level controls. Piano key controls. Pushbutton on/off. Switch for CrO<sub>2</sub> tapes. Indicator light for record. Finish: wood grain plinth with matt black panel and grey trim. Size:  $12\frac{3}{8} \times 3\frac{7}{8} \times 9\frac{1}{8}$ in. Weight: 7lb. Price: £71.97 (including VAT).



Amerex ACD 800

**ACR207**

Cassette tape recorder with built-in AM/FM radio. Speed:  $1\frac{7}{8}$ i/s. Compact cassettes. Mains or battery operation. Slider and pushbutton controls. Built-in capacitor microphone. Automatic shut-off at end of tape. Output: 1W RMS. 13 transistors, 12 diodes. Finish: black with burnished silver trim. Price: £47.98 (including VAT).



Bang & Olufsen Beocord 2200

**BANG & OLUFSEN (UK) LTD**

Eastbrook Road, Gloucester, GL4 7DE.

1el: Gloucester 21591.

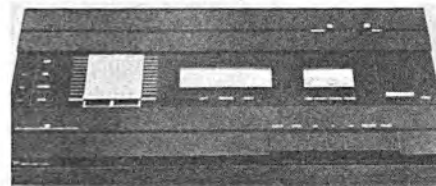

B & O Beocord 1700

**Beocord 900**

Stereo cassette tape deck.  $\frac{1}{2}$ -track. Speed:  $1\frac{7}{8}$ i/s. Compact cassettes. W and F: 0.35% (JIS). FR: 40Hz-12.5kHz. S/N ratio: > 50dB. Rewind time: 90 seconds for C60. Two VU meters. Inputs: mic 75 $\mu$ V 1K, radio 6mV 47K. Outlet: 800mV 470K. CrO<sub>2</sub> tape facility. Finish: teak or rosewood cabinet, brushed aluminium fascia. Size: 15.8 x 9.4 x 3.2in. Mains: 110-130 and 220-240V 50Hz. Price: (teak) £137.50, (rosewood) £76.90 (including VAT).

**Beocord 1700 ★**

Stereo  $\frac{1}{4}$ -track cassette tape deck with a specification identical to the Beocord 2200, except that the Dolby unit is supplied as an optional extra. Can be used without this facility on CrO<sub>2</sub> and standard tape. Price: (teak) £137.50, (rosewood) £138.50 (including VAT).

**Beocord 2200 ★**

Stereo  $\frac{1}{4}$ -track cassette tape deck incorporating Dolby noise reducing system. Speed:  $1\frac{7}{8}$ i/s. W and F: 0.12% (JIS). FR: 30Hz-15kHz. S/N ratio: > 62dB (with Dolby on), > 53dB (without Dolby). Switched characteristics for CrO<sub>2</sub> or standard tapes. Rewind time: 70 seconds for C60. High density ferrite heads. Inputs: mic 100  $\mu$ V 1K, radio 4mV 47K, aux 200mV 2.2M. Outlets: 660mV 6.3K and headphones 0.5-0.8mW. 3-digit tape counter. Mechanical auto-stop plus preset memory stop on rewind. Mains: 110-130 and 220-240V 50-60Hz. Size: 19.7 x 9.1 x 2.9in. Price: (teak) £159.50, (rosewood) £160.50 (including VAT).

**■ BASF**

BASF United Kingdom Ltd, Audio/Video Tapes Division, PO Box 473, Knightsbridge House, 197 Knightsbridge, London, SW7 1SA. Tel: 01-584 5080. Telex: 267574/5.

**CC9201**

$\frac{1}{2}$ -track cassette recorder. Battery mains operation. Speed:  $1\frac{7}{8}$ i/s. Compact cassette. W and F: 0.3%. Automatic switching system for chromium dioxide tape. Built-in capacitor microphone and remote control microphone. FR: (standard tape) 80Hz-kHz; (CrO<sub>2</sub> tape) 80Hz-(standard tape) 80Hz-10kHz; (CrO<sub>2</sub> tape) 80Hz-12.5kHz. Replay char: DIN. Meter level indicator. Output: 1.5W RMS. Fast 'review' button. Automatic or manual recording level button. Tape position indicator with reset button. Mains lead. Automatic cassette rejection. Size:  $11\frac{3}{4} \times 8\frac{1}{8} \times 2\frac{3}{8}$ in. Weight: 3 $\frac{3}{4}$ lb. Mains: 110, 220, 240V AC. Price: £65.22 (including VAT).

**CC9301 CrO<sub>2</sub>**

Mono cassette recorder. W and F: 0.3%. S/N: better than 45dB (Ferric oxide tape), better than 50dB (CrO<sub>2</sub>). FR: 80Hz-10kHz (Ferric oxide

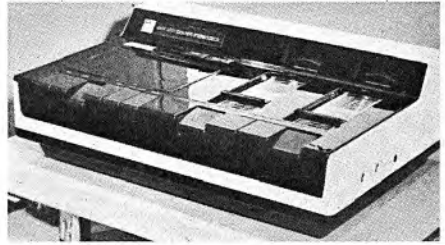

BASF Model 8200

tape), 80Hz-12.5kHz (CrO<sub>2</sub>). Switch for CrO<sub>2</sub> alters record and replay equalisation only. VU meter fitted. Inputs: mic 70dB 3.8K, line 0.1-2mV 50K. Outputs: line 0.2-2V 2.5K, speaker 1.5W 8 ohm. Power supply: mains 110/220-240V AC or 4 x SP2 batteries. Size:  $11\frac{3}{4} \times 9\frac{7}{8} \times 3\frac{1}{2}$ in. Includes radio. Price: £91.48 (including VAT).

**Model 8200 ★**

Stereo cassette deck. W and F: less than 0.2%. Fitted with both Dolby and DNL noise reduction. S/N: better than 45dB (Ferric oxide, NR out), better than 58dB (CrO<sub>2</sub> NR out). FR: 40Hz-10kHz (Ferric oxide), 40Hz-12.5kHz (CrO<sub>2</sub>) DIN. CrO<sub>2</sub> switch alters bias and record/replay equalisation. Two VU meters. Inputs: mic 70dB 1K, line 0.1-2mV 50K. Outputs: line 0.5-2V 2.5K, phones 8 ohms. Mains: 110/220-240V. Size: 407 x 147 x 270mm. Price: to be announced.

**■ BUSH-ARENA**

Rank Radio International Ltd, PO Box 596, Power Road, Chiswick, London, W4 5PW. Tel: 01-994 6491.

**C445**

Stereo cassette deck. W and F: 0.3% WRMS. S/N: 45dB (Ferric oxide tape), 50dB (CrO<sub>2</sub>). FR: 50Hz-9kHz (Ferric oxide tape). CrO<sub>2</sub> switch fitted. Twin VU meters. Inputs: Two stereo mic, DIN and line. Outputs: line, headphones. Size: 13.7 x 3.5 x 9.1in. Cassette deck fitted with auto-stop and supplied with microphones. Price: £79.95 (including VAT).

**■ CROWN**

Crown Radio Company Ltd, 128-9 Shoreditch High Street, London, E1 6JE. Tel: 01-739 2382

**CTD 270**

Stereo cassette deck. W and F: 0.25% RMS. FR: 30Hz-13kHz (CrO<sub>2</sub>). Dolby noise reduction fitted. S/N: better than 42dB, CrO<sub>2</sub> switch. Twin VU meters. Inputs: mic 0.2mV 600 ohms, aux 60mV 100K. Outputs: line 0.775V 10 ohms, phones 10mW 8 ohms. Mains: 220-240V AC

★ Indicates entry is illustrated

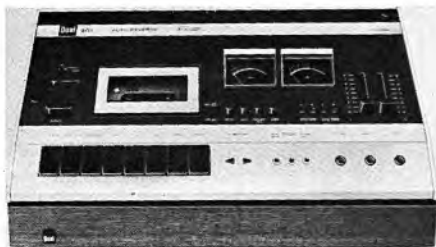

Dual 901



Ferguson Model 3272

50-60Hz. Size:  $15\frac{1}{2} \times 4 \times 11$  in. Dual capstan, slider controls for record and playback. Price: £140-60 (including VAT).

#### ■ DUAL

Audiodecks Ltd, Farnell House, 81 Kirkstall Road, Leeds, LS3 1HR. Tel: Leeds (0532) 35111.

#### C901 ★

Stereo cassette deck with record and playback in both directions. W and F: better than  $\pm 0.12\%$  DIN. Drift: better than 1%. FR: 30Hz-14kHz (Ferric oxide tape), 30Hz-10kHz (CrO<sub>2</sub> tape). S/N: better than 50dB (IEC Curve-A). Fitted with Dolby noise reduction. Inputs: mic 0.15mV, DIN 0.15mV, line 40mV. Outputs: phones, DIN 0.75V, line 0.75V. Size:  $16\frac{1}{2} \times 4\frac{3}{4} \times 11$  in. Automatic tape reversal, auto stop after both directions have been replayed. Continuous play override switch. Automatic selection for CrO<sub>2</sub> with manual switch for unmarked CrO<sub>2</sub> cassettes. Automatic level control or manual. Twin VU meters. Overload indicator. Fittings available for vertical mounting. Alternative walnut or white enamel (C901W) finish. Price: £198 (including VAT).

#### ■ DYNATRON

Dynatron Radio Ltd, St Peters Road, Maidenhead, Berks. SL6 7QY. Tel: Maidenhead 23331

#### Model CPI

Stereo cassette deck. W and F: 0.35%. Fitted with DNL noise reduction. S/N: better than



Grundig CN730



Hanimex HCD1000

45dB (DIN). FR: 60Hz-10kHz  $\pm 6$ dB (DIN). Twin VU meters. Inputs: mic 0.2mV 2K, DIN (1) 35mV 220K, DIN (2) 3.5mV 22K. Outputs: DIN (1) 500mV 30K, DIN (2) 35mV 10K. Mains: 110-240V, 50-60Hz. Size:  $13 \times 4 \times 9$  in. Auto-stop. Price: to be announced.

#### ■ FERGUSON

Thorn Consumer Electronics, 284 Southbury Road, Enfield, Middlesex, EN1 111. Tel: 01-366-1155.

#### Model 3257 Stereo ★

Stereo cassette recorder. FR: 40Hz-10kHz. S/N: 40dB. Inputs: 0.2mV 2K, line 220mV 10K, radio 0.2mV 2K. Phono (cer) 220mV 10K. Outputs: line 500mV 10K, speakers 2.5W (music). Mains: 240V AC, 50Hz. Size:  $4 \times 12\frac{1}{2} \times 9$  in. Complete with stereo mic, lead, two LS plugs and a C60 cassette. Price: on application.

#### Model 3429

Stereo cassette deck. Details as for Model 3257, but without power amplifier.

#### ■ GRUNDIG

Grundig (Great Britain) Ltd, Hi-Fi Division, Newlands Park, London, SE26 5NQ. Tel: 01-659 2468.

#### CN730 ★

Stereo cassette deck. W and F:  $\pm 0.2\%$  DIN. Fitted with Dolby noise reduction. FR: 30Hz-12.5kHz (Ferric oxide tape), DIN 30Hz-14kHz

(CrO<sub>2</sub> tape) DIN. S/N: better than 46dB (Ferric oxide tape), better than 49dB (CrO<sub>2</sub> tape). Inputs: mic 1mV 33K, radio 1mV 33K, phono 60mV 2.2M. Output: 500mV 20K. Size: 9½ × 4 × 10½ in. Price: £131 (including VAT).

#### ■ HANIMEX (UK) LTD

Hanimex House, 15-24 Great Dover Street, London, SE1. Tel: 01-407 8161.

#### HCD 1000 ★

Stereo cassette deck. W and F: less than 0.35% (DIN). S/N: better than 40dB. Fitted with DNL noise reduction system. FR: 40Hz-12kHz (Ferric oxide tape). Two VU meters. Inputs: mic 0.2mV 10K, line 100mV 1M DIN. Outputs: line 0.775V 10K, DIN 0.775V 10K. Motor: One mechanically governed DC motor. Mains: 117, 220, 240V. AC. Size: 220 × 310 × 90mm. Price: £63.50 (including VAT).

#### ■ HARMAN-KARDON

Distributors: Highgate Acoustics Ltd, 38 Jamestown Road, London, NW1 7ET. Tel: 01-267 4937.

#### ■ HITACHI

Hitachi Sales (UK) Ltd, New Century House, Coronation Road, Park Royal, London, NW10 7QN. Tel: 01-965 9861.

#### TRQ2000D

Stereo cassette tape deck with Dolby. Compact cassettes. Speed: 1½ i/s. FR: 20Hz-16kHz. ¼-track, two channel system. W and F: <0.12%. Dual VU meters. Inputs: two mic, two aux. Outputs: two 600 ohms, one headphones. Incorporates Dolby noise reduction system. Switching for standard or chromium dioxide tape. Auto stop. Two VU meters. Slider volume controls. Three-digit tape indicator with PB reset. Pushbutton controls. Size: 17¼ × 3⅞ × 9¼ i/s. Weight: 12lb. Price: £99 (including VAT).

#### TRQ30

Compact cassette tape recorder. Two-track mono. Speed: 1½ i/s. Output: 400mW. Speaker: 2½ in. Built-in capacitor microphone. One IC, six transistors, three diodes. FR: 100Hz-8kHz. Pushbutton controls with pause facility. Three-digit tape position indicator. Sockets for remote microphone, earphone and 6V DC adaptor. Size: 7¼ × 4¼ × 1¼ in. Weight: 1½ lb. Finish: metal and plastic cabinet with wrist strap. Level control meter. Automatic recording level control. Accessories: carry case, mains adaptor, remote mic, earpiece, demonstration cassette. Price: £49.90 (including VAT).

#### Model TRQ252D

Stereo cassette deck. W and F: less than 0.2%, single VU meters. Inputs: mic, line, DIN. Outputs: line, DIN. Mains: 220-240V AC,



ITT Stereo 82

50Hz. Price: £55 (including VAT).

#### Model 2040D

Stereo cassette deck. W and F: 0.25% RMS. FR: 40Hz-16kHz (CrO<sub>2</sub> tape) 40Hz-12kHz (Ferric oxide tape). Inputs: mic 20K, line 1M. Outputs: line 0.775V variable 100 ohms, phones 8 ohms. Motor: 4-pole hysteresis synchronous. S/N: better than 53dB CrO<sub>2</sub> switch fitted. Dolby noise reduction, two VU meters, memory rewind. Price: £119.00.

#### ■ ITT

ITT Consumer Products (UK) Ltd, Maidstone Road, Sidcup, Kent, DA14 5HT. Tel: 01-300 7733.

#### Studio 73

Mains/battery stereo tape recorder Speed: 1½ i/s. Compact cassette. W and F: 0.4%. Replay char: IEC. Rewind time: 50 sec for C60. Three-digit tape position indicator with PB reset. 26 transistors, 16 diodes. One motor. Size: 10⅝ × 3¼ × 9⅞ in. Weight: 7lb. Pause. Monitoring on record. Provision for CrO<sub>2</sub> tape. Auto or manual level control. Double-gap erase head. End-of-tape warning light. Tone control. Provision for Dryfit accumulator operation. Power supply: mains 110-150V or 200-240V AC, five HP11 or Dryfit accumulator. Price: £61.50 (including VAT).

#### SL75

Mono portable cassette recorder Incorporates LW/FM radio. Auto record level control. DIN socket for recording from other sources such as microphones. DIN speaker socket. Battery check button. Top loading, horizontal format. Price: £54 (including VAT).

#### Stereo 82 ★

Stereo cassette recorder. Finished in brushed aluminium and black to match the TA-1-200 and the DP-1-200, this mains-only cassette re-

★ Indicates entry is illustrated

corder combines with its companion tuner/amplifier and record deck to complete a superbly styled radio-disc-tape hifi chain. Features of the recorder include automatic or manual recording level, left and right channel level meters, independent slider controls for left and right channels, recessed socketry, switchable circuitry for Fe/Cr tapes, digital tape position indicator, automatic tape-end switch with warning light, mechanically coupled pause control, double gap erase head, sliding controls, headphone volume level switch, keys for fast rewind, record, stop, start and fast forward. The cassette release button is separate from the keybank. Microphone(s), record player, radio tuner, additional recorder, external amplifier and headphones are all catered for in the socketry, with a 5-pin DIN-to-DIN connecting lead as the link. Price: £63 (including VAT).

#### **Stereo 85 ★**

Stereo cassette recorder. Similar in appearance and functions to the Stereo 82, this model incorporates a 5-watts-per-channel-into-4-ohms stereo amplifier, enabling it to be used with a suitable pair of loudspeakers as a cassette-only stereo system. For this purpose, the KS 658W speakers in which complete a most attractive combination, at a total price (including VAT) for the outfit of £97.44. Alternatively, the Stereo 85's output may be fed into more powerful amplifiers, thus fulfilling the same 'system' role as the Stereo 82 in a sophisticated equipment chain.

#### **RC1000**

2-track mono cassette recorder. Battery/Mains operation. L, M, VHF and SW radio plus cassette record facilities. Built-in capacitor microphone. Automatic recording level only. Tape end switch with indicator lamp. Tape position indicator. Pushbutton wavechange. Roller tone, volume, station controls. Pause control. Top loading. Piano key operation. Electronic battery check button. 1.2W output. Osc. frequency switch (recording bias). Takes DSL rechargeable battery. Also takes external microphone with remote control stop/start. External speaker socket, or phones. Mic input/low-level output socket. Price: £72.50 (including VAT).

#### **JVC (UK) LTD**

453 Caledonian Road, London, N7 9BA.  
Tel: 01-607 6568.

#### **Model 1656**

New model introduced at the Dealers Radio Show, May 1974. No details available at time of going to Press.

#### **Model 1667**

Stereo cassette deck. W and F: 0.15%. Fitted with ANRS noise reduction which improves



*ITT Stereo 85*

S/N by 5dB at 1kHz and 10dB at 10kHz. S/N: 50dB. FR: 30Hz-13kHz (Ferric oxide tape), 30Hz-16kHz (CrO<sub>2</sub> tape). Fitted with CrO<sub>2</sub> switch. Twin VU meters. Inputs: aux 80mV 330K, mic 0.7mV 30K, DIN 20mV 10K. Outputs: line 1V 3.3K, DIN 0.5V 5K, phones 0.4mV 8 ohms. Mains: 100, 110, 120, 200, 220, 230V AC 50-60Hz. Price: £119 (plus VAT).

#### **Model 1668**

Stereo cassette deck. W and F: 0.13%. Fitted with ANRS noise reduction which improves S/N by 5dB at 1kHz and 10dB at 10kHz. S/N: 50dB. FR: 30Hz-13kHz (Ferric oxide tape), 30Hz-16kHz (CrO<sub>2</sub> tape) ±3dB. Fitted with switch which adjusts bias and equalisation for Ferric oxide (Norm), Cobalt (SH) and CrO<sub>2</sub> tapes. Twin VU meters. Inputs: aux 80mV 470K, mic 0.3µV 600 ohms, DIN 20mV 10K. Outputs: line 1V 3.3K, DIN 500mV 5K, phone 0.5mV 8 ohms. Price: to be announced.

#### **Model 1669**

Stereo cassette deck. W and F: 0.12%. Fitted with ANRS noise reduction which improves S/N by 5dB at 1kHz and 10dB at 10kHz. S/N: 53dB. FR: 30Hz-15kHz (Ferric oxide tape), 30Hz-16kHz (CrO<sub>2</sub> tape). Fitted with switch which alters bias and equalisation for CrO<sub>2</sub>, Cobalt (SH) and normal tapes. Twin VU meters. Inputs: aux 80mV 100K, mic 0.3mV 600 ohms, DIN 30mV 10K. Outputs: line 0.5V 8K, DIN 0.5V 5K variable. Mains: 100-230V AC 50-60 Hz. Solenoid deck control. Input and output faders, memory tape counter, peak level indicator with calibrated professional VU meters. External access to ANRS level presets. Calibration oscillator (400Hz) fitted. Price: to be announced.

#### **LEAK**

Rank Radio International Ltd, PO Box 596, Power Road, Chiswick, London, W4 5PW.  
Tel: 01-994 6491.

#### **Model 2002**

Stereo cassette recorder. W and F: 0.2% DIN.

Fitted with Dolby noise reduction. S/N: 54dB (Dolby out). FR: 50Hz-12.5kHz (CrO<sub>2</sub> tape). CrO<sub>2</sub> switch fitted. Twin VU meters. Inputs: mic. 300mV 1-5K, line 30mV 100K. Outputs: 580mV variable, phones, dual sensitivity. Size: 12×4×11½in. Price: £135.30 (including VAT).

### ■ NAKAMICHI

Natural Sound Systems Ltd, Strathcona Road, North Wembley, London, HA9 8QL. Tel: 01-904 0141.

#### Tri-tracer 1000 ★

Stereo cassette deck. W and F: less than 0.1%. Fitted with both Dolby and DNL noise reduction systems. S/N: 54dB (ref OVU), Dolby out. FR: 35Hz-20kHz. CrO<sub>2</sub> bias switch. Replay equalisation: 70µs or 120µs switchable. Two peak level meters. Motors: two phonic-wheel DC servo-motors. Size: 20.7×11.7×8.6in. Three head machine with tape monitor via Dolby processor. Built in calibration oscillator. Automatic head azimuth check and adjustment facility. Logic controlled function selectors. Memory and auto rewind. Price: £695 (including VAT).

#### Tri-tracer 700

Stereo cassette deck. W and F: less than 0.12%. Fitted with Dolby noise reduction. S/N: better than 54dB (ref OVU) Dolby out. FR: 35Hz-20kHz±4dB. CrO<sub>2</sub> switch fitted. Replay equalisation: 70µs or 120µs switchable. Twin peak level meters. Two phonic-wheel DC servo motors. Size: 20½×10.7×5.1in three head machine with tape monitor via Dolby processor. Built in calibration oscillator. Automatic head azimuth check and adjustment facility. Logic controlled function selectors. Memory rewind. Price: £439.54 (including VAT).

### ■ NORDMENDE

H. Vesshof & Co Ltd, (Vessco Vision & Radio), 62 Woodbridge Road, Guildford, Surrey, GU1 4RD. Tel: 0483 77877.

#### Hi-Fi Compact

Stereo cassette recorder. W and F: ±0.25% DIN. FR: 40Hz-12.5kHz DIN. Onesynchronous DC motor fitted. Rewind time: less than 100s with a C60. Twin VU meters, slider controls. Dolby noise reduction fitted; automatic level control, CrO<sub>2</sub> switch. Conforms to DIN Hi-Fi standard. Size: 245×95×230mm. Memory counter. Price: £110.21 (including VAT).

#### 6000 Hi-Fi ★

Stereo cassette recorder. W and F: ±0.25% DIN. FR: 40Hz-12.5kHz, DIN. One synchronous motor fitted. Rewind time: less than 100s with a C60. Twin VU meters. Dolby noise reduction fitted; automatic level control CrO<sub>2</sub> switch. Conforms to DIN Hi-Fi standard. Size:



Nakamichi Tri-Tracer 1000

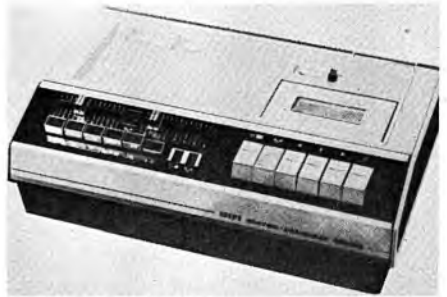

Nordmende model 6000

245×95×230mm. Memory counter. Price: £110.21 (including VAT).

#### Hi-Fi Comfort

Stereo cassette recorder. W and F: better than ±0.2% DIN. FR: 40Hz-14kHz using CrO<sub>2</sub> tape. Two motors. Rewind time: better than 100s for a C60. Automatic selection of bias for CrO<sub>2</sub> or standard tape. Automatic level control or manual sliders. Philips DNL noise reduction fitted. Twin VU meters. Meets DIN 45 500 Hi-Fi standard. Size: 345×100×245mm. Price: £152.64 (including VAT).

### ■ PHILIPS ELECTRICAL LTD

Century House, Shaftesbury Avenue, London, WC2H 8AS.

Tel: 01-437 7777. Cables: Phillamps, London.

#### N2401S

Mains operated stereo cassette recorder. Speed: 1½/s. W and F: <0.3%. H and N: >-43dB. FR: 60Hz-10kHz. Replay char: CCIR. Rewind time: <100 sec for C60 cassette. Meter level indicator. Inputs: mic/radio 0.25mV 2K, PU 100mV 1M. Outlets: diode 1V 20K, speakers (2) 4W 8 ohms Output: 4W RMS per channel External speakers. Transistors. Own deck. One motor. Pause. Monitoring. Straight-through amplifier. Automatic cassette changer. Size: 15¼×9½×6½in. Weight: 11lb. Mains: 110-250V

★ Indicates entry is illustrated

50-60Hz. Price: (less speakers) £100.10 (including VAT); (with speakers) £126.50 (including VAT).

#### **N2506 ★**

Mains operated stereo cassette unit to fit in with Audio plan Equipment. Includes dynamic noise limiter (DNL) circuit to improve subjective S/N ratio. Speed  $1\frac{7}{8}$ i/s. W and F: 0.35%. DIN weighted. H and N: better than 45dB. FR: 60Hz-10kHz. Rewind time: <80 sec for C60. Meter level indicator. Input/output sockets for external amplifier. Input/output socket for phono/micro. One motor. Pause. Size:  $8\frac{1}{2} \times 8\frac{1}{2} \times 2\frac{7}{8}$ in. Weight:  $4\frac{1}{2}$ lb. Mains: 110-240V 50-60Hz. Price: £70.70 (including VAT).

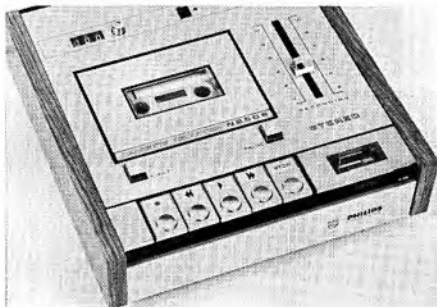

Philips N2506

#### **N2510 ★**

Mains operated stereo cassette tape deck. Speed:  $1\frac{7}{8}$ i/s. Compact cassette. W and F: <0.2% (DIN 45 507). Signal-to-noise: (standard tape) 45dB, (CrO<sub>2</sub>) 48dB. FR: (CrO<sub>2</sub>) 25Hz-14kHz (DIN 45 500). Replay char: DIN 45 500. Meter tuning indicator. Three-digit tape position indicator with PB reset. Inputs: mic 0.2mV 2K, radio 2mV 20K, line 100mV 1M. Outlets: line 0.5V 10K, monitor 400mV 10K. 98 silicon transistors. One tachometer-controlled motor. Own deck. Size:  $15\frac{1}{2} \times 8\frac{1}{2} \times 3\frac{3}{8}$ in. Weight:  $9\frac{1}{2}$ lb. Pause control. Monitoring on control. Input mixing. Facilities for chromium dioxide tape. Built-in dynamic noise limiter circuit. Price: £137.50 (including VAT).

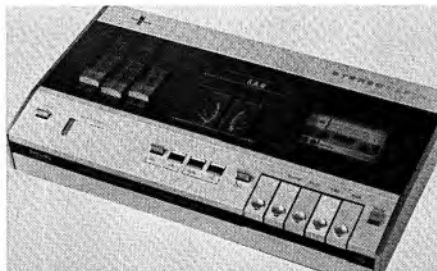

Philips N2510

#### **PIIONEER**

Shriro (UK) Ltd, Shriro House, The Ridgeway, Iver, Bucks. SL0 9JL.

Tel: Cedarwood (07538) 2222.

#### **CT3131A**

Stereo cassette deck. W and F: less than 0.13% WRMS. S/N: 47dB ref. max. rec. level. FR: 63Hz±3dB (Ferric oxide tape), 63Hz-12kHz (CrO<sub>2</sub>). Fitted with CrO<sub>2</sub> switch. Two VU meters. Inputs: mic 90mV 20K, line 40mV 7:300K, rec PB 15mV-2.2V 10K. Output: line 300mV 50K, rec PB 300mV 50K, phones 40mV 8 ohms. Motor: One electromechanically controlled DC type. Mains: 110-130V, 220-240V AC 50-60Hz. Size:  $15\frac{5}{8} \times 3\frac{3}{4} \times 9\frac{1}{2}$ in. Price: on application.

#### **CT4141A**

Stereo cassette deck. W and F: less than 0.13% WRMS. Dolby noise reduction fitted. S/N: 48dB at 333Hz (Ferric oxide tape). FR: 63Hz 10kHz±3dB (Ferric oxide tape), 63Hz-10kHz±3dB (CrO<sub>2</sub> tape) CrO<sub>2</sub> switch fitted. Twin VU meters. Inputs: mic 0.5-90mV 200 ohm, line 50mV 300K, rec PB 15mV-2.2V 10K. Outputs: line 300mV 50K, rec PB 300mV 50K, phones 40mV 8 ohms. Motor: one electromechanically controlled DC type. Mains: 110-130V, 220-240V, 50-60Hz. Size:  $15\frac{5}{8} \times 3\frac{3}{4} \times 9\frac{1}{2}$ in. Peak level indicator, independent

bias and equalisation switches. Price: on application.

#### **CT5151**

Stereo cassette deck. W and F: less than 0.12% WRMS. Fitted with Dolby B noise reduction. S/N: 48dB at 333Hz (Ferric oxide tape). FR: 63Hz-12kHz±3dB (Ferric oxide tape), 63Hz-13kHz±3dB (CrO<sub>2</sub> tape). Fitted with CrO<sub>2</sub> switch. Twin VU meters. Inputs: mic 0.5-90mV 200K, line 50mV 300K, rec/PB 15mV-2.2V 10K. Outputs: line 300mV 50K, rec/PB 300mV 50K, phones 40mV 8 ohms. Motors: one electronic controlled DC motor. Mains: 110-130V, 220-240V AC, 50-60Hz. Size:  $15\frac{5}{8} \times 3\frac{3}{4} \times 9\frac{1}{2}$ in. Peak level indicators and independent bias and equalisation switches fitted. Price: on application.

#### **PYE**

Pye Radio & Television Ltd, St Andrews Road, Cambridge, CB4 1DS. Tel: Cambridge 58985.

#### **9144 ★**

Mains-operated stereo cassette recorder. Speed:  $1\frac{7}{8}$ i/s. Compact cassette. W and F: ±0.35%. Noise level: >45dB (DIN). FR: 60Hz-10kHz (6dB DIN). Replay char: CCIR. Rewind time: (C60) 85 sec. Meter level indicator. Three-digit tape position indicator with PB reset. Inputs: PU 100mV 1M, radio 0.2mV 2K, mic 0.2mV 2K. Outlet: 0.5V 20K line. Output: 2.5W RMS per channel. One motor. Philips tape deck. Size:

13 $\frac{3}{8}$  × 8 $\frac{1}{4}$  × 2 $\frac{3}{8}$ in. Weight: 6 $\frac{3}{4}$ lb. Pause. Straight-through amplifier. Monitoring on record. End of tape autostop. Mains: 110, 127, 220, 240V AC. Price: £67.78 (including VAT).

#### Model 9145

Stereo cassette deck. W and F: 0.35% DIN. FR: 80Hz-10kHz within 6dB. Inputs: mic, radio, record player, tape recorder. Supplied complete with blank cassette, stereo microphone, connecting lead, cassette library rack. DNL noise reduction. Price: £65.21 (including VAT).

#### 9146 ★

Mains-operated stereo cassette recorder. Speed: 1 $\frac{7}{8}$ i/s. Compact cassette. W and F: ±0.35% (DIN). Noise level: >45dB (DIN). FR: 60Hz-10kHz (6dB DIN). Replay char: CCR. Rewind time: (C60) 85 sec. Meter level indicator. Three-digit tape position indicator with PB reset. Inputs: PU 100mV 1M, radio 0.2mV 2K, mic 0.2mV 2K. Outlets: 500mV 20K line, 5W 4-8 ohm speakers. Output: 5W RMS per channel. Separate speaker enclosures. One motor. Philips tape deck. Size: 14 × 8 $\frac{1}{2}$  × 3in. Weight: 6 $\frac{3}{4}$ lb. Pause. Straight-through amplifier. Electronic motor speed stabilisation. Mains: 110, 127, 220, 240V AC. Price: £65.81 (including VAT).

#### Model 9147

Stereo cassette deck. W and F: less than 0.2% (DIN 45 511). Fitted with DNL noise reduction. FR: 50Hz-11kHz ±6dB (Ferric oxide tape) 50Hz-14kHz ±6dB DIN (CrO<sub>2</sub> tape). Size: 3.25 × 14.5 × 9.375in. Fitted with automatic CrO<sub>2</sub> switching operated by cassette. CrO<sub>2</sub> indicator lamp. Twin VU meters. Price: £99 (including VAT).

#### Model 9148

Stereo cassette deck. W and F: better than 0.2% DIN. Fitted with DNL noise reduction. FR: 50Hz-11kHz (Ferric oxide tape), 50Hz-14kHz (CrO<sub>2</sub> tape) DIN. Automatic switch for CrO<sub>2</sub>. Inputs: mic, radio, record player. Slider record controls. Two VU meters. Meets the DIN Hi-Fi standard. Price: £139.59 (including VAT).

#### ■ SANSUI

Vernitron Ltd, Thornhill,  
Southampton, SO9 5QF.  
Tel: Southampton 444811.

#### SC700 (Dolby)

Stereo cassette tape deck. Speed: 1 $\frac{7}{8}$ i/s. Inputs: mic (L & R) 0.5mV 10K, mic (centre) 0.5mV 10K, line 70mV 100K, DIN 14mV 100K. Output: line (1) 1.2mV, line (2) 0.35mV, DIN 1.2mV, headphones 6mW at 8 ohms. W and F: 0-12%. Tape speed accuracy: within 1%. Fast rewind: 85 sec for C60 cassette. FR: 40Hz-13kHz (standard tape with Dolby); 40Hz-16kHz (Chrome tape with Dolby). S/N: ratio:



Pye 9144



Pye 9146

better than 50dB without Dolby, better than 56dB with Dolby. Mains: 100, 117, 220, 240V AC. Size 15 $\frac{1}{4}$  × 10 $\frac{1}{8}$  × 4 $\frac{1}{8}$ in. Price: £138.75 (plus VAT).

#### ■ SANYO

Sanyo Marubeni (UK) Ltd, Sanyo House,  
Bushey Mill lane, Watford, Herts WD2 4UQ.  
Tel: Watford (92) 30421.

#### RD4300X

Stereo cassette deck with Dolby system. No details of specification available as this edition of the Year Book closed for press. Price: £126.75 (including VAT).

#### RD4530

Stereo cassette deck. Fitted with DNL and CrO<sub>2</sub> switch. No other details available at time of going to press. Price £74.75 (including VAT).

#### ■ SHARP

Sharp Electronics (UK) Ltd, Sharp House,  
107 Hulme Hall Lane, Manchester, M10 8HL.  
Tel: 061-205 7321.

#### RT-480-H ★

Stereo cassette deck. FR: 25Hz-14kHz (standard tape), 20Hz-17kHz (CrO<sub>2</sub> tape). S/N: 56dB (with Dolby). Dolby noise reduction fitted. CrO<sub>2</sub> switch, dual VU meters. Motor: 4-pole synchronous hysteresis motor. Features an automatic programme finder that senses the blank sections between recordings and stops fast forward or rewind when switched in. Price: £109 (including VAT).





Sharp RT-480-H



Sony TC133CS

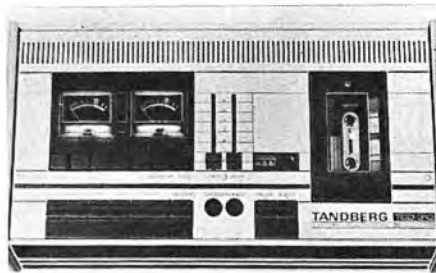

Tandberg TCD310



Sony TC134SD

## ■ SONY (UK) LTD

Pyrene House, Sunbury Cross, Sunbury-on-Thames, Middlesex. Tel: Sunbury 87644.

### TC124CS

Compact cassette mono/stereo recorder.  $\frac{1}{4}$ -track.  $1\frac{7}{8}$ i/s. W and F: better than 0.28%. H and N: better than 45dB. FR: 50Hz-10kHz. Replay char: NARTB. Level indicator: meter. Inputs: 2 microphone 0.25mV 400 ohms, 2 aux 78mV 100K. Output: 1W per channel to internal  $4 \times 2\frac{3}{4}$ in speaker and two ext speakers. Outlets: two ext speakers 775mV 8 ohms, headphone 24.5mV 8 ohms. Features: AGC recording system, monitoring through ext speakers or line outlets or 8 ohm headphones. Supplied with stereo mic fitted with stop/start switch and complete with int speaker and ext speakers. Power: four HPI1 batteries. 100, 110, 120, 220, 240V 50-60Hz. Weight: 4lb 13oz. Dimensions:  $6\frac{3}{4} \times 9\frac{3}{4} \times 2\frac{3}{4}$ in. Price: £79.95 (including VAT).

### TC131SD

Stereo cassette deck with Dolby.  $\frac{1}{4}$ -track.  $1\frac{7}{8}$ i/s. W and F: <0.22% RMS. S/N ratio: 49dB, Dolby improvement 10dB at 5kHz and over. Twin VU meters. Inputs: mic -72dB 0.6V low Z, line -22dB 0.06V, 100K. Outputs: line 0dB 0.775V 10K. Headphone: 8 ohms. One motor. Size:  $15\frac{5}{8} \times 3\frac{3}{4} \times 9\frac{1}{8}$ in. Pause. Mechanical auto shut-off. F and F head, Dolby on/off. CrO<sub>2</sub> selector. Slider level controls. Three-digit tape

counter. Rec/PB connector. Mains: 110, 126, 220, 240V AC. Price: £98.95 (including VAT).

### TC133CS ★

Stereo cassette tape recorder. Compact cassettes. Speed:  $1\frac{7}{8}$ i/s. W and F:  $\pm 0.38\%$ . H and N: -50dB. FR: (standard tape) 30Hz-12kHz, (CrO<sub>2</sub> tape) 30Hz-13kHz. Rewind time: 90 sec for C60 cassette. Twin VU meters. Inputs: mic 0.2mV low Z, PU 1.1mV 40K, line 0.035V 560K. Outlets: line -5dB 10K, phones 8 ohms or 10K, speakers 8 ohms. Output: 6W RMS per channel. Speakers (2) 5in. One motor. Size:  $15\frac{3}{4} \times 7\frac{3}{4} \times 12\frac{1}{2}$ in. Weight: 19 $\frac{3}{4}$ lb. Pause. Straight-through amplifier. Input mixing. Parallel track replay. Slider tone control. Separate level controls for each channel. Selector switch for standard or CrO<sub>2</sub> tape. Mains: 110, 127, 220, 240V AC. Price: £94.95 (including VAT).

### TC134SD ★

Stereo cassette deck. Dolby system.  $\frac{1}{4}$ -track.  $1\frac{7}{8}$ i/s. W and F: <0.2% NAB. S/N ratio: without Dolby 49dB, with Dolby up to 59dB. FR: CrO<sub>2</sub>, 30-17kHz. Std tape: 30-15kHz. Rewind time: 2 min. Twin VU meters. Inputs: mic -72dB 0.2mV low Z, line -22dB 0.06V 680K. Outputs: line 0.775V 10K. Phones 8 ohms. One motor. Size:  $16\frac{1}{2} \times 4\frac{9}{16} \times 8\frac{3}{8}$ in. Weight: 11lb 11oz. Pause. Auto-shut-off. Ferrite and ferrite head. Dolby on/off. CrO<sub>2</sub> selector. Slider con-

trols. Tape counter. Mains: 110, 127, 220, 240V AC. Price: £109.95 (including VAT).

#### TC146A

Cassette tape recorder. Mono recording, stereo playback. Speed:  $1\frac{7}{8}$  i/s. W and F: 0.22%. H and N: 45dB. FR: 40Hz-10kHz. Rewind time: 90 sec for C60 cassette. Auto level control. Inputs: mic 0.2mV 600 ohms, aux 60mV 560K. Outlets: line 10K, phones 8 ohms. One motor. Size:  $11\frac{1}{4} \times 2\frac{3}{4} \times 8\frac{3}{4}$  in. Weight: 6lb 3oz. Straight-through amplifier. Parallel track replay. Built-in electret mic. Tape end alarm. Mains: 127, 220, 240V AC. 6V DC from batteries (four 1.5V) or BP16 battery pack. Price: £67.95 (including VAT).

#### TC161SD

Stereo cassette deck. Dolby system.  $\frac{1}{4}$ -track.  $1\frac{7}{8}$  i/s. W and F: <0.1%. S/N ratio: without Dolby 49dB, with Dolby up to 59dB. FR: CrO<sub>2</sub> 20-17kHz. Std tape: 20-15kHz. Rewind time: 90 sec. C60. Two VU meters. Inputs: mic -72 dB 0.2mV low Z, line -22dB 0.06V 100K. Outputs: line 0.775V 100K. Phones 8 ohms. One motor. Closed loop dual capstan drive. Size:  $15\frac{3}{4} \times 5 \times 19\frac{3}{4}$  in. Weight: 14lb 4oz. Pause. Auto-shut-off. Ferrite and ferrite head. Dolby on/off. CrO<sub>2</sub> selector. Slider controls. Tape memory counter, memory on/off. Mains: 110, 127, 220, 240V AC. Price: £137.95 (including VAT).

#### TC152SD

Portable Dolby stereo cassette deck. W and F: 0.15% WRMS,  $\pm 0.3\%$  DIN. Fitted with Dolby B noise reduction. S/N: 48dB. FR: 30Hz-13kHz -15dB, 50Hz-11kHz DIN (Ferric oxide tape), 30Hz-15kHz -15dB, 50-12.5kHz DIN (CrO<sub>2</sub> tape). Fitted with CrO<sub>2</sub> switch. Twin VU meters. Inputs: mic 0.2mV/low, line -22dB (0dBm) 100K, DIN 10K. Outputs: line 0.775V 10K, DIN 0.775V 50K, phones 8 ohms. Internal speaker. One DC servo controlled motor. Power: 240V AC, 50-60Hz or 6V DC (4  $\times$  HP2) or rechargeable pack BP8. Size: 382  $\times$  108  $\times$  238 mm. Price: £99.95 (including VAT).

#### ■ TANDBERG

Farnell-Tandberg Ltd, Farnell House, 81 Kirkstall Road, Leeds, LS3 1HR. Tel: Leeds (0532) 35111.

#### TCD310 ★

Cassette stereo tape deck  $\frac{1}{4}$  track. Speed:  $1\frac{7}{8}$  i/s. Compact cassette. W and F: 0.2%. S/N: -52dB. FR: 40Hz-12.5kHz (ferric oxide tape), 40Hz-13.5kHz (CrO<sub>2</sub> tape). CrO<sub>2</sub> switch. Replay char: NARTB. Two meter level indicators. Four-digit tape position indicator with PB reset. Inputs: mic 0.1mV at less than 700 ohms, line 40mV 100K, radio 8mV 47K. Outlet: line 0.755V 10K, all DIN sockets. Three motors (synchronous hysteresis for capstan, precision

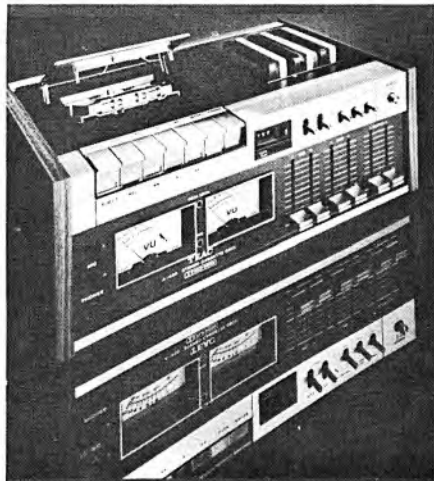

Teac A-450

fastwind reel motor). Size  $16\frac{3}{4} \times 4\frac{3}{4} \times 9\frac{1}{4}$  in. Weight: 14 $\frac{1}{2}$  lb. Pause. Monitoring on record. Parallel track replay. Hot-pressed ferrite heads. Dolby noise reduction system. Dual-capstan closed loop tape transport. Electronic controls. Auto-stop. Operates horizontally or vertically. Can be wall mounted. AC mains. Price: £159.10 (including VAT).

#### ■ TEAC

Acoustico Enterprises Ltd, Unit 7, Space Way, North Feltham Trading Estate, Feltham, TW14 0TZ. Tel: 01-751 0141.

#### A360

Stereo cassette tape deck. Speed:  $1\frac{7}{8}$  i/s.  $\frac{1}{4}$ -track stereo. W and F: 0.07%, H and N: (CrO<sub>2</sub> tape without Dolby) >47dB, (CrO<sub>2</sub> tape with Dolby) >58dB. FR: 30Hz-16kHz  $\pm$  3dB. Replay char: NAB. Rewind time: 95sec for C60. VU meter. Three-digit tape indicator with PB reset. Inputs: mic 0.25mV 600 ohms-10K, line 100mV 50K. Outlets: line 300mV 10K. One hysteresis synchronous motor. Pause control. Calibration tone. Memory rewind. Auto stop. Dolby system. Size:  $17\frac{3}{4} \times 4\frac{3}{4} \times 10\frac{1}{2}$  in. Weight: 16 $\frac{1}{2}$  lb. Mains: 100, 117, 220, 240V AC. Price: to be announced.

#### A450 ★

Mains-operated stereo cassette tape deck with Dolby system.  $\frac{1}{4}$ -track. Speed:  $1\frac{7}{8}$  i/s. W and F: 0.07%. H and N: (CrO<sub>2</sub> tape with Dolby) 47dB, (CrO<sub>2</sub> tape with Dolby) >60dB. FR: (CrO<sub>2</sub> tape) 30Hz-16kHz  $\pm$  2dB. Replay char: NAB. Rewind time: 85 sec for C60. VU meter. Three-digit tape position indicator with PB reset. Inputs: line 100mV 100K, mic 0.25mV 600

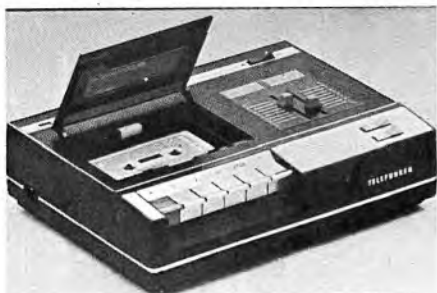

Telefunken Stereosound



Trio KX-710

ohms 10K. Outlet: line 300mV 10K. One hysteresis outer-rotor motor. Input mixing. Dolby FM copy. Timer switch. Auto stop. Dolby system. Size:  $17\frac{1}{2} \times 7 \times 10\frac{3}{8}$  in. Weight: 21lb. Pause control. Mains: 100, 117, 220, 240V AC. Price: £210 (plus VAT).

## ■ TECHNICS

Building 63, Whitby Road, Trading Estate, Slough, Bucks. Tel: Slough 35422.

### RS263US

Stereo cassette tape deck with Dolby noise reduction system. Normal or CrO<sub>2</sub> tapes. Auto stop. Pause button. Memory rewind. Slider and pushbutton controls. Two VU meters. FR: (normal tape) 30Hz-13kHz; (CrO<sub>2</sub> tape) 30Hz-15kHz. Full specification unobtainable as this edition of the Year Book closed for press. £97.95 (including VAT).

### RS271US

Stereo cassette tape deck with Dolby system. Normal or CrO<sub>2</sub> tapes. Ten-year guarantee on HFP head. Electronically controlled motor. Memory rewind. Lockable pause control. Photo-electric auto stop. FR: (normal tape) 20Hz-13kHz; (CrO<sub>2</sub> tape) 20Hz-15kHz. Full specification unobtainable as this edition of the Year Book closed for press. Price: £139.95 (including VAT).

### RS276US

Stereo cassette tape deck with Dolby system. Normal or CrO<sub>2</sub> tapes. Direct drive motor. Feather-touch controls. Lockable pause control. Memory rewind. Photo-electric auto shut-off. FR: (normal tape) 20Hz-16kHz; (CrO<sub>2</sub> tape) 20Hz-18kHz. Full specification unobtainable as this edition of the Year Book closed for press. Price: £219.95 (including VAT).

### RS279US

Stereo cassette tape deck with three heads, two motors and the Dolby noise reduction system. Ultra slow running DC motor. HFP heads with 10-year guarantee. Feather-touch electronic pushbuttons. Memory rewind. Photo-electric auto stop. Electronic pause control. FR: (normal tape) 20Hz-16kHz; (CrO<sub>2</sub> tape) 20Hz-18kHz. Full specification not obtainable as this edition of the Year Book closed for press. Price: £269.95 (including VAT).

## ■ TELEFUNKEN

AEG Telefunken (UK) Ltd, Bath Road, Slough, Bucks. Tel: Slough (75) 33311

### MC2100 Hi-Fi ★

Stereo cassette deck. W and F: better than 0.2%. Fitted with DNL noise reduction. S/N: 52dB (CrO<sub>2</sub> tape), 50dB (Ferric oxide tape). FR: 30Hz-10kHz (Ferric oxide tape), 30Hz-12.5kHz (CrO<sub>2</sub> tape). Automatic selection for CrO<sub>2</sub>. Twin VU meters. Inputs: radio 0.2mV 2.2K, mic 0.2mV 2.2K, phono (cer) 200mV 2.2M. Outputs: radio 0.8V 15K, phones 0.4V 3.3K. One electronic controlled DC motor. Mains: 110-220V AC. Size: 320 × 72 × 270mm. Memory counter. Automatic level control. Price: £99.50 (including VAT).

### MC2200 Hi-Fi ★

Stereo cassette deck. W and F: better than 0.2%. Fitted with Dolby noise reduction. S/N: better than 56dB (CrO<sub>2</sub> tape), better than 54dB (Ferric oxide tape). FR: 30Hz-12.5kHz (Ferric oxide tape), 30Hz-14kHz (CrO<sub>2</sub> tape). Automatic selector switch for CrO<sub>2</sub>. Two VU meters. Inputs: radio 0.2mV 2.2K, mic 0.2mV 2.2K. Phono (cer) 200mV 2.2M. Outputs: radio 0.8V 4.7K. Phones 2.5V 400 ohms. One electronic controlled DC motor. Mains: 110-220V AC. Size: 390 × 85 × 300mm. Memory counter. Slider volume control for headphones, and recording. Manual or automatic record level control. Price: £139.50 (including VAT).

## ■ TELETON

Teleton Electro (UK) Co Ltd, Teleton House, Waterhouse Lane, Chelmsford, Essex, CM1 1BD. Tel: Chelmsford (0245) 62442. Telex: 99338.



Wharfedale DC9

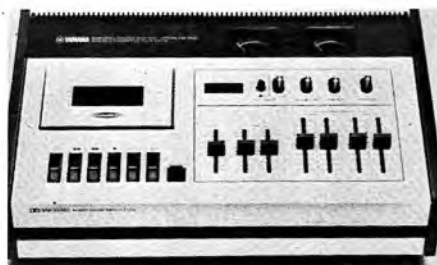

Yamaha TB-700

**Model CD100**

Stereo cassette deck. W and F: 0.35% DIN. Fitted with Dolby noise reduction. FR: 40Hz-10kHz (Ferric oxide tape), 40Hz-12.5kHz (CrO<sub>2</sub> tape). Inputs: mic 0.56mV 4K, aux 50mV 47K. Outputs: 0.775V 4.7K. Mains: 90 × 362 × 246mm. Motor: DC electronic stabilised. CrO<sub>2</sub> switch. Twin VU meters. Slider record controls. Price: £95.15 (including VAT).

**TRIO**

Distributors: B. H. Morris & Co (Radio) Ltd, Trio House, The Hyde Industrial Estate, The Hyde, London NW9 6JP. Tel: 01-205 6441.

**KX710 ★**

Stereo cassette deck with Dolby B noise reduction system.  $\frac{1}{2}$ -track. Speed:  $1\frac{1}{4}$ i/s. W and F: <0.13%. FR: CrO<sub>2</sub> 25Hz-16kHz, (standard tape) 25Hz-13kHz. Inputs: mic 0.24mV 10 ohms, line 77.5mV 470K. Output: 0dB (0.775V). Outlet for headphones: 8-16 ohms. Re-wind time 82 sec for C60 cassette. H and N: (Dolby in and CrO<sub>2</sub> tape) 58dB. Auto tapé switch for CrO<sub>2</sub>. Audio cue and review. Memory rewind. ALC. Automatic shut-off. Dolby indicator. Record level indicator. Three-digit tape position

indicator with PB reset. Headphone jack. Mains: 110-120V, 220-240V AC. Size:  $15\frac{1}{4} \times 5 \times 9\frac{1}{8}$ in. Weight: 7lb. Price: £115 (plus VAT).

**WHARFEDALE**

Rank Radio International Ltd, Power Road, Chiswick, London, W4 5PW. Tel: 01-994 6491.

**DC9 ★**

Cassette tape unit incorporating Dolby B noise reduction system. Stereo. Speed:  $1\frac{1}{4}$ i/s. Compact cassette. W and F: <0.18%. FR: 50Hz-12kHz  $\pm$ 2dB. Rewind time: <120 sec for C90 cassette. Level indicators: twin VU meters. Inputs: mic 0.2mV  $\pm$ 2dB for zero VU, 100mV  $\pm$ 2dB for zero VU. Solid state speed controlled DC motor. Pause control. Mains 240V 50Hz. For use with chromium dioxide or standard tape. Price: £111.41 (including VAT).

**WHD 20D**

Stereo cassette deck. W and F: 0.25% (DIN). Fitted with Dolby noise reduction. S/N: 54dB. FR: 50Hz-12kHz  $\pm$ 4dB (CrO<sub>2</sub>). Inputs: mic 300mV 1.5K, aux 30mV 100K. Outputs: line 580mV. Size: 97 × 285 × 300mm. CrO<sub>2</sub> switch. Price: £105.60 (including VAT).

**YAMAHA**

Natural Sound Systems, Strathcona Road, North Wembley, London, HA9 8QL. Tel: 01-904 0141.

**TB-700 (Dolby) ★**

Stereo  $\frac{1}{2}$ -track cassette tape deck incorporating Dolby noise reduction system. Speed:  $1\frac{1}{4}$ i/s. Compact cassette. W and F: 0.12%. H and N: (without Dolby) 50dB; (with Dolby) 59dB. FR: (standard tape) 30Hz-13kHz  $\pm$ 3dB, (CrO<sub>2</sub>) 30Hz-16kHz  $\pm$ 3dB. Adjustable replay characteristics. Rewind time: 90 sec for C90 cassette. Two VU meters. Adjustable output. DC servo-controlled motor. Pause. Monitoring. Input mixing. Tape speed control gives  $\pm$ 5% variation. Three-position bias switch for standard, high-energy and chromium-dioxide (CrO<sub>2</sub>) tapes. Size:  $17\frac{1}{2} \times 4\frac{3}{4} \times 11\frac{1}{8}$ in. Weight: 18 $\frac{1}{2}$ lb. Price: £150.36 (plus VAT).



**HMV hi-fi  
stereo system Model 2488  
£279.82 (inc. VAT)**

**DECK**

The superb Garrard 86 SB single record player. The pickup is the highly sophisticated Shure M75-ED Type 2 with its 18 x 5 micron elliptical diamond stylus (N75-ED Type 2) and fluid damped cueing lever.

**SPEAKERS**

Each unit houses three specialist hi-fi speakers from Goodmans. Two 8" bass speakers and one 1" treble dome radiator.

**CONTROLS Power Off**

Loudspeakers (local)\* Pressing this button puts you in touch with a glorious 120 watts of music power.

**Balance\*** Provides an electronic means of balance when using loudspeakers (remote) only.

(Pressing these two buttons\* simultaneously provides ambiphony with an extra pair of speakers.)

**Loudspeakers (remote) on Rumble Filter Scratch Filter Contour/Linear response Mono - Stereo and interstation muting**

Gives you superb reproduction on mono records and tapes because it switches channels to run in parallel. Releasing it gives you the full depth and beauty of stereo sound when receiving stereo. And a reduction in inter-station noise when tuning the radio in the stereo model (FM).

**Tape Monitor**

For playing back tapes. The

monitor facility being available for use with a "3 head" machine.

**Pickup**

Switches in the superb Garrard 86 - SB high performance record player.

**Ceramic PU and Auxiliary**

To connect the system to other audio equipment. Simply plug into the socket provided and press.

**FM Band Selector (FM AFC)**

**MW Band Selector**

**Preset FM Band Selectors**

**Manual Tuning Selector**

Allows you to use the Flywheel Tuner.

**Slide Tone Controls**

Treble and bass

**Volume Left Channel**

**Volume Right Channel**

Separate channel controls enable you to get the exact sound level you want right wherever you sit.

**VHF Preset Tuning Roller**

**Rotary Flywheel Tuner**

Takes you smoothly through the whole length of the waveband.

**Slide Switch (panel)**

Interconnection for FM and AM aerials.

**INDICATORS**

**Stereo Transmission Light**

**Off-Tune and Weak Signal Indicator**

The brightness of its light is linked to the accuracy of the tuning. The more 'on-tune' you are the dimmer it becomes. Eventually it disappears altogether.

**VHF-FM Frequency Meter**

For tuning preset buttons.

**On-Off indicator**

**SOCKETS Stereo Headphone DIN Sockets**

Loudspeakers, local LH, RH; loudspeakers, remote, LH, RH (or backspeakers for ambiphony 4-D); tape record/playback/monitor; auxiliary audio input; VHF aerial; AM aerial.

**Optional Extras**

Pair of speakers for 4-D sound. The 4-D system provides you with an entirely new experience. Completely surrounding you in sound. Stereo headphones.

**Appearance**

All three units are veneered in rich teak. The main unit has a black aluminium control panel and black controls. Speakers are elegantly proportioned with deep black acoustic front panels.

**Approximate dimensions**

Main unit: Width 24½", Height 8½", 19½" lid fully open, Depth 16½", 19½" lid fully open. Loudspeakers: Width 13½", Height 22", Depth 10½".

For further information write to Thorn Consumer Electronics Limited, Dept H 35 284 Southbury Road, Enfield, Middlesex EN1 1TJ.

Price is correct at time of preparing for publication.

**HMV**  
put quality first

HMV is the registered trademark of EMI Records Ltd

**If you think the small print's full of quality wait till you hear the Hi-Fi sound**

# Combination Units

★ Indicates entry is illustrated

Abbreviations used in this section are given on page 20.

## ■ ALPHA

Highgate Acoustics, 38 Jamestown Road, London, NW1 7EJ. Tel: 01-267 4937.

### GF2500 Conductor

Stereo amplifier and record deck in shelf cabinet with lift-up tinted plastic lid. Motor unit: Garrard SP25 Mk III. Speeds:  $33\frac{1}{3}$ , 45, 78rpm. Idler wheel drive. Cartridge: Pickering P/AT. Diamond stylus. Inputs: mag PU 6mV, radio 80mV-IV, tape 250mV-3V. Noise level: (tape and radio inputs) better than 60dB. (PU input) 48dB. Overload capability: 23dB on all inputs. Output: 15W RMS per channel. HD: <0.5% at 15W. Output impedance: 8 ohms. FR: 20Hz-25kHz (40Hz-14kHz  $\pm$  2dB). Headphone socket. Slider volume control. Finish: teak with anodised black and silver control panel. Size:  $17\frac{1}{2} \times 7 \times 13$ in. Mains: 240V AC. Price: £78-65 (including VAT). GF2500 Conductor with SL65B deck and Pickering P/AT cartridge. Price: £83-05 (including VAT).

## ■ ASA

ASA (UK) Television & Radio Ltd, 31-35 High Street, Shirehampton, Bristol, BS11 0DX. Tel: Avonmouth (027 52) 5035.

### 3704

FM stereo receiver in plinth with four-speed record deck. Motor unit: BSR P128. Speeds:  $16\frac{2}{3}$ ,  $33\frac{1}{3}$ , 45 and 78rpm. Four-pole motor.  $10\frac{1}{2}$ in diecast turntable. Wow: less than 0.2%. Flutter: less than 0.06%. Automatic or manual operation of pickup arm. Hydraulic lifting and lowering. Playing weight adjustable 0-6gm. Cartridge: Shure M75-6. Range: 87.5-104MHz. Sensitivity: better than 2 $\mu$ V for 26dB quieting. Aerial input: 240 ohms balanced. AFC. Variable tuning plus three presets. Quiet tuning facility. IC stereo decoder with auto switching and beacon. Output: 20W RMS per channel. FR: 30Hz-30kHz  $\pm$  1.5dB. HD: <1%. Tone controls: bass +18dB -15dB at 40Hz, treble +14dB -15dB at 10kHz. Rumble and scratch filters. Inputs: mag PU 4mV 47K, crystal PU 70mV 500K, tape play 260mV 500K. Front jack sockets for headphones (automatically mutes speaker outlets). 37 transistors, 15 diodes, one

IC, three varicap diodes. Mains: 220-240V 50Hz. Finish: anodised metal front with teak or rosewood cabinet. Size:  $20\frac{3}{8} \times 7\frac{1}{8} \times 13\frac{3}{8}$ in. Price: (teak) £124-27 (including VAT); (rosewood) £124-27 (including VAT).

## ■ BANG & OLUFSEN

Bang & Olufsen UK Ltd, Eastbrook Road, Gloucester, GL4 7DE.

Tel: Gloucester (0452) 21591.

### Beocenter 1400

AM/FM stereo receiver with built-in cassette recorder. Tuning range: FM 87.5-104MHz, LW 2040-857m, MW 578-187m. Variable tuning. Sensitivity: FM <1.8 $\mu$ V, AM: LW <15 $\mu$ V, MW <20 $\mu$ V. Aerial input: 75 ohms coaxial and 300 ohms balanced. Output: 20W RMS. HD: <0.5% at 20W. FR: 20Hz-30kHz  $\pm$  1.5dB. Inputs: mag PU 2.5mV 47K, tape 300mV 100K. Cassette section. Speed:  $1\frac{7}{8}$ i/s. W and F: 0.35% RMS. S/N ratio: >50dB. FR: 40Hz-12.5kHz. Mains: 110-130 and 220-240V AC 50Hz. Size:  $26 \times 10\frac{1}{4} \times 3\frac{1}{4}$ in. Finish: brushed aluminium fascia with teak or rosewood cabinet. Price: (teak) £187-50; (rosewood) £188-50 (including VAT).

### Beocenter 3500

FM stereo receiver in cabinet with record deck. Motor unit: B & O. Two speeds. 12in grooved aluminium alloy platter. Belt drive. High compliance pickup arm. Cartridge: B & O SP10A, 0.6 thou diamond stylus. Range: FM 87.5-104MHz. Variable tuning plus six presets. AFC. Ratio detector. 'Balanced light' tuning system. Usable sensitivity: 2 $\mu$ V. Aerial input: 75-ohm coaxial. Stereo decoder fitted. Inputs: PU (1) 3mV 47K, PU (2) 200mV-3V 1M, tape 200mV-3V 1M. Output: 40W RMS per channel. Output impedance: 4 ohms. Tone controls: bass  $\pm$  17dB at 50Hz, treble  $\pm$  14dB at 10kHz. Rumble filter: -12dB/octave below 80Hz, scratch filter -12dB/octave above 4kHz. HD: 0.3% at 1kHz at rated output (both channels driven). FR: 40Hz-20kHz  $\pm$  1.5dB. Mains: 110, 130, 220, 240V AC. Sizes:  $22\frac{7}{8} \times 13\frac{7}{8} \times 5\frac{3}{4}$ in. Finish: brushed aluminium fascia and deck, teak, rosewood or white side panels, hinged dust cover. Price: (teak) £265-50 (rosewood or white) £266-50 (including VAT).

## ■ BUSH-ARENA

Rank Radio International Ltd, PO Box 596, Power Road, Chiswick, London, W4 5PW. Tel: 01-994 6491.

### RTA2000

Stereo FM receiver in cabinet with record deck. Range: 88-108MHz. Five preset stations. AFC. Stereo decoder. Controls: volume on/off, bass  $\pm$  12dB at 50Hz, treble +12dB

★ Indicates entry is illustrated

-13dB at 10kHz, balance, loudness, input selectors, mono/stereo. Output: 15W RMS per channel into 3 ohms. Output impedance: 3-15 ohms. FR: 20Hz-25kHz -3dB. HD: <0.6% 40Hz-12.5kHz. Motor unit: Lenco B55 transcription deck. Cartridge: Goldring G800E with elliptical diamond stylus. Finish: teak. Price: £127.09 (including VAT).

#### RA2100

Integrated stereo amplifier in cabinet with record deck. Output: 15W RMS per channel into 3 ohms. Output impedance: 3-15 ohms. HD: <0.6% 40Hz-12.5kHz. FR: 20Hz-25kHz -3dB. Controls: volume on-off, bass  $\pm$ 12dB at 50Hz, treble +11dB -13dB at 10kHz, balance, loudness, input selector, mono/stereo. Input: tape 120mV 100K. Record deck: Garrard SP25 Mk III with Shure M75MB cartridge and spherical tip diamond stylus. Finish: teak veneer. Price: £93.20 (including VAT).

#### RA3700

Integrated stereo amplifier in cabinet with record deck. Output: 10W RMS per channel into 4 ohms. Output impedance: 4-15 ohms. HD: <1%. FR: 25Hz-20kHz -3dB. Controls: volume on/off, bass +12dB -15dB at 100Hz, treble +11dB -13dB at 10kHz, balance, mono/stereo, input selectors. Inputs: tape 90mV 200K, radio 70mV 150K. Record deck: Garrard SP25 Mk III with Goldring G800 magnetic cartridge. Diamond spherical tip 0.6 thou stylus. Finish: teak veneer. Price: £71.54 (including VAT).

#### ■ CROWN

Crown Radio Co Ltd,  
128-129 Shoreditch High Street, London,  
E1 6JE. Tel: 01-739 2382.

#### SM110

AM/FM receiver in cabinet with record deck. Range: FM 88-108MHz, MW 182-560m. Variable tuning. AFC. Stereo decoder fitted. Controls: bass, treble, low filter, high filter, volume, input selector, balance, main on/off, tuning. Output: 7.5W RMS per channel. Output impedance: 8 ohms. FR: 20Hz-25kHz. HD: <1% at 6W output. Finish: walnut veneer with silver trim. Price: £109.89 (including VAT).

#### SHC65F ★

AM/FM receiver in cabinet with cassette recorder and record deck. Range: FM 88-108 MHz, MW 182-560m. Variable tuning. AFC. Stereo decoder fitted. 27 transistors, one FET, six ICs. Controls: tuning, AFC on/off, muting, waveband selector, input function, high filter, loudness, bass, treble, left-channel record level, right-channel record level, balance, volume. Output: 7.5W RMS per channel. Output impedance: 8 ohms. FR: 50Hz-20kHz. Record deck: Garrard SP25 Mk III or Garrard 2025T.



Crown SHC65F

Finish: walnut veneer with black trim. Price: £248.95 (including VAT).

#### ■ DUAL

Audiodecks Ltd, Farnell House,  
81 Kirkstall Road, Leeds, LS3 1HR.  
Tel: Leeds (0532) 35111.

#### KA12L

AM/FM stereo receiver in cabinet with record deck. Range: FM/VHF, MW, LW, SW. Variable tuning. AFC. Ratio detector. Stereo decoder fitted. Output: 6W RMS per channel. Output impedance: 4 ohms. Motor unit: Dual 1211. Speeds: 33 $\frac{1}{3}$ , 45, 78rpm. Speed control: 6% variation. Cartridge: Dual CDS650. Turntable: 10 $\frac{1}{8}$ in diameter, 3 $\frac{1}{4}$ lb. Idler wheel drive. Tubular spring balanced pickup arm. Torsionally rigid with low dynamic mass. Playing weight: 4gm. Stylus: sapphire. Provisional specification. Price: to be announced.

#### ■ DUETTE

J. J. Silber Ltd, 11 Northburgh Street,  
London, EC1. Tel: 01-253 8031.

#### SS2005W

AM/FM stereo receiver in cabinet with stereo cassette recorder and record deck. Range: FM 88-108MHz, MW 185-565m. Aerial input: 300 ohms balanced. Ferrite rod AM aerial. Stereodecoder fitted. Separation: 30dB at 1kHz. Compact cassettes. Speed: 1 $\frac{7}{8}$ i/s. W and F: 0.25%. H and N: 45dB. Automatic or manual level control. Multiplex filter. Four-speed record deck. Ceramic cartridge with diamond stereo stylus. 11in platter. Four-pole motor with outer rotor. Audio output: 10W per channel. Output impedance: 8 ohms. FR: 35Hz-30kHz. Tone controls: bass +10dB -12dB at 100Hz, treble +9dB -17dB at 10kHz. Mains: 110, 117, 220, 240V 50-60Hz. Size: 22 $\frac{3}{4}$  x 9 x 17in. Weight: 35lb. This is a provisional specification as full details were not available as this issue of the Year Book closed for press. Price: £171.99 (including VAT).

**■ DYNATRON**

Dynatron Radio Ltd, St Peter's Road,  
Maidenhead, Berks. SL6 7QY.  
Tel: Maidenhead (0628) 23331.

**HFC30A**

Integrated stereo amplifier with record deck incorporated in same cabinet. Controls: mains on/off, volume, bass, treble, input selector, balance. Output: 8W RMS per channel into 3 ohms load. FR: 20Hz-20kHz -3dB at 20Hz and 20kHz. Output impedance: 3-16 ohms. HD: <0.35% -2dB at rated output. Motor unit: Garrard 40B. Cartridge: Goldring G850. Size: 19 x 15 x 7 $\frac{3}{8}$ in. Finish: teak veneer cabinet with black control panel and transparent plastic lid. Price: £70.14 (including VAT).

**HFC30M**

Integrated stereo amplifier with record deck incorporated in same cabinet. Similar specification to HFC30A but manual record deck instead of automatic: Record Unit: Garrard SP25S Mk III. Cartridge: Goldring G850. Price: £71.09 (including VAT).

**HFC55 Radio Carnival**

Combination unit comprising turntable and receiver. Record player section. Goldring G102 two speed unit (33 $\frac{1}{3}$ /45rpm). Belt driven 10in platter and tone arm fitted with bias compensation. Cartridge: Shure M75-6s. Receiver section: Output: speaker 15W per channel into 8 ohms. Power bandwidth: 30Hz-25kHz. THD: 0.3% at rated power. Inputs: radio 30%. Modulation produces rated output. Tape replay 180mV 100K, phono 4mV 50K, headphones 8-16 ohms. S/N: 60dB. Bands: AM-MW 525-1620kHz, LW 150-272kHz, SW 49 metre band. FM 87.5-104MHz presets. Sensitivity: 15 $\mu$ V for 20 S/N average (LW) 10 $\mu$ V for 20dB S/N average (MW and SW). FM: 2.5 $\mu$ V for 35dB S/N at 100% modulation. AF response (FM) 30Hz-15kHz  $\pm$ 3dB. AFC: pull-in range 300kHz, hold-in range 350kHz. Price: to be announced.

**HFC60 Cavalcade music centre**

Combination unit comprising turntable and receiver with cassette deck. Record deck: Goldring G102 two speed unit (33 $\frac{1}{3}$  and 45rpm). Cartridge: Shure M75-6s. Cassette deck: Philips N2505/51 with DNL noise reduction. Receiver section. Outputs: speakers 15W 8 ohms, tape 180mV 220K. Inputs: tape replay 180mV 100K, phono 4mV 50K, headphones 8 ohms. S/N: 60dB. Quadro-sound switch. Rear speaker level switch: -6dB. Wavebands: MW 525-1620kHz, LW 150-272kHz, SW 49 metre band. FM 87.5-104MHz. Other specifications as for the HFC55. Price: to be announced.

Dynatron market a very full range of music centres in furniture styled cabinets. Space considerations do not permit all these to be



*Dynatron HFC46*

detailed, but specifications and price can be obtained on application.

**Richmond HFC45**

AM/FM stereo tuner/amplifier in console cabinet with record storage. Motor unit: Goldring-Lenco GL72. Speeds: fully variable 16-78rpm with click stops. Cartridge: Goldring G850. Stylus: spherical diamond. Range: FM 87.5-108MHz, MW 187-570m, LW 1100-2000m. Variable tuning. AFC. Ratio detector. Meter tuning indicator. Usable sensitivity: FM 3 $\mu$ V, MW 10 $\mu$ V, LW 15 $\mu$ V. Aerial input: balanced and 75-ohm coaxial. Stereo decoder fitted. 32 transistors. Input: tape 26mV 12K. Noise level:  $\geq$  -65dB. Overload capability: 650mV. Output: 8W RMS per channel into 8 ohms. Output impedance: 4 ohms. Controls: tuning, bass, treble, input selector, balance, volume, rumble filter, scratch filter, loudness. HD: 1% at 8W. FR: 23Hz-20kHz -3dB. Mains: 240V AC. Size: 21 $\frac{3}{4}$  x 15 $\frac{1}{2}$  x 31in. Finish: teak veneer. Price: £145.97 (including VAT).

**Hambleton HFC46 ★**

Same specification as HFC45 but in Queen Anne period style cabinet finished in walnut veneers. Size: 23 $\frac{1}{4}$  x 16 $\frac{1}{4}$  x 8 $\frac{1}{2}$ in. Price: £165.88 (including VAT).

**Savoy HFC47**

Same specification as HFC45 but in Regency period style cabinet finished in mahogany veneers. Size: 23 $\frac{1}{4}$  x 16 $\frac{1}{4}$  x 8 $\frac{1}{2}$ in. Price: £165.88 (including VAT).

**HFC100**

Integrated stereo amplifier in cabinet with record deck. Motor unit: Goldring-Lenco GL75. Cartridge: Goldring G800. Stylus: spherical diamond. 34 transistors. Inputs: radio 165mV 230K,



★ Indicates entry is illustrated

tape 165mV 230K, mag pickup 24mV 47K. Noise level: (PU input)  $\geq -60$ dB, (other inputs)  $\geq -66$ dB. Overload capability: (PU input) 100mV, (other inputs) 6V. Output: 45W per channel at 8 ohms. Output impedance: 4-16 ohms. Controls: bass, treble, volume scratch filter, rumble filter, loudness, input selector, balance, A-B speakers. HD: 0.3%  $-\frac{1}{2}$ dB. FR: 16Hz-28kHz  $-3$ dB. Size:  $21 \times 16\frac{1}{4} \times 8\frac{1}{2}$ in. Finish: teak veneer. Price: £132.70 (including VAT).

#### HFC101A

Similar specification to HFC100 but with the addition of AM/FM radio. Also second tape input instead of mag PU. 59 transistors. Range: FM 87.5-108MHz, MW 185-570m, LW 1100-2000m. Variable tuning. AFC. Ratio detector. Meter tuning indicator. Usable sensitivity: FM  $3\mu$ V, MW  $10\mu$ V, LW  $15\mu$ V. Aerial input: balanced or 75-ohm coaxial. Stereo decoder fitted. Finish: teak veneer. Price: £168.72 (including VAT).

#### HFC102

Similar specification to HFC100 but with addition of FM/VHF radio and second tape input (300mV 450K) instead of mag PU. Range: 87-104MHz. Five preset tuning buttons. AFC. Ratio detector. Usable sensitivity:  $3\mu$ V. Aerial input: balanced or 75-ohm coaxial. Stereo decoder fitted. Finish: teak veneer. Price £159.25 (including VAT).

#### HFC103 ★

FM stereo tuner-amplifier with record deck and cassette recorder in period style cabinet with record and cassette storage space. Drawer for accessories. Motor unit: Goldring-Lenco GL75. Cartridge: Goldring G800. Stylus: spherical diamond. Tape unit: Philips N2505/10. Four-track stereo. Speed:  $1\frac{1}{2}$ i/s. Compact cassettes. Range: 87-104MHz. Five preset tuning buttons. AFC. Ratio detector. Usable sensitivity:  $3\mu$ V. Aerial input: balanced or 75-ohm coaxial. Stereo decoder fitted. 58 transistors. Inputs: radio 165mV 230K, tape (1) 165mV 230K, tape (2) 300mV 450K. Noise level: tape (2)  $\geq -60$ dB, (other inputs)  $\geq -66$ dB. Overload capability: 6V. Output: 45W RMS per channel into 8 ohms. Controls: bass, treble, balance, volume, tuning pushbuttons, rumble filter, scratch filter, loudness, input selector pushbuttons. HD: 0.3%  $-\frac{1}{2}$ dB. Output impedance: 4-16 ohms. FR: 16Hz-28kHz  $-3$ dB. Mains: 240V AC. Size:  $31\frac{1}{2} \times 21\frac{3}{4} \times 39\frac{1}{2}$ in. Finish: period style cabinet in selected walnut veneers. Price: £303.31 (including VAT).

#### ■ ELGAR

English Audio (1970) Ltd, North Station Road, Colchester, Essex. Tel: Colchester (0206) 73467.



Dynatron HFC103

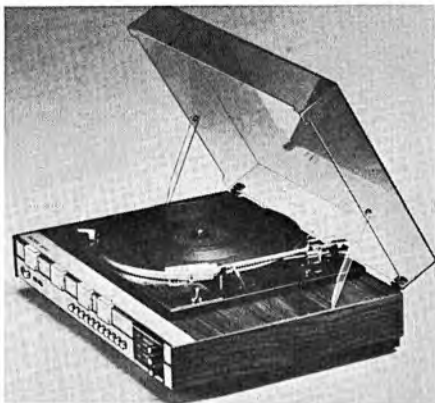

Goldring ST8000

#### Elgar

Integrated stereo amplifier in plinth cabinet with record deck and pickup. Clear plastic lid. Record unit: Thorens TD150 Mk II two-speed motor with lightweight arm. Cartridge: Shure M75EJ. Elliptical diamond stylus. Finish: teak. Built-in integrated stereo amplifier. Inputs: mag PU 3.5mV 56K. Ceramic PU 20mV 33K, radio 100mV 100K, tape 100mV 100K. Noise level:  $-65$ dB on all inputs. Output: 18W per channel. HD:  $<0.5\%$  at all levels up to rated output. FR: 20Hz-20kHz  $\pm 3$ dB. Overload capacity: 29dB on all inputs. Independent outlet for tape provides 200mV irrespective of volume setting. Controls: (rotary) bass, treble, volume, balance and input selector, (slider switches) mono/stereo. HF filter, loudness, phones/speaker. Indicator light. Output impedance: 8-16 ohms.

Connections by DIN plugs. Finish: teak case. Price: approximately £130 (including VAT).

### ■ GOLDRING

Goldring Ltd, 10 Bayford Street, Hackney, London, E8 3SE. Tel: 01-985 1152.

#### ST8000 ★

Combination unit comprising FM tuner, amplifier and turntable. Turntable: Goldring GL78 fitted with Goldring G800E cartridge. FM tuner section. Band: 87.5-105MHz. Sensitivity: 1.8µV for 26dB (at 40kHz deviation). Limiting: 4.6µV. IF: 455kHz. S/N: better than 62dB at 100µV. 40kHz deviation. Amplifier section. Output power: 2×40W 4 ohms. Distortion: less than 0.15% at rated power. Power bandwidth: 20Hz-30kHz at 20W 1% distortion factor. Inputs: tape 200mV 270K, phono 4mV 47K. S/N: better than 60dB (main amp), better than 55dB with pre-amplifier. Price: on application.

### ■ GOODMAN'S

Goodmans Loudspeakers Ltd, Downley Road, Havant, Hampshire, PO9 2NL. Tel: Havant (070 12) 6344. Telex: 86296.

#### Module 80 Compact ★

FM stereo receiver in cabinet with record deck. Motor unit: Goldring-Lenco GL75. Four speeds, infinitely variable. 12in diameter 8lb die-cast turntable. Vertical pulley drive. L75 pickup arm with weight adjustment. Cartridge: Goldring G800E. Stylus: elliptical diamond. Range: FM 87.5-108MHz. Variable tuning. Switched AFC. Dual-light tuning indicator. Usable sensitivity: <1.5µV for 26dB S/N. Aerial input: 240-300 ohms balanced. Stereo decoder included. Stereo beacon. 68 transistors, including two FETs. Inputs: aux 60mV 600K, tape play 320mV 50K. Noise level: mag PU -66dB, other inputs: -80dB. Overload capability: +23dB. Output: 35W RMS per channel. Output impedance: 4 ohms. Controls: bass, treble, balance, loudness, volume, on/off, speakers, high pass and low pass filters, input selectors. HD: <0.1% at rated output into 4 ohms, both channels driven. FR: 30Hz-20kHz ±1.5dB at rated output. Mains: 120, 220, 245V AC. Size: 22 × 6½ × 17¾in; (height with lid raised) 21in. Finish: teak, walnut or white with matt black fascia. Price: (teak or walnut) £143.78 (plus VAT); (white) £148.06 (plus VAT). Optional matching stand.

#### Module 90 Compact ★

AM/FM stereo receiver with transcription record player. Facilities: on fascia: two stereo headphone sockets, stereo beacon, tuning/signal strength meter, two output meters. Amplifier: 45W per channel into 4 ohms, 30W per channel into 8 ohms. THD: <0.1% at 35W into 4 ohms. FR: 25Hz-30kHz, -3dB. S/N: (Tape



Goodmans Module 80 Compact



Goodmans Module 90

input) -75dB. Radio bands: MW 525-1605kHz, FM 87.5-108MHz variable, 87.5-101MHz on presets. FM sensitivity: typically 2µV into 240 ohms or 1µV into 75 ohms, for 30dB S/N with 75kHz deviation. THD: typically 0.5% for 75kHz deviation. Transcription unit. Garrard Zero 100SB; W and F: 0.12% peak, rumble -63dB DIN. Cartridge: Shure M93E, elliptical stylus. Mains: 122V or 220-245V 50-60Hz. Size: 24½ × 15¾ × 8½in. Price: on application.

#### One-Ten Compact

AM/FM stereo receiver in case with record deck. Motor unit: Goldring GL85. Cartridge: Goldring G800E. Stylus: 0.3 × 0.8 thou diamond. Range: FM 87.5-108MHz, MW 187-572m, LW 1130-2000m, SW 48-51m. Variable tuning. Switched AFC. Signal strength meter. Usable sensitivity: FM 1µV into 75 ohms, 2µV into 240 ohms, AM 20µV MW and SW, 40µV LW. Aerial input: 75 ohms coaxial, 240 ohms balanced. Stereo decoder included. Stereo beacon. 89 semiconductors. Inputs: ceramic PU 200mV 1M, tape play 200mV 100K, radio to suit inbuilt tuner. Noise level: mag PU input -70dB. other inputs -80dB. Overload capability: 30dB. Output: 50W RMS per channel into 4 ohms. Controls: bass, treble, volume, rumble filter, contour, plus 17 tab controls. HD: <0.01% at 30W output, <0.1% at any power up to

★ Indicates entry is illustrated

rated maximum. FR: 20Hz-20kHz±1dB at rated power. Mains: 115-125V, 200-250V, 50-60Hz. Price: (teak or walnut) £209.68. (plus VAT); (white) £213.96 (plus VAT).

### ■ GRUNDIG

Grundig (Great Britain) Ltd, Newlands Park, London, SE26 5NQ. Tel: 01-659 2468. Telex: 22854.

#### Studio 2000C ★

AM/FM stereo receiver in cabinet with record deck. Range: FM 87.5-108MHz, MW 185-587m, LW 875-2069m, SW 19-55m. Variable tuning plus seven preset stations on FM. AFC. Ratio detector. Tuning meter for AM and FM. Usable sensitivity: MW 20-25µV, LW 25-28.5µV, SW 4-5µV, FM 3-4µV across 240 ohms. Aerial input: balanced. Output: 22.5W RMS per channel. Output impedance: 4 ohms. FR: 40Hz-16kHz±1.5dB. HD: <0.5% at 1kHz at rated output. Controls: volume, treble -20dB +12dB at 16kHz, bass -20dB +13dB at 40Hz, balance -9dB +3.5dB, pushbutton tuning selectors, pushbutton waveband selectors, pushbutton input and mode selectors. Stereo decoder fitted. Mains: 110, 130, 220, 240V AC 50Hz. Motor unit: Dual 1216. Pickup cartridge: Shure M75MB-D. Size: 25½ × 7 × 15¼ in. Finish: matt black with silver trim. Grundig 4D stereo operation. Price £263.75 (including VAT).

### ■ HACKER

Hacker Radio Ltd, Norreys Drive, Cox Green, Maidenhead, Berks, SL6 4BP. Tel: Maidenhead (0628) 22261.

#### GAR550 Mk 3 Centurion ★

Receiver in cabinet with record deck. FM/VHF radio covering 87.5-101MHz. Usable sensitivity: 5µV for 30dB signal-to-noise ratio (30kHz deviation). Station markers. AFC Garrard SP25 Mk IV fitted with Goldring G850 magnetic pickup and diamond stylus. Inputs: PU 3mV equalised. 30dB overload capability; radio 50mV 47K, infinite overload capability; aux/tape 50mV 47K, infinite overload capability. Output: 14W RMS per channel into 8 ohms, 10W RMS per channel into 15 ohms. Controls: bass +18dB -14dB at 40Hz, treble +18dB -20dB at 15kHz, low-pass filter -3dB at 7kHz, on/off, balance, volume, pushbutton selection for scratch filter, gram, aux/tape, radio and mono/stereo. HD: better than 0.2% at 8 ohms, better than 0.1% at 15 ohms. FR: 25Hz-30kHz±3dB. Inbuilt rumble filter operates at below 25Hz. H and N: better than 60dB down on all inputs. Outlet for tape recorder of 15mV at 25K. Headphone socket with automatic muting of speakers. Pushbutton operated stereo decoder. Separation: 35dB at 1kHz, 26dB at 5kHz. Finish: teak. Hinged lid and black front

panel or semi-transparent lid and black front panel. Mains: 200-245V 50Hz. Size: 18 × 7½ × 16in. Suggested speakers: Hacker LS1100 Three-way system with response 30Hz-18kHz. Size: 13½ × 20½ × 11¼ in. Price: on application. GAR 550/T (teak) lid or GAR 550/P (plastic) lid.

#### T45 Table

Teak table with inset top covered with black leathercloth. Designed to accommodate the Hacker Centurion series. Price: to be announced.

Note: Suffix 'P' in Hacker model numbers denotes a semi-transparent plastic lid (e.g. GAR500A/P Mk 3).

### ■ ITT

ITT Consumer Products (UK) Ltd, Maidstone Road, Sidcup, Kent, DA14 5HT. Tel: 01-300 7733.



Grundig 2000C



Hacker Centurion Mk 3

**KA1026**

Stereo player.  $4\frac{1}{2}$ W output and BSR record deck with sapphire stylus. Modern slider controls are used for bass, treble balance and volume, with pushbuttons for tape, disc and on/off. Sockets for tape record/playback, speakers and headphones. Transparent acrylic lift-off lid. Unit may be used with 8 or 16 ohm speakers. Recommended types KS661, KS662 and KS665. Real wood grain appearance. Price: £59.50 (including VAT).

**KA1255**

Stereo player. 15W per channel amplifier and BSR C141R 3-speed autochange-or-manual record deck fitted with Acos GP104 diamond stylus. Sliding controls for volume, bass, treble and balance, with pushbuttons for on/off, headphones, disc, tape and radio. Sockets are incorporated for radio, tape, record/playback, headphones, speakers. Acrylic lid, teak veneered. Speaker impedance 4 ohms. Pair supplied as standard KS661. Price: with speakers £76 (including VAT).

## ■ KLINGER

Klinger Controls Ltd, Spencer Court,  
7 Chalcot Road, London, NW1 8LU.  
Tel: 01-586 2922.

**KC360**

Integrated stereo amplifier with record deck. 21 transistors and seven diodes. Motor unit: Garrard SP25 Mk IV. Cartridge: Shure M44E. Diamond Stylus. Inputs: radio 100mV 10K, tape 100mV 10K. Noise level: 66dB. Overload capability: 30dB. Output: 12W RMS per channel. Tone controls: bass  $\pm 15$ dB, treble  $\pm 15$ dB. Full-range balance control. HD: 0.15% 1W. FR: 30Hz-50kHz  $\pm 2$ dB. Stereo headphone socket. Stabilised power supply. Size:  $16\frac{1}{2} \times 8\frac{1}{4} \times 14$ in. Price: £60.22 (plus VAT).

**KC340**

Integrated stereo amplifier with record deck. Motor unit: Garrard 2025TC. Cartridge: Garrard KS40A or Sonotone 3509. Diamond stylus. 14 transistor circuit. Inputs: radio 250mV 220K, tape 250mV 220K. Noise level: 65dB. Overload capability: 26dB. Output: 8W RMS per channel. Tone controls: bass +15dB -10dB, treble +15dB -10dB, HD: <1% at 5W. Output impedance: 8 ohms. FR: 40Hz-20kHz  $\pm 1.5$ dB at 1.5W. Stereo headphone socket. Mains: 240V AC (other voltages to order). Size:  $16\frac{1}{2} \times 4 \times 8$ in. Finish: teak with black and silver trim, transparent dust cover. Price: £49.10 (including VAT).

**KC94**

FM stereo receiver in cabinet with record deck. Motor unit: Garrard SP25 Mk III. Four



*Klinger KC95*

speeds. Idler wheel drive. Cartridge: Shure M44E. Diamond stylus. Range: 87.5-108MHz. Five preset stations. Switchable AFC. Usable sensitivity: 2 $\mu$ V. Aerial input: coaxial and balanced. Outlet for tape: 100mV. Stereo decoder included. Inputs: tape 50mV 220K, aux (1) 100mV 470K, aux (2) 0.15mV 30 ohms. Noise level: 70dB. Overload capability: 30dB. Output: 25W RMS per channel. Output impedance: 8 ohms. Tone controls: bass  $\pm 15$ dB, treble  $\pm 15$ dB, scratch filter 18dB/octave from 8kHz, rumble 12dB/octave from 80Hz. Loudness control. A/B monitor switch. HD: 0.1% at 20W. FR: 25Hz-35kHz 2dB at 20W. Switching for two pairs of speakers. Two stereo headphone sockets. Stabilised power supply. Size:  $21 \times 8 \times 15\frac{1}{2}$ in. Mains: 110-120V, 220-240V AC. Finish: teak cabinet with folding lid. Price: £146.12 (including VAT).

**KC95 ★**

Integrated stereo amplifier with record deck. Motor unit: BSR P144. Cartridge: Shure M44E. Diamond stylus. 28 transistor circuit. Inputs: radio 50mV 220K, tape 50mV 220K, aux 100mV 470K, mic 0.15mV 30 ohms. Noise level: 70dB. Overload capability: 30dB. Output: 25W RMS per channel. Tape outlet: 100mV. Tone controls: bass  $\pm 15$ dB, treble  $\pm 15$ dB, scratch filter 18dB/octave from 8Hz, rumble filter 12dB/octave from 80Hz. Loudness control. A/B monitor switch. HD: 0.1% up to 20W. Output impedance: 8 ohms. FR: 35Hz-35kHz  $\pm 2$ dB at 20W. Two stereo headphone sockets. Sockets and switches for two sets of speakers. Stabilised power supply. Mains: 110-120V, 220-240V AC. Size:  $21 \times 8 \times 15\frac{1}{2}$ in. Finish: teak with transparent folding lid. Price: £110.48 (including VAT).

**KC350**

Integrated stereo amplifier with record deck. Motor unit: choice of Garrard 6300 or SP25 Mk IV. Cartridge: Garrard KS40A or Sonotone 3509. Diamond stylus. 14 transistor circuit. In-

★ Indicates entry is illustrated

puts: radio 250mV 220K, tape 250mV 220K. Noise level: 65dB. Overload capability: 26dB. Output: 8W RMS per channel. Tape outlet: 200mV. Tone controls: bass +15dB -10dB, treble +15dB -10dB. Full-range balance control. HD: <1% at 8W. Output impedance: 8 ohms. FR: 40Hz-20kHz  $\pm 1.5$ dB at 1W. Stereo headphone socket. Mains: 240V AC (other voltages to order). Size: 16½ × 8 × 14in. Finish: teak cabinet with silver trim and transparent dust cover. Price: (with 6300) £49.65 (including VAT); (with SP25 Mk IV) £54.75 (including VAT).

### ■ KOYO

Distributors: Kingsway Mills Ltd,  
5 Worship Street, London, EC2.  
Tel: 01-628 6157.

### CFS-600

AM/FM stereo receiver with eight-track tape player. Range: FM 88-108MHz, MW 188-556m. 27 transistors, 15 diodes. Sensitivity: FM 3µV, MW 100µV. Output: 6.5W RMS per channel. Variable tuning. Stereo decoder with auto switching. Eight-track cartridge player. Speed: 3¾ i/s. W and F: better than 0.3%. Separation: better than 20dB at 1kHz. Indicator lights to show channel playing. Size: 22¾ × 4½ × 9½ in. Price: to be announced.

### ■ THOMAS LANEY AUDIO

Electronic Manufacturing Co (UK) Ltd,  
Devonshire House, High Street,  
Deritend, Birmingham, B12 0LP.  
Tel: 021-772 3669/7145.

### TLA200C

FM stereo receiver in cabinet with record deck. Range: FM 87.5-108MHz. Variable tuning plus five presets. Switchable AFC. Aerial input: 75 ohms coaxial, 240 ohms balanced twin. Sensitivity: 2µV for 30dB quieting. Limiting complete at 5µV. Stereo decoder fitted. Capture ratio: 1.5dB. Inputs: mag PU 2mV 47K, aux 100mV 100K. S/N ratio: (PU input) 65dB, (aux) 70dB. Overload capability: (PU input) 100mV, (aux) 1V. Controls: bass  $\pm 12$ dB at 40Hz, treble  $\pm 12$ dB at 10kHz, filter 12dB/octave at 4kHz, 7kHz and 10kHz, balance, volume, input selector. Bass, treble and balance controls are sliders with centre 'click' position. Output: 50W RMS per channel into 4 ohms. 30W RMS per channel into 8 ohms. HD: <0.1% (typically <0.02%) 35Hz-20kHz. Power bandwidth: 20 Hz-40kHz + 0dB - 3dB. Mains: 110, 120, 130, 220, 230, 240V AC. Two AC outlets (one switched). Two headphone jack sockets behind flap on front panel. Quiet tuning facility. Output fully protected against any load condition. Motor unit: BSR 810 record deck. Price: £180 (plus VAT) teak or walnut finish.



Nordmende 5006 SCP

### ■ NORDMENDE

H. Vesshof & Co Ltd, (Vessco Vision & Radio),  
62 Woodbridge Road, Guildford, Surrey,  
GU1 4RD. Tel: Guildford (0483) 77877.

### Quadrano QP-80

Combination unit of Quadrano receiver and record player. The receiver Z-80 is described in the Receiver section of this book. Record player: Dual 1218, three speeds, 33½, 45 and 78rpm with five speed control. Cartridge: Shure M91 MG D with diamond elliptical stylus. Quadraphonic decoder for CBS/SQ or synthesised surround sound. Available in natural walnut or white smooth lacquered wood. Record player has plexiglass cover. Price: on application.

### QP-40

Combination of the quadro-receiver Q-40 and a record deck, the Dual 1216. Three speeds, 33½, 45 and 78rpm. Cartridge: Shure M75 type D with elliptical diamond stylus. Finish: natural walnut or white smooth lacquered wood. Receiver described in Receiver section. Price: on application.

### 5006-SCP ★

Combination unit comprising receiver, turntable and cassette recorder. Receiver: 4-wavebands, 6AM and 9FM circuits, 5 preset FM stations. Built in AM/FM aerial, AFC, AM creep adjustment. Peak output 2 × 14W, four loudspeaker connections, headphone socket. Two VU meters for recording and a tuning indicator. Record deck: PE3010, three speeds, 33½, 45, 78 with five speed control. Cartridge: CD5 650 ceramic, sapphire stylus. Price: on application.

### 5006-SC

Combination unit as 5006-SCP but with receiver and cassette recorder.

### 5006-SP

Combination unit as 5006-SCP but with record player and receiver.

### ■ PHILIPS ELECTRICAL LTD

Century House, Shaftesbury Avenue,  
London, WC2H 8AS.  
Tel: 01-437 7777.

**RH802 ★**

AM/FM stereo receiver in cabinet with record deck. Motor unit: Philips GC008. Speeds: 33 $\frac{1}{3}$ , 45rpm. Turntable: 11 $\frac{1}{4}$ in. diameter. Belt drive. Tubular pickup arm with slide-in cartridge carrier. Antistatic mat. Cartridge: Philips GP400 Super M. Stylus: diamond spherical. Range: FM 87.5-104MHz, MW 211-577m, MW bandspread 187-214m, LW 870-2000m, SW 30.7-50.4m. Variable tuning plus five preset buttons on FM. Switchable AFC. Ratio detector. Moving coil tuning meter. Usable sensitivity: FM 6 $\mu$ V for 26dB quieting, AM 90 $\mu$ V for 26dB S/N ratio. Aerial input: 300 ohms balanced. Stereo decoder fitted. 46 transistors. Inputs: tape 270mV 500K, mic 0.5mV 2K. Noise level: -50dB. Output: 15W RMS per channel. Output impedance: 4 ohms. Tone controls: bass  $\pm$ 15dB at 50Hz, treble  $\pm$ 14dB at 10kHz. HD:  $\leq$ 0.1% at 12W per channel. FR: 20Hz-20kHz  $\pm$ 1dB. Mains: 110, 127, 220, 240V AC. Size: 23  $\times$  6 $\frac{3}{4}$   $\times$  14 $\frac{1}{4}$ in. Finish: walnut veneer cabinet with brushed aluminium fascia. Price: £149.69 (including VAT).



Philips RH802

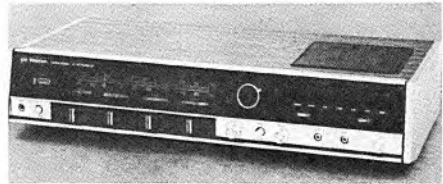

Teleton tuner/cartridge player combination

**■ SERVO-SOUND**

Cybernetic Hi-Fi, Lamb House, Church Street, London, W4 2PB. Tel: 01-995 4551.

**SC75BTE**

Stereo preamplifier in cabinet with record deck. Designed for operation with Servo-Sound SL20 speaker/power amplifier units and SR2 FM tuner (see appropriate sections). Lenco L75 record deck with tubular pickup arm, lightweight headshell and Stanton 500A magnetic cartridge. Inputs: PU 1.5mV 47K, tape 300mV 40K, aux (1) 300mV 40K, aux (2) 300mV 40K. Output: 1.2V per channel into not less than 400 ohms. HD: 0.3% at 1kHz. Output impedance: 400 ohms. FR: 30Hz-30kHz. 12 silicon transistors. Size: 15 $\frac{5}{8}$   $\times$  5 $\frac{7}{8}$   $\times$  14 $\frac{1}{8}$ in. Finish: wood and steel cabinet finished in walnut or white, black panel and clear plastic dust cover for record deck. Price: £111.90 (plus VAT).

**■ SONY**

Sony (UK) Ltd, Pyrene House, Sunbury Cross, Sunbury-on-Thames, Middlesex.  
Tel: Sunbury-on-Thames (76) 87644.

**HST-139**

AM/FM stereo receiver with cassette tape deck. Range: FM/VHF, MW. Variable tuning. AFC. FET front end. Ratio detector. Meter tuning indicator. Usable sensitivity: AM 20 $\mu$ V, FM 2.2 $\mu$ V. Aerial input: 300 ohms balanced. Stereo decoder fitted. 41 transistors and 20 diodes. Inputs: mag PU 3.5mV 47K, ceramic PU 300mV 3.6M, mic 0.775mV 600 ohms, tape 400mV 100K, record-playback 400mV

100K. Output: 12W RMS per channel. Output impedance: 8 ohms. FR: 40Hz-40kHz, (tape) 30Hz-12kHz. Mains: 110, 127, 222, 240V AC. Size: 21 $\frac{3}{8}$   $\times$  5 $\frac{1}{4}$   $\times$  12 $\frac{3}{8}$ in. Finish: walnut cabinet with brushed aluminium panel and black tuning scale. Automatic recording level. Cassette tape deck. Price: £105 (plus VAT).

**■ TELETON**

Teleton Electro (UK) Co Ltd, Teleton House, Waterhouse Lane, Chelmsford, Essex, CM1 1BD. Tel: Chelmsford (0245) 62442. Telex: 99338.

**SCX1510**

Receiver with cassette tape deck in one cabinet. Compact cassettes. Speed: 1 $\frac{7}{8}$ /s. Four track. Pause. Stereo record facility. Twin level meters. W and F: 0.2%. FR: (tape recorder) 70Hz-10kHz. AC bias. Vertical operating position. Range: FM88-108MHz, MW 187-560m. Aerial input: 75 ohms coaxial or 300 ohms balanced. Stereo decoder fitted. Output: 10W RMS per channel. HD: 0.5%. FR: (amplifier) 40Hz-20kHz. Input: mag PU 5mV. Output impedance: 8 ohms. Outputs for LS and headphones. 17 transistors, 22 diodes and three ICs. Controls: bass, treble, volume. (left and right), mode, mains on/off, record level (left and right). Slider controls. Finish: oiled walnut cabinet with matt black and satin aluminium trim. Mains: 220-240V AC. Size: 11 $\frac{1}{4}$   $\times$  13 $\frac{3}{4}$   $\times$  6 $\frac{1}{2}$ in. Price: £139 (including VAT).

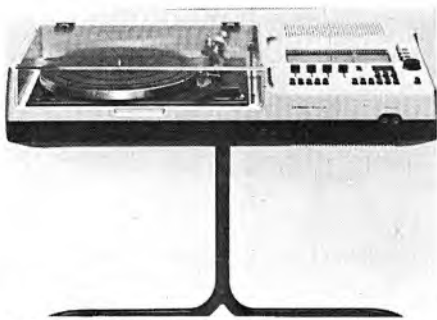

Teleton CS400



Yamaha MC-40



Yamaha MS-3



Yamaha MS-5B

## ■ WYE ELECTRONICS LTD

Queen Street North, Whittington Moor,  
Chesterfield, Derbyshire.

Tel: Chesterfield (0246) 51116.

### Stereo 550

Integrated stereo amplifier in cabinet with record deck. Inputs: mag PU 5mV 47K, ceramic PU 200mV 1M, tape head 7mV 47K, radio 150mV 500K. Controls: treble +11.5dB -13dB at 10kHz, bass +11dB -13dB at 60Hz. Filters: high -12dB at 7kHz and -12dB at 12kHz, low -12dB at 60Hz. FR: 37.5Hz-26kHz  $\pm$  3dB. HD: <1% at rated output. Output: 10W RMS per channel into 8 ohms, 15W per channel RMS into 4 ohms. Price: to be announced.

## ■ YAMAHA

Natural Sound Systems Ltd, Strathcona Road,  
North Wembley, London, HA9 8QL.

Tel: 01-904 0141.

### MC-40 ★

AM/FM stereo receiver in cabinet with record deck. Range: FM 88-108MHz, MW 186-560m. Variable tuning. AFC. Stereo decoder fitted. Controls: volume, loudness, mono/stereo, treble, tuning, bass, input selector, balance, mains on/off. Output: 15W RMS per channel. Output impedance: 8 ohms. FR: 20Hz-30kHz  $\pm$  2dB. HD: 0-15%. Two-speed belt drive Yamaha turntable. CG-5500 magnetic cartridge. Finish: straight grain American walnut. Price: £139.94 (plus VAT).

### MS-3 ★

AM/FM stereo receiver in cabinet with record deck. Range: FM 88-108MHz, MW 186-565m. Variable tuning. AFC. Stereo decoder fitted. Controls: volume, treble, bass, balance, acoustic equaliser, loudness, tape monitor, mono/stereo, mains on/off, speaker selector, input selector, tuning. Output: 22W RMS. Output impedance: 8 ohms. FR: 10Hz-30kHz+0dB -2dB. HD: 0-05%. Yamaha two-speed belt drive turntable. Yamaha CG-7000 magnetic cartridge. Finish: American walnut. Price: £224.65 (plus VAT).

### MS-5B ★

AM/FM stereo receiver in cabinet with record deck and cassette recorder. Range: FM 88-108MHz, MW 186-565m. Variable tuning. AFC. Controls: cassette tape record/playback, volume, treble, bass, balance, acoustic equaliser, function, loudness, high filter, mic volume, tuning, record level. Stereo decoder fitted. Output: 22W RMS per channel. Output impedance: 8 ohms. FR: 10Hz-30kHz-0dB +2dB. HD: 0-05%. Yamaha two-speed belt drive turntable. Yamaha CG-7000 magnetic cartridge. Finish: American walnut. Price: £284.79 (plus VAT).

# COMBERTON

AUDIO SYSTEMS FOR MORE  
THAN YOUR MONEY IS WORTH



## COMBERTON 1000 Audio System

Comprising Integrated Amplifier/Turntable With Magnetic Cartridge. Total Music Power 28 Watts Class 'AB' Circuit 2 Radio/Tape Inputs-On/Off/Volume, Bass, Treble, Balance, Function & Mono/Stereo Controls. Together with 15 Watt Comberton 15 Speakers All in Teak Veneer Cabinets. £98 plus VAT



## THE FABULOUS '40'

High Efficiency Loudspeaker System. Four Matched Loudspeaker Units plus Dome Tweeter. Frequency Range 30Hz - 20kHz. Handling Capacity 40 Watts. In Handcrafted Teak Veneered Enclosure. £55 plus VAT each.

**CHB SUPPLIES LTD. STOURPORT ROAD, KIDDERMINSTER, WORCS. Phone: 4861, 3293, 62154**

*Microphones*

- by **Gramplan**  
of course!

Model DP4 selected for the Design Centre, London.

A perfect match for all the other equipments, also by GRAMPIAN,  
for the complete sound installation.

**GRAMPIAN REPRODUCERS LTD HANWORTH TRADING ESTATE, FELTHAM, MIDDLESEX TEL. 01-894 9141**



# Music centres around Sanyo

Romancing with Andy Williams, rocking with Slade, relaxing or having fun. Music centres that combine record players, stereo radio and either cassette or cartridge. Instant entertainment at the touch of a button. Styled and designed to add more enjoyment to whatever you're doing.



**G2601 KL**  
Stereo cassette recorder, stereo turntable with ceramic cartridge, diamond stylus – plus tuner-amplifier tuning to MW, LW, VHF and VHF stereo. 30 watts total music power. Complete with speaker cabinets, microphones, stands and cassette.

**GXT4731 K**  
A superb 4-channel Quadraphonic music centre. Combines an MW/FM stereo radio, 3-speed turntable fitted with ceramic cartridge and sapphire stylus, plus an 8-track cartridge player that plays 4-channel discrete cartridges. Comes complete with two sets of matching speakers.



**SANYO**  a world of difference

Sanyo Marubeni (UK) Ltd., Sanyo House, Bushey Mill Lane, Watford WD2 4UQ. Tel: 30421  
(Reg. Office) Reg. in England No. 956870

# Complete Audio Systems

★ Indicates entry is illustrated  
Abbreviations used in this section are given on page 20.

## ■ ALBA

Alba (Radio & Television) Ltd,  
Bull Lane, Edmonton, London, N18 1RA  
Tel: 01-803 4451.

## UA7070D ★

AM/FM stereo tuner/amplifier in shelf mounting cabinet with two separate speakers. Range: VHF, LW, MW, Switched AFC on FM. Variable tuning. Ratio detector. BSR multi-speed player with cueing device. Slider controls for bass, treble, volume and balance. Pushbutton input selection and rotary tuning control. Outlet sockets for tape recorder and headphones. Finish: teak. Stereo decoder fitted. Price: (complete system with decoder) £94.38 (including VAT).

## ■ ALPHA

Highgate Acoustics Ltd,  
38 Jamestown Road, London, NW1 7EJ.  
Tel: 01-267 4937.

## Alpha MR15

Stereo tuner/amplifier in cabinet with record deck. Range: 88-108MHz, 187-572m. Variable tuning. AFC. Stereo decoder fitted. Controls: (slider) bass, (slider) treble, speaker selector, volume, balance, tuning, input selector, on/off, AFC, high pass filter, loudness, stereo/mono, tape monitor. Output: 18W RMS per channel. FR: 20Hz-35kHz. Output impedance: 8 ohms. HD: 0.5% at 15W. Motor unit: Lenco 75. Magnetic cartridge. Size:  $18\frac{1}{2} \times 18 \times 5\frac{1}{8}$  in. Speakers: Alpha HT20 Mk II with three units in each. Finish: walnut. Price: (complete system with two speakers) £195.50 (plus VAT).

## ■ AMEREX

Amerex (UK) Ltd,  
96 Piccadilly, London, W1V 9HA.  
Tel: 01-499 3537.

## ACR301C

Complete music centre comprising AM/FM stereo tuner/amplifier, BSR autochange record deck, eight-track cartridge player and matching speakers. Slider controls for bass, volume, treble and balance. Stereo decoder fitted. Range:

VHF, MW. Loudness switch, rumble and scratch filters. Wood grain finish with bright trim. Price £106.72 (including VAT).

## AMC-900

AM/FM stereo tuner/amplifier with cassette tape deck and matching speaker systems. Range: FM 88-108MHz, MW 185-582m, LW 857-2000m, SW 25-84m. Output: 10W (1HF) per channel into 8 ohms. HD: <1% FR: (normal listening level) 20Hz-15kHz-3dB. Inputs: mag PU 3mV, ceramic PU 250mV, aux 350mV. H and N: (mag PU input) better than 50dB, (aux) better than 60dB. Separation: better than 50dB. Tone controls: bass  $\pm 10$ dB at 100Hz, treble  $\pm 10$ dB at 10kHz. Cassette recorder section. Speed:  $1\frac{7}{8}$ i/s. W and F: 0.25%. Microphone input: 1mV. Speaker drive units:  $6\frac{1}{2}$ in. Size: (main unit)  $23\frac{3}{8} \times 14\frac{1}{4} \times 5$ in; (speaker units)  $13\frac{3}{8} \times 8\frac{3}{4} \times 8\frac{1}{4}$ in. Price: £227.05 (including VAT).

## ■ BANG & OLUFSEN

Bang & Olufsen (UK) Limited,  
Eastbrook Road, Gloucester, GL4 7DE.  
Tel: Gloucester (0452) 21591.

## Beosystem 901

Four-unit system comprising Beomaster 901 tuner/amplifier, Beogram 1202 turntable and two Beovox 1702 loudspeakers. Tuning range: FM 87.5-104MHz, LW 857-2040m, MW 187-578m. Variable tuning. AFC. Sensitivity: FM <1.8 $\mu$ V, LW <15 $\mu$ V, MW <20 $\mu$ V. Output: 20W RMS per channel. FR: 20Hz-30kHz  $\pm 1.5$  dB. HD: <0.5% at 20W. Inputs: mag PU 2.5mV 47K, tape 150mV 470K. Motor unit:  $3\frac{1}{2}$  and 45rpm. SPI4A cartridge. Rumble: 60dB. W and F: 0.06% RMS. Speakers: (two units) one 6in bass and 1in tweeter. FR: 50Hz-20kHz. HC: 20W RMS. Sizes: (Beomaster 901)  $19\frac{1}{2} \times 9 \times 3$ in; (Beogram 1202)  $17\frac{1}{2} \times 13 \times 4\frac{1}{2}$ in; (Beovox 1702)  $13\frac{1}{4} \times 7\frac{1}{8} \times 7\frac{1}{8}$ in. Price: (teak) £241; (rosewood) £246 (including VAT).

## Beosystem 1001

Four-unit system comprising Beomaster 1001 tuner/amplifier, Beogram 1202 turntable and two Beovox 1702 loudspeakers. Tuning range: 87.5-104MHz. Variable tuning plus three presets. AFC. Sensitivity: <1.8 $\mu$ V. Output: 15W RMS per channel. FR: 20Hz-30kHz  $\pm 1.5$ dB.



Alba UA7070D

★ Indicates entry is illustrated

HD: < 0.5% at 15W. Inputs: mag PU. 3.5mV 47K, tape 200mV 470K. Motor unit: 33 $\frac{1}{3}$  and 45rpm. SP14A cartridge. Rumble: better than 60dB. W and F: 0.06% RMS. Speakers: (two units) one 6in bass and one 1in. tweeter. FR: 50Hz-20kHz. HC: 20W RMS. Sizes: (Beomaster 1001) 21 $\frac{3}{8}$  × 8 $\frac{3}{8}$  × 3 $\frac{3}{8}$ in; (Beogram 1202) 17 $\frac{3}{8}$  × 13 × 4 $\frac{3}{8}$ in; (Beovox 1702) 13 $\frac{1}{2}$  × 7 $\frac{1}{4}$  × 7 $\frac{1}{8}$ in. Price: (teak) £231.30; (rosewood or white) £236.30 (including VAT).

#### Beosystem 1400

Three-unit system comprising Beocenter 1400 stereo tuner/amplifier/cassette and two Beovox 1702 loudspeakers. Tuning range: FM 87.5-104MHz, LW 857-2040m, MW 187-578m. Variable tuning, AFC. Sensitivity: FM < 1.8 $\mu$ V, LW < 15 $\mu$ V, MW < 20 $\mu$ V. Cassette section. Speed: 1 $\frac{7}{8}$ /s. FR: 40Hz-12.5kHz. S/N ratio: 50dB. W and F: 0.35% RMS. Output: 20W RMS. FR: 20Hz-30kHz  $\pm$  1.5dB. HD: < 0.5% at 20W. Inputs: mag PU 2.5mV 47K, tape 300mV 100K. Speakers: (two units) one 6in bass and one 1in tweeter. FR: 50Hz-20kHz. HC: 20W RMS. Sizes: (Beocenter 1400) 26 × 10 $\frac{1}{2}$  × 3 $\frac{1}{2}$ in; (Beovox 1702) 13 $\frac{1}{2}$  × 7 $\frac{1}{4}$  × 7 $\frac{1}{8}$ in. Price: (teak) £247; (rosewood) £251 (including VAT).

#### Beosystem 1700

Five-unit system comprising Beolab 1700 stereo amplifier, Beomaster 1700 stereo FM tuner, Beogram 1202 turntable and two Beovox 2702 loudspeakers. Tuning range: 87.5-104MHz. Variable tuning plus three presets. AFC. Sensitivity: < 2.0 $\mu$ V. Output: 20W RMS per channel. FR: 20Hz-30kHz  $\pm$  1.5dB. HD: < 0.5% at 20W. Inputs: mag PU 2.5mV 47K, 150mV 1M, tuner 150mV 350K. Motor unit: 33 $\frac{1}{3}$  and 45rpm. Rumble: 60dB. W and F: 0.06% RMS. SP14A cartridge. Speakers: (two units) one 7in. bass and one 1 $\frac{1}{2}$ in tweeter. FR: 45Hz-20kHz. HC: 25W RMS. Sizes: (Beolab 1700) 19 $\frac{3}{4}$  × 9 $\frac{3}{8}$  × 3in; (Beomaster 1700) 19 $\frac{3}{4}$  × 9 $\frac{3}{8}$  × 3in; (Beogram 1202) 17 $\frac{3}{8}$  × 13 × 4 $\frac{3}{8}$ in; (Beovox 2702) 16 × 8 × 8in. Price: (teak) £262.50; (rosewood) £269.50 (including VAT).

#### Beosystem 3000-2 ★

Four-unit system comprising Beomaster 3000-2 stereo tuner/amplifier, Beogram 3000 turntable and two Beovox 3702 loudspeakers. Tuning range: 87.5-104MHz. Variable tuning plus six presets. AFC. Sensitivity: 2 $\mu$ V. Output: 40W RMS per channel. FR: 40Hz-20kHz  $\pm$  1.5dB. HD: 0.3% at 40W. Inputs: mag PU 3mV 47K adjustable, ceramic PU 250mV 1M adjustable, tape 250mV 1M variable. Motor unit: 33 $\frac{1}{3}$  and 45rpm. SP10A cartridge. Rumble: better than 60dB. W and F: 0.06% RMS. Speakers: (three units) one 8in bass, one 3 $\frac{1}{2}$ in mid-range, one 1 $\frac{1}{2}$ in tweeter. FR: 40Hz-20kHz. HC: 40W RMS. Sizes: (Beomaster 3000-2) 22 $\frac{3}{4}$  × 10 $\frac{1}{4}$  ×

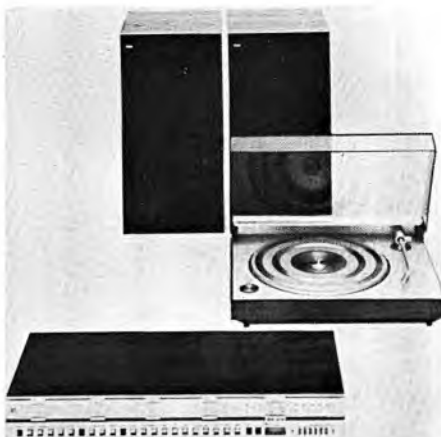

Bang & Olufsen Beosystem 3000-2

3 $\frac{1}{2}$ in; (Beogram 3000) 17 $\frac{3}{8}$  × 13 × 4 $\frac{1}{2}$ in; (Beovox 3702) 19 $\frac{3}{4}$  × 10 × 10in. Price: (teak) £366.50; (rosewood) £375.50 (including VAT).

#### Beosystem 3500

Three-unit system comprising Beocenter 3500 stereo tuner/amplifier/turntable plus two Beovox 3702 loudspeakers. Tuning range: 87.5-104MHz. Variable tuning plus six presets. AFC. Sensitivity: 2 $\mu$ V. Output: 40 RMS per channel. FR: 40Hz-20kHz  $\pm$  1.5dB. HD: 0.3% at 40W. Input: mag PU 3mV 47K adjustable, ceramic PU 250mV 1M adjustable, tape 250mV 1M adjustable. Motor unit: Beogram 3000. Speeds: 33 $\frac{1}{3}$  and 45rpm. SP10A cartridge. Rumble: better than 60dB. W and F: 0.06% RMS. Speakers: (three units) one 8in bass, one 3 $\frac{1}{2}$ in mid-range and 1 $\frac{1}{2}$ in tweeter. FR: 40Hz-20kHz. HC: 40W RMS. Sizes: (Beocenter 3500) 22 $\frac{3}{4}$  × 13 $\frac{3}{4}$  × 5 $\frac{1}{2}$ in; (Beovox 3702) 19 $\frac{3}{4}$  × 10 × 10in. Price: (teak) £364; (rosewood or white) £371 (including VAT).

#### ■ BIGSTON

J. Parkar & Co (London) Ltd, Parkar House, Beresford Avenue, Wembley, Middlesex, HA0 1YX. Tel: 01-903 5211.

#### ■ BUSH-ARENA

Rank Radio International Ltd, PO Box 596, Power Road, Chiswick, London, W4 5PW. Tel: 01-994 6491.

#### System 20

Stereo tuner/amplifier, record deck in plinth and two separate speakers. Comprises R925 record unit, TA3500 tuner/amplifier and two L810 speakers. See respective sections for full specifications. Price: £139.33 (including VAT).

**System 30**

Stereo tuner/amplifier, record deck in plinth and two separate speakers. Comprises R76 record unit, 1A2700 tuner/amplifier and two L820 speakers. See respective sections for full specifications. Price: £183.58 (including VAT).

**System 40**

Stereo tuner/amplifier and record deck in shelf cabinet plus two separate speakers (floor stand optional extra). Comprises R1A Compact unit and two L820 speakers. See respective sections for full specifications. Price: £183.58 (including VAT).

**System 50**

Five-band AM/FM stereo tuner/amplifier, record deck in plinth and two separate speakers. Comprises R76 record unit, 1A2800 tuner/amplifier and two L820 speakers. See respective sections for full specifications. Price: £187.34 (including VAT).

■ **COMBERTON**

CHB Supplies Ltd, Oldington Trading Estate, Stourport Road, Kidderminster, Worcs. Tel: Kidderminster (0562) 4861.

Range of stereo audio systems with speakers. No product information obtainable as this edition of the Yearbook closed for press.

■ **CROWN**

Crown Radio Ltd, 128-129 Shoreditch High Street, London, E1 6JE. Tel: 01-739 2382.

**SHC-53, CSP-13 (2)**

AM/FM stereo radio in cabinet with eight-track cartridge tape player, plus two separate speakers. Range: FM 88-108MHz. MW 182-560m. Switchable AFC. Variable tuning. 21 transistors, four ICs, 21 diodes. Cartridge deck. Speed:  $3\frac{3}{4}$ i/s. S/N ratio: >40dB. W and F: <0.35%. FR: 80Hz-12kHz. Output: 5W per channel. Automatic head cleaning device. Slider controls. Headphone jack socket. Speakers: infinite baffle enclosures with unit. One  $13\frac{1}{2} \times 8\frac{1}{4}$ in bass driver with two integral HF units. Impedance: 8 ohms. Finish: walnut cabinets. Amplifier/tape unit has black dial and bright trim, speaker enclosures have black grilles. Price: (complete system) £137.50 (including VAT).

**SHC-49F**

AM/FM radio plus stereo cassette recorder in cabinet, plus two separate speakers. Range: FM 88-108MHz, MW 182-560m. 38 transistors, 24 diodes. Variable tuning. Stereo decoder fitted. AFC. Output: 3W per channel. FR: (tape recorder) 100Hz-10kHz. Tape speed:  $1\frac{7}{8}$ i/s. Compact cassette. Mains: 240V AC. VU meters. Input for PU. Speaker units: 6 $\frac{1}{2}$ in full range.



Crown Radio SM110, CSP12(2)

Impedance: 8 ohms. Size: (main unit)  $11\frac{1}{2} \times 15\frac{3}{8} \times 5$ in; (speakers)  $11\frac{1}{2} \times 9\frac{3}{8} \times 4\frac{1}{8}$ in. Weight: (main unit) 14lb; (speakers) 4 $\frac{1}{2}$ lb. Finish: walnut veneer. Price: (complete system) £147.30 (including VAT).

**SHC-65F**

AM/FM stereo radio plus cassette recorder and record deck in one plinth cabinet, offered with two CSP13 speakers to form complete system. 27 transistors, one FET and six ICs. Range: FM 88-108MHz, MW 182-560m. Variable tuning. AFC. Stereo decoder fitted. Controls: tuning, AFC on/off, muting, waveband selector, input function, high filter, loudness, bass, treble, left-channel record level, right-channel record level, balance, volume. Output: 7.5W RMS per channel. Output impedance: 8 ohms. FR: 50Hz-20kHz. Record deck: Garrard SP25 Mk III or Garrard 2025T. Finish: Walnut veneer and black trim. Speakers: two CSP13 (CSP12 optional at lower cost). Price: (complete system) £292.40 (including VAT).

**SM110, CSP12 (2) ★**

AM/FM stereo tuner/amplifier with record deck in one cabinet, plus two CSP12 speaker systems. Range: FM 88-108MHz, MW 182-560m. Variable tuning. AFC. Stereo decoder fitted. Controls: bass, treble, low filter, high filter, volume, input selector, balance, mains on/off, tuning. Output: 7.5W RMS per channel. Output impedance: 8 ohms. FR: 20Hz-25kHz. HD: <1% at 6W output. Finish: walnut veneer with silver trim. Speakers: two CSP12. Price: (complete system) £142.34 (including VAT).

■ **DECCA**

Decca Radio & Television, Neachells Lane, Willenhall, Wolverhampton, Staffs. Tel: 0902 67367.

**Deccasound Compact 3 (DSS226) ★**

AM/FM tuner/amplifier in low-profile cabinet on stand, with record deck incorporated and two separate speakers. Range: FM 87.5-101 MHz, MW 185-577m, LW 1200-2000m, SW 16.7-50.4m. Variable tuning. AFC. Stereo de-

★ Indicates entry is illustrated

coder fitted. Controls: bass, treble, balance, volume, input selector, 12kHz filter, AFC on/off. Output: 6W RMS per channel. FR: 30-20,000 Hz. Motor unit: BSR C141. Speakers: 5in dual cone full-range drivers in acoustic enclosures. Price: (teak) £139.50 (including VAT); (rosewood) £142.50 (including VAT).

### DS 623

Complete audio system comprising amplifier/turntable unit and two loudspeakers. Specification. Power supply: 240V 50Hz. Power consumption: 50W. Slider controls. Input sockets: tuner, tape playback. Output sockets: headphones, tape record, loudspeakers. Power output: 6W RMS per channel. FR: (amplifier) 30H-20kHz -3dB. S/N: -60dB (volume control minimum). Tone control ranges:  $\pm 10$ dB bass and treble. Filter function: 60dB down at 12kHz. 2nd harmonic distortion: 0.3% at 5W into 8 ohms at 1kHz. Turntable: BSR C141/R, 3-speed autochanger with cue facility and bias compensation. Pickup: Acos 104 ceramic turn-over cartridge. Stylus: Acos, LP diamond, 78 sapphire. Speaker units: 5in round dual cone. Impedance: 8 ohms. FR: 100-18,000Hz. Volume (speakers): 0-12cu ft. Dimensions (speakers):  $8\frac{1}{2} \times 5\frac{1}{2} \times 12\frac{1}{2}$  in. Weight (speakers) 6 $\frac{1}{2}$  lb. Dimensions (deck/amp):  $17\frac{7}{8} \times 16\frac{1}{2} \times 7\frac{3}{4}$  in. Weight (deck/amp): 17 $\frac{1}{4}$  lb. Optional extras: Stand, height of stand 17 $\frac{3}{4}$  in. Finish: teak. Price: £75 (including VAT).

### DS 1503 ★

Complete audio system comprising amplifier/turntable and two alternative matching speaker systems. Specification. Power supply: 240V 50Hz. Power consumption: 75W. Slider controls. Inputs: tape playback, tuner, microphone. Output: tape record, auxiliary mains, headphones, loudspeakers. Power output: 15W RMS per channel at 1kHz into 8 ohms. FR: (amplifier) 25-18,000Hz  $\pm 3$ dB. S/N: -70dB (volume control Min). Tone control ranges: bass  $\pm 10$ dB at 100Hz, treble  $\pm 10$ dB at 10kHz. Filter functions: high and low (scratch and rumble). THD: better than 0.1% at 15W RMS output at 1kHz. Turntable: BSR C142R/A3, 3-speed autochanger with cue facility and bias compensation. Pickup: Sonotone V100 magnetic cartridge with diamond stylus type V100. Speaker units: 8in bass plus 1in tweeter. Impedance: 8 ohms. FR: 80-18,000Hz. Dimensions (speakers): L400  $13 \times 10\frac{1}{2} \times 21\frac{7}{8}$  in, L410  $11 \times 8\frac{3}{8} \times 16\frac{3}{8}$  in. Weight (speakers): L400 24lb. L410 14 $\frac{1}{2}$  lb. Dimensions (deck/amp):  $20\frac{1}{2} \times 17\frac{1}{2} \times 8\frac{1}{2}$  in. Weight (deck/amp): 25 $\frac{1}{2}$  lb. Optional extras: white mushroom-shaped stand, height of stand 14 $\frac{1}{2}$  in. Finish: teak and white. Price: (shelf) £135; (floor) £145 (including VAT).

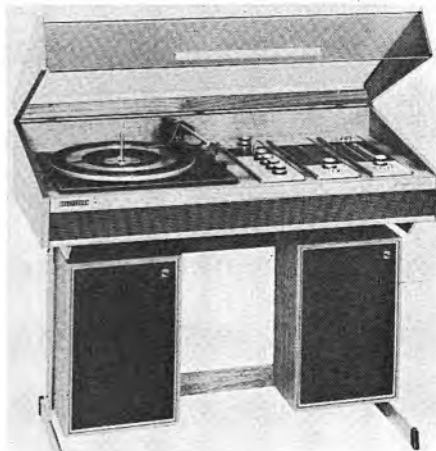

Deccasound compact 3



Decca DS1503

### Deccasound Compact 2

Consists of a record deck, amplifier and FM stereo tuner with matching speakers. Complete stereo system in one unit. Specification. Power supply: 200-240V 50Hz. Power consumption: 50W. Inputs: external FM aerial, tape playback. Output: tape record, loudspeakers. Radio coverage: 87.5-101MHz. Stereo decoder power output: 6W RMS per channel into 8 ohms at 1kHz. FR: (amplifier) 30-20,000Hz. S/N: 60dB. Tone control ranges: bass  $\pm 11$ dB -10dB at 70Hz, treble  $\pm 16$ dB -11dB at 10kHz. Scratch filter. THD: 0.4% at 5W into 8 ohms at 1kHz. Aerial: internal FM aerial. Turntable: BSR C123/R 3-speed autochanger with cue facility and bias compensator. Pickup: Acos 104 ceramic turn-over cartridge. Stylus: Acos GP 104, LP diamond stylus and sapphire 78 stylus. Speaker units: 5in round dual cone. Impedance: 8 ohms. FR: 100-18,000Hz. Volume (speakers): 0-12cu ft. Dimensions (speakers):  $8\frac{1}{2} \times 5\frac{1}{2} \times 12\frac{1}{2}$  in. Weight (speakers): 6 $\frac{1}{2}$  lb. Accessories supplied: wood and metal stand. Dimensions (main unit):  $26 \times 14\frac{3}{4} \times 8$  in. Height of stand: 16 $\frac{1}{8}$  in. Weight (main unit): 27 $\frac{1}{2}$  lb. Finish: teak. Price: £112 (including VAT).

**Deccasound Compact 4**

Consists of record deck, amplifier, two speakers, AM/FM tuner and a stereo cassette deck. Specification. Power supply: 240V 50Hz. Power consumption: 60W. Inputs: external aerials, microphone. Outputs: headphones, loudspeakers (4). Radio waveband coverage: FM 87.5-107.5MHz, AM 510-1620kHz. Power output: 10W RMS per channel. FR: (amplifier) 15-50,000Hz-3dB. Power bandwidth: 25-30,000Hz. S/N: 70dB. Tone control ranges: bass  $30\text{Hz} \pm 16\text{dB}$  100Hz  $\pm 10\text{dB}$ , treble 10kHz  $\pm 12\text{dB}$ . Filter function: 6dB down at 12kHz. Aerial: internal ferrite rod for AM, internal FM aerial. Turntable: BSR C141/R, 3-speed autochanger with cue facility, bias compensation and manual over-ride. Pickup: Sonotone 3559 ceramic turnover cartridge. Stylus: Sonotone 3559, LP diamond stylus and 78 sapphire stylus. Cassette recorder. FR: (playback) 40-10,000Hz-6dB. W and F: 0.35% RMS. Twin VU meters. Speaker units (L153): 5in round dual cone. FR: 100-18,000Hz. Impedance: 8 ohms. Dimensions:  $35\frac{1}{2} \times 14\frac{1}{2} \times 8\frac{3}{8}$ in. Accessories supplied: stand, height of stand 15 $\frac{1}{2}$ in. Weight (main unit): 37lb. Finish: teak, with satin aluminium trim. *Note*—Two extra loudspeaker sockets allow you to use Compact 4 as a 4-speaker system, by purchasing two further L153 speakers. Price: £189.75 (including VAT).

**Deccasound 9000**

Combined cassette/radio stereo system. Specification. Power supply: 240V 50Hz. Power consumption: 20W. Input: FM aerial, auxiliary, microphone. Output: loudspeakers, tape, headphones. Waveband coverage: FM 88-108MHz, MW 535-1605kHz. Stereo decoder power output: 4W RMS (FR) per channel. FR: 20-20,000Hz (power bandwidth). S/N: 60dB. Tone control ranges: bass  $\pm 8\text{dB}$  at 100Hz, treble  $\pm 6\text{dB}$  at 10kHz. Aerial: internal MW ferrite rod. Cassette type: standard Philips Musicassette type. FR: (playback) 40Hz 0dB 10kHz-3dB. W and F: 0.4%. Twin VU meters. Finish: teak and brushed aluminium trim. Speakers. Power handling capacity: 6W. Impedance: 8 ohms. Speaker units: 5in dual cone. FR: 100-18,000Hz. Volume: 0-12cu ft. Dimensions (main unit):  $19\frac{3}{8} \times 17 \times 5\frac{3}{8}$ in. Speaker enclosures:  $8\frac{1}{2} \times 5\frac{1}{2} \times 12\frac{3}{8}$ in. Weight (main unit): 18lb. Speaker enclosures: 6 $\frac{1}{2}$ lb each. Price: £115 (including VAT).

**DUETTE**

J. J. Silber Ltd,  
11 Northburgh Street, London, EC1.  
Tel: 01-253 8031.

**SS2005W**

AM/FM stereo tuner/amplifier in cabinet with



Duette SA505



Duette SA707

stereo cassette recorder and record deck. Range: FM 88-108MHz, MW 185-565m. Aerial input: 300 ohms balanced. Ferrite rod AM aerial. Stereodecoder fitted. Separation: 30dB at 1kHz. Compact cassettes. Speed:  $1\frac{3}{4}$ i/s. W and F: 0.25%. H and N: 45dB. Automatic or manual level control. Multiple filter. Four-speed record deck. Ceramic cartridge with diamond stereo stylus. 11in platter. Four-pole motor with outer rotor. Audio output: 10W per channel. Output impedance: 8 ohms. FR: 35Hz-30kHz. Tone controls: bass +10dB -12dB at 100Hz, treble +9dB -17dB at 10Hz. Mains: 110, 117, 220, 240V 50-60Hz. Size:  $22\frac{1}{2} \times 9 \times 17$ in. Weight: 35lb. This is a provisional specification as full details were not available as this issue of the Year Book closed for press. Designed for use with Duette speakers type 44SX, 66SX, or 88SX. No details of speakers available. Price: (main unit with two speakers) from approximately £208.87 (plus VAT).

**SA505 ★**

AM/FM stereo tuner/amplifier in plinth with record deck, plus two separate speaker enclosures. 19 transistors. Range: FM 88-108MHz, MW 187-560m. Stereo decoder fitted. Separation: >20dB at 1kHz. Output: 5W RMS per channel. HD: 1% at 4W RMS at 1kHz. Tone controls: bass  $\pm 7\text{dB}$  at 100Hz, treble  $\pm 7\text{dB}$  at 10kHz. Mains: 200-240V 50Hz. Speaker enclosures:  $9\frac{7}{8} \times 11\frac{1}{8} \times 7\frac{7}{8}$ in. Size: (main unit)  $16\frac{1}{2} \times 4\frac{1}{4} \times 13$ in. Price: £79.10 (plus VAT).

**SA707 ★**

AM/FM stereo tuner/amplifier in plinth with record deck and eight-track cartridge player, plus two separate speaker enclosures. 23 transistors. Range: FM 88-108MHz, MW 187-

★ Indicates entry is illustrated

560m. Stereo decoder fitted. Separation: >20 dB at 1kHz. Aerial input: 300 ohms balanced twin for FM, ferrite rod for MW. Output: 5W RMS per channel. HD: 1% at 4W RMS at 1kHz. W and F: <0.3%. Crosstalk: -40dB. Mains: 200-240V 50Hz. Speaker enclosures:  $9\frac{7}{8} \times 11\frac{3}{8} \times 7\frac{7}{8}$ in. Price: £108.14 (plus VAT).

#### Silver S1015

AM/FM stereo tuner/amplifier in cabinet with record player and stereo cassette recorder. Output: 10W per channel. Professional type P128 single play deck. Auto stop on cassette recorder on all functions. Separate speakers. Modern styling. Stereo ceramic cartridge. Price: (including speakers) £172.71 (plus VAT).

#### ■ DYNATRON

Dynatron Radio Ltd,  
St Peter's Road, Maidenhead, Berks, SL6 7QY.  
Tel: Maidenhead (0628) 23331.

#### Cavalcade HFC13A system

Integrated stereo tuner/amplifier with record deck in cabinet plus matching speakers. Range: FM 87-108MHz, MW 185-570m, LW 1100-2000m. Variable tuning. AFC incorporated. Stereo decoder fitted. Output: 8W RMS per channel. HD: <1% at rated output. FR: 40Hz-16kHz  $\pm 3$ dB. Output impedance: 4 ohms for speakers, 8 ohms or greater for phones. Controls: bass, treble, balance, volume, loudness, input selector, tuning, filter, AFC on/off. Motor unit: Garrard 2025TC. Cartridge: Sonotone 9TAHC. Size:  $19 \times 16\frac{1}{2} \times 9\frac{7}{8}$ in. Finish: teak. Suggested speakers: LS1434 (other types available). Price: (complete system including two speakers) £142.65 (including VAT).

#### HFC31M

Integrated stereo tuner/amplifier with record deck in cabinet plus matching speakers. Similar specification to HFC31A but with Garrard SP25S Mk III record deck and Goldring G850 cartridge. Suggested speakers: LS2034 (other types available). Size: (main unit)  $19 \times 16\frac{1}{2} \times 9\frac{7}{8}$ in. Price: (complete system with two suggested speakers) £158.76 (including VAT).

#### Cavalcade HFC32 system

Integrated stereo tuner/amplifier with record deck in cabinet plus matching speakers. Similar specification to HFC31A but with single-play transcription record unit. Record deck: Goldring-Lenco GL75. Cartridge: Goldring G800. Suggested speakers: LS2034 (other types available). Price: (complete system inc. two speakers) £185.31 (including VAT).

#### ■ EKCO

Pye Ltd, PO Box 49, St Andrews Road,  
Cambridge, CB4 1DS.  
Tel: Cambridge (0223) 58985.

#### ZU4L

FM stereo tuner/amplifier in plinth cabinet with record deck, plus two separate speakers. 40 transistors, 17 diodes. Range: 87.5-104MHz. Four preset tuning buttons. AFC. Stereo decoder fitted. Controls: volume, bass, treble, balance, input selector. Output: 7W RMS per channel. Output impedance: 4-8 ohms. HD: <1% at 7W per channel. FR: 30Hz-18kHz  $\pm 1.5$ dB. Motor unit: Lenco 725. Speakers: 7in full-range drivers in separate enclosures. Finish: teak veneer with matt black control panel. Price: (complete system) £157.37 (including VAT).

#### ZU5J

FM stereo tuner/amplifier in cabinet with record deck, plus two separate speakers. 36 transistors, 14 diodes. Range: FM 87.5-104MHz. Variable tuning plus four preset stations. Switchable AFC. Ratio detector. Stereo decoder fitted. Stereo beacon. Controls: volume, balance, bass, treble, tuning, input selector. Output: 20W RMS per channel. Output impedance: 4-8 ohms. FR: 30Hz-25kHz  $\pm 1.5$ dB with tone controls flat. Motor unit: Philips GC008 transcription unit with GP400 cartridge. HD: <0.2% at 17W per channel. Speakers: one 8in bass driver and one 1in dome tweeter in each enclosure. Finish: teak and matt black with teak end cheeks. Price: £195 (including VAT).

#### ZU5K

FM stereo tuner/amplifier in cabinet with cassette recorder and record deck, plus two separate speakers. 50 transistors, 17 diodes, one rectifier. Range: 87.5-100MHz. Variable tuning plus four preset stations. AFC. Ratio detector. Stereo decoder fitted. Controls: volume, stereo balance, bass, treble, record level, tuning, DNL over-ride. Output: 20W RMS per channel. Output impedance: 4-8 ohms. FR: 30Hz-25kHz  $\pm 1.5$ dB with tone controls flat. HD: <0.2% at 17W per channel. Motor unit: Philips GC008 with GP400 cartridge. Speakers: one 8in bass driver plus one 1in dome tweeter in each enclosure. Finish: silver and black with teak end cheeks. Price: (complete system) £249 (including VAT).

#### ZU9 ★

FM stereo tuner/amplifier in shelf-mounting cabinet with record deck, plus two or four separate speakers. 62 transistors, 48 diodes, two FETs and one IC. Range: FM 87.5-104MHz. Variable tuning plus five presets. Switchable AFC. Ratio detector. Stereo decoder fitted. Stereo beacon. Controls: volume, balance, bass, presence, treble, tuning, ambio level, three-position tone contour, rumble/scratch filters, input selectors. Output: 35W RMS per channel. Output impedance: 4-8 ohms. FR: 20Hz-30kHz  $\pm 1.5$ dB. HD: <0.1% at 32W output per chan-

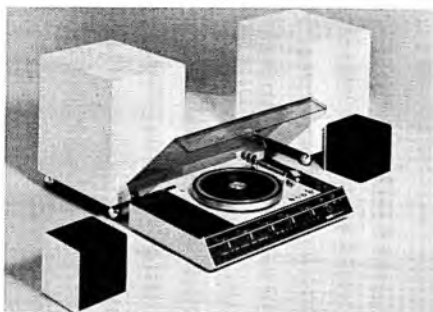

Ekco ZU9



Ekco Unit Audio Model ZU540

nel, <0.03% at 6W output per channel. Motor unit: Philips GC012 electronically controlled transcription deck with GP401 cartridge and elliptical diamond stylus. Finish: silver and matt black, (speakers) white, and black and white. Speakers: (DX321 system) comprises four enclosures, two with 10in bass drivers and two with 5in mid-range units and 1in dome tweeters: (5768 system) comprises two enclosures with one 10in woofer; one 5in mid-range and one 1in dome tweeter in each. Price: (complete system with DX321 speaker system) £488.53 (including VAT); (complete system with 5768 speaker system) £375.28 (including VAT).

**ZU440**

Complete audio system comprising record player, receiver, cassette recorder in one unit, with pair of matching loudspeakers. Cassette section: W and F <±0.35% DIN. FR: 60Hz-10kHz DIN. S/N: >45dB without NR. Fitted with DNL. Tuner section: FM tuner 87.5-104 MHz variable plus four presets. Stereo decoder. Amplifier section: Output 2×15W RMS. FR: 30Hz-20kHz±1.5dB at 1W. THD: <1%. Turntable unit: Philips GC 007. Finish: silver and matt black. Two-unit speakers finished in teak. Price: £279 (including VAT).

**ZU 540 ★**

Comprises amplifier, record player, cassette

recorder and tuner, with speakers. Amplifier section: 2×20W into 4 ohms. THD: <0.2% at 2×8W. FR: 30Hz-25kHz±1.5dB. S/N: >55 dB. Record player: Philips GC 008, 33 $\frac{1}{3}$  and 45rpm. Cartridge: Philips GP400 with diamond stylus. Cassette recorder: W and F ±0.2% DIN. FR: CrO<sub>2</sub> 40Hz-12.5kHz, Ferric oxide, 40Hz-10kHz. Fitted with Dolby NR. Tuner section: FM band 87.5-104MHz, manual or five preset stations. Stereo decoder. Speakers, twin unit enclosures. Size: 17 $\frac{1}{4}$ ×11 $\frac{1}{4}$ ×8 $\frac{1}{2}$ in. Price: £379 (including VAT).

■ **ERA**

De Banks Electronics Ltd, Tring, Herts.  
Tel: Tring (044-282) 2777.

■ **ERA BS71**

Complete stereo system. Designed and built around the Euphonic semi-conductor-activated cartridge. Principal features: amplifier output, 20W RMS per channel. FR: 18Hz to 40kHz. FM tuner with stereo decoder. Separate bass and treble controls for each speaker. Transcription turntable and hi-fi tone arm. Two hi-fi speaker systems. Price: on application.

■ **EXCELSIOR**

Oscar Radio Company.  
55-63 Goswell Road, London, EC1.  
Tel: 01-253 1802.

■ **Excelsior**

Furniture style stereo cassette recorder incorporating AM/FM radio and separate speakers. Range: FM and MW. Stereo decoder on radio. Automatic switching device with timer to record programmes at pre-arranged times. Twin VU meters. Output: 10W RMS. Size: 18in wide, 10in high, 4 $\frac{1}{2}$ in deep. Price: £114.27 (plus VAT).

■ **FALCON**

John Street (Manufacturers) Ltd,  
Falcon Works, Barmston Road, Catford,  
London, SE6. Tel: 01-698 1177.

■ **JS-TR8S**

Stereo tuner/amplifier with record deck and two separate speaker enclosures. Range: FM, MW, SW and LW. Variable tuning. Sensitivity: FM better than 5µV. Controls: bass ±12dB at 40Hz, treble ±10dB at 15kHz, volume, tuning, balance, input selector, mains on/off. Output: 6W RMS per channel. FR: 30Hz-20kHz±3dB. HD: <1% at all outputs. BSR record deck. 15 transistors, five diodes. Speaker units: 6 $\frac{1}{2}$ in 8 ohms. PU input: 100mV. DIN input and output sockets. Provision for tape record and playback. Headphone socket. Price: £75.07 (including VAT).

■ **Falcon 34**

AM/FM stereo tuner/amplifier with record deck



★ Indicates entry is illustrated



Ferguson Studio 6 Model 3460

and two speakers. Range: I.W, MW and FM/VHF. 13 transistors, five diodes. Output: 5W per channel. Controls: volume, on/off, tone, balance, tuning, pushbutton waveband selection. Decoder fitted. Headphone socket. BSR autochanger with stereo cartridge. Two speaker enclosures with 8×5in units. Price: £56.10 (including VAT).

#### Falcon 35

AM/FM stereo tuner/amplifier with record deck and two speakers. Range: LW, MW, SW and FM/VHF. 15 transistors, five diodes. Output: 10W per channel. Pushbutton selection of gram, and wavebands. Sensitivity: FM better than 5 $\mu$ V. BSR autochanger. Controls: bass  $\pm$ 12dB at 40Hz, treble  $\pm$ 10dB at 15kHz, volume, balance, tuning, on/off. Decoder fitted. Distortion better than 1% at all levels. Two speaker enclosures with ceramic magnet 8×5in units. Price: £63.73 (including VAT).

### ■ FERGUSON

Thorn Consumer Electronics Ltd,  
284 Southbury Road, Enfield, Middlesex  
EN1 1TJ. Tel: 01-366 1155.

#### Studio 6 ★

A complete audio system comprising receiver, turntable, cassette recorder and matching loudspeakers. Tuner wavebands: FM 87-104MHz, MW 525-1630kHz, LW 148-268kHz. Aerials: internal ferrite rod for MW and LW, plug-in dipole for FM. Cassette recorder. Four-track stereo. Stereo microphone supplied with table stand. FR of recorder: 40Hz-12kHz $\pm$ 6dB (at -20dB below OVU using CrO<sub>2</sub> tape) 40Hz-10kHz (using Ferric oxide). Sockets: FM aerial, stereo mic (5-pin DIN), speakers (DIN), stereo headphones (100-600 ohms). Size: 25 $\frac{3}{4}$  × 17 $\frac{3}{4}$  × 7-8in (lid open: 25 $\frac{3}{4}$  × 19 $\frac{3}{4}$  × 17 $\frac{3}{4}$ in). Speakers: 8-6 × 7 $\frac{1}{2}$  × 14 $\frac{1}{2}$ in. Price: £166 (including VAT).

### ■ FIDELITY RADIO LTD

6 Olaf Street, London, W11. Tel: 01-727 0131.

#### UA1 Unit Audio One

Stereo tuner/amplifier and record deck with two matched speakers. 20 transistors, one integrated circuit, 7 diodes. Range: FM 87.5-108.2MHz. MW 185-555m, LW 1200-2000m. Variable tuning, separate scales and pointers for AM and FM. Multiplex decoder fitted. Stereo beacon. Switchable AFC. Controls: (pushbuttons) gram, LW, MW, FM, auxiliary, AFC; (rotary controls) bass +16dB -13dB at 70Hz, treble +12dB -14dB at 14kHz, volume +8dB at 100Hz at 30dB down from maximum volume. Output: 6W RMS per channel into 8 ohms. HD: <1.5% at rated output. FR: 55Hz-23kHz $\pm$ 1.5dB at 1W with tone controls flat. Motor unit: Garrard SP25 Mk III. Cartridge: Acos GP104 ceramic. Speakers: 10in bass driver and 4in treble unit in each enclosure. Finish: teak. Size: (tuner/amplifier and record deck) 7in high, 17in wide, 15 $\frac{1}{2}$ in deep; (speakers) 13 $\frac{1}{2}$ in wide, 18 $\frac{1}{2}$ in high, 7 $\frac{1}{2}$ in deep. Price: (complete system) £114 (including VAT).

#### UA3 Unit Audio Three

AM/FM stereo tuner/amplifier and record deck in plinth with two separate speakers. Range: FM 87.5-108MHz, MW 186-555m, LW 1200-2000m. 11 transistors, three ICs, four diodes. Variable tuning. Switchable AFC. Stereo decoder included with beacon. Tone controls: bass +12.5dB -17dB at 100Hz, treble +13.5dB -13dB at 10kHz. Output: 4W RMS per channel into 8 ohms. FR: 40Hz-15kHz -3dB at 1W. HD: <1% (typically 0.1%). Motor unit: BSR changer (four speeds). Crystal cartridge. Speakers: 8×5in full range elliptical. Finish: teak. Price: (complete system) £70 (including VAT).

#### UA5 Unit Audio Five

Complete music centre comprising AM/FM stereo tuner/amplifier, record deck, stereo cassette tape unit and two matching speakers. Range: FM 87.5-108MHz, LW 1200-2000m, MW 186-555m. Sensitivity: FM better than 40 $\mu$ V, LW 1mV/m for 20dB S/N, MW 400 $\mu$ V/m for 20dB S/N. Stereo decoder with beacon. Variable tuning. Output: 4W RMS per channel into 8 ohms. HD: <1% at 5W. FR: (amplifier) 40Hz-15kHz $\pm$ 3dB. Tone controls: bass +12.5dB -17dB at 100Hz, treble +13.5dB -13dB at 10kHz. Piano key controls for recorder. Speed: 1 $\frac{7}{8}$ i/s. Compact cassettes. Three-digit tape position indicator. S/N ratio: 45dB. W and F: 0.25%. FR: (recorder) 35Hz-12kHz $\pm$ 3dB with standard tape, 35Hz-16kHz $\pm$ 3dB with CrO<sub>2</sub> tape. Speakers: one 6 $\frac{1}{2}$ in bass driver, one 3 $\frac{3}{8}$ in tweeter in each enclosure. Size: (unit) 21 × 7 $\frac{1}{2}$  × 16 $\frac{1}{2}$ in; (speakers) 10 × 6 × 15in. Weight: (unit)

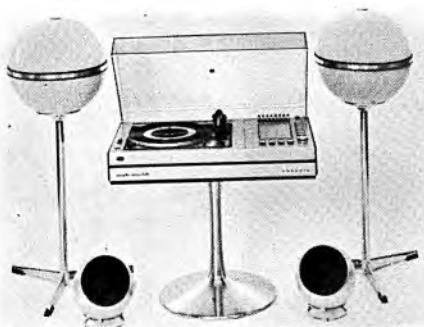

Grundig Hi-Fi System 2000C 4D



Grundig Hi-Fi System 901S

23½lb; (speakers) 10½lb each. Record deck: BSR three-speed autochanger with ceramic stereo cartridge. Cueing device. Bias compensation. Finish: satin black unit with wood grain end pieces and bright trim with tinted plastic cover. Speakers: wood grain finish with fabric grilles. Price: £149.50 (including VAT).

**UA6**

Stereo unit. Piano key selection for on/off. LW, MW and FM wavebands with AFC on FM and selection of phono and tape. Rotary tuning control, shadow illuminated dial, slider controls on left and right volume, base and treble. Sockets for two loudspeakers, tape recorder, FM/AM aerials, stereo headphone jack socket. Garrard SP25 Mk 4 single-play turntable, 3-speeds. Magnetic cartridge and cueing device. Power: 60W. Voltage: 220 to 245V at 50Hz. Output: 10W per channel RMS. Two 8 ohm speaker enclosures fitted with 6½in woofer and 3¾in tweeter. Price: (complete system) £120 (including VAT).

■ **GRUNDIG**

Grundig (Great Britain) Ltd,  
Newlands Park, London, SE26 5NQ.  
Tel: 01-659 2468. Telex: 22854.

**Studio 310 Mk II**

AM/FM stereo tuner/amplifier in cabinet with record deck, plus two separate speakers. 23 transistors, 15 diodes. Range: FM 87.5-108

MHz, MW 185-587m, LW 857-2069m, SW 18.5-50.8m. Variable tuning. Ratio detector. Slider controls for volume, balance, tone balance. Pushbutton selectors. Output: 5W RMS per channel. Output impedance: 4 ohms. Record deck: Dual 420. Speakers: System 106M with 5in drivers. Finish: black with satin metal trim and control panel. Price: (complete system) £159.75 (including VAT).

**System 800S**

AM/FM stereo tuner/amplifier in cabinet with record deck, plus two separate speakers. 44 transistors, 23 diodes, 2 rectifiers. Range: FM 87.5-108MHz, MW 185-587m, LW 857-2069m, SW 19-55m. Variable tuning plus seven preset stations on VHF. AFC. Ratio detector. Stereo decoder fitted. Controls: volume, treble -18dB +13dB at 16kHz, bass -15dB +12dB at 40Hz, balance -9dB +4dB. Pushbutton stations, wavebands and input selectors. Output: 12.5W RMS per channel. Output impedance: 4 ohms. FR: 40Hz-16kHz ±1.5dB. HD: ≤0.7% at 1kHz at rated output. Motor unit: Lenco GL75. Finish: walnut case with silver trim. Speakers: Grundig Troika 3012. Price: (complete system) £290.40 (including VAT).

**Studio 2000C 4D ★**

AM/FM stereo tuner/amplifier in cabinet with record deck, plus separate speakers. 44 transistors, 30 diodes, 3 rectifiers. Range: FM 87.5-108MHz, MW 185-587m, LW 857-2069m, SW 19-55m. Variable tuning plus seven preset stations on VHF. AFC. Ratio detector. Stereo decoder fitted. Controls: volume, treble -20dB +12dB at 16kHz, bass -20dB +13dB at 40Hz, balance -9dB +3.5dB. Pushbutton selectors for stations, wavebands and inputs. Output: 22.5W RMS per channel. Output impedance: 4 ohms. FR: 40Hz-16kHz ±1.5dB. HD: ≤0.5% at 1kHz at rated output. Motor unit: Dual 1216. Speakers: Grundig Auditorama 7000 and System 210a. Finish: matt. black with silver trim. Price: (complete system) £545.90 (including VAT).

**Hi-Fi System 901S ★**

System comprises tuner, amplifier, record deck and separate matching loudspeakers. Tuner section: 87.5-108MHz FM, 145-350kHz LW, 510-1620kHz MW, 5.4-16.2MHz SW. Tuning by seven preset selectors on FM, manual on LW, MW and SW. AFC and stereo decoder fitted. Amplifier output: 2 × 25W into 4 ohms FR: 40Hz-16kHz ±2dB. THD: <0.5% at 1kHz and full rated power. Model Goldring GL78 turntable. Finish: walnut case with silver and black trim. Price: £382 (including VAT)

**Hi-Fi System 2040SQ**

Quadraphonic hi-fi system comprising receiver and record deck with four loudspeakers. Tuner section: FM/AM bands 87.5 × 108MHz FM,



Hanimex HRC 5060

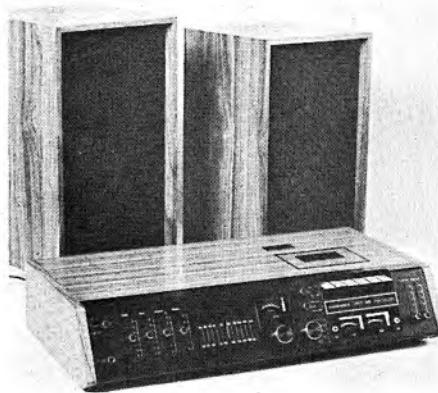

Hanimex HRC 5070

145-350kHz LW, 510-1620kHz MW, 5.4-16.2 MHz SW. Seven preset stations on FM, manual tuning on LW, MW and SW. AFC and stereo decoder. Record deck: dual 3-speed unit. Loudspeakers: Grundig Auditorama 4000 spherical speakers on stands. Price: £660 (including VAT).

#### ■ HACKER RADIO LTD

Norreys Drive, Cox Green, Maidenhead, Berks, SL6 4BP. Tel: Maidenhead 22261/5.

#### **GAR 550 Mk 3 Centurion**

Tuner/amplifier in cabinet with record deck. FM/VHF radio covering 87.5-101 MHz. Usable sensitivity:  $5\mu\text{V}$  for 30dB S/N (30kHz deviation). Station markers. AFC. Garrard SP25 Mk 4 fitted with Goldring G850 magnetic pickup and diamond stylus. Inputs: PU 3mV equalised, 30dB overload capability; radio 50mV 47K, infinite overload capability; aux/tape 50mV 47K, infinite overload capability. Output: 14W RMS per channel into 8 ohms, 10W RMS per channel into 15 ohms. Controls: bass +18dB -14dB at 40Hz, treble +18dB -20dB at 15kHz, low-pass filter -3dB at 7kHz, on/off, balance, volume, pushbutton selection for scratch filter, gram, aux/tape, radio and mono/stereo. HD: better than 0.2% at 8 ohms, better than 0.1% at 15

ohms. FR: 25Hz-30kHz  $\pm 3\text{dB}$ . In-built rumble filter operates at below 25Hz. H & N level better than 60dB down on all inputs. Outlet for tape recorder of 15mV at 25K. Headphone socket with automatic muting of speakers. Pushbutton operates stereo decoder. Separation: 35dB at 1kHz, 26dB at 5kHz. Finish: teak. Hinged lid and black front panel or semi-transparent lid and black front panel. Mains: 200-245V 50Hz. Size: 18in wide,  $7\frac{3}{4}$ in high, 16in deep. Suggested speakers: Hacker Ls1100 three-way system with response 30Hz-18kHz. Size:  $13\frac{1}{8} \times 20\frac{1}{2} \times 11\frac{1}{4}$ in. Price: plus two speakers on application. GAR 550/T (teak) lid or GAR 550/P (plastic) lid.

#### ■ HANIMEX

##### **HRC 5060 ★**

Complete system consisting turntable, 8-track cartridge player, AM/FM receiver and  $2 \times 10\text{W}$  RMS amplifiers, with two speaker enclosures. Record player: BSR P128R, 4-speeds, 16, 33, 45 and 78rpm. 1in diameter turntable. PU: BSR SC10H1 ceramic. Cartridge player: Hanimex HRC 5060. Price: on application.

##### **HRC 5070 ★**

Complete system consisting AM/FM receiver, stereo cassette deck and two speakers. Cassette deck has twin VU meters, slider controls, recording and playback facilities. Tuner features FET front end for high sensitivity. Power output  $2 \times 10\text{W}$  RMS. Price: on application.

#### ■ HIS MASTERS VOICE

Thorn Consumer Electronics Ltd, 284 Southbury Road, Enfield, Middlesex. Tel: 01-366 1155.

##### **HMV 2455 ★**

AM/FM stereo tuner/amplifier in cabinet with record deck, separate speakers. Range: FM 88-108MHz, MW 200-550m. Variable tuning plus four presets. Stereo decoder fitted. Integrated quadrature FM decoder. Slider controls for volume, treble, bass, balance. Pushbuttons for AFC, shape, tape monitor, input selector, wavebands, mode. Output: 25W to DIN 45 500. Output impedance: 4 ohms. FR: 25Hz-30kHz +0, -3dB. HD:  $< 0.1\%$  at all powers up to 20W. Motor unit: BSR P128. Cartridge: Goldring 800 magnetic. Finish: teak. Speakers: two 5in and one  $3\frac{3}{8}$ in drivers in each speaker enclosure. Price: (complete system) approximately £179.15 (including VAT).

##### **HMV 2456 ★**

As HMV 2455 but in console cabinet. Price: £259.20 (including VAT).

#### ■ HITACHI

Hitachi Sales (UK) Ltd, New Century House, Coronation Road, Park Royal, London, NW10 7QS. Tel: 01-965 9861.



HMV Model 2455



HMV Model 2456



ITT KA2010



ITT KA1255/KS661

**DPK311**

Four-waveband AM/FM stereo tuner/amplifier with record deck in shelf cabinet, plus two speaker systems. Range: FM 87.5-108MHz, LW 860-2000m, MW 187-566m, SW 30-85m. Variable tuning. Output: 8W RMS per channel. FR: 20Hz-20kHz. 28 transistors, 23 diodes, one FET. Motor unit: Hitachi two-speed (33 $\frac{1}{3}$ , 45 rpm). Cartridge: crystal XFS-182. Sapphire stylus. Stereo decoder fitted. Separate wide-range bass and treble controls. Mains: 220-240V AC 50Hz. Speakers: One 6in bass driver, one 2in tweeter in each enclosure. Size: (amplifier/deck unit) 16 $\frac{1}{2}$  x 8 $\frac{3}{8}$  x 16 $\frac{1}{2}$ in, (speaker enclosures) 9 $\frac{7}{8}$  x 17 x 7 $\frac{1}{2}$ in. Price: (complete system) £118.29 (including VAT).

■ **ITT**

**KA2010 ★**

Stereo radio system, 10W per channel with stereo radio tuner built-in. BSR C141R record deck. 3-speed autochange/manual unit fitted with SC5M diamond stylus. Radio VHF, long and medium wavebands, separate AM and FM scales. Sliders for volume, balance, treble and bass, pushbuttons for on/off, disc, tape, wave-change, and stereo headphones. Sockets: tape, record/playback, FM aerial, loudspeakers and headphones. Output: 4 ohms. System includes KS665 speakers. Price: £105.43 (including VAT).

■ **KA2255FM ★**

Complete audio system. FM radio. Varicap pushbutton tuning. BSR P128R record deck. System includes KS666 speakers. Price: £147.39 (including VAT).

■ **JVC (UK) LTD**

453 Caledonian Road, London, N7 9BA. Tel: 01-607 6568.

**GX 500F**

System comprises tuner, amplifier and turntable unit with loudspeakers. Tuner section: 87.5-108MHz FM, 520-1605kHz MW, variable. AFC and stereo decoder fitted. Amplifier output 4 x 13W into 8 ohms (Quadraphonic). FR: 20Hz-30kHz. THD: 1%. Twin unit speakers, JVC belt-driven turntable. Price: £412.50 (including VAT).

Comprehensive new range of complete hi-fi systems now available but no product information obtainable as this edition of the Year Book closed for press. Full specifications and prices on request.

■ **KLINGER**

Klinger Controls Ltd, Spencer Court, 7 Chalcot Road, London, NW1 8LU. Tel: 01-586 2922.

★ Indicates entry is illustrated

### KC94 plus two S50 Mk II speakers ★

FM stereo tuner/amplifier in cabinet with record deck plus two S50 Mk II speaker enclosures. Motor unit: Garrard SP25 Mk III. Four speeds. Idler wheel drive Cartridge: Shure M44E. Diamond stylus. Range: 87.5-108MHz. Five preset stations. Switchable AFC. Usable sensitivity: 2µV. Aerial input: coaxial and balanced. Outlet for tape: 100mV. Stereo decoder included. Inputs: tape 50mV 220K, aux (1) 100mV 470K, aux (2) 0.15mV 30 ohms. Noise level: 70dB. Overload capability: 30dB. Output: 25W RMS per channel. Output impedance: 8 ohms. Tone controls: bass ±15dB, treble ±15dB, scratch filter 18dB/octave from 8kHz, rumble 12dB/octave from 80Hz. Loudness control. A/B monitor switch. HD: 0.1% at 20W. FR: 25Hz-35kHz ±2dB at 20W. Switching for two pairs of speakers. Two stereo headphone sockets. Stabilised power supply. Size: 21 × 8 × 15½ in. Mains: 110-120V, 220-240V AC. Finish: teak cabinet with folding lid. Price: (KC94 unit, plus two S50 Mk II speakers) £162 (plus VAT).

### KC94 Transcription

Specification as for KC94 above but fitted with Garrard 86SB belt driven transcription deck and supplied with two Klinger S90 speaker systems. Price: £279.40 (including VAT).



Klinger KC94 Plus Two S50 MkII



Marconiphone 4459

### ■ MARCONIPHONE

Thorn Consumer Electronics Ltd.  
284 Southbury Road, Enfield, Middlesex.  
Tel: 01-366 1155.

### 4459 ★

AM/FM tuner/amplifier in cabinet with record deck, plus two separate speaker systems. Range: FM 87-104MHz, MW 183-576m, LW 1120-2020m, SW 25-50.8m. 35 transistors, 19 diodes. Variable tuning. AFC. Ratio detector. Stereo decoder fitted. Controls: tuning, on-off volume, bass, treble, balance. Pushbuttons for gram, mono, tape, waveband selection, shape. Output: 10W RMS per channel. Output impedance: 8 ohms. FR: 35Hz-17kHz ±1dB. Motor unit: Garrard 6/300. Finish: teak case with black and silver coloured control panels. Speaker systems: one 6in bass driver and one 3½in tweeter in each enclosure. Price: (complete system) £126.65 (including VAT).

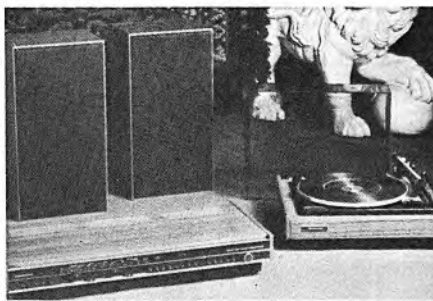

Marconiphone 4455B

### 4455B ★

AM/FM tuner/amplifier with separate record deck, plus two separate speaker systems. 48 transistors, 18 diodes, five ICs. Variable tuning plus four preset stations on FM. Range: FM 87.5-108MHz, MW 187-571m. AFC. Quadrature FM detector. Stereo decoder fitted. Controls: tuning, bass, treble, volume (left), volume (right), on-off, balance, speaker switching, loudness, mono/stereo, tape monitor, AFC on-off,



Murphy MS 3020 Stereo System

waveband selector. Output: 25W RMS per channel. Output impedance: 4 ohms. FR: 25 Hz-30kHz+0dB-3dB. HD: <0.1% up to 20W per channel. Record deck: Garrard SP25 Mk IV with Shure M75-6S. Finish: teak. Speaker systems: two 5in bass drivers and one 3½in tweeter in each enclosure. Additional pair of speakers available for 4D effect. Price: (complete system) £194.40 (including VAT).

#### ■ MURPHY

Rank Radio International, PO Box 596, Power Road, Chiswick, London, W4 5PW. Tel: 01-994 6491.

#### MS 3020 ★

A fully integrated stereo amplifier record player and stereo tuner unit in white on a black plinth. Wavebands: VHF, MW, LW. Output: 6W ±1dB at 10% THD (RMS). Controls: eight pushbutton switch unit, selecting AFC, on/off, VHF, LW, MW, tape, mains on/off switch, mono/stereo switch. Slider controls for volume, balance, bass, treble and rotary tuning control. Deck: 3-speed automatic single play with cueing device. Cartridge: SC7M2 double sapphire dual turnover type (or equivalent). Sockets: two 2-pin loudspeaker sockets, 5-pin DIN type socket for tape facilities. Socket for external VHF aerial (supplied). Jack plug socket for connection of stereo headphones. Speakers: enclosures with 8 × 5in (203 × 127mm) drive units. Dimensions (main unit): height 5½in (133mm), width 19½in (489mm), depth 13¼in (337mm). Speakers: height 12¾in (324mm), width 9¾in (248mm), depth 5½in (140mm). Price: £98 (including VAT).

#### ■ ONKYO

J. Parkar & Company (London) Ltd, Parkar House, 1 Beresford Avenue, Wembley, Middlesex, HA0 1YX. Tel: 01-903 5211.

#### SM-10

Stereo tuner/amplifier in cabinet with record deck, plus matching speaker enclosures. 23-transistor circuit. Range: FM 88-108MHz, MW 187-562m. Variable tuning. AFC. Stereo decoder and beacon fitted. Controls: (slider type) balance, volume and treble/bass; (rotary type) tuning, input selector. Output: 6W RMS per channel. Output impedance: 8 ohms. Own two-speed record deck with lightweight tubular arm and high-compliance ceramic pickup. Automatic return of pickup arm and switch-off. Reflex speaker enclosures with 8in full-range units. Finish: matt wood grain cabinets with black control panel and brushed aluminium trim. Size: (tuner/amplifier/player unit) 18½ × 7¾ × 15½in; (speaker enclosures) 15¾ × 9¾ × 7in. Price: (complete system) £129.98 (including VAT).



Onkyo Dynamic Four 800

#### Dynamic Four 800 ★

AM/FM stereo tuner/amplifier with separate record deck and speakers. 27 transistors and 21 diodes. Range: FM 88-108MHz, MW 187-565m. Variable tuning. Stereo decoder with auto switching. Stereo beacon. Tuning meter. Switchable AFC. Controls: bass, treble, loudness, balance, high filter, mode, tuning. Output: 25W per channel. Two-speed motor unit with auto-stop and auto return of arm. 12in belt-driven platter. Balanced tubular arm with moving magnet cartridge. Diamond stylus. Pw: 3gm. Two-way reflex speaker enclosures, each containing 8in bass driver and 5in mid/HF unit. Finish: teak veneer with brushed aluminium facia and tinted plastic dust cover. Price: (complete system) £221.39 (including VAT).

#### SM-100

AM/FM stereo tuner/amplifier in cabinet with record deck plus two separate speakers. 25 transistors, 19 diodes. Range: FM 88-108MHz, MW 187-565m. Variable tuning. Stereo decoder with beacon. Tuning meter. Controls: flywheel tuning, bass, treble, balance, volume, input selector, mains on/off. Output: 14W per channel. Sensitivity: FM 3µV, MW 15µV. Two-speed motor unit with auto cut-off and auto arm return. 12in platter. Balanced tubular arm with high compliance cartridge. Microphone input. Speaker system comprising 8in bass driver and 3in tweeter in bass reflex cabinet. Mains: 100, 110, 220, 240V 50-60Hz. Price: (complete system) £165.86 (including VAT).

#### Model X-1

Four-channel sound system comprising console cabinet with AM/FM tuner/amplifier and record deck, two main-channel speaker enclosures and two slim wall-fixing ambience speakers, 49 transistors and 32 diodes. Range: FM 88-108MHz, MW 187-565m. Variable tuning. Stereo decoder with auto switching and stereo beacon. Output:

★ Indicates entry is illustrated

16W per channel (total 64W). Sensitivity: FM 2 $\mu$ V, MW 12 $\mu$ V. Special 'Sound Composer' network permits matrix four-channel operation from two-channel sources in addition to discrete four-channel reproduction. Tuning meter. Headphone jack. Two-speed record deck with auto cut-off and return of pickup arm. 12in diameter belt drive. Moving magnet cartridge with diamond stylus. Pw: 1.5-2.5gm. Front speakers: two-way system incorporating 8in bass driver and 2 $\frac{1}{2}$ in mid/HF unit in each. Separate mic input mixing circuit. Price: (complete system) £385.23 (including VAT).

#### Model Y-2

Four-channel sound system comprising AM/FM tuner/amplifier, shelf-mounting record deck, two front-channel speakers and two rear-channel speakers. 47 transistors and 24 diodes. Range: FM 88-108MHz, MW 187-565m. Sensitivity: FM 2.5 $\mu$ V, MW 15 $\mu$ V. Stereo decoder with auto-switching and stereo beacon. Variable tuning. Output: 16W per channel (total 64W). Special 'Sound Composer' network permits matrix four-channel operation from two-channel sources in addition to discrete four-channel reproduction. Tuning meter. Headphone jack. Two-speed record deck with auto cut-off and return of pickup arm. 12in diameter belt-drive platter. Moving magnet cartridge with diamond stylus. Pw: 1.5-2.5gm. Front speakers: two-way reflex system with 8in bass driver and horn tweeter in each. Rear speakers: wall hanging type with single full-range 6 $\frac{1}{2}$ in unit in each. Price: (complete system) £292.25 (including VAT).

For Onkyo four-channel audio systems see Quadraphonic Equipment Section.

#### PHILCO

Philco Great Britain Ltd, Philco House, Sterling Trading Estate, Rainham Road South, Dagenham, Essex RM10 8TX.

Tel: 01-593 8613.

#### Super 20

AM/FM stereo tuner/amplifier in cabinet with record deck and separate speaker enclosures. Variable tuning. AFC. Decoder fitted. BSR C123 record deck. Socket for headphones and FM aerial. Output: 10W RMS per channel. Tape socket. Smoked plastic dust cover. Size: (main unit) 15 $\frac{1}{2}$  × 14 $\frac{1}{2}$  × 9in; (speaker enclosures) 14 × 9 × 6in. Price: £85.69 (including VAT).

#### PHILIPS

Philips Electrical Ltd, Century House, Shaftesbury Avenue, London, WC2H 8AS. Tel: 01-437 7777.

#### RH814

AM/FM stereo tuner/amplifier in cabinet with

record deck plus two separate speakers. 25 transistors, 13 diodes. Range: FM 87.5-104MHz, MW 214-577m, MW bandspread 187-214m, LW 870-2000m. AFC. Variable tuning. Ratio detector. Stereo decoder fitted. Tone controls: bass  $\pm$ 9dB at 100Hz, treble  $\pm$ 8dB at 10kHz. Output: 8W RMS per channel  $\pm$ 1dB. Output impedance: 4 ohms. FR: 45Hz-20kHz  $\pm$ 3dB. HD: <2% at 4.5W per channel. Motor unit: Philips GC060. Pickup cartridge: Philips GP205 (45/LP stylus only). Finish: simulated walnut veneer. Speakers: Philips RH412. Price: (including two RH412 speakers) £155 (including VAT).

#### RH837

FM tuner/amplifier in cabinet with record deck and two separate speakers. 46 transistors, 23 diodes and one IC. Range: 87.5-104MHz. Four preset stations. Switchable AFC. Stereo decoder fitted. Slider controls for volume, balance, bass, treble, presence, contour/rumble/scratch, quiet tuning, speaker selection, input selector, AFC, headphones, stereo-4. Output: 20W RMS per channel  $\pm$ 1dB. Output impedance: 4 ohms. FR: 30Hz-25kHz  $\pm$ 1.5dB. HD: <1%. Motor unit: Philips GC008. Finish: polystyrene case with tinted transparent plastic cover. Speakers: Philips RH431 enclosures. Price: (complete system) £239 (including VAT).

#### RF838

AM/FM tuner/amplifier with record deck in cabinet with separate speaker enclosures. 21 transistors, 5 diodes and one IC. Range: FM 87.5-104MHz, MW 185-57m, LW 1100-2080m. Variable tuning. Switchable AFC. Ratio detector. Stereo decoder fitted. Controls: balance, bass, treble, volume, tuning, AFC on/off, waveband selection, gram. Output: 8W RMS per channel  $\pm$ 1dB. Output impedance: 8 ohms. FR: 40Hz-20kHz  $\pm$ 3dB. HD: <2%. Motor unit: Philips GC047 autochanger. Finish: afrormosia veneer with satin silver effect trim. Matching speaker enclosures, each containing one 6 $\frac{1}{2}$ in dual-cone drive unit. Price: (complete system) £115 (including VAT).

#### RF839

AM/FM tuner/amplifier with record deck in cabinet with separate speaker enclosures. 17 transistors, 5 diodes, one IC. Range: FM 87.5-104MHz, MW 185-570m, LW 1180-2080m. Variable tuning. Switchable AFC. Ratio detector. Stereo decoder fitted. Controls: volume, balance, bass, treble, tuning, gram, waveband selection, AFC on/off. Output: 3W RMS per channel  $\pm$ 1dB. Output impedance: 8 ohms. FR: 40Hz-20kHz  $\pm$ 3dB at 50mW. HD: 10% (inc hum and noise). Motor unit: Philips GC047. Finish: walnut effect and matt chrome trim. Speakers: Philips 7in dual-cone full-range units

# For your complete home entertainment

## Deccasound Compact 4 Music Centre

This very advanced stereo system gives you a complete home entertainment centre in one elegant unit.

The Compact 4 provides a record deck, amplifier, two speakers, AM and FM-stereo radio tuners—*plus* a high quality stereo cassette deck. All integrated into a single impressive piece of equipment

The automatic turntable, twin 10-watt amplifiers, tuners and cassette deck are all contained in a handsome teak finished cabinet with a transparent hinged cover. Two speaker enclosures are mounted beneath the controls, on an attractive, cleanly designed stand. Detach them and place them apart for the very best stereo effect.

The Compact 4 also has two extra loudspeaker sockets. By buying two further LI53 speakers, you can use it as a 4-speaker system for the extra realism of all-around sound.

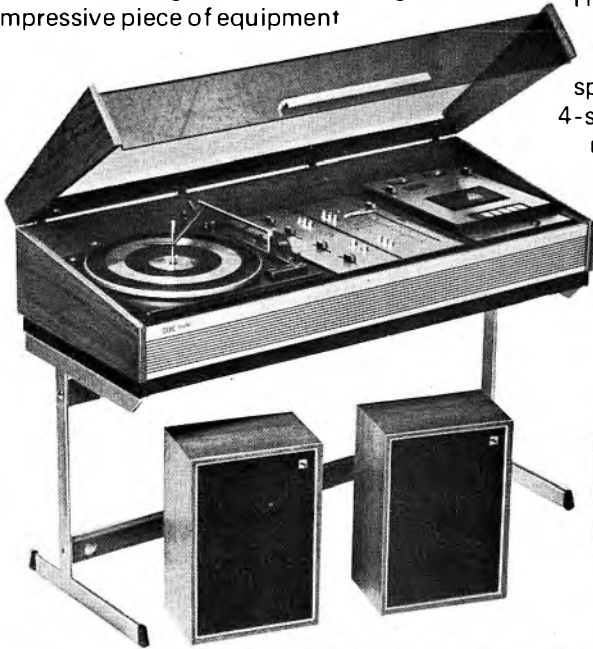

# DECCA

Decca Radio & Television,  
Neachells Lane, Willenhall,  
Wolverhampton, Staffordshire.

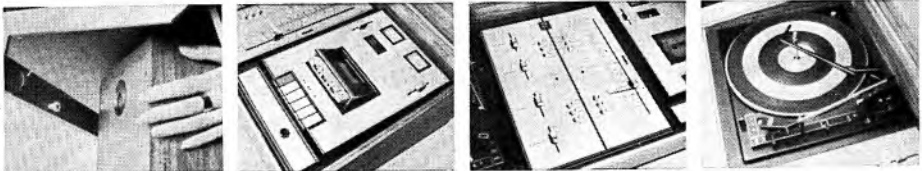



# The Ekco ZU Range



## ZU4L

Compact music centre.  
FM tuner-amplifier/Record Player/  
Cassette Recorder. 10 watts per channel music power.



## ZU440

Hi-Fi turntable/push button Stereo FM tuner-  
amplifier/Cassette Recorder with DNL.  
20 watts music power per channel. Built-in 'Stereo 4'  
ambiophony capability. 'Disc Jockey' mixing  
facility allows production of professionally dubbed cassettes.

**EKCO - there's one for everyone**

Pye Limited, P.O. Box 49 St. Andrews Road, Cambridge CB4 1DS  
A member of the  Pye Group of Companies.

# Zuperb

## ZU540

Transcription turntable/push button Stereo FM tuner-amplifier and hi-fi Cassette Recorder.

Dolby 'B' noise reduction system.

Stylish black and silver trim with white speakers. 30 watts music power per channel.



## ZU9

The most advanced specification ever from Ekco. Stereo FM tuner-amplifier/Transcription deck. 'Flight-deck' control panel/Slider controls including individual bass, presence and treble tone controls. Built-in 'Stereo 4' ambiophony capability. Two matching walnut veneer speakers – each with three separate drive units. 50 watts music power per channel.

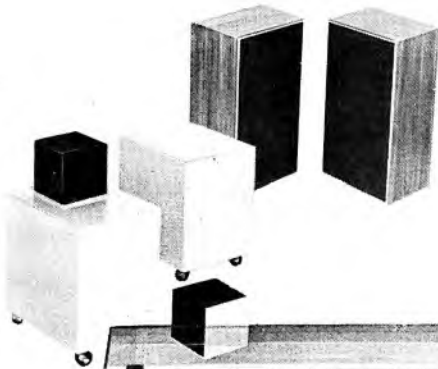

## ZU9DX

An alternative to the ZU9 with a revolutionary 4-speaker system. Two free standing bass speakers and two wall mounted treble/mid-range speakers. The perfect balance.

**EKCO – there's one for everyone**

Pye Limited, P.O. Box 49 St. Andrews Road, Cambridge CB4 1DS  
A member of the  Group of Companies.

Introducing Zenith Allegro™...  
the tuned sound system.

Because deep, rich sound  
gets trapped inside a speaker,  
we gave it a way to get out.

The whole idea of a stereo system is the sound that goes in should come out again—as faithfully reproduced as possible. But with a lot of systems, including many with sealed speakers, you never hear some of the deep, rich bass. It gets trapped inside the speaker cabinets.

With Zenith's new line of Allegro stereo systems,\* you'll hear those deep, rich sounds.



They're channeled out of the speaker through a unique opening in front called a "tuned port." Added to our specially-

designed woofer and horn-type tweeter, this innovative design means remarkable efficiency. A 60-watt Allegro system equals the sound performance of a 120-watt system with comparable size air-suspension speakers. By the same standard, in terms of size and efficiency, the Allegro system has the deepest, richest sounding speakers on the market today.

There's more to the Allegro story, of course. Innovative features. 4-channel adaptability—just by adding a few extras. Many models to choose from. But the best part about Allegro is how it sounds. Once you hear it, you'll know what we're talking about.



The Labelle, Model E584W, Allegro 1000

The surprising sound of Zenith

**ZENITH** Allegro

The quality goes in before the name goes on®

Represented in the United Kingdom by UNITED MERCANTILE COMPANY LTD., 17 Lettice Street, London SW6 4EH

\*patent pending

Zenith International Sales Corporation, a subsidiary of the Zenith Radio Corporation, Chicago, Illinois 60639. Makers of the world's finest television, stereophonic high-fidelity instruments, tape recorder/players, phonographs, and radios.



Pye 5002



Pye 5003

in separate enclosures. Price: £85 (including VAT).

#### **RH943**

AM/FM tuner/amplifier in cabinet with record deck and separate speaker enclosures. 51 transistors, 30 diodes. Range: FM 87.5-104MHz, MW (1) 214-577m, MW (2) 187-214m, LW 870-2000m, SW 30.7-50.4m. Variable tuning. AFC. Ratio detector. Stereo decoder fitted. Controls: volume, balance, bass, treble, gram/tape, waveband selectors, tuning, on/off. Output: 8W RMS per channel  $\pm$  1dB. Output impedance: 4 ohms. FR: 45Hz-20kHz  $\pm$  3dB. Motor unit: Philips GC007. Finish: walnut with silver trim. Speakers: RH412 enclosures with 6½ in dual cone full-range drivers. Price: (complete system) £210 (including VAT).

#### ■ **PYE**

Pye Ltd, PO Box 49, Cambridge, CB4 1DS.  
Tel: Cambridge (0223) 58985:

#### **5002 ★**

AM/FM stereo tuner/amplifier in cabinet with record deck. Separate speakers. 20 transistors, 16 diodes. Range: FM 87.5-104.5MHz, MW 182-570m, LW 1150-2050m. Variable tuning. Switchable AFC. Stereo decoder fitted. Controls: volume, balance, bass, treble, on/off, tuning, wavechange, input selector. Output: 5W RMS per channel. Output impedance: 8 ohms. FR: 40Hz-15kHz (controls level and within 3dB). HD: < 1.5% at 5W RMS per channel. Motor unit: BSR C123R1 or Glenburn AT100. Finish: moulded black cabinet with white trim and simulated teak. Speakers: one full-range 8 x 5 in unit in each enclosure. Price: £74.50 (including VAT).

#### **5003 ★**

AM/FM stereo tuner/amplifier in cabinet with record deck. Separate speakers and stand for mains unit supplied. 20 transistors, 16 diodes. Range: FM 87.5-104.5MHz, MW 182-570m, 1150-2050m. Variable tuning. AFC. Stereo decoder fitted and separate output sockets for 'stereo-4' ambiphony. Controls: volume, balance, bass, treble, on/off, input selector, waveband selectors, speaker muting switch. AFC on/off. Output: 7W RMS per channel. Output impedance: 8 ohms. FR: 40Hz-15kHz (controls level and within 3dB). HD: < 1% at 7W RMS per channel. Motor unit: BSR P128R. Finish: moulded black cabinet with orange and white trim and simulated teak end pieces. Speakers: one full-range 6½ in unit in each enclosure. Price: £119.50 (including VAT).

#### **Model 1514**

System comprises amplifier and turntable unit with matching speakers. Output: 2 x 4.8W RMS into 4 ohms. FR: 45Hz-30kHz  $\pm$  3dB. THD: 10% at 4.8W. Record deck: Philips GC014. Finished in matt black and silver with tinted lid. Price (with speakers): £55 (including VAT).

#### **Model 1570**

System comprises tuner, amplifier and record deck with matching speakers. Receiver section: 87.5-108MHz FM, 144-258kHz LW, 525-1625 kHz MW and 5.87-22.6MHz SW. Variable tuning, AFC and stereo decoder. Output: 2 x 10W per channel into 8 ohms. FR: 60Hz-20kHz  $\pm$  3dB at 1W. THD: < 5%. Record deck: BSR P128R. Twin unit loudspeakers in teak veneered cabinets. Price: to be announced.

#### ■ **QUADRASONICS**

Spenser House, Brettenham Road, Edmonton, London, N18. Tel: 01-807 5544/5999.

#### **Q4-20**

Complete AM/FM four-channel stereo system comprising tuner/amplifier in plinth cabinet with record deck plus four separate speaker enclosures. Range: FM 87.4-104.5MHz, MW 187-555m. Usable sensitivity: FM 2  $\mu$ V, MW 100  $\mu$ V on internal aerial, 10  $\mu$ V on external aerial. Output: 20W per channel (four channels) into 8 ohms. FR: 20Hz-20kHz  $\pm$  1dB. Signal-to-noise levels: PU input better than 60dB, radio input better than 70dB. Damping factor: better than 120 at 8 ohms load. Input overload capability: better than 38dB. Controls: master gain, master bass and treble, four separate channel balance controls, input and mode selectors. Record deck: Goldring G101 belt drive turntable with Goldring G850 magnetic cartridge. CBS SQ integrated circuit matrix decoder fitted as standard (plug-in edge connector). Two extra edge connector sockets for optional quadrasonic

★ Indicates entry is illustrated

system decoders. Speakers: one  $5\frac{1}{2}$ " in bass driver, one  $5\frac{1}{2}$ " in mid-range unit, two  $2\frac{1}{2}$ " in tweeters in each enclosure. HC: 20W RMS. FR: 30Hz-20kHz  $\pm 5$ dB. Size: (main console)  $26\frac{1}{2} \times 5\frac{1}{2} \times 14\frac{1}{2}$ " in; (speaker systems)  $9\frac{1}{2} \times 16 \times 8\frac{7}{8}$ " in. Price: £198 (plus VAT).

### ■ RADON

Radon Industrial Electronics Co Ltd, Brooklands Trading Estate, Orme Road, Worthing, Sussex. Tel: Worthing 34904.

#### Arundel AP200

Transistorised stereo tuner/amplifier and gram unit in compact table style cabinet. Range: 87-106MHz. Variable tuning. AFC. Stereo decoder fitted. Controls: input selector, AFC on/off, volume, balance, bass, treble, scratch filter, rumble filter, tuning, mains on/off. Output: 10W RMS per channel. FR: 35Hz-18kHz. Output impedance: 8-15 ohms. HD: 0.1% at rated output. Motor unit: Garrard SP25 Mk II or Garrard SL65B. Pickup cartridge: Goldring G800H. Size:  $8\frac{1}{2} \times 22 \times 16$ " in. Finish: teak with transparent cover, teak surround.

Complete systems available with Radon Pearl, Emerald, Opal or Topaz speakers. Prices from approximately £160 to £250 for complete system.

### ■ SERVO-SOUND

Lamb House, Church Street, London, W4 2PB. Tel: 01-995 4551.

#### Servo-Sound system

Comprises separate FM tuner, record deck in cabinet with preamplifier and two speaker systems incorporating power amplifiers. 26 transistors and 14 diodes. Range: 88-108MHz. Variable tuning. Switchable AFC. Squelch discriminator. Meter tuning indicator. Stereo decoder fitted. Controls: mains on/off, filter, mono/stereo, tape, aux, PU, bass, treble, balance, volume, tuning, headphones. Output: 15W RMS per channel. FR: 35Hz-20kHz. HD: 1.5% at 1kHz. Motor unit: Lenco L75. Cartridge: Stanton 500A. Speakers: one  $9\frac{1}{2} \times 6\frac{1}{2}$ " in unit with 15W amplifier in each infinite baffle enclosure. Price: (SR3 FM tuner, SC75BTE preamplifier and record deck, two SL20 speaker/amplifier units) £329.10 (plus VAT).

### ■ SHARP

Sharp Electronics (UK) Ltd, 107 Hulme Hall Lane, Manchester, M10 8HL. Tel: 061-205 7321

#### SR102E

Tuner/amplifier with eight-track tape player and two separate speakers. 26 transistors and 15 diodes. Range: FM 88-108MHz, MW 189-560m. Variable tuning. AFC. Ratio detector. Stereo decoder fitted. Controls: tuning, mains on/off,

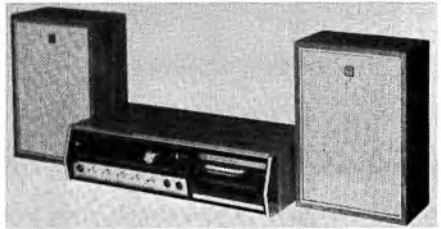

Sharp SC103/CP108H



Sharp SD305H

volume, balance, bass, treble, function switch, tape programme selector. Output: 1.5W RMS per channel. Output impedance: 8 ohms. FR: 20Hz-30kHz. HD: 1.5%. Sharp tape transport. Finish: wood veneered cabinet with dark matt metal fascia. Speakers in separate enclosures supplied. Price: £95.45 (plus £9.54 VAT).

#### SC103 (CP108H) ★

Tuner/amplifier with built-in cassette recorder and two separate speakers. 31 transistors (including one FET), 14 diodes, one IC. Range: FM 88-108MHz, MW 189-560m. Variable tuning. AFC. Ratio detector. Stereo decoder fitted. Controls: tuning, mains on/off, function selector, bass, treble, monitor volume control (record), left-channel volume, right-channel volume, pause button, fast forward, tape play, rewind, record interlock, reject cassette. Output: 3W RMS per channel. Output impedance: 8 ohms. FR: 40Hz-22kHz. Sharp tape deck. Finish: wood veneered cabinet with dark matt metal fascia. Speakers in separate enclosures supplied. Price: £127.23 (plus £12.72 VAT).

#### SD305H ★

Tuner/amplifier with built-in record deck and separate speakers. Range: FM 88-108MHz, MW 189-560m, LW 900-2000m, SW 16.5-50m. Variable tuning plus preset programmes on FM. AFC. Ratio detector. Stereo decoder fitted. Controls: volume, balance, bass, treble, tuning, mains on/off, function selector, mode. Output impedance: 8 ohms. Sharp motor unit. Magnetic cartridge. Finish: PVC film on wood with aluminium front panel. Separate speakers supplied. Price: £177.27 (plus £17.73 VAT).

**GS1980**

Complete quadraphonic system comprising tuner/amplifier, record deck and four speakers. 19 transistors, 14 diodes. Range: FM 88-108 MHz, MW 189-560m. AFC. Variable tuning. Ratio detector. Stereo decoder fitted. Output: 2W per channel. Output impedance: 8 ohms. Sharp motor unit with ceramic cartridge. Finish: PVC film on wood. Price: £101.32 (plus £10.13 VAT).

**GS5730E**

Complete quadraphonic system comprising tuner/amplifier, record deck and four speakers. Range: FM 88-108MHz, MW 189-560m. Variable tuning. AFC. Ratio detector. Stereo decoder fitted. Controls: mains on/off, volume, mic volume, tuning, bass, treble, function selector, loudness, tape monitor, mode, matrix/discrete four level controls. Output: 10W RMS per channel. Output impedance: 8 ohms. FR: 20Hz-30kHz. Sharp record deck with magnetic cartridge and diamond stylus. Price: £335.45 (plus £33.54 VAT).

**SG-155-H**

Combination unit comprising tuner/amplifier with stereo cassette recorder, and a 2-speed, semi-automatic record player. Output: 3W RMS per channel. Features include pushbutton recording of either disc or radio sources; ceramic cartridge with sapphire stylus fitted to tone arm and a teak cabinet housing. Complete with 2-unit matched speakers. Price: £159.95 (including VAT).

**SR-156-E**

Combination unit of AM/FM stereo receiver with an 8-track stereo cartridge recorder. Horizontal styling. Features include fast-forward, pause and auto-eject, speaker selector switch and separate level meters for recording. Output is 3W RMS per channel. Includes pair of matched speakers. Price: £149.95 (including VAT).

**SKANDIA ELECTRONICS**

Distributor: Golding Audio Ltd, London Road, Marks Tey, Colchester, Essex.  
Tel: Marks Tey (0206 21) 433.

**SK120**

System comprises tuner/amplifier incorporating stereo eight-track cartridge tape recorder. Range: FM 88-108MHz, MW 187-567 metres. Variable tuning. AFC. Stereo decoder fitted. Controls: volume, tuning, record level (right channel), record level (left channel), balance, AM/FM radio, low filter, high filter, treble, input selector, mono/stereo. Output: 45W RMS per channel. FR: 20Hz-20kHz. Output impedance: 8 ohms. HD: < 3%. Size: 29½ × 6½ × 13½in. Recommended speakers: Golding X100.



Sony HP511A

Finish: walnut. Price: Revised prices awaited as this edition of the Year Book closed for press.

**SK308**

System comprises tuner/amplifier incorporating stereo eight-track cartridge tape recorder. Range: FM 88-108MHz, MW 187-567 metres. Variable tuning. AFC. Stereo decoder fitted. Controls: volume on/off, record level (right channel), record level (left channel), balance, treble, bass, selector 1, selector 2, record on, play tape, stop tape. Output: 10W RMS per channel. FR: 30Hz-35kHz. Output impedance: 8 ohms. HD: < 3%. Matching three-unit speakers. Finish: walnut. Price: Revised prices awaited as this edition of the Year Book closed for press.

**SONY**

Sony (UK) Ltd,  
Pyrene House, Sunbury Cross,  
Sunbury-on-Thames, Middlesex.  
Tel: Sunbury-on-Thames (76) 87644.

**HP511A ★**

AM/FM stereo tuner/amplifier with record deck and separate speakers. Range: FM/VHF, MW. Variable tuning. Stereo decoder fitted. Output: 15W RMS per channel. Output impedance: 8 ohms. FR: 40Hz-50kHz ± 3dB. Record deck: Sony TTS400. Cartridge: VM22GA induced magnet. Finish: wood grain and silver trim. Price: £154 (plus VAT).

**CF610**

AM/FM stereo tuner/amplifier with cassette tape deck and separate speakers. Range: FM 87.5-108MHz, MW 187-566m. 43 transistors, 29 diodes. Variable tuning. AFC. Ratio detector. Stereo decoder fitted. Output: 6W RMS per channel. Output impedance: 8 ohms. FR: (tape) 30Hz-13kHz. HD: 2.5%. Sony cassette tape deck. Black leatherette finish. Price: £112 (plus VAT).

**CF620**

AM/FM stereo tuner/amplifier with cassette tape deck and separate speakers. 43 transistors, 29 diodes. Range: FM 87.5-108MHz, MW 187-566m. Variable tuning. AFC. Ratio detector.

Stereo decoder fitted. Output: 6W RMS per channel. Output impedance: 8 ohms. FR: (tape) 30Hz-13kHz. HD: 2.5%. Sony cassette tape deck. Finish: wood grain. Price: £130 (plus VAT).

#### **HP239A**

AM/FM stereo tuner/amplifier with cassette tape deck and record unit, plus separate speakers. Range: FM 87.5-108MHz, MW. Variable tuning. Ratio detector. Output: 10W RMS per channel. Output impedance: 8 ohms. FR: 40Hz-40kHz±3dB. Sony cassette tape deck. Sony TTS310 record deck. Sony VM10P induced magnet cartridge. Finish: wood grain with black and silver trim. Price: £172.50 (plus VAT).

#### **HP211A**

AM/FM stereo tuner/amplifier with record deck and separate speakers. 28 transistors and 18 diodes. Range: FM/VHF, MW. Variable tuning. Stereo decoder fitted. Output: 10W RMS. Output impedance: 8 ohms. FR: 40Hz-40kHz±3dB. Record unit: Sony TTS310. Cartridge: Sony VX23P ceramic. Finish: wood grain and black and gold panel. Price: £117.50 (plus VAT).

#### **HMK20**

Unit audio system with cassette recorder. Output: 5W RMS per channel. Sensitivity: VHF 2.2µV. S/N: 30dB, MW 48dB/m. Controls: volume, tone, function (AM, FM, phono, cassette) mode monitor, AFC switches. Speaker: 6½in full-range. Turntable: 2 speeds. Ceramic stereo cartridge. One of the HMP 20/HMW 20 family. Price: to be announced.

#### **SQP20**

Unit audio system with four-channel stereo (SQ). Output: 3W RMS per channel. Sensitivity: VHF 2.2µV. S/N 30dB. MW 48dB/m. Controls: volume, tone, system (2ch, 2-4ch, SQ, R-MTX, discrete). Function (AM, FM, phono), mode, tape monitor and AFC switches. Speakers: 6½in full-range×4. Turntable: 2-speeds. Cartridge: MM stereo. One of the HMP/HMW 20 family. Price: to be announced.

#### **■ STEEPLSTONE**

Steeplestone Products Ltd,  
Station Approach, Bicester, Oxon, OX6 7DP.  
Tel: Bicester (086 92) 42031

#### **600**

Complete system comprising FM stereo tuner/amplifier with record deck in cabinet plus two separate speakers. Range: 87.5-108MHz. Five preset stations. Switchable AFC. Ratio detector. Stereo decoder fitted. Controls: volume, balance, treble, bass, treble filter, bass filter, loudness, monitor switch, mono/stereo, speaker switching, headphone switching, AFC on/off. FR: (PU input equalised to RIAA) 40Hz-20kHz,

(radio and tape inputs) 25Hz-25kHz±2dB. HD: <0.1% at 20W output; <0.05% at 5W output. Motor unit: Garrard SP25 Mk IV. Speaker system: enclosures each containing one 8in long-throw bass driver, one 3in mid-range unit, one 2½in tweeter. Finish: teak and brushed aluminium. Price: £199.15 (including VAT).

#### **■ TANDBERG**

Farnell-Tandberg Ltd, Farnell House,  
81 Kirkstall Road, Leeds, LS3 1HR.  
Tel: Leeds (0532) 35111.

#### **TR200 Compact MPX**

FM stereo tuner/amplifier in shelf-mounting cabinet with record deck, plus two separate speakers. Range: 87.5-108MHz. Variable tuning plus six presets. AFC. Phase locked loop discriminator. Centre-zero tuning meter. Usable sensitivity: 1µV (75 ohms coaxial), 2µV 300 ohms balanced. Stereo decoder fitted. Inputs: mag PU 2.3mV 47K, ceramic PU 70mV, tape 250mV 30K, aux 100mV 100K. Noise level: -52dB. Output: 20W RMS per channel into 4 ohms, 15W RMS per channel into 8 ohms. Controls: treble +14dB -15dB at 10kHz, treble loudness +3.5dB at 10kHz, bass ±16dB at 50Hz, bass loudness +11dB at 50Hz. HD: 0.5% (DIN), 1% (IHF). Output impedance: 4 ohms. FR: (linear inputs, DIN) 20Hz-40kHz±3dB. Motor unit: Garrard SP25 Mk III. Three-speeds. Idler wheel drive. Shure M75E cartridge with diamond stylus. Choice of TL12 or TL25 speakers. Price: (teak with TL12 speakers) £223.09 (including VAT); (teak with TL25 speakers) £245.24 (including VAT); (rosewood with TL12 speakers) £233.45 (including VAT); (rosewood with TL25 speakers) £259.12 (including VAT).

#### **■ TELEFUNKEN**

AEG Telefunken (UK) Ltd, Bath Road,  
Slough, SL1 4AW. Tel: Slough (75) 33311.

#### **Hi-fi center 4040**

Radio receiver with 2×40W output. Four wavebands: FM, MW, SW, LW. 'Selecta' button waveband changeover, five FM station buttons. Switchable AFC. Slide controls for volume, treble, bass and balance. Switchable muting stereo indicator and tuning indicator. Headphone socket. Provision for connection of four loudspeakers. Built-in attenuator/pre-amplifier. Record changer, automatic, can also be used as a player. Speeds: 33½, 45, 78rpm. Heavy, balanced turntable 10½in diameter. Weight: 4½lb. Tubular pickup arm with adjustable counterweight. Manual cueing device. Pickup pressure adjusting device. Tinted transparent cover. Cabinet: light matt walnut or black and silver. Dimensions: 17¾×4¾×14½in. Height without cover: 8in. Price: £228 (including VAT).



Ultra Model 6453

### ■ TELUX

Tellux (Sound Productions) Ltd, Tallon Road, Hutton Industrial Estate, Brentwood, Essex. Tel: Brentwood 214708.

#### Audic Fifteen

AM/FM stereo tuner/amplifier in shelf-mounting cabinet with record deck, plus shelf speakers. Provision for fitting stereo decoder. Output: 5W RMS per channel. Price: £35.99 (plus VAT).

#### Audic Twenty

AM/FM stereo tuner/amplifier in shelf-mounting cabinet with record deck, plus two floor-standing speakers. Variable tuning. Plug-in stereo decoder. Output: 8W per channel. Output for tape recorder. Price: £46.50 (plus VAT).

### ■ ULTRA

Thorn Consumer Electronics Ltd, 284 Southbury Road, Enfield, Middlesex. Tel: 01-366 1155.

#### 6453 ★

AM/FM stereo tuner/amplifier in cabinet with record deck, plus two separate speaker systems. 48 transistors, 18 diodes, five ICs. Range: FM 87.5-108MHz. MW 187-571m. Variable tuning plus four preset stations on FM. Switchable AFC. Quadrature detector. Stereo decoder fitted. Controls: tuning, treble, bass, volume (right), volume (left), on/off, loudness, speaker switching, mono/stereo, input selector, waveband selector. Output: 25W RMS per channel. Output impedance: 4 ohms. FR: 25Hz-30kHz +0dB -3dB. HD: <0.1% up to 20W per channel. Motor unit: Garrard SP25 Mk IV with Shure magnetic cartridge. Finish: Bermuda white. Speaker systems: two 5in bass drivers and one 3½in tweeter in each enclosure. Additional pair of speakers available for 4D effect. Price: (complete system) £183.60 (including VAT).

### ■ YAMAHA

Natural Sound Systems Ltd, Strathcona Road, North Wembley, London, HA9 8QL. Tel: 01-904 0141.

#### MC-40

AM/FM stereo tuner/amplifier in cabinet with record deck. Range: FM 88-108MHz, MW 186-560m. Variable tuning. AFC. Stereo decoder fitted. Controls: volume, loudness, mono/stereo, treble, tuning, bass, input selector, balance, mains on/off. Output: 10W RMS per channel. Output impedance: 8 ohms. FR: 20Hz-30kHz ±2dB. HD: 0-15%. Two-speed belt drive Yamaha turntable. CG-5500 magnetic cartridge. Finish: American walnut. Recommended speakers: NS-410, NS-230, NS-250. Price: from £193.51 (plus VAT).

#### MS-3

AM/FM stereo tuner/amplifier in cabinet with record deck. Range: FM 88-108MHz, MW 186-565m. Variable tuning. AFC. Stereo decoder fitted. Controls: volume, treble, bass, balance, acoustic equaliser, loudness, tape monitor, mono/stereo, mains on/off, speaker selector, input selector, tuning. Output: 22W RMS. Output impedance: 8 ohms. FR: 10Hz-30kHz +0 -2dB. HD: 0.05%. Yamaha two-speed belt drive turntable. Yamaha CG-7000 magnetic cartridge. Finish: American walnut. Recommended speakers: NS-250, NS-625, NS-645. Price: from £319.79 (plus VAT).

#### MS-5B

AM/FM stereo tuner/amplifier in cabinet with record deck and cassette recorder. Range: FM 88-108MHz, MW 186-565m. Variable tuning. AFC. Stereo decoder fitted. Controls: cassette tape record/playback, volume, treble, bass, balance, acoustic equaliser, function, loudness, high filter, mic volume, tuning, record level. Output: 22W RMS per channel. Output impedance: 8 ohms. FR: 10Hz-30kHz -0, +2dB. HD: 0.05%. Yamaha two-speed belt drive turntable. Yamaha CG-7000 magnetic cartridge. Finish: American walnut. Recommended speakers: NS-250, NS-625, NS-645. Price: from £379.93 (plus VAT).



# Before you build a Heathkit send away for a free bookful of encouragement.

The new Heathkit catalogue.

In it you'll find the whole range of Heathkit electronic kits. The world's largest range in fact.

Every one of which you can build yourself. Easily. And quickly.

And, if you're not convinced, we're sure a quick glance through our catalogue will soon encourage you to try.

Especially with models like our new AJ-1510A digital FM stereo tuner to choose from. We call it our 'Computer

Tuner' because to select stations you simply tap out the frequency on a key-board. And the AJ-1510A will lock on to the selected station instantly and precisely.

Or how about a 90 watt stereo receiver like the AR-1500A. It'll give you AM, FM, 90 watt music power per channel and an incredibly good frequency response of 5 to 120,000Hz ( $\pm 3\text{dB}$ ).

Or our AR-1214 stereo receiver. Beautifully finished and delivering 20 watts music power per channel, it's the ideal basis for a complete stereo system.

Send us the coupon now and we'll send you your free catalogue. Or, if you're in London or Gloucester, call in and see us. The London Heathkit Centre is at 233 Tottenham Court Road. The Gloucester showroom is next to our factory in Bristol Road.

At either one you can be sure you'll get a lot of encouragement.

Heath (Gloucester) Limited,  
Dept. HFY-5, Bristol Road, Gloucester,  
GL2 6EE. Tel: Gloucester (0452) 29451.



## The new Heathkit catalogue. Out now. FREE.

To: Heath (Gloucester) Limited, Dept HFY-5, Gloucester, GL2 6EE. Please send me my free Heathkit catalogue.

Name \_\_\_\_\_ Address \_\_\_\_\_

Post Code \_\_\_\_\_

Remember easy terms are available with the Heathkit Monthly Budget Plan



# Constructional Kits

★ Indicates entry is illustrated

Abbreviations used in this section are given on page 20.

## ■ RICHARD ALLAN

Richard Allan Radio Ltd, Bradford Road, Gomersal, Cleckheaton, Yorkshire, BD19 4AZ. Tel: Cleckheaton (097 62) 2442. Cables: Acoustics, Bradford.

### Twin Assembly ★

Speaker kit comprising CBF8 bass/mid-range driver and CB4 treble unit. CN54 crossover, BAF wadding, Vynair fret material (with choice of three patterns), foam backing sheet, detailed assembly instructions, fixing screws, terminals, etc. FR: 40Hz-17kHz. HC: 12W RMS. Impedance: 8 or 15 ohms. Recommended cabinet size: 20 × 12 × 9in. Design based on Richard Allan Chaconne series II enclosure. Price: £10.20 (plus VAT).

### Triple-8 Assembly

Speaker kit comprising CF8L bass driver, CF5 mid-range unit, CB4 treble unit, ¼-section printed circuit crossover, BAF wadding, Vynair grille material (with choice of three patterns), foam backing sheet, detailed assembly instructions, fixing screws, terminals, etc. FR: 40Hz-17kHz. HC: 15W RMS. Impedance: 8 or 15 ohms. Recommended cabinet size: 20½ × 13 × 8½in. Design based on Richard Allan Flamenco series II enclosure. Price: £15.50 (plus VAT).

### Triple-12 Assembly

Speaker kit comprising CG12 bass driver, CP8 mid-range unit, CB4 treble unit, ¼-section printed circuit crossover, BAF wadding, Vynair fret material (with choice of three patterns), foam backing sheet, detailed assembly instructions, fixing screws, terminals, etc. FR: 30Hz-17kHz. HC: 20W RMS. Impedance: 8 or 15 ohms. Recommended cabinet size: 25 × 15½ × 12½in. Design based on Richard Allan Pavane series II enclosure. Price: £22.50 (plus VAT).

### Super-12 Assembly

Speaker kit comprising CG12 Super bass driver, CP8 mid-range unit, CB4 treble unit, ½-section crossover network. FR: 30Hz-17kHz. HC: 25W RMS. Impedance: 8 or 15 ohms. Recommended cabinet size: 25 × 15½ × 12½in. Design based on Richard Allan Sardana enclosure. Price: £27 (plus VAT).

## ■ AMTRON

Amtron (UK) Ltd, 4-7 Castle Street, Hastings, Sussex, TN34 3DY. Tel: Hastings 2875.

### UK165

RIAA equalised stereo preamplifier. Input impedance: 47K. Output impedance: 100K. Crosstalk: -70dB at 1kHz. Gain: 40dB at 1kHz. Power supply: 12V DC at 2mA. Four BC108B transistors. Price: £5.71 (including VAT).

### UK167

Stereo preamplifier to RIAA or CCIR standards. Input impedance: 47K. Output impedance: > 15K. Crosstalk: -70dB at 1kHz. Gain: 40dB at 1kHz. Power supply: 6-24V DC at less than 10mA. Three transistors. Price: £7.75 (including VAT).

### UK170

Mono preamplifier with tone controls. Inputs: crystal PU, high impedance, low impedance, aux, all at 100mV. Output: 1V. Tone controls: treble ± 15dB at 10kHz, bass ± 15dB at 50Hz. Power supply: 10.5V DC. Three BC108B transistors. Price: £19.01 (including VAT).

### UK175

Stereo preamplifier with tone controls. Inputs: crystal PU, high impedance, low impedance, aux, all at 100mV. Output: 1V per channel. Tone controls: treble ± 15dB at 10kHz, bass ± 15dB at 50Hz. Volume control for each channel. Slider controls. Power supply: 10.5V



Richard Allan Twin Assembly

★ Indicates entry is illustrated

DC. Six BC108B transistors. Price: £25.13 (including VAT).

#### UK275

Microphone preamplifier. Input impedance: 10K. Output impedance: 1.5K. Gain: 30dB at 1kHz. Two transistors. Power supply: 9V DC at 5mA. Very low noise level. Price: £6.42 (including VAT).

#### UK270

Integrated mono amplifier. Inputs: 200mV 150K, 230mV 220K. Output: 6W peak. Output impedance: 8 ohms. FR: 50Hz-15kHz. Power supply: 15V DC. Price: £6.92 (including VAT).

#### UK160

Integrated mono amplifier. Inputs: crystal PU 300mV, aux 80mV. Output: 8W peak. Output impedance: 5 ohms. One IC and two transistors. FR: 30Hz-25kHz. Power supply: 12-15V DC. Price: £9.46 (including VAT).

#### UK115

Mono power amplifier. Input: 2mV. Output: 8W peak. FR: 20Hz-20kHz. Output impedance: 8 ohms. Five transistors. Power supply: 18V DC. Price: £3.16 (including VAT).

#### UK120

Mono power amplifier. Input: 2mV. Output: 12W peak. FR: 20Hz-20kHz. Output impedance: 8 ohms. Five transistors. Power supply: 24V DC. Price: £4.27 (including VAT).

#### UK130

Mono control unit. Controls: volume, treble  $\pm 10$ dB at 10kHz, bass  $\pm 10$ dB at 100Hz. Passive system. Price: £3.88 (including VAT).

#### UK125

Stereo control unit. Designed for use with the UK115 and UK126 amplifiers. Controls: volume, balance, bass  $\pm 10$ dB at 100Hz, treble  $\pm 10$ dB at 10kHz. Passive system. Price: £4.62 (including VAT).

#### UK190

Mono power amplifier with slider volume control and on/off switch. Input: 1V at 1K. Output: (5% distortion) 50W peak, (1% distortion) 40W peak. FR: 10Hz-10kHz  $\pm 2$ dB. Output impedance: 4 ohms. Five transistors, four diodes. Power supply: 55V DC. Price: £25.06 (including VAT).

#### UK110/A

Integrated stereo amplifier. Input: 400mV. Output: 5W peak per channel. Output impedance: 4 ohms. Four transistors. Power supply: 12-15V DC. Price: £11.05 (including VAT).

#### UK535/C

Integrated stereo amplifier. Inputs: crystal PU 250mV 1M, aux 250mV 47K. Output: 7W peak per channel. Output impedance: 8 ohms. HD: 0.5%. FR: 20Hz-20kHz  $\pm 1$ dB. Tone controls:

bass  $\pm 10$ dB, treble  $\pm 10$ dB. Mains: 110, 125, 140, 160, 220V AC. 10 transistors, two diodes. Price: £23.47 (including VAT).

#### UK185

Integrated stereo amplifier with slider controls. Inputs: crystal PU 250mV 1M, mag PU 4mV 47K, aux 250mV 47K. Output: 20W RMS per channel. HD: 0.5%. FR: 20Hz-20kHz  $\pm 1$ dB. Tone controls: bass  $\pm 20$ dB, treble  $\pm 20$ dB. S/N: 70dB. Output impedance: 4 ohms. Mains: 110, 125, 220, 240V AC. 15 transistors, two diodes, three zeners, one bridge rectifier. Pushbutton input selector. Price: £54.91 (including VAT).

#### UK187

Integrated stereo amplifier with provision for two rear speakers. Inputs: mag PU 3mV 47K, aux 70mV 100K, line 70mV 100K. Output: 20W RMS per channel at 1% distortion. FR: 10Hz-30kHz+0dB -3dB. Output impedance: 4 ohms. Signal-to-noise: 80dB. Tone controls: bass  $\pm 15$ dB at 100Hz, treble  $\pm 15$ dB at 10kHz. Mains: 117, 125, 220, 240V AC 50Hz. 26 transistors, four zeners, two diodes, one bridge rectifier. Slider controls. Pushbutton input selectors. Price: £87.85 (including VAT).

#### UK192

Stereo power amplifier. Input: 1V at 1K. Output: (5% distortion) 50W per channel, (1% distortion) 40W per channel. FR: 10Hz-100kHz  $\pm 2$ dB. Output impedance: 4 ohms. Separate slider volume controls. Power supply: 55V +55V DC. 10 transistors, eight diodes. Price: £41.96 (including VAT).

#### UK180

Four channel decoder unit. Inputs: (2) 4-8 ohms at up to 12W. Outputs: (4) 4-8 ohms. Operating modes: normal stereo, four-channel stereo, four-channel reverse stereo. Independent level adjustment for front and rear speakers. Provides depth and reverberation effects. Price: £23.98 (including VAT).

#### UK805

Three-way crossover filter. 6dB/octave. HC: 25W nominal. Impedance: 8 ohms. Price: £4.36 (including VAT).

#### UK800

Three-way crossover filter. 12dB/octave. HC: 25W nominal. Impedance: 8 ohms. Price: £6.34 (including VAT).

#### UK765

Permits three pairs of stereo phones to be connected to the output of a stereo amplifier. Price: £3.14 (including VAT).

#### UK890

Two-channel mixer with slider controls. Inputs: 470K, 10K. Output impedance: approximately 2K. Price: £4.71 (including VAT).

**UK710/C**

Four-channel active mixer. Inputs: (2) 2mV at 200K, (2) 300mV at 1M. Individual gain controls. Output impedance: 10K. Power supply: 9V DC at 4mA. Four transistors. Price: £9.42 (including VAT).

**CLARK SPEAKERS**

122 Hull Road, Anlaby, Hull, HU10 6UV  
Tel: Hull (0482) 656706.

**System A1/1**

Transmission line enclosure with units and crossover. One Richard Allan CF8 8in bass/mid-range driver, one Peerless MT25 2½in tweeter. HC: 10W RMS. Impedance: 8 ohms. FR: 25Hz-20kHz. Crossover: 3kHz ¼-section two-element. Size: 30¾ × 18 × 15in. Finish: teak or mahogany. Also available with extension shelf unit to left or right to accommodate equipment, records, etc. Also available in kit form for home assembly. Full details and prices on request. Price: (kit) £26.50 (including VAT); (ready assembled) £32.32 (including VAT).

**System A1/1 (KEF)**

Similar to A1/1 above but fitted with KEF B200 bass driver. HC: 25W RMS. Price: (kit) £28 (including VAT); (ready assembled) £33.82 (including VAT).

**System A1/2**

Transmission line enclosure with units and crossover. One Richard Allan CF8 8in bass driver, one Fane 501 5in mid-range unit, one Peerless MT25 2½in tweeter. HC: 15W RMS. Impedance: 8 ohms. FR: 25Hz-20kHz. Crossover: 500Hz and 3.5kHz, ½-section nine element crossover. Size: 35 × 18 × 15in. Finish: teak or mahogany. Also available with shelf unit to left or right to accommodate equipment, records, etc. Also available in kit form for home assembly. Full details and prices on request. Price: (kit) £39.94 (including VAT); (ready assembled) £46.76 (including VAT).

**System A1/2 (KEF)**

Similar to A1/2 above but fitted with KEF B200 bass driver. HC: 25W RMS. Price: (kit) £41.44 (including VAT); (ready assembled) £48.26 (including VAT).

**CONNOISSEUR**

A. R. Sugden & Co (Engineers) Ltd,  
Connoisseur Works, Atlas Mill Road,  
Brighouse, Yorks, HD6 1ES.  
Tel: Brighouse (048 47) 2142.  
Cables: Connoisseur, Yorkshire.

**BD1 Turntable kit**

Description and specification as for BD1 motor unit. (See Record Decks section.) Easy one-hour assembly. No soldering. Price: £13.50 (plus VAT).

**EATON AUDIO FITMENTS**

Leopold Street, Long Eaton, Nottingham,  
NG10 4QF. Tel: Long Eaton (060 76) 2662/2818.

**Wharfedale Unit 3 cabinet kit**

Made to Wharfedale specification from ½in material accurately machined for simplicity of assembly, with the main parts veneered (unpolished) in teak, mahogany and walnut. All kits are complete with screws for fixing the back, bolts for fixing fret panel, and fret material. Baffle holes are cut and cabinets veneered all four sides. Size: 11½ × 21 × 9½in. Price: £6.20.

**Wharfedale Unit 4 cabinet kit**

Made to Wharfedale specification from 17mm material accurately machined for ease of assembly. Main parts veneered (unpolished). All kits complete with screws, bolts and fret material. Finish: teak veneer. Largest size recommended: 24 × 14 × 12in. Price: £8.65.

**Wharfedale Unit 5 cabinet kit**

Details as Unit 4 cabinet kit except size 29 × 17 × 11¼in. Finish: teak. Price: £10.50.

**Wharfedale Pipe kits**

Column cabinets using specially designed filter and absorbent pads of bonded acetate fibre. Designed for a single full range 8in speaker (rec Super 8/RS/DD). FR: 40Hz-20kHz. Suitable for 8 or 15 ohm amplifiers; other impedances by matching transformer WMT1. Dimensions: 3ft high by 1in diameter. Power handling capacity: 6W RMS. Price on application.

**Eaton Plain Chipboard kits**

Designed for enthusiasts working on low budgets. Up to one cubic foot made from 12mm high-density chipboard, all other sizes made from 18mm high-density chipboard. Main joints fit together to form airtight joints without use of screws or nails. Building time under one hour. All kits based on designs by leading speaker manufacturers. Each kit comprises: top, bottom, two sides, baffle (with holes cut to suit speaker), back, battens for fixing back, screws/nails as necessary. No internal damping or fret material is provided. **U4/F2/E** large enclosure for Wharfedale Unit 4 (24¼ × 14½ × 11½in) £5.82; **U5/J2/E** large enclosure for Wharfedale Unit 5 (29 × 17 × 11½in) £7.24. **AXM/8/ES** small enclosure for Goodmans Twinaxiom 8 (19½ × 10¾ × 9¼in); **AXM/8/EL** large enclosure for Goodmans Twinaxiom 8 (24½ × 13½ × 12½in); **AXM/10/ES** small enclosure for Goodmans Twinaxiom 10 (19¾ × 12¼ × 9¼in); **AXM/10/EL** large enclosure for Goodmans Twinaxiom 10 (24 × 17 × 13in); **350/E** enclosure for EMI 13 × 8in unit (21½ × 15 × 9¾in); **1/C/E** one cubic foot reflex enclosure for Wharfedale 8in (24 × 11 × 9in). All the enclosures



Goodmans DIN 20 Kit

(except 1/C/E) are infinite baffle. Material is plain unveneered chipboard as specified. Other prices: on application. Prices are all ex-works, tax paid. Add 85p carriage for one kit, £1.50 for two kits.

#### ■ EMI

EMI Sound & Vision, EMI Pathé Division, 252 Blyth Road, Hayes, Middlesex, UB3 1HW. Tel: 01-573 3888. Telex: 22417.

#### LEK 175/8

Speaker kit comprising 8 × 5in full range driver, teak cabinet, glue, full instructions and all accessories. Price: on application.

#### LEK 275/8

Speaker kit comprising 8in bass/mid-range driver, 3½in tweeter, crossover network, teak cabinet, glue, full instructions and all accessories. Price: on application.

#### LEK 575/8

Speaker kit comprising 13 × 8in bass driver, 8 × 5in mid-range/HF unit, crossover network, teak cabinet, glue, full instructions and all accessories. Price: on application.

#### ■ FALCON ELECTRONICS

Components Division, 33 Station Road, Bexhill-on-Sea, Sussex. Tel: Bexhill (0424) 211908.

Speaker crossover components, BAF wadding, acoustically transparent micro-porous foam, constant impedance 'L' pads, grille fabrics, etc. See Speaker Accessories Section for further details.

Kits of network components for articles in the various Hi-Fi Magazines including:



Heathkit AR-1500

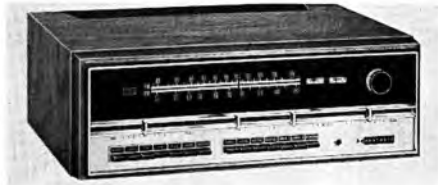

Heathkit AR-1302

1. *Hi-Fi Answers*. August 1973. Monitor Loudspeaker, C. Rogers.
2. *Popular Hi-Fi*, December 1972, April 1973. Mini Monitor, M. Colloms.
3. *Hi-Fi News*. February 1974. No compromise loudspeaker, L. R. Frisby.

#### ■ GOODMAN'S LOUDSPEAKERS LTD

Downley Road, Havant, Hampshire, PO9 2NL. Tel: Havant (070 12) 6344. Telex: 86296.

#### DIN 20 Kit ★

A complete kit of parts (except timber) for building a two-unit reflex speaker system. Comprehensive instructions including exploded diagrams. No soldering necessary. One 8in bass driver, one 1in dome tweeter. Crossover: 4kHz. Interior volume: 22 litres. FR: 45Hz-22kHz (DIN 45 500). HC: 20W (DIN). Impedance: 4 ohms. Connections: DIN plug and cable. Size: 19 × 10½ × 9½in. Price: £10.43 (plus VAT).

#### Mezzo Twin

Loudspeaker parts kit. No details available at time of going to press.

#### ■ HEATHKIT

Heath (Gloucester) Ltd, Bristol Road, Gloucester, GL2 6EE. Tel: Gloucester (0452) 29451.

#### AR-1500 ★

AM/FM stereo receiver. Range: FM 88-108MHz, MW 185-560m. Sensitivity: FM 1.8µV, AM 50µV. Aerial input: 75 ohms coaxial and 300 ohms balanced. Built-in ferrite rod for MW. Stereo decoder fitted. Tuning meter. Stereo beacon. Variable tuning. Pushbutton waveband selectors. Output: 60W sine wave into 8 ohms per channel. HD: < 2%. H and N:

-40dB. Inputs: mag PU 1.8mV, tape 140mV, aux 140mV. Two AC outlet sockets. Size:  $18\frac{1}{2} \times 5\frac{1}{8} \times 13\frac{7}{8}$ in. Mains: 120 or 240V 50-60Hz. Price: (kit) £179.30, (cabinet) £13.20.

**AR-1302 ★**

AM/FM stereo receiver. Range: FM 88-108 MHz, MW 185-560m. Sensitivity: FM 1.9µV, MW 300µV. Aerial input: 75 ohms coaxial and 300 ohms balanced. Built-in ferrite rod for MW. Stereo decoder fitted. Stereo beacon. Tuning meter. Inputs: mag PU 2.4mV, tape and aux 180mV. Variable tuning. Slider controls for bass, treble, balance and volume. Pushbuttons for waveband selection, mode and speakers. Output: 20W per channel sine wave into 8 ohms. Two AC outlet sockets. Mains: 120 or 240V 50-60Hz. Size:  $16\frac{3}{4} \times 5\frac{1}{8} \times 14\frac{1}{2}$ in. Price: (kit) £127.60.

**AR-1214 ★**

AM/FM stereo receiver. Range: FM 88-108MHz, MW 185-560m. Sensitivity: FM 2µV, AM 100µV. Aerial input: 75 ohms coaxial or 300 ohms balanced. Built-in ferrite rod for MW. Stereo decoder fitted. Stereo beacon. Variable tuning. Pushbutton waveband and mode selection. Output: 15W per channel sine wave into 8 ohms. Inputs: mag PU 2mV, tape 190mV. Two AC outlet sockets. Mains: 120 or 240V 50-60Hz. Size:  $17 \times 3\frac{7}{8} \times 13$ in. Price: (kit) £74.80.

**AR-2000**

Multi-waveband AM/FM stereo receiver. Range: 88-108MHz, MW 185-560m, LW 860-2000m, SW 26-52m. Variable tuning. Aerial input: 75 ohms coaxial and 300 ohms balanced. Sensitivity: FM 2µV, SW 15µV, MW 25µV, LW 50µV. Input: mag PU 2.8mV, crystal PU 200mV, tape 200mV. Output: 20W sine wave per channel into 8 ohms. HD: <0.25% at 20W. FR: 10Hz-30kHz  $\pm 1$ dB. Output impedance: 4-16 ohms. Tape outlet socket: 1V adjustable at 100K. Treble control: +14dB -16dB at 20kHz, bass control +16dB -20dB at 20Hz. Mains: 110, 130, 220-230, 240-250V AC. Size:  $24\frac{5}{8} \times 4\frac{1}{2} \times 11\frac{1}{8}$ in. Finish: walnut or teak. Price: (kit) £96.80, (cabinet) £7.70.

**AR14**

FM stereo receiver. Range: 88-108MHz. Variable tuning. Aerial input: 300 ohms balanced. Stereo decoder fitted. Output: 10W sine wave per channel. Output impedance: 4-16 ohms. 31 transistors, 10 diodes. FR: 12Hz-60kHz  $\pm 1$ dB. Inputs: mag PU 4.5mV, aux 300mV. HD: 0.5% or less at 1kHz. Controls: input selector, treble, bass, volume, phase, tuning. Mains: 120-240V AC. Size:  $15\frac{1}{4} \times 3\frac{7}{8} \times 12$ in. Finish: walnut or teak. Price: (kit) £49.94.



Heathkit AS-9560, AS-9520, AS-9515, AS-9530



Heathkit AR-1214

**AA-1214**

Stereo integrated amplifier. Specification the same as amplifier section of AR-1214. Size:  $12\frac{3}{4} \times 3\frac{7}{8} \times 12$ in. Finish: teak or walnut end panels. Price: (kit) £39.60.

**AJ-1214**

AM/FM stereo tuner. Specification the same as tuner section of AR-1214. Output: AM 0-6V nominal, FM 1V nominal. Size:  $12\frac{3}{4} \times 3\frac{7}{8} \times 13$ in. Finish: teak or walnut end panels. Price: (kit) £44.

**AS-9560 ★**

Speaker system with units HC: 60W RMS. FR: 25Hz-27kHz. Crossover: 650Hz and 5kHz. Infinite baffle. Impedance: 8 ohms. Finish: teak or walnut. Size:  $32 \times 16 \times 12$ in. Weight: 60lb. Price: (kit) £59.40.

**AS-9530 ★**

Infinite baffle enclosure with units KEF B139 13  $\times$  9  $\frac{1}{2}$ in bass driver, KEF B110 5  $\frac{1}{2}$ in mid-range unit, KEF T27 dome tweeter. Crossover: 600Hz and 3kHz. Impedance: 8 ohms. HC: 30W RMS. FR: 30Hz-27kHz. Size:  $26 \times 16 \times 12$ in. Weight: 32lb. Finish: teak or walnut. Price: (kit) £44.

**AS-9520 ★**

Infinite baffle enclosure with units KEF B200 bass driver, KEF T15 mid-range and HF unit HC: 20W RMS. FR: 35Hz-20kHz. Impedance: 8 ohms. Crossover: 3kHz. Size:  $20 \times 12 \times 10$ in. Weight: 23lb. Finish: teak or walnut. Price: (kit) £29.70.

★ Indicates entry is illustrated

#### AS-9515 ★

Infinite baffle enclosure with units. One full-range Peerless E396M elliptical driver. HC: 15W RMS. FR: 50Hz-16kHz. Impedance: 8 ohms. Size: 7 × 12 × 6in. Finish: teak or walnut. Weight: 6lb. Price: (kit) £12.10.

#### AV-3U

Audio valve millivoltmeter. Measures voltages as low as 1mV to a maximum of 300V at high impedances in 10 ranges. Frequency range 10-400,000Hz. Uses a 4½in meter. Cathode follower output. Price (kit): £21. Carriage extra.

#### AW-1U

Audio wattmeter. Uses external loads or the following internal loads: 3, 8, 15 and 600 ohms. 5 power ranges from 0.5mW to 50 watts. 4½in meter calibrated in watts and dB. Price (kit): £25. Carriage extra.

#### AO-1U

Inexpensive audio generator covering 20Hz-150kHz sine wave, 20Hz-25kHz square wave. Output up to 10V RMS sine wave or 80V peak-to-peak square wave. Size: 9½ × 6½ × 5in. Price (kit): £16.50. Carriage extra.

#### IM-58U

Low-priced audio distortion meter. Simple to use. Measures distortion at frequencies between 20Hz and 20kHz. Size: 13 × 7 × 8½in. Price (kit): £33.50. Carriage extra.

#### AG-9U

Audio signal generator. Range: 10Hz-100kHz. Distortion less than 0.1% from 20Hz-20kHz. Decade switching over 8 voltage ranges from 3mV-10V monitored. Uses 4½in meter. Price (kit): £31. Carriage extra.

#### IM-18E

Valve voltmeter kit. Printed circuit. Measures AC volts 0.1-5, 5, 15, 50, 150, 500, 1500 RMS. AC volts 0.4, 14, 40, 140, 400, 1400, 4000 peak-to-peak, DC volts 0.1-5, 5, 15, 50, 150, 500, 1500. Ohms (with 10 ohms centre) × 1, 10, 100, 1000, 10K, 100K, 1M, 0.1ohms to 1000M with internal battery. Input resistance: 11M, 200µA meter movement. Price (kit): £17.50. Carriage extra.

#### IM-28U

Laboratory valve-voltmeter kit. Printed circuit. Gimballed mounting, for viewing from any angle. Measures AC volts 0.1-5, 5, 15, 50, 150, 500, 1500 RMS; AC volts 0.4, 14, 140, 400, 1400, 4000 peak-to-peak. DC volts 0.1-5, 5, 15, 50, 150, 500, 1500. Ohms (with 10 ohms centre) × 1, × 10, × 100, × 1000, 10K, 100K, 1M. 0.1 ohms to 1000M with internal battery. Input resistance: 11M. 200µA meter movement. Price (kit): £29.70. Carriage extra.

#### OS-2

Service oscilloscope. 2½in tube. Vertical band-



Helme Cabinet Kit (speakers)

width 2Hz-3MHz. Automatic lock-in sync. Mu-metal CRT shield. Printed circuit. Switched ext/int Y plate connections. Vertical amplifier: sensitivity 100mV/cm, input impedance: 3-3M shunted by 20pF, response 2Hz-3MHz ± 3dB. Horizontal amplifier: sensitivity 100mV/cm, input impedance: 10M shunted by 20pF, response 2Hz-3MHz. Time base: 20Hz-200kHz in four steps. Size: 5 × 7½ × 12in. Weight: 9¼lb. Price (kit): £34.65. Carriage extra.

#### IO-18U

General purpose oscilloscope kit. 5in flat face CR tube. Printed circuits. Vertical band-width 3Hz-4.5MHz. Built-in 1V calibrator, Y-sensitivity 10mV RMS per cm at 1kHz. X-sensitivity 50mV RMS per cm at 1kHz. Price: (kit): £46.75. Carriage extra.

#### IG-18

Sine-square wave generator. Sine wave output: 1Hz-100kHz. Square wave output: 5Hz-100kHz. Frequency accuracy: ± 5%. Sine wave in eight ranges, square wave in three ranges. Output meter: two voltage scales and one dB scale. Distortion: < 0.1% 10Hz-20kHz. Mains: 105-125V or 210-250V AC. Size: 13¼ × 5½ × 7in. Weight: 7lb. Price: (kit) £46.75, (assembled) £64.45.

#### ■ HELME

Helme Audio Products Ltd, Summerbridge, Harrogate, HG3 4DR, Yorks. Tel: Darley (042 372) 279.

#### Range of easy-to-assemble speaker enclosures for the home constructor ★

Each kit comprises fully finished and polished outer shell (veneered natural teak), set of

terminals, wire, uncut baffle, brown Vynair covering. All nuts, bolts and screws are included, also BAF wadding for inside cabinet.

All cabinets are infinite baffle type. Speaker units are not specified but internal volume of cabinet will provide guide together with speaker unit literature and data.

Helme cabinet kits include:

#### RV10

Size: 14 × 9 × 7in. Volume: 10 litres. Price: from £9 (plus VAT).

#### RV16

Size: 18 × 10 × 9in. Volume: 16 litres. Price: from £10.30 (plus VAT).

#### RV20

Size: 20 × 11 × 9in. Volume: 20 litres. Price: from £13.60 (plus VAT).

#### RV30

Size: 22½ × 12½ × 10in. Volume: 30 litres. Price: from £14.20 (plus VAT).

#### RV50

Size: 26¾ × 15 × 10¾in. Volume: 50 litres. Price: from £23 (plus VAT).

#### XLK-25 ★

Comprises low-resonance bass driver and 3in square tweeter with aluminium cone. Half-section crossover. Price: (per pair) £23.17 (including VAT).

#### XLK-50

Comprises 13 × 8in bass driver with Bextrene cone and 3in square tweeter with aluminium cone. Half-section crossover. Price: (per pair) £42.18 (including VAT).

Ready-made versions of the XLK-25 and XLK-50, also matching cabinets, are available. Full details and prices on request.

#### ■ IMPEX

F.I.R. McArdle Ltd, 15 Queen Street, Newcastle upon Tyne, NE1 3UG.

#### MS7

Stereo magnetic pickup preamplifier. Input: 3mV 47K. Output: 100mV 470 ohms at 1kHz. HD: <0.03% at 100mV output. Overload margin: >28dB. S/N ratio: >60dB. Power supply needed: 50V DC at 7mA. Price: (printed circuit boards) 60p; (complete set of transistors, resistors, capacitors and printed board—Part A) £3.49; (Case including spacers, screws, etc—Part B) £1.48; (phono sockets, DIN plugs and jack plugs with cable—Part C) £1.28. Posting and packing (UK): 13p per order. All prices exclude VAT.

#### MS24

Similar specification but designed to operate from supply of 22-25V DC at 6-7.5mA.

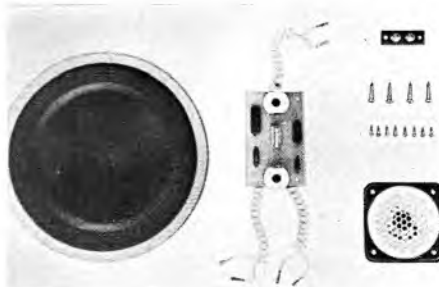

Helme XLK-25

#### ■ KEF ELECTRONICS LTD

Tovil, Maidstone, Kent, ME15 6QP  
Tel: Maidstone (0622) 57258. Cables: KEF, Maidstone.

#### Kefkit 2

B139 and T15 drive units supplied mounted on 22½ × 13½ × 4in baffle. Complete with grille fabric, mounting bolts, BAF padding, speaker terminals and full mounting instructions. HC: 25W. FR: 35Hz-35kHz. Impedance: 8 ohms. Price: £25 (plus VAT).

#### Kefkit 3

B139, B110 and T27 units supplied mounted on 28 × 14 × 10½in baffle. Complete with grille fabric, mounting bolts, BAF padding, speaker terminals and full mounting instructions. HC: 30W. FR: 30Hz-30kHz. Impedance: 8 ohms. Price: £36 (plus VAT).

#### KEF Components

BAF wadding (5yds 12 × 1in) £1.20; terminal panels (pair) 17p; 0.25mH inductor (per pair) 58p; 0.6mH inductor (per pair) 70p; 1mH inductor (per pair) 76p; 2mH inductor (per pair) 80p; 5mH inductor (per pair) £1.05; 4mfd 50V capacitor (per pair) 38p; 6mfd 50V capacitor (per pair) 38p; 8mfd 50V capacitor (per pair) 48p; 60mfd 50V capacitor (per pair) 68p; 80mfd 50V capacitor (per pair) 78p. All prices exclude VAT which must be added.

See Speaker Accessories Section for details of KEF crossover networks.

#### ■ MAC

Modular Audio Components Ltd,  
Canterbury Road, Nottingham, NG8 1PQ.  
Tel: Nottingham (0602) 862 647.

#### AAU-K

Audio adaptor unit kit enables dealers and enthusiasts to build their own particular switching circuits. Complete chassis includes sub-panel with 20 wiring pins, rear panel with 4 phono sockets, or with 5-pin DIN socket



★ Indicates entry is illustrated

(AAU-KD). 3-way switch position engraved on fascia. Price: £3.15 (plus VAT).

## ■ PEERLESS

Distributor: Helme Audio Products Ltd, Summerbridge, Harrogate, HG3 4DR, Yorks. Tel: Darley (042 372) 279.

Peerless speaker kits are of 8 ohms impedance. A range of crossover networks is available ready wired and assembled on printed circuit boards.

All kits are complete with crossover network or components.

### 2-8 kit

6½in bass and 2½in HF units. HC: 10W. FR: 50Hz-18kHz. Crossover: 4kHz. Price: £16.82 per pair (plus VAT).

### 10-2 kit

6½in bass driver with rubber roll surround, 2½in tweeter. Crossover: 2.5kHz. HC: 15W RMS. FR: 45Hz-18kHz. Price: £24.55 per pair (plus VAT).

### 3-15 kit

8in bass, 5in mid-range and 2in tweeter. HC: 15W. FR: 45Hz-18kHz. Crossover: 750Hz and 4kHz. Price: £31.36 per pair (plus VAT).

### 4-30/12 kit

12in bass, 7×5in mid-range and two 2½in tweeters. HC: 40W. FR: 30Hz-18kHz. Crossover: 500Hz and 3.5kHz. Price: £78.18 per pair (plus VAT).

### 20-2 kit

8in bass driver, 2½in HF unit. HC: 40W. FR: 40Hz-20kHz. Crossover: 2.5kHz. Price: £30.91 per pair (plus VAT).

### 20-3 kit ★

8in bass driver, 5in mid-range unit, 2½in tweeter. HC: 40W. FR: 40Hz-20kHz. Crossover: 1.5kHz, 6kHz. Price: £45.45 per pair (plus VAT).

### 50-4

12in bass driver, 7×5in mid-range unit, two 2½in tweeters. HC: 40W. FR: 30Hz-18kHz. Crossover: 500Hz and 3.5kHz. Price: £68.18 per pair (plus VAT).

## ■ SINCLAIR

Sinclair Radionics Ltd, London Road, St Ives, Huntingdonshire, PE17 4HJ. Tel: St Ives (0480) 4311.

### Sinclair Z-50

Transistorised mono-amplifier module. 11 transistors. Incorporates transient overload protection. Otherwise similar specification to the Z-30. Output: 40W RMS into 3-4 ohms. 30W RMS into 8 ohms. Price: £5.48 (plus VAT).

### Power supply units

(PZ-5) 30V unswitched. Suitable for two Z30



Peerless 20-3 Kit

and Stereo 60. Price: £5.49 (including VAT). (PZ-6) 35V stabilised. Suitable for two Z-30 and Stereo 60 when low efficiency speakers used. Price: £8.77 (including VAT). (PZ-8) 45V for use with Z-50 amplifiers. Price: (less mains transformer) £8.77 (including VAT).

PZ-8 power supply unit features re-entrant current limiting and is completely short-circuit proof. Price: £8.77 (including VAT).

## ■ TATE

Tate Audio Transmission Equipment Ltd, 5-7 Covent Garden, Cambridge, CB1 2HS. Tel: Cambridge (0223) 67873.

Three SQ four-channel decoders in module form and with easy to assemble cabinet kit. Specification (Models 2, 4 and 6) input impedance: 40K, output impedance: 300 ohms, phase shift network, linearity 20Hz-18kHz±2dB, unity gain, FR: 5Hz-100kHz±3dB, input level 250 mV, HD: 0.025%, clipping point 2.5V RMS, front separation better than 60dB, rear separation better than 20dB. Power supply: (Model 2) 18-30V DC at 11mA; (other models) 220-240V AC at 3W.

### Tate 2

High definition SQ quadraphonic decoder module. Price: £12.95 (plus VAT).

### Tate 3

IC based SQ quadraphonic decoder module with integrated power supply, switching, master volume and blend control. Price: £16.95 (plus VAT).

### Tate 4 ★

High definition SQ quadraphonic decoder module featuring wide-band matrix decoding circuit with integrated power supply, switching, master gain and rear level control. Price: £21.95 (plus VAT).

### Tate 6

High definition SQ quadraphonic decoder module with easy-to-assemble cabinet kit. In-

cludes integrated power supply, switching, master gain and rear level control. Price: £29.95 (plus VAT).

■ VALEK LTD

Lark Street, Darwen, Lancs, BB3 2LT.  
Tel: Darwen (0254) 71881.

**Turntable kits**

Kits of parts for home assembly of record turntable units. Full details and prices on request.

■ VERO

Vero Electronics Ltd, Industrial Estate, Chandler's Ford, Eastleigh, Hants, SO5 3ZR.  
Tel: Chandler's Ford (042 15) 2952.  
Telex: 47551.

**Audio Equipment Cases ★**

Wide range of equipment cases suitable for hi-fi units, tuners, power supplies and test gear. Available in various panel heights and with or

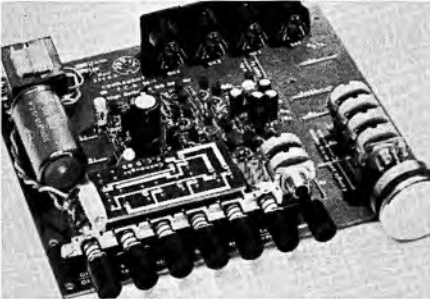

Take 4

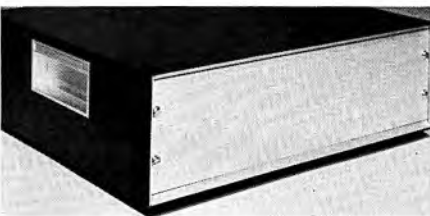

Vero Type D case

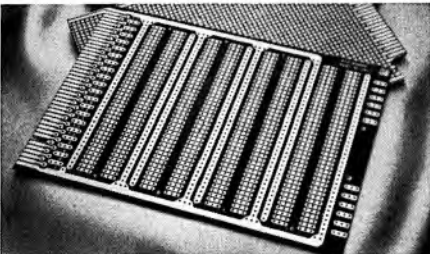

Vero printed boards

without anodised aluminium front handles. Made in light gauge steel finished in RAF blue/grey vinyl paint. Integral aluminium trim. Neat slim-line appearance. Ventilation slots incorporated. Full list of sizes, accessories and prices, available on request. Ask for Vero 'D' series cases.

**Printed circuit boards ★**

Vero circuit boards comprise resin-bonded paper laminate clad on one side with 1oz copper foil of nominal thickness 1.5mm. Base material cut to width and punched with a matrix of holes. Copper foil is in parallel strips along the lines of holes. Enables small electronic assemblies to be built easily and quickly. Vero boards are produced in various sizes, also double-sided, in strips, with plug-in terminations, edge-connectors, breadboards and in plain non-coppered versions. Accessories include connector contacts, D-I-P sockets, terminal pins, pin insertion tool, spot face cutter and numerous design-aid sheets. Catalogue on request.

■ WHARFEDALE

Rank Radio International Ltd, PO Box 596, Power Road, Chiswick, London, W4 5PW.  
Tel: 01-994 6491.

**Linton 2 Kit**

Two-speaker kit comprising 8in bass driver and 2in mid-range/treble unit. Based on the Wharfedale Linton 2-speaker system. Impedance: 6 ohms nominal. Crossover: 1.2kHz. FR: 55Hz-18kHz or 70Hz-18kHz depending on enclosure size. HC: 20W DIN. Size of enclosure recommended: 21 x 11½ x 9½ in or 14 x 9¾ x 8¾ in. Enclosures not included. Full constructional details supplied. Price: (per pair) £25.20 (including VAT).

**Glendale 3 Kit**

Three-speaker kit comprising 10in bass driver, 4in mid-range unit and 1in tweeter. Impedance: 6 ohms nominal. Crossover: 800Hz and 5kHz. FR: 50Hz-22kHz or 45Hz-22kHz depending on enclosure size. HC: 30W DIN. Size of enclosure recommended: 24 x 14 x 12in or 22¼ x 12 x 10½ in. Enclosures not included. Full constructional details supplied. Price: (per pair) £46.02 (including VAT).

**Dovedale 3 Kit**

Three-speaker kit comprising 12in bass driver, 5in mid-range unit and 1in tweeter. Impedance: 6 ohms nominal. Crossover: 600Hz and 5kHz. FR: 40Hz-22kHz or 35Hz-22kHz depending on size of enclosure. HC: 50W DIN. Size of enclosure recommended: 29¼ x 16¾ x 11¼ in or 24 x 14 x 12in. Enclosures not included. Full constructional details supplied. Price: (per pair) £71.22 (including VAT).

# SOMETHING OLD SOMETHING NEW

And the blend is superb. . . .

We specialise in combining high quality sound equipment with antique or modern furniture. Our selection of antique commodes, chests and cupboards has been carefully chosen to be ideal for housing high fidelity equipment, or we will help you select the best sound system to fit your own cabinet and expertly install it. Write, phone or visit our showrooms for further details.

**h**  
**HI**  
**FI**

## Hampstead High Fidelity

91 Heath Street, Hampstead, London N.W.3 6SS

Tel: 01-435 0999/6377



# Hi Fi Cabinets

★ Indicates entry is illustrated  
Abbreviations used in this section are given on page 20.

## ■ ABSTRACTA

Abstracta Construction Ltd, Unit C,  
Staples Corner Trading Estate, Edgware Road,  
Cricklewood, London, NW2.  
Tel: 01-450 2511.

### Home Frames

A range of slim-line chromium-plated steel tubular frameworks with white melamine faced shelves to accommodate hi-fi equipment. Twelve suggested layouts for audio storage, including space for records, tapes and books. Can be adapted for most types and makes of equipment. Sizes range from 33in to 71in and system can be extended as required. Supplied in flat packs for easy assembly. Additional shelves can be added if needed. Home Frames hi-fi leaflet available on request from makers. Prices: from about £9.96 to £64.16 for complete systems, additional shelves extra.

## ■ A/R/D

Audio Research and Development Ltd,  
PO Box 73, Hounslow, Middlesex, TW3 1RD.  
Tel: 01-570 0471.

### 2000

Contemporary table-top cabinet designed to accommodate Garrard SP25 Mk III or Dual 1216 or 1218 record decks. Designed to match A/R/D tuner and amplifier units. Lift-up or lift-off lid. Size:  $12\frac{3}{4} \times 16\frac{1}{2} \times 6\frac{3}{4}$ in. Finish: stove enamel silver, solid teak sides, dark grey tinted plastic lid. Available with units ready fitted (see Motor Units Section). Price: (cabinet only) £13 (plus VAT).

## ■ ARNEX PRODUCTS LTD

London Road, Daventry, Northants,  
NN11 4DU. Tel: Daventry (03272) 2231.

### Hi-Fi Table

Modern style table designed to accommodate hi-fi system or unit audio. Teak finish top, rack beneath to take bookshelf speakers or records, shaped metal legs with silent castors. Comes packed flat in carton for easy home assembly using just a screwdriver. Full details and leaflet on request.

### Audio stand

Model E50 (black), E51 (chrome). A modern design, tubular steel stand with adjustable width

clamping for audio equipment. Suitable for music centres etc. Height: 12in. Width: adjustable from 14 to 26in. Price: £4.50 (E50), £5 (E51) (including VAT).

### Loudspeaker stand

Model E57 (black), E58 (chrome). A modern design, tubular steel stand with adjustable width clamping. Stands on four carpet glides and is knock-down proof. Height: 12in. Width: adjustable from 8 to 14in. Price: (E57) £4.50; (E58) £5 (including VAT).

## ■ BSR McDONALD

(McDonald Division) BSR Ltd, Cradley Heath,  
Warley, Worcs, B64 5QH.  
Tel: Cradley Heath 69272.

### Plinths and covers ★

Teak veneered wood plinth with aluminium trim. Opaque black brushed satin insert. Designed for BSR 810 and 710 decks. Price: £8.50 (plus VAT). Afrormosia wood plinth with black baseboard. Designed for BSR MP60, HT70 and 610 turntables. Price: £4.03 (plus VAT). Smoke-tinted low-line Perspex dust cover for BSR 810 deck. Price: £4 (plus VAT). Smoke coloured styrene dust cover for BSR MP60, HT70 and 610. Price: £2.82 (plus VAT).

### Plinths

Specially for the 810 and 710. Wooden plinth with teak veneer. Polished aluminium trim with opaque black brushed satin insert. Price: £10.09 (plus VAT). Afrormosia-wood plinth with black baseboard designed to fit the MP60, HT70 and 610 turntables. Price: £4.69 (plus VAT).

### Covers

Only for the 810 and 710. Classic smoke-tinted low line dust cover fashioned from genuine perspex. Price: £4.63 (plus VAT). Smoke coloured styrene dust cover designed to suit the MP60, HT70 and 610 turntables. Price: £3.28 (plus VAT).

## ■ CALYX

Calyx Shelving Systems Ltd, Stanley Works,  
Belgrave Road, London, SE25 5AN.  
Tel: 01-771 1221.

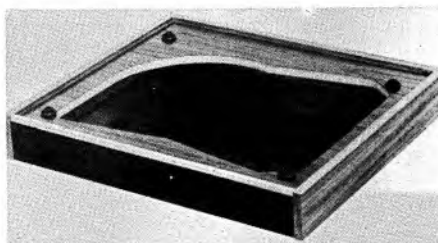

BSR plinth for 710 and 810

★ Indicates entry is illustrated



Calyx Groove 42



Dual PT4

### Groove 42 ★

Lowline style table with shelf and record storage beneath. Will accommodate most makes and models of tuner, tuner/amplifier, amplifier and record deck. Size: 42in wide, 18in deep, 24in high; also available in mini size measuring 32in wide, 15in deep and 20in high. Finish: all teak in natural veneers or white with teak trim. The system incorporates two adjustable compressor plates to hold up to 250 records on solid 1½in teak rails. Price: Groove 42 £27, Groove 32 £22 (including VAT).

### Universal console Mk III

Modern style equipment unit comprising top, middle shelf storage compartment for records with sliding doors at the bottom. Lower shelf contains spring loaded compressor plates to provide storage for up to 200 records and prevent warping. Accommodates most combinations of equipment. Size: 36 × 18 × 32in. Internal shelf is 16½in deep, top 8in high, lower shelf 18½in high.

### M5 Audio Cabinet

Similar in style to the Universal console above, but smaller and without spring loaded plates in record storage compartment. Will accommodate most amplifiers or tuners, receivers, etc. and a record deck. Mounted on castors. Size: 26½ ×

26½ × 18½in. Internal shelf 17in deep. Finish: white or teak.

### P3 Calyxos

Record storage rack system. Made in acrylic and aluminium. Holds up to 50 LPs. Adjustable plates to keep records in good condition. Full details in colour brochure available on request with 6p in stamps (not s.a.e.).

### ■ A. DAVIES & CO

56 Wellesley Road, London, NW5.  
Tel: 01-485 5775.

### Handmade cabinets

Cabinets for most makes of equipment and speaker units. Standard range of cabinets or individually designed units made to order. Standard finishes: sapele, oak, walnut, teak or veneer to choice. Polished or satin finish.

### ■ DUAL

Audiodecks Ltd, Farnell House, 81 Kirkstall Road, Leeds, LS3 1HR. Tel: Leeds 35111.

### PT1

Hi-fi equipment table with compartments below to accommodate small speaker systems. On castors. Finish: walnut or white. Full details on request. Price: (walnut) £15·81 (including VAT); (white) £81·41 (including VAT).

### PT2

Hi-fi equipment table with shelf for tuner or amplifier and compartments below for speaker units or records, etc. On castors. Finish: walnut or white. Full details on request. Price: (walnut) £22·45 (including VAT); (white) £25·32 (including VAT).

### PT4 ★

Hi-fi equipment table with shelf for tuner or amplifier and compartments below for speaker units, records, etc. On castors. Similar to the PT2 but twice as wide. Finish: walnut or white. Full details on request. Price: to be announced.

### ■ DYNATRON RADIO LTD

St Peters Road, Maidenhead, Berks, SL6 7QY.  
Tel: Maidenhead 23331.

### RSU3

Walnut-finish Queen Anne period cabinet with shelf for TVR26 tuner/amplifier and space for about 150 LPs. Mounted on castors. Size: 23½ × 21¼ × 14¼in. Price: £46·17 (including VAT).

### RSU2

Modern-style teak-veneered cabinet with drop-down front for sorting records. Top will accommodate audio units. Space for about 250 LPs. Price: £35·90 (including VAT).

### RSU4 ★

Upright contemporary style record storage unit

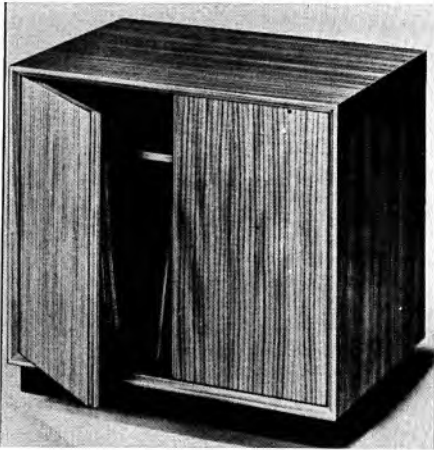

Dynatron RSU 4

with doors. Mounted on ball type castors. Two hinged front doors with lock and key. Space for approximately 150 records. Size:  $21\frac{3}{4} \times 23\frac{1}{4} \times 16\frac{1}{4}$  in. Finish: teak veneer. Designed to accommodate on top a range of Dynatron Audio Separate units. Price: £28.47 (including VAT).

**RSU5**

Contemporary style record storage unit with lockable doors providing access to vertical storage space for approximately 150 records and a shelf for accessories. Size:  $21\frac{3}{4} \times 23\frac{1}{2} \times 16\frac{1}{4}$  in. Finish: teak. Fitted with castors. Price: £37.20 (including VAT).

**RSU6**

Lowline contemporary record storage cabinet mounted on legs. Drop-down front, held in horizontal position, will accept approximately 275 records. Top will accommodate Dynatron Audio Separates. Price: £45.80 (including VAT).

**RSU7**

Period record storage unit in Queen Anne style. Has two lockable vertically hinged doors. Holds approximately 150 records with a shelf for accessories. Size:  $23\frac{1}{2} \times 21\frac{1}{4} \times 16\frac{1}{4}$  in. Finish: walnut hurr veneers. Fitted with castors. Price: £54.25 (including VAT).

**ST16**

Metal pedestal stand for use with Dynatron Audio Separates. Black finished pillar with chrome feet and adjustable studs. Price: £5.80 (including VAT).

**ST21**

Metal framed, two tier trolley stand fitted with castors. Shelves finished in plastic laminate, white one side, teak the other; can be fitted to suit the equipment. Top shelf designed to take

Dynatron Audio Separates, lower shelf for speakers. Record rack. Frame finished in matt black. Price: £16.90 (including VAT).

**ST22**

Teak veneered table stand for Audio Separates. Shelf below. Price: £11.29 (including VAT).

**ST24**

Furniture look contemporary style stand. Top will accept Dynatron Audio Separates, vertical storage space below for records or two LS1428 speakers and some records. Size:  $22\frac{7}{8} \times 28 \times 16\frac{3}{4}$  in. Finished in teak veneer; mounted on castors. Price: £31.70 (including VAT).

**ST25**

All metal chromium plated stand for accommodating contemporary style Audio Separates. Mounted on castors. Price: £9.40 (including VAT).

**ST26**

Teak veneered table-stand, fitted with shelf. Size:  $16.6 \times 18.25 \times 14.7$  in. Price: £16.90 (including VAT).

**■ EDWARD MICHELSEN CUSTOM CABINETS**

216 Brampton Road, Bexleyheath, Kent.  
Tel: 01-303 9272.

Manufacturers of hi-fi equipment cabinets and speaker enclosures in ready-built or kit versions. Full details on request. No product information or prices obtainable as this edition of the Year Book closed for press.

**■ EMPHASIS**

50a The Avenue, Kilburn, London, NW6.  
Tel: 01-451 0517.

**Hi-Fi Equipment Cabinets**

Handbuilt custom cabinets to accommodate most hi-fi equipment including record and tape decks, amplifiers and tuner/amplifiers. Space for record and tape storage. Also custom made speaker enclosures.

**DB4**

Modern style cabinet with space for tuner/amplifier and record deck recessed into upper surface under smoke tinted plastic cover. Access doors to tape and record storage open out, down, or gull-wing to order. Finish: teak, rosewood or any combination of colours. Also available in black, white or hessian. Size: (standard version)  $72 \times 24 \times 24$  in; (special version with space for tape deck also)  $90 \times 24 \times 24$  in. Prices according to specification.

**DB6**

Similar accommodation to the DB4 but available with flat or curved upper surface. Finish: teak, rosewood or colours, also lacquer and

★ Indicates entry is illustrated

hessian. Drawers or door to order. Prices according to specification.

#### **DBS-9**

Matched cube-shaped cabinets on chrome pillars. One contains tuner, amplifier and record deck with storage below. Two similar cabinets comprise speaker enclosures employing Tannoy Monitor Gold 12 or Altec Lansing 604E driver units. Size: (each cube) 24×24×24in on 6in pillar. Finish: teak, rosewood, coloured lacquers or hessian. Prices according to specification.

#### ■ **GUSDORF**

Distributors: C. E. Hammond & Co. Ltd, Lamb House, Church Street, London, W4 2PB. Tel: 01-995 4551.

#### **Hi-Fi furniture**

48 different models to accommodate any hi-fi or unit audio system. Prices and details on application.

#### **Model 3378 ★**

Hi-fi trolley suitable for carrying complete audio system. Includes record rack. Price: £15 (including VAT). Variations available from £7.95 to £29. Packed flat for home assembly using a screwdriver only.

#### **Model 3355**

Hi-Fi trolley. Size: 45.25×12.8×20.5in. Price: £11.50 (including VAT).

#### ■ **HACKER RADIO LTD**

Norreys Drive, Cox Green, Maidenhead, Berks, SL6 4BP. Tel: Maidenhead 22261/5.

#### **T45**

Teak table with inset top covered in black leather-cloth. Designed specifically for the Hacker Centurion equipment but suitable for other makes. Size: 19¼in wide, 17¾in deep, 16¼in high. Price: to be announced.

#### **RST100A ★**

Teak finished record and tape recorder storage cabinet. Front opening doors. Record storage on right, shelf for recorder on left with storage space below. Shelf for recorder slides out on ball-bearing slides for ease of access. Size: 32in wide, 17¾in deep, 27½in high. Price: to be announced.

#### **SR1000 ★**

Teak finished record storage cabinet. Size: 32in wide, 16½in deep, 24½in high. Price: to be announced.

#### ■ **HAMPSTEAD HIGH FIDELITY**

91 Heath Street, Hampstead, London, NW3. Tel: 01-435 6377 and 0999.

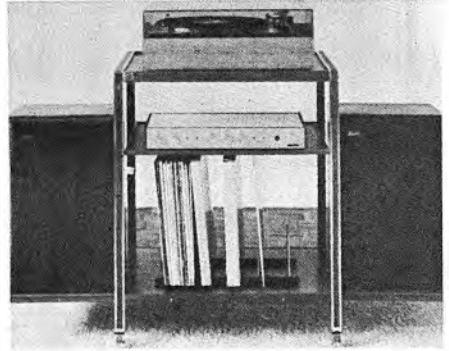

*Gusdorf model 3378*



*Hacker record storage cabinet SR1000*

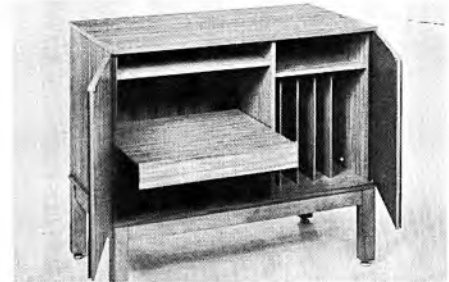

*Hacker RST 100A*



*Hampstead HQ1*

**Hampstead**

Low upright cabinet with split lift-up lids. Takes gram unit and tape deck. Pull-out front hopper for tuner and control unit or integrated amplifier. Accommodates any control unit or integrated amplifier not exceeding 14in in depth. Available with well to hold complete tape recorder not exceeding 9in high. Space to take Ferrograph or Revox with professional spools. Size: (standard model) 40 × 26 × 21in. Finish: teak; other finishes to order. Price: on application.

**Heath ★**

Equipment cabinet specially designed to accommodate Quad/Leak units mounted horizontally in top section, together with record deck. Base of cabinet will house 250 records or tape recorder and smaller number of records. Split lids with flap-back to expose amplifier control panel only. Size: 34 × 26 × 20in. Finish: teak; other special finishes to order. Prices: on application.

**HQ1 Housing Unit ★**

Designed specifically to house Quad equipment neatly and efficiently. Accommodation for Quad 30, 33, 303 also Quad AM/FM tuner and choice of turntable. Supplied with cut-outs for Quad and Thorens equipment. Size: 24in wide, 20½ in high, 23in deep. Made from high quality birch ply with tinted plastic lid. Desk top permits easy access to controls. Undertray protects equipment and contains all interconnecting wires. Shelf provides space for power unit and accessories. Finish: White or Mexican brown. Prices: on application.

**Music Bench**

A two-section unit with well to hold either tape recorder or gramophone turntable. Sectional record storage compartments below. Two pull-out drawers. Finish: rosewood, teak or white. Size: approximately 63in wide (extending to 122in wide), 24¾ in high, 19¾ in deep. Prices: on application.

**Antique Commodes/Chests**

A fine selection of antique commodes and chests are available with or without suitable sound systems from stock. The prices range from about £150 (plus VAT) for the cabinet. Each cabinet is a genuine antique.

Special cabinets and fittings made to order. Designs and drawings prepared for complete room or house hi-fi schemes.

■ **HOLDER PEARCE LTD**

66 Grove Road, Eastbourne, Sussex, BN21 4UH. Tel: Eastbourne 26565.

Built-in or free-standing equipment cabinets designed and built to meet customers' exact requirements. Lift-up or drop-down lids, accom-

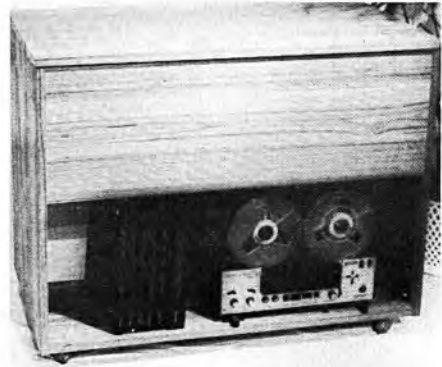

*Hampstead High Fidelity Heath cabinet*



*Howland-West HW12*

modation to suit any equipment, all standard finishes and also special finishes to blend with furnishing. Details and prices on application.

■ **HOWLAND-WEST LTD**

3-5 Eden Grove, London, N7 8EQ.  
Tel: 01-609 0293.

**Clearview HW1**

Cabinet in teak, walnut or rosewood. Takes gram unit or tape deck. Lift-off Perspex lid. Overall size: 18¼ × 16½ × 8½ in. Clearance above board 3¾ in, below board 4½ in. Price: £14-30 (including VAT).

**Clearview HW12 ★**

Cabinet in teak. Takes gram unit or tape deck. Lift-off perspex lid. Overall size: 23½ × 19 × 8½ in. Clearance above board 3¾ in, below board 4½ in. Price: £17-05 (including VAT).

**Clearview HW14**

De luxe turntable or tape deck cabinet with Perspex cover. Teak or rosewood with black base. Size: 18¼ × 19¼ × 9½ in. Space above board 4in, below top of board 4½ in. Fully-sprung anti-feedback base, adjustable feet for levelling, fitted with Bulgin mains socket and colour-



★ Indicates entry is illustrated

coded phono sockets; supplied with Clearview lid stay and spirit level for fitting by user. Price: £25-85 (including VAT).

#### **Clearview HW15LT**

Teak/black turntable cabinet with Perspex cover. Size:  $17\frac{1}{2} \times 16\frac{1}{4} \times 7\frac{1}{4}$  in. Space above board  $3\frac{1}{4}$  in, below top of board  $3\frac{1}{2}$  in. LT version board uncut. 1LT version board cut for Garrard SP25, AT60, 3000 etc.. 4LT version cut for Garrard AP75, SL75, SL95 etc. Price: £9-90 (including VAT).

#### **Clearview HW15HT**

Teak/black turntable cabinet with Perspex cover. Size:  $17\frac{1}{2} \times 16\frac{1}{4} \times 9$  in. Space above board 5 in, below top of board  $3\frac{1}{4}$  in. Cut-board versions, 1HT and 4HT, as above. Price: £10-45 (including VAT).

### ■ NEW CLASSIC

J. W. (Wholesale) Co, 26 Rosoman Street, London, EC1. Tel: 01-837 3041.

#### **Anti-warp record storage**

Features of the New Classic record storage system include spring-loaded panels that keep records flat, upright and easy to withdraw and replace. Also all models have built-in press for dealing with badly warped records.

#### **Compact 100**

Contemporary style storage unit with accommodation for 100 LP records. Incorporates anti-warp storage equipment as listed above. Size: 16 $\frac{1}{2}$  in wide, 13 $\frac{3}{4}$  in high, 13 $\frac{3}{4}$  in deep. Finish: meranti (to blend with teak finishes). Price: £5-40 (plus 54p VAT).

#### **Major 200 ★**

Traditional style record storage cabinet on legs. Accommodation for 200 LPs and record press (as described above). Size: 36 $\frac{1}{2}$  in wide, 27 $\frac{1}{2}$  in high (including legs), 15 $\frac{1}{2}$  in deep. Finish: selected teak veneers hand polished to satin finish. Price: £29-50 (plus £2-95 VAT).

### ■ PAGEANTRY RADIO & TV CO LTD

104 Felsham Road, Putney, SW15 1DQ. Tel: 01-788 5588.

#### **Custom-built cabinets ★**

Hand-made cabinets to house hi-fi systems. Two standard designs. Typical is antique reproduction model in selected walnut veneers hand-finished with traditional French polish. Features include intricate hand-carved mouldings on front side panels. Size: 54 in wide, 21 in deep, 32 in high. Lower centre front houses record storage drawer running on precision runners. Size of drawer: 17 in wide, 15 $\frac{1}{2}$  in deep, 13 in high. Full details of hi-fi cabinets including prices and delivery available on request.



*New Classic Major 200*



*Pageantry cabinet*

### ■ RECORD HOUSING

Brook Road, Wood Green, London, N22. Tel: 01-888 7487.

#### **Soundmaster Trolley**

Lowline equipment cabinet on wheels. Accommodation for turntable, tuner, amplifier, plus 50 records. Adjustable partitions provide facilities for housing a variety of equipment, including Soundmaster 1266 audio system. Size: 25 in wide, 23 in high, 17 in deep. Finish: afrormosia. Price: £23-90 (including VAT).

#### **Stereo Trolley**

Upright style equipment cabinet on wheels. General purpose equipment/record cabinet. Accommodation for turntable, amplifier (or tuner/amplifier) plus 125 records. Size: (amplifier section) 19 in wide, 6 in high, 18 in deep; (overall) 20 in wide, 18 in deep, 24 in high. Finish: walnut or afrormosia. Price: £27-50 (including VAT).

#### **Capri ★**

Contemporary equipment cabinet on legs. Accommodation for turntable, tuner, amplifier (or records). Front-opening doors. Vertical record partitions slide out and can be replaced in horizontal position as shelves, providing flexible

arrangement for housing records and equipment. Size: 32in wide, 16½in deep, 16in high (plus 12in legs). Finish: walnut or afrormosia. Price: £27.50 (including VAT).

**Highmaster Trolley**

Lowline equipment and record cabinet on wheels. Two sliding type front-opening doors in lower section holding records. Accommodation for turntable, tape deck, tuner, amplifier and 250 records. Size: (equipment shelf) 35in. wide, 6in high, 16in deep; (overall) 36in wide, 24in high, 16½in deep. Finish: medium walnut or natural afrormosia. Price: £44 (including VAT).

**Scan record unit**

Contemporary style record storage cabinet. Accommodation for 125 records in each cabinet. Designed as add-on units permitting users to build up a library. Size: 20in long, 15in high, 16½in deep. Finish: walnut or afrormosia. Price: £15.90 (including VAT).

■ **SONY (UK) LTD**

Pyrene House, Sunbury Cross, Sunbury-on-Thames, Middlesex. Tel: Sunbury 87644/7.

**TAC-1**

Walnut finished wood case for the following Sony models: TA3200F, ST5000, STR6045, TA1130, TA1140, TA2000F, TA1120, SQD-2020, TA1150, ST5150. Price: £1.50 (plus VAT).

**TAC-5**

Walnut finished wood case for the following Sony models: STR6055, STR6060FW, STR-5050. Price: £8.50 (plus VAT).

**TAC-6**

Walnut finished wood case for the following Sony models: STR6200F, STR6120. Price: £9.50 (plus VAT).

■ **STAPLES & CO LTD**

Staples Corner, Junction Edgware Road and North Circular Road, London, NW2 6LS. Tel: 01-452 1144/7.

**Ladderax ★**

Unit system hi-fi cabinet designed to fit Staples Ladderax assembly. Lift-up main lid giving access to space for tuner, control unit and record or tape deck. Front panel removable to facilitate installation. Will accept most modern equipment. Size: 35in wide, 17in deep, 18¾in high. Motorboard: 33½ × 16 × ½in, height above 5¾in. Finish: teak or rosewood veneer. Full details of other matching units on request. Prices from £47.90.

■ **TYSONS SOUND ENGINEERS**

(Prop. John E. Barkley), 41 Russell Street, Leamington Spa. Tel: Leamington Spa 24935.



*Record Housing Capri*



*Staples Ladderax Hi-Fi*

**Hand-made Dower Chests**

Reproduction style in oak. Suitable for gram unit, tape deck, tuner, amplifier. Lift-up lid. Generally 36in to 48in long. Price: £55 to £75.

Equipment installed in antique or reproduction furniture to customers' requirements. Dower chests a speciality. Agents for all leading manufacturers of hi-fi equipment.

■ **VERO**

Vero Electronics Ltd, Industrial Estate, Chandler's Ford, Eastleigh, Hants, SO5 3ZR. Tel: Chandler's Ford 2952. Telax: 47551.

Wide range of equipment cases suitable for hi-fi units, tuners, power supplies and test gear. Available in various panel heights and with or without anodised aluminium front handles. Made in light gauge steel finished in RAF blue/grey vinyl paint. Integral aluminium trim. Neat slim-line appearance. Ventilation slots incorporated. Full list of sizes, accessories and prices available on request. Ask for catalogue of Vero 'D' series cases.

# there's a good deal for you ~ at IMHOFS

Yes! There's a good deal to see and a good deal to hear. For here at Imhof House we now have a number of specialised showrooms, each devoted to one of the worlds leading manufacturers – Bang & Olufsen, Dual, Dynatron, Eddystone, Hacker, Jensen, Sony, Tandberg and Telefunken. Not only can you see the most comprehensive selection of equipment, you will also have the advantage of manufacturer trained representatives to advise and to serve you.

Of course, we still have our famous hi-fi demonstration room on the 4th floor and our world renowned record departments are on the ground floor. Then there is the Service Shop on the 2nd floor and here, besides selling our famous IM styli and other accessories, they will look after the servicing of all equipment purchased from us.

And a point to remember is that any new item of equipment bought from us is covered by the "Imhof Sales Charter" which includes the first 12 months service completely free of charge. So, if you are in town, pop into Imhofs – there's a "full house" waiting for you.

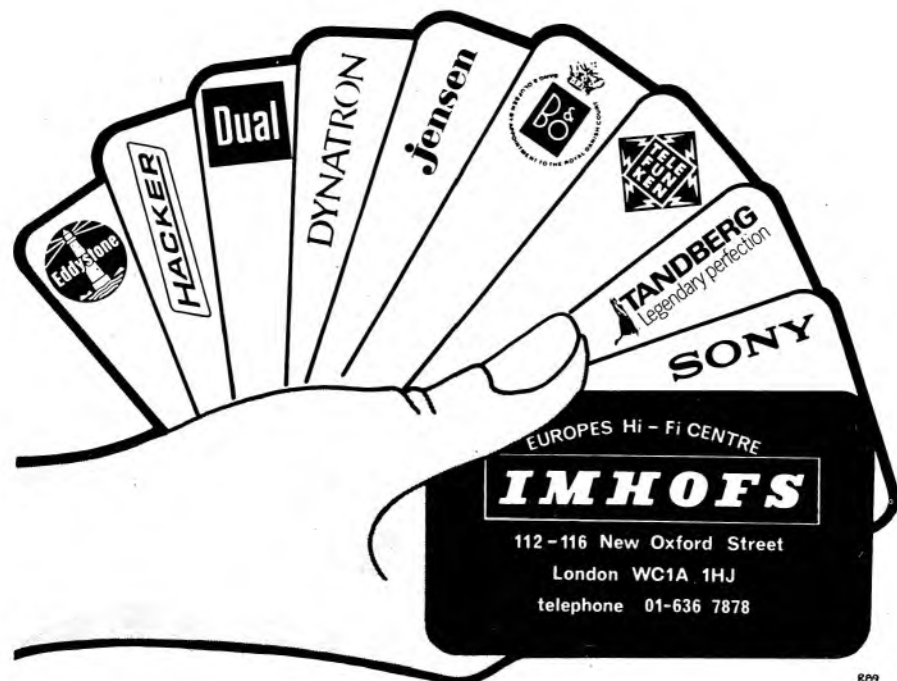

R09

# Hi Fi Headphones

★ Indicates entry is illustrated

Abbreviations used in this section are given on page 20.

## ■ ADASTRA

Adastra Electronics Ltd, Unit N22, Cricklewood Trading Estate, Claremont Road, London, NW2 1TU. Tel: 01-452 6288.

### H7/G1120

Mono headphones. Impedance: 16 ohms. Maximum input: 250mW. FR: 20Hz-10kHz. Weight: 15oz. 5ft lead. Fitted with dynamic boom mic. Two-tone grey. Adjustable headband. Washable ear cushions. Price: £11.00 (including VAT).

### H13/G2220

Stereo headphones. Impedance: 8-16 ohms. Maximum input: 650mW. FR: 25Hz-18kHz. Weight: 13oz. 9ft coiled lead. Moulded stereo jack plug. Simulated wood grain finish with black trim. Individual volume controls. Adjustable headband. Washable ear cushions. Mono/stereo slide switch. Price: £9.30 (including VAT).

### H14/G3333

Stereo headphones. Impedance: 4-32 ohms. Maximum input: 500mW. FR: 20Hz-20kHz. Weight: 17oz. 5½ft coiled lead. Stereo jack plug. Grey moulded earpieces. Separate 3in and 1½in units in each earpiece. Individual treble control for each earpiece. Soft ear cushions and adjustable headband. Price: £12.30 (including VAT).

### H15/G3000B

Stereo headphones. Impedance: 8 ohms. Maximum input: 650mW. FR: 50Hz-19kHz. Weight: 19oz. 10ft coiled lead. White moulded earpieces with black and silver fittings. Control box in lead with volume controls and mono/stereo switch. Adjustable leather padded headband. Washable ear cushions. Price: £11.56 (including VAT).

### H17/G6000

Stereo headphones. Impedance: 4-16 ohms. Maximum input: 500mW. FR: 15Hz-25kHz. Weight: 21oz. 15ft coiled cord. Stereo plug. Satin white earpieces with black trim. Open back housings with 3½in units. Slide volume controls. Adjustable headband. Washable ear cushions. Price: £12.60 (including VAT).

### H18/G5555

Stereo headphones. Impedance: 4-16 ohms.

Maximum input: 600mW. FR: 20Hz-20kHz. Weight: 17oz. 10ft coiled lead. Stereo jack plug. All-black moulding with chrome trim. 2½in units. Adjustable headband. Washable ear cushions. Price: £17.30 (including VAT).

### H19/G3500

Stereo headphones. Impedance: 4-16 ohms. Maximum input: 900mW. FR: 15Hz-25kHz. Weight: 24oz. 8ft coiled lead. Moulded stereo jack plug. Black moulding with chrome trim. 3½in and 1½in units in each earpiece. Wire-wound volume controls. Adjustable headband and washable ear cushions. Price: £23.00 (including VAT).

### H20/G8030

Stereo electrostatic headphones. Impedance: 4-16 ohms. Normal listening input: 8W. Maximum input: 10W. FR: 20Hz-19kHz. Weight: (headphones only) 19oz; (headphones and energiser unit) 5½lb. 8ft coiled lead. Black moulding with black leather headband. Adjustable padded headband. Price: £51.50 (including VAT).

### H63/G1305

Headphone remote control unit. Slider volume controls for individual channel gain. Stereo/mono mode switch. Stereo jack socket. Moulded case. 10ft self-coiling lead with jack plug. Price: £4.10 (including VAT).

### Sprite

Featherweight stereo headphones. Impedance: 4 ohms. Maximum input: 200mW. FR: 30Hz-13kHz. Sensitivity: -105dB. Weight: 5oz. One-piece moulded headband in brilliant red. Black padded ear cushions. Fully adjustable. Mylar reproducer units. Price: £3.10 (including VAT).

### H23/G8000

Stereo headphones with compact Mylar reproducers. Impedance: 4-16 ohms. Maximum input: 500mW. FR: 20Hz-22kHz. Weight: 12oz. Washable ear cushions secured with press-studs. Matching punched leather headband. 10ft coiled lead. Price: £11.95 (including VAT).

### H36/G3600

Quadraphonic headphones with two full-range 2in units in each earpiece. Impedance: 8-16 ohms. Maximum input: 200mW. FR: 20Hz-20kHz. Weight: 21lb 10oz. Stereo/quadraphonic switching. 15ft coiled lead. Padded ear cushions and headband. Price: £22.25 (including VAT).

### G1305

Headphone remote control unit. Provision for connecting headphone leads and includes slider controls for volume/balance adjustment. Switching for mono/stereo. 10ft coiled lead. Finish: black moulded case with silver coloured fascia. Price: £4.10 (including VAT).

★ Indicates entry is illustrated

For other T.T.C. headphone/speaker control units please see Speaker Accessories Section.

#### AKAI

Rank Audio Visual Ltd, PO Box 70,  
Great West Road, Brentford, Middlesex,  
TW8 9HR. Tel: 01-568 9222. Telex: 24408.

#### ASE 11 ★

Stereo headphones with acoustic control. Impedance: 8 ohms. Maximum input: 500mW. FR: 25Hz-15kHz. Weight: 18oz approx. Length of cord: 6ft. Price: £8.90 (including VAT).

#### ASE20

Stereo headphones with acoustic loudness control. Impedance: 8 ohms. Maximum input: 500 mW. FR: 25Hz-18kHz. Weight: 17oz approx. Length of cord: 6ft. Price: £11.50 (including VAT).

#### ASE22 ★

Stereo headphones. Built-in mechanical two-way system. Mylar film diaphragms. Impedance: 8 ohms. FR: 20Hz-10kHz. Normal input: 1mW. Maximum input: 500mW. Sensitivity: 110dB. Weight: 18oz approx. Price: £14.50 (including VAT).



Akai ASE 11



Akai ASE 22

#### A.K.G.

Distributors: A.K.G. Equipment Ltd,  
182-184 Campden Hill Road, Kensington,  
London, W8 7AS. Tel: 01-229 3695.

#### K60 ★

Dynamic stereo headphones. FR: 16Hz-20kHz. Impedance: 75 ohms  $\pm 20\%$  per channel over entire range, or 600 ohms  $\pm 20\%$ . Distortion:  $< 1\%$  max output. Weight: 7oz. Ear cushions removable for washing. Price: £15 (plus VAT).

#### K150

Mono/stereo 600 ohms, ultra lightweight. Complete with Z50A ear muffs, grey/silver. Price: £11.50 (plus VAT).

#### K180

Mono/stereo 600 ohms. Incorporates control for moving distance of transducer from ear. Large comfortable design. Price: £28 (plus VAT).

#### Accessories

Z50A (ear cushions for K50, K150). Price: 55p pair; Z60 (adaptor for mounting Z60 on K50 and K150). Price: £1.65; Z61 (ear cushions for K60; K50 and K150). Price: £2.35. All prices exclude VAT.

#### ALPHA

Highgate Acoustics,  
38 Jamestown Road, London, NW1 7EJ.  
Tel: 01-267 4937.

#### Alpha SDH-7

Stereo headphones. Impedance: 4-16 ohms.

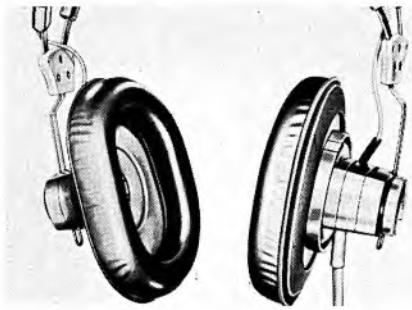

A.K.G. K60



Amstrad HPS 6A

Maximum input: 0.5W. FR: 25Hz-17kHz. Weight: 12oz. 6ft cord. Three-pole jack plug. Finish: grey and black headbands and ear cushions. Adjustable headband. Price: £4.40 (plus VAT).

■ **AMSTRAD**

AMS Trading (Amstrad) Ltd,  
89 Ridley Road, London, E8.  
Tel: 01-249 5237.

**HPS 5A**

Stereo headphones wired for mono and stereo. Impedance: 4-16 ohms. FR: 20Hz-20kHz. HD: 0.5%. Weight: 12oz. 10ft coiled cord. Supplied with jack plug. Finish: black. Fitted with two volume controls and mono/stereo switch. Price: £8.25 (including VAT).

**HPS 7A**

Stereo headphones. Wired for stereo. Impedance: 4-16 ohms. FR: 20Hz-25kHz. HD: 0.2%. 13ft coiled cord. Weight: 16oz. Fitted with standard jack plug. Finish: brown and silver. Each earpiece contains LF and HF units. Four slider controls for adjusting levels in each unit. Price: £15.34 (including VAT).

**HPS 6A ★**

Stereo headphones wired for mono and stereo. Impedance: 4-16 ohms. Normal listening level: 200mW. Max input: 500mW. FR: 20Hz-25kHz. HD: 1%. Weight: 13oz. 10ft cord with standard jack plug. Finish: black. Individual volume controls for each earpiece. Washable earcups. Mono/stereo switch. Price: £11.77 (including VAT).

**HPS 606**

Stereo headphones wired for stereo only. Impedance: 4-16 ohms. Normal listening level: 200mW. Maximum input: 500mW. FR: 20Hz-25kHz. HD: 1%. Weight: 14oz. 10ft cord fitted with standard jack plug. Finish: black. Has special reel cord arrangement by which cable is retracted into the headphone cups when not in use. Price: £11.77 (including VAT).

■ **AUDIO DEVELOPMENTS**

UK distributors: B. H. Morris & Co (Radio) Ltd,  
Trio House, The Hyde, London, NW9 6JP.  
Tel: 01-205 6441.

**AD11**

Stereo headphones. Fully adjustable with soft ear cushions and padded headband. Coiled lead fitted with jack plug. Impedance: 8 ohms. FR: 40Hz-19kHz. Price: £5.95 (plus VAT).

■ **BEYER**

Beyer Dynamic (GB) Ltd,  
1 Clair Road, Haywards Heath, Sussex.  
Tel: Haywards Heath 51003.



Beyer DT96



Beyer DT100

**DT48**

Moving coil stereo headphones. FR: 16Hz-20kHz. Impedances: 8 ohms, 25 ohms, 200 ohms per earpiece. Input: (8 ohms) 80mV, (25 ohms) 150mV, (200 ohms) 450mV. Cable: 6½ft open end. Price: (DT48 mono) £45.07 (plus VAT); (DT48 stereo) £45.51 (plus VAT).

**DT96 ★**

Lightweight moving coil stereo headphones. FR: 30Hz-17kHz. Impedances: 50 ohms or 400 ohms per earpiece. Max power: 100mW. Various cable lengths and terminations available. Also available with coiled cable. Price: £13.63 (plus VAT).

**DT100 ★**

Moving coil stereo headphones. FR: 30Hz-20kHz. Various impedances and cable terminations available. Price: £17.11 (plus VAT).

**DT100RR**

Similar to the DT100 but fitted with individual volume controls. Price: £24.50 (plus VAT).

★ Indicates entry is illustrated



Beyer DT900



Brahms BHP250

#### DT480

Moving coil stereo headphones. FR: 20Hz-20kHz. Various impedances available. Rated input: 350mW, max 1W. Cable: 10ft. Various terminations offered. Price: £32.66 (plus VAT).

#### DT900 ★

Moving coil stereo headphones. FR: 30Hz-18kHz. Impedance: 600 ohms per earpiece. Maximum input: 200mW. Lightweight, gaily coloured. Price: £10.46 (plus VAT).

#### DT900RR

Similar to the DT900 but fitted with individual volume controls. Price: on application.

#### ■ BINATONE

J. Parkar & Co (London) Ltd, Parkar House, Beresford Avenue, Wembley, Middlesex, HA0 1YX. Tel: 01-902 8991.

Binatone headphones with sliding volume control. Price: £6.60 (plus VAT).

#### ■ BRAHMS

Brahms Manufacturing & Development Co, Unit F, Rochester Airport, Maidstone Road, Rochester, Kent, ME1 3QJ. Tel: Medway (0634) 48816.



Bush-Arena K600



Duette ES1000

#### BHP250 ★

Stereo headphones. Impedance: 8 ohms. Max input: 0.5W per channel. FR: 20Hz-22kHz. Weight: 1lb. 13ft coiled cord. Adjustable leather headband. Bronze coloured earpieces. Removable and washable earpads. Price: £10.68 (including VAT).

#### ■ BUSH-ARENA

Rank Radio International Ltd, PO Box 596, Power Road, Chiswick, London, W4 5PW. Tel: 01-994 6491.

#### K600 ★

Stereo headphones made for use with Bush-Arena equipment by Koss. Removable foam-filled ear cushions, adjustable headband, coiled lead with jack plug. Impedance: 4 ohms. Price: £13.09 (including VAT).

#### ■ CITY AUDIO SERVICES LTD

144 Lavender Hill, London, SW11 5RA. Tel: 01-223 2496.

#### SF.40

Stereo headphones. Comfortable cushioned earpads exclude extraneous noises. High sensitivity units in acoustic chambers. FR: 25Hz-16kHz. Price: £7 (plus VAT).

■ **CLEEN**

Kirkman (Crawley) Ltd,  
40 The Broadway, Crawley, Sussex.  
Tel: Crawley 26670.

**Cleen Stereo Headphone Unit**

Supplied in chassis form for mounting on panel or shelf (teak case will be available later). Signal from each channel is delayed and fed to opposite channel to simulate natural stereo. Three-position switch: loudspeakers, headphones, attenuated headphones. Jack socket for two pairs of phones. Impedance to amplifier: 8 ohms resistive. Suitable for headphones: 8-600 ohms. Size:  $3\frac{1}{8} \times 1\frac{1}{2} \times 8$ in. Price: £15 (plus VAT).

**Cleen Stereo Headphones**

Monitoring quality with good transient response. Recommended for use with Cleen stereo headphone unit. Impedance: 40 ohms. Sensitivity: 104dB for 1mW at 1kHz. Weight: 16oz. Supplied with 10ft lead and jack plug ( $\frac{1}{4}$ in stereo). Sound exclusion approximately 40dB. Price: £10.50 (plus VAT).

■ **DARBY INDUSTRIES**

38-42 Chestnut Grove, New Malden,  
Surrey, KT3 3JW. Tel: 01-942 1596.

**Amplified headset**

Headphones with built-in battery-operated amplifier for direct listening from pickup cartridge, etc. Price: £18 (plus VAT).

**Guitar adaptor**

Adaptor for use with amplified headphones for connecting to acoustic guitar. Price: £1.50 (plus VAT).

■ **DUETTE**

Distributors: J. J. Silber Ltd,  
11 Northburgh Street, London, EC1.  
Tel: 01-253 8031.

**ES350**

Stereo headphones. Impedance: 8-16 ohms. FR: 25Hz-13kHz. Max input: 0.5W. Price: £9.14 (plus VAT).

**ES300D**

Stereo headphones. Impedance: 8-16 ohms. FR: 25Hz-18kHz. Max input: 0.5W. Price: £8.12 (plus VAT).

**ES1000 ★**

Stereo headphones. Switchable mono/stereo connections. Left and right vernier volume controls. Padded headband. Coiled lead with jack plug. Price: £12.87 (plus VAT).

■ **DYNATRON RADIO LTD**

St Peters Road, Maidenhead, SL6 7QY, Berks.  
Tel: Maidenhead (0628) 23331.

**SP3**

Stereo moving coil headphones with separate

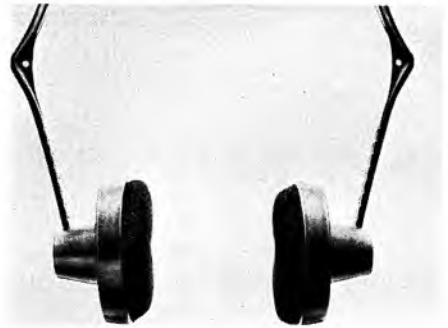

*Eagle FF16*

bass and treble units. FR: 16Hz-22kHz. Sensitivity: 100dB at 600Hz at 1mV input. Max input: 0.5W. Impedance: 8-16 ohms each channel. Price: £17.20 (including VAT).

**SP4**

Stereo moving coil headphones with individual volume controls to each unit. Padded earpieces. Impedance: 8 ohms. FR: 20Hz to 20,000Hz. Price: £13.50 (including VAT).

■ **EAGLE INTERNATIONAL**

Heather Park Drive, Wembley, HA0 1SU.  
Tel: 01-903 0144.

**S.E.1**

Professional stereo headphones. FR: 25Hz-15kHz. 3in dynamic speakers. Isolated right and left channels. 'Flexifoam' seals. Dual impedance: 15 ohms. Price: £6.60 (including VAT).

**S.E.5**

Budget stereo headphones. FR: 30Hz-15kHz. Lightweight single headband. Impedance: 8 ohms. Price: £4.40 (including VAT).

**S.E.30**

Studio stereo/mono headphones. FR: 25Hz-16 kHz. Built-in stereo/mono switch. Impedance: 8 ohms. Leather ear cushions. Price: £10.34 (including VAT).

**S.E.60**

Studio stereo headphones. FR: 25Hz-18kHz. Impedance: 8 ohms. Lightweight with punched ventilated headband. Price: £11.88 (including VAT).

**JB3**

Stereo headphone and speaker switching and attenuation unit. Jack socket for phones. Switch permits phones only, speakers only, or both together. DIN version available. Moulded case. Price: £2.09 (including VAT).

**FF16 ★**

Stereo headphones. Impedance: 8 ohms. FR:





Eagle FF29

30Hz-15kHz. Three-pole jack plug. Washable brushed nylon ear cushions. Adjustable headband. Price: £5.50 (including VAT).

#### FF6

Dynamic 8 ohm headphones with in-line control box containing volume controls for each channel and a mono/stereo switch. FR: 25Hz-18kHz. Jack plug. Price: £14.08 (including VAT).

#### FF44

Four channel headphones suitable also for stereo. Incorporates switched phase-shifting network to provide synthetic surround sound from a conventional stereo amplifier. Stereo jack plugs. FR: 18Hz-21kHz. Price: £26.40 (including VAT).

#### SF40

Studio stereo headphones, 8 ohm impedance. FR: 30Hz-16kHz. Stereo jack plug. Price: £9.46 (including VAT).

#### FF29 ★

Four-channel headphones. Switchable for stereo or four-channel. Impedance: 8 ohms. FR: 20 Hz-20kHz. Supplied with two three-pole jack plugs. Adjustable headband. Coiled lead. Price: £19.80 (including VAT).

#### ECHO

Sole Distributors: Adastra Electronics Ltd, Unit N22, Cricklewood Trading Estate, Claremont Road, London, NW2 1TU. Tel: 01-452 6288.

#### HS.606M

Dual impedance mono headphones. Specially designed for monitoring, electronic musical instruments, language laboratories, etc. Instant switching from 8-16 ohms to 4K. Adjustable earpieces. Soft padded ear cushions. FR: 25Hz-17kHz. Power handling capacity: 0.5W. Supplied with 10ft coiled cord lead fitted with jack plug. Price: £7.40 (including VAT).

#### JB400

Quadraphone remote control unit. Hand size control unit with 4 slide controls for adjustment of individual channel gain on quadraphonic headphones. 6ft lead fitted with two standard stereo jack plugs. Price: £6.20 (including VAT).

#### JB40

Quadraphonic remote control unit. Free standing moulded case in black and silver with individual slider channel controls and twin mode headphone/speaker switching headphone sockets. Rear tag terminals. Price: £8.25 (including VAT).

#### GOLDRING LTD

10 Bayford Street, Hackney, London, E8 3SE. Tel: 01-985 1152.

#### Lenco K105

Stereo headphones. Impedance: 8 ohms. Maximum recommended input: 700mW. FR: 18Hz-22kHz. Cable: 220cms coiled lead. Jack plug supplied. Price: £12.90 (plus VAT).

#### GRUNDIG (Great Britain) LTD

Newlands Park, London, SE26 5NQ. Tel: 01-659 2468.

#### 220

High-quality stereo headphones. Fitted with 5½ft of cable and J29 plugs. FR: 16Hz-20kHz. Distortion factor: less than 0.3% at intensities of 120 phn. Fluid-filled ear covers. Padded headband. Impedance: 400 ohms per system. Adaptor (279) to J21 plugs available. Price: £33.74 (including VAT).

#### HACKER RADIO LTD

Norreys Drive, Cox Green, Maidenhead, Berks, SL6 4BP. Tel: Maidenhead (0628) 22261.

#### HPI ★

Stereo headphones. Light and comfortable to wear. Supplied complete with coiled lead and jack plug. Impedance: 8-16 ohms. Price: to be announced.

#### HITACHI

Hitachi Sales (UK) Ltd, New Century House, Coronation Road, Park Royal, London, NW10 7QN. Tel: 01-965 9861.

#### HD66

Moving coil stereo headphones. Impedance: 8 ohms. FR: 20Hz-18kHz. Distortion: 1% at 1mW input. Input power: (normal listening) 1mW, (maximum) 500mW. 2½in diameter cones. 6½ft coiled cord. Weight: 12½oz. £9.90 (including VAT).

#### HD-55

Moving coil stereo headphones with specification similar to the HD66 above but with response 30Hz-15kHz. Price: £6.90 (including VAT).

■ **HOWLAND-WEST LTD**

3-5 Eden Grove, London, N7 8EQ.  
Tel: 01-609 0293.

**CIS.200**

Stereo headphones. Impedance: 8 ohms. Maximum input: 200mW. FR: 20Hz-15kHz. Weight: 12oz. Fitted stereo jack plug. Finish: grey with black pads. Price: £4-29 (including VAT).

**CIS.250**

Stereo headphones. Impedance: 8 ohms. Maximum input: 500mW. FR: 20Hz-20kHz. Weight: 14oz. Special stretch cord. Standard jack. Finish: black. Price: £8-25 (including VAT).

**CIS.300**

Stereo headphones. Supplied complete with standard stretch cable and alternative remote



Hacker stereo headphones HPI



Howland-West CIS.2000



Howland-West Headphone doubler

control cable featuring left- and right-channel volume controls and mono/stretch switch. FR: 18Hz-21kHz. Impedance: 8 ohms. Price: £10-56 (including VAT).

**CIS.500**

Stereo headphones. Impedance: 8 ohms. Maximum input: 500mW. FR: 20Hz-20kHz. Weight: 23oz. Stretch cord. Standard jack. Finish: white/black in luxury lined carry case. Dual concentric driver units in each earpiece (1½ in and ¾ in). Wirewound volume controls for each channel. Price: £16-50 (including VAT).

**CIS.800**

Stereo headphones. Impedance: 8 ohms. Maximum input: 400mW. FR: 20Hz-17kHz. Weight: 14oz. Fitted stereo jack plug. Finish: available in red, yellow or white, with black earpads. Price: £7-92 (including VAT).

**CIS.800V**

Similar to the CIS.800 but fitted with independent volume control on each earpiece. Price: £9-35 (including VAT).

**CIS.1000**

Stereo headphones. Impedance: 8 ohms. Maximum input: 500mW. FR: 20Hz-22kHz. Weight: 8oz. Fitted with stereo jack plug. Finish: polished metal with black earpads and headband. Price: £11-55 (including VAT).

**CIS.2000 ★**

Stereo headphones. Impedance: 8 ohms. Maximum input: 500mW. FR: 20Hz-22kHz. Fitted standard jack plug. Finish: green earpieces with black ear cushions. Removable stretch cord. Luxury carrying case. Price: £23-10 (including VAT).

**Headphone Doubler ★**

Splits headphone outlet and permits two pairs of stereo phones to be used. Mono/stereo switch. Independent volume controls for left and right channels. Stretch cord connection with standard jack plug fitted. Neat moulded box with control panel on top and outlet sockets for headphones. Price: to be announced.

■ **ITT COMPONENT GROUP EUROPE**

Standard Telephones & Cables Ltd,  
Electrical Products Division, Edinburgh Way,  
Harlow, Essex. Tel: Harlow 26811.

**65/1B ★**

Broadcast quality headset. FR: 30Hz-15kHz. Impedance: 300 ohms. Foam rubber earpads. Supplied complete with 54in tinsel cable. Price: on request.

■ **JECKLIN**

Distributors: Belcaire Trading, 59 Cheriton  
High Street, Folkestone, Kent  
Tel: Folkestone (0303) 76834



I.T.T. Components 65/1B

### Jacklin Float

Electrostatic headphones mounted on a metalized acrylic glass headband with foam cushioning. Transducers: electrostatic with constant-voltage charge. Size: 85×95mm. Membranes sealed in air-tight capsules. Interchangeable, plug-in modules. FR: 30Hz-18kHz±0dB. Sound level: 106dB for 10W into 8 ohms. Weight: 625gm. Cable length: 3 metres (10ft). Power supply/switching unit. Functions: speaker-headphone switching; polarizing supply for transducers; output transformer for electrostatic loudspeakers. System voltage: 1500V/0.002mA. Input/output: 8 ohms. Power handling: 80W at 8 ohms. Two sets of headphones may be connected. Price: on application.

### ■ JVC (UK) LTD

453 Caledonian Road, London, N7 9BA.  
Tel: 01-607 6568.

### STH-10E

Moving coil stereo headphones. FR: 20Hz-20kHz. Impedance: 8 ohms. Nominal input: 1mW. Maximum input: 500mW per channel. Distortion: < 1% at 1mW. 9½ft coiled cord. Padded headband and ear cushions. Price £14.30 (including VAT).

### 5944

Moving coil stereo and four-channel headphones. FR: 20Hz-20kHz. Impedance: (each channel) 8 ohms, (each terminal) 11 ohms. Nominal input: 1mW. Maximum input: 100mW. Distortion: < 0.5% at 1mW. 6½ft coiled cord. Built-in phase shifter switches. Soft ear cushions, adjustable padded headband. Two units per earpiece. Price: £25.30 (including VAT).

### ■ KALIMAR

Highgate Acoustics Ltd, 38 Jamestown Road, London, NW1 7EJ. Tel: 01-267 4937.

### T855

Stereo headphones. Impedance: 8-16 ohms and 400 ohms (switched). Maximum input: 0.5W. FR: 30Hz-20kHz. Weight: 15oz with cord. Three-pole jack plug, 6ft lead. Adjustable headband. Finish: cream with grey band and ear cushions. Price: £6.50 (plus VAT).

### T862

Stereo/mono headphones. Impedance: 8-16 ohms and 20K (switched). Maximum input: 0.5W. FR: 15Hz-20kHz. Weight: 12oz with cord. 7ft coiled cord. Three-pole jack plug. Finish: rosewood colour with black cord and padding. Individual volume adjustment. Adjustable headband. Price: £12.50 (plus VAT).

### T865

Stereo headphones. Impedance: 8 and 16 ohms. Maximum input: 0.5W. FR: 15Hz-20kHz. Weight: 14oz with cord. 13ft coiled lead. Three-pole jack plug. Individual slider volume controls for each earpiece. Adjustable headband. Finish: black and white. Price: £14.50 (plus VAT).

### ■ KOSS

Tape Music Distributors Ltd,  
114 Ashley Road, St Albans, Herts, AL1 5JR.  
Tel: St Albans (56) 64337. Telex: 28474.

### HV-1

Stereo dynamic headphones. Rear sound waves vented without raising resonance or limiting transient response. 2in driver units. Designed to operate from outputs of 3.2 to 600 ohms. FR: 20Hz-20kHz. HC: 5V RMS continuous. 10ft coiled three-core cable. Soft acoustical sponge earpieces. Extendable headband with pivoting yokes. Padded and vinyl covered. Weight: (less cord) 9½ oz. Price: £25 (plus VAT).

### K6 ★

Stereo headphones. Suitable for outputs of 4-16 ohms. Normal listening input: 95dB SPL - 18mV. Maximum input: 3.7V. FR: 10Hz-16kHz. HD: unmeasurable at 95dB SPL. Weight: 450gm. Special coiled cord, 3ft coiled, 10ft extended. Standard stereo jack plug. Bronze finish. Washable ear cushions. Adjustable headband. Price: £13.95 (plus VAT).

### K6LC

Stereo headphones. Suitable for outputs of 4-16 ohms. Normal listening input: 95dB SPL - 73mV. Maximum input: 1.25V. FR: 10Hz-16kHz. HD: unmeasurable at 95dB SPL. Weight: 450gm. Special coiled cord: 3ft coiled, 10ft extended. Standard stereo jack plug. Bronze finish. Washable ear cushions. Individual volume adjustment for each ear. Adjustable headband. Price: £15.95 (plus VAT).

### K711 and KR711

Stereo headphones. Suitable for outputs of 4-



Koss K6

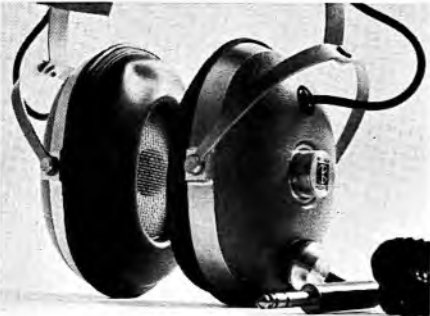

Koss PRO4AA

600 ohms. Normal listening input: 95dB SPL -1.4V. Maximum input: 29V. FR: 10Hz-17kHz. HD: <0.5% at 110dB SPL. Weight: 320gm. Special coiled cord: 3ft coiled, 10ft extended. Standard stereo jack plug. Finish: (K711) black moulding; (KRD711) red moulding. Adjustable headband. Price: £12.50 (plus VAT).

**KO727B**

Stereo headphones. Suitable for outputs of 4-16 ohms. Normal listening input: 95dB SPL -12mV. Maximum input: 2.6V. FR: 10Hz-18kHz. HD: unmeasurable at 95dB SPL. Weight: 450gm. Special coiled cord: 3ft coiled, 10ft extended. Standard stereo jack plug. Black finish. Washable ear cushions. Adjustable headband. Price: £18 (plus VAT).

**KO747**

Stereo headphones. Suitable for outputs of 4-16 ohms. Wired for mono and stereo with changeover switch. Weight: 500gm. Special coiled cord: 3ft coiled, 10ft extended. Standard stereo jack plug. Finish: two-tone brown. Washable ear cushions. Individual volume adjustment. Adjustable headband. Fluid-filled ear cushions. Frequency response is 30 to 20,000Hz with a distortion of less than 1% at maximum output of 110dB SPL. Impedance is nominally 300ohms

each channel but can be used with systems having output taps of 4, 8, or 16 ohms as well as with stereophone jacks at resistance values to 600 ohms. 10ft coiled cord.

**PRO4AA ★**

Stereo headphones. Suitable for outputs of 4-16 ohms. Normal listening input: 95dB SPL -260mV. Maximum input: 4.1V. FR: 10Hz-20kHz. HD: negligible at 95dB SPL. Weight: 650gm. Special coiled cord: 3ft coil, 10ft extended. Standard stereo jack plug. Finish: beige with black cushions. Washable ear cushions. Adjustable headband. Fluid-filled cushions. Price: £31.50 (plus VAT).

**PRO-5LC**

Professional dynamic headphones. FR: 10Hz-20kHz. Designed to work from amplifier outputs of 4-1000 ohms impedance. HC: not to exceed 5V RMS. Total harmonic distortion: <1% at 95dB SPL. Driver units: lin diameter voice coils, 4sq in radiating area. 10ft coiled cable. Fluid filled vinyl ear cushions. Extendable headband with pivoting yokes in stainless steel. Headband covered with soft moulded PVC and sponge rubber cushioning. Finish: beige with black cushions and cord, brushed chrome trim. Weight: 19oz. Price: £34.50 (plus VAT).

**ESP6**

Electrostatic stereo headphones. Suitable for outputs of 4-16 ohms. Normal listening input: 1V at 80dB SPL. Maximum input: 20V. FR: 30Hz-19kHz±5dB. HD: <0.2% at 110dB SPL. Weight: 850gm. Special coiled cord: 3ft coiled, 10ft extended. Standard stereo jack plug plus connector box. Finish: black. Washable fluid-filled ear cushions. Neon level indicators. Adjustable headband. Carry case included in price. Price: £59 (plus VAT).

**ESP9**

Electrostatic studio monitor stereo headphones. Suitable for outputs of 4-16 ohms. Normal listening input: 1V at 80dB SPL. Maximum input: 20V. FR: 15Hz-15kHz±2dB (10Hz-19kHz±5dB). Weight: 590gm. 6ft cord. Supplied with speaker output terminals. Finish: black. Fluid-filled ear cushions. AC or self-energised selector switch. Price: £79 (plus VAT).

**K2+2**

Four-channel dynamic headphones. Wired for stereo and quadraphonic. Suitable for outputs of 3-600 ohms. Normal listening input: 1.4V at 95dB SPL. Maximum input: 29V. FR: 10Hz-20kHz. HD: negligible at 95dB SPL. Weight: 600gm. Special coiled cord: 3ft coiled, 10ft extended. Two headphone jack plugs. Black finish. Washable fluid-filled ear cushions. Adjustable headbands. Switch for two- or four-channel operation. Price: £49 (plus VAT).



Koss K-6LCQ

#### **Two-way adaptor TPA**

For connecting two pairs of headphones to single output. Extends length by 3ft. Price: £3.25 (plus VAT).

#### **Extension cable EC25KK**

25ft coiled cord terminated with stereo jack plug and socket. Price: £4 (plus VAT).

#### **T3 Switchbox**

Speaker/headphone switchbox. Jack socket for phones, terminals for speaker and connection to amplifier output. Switch selects speakers on or off. Price: £4 (plus VAT).

#### **T4A Connector box**

Accepts up to five pairs of stereo headphones. 14ft extension lead with jack plug for amplifier. Simulated rosewood base with black trim, spun aluminium panel. Price: £7.50 (plus VAT).

#### **T-5D**

Remote control station suitable for running two pairs of stereo headphones. Speaker on/off switch incorporated, but headphones are always on. The volume of headphones plugged into left-hand jack individually controlled (other set of headphones controlled by volume knob on amplifier). Fitted DIN sockets for amplifier and speaker connections. Matches any amplifier with 4, 8 or 16 ohms output. Finish: black with simulated walnut top. Connecting cable seven-core colour-coded 3ft long. Size:  $3\frac{1}{8} \times 3\frac{1}{8} \times 2\frac{3}{8}$  in. Weight:  $10\frac{1}{2}$  oz. Price: £8.50 (plus VAT).

#### **T10A**

Chairside listening station. Provides separate volume controls for two pairs of stereo headphones, also speaker on/off switch. Wires



Koss HV/1LC

directly to amplifier output. Seven-core flat cable suitable for under carpet installation. Tinted plastic cover. Price: £11.50 (plus VAT).

#### **Continental adaptor leads**

For use with amplifiers having DIN output sockets instead of jack sockets. Comprises: two DIN speaker plugs with lead and stereo jack socket. Two 100-ohm resistors inserted for attenuation. Price: £1.50 (plus VAT).

#### **K-6LCQ ★**

Quadraphonic headphones with 4 drivers. Operates from 3.2 ohms to 600 ohms impedance. Power for normal listening level (1kHz): 160mW. Max. input: 5V RMS with provision for 14dB transients above this. FR: 20Hz-17kHz. THD: 0.5% at 109dB-SPL. Sensitivity: 90dB-SPL/100mV (2-channel) 96dB-SPL (4-channel). Cord length: 120in. Two stereo jacks. Brown finish. Price: £29 (plus VAT).

#### **Pro-5Q**

Quadraphonic headphones with four drivers. Operate from 3.2 ohms to 600 ohms. Power for normal listening level (1kHz): 160mW. Max. input: 5V RMS with provision for 14dB transient peaks beyond this. FR: 20Hz-20kHz. THD: <0.5% at 109dB-SPL. Sensitivity: 90dB-SPL/100mV (2-channel) 96dB-SPL/100mV (4-channel). Weight: 21oz. Cord length: 120in. Two stereo jack plugs. Brown finish. Price: £45 (plus VAT).

#### **K0-747Q**

Quadraphonic headphones with four drivers. Operate from 3.2 ohms to 600 ohms. Power for normal listening level (1kHz): 160mW. Max. input: 5V RMS with provision for 14dB

transient peaks beyond this. FR: 20Hz-19kHz. THD: < 0.5% at 109dB-SPL. Sensitivity: 90dB-SPL/100mV (2-channel) 96dB-SPL/100mV (4-channel). Weight: 22oz. Cord length: 120in. Two stereo jack plugs. Brown finish. Price: £42 (including VAT).

**K2+2**

Four-channel dynamic headphones. Wired for quadrasonic and stereo. Suitable for amplifiers having output impedance of 3-600 ohms. Normal listening input: 1.4V at 95dB-SPL. Maximum input: 29V. FR: 10Hz-20kHz. HD: negligible at 95dB-SPL. Weight: 600gm. Special coiled cord: 3ft coiled, 10ft extended. Two headphone jack plugs. Black finish. Washable fluid-filled earcushions. Switch for two- or four-channel operation. Price: £49 (plus VAT).

**HV/ILC ★**

High velocity stereo headphones. Specifications. Elements: 2in diameter velocity operated. Source impedance: 3.2 to 600 ohms. FR: 20Hz-20kHz. Distortion: 0.5% at 109dB-SPL. Sound pressure level: 95dB-SPL 0.6V RMS. Power handling: 5V RMS continuous. Ear cushions: soft acoustical foam. Volume/balance controls: one miniature rotary type per earcup. Weight: 280gm. Price: £29 (plus VAT).

**■ MAC**

Modular Audio Components Ltd, Canterbury Road, Nottingham, NG8 1PQ. Tel: Nottingham (0602) 862647.

**AAU-TV**

Provides a ready means of connecting various items of Hi-Fi equipment to a Television Receiver with complete safety. Built-in Isolating Transformer, tapped 3-8-15 ohms, for matching external speaker. Switchable output attenuator for matching input of amplifier or tape recorder. Switching circuit enables TV speaker to be switched on or off as required. Phone jack fitted to suit low impedance headphones. Price: £8.40 (plus VAT).

**AAU-2**

Audio adaptor unit with three-way switch and socket for headphones. Screw connections for a stereo pair of main speakers and a stereo pair of extension speakers. Switch positions give: main speakers only, extension speakers and phones, main and extension speakers. Colour-coded four-way connecting cable. Finish: panel and knob jaguar silver. Price: £4.40 (plus VAT).

**AAU-HP**

Audio adaptor unit for connecting up to four stereo headphones to a stereo amplifier. Individual gain controls with balancing resistive networks incorporated. Fitted with 3ft connecting cable with 3-pole jack plug. Size: 3¼ × 3¼ × 3½ in.

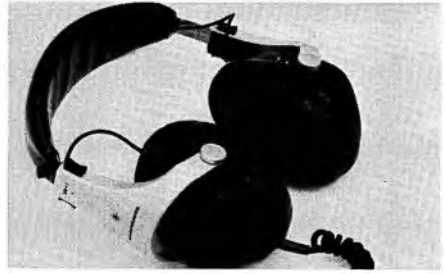

Marantz SD1

Finish: jaguar silver. Price: £8 (plus VAT).

All MAC AAU units are available in solid teak case at an additional cost of £1.32 (plus VAT).

**■ MARANTZ**

Pyser Ltd, Fircroft Way, Edenbridge, Kent. Tel: Edenbridge (0732-71) 4111.

**SD1 ★**

Stereo headphones. Impedance: 8 ohms. Max input: 1W. FR: 20Hz-20kHz. Weight: 11b. 10ft cable with jack plug. Finished in gold with black leather ear cushions and fully adjustable headband. Price: £12.65 (including VAT).

**■ MEDWAY**

Brahms Manufacturing and Development Company, Unit E, Rochester Airport, Maidstone Road, Rochester, Kent, ME1 3QJ. Tel: Medway (0634) 48816.

**MHP101**

Stereo headphones. Impedance: 8 ohms. Max input: 500mW. FR: 20Hz-20kHz. Weight: 11b approx. Cable: coiled lead extending to 12ft. Stereo headphones. Impedance: 8 ohms. Max with black padded headband and earmuffs. Adjustable headband. Price: £6.11 (including VAT).

**■ MICRO**

Howland-West Ltd, 3-5 Eden Grove, London, N7 8EQ. Tel: 01-609 0293.

**MX1**

Comprises headset MS2 and power source MP1. Stereo electrostatic headphones. Impedance: 8 ohms. Maximum input: 8V at 1kHz RMS. FR: 20Hz-20kHz ± 1dB. HD: < 1% at 115dB sound pressure level. Sensitivity: 98dB sound pressure level at 1kHz. Cord: 8ft approx. Finish: metallic and black. Extension cable available to enable two sets of headphones to be used from a single power source. Power supply: single PP9 battery gives about 2000 hours listening. Price: £39.60 (including VAT).

★ Indicates entry is illustrated

■ **NATIONAL PANASONIC (UK) LTD**

Building No 63, Whitby Road,  
Trading Estate, Slough, Bucks.  
Tel: Slough 34522.

**EAH75**

Stereo headphones. Price: £6-50 (including VAT).

**EAH65**

Stereo headphones. Price: £9-95 (including VAT).

**EAH60**

Stereo headphones. Price: £12-50 (including VAT).

**EAH88**

Stereo headphones. Price: £19-95 (including VAT).

**EAH80**

Electrostatic stereo headphones. Price: £34-95 (including VAT).

■ **NIKKO**

Nikko Electric Mfg. Co Ltd,  
Distributors: Howland-West Ltd,  
3-5 Eden Grove, London, N7 8EQ.  
Tel: 01-609 0293.

**HW3S**

Stereo headphones. Single speaker. Impedance: 8 ohms. FR: 20Hz-18kHz. Max input: 0.3W. Price: £5 (plus 50p VAT).

**77S ★**

Stereo headphones. High response lightweight phones with silicon varistor overload protection. FR: 18Hz-21kHz. Sensitivity: 105dB/mV. Max input: 0.3W. Price: £16 (plus £1.60 VAT).

■ **ONKYO**

J. Parkar & Co (London) Ltd,  
Parkar House, Beresford Avenue,  
Wembley, Middlesex, HA0 1YX.  
Tel: 01-903 5211.

Onkyo Headphones Model No 737 with sliding volume control. Price: £7-90 (plus VAT).

Onkyo Headphones Model No 747 with sliding volume control. Price: £13 (plus VAT).

■ **PHILIPS ELECTRICAL LTD**

Century House, Shaftesbury Avenue, London, WC2H 8AS. Tel: 01-437 7777.

**N6300**

Stereo headphones. Impedance: 600 ohms each channel. FR: 40Hz-18kHz. Price: £7 (including VAT).

**N6301**

Stereo headphones. Impedance: 600 ohms each channel. FR: 20Hz-20kHz. Price: £11 (including VAT).

**N6302**

Stereo headphones fitted with stereo sound

# ROSS ELECTRONICS

THE NAME FOR  
HEADPHONES



32 Rathbone Place, London W1P 1AD. Tel: 01-580 7112/3



Nikko 775

'dimension control' to permit listener to adjust stereo effect to suit personal taste. FR: 16Hz-20kHz. Impedance: 600 ohms. Price: £22 (including VAT).

■ PICKERING

Highgate Acoustics, 38 Jamestown Road, London, NW1 7EJ. Tel: 01-267 4937.

OA1

Dynamic 8 ohm headphones. Max. input: 300mW RMS. FR: 30Hz-19kHz. Weight: 10.9oz. Cord length: 84in. Jack plug. Price: £9.35 (including VAT).

OA3

Dynamic 15 ohm headphones. Max. input: 200mW RMS. FR: 20Hz-20kHz. Weight: 7.5oz. Cord length: 120in. Jack plug. Price: £19.35 (including VAT).

PH4933

Dynamic 8 ohm headphones. Max. input: 500mW RMS. FR: 30Hz-20kHz. Weight: 21oz. Cord length: 120in. Jack plug. Price: £22 (including VAT).

PH4955

Dynamic 8 ohm headphones. Max: 500mW RMS. FR: 10Hz-22kHz. Weight: 28oz. Cord length: 120in. Jack plug. Sensitivity: 100dB-SPL/0-11V. Price: £30.80 (including VAT).

■ PIONEER

Shriro (UK) Ltd, Shriro House, The Ridgeway, Iver, Bucks, SL0 9JL. Tel: Cedarwood (07538) 2222.

SE505

Dynamic headphones. Impedance: 4-16 ohms. Maximum power input: 500mW. FR: 20Hz-20kHz. Distortion: 1%. Sensitivity: 108dB at 300mV. Weight: 690gm. Cord length: approximately 60in. Jack plug. Two-way speaker volume/tone controls. Price: to be announced.

SE305

Dynamic headphones. Impedance: 4-16 ohms. Maximum power input: 500mW. FR: 20Hz-



Ross RE220

20kHz. Distortion: 1%. Sensitivity: 113dB at 300mV. Weight: 435gm. Cord length: 60in. Jack plug. Price: to be announced.

SE205

Dynamic headphones. Impedance: 4-16 ohms. Maximum power input: 500mW. FR: 20Hz-20kHz. Distortion: 1%. Sensitivity: 115dB at 30mV. Weight: 450gm. Cord length: 84in. Jack plug. Price: to be announced.

SE100J

Electret headphones. Impedance: 4-16 ohms. Maximum power input 500mW. FR: 20Hz-35kHz. Distortion: 1%. Sensitivity: 95dB at 100mV. Weight: 360gm. Cord length: 84in. Adaptor unit in walnut case included. Price: to be announced.

■ ROSS

Ross Marks Ltd, 32, Rathbone Place, London, W1P 1AD. Tel: 01-580 7112.

RE-220 ★

Budget stereo headphones. Lightweight headband, padded earmuffs. FR: 20-20,000Hz. Maximum input: 200mW. Impedance: 8 ohms. 10ft lead. Price: £3.93 (including VAT).

RE-225

Stereo headphones with lightweight adjustable headband, padded earmuffs. FR: 20-20,000Hz. Maximum input: 200mW. Impedance: 8 ohms. 3-metre spiral cord. Price: £5.25 (including VAT).

RE-230

Stereo headphones with fully padded adjustable headband and earmuffs. Independent volume controls. FR: 20-20,000Hz. Maximum input: 200mW. Impedance: 8 ohms. 3-metre spiral cord. Price: £7.12 (including VAT).

RE-235

Super lightweight stereo headphones. One-piece plastic covered adjustable headband; foam earmuffs. Earpiece and headband finished bright yellow. FR: 20-17,000Hz. Impedance: 8 ohms. 6ft lead. Price: £7.73 (including VAT).





Ross RE-264

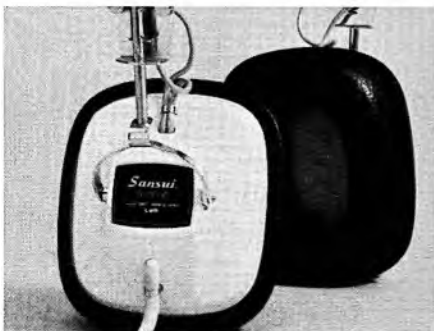

Sansui SS2

**RE-240**

Stereo headphones with leather grain padded headband and earmuffs. Fitted 3in diameter wide-range loudspeakers and slide volume controls. FR: 20-20,000Hz. Maximum input: 1W. Impedance: 8 ohms. 3-metre spiral cord. Price: £9.60 (including VAT).

**RE-245**

Mono/stereo headphones. Leather grain padded headband and earmuffs. Fitted 3in diameter loudspeakers, slide controls for volume and bass/treble. Mono/stereo switch. FR: 20-20,000Hz. Maximum input: 1W. Impedance: 8 ohms. 3-metre spiral cord. Price: £11.25 (including VAT).

**RE-250**

Semi-professional stereo headphones. Lightweight headband, padded earmuffs. Fitted with specially designed, 60mm mylar cone loudspeakers. Independent slide volume controls. FR: 20-22,000Hz. Maximum input 500mW. Sensitivity: 130dB at 800Hz for 1mW. Impedance: 8 ohms. 3½-metre spiral cord. Price: £11.25 (including VAT).



Sennheiser HD.110



Sennheiser HMD.414

**RE-255**

Semi-professional stereo headphones. Padded adjustable headband and earmuffs. Fitted high-grade, wide-range loudspeakers and recessed, vertically operated slide controls for volume and bass/treble. FR: 20-20,000Hz. Sensitivity: 108dB at 1000Hz. for 1mW output. Impedance: 8 ohms. 3-metre spiral cord. Price: £15.05 (including VAT).

**RE-264 ★**

Stereo/quadrasonic headphones. Padded headband and earmuffs. Fitted with 50mm front and rear loudspeakers angled to provide realistic 4-channel listening from discrete or matrix systems. Maximum input: 200mW per channel. Impedance: 8 ohms. Price: £10.82 (including VAT).

**JB-3 Stereo Headphone Junction Box**

Provides switched selection of headphones only, loudspeakers only or both. Connecting leads have spade terminals. Price: £11.97 (including VAT).

**JB-3D**

As above, but with connecting leads fitted with

2-pin DIN plugs. Price: £2.28 (including VAT).

**RE-208 Stereo Headphone Junction Box**

Provides 3-way switched selection of headphones only, loudspeakers only or both. Fitted with 2-pin DIN plug connectors and input sockets, and twin headphone sockets. Price: £2.99 (including VAT).

**RE-202 Stereo Headphone Extension Lead**

Spiral lead fitted with stereo jack plug one end, jack socket at other. Lead extends to 25ft. Price: £2.05 (including VAT).

**ROTEL**

Rank Audio Visual Ltd, PO Box 70, Great West Road, Brentford, Middlesex, TW8 9HR. Tel: 01-568 9222.

**RH630**

Stereo headphones. Impedance: 8 ohms. Price: £10.25 (including VAT).

**RH700**

Stereo headphones. Impedance: 8-16 ohms. Maximum input: 500mW. FR: 20Hz-20kHz. 10ft coiled cord. Black headband and ear cushions. Adjustable headband. Price: £15.50 (including VAT).

**RH430**

Stereo headphones. Impedance: 8 ohms. Price: £6.25 (including VAT).

**SANSUI**

Vernitron Ltd, Thornhill, Southampton, SO9 5QF. Tel: Southampton (0703) 444811.

**SS2 ★**

Stereo headphones. Impedance: 8 ohms. Normal listening input: 1mW. Maximum input: 500mW. FR: 20Hz-18kHz. HD: < 1%. Weight: 12½oz. Cord: 6ft. Three-pole jack plug. Black headband and ear cushions, white earpieces. Adjustable headband, washable ear cushions. Price: £8.51 (plus VAT).

**SS10**

Stereo headphones. Impedance: 8 ohms. Normal listening input: 1mW. Maximum input: 500mW. FR: 20Hz-20kHz. HD: < 0.8%. Sensitivity: better than 110dB. Weight: 22oz. 9.8ft coiled cord. Three-pole jack plug. Washable ear cushions. Individual volume adjustment. 6½ft dual extension lead. Black headband, white earpieces. Price: £14.72 (plus VAT).

**SS20**

Stereo headphones. Impedance: 8 ohms. Normal listening input: 1mW. Maximum input: 500mW. FR: 20Hz-20kHz. HD: < 0.8%. Sensitivity: 105dB at 200Hz. Weight: 27½oz. 8ft coiled cord. Individual volume adjustment. Individual tone adjustment. Adjustable headband. 6½ft dual extension lead. Two drive units in each earpiece. Black headband and ear-

cushions, white earpieces. Price: £19.52 (plus VAT).

**SCAN-DYNA**

Scandinavian Audio Systems Ltd, Sun Alliance Building, 65 London Road, Gloucester, GL1 3HF. Tel: Gloucester (0452) 32791.

**K72**

Stereo headphones. Impedance: 4-16 ohms per channel. FR: 20Hz-20kHz. Sensitivity: 95dB with 0.2% distortion. Weight: 12½oz. Coiled cord (11½ft extended). Standard jack plug. Three-position tone control. Individual volume control for left and right in line lead. Price: £16.90 (including VAT).

**SENNHEISER ELECTRONIC**

Distributors: Hayden Laboratories Ltd, Hayden House, 17 Chesham Road, Amersham, Bucks, HP6 5AG. Tel: Amersham (02403) 5511.

Audio showroom, service department and despatch department: 6 Bendall Mews, Bell Street, London, NW1.

**HD.110 ★**

Stereo headphones wired for mono and stereo. Robust design. Removable washable ear cushions. Easily replaceable cable. FR: 20Hz-20kHz. Impedance: 200 ohms ± 15% per earpiece. Output: 1mW per capsule produces 98dB (16µbar) at 1kHz. Maximum output: 120dB (200µbar) for 1% distortion. Weight: 10oz. Price: £29.25 (plus VAT).

**HD.414**

Stereo headphones. Wired for mono or stereo. Lightweight robust design. Removable washable sponge ear pads. FR: 20Hz-20kHz. Impedance: 2000 ohms per capsule. Weight: 5oz. Price: £13.50 (plus VAT).

**HMD.110**

Stereo headset type HD.110 with close-talking boom microphone. FR: 50Hz-14kHz. Response tailored for close speaking. Sensitivity: 0.07mV/µbar. Impedance: 200 ohms. Price: £33.75 (plus VAT).

**HMD.414 ★**

Stereo headset HD.414 with close-talking boom microphone located near corner of mouth. Especially high ratio of desired sound to background noise. Sensitivity: 0.1mV/µbar. Impedance: 200 ohms. Price: £32.65 (plus VAT).

**HD.44**

Ultra light stereo headphones with volume control on each capsule. Can be used mono. FR: 40Hz-15kHz. Impedance: 640 ohms. Weight: 33gm. Price: £8.50 (plus VAT).

**HD.424**

Stereo headphones (can be used mono) with

★ Indicates entry is illustrated

good low frequency response. FR: 16Hz-20kHz. Impedance: 2K. Weight: 170gm. Price: £22 (plus VAT).

#### **HD.412**

Stick type headphone designed for use in record booths, etc. FR: 20Hz-20kHz. Impedance: 2K. Price: £14.25 (plus VAT).

#### **HD.4004**

Lightweight mono stethoset. Weight: 19gm. FR: 100Hz-6kHz. Impedance: 17 ohms. Price: £6.50 (plus VAT).

#### **■ SHARP**

Sharp Electronics (UK) Ltd, 107 Hulme Hall Lane, Manchester, M10 8HL.

Tel: 061-205 7321.

#### **HP100**

Stereo headphones. Fully adjustable slide fittings. Double headband. Padded comfortable earpieces. FR: 30Hz-18kHz. Complete with lead and jack plug. Price: £7.49 (plus 75p VAT).

#### **HP200**

Stereo headphones. Fully adjustable slide fittings. Single headband. Padded comfortable earpieces. FR: 30Hz-17kHz. Complete with lead and jack plug. Price: £5.45 (plus 54p VAT).

#### **HP400**

Stereo headphones. Fully adjustable slide fittings. Extra thick padding for comfort. Twin units in each earpiece. Independent volume controls. FR: 30Hz-20kHz. Complete with lead and jack plug. Price: £17.72 (plus £1.77 VAT).

#### **■ SONAB LTD**

PO Box 4, Oldfield Road, Hampton, Middlesex, TW12 2HN. Tel: 01-979 0134.

#### **H10**

Stereo headphones. Moving coil. Impedance: 400 ohms per earpiece. Maximum input: 100mW. HD: <1% at 120dB at 1kHz. FR: 20Hz-16kHz. Close-fitting, plastic-faced, foam plastic ear cushions. 8½ft cable with jack plug. Finish: red moulded earpieces. Gimballed mounted. Price: £21.13 (plus VAT).

#### **H20**

Stereo headphones. Moving coil. Impedance: 400 ohms per earpiece. Maximum input: 250mW. HD: <0.3% at 120dB at 1kHz. FR: 20Hz-20kHz. Close fitting, plastic-faced, foam plastic earcushions. 12½ft cable with jack plug. Finish: black moulded earpieces, matt nickel plate. Gimballed mounted. Price: £26.82 (plus VAT).

#### **■ SONY (UK) LTD**

Pyrene House, Sunbury Cross, Sunbury-on-Thames, Middlesex. Tel: Sunbury-on-Thames (76) 87644.

#### **DR4A, DR4C**

Stereo headphones. Impedance: (DR4A) 8 ohms, (DR4C) 10K. Normal listening input: 1mW. Max input: 100mW. FR: 50Hz-17kHz. Cord: two metres. Standard ¼in jack plug. Lightweight. Black vinyl earpads with aluminium fittings. Adjustable headband. Price: (DR4A) £9.35 (plus VAT); (DR4C) £10.45 (plus VAT).

#### **DR5A**

Stereo headphones. Impedance: 8 ohms. Normal listening input: 1mW. Max input: 100mW. FR: 50Hz-17kHz. Cord: two metres. ¼in standard jackplug. Double adjustable headband. Larger earpads than DR4A. Price: £7.43 (plus VAT).

#### **■ STAX**

Distributor: Wilmex Ltd, Stax Division, 24-26 Ensign Street, London, E1.

Tel: 01-949 2545.

#### **Stax SR-3**

Lightweight electrostatic headphones. Push/pull operation. FR: 30Hz-25kHz. Impedance: 130K at 10kHz. Sound pressure level: 95dB at input 100V RMS. Polarising voltage: 200V DC. Adjustable headband. All metal parts stainless steel. Ear cushions of soft vinyl leather, replaceable. Total weight approximately 11lb, including cord. Price: see SRD-5 adaptor below.

#### **Stax SRD-6**

Adaptor for use with SR-3 phones. Connects to amplifier output and provides switching between speakers and headphones, also supplies polarising voltage to phones. Mains: 110-120V AC, 200-240V AC. Price: (complete system comprising SR-3 phones and SRD-6 adaptor) approximately £56 (including VAT).

#### **■ THORN CONSUMER ELECTRONICS**

284 Southbury Road, Enfield, Middlesex.

Tel: 01-366 1155.

#### **Monitoring Stethoset TA/29**

Stethoscope type earpiece to monitor programme during tape recording. Fitted with continental speaker plug. Designed primarily for use with Marconiphone and Ferguson tape recorders. Price: £1.60 (including VAT).

#### **TA/39**

Stereo headphones. General purpose. Fitted with standard jack plug. Price: £8.91 (including VAT).

#### **TA/41**

Stereo headphones. 600 ohm impedance: High performance. Price: £10.97 (including VAT).

#### **■ TRIO**

B. H. Morris & Co (Radio) Ltd, Trio House, The Hyde, London, NW9 6JP. Tel: 01-205 6441.



Wharfedale Isodynamic headphones

**KH71**

Stereo headphones. Impedance: 8 ohms. Maximum input: 500mW. FR: 20Hz-20kHz. Weight: 1lb. 10ft cloth-covered cord. Brown—real leather finish. Padded headband and ear cushions. Uni-pivot device makes headphones particularly suitable for spectacle wearers. Open-back system. Price: £18 (plus VAT).

**KH51**

Stereo headphones. Impedance: 8 ohms. Maximum input: 500mW. FR: 20Hz-20kHz. Weight: 15oz. 6½ft vinyl-covered cord. Brown—simulated leather finish. Padded headband and ear cushions. Uni-pivot device makes headphones particularly suitable for spectacle wearers. Open-back system. Price: £11 (plus VAT).

■ **TTC**

TTC Division, Precision Centre, Heather Park Drive, Wembley, Middlesex, HA0 1SU. Tel: 01-903 0144.

**G3000**

Dynamic 8 ohm headphones including an in-line control box with volume controls and stereo/mono switch. White finish. FR: 20Hz-20kHz. Price: £13.75 (including VAT).

**G5555**

Dynamic 8 ohm headphones. Finished in black. FR: 20Hz-20kHz. Jack plug. Price: £16.50 (including VAT).

**G3600**

Quadraphonic headphones fitted with four drive units angled for maximum effect. Will also operate in stereo. 8 ohm impedance. FR: 20Hz-20kHz. Coded stereo jacks. Price: £20.90 (including VAT).

**G8030**

Electrostatic headphones with control unit, matching 4-16 ohm impedances. FR: 10Hz-25kHz. Price: £49.50 (including VAT).

**G1000**

Dynamic 8 ohm headphones. FR: 35Hz-16kHz. White finish. Price: £3.96 (including VAT).

**G1111**

Dynamic 8 ohm headphones. Grey finish. Jack plug. FR: 25Hz-15kHz. Price: £5.72 (including VAT).

**G2222**

Dynamic 8 ohm headphones fitted with stereo/mono switch, level controls on each earpiece and a coiled lead. FR: 20Hz-18kHz. Price: £8.80 (including VAT).

**G8000**

Dynamic 8 ohm headphones fitted with ventilated headband and 2in mylar cone drive units. Grey finish. FR: 20Hz-22kHz. Jack plug. Price: £11.44 (including VAT).

**G6000**

Dynamic 8 ohm headphones with slide volume controls on each earpiece and stereo/mono switch. White finish. FR: 20Hz-20kHz. Jack plug. Price: £12.10 (including VAT).

■ **UHER**

Distributors: Uher (UK) Ltd, 15 Broomhills Estate, Braintree, Essex. Tel: Braintree 23192.

**W671A**

Stereo moving-coil headphones. Price: £21.20 (plus VAT).

**W673**

Stereo moving-coil headphones for use with Uher Compact Report Stereo. Price: £21.20 (plus VAT).

■ **WHARFEDALE**

Rank Radio International Ltd, PO Box 596, Power Road, Chiswick, London, W4 5PW. Tel: 01-994 6491.

**D.D.1**

Dynamic moving-coil stereo headphones. Two way system (i.e. separate bass and treble units) with electrical crossover network. Impedance: 8-16 ohms. FR: 16Hz-22kHz ± 3dB. Distortion: less than 1%. Supplied with 4½m (15ft) non-tangle coiled cable. Cushions readily removable for easy cleaning. Price: £13.75 (including VAT).

**Isodynamic Headphones ★**

High quality headphones using an electromagnetic technique which distributes the drive over the whole of the diaphragm in the manner of an electrostatic system. Impedance: 40 ohms per capsule but suitable for connection to the output terminals of amplifiers with impedance of 8 ohms. Response down to 35Hz without need for strong side force to seal the cups to the head. Light weight. Adjustable padded headband. Coiled lead. Soft ear pads. Modern white plastic appearance. Price: £21.95 (including VAT).

# Why Agfa-Gevaert's professional tape was made for amateurs.

It's a fact that most "professional tape is just that.

Only professionals can afford it.

And it only works properly on big, expensive professional machines.

That's why Agfa developed their own Professional tape. PEM 368 and PEM 268.

So now amateurs can have the pros without the cons.

## Why our matt black back means better winding.

Agfa PEM tape has a studio-type matt backing.

This matt coating gives you firm, even winding, particularly on the new generation of semi-professional machines.

And what's more it prevents static build-up, so your precious tapes stay dust-free.

## How our needle-shaped oxide gives sharper sound.

The new needle-shaped ferric oxide coating on PEM tape is designed for lower HF distortion, better high frequency performance and 40% less tape hiss than conventional low-noise tape.

And we've polished the oxide coat to reduce wear and flutter due to friction.

## Agfa PEM tape and your machine.

Specially suited to Agfa's PEM tape are high quality machines like Revox, Teac and Nagra.

So try PEM tape for yourself, and find out why our Professional tape is so good for amateurs.

Contact Ted Bowden at:  
Agfa-Gevaert Ltd., 27 Great West Road,  
Brentford, Middlesex TW8 9AX.



# Magnetic Tape

Abbreviations used in this section are given on page 20.

## ■ AGFA-GEVAERT LTD

Great West Road, Brentford, Middlesex.  
Tel: 01-560 2131 (20 lines). Telex: 28154.

### PE36

Low-noise, long-play tape supplied in plastic library case. 13cm 270m £2.18; 15cm 360m £2.49½; 18cm 540m £3.59½; 26cm 1280m £8.95½. All prices include VAT.

### PE46

Low-noise, double-play tape supplied in plastic library case. 13cm 360m £2.58½; 15cm 540m £3.59½; 18cm 720m £4.45½. Prices include VAT.

### PE66

Low-noise, triple-play tape supplied in plastic library case. 13cm 540m £3.74; 15cm 720m £4.51; 18cm 1080m £5.61. Prices include VAT.

### PEM368

Low-noise, long-play, matt-backed tapes supplied in plastic library case. Metal spools: 13cm 270m £2.64; 18cm 540m £4.62; 26cm 1100m £9.46. Plastic spools: 13cm 270m £2.38½; 18cm 540m £4.18; 26cm 1100m £8.54½.

### PEM268

Low-noise, double-play, matt-backed tape supplied in plastic library case. Metal spools: 13cm 320m £2.98½; 18cm 640m £5.55½. Plastic spools: 13cm 320m £2.70; 18cm 640m £5.00½.

### Compact Cassettes

Conventional and colour. C60 (2×30 min) 82½p; C90 (2×45 min) £1.14; C120 (2×60 min) £1.71½. All prices include 10% VAT.

### Cassette Album

Three C60 plus three C90 cassettes. £5.89 (including VAT).

### Stereochrom

Chromium dioxide tape cassettes. C60 (2×30 min) £1.48; C90 (2×45 min) £1.92. All prices include 10% VAT.

### Super Cassettes

Super C60+6 (2×33 min) £1.04½; Super C90+6 (2×48 min) £1.37½; Super C120 (2×60 min) £2.10. All prices include 10% VAT.

For empty library boxes and spare spools see Tape Accessories Section.

## ■ AUDIO MAGNETICS (UK) LTD

12 Life Road, Kingston-on-Thames, KT1 1SZ.  
Tel: 01-549 3271/2.

### Compact Cassettes

C60. In library case. Low-noise tape giving 60 min recording time. Price: 50p.

C90. In library case. Low-noise tape giving 90 min recording time. Price: 70p.

C120. In library case. Low-noise tape giving 120 min recording time. Price: 90p.

Also available in budget priced economy packs of three cassettes (without library case), and in the well-known Twinpack presentation.

## ■ BASF UNITED KINGDOM LTD

Audio/Video Tapes Division, PO Box 473, Knightsbridge House, 197 Knightsbridge, London, SW7 1SA.  
Tel: 01-584 5080. Telex: 267574.

### LP35 Long Play Tape

Long play. Round pack: 3in 210ft 67p; 5in 900ft £1.66; 5½in 1200ft £1.99; 7in 1800ft £2.84. In plastic swivel box: 5in 900ft £1.87; 5½in 1200ft £2.15; 7in 1800ft £3.12. All prices exclude VAT.

### LP35 LH

Long play. Low noise, high output. In plastic swivel box: 5in 900ft £2.18; 5½in 1200ft £2.50; 7in 1800ft £3.59/cardboard box; 10in 3280ft £6.65; 10½in 4200ft £8.95. All prices exclude VAT.

### DP26

Double play. Round pack: 3in 300ft 95p; 5in 1200ft £2; 5½in 1800ft £3; 7in 2400ft £3.70. In plastic swivel box: 5in 1200ft £2.15; 5½in 1800ft £3.15; 7in 2400ft £3.85. All prices exclude VAT.

### DP26 LH

Double play. Low noise, high output. In plastic swivel box: 5in 1200ft £2.58; 5½in 1800ft £3.60; 7in 2400ft £4.45. All prices exclude VAT.

### TP18

Triple play. Round pack: 4in 900ft £1.80; 8in 1800ft £3; 5½in 2400ft £3.60; 7in 3600ft £4.50. In plastic swivel box: 4in 900ft £1.87; 5in 1800ft £3.12; 5½in 2400ft £3.85; 7in 3600ft £4.82. All prices exclude VAT.

### TP18 LH

Triple play. Low noise, high output. In plastic swivel box: 5in 1800ft £3.74; 5½in 2400ft £4.50; 7in 3600ft £5.60. All prices exclude VAT.

### LPR35 LH Matt back

Semi-professional, long play, low noise, high output tape with conductive matt back for fast winding machines using metal reels. Soft plastic box: 7in 1770ft £5.94; 10½in 3610ft £11.55. All prices exclude VAT.

### DPR26 LH Matt back

As LPR35 LH Matt back, but double play tape: 7in 2100ft £6.93; 8½in 3000ft £10.23; 10½in 4200ft £13.53. All prices exclude VAT.

### Compact Cassettes

BASF LH tape, in snap pack box: C30 68p;

★ Indicates entry is illustrated

C60 80p; C90 £1.10; C120 £1.62. All prices exclude VAT.

### SM Compact Cassettes

Incorporate BASF special mechanics for smooth winding and avoidance of jamming. Reduces wow and flutter. In snap pack box: C60 90p; C90 £1.20; C120 £1.72. All prices exclude VAT.

### Chromium Dioxide Cassettes (SM)

CrO<sub>2</sub> tape, better dynamic range, lower background noise, when used with suitable machines. Special mechanics incorporated snap pack box: C60 £1.40; C90 £1.80; C120 £2.40. All prices exclude VAT.

### 8-track Cartridges (unrecorded)

45min price will be advised; 64min £1.75; 90min price will be advised. All prices exclude VAT.

### Special requirements tapes

See details in Tape Accessories Section.

### ■ CAPITOL 2

Musitapes, 402 Edgware Road, London, W2 1ED. Tel: 01-723 7491.

High output low noise cassettes available in C40, C60, C90 and C120. Packed in a self-stacking plastic storage drawer in pairs.

### ■ EMI TAPE LTD

Tape House, Dawley Road, Hayes, Middlesex, UB3 1BT.

Tel: 01-573 3888. Telex: 22417.

### 88 Standard Play (Red Band)

Prestretched polyester base. 3in 175ft 43p; 4in 300ft 59p; 5in 600ft £1.18; 5½in 900ft £1.56; 7in 1200ft £2.01. All prices exclude VAT.

### 99 Long Play (Green Band)

Prestretched polyester base. 3in 210ft 52p; 4in 450ft 81p; 5in 900ft £1.58; 5½in 1200ft £2.01; 7in 1800ft £2.82. All prices exclude VAT.

### 100 Double Play (Blue Band)

Superflex polyester base. 3in 300ft 79p; 4in 600ft £1.39; 5in 1200ft £2.36; 5½in 1800ft £3.11; 7in 2400ft £4.34. All prices exclude VAT.

### 300 Triple Play (Grey Band)

Extra tensile polyester base. 3in 450ft £1.24; 4in 900ft £2.13; 5in 1800ft £3.69. All prices exclude VAT.

All Emitape is supplied in transparent hinged library case. A prefolded index card is included. Card is designed to provide maximum space for titling with easily visible reference without opening the box.

### Compact Cassettes

C60 (1 hour playing time) 71p; C90 (1½ hours playing time) 98½p; C120 (2 hours playing time) £1.48½. All prices exclude VAT.

EMI cassettes are supplied in library case with

index sheet. Playing time is measured at the appropriate tape speed (normally 1½i/s for compact cassettes).

### HMV Voice Letter

Supplied in mailing pack. 3in spool. Price: 30p (plus VAT).

### Plastic Spools

In cartons: 4in 14p; 5in 15p; 5½in 16p; 7in 18p. In self-standing dust-proof plastic library cases with index: 3in 12p; 4in 20p; 5in 25p; 5½in 25p; 7in 30p. All prices exclude VAT.

### ■ GRUNDIG (Great Britain) LTD

Newlands Park, London, SE26 5NQ.  
Tel: 01-778 2211.

### GT11

Triple-play: 4½in 1200ft £2.78 (including VAT).

### GL15 Hi-Fi

Long-play: 5½in 1200ft £2.20 (including VAT).

### GD15 Hi-Fi

Double-play: 5½in 1800ft £3.97 (including VAT).

### GL18 Hi-Fi

Long-play: 7in 1800ft £3.74 (including VAT).

### GD18 Hi-Fi

Double-play: 7in 2400ft £5.26 (including VAT).

### C60 Hi-Fi

Compact cassette. 60 minutes playing time at 1½i/s. Price: £1.24 (including VAT).

### C90 Hi-Fi

Compact cassette. 90 minutes playing time at 1½i/s. Price: £1.63 (including VAT).

### DC90

Cassette. 90 minutes playing time. Price: £2.17 (including VAT).

### DC120

Cassette. 120 minutes playing time. Price: £2.49 (including VAT).

### ■ HITACHI

Hitachi Sales (UK) Ltd, New Century House, Park Royal, London, NW10 7QN.

Tel: 01-965 9861.

### Cassettes

UDC60 £1.20; UDC90 £1.50; UDC120 £1.80. All prices include VAT.

### Cartridges

8T-200 40 minutes £1.25; 8T-300 60 minutes £1.70; 8T-400 80 minutes £2.25. All prices include VAT.

### ■ LENNARD DEVELOPMENTS LTD

206 Chase Side, Enfield, Middlesex, EN2 0QX.  
Tel: 01-363 8238.

### Playfair Compact Cassettes

Available in C60, C90 and C120 sizes. Price: to be announced.

**MASTERTAPE (MAGNETIC) LTD**

Blackthorne Road, Poyle Trading Estate,  
Colnbrook, Bucks, SL3 0AQ.

Tel: 01-964 2431.

**Standard (red)**

5in 600ft £1.27; 5½in 900ft £1.57; 7in 1200ft  
£1.96 (including VAT).

**Long Play (green)**

5in 900ft £1.57; 5½in 1200ft £1.96; 7in 1800ft  
£2.84 (including VAT).

**Double Play (blue)**

5in 1200ft £1.96; 5½in 1800ft £2.84; 7in 2400ft  
£3.63 (including VAT).

**Compact Cassettes**

C60 76p; C90 £1.04; C120 £1.35 (including  
VAT).

**MAXELL**

Distributors: Acoustico Enterprises Ltd,  
Unit 7, Space Way, North Feltham Trading  
Estate, Feltham, Middlesex, TW14 0TZ.  
Tel: 01-751 0141.

**Compact Cassettes**

Ultra Dynamic available in C46, C60, C90, C120.  
Low noise type available in C30, C60, C90 and  
C120. Chromium dioxide cassettes in C60 and  
C90. Prices: to be announced.

All cassettes have a head cleaning leader tape.

**Open reel tapes**

Ultra Dynamic. Professional low noise high out-  
put mastering tape. UD50-7 7in 1200ft £3; UD  
35-7 7in 1800ft £3.60; UD35-7VP 7in (in vinyl  
case) 1800ft £4.75; UD35-10 10½in (NAB spool)  
3600ft £8.25; UD50-10 10½in (NAB spool, ½in  
tape) 2500ft £9.25; UD50-10 (1in tape on 10½in  
NAB spool) £18.35. Low noise type: LNE 35-7  
7in 1800ft £3.15; LNE 35-5 5in 900ft £1.75; LNE  
25-7 7in 2400ft £3.80; LNE 25-5 5in 1200ft £2.  
All prices exclude VAT.

**MEMOREX (UK) LTD**

50 Salisbury Road, Hounslow West, Middlesex.  
Tel: 01-570 7716.

**Cassettes (Ref 702)**

C30 (00175) 55p; C45 (00302) 67p; C60 (00183)  
75p; C90 (00191) £1; C120 (00209) £1.50.

**Chromium dioxide cassettes (Ref 704)**

CC45 (00051) £1.10; CC60 (00217) £1.35; CC90  
(00031) £1.75.

**Cartridges (Ref 703)**

8T-40 (00013) £1.55; 8T-64 (00025) £1.70; 8T-80  
(00037) £1.85.

**Reel-to-reel Standard**

5in 600ft £1.34; 7in 1200ft £2.26.

**Reel-to-reel Long Play**

5in 900ft £1.89; 7in 1800ft £3.21.

**Reel-to-reel Double Play**

5in 1200ft £2.26; 7in 2400ft £4.01.

**Audio Training Cassette Kit**

Available in boxes of 50 in C30, C45, C60, C90  
and C120 sizes. Full details and prices on  
application.

**PHILIPS ELECTRICAL LTD**

Century House, Shaftesbury Avenue,  
London, WC2H 8AS.

Tel: 01-437 7777. Cables: Philamps, London.

**Long Play (Red) in library case**

Coercivity 290OE, retentivity 950G, tensilised  
polyester base, S/N at 3½i/s better than 50dB,  
print through about 55dB, relative frequency  
response 333Hz-12.5kHz+1dB. Price: 5in 900ft  
£1.96; 5½in 1200ft £2.25; 7in 1800ft £3.30. All  
prices include VAT.

**Double Play (Blue) in library case**

Coercivity 290OE, retentivity 950G, tensilised  
polyester base, S/N at 3½i/s better than 50dB,  
print through about 55dB, relative frequency  
response 333Hz-12.5kHz±1dB. Price: 5in  
1200ft £2.60; 5½in 1800ft £3.60; 7in 2400ft £4.45.  
All prices include VAT.

**Triple Play (Olive)**

Price: 5in 1800ft £3.75 (including VAT).

**10½ in cine centre**

Red LP26 3600ft £7.60 (including VAT).

**Compact Cassettes**

Polyester base, S/N 50dB, bias adjustment 0dB,  
maximum output level (MOL) at 333Hz 0dB,  
maximum output level (MOL) at 8kHz -10dB,  
relative frequency response (RFR) at 10kHz  
0dB, relative tape sensitivity (RTS) at 333Hz  
0dB (tape speed 1½i/s). C60 (one hour playing  
time) 85p; C90 (1½ hours playing time) £1.19;  
C120 (two hours playing time) £1.75. All prices  
include VAT.

**CrO<sub>2</sub> Hi-Fi Cassettes**

Chromium dioxide tape in Compact cassettes.  
Bias adjustment: +5dB (relative 0dB standard  
tape). Max output level: (333Hz) +2.5dB (rela-  
tive 0dB standard tape); (8kHz) -7dB (rela-  
tive -10dB standard tape). S/N ratio: 57dB (rela-  
tive 51dB standard tape). Suitable for recorders  
with facilities for recording with chromium di-  
oxide tape, preferably models that conform to  
DIN 45 500 standards. 13½in leadertapes. C60  
(one hour playing time) £1.46; C90 (1½ hours  
playing time) £1.90. All prices include VAT.

**EL1907/52 Endless loop cassette CE.10**

Approximate playing time: 40 minutes at 1½i/s.  
Approximately 195ft. Price: £3.84 (including  
VAT).



★ Indicates entry is illustrated

## ■ PYRAL (UK) LTD

Airport House, Purley Way,  
Croydon, Surrey CRO 0XZ.  
Tel: 01-681 2833. Telex: 946670.

### CJ86 Professional Studio Quality

$\frac{1}{4}$ in 180M plastic spool 85p; 375M £1-58; 750M NAB or Euro 86 £3-39; 1125M NAB or Euro 86 £4-68;  $\frac{1}{2}$ in 750M NAB114 £7-03; NAB (plastic) £9-06; 1in 750M NAB114 £11-88; NAB (plastic) £13-87; 2in 750M NAB 114 £27-54; NAB (plastic) £32-81. Prices exclude VAT.

### CJ47 Professional Studio Quality

$\frac{1}{4}$ in width on plastic spool: 180M 76p; 375M £1-42; 750M NAB267 or Euro 86 £3-05; 1125M NAB or Euro 86 £4-21. Prices exclude VAT.

### Pyral Standard (TS)

$\frac{1}{4}$ in plastic spool: 4in 295ft 55p; 5in 585ft 80p; 7in 1170ft £1-44; 9 $\frac{1}{2}$ in 2400ft £2-79. Prices exclude VAT.

### Pyral Long Play (TL)

$\frac{1}{4}$ in plastic spool: 5in 900ft 95p; 5 $\frac{1}{2}$ in 1200ft £1-15; 7in 1800ft £1-59; 9 $\frac{1}{2}$ in 2400ft £2-33. Prices exclude VAT.

### Pyral Double Play (TD)

$\frac{1}{4}$ in on plastic spool: 5in 1170ft £1-09; 5 $\frac{1}{2}$ in 1700ft £1-43; 7in 2350ft £1-84. Prices exclude VAT.

## ■ ROSS ELECTRONICS

32 Rathbone Place, London, W1P 1AD.

### Ross 66 Series Compact Cassettes

High output, low-noise. Super-calendered for consistent performance with minimum wear. Five-screw fixing. Supplied with library case and index. Prices: C60 50p; C90 71p; C120 87p (including VAT).

## ■ SCOTCH

3M (UK) Ltd, 3M House, Wigmore Street, London, W1. Tel: 01-486 5522.

### 175

Standard play, polyester base. 5in 600ft £1-21; 5 $\frac{1}{2}$ in 900ft £1-56; 7in 1200ft £1-93. All prices include VAT.

### 215

Long play, polyester base. 3in 300ft 57p; 4in 500ft 94p; 5in 900ft £1-54; 5 $\frac{1}{2}$ in 1200ft £1-93; 7in 1800ft £2-75; 8 $\frac{1}{4}$ in 2400ft £3-66; 10 $\frac{1}{2}$ in 3600ft £5-55. All prices include VAT.

### 220

Double play, tensilised polyester base. 3in 400ft 83p; 4in 600ft £1-26; 5in 1200ft £2-07; 5 $\frac{1}{2}$ in 1800ft £2-95; 7in 2400ft £3-72. All prices include VAT.

## Scotch Dynarange Specification

Coercivity 315 oersteds, retentivity 790 gauss, remanence 0-64 lines/quar.in, erasing field required 1000 oersteds, standard bias 100%, peak bias 117% compared with standard tape. Full technical data on Scotch Dynarange magnetic tape available on Sheet 202-203 which includes notes on testing.

### Hi-Fi range 222

Polyester base. Standard play in library cases. 5in 600ft £1-58; 5 $\frac{1}{2}$ in 900ft £2-02; 7in 1200ft £2-33. All prices include VAT.

### Hi-Fi range 223

Polyester base. Long play in library cases. 5in 900ft £2-02; 5 $\frac{1}{2}$ in 1200ft £2-37; 7in 1800ft £3-18. Long play in cardboard boxes: 8 $\frac{1}{4}$ in 2400ft £4-29. All prices include VAT.

### Hi-Fi range 224

Polyester base. Double play in library case. 5in 1200ft £2-50; 5 $\frac{1}{2}$ in 1800ft £3-41; 7in 2400ft £4-37. All prices include VAT.

### Hi-Fi range 225

Triple play in library box. 5in 1800ft £3-61; 5 $\frac{1}{2}$ in 2400ft £4-29; 7in 3600ft £5-28. All prices include VAT.

### Scotch low-noise cassettes

Using Dynarange low-noise tape. C60 77p; C90 £1-08; C120 £1-63. All prices include VAT.

### Scotch high energy cassettes

High output cobalt energised tape for use with new generation cassette tape recorders. C60 £1-20; C90 £1-58. Both prices include VAT.

### Eight-track low-noise cartridges

45 minutes £1-65; 90 minutes £1-88. Both prices include VAT.

## ■ SONY (UK) LTD

Pyrene House, Sunbury Cross,  
Sunbury-on-Thames, Middlesex.  
Tel: Sunbury 87644/7.

### PR150/PR200 series specification

Polyester base. Bias current: 100%. Sensitivity:  $\pm 2$ dB. Uniformity: (333Hz)  $\pm 0.5$ dB, (10kHz)  $\pm 0.5$ dB. FR: 10kHz  $\pm 2$ dB. HD: 6% max at 333Hz. S/N: 58dB minimum. Print-through ratio: 50dB minimum. Erasure: 70dB minimum. Test conditions: 7 $\frac{1}{2}$ i/s, NAB reference tape.

### PR150

3in spool 300ft 33p; 5in spool 900ft 80p; 6in spool 1200ft £1-10; 7in spool 1800ft £1-50. All prices exclude VAT.

### PR200

3in spool 400ft 61p; 5in spool 1200ft £1-30; 6in spool 1800ft £1-60; 7in spool 2400ft £2-10. All prices exclude VAT.

### SLH (low-noise/high-output) specification

Polyester base, Bias current: 108%. FR: 10kHz

+4.5dB, 16kHz +7dB. HD: 3%. Linearity: (16kHz) +10dB. Dynamic range: +6.5dB. S/N ratio: 62dB. Erasure: 68dB. Retentivity: 1100 gauss. Intrinsic coercivity: 300 oersted. Test conditions: NAB reference tape.

#### SLH

72-370BL 7in 1200ft £2.17; 7-550BL 7in 1800ft £2.77; 11-740B 10½in NAB 2400ft £5.97. All prices exclude VAT.

#### HF series specification

Sensitivity: at 333Hz: (C60HF) +1.5dB, (C90HF) +1.0dB, (C120HF) -1.0dB. S/N ratio: 58.5dB. Bias current: (C60HF) 100%, (C90HF and C120HF) 95% (C60CR) Sensitivity 0dB, S/N 57dB, bias current 110%.

#### Cassettes

C60K 62p; C60HF 86p; C60CR £1.43; C90K 86p; C90HF £1.24; C120/C120K £1.24; C120HF £1.42. All prices exclude VAT.

#### SYNCHROTAPE

Sole distributors: Adastra Electronics Ltd, Unit N22, Cricklewood Trading Estate, Clarendon Road, London, NW2 1TU. Tel: 01-452 6288.

Specification of Sychrotape includes the following: Coercivity 270 oersteds, remanent induction 0.75 maxwell per 6.25 mm width. At 7½/s ½-track biased to give max output at 1kHz, with DIN 70µ Sec playback equalisation, main characteristics are: recorded flux for 2% third harmonic distortion 0.2 maxwell, unweighted RMS noise referred to 0.2 maxwell -65dB, print-through after 72 hours at 20°C -58dB.

#### Standard Play

PVC base. 3in 150ft 27p; 5in 600ft £1; 5¾in 900ft £1.15; 7in 1200ft £1.60. All prices include VAT.

#### Long Play

PVC base. 2¾in 200ft 33p; 3in 200ft 36p; 4in 450ft 82p; 5in 900ft £1.15; 5¾in 1200ft £1.40; 7in 1800ft £2. All prices include VAT.

#### Double Play

Tensilised polyester base. 2¾in 300ft 41p; 3in 300ft 50p; 4in 600ft £1.23; 5in 1200ft £1.85; 5¾in 1800ft £2.40; 7in 2400ft £3.20. All prices include VAT.

#### Triple Play

Tensilised polyester base 3in 450ft 90p; 4in 900ft £1.56; 5in 1800ft £2.55; 5¾in 2400ft £3.20 7in 3600ft £4.45. All prices include VAT.

Except for 2¾in and 3in spools, all Sychrotape tapes have leader, trailer and double metallic stop-foils.

#### Syncassettes

Compact cassettes. C60 66p; C90 82p; C120 £1.19. All prices include VAT.

#### TELEFUNKEN

AEG Telefunken (UK) Ltd, Bath Road, Slough, Bucks. Tel: Slough (75) 33311.

#### Telefunken Endless Tape Cassette

Price: £3.36 (plus VAT).

#### TDK

TDK Tape Distributor (UK) Ltd, 341 Brighton Road, South Croydon, Surrey, CR2 6EQ. Tel: 01-688 7372.

#### Cassettes

Extra Dynamic (EDC) cassettes available in: C45 £1.50; C60 £1.59; C90 £2.32. Super Dynamic (SDC) cassettes available in: C45 £1.10; C60 £1.21; C90 £1.65; C120 £2.35. Chromium dioxide cassettes (KROM-02) available in: C60 £1.65; C90 £2.35. Dynamic cassettes (DC) available in: C45 85p; C60 93p; C90 £1.32; C120 £1.72; C180 (for use only on highest quality cassette decks) £4.12. All prices including VAT.

#### Open reel tape

Super Dynamic available in: 1200SD (7in large hub) 1200ft £2.75; 1800SD (in cardboard box with standard hub) 1800ft £3.67; 3600-10½ SD (NAB spool) 3600ft £8.65. Low noise available in: 150.5 900ft £1.65; 150.7 1800ft £2.75; 200.5 1200ft £2.20; 200.7 2400ft £4.32. All prices including VAT.

#### Cassette head cleaner HCl

Head cleaning tape, loaded into a standard cassette. Price: 79p (including VAT).

#### Open reel spools

7in plastics reel AR7D 81p; 7in plastics reel, large hub AR7HD 89p; 7in metal reel AR7M £3.14; 7in metal reel large hub, AR7HM £4.40; 10½in metal reel, NAB hub AR10M £4. All prices including VAT.

#### TUDOR TAPE

A. C. Farnell Ltd, Kenyon Street, Sheffield, S1 4BD. Tel: 0742 78901.

#### Standard Play (green)

5in 600ft.

#### Long Play (red)

3in 250ft; 5in 900ft; 5¾in 1200ft; 7in 1800ft.

#### Double Play (blue)

5in 1200ft; 5¾in 1800ft; 7in 2400ft.

#### Cassettes

C60, C90 and C120.

#### Empty spools in boxes

3in, 4in, 5in, 5¾in and 7in.

No retail prices are quoted for Tudor Tape.

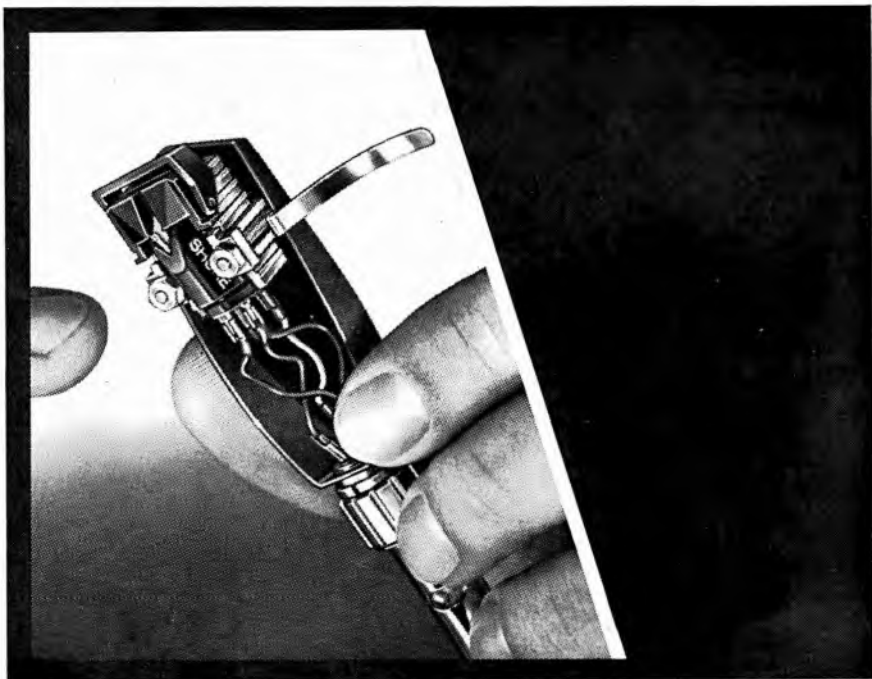

## The heart of hi-fi.

Beauty is truth, truth beauty. The fact is that all too few music lovers realise that while certain high fidelity components can be less than best, there is one component that cannot endure a sacrifice in quality: the cartridge. Because the hi-fi cartridge functions as the *source of sound* (the point at which

the recording is linked with the balance of the hi-fi system), its role is absolutely critical. Just as the camera can be no better than its lens, the finest hi-fi system in the world cannot compensate for an inferior cartridge. Suggestion: For a startling insight into the role of the cartridge in the overall hi-fi system, and a breathtaking recreation of your favourite recording, see your nearby Shure cartridge dealer. He'll introduce you to the Shure cartridge that is correct for your system and your exchequer. Or, next best, send for our brochure:



Shure Electronics Limited  
Eccleston Road, Maidstone ME15 6AU  
Telephone: Maidstone (0622) 59881



**SHURE**

®

# Microphones

★ Indicates entry is illustrated  
Abbreviations used in this section are given on page 20.

## ■ ACOS

Cosmocord Ltd, Eleanor Cross Road,  
Waltham Cross, Herts, EN8 7NX.  
Tel: Waltham Cross (97) 27331.

### Mic 70/12

Omni-directional moving coil. FR: 80Hz-12 kHz (10dB down at 50Hz and 15kHz). Impedance: 200 ohms. Rec load: 200 ohms-10K. Sensitivity: -80dB re 1V/ $\mu$ b. Price: £4.91 (plus VAT).

### Mic 70/11

Omni-directional moving coil. FR: as for Mic 70/12. Impedance: 50K nominal. Sensitivity: -57dB re 1V/ $\mu$ b. Price: £6.55 (plus VAT).

## ■ ADASTRA ELECTRONICS LTD

Unit N22, Cricklewood Trading Estate,  
Claremont Road, London, NW2 1TU.  
Tel: 01-452 6288.

### Imp-Verta ★

Matches low impedance microphones, PU cartridges and tape heads into high impedance amplifier inputs. Solid state printed circuit device using silicon transistor. Automatically switched internal 9V battery. Negligible drain. Conversion factor approximately 20 (depending on load). Virtually no hum or signal loss. Metal case, black crackle finish. Size:  $5 \times 1\frac{1}{2} \times 1\frac{1}{2}$  in. Price: £3.75 (including VAT).

## ■ AKAI

Rank Audio Visual Ltd,  
PO Box 70, Great West Road, Brentford,  
Middlesex, TW8 9HR. Tel: 01-568 9222.

### ADM14

Dynamic microphone. Uni-directional. FR: 100Hz-10kHz  $\pm$  5dB. Price: £7.50 (including VAT).

## ■ A.K.G.

Distributors: A.K.G. Equipment Ltd,  
182/184 Campden Hill Road, Kensington,  
London, W8 7AS. Tel: 01-229 3695.

### C24

Stereo condenser. Sensitivity 1mV/ $\mu$ bar. Imp 200 or 500 ohms. Response 30Hz-20kHz. Omni-directional cardioid; bi-directional, hyper-cardioid. Plus 5 intermediate patterns. Sensitivity approx 1mV per microbar (at 200 ohms output

terminals) -33dB re 1 milliwatt at a sound pressure of 10 dynes/cm<sup>2</sup>. Crosstalk between channels < 40dB throughout entire range. Imp: < 200 ohms when delivered. 50 ohms by changing solder connections. N.24 power supply unit. Remote control unit. Twin remote control cable. Price: £490 (plus VAT).

### C414 ★

FET studio microphone with large capsule and pattern selector for cardioid, omni-directional, figure-of-eight and hyper-cardioid. Capacitor unit. Switchable -10dB attenuator. FR: 20Hz-20kHz. Sensitivity: 0.6mV/ $\mu$ bar. Price: £160 (plus VAT).

### C451-FET

FET condenser microphone with cardioid, sharp cardioid or omni-directional capsule. Various types available as part of Modular system. FR: 20Hz-20kHz. Prices: on application.



Adastra Imp-Verta



A.K.G. C414 Condenser Microphone

★ Indicates entry is illustrated

#### D12

Moving coil with cardioid directional pattern. Response 40Hz-12kHz±4dB. Front to back ratio 15dB. Sensitivity: -77dB. Imp 60 ohms, or to order. Price: £43 (plus VAT).

#### D14S

Dynamic cardioid microphone. Imp 60-40,000 ohms. Response 50Hz-15kHz. On/off switch. Swivel joint fits all stand threads. Supplied with 5½yds two-core screened lead. Weight: 8oz. Price: £14 (plus VAT).

#### D58C

Moving coil, close-talk microphone. Response 50Hz-12kHz. Sensitivity: 0.1mV/μbar. Imp 60 or 200 ohms. Price: £18 (plus VAT).

#### D109

Omni-directional moving coil. FR: 50Hz-15kHz ±3.5dB. Sensitivity: -98dB. Impedance: 60 and 200 ohms. Rec load ≥400 ohms. Hand and lavalier type. Supplied with lavalier cord. Higher frequencies boosted when lavalier attached. Metal case nickel plated. Price: £19 (plus VAT).

#### D190E

Unidirectional moving coil microphone. Robust construction. FR: 30Hz-16kHz. Ideal for sound recording and public address systems. Complete with Cannon XLR 3-11C connector. Prices: low impedance (60 or 200 ohms) D190E £28 (Lo-Z); high impedance £30 (Hi-Z). All (plus VAT).

#### D200C

Two-system cardioid microphone. Incorporates two moving coils, one covering the low and the other the high frequencies. FR: 40Hz-16kHz. Sensitivity: 0.16mV/μbar. Imp 200 ohms. Price: £37 (plus VAT).

#### D202E1

Similar specification to D202ES except it is supplied without on/off switch and has three-position bass attenuation step switch (0, -7dB and -20dB) instead of potentiometer. Individually calibrated frequency response curve supplied with each microphone. Price: £50 (plus VAT).

#### D202ES

Moving coil microphone with marked cardioid response (-20dB minimum). FR: 30Hz-15kHz ±2dB. Sensitivity: -53dB. Impedance: 200 ohms. Rec load: ≥400 ohms. Stand fitting swivel adaptor. ⅜in Whit, ½in 26tpi, ⅝in 27tpi. On/off switch and variable bass control providing 0 to -20dB at 50Hz. Strong black metal case with sintered bronze grille. Price: £47 (plus VAT).

#### D224 ★

Mono moving coil. Sensitivity: -78dB re 1V/μbar. Cardioid response. FR: 20Hz-20kHz



AKG microphone shock mount

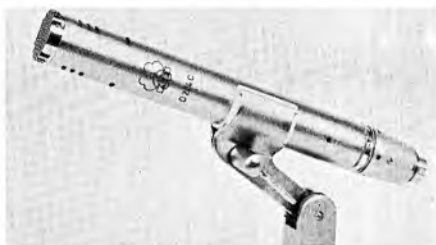

AKG D224

±2dB. Impedance: 200 ohms. Rec load: 500 ohms or more. Fitting: ⅜in Whit, ½in 26tpi, ⅝in 27tpi. Features bass cut switch. Finish: metal satin silver. Price: £67 (plus VAT) (DIN connector); £67 (plus VAT) (Cannon).

#### D707

Mono moving coil. Sensitivity: -74dB re 1V/μbar. Cardioid response. FR: 80Hz-16kHz ±3.5dB. Impedance: 200 ohms. Rec load: 400 ohms or more. Fitting: ⅜in Whit, ½in 26tpi, ⅝in 27tpi. Finish: metal satin silver. Price: £22 (plus VAT) (DIN connector); £24 (plus VAT) (Cannon).

#### ST200

Microphone floor stand. Telescopic. Height: 42 to 77in. Three collapsible feet with main support locking device. Anti-vibration characteristics. Microphone may be clamped to face any direction. Price: £25 (plus VAT).

#### ■ BEYER

Beyer Dynamic (GB) Ltd,  
1 Clair Road, Haywards Heath, Sussex.  
Tel: Haywards Heath 51003.

#### M55ML

Mono moving coil omni-directional. FR: 70Hz-16kHz±4dB. Sensitivity: (low Z) 0.17mV; (high Z) 1.5mV. Impedance: (low Z) 500 ohms;

(high Z) 50K. Rec load: (low Z) 2K; (high Z) 200K. Hand mic with plastic table stand and clamp. Polished metal finish. Price: £12.43 (plus VAT).

**M57**

Mono moving coil omni-directional. FR: 300 Hz-14kHz  $\pm$  3dB. Sensitivity: 0.2mV/ $\mu$ bar. Impedance: 200 ohms. Rec load: 1K. Hand mic with cable. Steel case. Price: £16.38 (plus VAT).

**M64**

Mono moving coil cardioid. FR: 100Hz-10kHz  $\pm$  3dB. Sensitivity: 0.2mV/ $\mu$ bar. Impedance: 200 or 37.5 ohms. Rec load: 1K. Stand mic. Grey plastic case. Price: £14.22 (plus VAT).

**M64SH**

As M64 but with gooseneck and base plate. Price: £20 (plus VAT).

**M67N**

Mono moving coil cardioid. FR: 40Hz-18kHz  $\pm$  2.5dB. Sensitivity: 0.25mV/ $\mu$ bar. Impedance: 37.5 or 500 ohms. Rec load: 1K. Rubber suspended hand mic. Brushed aluminium finish. Suitable for any climatic conditions. Built-in speech/music switch. Price: (M67N) £39.18; (M67N-C) £40.90. All plus VAT.

**M68**

Mono moving coil cardioid. FR: 100Hz-10kHz  $\pm$  3dB. Sensitivity: 0.2mV/ $\mu$ bar. Impedance: 37.5 or 200 ohms. Rec load: 1K. Fitted with gooseneck and built-in switch. Grey plastic finish. Price: £22.24 (plus VAT).

**M69 ★**

Mono moving coil uni-directional cardioid. FR: 50Hz-15kHz  $\pm$  3dB. Sensitivity: 0.24mV/ $\mu$ bar. Impedance: 37.5 or 200 ohms. Rec load: 1K. Hand mic with optional speech-off-music switch. Steel case finished blue stove enamel. Price: (M69) £31.64; (M69SM) £35.15; (M69N-C) £33.35. All plus VAT.

**M81HL ★**

Mono moving coil cardioid. FR: 50Hz-16kHz  $\pm$  3dB. Sensitivity: (low Z) 0.23mV/ $\mu$ bar; (high Z) 1.7mV/ $\mu$ bar. Impedance: (low Z) 500 ohms; (high Z) 25K. Rec load: (low Z) 2K; (high Z) 100K. Hand mic supplied complete with plated table stand and clamp. Polished metal finish. Price: £15.95 (plus VAT).

**M88**

Mono moving coil hypercardioid. FR: 30Hz-20kHz  $\pm$  2.5dB. Sensitivity: 0.25mV/ $\mu$ bar. Impedance: 200 ohms. Rec load: 1K. Hand mic available with cannon plug. Satin chrome case. Price: (M88) £76.74 (plus VAT).

**M101N**

Mono moving coil omni-directional. FR: 40Hz-20kHz  $\pm$  2.5dB. Sensitivity: 0.13mV/ $\mu$ bar. Impedance: 200 ohms. Rec load: 1K. Hand mic

with windshield. Anodised aluminium case. Price: (M101N) £37.98; (M101N-C) £39. All plus VAT.

**M111N**

Mono moving coil omni-directional. FR: 60Hz-15kHz. Sensitivity: 0.08mV/ $\mu$ bar. Impedance: 200 ohms. Rec load: 1K. Lavalier mic. Anodised aluminium case. Price: £54.19 (plus VAT).

**M160**

Mono double-ribbon super cardioid. FR: 40Hz-18kHz  $\pm$  2.5dB. Sensitivity: 0.1mV/ $\mu$ bar. Impedance: 37.5 or 200 ohms. Rec load: 1K. Hand mic. Satin chrome steel case. Price: £83.94 (plus VAT).



Beyer M69

Beyer M260

Beyer M500



Beyer M81HL

★ Indicates entry is illustrated

**M260 ★**

Mono ribbon super cardioid. FR: 50Hz-18kHz  $\pm 3$ dB. Sensitivity: 0.09mV/ $\mu$ bar. Impedance: 37.5 or 200 ohms. Hand mic. Steel case stove enamelled blue. Price: £33.52 (plus VAT).

**M320**

Mono ribbon super cardioid. FR: 30Hz-18kHz  $\pm 3$ dB. Sensitivity: 0.1mV/ $\mu$ bar. Impedance: 200 ohms. Rec load: 1K. Stand mic with three position music-off-speech switch. Grey plastic case. Price: £40.12 (plus VAT).

**M360**

Mono ribbon cardioid. FR: 30Hz-20kHz  $\pm 2.5$  dB. Sensitivity: 0.14mV/ $\mu$ bar. Impedance: 200 ohms switchable to 50 ohms. Rec load: 1K. Stand microphone for studio use. Completely hand made. Supplied with lead. Metal case stove enamelled grey. Price: £109.75 (plus VAT).

**M410**

Mono moving coil cardioid. FR: 300Hz-12kHz  $\pm 3$ dB. Sensitivity: 0.25mV/ $\mu$ bar. Impedance: 200 ohms. Rec load: 1K. Hand mic designed for heavy duty use. Black plasticised steel case. Price: £24.08 (plus VAT).

**M411N**

Mono moving coil uni-directional cardioid. FR: 200Hz-12kHz. Sensitivity: 0.14mV/ $\mu$ bar. Impedance: 200 ohms. Rec load: 1K. Hand mic with built-in switch. Designed for close-talking applications. Anodised aluminium finish. Price: (M411NT) £25.96; (M411N-TS) £29.50; (M411N(C)) £27.03. All plus VAT.

**M500 ★**

Mono ribbon hypercardioid. FR: 40Hz-18kHz. Sensitivity: 0.13mV/ $\mu$ bar. Impedance: 500 ohms. Rec load: 1K. Hand mic. Anodised aluminium finish. Price: (M500) £37.75; (M500N-T) and (M500N-C) £38.75. All plus VAT.

**M818HL ★**

Stereo moving coil cardioid. Comprises pair of matched M81HL. FR: 50Hz-16kHz  $\pm 3$ dB. Sensitivity: (low Z) 0.17mV/ $\mu$ bar; (high Z) 1.5mV/ $\mu$ bar. Impedance: (low Z) 500 ohms; (high Z) 25K. Rec load: (low Z) 2K; (high Z) 25K. Polished metal case. Price: £34.64 (plus VAT).

**Soundstar XI**

Mono moving coil cardioid. FR: 30Hz-18kHz  $\pm 2.5$ dB. Sensitivity: 0.2mV/ $\mu$ bar. Impedance: (XIN) 200 ohms; (XIHLM) 200, 500 or 25K switchable. Rec load: (XIN) 1K; (XIHLM) 1K, 2K, 100K. Stand mic with built-in pop filter and hum compensation. Cannon plug. Moulded case. Price: (XIN-T) £28.38; (XIN-C) £28.38; (XIHLM) £32.75; (XIHL-C) £33.44; (XIN) £27.35. All plus VAT.

**M550LM**

Omni-directional moving coil. FR: 70Hz-18

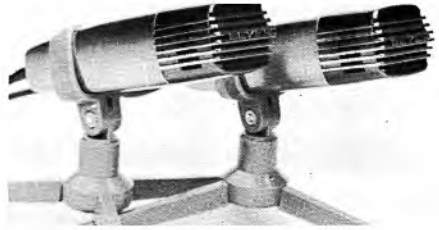

Beyer M818HL

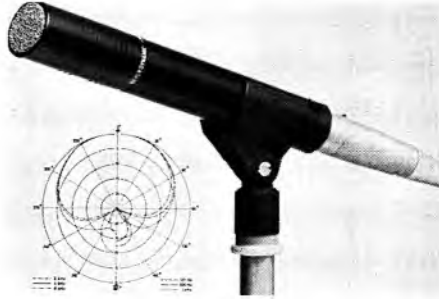

Beyer M201N



Calrec CM852 and CM600



Calrec CM655

kHz. Sensitivity: 0.17mV/ $\mu$ bar. ( $-75$ dB). Impedance: 500 ohms. Price: £11.83 (plus VAT).

**M810N**

Cardioid moving coil. FR: 50Hz-16kHz. Sensitivity: 0.23mV/ $\mu$ bar ( $-73$ dB). Impedance: 500 ohms. Price: £23.06 (plus VAT).

**M201N ★**

Hypercardioid moving coil. FR: 40Hz-18kHz. Output level: 0.14mV/ $\mu$ bar. Impedance: 200 ohms. Rec load:  $>1000$  ohms. Hand-held or stand-mounted type. Size: 6in long 0.95in diameter. Weight:  $8\frac{1}{2}$ oz. £51.09.

**■ CALREC**

Calrec Audio Ltd, Haningroyd Lane, Hebden Bridge, Yorks, HX7 7DD. Tel: Hebden Bridge 2159.

Distributors for South of England, Scotland and overseas: Beyer Dynamic (GB) Ltd, 1 Clair Road, Haywards Heath, Sussex.

**CM600 ★**

General purpose condenser microphone. Omni-directional. FR: 20Hz-20kHz $\pm$ 2dB. Output: 1.5mV/microbar. Impedance: 50 ohms (unbalanced). Rec load: 30-50K (adjustment on mic). Slim hand or stand mic. Robust encapsulated FET amplifier. Optional windshield. Three-pin DIN lock-ring connectors. Two-year guarantee. Price: approximately £48 (including VAT).

**CM652**

Mono condenser microphone. Cardioid response. FR: 40Hz-20kHz $\pm$ 2dB (related to standard curve). Sensitivity:  $-56$ -5dB. Source impedance: 100 ohms. Rec load: adjustable 30 ohms to 50K. Hand type.  $\frac{3}{8}$ in whit clip supplied. Satin chrome finish. Price: approximately £48 (including VAT).

**CM654**

Condenser microphone with cardioid pattern and reduced bass response for close-talking applications. Other details as for CM600. Price: approximately £48 (including VAT).

**CM655 ★**

Cardioid condenser microphone with spherical mesh head, specially designed for outdoor PA and pop group work. Price: approximately £52 (including VAT).

**CM1001**

Studio condenser microphone. Omni-directional. Specially designed for in-shot hand-held TV vocals. FR: 20Hz-20kHz $\pm$ 2dB. Output: 0.3 mV/microbar. Impedance: 50 ohms. Rec load: 200 ohms (30 ohms when used with lead CL1081.) Slim hand or stand mic. Cannon XLR connectors. Robust encapsulated FET amplifier. Two year guarantee. Windshield enclosed in

body tube. Price: approximately £62 (including VAT).

**CM1050**

Studio cardioid microphone with accurate directional pattern. Other details as for CM1001, except needs external windshield. Price: approximately £62 (including VAT).

**CM1051**

Specification as for the CM1050 except incorporates bass roll-off for close vocal work. Price: approximately £62 (including VAT).

**CB1000**

Pre-amplifier for condenser microphones CM1001, CM1050 and CM1051. Model numbers CC1001, CC1050 and CC1051 respectively. Capsule is adaptor for insertion of extension tubes etc. Price: (pre-amplifier plus capsule) approximately £66 (including VAT).

Wide range of accessories including battery power units, mains power units, connecting leads, windshields, jacks, plugs, adaptors, presentation boxes, twin screened cables etc. Full details and price list on request.

**■ EAGLE INTERNATIONAL**

Heather Park Drive, Wembley, HA0 1SU. Tel: 01-903 0144.

**DM18HL**

Mono moving coil. Omni-directional. FR: 60 Hz-12kHz $\pm$ 3dB. Sensitivity:  $-57$ dB. Impedance: 600 ohms and 50K. Built-in impedance switch. Rec load: 600 ohms and 50K. Stick mic for hand or stand. Fitting: 15.5 $\times$ 1mm thread. Complete with desk stand. Finish: black anodised aluminium. Price: £11.55 (including VAT).

**UD50HL**

Mono moving coil. Cardioid. FR: 40Hz-14kHz $\pm$ 3dB. Sensitivity:  $-62$ dB. Impedance: 600 ohms and 50K. Hand and stand mic. Fitting: 15.5 $\times$ 1mm thread. Built-in on/off switch. Finish: satinised stainless steel. Price: £13.20 (including VAT).

**CO92**

Mono omni-directional condenser. FR: 30Hz-16kHz. Impedance: 600 ohms. Sensitivity: 75dB. Powered by single cell and incorporating built-in low-noise preamplifier. Supplied with 6 metres of screened cable and detachable windshield. Price: £15.40 (including VAT).

**CO96**

Mono condenser. Similar specification to CO92 but with better than 20dB cardioid response. Impedance: 600 ohms. FR: 30Hz-16kHz. Sensitivity: 70dB. Price: £19.80 (including VAT).

**DD5**

Electret paging microphone. Omni-directional. FR: 600Hz-9kHz for optimum speech clarity.



★ Indicates entry is illustrated



Eagle DD6



Eagle PRO-M20

Sensitivity:  $-70\text{dB}$  (ref  $1\text{V}/\text{dyne}/\text{cm}^2$ ). Impedance: 600 ohms. Rec load: 600 ohms or greater. Contacts for paging over-ride circuit. Finish: chrome and matt black. Price: £15.40 (including VAT).

**Model DD6 ★**

Omni-directional dynamic lavalier type. Impedance: 600 ohms 50K. FR: 60Hz-12kHz. Sensitivity:  $-54\text{dB}$  ( $2.8\text{mV}/50\text{K}$ )  $-74\text{dB}$  ( $280\mu\text{V}/600$  ohms). Price: £12.32 (including VAT). Windshield included.

**Model DD7**

Cardioid dynamic microphone complete with desk stand and gooseneck. On/off switch with spare contacts to operate a paging over-ride circuit. Impedance: 50K. FR: 600Hz-9kHz. Sensitivity:  $-54\text{dB}$ . Price: £13.20 (including VAT).

**Model DM94**

Omni-directional dynamic, supplied with windshield. Impedance: 50K. FR: 80Hz-10kHz. Sensitivity:  $-50\text{dB}$ . Price: £10.45 (including VAT).

**PRO-M5 ★**

Mono omni-directional capacitor microphone. FR: 50Hz-13kHz. Sensitivity:  $-65\text{dB}$ . Impedance: 600 ohms. Lapel type. Sub-miniature FET circuitry built into mic capsule. Price: £17.60 (including VAT).

**PRO-M10**

Mono omni-directional capacitor microphone. FR: 30Hz-17kHz. Sensitivity:  $-70\text{dB}$ . Impedance: 600 ohms balanced (floating). Hand or

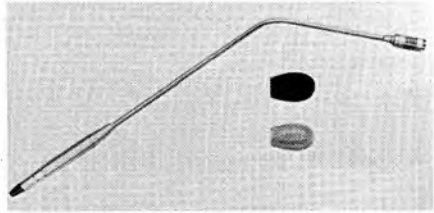

Eagle PRO-M25



Eagle PRO-M5

stand type. Supplied with stand adaptor. Built-in switch, windshield. Price: £33 (including VAT).

**PRO-M20 ★**

Mono uni-directional capacitor microphone. FR: 30Hz-17kHz. Sensitivity:  $-60\text{dB}$ . Impedance: 600 ohms balanced (floating). Hand or stand type. Supplied with stand adaptor. Built-in switch, windshield. Price: £35.20 (including VAT).

**PRO-M25 ★**

Mono cardioid capacitor boom-arm microphone. FR: 20Hz-18kHz. Sensitivity:  $-70\text{dB}$ . Impedance: 600 ohms balanced (floating). Stand type adaptor supplied. Built-in switch. 23 $\frac{3}{4}$ in boom arm. Price: £38.06 (including VAT).

■ **ELECTRO-VOICE**

Gulton Europe Ltd, Special Products Division, The Hyde, Brighton, BN2 4JU. Tel: 0273 66271.

**635A ★**

Moving coil omni-directional hand/stand microphone. FR: 80Hz-13kHz. Sensitivity:  $-149\text{dB}$  EIA rated. Output:  $-55\text{dB}$  (ref  $1\text{mW}/10$  dynes/cm $^2$ ). Impedance: 150 ohms. Supplied with 312A stand adaptor. Built-in pop filter. Fitted with Switchcraft connector and cable. Finish: non-reflecting steel case. Price: £33.75 (including VAT).

**RE10**

Moving coil super cardioid hand or boom microphone. FR: 90Hz-13kHz. Sensitivity:  $-150\text{dB}$  EIA rated. Output:  $-56\text{dB}$  (ref  $1\text{mW}/10$  dynes/cm $^2$ ). Impedance: 150 ohms. Supplied with

312A stand adaptor, or 307 boom mounting. Fitted with Switchcraft connector and cable. Finish: non-reflecting Micomatte steel case. Price: £63.80 (including VAT).

**RE11**

Moving coil super cardioid hand or boom microphone. FR: 90Hz-13kHz. Sensitivity: -150dB EIA rated. Output: -56dB (ref 1mW/10 dynes/cm<sup>2</sup>). Impedance: 150 ohms. Supplied with 312A stand adaptor, or 307 boom mounting. Built-in pop filter. Fitted with Switchcraft connector and cable. Finish: non-reflecting Micomatte finished steel case. Price: £68.20 (including VAT).

**RE15**

Moving coil supercardioid hand or boom microphone. FR: 80Hz-15kHz. Sensitivity: -150dB EIA rated. Output: -56dB (ref 1mW/10 dynes/cm<sup>2</sup>). Impedance: 150 ohms. Supplied with 312A stand adaptor, or 307 boom mounting. Fitted with Switchcraft connector and cable. Bass tilt switch incorporated. Finish: fawn beige with Micomatte non-reflect finish. Price: £109.45 (including VAT).

**RE16**

Moving coil super cardioid hand or boom microphone. FR: 80Hz-15kHz. Sensitivity: -150dB EIA rated. Output: -56dB (ref 1mW/10 dynes/cm<sup>2</sup>). Impedance: 150 ohms. Supplied with 310A stand adaptor, or 307 boom mounting. Fitted with Switchcraft connector and cable. Built-in pop filter. Bass tilt switch incorporated. Finish: non-reflecting Micomatte finished steel case. Price: £113.30 (including VAT).

**RE20 ★**

Moving coil wide range cardioid stand or boom microphone. FR: 45Hz-18kHz. Sensitivity: -150dB EIA rating. Output: -57dB (ref 1mW/10 dynes/cm<sup>2</sup>). Impedance: 50, 150 and 250 ohms selectable. Supplied with 302 stand adaptor, or 309 boom mounting. Fitted with Switchcraft connector and cable. Built-in pop filter. Finish: non-reflecting satin nickel steel case. Price: £176 (including VAT).

**RE55**

Moving coil omni-directional hand, stand or boom microphone. FR: 40Hz-20kHz. Sensitivity: -149dB EIA rated. Output: -55dB (ref 1mW/10 dynes/cm<sup>2</sup>). Supplied with 310A stand adaptor and metal carrying case. Fitted with Switchcraft connector and cable. Finish: non-reflecting satin nickel steel case. Price: £90.20 (including VAT).

**670, 670V Top Brass**

Moving coil cardioid hand or stand microphone. FR: 60Hz-14kHz. Sensitivity: -150dB EIA rated. Output: -58dB (ref 1mW/10 dynes/cm<sup>2</sup>). Impedance: 150 ohms or high Z selectable.

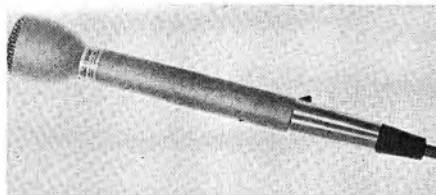

Electro-Voice 635A



Electro-Voice RE20

Model 670 has built-in switch and pop filter. Model 670V has built-in volume control and pop filter. Fitted with Switchcraft connector. Finish: anodised aluminium. Price: (670) £41.25 (including VAT); (670V) £44.55 (including VAT).

**DS 35**

Cardioid dynamic microphone with built-in pop filter, Switchcraft connector. Impedance: 150K. FR: 60Hz-17kHz. Sensitivity: -56dB (0dB = 1mV/10 dynes/cm<sup>2</sup>). Supplied with stand adaptor and cable. Finish: non-reflecting grey. Price: £43.89 (including VAT).

**Model 660**

Super cardioid dynamic microphone with Switchcraft connector. Impedance: 120K or Hi-Z selectable. FR: 90Hz-13kHz. Sensitivity: Lo-Z -56dB, Hi-Z -55.5dB (0dB = 1mV/10 dynes/cm<sup>2</sup>). Finish: chrome. Price: £44 (including VAT).

**Model 671**

Cardioid dynamic microphone with Switchcraft connector. Impedance: 150K or Hi-Z. FR: 60Hz-14kHz. Sensitivity: Lo-Z -61dB, Hi-Z -60dB (0dB = 1mV/10 dynes/cm<sup>2</sup>). Supplied with stand adaptor and cable. Price: £40.15 (including VAT).

**■ FILM INDUSTRIES LTD**

Station Avenue, Kew Gardens, Surrey.  
Tel: 01-940 8078.

Manufacturers of a range of hi-fi and professional microphones, stands and accessories. No product information or prices obtainable as this edition of the Year Book closed for press.

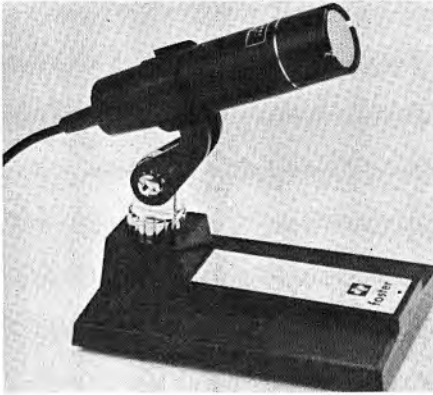

Foster DF1X



Gardner mic transformers

■ **FOSTER**

Distributors: Adastra Electronics Ltd, Unit N22, Cricklewood Trading Estate, Claremont Road, London, NW2 1TU. Tel: 01-452 6288.

**M55/DF72BC**

Mono moving coil omni-directional stick microphone. FR: 80Hz-12kHz±8dB. Sensitivity: -76dB±3dB (600 ohms), -59dB±3dB (50 kHz). Impedance: 600 ohms and 50K. Adjustable cradle fitting. Built-in switch. Removable windshield. Metal case with matt black and silver finish. Price: £9.90 (including VAT).

**M53/MDF623C**

Mono moving coil cardioid stick microphone. FR: 200Hz-10kHz. Impedance: 600 ohms and 50K. Sensitivity: (600 ohms) -82dB, (50K) -63dB. Adjustable cradle fitting. Microphone holder and neck cord. Satin metal case. Price: £15.50 (including VAT).

**M58/MDF619BC**

Mono moving coil cardioid stick microphone. FR: 200Hz-10kHz±6dB. Impedance: 600 ohms and 50K. Sensitivity: (600 ohms) -76dB±3dB, (50K) -58dB±3dB. Adjustable cradle fitting. Built-in switch. Windshield. 16ft cord.

Satin gold finish with chrome trim. Price: £18.50 (including VAT).

**M60/MDF611BC**

Mono moving coil cardioid stand microphone. FR: 100Hz-10kHz±6dB. Impedance: 600 ohms and 50K. Sensitivity: (600 ohms) -76dB±3dB, (50K) -58dB±3dB. Adjustable fitting. Built-in switch. 16ft lead. Moulded housing wiremesh surround. Price: £16.50 (including VAT).

**M57/DF104BC**

Mono moving coil omni-directional stick microphone. FR: 80Hz-12kHz. Impedance: 600 ohms and 50K. Sensitivity: (600 ohms) -76dB±3dB, (50K) -58dB±3dB. Adjustable cradle fitting. Built-in switch. Removable windshield. 9ft lead. Satin finish sprayed case. Price: £22.20 (including VAT).

**M59/DF106BC**

Mono moving coil omni-directional stick microphone. FR: 60Hz-13kHz+2dB -6dB. Impedance: 600 ohms. Sensitivity: -74dB±3dB. Adjustable cradle fitting. Slip-on windshield. Wood presentation cabinet. 16ft heavy duty lead. Heavy duty satin finished turned metal case. Price: £51.50 (including VAT).

■ **GARDNERS**

Gardners Transformers Ltd, Christchurch, Hampshire, BH23 3PN. Tel: (0201 5) 2284. Telex: 41276.

**Audio transformers ★**

Wide range of microphone and line transformers available in standard models. Obsolete items can be made to special order and quotations will be provided on request. Standard types available include miniature mic transformers, standard microphone and A.F. line matching transformers, wide band microphone and A.F. matching transformers, extra wide-band microphone and A.F. line matching transformers and super-fidelity wide band microphone and line matching transformers.

■ **GRAMPIAN REPRODUCERS LTD**

19 Hanworth Trading Estate, Hampton Road West, Feltham, Middlesex, TW13 6EJ. Tel: 01-894 9141. Cables: Reamp, Feltham.

**DP4/H**

Moving coil. FR: 50-15,000Hz. Sensitivity: -52dB, -70dB, -86dB, for high, medium and low impedance, 50,000, 600 and 25 ohms. Tubular case. Price including lead, high or medium impedance: on application; low impedance on application.

**DP6 ★**

Moving coil. Omni-directional. FR: 200Hz-15 kHz. Sensitivity: -87dB (25 ohms), -75dB

(200 ohms), -50dB (600 ohms), -52dB (50K). Built-in transformer fitted to all but low impedance model. Price: (low impedance) on application; (other three models) on application.

### GC2 and GC3

Mono moving coil microphone for hand (GC2) or desk mounting (GC3). Uni-directional response. FR: 70Hz-14kHz. Impedance: (L) 25 ohms; (X) 200 ohms; (M) 600 ohms; (H) 50K. Sensitivity: (L) -86dB 50 $\mu$ V, (X) -75dB 180  $\mu$ V, (M) -70dB 300 $\mu$ V, (H) -52dB 2.5mV. All sensitivity figures per microbar. Easily replaceable diaphragm and coil assembly. GC2 has on/off switch and is supplied with swivel holder for fitting to floor or table stand. Prices: on application.

### GR1

Ribbon. Unequal figure-of-eight. Response: 40 Hz-15kHz. Sensitivity: -90dB (25 ohms), -81 dB (200 ohms), -76dB (600 ohms), -58dB (50K). Imp: 25, 200, 600 ohms, 50K. Built-in transformer. Easily replaceable ribbon. Price: on application.

### GR2

Details as for GR1, but equal figure-of-eight response.

### DP8 series ★

Moving coil omni-directional microphones.



Gramphon DP6



Gramphon DP8

## The great condenser mike myth.

For a long while, condenser mikes have been at the top end of the microphone market.

They still are—in performance. But since Unisound introduced their range of Electret condenser mikes exclusively for us the price has plummeted to an incredible £13.00, including VAT.\* And Unisound have another big plus.

Gone is the bulky power pack that made this type of mike function.

Replacing it is a tiny UM-3 battery which has all the power required to turn in the necessary sensitivity and response. In fact, a breakthrough. Find out more about Unisound's condenser mike. All in all, it's quite a surprise package.

**Condor**   
The fastest bird in the business.

Condor Electronics Limited,  
100 Coombe Lane,  
London SW20 0AY.  
Telephone: 01-946 0033 (4 lines).  
Distributors of cartridges, styli,  
condenser microphones and headsets.  
Guaranteed 24 hour delivery.



\*Recommended retail price

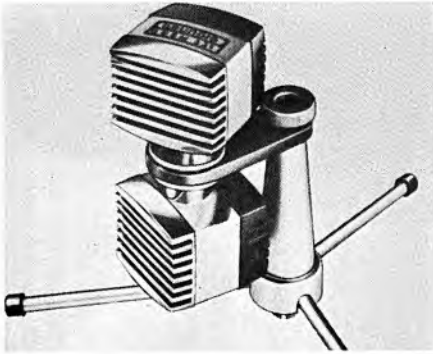

Grundig GDSM331

FR: 50Hz-15kHz $\pm$ 5dB. Built-in on/off switch. Interchangeable leads. Hand type with swivel holder for stand use. Sensitivities, impedances and rec loads as for DP4 series. Prices: on application.

#### Boom arm

Suitable for use with various types of mics and stands. The clamp, locked by a single lever, allows the reach and angle to be readily adjusted as required. Length: 34in. Weight: 1 $\frac{3}{4}$ lb. Thread termination for mic  $\frac{3}{8}$ in BSF male, thread termination for stand  $\frac{3}{8}$ in  $\times$  27tpi female. Supplied with adaptor to  $\frac{3}{8}$ in BSF female. Adaptors for other sizes available. Price: on application.

#### Windshields

For use with DP4, DP6 and DP8 mics. Pressure moulded cage with an inner lining and acoustic resistance network to reduce air turbulence to a low value. Size: 2 $\frac{3}{4}$ in diameter. Weight:  $\frac{3}{4}$ oz. Price: on application.

#### Grampian Parabolic Reflector ★

Diameter 24in, depth 5in. Gain 14dB 500Hz-5kHz. Takes Grampian DP4 and DP6 microphones. Weight: 4 $\frac{3}{4}$ lb. Prices: on application.

#### ■ GRUNDIG (Great Britain) LTD

Newlands Park, Sydenham, London, SE26 5NQ. Tel: 01-659 2468.

#### GDM305C

Mono moving coil hand microphone. Omni-directional. FR: 80Hz-12.5kHz. Sensitivity: -74dB (ref 1V/dyne/cm<sup>2</sup>). Impedance: 500-700 ohms. On/off switch. Table stand supplied. 7-pin DIN plug. Finish: moulded black and silver trim. Price: £8.86 (including VAT).

#### GDM312

Mono moving coil hand microphone. Omni-directional. FR: 150Hz-15kHz. Impedance: 200 ohms and 100K. Wire table stand supplied. Finish: moulded black and grey body. Price: £8.91 (including VAT).

#### GDM314

Mono moving coil hand microphone. Omni-directional. FR: 80Hz-15kHz. Impedance: 200 ohms and 10K. Table stand supplied. 3-pin DIN plug. Extension cable (MEC 10) available at £2.86 including VAT. Finish: black and metallic. Price: £10.40 (including VAT).

#### GDM318SC

Mono moving coil hand microphone. Cardioid response (< 15dB at 180°). FR: 100Hz-15kHz. Sensitivity: -72dB (ref 1V/dyne/cm<sup>2</sup>). Impedance: 700 ohms. Table stand supplied. Fitted 7-pin DIN plug. On-off switch fitted. Finish: moulded black and silver trim. Price: £22.19 (including VAT).

#### ■ LAMB LABORATORIES

Lamb House, Church Street, London, W4 2PB. Tel: 01-995 4551.

#### Type MIT

Microphone transformer, professional in-line balanced to unbalanced. Impedance: 200 ohm source into 1.5K. FR: (at +4dBm) +0 -0.5dB, 20Hz-30kHz, 10Hz -1.5dB. Max level: +14 dBm at 0.1% THD, 100Hz-10kHz. Insertion loss: less 1.5dB at 1kHz at +4dBm. Price: MIT 1 (wire ends only) £4.80 (plus VAT); MIT 2 (fitted with Cannon connectors) £7.75 (plus VAT).

#### ■ LAWTRONICS

139 High Street, Edenbridge, Kent, TN8 5AX. Tel: Edenbridge (073 271) 5191.

#### Model LM23

A subminiature electret microphone with FR: 30Hz-15kHz $\pm$ 6dB. Size: 24 $\times$ 10mm. Weight: 7.5gm. Powered from parent equipment or its own power adaptor. Supplied with adaptor, battery, spare connectors and tie pin in presentation case. Price: £18 (including VAT).

#### ■ LEM

Distributors: Douglas A. Lyons and Associates Ltd, 99 Larkhall Lane, London, SW4. Tel: 01-622 0287. Cables: Daliona, London SW4.

#### DH80

Miniature moving coil. Omni-directional. FR: 70Hz-14kHz $\pm$ 4dB. Impedance: 50 ohms or 80K. Sensitivity: (low imp) -82dB, (high imp) -52dB. May be used as hand microphone, desk stand, or attached to floor stand. Price: from about £7 (plus VAT).

#### DO35

Miniature lavalier moving coil microphone. Omni-directional. FR: 80Hz-12kHz $\pm$ 3dB. Sensitivity: -80dB. Impedance: 200 ohms. Can also be used as hand or stand microphone. Size: 2 $\frac{1}{2}$ in long,  $\frac{7}{8}$ in diameter. Weight: 1 $\frac{3}{8}$ oz. Price: approximately £20.

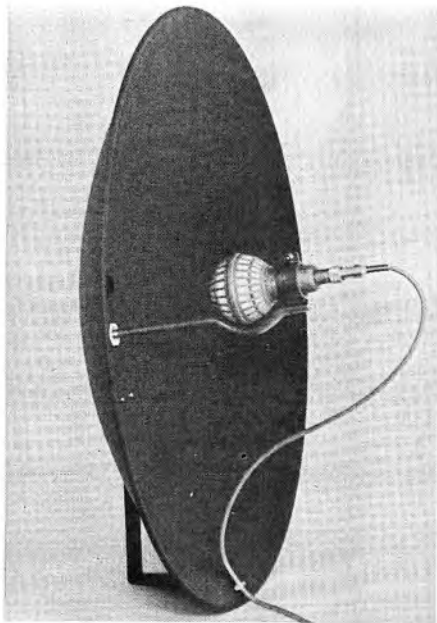

*Grampian Parabolic Reflector*

#### **DO21B**

Studio-quality omni-directional moving coil microphone. FR: 30Hz-16kHz  $\pm$  3dB. Impedance: 50 ohms or 200 ohms. Sensitivity: (200 ohms) - 77dB. Individually calibrated response curves. Suitable for hand or stand use. Price: approximately £20 (plus VAT).

#### **DO20**

Hand or stand type coil microphone. Omni-directional. FR: 40Hz-15kHz. Impedance: 50 ohms, 200 ohms or 80K. Sensitivity: 50 ohms - 82dB, 200 ohms - 76dB, 80K - 50dB. Internal element resiliently mounted to avoid mechanical shock. Price: approximately £14 (plus VAT).

#### **DO42**

Miniature lavalier. Similar specification to type DO35 but incorporates special features to avoid rubbing noises. Price: approximately £22 (plus VAT).

#### **■ LUSTRAPHONE LTD**

St George's Works, Regent's Park Road, London, NW1 8XG. Tel: 01-722 8844.

#### **4-20**

Mono, moving coil, omni-directional stick type with clip for stand mounting. FR: 50Hz-15kHz  $\pm$  5dB. Sensitivity: - 80dB ref 1V/ $\mu$ bar. Impedance: multiple, 30 ohms, 200 ohms, 600 ohms or higher. Built-in windshield and anti-noise



*Melodium 77A*



*Melodium 76A*

protection. Finish: black and silver anodised aluminium. Price: £16.75 (plus VAT).

#### **4-30**

Mono, moving coil cardioid stick type with clip for stand mounting. Sensitivity: - 78dB ref 1V/ $\mu$ bar. Impedance: multiple, 30 ohms, 200 ohms, 600 ohms or higher. FR: 50Hz-15kHz  $\pm$  3dB. Built-in windshield and anti-noise protection. Finish: black and silver anodised aluminium. Price: £25 (plus VAT).

#### **■ MELODIUM**

Distributor: Keith Monks (Audio) Ltd, 26-30 Reading Road South, Fleet, near Aldershot, Hants. Tel: Fleet (02514) 7316 and 3566.

#### **76A ★**

Moving coil, cardioid. FR: 100Hz-15kHz (3dB). Sensitivity: - 63dB (0dB = 1mW/10 $\mu$ bars) 30 ohms or 200 ohms impedance. Windshields available. Price: (head) £21.84 (plus VAT).

#### **77A ★**

Moving coil omni-directional. FR: 40Hz-17kHz  $\pm$  3dB. Sensitivity: - 72dB = 0.25mV. 200 ohms impedance. Hand stick. Clamp fitting with  $\frac{1}{2}$  in Whit. Windshields available. Black plastic. Price: on application.

#### **78A or 78A/108**

Moving coil cardioid. FR: 50Hz-15kHz  $\pm$  3dB.

★ Indicates entry is illustrated

Sensitivity: -67dB (0dB = 1mV/10µbar, 0.042 mV/µbar), 30 ohms or 600 ohms impedance. Stick, head removable for fitting to swan neck. Clamp or swan neck fitting. ½ in Whit. Switch available on microphone or swan neck. Windshields available. Steel. Price: (head) £27.44 (plus VAT).

#### RM6

Ribbon bi-directional. FR: 30Hz-18kHz ± 2dB. Sensitivity: (200 ohms) -56dB 0.1mV/µbar, (50 ohms) -61dB 0.09mV/µbar (0dB = 1mV/10µbar), 50 ohms or 200 ohms impedance. Stick. Clamp fitting. Four position sensitivity and on/off switch. Steel. Price: on application.

#### C121

Moving coil, Cardioid. Noise-cancelling miniature. FR: 150Hz-14kHz ± 3dB. Sensitivity: -89 dB (0.036mV). Removable head for fitting to swan neck or for use as stick mic. With 3-pin DIN connector. Price: £20.72 (plus VAT).

#### C133 ★

Moving coil. Cardioid. Stick type mic. FR: 50 Hz-15kHz ± 3dB. Sensitivity: -83dB (0.072 mV) at 30 ohms, -71dB (0.28mV) at 600 ohms. Built-in pop shield. With or without on/off switch. Melodium or three-pin DIN screened plug. Price: (less on/off switch) £27.80 (plus VAT); (with on/off switch) £30.24 (plus VAT). Lead, plug and clamp extra.

#### Optional accessories

Wide range of plugs, sockets, adaptors, clamps, goosenecks, stands, stereo bars, mounting blocks, windshields, lavalier cords, transformers and adaptors. Full details and prices on request.

#### ■ KEITH MONKS (Audio) LTD

26-30 Reading Road South, Fleet,  
near Aldershot, Hants.  
Tel. Fleet (02514) 7316 and 3566.

#### Microphone stands

High quality chrome finish. Detachable legs with rubber feet. Nylon bushes. Model MS/S floor stand with three screw-in legs. Price: £10.36 (plus VAT). Model MS/M floor stand with three screw-in legs. Price: £14.15 (plus VAT). Model MS/PA floor stand with four screw-in legs and toggle. Aluminium stem and anti-shine legs. Price: £16.36 (plus VAT). Model MS/PA/B floor stand with four screw-in legs and toggle. Black anti-shine finish. Price: £16.36 (plus VAT). Model MS/L studio floor stand with four screw-in legs. Price: £17.08 (plus VAT). Model MS/CT/2 floor stand with 11lb cast base. Price: £14.41 (plus VAT). Model BS/1/B banqueting stand with two-angle operation and cast base. Finished in black. Price: £8.47 (plus VAT). Model BS/2/B banqueting stand with two-angle operation and cast base. Finished in black. Price: £10.60 (plus VAT). Model BS/2/S



Melodium C133 with 326 gooseneck

banqueting stand with slope stem and on/off switch. Price: on specification. Model MS/CT/3 cast base floor stand. Price: £12.18 (plus VAT). Model MS/CT/2/B heavy duty cast base floor stand with black anti-shine stem. Price: £12.47 (plus VAT). MS/L/2 studio four-legged stand with 22in legs. Price: £19.13 (plus VAT).

#### Boom arms and accessories

Model BA/S boom arm with single action. Price: £6. Model BA/M boom arm with two actions. Price: £7.20. Model SB/1 stereo bar for fitting two microphones to one stand. Price: £2.40. Model SC/1 adjustable bar for fitting microphone to side of stand. Price: £2.50. Model CCI plastic clips (three pairs of different sizes). Price: 25p. Comprehensive range of thread adaptors to suit most Whitworth, continental and British threads, internal and external. Full details on request. Prices. (S1A range) from 30-65p. EXT/1 extension tube (36in adjustable). Price: £4.20; DB/1 drum boom extension. Price: £7.20; SC/1 side clamp. Price: £2.50; CD/1 cable drum. Price: £16.20. All prices include VAT.

#### Studio stands

Studio 1 (MS/L1 and BA/L1). Price: £29.81; Studio 2 (MS/L2 and BA/L3). Price: £32.34; Studio 3 (MS/L2 and BA/L4). Price: £29.20; Studio 4 (as Studio 2 but with 36in extension). Price: £36.54; Studio 5 (as Studio 3 but with 36in extension). Price: £33.40. All prices plus VAT.

#### Studio boom arms

BA/L1 (64in long with 2lb weight). Price: £10.78; BA/L2 (42in long with 2lb weight). Price: £7.39; BA/L3 (64in long with 4lb weight). Price: £13.11; BA/L4 (42in long with 4lb weight). Price: £9.72. All prices include VAT.

#### Studio boom arms

BAL 42/2 (42in long with 2lb weight). Price:

£9.59; BAL 42/4 (42in long with 4lb weight). Price: £10.07; BAL 72/2 (72in long with 2lb weight). Price: £12.73; BAL 72/4 (72in long with 4lb weight). Price: £13.21. All prices plus VAT.

## ■ NEUMANN GMBH

Sole UK Agents: F. W. O. Bauch Ltd,  
49 Theobald Street, Boreham Wood, Herts,  
WD6 4RZ. Tel: 01-953 0091.

### KM73

Transistor (FET) condenser. Omni-directional. FR: 40Hz-16kHz  $\pm$  2dB. Sensitivity across 1K: 2.5mV/dyne/cm<sup>2</sup>. Impedance: 200 ohms without transformer. Printed circuit. Miniature pressure mic. Price on application.

### KM74 ★

Transistor (FET) condenser. Cardioid. FR: 40Hz-16kHz  $\pm$  2dB. Sensitivity across 1K: 2.5 mV/dyne/cm<sup>2</sup>. Impedance: 200 ohms without transformer. Printed circuit. Miniature pressure-gradient mic. Price on application.

### KM76 ★

Transistor (FET) condenser. Switchable: omni-directional, cardioid, figure-of-eight. FR: 40Hz-16kHz  $\pm$  2dB. Sensitivity across 1K: 2.6mV/dyne/cm<sup>2</sup>. Impedance: 200 ohms without transformer. Printed circuit. Miniature pressure-gradient mic. Price on application.

### KML

Lavalier transistor (FET) condenser. Cardioid. FR: 40Hz-16kHz  $\pm$  2dB. Sensitivity across 1K: 0.5mV (18V) or 1.8mV (45V) per dyne/cm<sup>2</sup>. Impedance: 50 or 200 ohms. Built-in transformer. Printed circuit. Battery driven (18V or 45V). Miniature pressure-gradient mic. Price on application.

### U77

Condenser FET. Switchable omni-directional or cardioid or figure-of-eight. FR: 40Hz-16kHz. Sensitivity across 1K: 2.6mV/microbar (omni), 5mV/microbar (figure-of-eight), 3mV/microbar (cardioid). Impedance: 200 ohms. Pressure-gradient mic. Bass cut and sensitivity switch of -10dB. Price on application.

### KM83

FET condenser. Omni-directional. FR: 40Hz-16kHz. Sensitivity: 0.5mV/microbar. Impedance: 50 or 200 ohms. Built-in transformer. Sensitivity switch: -10dB. Price on application.

### KM84

FET condenser. Cardioid. FR: 40Hz-16kHz. Sensitivity: 0.5mV/microbar. Impedance: 50 or 200 ohms. Built-in transformer. Sensitivity switch: -10dB. Price on application.

### KM86

FET condenser. Cardioid. FR: 40Hz-16kHz.



Neumann KM74

Neumann KM76

Sensitivity: 0.5mV/microbar. Impedance: 50 or 200 ohms. Built-in transformer. Sensitivity switch: -10dB. Price on application.

### U87

FET condenser. Switchable to omni-directional, cardioid or figure-of-eight. FR: 40Hz-16kHz. Impedance: 50 or 200 ohms. Built-in transformer. Bass cut and sensitivity switch of -10dB. Price on application.

### KM88

FET condenser. Switchable to omni-directional or cardioid. FR: 40Hz-16kHz. Impedance: 50 or 200 ohms. Sensitivity across 1K: approx 0.7 mV/microbar. Built-in transformer. Sensitivity switch -10dB. Price on application.

### SM69 FET

Stereo transistor condenser. Both systems separately remote controlled: omni-directional, cardioid or figure-of-eight. FR: 40Hz-16kHz. Sensitivity across 1K: 2mV/microbar. Impedance: 50 or 200 ohms. Built-in transformers. Pressure-gradient. Price on application.

### U47 FET ★

Mono condenser. Cardioid. FR: 40Hz-16kHz. Sensitivity: 0.8mV/ $\mu$ bar. Impedance: 150 ohms balanced. Recommended load:  $\geq$  750 ohms. Stand swivel with thread adaptor. Continues the tradition of the U47 produced from 1947-1960. Elastically mounted capsule and various





Neumann U47 FET



Neumann KMS 85

switches. Finish: matt nickel plated. Price on application.

#### **KMS 85 ★**

Mono condenser. Cardioid. FR: 40Hz-16kHz. Sensitivity: 0.6mV/ $\mu$ bar. Impedance: 150 ohms balanced. Recommended load:  $\geq 750$  ohms. Hand type. Multistage mechanical filter in front of condenser capsule provides protection against close-talking popping noises and other explosive sounds. Finish: matt nickel plated. Price on application.

#### **KMA**

Mono condenser. Cardioid. FR: 40Hz-16kHz. Sensitivity: 0.5mV open circuit voltage. Impedance: 800 ohms balanced. Recommended load:  $\geq 2.7k$ . Lavalier type. Tie-clip fitting. Low sensitivity to noise of clothing etc. Finish: dark satin nickel plate. Price: on application.

#### **PEARL**

Allotrope Ltd,  
90 Wardour Street, London, W1V 3LE.  
Tel: 01-437 1892. Telex: 21624.

#### **M-68**

Mono ceramic microphone. Noise-cancelling type. FR: 500Hz-5kHz -6dB. Sensitivity: 0dBm for normal voice  $\frac{1}{2}$ in from microphone. Impedance: 600 ohms. Hand type. Military specification with built-in on/off switch and four transistor pre-amplifier. External metal parts non-ferrous and black anodised. Price: £73.37 (including VAT).

#### **CL-3**

Sub-miniature omni-directional tie-pin capacitor microphone. FR: 80Hz-17kHz -3dB. Sensitivity: 32mV/Pascal. Impedance: 200 ohms. Recommended load:  $\geq 200$  ohms. Size:  $1\frac{1}{2} \times \frac{5}{16} \times \frac{1}{4}$ in. Finish: brass and satin chrome. Price: £104.60 (including VAT).

#### **HM49**

Moving coil omni-directional stand microphone. FR: 50Hz-18kHz -6dB. Sensitivity: -74dB. Impedance: 200 ohms. Rec load:  $\geq 200$  ohms. Fitting:  $\frac{5}{8}$ in  $\times$  27tpi. Finish: black anodised alloy. Price: £44.60.

#### **HM47**

Moving coil omni-directional lavalier microphone. FR: 100Hz-10kHz -6dB. Sensitivity: -76dB. Impedance: 200 ohms. Rec load:  $\geq 200$  ohms. Fitting: lavalier neck cord. Polyester diaphragm. Finish: brass, satin chrome. Price: £29.23 (including VAT).

#### **RD34/36**

Moving coil cardioid stand microphone. FR: 40Hz-16kHz -6dB. Sensitivity: -74dB. Impedance: (RD34) 200 ohms; (RD36) 200 ohms and high Z. Rec load:  $\geq 200$  ohms. Fitting:  $\frac{5}{8}$ in  $\times$  27tpi adaptor. Polyester diaphragm. Finish: black anodised alloy. Price: (RD/34) £20.52 (including VAT); (RD36) £27.48 (including VAT).

#### **RD16**

Moving coil cardioid lavalier or stand microphone. FR: 80Hz-12kHz -6dB. Sensitivity: -70dB. Impedance: 200 ohms. Rec load:  $\geq 200$  ohms. Fitting:  $\frac{5}{8}$ in  $\times$  27tpi adaptor. Polyester diaphragm. Finish: black anodised alloy. Price: £19.90 (including VAT).

#### **LD18/19**

Moving coil omni-directional stand microphone. FR: 80Hz-16kHz -6dB. Sensitivity: -74dB. Impedance: (LD18) 200 ohms; (LD19) 200 ohms and high Z. Rec load:  $\geq 200$  ohms. Fitting:  $\frac{5}{8}$ in  $\times$  27tpi. Polyester diaphragm. Finish: black anodised alloy. Price: (LD18) £18.66 (including VAT); (LD19) £23 (including VAT).

#### **D44LS/BS**

Moving coil cardioid lavalier or stand microphone. FR: 100Hz-13kHz -6dB. Sensitivity: -71dB. Impedance: (D44LS) 200 ohms; (D44BS) 200 ohms and high Z. Fittings:  $\frac{5}{8}$ in  $\times$  27tpi. Built-in on/off switch and windshield. Finish: anodised black alloy. Price: (D44LS) £9.82 (including VAT); (D44BS) £14.93 (including VAT).

#### **ST8**

Capacitor stereo microphone with variable response pattern. FR: 30Hz-18kHz. Sensitivity: -61dB. Impedance: 200 ohms. Rec load:  $\geq 200$  ohms. Stand fitting:  $\frac{5}{8}$ in  $\times$  27tpi. Variable pat-



Pearl DC73



Pye/Philips LBB9005/05

tern with remote control, one capsule may be rotated through 180 deg. Finish: brass, satin chrome. Price: £469.77 (including VAT).

#### FP92C/FP92K

Capacitor mono stand microphone. Response: (FP92C) cardioid; (FP92K) omni-directional. FR: 30Hz-16kHz-3dB. Sensitivity: -66dB. Impedance: 200 ohms. Rec load:  $\geq 200$  ohms. Fitting:  $\frac{5}{8}$ in  $\times$  27tpi. Permanent pre-polarisation. Built-in 6V battery supply. Weight: 6oz. Finish: brass, satin chrome. Price: £78.97 (including VAT).

#### TCV4V

Capacitor stand microphone with variable remote-controlled response pattern. FR: 40Hz-18kHz-3dB. Sensitivity: -56dB. Impedance: 200 ohms. Rec load:  $\geq 200$  ohms. Fitting:  $\frac{5}{8}$ in  $\times$  27tpi. Finish: brass, satin chrome. Price: £123.74 (including VAT).

#### DC96

Capacitor stand microphone with cardioid response. FR: 30Hz-18kHz-3dB. Sensitivity: -61dB. Impedance: 200 ohms. Rec load:  $\geq 200$  ohms. Fitting:  $\frac{5}{8}$ in  $\times$  27tpi. Finish: brass, satin chrome. Price: £107.25 (including VAT).

#### DC73 ★

Capacitor hand or stand cardioid microphone. FR: 40Hz-17kHz-3dB. Sensitivity: -60dB. Impedance: 200 ohms. Rec load:  $\geq 200$  ohms. Fitting:  $\frac{5}{8}$ in  $\times$  27tpi. Switchable pop filter. Shockproof elastic suspension. Finish: brass, satin chrome. Price: £71.10 (including VAT).

#### DC63

Capacitor stand microphone with variable response pattern. FR: 30Hz-18kHz-3dB. Sensitivity: -60dB. Impedance: 200 ohms. Rec load:  $\geq 200$  ohms. Fitting:  $\frac{5}{8}$ in  $\times$  27tpi. Variable response pattern gives 44 combinations. Switchable bass cut. Switched attenuator. Finish: polished alloy and brass, satin chrome. Price: £182.81 (including VAT).

#### DC20/DC21

Capacitor stand microphone. Response: (DC20) omni-directional; (DC21) cardioid. FR: 30Hz-18kHz-3dB. Sensitivity: -56dB. Impedance: 200 ohms. Rec load:  $\geq 200$  ohms. Fitting:  $\frac{5}{8}$ in  $\times$  27tpi. Miniature microphone measuring  $2\frac{1}{2}$ in long and  $\frac{3}{4}$ in diameter. Finish: polished alloy or brass, satin chrome. Price: £54.10 (including VAT).

#### VM40/41

The VM40 (omni-directional) and VM41 (cardioid) Condenser Microphones combine new design and construction with increased facilities. A four position ring switch mounted near the microphone head selects 10dB attenuation and/or low frequency roll off. Rec load: 200 ohms. FR: 30Hz-18kHz, 48V symmetrical signal cable powering. Price: £94.05 (including VAT).

#### VM40/12 and VM41/12

Condenser Microphones as VM40/41 above, but can be operated by a symmetrical signal cable supply of between 10 and 48V. Price: £111.93 (including VAT).

#### SP84/85

The SP84 (omni-directional) and SP85 (cardioid) are self-powered versions of the VM40/41 condenser microphones above. An internal 15V battery operates a d.c. to d.c. converter providing the capsule polarising voltage. The supply is controlled by a plunger on/off switch in the microphone body operated by the mating connector. Price: £121 (including VAT).

#### ■ PHILIPS

Pye Business Communications Ltd,  
Cromwell Road, Cambridge, CB1 3HE.  
Tel: Cambridge (0223) 45191.

#### LBB9005/05 ★

Moving coil cardioid microphone. FR: 40Hz-18kHz. Impedance: 500 ohms. Sensitivity: -71dB. On/off switch. Quick-release holder for



Pye/Philips EL6042/05



Philips LBB 9003/05

stands with  $\frac{3}{8}$ ,  $\frac{1}{2}$  or  $\frac{5}{8}$ in Whit threads. 10ft twin screened lead. Price: £24 (plus VAT).

**LBB9007/05**

Moving coil cardioid microphone. FR: 40Hz-18kHz. Impedance: 500 ohms and 25K. Sensitivity: 500 ohms -71dB, 25K -4dB. Combined on/off and impedance selector switch. Fitted flexible shaft and 10ft twin screened lead. Finish: brushed satin stainless steel head and chromium plated shaft. Fits stand with  $\frac{3}{8}$ ,  $\frac{1}{2}$  or  $\frac{5}{8}$ in Whit threads. Price: £30 (plus VAT).

**LBB9008/05**

Moving coil cardioid microphone. Similar specification to LBB9007 except for panel mounting (or stand mounting with LBC.1201 adaptor) and single impedance (200 ohms). No on/off switch. Capsule with hum-compensating coil. Price: on application.

**LBB9100/05**

High quality cardioid microphone for speech and music. FR: 50Hz-16kHz. Impedance: 200 ohms. Front-to-back ratio: 18dB. Speech music switch. Built-in DIN connector. All-metal housing. Price: £40 (plus VAT).

**FL.6042/05 ★**

Professional quality omni-directional moving

coil. FR: 30Hz-20kHz. Impedance: 200 ohms. Sensitivity: -79dB at 1kHz reference 1V/ $\mu$ bar. Size:  $5\frac{1}{8} \times \frac{3}{4}$ in. Finish: matt chrome plate. Quick-release holder-clamp for stands with  $\frac{3}{8}$ ,  $\frac{1}{2}$  or  $\frac{5}{8}$ in Whit threads. Three-pole plug for twin screened cable. Individually calibrated frequency response. Price: £42 (plus VAT).

**LBB9018**

High quality noise cancelling microphone. FR: 200Hz-12.5kHz. Front-to-rear sensitivity: 16 dB. Impedance: 250 ohms. Supplied with four-core and screened cable. On/off button. Suspension bracket. Price: £24 (plus VAT).

**LBB9003/05 ★**

Moving coil omni-directional lavalier microphone. FR: 50Hz-15kHz. Impedance: 200 ohms. Sensitivity: -78dB. Suitable also for hand use. Complete with neck cord and 33ft cable. Price: £21 (plus VAT).

**LBB9102/05**

High quality microphone for speech and music. FR: 50Hz-16kHz. Impedance: 200 ohms. Front-to-back ratio: 18dB. Supplied with 16ft cable. Mounted on wood shaft. Price: £40 (plus VAT).

**LBB9020/05**

High quality cardioid with on/off switch. FR: 40Hz-17kHz. Impedance: 200 ohms. Front-to-rear sensitivity: 20dB constant impedance even when 'off', built-in DIN connector, stand clamp. Price: £40 (plus VAT).

**LBB9105/05**

High quality cardioid speech/music microphone. FR: 40Hz-17kHz. Impedance: 200 ohms. Front-to-rear sensitivity 20dB. Speech/music switch, built-in DIN connector, stand clamp. Price: £40 (plus VAT).

**LBB9050/05**

Studio quality dual capsule microphone with crossover filters. Moving coil. Cardioid. FR: 25Hz-20kHz. Impedance: 200 ohms. Sensitivity: -77dB. Quick release holder for all stands. Price: £38 (plus VAT).

**LBB9101/05**

Moving coil microphone with an all-metal housing. FR: 30Hz-20kHz. Speech/music switch. Built-in DIN connector. Impedance: 200 ohms. Price: £40 (plus VAT).

**EL.6204**

Universal microphone table stand. Provided with  $\frac{3}{8}$ in Whit thread and possibility of mounting signal lamps or switches, etc. Price: £5.50 (plus VAT).

**ET907**

Telescopic floor stand with heavy base, 42in closed, 72in extended. Price: £14.50 (plus VAT).

**LBC1203/00**

Table stand. Tripod type. Price: £3 (plus VAT).



Reslo UDI



Reslo 580 Superstar



Reslo PD3



Reslo UD3

**LBC1207/00**

Windshield for LBB9005, LBB9007, LBB9008, LBB9100, LBB9101, LBB9500. Price: £1.50 (plus VAT).

**LBC1209/00**

Windshield for LBB9050. Price: £1.80 (plus VAT).

**EL6207**

Vibration damper for use with EL6033 on floor or table stands. Price: £4.50 (plus VAT).

**LBC1200**

Short flexible shaft fitted with socket to accept microphones EL6033, EL6042, LBB9100, LBB9101. Length 8in. Complete with 5 yards cable. Price: £10.50 (plus VAT).

**LBC1205/01**

Cable with switched plug for use with LBB9050, LBB9100, LBB9101, EL6042 and EL6033. Price: £7 (plus VAT).

**LBC1210/00**

Three-pole DIN microphone plug for use with LBB9050, LBB9100, LBB9101, EL6042, EL6033. Price: £1 (plus VAT).

**LBC1208/10**

Ten-metre extension cable complete with plugs. For use with LBB9050, LBB9100, LBB9101, EL6042, EL6033. Price: £7 (plus VAT).

**N8500**

Hyper-cardioid electret microphone designed particularly for use with high quality cassette and open reel recorders. FR: 100Hz-16kHz (DIN 45-500). Impedance: 1K. Power supply:

1.5V Penlight. Price: £16 (including VAT).

Stereo test record 'For the love of mike' available free on request.

**RESLOSOUND LTD**

Spring Gardens, London Road,

Romford, Essex, RM7 9LJ.

Tel: Romford (70) 61926. Telex: 897311.

**UD.1 ★**

Uni-directional hand or stand microphone. FR: 50Hz-17kHz (-4dB at 100Hz, +8dB at 16kHz). Rear pickup -10 to -20dB between 200Hz-15kHz. Sensitivity: -88dB at 30-50 ohms. Output: average voice 6in from front of mic 150µV (low imp), 250-450µV (medium imp), 2-4mV (high imp). Output increases approximately 10 times at one inch from microphone. Impedances: UD.1/L 30-50 ohms or 600 ohms; UD.1/M medium impedance, 200-300 ohms; UD.1/MT, 600-1000 ohms; UD.1/H, high impedance. Finish: main case beige nylon, top case satin silver. Price: £25 (plus VAT).

**S80 Superstar ★**

Moving coil cardioid hand or stand microphone. FR: 50Hz-15kHz. Sensitivity: -58dB (50K). Impedance: (S80L) 30 or 600 ohms, (S80H) 250 ohms or 50K. Optional accessories: carry case, dual impedance cable set. Price: (both versions) £34 (plus VAT).

**UD3 ★**

Moving coil super cardioid stand microphone. FR: 100Hz-16kHz. Sensitivity: -58dB (50K). Impedance: (UD3/LM) 30 or 600 ohms, (UD3/

★ Indicates entry is illustrated

MH), 200 ohms or 50K. Terminated with Reslo connector and suitable for use with any of the six flexible stems. Price: (both versions) £16 (plus VAT).

#### PD3 ★

Moving coil omni-directional pencil microphone. FR: 30Hz-17kHz. Sensitivity: -88dB (30 ohms). Impedance: (PD3/L) 30 ohms, (PD3/M Dual) 200 or 600 ohms, (PD3/H) 50K. Supplied with 16ft directly-connected cable. Optional extras: SA6019 stand adaptor, MS500 desk base. Price: (all versions) £14 (plus VAT).

#### MRI

Ribbon semi-cardioid stand microphone. FR: 35Hz-16kHz. Sensitivity: -58dB (50K). Impedance: (MRI/L) 30 ohms, (MRI/M Dual) 250 or 600 ohms, (MRI/H) 50K, (MRI/MT Level) bass version for transistor inputs of 600-1000 ohms. Price: £26 (plus VAT).

#### MPD

Moving coil omni-directional miniature pencil stand or lavalier microphone. FR: 50Hz-15kHz. Sensitivity: -88dB (30 ohms). Impedance: 30 ohms. Available as head only (MPD/HD), lavalier type (MPD/L) and desk version (MPD/D) with 8in flexible stem and desk base. Price: (MPD head) £9 (plus VAT); (MPD/lavalier) £13 (plus VAT); (MPD/D desk) £17 (plus VAT).

#### MPD/L

Dynamic, omni-directional, lavalier. FR: 50 Hz-15kHz -12dB at 100Hz, +4dB at 14kHz. Sensitivity: 88dB below. Impedance: low. Finish: satin anodised. Price: £14 (plus VAT).

#### MPD/D

Dynamic, omni-directional, desk base fitted with 8in flexible stem. FR: 50Hz-10kHz. Sensitivity: 88dB below. Impedance: low. Finish: satin anodised microphone, chrome stem, grey enamel base. Price: £18 (plus VAT).

#### Silverstar S91

Cardioid electret microphone. Impedance: 30-600 ohms and high impedance. FR: 40Hz-20kHz. Sensitivity: -76dB. Stand mounting type. Price: £47.30 (including VAT). Switched version available.

#### P200

Parabolic reflector microphone, dynamic type. Impedance: 150-600 ohms. FR: 300Hz-15kHz. Sensitivity: -52dB. Hand or tripod mounting. Price: £44 (including VAT).

#### EPM

As for the P200, but FR: 150Hz-20kHz. Sensitivity: -42dB. Price: £132 (including VAT).

#### Microphone transformers MT101, MT102

Designed for internal mounting in equipment having only high impedance inputs. Input imp: MT101 15-50 ohms, MT102 300-600 ohms.



Ross RE-345 (left) and RE-350

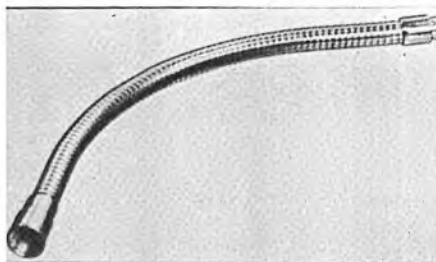

Ross 13in Gooseneck

Nominal output imp: 100K. Response: 50Hz-15kHz±2dB. Price: £3.50 (plus VAT).

#### MS.110B

Adjustable floor stand. Minimum height: 40in, maximum height: 62in. Grey hammertone base, chrome outer and inner stem. Price: £14 (plus VAT).

#### MS.175 and MS.180

Boom arm fitting available for use with Reslo floor stands. Price: £17 (plus VAT).

#### MS.200

Adjustable table stand. Minimum height: 1ft 4in. Maximum height: 2ft 2in. Grey hammertone base with chrome stem and extension piece. Price: £10 (plus VAT).

#### MS.300

Circular desk stand. Grey hammertone base fitted with 3in chrome stem. Price: £6 (plus VAT).

#### MS.500

Rectangular desk base. Fitted with rubber feet. Finished in silver grey hammertone. Muting switch optional extra. Price: £3.50 (plus VAT).

#### Reslo radio microphones

Range of radio microphones for all purposes. Full details on request.

#### ROSS ELECTRONICS

32 Rathbone Place, London, W1P 1AD.  
Tel: 01-580 7112.

#### RE-320

Dynamic, omni-directional ball type. Impedance: 50K. Response: 50Hz-12kHz. Sensitivity:

— 54dB at 50K. Satin finish, diecast case. On/off switch. Price: £10.31 (including VAT).

**RF-325**

Uni-directional, cardioid dynamic. Dual impedance: 600 ohms and 50K. Satin and black anodised finished, diecast case. On/off switch. Price: £11.69 (including VAT).

**RF-330**

Uni-directional, cardioid dynamic. Dual impedance: 600 ohms and 50K. Response: 50Hz-15kHz. Sensitivity: —55dB at 50K. Satin finished diecast case. On/off switch. Price: £13.40 (including VAT).

**RF-335**

Dynamic, omni-directional slimline type with detachable foam windshield. Dual impedance: 600 ohms and 50K. Response: 50Hz-17kHz. Sensitivity: —57dB at 50K. Satin finish, diecast case. On/off switch. Price: £13.40 (including VAT).

**RE-345 ★**

Uni-directional, cardioid dynamic. Switched dual impedance: 600 ohms and 50K. Response: 50Hz-15kHz. Sensitivity: —72dB at 600 ohms, —56dB at 50K. Diecast casing finished matt silver with parallel flutes and black mesh screen. On/off switch. Price: £14.05 (including VAT).

**RF-350 ★**

Uni-directional, cardioid dynamic. Switched dual impedance: 600 ohms and 50K. Response: 50Hz-15kHz. Sensitivity: —72dB at 600 ohms, —56dB at 50K. Case and machined head with deep drawn wire mesh screen. Price: £14.65 (including VAT).

**Gansneck ★**

$\frac{3}{8}$ in diameter. Minimum bend radius  $1\frac{1}{2}$ in. Male/female threaded ends. Available in 13in and 21in lengths. Prices: (13in) £2.70 (including VAT); (21in) £3.93 (including VAT).

**B.2004 Mixer**

4-channel transistorised audio mixer with mono/stereo selector switch. High impedance inputs into standard jack sockets; phono plug output. Max input 1V. Output 1.3V. Noise ratio: —60 dB. Gain approximately 3dB. Price: £7.94 (including VAT).

**■ SENNHEISER ELECTRONIC**

Distributors: Hayden Laboratories Ltd, Hayden House, 17 Chesham Road, Amersham, Bucks, HP6 5AG. Tel: Amersham (02403) 5511.

Audio equipment showroom, service department and despatch department: 6 Bendall Mews, Bell Street, London, NW1.

# ROSS ELECTRONICS

THE NAME FOR  
MICROPHONES



32 Rathbone Place, London W1P 1AD. Tel: 01-580 7112/3



Sennheiser MD214

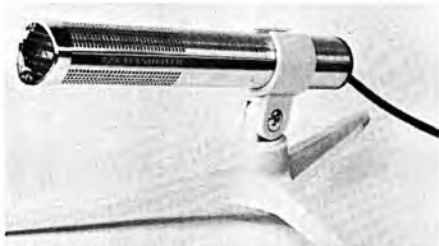

Sennheiser MD402LM

#### **MD21**

Omni-directional moving coil hand or stand microphone. FR: 40Hz-18kHz  $\pm$  3dB. Sensitivity: 0.2mV/ $\mu$ bar  $\pm$  3dB. Impedance: 200 ohms. Rec load: 1K. Light alloy case finished hammer stove enamel. Windshield MZW421 optional extra. Price: (microphone) £29.80 (plus VAT); (windshield MZW421) £3.40 (plus VAT); (desk stand MZT21) £3.60 (plus VAT).

#### **MD21HL**

Dual-impedance version of MD21. Price: £31.20 (plus VAT).

#### **MD21IN**

Omni-directional moving coil miniature studio microphone. Hand or stand use. FR: 30Hz-20kHz  $\pm$  2.5dB. Sensitivity: 0.13mV/ $\mu$ bar  $\pm$  2.5dB. Impedance: 200 ohms. Rec load: 1K. Metal case with satin chrome finish. Windshield MZW201 optional extra. Price: (microphone) £53.80 (plus VAT); (windshield MZW201) £3.05 (plus VAT); (small tripod desk stand MZT104) £3.05 (plus VAT).

#### **MD214 ★**

Omni-directional moving coil lavalier microphone. Built-in 'natural voice' equaliser to studio standards. FR: specially designed for lavalier operation. Sensitivity: 0.10mV/ $\mu$ bar  $\pm$  2.5dB. Impedance: 200 ohms. Rec load: 1K. Metal case finished special 'non-glare' enamel. Price: £50.85 (plus VAT).

#### **MD408N**

Super cardioid moving coil microphone with flexible shaft. Specially suitable for PA applications. FR: 50Hz-15kHz  $\pm$  3dB. Impedance: 200 ohms. Sensitivity: 0.13mV/ $\mu$ bar  $\pm$  3dB. Case of light gauze woven wire cloth. Price: £28 (plus VAT).

#### **MD420-2**

Super-cardioid noise cancelling moving coil mono microphone. FR: 200Hz-10kHz (special response curve for noise cancellation). Impedance: 200 ohms. Rec load: 1K. Sensitivity: 0.18mV/ $\mu$ bar. Hand or stand microphone with large Tuchel plug. Metal case with silver finish. Price: (MD420-2) £22.90 (plus VAT); (MD420-2T with switch) £25.45 (plus VAT).

#### **MD420-9**

Shorter version of MD420 for gooseneck mounting. Price: £22.90 (plus VAT).

#### **MD402LM ★**

Mono moving coil super cardioid microphone. FR: 80Hz-12.5kHz. Sensitivity: 2.3mV/ $\mu$ bar. Impedance: 750 ohms. Rec load: 4K. Hand mic with stand and clip. Rugged construction. Frequency response tailored for domestic applications. Finish: satin chrome. Price: £13.50 (plus VAT).

#### **MD409N**

Mono moving coil super cardioid. FR: 50Hz-15kHz. Sensitivity: 0.18mV/ $\mu$ bar. Impedance: 200 ohms. Rec load: 200 ohms or greater. Stand mounted musicians' microphone. Finish: black and gold. Price: £42 (plus VAT).

#### **MD421**

Mono moving coil cardioid microphone. FR: 30Hz-17kHz. Sensitivity: 0.2mV/ $\mu$ bar at 1kHz. Impedance: (HL series) 200 ohms and 24K; (N, U and 2 series) 200 ohms. Rec load: (high Z version of HL series) 50K, (all others) 1K. Hand/stand microphone  $\frac{3}{8}$ in thread fitting. Built-in bass cut switch. Low handling noise. Finish: (standard versions) grey plastic body with chrome grille. Price: (MD421N & MD421U) £49.50; (MD421HL) £51. All plus VAT.

#### **MD441 ★**

Mono moving coil super cardioid microphone. FR: 30Hz-20kHz. Sensitivity: 0.2mV/ $\mu$ bar  $\pm$  3dB. Impedance: 200 ohms. Rec load: 1K. Hand microphone, with optional mounting clip available. Choice of ten switchable frequency responses. Low handling noise. Pclar diagram constant over frequency range. Finish: shock resistant metal case. Silver-plated metal grille on matt black body. Price: (MD441N, MD441-2, MD441-U) £69 (plus VAT).

#### **MKH105T**

Mono capacitor omni-directional microphone. FR: 20Hz-20kHz. Sensitivity: 2mV/ $\mu$ bar. Im-



Sennheiser MD441

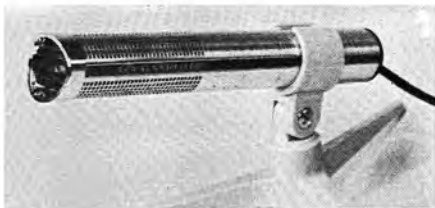

Sennheiser MD402LM



Sennheiser MKH124



Sennheiser MKE201

pedance: 20 ohms. Rec load: 200 ohms or greater. Hand/stand microphone. Table stands MZT104 and 105 available. Low self noise. Windshield (MZW201) optional extra. Finish: satin chrome on brass. Price: £108 (plus VAT).

#### **MKH124 ★**

Mono capacitor omni-directional. FR: 40Hz-20kHz. Sensitivity: 0.32mV/ $\mu$ bar. Impedance: 150 ohms. Rec load: 200 ohms or greater. Lapel or lavalier microphone with clip or lanyard. Small size: flat frequency response. Presence lift. Finish: matt grey enamel. Price: £144 (plus VAT).

#### **MKH125**

Mono capacitor omni-directional microphone. FR: 40Hz-20kHz. Sensitivity: 2mV/ $\mu$ bar. Impedance: 10 ohms. Rec load: 200 ohms. Lapel/lavalier microphone with lanyard or clip. Small size. Flat frequency response. Presence lift. Finish: matt grey enamel. Price: £153 (plus VAT).

#### **MKH415T/TU**

Mono capacitor super cardioid microphone. FR: 40Hz-20kHz. Sensitivity: 2mV/ $\mu$ bar. Impedance: 20 ohms. Rec load: 200 ohms. Hand/stand microphone. Table stand MZT415 available. Low self noise. Good wind noise rejection. Windshield MZW415. Finish: satin chrome on brass. Price: £130 (plus VAT).

#### **MKH815T/TU**

Mono capacitor uni-directional (narrow beam) microphone. FR: 50Hz-20kHz. Sensitivity: 4mV/ $\mu$ bar. Impedance: 20 ohms. Rec load: 200 ohms. Gun microphone. Fittings: boom MZS-

805 or pistol grip MZP805. Low self noise. Very narrow beam. Windshield: MZW804 and MZW-815. Finish: satin chrome on brass. Price: £172 (plus VAT).

#### **MD412LM**

Moving coil super cardioid mono microphone. FR: 50Hz-12.5kHz. Impedance: 800 ohms. Sensitivity: 0.2mV/ $\mu$ bar  $\pm$  3dB. Built-in roll-off filter. With desk stand. Price: £21 (plus VAT).

#### **MKH435T/TU**

Studio quality capacitor microphone. Cardioid polar diagram. FR: 40Hz-20kHz. Sensitivity: 2mV/ $\mu$ Bar  $\pm$  1dB. Impedance: 200 ohms. Hand/stand type microphone. Price: £126 (plus VAT).

#### **MD416NU**

Moving coil mono microphone. Cardioid-polar diagram. Insensitive to handling or mechanical vibrations. Designed for vocal or instrumental soloists. FR: 50Hz-15kHz. Sensitivity: 0.13mV/ $\mu$ bar  $\pm$  3dB. Impedance: 200 ohms. Hand or stand microphone. Low sensitivity to pop and wind noises. Price: £49 (plus VAT).

#### **MD413NU**

Moving coil mono microphone. Cardioid diagram. FR: 50Hz-15kHz. Impedance: 200 ohms. Sensitivity: 0.13mV/ $\mu$ bar  $\pm$  3dB. Rec load: 200 ohms or greater. Hand or stand microphone. Built-in 'pop' protector. Good immunity to feedback. Finish: solid brass with satin chrome finish. Price: £39 (plus VAT).

#### **MKE201 ★**

Electret omni-directional mono microphone. FR: 50Hz-15kHz. Sensitivity: 2mV/ $\mu$ bar  $\pm$  3dB. Recload: (minimum) 1.5K. Battery requirement:



★ Indicates entry is illustrated

5-6V DC (Mallory PX23). Operating time on one battery greater than 600 hours. Hand or stand type supplied with MZT104 stand. Finish: satin nickel. Price: £32.05 (plus VAT).

#### **MKE401**

Similar specification to the MKE201 but with super cardioid polar diagram. Price: £37.40 (plus VAT).

### ■ SHURE ELECTRONICS LTD

Eccleston Road, Maidstone, ME15 6AU.  
Tel: Maidstone (0622) 59881.

#### **545 Unidyne III ★**

Cardioid moving coil. FR: 50Hz-15kHz. Sensitivity: -55dB. Source impedance: 25-250 ohms and high. Built-in transformer. Price: (545 less switch) £36.30 (including VAT); (545SD with switch) £38.28 (including VAT).

#### **565 Unisphere I ★**

Moving coil. Cardioid (with polar diagram uniform with frequency, symmetrical about axis). FR: 50Hz-15kHz. Dual impedance: (50-250 ohms and high). Sensitivity: (low Z) -78dB, (high Z) -55dB. Hand or stand. Built-in wind/breath filter. Available with or without switch. Detachable 15ft three-core screened lead. Finish: satin chrome body with plated steel grille. Size: 6½in long, 2in diameter over head. Price: (565 less switch) £41.58 (including VAT); (565SD with switch) £42.90 (including VAT).

#### **588SA Unisphere B**

Moving coil. Cardioid. FR: 50Hz-13kHz. Impedance: high Z (low version 25-200 ohms available). Sensitivity: (high Z) -59dB, (low Z) -81.5dB. Hand or stand microphone supplied with swivel stand adaptor. Built-in switch with provision for locking on. Wind/breath filter. Detachable 15ft cable. Finish: satin chrome with steel mesh grille. Size: 6½in long, 2½in diameter. Price: (588SA high Z) £26.40 (including VAT); (588SB low Z) £25.08 (including VAT).

#### **515SA Unidyne B**

Moving coil. Cardioid. FR: 80Hz-13kHz. Sensitivity: -58dB. High impedance (low impedance version available). Hand or stand. On/off switch with lock. Size: 6½in long, 1½in diameter. Satin chrome body with black grille and stainless steel screens. Price: 515SA (high impedance) £18.48 (including VAT); 515SB (low impedance) £17.82 (including VAT).

### ■ SONY

Sony (UK) Ltd, Pyrene House,  
Sunbury Cross, Sunbury-on-Thames, Middx.  
Tel: Sunbury-on-Thames 87644.

#### **Model F25S**

Cardioid microphone. Impedance: 320 ohms. FR: 80Hz-13kHz. Output: 1mV. Remote con-

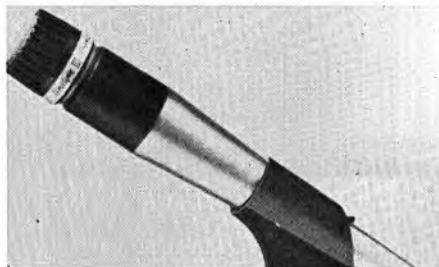

*Shure Model 545 Unidyne III*



*Shure Model 565 Unisphere I*

trol switch for tape recorder. Price: £3.95 (including VAT).

#### **Model F96H**

Omni-directional microphone. Impedance: 10K. FR: 70Hz-14kHz. Output: 5mV. Price: £3.95 (including VAT).

#### **Model F96L**

Omni-directional microphone. Impedance: 230 ohms. FR: 70Hz-14kHz. Output: 1mV. Price: £3.95 (including VAT).

#### **Model 98L**

Cardioid microphone. Impedance: 230 ohms. FR: 70Hz-14kHz. Output: 1mV. Price: £4.95 (including VAT).

#### **Model 99B**

Stereo single point cardioid microphone. Impedance: 200 ohms. FR: 80Hz-12kHz. Output: 0.7mV. Price: £8.50 (including VAT).

#### **Model ECM 22P**

Cardioid electret microphone. Impedance: dual 250 ohms or 600 ohms. FR: 20Hz-20kHz. Output: 1.5mV at 250 or 600 ohms. Price: £70.95 (including VAT).

**Model ECM 95S**

Cardioid electret microphone. Impedance: 1.5K. FR: 70Hz-10kHz. Output: 2mV. Price: £6.95 (including VAT).

**Model ECM 99**

Cardioid electret microphone. Impedance: 250 ohms. FR: 50Hz-12kHz. Output: 1.6mV. Price: £15.95 (including VAT).

**Model ECM 170**

Omni-directional electret microphone. Impedance: 200 ohms. FR: 20Hz-16kHz. Output: 1.6mV. Bass roll-off switch. Price: £23.95 (including VAT).

**Model ECM 280**

Cardioid electret microphone. Impedance: 200 ohms. FR: 30Hz-18kHz. Output: 1.6mV. Bass roll-off switch. Price: £32.95 (including VAT).

**■ STC**

Coles Engineering Ltd, Pindar Road, Hoddesdon Road, Herts.  
Tel: Hoddesdon (61) 66685.

Distributors: Hampstead High Fidelity, 91 Heath Street, Hampstead, London, NW3 (01-435 0999); Horns Ltd, 6 South Parade, Oxford (Oxford 55360).

**4037**

Omni-directional moving coil stick microphone for field work and P.A. Extremely rugged in construction. FR: 80Hz-10kHz. Impedance: 30 ohms or 300 ohms. Sensitivity: -76dB. Long (A) or short (C) models available. Available in colours for use in discos and on colour television. Price: approximately £42.49 retail (plus VAT).

**4038**

Studio ribbon microphone. Accurate figure-of-eight response. Flat frequency response 30Hz-15kHz. Impedance: 30 ohms or 300 ohms. Sensitivity: -85dB. Non-linear distortion 0.1%. Controlled transient response. Price: approximately £100.81 retail (plus VAT).

**4104**

Broadcast quality commentator's noise-cancelling ribbon lip microphone. Output: -82dB. Impedance: 30 or 300 ohms. Price: approximately £68.64 retail (plus VAT).

**4105A**

Cardioid moving coil microphone specially designed for speech. Flat response 60-10,000Hz. Impedance: 30 ohms. Sensitivity: -82dB. Front to back ratio 15-20dB. Price: approximately £42.49 retail (plus VAT).

**4136 ★**

Condenser cardioid microphone, uniform polar frequency response. Front/back ratio better than 20dB. FR: 40Hz-18kHz. Impedance: 30 or



STC 4136



Thorn Consumer Electronics TA24

300 ohms. Sensitivity: -50dB at 300 ohms. FET head amplifier. Phantom power supply for combined mains and battery supply unit. Complete system with windshield and connecting cable. Price: approximately £158.44 retail (plus VAT).

**■ THORN CONSUMER ELECTRONICS LTD**

284 Southbury Road, Enfield, Middlesex.  
Tel: 01-366 1155.

**TA24 Cardioid microphone ★**

Dynamic microphones with variable cardioid characteristics. Switch positions for optimum results on speech and music. Supplied complete with desk stand and tripod adaptor. Low impedance version TA/24. High impedance version TA/20. Price: £10.69 (including VAT).

**■ TURNER**

Millbank Electronics Group, Bellbrook Estate, Uckfield, Sussex. Tel: Uckfield (0825) 4166.

**2203**

Mono moving coil stick type hand or stand microphone. Cardioid response. FR: 50Hz-15kHz. Sensitivity: -57dB (0=1mV/10µbars). Rec load: 200 ohms. Finish: diecast zinc alloy with satin chrome finish, bright chrome grille. Price: £39.80 (plus VAT).



TTC B1060

### 2255

Mono moving coil stick type hand or stand microphone. Cardioid response. FR: 70Hz-13kHz. Sensitivity:  $-57\text{dB}$  ( $0=1\text{mV}/\mu\text{bars}$ ). Rec load: 200 ohms. Fitting:  $\frac{3}{8}\text{in} \times 27\text{tpi}$  (stand adaptor provided). Built-in switch. Finish: die-cast zinc alloy with satin chrome finish, bright chrome grille. Price: £29.36 (plus VAT).

### 2302

Mono moving coil stick type hand or stand microphone. Omni-directional response. FR: 50Hz-15kHz. Sensitivity:  $-57\text{dB}$  ( $0=1\text{mV}/10\mu\text{bars}$ ). Rec load: 200 ohms. Fitting:  $\frac{3}{8}\text{in} \times 27\text{tpi}$  (stand adaptor provided). Built-in switch. Finish: diecast zinc alloy with satin chrome finish, bright chrome grille. Price: £35.69 (plus VAT).

## ■ TTC

Precision Centre, Heather Park Drive, Wembley, Middlesex, HA0 1SU.

Tel: 01-903 0144.

## MDF-G11

Cardioid dynamic microphone. Dual impedance: 600 ohms 50K. FR: 100Hz-10kHz. Sensitivity:  $-58\text{dB}$  (2.8mV) at 50K,  $-76\text{dB}$  (260V) at 600 ohms. Stand mounting, complete with leads and carrying case. Price: £16.28 (including VAT).

## HDF 619

Cardioid dynamic microphone. Dual impedance: 600 ohms or 50K. FR: 200Hz-10kHz. Output: 2.2mV at 50K. Stand mounting, complete with windshield. Price: £16.50 (including VAT).

## B7110

Omni-directional electret lavalier microphone. Impedance: 800 ohms. FR: 50Hz-13kHz. Sensitivity:  $-65\text{dB}$  (170V). Weight: 28gm. Mic incorporates FET pre-amp powered by a penlight cell fitted into the jack plug. Price: £13.75 (including VAT).

## B1075

Cardioid dynamic microphone. Dual impedance: 600 ohms or 50K. Sensitivity:  $-54\text{dB}$  at 50K,  $-73\text{dB}$  (210V) at 600 ohms. Mounting: stand. Price: £9.90 (including VAT).

## DF 100

Omni-directional dynamic microphone. Impedance: 600 ohms. FR: 100Hz-9kHz. Sensitivity:  $-76\text{dB}$  (210V). Lavalier type, supplied also with lapel clip. Price: £6.93 (including VAT).

## B1238

Omni-directional electret microphone. Impedance: 600 ohms. FR: 30Hz-13kHz. Sensitivity:  $-74\text{dB}$  (180V). Mounting: clip. Supplied complete with windshield and table stand. FET pre-amp powered by battery in mic body. Price: £9.90 (including VAT).

## DF 72 BC

Omni-directional dynamic microphone. Impedance: dual, 600 ohms or 50K. FR: 80Hz-12kHz. Sensitivity:  $-76\text{dB}$  (250V) at 600 ohms,  $-59\text{dB}$  (2.5mV) at 50K. Mounting: clip. Supplied with detachable windshield. Price: £9.46 (including VAT).

## B1060 ★

Omni-directional dynamic microphone. Impedance: dual, 500 ohms or 50K. FR: 80Hz-13kHz. Sensitivity:  $-59\text{dB}$  at 50kHz,  $-77\text{dB}$  at 600 ohms. Supplied with detachable windshield. Price: £5.94 (including VAT).

## DF1X

Omni-directional dynamic made in three versions: DF1XL, 50 ohms,  $-110\text{dB}$  (200V) sensitivity; DF1XM, 500 ohms,  $-76\text{dB}$  (210V) sensitivity and DF1XH, 50K,  $-57\text{dB}$  (2.4mV) sensitivity. FR: 100Hz-10kHz. Mounting: desk stand or lavalier cord (both supplied). Clip can be detached from desk stand for use with a floor stand. Price: £5.94 (including VAT).

## ■ UHER

Distributors: Uher (UK) Ltd, 15 Broomhills Estate, Braintree, Essex. Tel: Braintree 23192.

## M154 ★

Dynamic microphone with remote control switch providing: record, stop, start, rewind. FR: 50Hz-20kHz. Impedance: 200 ohms. For use with model 5000 tape recorder. Price: approximately £22 (plus VAT).

## M517 ★

Dynamic cardioid microphone for use with battery portable series. Remote stop/start switch. Speech/music switch. FR: 70Hz-14kHz. Windshield fitted. Impedance: 500 ohms. Price: £23 (plus VAT).

## M534

Dynamic cardioid microphone with speech/music switch. Sensitivity:  $0.23\text{mV}/\mu\text{bar}$ . FR: 50Hz-16kHz. Impedance: 500 ohms. For recording under adverse acoustic conditions.



Uher M154



Uher M517



Uher M634 Stereo System

Pressure diecast case. Includes table stand (M923). Plug wiring: unbalanced 3/2. Price: £19.90 (plus VAT).

**M537**

Dynamic cardioid microphone with speech/music switch. Sensitivity: 0.23mV/ $\mu$ bar. FR: 40Hz-18kHz. Impedance: 500 ohms. Flexibly supported microphone system. Includes stand connecting piece (M937) and table stand (M923). Supplied without connecting lead. Plug wiring: balanced 1-2/3. Price: £47.50 (plus VAT).

**M538**

Dynamic cardioid studio microphone. Sensitivity: 0.14mV/ $\mu$ bar. FR: 30Hz-18kHz. Impedance: low Z. Sintered bronze head. Separate bass and treble systems incorporated. Includes stand connecting piece (M937) and table stand

(M923). Supplied without connecting lead. Plug wiring: 1-2/3. Price: £74.50 (plus VAT).

**M539**

Dynamic omni-directional studio microphone. Sensitivity: 0.18mV/ $\mu$ bar. FR: 40Hz-17kHz. Low impedance. Flexibly supported microphone system. Includes stand connecting piece (M937) and table stand (M923). Supplied without connecting lead and windshield. Plug wiring: balanced 1-2/3. Price: £49 (plus VAT).

**M634 (stereo) ★**

Dynamic cardioid stereo microphone system. Sensitivity: 0.23mV/ $\mu$ bar. FR: 50Hz-16kHz. Impedance: 500 ohms. Comprises two M534 microphones, one M925 stereo bar and one M923 table stand. Speech/music switch. Price: £39.50 (plus VAT).

**■ UNISOUND**

Condor Electronics Ltd, 100 Combe Lane, London, SW20 0AY. Tel: 01-946 0033.

**EM-82**

Electret capacitor microphone. Omni-directional. FR: 40Hz-18kHz. Impedance: 600 ohms. Sensitivity:  $-65\text{dB} \pm 3\text{dB}$ . Supply voltage: 1.1-1.5V. Cable: 16½ft with plug. Size: 6⅝ × 7⁄8in diameter. Weight: 6¼oz. On/off switch. Holder. Lavalier cord. Windshield. Price: £9.95 (plus VAT).

**EM-82H**

Electret capacitor microphone. Omni-directional. FR: 40Hz-18kHz. Impedance: 50K. Sensitivity:  $-45\text{dB} \pm 3\text{dB}$ . Supply voltage: 1.1-1.5V. Cable: 16½ft with plug. Size: 6⅝ × 7⁄8in diameter. Weight: 6¼oz. On/off switch. Holder. Lavalier cord. Windshield. Price: £9.95 (plus VAT).

**EM-83**

Electret capacitor microphone. Uni-directional. FR: 40Hz-18kHz. Impedance: 1K. Sensitivity:  $-68\text{dB} \pm 3\text{dB}$ . Supply voltage: 1.1-1.5V. Cable: 16½ft with plug. Size: 6⅝ × 7⁄8in diameter. Weight: 6¼oz. On/off switch. Holder. Lavalier cord. Windshield. Price: £10.95 (plus VAT).

**EM-83H**

Electret capacitor microphone. Uni-directional. FR: 40Hz-18kHz. Impedance: 50K. Sensitivity:  $-50\text{dB} \pm 3\text{dB}$ . Supply voltage: 1.1-1.5V. Cable: 16½ft with plug. Size: 6⅝ × 7⁄8in diameter. Weight: 6.9oz. On/off switch. Holder. Lavalier cord. Windshield. Price: £10.95 (plus VAT).

**EM84**

Tie-clip miniature electret capacitor microphone. FR: 50Hz-16kHz. Impedance: 600ohms. Sensitivity:  $-65\text{dB} \pm 3\text{dB}$ . Supply voltage: 1.1-1.5V. Cable: 13¼ft with miniature plug. Size: 1⅝ × ½in approx. diameter. Weight: 2.3oz. Price: £9.95 (plus VAT).

# The Decca record brush -a clean breakthrough



## cleans the record and removes static

This completely new product from Decca is unique in that it serves a dual purpose, *effectively*.

The Brush consists of a million tiny fibre 'bristles'. Each sweep of the record surface thus allows upwards of a thousand 'bristles' to enter *each groove* to clean it and remove more dust, dirt and grit than any other product available. And, in addition, each 'bristle' is electrically conductive. Static on the record is removed through the bristles as you clean, without the aid of fluids or compounds.

At last, a record surface cleaner which also removes static: the Decca Record Brush

Now you can see your way clear to interference-free records.



For further information write to:  
Decca Special Products, Ingate Place, Queenstown Road,  
London SW8 3NT

# Pickup Accessories

★ Indicates entry is illustrated

Abbreviations used in this section are given on page 20.

## ■ ACOS

Cosmocord Ltd, Eleanor Cross Road,  
Waltham Cross, Herts, EN8 7NX.  
Tel: Waltham Cross (97) 27331. Telex: 24294.

### Dust Jockey ★

Record cleaner comprising brush to sweep the grooves and a plush pad to lay a film of anti-static solution. Suction base for easy fitting. Automatic action. Designed to fit most single playing units and auto-changers when used manually. Price: 98p (including VAT).

## ■ ADASTRA ELECTRONICS LTD

Unit N22, Cricklewood Trading Estate,  
Claremont Road, London, NW2 1TU.  
Tel: 01-452 6288.

### Imp-Verfa

Matches low impedance PU cartridges, microphones and tape heads into high impedance amplifier inputs. Solid state printed circuit device using silicon transistor. Automatically switched internal 9V battery. Negligible drain. Conversion factor approximately 20 (depending on load). Virtually no hum or signal loss. Metal case, black crackle finish. Size: 5 × 1½ × 1½ in. Price: £3.90 (including VAT).

## ■ AUDIO PACKS

Audio Packs Ltd, 206-210 Ilderton Road,  
London, SE15 1NS. Tel: 01-639 7844.

### Audio Packs

Pre-packed spares and audio accessories.

### Connecting cords

Cables of various types with plugs, sockets and other terminations covering all equipment in use for domestic radio.

### Adaptors

Convert from any type of plug or socket termination to any other type.

### Audio spares

Plugs, sockets, chassis mounted components, fuses and audio accessories. Pre-packed for counter or showroom display.

### Mains units

Three different 6-12V battery eliminators complete with connecting leads for use with all stan-

dard battery-operated tape recorders and radios. Full specifications on request.

### Sound selector units

A range of five units for routing signals to phones, speakers and amplifiers. Four of the units provide for the selection of up to three pairs of stereo headphones or up to three pairs of speakers. The fifth unit, model HZ793, provides facilities for connecting any three signal sources to any three amplifiers. Particularly suitable for demonstration purposes in showrooms and for comparative tests. Prices on request.

### Auto adaptors

To enable battery radios and cassette recorders to be operated from a 12V car battery. Three models available, 500mA output, for 6V, 7.5V and 9V battery run equipment. Full details on request.

## ■ BIR

Bib Hi-Fi Accessories Ltd, PO Box 78,  
Hemel Hempstead, Herts.  
Tel: Hemel Hempstead (0442) 3636.

### Model 42/42L

Record cleaner consisting of an aluminium arm with integral rest, fitted to a self-adhesive base with a brush and velvet roller attached. Model 42L, as above but with smaller base to suit low turntables. Price: £1.76 (plus VAT).

### Model 45 Auto-changer Groov-Kleen ★

Finished in chrome and fits most units with flat top cartridge housings. Complete with velvet

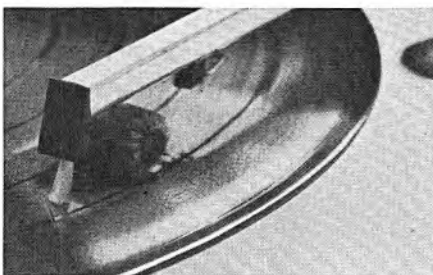

Acos dust jockey

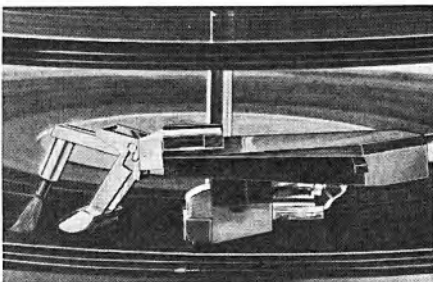

Bib Model 45 Groov-Kleen

★ Indicates entry is illustrated

and stylus cleaning brush. Pat. applied for. Adaptor available for the Zero 100. Price: £1.08 (including VAT).

#### **Model 50 Groov-Kleen**

Has all the features of the Model 60 but is made in high quality plastic. The base is black and the cranked arm is white. Price: £1.19 (including VAT).

#### **Model 43 Record care unit**

Contains Groov-Kleen in chrome finish, record dust off, spirit level, stylus and turntable cleaner. Price: £2.42 (including VAT).

#### **Model 60 Groov-Kleen**

Chrome finished with armrest and counterweight to ensure light tracking. Reg. Design. Price: £1.50 (including VAT).

#### **Stylus balance ★**

Made from non-magnetic material and fitted with non-scratch base. Measures from  $\frac{1}{4}$  to 5gm and calibrated to be accurate to within  $\frac{1}{4}$ gm. Simple to use and supplied with full instructions. In presentation case. Price: £1.36 (including VAT).

#### **Hi-fi stereo hints and tips**

Book for hi-fi enthusiasts describing how to make the most of audio equipment. Contains illustrations, diagrams and reference tables. Written by John Borwick, B.Sc. Price: 38p (VAT exempt).

#### **Stylus and turntable cleaning kit**

Includes: cleaning cloth, non-inflammatory anti-static cleaning fluid and small nylon brush applicator. Free standing brush fitting. Price: 37p (including VAT).

#### **Record Handlers Ref 25**

For removing records from sleeves easily and protecting records from finger prints and dirt. Pat. applied for. Reg. Design 958457. Price: 42p (including VAT).

#### **Model 36A Record and stylus cleaning kit ★**

A kit for removing dust from records and stylus. Comprises two record cleaning cloths and a stylus cleaning brush. Price: 33p (including VAT).

#### **Record Dust-off Size 48**

Record cleaning pad mounted on plastic handle. Size:  $3\frac{1}{2}$  in long, 1 in wide. Velvet cleaning pad with foam backing. Is applied to record on turntable while rotating to remove dust and dirt. Price: 24p (including VAT).

#### **Record cue and swinger detector**

Identifies selected items on records. Comprises graduated scale that swings across record. Moves clear for changing record. Self-adhesive base to fit all turntables. Detects 'swinger' records. Pat. 2460/72. Price: £1.36 (including VAT).

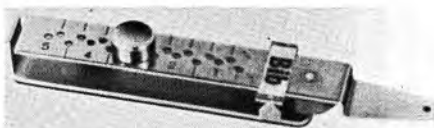

*Bib stylus balance*

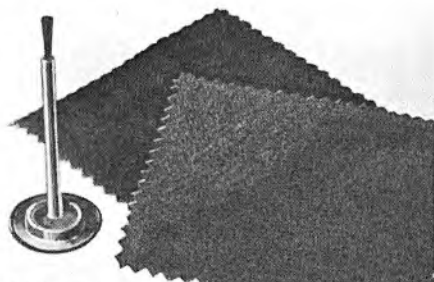

*Bib Record and stylus cleaning kit*

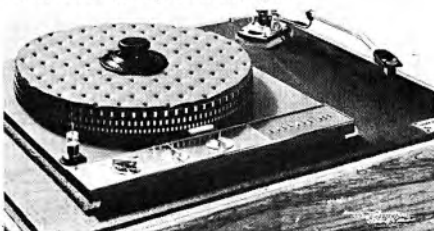

*Black Knight anti-vibration system*

#### ■ **B+J PHOTOGRAPHIC IMPORTS**

305 Kenton Road, Kenton, Harrow, Middlesex, HA3 0HP. Tel: 01-907 6667.

#### **Stereo stamp**

Rubber stamp to enable record collectors to label stereo discs to make them immediately visible. Price: 40p including postage.

#### ■ **BLACK KNIGHT RUMBLECURE**

Bank Top, Currier Lane, Ashton-under-Lyne, Lancs, OL6 6TA.

Tel: 061-330 2836 (open 7 days).

Specialists in curing rumble due to acoustic feedback through floors and cabinets. (Patent 15493/71). Plinths as used by the BBC, fitted with Rumblecure equipment available. Details on request. Many standard items now available and more being added all the time. Quotations on receipt of full equipment details. Prices: from £30. Kits not available separately. (Patent 28949/69) ★

#### ■ **BSR McDONALD**

BSR Ltd, Monarch Works, Cradley Heath, Warley, Worcs, B64 5QH.

Tel: Cradley Heath 69272.

**Cartridge carrier**

Quick-change slide-in carrier. Permits changing or inspecting cartridge easily and quickly without interfering with wiring. Models to suit all BSR McDonald pickup arms (except 210 mini-changer). Price: 40p (plus VAT).

■ **CLENDISC (Mail Order) LTD**

7 Trinity Court, Gray's Inn Road, London, WC1X 8JX. Tel: 01-837 9088.

**Clendisc**

An anti-static cleaner and preservative for records, photographic and optical lenses, copying machines, tape heads and computers. 4 fl oz bottles. Price: 25½p (including VAT).

**Clendisc Cleaning Pad**

Pad impregnated with Clendisc fluid which assists in the removal of dust and dirt and also neutralises any electrostatic charges present. Price: 15½p (including VAT).

■ **COLTON**

Musonic Ltd, 34-38 Verulam Road, St Albans, Herts, AL3 4DF. Tel: St Albans (56) 50611.

**Varilift Mk III**

Fluid damped pickup lifting and lowering device. Price: £5.45 (including VAT).

**Precision Turntable level**

Circular bubble-type spirit level in white plastic case 1½in diameter, ½in high. Three fixing holes provided or it may be fixed with adhesive. Ensures accurate levelling in all directions. Price: 53p (including VAT).

**Antistatimat**

All-rubber 12in turntable mat. Accurately balanced and moulded with guard edge recess. Introduction of certain materials into the rubber renders it conductive to static charges on micro-groove records. When a record is placed on the mat static charges are dispersed freeing the record from induced noises without use of sprays, etc. Price: £1.35 (including VAT).

**Times-Fifty**

Miniature pocket microscope with stylus locating slot and adjustable focus. Gives clear picture of stylus tip at X 50 magnification. 4½in long and fitted with pen clip. Price: £1.10 (including VAT).

**Magnalift Mk II ★**

Centre lift-off device. Fixes beside pickup and automatically lifts arm off record at end of playing cycle. Price: £3.53 (including VAT).

**Variscale ★**

Tracking force indicator. Simple and accurate stylus balance measuring from ½ to 6gm. Finish: black wrinkle and satin chrome. Price: £1.25 (including VAT).

**Precise Lift ★**

Manually operated pickup lifting device. Simple precise movement. Single hole mounting. Finish: satin chrome. Price: £3.33 (including VAT).

**Gripex**

Anti-slip dressing. A spirit suspended solution supplied in 30cc bottles with brush. Applied thinly to drive surfaces of belts or friction wheels, it dries in 10-15 minutes. Price: (30cc.) 26p (including VAT).

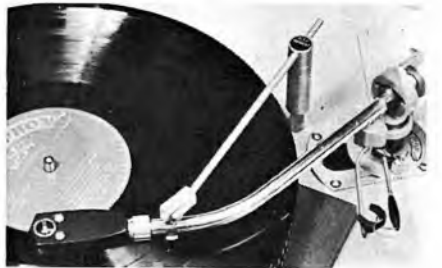

Colton Magnalift



Colton Variscale



Colton Precise lift



★ Indicates entry is illustrated

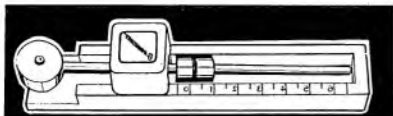

Connoisseur stylus balance



Decca record brush



Eagle PRE 402 pickup preamp

## ■ CONNOISSEUR

A. R. Sugden & Co (Engineers) Ltd,  
Connoisseur Works, Atlas Mill Road,  
Brighouse, Yorks, HD6 1ES.  
Tel: Brighouse (048 47) 2142.  
Cables: Connoisseur, Brighouse.

### Connoisseur Stylus Balance ★

Precision stylus balance with sliding weight adjustment. Scale calibrated 0-6gm. Simple operation giving accurate stylus pressure settings. Price: £1-21 (including VAT).

## ■ DECCA

Decca Special Products, Ingate Place,  
Queenstown Road, London, SW8 3NT.  
Tel: 01-622 6677.

### Magnetic bias compensator

Neat, simple, unobtrusive device using magnetism precisely to neutralise the forces which draw a pickup towards the centre of the turntable. Type A for Mk I and Mk I 'Super' *ffss* arms, and for Deram ARI arm. Price: £1-13 (including VAT).

### Centre locator

Fits on *ffss* arm like *ffss* head. Pickup arm is correctly positioned when the locator moulding

fits the turntable centre spindle. Price: 28p (including VAT).

## Deccalift

Motorised lifting and lowering device which can be controlled at the turntable and/or remotely. Requires 6-3V AC. Transformer optional extra. Price: £7-77 (including VAT).

## London cartridge adaptors

Type A. Simple slide-on adaptor for use with *ffss* arms (Mk I, Mk I Super and Professional) to accommodate the London cartridge. Automatically adjusts playing weight. Price: £1-41 (including VAT). Type B. Simple slide-on adaptor for use with International arm to accommodate the London cartridge. Collar arrangement to adjust for correct playing weight. Price: 23p (including VAT).

## Record Brush ★

One million conductive man-made bristles, each 8-9 microns in diameter. Cleans the record of dust and static. No anti-static fluids required. Price: £4-95 (including VAT).

## Record Cleaner

An electrically conducting arm carrying a brush made from 20,000 conducting man-made bristles. Can be accommodated on most turntables. Requires no anti-static fluid. Price: £4-95 (including VAT).

## ■ DISCWASHER

Distributor: Wilmex Ltd, Import Division,  
Compton House, New Malden, Surrey,  
KT3 4DE. Tel: 01-949 2545.

### Discwasher

Disc mop on wooden handle, includes anti-static cleaning fluid. Prices: £9-95 (including VAT).

## ■ EAGLE INTERNATIONAL

Heather Park Drive, Wembley, Middx,  
HA0 1SU. Tel: 01-903 0144.

### PRE 402 ★

Mains powered stereo pickup preamplifier for magnetic cartridges including Eagle LC 05 and LC 07. Provided with dual phono sockets. Price: £8-80 (including VAT).

### FF2 Stereo pickup amplifier

Designed for use with magnetic cartridges, having RIAA equalisation. Fitted with phono socket input and outputs, powered by a PP3 battery or equivalent. Price: £6-60 (including VAT).

## ■ EXPERT PICKUPS LTD

PO Box No. 3, Ashtead, Surrey, KT21 2QD.  
Tel: Ashtead (27) 76604.

### Replacement stylus service

For detachable cantilever systems using client's



Groovac dust pick-up



Groov-Kleen Model 42

own stylus assembly. Radius to choice; from 0.5 thou (stereo) to 4 thou (78 oversize). Ellipticals where suitable. Radius checked using X 500 magnification.

**Grade A transcription diamond styli**

Finest quality, highly polished, giving minimum background noise and optimum results. Spherical or elliptical tip.

**Grade B**

Commercial standard, 0.5 thou to 2.5 thou only. Oversize sapphires and diamonds (Grade A only) for Pathe and Edison reproducers formed and fitted. Expert Pickup diamonds are manufactured only to customers' specifications.

Special quotations and prospectus on request.

**To collectors of 78rpm records**

Advice available as to the best method of reproducing from old 78rpm records.

**Replacement styli**

Complete range of new replacement styli in sapphire and commercial diamond, also professional Grade A diamonds of our own manufacture.

**Leak pickup servicing**

Sole agents for the servicing of Leak Mk I and Mk II pickups.

**EMI pickup servicing**

Sole agents for the repair of the EMI EPU100 pickup head and arm.

**■ GOLDRING**

Goldring Ltd, 10 Bayford Street, Hackney, London, E8 3SE. Tel: 01-985 1152.

**Lenco STB.2**

Stylus pressure balance. A simple and accurate device, not relying on springs. Price: £1.05 (plus VAT).

**Lencoclean**

Record cleaning device mounted on turntable.

Tracks in front of the pickup, dispensing a narrow band of special fluid. Leaves no deposit on record, cleans the groove and cools the point contact. Keeps stylus point clean. Price: £3.90 (plus VAT).

**Lencoclean super refill**

Price: 90p (plus VAT).

**Goldring/Lenco VV7**

Stereo preamplifier for magnetic cartridges. Input: 1mV 47K. Noise level: -60dB. Output: 100mV RMS. Mains: 200-240V 50Hz. Size: 4 3/4 x 2 x 1 1/2 in. Price: £11.10 (plus VAT).

**■ GROOVAC**

R.I. Audio, Kernick Road, Penryn, Cornwall, TR10 9DQ.

Tel: Penryn (032 67) 2753.

**Vacuum record cleaner ★**

Consists of a precision lightweight arm and a suction unit acoustically isolated in a special enclosure. Fitted with mains switch and indicator (unit inaudible at a distance of 2 metres). Tracking force 0.7gm. Fine hairs incorporated in nozzle to facilitate removal of dust from bottom of grooves. Counterbalanced. Fixes by magnetic base, or self-adhesive pad available as an extra. Adjustable height. Integral rest incorporates new anti-skate device. Price: £9.79 (including VAT), plus 55p, postage and packing.

**■ G. F. C. HADCOCK**

Audio Division, The Old Vicarage, Doveridge, Derby, DE6 5NN.

Tel: Uttoxeter (088 93) 2452.

**GH Uni-lift Mk III**

Raising and lowering device suitable for most pickup arms. Two-hole fixing for stability. Allen key provided for height adjustment and for controlling rate of descent. Suitable for sprung pickup mounting boards. Damped adjustable rate of descent ensures accurate lowering and cueing. Price: £5.94 (including VAT).

**■ HOWLAND-WEST LTD**

3-5 Eden Grove, London, N7 8EQ.

Tel: 01-609 0293.

**Howland-West Alignment Protractor**

Made in laminated Perspex. Provides facilities for checking: (1) vertical tracking angle, (2) lateral tracking angle and (3) channel balance and separation. Price: 44p (including VAT).

**Discduster ★**

Record cleaning instrument comprising lightweight arm equipped with brush and cylindrical pad. Balance and height adjustable. Heavy stand permits full operation without need for permanent fixing to motor board. Supplied with two spare brushes and two spare cylinders. Polished

★ Indicates entry is illustrated

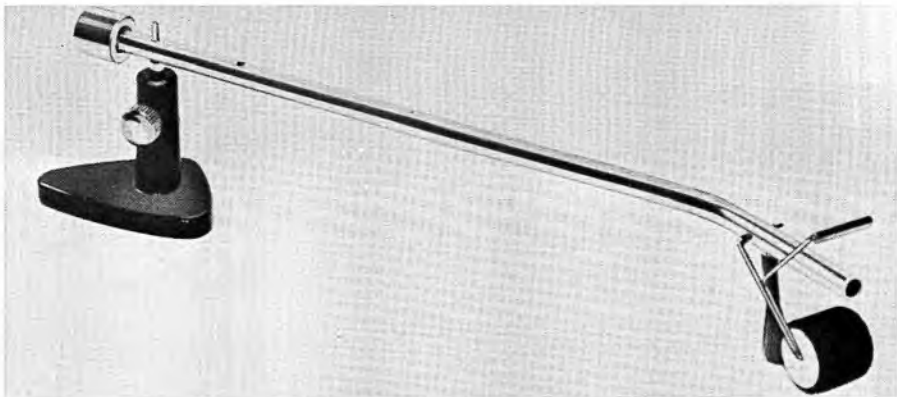

Howland-West Discduster

tubular arm with black base. Price: £1.98 (including VAT).

#### ■ IMPEX

F. I. R. McArdle Ltd,  
15 Queen Street, Newcastle-upon Tyne,  
NE1 3UG.

#### MS7 and MS24

Stereo pickup amplifiers. See Constructional Kit section.

#### ■ LENNARD DEVELOPMENTS LTD

206 Chase Side, Enfield, Middlesex, EN2 0QX.  
Tel: 01-363 8238.

#### Play-fair Stylus Timer

Manually operated device which indicates when stylus is due for replacement. Self-adhesive to attach to motor board if desired. Swiss mechanism. Neat plastic case with instructions. Two models: one for sapphires, one for diamonds. Price (either model): 80p (plus VAT).

#### Play-fair Cleaning Pad

Anti-static. Price: 10p (plus VAT).

#### Play-fair Stylus Cleaner

Cleaning fluid with separate brush. In presentation case. Price: 30p (plus VAT).

#### Play-fair Antistatic Cleaning Fluid

30cc polythene bottle. Price: 23p (plus VAT).

#### Play-fair Discoda

Record sleeve indexing device for quick identification of records. Price: 3 for 13p, 12 for 40p (plus VAT).  
(Bulk prices on application).

#### Micro-Diamond replacement styli

Comprehensive range. Also retipping service. Price: on application.

#### Micro-Sapphire replacement styli

Comprehensive range. Also retipping service. Price: on application.

#### Play-fair Discoduster

Record cleaning device. Two models; one for single play record decks, one for autochangers. Price: to be announced.

#### ■ MAC

Modular Audio Components Ltd,  
Canterbury Road, Nottingham, NG8 1PQ.  
Tel: Nottingham (0602) 862647.

#### Manual Groovy Clean

A record cleaner brush designed for use on discs that do not respond to normal cleaning methods. Micro-fibre brush penetrates to bottoms of the grooves. Stands up to continued use in record cleaning solutions and water. Brush mounted in extruded plastic section. Price: 39p (including VAT).

#### AAU-3 ★

Audio adaptor unit for connecting three pickups to a common amplifier input, also suitable for

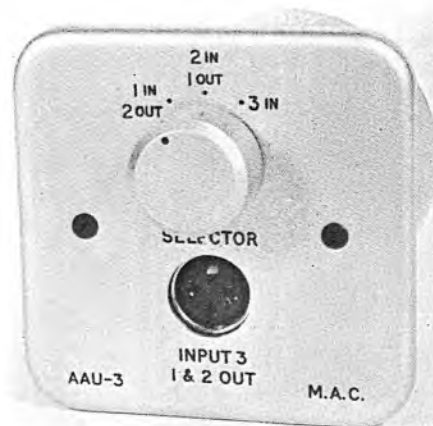

MAC AAU-3 adaptor

microphones, tuners, tapes, etc. Two phono inputs at rear alternately switched to front DIN sockets for feeding other equipment. Fitted with 24in leads with phono plugs, or with DIN plug (AAU-3Q). Provision for fitting attenuator or load resistors internally. Dimensions: 3 × 3 × 3in. Finish: jaguar silver. Price: £5.57 (including VAT).

All MAC AAU units are available in solid teak case at an additional cost of £1.65 (including VAT).

## ■ METROCARE

Metrosound Audio Products Ltd, Audio Works, Cartersfield Road, Waltham Abbey, Essex, EN9 1JF.

Tel: Waltham Cross (97) 31933.

### M.3 Record Care Kit No. 1

Comprising bottle of Metro-Spray spirit-based anti-static record cleaning fluid; special texture sponge applicator with moulded handle; and soft stylus cleaning brush. Price: 49½p (including VAT).

### M4 Klenzatape Kit

Reel to reel tape recorder cleaner tape. Two 3in spools and bottle of specially formulated cleaning fluid; complete with polythene storage wallet. Price: 88p (including VAT).

### M11 Hi-Fi Stylus Cleaning Kit

Bottle of specially developed mild solvent fluid. Moulded plastic retaining clip on bottle for soft nylon cleaning brush. Price: 44p (including VAT).

### M26 Ioniser

High-fidelity record cleaner. Permanently anti-static humid soft velvet enclosed in plastic moulding. Price: 55p (including VAT).

### M32 Head Cleaner Cassette

Complete cassette conforming to international specification; loaded with silicone impregnated, non-abrasive, fibrous tape; contained in plastic library case. Price: 55p (including VAT).

### M39 Cartridge Head and Capstan Cleaner

8-track cartridge moulding containing fluid tank with soft felt pad activated by sprung lever in rear cavity. Bottle of specially formulated cleaning fluid and nylon tuft brush for cleaning pad. Price: £1.21 (including VAT).

### M43 Super Groovemaster

High quality record cleaning arm finished in satin anodised aluminium and contrasting black; pivoted on dye-case free standing base. Brush supplied for cleaning velvet roller after use. Price: £1.98 (including VAT).

### M45 Percy Wilson Discmaster

Dual purpose record cleaning arm; includes wet cleaning version for pre-cleaning badly

contaminated discs and dry version similar in specification to the M43 Groovemaster. Held in presentation tray complete with 100cc record cleaning fluid. Price: £3.08 (including VAT).

### M46 Stereo Test Cassette and Music Sampler

Pre-recorded test cassette containing commentary and music for correct phasing and setting up of cassette players. Price: £2.20 (including VAT).

### M48 Dolby Tone Test Cassette

A very carefully produced pre-recorded tape for correct setting up, alignment and calibration of high quality Dolby cassette players. Price: £1.81½ (including VAT).

### M52 Metrocare Hi-Fi Kit No. 2

Moulded record cleaner with plush velvet foam backed pad held in protective tray. Bottle of record/stylus cleaning fluid and stylus cleaning brush. Price: 71½p (including VAT).

### M53 Metrocare Hi-Fi Kit No. 3

Metrocare Ioniser, record/stylus cleaning fluid and stylus cleaning brush contained in permanent moulded storage case with tinted transparent cover. Price: £1.21 (including VAT).

### M54 Metrocare Hi-Fi Kit No. 4

Metrocare Super Groovemaster, Ioniser, record/stylus cleaning fluid and stylus cleaning brush contained in permanent moulded storage case with tinted transparent cover. Price: £3.02½ (including VAT).

### M55 Autochange Groovemaster

Record cleaning device attached to pickup head-shell by means of self-adhesive shoe. Finished in bright chrome plate. Whole unit weighs less than 1½gm. Price: 99p (including VAT).

### M59 8-Track De-magnetiser Cartridge

8-track cartridge with neon mains switch in the rear and 9ft of mains cable. When operated for 12 seconds will remove magnetism absorbed within re-play head on 8-track tape machines increasing the life of music tapes and improving reproduction. Price: £2.75 (including VAT).

### M60 Junior Groovemaster

Record cleaning arm finished in bright chrome plated plastic, pivoted on adjustable self-adhesive base. Price: £1.32 (including VAT).

### M62 Cassette Salvage Kit

Kit contains one complete compact cassette, splicing block, editabs, hub key and cutter to facilitate easy and economical repair of damaged cassettes. Price: on application.

Replacement kits and fluid are available individually for all Metrocare Hi-Fi Audio Accessories.

Many other Metrocare products are available not listed here. Included among these are accessories for Thorens turntables.



Micro MSB-1



Keith Monks Professional Record Cleaning Machine

### ■ MICRO

Howland-West Ltd, 3-5 Eden Grove, London, N7 8EQ. Tel: 01-609 0293.

### MSB-1 ★

Micro shock absorber. Microsorber employs air-damped high efficiency materials to eliminate acoustic feedback to the record playing deck. Adjustable for height to equalise unbalanced weight of turntable. Price (set of four): £4.95 (including VAT).

### ■ KEITH MONKS (Audio) LTD

26-28 Reading Road South, Fleet, near Aldershot, Hants.  
Tel: Fleet (025 14) 7316 and 3566.

### Professional Record Cleaning Machine ★

Used by broadcasting companies, sound studios, record retailers and gramophone libraries.

Special washing, scrubbing and suction action leaves record clean and dry. Retail price: (single) £278.66 (including VAT); (double) £403.33 (including VAT).

### Record Cleaning Service

The following dealers offer a record-cleaning service to the public using Keith Monk's equipment. The list is not necessarily comprehensive.

Curtiss Records, Sheffield.

Grahams, Pentonville Road, London, N1.

Ken Rose, Fleet, Hants.

Marble Arch Cameras, Edgware Road, London.

Sound Incorporated, Wimbledon, London, SW19.

Sound Studios, Crawley, Sussex.

Audio T, London, NW6.

Lasky's Radio, London, W1.

Sound Incorporated, Brighton.

Complete Audio, Eastbourne.

Audio Systems, Dorking.

Lloyds & Keyworth, Farnham.

Fox Radio, Swindon.

House of Sound, Bristol.

Gears, Falmouth.

Peter Scott, Exeter.

Peter Scott, Torquay.

Oxford Audio Visual, Heddington, Oxford.

Audio Impressions, Dunstable.

Grimsby Audio Centre, Grimsby.

Southport Hi-Fi Centre, Southport.

Gerald Carter, Garstang.

Fred Benfell, Blackpool.

Hampshire Audio, Chandlers Ford, Southampton.

Anglia Audio, Bury St Edmunds.

Garnet, Settle, West Riding.

Avargarde Galleries, Manchester.

James Kerr, Glasgow.

Hi-Fi Corner, Edinburgh.

Sound Centre, Aberdeen.

J. B. Windows, Newcastle-upon-Tyne.

Wireless Supplies Unlimited, Bournemouth.

Bardells Ltd, Wisbech.

Melody Fayre, Derby.

Lindair, 227 Tottenham Court Road, London.

Downing and Davis, Stourbridge.

### ■ MUSONIC LTD

34-38 Verulam Road, St Albans, Herts, AL3 4DF. Tel: St Albans (56) 50611.

### DisCleans

Soft cloth impregnated with anti-static solution for cleaning records. Price: 19p (including VAT).

### DisCentres

Record centre adaptors designed to convert 7in 45rpm records from large hole to standard spindle size. In packs of ten. Price: 23p (including VAT).

### DiscSleeves

Made from 200 gauge polythene. Protect records from dust and dirt. Round bottomed. In packets of 10. Price: (7in size) 40p (including VAT); (12in size) 40p (including VAT).

**DisCovers**

Made from 200 gauge polythene. Protect record sleeves against rubbing and scratching. Supplied in packets of 12. Price: (12in size only) 40p (including VAT).

**DisCase**

Record case finished in wood and plastic. Three sizes, 60 7in records, 30 12in records, 60 12in records. Padded. Available in black, blue, brown, green and red. Price: (60 7in size) £2.30 (including VAT); (30 12in size) £2.67 (including VAT); (60 12in size) £3.23 (including VAT).

**DiscRack**

Heavy gauge steel wire rack welded at all points and with plastic coated or plated finish. For 36 7in records. Price: 69p (including VAT). For 50, 12in records. Price: 95p (including VAT).

**Stylus Cleaner**

A special solution which cleans and renders stylus tip anti-static. Application brush provided. Price: 39p (including VAT).

**Superactive**

New formula anti-static fluid for cleaning and neutralising static in records and other plastic surfaces. Applied with sponge or cloth. No sticky deposit. Suitable for recharging anti-static devices. Price: (15cc) 15p (including VAT); (30cc) 26p (including VAT).

**Electro-Duster**

Consists of an endless PVC belt held in place between two pulleys, one of which is connected to a small rubber wheel. This wheel rests on the record label and thus drives the endless belt. Static charge created on the belt picks up dirt from the record. Belt is wiped by felt pad. An additional velvet pad also traverses record to drag dirt from grooves to be picked up by the belt. Replacement pads fitted easily and device readily lifted clear of record to facilitate record changing. Price: to be announced.

**PD CONNECTORS**

Parry Electronic Developments Ltd, Assay House, 28 Greville Street, London, EC1N 8SU. Tel: 01-242 1100.

**DIN plugs**

New design of DIN plug which requires no soldering or screw connections. Pins interchangeable to match any DJN configuration. Space inside housing to accommodate matching or attenuating resistors. Ratchet-type cable clamp adjusts to all sizes of connecting lead. Designed for home constructors and hi-fi enthusiasts. Price: 28p (plus VAT).

**QAS**

Quality Audio Supplies, Wollaton Road, Beeston, Nottingham, NG9 2PB. Tel: Nottingham (0602) 252222 and 256141.

Wide range of individually blister-packed audio accessories including phono plugs, DIN plugs and sockets, 4mm and wander plugs, couplers, screw terminals, slider switches, connecting leads with all types of terminations, audio switching units and remote control stations.

**Dusta-Disc**

Counterbalanced arm to mount alongside turntable for cleaning records while playing. Comprises base with height adjustment, arm with counterbalance weight, super-fine brush for cleaning grooves, plus a soft fabric roller for applying anti-static fluid.

See Speaker Accessories Section for details of other QAS equipment.

**SHURE ELECTRONICS LTD**

Eccleston Road, Maidstone, Kent, ME15 6AU. Tel: Maidstone (0622) 59881.

**SFG2 Stylus gauge ★**

Accurate beam balance type gauge designed for measuring tracking force in the range of 0.5gm to 3gm. Measures existing playing weight of arm, or can be used to adjust arm to a desired tracking force. Price: £3.96 (including VAT).

**M64-2E**

Preamplifier for use with magnetic pickup head and amplifier not having sensitive enough input. Full specification and price in Amplifier Section.

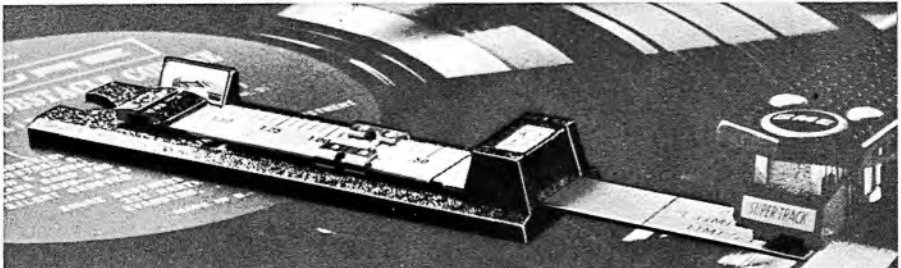

Shure SFG2 Stylus Tracking Force Gauge

★ Indicates entry is illustrated

## ■ SONY

Sony (UK) Ltd, Pyrene House, Sunbury Cross, Sunbury-on-Thames, Middlesex.  
Tel: Sunbury-on-Thames 87644.

### Replacement styli

NDI26GA stylus suitable for PS 5520/PS 230/HP 511A/SQP 20. Price: £3.75 (including VAT).

ND114P stylus for HP 211A/HP 239A. Price: £2.95 (including VAT).

NS128P stylus for HMP 20/HMW 20/HMK 20. Price: £1.25 (including VAT).

## ■ TELFEI

Sound take-off adaptor for feeding hi-fi system from TV. See Tape Recorder Accessories and Radio Tuner sections.

## ■ TRANSCRIPTORS

Transcriptors Ltd, Sole Agents:  
J. H. Nelson Audio, Mycott House,  
Station Road, Boreham Wood, Herts.  
Tel: 01-953 9851.

### Transcriptors Stylus Scale

Precision scales in polished aluminium with jewelled pivot. Sensitive to less than 0.01gm. Accuracy better than 0.02gm. Measures 0-5gm in increments of 0.05gm. Bubble read-out. Sup-

plied with reference calibration check weights. British made. Price: £4.40 (including VAT).

### Transcriptors Sweep Arm ★

Record cleaning device for permanent fixing. Height adjustable over 3½ in. Tracks at ¼-½ gm. Balance cursor. Integrated parking device. Precision unipivot construction. Polished aluminium. British made. Price: £4.40 (including VAT).

### Transcriptors Stylus Brush ★

For permanent installation. Comprises squirrel hair brush for cleaning stylus. Adjustable for height. Single hole fixing. Polished aluminium construction. British made. Price: £2.91½ (including VAT).

## ■ TTC DIVISION PRECISION CENTRE

Heather Park Drive, Wembley, Middx,  
HA0 1SU. Tel: 01-903 0144.

### Discoduster

Automatic adaptable record cleaner kit. Lightweight aluminium arm and weighted base for fixed or free-standing operation. Velvet cylindrical pad and fine groove cleaning brush. Supplied with spare cylinders, fluff removing brush and two pivots. Finish: satin aluminium and black. Length: 9½ in. Price: £1.81 (including VAT).

### RC10 Record Cleaner

Counterweighted cleaner with anti-static pad and brush. Height and balance adjustable. Base weighted to be free standing or fixed by a self adhesive pad. Supplied with two spare pads and one spare brush. Price: £1.76 (including VAT).

## ■ CECIL F. WATTS LTD

Darby House, Sunbury-on-Thames, Middx.  
Tel: Sunbury-on-Thames (76) 83252.

### Watts Dust Bug

Claimed to be the most efficient method of removing static and dust from records as they are played. Instantly fitted, suitable for all types of records. Record quality is improved, surface noise and wear reduced. Price: £1.38½ (including VAT).

### Watts Disc Preener

For record maintenance where anti-static agents are not desirable (where stylus force is less than 2gm). Price: 48½ p (including VAT).

### Watts Manual Parastat with Humid Mop ★

Manual model Parastat record cleaning machine. For cleaning and applying anti-static agents to LP records. Complete with humid mop for cleaning bristles and velvet pads. Price: £3.64 (including VAT).

### Watts Manual Parastat

Available separately (without Humid Mop). Price: £3.30 (including VAT).

# PLAY-FAIR

Record Accessories.  
Stylus Timers, Stylus Cleaners, Antistatic Cleaning Pads, Antistatic Fluid, Discodas, Discodusters (Record Changer and Single Player models), Tape Cassettes and Cartridges, Cassette and Cartridge Cleaners, Record Cleaners, Cassette and Cartridge Carrying Cases.

# MICRO-DIAMOND

## MICRO-SAPPHIRE

Replacement Styli. Most comprehensive range, best quality, reliable service, keen prices; also MICRO-DIAMOND retipping service.

## DRY-SPLICE and TAPE ACCESSORIES

(Tapes, Spools and Plastic Tape Boxes).

## WOELKE - Tape Heads (formerly Miniflux).

Manufacturers and Distributors:

## LENNARD DEVELOPMENTS LTD

206, CHASE SIDE,  
ENFIELD, Middx. EN2 0QX.  
Tel. (01) 363 8238



Transcribers sweep arm and stylus brush



Watts Manual Parastat with Humid Map



Watts Humid Map and new formula fluid

**Watts Humid Mop ★**

Available separately. Price: 34p (including VAT).

**Hi-Fi Parastat Model Mk 4**

Gramophone record maintenance and stylus cleaning kit. Designed for use on records in new condition which are played with pickups requiring very low tracking pressures. Price: £3-02½ (including VAT).

**Watts Stylus Cleaner**

As included with Hi-Fi Parastat kit. Price: 34p (including VAT).

**Watts Spares and Replacements**

Dust hug nylon bristle and plush pad. Price: 14½p (including VAT).

New Formula Dispenser. Price: (½ oz) 21p (including VAT); (1oz) 34p (including VAT).

Preener Wicks. Price: (packet of four) 14½p (including VAT).

Manual Parastat Brush. Price: 89p (including VAT).

Parastat Nylon Velvet Pad Covers. Price: 27½p (including VAT) a pair.

Parastat White PVC Sponge. Price: 7p (including VAT).

Humid Mop (sponge and four wicks). Price: 21p (including VAT).

Hi-Fi Parastat Distilled Water Dispenser. Price: 28p (including VAT).

Hi-Fi Parastat pad cover and ribbons. Price: 14½p (including VAT).

**■ WILSON STEREO LIBRARY LTD**

104-106 Norwood High Street, London, SE27.  
Tel: 01-670 6394.

**W.S.L. Blank Disc**

Highly polished blank vinyl disc for adjusting side thrust and alignment. Indicates the amount of side thrust to be corrected. Mirror-like surface reflects underside of cartridge and stylus and assists in accurate alignment. Supplied with instructions for correcting side thrust. Price: 75p, postage and packing included.

**W.S.L. Side Thrust Corrector**

Pulley device which may be fitted to any pickup to correct side thrust. Should be used in conjunction with W.S.L. Blank Disc for precise elimination of side thrust. Price: 45p, postage and packing included.



# The new Micro-Acoustics QDC-1 Stereo Phono Cartridge:

It will make  
any well recorded LP  
sound exactly like its master tape.

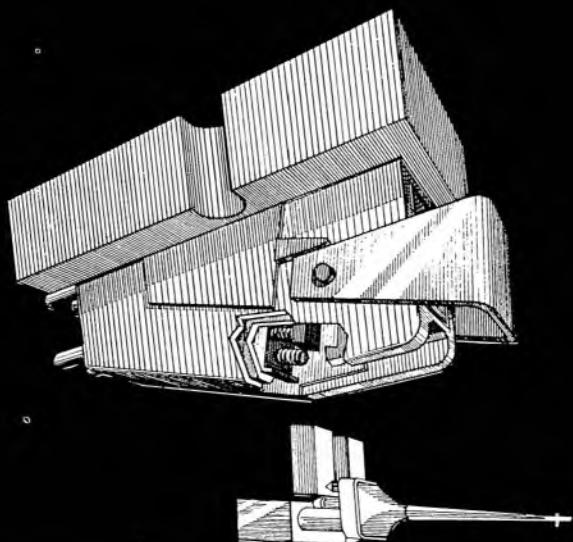

Specifications	QDC-1e	QDC-1s	QDC-1q
Stylus Configuration (User Replaceable)	.0002 x .0007 elliptical solid nude diamond	.0005 spherical, solid nude diamond	Quadra-Point / CD-4 solid nude diamond
Frequency Response	5 Hz to 20 kHz $\pm$ 2 dB	5 Hz to 20 kHz $\pm$ 2 dB	5 Hz to 50 kHz $\pm$ 3 dB
Tracking Force Range	0.75 to 1.5 grams	0.9 to 1.5 grams	0.9 to 2 grams
Channel Separation	Nominally 30 dB at 1 kHz Nominally 20 dB at 10kHz	Nominally 30 dB at 1 kHz Nominally 20 dB at 10 kHz	Nominally 30 dB at 1 kHz Nominally 15 dB at 20 kHz
Output Voltage	3.5 mv each channel at 5 cm/sec peak recorded velocity	3.5 mv each channel at 5 cm/sec peak recorded velocity	3mv each channel at 5 cm/sec peak recorded velocity

Sole UK Distributor:  
**Gale Electronics & Design Limited**  
39 Upper Brook Street London W1Y 1PE

# Pickups and Arms

★ Indicates entry is illustrated

Abbreviations used in this section are given on page 20.

## ■ ACOS

Cosmocord Ltd, Eleanor Cross Road,  
Waltham Cross, Herts, EN8 7NX.  
Tel: Waltham Cross (97) 27331. Telex: 24294.

### GP91-1 SC ★

Mono/stereo compatible crystal cartridge. Turnover dual stylus. Pw: 3-6gm. Tip mass: 2-5mg (sapphire), 2-8mg (diamond). Dynamic compliance: vertical  $2 \times 10^{-6}$ cm/dyne, lateral  $4 \times 10^{-6}$ cm/dyne. FR: 50Hz-12kHz. Output: 178 mV. Min load 1M. Price: (diamond/sapphire) £1-82 (including VAT).

### GP92-1 SC

Mono ceramic cartridge. Turnover stylus assembly. Stereo/LP 0-6/0-8 thou diamond or sapphire, 78-2-5 thou sapphire. Pw: 4-10gm. Tip mass: 2-5mg dynamic. Compliance: vertical  $2.5 \times 10^{-6}$ , FR: 150Hz-16kHz  $\pm 3$ dB, 12dB down at 30Hz relative to 1kHz. Output: 100mV. Load impedance 1M. Low temperature coefficient. Price: (diamond/sapphire) £1-97 (including VAT).

### GP93 ★

Stereo crystal cartridge. Turnover dual stylus. Stylus 0-6/0-8 thou diamond or sapphire, 2-5 thou sapphire. Pw: 4-8gm. Tip mass: 2-5mg dynamic. Compliance: vertical  $2.2 \times 10^{-6}$ cm/dyne, lateral  $2.2 \times 10^{-6}$ cm/dyne. FR: flat 250 Hz-18kHz 3dB down at 100Hz relative to 1kHz. Output: 250mV. Rec load 1M. Low temperature coefficient. Price: (diamond/sapphire) £2-42 (including VAT).

### GP94

Stereo ceramic cartridge. Turnover dual stylus. Stylus 0-6/0-8 thou diamond or sapphire, 2-5 thou sapphire. Pw: 2-4gm. Tip mass: 2-5mg dynamic. Compliance: lateral  $5 \times 10^{-6}$ cm/dyne, vertical  $6 \times 10^{-6}$ cm/dyne. FR: flat 100Hz-12 kHz, 7-8dB at 30Hz relative to 1kHz. Separation 20dB at 1kHz, 8dB at 10kHz, minimum. Output: 80mV average. Load impedance: 1M each channel. High capacity ceramic elements (1000pF). Low temperature coefficient. Price: (diamond/sapphire) £3-14 (including VAT).

### 104

Stereo ceramic cartridge. Two versions; turnover and single-sided. Stylus: 0-5/0-7 thou and

2-5/3 thou. Sapphire or diamond. Pw: 3-4gm. Tip mass: 2-3mg. Compliance: (static) lateral  $20 \times 10^{-6}$ , vertical  $17 \times 10^{-6}$ ; (dynamic) lateral  $6 \times 10^{-6}$ , vertical  $5 \times 10^{-6}$ . Separation: 20dB at 1kHz, 7dB at 10kHz. FR: 70Hz-15kHz  $\pm 5$ dB. Output: 100mV. Rec load minimum 1M. Prices: (sapphire/sapphire) £2-48 (plus VAT); (diamond/sapphire) £2-84 (plus VAT).

### 104 Transcription

Stereo ceramic cartridge. Single sided. Diamond stylus 0-5/0-7 thou. Pw: 2-5gm. Tip mass: 1-6-2-6mg. Compliance: (static) lateral  $20 \times 10^{-6}$ cm/dyne, vertical  $17 \times 10^{-6}$ cm/dyne; (dynamic) lateral  $6 \times 10^{-6}$ cm/dyne, vertical  $5 \times 10^{-6}$ cm/dyne. FR: 70Hz-12kHz  $\pm 5$ dB. Channel separation not less than 20dB at 1kHz. Output: 100mV. Rec load: 1M. Price: £3-05 (plus VAT).

### M6 ★

Stereo magnetic cartridge. Sensitivity: 1-25mV at 1cm/sec. Rec load: 47K. Separation: > 15dB



Acos GP91-1SC



Acos GP93 Crystal Stereo

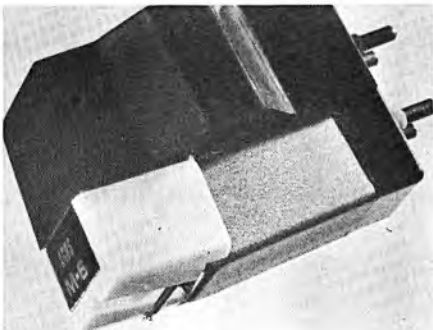

Acos M6 cartridge

★ Indicates entry is illustrated



Acos Lustre arm

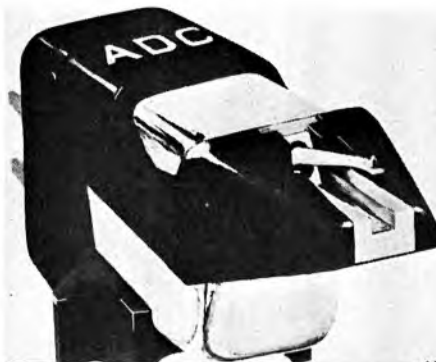

ADC XLM/VLM

at 1kHz. FR: 20Hz-20kHz. Stylus: 0.5/0.7 thou. Pw: 1½-2½gm. Price: £4.90 (plus VAT).

#### M6E

Stereo magnetic cartridge. Sensitivity: 1.25mV at 1cm/sec. Rec load: 47K. Separation: >18dB at 1kHz. FR: 10Hz-25kHz. Stylus: 0.25 × 0.8 thou. Pw: 1½-2gm. Price: £10.96 (plus VAT).

#### M6EX

Stereo magnetic cartridge. Sensitivity: 0.8mV at 1cm/sec. Rec load: 47K. Separation: >18dB at 1kHz. FR: 10Hz-30kHz. Stylus: 0.25 × 0.8 thou. Pw: 1-2gm. Price: £13.95 (plus VAT).

#### Lustre ★

Transcription pickup arm with headshell. Magnetic bias compensation. Easy height and over-hand adjustment. Direct reading stylus pressure gauge with ½gm calibration marks. Machine finish. Supplied with two headshells. Price: £31.50 (including VAT).

### ■ AUDIO DEVELOPMENTS

UK distributors: R. H. Morris & Co (Radio) Ltd, Trio House, The Hyde, London, NW9 6JP. Tel: 01-205 6441.

#### AD76K

Moving magnet stereo cartridge for stereo and LP only. FR: 20Hz-20kHz. Sensitivity 5mV at 1kHz. Diamond stylus. Channel balance within 2dB. Separation: 20dB. Compliance:  $10 \times 10^{-6}$  cm/dyne. Tracking force: 0.5gm. Weight: 5gm.

Dimensions: 30 × 10 × 16mm with standard ½in centres. Price: £3.50 (plus VAT). Replacement stylus JS-P1 £1.70 (plus VAT).

#### AD76KE

Similar specification to AD76K but fitted with elliptical diamond stylus. Price: £5.50 (plus VAT); replacement stylus AA25E £4.50 (plus VAT).

### ■ AUDIO DYNAMICS CORPORATION

Sole UK agents: Hisonic Ltd, Tovil, Maidstone, Kent. Tel: Maidstone (0622) 57258.

#### ADC XLM ★

Stereo cartridge. Induced magnet with controlled electrodynamic damping. Sensitivity: 4mV at 5.5cm/sec. Separation: 30dB 50Hz-25kHz. FR: 10Hz-25kHz ± 2dB. Vertical tracking angle 15°. Pw: 0.4-1gm. Stylus: 0.3 × 0.7 thou. Rec load: 47K. Compliance:  $50 \times 10^{-6}$  cm/dyne. Price: £28.40 (plus VAT).

#### ADC VLM ★

Stereo cartridge. Induced magnet with controlled electrodynamic damping. Sensitivity: 4mV at 5.5cm/sec. Separation: 30dB 50Hz-25kHz. FR: 10Hz-22kHz ± 2.5dB. Vertical tracking angle 15°. Pw: 0.75-1.5gm. Stylus: 0.3 × 0.7 thou. Rec load: 47K. Compliance:  $35 \times 10^{-6}$  cm/dyne. Price: £23.20 (plus VAT).

#### ADC Q36

Stereo cartridge. Induced magnet with controlled electrodynamic damping. Sensitivity: 4.5mV at 5.5cm/sec. Separation: 25dB. FR: 10Hz-20kHz ± 3dB. Vertical tracking angle 15°. Pw: 0.75-1.5gm. Stylus: 0.3 × 0.7 thou. Rec load: 47K. Compliance:  $30 \times 10^{-6}$  cm/dyne. Price: £13.95 (plus VAT).

#### ADC Q32

Stereo cartridge. Induced magnet with controlled electrodynamic damping. Sensitivity: 4.5mV at 5.5cm/sec. Separation: 20dB. FR: 10Hz-20kHz ± 3dB. Vertical tracking angle 15°. Pw: 1-2gm. Stylus: 0.3 × 0.7 thou. Rec load: 47K. Compliance:  $25 \times 10^{-6}$  cm/dyne. Price: £10.30 (plus VAT).

#### ADC Q30

Stereo cartridge. Induced magnet with controlled electrodynamic damping. Sensitivity: 4.5mV. Separation: 20dB. FR: 10Hz-18kHz ± 3dB. Vertical tracking angle 15°. Pw: 1-2gm. Stylus: 0.7 thou spherical. Rec load: 47K. Compliance:  $25 \times 10^{-6}$  cm/dyne. Price: £7.50 (plus VAT).

### ■ AUDIO TECHNICA

Distributors: Shriro (UK) Ltd, Shriro House, The Ridgeway, Iver, Bucks, SL0 9JL. Tel: Cedarwood (075 38) 2222.

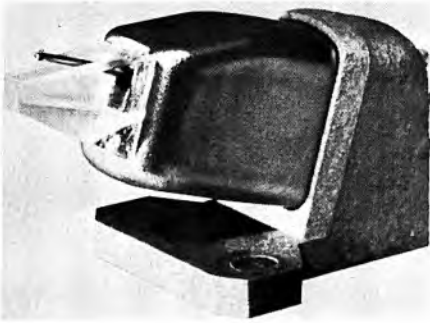

Bang & Olufsen SP15

**AT21**

Stereo magnetic cartridge. Stylus: 0.7 thou (compatible) or 0.5 thou (stereo only). Also available with 0.7 × 0.3 elliptical stylus. All diamond. Pw: (0.7 and 0.5) 1.2gm, (elliptical) ½-2gm. Effective tip mass: 0.6mg. Compliance: 30 × 10<sup>-6</sup>cm/dyne. FR: 20Hz-25kHz ± 2dB. Channel separation: 31dB at 1kHz. Output: 1.6mV/cm/sec. Price: (0.7 and 0.5 thou stylus) approximately £11 (including VAT); (elliptical) approximately £17 (including VAT).

**AT66**

Stereo magnetic cartridge. Stylus: (diamond) 0.5, 0.7, 2.5 or elliptical. Pw: 1.2-5gm. Effective tip mass: 0.6mg. Compliance: 30 × 10<sup>-6</sup>cm/dyne. FR: 20Hz-20kHz ± 2dB. Channel separation: better than 25dB at 1kHz. Output: 1mV/cm/sec. Price: (0.5, 0.7 and 2.5 thou stylus) approximately £6.50 (including VAT); (elliptical) approximately £15.90 (including VAT).

**AT1005 Mk II**

Tubular counter-balanced pickup arm. Length 12¾in. Effective length: 9½in. Bias compensation. Calibrated weight adjustment. Hydraulic lift and lowering. Tracking error: < 1.5°. Price: £26.08 (plus VAT).

**■ BANG & OLUFSEN**

Bang & Olufsen UK Ltd,  
Eastbrook Road, Gloucester, GL4 7DE.  
Tel: Gloucester (0452) 21591.

**SP10, SP12**

Stereo cartridges. Standard ½in centres. Moving iron. Pw: 1-1.5gm. Compliance: 25 × 10<sup>-6</sup>cm/dyne. FR: 15Hz-24kHz ± 3dB. Separation: > 25dB at 1kHz. Output: 5mV per channel (1mV/cm/sec). Rec load: 47K. Effective tip mass: < 1mg. SP10: 0.6 thou diamond. SP12: 0.7 × 0.2 thou diamond (interchangeable). Price: (SP10) £14.50, (SP12) £18.90 (including VAT).

**SP10A, SP12A**

Plug-in versions of the SP10 and SP12, for use

with Beogram 3000. Price: (SP10A) £14.50, (SP12A) £18.90 (including VAT).

**SP14, SP14A**

Identical to SP10 and SP10A respectively except for compliance which is 15 × 10<sup>-6</sup>cm/dyne. Price: £9.90 (including VAT).

**SP15 ★**

Stereo magnetic integrated cartridge. Factory sealed assembly and therefore no replacement stylus available. Exchange cartridge available at half price. Stylus: 0.2 × 0.65 thou diamond. Pw: 1gm. Compliance: 30 × 10<sup>-6</sup>cm/dyne. FR: 50Hz-20kHz ± 1.5dB. Separation: 24-30dB at 1kHz, 20dB at 500Hz-10kHz. Output: 0.6mV. Rec load: 47K. Price: £39.50 (including VAT).

**■ COLTON**

Musonic Ltd, 34-38 Verulam Road, St Albans, Herts, AL3 4DF. Tel: St Albans (56) 50611.

**MC101**

Pick-up arm with lateral balance and anti-skate bias adjustment. Tracking error: +1.5°, -0.5°. Price: £27.72 (including VAT).

**■ CONDOR**

Condor Electronics Ltd, 100 Coombe Lane, London, SW20 0AY. Tel: 01-946 0033.

**SM500/5**

Stereo magnetic cartridge. Conical diamond stylus, tip: 13µm. Pw: 1.2-2.2gm. Effective tip mass: 0.7mg. Lateral and vertical compliance: 10 × 10<sup>-6</sup>cm/dyne. FR: 15Hz-22kHz, 50Hz-15kHz (-1dB, +4dB). Separation: 20dB at 1kHz, 16dB from 50Hz-6kHz. Output: 3.5mV at 5cm/s. Rec load: 47k ohms. Price: £7.91.

**SM500/E**

Stereo magnetic cartridge. Elliptical diamond stylus, tip: 6.5 × 20µm. Pw: 1.2-1.8gm. Effective tip mass: 0.6mg. Lateral and vertical compliance: 10 × 10<sup>-6</sup>cm/dyne. FR: 10Hz-25kHz, 50Hz-15kHz (-1dB, +3dB). Separation: 20dB at 1kHz, 16dB from 50Hz-6kHz. Output: 3.5mV at 1kHz, 5cm/s. Rec load: 47k ohms. Price: £12.95.

**SM500/7**

Stereo magnetic cartridge. Conical diamond stylus, tip: 15µm. Pw: 1.5-2.5gm. Effective tip mass: 0.8mg. Lateral and vertical compliance: 10 × 10<sup>-6</sup>cm/dyne. FR: 20Hz-20kHz, 50Hz-15kHz (-2dB, +4dB). Separation: 18dB at 1kHz, 15dB from 50Hz to 6kHz. Output: 3.5mV at 1kHz, 5cm/s. Rec load: 47k ohm. Price: £7.95.

**■ CONNOISSEUR**

A. R. Sugden & Co (Engineers) Ltd  
Connoisseur Works, Atlas Mill Road,  
Brighouse, Yorks, HD6 1ES.  
Tel: Brighouse 2142. Cables: Connoisseur,  
Brighouse.

★ Indicates entry is illustrated

### SCU1 ★

Stereo ceramic cartridge with  $\frac{1}{2}$ in fixing centres. Stylus diamond 0.5-0.6 thou or 1 thou for mono. Pw: 2.4gm. Tip mass 1mg. Compliance: lateral  $12 \times 10^{-6}$ cm/dyne; vertical  $8 \times 10^{-6}$ cm/dyne. Range: 25Hz-18kHz  $\pm 3$ dB. Separation (1kHz) 25-30dB; (10kHz) 18dB. Output with rec load of 100K, 50mV per channel, RIAA equalisation required. Output with 2M load, 150mV per channel, no equalisation required. Features: Four-terminal output, easily replaceable diamond stylus. Price: £6.40 (including VAT).

### SAU2

Pickup arm with gimbal mountings on ball bearings set at 45/45. Automatic bias compensator. Hydraulic lowering device. Decoupled counter-balance weight. Additional weight supplied to accommodate different cartridges. Single hole fixing. Height adjustable from 1in to 2in. Light-weight shell with  $\frac{1}{2}$ in fixing centres. Five-pin plug connection to base of pick-up. Low resistance self-cleaning contacts. New head shell allows backward-forward horizontal adjustment so that minimum tracking error is obtained with all cartridges. Alignment protractor provided. Supplied with set of leads and separate precision balance with range 0-6gm. Price: £15.95 (including VAT). Extension stem for use with high turntables. Price: 44p (including VAT).

### ■ DECCA

Decca Special Products, Ingate Place, Queenstown Road, London, SW8 3NT. Tel: 01-622 6677.

### Deram ceramic (New series)

Stereo/mono cartridge. White shell transcription quality. Pw: 2.5gm. Tip mass: 0.6mg. Compliance:  $9 \times 10^{-6}$  lateral,  $5 \times 10^{-6}$  vertical. FR: 18Hz-18kHz  $\pm 3$ dB. Separation better than -20 dB at 1kHz. Output: 200mV at 5cm/sec. Rec load impedance: 2M. Stylus: diamond. Price: (spherical stylus) £4.74 (including VAT); (elliptical stylus) £5.68 (including VAT).

### Deram ceramic ★

Mono cartridge. Stylus 1 thou diamond. All other details as for stereo/mono cartridge. Price: £4.74 (including VAT).

### NOTE

All Deram cartridges are of transcription quality, the black shell range intended primarily for cheaper auto-changers is discontinued.

Deram heads are suitable for use with amplifiers having a sensitivity of 100mV.

Diamond styli for all Deram pickup heads, including 78 heads, are £1.37 (including VAT). Replacement Deram elliptical styli are now available at £2.36 (including VAT).

### ffss Mk 4 cartridge 78C

Mono magnetic cartridge. Diamond stylus 2.8 thou. Pw: 3.5gm. Tip mass less than 1mg. Compliance:  $15 \times 10^{-6}$ cm/dyne lateral. FR: 30Hz-16kHz  $\pm 3$ dB. Output: 1.5mV cm/sec. Rec load: 47K. Available to special order only. Price: £9.62 (including VAT).

### London

Stereo magnetic cartridge. *ffss* sum-and differ-



Connoisseur SCU1

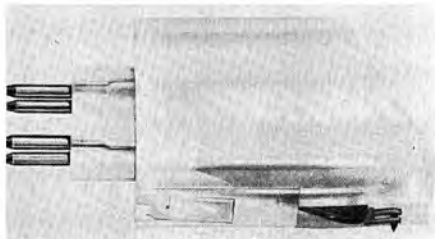

Decca Deram Cartridge

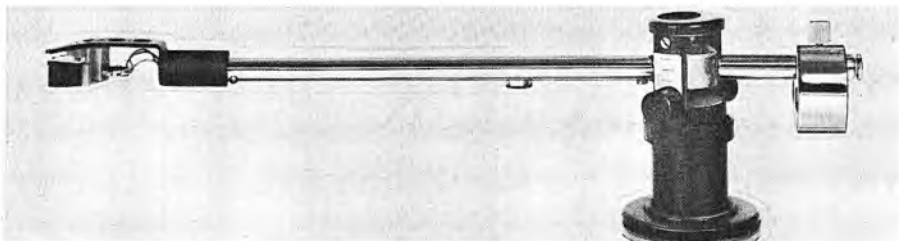

Decca International Arm

ence system. Stylus: 0.6 thou spherical diamond. Pw: 3gm. Effective tip mass: < 1mg. Compliance: (lateral)  $12 \times 10^{-6}$ cm/dyne, (vertical)  $5 \times 10^{-6}$ cm/dyne. FR: 20Hz-20kHz. Channel separation: better than 20dB. Output: 7.5mV for 5cm/sec. Rec load: 47K. Price: £25.59 (including VAT).

**London cartridge adaptors**

Type A. Simple slide-on adaptor for use with *ffss* arms (Mk I, Mk I Super and Professional) to accommodate the London cartridge. Automatically adjusts playing weight. Price: £1.41 (including VAT). Type B. Simple slide-on adaptor for use with International arm to accommodate the London cartridge. Collar arrangement to adjust for correct playing weight. Price: 23p (including VAT).

***ffss* 'International' Arm ★**

Stereo pickup arm. Jewelled uni-pivot. Pw:  $\frac{1}{2}$ - $3\frac{1}{2}$  gm. Constantly variable magnetic bias compensation. Suspended on magnetic cushion. Provision for damping lateral and vertical resonances. Price: £24.16 (including VAT).

Decca *ffss* pickup heads can be inspected for a charge of 77p (including VAT). When the stylus is worn on a Decca *ffss* head it must be returned to the maker for replacement. The service offered is complete replacement of the head with a re-conditioned head having a new stylus. Performance is guaranteed to be as new. Prices for this service are as follows: Mk III elliptical styli £8.47 (including VAT); Mk I and Mk II spherical styli £6.82 (including VAT); mono LP and 78 styli £6.60 (including VAT); Mk 4 H4E and C4E elliptical styli £9.35 (including VAT); Mk 4 SH4E and SC4E elliptical styli £12.10 (including VAT); Mk 4 78C spherical styli £6.05 (including VAT).

■ **EAGLE**

Eagle International, Heather Park Drive, Wembley, HA0 1SU. Tel: 01-903 0144.

**LC05**

Stereo cartridge. Moving magnet. FR: 30Hz-18 kHz. Compliance:  $9 \times 10^{-6}$ cm/dyne. Separation: 20dB at 1kHz. Output: 6mV per channel. Rec load: 47K. Price: £5.50 (including VAT).

**LC07**

Stereo cartridge. Moving magnet. LP and stereo. FR: 20Hz-21kHz. Compliance:  $12 \times 10^{-6}$ cm/dyne. Separation: 28dB at 1kHz. Output: 7mV per channel. Rec load: 47K. Price: £7.48 (including VAT).

**FF12E ★**

Stereo cartridge. Magnetic.  $\frac{1}{2}$ in fixing centres. Elliptical diamond stylus. Pw: 2gm. Compliance:  $15 \times 10^{-6}$ cm/dyne. FR: 20Hz-20kHz. Separation: 28dB at 1kHz. Output: 5mV at 5cm/sec.

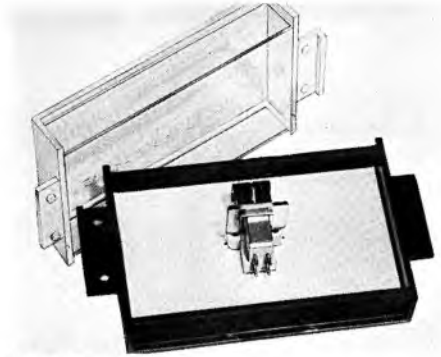

Eagle FF12E



Eagle FF20E

Rec load: 47K. Price: £10.78 (including VAT).

**FF20E ★**

Stereo cartridge. Magnetic.  $\frac{1}{2}$ in fixing centres. Elliptical diamond stylus. Pw: 1.5gm. Compliance:  $15 \times 10^{-6}$ cm/dyne. FR: 20Hz-25kHz. Separation: 30dB at 1kHz. Output: 5mV at 5cm/sec. Rec load: 47K. Price: £13.30 (including VAT).

■ **EMPIRE SCIENTIFIC**

Empire Scientific Corporation, U.S.A. Distributors: Rank Audio Visual Ltd, PO Box 70, Great West Road, Brentford, Middlesex, TW8 9HR. Tel: 01-568 9222. Telex: 24408.

**999TE/X**

Stereo magnetic cartridge. Elliptical diamond stylus, 0.2 x 0.7 thou. Pw:  $\frac{1}{2}$ - $1\frac{1}{2}$  gm. Compliance:  $30 \times 10^{-6}$ cm/dyne. FR: 6Hz-36kHz. Separation: 35dB. Output: 6mV. Price: £24.73 (including VAT).

★ Indicates entry is illustrated

#### 999VE/X

Stereo magnetic cartridge. Hand polished elliptical diamond stylus. Tip:  $0.2 \times 0.7$  thou. Pw:  $\frac{1}{4}$ - $1\frac{1}{4}$  gm. Compliance:  $35 \times 10^{-6}$  cm/dyne. FR: 4Hz-40kHz. Separation: 35dB at 1kHz, 25dB at 20kHz. Output: 5mV per channel. Price: £42.05 (including VAT).

#### 1000ZE/X

Stereo magnetic cartridge. Hand-polished diamond stylus. Tip:  $0.2 \times 0.7$  thou. Pw:  $\frac{1}{4}$ - $1\frac{1}{4}$  gm. Compliance:  $35 \times 10^{-6}$  cm/dyne. FR: 4Hz-40 kHz. Separation: 35dB at 1kHz, 25dB at 20kHz. Output: 5mV per channel. Price: £58.87 (including VAT).

#### 999QE/E

Stereo magnetic cartridge. Elliptical diamond stylus. Tip:  $0.2 \times 0.7$  thou. Pw: 1.4gm. Compliance:  $30 \times 10^{-6}$  cm/dyne. FR: 15Hz-25kHz. Separation: 30dB. Output: 8mV. Price: £14.50 (including VAT).

#### 999RE/X

Stereo magnetic cartridge. Elliptical diamond stylus. Tip:  $0.2 \times 0.7$  thou. Pw:  $1\frac{1}{2}$ - $2\frac{1}{4}$  gm. Compliance: 10cm/dyne. FR: 15Hz-20kHz. Separation: 30dB. Output: 8mV. Price: £10.75 (including VAT).

#### 999YE/X

Stereo magnetic cartridge. Elliptical diamond stylus. Tip:  $0.2 \times 0.7$  thou. Pw:  $\frac{1}{4}$ - $1\frac{1}{4}$  gm. Compliance: 30cm/dyne. FR: 8Hz-34kHz. Separation: 35dB. Output: 6mV. Price: £17.50 (including VAT).

#### ■ EXCEL

Excel Sound Corporation,  
Mathers Photographic Ltd,  
35 John Dalton Street, Manchester 2.  
Tel: 061-834 6133.

#### ES70S

Stereo magnetic cartridge.  $\frac{1}{2}$ in mounting centres. Stylus: 0.6 thou spherical diamond. Pw: 2gm. Compliance:  $10 \times 10^{-6}$  cm/dyne. FR: 15Hz-25kHz. Separation:  $>20$ dB at 1kHz. Output: 5mV at 1kHz at 5cm/sec. Price: £5 (including VAT); (replacement styli) £1.95 (including VAT).

#### ES70E

Stereo magnetic cartridge.  $\frac{1}{2}$ in mounting centres. Stylus:  $0.2 \times 0.8$  thou elliptical diamond. Pw: 1.25gm. Compliance:  $15 \times 10^{-6}$  cm/dyne. FR: 10Hz-30kHz. Separation:  $>20$ dB at 1kHz. Output: 5mV at 1kHz at 5cm/sec. Price: £8 (including VAT); (replacement styli) £4.25 (including VAT).

#### ES70EX

Stereo magnetic cartridge.  $\frac{1}{2}$ in mounting centres. Stylus:  $0.2 \times 0.8$  thou diamond elliptical. Pw: 0.7-2gm. Compliance:  $20 \times 10^{-6}$  cm/dyne. FR:



Goldring L75 pickup arm



Goldring 800

10Hz-35kHz. Separation: 30dB at 1kHz. Output: 3mV at 1kHz at 5cm/sec. Effective tip mass: 0.5mg. Price: £20 (including VAT); (replacement styli) £11 (including VAT). Cartridge supplied in presentation box with cleaning brush, stylus guard and two sets of mounting screws.

#### ■ GOLDRING LTD

10 Bayford Street, London, E8 3SE.  
Tel: 01-985 1152.

#### Goldring/Lenco L75 ★

Transcription pickup arm. Calibrated stylus pressure adjustment. Removable plug-in shell with adjustable stylus position. Anti-skating bias compensator. Price: £13.50 (plus VAT).

#### Goldring/Lenco L69

Pickup arm. Stereo. Low mass tubular arm. Removable plug-in shell with stylus position adjustment. Sliding counterweight stylus pressure adjustment, height adjustment. Price: £10.50 (plus VAT).

#### CS90

Stereo ceramic cartridge. Stylus 0.5 or 0.7 thou diamond. Pw: 2gm. Compliance:  $8 \times 10^{-6}$  cm/dyne. FR: 30Hz-20kHz. Separation: 20dB at 1kHz, 10dB at 10kHz. Output: 80mV. Rec load: 1-2M. Price: £4.20 (plus VAT).

#### CS91E

Stereo/LP ceramic cartridge. Stylus: elliptical diamond. Pw: 1.3gm. Tip mass: 1mg. FR: 30Hz-20kHz. Separation: 20dB. Output: 30mV. Rec load: 1-2M. Price: £6.30 (plus VAT).

#### '800' ★

Stereo magnetic cartridge. Stylus 0.5 thou diamond. Pw:  $1\frac{1}{2}$ - $2\frac{1}{2}$  gm. Tip mass less than 1mg.

Compliance:  $20 \times 10^{-6}$ cm/dyne. FR: 20Hz-20 kHz  $\pm 3$ dB. Separation: 20dB at 1kHz, 15dB at 10kHz. Output: 1mV. Rec load: 47K. Price not quoted.

**G800E**

Stereo magnetic cartridge. Stylus:  $0.3 \times 0.7$  diamond. Pw:  $\frac{3}{4}$ - $1\frac{1}{2}$  gm. Tip mass: less than 1mg. Compliance:  $30 \times 10^{-6}$ cm/dyne lateral and vertical. FR: 10Hz-23kHz. Separation: 20dB at 1kHz, 15dB at 10kHz. Output: 1mV. Rec load: 47K-100K. Price not quoted.

**G800E Super E**

Stereo magnetic cartridge. Single-sided with elliptical diamond,  $0.3 \times 0.7$  thou replaceable. Pw:  $\frac{1}{2}$ - $1\frac{1}{4}$  gm. Tip mass less than 1mg. Compliance:  $35 \times 10^{-6}$ . FR: 10Hz-23kHz. Channel separation: 25dB (1kHz) and better than 15dB (10kHz). Output voltage: 0.8mV. Rec load: 47K. Price not quoted.

**Goldring G800/H**

Magnetic stereo cartridge. Single-sided with 0.7 thou tip radius diamond. Replaceable. Pw:  $2\frac{1}{2}$ - $3\frac{1}{2}$  gm. Tip mass 1.2mg. Compliance:  $18 \times 10^{-6}$ . FR: 20Hz-20kHz. Separation: 20dB at 1kHz, 10dB at 10kHz. Output: 1.6mV. Rec load: 47K. Price not quoted.

**Goldring 850**

Magnetic stereo cartridge. Single-sided,  $\frac{1}{2}$ in fixing centres. Stylus: 0.7 thou diamond, replaceable. Pw: 2-4gm. FR: 20Hz-18kHz. Separation: 20dB at 1kHz. Output: 1.6mV. Rec load: 47K-100K. Price: £5.25 (plus VAT).

**820 ★**

Stereo magnetic cartridge.  $\frac{1}{2}$ in fixing centres. Diamond spherical stylus. Pw: 2gm. Tip mass: 1mg. Compliance:  $20 \times 10^{-6}$ cm/dyne. FR: 20Hz-20kHz. Separation: 20dB. Output: 1mV. Rec load: 47K-100K. Price: £10 (plus VAT).

**820E**

Stereo magnetic cartridge.  $\frac{1}{2}$ in fixing centres. Diamond elliptical stylus. Pw: 1.5gm. Tip mass: < 1mg. Compliance:  $25 \times 10^{-6}$ cm/dyne. FR: 10Hz-23kHz. Separation: 20dB. Output: 1mV. Rec load: 47K-100K. Price: £15 (plus VAT).

**820E Super**

Stereo magnetic cartridge.  $\frac{1}{2}$ in fixing centres. Diamond elliptical stylus. Pw: 1.25gm. Tip mass: < 1mg. Compliance:  $30 \times 10^{-6}$ cm/dyne. FR: 10Hz-23kHz. Separation: 25dB. Output: 0.8mV. Rec load: 47K-100K. Price: £20 (plus VA1)

■ **GRADO**

Distributors: Howland-West Ltd, 3-5 Eden Grove, London, N7 8EQ. Tel: 01-609 0293.

**F3E ★**

Stereo magnetic cartridge. Stylus:  $0.7 \times 0.3$  thou

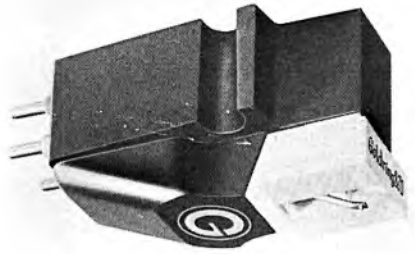

Goldring 820

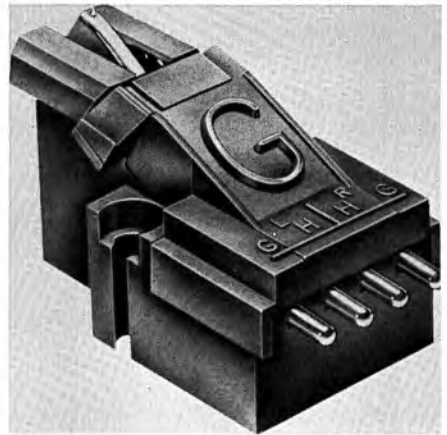

Grado F series

diamond. Pw:  $1\frac{1}{2}$ - $3\frac{1}{2}$  gm. FR: 10Hz-35kHz. Output: 3mV. Price: £16.50 (including VAT).

**F2 ★**

Stereo magnetic cartridge. Stylus:  $0.6 \times 0.3$  thou diamond. Pw: 1-2gm. FR: 7Hz-60kHz. Output: 3mV. Price: £27.50 (including VAT).

**FTR ★**

Stereo magnetic cartridge. Stylus: 0.6 thou spherical diamond. Pw:  $1\frac{1}{2}$ - $3\frac{1}{2}$  gm. FR: 10Hz-35kHz. Output: 3mV. Price: £7.70 (including VAT).

**FTE ★**

Stereo magnetic cartridge. Stylus:  $0.7 \times 0.3$  thou diamond. Pw:  $1\frac{1}{2}$ - $3\frac{1}{2}$  gm. FR: 10Hz-35kHz. Output: 3mV. Price: £12.10 (including VAT).

**F1**

Stereo magnetic cartridge.  $\frac{1}{2}$ in fixing centres. Twin spherical diamond. Pw: 1-2gm. FR: 7Hz-60kHz. Channel separation: 25dB. Output: 3mV. Rec load: greater than 10K. Price: £35.20 (including VAT).



★ Indicates entry is illustrated

### ■ G. F. C. HADCOCK

Audio Division, The Old Vicarage, Doveridge, Derby, DE6 5NN. Tel: Uttoxeter (088 93) 2452.

#### GH Unipoise Series 3 ★

Precision ultra low mass pickup arm. Pivot friction: less than 0.006gm. Tubular aluminium arm with slotted headshell suitable for low mass high compliance cartridges. Standard 0.5in (12.7mm) centres. Bias adjustable to vertical tracking force. Easily adjusted calibrated weight 0.3gm. Length: 11.65in (295.9mm). Pivot to stylus tip: 9in (228.6mm). Rear overhang: 2.25in (51.75mm). Price: £23.10 (including VAT). GH Unilift lowering device available separately. (See Pickup Accessories).

### ■ HOWLAND-WEST LTD

3.5 Eden Grove, London, N7 8EQ.  
Tel: 01-609 0293.



Hadcock GH Unipoise

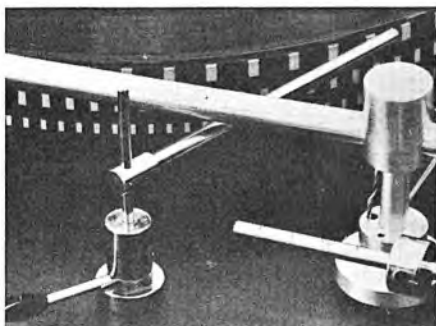

Hadcock GH Uni-lift

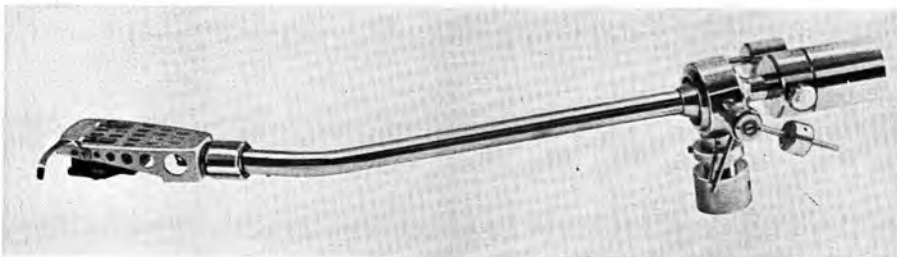

Howland-West G20 B/L

### G20 B/L ★

Transcription pickup arm with headshell but less cartridge. Provision for accommodating cartridges with  $\frac{1}{2}$ in fixing centres. Lowering device. Bias compensation. Adjustable counterbalance weight. Lightweight headshell. Tubular polished metal arm. Adjustable height. Price: £16.50 (including VAT).

### ■ JVC

JVC (UK) Ltd, 453 Caledonian Road, London, N7 9BA. Tel: 01-607 6568.

#### 4MD20X

Four-channel stereo cartridge. Developed for playing discrete four-channel records. Shibata diamond stylus. FR: 20Hz-60kHz. Pw:  $1\frac{1}{2}$ gm. Output: 2mV. Price: £32.01 (including VAT).

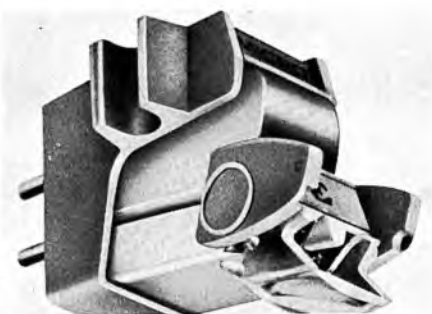

Micro VF3200E



Micro MA101 Mk II

■ **MICRO**

Howland-West Ltd, 3-5 Eden Grove, London, N7 8EQ. Tel: 01-609 0293.

**VF3200/6**

Stereo variable flux cartridge.  $\frac{1}{2}$ in fixing centres. Stylus: 0.6 spherical diamond. Pw: 1.5gm. Compliance:  $30 \times 10^{-6}$ cm/dyne. FR: 5Hz-35kHz. Separation: 30dB at 1kHz. Output: 3mV at 1kHz at 3.54cm/sec. Rec load: 47-50K. Price: £6.60 (including VAT).

**VF3200XE**

Stereo variable flux cartridge.  $\frac{1}{2}$ in fixing centres. Stylus:  $0.3 \times 0.8$  thou diamond. Pw: 1.5gm. Compliance:  $30 \times 10^{-6}$ cm/dyne. FR: 5Hz-35kHz. Separation: 30dB at 1kHz. Output: 3mV at 1kHz at 3.54cm/sec. Rec load: 47-50K. Price: £11 (including VAT).

**VF3200E ★**

Stereo variable flux cartridge.  $\frac{1}{2}$ in fixing centres. Stylus:  $0.3 \times 0.8$  thou low-mass diamond. Pw: 1.5gm. Compliance:  $30 \times 10^{-6}$ cm/dyne. FR: 5Hz-35kHz. Separation: 30dB at 1kHz. Output: 3mV at 1kHz at 3.54cm/sec. Rec load: 47-50K. Price: £13.20 (including VAT).

**MA101 Mk II ★**

Transcription pickup arm without cartridge. Damped cueing device. Spring-loaded adjustable bias compensation. Revolving dual counterweight. Tracking error  $< 1.5^\circ$ . Stylus pressure: adjustable 0-3gm. Price: £33 (including VAT).

■ **N. MIERS & CO LTD**

28 Piercing Hill, Theydon Bois, Epping Essex, CM16 7LE. Tel: 037-881 2611.

**SX6M**

Stereo crystal cartridge. LP/78 diamond stylus. Pw: 4-6gm. Output: 280mV. Price: £2.60 (plus VAT).

**SX6H**

Stereo crystal cartridge. LP/78 diamond stylus. Pw: 7gm. Output: 700mV. Price: £2.60 (plus VAT).

**SC5M**

Stereo ceramic cartridge. LP/78 diamond stylus. Pw: 2-6gm. Output: 110mV. Price: £3.13 (plus VAT).

**SC5H**

Stereo ceramic cartridge. LP/78 diamond stylus. Pw: 5-7gm. Output: 190mV. Price: £3.13 (plus VAT).

**SC8M**

Stereo ceramic cartridge. LP/78 diamond stylus. Pw: 2-6gm. Output: 110mV. Price: £3.62 (plus VAT).

**SC8H**

Stereo ceramic cartridge, diamond stylus. Pw:

4-6gm. Output: 170mV. FR: 40Hz-7kHz. Price: £3.62 (plus VAT).

**SC10M**

Stereo ceramic cartridge, diamond stylus. Pw: 2-6gm. Output: 100mV. FR: 40Hz-15kHz. Price: £3.76 (plus VAT).

**SC10H**

Stereo ceramic cartridge, diamond stylus. Pw: 4-6gm. Output: 170mV. FR: 40Hz-12kHz. Price: £3.76 (plus VAT).

**X5M**

Monaural crystal compatible cartridge, sapphire stylus. Pw: 3-6gm. Output: 400mV. FR: 40Hz-10kHz. Price: £1.50 (plus VAT).

**X5H**

Monaural crystal compatible cartridge, sapphire stylus. Pw: 5-9gm. Output: 1V. FR: 40Hz-10kHz. Price: £1.50 (plus VAT).

■ **ORBIT**

Distributors: Highgate Acoustics, 38 Jamestown Road, London, NW1 7EJ. Tel: 01-267 4937.

**NM22**

Stereo magnetic cartridge. Diamond stylus. FR: 20Hz-20kHz. Channel separation: 20dB at 1kHz. Output: 5mV. Rec load: 50K-100K. Pw: 2-3gm. Price: (complete cartridge) £4 (plus VAT); (replacement stylus) £2.40 (plus VAT).

■ **ORTOFON**

Distributed in the UK by Metrosound (Sales) Co Ltd, Cartersfield Road, Waltham Abbey, Essex, EN9 1JF. Tel: Waltham Cross 31933.

**SL15/E**

Moving coil stereo cartridge. Pw: 1-2gm. Tip mass: 0.9mg. Compliance:  $25 \times 10^{-6}$ cm/dyne. FR: 10Hz-40kHz. Separation: 20-30dB. Output: 0.04mV/cm/sec (loaded). Output impedance: 2 ohms. Matching transformer required for most amplifiers (see transformer below). Stylus diamond  $0.6 \times 0.3$  thou. Tracking angle:  $15^\circ$ . Price: £34.34 (including VAT).

**SL15**

Similar specification to SL15/E but with spherical 0.6 thou diamond stylus. Price: £33 (including VAT).

**Transformer module**

Primary impedance: 2 ohms. Secondary impedance: 15K. Load: 10K to 50K without change in frequency response. FR: 20Hz-40kHz. Price: £13.20 (including VAT).

**M15E Super ★**

Moving magnet stereo cartridge. Compliance: (horizontal)  $50 \times 10^{-6}$ cm/dyne; (vertical)  $30 \times 10^{-6}$ cm/dyne. Trackability: 80µm. Output: 0.8mV. FR: 20Hz-20kHz. Pw:  $\frac{3}{4}$ -1½gm. Separation:



Ortofon M15E super

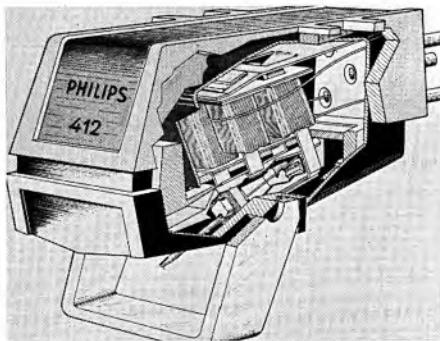

Philips GP412

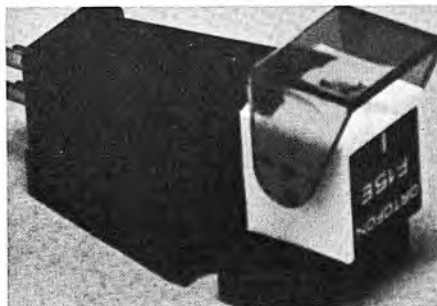

Ortofon F15E cartridge

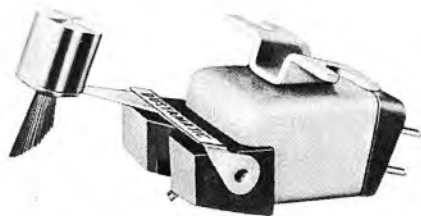

Pickering V-15 Series

tion: better than 25dB at 1kHz. Price: £38.50 (including VAT).

#### M15 Super

Moving magnet stereo cartridge. Compliance: (horizontal)  $50 \times 10^{-6}$ cm/dyne; (vertical)  $30 \times 10^{-6}$ cm/dyne. Trackability:  $80\mu\text{m}$ . Output: 0.8 mV. FR: 20Hz-20kHz. Pw:  $\frac{3}{4}$ - $1\frac{1}{2}$ gm. Separation: better than 25dB at 1kHz. Price: £31.90 (including VAT).

#### F15E ★

Stereo cartridge. Compliance: (horizontal and vertical)  $25 \times 10^{-6}$ cm/dyne. Trackability:  $60\mu\text{m}$ . Output: 1mV. FR: 20Hz-20kHz. Separation: better than 25dB at 1kHz. Pw: 1-2gm. Price: £14.85 (including VAT).

#### F15

Stereo cartridge. Compliance: (horizontal and vertical)  $25 \times 10^{-6}$ cm/dyne. Trackability:  $60\mu\text{m}$ . Output: 1mV. FR: 20Hz-20kHz. Separation: better than 25dB at 1kHz. Pw: 1-2gm. Price: £12.10 (including VAT).

#### FF15E

Stereo cartridge. Compliance: (horizontal and vertical)  $20 \times 10^{-6}$ cm/dyne. Trackability:  $60\mu\text{m}$ . Output: 1mV. FR: 20Hz-20kHz. Separation: better than 25dB at 1kHz. Pw: 1-3gm. Price: £14.85 (including VAT).

#### FF15

Stereo cartridge. Compliance: (horizontal and

vertical)  $20 \times 10^{-6}$ cm/dyne. Trackability:  $60\mu\text{m}$ . Output: 1mV. FR: 20Hz-20kHz. Separation: better than 25dB at 1kHz. Pw: 1-3gm. Price: £12.10 (including VAT).

#### Replacement styli

SL15E elliptical diamond. Price: £16.50 (including VAT); SL15 0.6 thou spherical diamond. Price: £14.30 (including VAT); M15E Super elliptical diamond stylus. Price: £22 (including VAT); M15 0.6 thou spherical diamond. Price: £17.60 (including VAT); F15. Price: £6.60 (including VAT); F15E. Price: £8.53 (including VAT); FF15. £6.60 (including VAT); FF15E. Price: £8.53 (including VAT).

Note: SL15 Series styli are factory-replaceable only and the charge includes reconditioning the cartridge.

#### AS212

12in pickup arm for stereo and mono cartridges. Playing weight: adjustable 0-3gm. Magnetic anti-skating device. Hydraulic lifting, lowering and cueing. Easy to mount. Arm base to turntable centre:  $8\frac{3}{8}$ in. Height adjustable:  $1\frac{1}{4}$ - $2\frac{3}{8}$ in. Effective length: (stylus to pivot) 9in. Optimum overhang:  $\frac{3}{8}$ in. Maximum tracking error: 0.16 deg/cm. Price: £38.50 (including VAT).

#### M Shell

Type M metal shells for 15 Series cartridges. Price: £1.50 (including VAT).

## ■ PHILIPS

Philips Electrical Ltd, Century House,  
Shaftesbury Avenue, London, WC2H 8AS.  
Tel: 01-437 7777.

### GP412 ★

Stereo magnetic dynamic cartridge. 45/LP only. Standard  $\frac{1}{2}$ in mounting centres. Stylus:  $0.3 \times 0.7$  thou bi-radial diamond. Pw: 0.75-1.5gm. Effective tip mass:  $<0.75$ mg. Compliance: lateral  $>25$  typical 30; vertical  $>15$  typical 20. FR: 20Hz-20kHz  $\pm 2$ dB. Channel separation:  $>25$  dB at 1kHz,  $>16$ dB at 10kHz. Output: 1.2mV/cm/sec. Rec load: 47K. Net weight: 7gm. Price: £35.08 (including VAT).

### GP400

Stereo magnetic dynamic cartridge. 45rpm and LP only.  $\frac{1}{2}$ in fixing centres. Pw: 1.5-3gm. Sensitivity: 1.2mV/cm/sec. Stylus: 0.6 thou diamond. Compliance: 20mm/N lateral, 16mm/N vertical. Rec load: 47K. Separation:  $>20$ dB at 1kHz. Dynamic mass:  $<0.8$ mg. FR: 20Hz-20kHz  $\pm 3$ dB. Net weight: 7gm. Price: £17.06 (including VAT).

### GP401

Specification as for GP400 but fitted with elliptical stylus  $0.7 \times 0.3$  thou diamond. Price: £22.28 (including VAT).

### GP213

Stereo ceramic cartridge.  $\frac{1}{2}$ in fixing centres. Stylus: 0.6 thou diamond LP, 3 thou sapphire 78 (turnover assembly). Pw: 3-7gm. Sensitivity: 65mV/cm/sec at 1kHz. Compliance:  $>5$ mm/N. Rec load: 1M. Separation:  $>18$ dB at 1kHz. Net weight: 2.5gm. Price: £2.65 (including VAT).

## ■ PICKERING

Distributors: Highgate Acoustics,  
38 Jamestown Road, London, NW1 7EJ.  
Tel: 01-267 4937.

### XV-15 DCF Series ★

With Dustamatic. Stereo magnetic cartridges all with 35dB channel separation. Series comprises the following:

#### 1200E

Price: £42.50 (plus VAT).

#### 750E

Output: 4.4mV. FR: 10Hz-25kHz. Pw:  $\frac{1}{2}$ -1gm. Stylus:  $0.2 \times 0.9$  thou. Price: £32.50 (plus VAT).

#### 400E

Output: 4.5mV. FR: 10Hz-25kHz. Pw:  $\frac{3}{4}$ -1  $\frac{1}{2}$ gm. Stylus:  $0.3 \times 0.9$  thou. Price: £21 (plus VAT).

#### 140E

Output: 8mV. FR: 10Hz-20kHz. Pw: 3-5gm. Stylus:  $0.4 \times 0.9$  thou. Price: £16.85 (plus VAT).

#### 350

Output: 6mV. FR: 10Hz-25kHz. Pw: 1-3gm. Stylus: 0.7 thou spherical. Price: £16 (plus VAT).

#### 150

Output: 8mV. FR: 10Hz-25kHz. Pw: 2-5gm. Stylus: 0.7 thou. Price: £13.50 (plus VAT).

#### 100

Output: 8mV. FR: 10Hz-20kHz. Pw: 3-7gm. Stylus: 0.7 thou. Price: £11.50 (plus VAT).

### V15 Micro IV AME

Stereo magnetic cartridge. Stylus:  $0.3 \times 0.7$  thou elliptical diamond. Pw: 1-2gm. FR: 20Hz-20kHz. Channel separation: 30dB. Output: 5.5mV. Rec load: 47K. Price: £17 (plus VAT).

### V15 Micro IV AM

Stereo magnetic cartridge. Stylus: 0.7 thou spherical diamond. Pw: 1-3gm. FR: 20Hz-20kHz. Channel separation: 30dB. Output: 6.5mV. Rec load: 47K. Price: £13.50 (plus VAT).

### V15 Micro IV AT

Stereo magnetic cartridge. Stylus: 0.7 thou spherical diamond. Pw: 2-4gm. FR: 20Hz-18kHz. Rec load: 47K. Price: £11.50 (plus VAT).

### V15 Micro IV ACE

Stereo magnetic cartridge. Stylus:  $0.4 \times 0.9$  thou elliptical diamond. Pw: 3-5gm. FR: 20Hz-17kHz. Channel separation: 26dB. Output: 7.5mV. Rec load: 47K. Price: £11.50 (plus VAT).

### V15 Micro IV AC

Stereo magnetic cartridge. Stylus: 0.7 thou spherical diamond. Pw: 4-6gm. FR: 20Hz-17kHz. Channel separation: 26dB. Output: 7.5mV. Rec load: 47K. Price: £10.25 (plus VAT).

### P Series P/ATE

Stereo magnetic cartridge. Stylus:  $0.5 \times 1.0$  thou elliptical diamond. Pw: 2-5gm. FR: 20Hz-20kHz. Channel separation: 35dB. Output: 5.5mV. Rec load: 47K. Price: £10.25 (plus VAT).

### P Series P/AT

Stereo magnetic cartridge. Stylus: 0.7 thou spherical diamond. Pw: 2-5gm. FR: 20Hz-20kHz. Channel separation: 35dB. Output: 6.9mV. Rec load: 47K. Price: £8 (plus VAT).

### P Series P/AC

Stereo magnetic cartridge. Stylus: 0.7 thou spherical diamond. Pw: 3-7gm. FR: 20Hz-20kHz. Channel separation: 35dB. Output: 7.5mV. Rec load: 47K. Price: £6.50 (plus VAT).

### UV-15/2400Q

Stereo and quadraphonic magnetic cartridge. The special stylus is designed to match the requirements for scanning carrier quadraphonic records as well as conventional stereo or matrix quadraphonic records. FR: 10Hz-50kHz. Separation: 35dB. Output: 0.69mV. Rec load: 100K and 100pF. Price: £64.90 (including VAT).

■ SHURE

Shure Electronics Ltd,  
Ecclestone Road, Maidstone, ME15 6AU.  
Tel: Maidstone (0622) 59881.

**M3D**

Stereo Dynetic cartridge. Moving magnet.  $\frac{1}{2}$  in fixing centres. Stylus: 0.7 thou diamond. Pw: 3.6 gm. Compliance:  $4 \times 10^{-5}$  cm/dyne. FR: 20Hz-15kHz. Separation: 20dB at 1kHz. Output: 1mV. Load impedance: 47K. Price: £5.61 (including VAT).

**M44C**

Stereo Dynetic cartridge. Moving magnet.  $\frac{1}{2}$  in fixing centres. Stylus: 0.7 thou diamond (1 thou and 3 thou styli available). Pw: 3.5gm. Compliance:  $7.5 \times 10^{-6}$  cm/dyne. FR: 20Hz-20kHz. Separation: 25dB at 1kHz. Output: 1.8mV. Load impedance: 47K. Price: £7.26 (including VAT).

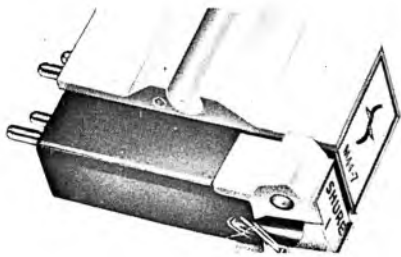

Shure M55E



Shure M75ED Type 2



Shure V15-III

**M44E**

Stereo Dynetic cartridge. Moving magnet.  $\frac{1}{2}$  in fixing centres. Stylus: 0.7 x 0.4 thou bi-radial diamond (3 thou stylus available). Pw:  $1\frac{3}{4}$ -4gm. Compliance:  $15 \times 10^{-5}$  cm/dyne. FR: 20Hz-20 kHz. Separation: > 25dB at 1kHz. Output: 1.8 mV. Rec load: 47K. Price: £7.92 (including VAT).

**M44G**

Stereo Dynetic cartridge. Moving magnet.  $\frac{1}{2}$  in fixing centres. Stylus: 0.6 thou diamond (1 thou and 3 thou styli available). Pw:  $\frac{3}{4}$ -1.1 gm. Compliance:  $25 \times 10^{-5}$  cm/dyne. FR: 20Hz-20kHz. Separation: 25dB at 1kHz. Output: 1.4mV. Load impedance: 47K. Price: £7.59 (including VAT).

**M44-7**

Stereo Dynetic cartridge. Moving magnet.  $\frac{1}{2}$  in fixing centres. Stylus: 0.7 thou diamond (1 thou and 3 thou styli available). Pw:  $1\frac{1}{2}$ -3gm. Compliance:  $20 \times 10^{-5}$  cm/dyne. FR: 20Hz-20kHz. Separation: 25dB at 1kHz. Output: 2.2mV. Load impedance: 47K. Price: £7.26 (including VAT).

**M55E ★**

Stereo Dynetic cartridge. Moving magnet.  $\frac{3}{8}$  in fixing centres. Stylus: 0.7 x 0.2 thou elliptical diamond (3 thou stylus available). Pw:  $\frac{3}{4}$ -2gm. Compliance:  $15 \times 10^{-6}$  cm/dyne. Output: 1.3mV. Load impedance: 47K. Price: £8.91 (including VAT).

**M75B Type 2**

Stereo Dynetic cartridge. Moving magnet.  $\frac{1}{2}$  in fixing centres. Stylus: 0.6 thou conical diamond (3 thou stylus available). Pw:  $1\frac{1}{2}$ -3gm. Trackability (see note at end) at 2gm in SME 3009 arm: 400Hz 28cm/sec, 1kHz 35cm/sec, 10kHz 20cm/sec. FR: 20Hz-20kHz. Separation: > 25dB at 1kHz. Output: 1mV. Rec load: 47K per channel. Price: £12.54 (including VAT).

**M75ED Type 2 ★**

Stereo Dynetic cartridge. Moving magnet.  $\frac{1}{2}$  in centres. Stylus: 0.7 x 0.2 thou elliptical diamond (3 thou stylus available). Pw:  $\frac{3}{4}$ -1.1 gm. Trackability (see note at end) at 1 gm in SME 3009 arm: 400Hz 22cm/sec, 1kHz 33cm/sec, 5kHz 28cm/sec, 10kHz 19cm/sec. FR: 20Hz-20kHz. Separation at 1kHz: 25dB. Output: 5mV. Rec load: 47K per channel. Price: £17.49 (including VAT).

**M75G Type 2**

Stereo Dynetic cartridge. Moving magnet.  $\frac{1}{2}$  in fixing centres. Stylus: 0.6 thou conical diamond (3 thou stylus available). Pw:  $\frac{3}{4}$ -1.1 gm. Trackability (see note at end) at 1gm in SME 3009 arm: 400Hz 20cm/sec, 1kHz 28cm/sec, 10kHz 18cm/sec. FR: 20Hz-20kHz. Separation: > 25dB at 1 kHz. Output: 1mV. Rec load: 47K per channel. Price: £13.53 (including VAT).

**M75EJ Type 2**

Stereo Dynetic cartridge. Stylus:  $0.7 \times 0.4$  thou bi-radial diamond. Pw:  $1\frac{1}{2}$ -3gm. Trackability at 2gm in SME 3009 arm: 400Hz 28cm/sec, 1kHz 35cm/sec, 10kHz 20cm/sec. Price: £14.19 (including VAT).

**V15-Type III ★**

Stereo Dynetic cartridge. Moving magnet.  $\frac{1}{2}$ in fixing centres. Stylus:  $0.7 \times 0.2$  thou bi-radial diamond (0.6 thou and 2.5 thou spherical tips also available). Pw:  $\frac{3}{4}$ - $1\frac{1}{4}$ gm. Trackability (see note at end) at 1gm in SME 3009 arm: 400Hz 26cm/sec, 1kHz 38cm/sec, 5kHz 35cm/sec, 10kHz 26cm/sec. FR: 10Hz-25kHz. Separation: 25dB at 1kHz, 20dB at 10kHz. Output: 3.5mV at 1kHz (5cm/sec peak recorded velocity). Rec load: 47K. Price: £39.60 (including VAT).

**NOTE**

Trackability is a term introduced by Shure to give a measure of the total performance of a cartridge. It takes into account the mechanical design parameters of tip mass, inertia, compliances throughout the system, tracking pressure, recorded velocity, etc. Explanatory leaflet available on request.

**Model 3009/S2 (Series II improved)**

Precision pickup arm. Detachable head shell. Effective mass 9.5gm. All other details as for the 3009 above. Price: £34.50 (plus VAT).

**Accessories**

S2 shell for use with Model 3009/S2 Series II Improved and Series II arm. Price: £2.52 (plus VAT).

**■ SME**

SME Ltd,  
Steyning, Sussex, BN4 6GY.  
Tel: Steyning 0903 814321.

**Model 3009**

Series II Improved precision pickup arm. Non-

detachable shell. Pivot to stylus 9in nominal. Effective mass 5.5gm. Low-friction pivots. Vertical axis; high precision fully protected ball races. Horizontal axis, knife edges. Less than .020gm applied at the stylus will deflect the arm in either plane. Low inertia, fixed elements of the balance system are light, moveable elements are heavy and close to the fulcrum. Low distortion geometry. Bias adjustable to correspond with tracking force. Base slides on bedplate for tracking adjustment with protractor. Arm mass divided by elastic coupling. Tracking force 0.1-5gm applied precisely without the use of a gauge. Lever operated hydraulically damped lowering and raising control. Shell accepts all cartridges with  $\frac{1}{2}$ in (12.7mm) fixing centres and weighing 4-9gm. 4ft (1.22m) audio lead, low capacity for magnetic cartridges. SME phono plugs are standard, DIN 5-pole supplied on request. Camera finish in satin chrome, gun black, anodised alloy and polished stainless steel. Complete with mounting template, alignment protractor, shell hardware, fixing screws and fully illustrated instruction book. Recommended price: £34.65.

**Model 3009/S2 ★**

Series II Improved precision pickup arm. Detachable shell. Effective mass 9.5gm. Other details as above. Recommended price: £37.95.

**Accessories**

S2 Shell for use with Model 3009/S2 and earlier Series II arms. Price: £2.76.

P1 Spacer. Required where height difference between motor board and turntable is greater than  $1\frac{1}{8}$ in. Price: £1.50.

**Pickup Mounting Boards:**

TD124/3009 for Model 3009 on Thorens TD124. Price: £3.18.

TD150/3009 for Model 3009 on Thorens TD150. Price: £3.18.



SME3009 (Series II Improved)

★ Indicates entry is illustrated

TD125/3009 for Model 3009 on Thorens TD125.

Price: £3-18.

TD160/3009 mounting kit Model 3009 Series II Improved on Thorens TD160. Price: £3-60.

Mounting Brackets:

Can be used for fitting Thorens TD125 to motor board. Price: £1-38.

Spring mounts complete with foam damping blocks. (Set of 4). Price: £4-41.

**United Kingdom only**

All prices subject to VAT at the current rate.

## ■ SONOTONE

Vernitron Ltd, Thornhill, Southampton, Hants, SO9 5QF.

Tel: Southampton (0703) 444811. Telex: 47138.

### 2T

Monaural ceramic cartridge with turnover stylus. Stylus sapphire 2.5 thou (78), 0.7 thou (LP). Pw: 8-10gm. Compliance:  $1 \times 10^{-6}$ cm/dyne. Output: 180mV/cm/sec at 1kHz. Capacitance: 650pF. Serviceable under all climatic conditions and compatible for 33 $\frac{1}{3}$ , 45 and 78rpm records. Price: £1-37 (including VAT).

### 8T4A

Stereo ceramic cartridge with turnover stylus. Sapphire, 2.5 thou (78), 0.7 thou (LP). Pw: 4-6 gm. Compliance:  $1.4 \times 10^{-6}$ cm/dyne. Separation: 24dB at 1kHz. Output: 90mV/cm/sec at 1kHz. Capacitance: 650pF. Price: £1-92 (including VAT).

### 9TA

Stereo turnover ceramic cartridge. Sapphire stylus. Pw: 2-4gm. Tip mass: 3-5mg. Compliance:  $5.3 \times 10^{-6}$ cm/dyne. FR: 30Hz-15kHz  $\pm$  3dB. Separation: 27dB. Output voltage: 80-120mV. Load imp: 2M. Price: £2-75 (including VAT).

### 9TA-G

As 9TA but for single-hole slim fitting head shells.

### 9TAD

Similar specification to 9TA but with diamond stylus. Price: £3-57 (including VAT).

### 9TAHC

Stereo turnover ceramic cartridge. Choice of both sapphire styli or sapphire 78/diamond stereo LP. FR: 20Hz-20kHz  $\pm$  3dB from 1kHz. Rec load: 2M. Sensitivity: 55-85mV/cm/sec at 1kHz. Lateral compliance:  $8.5 \times 10^{-6}$ cm/dyne. Separation: 25dB at 1kHz. Pw: 1-3gm. Tip mass: 2-5mg. Capacitance: 800pF. Price: (with sapphire stylus) £2-75 (including VAT); (with diamond stylus) £3-57 (including VAT).

### 9TAHC-G

As 9TAHC but for single-hole slim fitting head shells.

### 2109

Mono Rochelle cartridge. Output at 1kHz 700 mV/cm/sec. Capacitance: 1000pF. Compliance:  $1.5 \times 10^{-6}$ cm/dyne. Tracking: +12dB at 6gm. FR: 100Hz-8kHz  $\pm$  3dB. Rec stylus force: 6-8 gm. Price: £1-52 (including VAT).

### 2509

Stereo Rochelle cartridge. Output at 1kHz: 340mV. Capacitance: 1000pF. Channel difference less than 3dB. Separation at 1kHz better than 12dB. Pw: 7gm. FR: 50Hz-8kHz  $\pm$  3dB. Price: £2-15 (including VAT).

### 2539

Stereo Rochelle cartridge. Output at 1kHz 550 mV/cm/sec. Capacitance: 1000pF. Channel difference less than 3dB. Separation at 1kHz better than 12dB. Tracking: +12dB at 9gm. FR: 100Hz-8kHz. Rec stylus force 8-10gm. Price: £2-15 (including VAT).

### 3509

Stereo ceramic cartridge. Output at 1kHz: 140 mV/cm/sec. Channel difference less than 3dB. Separation at 1kHz: better than 15dB, typically 20dB. Capacitance: 600pF. Tracking: +12dB, typically +15 at 5gm. FR: 100Hz-10kHz  $\pm$  3dB. Rec stylus force: 5-7gm. Price: (with sapphire stylus) £2-75 (including VAT); (with diamond stylus) £3-13 (including VAT).

### 3559

Ceramic stereo cartridge with stylus. Pw: 2 $\frac{1}{2}$ -4gm. FR: 20Hz-12kHz. Separation: better than 15dB at 1kHz. Output: 70mV/cm/sec nominal. Rec load: 2M and 100pF. Price: (sapphire stylus) £2-75 (including VAT); (with diamond stylus) £3-13 (including VAT).

### 3549

Ceramic stereo cartridge with stylus. Pw: 3-5gm. FR: 30Hz-10kHz. Separation: better than 15dB at 1kHz. Output: 100mV/cm/sec nominal. Rec load: 2M and 100pF. Price: (sapphire stylus) £2-75 (including VAT); (with diamond stylus) £3-13 (including VAT).

### V100

Stereo magnetic cartridge.  $\frac{1}{2}$ in fixing centres. Diamond styli with 0.6 thou spherical tip. Pw: 2-2 $\frac{1}{2}$ gm. Tracking: +18dB at 2 $\frac{1}{2}$ gm (CBS STR111-band 4B). FR: 20Hz-20kHz. Separation: better than 20dB at 1kHz. Output: 1.4mV at 1cm/sec at 1kHz. Rec load: 200mH per channel. Price: £8 (including VAT).

### V200S

Stereo magnetic cartridge.  $\frac{1}{2}$ in fixing centres. Diamond stylus with 0.6 thou spherical tip. Pw: 2-2.8gm. Tracking: +18dB at 2.4gm (CBS STR111-band 4B). FR: 15Hz-25kHz. Separation: better than 20dB at 1kHz. Output: 1mV at 1cm/sec at 1kHz. Rec load: 360mH per channel. Price: £10 (including VAT).

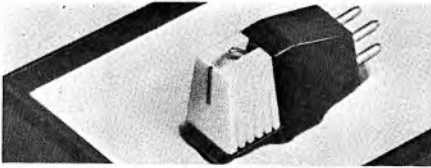

TTC - J2203 cartridge

#### V200E

Stereo magnetic cartridge.  $\frac{1}{2}$ in fixing centres. Diamond stylus with  $0.8 \times 0.3$  tip. Pw: 2-2.5gm. Tracking: +18dB at 2.4gm (CBS STR111-band 4B). FR: 10Hz-30kHz. Separation: better than 20dB at 1kHz. Output: 1mV at 1cm/sec at 1kHz. Rec load: 360mH per channel. Price: £15 (including VAT).

#### V200EX

Stereo magnetic cartridge.  $\frac{1}{2}$ in fixing centres. Diamond stylus with  $0.8 \times 0.2$  tip. Pw: 2-2.5gm. Tracking: +18dB at 2.2gm (CBS STR111-band 4B). FR: 10Hz-35kHz. Separation: better than 20dB at 1kHz. Output: 0.6mV at 1cm/sec at 1kHz. Rec load: 360mH per channel. Price: £20 (including VAT).

#### TRANSCRIPTORS LTD

Sole UK Agents: J. H. Nelson Audio, Mycott House, Station Road, Boreham Wood, Herts. Tel: 01-953 9851.

#### Vestigial arm

Low mass arm, moving horizontal mass 37.5gm; vertical 25gm. Effective mass with cartridge: 6gm horizontal, 0.5gm vertical. Vertical tracking pressures recommended down to 0.1gm. Will accept conventional magnetic or induced magnetic cartridges with compliances up to  $40 \times 10^{-6}$  cm/dyne or better. Price (approx.): £30 (including VAT).

#### TTC

TTC Precision Centre, Heather Park Drive, Wembley, Middlesex, HA0 1SU. Tel: 01-903 0144.

#### J2203 ★

Magnetic cartridge. Stylus: 0.7 thou diamond. Pw: 2gm. Compliance:  $9 \times 10^{-6}$ cm/dyne. FR: 30Hz-18kHz. Separation: 28dB at 1kHz. Output: 6mV per channel. Rec load: 47K. Price: £4.95 (including VAT).

#### J2203E

Moving magnet stereo cartridge. Stylus:  $0.8 \times 0.3$  thou diamond. All other details as per J2203 above. Price: £8.50 (including VAT); (replacement stylus) £6.27 (including VAT).

#### J3000E

Moving magnet stereo cartridge. Stylus:  $0.8 \times 0.3$  thou diamond. Pw:  $1\frac{1}{2}$ -2 $\frac{1}{2}$ gm. Compliance:  $12 \times 10^{-6}$ cm/dyne. FR: 20Hz-20kHz. Separation:

tion: 20dB. Balance: within  $\pm 1$ dB. Rec load: 2M. Output: 5mV. Supplied in presentation case with spare stylus. Price: (including spare elliptical diamond stylus) £14.30 (including VAT).

#### J1111

Complete pickup arm with moving magnet stereo cartridge. Stylus: 0.7 thou diamond. Pw:  $1\frac{1}{2}$ -2 $\frac{1}{2}$ gm. Compliance:  $12 \times 10^{-6}$ cm/dyne. FR: 20Hz-20kHz. Separation: 20dB. Balance: within  $\pm 1$ dB. Overall length:  $11\frac{1}{4}$ in. Effective length:  $8\frac{3}{4}$ in. Output: 5mV. Precision turned stainless steel arm. Weight/bias adjustment. Tracking error: 5°. Self-lubricating ball bearings. Supplied with J2203 cartridge but will accept most other makes. Price: £10.56 (including VAT).

#### PU402

Complete pickup arm with moving magnet stereo cartridge. Stylus: 0.7 thou diamond. Pw:  $1\frac{1}{2}$ -2 $\frac{1}{2}$ gm. Compliance:  $12 \times 10^{-6}$ cm/dyne. FR: 20Hz-20kHz. Separation: 20dB. Balance: within  $\pm 1$ dB. Output: 5mV. Overall length:  $12\frac{3}{4}$ in. Effective length:  $8\frac{3}{4}$ in. Chrome finished transcription arm. Bias compensation. Weight adjustable 0.25-14gm. Adjustable mounting pillar. Tracking error: +4 to -1°. Fitted with J2203 cartridge but will accept most other makes. Price: £18 (including VAT).

**THE BEST SPEAKERS  
IN THE HOUSE**

**WHEN OUR SPEAKERS TAKE THE  
FLOOR ... EVERYONE LISTENS!**

**MDC AUDIO APPROACH**

**10 GALS WORTHY CLOSE, GORING  
SUSSEX BN12 6LP Tel: 0903 40997**



# What makes Tottenham Court Road a hi-fi paradise?



## Lindair House

Lindair House. Where the sounds of the world all come together. The widest range of top quality hi-fi, radio and T.V. from the world's top makers, together under one roof. 2000 square feet of the most professional demo studios in London, where you can listen to hundreds of different systems and find one to suit your ear as well as your pocket. A whole store of tapes, cartridges, headphones, and in-car equipment plus expert advice, friendly service and competitive prices, all at Lindair.

Every item is backed by the Lindair guarantee. And we offer the usual payment facilities, including H.P. So pop into Lindair House and grab an earful of the best sounds around.



227 Tottenham Court Road, London W1 01-580 7383  
*open until 1pm Thursday and all day Saturday*

also branches at:-

241-242 Tottenham Court Road, London W1 01-580 2255  
137 Charing Cross Road, London WC2 01-437 8718  
94-96 Upper Parliament Street, Nottingham 0602 40403

# Of all multi-band portable radios, only the Zenith Trans-Oceanic® is styled to look like what it is:

the most distinguished of all radios powered to tune the world. With the finest combination of power, tuning ease, and professional designed into such a lightweight, so compact portable.

Though imitations exist, none has equaled — or even come close to equaling — the world-famous Trans-Oceanic for styling, performance, and all-around dependability.

The Zenith Trans-Oceanic tunes bandspread on the most popular 31, 25, 19, 16 and 13 meter International Shortwave bands... also Medium, FM, and European Longwave... plus Marine-Weather, Ship-to-Ship and Ship-to-Shore... Time Signals, Amateur, CW, and SSB signals... and the new crystal tuned VHF weather band broadcasts. Works on either 115V or 230V AC...



with up to 300 hours of listening pleasure on "D" cell batteries available anywhere.

Also featured for the first time in this newest Trans-Oceanic: a solid-state chassis; Beat Frequency Oscillator (BFO) Control; RF Gain Control; "Norm-Sharp" IF Switch; Tuner Output Jack and a Tuning Meter.

No wonder the list of owners of this world-famous series of portable radios reads like an international "Who's Who".

Only 9-3/8"H; 13-3/4"W; 6-1/4"D. About 23 x 34 x 15 cm. Weighs less than 16 lbs. (7.2 kg), complete with 9 "D" cell batteries.



Trans-Oceanic Model Royal 7000-1

Write now for free, full-color literature.  
**UNITED MERCANTILE COMPANY, LTD.**  
 17 Lettice Street, London, S W.6. 4EH

**ZENITH**  
 The Quality Goes In  
 Before The Name Goes On®

Zenith Radio Corporation, International Division, Chicago, 60639, U.S.A. The Royalty of television, stereophonic high fidelity instruments, phonographs, and radios.

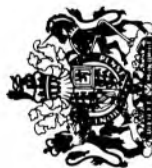

TO HER MAJESTY QUEEN ELIZABETH II  
BY APPOINTMENT  
TELEVISION AND RADIO BROADCASTERS  
DYNATRON RADIO LTD. MAIDENHEAD BERKS.

# DYNATRON

Sounds & Looks Beautiful

Dynatron Radio Limited  
St Peter's Road Maidenhead,  
Berkshire SL6 7QY England  
Telephone (0628) 23331

# Radio Tuners

★ Indicates entry is illustrated

Abbreviations used in this section are given on page 20.

## ■ ACOUSTICAL MANUFACTURING

See Quad.

## ■ AKAI

Rank Audio Visual Ltd, PO Box 70, Great West Road, Brentford, Middlesex, TW8 9HR. Tel: 01-568 9222. Telex: 24408.

### AT550 ★

AM/FM stereo tuner. Range: FM 88-108MHz, MW 187-560m. Variable tuning. Meter signal strength indicator. Centre-zero FM tuning meter. Sensitivity: FM 1.8µV, MW 150µV/m. Stereo decoder fitted. Aerial input: 300 ohms balanced twin, 75 ohms coaxial. Output: 500mV fixed, 0-1.8V variable. Mains: 100-240V 50-60 Hz. Size:  $17\frac{1}{8} \times 5\frac{5}{8} \times 12\frac{3}{8}$ in. Weight: 16 $\frac{3}{4}$ lb. Price: £104.90 (including VAT).

### AT580

AM/FM stereo tuner. Range: FM 88-108MHz, MW 187-560m. Variable tuning. Meter signal strength indicator. Centre-zero FM tuning meter. Sensitivity: FM 1.6µV, MW 150µV/m. Stereo decoder fitted. Aerial input: 300 ohms balanced twin, 75 ohms coaxial. Output: 500mV fixed, 0-1.8V variable. Mains: 100-240V 50/60Hz. Size:  $17\frac{1}{8} \times 5\frac{5}{8} \times 12\frac{3}{8}$ in. Weight: 17 $\frac{1}{4}$ lb. Price: £146.90 (including VAT).

## ■ ALBA

Alba (Radio & Television) Ltd, Bull Lane, Edmonton, London, N18 1RA. Tel: 01-803 4451.

### UA800D ★

Stereo AM/FM tuner designed to match the Alba UA700 amplifier and UA300 speaker system. Range: FM87-104MHz, MW183-560m, LW 1070-1850m. Variable tuning. Sensitivity: (FM) 2µV to IHF rating, 4µV for full limiting. (MW) 250µV/metre for 100mV output at 30% modulation, (LW) 500µV/metre for 100mV at 30% modulation. 16 transistors, 12 diodes. Decoder fitted. Stereo beacon. Novel tuning indicator. Quiet tuning facility. Push-buttons for waveband selection, decoder, AFC, quiet tuning, mains on-off. DIN output socket. Mains: 240V 40-60Hz. Finish: teak. Size:  $16\frac{1}{2} \times 4 \times 7\frac{3}{8}$ in. Price: £46.74 (including VAT).

## ■ ALPHA

Highgate Acoustics, 38 Jamestown Road, London, NW1 7EJ. Tel: 01-267 4937.

### FT150

AM/FM stereo tuner. Range: FM 88-108MHz, MW 176-600m. Variable tuning. AFC. Balanced ratio detector. Meter tuning indicator. Usable sensitivity: AM 25µV, FM 2.5µV. Aerial input: 300 ohms balanced. Stereo decoder fitted. Output: 1V. Adjustable AM aerial. Finish: teak with brushed aluminium. Mains: 110, 240V AC. Size:  $14\frac{1}{2} \times 5 \times 13\frac{1}{2}$ in. Price: £49.50 (including VAT).

### Executive 0007

FM stereo tuner. Five preset stations. Phase lock loop stereo decoder. Quiet tuning facility. Auto stereo/mono switching. AFC. Ceramic IF filters. Usable sensitivity: 1.8µV. FR: 20Hz-15kHz ±1dB. Hum and noise: -60dB. Capture ratio: 3:5dB. Aerial inputs: 75 ohms coaxial and 300 ohms balanced twin. Output: (1) 50mV 10K, (2) 500mV 10K. Size:  $16\frac{1}{2} \times 6 \times 3\frac{1}{2}$ in. Finish: teak veneer. Mains: 110 or 240V 50-60Hz. Price: £54.45 (including VAT).

## ■ AMSTRAD

AMS Trading (Amstrad) Ltd, 89 Ridley Road, London, E8. Tel: 01-249 5237.

### Multiplex 3000 ★

Stereo FM tuner. Range FM/VHF. Variable tuning. AFC. Ratio detector. Neon tuning indicator. Usable sensitivity: 5µV. Aerial input:



Akai AT550



Alba UA800D

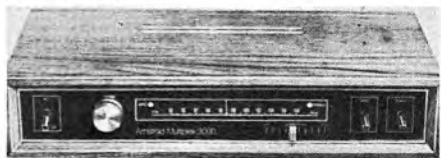

Amstrad Multiplex 3000

★ Indicates entry is illustrated

70 ohms coaxial. Output: 500mV nominal. Stereo decoder included. Mains: 220-240V AC. Size: 17×3×7½in. Finish: teak cabinet with black facia and silver trim. Preset gain control incorporated. Price: £42 (including VAT).

### ■ ARMSTRONG

Armstrong Audio Ltd, Warlters Road, Holloway, London, N7 0RZ.  
Tel: 01-607 3213.

#### Model 623 ★

AM/FM stereo tuner. Range: FM87.5-108MHz, MW/LW continuous 185-2070m. Variable tuning plus three preset FM stations and three preset AM stations. AFC. Foster Seeley discriminator. Phase-locked loop decoder. Centre-zero tuning meter and field strength. Usable sensitivity: FM 1µV, AM 25µV. Aerial input: 75-80 ohms coaxial, 240-300 ohms twin balanced. Output: (high) 0dB (0-775V) 600 ohms, (low) 100mV 68K for 30% mod. Stereo decoder fitted. Mains: 105-135V, 215-250V AC. Size: 12½×3¼×11¼in. Finish: zinc diecast front panel enamelled black, wood case in teak or rosewood. Built-in ferrite rod aerial on AM. Outlet socket for AC mains. Price: £85.58 (including VAT).

#### Model 624

FM stereo tuner. Range: 87.5-108MHz. Variable tuning plus six preset stations. AFC. Foster Seeley discriminator. Phase locked loop decoder. Centre-zero tuning meter and field strength. Usable sensitivity: 1µV. Aerial input: 75-80 ohms coaxial, 240-300 ohms balanced twin. Output: (high) 0dB (0-775V) 600 ohms, (low) 100mV 68K for 30% mod. Stereo decoder fitted. Mains: 105-135V, 215-250V AC. Size: 12½×3¼×11¼in. Finish: zinc diecast front panel enamelled black, wood case in teak or rosewood. Outlet socket for AC mains. Price: £64.13 (including VAT).

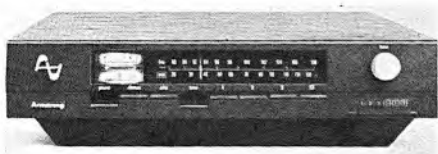

Armstrong Model 623

### ■ BANG & OLUFSEN

Bang & Olufsen UK Ltd, Eastbrook Road, Gloucester, GL4 7DF.  
Tel: Gloucester (0452) 21591.

#### Beomaster 1700 ★

FM stereo tuner. Range: 87.5-104MHz. Variable tuning plus 3 preset stations. 'Balanced light' tuning indicator. Sensitivity <2.0µV. AFC. Aerial input: 75 ohms coaxial and 300 ohms balanced. Output: 0-1V variable and 90mV approx. Decoder fitted. Size: 19.7×9.1×2.9in. Finish: teak or rosewood. Price: (teak) £65.90 (including VAT); (rosewood) £66.90 (including VAT).

### ■ CAMBRIDGE AUDIO

Cambridge Audio Ltd, The River Mill, St Ives, Huntingdon, Hunts, PE17 4EP.  
Tel: St Ives (0480) 62901.

#### T55 ★

Stereo FM tuner incorporating advanced techniques. Range: 88-108MHz. Variable tuning. Switchable AFC. Quadrature detector. Sensitivity: 1.8µV for 30dB quieting. Aerial input: 75 ohms coaxial or 300 ohms balanced. Tuning indicator: two lamps. Output: up to 1V adjustable at 5K. Phase locked loop decoder. Stereo beacon. MOS input stage with capacity diode tuning. Ceramic filters in IF stages. IC amplifier in IF strip. Image rejection: 70dB. IF rejection: 84dB. Capture ratio: 0.5dB. Signal-to-noise ratio: (mono) 70dB. FR: 20Hz-15kHz±1dB. HD: (mono) 0.1%, (stereo) 0.5%. Pilot tone suppression: 60dB. Stereo separation: 34dB at 1kHz. De-emphasis: 50 microsecs or 75 microsecs. Controls: tuning, AFC on-off, stereo defeat, interchannel muting, mains on-off, audio output level (preset at rear). Mains indicator light. Finish: black or silver to match with

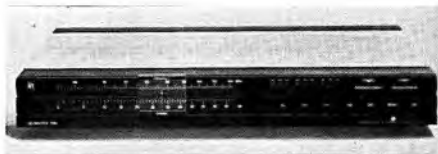

Bang & Olufsen Beomaster 1700

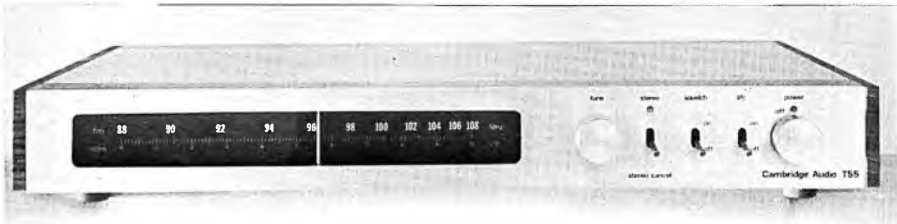

Cambridge Audio T55

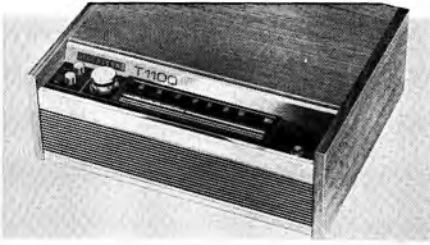

Decca T1100

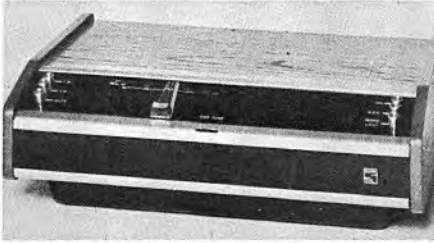

Decca T1501 Tuner

Cambridge 'P' Series amplifiers. Price: £95 (plus VAT).

■ **DECCA**

Decca Radio & Television, Neachells Lane, Willenhall, Wolverhampton, Staffs. Tel: 0902 67367.

**T1100 ★**

FM tuner. Range: 87.5-102MHz. Variable tuning. AFC (switchable). Stereo decoder optional extra. Size:  $12 \times 9\frac{1}{2} \times 4\frac{3}{4}$  in. Finish: teak with silver coloured trim. Price: £26.08 (including VAT).

**T1501 ★**

AM/FM stereo tuner. Range: FM 87.5-107.5 MHz, MW 185-588m. Variable tuning. AFC. Stereo decoder fitted. Size:  $15\frac{3}{4} \times 10\frac{3}{8} \times 5$  in. Finish: teak. Price: to be announced.

**T2000**

AM/FM tuner. Range: FM 87.5-102MHz, MW 185-577m, LW 1200-2000m, SW 16.7-50.4m. Variable tuning. AFC. Stereo decoder optional extra. Size:  $24\frac{1}{8} \times 9\frac{1}{2} \times 4\frac{3}{4}$  in. Finish: teak and silver coloured trim. Price: £54.60 (including VAT).

■ **DUAL**

Audiodecks Ltd, Farnell House, 81 Kirkstall Road, Leeds, LS3 1HR. Tel: Leeds (0532) 35111.

**CT18 ★**

AM/FM stereo tuner. Range: 87-108MHz, MW 182-600m, LW 857-2000m, SW1 19-44m, SW2



Dual CT18



Eagle TST152



Eagle AA8

49m band. Variable tuning plus five presets on FM. AFC. Ratio detector. Meter tuning indicator. Usable sensitivity: SW  $10\mu\text{V}$ , MW  $20\mu\text{V}$ , LW  $50\mu\text{V}$ , FM (mono)  $1\mu\text{V}$ , FM (stereo)  $7\mu\text{V}$ . Aerial input: 240 ohms coaxial, high Z AM socket. Output: 800mV. Stereo decoder fitted. Mains: 110-125V, 220-240V 50-60Hz. Size:  $16\frac{1}{2} \times 11\frac{1}{4} \times 4\frac{1}{4}$  in. Finish: white or walnut. Price: (walnut) £121.74 (including VAT); (white) £124.33 (including VAT).

■ **EAGLE**

Eagle International, Heather Park Drive, Wembley, Middx, HA0 1SU. Tel: 01-903 0144.

**TST152 ★**

AM/FM stereo tuner matching the Eagle TSA-149 and TSA151 integrated amplifiers. Range: FM 87-109MHz, MW 182-560 metres. Variable tuning. AFC. Inter-station muting. Sensitivity: FM  $2\mu\text{V}$  for 20dB quieting. AM  $150\mu\text{V}$ . Stereo separation: 28dB at 1kHz. Aerial input: 75 ohms coaxial. Output: 0-1V adjustable. Size:  $13 \times 3\frac{3}{8} \times 8\frac{3}{4}$  in. Wood shelf-mounting cabinet. Price: £48.40 (including VAT).

**AA8 ★**

Stereo AM/FM tuner. Range: FM 88-108MHz, MW 187-560 metres. Variable tuning. Switchable AFC. Meter tuning indicator. Usable sensitivity: AM  $150\mu\text{V}$ , FM  $3\mu\text{V}$ . Aerial input: 75 ohms coaxial, 300 ohms balanced. Output: 0-1V adjustable. Stereo decoder included. Mains: 240V AC. Size:  $13 \times 10\frac{1}{2} \times 3\frac{3}{8}$  in. Finish: teak cabinet with metal fascia. Inter-station muting switch. Price: £68.20 (including VAT).

★ Indicates entry is illustrated

#### ■ ERA

De Banks Electronics Ltd, Market House,  
High Street, Tring, Herts.  
Tel: Tring (044282) 2777.

#### Model TS2

FM/LW/MW stereo tuner. Bands: 87-104MHz FM, 150-275kHz LW, 550-1600kHz MW. Manual tuning plus three FM pre-sets. Switchable AFC and signal strength meter. Aerial: 75 or 300 ohms. Variable output voltage. Mains: 110, 127, 220V AC 50Hz. Size:  $15\frac{1}{4} \times 8 \times 4$  in. Brushed aluminium and matt black finish. Price: £170.50 (including VAT).

#### ■ FAL

Futuristic Aids Ltd, 104 Henconner Lane,  
Leeds, LS13 4LQ. Tel: Pudsey 5478.

#### FAL ICFM ★

FM stereo tuner. Range: FM 87.5-104.5MHz. Variable tuning plus four preset pushbuttons. Electronic varicap tuning. FET front end. Ceramic filters in IF stages. Switchable AFC. Usable sensitivity:  $7\mu\text{V}$ . Audio output:  $>600$  mV. Aerial input: 75 ohms coaxial or 300 ohms balanced. Separation: 45dB at 1kHz. AM rejection: 53dB. Distortion: 0.35%. Balance: 0.5dB at 100mV. Size:  $14\frac{3}{4} \times 10 \times 4\frac{1}{2}$  in. Weight: 10lb. Stabilised power supply. Tuning meter. Auto stereo beacon. Decoder fitted. Price: £46.75 (including VAT).

#### ■ FERROGRAPH

The Ferrograph Company Ltd,  
Auriema House, 442 Bath Road,  
Cippenham, Slough, Bucks. SL1 6BB.  
Tel: Burnham (062 86) 62511.

#### SFM 1

VHF stereo tuner. Range: 87.5-108MHz, variable. AFC: switched. Tuning and signal strength meters. Sensitivity:  $1.5\mu\text{V}$  (IHF). Aerial: 300 and 75 ohm. VHF S/N: 60dB at 1mV input. Distortion: 1.0%. Output: 200mV for 25kHz deviation into 300 ohms. Mains: 100-120V, 200-240V AC. Size:  $18 \times 9 \times 4\frac{1}{2}$  in. Finish: teak, walnut or white cabinet with brushed aluminium fascia. Continuously adjustable mute threshold and adjustable stereo separation control from 40dB (1kHz) to zero (mono). Price: £104.40 (including VAT).

#### ■ HANIMEX

Hanimex (UK) Ltd, Hanimex House,  
Dorcan, Swindon, Wilts, SN3 5HW.  
Tel: Swindon (0793) 26211.

New range of hi-fi stereo tuners to be introduced under Hanimex brand name. No details of models available as this edition of the Year Book closed for press.

#### ■ HEATHKIT

See Constructional Kits Section.



Fal ICFM Tuner

#### ■ HITACHI

Hitachi Sales (UK) Ltd, New Century House,  
Coronation Road, Park Royal, London,  
NW10 7QN. Tel: 01-965 9861.

#### FT600

AM/FM stereo tuner. Range: FM 88-108MHz, 187-572m. Usable sensitivity: FM  $1.8\mu\text{V}$ , MW  $15\mu\text{V}$ . Tuning light indicator. Capture ratio: 1.5dB. Output: 1.5V (fixed) and 0-1.5V adjustable. Quiet tuning facility. Noise filter. Stereo decoder with auto switching and beacon. 28 transistors, 21 diodes, three ICs, one FET. Variable tuning and pushbutton selectors. Size:  $16\frac{1}{4} \times 4\frac{3}{8} \times 12\frac{3}{8}$  in. Weight:  $16\frac{1}{4}$  lb. Price: £99 (including VAT).

#### ■ HOWLAND-WEST

Howland-West Ltd, 3-5 Eden Grove,  
London, N7 8EQ. Tel: 01-609 0293.

#### DA1000T

AM/FM stereo tuner. Range: FM 88-108MHz, MW 182-556m. Variable tuning. AFC (switchable). Output: 1V. Stereo decoder fitted. Mains: 240V AC. Size:  $14\frac{3}{4} \times 4\frac{1}{4} \times 7\frac{7}{8}$  in. Finish: wood cabinet with metal control panel and trim. No further details of specification available at time of going to press. Price: £33.55 (including VAT).

#### ■ JVC (UK) LTD

453 Caledonian Road, London, N7 9BA.  
Tel: 01-607 6568.

#### VT-500

AM/FM stereo tuner. Range FM and MW. Quiet tuning facility. Stereo decoder fitted. Variable tuning. Signal strength tuning meter. Provision for connecting quadraphonic decoder. Aerial inputs for 300 ohm balanced twin and 75 ohms coaxial. Size:  $15 \times 5\frac{3}{8} \times 12$  in. Weight:  $15\frac{1}{2}$  lb. Price: £85.80 (including VAT).

#### VT-700

AM/FM stereo tuner. Range: FM and MW. Variable tuning. Stereo decoder fitted. Provision for quadraphonic decoder. FET front end. Capture ratio: 0.8dB. Signal strength meter and centre-zero tuning meter. Quiet tuning facility. Aerial input: 300 ohm balanced twin or 75 ohm coaxial. Size:  $16\frac{5}{8} \times 5\frac{3}{8} \times 12\frac{1}{2}$  in. Weight:  $16\frac{1}{2}$  lb. Price: £132 (including VAT).

**MCT-105**

AM/FM stereo tuner. Variable tuning. Stereo decoder fitted. No further product information obtainable as this edition of the Year Book closed for press. Price: £109.45 (including VAT).

■ **KLINGER**

Klinger Controls Ltd, Spencer Court, 7 Chalcot Road, London, NW1 8LU. Tel: 01-586 2922.

**KC91 ★**

Stereo FM tuner. Range: 87.5-108MHz. Five preset stations. Switchable AFC. Ratio detector. Usable sensitivity: 2µV. Aerial input: balanced and coaxial. Output: 0-2V. Stereo decoder fitted. Mains: 100-120V, 200-240V AC. Ceramic filters in IF strip. IC. Complies with DIN 45 500 spec. Finish: teak with diecast enamelled sides. Size: 13 × 4½ × 8½in. Price: £49.11 (including VAT).

■ **KORTING**

Europa Electronics Ltd, 9 Howard Place, Shelton, Stoke-on-Trent, ST1 4NW. Tel: Stoke-on-Trent (0782) 29316.

**T510**

AM/FM stereo tuner. Range: VHF, MW, LW, SW. Nine transistors, six diodes, two ICs. IC stereo decoder with beacon. Internal ferrite rod for AM, input sockets (240 ohms) for FM aerial. Mains: 130, 230V AC. Pushbuttons for AFC, on-off, stereo, wavebands. Full specification and price on request.

**T710**

AM/FM stereo tuner. Range: VHF, MW, LW, SW. 18 transistors, 17 diodes, two ICs. 12 push-button controls. Stereo decoder. Ferrite rod for AM, sockets for FM aerial (240 ohms). Full specification and price on request.

■ **LEAK**

Rank Radio International Ltd, PO Box 596, Power Road, Chiswick, London, W4 5PW. Tel: 01-994 6491.

**Delta AM/FM ★**

AM Tuner Section: Range 182-587m. Sensitivity: 25 microvolts for 20dB signal/noise at 1MHz. FM Tuner section: Range: 87-108MHz. Sensitivity: 2.5 microvolts for 30dB signal/noise at 75kHz deviation. AM suppression 50dB. Distortion: less than 0.5% for 75kHz deviation. Dimensions of both tuners: 12¼ × 4¼ × 9½in. Price: £83.79 (including VAT).

**Delta FM**

Specifications as for FM section of Delta AM/FM. Price: £74.43 (including VAT).

**Model 2300 ★**

FM/MW/LW stereo tuner. Bands: 87.5-108 MHz FM, 150-350kHz LW, 510-1650kHz MW.



Klinger KC91

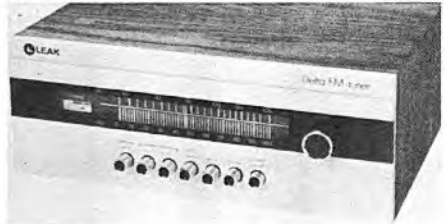

Leak Delta



Leak 2300 tuner



L & H Signalmaster Mk III 6t

Manual tuning, switched AFC, centre tuning meter. Sensitivity: 1.6µV IHF (FM), 20µV AM. Aerial: 75 and 300 ohms. S/N: > -65dB. Distortion: 0.5% at 1kHz. Output: 400mV 600 ohms for 30% modulation. Mains: 240V 50-60 Hz AC. Size: 5.2 × 16.3 × 12.2in. Weight: 13.2lb. Teak finish. Variable mute level, quasi stereo control. Price: £108 (including VAT).

■ **L & H**

Distributors: Britimpex Ltd, 8-12 Rickett Street, London, SW6. Tel: 01-385 0883. Telex: 22758 Brytron, London.

**Signalmaster Mk III 6087 ★**

Self-contained battery-operated FM/VHF tuner. Will also operate from 32V from L & H Audiomaster amplifier. Plug-in V aerial. Socket for 70 ohms external aerial. Pushbutton on/off and AFC. Illuminated tuning scale. Transistors. Range: 86-104MHz. PP9 or equivalent battery. Consumption: 9mA. Teak case. Size: 11¼ × 3½ × 7¾in. Price: £31.45.



★ Indicates entry is illustrated

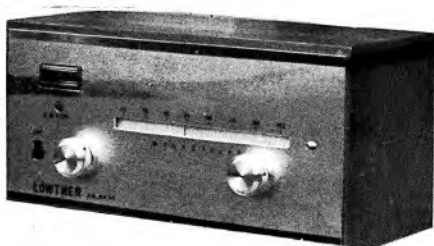

Lowther FM Tuner Mk VII



Lux WL717

#### Stereo decoder module

Plug-in type suitable for Signalmaster Mk III. Fits inside case. Channel separation better than 32dB at 1kHz. Consumption: 3mA. Automatic stereo beacon. Price: £7.87. Connecting lead with 5-pin plug. Price: 75p.

#### ■ LOWTHER

Lowther Acoustics Ltd, Lowther House, St Mark's Road, Bromley, Kent, BR2 9HQ. Tel: 01-460 5225. Cables: Lowther, Bromley.

#### FM Tuner Mk VII ★

Self-powered transistorised VHF/FM tuner. Range: 87.5-108MHz. Variable tuning with switchable AFC. Stereo decoder fitted. Aerial input: 72 ohms coaxial. Output: 0.75V RMS. Stereo beacon. Tuning meter. Finish: teak or walnut with satin chrome panel. Size:  $10\frac{3}{8} \times 5\frac{1}{8} \times 5\frac{1}{8}$  in. 200-240V 50Hz. Price: £40 (plus VAT).

#### TV Sound Tuner

Self-powered TV tuner. Range: UHF bands IV and V. Pushbutton tuning, adjustable to all channels. Output: preset gain control 0-500mV RMS. Output socket for tape recorder. Aerial input: 72 ohms coaxial. Size:  $10\frac{3}{8} \times 5\frac{1}{8} \times 5\frac{1}{8}$  in. Finish: teak or walnut with satin chrome panel. 200-240V 50Hz. Price: £38 (plus VAT).

#### ■ LUSTRAPHONE

Lustraphone Hi-Fi Ltd, Unit 2, Browells Lane, Feltham, Middlesex, TW13 7EL. Tel: 01-890 0887.

#### Lustraphone tuner

FM stereo tuner. Range: 87-108MHz. Variable tuning. Sensitivity: 1.5µV for 30dB quieting



Lux WL700

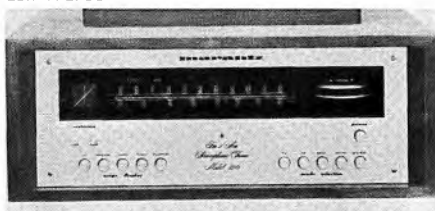

Marantz 120

(IHF rating). Distortion: (mono) 0.3%, (stereo) 0.5% for full deviation. Separation: better than 40dB at 1kHz. FR: 30Hz-15kHz. De-emphasis: 50µsec. Switchable 'birdie' filter. Stereo noise filter. Tuning indicator. Size:  $16\frac{1}{2} \times 13 \times 4\frac{1}{2}$  in. Mains: 110-250V 50-60Hz. Price: on application.

#### ■ LUX

Howland-West Ltd, 3-5 Eden Grove, London, N7 8EQ. Tel: 01-609 0293.

#### WL717 ★

AM/FM stereo tuner. Range: 88-108MHz, 187-572 metres. Variable tuning. Meter tuning indicator. Sensitivity: 3µV for 20dB quieting. Output: 700mV. Stereo decoder fitted. FET cascode amplifier in front end. Mains: 240V AC. Size:  $15\frac{3}{8} \times 5\frac{1}{8} \times 9\frac{1}{8}$  in. Price: £74 (plus £7.40 VAT).

#### WL212

AM/FM stereo tuner. Range: 88-108MHz, 187-572 metres. Variable and preset tuning. Meter tuning indicator. Sensitivity: 1.7µV for 20dB quieting. Aerial input: 75 ohm coaxial or 300 ohm balanced. Output: 1V. Stereo decoder fitted. Five preset stations on FM. Mains: 100, 117, 220, 240V AC. Size:  $18\frac{7}{8} \times 6\frac{1}{2} \times 11$  in. Price: £236 (plus £23.60 VAT).

#### WL500

AM/FM stereo tuner. Range: FM 88-108MHz, MW 187-572 metres. Variable tuning. Signal strength meter. Centre-zero tuning meter. Stereo decoder included. Auto stereo beacon. Usable sensitivity: FM 1.7µV, MW 45µV. Dual gate FET front end. Quiet tuning facility. Noise limiter switch. Mains: 240V AC. Size:  $17\frac{1}{2} \times$

$6\frac{3}{8} \times 10\frac{1}{2}$  in. Finish: rosewood. Price: £160 (plus £16 VAT).

**WL700 ★**

AM/FM stereo tuner. Range: FM 87.5-108MHz, MW 187-571m. Variable tuning. AFC. One signal strength meter, one centre-zero tuning meter. Usable sensitivity: MW  $40\mu\text{V}$ , FM  $2.2\mu\text{V}$ . Aerial input: 300 ohms balanced twin, 75 ohms coaxial. Output: (FM) 750mV, (AM) 400mV. Stereo decoder fitted. Mains: 120/240V AC. Size:  $15\frac{7}{8} \times 9\frac{3}{4} \times 5\frac{1}{8}$  in. Finish: wood cabinet with champagne coloured panel. Price: £110 (including VAT).

■ **MARANTZ**

Pysier Ltd. Fircroft Way, Edenbridge, Kent.  
Tel: Edenbridge (073 271) 4111.

**Model 20**

Stereo FM tuner. Range: 88-108MHz. Variable tuning with gyro control. Oscilloscope tuning indicator. Usable sensitivity: (IHF)  $1.8\mu\text{V}$  or better. Aerial input: 300 ohms balanced, 75 ohms unbalanced. Stereo decoder included, with automatic photoelectric switching. Steep quieting slope. Four limiter stages. Aerial attenuator switch. Parametric muting to eliminate AM burst modulation effects. Dual-gate FET RF amplifier. Individually calibrated tuning scale. Quiet tuning facility. Separation: 40dB at 20Hz, 30dB at 15kHz. FR: 20Hz-15kHz  $\pm 0.5\text{dB}$ . HD: (mono) 0.15%, (stereo) 0.15%. 19kHz and 38kHz rejection: better than 60dB. AM suppression: better than 40dB. H and N: better than -73dB below 100% modulation. Circuit comprises nine FETs, 31 transistors and 44 diodes. AC mains: Size:  $15\frac{3}{8} \times 5\frac{1}{4} \times 14\frac{1}{8}$  in. Weight: 24lb. Price: £489.50 (including VAT).

**Model 120 ★**

Stereo AM/FM tuner. Range: FM 88-108MHz, MW 187-555 metres. Variable tuning. Ratio detector. Oscilloscope tuning indicator. Usable sensitivity: AM  $20\mu\text{V}$ , FM  $1.4\mu\text{V}$  for 30dB quieting. Aerial input: 300 ohms balanced, 75 ohms coaxial. Stereo decoder included and ready for quadraphonic transmissions. Size:  $15\frac{3}{8} \times 5\frac{3}{4} \times 13$  in. Gold anodised front panel. Price: £242 (including VAT).

**Model 105**

AM/FM stereo tuner. Range: FM 88-108 MHz, MW 187-555m. Variable tuning with 'Gyro-touch'. AFC not necessary. Ratio detector. Meter tuning indicator. Usable sensitivity: FM  $2.8\mu\text{V}$ , MW  $25\mu\text{V}$ . Aerial input: 75 ohms coaxial, 300 ohms balanced twin. Stereo decoder fitted. Mains: 110, 220, 240V AC. Size:  $14\frac{1}{2} \times 4\frac{3}{4} \times 12$  in. Finish: walnut, teak, white (optional cabinet) or simulated walnut metal chassis. Price: £82.50 (including VAT).

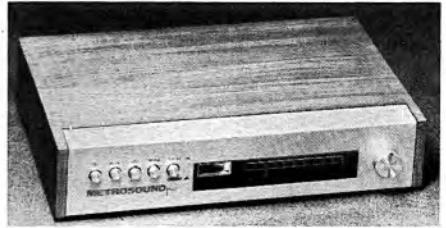

Metrosound FMS20 Mk II

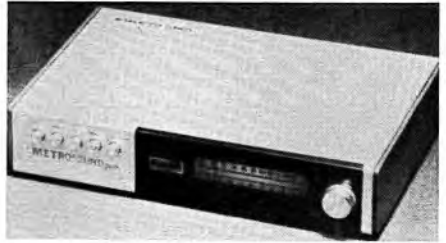

Metrosound FMS40

**Model 115**

AM/FM stereo tuner. Range: FM 88-108MHz, MW 187-555m. Variable tuning with 'Gyro-touch' AFC not necessary. Ratio detector. Signal strength meter. Centre-zero tuning meter. Usable sensitivity: FM  $1.7\mu\text{V}$ , MW  $20\mu\text{V}$ . Aerial input: 75 ohms coaxial, 300 ohms balanced twin. Stereo decoder fitted. Mains: 110, 220, 240V AC. Size:  $15\frac{3}{8} \times 5\frac{3}{4} \times 13$  in. Finish: walnut (cabinet optional), simulated walnut metal chassis. Output level control. Quiet tuning facility with threshold level control. Price: £126.50 (including VAT).

■ **METROSOUND**

Metrosound Audio Products Ltd, Cartersfield Road, Waltham Abbey, Essex, EN9 1JF.  
Tel: Waltham Cross (97) 31933.

**FMS20 Mk II ★**

Stereo FM tuner. Range: 87.5-108MHz. Variable tuning. Switchable AFC ( $\pm 200\text{kHz}$  pull in). Phase locked loop detector. Meter tuning indicator. Usable sensitivity:  $1.6\mu\text{V}$  for 30dB quieting at 90MHz. Aerial input: 75 ohm coaxial. Output: 0-200mV across 3.3K per channel. Stereo decoder fitted. Stereo beacon. Mains: 200-250V AC (100-120V AC to special order). Finish: teak cabinet with wrap-round aluminium fascia. Three-gang FET front end. Quiet tuning facility. Stereo signal sensitivity control. Size:  $15\frac{1}{4} \times 10 \times 3\frac{1}{2}$  in. Price: £61.05 (including VAT).

**FMS40 ★**

Stereo FM tuner. Specification identical to the FMS20 Mk II above. Finish and presentation: anodised aluminium wrap-round cabinet with

★ Indicates entry is illustrated

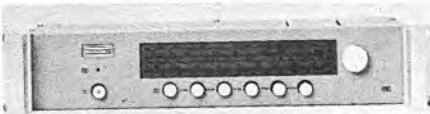

Millbank 2001C

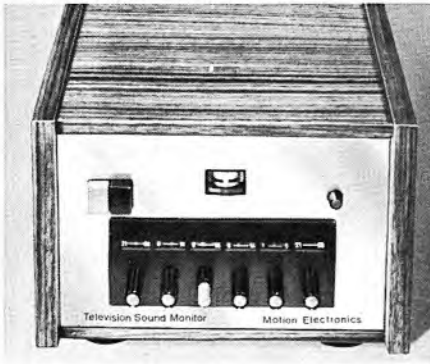

Motion Electronics TV Tuner

teak grained end panels. Price: £61.05 (including VAT).

#### ■ MILLBANK ELECTRONICS GROUP

Bellbrook Estate, Uckfield, Sussex, TN22 1PS.  
Tel: Uckfield (0825) 4166.

#### MET2001C ★

AM/FM stereo tuner designed for building in or rack mounting. Range: FM 88-108MHz, MW 190-590m, LW 830-2010m, SW 40-52m. Variable tuning. Switchable AFC. Foster-Seeley discriminator. Meter tuning indicator. Usable sensitivity:  $3\mu\text{V}$  for 26dB S/N with 125kHz deviation. Aerial input: (FM) 80 ohms coaxial, (AM) ferrite rod plus external terminals. Output: 100mV. Stereo decoder fitted. Mains: 220-240V 50-60Hz. Four-stage IF amplifier with automatic control of bandwidth. Module construction for easy servicing. Size:  $19 \times 3\frac{1}{2} \times 5\frac{1}{2}$  in. Price: £99.22 (plus VAT).

#### MET500FM

FM tuner designed for building in. Range: 88-108MHz. Tuning by remote pushbutton unit (varicap tuner). Switchable AFC. Tuning meter. Usable sensitivity:  $5\mu\text{V}$  for 30dB S/N ratio at 25kHz deviation. Aerial input: 80 ohms coaxial. Mains: 220-250V 50-60Hz. Output: 500mV. No multiplex decoder. Metal housing. Price: £47.69 (plus VAT).

#### ■ MOTION ELECTRONICS

Addlestead Farm, Tonbridge Road,  
East Peckham, Kent.  
Tel: East Peckham (0622) 871354.

#### Television Sound Monitor ★

Tuner unit designed to receive VHF and UHF television sound broadcasts. Varicap tuning with six preset pushbuttons, all manually adjustable. Ratio detector for FM, diode detector for AM. Centre-zero tuning meter. Sensitivity: 100 microvolts. Aerial input: 75 ohms coaxial or 300 ohm balanced. Output adjustable up to 0-5V. Mains: 110-240V AC. Consumption: 5W. Available in cabinet or chassis form for building-in. Cabinet teak veneered with finely grained silver finished front panel. Suitable for vertical or horizontal mounting. VHF coverage: 41-66.75MHz and 176-215MHz. UHF coverage: 470-846MHz. Prices: (VHF—only chassis) £36.10 (plus £3.61 VAT); (VHF—only in cabinet) £39.56 (plus £3.95 VAT); (UHF—only chassis) £35.56 (plus £3.56 VAT); (UHF—only in cabinet) £39.15 (plus £3.91 VAT); (VHF/UHF chassis) £40 (plus £4 VAT); (VHF/UHF in cabinet) £43.50 (plus £4.35 VAT).

#### Television Sound Monitor plus VHF Radio

Television section similar to specification for Sound Monitor listed above. Radio section employs vari-cap tuning. Built-in stereo decoding with automatic switching. Centre-zero tuning meter. Stereo beacon. Mono over-ride control. Pushbutton programme selection. AFC. Separation: better than 45dB at 1kHz. Sensitivity:  $5\mu\text{V}$  for 35dB signal-to-noise. Ultrasonic frequency rejection: (19kHz) 40dB, (38kHz) 40dB. Output impedance: 5K per channel. Output: 0-1.5V balanced to within 1dB. Aerial input: 75 ohms coaxial. Available in chassis form or in teak or walnut veneered cabinet. Mains: 110-120V AC and 210-240V AC. Size: (chassis)  $5\frac{5}{8} \times 3\frac{5}{8} \times 10\frac{1}{4}$  in. deep; (cabinet)  $6\frac{2}{3} \times 5 \times 11\frac{1}{4}$  in. deep. Price: (UHF/VHF stereo radio chassis) £53.65 (plus £5.36 VAT); (UHF/VHF stereo radio in cabinet) £57.20 (plus £5.72 VAT).

#### ■ NATIONAL PANASONIC (UK) LTD

Whitby Road, Trading Estate, Slough, Bucks.  
Tel: Slough 34522. Telex: 847652.

#### ST3000

Stereo tuner. Full specification on request.  
Price: £74.95 (including VAT).

#### ST3400

Stereo tuner. Full specification on request.  
Price: £119.95 (including VAT).

#### ST3600

Stereo tuner. Full specification on request.  
Price: £139.95 (including VAT).

#### ■ NIKKO ELECTRIC MFG CO LTD

Distributors: Howland-West Ltd,  
3.5 Eden Grove, London, N7 8EQ.  
Tel: 01-609 0293/4/5.

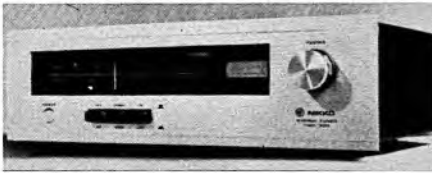

Nikko FAM-300

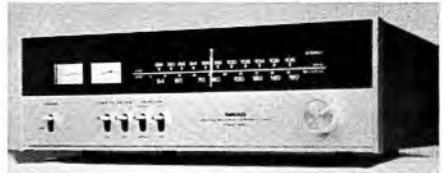

Nikko FAM500



Nikko FAM-400



Nikko FAM-1200

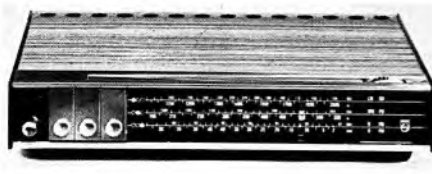

Philips RH690



Philips RH621

**FAM-300 ★**  
 AM/FM stereo tuner. Range: FM 88-108MHz, MW 187-566m. Variable tuning. Meter tuning indicator. Usable sensitivity: FM 1.8µV, MW 200µV. Aerial input: 75 ohms coaxial, 300 ohms balanced. Stereo decoder included. Output: FM 1V, MW 300mV. Mains: 240V AC. Size: 12 × 9½ × 3½ in. Metal case. Price: £52 (plus £5.20 VAT).

**FAM-400 ★**  
 AM/FM stereo tuner. Range: FM 88-108MHz, MW 187-566m. Variable tuning. Meter tuning indicator. Aerial input: 75 ohms coaxial, 300 ohms balanced. Usable sensitivity: FM 1.5µV, MW 150µV. Output: FM 1V, MW 300mV. Stereo decoder included. Mains: 240V AC. Size: 12 × 9½ × 3½ in. Metal case. Price: £65 (plus £6.50 VAT).

**FAM-500 ★**  
 AM/FM stereo tuner. Range: FM 88-108MHz, MW 187-555m. Variable tuning. AFC. One signal strength meter, one centre-zero tuning meter. Usable sensitivity: FM 2µV, MW 150µV. Aerial input: 300 ohms balanced twin, 75 ohms coaxial. Output: FM 1V, AM 300mV. Stereo decoder fitted. Mains: 120, 220, 240V 50-60Hz. Size: 15 × 12½ × 8½ in. Finish: wood cabinet with champagne front panel. Price: £79.20 (including VAT).

**FAM-1200 ★**  
 AM/FM stereo tuner. Range: FM 88-108MHz, MW 187-566m. Variable tuning. AFC. Meter tuning indicator. Usable sensitivity: FM 1.5µV, MW 100µV. Aerial impedance: 75 ohms coaxial, 300 ohms balanced. Output: FM 1.2V, MW 300mV. Stereo decoder included. Mains: 100, 120, 220, 240V AC. Size: 15½ × 4½ × 12½ in. Modular construction, Headphone amplifier included. Metal case. Price: £130 (plus £13 VAT).

■ PHILIPS

Philips Electrical Ltd, Century House, Shaftesbury Avenue, London, WC2H 8AS. Tel: 01-437 7777.

**RH690 ★**  
 Three waveband stereo tuner. 87.5-104MHz, 187-577m and 1154-2000m with variable tuning and ratio FM det. Sensitivity: 7µV (VHF) for 26dB quieting: 500µV (AM). Aerial 300 ohm balanced and ferrite rod. Switchable decoder with indicator lamp. AFC. Output: 250mV, 10K. Psn: 110, 127, 220, 240V AC. Dimensions: 13½ × 2¾ × 8½ in. Price: £55 (including VAT).

**RH621 ★**  
 AM/FM stereo tuner. Range: FM 87.5-104MHz, MW 187-577m, LW 877-2000m, SW 16.8-50.4m. variable tuning plus five presets on FM. Switchable AFC. Ratio detector. Moving coil tuning

★ Indicates entry is illustrated



#### Quad FM3

meter. Usable sensitivity: FM  $1\mu\text{V}$  at 75 ohms for 26dB quieting, AM  $80\mu\text{V}$  for 26dB S/N. Aerial input: 75 ohms coaxial, 300 ohms balanced. Output: FM 0.6V at 40kHz deviation, AM 350mV at 30% modulation. Stereo decoder fitted. Mains: 110, 127, 220 and 240V AC. Size:  $16\frac{1}{2} \times 11\frac{3}{8} \times 4\frac{3}{8}$ in. Finish: walnut veneer cabinet with brushed aluminium fascia. Silent tuning facility on FM. Price: £125 (including VAT).

#### ■ PHOTAX (LONDON) LTD

Hampden Park, Eastbourne, Sussex.  
Tel: 0323 51197.

#### Concertone 620X

VHF/MW stereo tuner. Range: VHF, 88-108MHz, MW, 54-150m variable tuning. AFC: switched. Tuning meter fitted. Sensitivity:  $2.2\mu\text{V}$  (IHF) VHF,  $25\mu\text{V}$  (IHF) MW. Aerial: 300 and 75 ohm. VHF S/N:  $>65\text{dB}$ . VHF distortion:  $<0.5\%$  mono,  $<0.8\%$  stereo. Output: fixed, VHF 1V at 75kHz deviation 330mV at 30% AM. Variable 0-1V. Mains: 100-240V AC, 50-60Hz. Teak case, aluminium fascia. Price: £82 (including VAT).

#### ■ PIONEER

Distributors: Shiro (UK) Ltd,  
Shiro House, The Ridgeway, Iver, Bucks,  
SLO 9JL. Tel: Cedarwood (073 28) 2222.

#### TX 500A

FM/AM stereo tuner. Bands: 87.5-108MHz FM, 525-1605kHz AM. Manual tuning, tuning meter. Sensitivity:  $2.3\mu\text{V}$  IHF (FM),  $15\mu\text{V}$  (AM). Aerial: 75 or 300 ohms. S/N: 70dB. Distortion: 0.6% at 100% modulation. Output: 0.06-1.8V 10K. Mains: 110, 120-130, 220-240V AC. Size:  $13 \times 4\frac{7}{8} \times 13\frac{1}{2}$ in. Walnut and aluminium trim. Price: on application.

#### TX 6200

FM/AM stereo tuner. Bands: 87.5-108MHz FM, 525-1605kHz AM. Manual tuning, tuning meter. Sensitivity:  $1.9\mu\text{V}$  IHF (FM),  $15\mu\text{V}$  (AM). Aerial: 75 or 300 ohms. S/N: 70dB. Distortion: 0.2%. Output: 570mV 2.7K (fixed), 60mV-1.8V 2.5K (variable). Load: 10K or more. Mains: 110-120, 130-220, 240V AC. Size:  $16 \times 5 \times 13\frac{3}{8}$ in. Walnut with aluminium trim. FET front end. Price: on application.

#### TX 7100

FM/AM stereo tuner. Bands: 87.5-108MHz FM, 525-1605kHz AM. Manual tuning, signal strength and centre tuning meter. Sensitivity:  $1.9\mu\text{V}$  IHF (FM),  $15\mu\text{V}$  (AM). Aerial: 75 and 300 ohms. S/N: 70dB. Distortion: 0.2%. Outputs: 650mV 4.7K (fixed), 70mV-2V 300 ohms. Load impedance: 10K. Mains: 110-120, 130-220, 240V AC. Size:  $16 \times 5 \times 13$ in. Walnut with aluminium trim. Incorporates a 5-stage limiter for improved performance. Price: on application.

#### TX8100

FM/AM stereo tuner. Bands: 87.5-108MHz FM, 525-1605kHz AM. Manual tuning, signal strength and centre tuning meter. Sensitivity:  $1.8\mu\text{V}$  IHF (FM),  $15\mu\text{V}$  AM. Aerial: 75 and 300 ohms. S/N: 70dB. Distortion: 0.2%. Output: 650mV 4.7K (fixed); headphones: 150mV 8 ohms. Line output load impedance: 10K. Mains: 110-120, 130-220, 240V AC. Size:  $16 \times 5 \times 13$ in. Walnut with aluminium trim. IF strip contains ceramic filters. Price: on application.

#### TX 9100

FM/AM stereo tuner. Bands: 87.5-108MHz FM, 525-1605kHz AM. Manual tuning, signal strength and centre tuning meters. Sensitivity:  $1.5\mu\text{V}$  IHF (FM),  $15\mu\text{V}$  AM. Aerial: 75 and 300 ohms. S/N: 75dB. Distortion: 0.2%. Outputs: 650mV 4.7K. Load impedance: 10K. Mains: 110-120, 130-220, 240V AC. Size:  $16 \times 5 \times 13$ in. Walnut with aluminium trim. Phase lock loop stereo decoder. Front end contains dual gate MOS FETs. Price: on application.

#### ■ QUAD

Acoustical Manufacturing Co Ltd,  
Ft Peter's Road, Huntingdon, PE18 7DB  
Tel: Huntingdon (0480) 52561.  
Cables: Acoustical.

#### Quad FM3 ★

Stereo FM tuner. Range: 88-108MHz. Variable tuning. High stability tuned stages maintain accuracy without AFC. Twin neon tuning indicator. Sensitivity:  $2\mu\text{V}$  for full limiting. Aerial input: 75 ohms coaxial and 300 ohms balanced. Output: 100mV per channel for 30% modulation. Stereo decoder fitted. Image rejection: 56dB. IF rejection: 80dB. Capture ratio: 3dB. FR: 20Hz-15kHz  $\pm 1\text{dB}$ . Separation: 40dB at 1kHz. Distortion: 1kHz at 40kHz deviation, 0.3%. Recommended load: greater than 50K. De-emphasis: 50 $\mu\text{Sec}$  or 75 $\mu\text{Sec}$  as required. Mains: 100-125V, 200-250V 50-60Hz. Dual gate MOS FET input stage. Integrated circuits (ICs) in IF and decoder. Ceramic filters in IF chain. Output via 5 pin DIN connector. Size:  $10\frac{1}{4} \times 3\frac{1}{4} \times 5\frac{1}{2}$ in. Price: £74.80 (including VAT).

■ **RADFORD AUDIO LTD**

Ashton Vale Road, Bristol, BS3 2HZ.  
Tel: Bristol 662301.

**Model FMT 5**

FM tuner with varicap tuning, FET front end, ceramic filters in IF, phase lock loop decoder. Size:  $17 \times 4\frac{3}{4} \times 11$ in. Price: £135 (including VAT).

■ **REVOX**

Distributors: C. E. Hammond & Co Ltd, Lamb House, Church Street, London, W4 2PB. Tel: 01-995 4551. Telex: 934047.

**Model A76 ★**

Stereo tuner, VHF only: 87.5-108MHz, variable tuning. Two tuning meters. Sensitivity:  $1\mu\text{V}$  mono (IHF),  $10\mu\text{V}$  stereo (IHF). Aerial: 60 ohms. VHF S/N: 70dB at 75kHz deviation. VHF distortion: 0.2% at 1kHz, 40kHz, deviation mono or stereo. Output: 1V at 75kHz deviation. Mains: 110-250V, 50-60Hz AC. Price: £223.30 (including VAT).

**Model A720 Digital Tuner/pre-amp ★**

Stereo tuner and preamplifier combined. VHF only, tuning range: 87-107.95MHz in 50kHz steps. Tuner uses frequency synthesiser. Sensitivity:  $1\mu\text{V}$  mono (IHF),  $10\mu\text{V}$  stereo (IHF). Tuning indication by digital readout on Nixie tubes. Aerial: 75 ohms, BNC socket or 300 ohms DIN. VHF S/N: 70dB weighted ASA-A. Distortion: 0.2% at 1kHz, 40kHz deviation. Output: 1.5V at 40kHz deviation. Pre-amp section; Inputs: Aux, 100mV/100K sensitivity variable over 20dB range. Tape 1, 100mV/100K sensitivity variable over 20dB range. Tape 2, 100mV/100K sensitivity variable over 20dB range. Phono 1, (RIAA) 3mV/50K adj  $\pm 5$ dB. Phono 2, (RIAA) 3mV/50K adj  $\pm 5$ dB. Overload margin on all inputs > 30dB. Outputs: 1 and 2: 1.5V into load > 10K. Tape out, front panel and two rear: 200mV into load > 50K. Phono socket, bass, treble and presence controls. Low, high and loudness filter. Distortion: 0.1% at 1.5V output. FR: 20Hz-20kHz  $\pm 1$ dB. S/N, Phono, 65dB. Other inputs: 85dB. Price: £544.50 (including VAT).

■ **ROGERS DEVELOPMENTS**

**(Electronics) LTD**

4-14 Barmeston Road, Catford, London, SE6 3BN. Tel: 01-698 7424/4340.

Cables: Rodevco, London, SE6.

**Ravensbrook FET PM tuner, Series II ★**

Range: 88-108MHz. Variable tuning. Quadrature detector. Centre-zero meter. Sensitivity: better than  $5\mu\text{V}$  (IHF). Aerial impedance: 75 ohms coaxial and 300 ohms balanced. Output: 200mV for 30% modulation. Phase lock loop stereo decoder. Switchable AFC. Three-gang



Revox A76

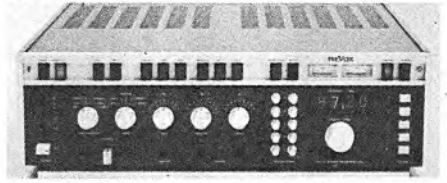

Revox Digital FM Tuner-Preamp A720



Ravensbrook tuner

FET front-end. Dual ceramic IF filters using IC techniques. Built-in 55kHz filter. Switchable interstation noise suppression. Mains: 105-125V, 200-250V, 50-60Hz. Consumption: 9W. Size: (chassis)  $3\frac{3}{4} \times 10\frac{3}{4} \times 10$ in; (cabinet)  $5 \times 11\frac{1}{2} \times 10$ in. Prices: (chassis) £49.50 (including VAT); (in cabinet) £55 (including VAT).

**Ravensbourne 2 FET tuner, Series II**

Range: 88-108MHz. Variable tuning. Quadrature detector. Centre-zero tuning meter. Sensitivity: better than  $24\mu\text{V}$  for 30dB quieting. Aerial impedance: 75 ohms coaxial. Output: 200mV average for 30% modulation. Dual ceramic IF filters using IC techniques. Built-in 55kHz filter. Switched AFC. FET front end. Inter-station noise suppression. Phase lock loop stereo decoder. Mains: 200-250V AC. Consumption: 8W. Size: (chassis)  $11\frac{1}{2} \times 11 \times 4$ in; (case)  $12\frac{1}{2} \times 11\frac{1}{2} \times 5\frac{1}{2}$ in. Prices: (chassis with decoder) £63.25 (including VAT); (in cabinet with decoder) £67.65 (including VAT).

■ **ROTEI.**

Rank Audio Visual Ltd, PO Box 70, Great West Road, Brentford, Middlesex, TW8 9HR. Tel: 01-568 9222. Telex: 24408.

**RT 322★**

Stereo VHF/MW tuner with fixed AFC and tuning meter. Sensitivity:  $2\mu\text{V}$  (IHF) VHF,



Rotel RT 322



SAE Mark VI Digital tuner

200 $\mu$ V (IHF) MW. Aerial: 75 ohms. VHF S/N: 65dB (IHF). VHF distortion: <0.5%. Output: 120mV into load of 150K. Mains: 100-240V AC. Case: 14 $\times$ 7 $\frac{1}{2}$  $\times$ 4 $\frac{1}{2}$ in. Cabinet finish: brushed stainless steel front panel, teak/walnut sleeve. Price: £74.50 (including VAT).

#### RT 222

Stereo VHF/MW tuner with fixed AFC and tuning meter. Sensitivity: 4 $\mu$ V (IHF) VHF, 250 $\mu$ V (IHF) MW. Aerial: 75 ohms. VHF S/N: 63dB (IHF). VHF distortion: <0.5%. Output: 120mV. Rec load: 150K. Mains: 100-240V AC. Case: 13 $\times$ 6 $\frac{1}{2}$  $\times$ 4in. Cabinet finish: brushed stainless steel front panel, teak/walnut sleeve. Price: £51.50 including VAT).

#### RT 622

No specification available at time of going to press. Price: £111.50 (including VAT).

#### RT 1220

Stereo VHF/MW tuner with fixed AFC and tuning meter. Sensitivity: 1.5 $\mu$ V (IHF) VHF, 15 $\mu$ V (IHF) MW. Aerial: 75 ohms. VHF distortion: <0.5%. Case: 16 $\frac{1}{2}$  $\times$ 12 $\times$ 5 $\frac{1}{2}$ in. Uses supersensitive MOS FET front end tuner section. Price: £139.90 (including VAT).

#### ■ SABA TELEVISION LTD

6-12 Cornbrook Park Road, Manchester, M15 4EE. Tel: 061-872 7661.

#### VSR0

AM/FM stereo tuner. Range: FM, LW, MW, SW. Variable tuning plus five preset tuning buttons on FM. Tuning meter. Stereo decoder with auto switching. 25 transistors and 21 diodes. Mains: 120-240V AC. Size: 16 $\frac{3}{8}$  $\times$ 4 $\frac{3}{8}$  $\times$ 11in. Finish: light walnut or white. Price: £97.93 (including VAT).

#### ■ S.A.E.

Distributor: Gale Electronics and Design Ltd, London, W1Y 1PE. Tel: 01-499 9966.

#### Mark VI ★

FM/Digital tuner with frequency indicated by Nixie tubes. Band: 87-108MHz variable. Sensitivity: 1.6 $\mu$ V for 30dB S/N (IHF). THD: 0.1% mono, 0.15% stereo. S/N: 75dB unweighted. Capture ratio: 1.5dB. AM suppression: 100dB. FR: 20Hz-15kHz $\pm$ 0.5dB. Aerial: 75 or 300 ohms. Four-gang FET RF front end. 14-pole Butterworth type toroid phase-linear IF filter. 3in rectangular oscilloscope displays the presence of multipath and centre-tuning, relative signal strength and Lissajous displays of all stereo and mono signals, with provision for external input. All-aluminium black-anodised chassis with gold-anodised front panel. Five years parts and labour guarantee. Output: 1V RMS. Mains: 120, 240V AC 50-60Hz. Size: 17 $\times$ 5 $\frac{3}{4}$  $\times$ 10 $\frac{1}{2}$ in. Optional walnut cabinet. Stereo rear panel jack provided for 4-channel MPX decoder. Price: £680 (plus VAT).

#### ■ SANSUI

Vernitron Ltd, Thornhill, Southampton, SO9 5QF. Tel: Southampton 444811.

#### TU7500 ★

AM/FM stereo tuner. Range: FM 88-108MHz, MW 187-560m. Variable tuning. AFC. Ratio detector. Meter for AM signal strength. Centre-zero FM tuning meter. Usable sensitivity: FM 1.9 $\mu$ V. Aerial input: 300 ohms balanced twin. 75 ohms coaxial. Stereo decoder fitted. Output: 0.1V. Mains: 100, 117, 220, 240V 50-60Hz. Size: 17 $\frac{3}{8}$  $\times$ 12 $\frac{3}{4}$  $\times$ 5 $\frac{3}{8}$ in. Finish: matt black cabinet, satin chrome trim (matches Sansui AU6500 and AU7500). Quiet tuning facility. Two output terminals. Price: £163.81 (including VAT).

#### TU9500 ★

AM/FM stereo tuner. Range: FM 88-108MHz, MW 187-560m. Variable tuning. AFC. Ratio detector. Meter for AM signal strength. Centre-zero FM tuning meter. Usable sensitivity: FM 1.7 $\mu$ V. Aerial input: 0-1V adjustable. Stereo decoder fitted. Mains: 100, 117, 220, 240V 50-60Hz. Size: 19 $\frac{3}{4}$  $\times$ 13 $\frac{3}{4}$  $\times$ 5 $\frac{5}{8}$ in. Finish: matt black with satin chrome trim (matches AU9500). Quiet tuning facility. Direct recording outlet. Price: £206.26 (including VAT).

#### ■ SANYO

Sanyo Maruheni (UK) Ltd, Sanyo House, Bushey Mill Lane, Watford, Herts. Tel: Watford 30421.

#### FMT 1400K

AM/FM stereo tuner. Range: MW 187-560m, FM 88-108MHz. Variable tuning. Meter tuning indicator. Usable sensitivity: MW 15 $\mu$ V, FM

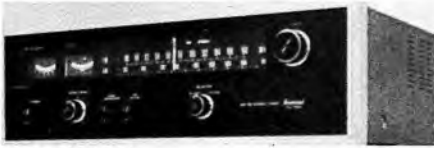

Sansui TU7500



Sansui TU9500



Servo-Sound Tuner TU4



Sharp ST-510-H

1.9µV. Output voltage: 0.4-0.5V. Decoder included. FR: (FM) 10Hz-15kHz. Signal to noise: FM better than 60dB, AM better than 50dB. Stereo noise filter. Muting switch. Incorporates FET input and IC. Price: £63.01 (including VAT).

■ SCIENTELEC

35a Beddington Lane, Croydon, Surrey.  
CR0 4TB. Tel: 01-686 9341/4.

Club

FM stereo tuner. Range: 86-108MHz. Variable tuning plus four presets. AFC. Synchronous discriminator. Meter for signal strength, centre-zero tuning meter. Usable sensitivity: 1µV for 28dB signal-to-noise level. Aerial input: 75 ohms coaxial or 300 ohms balanced. Output: 400mV. Stereo decoder included. Three FETs. Four varicap diodes in tuning circuits. Squelch circuit. Four-IC IF amplifier. 19 transistors, 16 diodes. Mains: 220-240V AC 50Hz. Size: 17 $\frac{7}{8}$  × 12 × 4 $\frac{1}{2}$ in. Finish: black leather cabinet with extruded aluminium front. Price: £120.41 (including VAT).

■ SCOTT

Photax (London) Ltd, Hampden Park,  
Eastbourne Sussex. Tel: 0323 51197.

t33s

FM/Digital stereo tuner. Band: 87.5-107.9MHz. Digital tuning accurate 0.001%, digital readout, station pre-selection by punched cards to within 100kHz, with scanning and memory. Sensitivity: 1.8µV IHF. Aerial: 75 or 300 ohms. S/N: 70dB ref ± 75kHz deviation. Distortion: 0.25% mono, 0.35% stereo. Output: 1V (adjustable). Mains: 100-120V or 200-240V AC 50-60Hz. Price: to be announced.

■ SERVO-SOUND

Lamb House, Church Street, London, W4 2PB.  
Tel: 01-995 4551.

TU4 ★

Stereo FM tuner. Range: 88-108MHz. Variable tuning. Switchable AFC. Squelch circuit FM discriminator. Meter tuning indicator. Usable sensitivity: 0.9µV for 30dB signal-to-noise. Aerial input: 240-300 ohms balanced. Output: 1V. Stereo decoder included. Circuit includes two FETs and one IC. Size: 15 $\frac{1}{2}$  × 3 × 7 $\frac{1}{2}$ in. Mains: 110-240V AC. Finish: metal front and black wood cabinet. Price: to be announced.

■ SHARP ELECTRONICS (UK) LTD

107 Hulme Hall Lane, Manchester, M10 8HH.  
Tel: 061-205 7321.

ST-510-H ★

VHF/MW/LW/SW stereo tuner meeting DIN 45 500 Hi-Fi Standard. Sensitivity: 2.5µV (DIN). Tuning range: FM, 87.5-107.5MHz MW, 520-1620kHz. Finish: Teak. Price: £76 (including VAT).

■ SHERWOOD

Acoustico Enterprises Ltd, Unit 7,  
Space Way, North Feltham Trading Estate,  
Feltham, Middlesex, TW14 0TZ.  
Tel: 01-751 0141.

Model 2400

FM/AM stereo tuner. Bands: 87.5-108.5MHz FM, 530-1625kHz AM. Manual tuning, signal strength and centre tuning meters. Sensitivity: 1.8V IHF (FM), 10V (AM). Aerial: 75 or 300 ohms. S/N: 70dB IHF. Distortion: 0.25%. Mains: 220-240V AC. Size: 17 $\frac{1}{2}$  × 5 $\frac{1}{2}$  × 14in. Walnut with satin chrome finish. MPX output available for quadrasonic decoder. Variable output control, oscilloscope output for visual multipath display. Price: £134.20 (including VAT).



★ Indicates entry is illustrated

### ■ SINCLAIR RADIONICS LTD

London Road, St Ives, Huntingdonshire.  
PE17 4HJ. Tel: St Ives (Hunts) 4311.

#### Project 60

Stereo FM tuner employing phase lock loop principle of detection. Range: 87.5-108MHz. Capture ratio: 1.5dB. Sensitivity: 7µV for full limiting. AFC fitted (range ±200kHz). S/N: >65dB. FR: 10Hz-15kHz±1dB. HD: 0.15% for 30% modulation. Stereo decoder fitted (operating level 2µV). Pilot tone suppression: 30dB. Crosstalk: 40dB. Output: 150mV per channel RMS for 100% modulation. Aerial input impedance: 75 ohms. Tuning indicator. Stereo beacon. Power supply required: 25-30V DC. Size: 8½ × 1⅝ × 3⅝in. Varicap diode tuning. Printed circuit coils. IC decoder: 16 discrete transistors. Inter-station muting. Price: £20 (plus VAT).

#### System 2000

Stereo FM tuner. Range: 88-108MHz. Variable tuning. Phase lock loop discriminator. Lamp tuning indicator. Usable sensitivity: 7µV for full limiting. Aerial input: 75 ohm coaxial and 300 ohm balanced. Output: 150mV for 100% modulation. Stereo decoder fitted. Mains: 120-240V AC. Size: 12 × 6 × 2in. Finish: brushed aluminium. Price: £39 (plus VAT).

#### System 3000

Identical specification to the system 2000 but finished in matt black. Price: £39 (plus VAT).

#### Project 80

FM tuner. Bands: 87-108MHz. Detector: IC balanced coincidence. AFC: switched, low drift thermistor controlled. Varicap tuning. Distortion: 0.3% at 1kHz at 75kHz deviation. Ceramic IF filter. Aerial: 75 ohms or 240-300 ohms. Sensitivity: 4µV for 30dB quieting. Power: 12-45V DC. Price: £13.14 (plus VAT). Stereo decoder, supplied separately. Size: 1⅞ × 2 × ¾in. Power: 30V. Output: 150mV per channel. Price: £8.19 (plus VAT).

#### System 2000 Mk III

FM tuner. Size: 308 × 152 × 50mm. Stereo indicator. Aerial: 75 ohms or 240-300 ohms. Output: 2 × 100mV RMS at 30% modulation. Pilot tone suppression: 30dB. Crosstalk: 40dB. THD: (for 30% modulation) 0.2%. S/N: 65dB. AFC: ±600kHz. Muting level: 10µV. Sensitivity: 3µV for 30dB quieting. Capture ratio: 3dB. Price: £39.95 (plus VAT).

### ■ SONY (UK) LTD

Pyrene House, Sunbury Cross,  
Sunbury-on-Thames, Middlesex.  
Tel: Sunbury 87644/7.

#### ST88

AM/FM stereo tuner. Range: FM 87-108MHz, MW 187-566m. Variable tuning. Meter tuning

indicator. Sensitivity: FM 1.7µV for 30dB S/N, MW 100µV 48dB (external aerial). Aerial input: (FM) 300 ohms balanced. Stereo decoder fitted. Two FETs, 16 transistors, 18 diodes. FM image rejection: 45dB. FR: 30Hz-15kHz±2dB. Separation: better than 35dB at 400Hz. HD: (FM) stereo 0.8%, mono 0.5%. Mains: 110, 127, 220, 240V 50-60Hz. Consumption: 10W. Finish: walnut with black and satin silver front panel. Price: £45 (plus VAT).

#### ST-5055L

AM/FM stereo tuner. Range: VHF, LW, MW. Variable tuning. Ratio detector. Meter tuning indicator. Usable sensitivity: FM 2.2µV (IHF), 1.7µV for 30dB S/N. Aerial input: balanced 240-300 ohms. Stereo decoder fitted. FET front end. Ceramic filters. IC amplifier stage. Balanced diode limiter. High blend noise cancelling circuit. Auto mono/stereo switching. Two outputs. Pushbutton selection. Finish: walnut cabinet, brushed aluminium panel and black scale. Price: £70 (plus VAT).

#### ST70

AM/FM stereo tuner. Variable tuning. AFC. Ratio detector. Meter tuning indicator. Usable sensitivity: AM 20µV, FM 2µV. Aerial input: 300 ohms balanced. Output: (high) 2V, (low) 750mV. Stereo decoder fitted. Mains: 220-240V AC. Size: 13 × 7½ × 9⅝in. Finish: walnut cabinet and anodised aluminium panel and trim. Price: £35 (plus VAT).

#### ST 5066

FM/AM stereo tuner. Range: VHF 87.5-108 MHz, MW 530-1605kHz. Sensitivity: VHF 1.7µV 30dB. S/N: MW 48dB/m, built-in aerial. Harmonic distortion: (VHF) mono 0.5%, stereo 0.8%; (MW) 0.8%. Tuner input meter, push button function controls, brushed aluminium control panel, wood finish cabinet, illuminated dial pointer. Price: to be announced.

#### ST5130

VHF FM/AM tuner. Bands: FM 87.5-108MHz, AM 530-1605kHz manual tuning. Switched AFC. Signal strength and centre tuning meters. Sensitivity: FM 1.5µV IHF, AM 50dB/m (internal aerial), 30µV (external aerial). Aerial: 300 ohms balanced or 75 ohms unbalanced for FM. Ferrite rod or external wire for AM. S/N: 75dB IHF. FM distortion: mono 0.2% at 400Hz, 100% modulation. Stereo 0.3% at 400Hz, 100% modulation. Outputs: fixed line 750mV 10K, variable 0.2V 1.8K, multipath 150mV per output 18K. Mains: 100, 120, 220, 240V 50-60Hz. Size: 15¼ × 13⅝ × 5⅝in. Finish: metal case with brushed aluminium fascia. Teak case. Switched muting and hi-blend, interference and spurious interference suppressor. Price: £179.95 (including VAT).



J. E. Sugden R51

**ST 5150**

FM/AM stereo tuner. Range: VHF 87.5-108 MHz, MW 530-1605kHz. Sensitivity: VHF 1.6µV -30dB.S/N: MW 50dB/m, built-in aerial. Harmonic distortion: (VHF) mono 0.3%, stereo 0.5%; MW 0.6%. Outputs: fixed 750mV 10K variable 0.2V 1.8K. Multipath output: vertical 150mV 10K, horizontal 150mV 100K. Size: 15½ × 5½ × 13⅞ in. Weight: 15lb 5oz. Mains: 240V AC 50Hz. 25W. Tuning meter, tuner input meter, FM stereo indicator, muting on/off, hi-blend, function selector. Price: to be announced.

**STEREOSOUND PRODUCTIONS LTD**

Wakefield Road, Brighouse, Yorks.  
Tel: Brighouse 4355.

**Stereosound T20D**

AM/FM radio tuner. Range: FM 87.4-104.5 MHz, MW 185-555 metres, LW 1110-1940 metres. Variable tuning. AFC. Ratio detector. Stereo decoder fitted. Aerial input: 75 ohms coaxial. Output: 50mV and 750mV. Mains: 240V AC. Size: 18½ × 4½ × 8in. Finish: teak cabinet with clear plastic scale. Price: £36.30 (including VAT).

**J. E. SUGDEN & CO LTD**

Carr Street, Cleckheaton, Yorks, BD19 5LA.  
Tel: Cleckheaton 2501.

**R21 and R51 ★**

FM stereo tuner. Range: 88-104MHz. Variable and preset tuning. Ratio detector. Centre-zero tuning indicator. Sensitivity: 2µV for 20dB quieting. Aerial input: 75 ohms coaxial and 300 ohms balanced. Output: 0.5V. Stereo decoder fitted. AFC. Mains: 110, 120, 220, 230 and 240V AC. Thermometer type tuning dial. Special decoder filter to prevent spurious responses. Switchable decoder filter for low-level transmissions. R21 designed to match J. E. Sugden A21 and A48 amplifier. R51 designed to match J. E. Sugden C51 amplifier. Size: (R21) 12 × 9 × 5in; (R51) 11 × 4 × 7in. Price: (R21) £74.80 (including VAT); (R51) £79.20 (including VAT).

**R21 and R48**

Combination of R21 tuner and A48 amplifier in one case. Price: £173.80 (including VAT).

**TEAC**

Acoustico Enterprises Ltd, Unit 7, Space Way, North Feltham Trading Estate, Feltham, Middlesex, TW14 0TZ. Tel: 01-751 0141.

**AT-100**

Stereo FM tuner. Range: 88-108MHz. Variable tuning. AFC. Two tuning meters. Usable sensitivity: 2µV (IHF). Aerial input: 75 ohms coaxial and 300 ohms balanced. Output: 1V. Stereo decoder fitted. Mains: 100, 117, 220, 240V AC. Size: 16½ × 5½ × 13in. Finish: silver and black, black-out dial. Dual gate FET front end. Six ceramic filters in IF strip. Price: £106 (plus VAT).

**TELEFI**

Rola-Telephon Ltd, Ditton Works, Foxhall Road, Ipswich, Suffolk, IP3 8JP.  
Tel: Ipswich (0473) 73131.

**Teledi**

Special adaptor to permit sound channel output to be taken from most UHF 625-line television receivers. Easy fitting. No connections or modifications to TV. Usually operates without even removing cabinet back. Special probe picks up stray 6MHz inter-carrier sound signal, prior to TV sound detector, and processes the signal to provide a high quality audio output for feeding hi-fi system. Finish: teak. AC mains. Output: typically 100mV-1V adjustable. Output impedance: 2K. Distortion: <1%. FR: 30Hz-20kHz. Two screened leads 6ft long. Price: £30 (including VAT).

**TELETON**

Teleton Electro (UK) Ltd, Teleton House, Waterhouse Lane, Chelmsford, Essex, CMI 1BD.  
Tel: Chelmsford (0245) 62442. Telex: 99338.

**GT202**

AM/FM stereo tuner. Range: FM 88-104MHz, MW 187-577m, LW 857-2000m. Sensitivity: FM 1.5µV (IHF). Image rejection: >50dB. Capture ratio: 2dB. Aerial input: (FM) 300 ohms balanced. Stereo decoder fitted. Switchable AFC. Controls: mains on/off, AFC, waveband selector, tuning. Mains: 115-240V AC 50-60Hz. Size: 15½ × 9 × 2½ in. Designed to match GA202 amplifier. Price: £50.71 (including VAT).

**TOSHIBA**

Toshiba (UK) Ltd, Toshiba House, Great South West Road, Feltham, Middlesex.  
Tel: 01-751 1281.

**ST-500 ★**

FM/AM stereo tuner. Bands: 88-108MHz FM, 540-1600kHz AM. Manual tuning, signal strength and centre tuning meter. No further details at time of going to press. Price: £109.50 (including VAT).

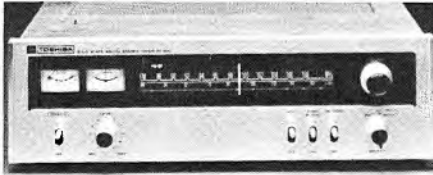

Toshiba ST-500

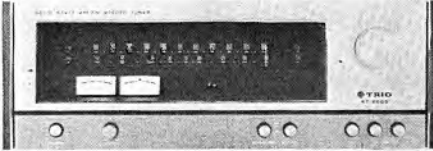

Trio KT6005

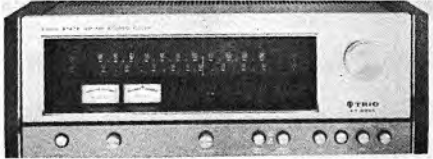

Trio KT8005

## ■ TRIO

Distributors: B. H. Morris & Co (Radio) Ltd.  
Trio House, The Hyde Industrial Estate,  
The Hyde, London, NW9 6JP.  
Tel: 01-205 6441.

### KT1000A

AM/FM stereo tuner. Range: FM 88-108MHz, MW 187-556m. Variable tuning. Meter tuning indicator. Sensitivity:  $3\mu\text{V}$  (IHFM standard). Aerial input: 75 ohms coaxial and 300 ohms balanced. Output: 1V FM, 0.4V AM. Stereo decoder fitted. Multiplex noise filter fitted (switchable). Mains: 100-120V and 220-240V 50-60Hz. Price: £50 (plus VA1).

### KT2001A

AM/FM stereo tuner. Range: FM 88-108MHz, MW 187-556m. Variable tuning. Meter tuning indicator. Sensitivity:  $2\mu\text{V}$  (IHFM standard). Aerial input: 75 ohms coaxial and 300 ohms balanced. Output: 1V FM, 0.4V AM. Stereo decoder fitted. Circuit incorporates ICs. Multiplex noise filter fitted (switchable). Mains: 110-120V and 220-240V AC 50-60Hz. Size:  $13 \times 4\frac{3}{8} \times 9\frac{1}{2}$  in. Price: £58 (plus VA1).

### KT 4005

FM/AM stereo tuner. Bands: 88-108MHz FM, 540-1600kHz AM. Manual tuning, signal strength and centre tuning meters. Sensitivity:  $1.9\mu\text{V}$  IHF (FM),  $18\mu\text{V}$  (AM). FR: 20Hz-15kHz ( $\pm 0.2\text{dB}$ ,  $-1.5\text{dB}$ ). THD: 0.4% mono, 0.7% stereo. S/N: 70dB. Output: 1.5V 12.5K. Aerial: 75 or 300 ohms. Price: to be announced.

### KT5000

FM stereo tuner. Range: FM 88-108MHz.

Variable tuning. Two tuning meters. Sensitivity:  $1.7\mu\text{V}$  (IHFM standard). Aerial input: 75 ohms coaxial and 300 ohms balanced. Output: 1V  $\pm 1\text{dB}$ . Stereo decoder fitted. Circuit incorporates FET input and ICs. Output level control. Mains: 110-120V and 220-240V 50-60Hz. Size:  $16\frac{1}{4} \times 5\frac{1}{4} \times 11$  in. Price: £79.50 (plus VAT).

### KT6005 ★

AM/FM stereo tuner. Range: FM 88-108MHz, MW 187-556m. Variable tuning. AFC. Tuning and signal strength meters. Usable sensitivity: FM  $1.5\mu\text{V}$ , AM (internal aerial)  $300\mu\text{V}$ , (external aerial)  $13\mu\text{V}$ . Aerial input: 300 ohms balanced and 75 ohms coaxial. Stereo decoder included. Output: 1.5V at 100% modulation at 400Hz. Three FETs, one IC. Quiet tuning facility on FM. Auto stereo switching. Multiplex filter. Output level control. Finish: wood sides with satin chrome face. Size:  $17\frac{1}{8} \times 6\frac{1}{8} \times 11\frac{7}{8}$  in. Price: £105 (plus VAT).

### KT8005 ★

AM/FM two-band stereo tuner. Range: 88-108MHz, MW 187-556m. Variable tuning. Signal strength meter, centre-zero tuning meter. Usable sensitivity: FM  $1.5\mu\text{V}$  (IHF). Multipath detection in FM stereo mode. Stereo decoder fitted. Special switchable muting circuit cuts out mono stations and receives stereo only. Aerial input: 75 ohms coaxial or 300 ohms balanced. Output: (FM) 1.5V, (AM) 150mV. Mains: 110 or 230V AC. Weight: 24.9lb. Size:  $17\frac{1}{8} \times 6\frac{1}{8} \times 11\frac{1}{2}$  in. Price: £145 (plus VAT).

## ■ YAMAHA

Natural Sound Systems Ltd,  
Strathcona Road, North Wembley,  
Middx, HA9 8QL. Tel: 01-904 0141.

### CT 800

VHF/MW stereo tuner with touch sensitive AFC switch, tuning and signal strength meters. Variable tuning. Sensitivity:  $1.7\mu\text{V}$  (IHF) VHF,  $52\mu\text{V/m}$  (IHF) MW. Aerial: 300 ohms and 75 ohms. VHF S/N: 75dB (IHF). VHF distortion: 0.3% at 400Hz, 1% 50Hz-10kHz. Output: 100mV and 0.1V variable. Rec load: 40K. Mains: 110-240V AC. Cabinet finish: satin aluminium facia, American walnut case. Price: to be announced.

### CT7000

VHF stereo tuner. Tuning range: 88-108MHz, variable. Sensitivity:  $< 1\mu\text{V}$  (IHF). Aerial: 300 ohms and 75 ohms. VHF S/N: better than 80dB. VHF distortion:  $< 0.2\%$  at 400Hz, 0.8% 50Hz-10kHz. Outputs: 100mV/40K, 0.1V/40K. Mains: 110-240V AC. Finish: satin aluminium facia and American walnut case. Uses a 7-gang solid state filter front end. Price: to be announced.

# Radford

## Radford Choice

We are proud to offer the most comprehensive range of the latest equipment in the world in our spacious showrooms on three floors.

## Radford Service

Professional unbiased advice from experts and unequalled demonstration facilities. A full guarantee is given on all equipment.

## Radford Discounts

Intelligent purchasing techniques enable us to offer huge discounts that will match any price. Just telephone for your special discount quotation. Mail order, Barclaycard/Access by telephone, free and safe delivery by Securicor anywhere in the UK and exports to all parts of the world.

**Radford HiFi Limited**  
**52/54 Gloucester Road**  
**Bristol BS7 8BH England**  
**Telephone 0272-422709**

Professional and Technical Division  
 for video, CCTV and studio sound  
 equipment telephone  
 0272-44593

- ACOUSTIC RESEARCH
- ARMSTRONG
- JBL
- STUDIO CRAFT
- KLH
- DUAL
- HARMAN KARDON
- TECHNICS
- BOSE
- TEAC
- ACOS
- AKAI
- ADC
- CELESTION
- BSR
- EMPIRE
- GARRARD
- GOLDRING
- GOODMANS
- KOSS
- LEAK
- METROSOUND
- RODGERS
- ROTEL
- TANDBERG
- THORENS
- SHURE
- SANSUI
- ORTOPON
- AKG
- B & W
- CAMBRIDGE
- CONNOISSEUR
- ERA
- ESS
- HARRISON
- IMF
- INTERAUDIO
- JENSEN
- KEF
- LARSON
- LECCON
- LOWTHER
- LUX
- MARANTZ
- AUDIO MONITOR
- MORDAUNT SHORT
- NAIM
- NATIONAL
- KARAMICHI
- NEAL
- NIKKO
- PICKERING
- REVOX
- SHERWOOD
- SME
- SONIC ART
- STANTON
- STAX
- TRANSCRIPTORS
- UHER
- YAMAHA
- GALE
- GRACE
- DUAD
- SCAN-DYNA
- LINNSONDER
- TANNOY
- CLR
- AMCRON
- AMPEX
- PIONEER
- TDI
- MEMOREX
- SENNHEISER
- TELEFUNKEN
- 3M
- STUJER
- DESIGN ACOUST
- SHIBADEN
- LIEVERS-RICHE
- ALICE
- CTS
- RTR

and many others

# Hervic

## HR150 Digital Receiver A New Tuner/Amplifier of Outstanding Specifications and Design



Sole UK Distributor:  
**Gale Electronics & Design Limited**  
39 Upper Brook Street London W1Y 1PE

# Receivers

★ Indicates entry is illustrated

Abbreviations used in this section are given on page 20.

## ■ AKAI

Rank Audio Visual Ltd, PO Box 70, Great West Road, Brentford, Middlesex, TW8 9HR.

Tel: 01-568 9222. Telex: 244008.

### AA8030 ★

AM/FM stereo tuner/amplifier. Range: FM 88-108MHz, MW 187-560m. Sensitivity: FM 2.5  $\mu$ V, MW 250  $\mu$ V/m. Variable tuning. Centre-zero tuning meter. Aerial input: 300 ohms balanced twin, 75 ohms coaxial. Stereo decoder fitted. Output: 25W RMS per channel into 8 ohms. HD: <0.05%. FR: 15Hz-40kHz -3dB. Inputs: mag PU 3mV 50K, aux 150mV 50K, tape 150mV 50K. H and N: (PU input) -60dB, (other inputs) -75dB. Separation: better than 50dB. Tone controls: bass  $\pm$ 10dB at 100Hz, treble  $\pm$ 10dB at 10kHz, loudness +8dB at 100Hz +5dB at 10kHz, high filter -8dB at 10kHz. 4l transistors, one FET, one IC, 31 diodes. Mains: 100-240V 50-60Hz. Size: 18 $\frac{1}{4}$   $\times$  6 $\frac{1}{4}$   $\times$  13 $\frac{3}{4}$ in. Weight: 25 $\frac{1}{2}$ lb. Price: £149.50 (including VAT).

### AA8080 ★

AM/FM stereo tuner/amplifier. Range: 88-108MHz, MW 187-560m. Sensitivity: FM 2  $\mu$ V, MW 300  $\mu$ V/m. Variable tuning. Signal strength meter. Centre-zero tuning meter. Aerial input: 300 ohms balanced twin, 75 ohms coaxial. Stereo decoder fitted. Output: 40W RMS per channel into 8 ohms. HD: <0.03% at 8 ohms 20W. FR: 10Hz-50kHz -3dB. Inputs: mag PU 3mV 50K, aux 160mV 50K, tape 160mV 50K, mic 2.5mV 50K. H and N: (PU input) -65dB, (other inputs) -80dB. Separation: (PU input) 55dB, (other inputs) 65dB. Tone controls:  $\pm$ 10dB at 100Hz, treble  $\pm$ 10dB at 10kHz, loudness +8dB at 100Hz +5dB at 10kHz, high filter -5.5dB at 10kHz, low filter -4.5dB at 50Hz. 50 transistors, two FETs, two ICs, 38 diodes. Mains: 100-240V 50-60Hz. Size: 18 $\frac{1}{4}$   $\times$  5 $\frac{3}{4}$   $\times$  15 $\frac{1}{4}$ in. Weight: 30lb. Finish: wood grain side panels and satin metal control panel. Price: £146.90 (including VAT).

## ■ ALPHA

Highgate Acoustics, 38 Jamestown Road, London, NW1 7EJ. Tel: 01-267 4937.

## R150 ★

Stereo tuner/amplifier. Range: 87-103MHz, 187-572m. Variable tuning FM ratio detector. Meter tuning indicator. Sensitivity: 2  $\mu$ V for 20dB quieting. Aerial input: 300 ohms balanced. Stereo decoder fitted. AFC. Inputs: magnetic PU 3mV, crystal PU 250mV, aux 250mV. Output: 8W RMS per channel. HD: 0.5% at rated output. FR: 30Hz-30kHz. Output impedance: 8 ohms. Mains: 117, 220, 240V AC. Size: 15 $\frac{1}{4}$   $\times$  4 $\frac{1}{4}$   $\times$  10 $\frac{1}{2}$ in. Price: £64.90 (including VAT).

## FR2000

Stereo tuner/amplifier. Range: 87-108MHz, 187-572m. Variable tuning FM ratio detector. Meter tuning indicator. Sensitivity: 3  $\mu$ V for 20dB quieting. Aerial input: 300 ohms balanced. Stereo decoder fitted. AFC. Inputs: magnetic PU 3mV, crystal PU 250mV, aux 250mV. Output: 10W per channel. HD: 0.5% at 10W. FR: 30Hz-30kHz. Output impedance: 8 ohms. Mains: 117, 220, 240V AC. Slider controls for bass, treble and volume. Size: 17  $\times$  12  $\times$  5 $\frac{3}{4}$ in. Price: £74.80 (including VAT).

## FR3000

AM/FM stereo tuner/amplifier. Range: FM 88-108MHz, MW 176-600m. Variable tuning. AFC. Balanced ratio detector. Meter tuning indicator. Usable sensitivity: AM 25  $\mu$ V, FM 3  $\mu$ V. Aerial input: 300 ohms balanced. Stereo decoder fitted. FET front end. Inputs: crystal PU 250mV 1M, mag PU 3mV 50K, aux 200mV

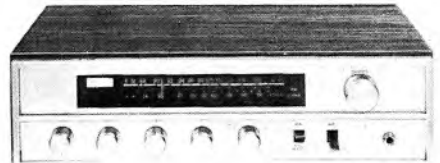

Alpha R150



Akai AA8030

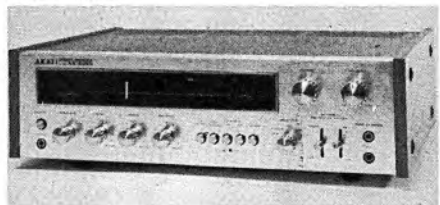

Akai AA8080

★ Indicates entry is illustrated

100K, tape 200mV 100K. Noise level: (mag PU) 60dB, (other inputs) 70dB. Output: 15W RMS per channel. Tone controls: bass slider  $\pm 10$ dB at 50Hz, treble slider  $\pm 12$ dB at 10kHz, loudness switch + 12dB at 50Hz and + 4dB at 10kHz. HD: 0.5% at 12W output. Output impedance: 8 ohms. FR: 20Hz-25kHz  $\pm 3$ dB at 12W. Mains: 110, 240V AC. Finish: teak with brushed aluminium. Size: 17  $\times$  12  $\times$  5 $\frac{1}{8}$  in. Price: £94.60 (including VAT).

#### FR4000

AM/FM stereo tuner/amplifier. Range: FM 88-108MHz, MW 176-600m. Variable tuning. AFC. Balanced ratio detector. Meter tuning indicator. Usable sensitivity: AM 25 $\mu$ V, FM 2 $\mu$ V. Aerial input: 300 ohms balanced. IC stereo decoder fitted. FET front end. Inputs: mag PU 3mV 50K (noise level 60dB), crystal PU 250mV 1M (noise level 70dB), aux 200mV 100K (noise level 70dB), tape 200mV 100K (noise level 70dB). Output: 20W RMS per channel. Output impedance: 8 ohms. Tone controls: treble  $\pm 12$ dB at 10kHz, bass  $\pm 10$ dB at 50Hz, loudness  $\pm 12$ dB at 50Hz and + 4dB at 10kHz. HD: 0.5% at 15W output. FR: 20Hz-30kHz  $\pm 3$ dB. Mains: 110, 240V AC. Finish: teak with brushed aluminium. Size: 17 $\frac{1}{4}$   $\times$  12  $\times$  5 $\frac{1}{8}$  in. Price: £105.05 (including VAT).

#### AMSTRAD

AMS Trading (Amstrad) Ltd,  
89 Ridley Road, London, E8. Tel: 01-249 5237.

##### Model 5000 ★

25W RMS/channel MW, LW and VHF facility. AFC, muting, in-built stereo decoder, headphones, four speaker outputs. Inputs: phono (mag), phono (cer). Tape in/out. Tuner sensitivity: 2 $\mu$ V. THD: 0.1% at 20W. Scratch, rumble and loudness filters mono/stereo, bass, treble and middle, separate volume controls. Size: 23 $\frac{1}{4}$   $\times$  8 $\frac{3}{4}$   $\times$  3 $\frac{1}{8}$  in. Price: £90 (including VAT).

#### ARMSTRONG

Armstrong Audio Ltd,  
Warlters Road, Holloway, London, N7 0RZ.  
Tel: 01-607 3213.

##### Model 625 ★

FM stereo tuner/amplifier. Range: 87.5-108MHz. Variable tuning plus six preset stations. AFC. Foster Seeley discriminator. Phase locked loop stereo decoder. Centre-zero tuning meter and field strength. Usable sensitivity: 1 $\mu$ V. Aerial input: 75-80 ohms coaxial, 240-300 ohms balanced twin. Stereo decoder fitted. 33 transistors, 36 diodes. Inputs: mag PU 2.7mV and 10mV switchable 47K, tape 250mV 68K, radio 120mV 68K, aux 120mV 68K. Noise level: (all inputs) better than -65dB. Overload capability: (mag PU inputs) 70mV and 300mV, (tape input)

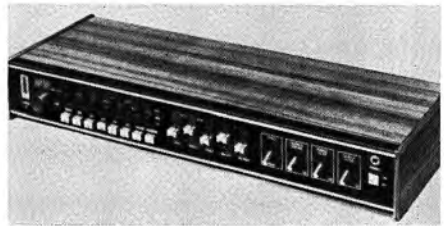

Amstrad Model 5000



Armstrong Mod. 625 FM Receiver

7V, (other inputs) 3V. Output: 40W RMS per channel into 8 ohms, 50W RMS per channel into 4 ohms. Controls: bass  $\pm 15$ dB at 70Hz, treble  $\pm 13$ dB at 14kHz, electronic gate input selector, switches for two pairs of speakers, loudness, tape monitor, mono/stereo, 2  $\times$  high filters and slope control, high filter, low filter. HD: < 0.08%. Output impedance: 4-16 ohms. FR: 25Hz-25kHz  $\pm 1$ dB at 1W output. Mains: 105-135V, 215-250V AC. Size: 19 $\frac{3}{4}$   $\times$  3 $\frac{1}{4}$   $\times$  11 $\frac{1}{4}$  in. Finish: zinc diecast front panel enamelled black, wood case in teak or rosewood. Sockets all DIN type. Outlet socket for AC mains. Price: £118.80 (including VAT).

##### Model 626

AM/FM stereo tuner/amplifier. Range: FM 87.5-108MHz, MW/LW continuous 185-2070m. Variable tuning plus three preset FM stations and three AM stations. AFC. Foster Seeley discriminator. Phase locked loop decoder. Centre-zero tuning meter and field strength. Usable sensitivity: FM 1 $\mu$ V, AM 25 $\mu$ V. Aerial input: 75-80 ohms coaxial, 240-300 ohms balanced twin. Stereo decoder fitted. 42 transistors, 40 diodes. Inputs: mag PU 2.7mV and 10mV switchable at 47K, tape 250mV 68K, radio 120mV 68K, aux 120mV 68K. Noise level: (all inputs) better than -65dB. Overload capability: (mag PU inputs) 70mV and 300mV, (tape input) 7V, (other inputs) 3V. Output: 40W RMS per channel into 8 ohms, 50W RMS per channel into 4 ohms. Controls: bass  $\pm 15$ dB at 70Hz, treble  $\pm 13$ dB at 14kHz, electronic gate input selector, switches for two pairs of speakers, loudness, tape monitor, mono/stereo, 2  $\times$  high filters and slope control, high filter, low filter. HD: < 0.08%. Output impedance: 4-16 ohms. FR: 25Hz-25kHz  $\pm 1$ dB at 1W output. Mains: 105-135V, 215-250V AC. Size: 19 $\frac{3}{4}$   $\times$  3 $\frac{1}{4}$   $\times$  11 $\frac{1}{4}$  in. Finish: zinc diecast front panel enamelled black, wood case in teak or rosewood. Sockets all DIN

type. Outlet socket for AC mains. Price: £142.56 (including VAT).

### ■ ASA

ASA (UK) Television and Radio Ltd,  
31-35 High Street, Shirlhampton, Bristol,  
BS11 0DX. Tel: Avonmouth (027 52) 5035.

#### 3199

FM stereo tuner/amplifier. Range: 87.5-104 MHz. Sensitivity: better than  $2\mu\text{V}$  for 26dB quieting. Three preset tuning buttons. AFC. Aerial input: 240 ohms balanced. Stereo decoder with auto switching and beacon. Output: 8W RMS per channel. FR: 40Hz-20kHz  $\pm 1.5$  dB. HD:  $< 1\%$ . Tone controls: bass +18dB -15dB at 40Hz, treble +14dB -15dB at 10kHz. Rumble and scratch filters. Inputs: mag PU 5-70mV 47K, crystal PU 80-1200mV 500K, tape play 260-3800mV 500K. 30 transistors, one IC, 13 diodes. Mains: 220-240V AC. Finish: anodised metal front, teak or rosewood cabinet. Size:  $17\frac{3}{8} \times 3\frac{1}{8} \times 9\frac{1}{4}$  in. Price: teak and rosewood £73.57 (including VAT).

#### 3703

FM stereo tuner/amplifier. Range: 87.5-104 MHz. Sensitivity: better than  $2\mu\text{V}$  for 26dB quieting. Aerial input: 240 ohms balanced. AFC. Variable tuning plus three presets. Quiet tuning facility. IC stereo decoder with auto switching and beacon. Output: 20W RMS per channel. FR: 30Hz-30kHz  $\pm 1.5$  dB. HD:  $< 1\%$ . Tone controls: bass +18dB -15dB at 40Hz, treble +14dB -15dB at 10kHz. Rumble and scratch filters. Inputs: mag PU 4mV 47K, crystal PU 70mV 500K, tape play 260mV 500K. Front jack sockets for headphones (automatically mute speaker outlets). 37 transistors, 15 diodes, one IC, three varicap diodes. Mains: 220-240V 50Hz. Finish: anodised metal front with teak or rosewood cabinet. Size:  $20\frac{1}{2} \times 3\frac{1}{8} \times 9\frac{1}{4}$  in. Price: teak and rosewood £88.86 (including VAT).

### ■ BANG & OLUFSEN

Bang & Olufsen (UK) Ltd, Eastbrook Road,  
Gloucester, GL4 7DE.  
Tel: Gloucester (0452) 21591.

#### Beomaster 800 and 901 ★

20W per channel stereo tuner/amplifiers: 800 with integral speakers, 901 without speakers. Tuning range: FM 87.5-104MHz. LW 147-350 kHz, MW 520-1610kHz. Variable tuning. 'Balanced light' tuning indicator. Sensitivity:  $< 1.8 \mu\text{V}$  FM;  $< 15\mu\text{V}$  LW,  $< 20\mu\text{V}$  MW. AFC. Aerial input: 75 ohms coaxial and 300 ohms balanced. FR: 20Hz-30kHz  $\pm 1.5$  dB. HD:  $< 0.5\%$  at full output. S/N ratio: mag PU  $> 55$  dB, other inputs  $> 65$  dB. Inputs: mag PU 2.5mV 47K, tape 150mV 470K. Outputs: 4 ohms and headphones

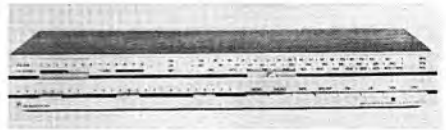

Bang & Olufsen Beomaster 901

100 ohms minimum. Mains: 110-130 and 220-240V 50-60Hz. Size: (800)  $33.8 \times 9.0 \times 3.7$  in. (901)  $19.6 \times 9.0 \times 2.95$  in. Price: (800) £119.50 (teak); £116.50 (rosewood), (901) £115.50 (teak); £120.50 (rosewood) (including VAT).

#### Beomaster 1001

15W per channel stereo FM tuner/amplifier with ambiophonic facility. Tuning range: 87.5-104MHz. Variable tuning plus 3 presets. Tuning indicator. AFC. Sensitivity:  $< 1.8\mu\text{V}$  (IEC). Aerial input: 75 ohms coaxial and 300 ohms balanced. FR: 20Hz-30kHz  $\pm 1.5$  dB. HD:  $< 0.5\%$  at full output. S/N ratio: mag PU  $> 55$  dB, other inputs  $> 65$  dB. Inputs: mag PU 3.5mV 47K, tape 200mV 470K. Outputs: 4 ohms and headphones 100 ohms minimum. Mains: 110-130 and 220-240V AC 50-60Hz. Special features include ambiophonic speaker switch for side or rear loudspeakers plus black anodised control panel. Horizontal or vertical use. Wall mounting bracket optional. Size:  $21.4 \times 8.1 \times 3.1$  in. Price: (teak) £105.50; (rosewood or white) £106.50; wall bracket £2.43 (including VAT).

#### Beomaster 3000-2

Stereo, transistorised, 40W per channel. Range: 87.5-104MHz. Variable tuning plus six presets. Meter indicator. Decoder fitted. Ratio detector. Switched AFC. Aerial: IEC sockets for 75 ohms and 240 ohms. FR: ( $\pm 1$  dB): 40Hz-20kHz. HD: 0.3%. Noise level: -65dB. Inputs: mag PU variable 1.5-100mV 47K; crystal/ceramic variable 200mV-3V 1M; tape variable 200mV-3V 1M. Controls: tuning and presets, volume, balance, mono L, mono R, Speakers 1, Speakers 2, low filter (80Hz, 12dB/octave), high filter (4kHz, 12dB/octave), bass  $\pm 17$  dB at 50Hz, treble  $\pm 14$  dB at 10kHz. Features include: FE's, ceramic filters, integrated circuits, special tuning device, variable input sensitivities, slider controls. Mains: 110, 130, 220, 240V 50-60Hz. Dimensions:  $22\frac{3}{4} \times 10\frac{1}{4} \times 3\frac{3}{8}$  in. Price: (teak) £179.50; (rosewood or white) £180.50 (including VAT).

#### Beomaster 4000

Stereo 60W per channel FM tuner/amplifier. Tuning range: 87.5-104MHz. Variable tuning plus six preset stations. Meter indicator plus 'balanced light' tuning. AFC. Sensitivity:  $< 1.4 \mu\text{V}$ . Aerial inputs: 75 ohms coaxial and 300 ohms balanced. FR: 20Hz-30kHz  $\pm 1.5$  dB. HD:



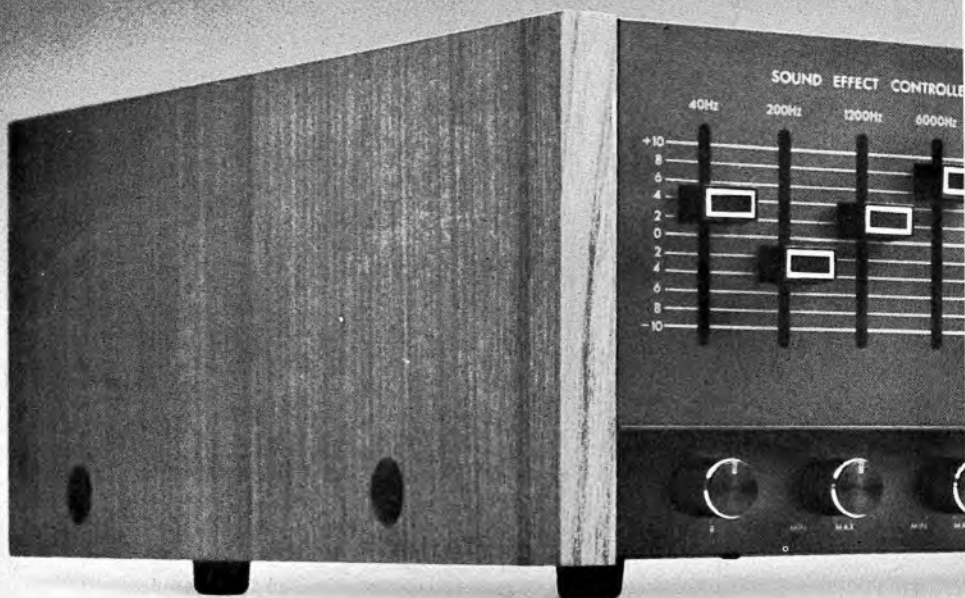

## Whether it produces 60 watts Eagle put the same

It may surprise you to know the Eagle name is on over 800 pieces of electronic equipment—the widest range in this country.

Not that quantity alone proves quality.

Everything we sell has come a long way before we put our name on it.

It's undergone months, sometimes years of research. Including constant comparisons with competitive products.

And each item is individually tested before it leaves us.

(That means our technical people

check every single piece of equipment—not just one in a hundred—to make sure it works when you get it home.)

Of course a range like ours has other advantages.

Your equipment can be totally matched.

From tuner amplifiers right down to din plugs and connecting leads.

One look at our catalogue will take in the rest.

Our AA38 turntable, for example, with its FF12E cartridge. Perhaps our AA14 speaker system. Stereo or quadra-



## or makes no sound at all, care into both.

phonic headphones, and so on.

As far as service goes we have spare parts on our shelves for all our equipment. So we won't keep you waiting while components come from foreign parts.

What it all adds up to is reliability.

Whether you spend over £300 on a complete hi-fi system or 18p on a car aerial plug.

That's why we confidently hang a two year guarantee on everything we make.

Or more importantly, our reputation.

Please send me the Eagle 1974 Hi-Fi  
Colour Brochure and your latest  
Electronics Range Catalogue.

Name \_\_\_\_\_

Address \_\_\_\_\_

\_\_\_\_\_

**Eagle**<sup>®</sup>

HFYB1

The name on Britain's widest range of electronic equipment.

• Eagle International, Precision Centre, Heather Park Drive,  
Wembley HA0 1SU. Telephone 01-903 0144.

★ Indicates entry is illustrated

<0.2% at 60W. S/N ratio: mag PU >62dB at full output, tape >75dB at full output. Inputs: mag PU 3mV 47K variable, tape (1) 250mV 1M variable, tape (2) 250mV 1M variable. Outputs: speakers 4 ohms, ambiphonic speakers 4 ohms, plus headphones. Special features include ambiphonic reproduction via side or rear speakers, black anodised panel. Mains: 110-130 and 220-240V AC 50-60Hz. Size: 22.4×10.6×3.7in. Price: (teak) £218.50; (rosewood) £219.50 (including VAT).

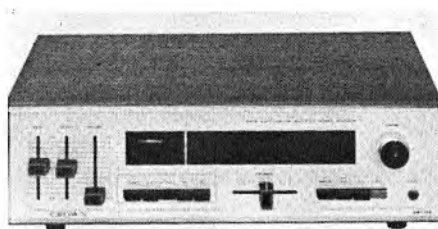

Crown SM-120

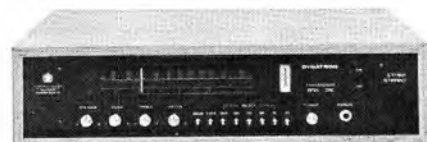

Dynatron TVR26

### ■ BRAHMS

Brahms Manufacturing and Development Co, Unit E, Rochester Airport, Maidstone Road, Rochester, Kent. Tel: Medway (0634) 48816.

#### Model Stereo 2000

FM stereo receiver. Five presets for timing. Tuning meter. Band: 87-104MHz. Inputs for two tape recorders, phono (mag) phono (ceramic), mic, and 75 ohm aerial. Outputs for two tape recorders, two sets of speakers (4 ohms), stereo headphones (8-600 ohms). Power output: 20Hz-30kHz. THD: <0.5% at rated power. Price: £114 (including VAT).

### ■ BUSH-ARENA

Rank Radio International Ltd, PO Box 596, Power Road, Chiswick, London, W4 5PW. Tel: 01-994 6491.

#### TA2700

FM stereo tuner/amplifier. Range: 88-108MHz. Sensitivity: 1.5µV for 36dB signal/noise. Five preset stations. Aerial input: 75 ohms coaxial. Inputs: mag PU 3mV 47K, tape 120mV 100K, aux (2) 60mV 47K. Controls: volume on/off, bass ±12dB at 50Hz, treble +11dB -13dB at 10kHz, balance, loudness, rumble filter, mono/stereo, speaker selection. Output: 15W per channel RMS. Output impedance: 3-15 ohms. FR: 20Hz-15kHz-3dB. HD: <0.6% 40Hz-12.5kHz. Mains: 110, 130, 220, 240V 50Hz. Size: 19 $\frac{3}{8}$ ×4 $\frac{3}{8}$ ×10 $\frac{1}{2}$ in. Output for stereo phones. Price: £85.67 (including VAT).

#### TA2800

AM/FM stereo tuner/amplifier. Range: FM 88-108MHz, LW 833-2000m, MW 182-583m, SW1 49m band, SW2 68.2-187m. Sensitivity: FM 1.5µV for 26dB signal/noise, LW 60µV, MW 25µV, SW1 10µV, SW2 8µV. Inputs: mag PU 3mV 47K, tape 120mV 100K. Controls: volume on/off, bass ±12dB at 50Hz, treble +11dB -13dB at 10kHz, balance, loudness, mono/stereo, speaker selection. FR: 20Hz-25kHz-3dB. HD: <0.6% 40Hz-12.5kHz. Output: 15W RMS per channel into 3 ohms. Output impedance: 3-15 ohms. Mains: 110, 130, 220, 240V 50Hz. Size: 19 $\frac{3}{8}$ ×6×9 $\frac{1}{8}$ in. Finish: teak

vener with brushed aluminium panel. Price: £89.43 (including VAT).

### TA3500

FM stereo tuner/amplifier. Range: 88-108MHz. Five preset stations. AFC stereo decoder fitted. Stereo beacon. Inputs: mag PU 2.25mV 47K, tape 90mV 200K. Controls: volume, bass +12dB -15dB at 100Hz, treble +11dB -13dB at 10kHz, balance, mono/stereo, on/off, input selection. Output: 10W per channel RMS into 4 ohms. Output impedance: 4-15 ohms. FR: 25Hz-20kHz-3dB. HD: 1%. Mains: 220, 240V 50Hz. Size: 21 $\frac{3}{8}$ ×3 $\frac{3}{8}$ ×8 $\frac{3}{8}$ in. Finish: teak veneer. Price: £74.37 (including VAT).

### ■ CROWN

Crown Radio Co Ltd, 128-9 Shoreditch High Street, London, E1 6JE. Tel: 01-739 2382.

#### Model SM 120 ★

FM/AM stereo receiver. Bands: 88-108MHz plus AM/MW. Fitted with AFC and tuning meter. Sensitivity: 3µV IHF (FM), 25µV AM. Aerial: 300 ohms plus AM ferrite rod. Inputs: phono (mag) 4mV, aux 200mV, phone (ceramic) 250mV, tape 200mV. S/N: >50dB phono, 70dB aux. Output: 14W per channel into 8 ohms. THD: <0.5% at 12W. FR: 30Hz-20kHz. Size: 387×120×290mm. Price: £97.90 (including VAT).

### ■ DYNATRON

Dynatron Radio Ltd, St Peter's Road, Maidenhead, Berks, SL6 7QY. Tel: Maidenhead (0628) 23331.

#### TVR26 ★

Stereo transistorised AM/FM tuner/amplifier. Ranges: 87-108MHz, MW 185-570m, LW 1100-

2000m. Variable tuning. Ratio detector. Meter tuning indicator. Sensitivity:  $5\mu\text{V}$  for 20dB quieting. Aerial input VHF: 75 ohms coaxial. Stereo decoder fitted. AFC. Output: 8W per channel at less than 1% distortion. FR: ( $\pm 3\text{dB}$ ) 40Hz-16kHz at  $\frac{1}{2}$ W. Noise level -90dB. Output impedances: speakers 4 ohms, earphones 8 ohms or greater. Inputs: tape 35mV 20K, noise level -70dB; crystal PU 75mV 100K (special correction), noise level -60dB; magnetic PU 5mV, noise level -60dB. Controls: tuning, balance, input selector, bass, treble, volume, loudness, AFC, filter, on/off. Size:  $19 \times 14 \times 5\frac{1}{2}$ in. Mains: 240V AC only. Price: £82.47 (including VAT).

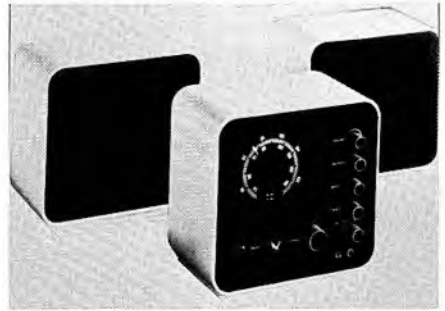

Eagle SC720

### ■ EAGLE

Eagle International, Heather Park Drive, Wembley, Middlesex, HA0 1SU.  
Tel: 01-903 0144.

#### SC720 ★

AM/FM stereo tuner/amplifier with two separate speakers. Range: FM 88-108MHz, MW 186-578m. Variable tuning with AFC. Usable sensitivity: FM  $12\mu\text{V}$ , AM  $200\mu\text{V}$ . Aerial input: 75 ohms coaxial, or balanced. Stereo decoder included, with automatic beacon. Mains: 240V AC. Size:  $9\frac{1}{2} \times 9\frac{1}{2} \times 6\frac{3}{4}$ in. Finish: matt white moulded cases, black facia with dial illuminated in green. Price: £63.80 (including VAT).

#### AA28 ★

AM/FM stereo tuner/amplifier. Range: FM 88-108MHz, MW 187-560m. Variable tuning. AFC. Ratio detector. Meter tuning indicator. Usable sensitivity: FM  $3\mu\text{V}$ , MW  $150\mu\text{V}$ . Aerial input: 75 ohms coaxial, 300 ohms balanced. Stereo decoder fitted. 44 transistors, 23 diodes. Inputs: mag PU 3mV 47K, aux 180mV 100K, tape 180mV 100K. Noise level: (PU input) -64dB, (other inputs) -70dB. Overload capability: (PU input) 70mV. Output: 30W RMS per channel into 8 ohms. Tone controls: bass  $\pm 12\text{dB}$  at 40Hz, treble  $\pm 10\text{dB}$  at 12kHz, filter -10dB at 8kHz. HD: <0.2%. Output impedance: 8 ohms. FR: 15Hz-36kHz  $\pm 2\text{dB}$  at 6dB below full output. Size:  $17 \times 5\frac{1}{2} \times 13\frac{3}{4}$ in. Has ambiophony facility. Mains: 240V AC. Finish: black and teak. Price: £134.20 (including VAT).

#### AA30

AM/FM stereo tuner/amplifier. Range: FM 88-108MHz, MW 187-560m. Variable tuning. AFC. Ratio detector. Meter tuning indicator. Usable sensitivity: FM  $3\mu\text{V}$ , MW  $150\mu\text{V}$ . Aerial input: 75 ohms coaxial, 300 ohms balanced. Stereo decoder fitted. 44 transistors, 23 diodes. Inputs: mag PU 3mV 47K, aux 180mV 100K, tape 180mV 100K. Noise level: (PU input) -64dB, (other inputs) -70dB. Overload capability: (PU input) 70mV. Output: 30W RMS per chan-



Eagle AA28

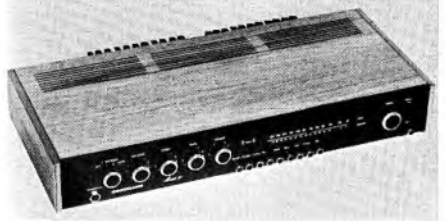

Goodmans Module 80

nel into 8 ohms. Tone controls: bass  $\pm 12\text{dB}$  at 40Hz, treble  $\pm 10\text{dB}$  at 12kHz, loudness +6dB at 100Hz+6dB at 10kHz. HD: <0.2%. Output impedance: 8 ohms. FR: 15Hz-36kHz  $\pm 2\text{dB}$  at 6dB below rated output. Mains: 220-240V AC. Size:  $17 \times 5\frac{1}{2} \times 13\frac{3}{4}$ in. Has ambiophony facility. Finish: teak and black. Special sound effect controllers giving  $\pm 10\text{dB}$  at 40Hz, 200Hz, 1.2kHz, 6kHz and 15kHz. Price: £147.40 (including VAT).

### ■ GOODMANS

Goodmans Loudspeakers Ltd, Downley Road, Havant, Hampshire, PO9 2NI.  
Tel: Havant (070 12) 6344. Telex: 85296.

#### Module 80 ★

FM stereo tuner/amplifier. Range: 87-108MHz. Variable tuning with switchable AFC. Tuning indicator. Stereo decoder fitted. Automatic stereo beacon. Aerial input: 240-300 ohms balanced. Inputs: magnetic PU 2mV 50K, aux and crystal PU 60mV 600K, tape play 320mV 50K. Controls: mains on/off and speaker selector, balance, treble +10dB -17dB at 10kHz, bass

★ Indicates entry is illustrated

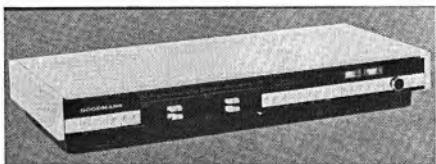

Goodmans Module 90

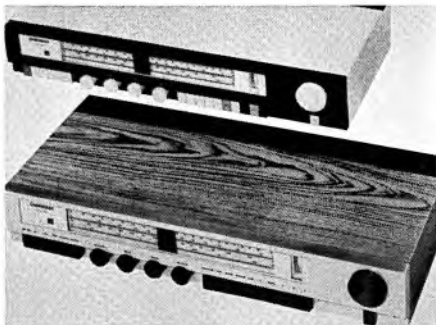

Goodmans Model One Ten

$\pm 13$ dB at 50Hz, volume, HF filter  $-11$ dB at 16kHz, LF filter  $-11$ dB at 25Hz, loudness  $+11$ dB at 50Hz and  $+6$ dB at 10kHz (with volume control retarded 30dB), left/right reverse, stereo/mono, tape play and monitor, tuning, input selector buttons, AFC, on/off. Output: 35W RMS per channel into 4 ohms. HD:  $<0.1\%$  at 30W per channel. FR: 30Hz-20kHz  $\pm 1.5$ dB. Damping factor: (4 ohm load) 40; (8 ohm load) 80; (15 ohm load) 150. Socket for stereo phones. DIN sockets for two sets of speakers. AC mains outlet socket. H and N: 80dB below 35W on tape/aux input, 66dB below 35W on magnetic PU input. Crosstalk between channels: better than 45dB 40Hz-13kHz. FM radio sensitivity: better than  $1.5\mu\text{V}$  for 26dB S/N. Pilot tone rejection:  $-36$ dB at 19kHz and 38kHz (ref 0dB at 67kHz deviation). 68 semiconductors (including two FETs). Size:  $22 \times 3\frac{3}{4} \times 11\frac{3}{4}$ in. Mains: 120V, 220V or 240V AC. Consumption: 150W maximum. Price: £79.59 (plus VAT).

#### Module 90 ★

AM/FM stereo tuner-amplifier. Range: FM 87.5-108MHz, MW 525-1630kHz, four pre-selected FM stations and variable tuning. Switched AFC. Illuminated tuning/weak signal indicator. Aerial inputs: 240 ohms balanced FM and AM sockets. Usable sensitivity: typically  $2\mu\text{V}$  FM,  $50\mu\text{V}$  AM. Ceramic filters in IF amplifier. 73 semiconductors. Inputs: mag PU 3mV 50K, ceramic PU 100mV 500K, tape play 200mV 33K. Noise level: tape  $-75$ dB, PU  $-60$ dB. Overload capability:  $+23$ dB. Output:

45W RMS into 4 ohms. Controls: slides for treble, bass, volume/balance, rotary/tuning, 15 tabs for functions and four pre-selected FM stations. HD: less than  $0.1\%$  at 35W. FR: 25Hz-30kHz  $+0.3$ dB. Mains: 220-245V AC, 122V dealer adjustable. Size:  $24\frac{1}{2} \times 11\frac{3}{4} \times 4$ in. Finish: teak, walnut veneered or white lacquer sleeve. Price: £101.85 veneer, £103.56 white finish.

#### Model One Ten ★

AM/FM stereo tuner/amplifier. Range: FM 87.5-108MHz, MW 187-570m, LW 1130-2000m, SW 48-51m. Variable tuning. Switched AFC. Signal strength meter. Aerial input: 75 ohms coaxial, 240 ohms balanced. Usable sensitivity: (FM 75 ohms)  $1\mu\text{V}$ ; (FM 240 ohms)  $2\mu\text{V}$ ; AM typically 20-40 $\mu\text{V}$ . Ceramic filters in IF amplifier. Quiet tuning facility on FM. 89 semiconductors. Inputs: mag PU 2.5mV 56K, ceramic PU 200mV 1 megohm, tape play 200mV 100K. Noise level: mag PU  $-70$ dB, other inputs  $-80$ dB. Overload capability:  $+30$ dB. Output: 50W RMS into 4 ohms. Controls: balance, bass, treble, volume, contour, plus 17 tabs for all functions. HD:  $<0.01\%$  at 30W,  $<0.1\%$  at any power up to maximum. FR: 15Hz-45kHz  $\pm 3$ dB. 20Hz-20kHz  $\pm 1$ dB. Mains: 115-125V, 200-250V AC. Size:  $23 \times 5\frac{7}{8} \times 12$ in. Finish: teak or walnut with brushed aluminium facia, or black and white with white controls and black facia. Electronic protection of output stages. Price: (with tuner) £118.96 (plus VAT).

#### ■ GRUNDIG

Grundig (Great Britain) Ltd, Hi-Fi Division, Newlands Park, London, SE26 5NQ. Tel: 01-659 2468. Telex: 22854.

#### RTV800 ★

AM/FM stereo tuner/amplifier. Range: FM 87.5-108MHz, MW 185-587m, LW 857-2069m, SW 19-55m. Variable tuning on AM plus seven preset buttons on FM. AFC. Ratio detector. Meter tuning indicator. Usable sensitivity: FM  $2.2\mu\text{V}$  across 240 ohms, MW 12-25 $\mu\text{V}$ , LW 21-5 $\mu\text{V}$ , SW 4.7-5.2 $\mu\text{V}$ . Aerial input: 240 ohms balanced. Stereo decoder fitted. 38 transistors and 23 diodes (plus two rectifiers). Inputs: mag PU 3mV 47K, crystal PU 200mV 470K, tape 200mV 470K. Noise level (for 12.5W output)  $>60$ dB. Overload capability: 28dB. Output: 12.5W RMS per channel into 4 ohms. Controls: volume, treble  $-18$ dB to  $+13$ dB at 16kHz, bass  $-15$ dB to  $+12$ dB at 40Hz, balance  $-9$ dB to  $+4$ dB. HD:  $<0.5\%$  at 1kHz. Output impedance: 4 ohms. Stereo headphone socket. FR: 40Hz-16kHz  $\pm 2$ dB for mag PU ( $\pm 1.5$ dB for other inputs). Mains: 110, 130, 220, 240V AC 50-60Hz. Size:  $23\frac{3}{4} \times 5\frac{1}{8} \times 11\frac{1}{2}$ in. Finish: walnut finish case with silver trim. Price: £150.40 (including VAT).



Grundig RTV800

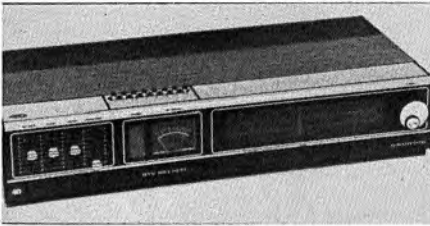

Grundig RTV901 Tuner Amplifier

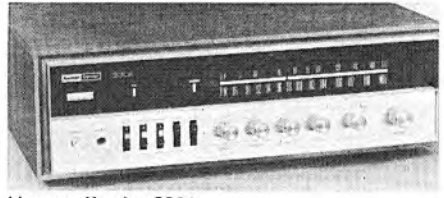

Harmon Kardon 330A

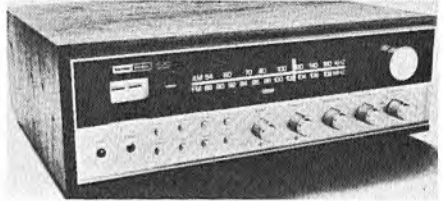

Harmon Kardon 630

**RTV 901 ★**

FM/AM stereo and synthesized four channel receiver. Bands: 87.5-108MHz FM, 145-350kHz LW, 510-1620kHz MW, 5.4-16.2MHz SW. Seven preset selectors for FM, Manual for AM. Sensitivity: 1.9µV DIN (FM), 12-25µV MW, 21-21.5µV LW, 4.7-5.2µV SW. Aerials: 240 ohms (FM) wire (AM). Inputs: phono (mag) 3.3mV 470K, phono (ceramic) 300mV 470K, tape 300mV 470K. Output: 25W per channel into 4 ohms. Damping factor: 20. THD: 0.5% at 1kHz and full rated power. FR: 40Hz-16kHz ± 2dB. Size: 23½ × 5¼ × 1½ in. Price: £198 (including VAT).

**■ HANIMEX**

Hanimex (UK) Ltd, Hanimex House, Dorcan, Swindon, Wilts. SN3 5HW. Tel: Swindon (0793) 26211.

New range of hi-fi stereo tuner/amplifiers to be introduced under Hanimex brand name. No details of models available as this edition of the Year Book closed for press.

**■ HARMAN-KARDON**

Highgate Acoustics Ltd, 38 Jamestown Road, London, NW1 7EJ. Tel: 01-267 4937.

**330A ★**

AM/FM stereo tuner/amplifier. Range: FM 88-108MHz, MW 175-600m. Variable tuning. AFC. Ratio detector. Meter tuning indicator. Usable sensitivity: MW 25µV, FM 1.9µV. Aerial input: 300 ohms balanced, 75 ohms coaxial. Stereo decoder included. Inputs: mag PU 1.9mV 47K, aux 300mV 20K. S/N ratio: PU 65dB. Overload capability: (PU) 90mV. Output: 22.5W RMS per channel. Tone controls: (independent bass and treble controls for each channel) bass ± 12dB, treble ± 12dB, contour + 8dB

at 50Hz. HD: 0.2% at 20W. Output impedance: 8 ohms. FR: 7Hz-50kHz ± 1dB. at 20W. Mains: 110, 240V AC. Finish: black cabinet with brushed aluminium trim, walnut sleeve optional extra. Price: £137.50 (including VAT).

**630 ★**

AM/FM stereo tuner/amplifier. Range: FM 88-108MHz, MW 175-600m. Variable tuning. AFC. Ratio detector. Meter tuning indicator. Usable sensitivity: MW 15µV, FM 1.9µV. Aerial input: 300 ohms balanced, 75 ohms coaxial. Stereo decoder included. Inputs: mag PU 1.5mV 47K, aux (1) 300mV 20K, aux (2) 300mV 20K. Noise level: PU input 65dB, aux inputs 85dB. Output: 30W RMS per channel. Tone controls: (independent bass and treble controls for left and right channels) bass ± 12dB, treble ± 12dB, contour + 8dB at 50Hz, high cut filter - 8dB at 10kHz (6dB/octave). HD: 0.2% at 30W. Output impedance: 8 ohms. FR: 4Hz-70kHz ± 0.5dB. Mains: 110, 240V AC. Size: 12 × 4¼ × 13¾ in. Finish: black case with brushed aluminium trim, walnut sleeve optional extra. External Dolby B input/output equalisation. Quiet tuning facility on FM. Price: £207.90 (including VAT).

**930**

AM/FM stereo tuner/amplifier. Range: FM 88-108MHz, MW 175-600m. Variable tuning. AFC. Ratio detector. Tuning indicators: FM centre-zero meter, AM/FM signal strength meter. Usable sensitivity: MW 15µV, FM 1.8µV. Aerial input: 300 ohms balanced, 75 ohms coaxial. Stereo decoder included. Quiet tuning facility on FM. FET front end. Rotating AM ferrite rod aerial. Inputs: mag PU (1) 1.5mV 47K, mag PU (2) 1.5mV 47K, aux (1) 300mV 20K, aux (2) 300mV 20K. Noise level: PU in-

★ Indicates entry is illustrated

puts 65dB, aux inputs 85dB. Overload capability: (PU inputs) 90mV. Output: 45W RMS per channel. Tone controls: (independent bass and treble controls for each channel) bass  $\pm 12$  dB, treble  $\pm 12$ dB, high cut filter  $-8$ dB at 10kHz (6dB/octave), low cut filter  $-15$ dB at 25Hz, contour  $+8$ dB at 50Hz. HD: 0.2% at 45W. Output impedance: 8 ohms. FR: 8Hz-100kHz. Separate power supply for left and right channels. Size:  $17 \times 4\frac{1}{2} \times 13\frac{3}{4}$  in. Mains: 110, 240V AC. Finish: black case with brushed aluminium trim, walnut sleeve optional extra. Price: £284.90 (including VAT).

#### Model 50+

FM/AM stereo or quadraphonic receiver. Bands: 84-108MHz FM, 535-1605kHz AM. Manual tuning meter. Sensitivity:  $2.9\mu\text{V}$  IHF (FM),  $30\mu\text{V}$  (AM). Aerial: 75 or 300 ohms. S/N: 62dB FM. THD: stereo 0.9%. Size:  $15\frac{1}{8} \times 12\frac{3}{4} \times 4\frac{3}{4}$  in. SQ and discrete 4-channel facilities. No further details available concerning amplifier section. Price: £174.90 (including VAT).

#### Model 70+

FM/AM stereo or quadraphonic receiver. Bands: 84-108MHz FM, 535-1605kHz AM. Manual tuning meter. Sensitivity:  $2\mu\text{V}$  IHF (FM),  $15\mu\text{V}$  (AM). Aerial: 75 or 300 ohms. S/N: 70dB (FM). THD: 0.6% mono, 0.7% stereo. Size:  $17 \times 16\frac{1}{4} \times 5\frac{1}{4}$  in. SQ matrix and discrete 4-channel facilities. No further details concerning amplifier section. Price: £284.90 (including VAT).

#### HEATHKIT

See Constructional Kits Section.

#### HITACHI

Hitachi Sales (UK) Ltd, New Century House, Coronation Road, Park Royal, London, NW10 7QN. Tel: 01-965 9861.

#### SR800 ★

AM/FM stereo tuner/amplifier. Similar specification to the SR700 above but with higher output and additional centre-zero tuning meter. Output: 40W RMS per channel into 4 ohms (both channels driven). Price: £139 (including VAT).

#### SR1100

AM/FM stereo tuner/amplifier. Range: FM 88-108MHz, MW 187-572m. Usable sensitivity: FM  $1.6\mu\text{V}$ , MW  $10\mu\text{V}$ . Capture ratio: 0.8dB. Aerial input: 300 ohms balanced. Inputs: mag PU (low) 1.8mV, mag PU (high) 4mV, aux 125 mV, mic 2mV, tape monitor 500mV, main 800 mV. Tone controls: bass  $\pm 16$ dB at 50Hz, treble  $\pm 16$ dB at 15kHz, high filter  $-10$ dB at 10kHz, low filter  $-8$ dB at 50Hz. Loudness  $+10$ dB at 50Hz  $+4$ dB at 10kHz. Output: 50W RMS per channel into 4 ohms (both channels driven). Out-

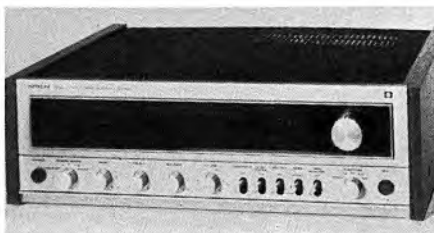

Hitachi SR-800



JVC 4VR 5436

put impedance: 4-8 ohms. FR: 20Hz-50kHz. HD: 0.05%. Damping factor: 50. FET front end. Stereo decoder. Signal strength meter and centre-zero tuning meter. Quiet tuning facility. Outputs for two pairs of speakers. Size:  $17\frac{3}{8} \times 5\frac{3}{8} \times 13$  in. Weight:  $27\frac{1}{2}$  lb. Price: £189 (including VAT).

#### Model KH.5000

No technical details available at time of going to Press. Price: £429.

#### JVC

JVC (UK) Ltd, 453 Caledonian Road, London, N7 9BA. Tel: 01-607 6568.

#### 5501

AM/FM stereo tuner/amplifier. Variable tuning. Range: FM, MW, LW. Output: 10W RMS per channel (sockets for two pairs of speakers). Loudness control. Stereo decoder fitted. Price: £108.35 (including VAT).

#### 5521

AM/FM stereo tuner/amplifier. Variable tuning. Range: FM, MW, LW. Stereo decoder fitted. Output: 25W RMS per channel. Stereo beacon. Special sound effect amplifier (SEA) tone control system. Price: £172.70 (including VAT).

#### 4MM1000

AM/FM stereo and four-channel tuner/amplifier. Variable tuning. Output: 10W per channel (four channels). Stereo decoder fitted. Two-channel to four-channels synthesis. Price: £161.15 (including VAT).

#### 4VR1006

AM/FM stereo and four-channel tuner/ampli-

fier. Variable tuning. Output: 10W RMS per channel (four channels). Stereo decoder fitted. Discrete and matrix four-channel decoders fitted. Price: £229.35 (including VAT).

**4VR5414**

AM/FM stereo and four-channel tuner/amplifier. Variable tuning. Output: 15W RMS per channel (four channels). Stereo and four-channel decoders fitted. Special sound effect amplifier (SEA) tone control system. Price: £229.35 (including VAT).

**4VR5445**

AM/FM stereo and four-channel tuner/amplifier. Variable tuning. Output: 21W RMS per channel (four channels). Special sound effect amplifier (SEA) tone control system. Stereo and four-channel decoders fitted. Price: £308 (including VAT).

**4VR5456**

FM/AM stereo and quadraphonic receiver. Bands: 88-108MHz FM, 525-1605kHz AM. Sensitivity: 1.8µV IHF (FM), 30µV AM. Tuning meter, manual tuning. Inputs: phono (1) 3mV, phono (2) 1.5mV, aux (1&2) 200mV, tape play 200mV. Output: 45W per channel (4) into 8 ohms at 1kHz. THD: 0.5% 10Hz-50kHz ±1dB. Size: 20 × 7 $\frac{1}{8}$  × 15 $\frac{3}{8}$ in. Sound effects amplifier: CD-4 demodulator and matrix decoder. Price: £385 (including VAT).

**4VR5446**

FM/AM stereo and quadraphonic receiver. Bands: 88-108MHz FM, 525-1605kHz AM. Sensitivity: 2.0µV IHF (FM), 30µV AM. Tuning meter, manual tuning. Inputs: phono (1) 3mV, phono (2) 1.5mV, aux (1&2) 200mV, tape play 200mV. Output: 22W per channel (4) into 8 ohms at 1kHz. THD: 0.5%. FR: 10Hz-30kHz ±1dB. Size: 20 × 6 $\frac{3}{8}$  × 15 $\frac{3}{8}$ in. Sound effects amplifier. CD-4 demodulator and matrix decoder. Price: £308 (including VAT).

**4VR5436 ★**

FM/AM stereo and quadraphonic receiver. Bands: 88-108MHz FM, 525-1605kHz AM. Sensitivity: 2µV IHF (FM), 30µV AM. Inputs: phono 1.5mV, aux (1&2) 200mV, tape mon (1&2) 250mV. S/N: phono 65dB, all others 75dB. Output 17W per channel (4) into 8 ohms at 1kHz. THD: 0.8%. FR: 20Hz-20kHz ±1dB. Size: 20 × 6 $\frac{3}{8}$  × 15 $\frac{3}{8}$ in. Sound effects amplifier, CD-4 demodulator, matrix decoder. Price: £258.50 (including VAT).

**VR 5535L**

FM/MW/LW stereo receiver. Bands: 88-108MHz FM, 515-1605kHz MW, 150-390kHz LW. Manual tuning, tuning meter. Sensitivity: 2µV IHF (FM) 30µV AM. Inputs: phono 2.5mV, aux (1&2) and tape play 150mV. S/N: phono 65dB, all others 70dB. Outputs: 34W per



Klinger KC96

channel into 8 ohms at 1kHz. THD: 0.3%. FR: 10Hz-50kHz. Size: 18 $\frac{3}{8}$  × 6 $\frac{1}{2}$  × 12 $\frac{3}{4}$ in. Sound effects amplifier, CD-4 demodulator, matrix decoder. Price: £214.50 (including VAT).

**VR 5525L**

FM/MW/LW stereo receiver. Bands: 88-108MHz FM, 515-1605kHz MW, 150-390kHz LW. Manual tuning, tuning meter. Sensitivity: 2.2µV IHF (FM), 30µV AM. Inputs: phono 2.5mV, aux (1&2) and tape play 150µV. S/N: phono 65dB, all others 70dB. Output: 25W per channel into 8 ohms at 1kHz. THD: 0.5%. FR: 10Hz-50kHz. Size: 18 $\frac{3}{8}$  × 6 $\frac{1}{8}$  × 12 $\frac{3}{4}$ in. Sound effects amplifier, mic mixing. Price: £186.45 (including VAT).

**VR 5515L**

FM/MW/LW stereo receiver. Bands: 88-108MHz FM, 515-1605kHz MW, 150-390kHz LW. Sensitivity: 2.2µV IHF (FM), 30µV AM. Inputs: phono 2.5mV, aux (1&2) and tape play 150mV. S/N: phono 65dB, all others 70dB. Output: 25W per channel into 8 ohms at 1kHz. THD: 0.5%. FR: 15Hz-50kHz. Size: 17 $\frac{3}{8}$  × 6 $\frac{1}{8}$  × 12 $\frac{3}{4}$ in. Microphone mixing. Price: £148 (including VAT).

**VR 5505L**

FM/MW/LW stereo receiver. Bands: 88-108MHz FM, 515-1605kHz MW, 150-390kHz LW. Sensitivity: 2.2µV IHF (FM), 100µV AM. Manual tuning, tuning meter. Inputs: phono 3.0mV, aux and tape 100mV. Output: 10W per channel into 8 ohms at 1kHz. FR: 20Hz-20kHz. Size: 18 $\frac{1}{4}$  × 5 $\frac{1}{4}$  × 13in. Price: £109.45 (including VAT).

**■ KLINGER**

Klinger Controls Ltd, Spencer Court,  
7 Chalcot Road, London, NW1 8LU.  
Tel: 01-586 2922.

**KC96 ★**

FM stereo tuner/amplifier. Range: 87.5-108MHz. Five preset stations. Switchable AFC. Usable sensitivity: 2µV. Aerial input: balanced and coaxial. Stereo decoder fitted. Circuit comprises 37 transistors, 40 diodes and one IC. Inputs: mag PU 2mV 47K, tape 50mV 220K, aux (1) 100mV 470K, aux (2) 0.15mV 30 ohms. Noise level: (mag PU) 60dB, (other inputs) 70dB. Overload capability: 30dB. Output: 25W RMS per channel. Output impedance: 8 ohms.



★ Indicates entry is illustrated

Tone controls: bass  $\pm 15$ dB, treble  $\pm 15$ dB, scratch filter 18dB/octave from 8kHz, rumble filter 12dB/octave from 80Hz. Full range balance control. HD: 0.1% at 20W. FR: 35Hz-35kHz  $\pm 2$ dB at 20W. Stabilised power supply. Two pairs of switched speaker sockets. Two outlets for stereo headphones. Direct and switched mains outlets. Finish: teak with diecast enamelled sides. Size 21  $\times$  4 $\frac{1}{2}$   $\times$  8in. Price: £97.65 (including VAT).

#### ■ KORTING

Europa Electronics Ltd, 9 Howard Place, Shelton, Stoke-on-Trent, ST1 4NW.  
Tel: Stoke-on-Trent (0782) 29316.

##### 310T

AM/FM stereo tuner/amplifier. Range: VHF, LW, MW, SW. AFC. 17 transistors, seven diodes, two ICs. Slider controls and push-buttons. Output: 5W per channel into 4 ohms. Full specification on request. Price: £68.20 (including VAT).

##### 410T

AM/FM stereo tuner/amplifier. Range: VHF, LW, MW, SW. AFC. 26 transistors, two ICs, eight diodes. Variable tuning plus five preset stations. Slider controls plus pushbuttons. Stereo decoder with beacon. Output: 10W per channel into 4 ohms. Full specification on request. Price: £84.15 (including VAT).

##### 800L ★

AM/FM stereo tuner/amplifier. Range: VHF, LW, MW, SW. AFC. 43 transistors, 21 diodes, three rectifiers. Variable tuning plus six push-buttons for preset stations. Tone controls: bass  $\pm 15$ dB, treble  $\pm 15$ dB. Balance control:  $\pm 15$  dB. Stereo decoder with beacon. Output: 16W RMS per channel into 4 ohms. Full specification on request. Price: £144.92 (including VAT).

##### 1600L ★

AM/FM stereo tuner/amplifier. Range: VHF, LW, MW, SW. 59 transistors, 25 diodes, three rectifiers. 24 pushbutton controls plus five sliders and two rotary knobs. AFC. Variable tuning plus five preset stations. Tuning indicator. Stereo decoder with beacon. Tone controls: bass  $\pm 15$ dB, treble  $\pm 18$ dB. Output: 40W RMS per channel. Full specification on request. Price: £207.35 (including VAT).

#### ■ KOYO

Distributors: Kingsway Mills Ltd, 5 Worship Street, London, EC2.  
Tel: 01-628 6157.

##### FS-900

AM/FM stereo tuner/amplifier. Range: FM 88-108MHz. MW 187-556m. Variable tuning. AFC. Inputs: pickup jack socket, tape recorder socket. Sensitivity: FM 3 $\mu$ V, AM 100 $\mu$ V. Out-

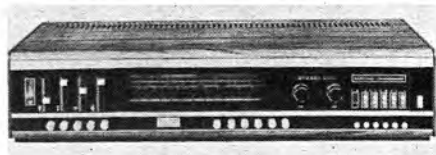

Korting-Transmare Stereo 800L

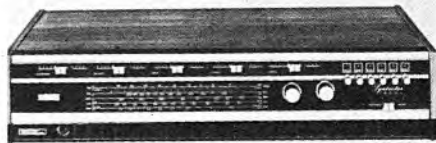

Korting-Transmare Stereo 1600L



Leak Delta 75

put: 10W per channel. Stereo decoder included, with beacon. Slide rule tuning scale. Slider controls for bass, treble, volume and balance. Size: 17 $\frac{3}{8}$   $\times$  4 $\frac{3}{4}$   $\times$  9 $\frac{7}{8}$  in. Finish: walnut end panels with leather finish top. AC mains. 29 transistors, 1 diode. Price: to be announced.

#### ■ THOMAS LANEY AUDIO

Electronic Manufacturing Co (UK) Ltd, Devonshire House, High Street, Deritend, Birmingham, B12 0LP.  
Tel: 021-772 3669/7145.

##### TLA200

FM stereo tuner/amplifier. Range: FM 87.5-108MHz. Variable tuning plus five presets. Switchable AFC. Aerial input: 75 ohms coaxial, 240 ohms balanced twin. Sensitivity: 2 $\mu$ V for 30dB quieting. Limiting complete at 5 $\mu$ V. Stereo decoder fitted. Capture ratio: 1:5dB. Inputs: mag PU 2mV 47K, aux 100mV 100K. S/N ratio: (PU input) 65dB, (aux) 70dB. Overload capability: (PU input) 100mV, (aux) 1V. Controls: bass  $\pm 12$ dB at 40Hz, treble  $\pm 12$ dB at 10kHz, filter 12dB/octave at 4kHz, 7kHz and 10kHz, balance, volume, input selector. Bass, treble and balance controls are sliders with centre 'click' position. Output: 50W RMS per channel into 4 ohms, 30W RMS per channel into 8 ohms. HD: <0.1% (typically <0.02%) 35Hz-20kHz. Power bandwidth: 20Hz-40kHz +0dB -3dB. Mains: 110, 120, 130, 220, 230, 240V AC.

Two AC outlets (one switched). Two headphone jack sockets behind flap on front panel. Quiet tuning facility. Output fully protected against any load condition. Details of cabinet finish and size not available as this edition of the Year Book closed for press. Finish: teak or rosewood. Price: £129 (plus VAT).

### LEAK

Rank Radio International Ltd, PO Box 596, Power Road, Chiswick, London, W4 5PW. Tel: 01-994 6491.

#### Delta 75 ★

AM/FM solid state tuner/amplifier. Range: FM 87.5-108MHz; MW 187-556m. Variable tuning. Aux tape (2). Inputs: tape and aux 100mV 50K, mag PU 3.5mV, ceramic PU 20mV 33K. Stereo beacon. Controls: waveband selectors, tuning, volume, on/off, balance, treble, bass, push-buttons for filter, loudness, tape, aux, disc, radio, mono, quasi stereo, mute and AFC. Output: 35W RMS into 8 ohms. 40W RMS into 4 ohms. HD: (8 ohms) less than 0.07%, (4 ohms) <0.14%, (15 ohms) <0.05%. FM: stereo crosstalk better than 35dB at 1kHz. Headphone socket. Will drive two pairs of speakers. Finish: teak or walnut. Size:  $16\frac{3}{8} \times 4\frac{1}{2} \times 12\frac{1}{4}$ in. Price: £163.83 (including VAT).

### LUX

Distributors: Howland-West Ltd, 3-5 Eden Grove, London, N7 8EQ. Tel: 01-609 0293.

#### FQ990 ★

AM/FM stereo tuner/amplifier. Range: FM 87.5-108.5MHz, MW 187-572m. Variable tuning plus preset stations on FM. AFC. Centre-zero tuning meter. Usable sensitivity: FM  $2\mu\text{V}$ . MW  $18\mu\text{V}$ . Aerial input: 75 ohms coaxial, 300 ohms balanced. Stereo decoder included. Inputs: mag PU 2mV 50K, PU (2) 10mV 50K, aux 100mV 100K, tape 100mV 100K, tape head ( $3\frac{3}{4}$ i/s) 1.8mV 100K, tape head ( $7\frac{1}{2}$ i/s) 2mV 100K. Noise level: PU inputs -60dB, tape head inputs -55dB, aux input -75dB. Overload capability: mag PU and tape head 130mV, aux 5V. Controls: mode switch, tape monitor, noise level, volume, loudness, main or remote speakers, slope selector bass, slope selector treble, three FM preset buttons. HD: 0.1%. Output: 70W RMS per channel. Output impedance: 8 ohms. FR: 10Hz-40kHz. Size:  $18\frac{1}{2} \times 13\frac{1}{2} \times 6$ in. Price: £283 (including VAT).

#### R800 ★

AM/FM stereo tuner/amplifier. Range: FM 88-108MHz, MW 187-540m. Variable tuning. AFC. Signal strength meter and centre-zero tuning meter. Usable sensitivity: FM  $1.8\mu\text{V}$ , MW  $200\mu\text{V}$ . Aerial input: 300 ohms balanced twin,



Lux FO990



Lux R800

75 ohms coaxial. Stereo decoder fitted. Inputs: mag PU (2), aux (2), tape (2), mic (2). Noise level: (mic) 60dB, (PU) 65dB, (other inputs) 80dB. Overload capability: (PU) 130mV. Output: 40W RMS per channel. Controls: treble  $\pm 10$ dB at 10kHz, bass  $\pm 10$ dB at 300Hz, low cut 20Hz-70Hz 6dB/octave, high cut 6kHz-12kHz 6dB/octave. HD: <1% at 40W. Output impedance: 8 ohms. FR: 10Hz-40kHz  $\pm 1$ dB. Mains: 100, 120, 220, 240V 50-60Hz. Finish: rosewood cabinet with champagne panel. Price: £225 (including VAT).

### MAJOR

Impo Hi-Fi, 22 Buckingham Palace Road, London, SW1. Tel: 01-834 0050.

#### RS2020L

FM/MW/LW stereo receiver. Bands: 88-108 MHz FM, 525-1600kHz MW, 145-380kHz LW. Sensitivity:  $1.9\mu\text{V}$  IHF (FM). Manual tuning, signal strength meter. Aerial: 300 ohms. Inputs: phono (mag) 3.5mV, phono (ceramic) 130mV, aux 200mV tape play 350mV. Tape output: 30mV (DIN socket), 300mV at high level output. Output: 10W per channel into 8 ohms, 15W at 4 ohms. THD: 0.07% at 1kHz and 1W. Power bandwidth: 25Hz-40kHz. Size:  $390 \times 320 \times 120$ mm. Price: on application.

### MARANTZ

Pyser Ltd, Fircroft Way, Edenbridge, Kent. Tel: Edenbridge (0732 71) 4111.

#### Model 19

Stereo FM tuner/amplifier. Range: 88-108MHz.

★ Indicates entry is illustrated

Variable tuning with gyro control. Oscilloscope tuning indicator. Sensitivity: (IHF) 1.8 $\mu$ V or better. Separation: 40dB at 20Hz, 30dB at 15kHz. Capture ratio: 3.5dB. HD: 0.15%, 19kHz and 38kHz. Suppression: better than 60dB. Aerial impedance: 300 ohms balanced, 75 ohms coaxial. Inputs: PU 1mV 47K, aux 100mV 100K. Output: 50W RMS per channel into 8 ohms, 30W per channel into 16 ohms. HD: <0.15% (typically <0.06%). FR: 20Hz-20kHz  $\pm$ 0.5dB. Tone controls: bass  $\pm$ 10dB at 100Hz, treble  $\pm$ 10dB at 10kHz. High filter: 12dB/octave at 7kHz. Low filter: 12dB/octave at 70Hz. Mains: 220V AC. Size: 18 $\frac{1}{4}$   $\times$  5 $\frac{3}{4}$   $\times$  16in. Weight: 46lb. Finish: walnut. Price: £799.50 (including VAT).

FM/AM stereo and quadraphonic receiver. Bands: 88-108MHz FM, 540-1600kHz MW. Signal strength, centre tuning meters. Filled with two stereo Dolby noise reduction processors permitting simultaneous recording and playback from a tape machine. Output: 40W per channel (4) into 8 ohms. THD: <0.15% at rated power. Mode switch for mono, stereo, matrix, SQ and discrete. No further details available. Price: £545 (plus VAT).

#### Model 2010 ★

AM/FM stereo tuner/amplifier. Range: FM 88-108MHz, MW 187-555m. Variable tuning with 'Gyro touch'. AFC not necessary. Ratio detector. Meter tuning indicator. Usable sensitivity: FM 2.6 $\mu$ V, MW 25 $\mu$ V. Aerial input: 75 ohms coaxial, 300 ohms balanced twin. Stereo decoder fitted. Stereo beacon. Inputs: mag PU 2.2mV 47K, high level 150mV 120K, radio, aux. Overload capability: (PU input) 100mV. Output: 10W RMS per channel into 4 or 8 ohms. Controls: treble  $\pm$ 12dB at 15kHz, bass  $\pm$ 12dB at 50Hz, balance, tuning. Pushbuttons for tape monitor, FM quieting tuning, loudness, remote/main speakers. Headphone jack socket. HD: 0.3%. FR: 20Hz-20kHz  $\pm$ 1.5dB at 1W. Mains: 110, 220, 240V AC. Size: 14 $\frac{1}{4}$   $\times$  4 $\frac{3}{4}$   $\times$  12in. Finish: walnut, teak or white (cabinet optional) or simulated walnut metal chassis. Front panel gold anodised. Price: £121 (including VAT).

#### Model 2220

Stereo AM/FM tuner/amplifier. FM 88-108MHz, MW 187-555m. Variable tuning. Ratio detector. Tuning meter. Usable sensitivity: AM 26 $\mu$ V, FM 2.0 $\mu$ V for 30dB quieting. Aerial input: 300 ohms balanced, 75 ohms coaxial. Stereo decoder included. 56 transistors and one IC. Inputs: PU 2.1mV 47K, mic 2.1mV, aux 150mV. Output: 20W RMS per channel (both channels driven) into 8 ohms. Tone controls: bass  $\pm$ 12dB at 50Hz, treble  $\pm$ 12dB at 15kHz. HD: 0.3% 20Hz-20kHz. Size: 16 $\frac{7}{8}$   $\times$  5  $\times$  14in.



Marantz 2010

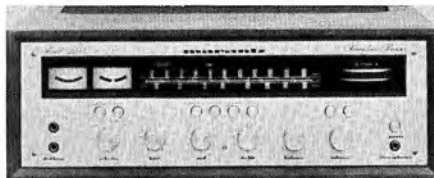

Marantz 2245

Gold anodised front panel. Price: £159.50 (including VAT).

#### Model 2230

AM/FM stereo tuner/amplifier. Range: FM 88-108MHz, MW 187-555m. Variable tuning. Ratio detector. Tuning meter. Usable sensitivity: AM 20 $\mu$ V, FM 2 $\mu$ V for 30dB quieting. Aerial input: 300 ohms balanced, 75 ohms coaxial. Stereo decoder included. 68 transistors plus one IC. Impedance: PU 1.8mV 47K, mic 1.8mV, aux 180mV. Noise level: (PU input) -96dB. Output: 30W RMS per channel, both channels driven. Output impedance: 8 ohms. Tone controls: bass  $\pm$ 15dB at 50Hz, treble  $\pm$ 15dB at 15kHz, middle  $\pm$ 6dB at 700Hz. HD: <0.5% 40Hz-20kHz. FR: 20Hz-20kHz  $\pm$ 0.5dB. Size: 16 $\frac{7}{8}$   $\times$  5  $\times$  14in. Finish: gold anodised front panel. Price: £203.50 (including VAT).

#### Model 2245 ★

AM/FM stereo tuner/amplifier. Range: 88-108MHz, MW 187-555m. Variable tuning. Ratio detector. Tuning meter and signal strength meter. Usable sensitivity: AM 20 $\mu$ V, FM 1.7 $\mu$ V for 30dB quieting. Aerial input: 300 ohms balanced, 75 ohms coaxial. Stereo decoder included. 87 transistors plus one IC. Inputs: mag PU 1.8mV 47K, mic 1.8mV, aux 180mV. Noise level: PU input -96dB. Output: 47W per channel RMS into 4 and 8 ohms, both channels driven. Output impedance: 8 ohms. Tone controls: bass  $\pm$ 15dB at 50Hz, treble  $\pm$ 15dB at 15kHz, middle  $\pm$ 6dB at 700Hz. HD: <0.3%. FR: 7Hz-70kHz for 0.3% THD. Size: 16 $\frac{7}{8}$   $\times$  5  $\times$  14in. Finish: gold anodised front panel. Price: £247.50 (including VAT).

#### Model 2270

AM/FM stereo tuner/amplifier. Range: 88-108

MHz, MW 187-555m. Variable tuning. Ratio detector. Signal strength meter and tuning meter. Usable sensitivity: AM  $20\mu\text{V}$ , FM  $1.7\mu\text{V}$  for 30dB quieting. Aerial input: 300 ohms balanced, 75 ohms coaxial. Stereo decoder included. 87 transistors and one IC. Inputs: mag PU  $1.8\text{mV}$  47K, mic  $1.8\text{mV}$ , aux  $180\text{mV}$ . Noise level:  $-96\text{dB}$ . Output: 70W per channel RMS into 8 ohms, both channels driven. Output impedance: 8 ohms. Tone controls: bass  $\pm 15\text{dB}$  at 50Hz, treble  $\pm 15\text{dB}$  at 15kHz, middle  $\pm 6\text{dB}$  at 700Hz. HD:  $<0.3\%$ . FR: 20Hz-20kHz  $\pm 0.25\text{dB}$ . Size:  $16\frac{7}{8} \times 5 \times 14\text{in}$ . Finish: gold anodised front panel. Price: £302.50 (including VAT).

### ■ MITSUBISHI

Mitsubishi Corporation, Bow Bells House, Bread Street, London, EC4. Tel: 01-248 3292.

#### DA-R400

AM/FM stereo four-channel tuner/amplifier. Range: FM 88-108MHz, MW 187-572m. Usable sensitivity: FM  $2\mu\text{V}$ , MW  $18\mu\text{V}$ . Capture ratio: 2dB. Inputs: mag PU  $2.5\text{mV}$  50K, aux  $150\text{mV}$  50K, discrete  $150\text{mV}$  50K. Tone controls: bass  $\pm 10\text{dB}$  at 100Hz, treble  $\pm 10\text{dB}$  at 10kHz. Output: 40W RMS into 8 ohms. HD:  $<1\%$  at 1kHz at rated output. Power bandwidth: 30Hz-25kHz. Stereo decoder comprises regular matrix (RM) and stereo-quad (SQ) suitable for both types of four-channel signal. Additional demodulator allows CD-4 reproduction. Facilities for four-channel discrete tape reproduction. Input-mixing microphone circuit. Size:  $19\frac{1}{2} \times 5\frac{1}{8} \times 15\text{in}$ . Weight:  $28\frac{1}{2}\text{lb}$ . Price: to be announced.

### ■ NATIONAL PANASONIC TECHNICS

Whitby Road, Trading Estate, Slough, Bucks. Tel: Slough (75) 34522.

#### SA5200

AM/FM stereo tuner/amplifier. Full specification on request. Price: £119.95 (including VAT).

#### SA4400

AM/FM stereo tuner/amplifier. Full specification on request. Price: £154.50 (including VAT).

#### SA5800

AM/FM stereo tuner/amplifier. Full specification on request. Price: £169.50 (including VAT).

#### SA6400X

AM/FM stereo four-channel tuner/amplifier. Full specification on request. Price: £255 (including VAT).

#### SA6800X

AM/FM stereo four-channel tuner/amplifier. Full specification on request. Price: £339.95 (including VAT).

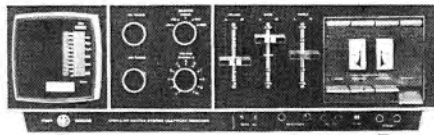

Nikko STA-1101



Nikko STA-6010

### ■ NIKKO ELECTRIC MFG CO LTD

Distributors: Howland-West Ltd, 3-5 Eden Grove, London, N7 8EQ. Tel: 01-609 0293.

#### STA-1101 ★

Stereo transistorised tuner/amplifier. Range: 88-108MHz and 187-560m. Variable tuning. Meter tuning indicator. Sensitivity (for 20dB quieting):  $1.5\mu\text{V}$ . Stereo decoder fitted. AFC. Output: 37W per channel at 0.3% distortion. FR: ( $\pm 1\text{dB}$ ): 10Hz-70kHz. Output impedance: 4-16 ohms. Inputs: gram  $2\text{mV}$  50K, tape  $200\text{mV}$  100K, mic  $2\text{mV}$  100K. Controls: FM tuning, AM tuning, function, volume, loudness, balance, bass, treble, remote speaker selector, remote speaker volume control. Includes six FETs and twelve ICs. Size:  $18\frac{1}{2} \times 14\frac{3}{8} \times 6\frac{1}{2}\text{in}$ . Mains: 120, 220, 240V AC. Price: £255.20 (including VAT).

#### STA-6010 ★

AM/FM stereo tuner/amplifier. Range: FM 88-108MHz, MW 182-556m. Variable tuning. Meter tuning indicator. Usable sensitivity: FM  $1.8\mu\text{V}$ , MW  $150\mu\text{V}$ . Aerial input: 75 ohms coaxial, 300 ohms balanced. Stereo decoder included. Inputs: mag PU  $2.8\text{mV}$  50K, tape head  $1.8\text{mV}$  200K, aux (1)  $150\text{mV}$  250K, aux (2)  $750\text{mV}$  1M, tape monitor  $200\text{mV}$  100K. Noise level: tape head input 55dB, mag PU 60dB, other inputs  $<65\text{dB}$ . Output: 18W RMS per channel. Output impedance: 8 ohms. Tone controls: bass  $\pm 13\text{dB}$  at 70Hz, treble  $\pm 13\text{dB}$  at 10kHz, low filter  $-5\text{dB}$  at 70Hz, high filter  $-8\text{dB}$  at 10kHz. HD: 0.8%. FR: 20Hz-30kHz  $\pm 1\text{dB}$ . Mains: 100, 120, 220, 240V AC. Size:

★ Indicates entry is illustrated

15¼ × 12¼ × 4½ in. Price: £121 (including VAT).

#### STA-8010

AM/FM stereo tuner/amplifier. Range: FM 88-108MHz, MW 182-556m. Variable tuning. Meter tuning indicator. Usable sensitivity: FM 1-8µV, MW 150µV. Aerial input: 75 ohms coaxial, 300 ohms balanced. Stereo decoder included. Inputs: mag PU 2.8mV 50K, aux (1) 150mV 250K, aux (2) 750mV 100K, tape head 1.8mV 250K, tape monitor 200mV 100K. Output: 26W RMS per channel. Output impedance: 8 ohms. Tone controls: bass ±13dB at 70Hz, treble ±13dB at 10kHz, loudness +13dB at 70 Hz+9dB at 10kHz. Low and high filters. HD: 0.8%. FR: 20 Hz-30kHz ±1dB. Size: 15¼ × 12¼ × 4½ in. Mains: 100, 120, 220, 240V AC. Price: £139.70 (including VAT).

#### STA-9010

AM/FM stereo tuner/amplifier. Range: FM 88-108MHz, MW 182-556m. Variable tuning. Meter tuning indicator. Usable sensitivity: FM 1-5µV, MW 150µV. Aerial input: 75 ohms coaxial, 300 ohms balanced. Stereo decoder included. Inputs: mag PU 2.5mV 50K, mic input 2.5mV 50K, aux 240mV 200K, tape 240mV 200K. Noise level: mag PU and mic inputs ±65dB, other inputs ±80dB. Output: 45W per channel RMS. Output impedance: 8 ohms. Controls: sliders for bass, treble, balance and volume. Low and high filters. Mains and remote speaker-switch. HD: 0.5%. FR: 20Hz-40kHz ±1dB. Mains: 100, 120, 220, 240V AC. Size: 16½ × 13½ × 5in. Price: £165 (including VAT).

#### STA-5010

AM/FM stereo tuner/amplifier. Range: FM 88-108MHz, MW 182-556m. Variable tuning. AFC. Meter tuning indicator. Usable sensitivity: FM: 2.5µV, MW 250µV. Aerial input: 300 ohms balanced twin, 75 ohms coaxial. Stereo decoder fitted. 57 transistors. Inputs: mag PU 2mV 50K, aux 140mV 100K, tape 200mV 60K. Noise level: (mag PU input) -60dB, (other inputs) -70dB. Output: 26W RMS per channel into 8 ohms. Controls: bass, treble, balance, mono/stereo, FM muting, volume, input-selector, tape, speaker switching. HD: 0.1% at 1W, 0.8% at rated output. Output impedance: 8 ohms. FR: 10Hz-50kHz ±1dB. Mains: 120, 220, 240V 50-60Hz. Size: 17¾ × 15 × 5½ in. Finish: wood cabinet with metal trim. Tape dubbing or dual recording facility provided. Price: £115.50 (including VAT).

#### STA-7070 ★

AM/FM stereo tuner/amplifier. Range: FM 88-108MHz, MW 182-556m. Variable tuning. AFC. Meter tuning indicator. Usable sensitivity: FM 2µV, MW 150µV. Aerial input: 300 ohms balanced twin, 75 ohms coaxial. Stereo

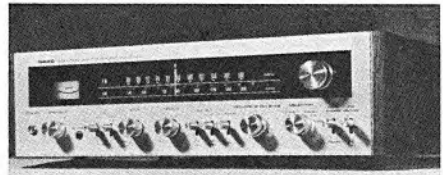

Nikko STA-7070



Nikko STA-8080

decoder fitted. 76 transistors. Inputs: mag PU (2) 2.2mV 50K, aux (1) 160mV 100K, aux (2) 320mV 120K, tape (2) 160mV 100K. Noise level: (mag PU input) -65dB, (other inputs) -80dB. Output: 40W RMS per channel into 8 ohms. Controls: bass ±10dB at 70Hz, treble ±10dB at 10kHz, loudness +9dB at 70Hz+5.5dB at 10kHz, speaker switch (A, A+B, B), balance, mono/stereo, FM muting, low filter -8dB at 70Hz, high filter -7dB at 10kHz, tape/dubbing. HD: 0.1% at 1W, 0.5% at rated output. Output impedance: 8 ohms. FR: 10Hz-50kHz ±1dB. Mains: 120, 220, 240V 50-60Hz. Size: 18 × 14¾ × 5¾ in. Finish: wood cabinet and metal trim. Price: £143 (including VAT).

#### STA-8080 ★

AM/FM stereo tuner/amplifier. Range: FM 88-108MHz, MW 182-556m. Variable tuning. AFC. One signal strength meter, one centre-zero tuning meter. Usable sensitivity: FM 2µV, MW 150µV. Aerial input: 300 ohms balanced twin, 75 ohms coaxial. Stereo decoder fitted. 78 transistors. Inputs: mag PU (2) 2.2mV 50K, aux (1) 160mV 100K, aux (2) 320mV 120K, tape 160mV 100K. Output: 55W RMS per channel. Controls: bass ±10dB at 70Hz, treble ±10dB at 10kHz, loudness +9dB at 70Hz+5.5dB at 10kHz, speaker switch (A, A+B, B), balance, mono/stereo, FM muting, low filter -8dB at 70Hz, high filter -7dB at 10kHz, tape/dubbing. HD: 0.1% at 1W, 0.5% at rated output. Output impedance: 8 ohms. FR: 10Hz-50kHz ±1dB. Mains: 120, 220, 240V 50-60Hz. Size: 18 × 14¾ × 5¾ in. Finish: wood cabinet with metal trim. Price: £158.40 (including VAT).

#### ■ NORDMENDE

Importer and main distributor: H. Vesshof and Co Ltd (Vessco Vision and Radio), 62 Woodbridge Road, Guildford, Surrey, GU1 4RD. Tel: Guildford (0483) 77877.

Northern Distributors: TAK Continental Importers, 16a High Street, Stone, Staffordshire. Tel: Stone 3232, 3233.

#### 5003ST ★

Stereo tuner/amplifier. Ranges: FM/VHF, LW, MW and 49 metre band. Electronic mono/stereo switching with indicator, ICs, ceramic IF filters, panoramic scale. Output:  $2\frac{1}{2}$ W RMS per channel. Finishes: walnut, teak, elm or Rio rosewood. Dimensions:  $550 \times 85 \times 190$ mm. Full specification and price on request.

#### 5005ST

AM/FM stereo tuner/amplifier. Range: VHF, LW, MW, 49m band. 20 transistors, 20 diodes, one rectifier. Output: 14W peak per channel. Finish: walnut. Full specification and price on request.

#### ONKYO

J. Parkar & Co (London) Ltd, Parkar House, Beresford Avenue, Wembley, Middlesex, HA0 1YX. Tel: 01-903 5211.

#### Integra 225 ★

AM/FM stereo tuner/amplifier incorporating IC in decoder stage, four-gang tuning, six-element ceramic IF filter and four-stage limiter.

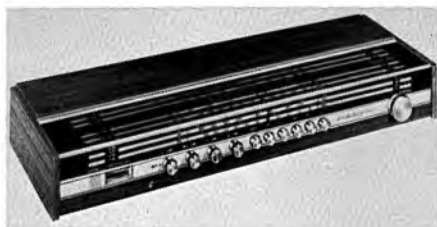

Nordmende 5003ST



Onkyo Model 225

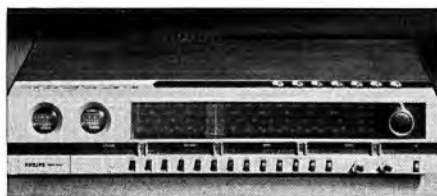

Philips RH720

Range: FM 88-108MHz, MW 187-565m. Variable tuning. Sensitivity: FM  $2\mu\text{V}$ , MW  $40\mu\text{V}$ . S/N ratio: FM 65dB, MW 45dB. Stereo decoder with auto switching. Stereo beacon. Tuning meter. Quiet tuning facility on FM. Inputs: PU 2mV 50K, aux 100mV 100K. Tone controls: bass +14dB -18dB at 20Hz, treble +11dB -14dB at 20kHz, low filter -6dB/octave from 70Hz, high filter -6dB/octave from 7kHz. Output: 22W RMS per channel. Output impedance: 4-16 ohms. Outlets for headphones and AC mains. FR: 15Hz-30kHz  $\pm$  1dB. HD: <0.3% at rated output. H and N: better than 70dB on PU input, better than 85dB on aux input. Mains: 100-110V or 220-240V 50-60Hz. 50-60Hz. Size:  $17\frac{1}{4} \times 5\frac{3}{8} \times 13\frac{3}{4}$ in. Weight:  $22\frac{1}{8}$ lb. Price: £156.39 (including VAT).

#### Y3A

AM/FM stereo and four-channel tuner/amplifier. Range: FM 88-108MHz, MW 187-568m. Variable tuning. Meter tuning indicator. Usable sensitivity: FM  $2\mu\text{V}$  for 30dB signal-to-noise, AM  $12\mu\text{V}$  for 20dB signal-to-noise. Stereo decoder fitted. Output: 20W RMS per channel (stereo); 12W RMS per channel (quadraphonic). Mains: 110, 120, 220, 240V 50-60Hz. Size:  $20 \times 5\frac{3}{8} \times 13\frac{3}{4}$ in. Finish: walnut. Microphone mixing. Four-channel matrix system. Discrete four-channel tape input. Price: £133.52 (including VAT).

#### PHILIPS

Philips Electrical Ltd, Century House, Shaftesbury Avenue, London, WC2H 8AS. Tel: 01-437 7777.

#### RH720 ★

AM/FM stereo tuner/amplifier. Range: FM 87.5-104MHz, MW 187-577m, LW 857-2000m, SW 16.7-50.4m. Variable tuning plus six presets with touch controls. Switchable AFC. Ratio detector. Moving coil tuning meter. Usable sensitivity: FM  $2\mu\text{V}$  for 26dB quieting, AM  $80\mu\text{V}$  for 26dB S/N ratio. Aerial input: 300 ohms balanced. Stereo decoder fitted. Silent tuning facility of FM. 75 transistors plus two ICs. Inputs: mag PU 2mV 50K, crystal PU 60mV 100K, tape 250mV 100K, mic 1mV 2K. Output: 30W RMS per channel. Output impedance: 4 ohms. Tone controls: bass  $\pm$  14dB at 50Hz, treble  $\pm$  15dB at 10kHz. Two-position loudness control. HD: <0.1% at 20W per channel. FR: 15Hz-40kHz+0.5dB -3dB. Mains: 110, 127, 220, 240V AC. Size:  $21\frac{1}{4} \times 4\frac{3}{4} \times 11$ in. Finish: walnut veneer cabinet, brushed aluminium facia. Socket outlet for headphones. Scratch filter. Price: £235 (including VAT).

#### RH 732

FM/AM stereo receiver. Bands: 87.5-104MHz FM, 150-340kHz LW, 520-1420kHz MW1.

★ Indicates entry is illustrated

1405-1605kHz MW2, 5.95-9.8MHz SW. Sensitivity: 1.3 $\mu$ V DIN (FM), 90 $\mu$ V (AM). Tuning: manual plus 5 FM presets. Tuning meter. Aerials: 300 ohms (FM), wire and internal ferrite rod (AM). Inputs: phono 1.7mV 50K, tape 250mV 500K, mic 0.5mV 2K, phono (ceramic) 250mV 50K. S/N: phono 50dB (DIN) referred to rated output. Output: 12W per channel into 4 ohms. Damping factor: 20. THD: 1% at 12W. FR: 20Hz-20kHz  $\pm$  1dB. Size: 22 $\frac{3}{8}$   $\times$  4 $\frac{1}{2}$   $\times$  9 $\frac{1}{2}$  in. Price: £132 (including VAT).

#### RH 734

FM/AM stereo receiver. Tuner section as for RH 732. Inputs: phono 1.8mV 50K, tape 260mV 500K, mic 1.1mV 2K, phono (ceramic) 260mV 500K. S/N: 55dB referred to rated output. Output: 20W per channel into 4 ohms. Damping factor: 30. THD: 1% at 20W. FR: 20Hz-20kHz  $\pm$  1dB. Size: 23  $\times$  4 $\frac{1}{2}$   $\times$  10 $\frac{1}{2}$  in. Price: £155 (including VAT).

#### RH901 ★

AM/FM stereo tuner/amplifier. Ranges: FM 87.5-104MHz, MW 214-577m, MW bandsread 182-214m, LW 870-2000m, SW 30.7-50.4m. Variable tuning. AFC. Ratio detector. Usable sensitivity: FM 7 $\mu$ V for 26dB quieting, AM 70 $\mu$ V for 26dB. S/N ratio. Aerial input: 300 ohms balanced. Stereo decoder fitted. 25 transistors. Inputs: ceramic PU 210mV 350K, tape 400mV 500K. Noise level: -50dB. Output: 8W RMS per channel. Tone controls: bass  $\pm$  9dB at 100 Hz, treble  $\pm$  8dB at 10kHz. HD: < 2% at 1kHz at 4.5W output per channel. Output impedance: 4 ohms. FR: 45Hz-20kHz  $\pm$  3dB. Mains: 110, 127, 220, 240V AC. Size: 20  $\times$  3 $\frac{1}{4}$   $\times$  8 $\frac{3}{4}$  in. Finish: simulated walnut veneer. Price: (including two RH421 speakers) £87.27 (including VAT).

#### ■ PHOTAX-CONCERTONE

Photax Ltd, Hampden Park, Eastbourne, Sussex.

#### Model 22 ★

FM/AM stereo receiver. Bands: 88-108MHz FM, 535-1605kHz AM. Sensitivity: 2.2 $\mu$ V IHF (FM), 20 $\mu$ V (AM). Signal strength meter. Aerial: 300 ohms external and internal ferrite rod. Inputs: phono 3mV 50K, phono (ceramic) 100mV 100K, aux 150mV 50K. S/N: phono (mag) 55dB, aux 60dB. Output: 10W per channel into 8 ohms. THD: < 0.8% at rated output. Power bandwidth: 25Hz-35kHz. Price: £89.98 (including VAT).

#### Model 333

FM/AM stereo receiver. Bands 88-108MHz FM, 535-1605kHz AM. Sensitivity: 3 $\mu$ V IHF (FM), 200V AM. Aerial: built-in ferrite rod and 300 ohms unbalanced external. Inputs: phono (1) 2.5mV 50K, phono (2) 200mV 800K, aux

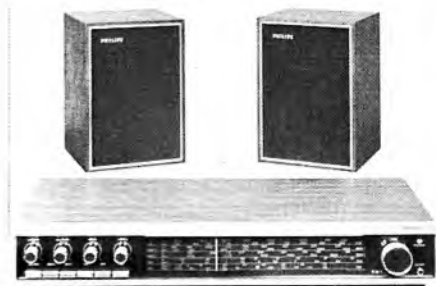

Philips RH901



Photax-Concertone Tuner/Amp 22

100mV, tape 100mV 100K. S/N: phono 50dB, aux 70dB. Output: 22W per channel into 8 ohms. THD: 0.4% at rated output. Power bandwidth: 40Hz-15kHz (IHF) Price: £120 (including VAT).

#### ■ PIONEER

Distributors: Shiro (UK) Ltd, Shiro House, The Ridgeway, Iver, Bucks. SL0 9JL. Tel: Cedarwood (075 38) 2222.

#### SX 300

FM/AM stereo receiver. Bands: 88-108MHz FM plus AM band on MW. Manual tuning. Centre tuning meter. Sensitivity: 2.3 $\mu$ V IHF (FM), 15 $\mu$ V AM. Aerial: 75 and 300 ohms. Inputs: phono 2.5mV 50K, aux 150mV 100K, tape (1&2) 150mV 100K. S/N: 65dB FM, 50dB AM, ref full power. Output: 10W per channel into 8 ohms, 12W per channel into 4 ohms. Damping factor: 20 at 1kHz into 8 ohms. THD: 0.1% at rated power. FR: 20Hz-15kHz + 0.2dB - 2dB. Size: 17 $\frac{3}{8}$   $\times$  5 $\frac{1}{8}$   $\times$  12 $\frac{3}{4}$  in. Price: on application.

#### SX 434

FM/AM stereo receiver. Bands: 88-108MHz FM plus AM/MW band. Manual tuning. Centre tuning meter. Sensitivity: 1.9 $\mu$ V IHF (FM), 15 $\mu$ V AM. Aerial: 75 and 300 ohms. Inputs: phono 2.5mV 50K, mic 10mV 90K, aux 150mV 80K, tape 150mV 80K. S/N: 70dB FM, 50dB AM, ref full power. Output: 16W per channel into 8 ohms, 18W per channel into 4 ohms. Damping factor: 25 at 1kHz into 8 ohms. THD: 0.1% at rated power. FR: 20Hz-15kHz + 0.2dB - 2dB. Size: 16 $\frac{1}{8}$   $\times$  5 $\frac{1}{2}$   $\times$  13 $\frac{1}{8}$  in. Price: on application.

# SABA

## sounds great

SABA Hifi systems are in the international class. Unsurpassed technical excellence is matched by sophisticated elegance in design. Like the SABA Freiburg Telecommander—the world's outstanding cordless remote controlled Hifi stereo tuner/amplifier combination—the ultimate in listening pleasure, completely controlled from the listener's armchair. Just one model from the SABA range of hifi stereo equipment, which includes tuners, amplifiers, tape recorders and speaker systems.

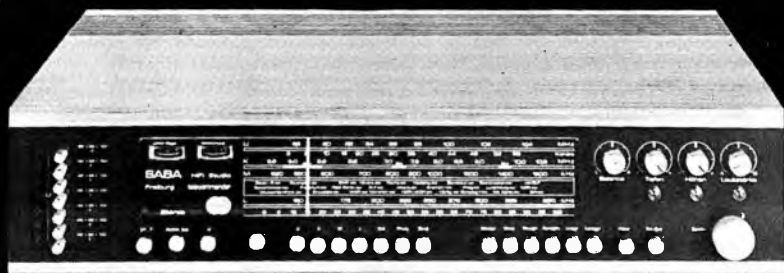

For fuller details and information on becoming an accredited SABA dealer, send in the coupon.

**SABA**  
brings the world to life

To: Saba Radio and Television Limited  
6-12 Combrook Park Road, Manchester M15 4EE  
I am interested in selling SABA. Please tell me more.

Name.....  
Company.....  
Address.....  
HFY 7A



# Sanyo power amplifiers

**with direct coupling and  
pure complementary circuitry**

An outstanding feature of these stereo receivers is their direct-coupled systems. By eliminating output capacitors, the possibility of distortion is greatly reduced, and the damping factor is much more effective even at low frequencies.

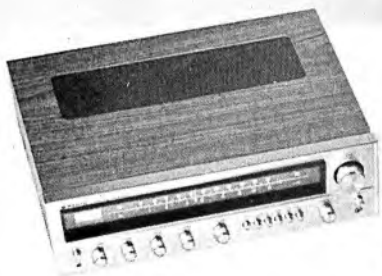

#### **DCX 4000K**

This sophisticated model includes among its many features two separate muting buttons for audio and FM, two tape monitor buttons and a mic. volume control.

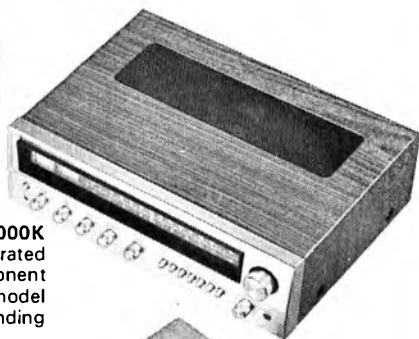

#### **DCX 6000K**

Easily incorporated into any component system, this model provides outstanding FM monaural, FM stereo and AM reproduction with high sensitivity, minimized distortion and an excellent s/n ratio.

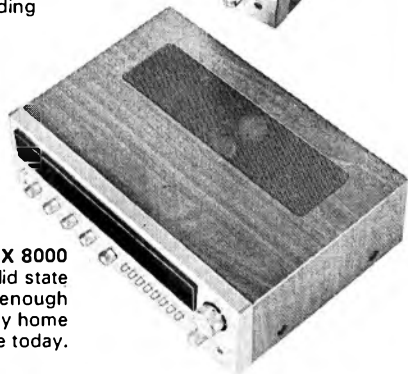

#### **DCX 8000**

This performance-proven solid state amplifier/stereo receiver has enough power to drive practically any home music system available today.

**SANYO**  a world of difference

Sanyo Marubeni (UK) Ltd., Sanyo House, Bushey Mill Lane, Watford WD2 4UQ. Tel: 30421  
(Reg. Office) Reg. in England No. 956870

**SX 636**

FM/AM stereo receiver. Bands: 88-108MHz and AM/MW. Manual tuning. Centre tuning meter. Sensitivity:  $1.9\mu\text{V}$  IHF (FM)  $15\mu\text{V}$  AM. Aerial: 75 and 300 ohms. Inputs: phono 2.5mV 50K, mic 7mV 85K, aux 150mV 60K, tape (1) 150mV 60K, tape (2) DIN 150mV 60K. S/N: 70dB FM, 50dB AM, ref full power. Output: 27W into 8 ohms, 30W into 4 ohms. Damping factor: 35 at 1kHz into 8 ohms. FR: 20Hz-15kHz+0.2dB -2dB. Size:  $22 \times 8\frac{1}{2} \times 18\frac{1}{8}$ in. Price: on application.

**SX 737**

FM/AM stereo receiver. Bands: 88-108MHz and AM/MW. Manual tuning. Centre tuning meter. Sensitivity:  $1.9\mu\text{V}$  IHF (FM),  $15\mu\text{V}$  AM. Aerial: 75 and 300 ohms. Inputs: phono 2.5mV 50K, mic 2.5mV 50K, aux 150mV 50K, tape (1 & 2) 150mV 50K. S/N: 70dB FM, 50dB AM ref full power. Output: 40W into 8 ohms, 50W into 4 ohms. Damping factor: 40 at 1kHz into 8 ohms. THD: 0.05% at full rated power. FR: 20Hz-15kHz+0.2dB -2dB. Size:  $24 \times 10 \times 19$ in. Price: on application.

**SX 838**

FM/AM stereo receiver. Bands: 88-108MHz FM and AM/MW. Manual tuning. Centre tuning meter. Sensitivity:  $1.8\mu\text{V}$  IHF (FM),  $15\mu\text{V}$  (AM). Aerial: 75 and 300 ohms. Inputs: phono (1&2) 2.5mV 50K, mic 2mV 50K, aux 150mV 80K, tape (1) 150mV 80K, tape (2) pre-out 150mV-1V 2K. S/N: 70dB FM, 50dB AM. Outputs: 55W into 8 ohms, 70W into 4 ohms. Damping factor: 45 at 1kHz into 8 ohms. THD: 0.3% at full rated power. FR: 20Hz-15kHz+0.2dB -2dB. Size:  $20\frac{1}{2} \times 6\frac{7}{8} \times 16$ in. Price: on application.

**SX 939**

FM/AM stereo receiver. Bands: 88-108MHz FM, 550-1600kHz AM/MW. Manual tuning. Centre tuning meter. Sensitivity:  $1.8\mu\text{V}$  IHF (FM),  $15\mu\text{V}$  AM. Aerial: 75 and 300 ohms. Inputs: phono (1&2) 2.5mV 50K, mic 2mV 50K, aux 150mV 70K, tape (1&2) 150mV 70K. S/N: 70dB FM, 50dB AM referred to full output. Output: 75W into 8 ohms, 100W into 4 ohms. Damping factor: 45 at 1kHz into 8 ohms. THD: 0.3% at full power. FR: 20Hz-15kHz+0.2dB -2dB. Size:  $20\frac{1}{2} \times 6\frac{7}{8} \times 16$ in. Price: on application.

**SX 1010**

FM/AM stereo receiver. Bands: 88-108MHz FM, 550-1600kHz AM/MW. Manual tuning. Centre tuning meter. Sensitivity:  $1.7\mu\text{V}$  IHF (FM),  $15\mu\text{V}$  (AM). Aerial: 75 and 300 ohms. Inputs: phono (1&2) 2.5mV 50K, mic 2mV 50K, aux 150mV 70K, tape (1) 150mV 70K, tape (2) DIN 150mV 70K. S/N: 72dB FM, 50dB AM ref full output. Output: 110W into 8 or



Pioneer 4 Channel Receiver QX949

4 ohms. Damping factor: 50 at 1kHz into 8 ohms. THD: 0.1% at full power. FR: 20Hz-15kHz+0.2dB -2dB. Size:  $20 \times 6\frac{7}{8} \times 17$ in. Price: on application.

**QX 646**

FM/AM stereo-quadrasonic receiver. Bands: 88-108MHz FM, 550-1600kHz AM/MW. Manual tuning. Signal strength meter. Sensitivity:  $2.2\mu\text{V}$  IHF (FM),  $15\mu\text{V}$  AM. Aerial: 75 or 300 ohms. Inputs: phono 2.5mV 100K, aux 180mV 90K, tape monitor (2-channel, 4-channel) 180mV 100K. S/N: 65dB FM, 50dB AM, ref to full power. Output: 10W (4-channel) into 8 ohms, 11W (4-channel) into 4 ohms. Damping factor: 40 at 1kHz into 8 ohms. THD: 1% ref to full power. FR: 10Hz-30kHz power bandwidth. Size:  $20 \times 5\frac{7}{8} \times 14$ in. All regular matrix, SQ and CD-4 systems decoded. Price: on application.

**QX 747**

FM/AM stereo-quadrasonic receiver. Bands: 88-108MHz FM, 550-1600kHz AM/MW. Manual tuning. Centre tuning meter. Sensitivity:  $1.9\mu\text{V}$  IHF (FM),  $15\mu\text{V}$  (AM). Aerial: 75 or 300 ohms. Inputs: phono 2.2mV 50K, aux 140mV 100K, tape monitor 140mV 100K, tape rec (2) 140mV 100K. S/N: 70dB FM, 50dB AM. Output: 25W (4-channel) into 8 ohms, 30W (4-channel) into 4 ohms. Damping factor: 35 at 1kHz into 8 ohms. THD: 0.2%. Power bandwidth: 7Hz-40kHz. Size:  $21 \times 6 \times 16$ in. All regular matrix, SQ and CD-4 sources decoded. Price: on application.

**QX 949 ★**

FM/AM stereo-quadrasonic receiver. Bands: 88-108MHz FM, 550-1600kHz AM. Manual tuning. Centre tuning and signal strength meters. Sensitivity:  $1.8\mu\text{V}$  IHF (FM),  $15\mu\text{V}$  (AM). Aerials: 75 or 300 ohms. Inputs: phono (1 & 2) 2.5mV 50K, aux 150mV 100K, tape mon (1) 150mV 100K, tape rec 150mV. S/N: 70dB FM, 50dB AM ref full power output. Output: 44W (4-channel) into 8 ohms, 58W (4-channel) into 4 ohms. Damping factor: 35 at 1kHz into 8 ohms. THD: 0.3% at full power. Power bandwidth: 7Hz-40kHz. Size:  $21 \times 6 \times 17$ in. All regular matrix, SQ and CD-4 sources decoded. Price: on application.

★ Indicates entry is illustrated

## ■ RGD

ITT Consumer Products (UK) Ltd,  
Maidstone Road, Sidcup, Kent, DA14 5HT.  
Tel: 01-300 7733.

## RA20

AM/FM stereo tuner/amplifier. Range: FM 87.5-104MHz, LW 1091-2041m, MW 186-588m, SW 38.9-51.7m. Variable tuning plus four pre-sets. Switchable AFC. Stereo decoder and beacon. Stereo/mono over-ride control. Sockets for AM and FM aerials, tape record and playback, PU and speakers. Output: 8W per channel into 4.5 ohms. FR: 40Hz-20kHz  $\pm$  3dB. Output impedance: not less than 4 ohms. 23 transistors, 13 diodes, two ICs. Size:  $19\frac{1}{4} \times 3\frac{3}{8} \times 11\frac{5}{8}$ in. Weight: 11lb. Price: £82.50 (including VAT).

## ■ ROGERS

Rogers Developments (Electronics) Ltd,  
4-14 Barmeston Road, Catford,  
London, SE6 3BN. Tel: 01-698 7424/4340.

## Ravensbrook ★

Integrated stereo tuner/amplifier. Range: 88-108MHz. Variable tuning. Quadrature detector. Aerial input: 75 ohms coaxial and 300 ohms balanced. Phase lock loop stereo decoder. Three-gang FET front end. Dual ceramic IF filters using IC techniques. Inter-station quiet tuning. Output: 13W RMS per channel into 15 ohms, 20W RMS per channel into 8 ohms. HD: <0.1% at rated output. FR: 20Hz-50kHz  $\pm$  3dB. S/N: PU input - 53dB. Pushbutton input selector. Controls: bass, treble, volume, balance, high filter, low filter. Tuning meter. Price: (chassis) £95 (including VAT); (incabinet) £102.50 (including VAT).

## ■ ROTEL

Rank Audio Visual Ltd,  
PO Box 70, Great West Road, Brentford,  
Middlesex, TW8 9HR.  
Tel: 01-568 9222. Telex: 24408.

## RX150A

AM/FM stereo tuner/amplifier. Range: FM 88-108MHz, MW 188-545m. Variable tuning. Usable sensitivity: FM 5 $\mu$ V, MW 30 $\mu$ V. Meter tuning indicator. Aerial input: 300 ohms. Stereo decoder fitted. Inputs: mag PU 2.8mV 45K, ceramic PU 100mV 190K, aux 250mV 125K. Noise level: PU inputs - 60dB, aux inputs - 70dB. Output: 11W RMS per channel into 4 ohms. Output impedance: 4-8 ohms. Tone controls: bass +14dB - 11.5dB, treble +11dB - 14dB. HD: 0.35% at 30W. FR: 30Hz-20kHz at 30W. Mains: 240V AC. Size:  $16\frac{3}{8} \times 6\frac{7}{8} \times 5\frac{1}{2}$ in. Weight: 10lb. Finish: wood grain. Price: £78.50 (including VAT).



Rogers Ravensbrook

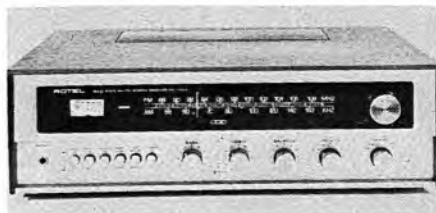

Rotel RX400A



Rotel RX454 four channel receiver

## RX200A

AM/FM stereo tuner/amplifier. Range: FM 88-108MHz, MW 187-562m. Variable tuning. Meter indicator. Sensitivity: 3.5 $\mu$ V. Aerial input: 300 ohms balanced (can be changed to 75 ohms coaxial). Stereo decoder fitted. Inputs: mag PU 2mV 35K, crystal PU 200mV 150K, tape 250mV 13K, aux 130mV 50K. Noise level: - 60dB on PU inputs, - 70dB on other inputs. Output: 16W RMS per channel into 4 ohms, 12W RMS per channel into 8 ohms. Controls: bass +12dB - 14dB at 50Hz, treble +13dB - 12dB at 10kHz, loudness, balance, volume, tape monitor, tuning. HD: 0.2% at rated output. FR: 30Hz-20kHz - 1.5dB at 10W. Output impedance: 4, 8, 16 ohms. Mains: 100, 120, 200, 240V 50-60Hz. Size:  $14\frac{1}{2} \times 4 \times 8\frac{1}{2}$ in. Price: £92.90 (including VAT).

## RX400A ★

AM/FM stereo tuner/amplifier. Range: FM 88-108MHz, MW 187-562m. Variable tuning. Meter indicator. Sensitivity: (FM) 2.5 $\mu$ V for

20dB quieting. (AM) 30 $\mu$ V. Aerial input: 300 ohms balanced (can be changed to 75 ohms coaxial). Stereo decoder fitted. FET front end. Integrated circuits. A plus B, or A and B speaker switching. Inputs: mag PU 3mV 50K, tape 400mV 15K, aux 200mV 100K. Noise level: PU -60dB, other inputs -70dB. Controls: bass +14dB -12dB at 50Hz, treble  $\pm$ 12dB at 10kHz, loudness, volume, tuning, balance, input selector. Output: 22W RMS per channel into 4 ohms, 20W RMS per channel into 8 ohms. FR: 15Hz-50kHz into 8 ohms. Output impedance: 4, 8, 16 ohms. Mains: 100, 120, 200, 240V 50-60Hz. Size: 17 $\frac{3}{8}$   $\times$  5  $\times$  12 $\frac{1}{2}$  in. Price:  $\pounds$ 117-50 (including VAT).

#### **RX600A**

AM/FM stereo tuner/amplifier. Range: FM 88-108MHz, MW 182-566m. Variable tuning. Meter signal strength indicator, centre-zero tuning meter. Sensitivity: FM 2.2 $\mu$ V. Aerial input: 300 ohms balanced twin, 75 ohms coaxial. Stereo decoder fitted. Inputs: mag PU (2) 2mV, crystal PU 100mV, aux 130mV. H and N: (PU input) -67dB, (aux input) -80dB. Output: 55W RMS per channel into 4 ohms, 30W RMS per channel into 8 ohms. Tone controls: bass  $\pm$ 12dB, treble  $\pm$ 12dB. Output impedance: 4, 8, 16 ohms. HD: 0.2%. FR: 9Hz-100kHz. AC mains. Size: 17 $\frac{3}{8}$   $\times$  5 $\frac{1}{2}$   $\times$  21 $\frac{1}{2}$  in. Weight: 19 $\frac{1}{2}$  lb. Finish: wood cabinet with satin aluminium panel. Price:  $\pounds$ 168-50 (including VAT).

#### **RX154A**

AM/FM four-channel tuner/amplifier. Range: FM 88-108MHz, MW 187-560m. Variable tuning. Tuning meter. Sensitivity: FM 4 $\mu$ V, MW 30 $\mu$ V. Stereo decoder fitted. Inputs: mag PU, aux. Output: 10W RMS per channel with four channels driven. Tone controls: bass  $\pm$ 12dB at 50Hz, treble  $\pm$ 12dB at 10kHz. HD: 0.5%. Output impedance: 4, 8, 16 ohms. FR: 20Hz-50kHz. AC mains: Size: 16 $\frac{3}{4}$   $\times$  13 $\frac{3}{8}$   $\times$  5 $\frac{3}{8}$  in. Weight: 17 $\frac{1}{2}$  lb. Finish: wood cabinet with metal front panel and knobs. Price:  $\pounds$ 147-50 (including VAT).

#### **RX454** ★

FM/AM stereo and four channel receiver with manual tuning, AFC and a tuning meter. Sensitivity: 2.5 $\mu$ V IHF (FM), 25 $\mu$ V/m (AM). Aerial: 75 and 300 ohms. Inputs: phono 2.5 $\mu$ V, aux 100mV, tape mon 200mV, tape DIN 330mV. S/N: phono 65dB, all others 75dB. Output: 24W per channel (four channel). FR: 15Hz-90kHz -3dB. Size: 18 $\frac{1}{2}$   $\times$  13 $\frac{3}{4}$   $\times$  5 in. Price:  $\pounds$ 217-50 (including VAT).

#### ■ SABA

Saba Television Ltd, 6-12 Cornbrook Park Road, Manchester, M15 4EE.  
Tel: 061-872 7661.



Saba Hi-Fi Studio 8035



Saba Hi-Fi Studio 8080

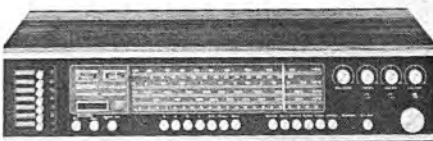

Saba Freiburg Telecommander

#### **Hi-Fi Studio 8035** ★

AM/FM stereo tuner/amplifier. Range: FM, LW, MW, SW. Variable tuning. Slider controls. Tuning meter. Output: 18W music power per channel. HD: <0.25% at 12W output. 62 semiconductors. Output impedance: 4-16 ohms. Output fully protected against short circuits. Headphone socket on front panel. Inputs for mag PU, crystal PU and tape recorder. Size: 23 $\frac{3}{8}$   $\times$  5 $\frac{3}{8}$   $\times$  11 $\frac{1}{8}$  in. Finish: light walnut or white. Price:  $\pounds$ 110 (including VAT).

#### **Hi-Fi Studio 8080** ★

AM/FM stereo tuner/amplifier. Range: FM, LW, MW, SW. Variable tuning plus six preset FM stations. Tuning meter. FET front-end on all bands. Quiet tuning facility on FM. 54 transistors, 30 diodes, one IC. Output: 30W RMS per channel. HD: <0.1%. Socket for reverberation unit. Output protected against short circuits. Mains: 110, 130, 220, 240V AC. Size: 23 $\frac{3}{8}$   $\times$  5 $\frac{3}{8}$   $\times$  12 $\frac{1}{2}$  in. Finish: walnut or white. Price:  $\pounds$ 165 (including VAT).

#### **Freiburg Telecommander** ★

AM/FM stereo tuner/amplifier with ultrasonic cordless remote control. Range: LW, MW, SW, FM/VHF. Variable tuning plus seven preset stations on FM. AFC. Meter tuning indicator. 69 transistors, 36 diodes, 13 rectifiers, 8 thyristors and 5 ICs. Output: 40W RMS per channel. Inputs for mag PU, tape, aux. Connection for reverberation unit. HD: <0.1%. Output

★ Indicates entry is illustrated



Sansui receiver model six

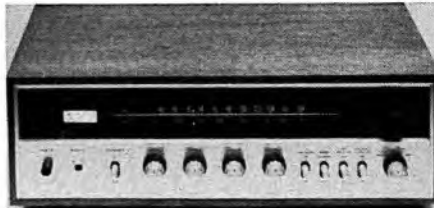

Sansui 350A

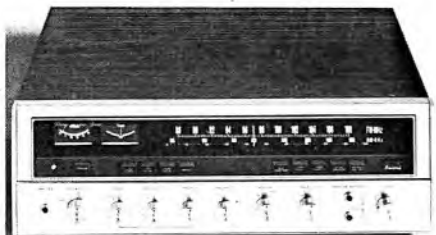

Sansui Seven

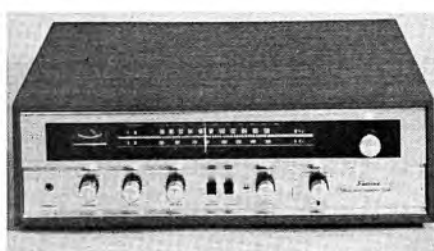

Sansui model 210

circuits protected against short circuit. Silent tuning facility on FM. Size:  $29\frac{3}{8} \times 6\frac{7}{8} \times 13$ in. Finish: light walnut and white. Price: £285 (including VA1).

## ■ SANSUI

Vernitron Ltd, Thornhill, Southampton,  
SO9 5QF. Tel: Southampton (0703) 444811.

### Six ★

AM/FM stereo tuner/amplifier. Range: FM 88-108MHz, MW 187-560m. Variable tuning. AFC. Meter tuning indicator. Ratio detector. Usable sensitivity: FM  $2\mu\text{V}$ . Aerial input: 300 ohms balanced twin, 75 ohms coaxial. Stereo decoder fitted. Inputs: mag PU  $2.5\text{mV}$  50K, aux  $150\text{mV}$  50K, tape  $150\text{mV}$  50K, noise reduction adaptor  $150\text{mV}$  50K, four-channel adaptor  $150\text{mV}$  50K, power amplifier  $800\text{mV}$  50K. Noise level: (mag PU input) better than 70dB, (other inputs) better than 80dB. Overload capability: (mag PU)  $100\text{mV}$ . 73 transistors, 45 diodes. Output: 39W RMS per channel. Controls: bass  $\pm 15\text{dB}$  at 20Hz (3dB steps), treble  $\pm 15\text{dB}$  at 15kHz (3dB steps), low filter  $-10\text{dB}$  at 50Hz, high filter  $-10\text{dB}$  at 10kHz, loudness  $+10\text{dB}$  at 50Hz  $+3\text{dB}$  at 10kHz. HD:  $<0.3\%$ . Output impedance: 4-16 ohms. FR: 20Hz-40kHz  $+1\text{dB}$   $-1.5\text{dB}$  at 1W. Mains: 100, 117, 220, 240V 50-60Hz. Size:  $16\frac{3}{4} \times 5\frac{3}{8} \times 12\frac{1}{2}$ in. Finish: walnut cabinet, satin chrome front panel and satin chrome knobs. Facilities for two tape decks, a four-channel adaptor, noise reduction unit. Outlets for three pairs of speakers. Price: to be announced.

### Seven ★

AM/FM stereo tuner/amplifier. Range: FM 88-108MHz, MW 187-560m. Variable tuning. AFC. Ratio detector. Tuning meters. Usable sensitivity: FM  $1.8\mu\text{V}$ . Aerial input: 300 ohms balanced twin, 75 ohms coaxial. Stereo decoder fitted. 74 transistors, 46 diodes. Inputs: mag PU  $2.5\text{mV}$  50K, aux  $150\text{mV}$  50K, tape  $150\text{mV}$  50K, noise reduction unit  $150\text{mV}$  50K, four-channel adaptor  $150\text{mV}$  50K, power amplifier  $800\text{mV}$  50K. Noise level: (mag PU input) 70dB, (other inputs) 80dB. Overload capability: 100 mV. Output: 47W RMS per channel. Controls: bass  $\pm 15\text{dB}$  at 20Hz (3dB steps), mid-range  $\pm 5\text{dB}$  at 1.5kHz (1dB steps), treble  $\pm 15\text{dB}$  at 20kHz (3dB steps), low filter  $-10\text{dB}$  at 50Hz, high filter  $-10\text{dB}$  at 10kHz, loudness  $+10\text{dB}$  at 50Hz  $+8\text{dB}$  at 10kHz. HD:  $<0.3\%$ . Output impedance: 4-16 ohms. FR: 15Hz-40kHz  $+1\text{dB}$   $-1.5\text{dB}$  at 1W. Mains: 100, 117, 220, 240V 50-60Hz. Size:  $17\frac{3}{8} \times 15\frac{3}{8} \times 13$ in. Finish: walnut cabinet, satin chrome front panel, satin chrome trim and knobs. Facilities for two tape decks, four-channel adaptor, noise reduction unit. Two AC outlet sockets. Outlets for three pairs of speakers. Price: to be announced.

### Eight

AM/FM stereo tuner/ amplifier. Stereo decoder fitted. Output: 60W RMS per channel into 8 ohms. HD:  $<0.3\%$  at rated output: FR: 5Hz-50kHz. Sensitivity: FM  $1.4\mu\text{V}$ . Range: FM 88-108MHz. Pushbutton controls. Provision for three sets of speakers. Controls: bass, treble, mid-range, balance, volume, input selector, tuning. Sockets for headphones, tape record/

play. Balance check pushbutton. High-pass and low-pass filters. FM quiet tuning. Price: £265.84 (plus VAT).

### 350A ★

AM/FM multiplex stereo. Solid state. Range: 88-108MHz, 187-562m. Variable tuning with meter indicator. Sensitivity:  $2.5\mu\text{V} \pm 3\text{dB}$  (20dB quieting) FM:  $25\mu\text{V} \pm 3\text{dB}$  at 1MHz on AM. Inputs: pickup  $2.2\text{mV} \pm 3\text{dB}$ ; aux  $150\text{mV} \pm 3\text{dB}$ ; tape monitor  $150\text{mV} \pm 3\text{dB}$ ; H and N: pickup 60dB, aux 65dB. Power output: 20W per channel  $\pm 1\text{dB}$  at 8 ohms. FR: 30Hz-20kHz. Distortion: 1%. Dual speaker system. Aerial: 75 and 300 ohms. Controls: tuning, bass, treble, volume, balance, selector, switches for speakers, multiplex noise canceller, loudness, mono mode and tapemonitor. Mains: 100, 117, 220 and 240V 50 or 60Hz. Size:  $4\frac{1}{2} \times 15\frac{1}{8} \times 13\frac{1}{8}$ in. Weight: 19.5lb. Price: £128.47 (plus VAT).

### 210 ★

Stereo AM/FM tuner/amplifier. Range: FM 88-108MHz, MW 187-560m. Variable tuning. AFC. Ratio detector. Meter tuning indicator. Usable sensitivity: FM  $3\mu\text{V}$ , MW 370 $\mu\text{V}$ . Aerial input: 75 ohms coaxial, 300 ohms balanced. Stereo decoder fitted. Mains: 100, 117, 220, 240V AC. Size:  $17\frac{1}{8} \times 11\frac{1}{8} \times 5$ in. Finish: light walnut cabinet. Output: 10W RMS per channel. Inputs for mag PU (3mV), tape, aux. Outputs for tape, headphones. Two AC outlet sockets. Price: £73.06 (plus VAT).

### 310

Stereo AM/FM tuner/amplifier. Range: FM 88-108MHz, MW 187-560m. Variable tuning. AFC. Ratio detector. Meter tuning indicator. Usable sensitivity: FM 2.3 $\mu\text{V}$ , MW 180 $\mu\text{V}$ . Aerial input: 75 ohms coaxial, 300 ohms balanced. Stereo decoder fitted. Mains: 100, 117, 220, 240V AC. Size:  $17\frac{1}{8} \times 11\frac{1}{8} \times 5$ in. Finish: light walnut cabinet with black fascia. Output: 15W RMS per channel. Two speaker systems. Multiplex filter. Tape monitor socket. Price: £97.96 (plus VAT).

### 1000X

Stereo AM/FM tuner/amplifier. Range: FM 88-108MHz, MW 187-560m. Variable tuning. AFC. Ratio detector. Meter tuning indicator. Usable sensitivity: FM  $2\mu\text{V}$ , MW 150 $\mu\text{V}$ . Aerial input: 75 ohms coaxial, 300 ohms balanced. Stereo decoder fitted. Mains: 100, 117, 220, 240V AC. Size:  $16\frac{3}{8} \times 11\frac{1}{8} \times 5\frac{1}{8}$ in. Finish: light walnut cabinet, silver control panel, black dial. Output: 28W RMS per channel. Two sets of speaker outlets. Sockets for tape, phones. Quiet tuning facility. Price: £152.70 (plus VAT).

### QRX 5500

Four channel FM/AM stereo receiver with QS variomatrix. Bands: 88-108MHz FM, 535-1605kHz AM. Sensitivity: 1.9 $\mu\text{V}$  IHF (FM).

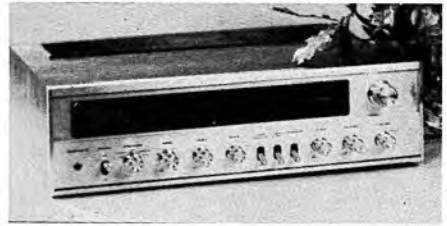

Sanyo DCX2500K

Aerial: 75 or 300 ohms. Inputs: phono 2.5mV 50K, mic 2.5mV 10K, aux (two and four channel) 100mV 50K, tape mon (pin) (two and four channel) 100mV 50K, DIN (two channel) 100mV 50K. Outputs: tape (pin) (two and four channel) 100mV 50K, DIN (two channel) 30mV 50K. FR: 30Hz-30kHz, +1dB -1.5dB. Power output: 25W per channel (4) into 8 ohms at 1kHz. THD: 0.3%. Size: 594 x 203 x 370mm. Price: on application.

### Model 661

FM/AM stereo receiver. Bands: 88-108MHz FM, 535-1605kHz AM. Sensitivity: 2.2 $\mu\text{V}$  IHF (FM). Aerial: 75 or 300 ohms. Inputs: phono 2.5mV 50K, aux 100mV 50K, tape mon 100mV 50K. Outputs: tape (DIN) 30mV, (pin) 100mV. S/N: phono 70dB, aux 80dB. FR: 15Hz-30kHz +1dB -2dB. Power output: 27W per channel into 8 ohms at 1kHz. THD: 0.5% at rated power. Size: 444 x 135 x 300mm. Price: on application.

### Model 771

FM/AM stereo receiver. Bands: 88-108MHz FM, 535-1605kHz AM. Sensitivity: 2.0 $\mu\text{V}$  IHF (FM). Aerial: 75 or 300 ohms. Inputs: phono 2.5mV 50K, mic 2.5mV 50K, aux (1&2) 100mV 50K. Tape monitor (four channel) 100mV 50K. Outputs: (DIN) 30mV, (PIN) 100mV. Speakers 40W per channel into 8 ohms. THD: 0.5% at rated output. H & N: phono 70dB, aux 80dB. FR: 15Hz-30kHz +1dB -2dB. Size: 480 x 135 x 300mm. Price: on application.

### ■ SANYO

Sanyo Marubeni (UK) Ltd, Sanyo House, Bushey Mill Lane, Watford, Herts, WD2 4UQ. Tel: Watford (92) 30421.

### DCX2500K ★

Stereo tuner/amplifier. AM/FM. Stereo decoder included. Output: 10W sine per channel, 15W music power. Inputs: PU 2.5mV, aux 100mV, tape play 150mV. FR: 30Hz-40kHz. Controls: volume, bass, treble, input selector, mode selector, tape monitor, high filter and loudness. Bass control:  $\pm 10\text{dB}$  at 100Hz. Treble control:  $\pm 10\text{dB}$  at 10kHz. Loudness control:  $\pm 10\text{dB}$  at 100Hz. Signal to noise: better than 45dB. Meter

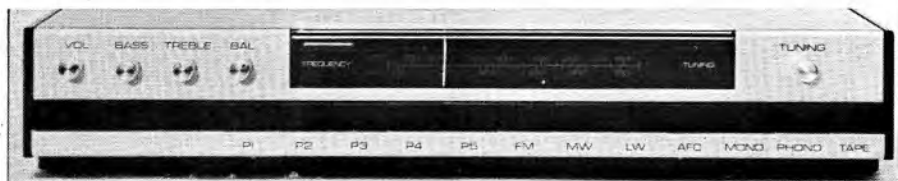

Scan-Dyna 2000



Scan-Dyna 3000



Scan-Dyna 4000

tuning indicator. Outlet for stereo headphones, tape recorder, two sets of speakers. Price: £84.75 (including VAT).

### DCX2300K

Stereo tuner/amplifier. AM/FM. Stereo decoder included. Output: 15W sine per channel, 22.5W music power. Inputs: PU 2.5mV, aux 100mV, tape play 150mV. Signal to noise: PU 60dB, aux 70dB. FR: 15Hz-80kHz. Sockets for stereo headphones, tape recorder, PU, microphone and speakers. Controls: volume, mic volume, bass  $\pm 10$ dB at 100Hz, treble  $\pm 10$ dB at 10kHz, loudness: +10dB at 100Hz and +5dB at 10kHz, balance, plus switches for speakers, input selector, monitoring high filter and mono/stereo. 32 transistors, one IC, one FET. Mains: 120-240V AC. Usable sensitivity on radio: AM 25 $\mu$ V, FM 3 $\mu$ V. Price: £99.75 (including VAT).

### DCX3000KA

AM/FM stereo tuner/amplifier. Full specification not available as this edition of the Year Book closed for press. Price: £126.75 (including VAT).

### DCX3300KA

AM/FM stereo tuner/amplifier. Full specification not available as this edition of the Year Book closed for press. Price: £176.75 (including VAT).

## ■ SCAN-DYNA

Scandinavian Audio Systems Ltd,  
Sun Alliance Building, 65 London Road,  
Gloucester, GL1 3HF.  
Tel: Gloucester (0452) 32791.

### 2000 ★

AM/FM stereo tuner/amplifier. Range: 87-104MHz, MW 181-588m, LW 833-2069m. Variable tuning plus five presets on FM. Switchable AFC. Ratio detector. Meter for signal strength (AM) and tuning (FM). Usable sensitivity: FM 1.8 $\mu$ V (IHFM). Aerial input: 75

ohms coaxial. Stereo decoder fitted. Inputs: mag PU 2mV, tape 200mV. Output: 25W RMS per channel. HD: <1%. FR: 20Hz-20kHz  $-1.5$ dB. Controls: tuning, volume on/off switch, bass  $\pm 15$ dB, treble  $\pm 15$ dB, balance (zero to maximum). Pushbuttons for wavebands, input selector, mono/stereo. AFC. Output impedance: 4-16 ohms. Headphone socket: 8-200 ohms. Mains: 220-240V 50Hz. Size: 21 $\frac{3}{8}$   $\times$  9 $\frac{3}{8}$ in. Weight: 11 $\frac{1}{2}$ lb. Finish: black. Price: £112.90 (including VAT).

### 2400

FM stereo tuner/amplifier. Range: FM 87-108MHz. Sensitivity: 1.2 $\mu$ V (limiting 0.8 $\mu$ V for 3dB S/N). Capture ratio: 2dB. Quiet tuning level: 1 $\mu$ V-1mV adjustable. Output: 30W RMS per channel into 8 ohms, 40W RMS per channel into 4 ohms. HD: 0.5% 20Hz-20kHz. Inputs: mag PU 2mV 47K, ceramic PU 200mV 470K, mic 2mV 22K, tape 200mV 470K. Tone controls: bass  $\pm 18$ dB, treble  $\pm 18$ dB. Output impedance: 4-16 ohms. Headphone outlets: 4 ohms and higher. Damping factor: 40 at 8 ohms. Finish: beige/silver, black/silver. Price: £169.90 (including VAT).

### 3000 ★

AM/FM stereo tuner/amplifier. Range: FM 87-108MHz, MW 181-588m. Variable tuning. Switchable AFC. Ratio detector. Meter tuning indicator. Usable sensitivity: 1.6 $\mu$ V (IHFM). Aerial input: 75 ohms coaxial and 300 ohms balanced twin. Stereo decoder fitted. 48 transistors, two ICs, 19 diodes. Inputs: mag PU 2mV 47K, tape 200mV IM, monitor 200mV 0.5M. Output: 50W RMS per channel into 4 ohms. HD: <1% at rated output. FR: 20Hz-20kHz  $\pm 1.5$ dB. Controls: volume, bass, treble, balance, rumble filter (12dB per octave from 40Hz), scratch filter (18dB per octave from 4kHz). Mains: 110, 240V 50-60Hz. Size: 21 $\frac{1}{2}$   $\times$  5  $\times$  10in. Finish: teak or rosewood. Price: £139.90 (including VAT).

**4000 ★**

AM/FM stereo tuner/amplifier. Range: FM 87-108MHz, MW 181-588m, LW 833-2069m. Variable tuning. Tuning meter. Usable sensitivity: FM 1.6µV (IHF), MW 1µV for 3dB S/N. Aerial input: 75 ohms coaxial, 300 ohms balanced twin. Stereo decoder fitted. 48 transistors, two ICs, 19 diodes, eight valves. Inputs: mag PU 2mV 47K, tape 200mV 1M, monitor 200mV 0.5M. Output: 60W RMS per channel into 4 ohms. HD: < 1% at rated output. FR: 20Hz-20kHz ± 1.5dB. Controls: volume, bass, treble, balance, tuning, rumble filter (-12dB/octave from 40Hz), scratch filter (-18dB/octave from 4kHz). Pushbuttons for loudness, monitor 1, monitor 2, AFC. Mains: 110, 240V AC 50-60Hz. Size: 21½ × 5½ × 10in. Finish: teak or rosewood. Price: £159.90 (including VAT).

**SHARP**

Sharp Electronics (UK) Ltd,  
107 Hulme Hall Lane, Manchester, M10 8HL.  
Tel: 061-205 7321.

**SA606**

Stereo AM/FM tuner/amplifier. Range: FM 88-108MHz, MW 189-560m, LW 1000-2000m, SW 16-50m. Variable tuning plus FM presets. AFC. Ratio detector. Meter tuning indicator. Usable sensitivity: FM 5µV, AM 100µV. Aerial input: 300 ohms balanced. Decoder included. Output: 4W RMS per channel DIN. Output impedance: 8 ohms. Mains: 110, 220, 240V AC. Finish: Cabinet PVC laminated veneer, front panel aluminium. Size: 18¾ × 13¾ × 4½in. Price: £105.62 (including VAT).

**SHERWOOD**

Distributors: Acoustico Enterprises Ltd,  
Unit 7, Space Way, North Feltham Trading  
Estate, Feltham, Middlesex, TW14 0TZ.  
Tel: 01-751 0141. Telex: 935437.

**Model S7050**

FM/AM stereo receiver. Bands: 88-108MHz FM, 540-1600kHz AM. Sensitivity: 3.5µV IHF (FM) 5µV for 10dB S/N AM. Manual tuning, signal strength meter. Aerial: 300 ohms balanced. Input: phono 2mV, aux 200mV. S/N: phono 65dB, aux 70dB. Output: 10W per channel into 8 ohms at 1kHz, 12W per channel into 4 ohms at 1kHz. Damping factor: 30 at 1kHz into 8 ohms. THD: 1% into 8 ohms at rated output. FR: 30Hz ± 1dB. Size: 5½ × 16 × 12in. Price: on application.

**Model S7100A**

FM/AM stereo receiver. Bands: 88-108MHz (FM), 540-1600kHz (AM). Sensitivity: 1.9µV IHF (FM) 5µV for 6dB S/N AM. Manual tuning, signal strength meter. Aerial: 300 ohms. Inputs: phono 60mV, aux 200mV. S/N: phono



Sherwood S7200

65dB, aux 75dB. Output: 22W per channel into 8 ohms at 1kHz, 27W per channel into 4 ohms at 1kHz. Damping factor: 30 at 1kHz into 8 ohms. THD: 0.9% at rated output into 8 ohms. FR: 20Hz-20kHz ± 1dB. Size: 5½ × 17½ × 13½in. Price: on application.

**Model S7200 ★**

FM/AM stereo receiver. Bands: 88-108MHz (FM), 540-1600kHz (AM). Sensitivity: 1.8µV IHF (FM), 10µV for 20dB S/N (AM). Manual tuning, centre tuning meter. Aerial: 300 ohms. Inputs: phono 2.2mV, aux 230mV. S/N: phono 60dB, aux 80dB. Output: 40W per channel into 8 ohms at 1kHz. 50W per channel into 4 ohms at 1kHz. Damping factor: 40 at 1kHz into 8 ohms. THD: 0.7% at rated power, 8 ohms. FR: 20Hz-20kHz ± 0.5dB. Size: 5¾ × 17½ × 14in. Price: on application.

**Model S7900A**

FM/AM stereo receiver. Bands: 88-108MHz (FM), 540-1600kHz (AM). Sensitivity: 17µV IHF (FM), 4µV for 10dB S/N (AM). Manual tuning, centre tuning meter. Aerial: 75 or 300 ohms. Inputs: phono 1.5mV, 3.8mV or 8mV switched aux 2.5V. S/N: phono 65dB, aux 80dB. Output: 65W per channel into 8 ohms at 1kHz. 90W per channel into 4 ohms at 1kHz. THD: 0.3% at rated power into 4 ohms. FR: 20Hz-20kHz ± 1dB. Size: 17 × 14 × 6¾in. Price: on application.

**SIEMENS**

Siemens Ltd, Great West House,  
Great West Road, Brentford, Middlesex.  
Tel: 01-568 8281.

**RS 305**

FM/SW/MW/LW stereo and synthesised four-channel receiver. Bands: 87.5-104MHz FM, 5.9-7.4MHz SW, 510-1620kHz MW, 145-360kHz LW. Size: 135 × 642 × 300mm. Price: £206.39 (plus VAT).

**RS 502**

FM/SW/MW/LW stereo/quadrasonic receiver. Bands: 87.5-104MHz FM, 5.85-10.2MHz SW(1), 10.18-5MHz SW(2), 510-950kHz MW(1), 930-1635kHz MW(2), 145-350kHz LW. Size: 150 × 635 × 365mm. SQ decoder and CD-4 demodulator. 4-VU meters. 230W music power (total). Price: £435.64 (plus VAT).



★ Indicates entry is illustrated



Sonab R7000



Sony STR-6036

### ■ SONAB

Sonab Ltd, PO Box 4, Oldfield Road, Hampton, Middlesex, TW12 2HN.  
Tel: 01-979 0134.

### R7000 ★

Stereo tuner/amplifier. Range: FM/VHF. Variable tuning. Tuning indicator. Aerial input: coaxial. Stereo decoder fitted. AFC. Transistors. Output: 50W RMS per channel into 8 ohms. HD: 0.02% at 1kHz and 30W into rated load (never more than 0.1% at all levels 25Hz-25kHz). FR: 25Hz-25kHz±0.5dB. Size: 15×3×11in. Mains: 240V AC. Price: £243-18 (plus VAT).

### R4000/2

FM stereo tuner/amplifier. Range: 87.5-104 MHz. Variable tuning plus four presets. AFC. Tuning and signal strength meter. Usable sensitivity: better than 2µV (300 ohms input) and 1µV (75 ohms input). Aerial input: 300 ohms balanced twin, 75 ohms coaxial. Stereo decoder fitted. Inputs: mag PU 2mV 68K, aux 100mV 100K, tape 100mV 100K. Overload capability: >36dB for low level inputs. Output: 70W RMS per channel into 4 ohms, 50W RMS per channel into 8 ohms. Controls: input selector, mono/stereo, loudness, high filter 12dB/octave -3dB at 8kHz, volume, bass ±12dB at 50Hz, treble ±8dB at 10kHz, balance, preset stations, AFC on/off. HD: <0.5% 20Hz-20kHz at 35W on single channel, <1.0% at 1kHz all levels up to 35W on both channels. Output impedance: (speakers) two pairs at 4-16 ohms, tape 10K, headphones 8-2000 ohms. FR: 15Hz-25kHz ±1.5dB. Mains: 110, 130, 220, 240V 50-60Hz. Size: 18½×9¾×4¾in. Finish: black. Price: £172-96 (plus VAT).

### ■ SONY

Sony (UK) Ltd, Pyrene House, Sunbury Cross, Sunbury-on-Thames, Middlesex.  
Tel: Sunbury-on-Thames (76) 87644.

### STR-6036 ★

AM/FM stereo tuner/amplifier. Range: FM/VHF, MW. Variable tuning. Ratio detector. Meter tuning indicator. Usable sensitivity: FM 2µV, AM 30µV. Stereo decoder fitted. FET front end. 39 transistors and one FET. Inputs: mag PU 2.5mV 47K, mic 2mV 47K, aux 250mV 100K, tape 250mV 100K. Noise level: (low level inputs) 60dB, aux 70dB, tape 80dB. Output: 16W RMS per channel into 8 ohms. Tone controls: bass ±10dB at 100Hz, treble ±10dB at 10kHz. HD: 0.1% at 1W. FR: 30Hz-40kHz +0dB -3dB. Mains: 100, 120, 240V AC. Size: 17½×5½×3¾in. Finish: wood grain cabinet with black and silver facing. PA facility. Loudness control. Price: £72 (plus VAT).

### STR-6046

AM/FM stereo tuner/amplifier. Range: FM/VHF, MW. Variable tuning. Ratio detector. Meter tuning indicator. Usable sensitivity: MW 30µV, FM 1.4µV. Aerial input: 300 ohms balanced. Stereo decoder fitted. 44 transistors and one FET. Inputs: mag PU 2.5mV 47K, mic 2mV 47K, aux 250mV 100K, tape 250mV 100K. Noise level: (low level inputs) 60dB, aux 70dB, tape 80dB. HD: <1% at 1W output. Output: 25W RMS per channel into 8 ohms. FR: 30Hz-40kHz +0dB -3dB. Mains: 100, 120, 220, 240V AC. Size: 17½×5½×13¾in. Finish: wood grain cabinet with black and silver panel. Input mixing facility. Illuminated mode display. Price: £105 (plus VAT).

### ■ STEEPLETONE

Steepletone Products Ltd, Station Approach, Bicester, Oxon, OX6 7DP.  
Tel: Bicester (086 92) 42031.

### S500

Stereo FM tuner/amplifier. Range: 87.5-108 MHz. Five preset station buttons. Switchable AFC. Ratio detector. Usable sensitivity: 2µV. Aerial input: 240-300 ohms balanced twin, 70-80 ohms coaxial. Low level output 0-2V variable. Stereo decoder fitted. 37 transistors, 39 diodes, one IC. Inputs: mag PU 2mV 47K, radio 50mV 220K, tape 50mV 220K, aux (1) 100mV 470K, aux (2) 100µV 30-600 ohms. Noise level: mag PU input better than -66dB, other inputs better than -70dB. Overload capability: all inputs 30dB. Output: 25W RMS per channel. Controls: volume, balance, bass ±15dB at 40Hz, treble ±15dB at 14kHz, bass filter 12dB/octave from 80Hz, treble filter 18dB/octave from 8kHz, loudness, monitor switch, mono/stereo. HD: <0.1% at 20W, <0.05% at 5W. Output impedance: 8 ohms. FR: 40Hz-20kHz (PU input equalised to RIAA), 25Hz-25kHz±2dB (radio and tape play inputs). Mains: 200-250V AC. Size: 21×4¼×8½in. Finish: teak with brushed aluminium. Price: £89-99 (including VAT).

**STR-6055**

AM/FM stereo tuner/amplifier. Range: FM/VHF, MW. Variable tuning. Ratio detector. Meter tuning indicator. FET front end. Usable sensitivity: FM 1.8 $\mu$ V, MW 20 $\mu$ V. Aerial input: 300 ohms balanced. Stereo decoder fitted. 51 transistors and five FETs. Inputs: mag PU 1.8mV 47K, aux (2) 140mV 100K, tape 140mV 100K. Noise level: mag PU 70dB, other inputs 90dB. Output: 40W RMS per channel into 8 ohms. HD: <1% at 1W. FR: 10Hz-60kHz +0dB -3dB. Mains: 100, 117, 220, 240V AC. Size: 18 x 5 $\frac{7}{8}$  x 13 $\frac{3}{8}$ in. Price: £140 (plus VAT).

**STR-6200F**

FM stereo tuner/amplifier. Range: 87.5-108 MHz. Variable tuning. FET front end. Ratio detector. Twin tuning meters. Usable sensitivity: 1.8 $\mu$ V. Aerial input: 75 ohms coaxial, 300 ohms balanced. Stereo decoder fitted. 71 transistors and 5 FETs. Inputs: mag PU 1.4mV 47K, aux (3) 140mV 100K, tape (2) 140mV 100K. Output: 100W RMS per channel into 8 ohms. HD: <2%. FR: 10Hz-100kHz+0dB -3dB. Mains: 100, 117, 220, 240V AC. Size: 19 x 5 $\frac{7}{8}$  x 15 $\frac{7}{8}$ in. Finish: wood grain and brushed aluminium. Mating facility. Bass compensator. Price: £300 (plus VAT).

**TANDBERG**

Distributors: Farnell-Tandberg Ltd, Farnell House, 81 Kirkstall Road, Leeds, LS3 1HR. Tel: Leeds (0532) 35111.

**TR200MPX ★**

Stereo FM tuner/amplifier. Range: 87.5-108 MHz. Variable tuning plus five presets. AFC. Meter tuning indicator. Usable sensitivity: 1 $\mu$ V. Aerial input: 75 ohms coaxial. Stereo decoder fitted. Inputs: tape 250mV 30K, PU 2.3mV 47K, aux 100mV 100K. Noise level: -52dB. Output: 15W per channel into 8 ohms, 20W per channel into 4 ohms. Output impedance: 4 ohms. Tone controls: bass  $\pm$ 16dB at 50Hz, treble  $\pm$ 15dB at 10kHz. Loudness: +11dB at 50Hz. HD: 1% at rated output. FR: 20Hz-40kHz  $\pm$ 3dB. Size: 17 x 3 $\frac{1}{2}$  x 9 $\frac{1}{2}$ in. Speaker selector switch. Magnetic/crystal PU switch. Tape monitor switch. Headphone socket. Finish: teak or rosewood. Price: (teak or rosewood) £116.75 (including VAT).

**TR1000MPX ★**

Stereo FM tuner/amplifier. Range: 87.5-108 MHz. Variable tuning plus six presets. AFC. Phase locked loop discriminator. Meter tuning indicator. Usable sensitivity: 2 $\mu$ V. Aerial input: 75 ohms coaxial. Stereo decoder fitted. Inputs: mag PU 2mV 47K, tape 200mV 100K, aux (2) 200mV 100K. Noise level: -70dB. Overload capability: (PU input) 25dB, (other inputs) 20dB. Output: 50W RMS into 4 ohms, 35W

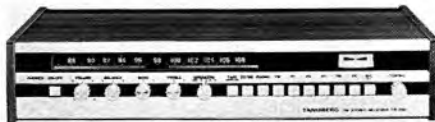

Tandberg TR200MPX



Tandberg TR1000MPX

RMS into 8 ohms. Controls: bass  $\pm$ 16dB at 50Hz, bass loudness +12dB at 50Hz, high filter (1) -12dB at 15kHz, high filter (2) -5dB at 15kHz, treble  $\pm$ 14dB at 10kHz, treble loudness +7dB at 7kHz, low filter -8dB at 50Hz. HD: 0.1% at 1dB below rated output power. Output impedance: 8 ohms. FR: 20Hz-20kHz  $\pm$ 2dB at 50W. Size: 17 x 4 $\frac{3}{4}$  x 12in. Finish: teak or rosewood cabinet with black dial and satin finish front panel. Front jack for stereo headphones. Price: (teak or rosewood) £184.84 (including VAT).

**TR1010MPX**

AM/FM stereo tuner/amplifier. Range: FM 87.5-108MHz, MW 187-579m. Variable tuning plus six presets. AFC. Phase locked loop discriminator. Meter tuning indicator, meter signal strength indicator. Usable sensitivity: FM 1 $\mu$ V, MW 60 $\mu$ V. Aerial input: 75 ohms coaxial. Stereo decoder fitted. 57 transistors, 34 diodes, 3 FETs. Inputs: mag PU 1.8mV 47K, tape 130mV 100K, aux 130mV 100K. Noise level: -70dB. Overload capability: (PU input) 25dB, (other inputs) 20dB. Output: 50W RMS into 4 ohms, 35W RMS into 8 ohms. Controls: bass  $\pm$ 16dB at 50Hz, bass loudness +12dB at 50Hz, treble  $\pm$ 14dB at 10kHz, treble loudness +7dB at 7kHz, low filter -8dB at 50Hz, high filter (1) -12dB at 15kHz, high filter (2) -5dB at 15kHz. HD: 0.1% at 1dB below rated output power. Output impedance: 4-8 ohms. FR: 20Hz-20kHz  $\pm$ 2dB at 50W. Mains: 220-240V 50-60Hz (can be rewired for 115V AC). Size: 17 x 4 $\frac{3}{4}$  x 12in. Finish: teak or rosewood cabinet with black dial and satin finished metal panel. Quiet tuning facility. AFC over-ride. Price: (teak or rosewood) £199.10 (including VAT).

**Huldra 10 MPX ★**

AM/FM stereo tuner/amplifier. Range: FM 87.5-108MHz, MW 187-579m, LW 1120-2000m, SW1 30-90m, SW2 15-30m, SW3 10-15m. Variable tuning plus four presets. AFC. Meter

★ Indicates entry is illustrated

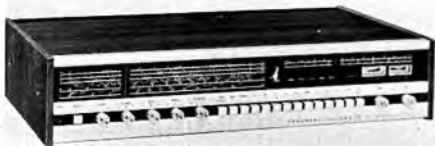

Tandberg Huldra 10 MPX



Teac AG6500

tuning indicator. Usable sensitivity: FM  $1\mu\text{V}$ , AM  $2\mu\text{V}$ . Aerial input: 75 ohms coaxial. Stereo decoder fitted. Inputs: mag PU  $2\text{mV}$  47K, tape 200mV 100K. Noise level:  $-70\text{dB}$ . Overload capability: 25dB. Output: 35W RMS per channel. Controls: bass  $\pm 17.5\text{dB}$  at 50Hz, treble  $\pm 15\text{dB}$  at 10kHz, loudness  $+12\text{dB}$  at 50Hz. HD: 0.2% at 35W RMS. Output impedance: 4.8 ohms. FR: 20Hz-20kHz  $\pm 2\text{dB}$ . Mains: 220-240V 50-60Hz. Size:  $21 \times 4\frac{3}{4} \times 12\text{in}$ . Finish: teak or rosewood cabinet with black dials and satin finished metal panel. Outputs for four speakers. Quiet tuning facility. Price: (teak or rosewood) £197.63 (including VAT).

#### TEAC

Acoustico Enterprises Ltd, Unit 7, Space Way, North Feltham Trading Estate, Feltham, Middx, TW14 0TZ.

Tel: 01-751 0141.

#### AG6500 ★

AM/FM stereo tuner/amplifier. Range: FM 88-108MHz, MW 187-560m. Variable tuning. AFC. Two tuning meters. Usable sensitivity: FM  $1.7\mu\text{V}$ , MW  $10\mu\text{V}$ . Aerial input: 75 ohms coaxial, 300 ohms balanced. Stereo decoder fitted. Output: 45W per channel. Output impedance: 8 ohms. HD:  $< 0.5\%$ . FR: 5Hz-20kHz  $+0\text{dB} - 1\text{dB}$ . Mains: 100, 117, 220, 240V AC. Finish: walnut and black with silver trim. Price: £220 (plus VAT).

#### TELEFUNKEN

AEF Telefunken (UK) Ltd, Bath Road, Slough, Bucks. Tel: Slough (75) 33311.

#### Concertino 301

Four waveband transistorised stereo tuner/amplifier with five FM station buttons. Ranges: FM, SW, MW, LW. Separate flywheel FM and

AM tuning. AFC with meter. Separate VU meter for station tuning control. Automatic stereo indicator. Sensitivity: FM  $1\mu\text{V}$  for 26dB signal/noise ratio at 40kHz deviation. Output: 15W per channel RMS. HD not greater than 1%. FR: ( $\pm 1.5\text{dB}$ ) 20Hz-20kHz. Sockets for 240 ohms FM dipole, local FM dipole (attenuator fitted), AM aerial, PU (high impedance), tape recorder (record and playback), two extension speakers. Controls: volume, balance, bass, treble. Pushbuttons: on/off, stereo, PU/tape, wavebands, 5 FM stations, AFC. Mains: 110-127, 220-240V 50Hz. Price: £122.98 (including VAT).

#### Concerto Hi-Fi 101 ★

Five waveband stereo tuner/amplifier. Range: 87.6-104MHz, 910-2000 metres, 186-212 metres, 211-578 metres, 19-51 metres. Variable tuning plus seven preset FM stations. Tuning meter. Sensitivity: FM  $1\mu\text{V}$  for 26dB S/N; AM  $6\mu\text{V}$  for 50mW output at 30% modulation,  $15\mu\text{V}$  for 10dB S/N. Stereo decoder fitted. Stereo beacon. Switchable AFC. Inputs: magnetic PU, crystal PU, tape recorder. Controls: pushbuttons for preset FM stations. AFC, wavebands, mono/stereo, input selector. Rotary controls for tuning volume, balance, treble, bass. Output: 30W music power per channel, 22W RMS per channel. HD: better than 1% at rated output. FR: 20Hz-20kHz  $\pm 1.5\text{dB}$ . Output impedance: 4 ohms. Socket for stereo phones, 43 transistors, 20 diodes, 4 rectifiers. Mains: 110, 127, 220, 240V 50Hz. Two FETs in FM tuner stage. Variable capacity diode tuning. Price: £132.55 (including VAT).

#### Hi-Fi Compact 2000

FM tuner/amplifier. Range: FM 87.6-104MHz. Variable tuning. Stereo decoder fitted. Inputs: magnetic PU, crystal PU, tape. Controls: treble, bass, balance, volume, pushbutton function selectors. Switchable AFC. Output: 15W RMS per channel, 22W music power per channel. HD:  $< 1\%$  at rated output. FR: 20Hz-20kHz  $\pm 1.5\text{dB}$ . Output impedance: 4 ohms. 43 transistors, 10 diodes, 3 rectifiers, Stereo headphone socket. Mains: 110, 220V 50-60Hz. Consumption: 65W maximum. Sensitivity:  $1.3\mu\text{V}$  for 26dB S/N. Price: £99.28 (including VAT).

#### Hymnus 101

AM/FM stereo tuner/amplifier. Range: FM, MW, LW, SW. Variable and preset tuning. AFC. Meter tuning indicator. Stereo decoder fitted. Output: 30W RMS per channel. Mains: 220-240V AC. Size:  $25 \times 10\frac{1}{2} \times 4\frac{3}{4}\text{in}$ . Finish: light matt walnut. Price: £147.18 (including VAT).

#### Hymnus 5050 ★

FM/AM stereo receiver. Bands: 88-108MHz (FM), 145-330kHz (LW), 515-1645kHz (MW),



Telefunken Concerto Hi-Fi 101

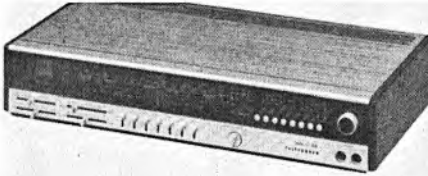

Telefunken Hymnus 5050

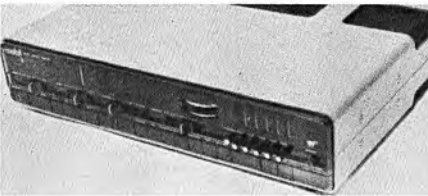

Teleton TFS 70

5.75-15.55MHz (SW). Seven presets plus manual tuning. Signal strength meter. Sensitivity: 2.4µV DIN (FM), 20µV DIN (AM). Aerial: 240 ohms. Inputs: phono 1.8mV 47K, phono (ceramic) 240mV 470K, tape 240mV 470K. Outputs: 2 × headphones, 6 × loudspeakers (4-16 ohms), tape 1.7mV. Power output: 30W per channel. THD: 0.5%. FR: 20Hz-20kHz ± 5dB. Selector switches for four speakers, room 1 (four channel stereo); two speakers, room 2. Adjustable muting. Price: £182 (including VAT).

#### Opus 6060

FM/AM stereo receiver. Tuner specification as for the Hymnus. Amplifier section. Inputs: phono (mag) 2mV 47K, phono (ceramic) 269mV 470K. Outputs: tape 1.7mV headphones 2 × 200 ohms 6 × speakers (4-16 ohms). THD: 0.5%. FR: 20Hz-20kHz ± 5dB. Power output: 60W per channel. Size: 24½ × 4¾ × 12in. Price: £232 (including VAT).

#### Concertino 3030

FM/AM stereo receiver. Bands: 87.6-108MHz (FM), 520-1630kHz (MW), 5.9-15.55MHz (SW), 148-330kHz (LW). Five presets plus manual tuning. Signal strength meter. Sensitivity: 2.4µV DIN (FM), 20µV DIN (AM). Aerial: 240 ohms. Inputs: phono (mag) 2.7mV 47K, phono (ceramic) 180mV 600K, tape 180mV 600K. Outputs: headphones 4 ohms, speakers 15W per channel. THD: <0.5%. FR: 20Hz-20kHz ± 1.5dB. Size: 21¾ × 4¾ × 10½in. Price: £137 (including VAT).

#### Concertino 4040

FM/AM stereo receiver. Bands: 87.6-108MHz (FM), 520-1630kHz (MW), 5.75-15.55MHz (SW), 145-330kHz (LW). Five presets plus manual tuning. Signal strength meter. Sensitivity: 2.4µV DIN (FM), 8µV DIN (SW), 12µV DIN (MW), 30µV (LW). Inputs: phono (mag) 3mV 47K, phono (ceramic) 220mV 600K, tape 220mV 600K. Outputs: headphones > 200 ohms, speakers 4-16 ohms, tape 700mV/K. Power output: 40W per channel. FR: 20Hz-20kHz. Size: 21¾ × 4¾ × 10½in. Price: £137 (including VAT).

#### TELETON

Teleton Electro (UK) Ltd, Teleton House, Waterhouse Lane, Chelmsford, Essex. CMI 1BD.

Tel: Chelmsford (0245) 62442. Telex: 99338.

#### TA 3000

FM/AM stereo receiver. Bands: 87.4-104MHz (FM), 510-1605kHz (MW). Aerial: 240 ohms FM. Sensitivity: 10µV (IHF) FM, 400µV AM. Inputs: phono 3mV 50K, tape 250mV 120K, aux 200mV 120K. FR: 20Hz-20kHz ± 1.5dB. H & N: -20dB (volume, bass and treble max.). Outputs headphones 500mV/8 ohms, speakers 3.5W per channel into 8 ohms. Damping factor: 20. THD: 0.3% at rated output. Price: on application.

#### TFS 70 ★

FM/AM stereo receiver. Bands: 87.5MHz (FM), 145-350kHz (LW), 510-1710kHz (MW), 145-350kHz (LW). Aerial: 300 ohms. Sensitivity: 2.5µV (IHF) (FM), 450µV (SW), 350µV (MW), 750µV (LW). Inputs: phono 3mV 47K, phono (ceramic) 250mV 3K, tape 350mV 47K, aux 200mV 100K. H & N: phono 50mV, others 30mV at output, full rated power. THD: 0.4% at 6W, 1kHz. FR: 30Hz-25kHz ± 1.5dB. Outputs: tape 45mV 47K, headphones 8 ohms, speakers 30W per channel into 8 ohms. Damping factor: 20. Price: on application.

#### TFS 50

FM/AM stereo receiver. Bands: 87.5-104.5MHz FM, 510-1630kHz (MW), 145-350kHz (LW). Aerial: 75 or 300 ohms. Sensitivity: 2.5µV (IHF) (FM). Inputs: phono 3mV 47K, tape 200mV 47K, aux 200mV 47K, aux 200mV 100K. H & N: phono 30mV, others 15mV reffull output power. Outputs: tape 70mV 22K, headphones 8 ohms, speakers 25W per channel into 8 ohms. Damping factor: 30. Size: 4½ × 19½ × 13in. Price: on application.

#### TRIO

Distributors: B. H. Morris & Co (Radio) Ltd, Trio House, The Hyde, London, NW9 6JP. Tel: 01-205 6441.

#### KR-2400

FM/AM stereo receiver. Bands: 88-108MHz (FM), plus AM/MW. Sensitivity: 2.5µV (IHF) (FM), 25µV (AM). Manual tuning. Aerial: 75 or 300 ohms. Inputs: phono 2.5mV 50K, aux 150mV 45K, tape play 150mV 45K. S/N: phono 70dB, aux 87dB, tape play 87dB (IHF-A curve). Output: 16W per channel into 8 ohms, 20W per channel into 4 ohms, both at 1kHz. THD: 1% at rated power into 8 ohms. Power bandwidth: 10Hz-30kHz. Size: 480 × 137 × 344mm. Price: £104 (plus VAT).

#### KR-3400

FM/AM stereo receiver. Bands: 77-108MHz plus AM/MW. Sensitivity: 2.5µV (IHF) (FM) 25µV (AM). Manual tuning. Aerial: 75 or 300 ohms. Inputs: phono 2.5mV 50K, aux 150mV 45K, tape play 150mV 45K. S/N: phono 70dB, aux and tape play 87dB (IHF-A curve). Output: 22W per channel into 8 ohms, 29W per channel into 4 ohms, both at 1kHz. THD: 0.8% at rated power into 8 ohms. Power bandwidth: 10Hz-30kHz. Size: 480 × 137 × 344mm. Price: £119.25 (plus VAT).

#### KR-400

FM/AM stereo receiver. Bands: 88-108MHz plus AM/MW. Sensitivity: 2.1µV (IHF) (FM), 20µV (AM). Manual tuning. Aerial: 75 or 300 ohms. Inputs: phono (1&2) 2.5mV 50K, aux 150mV 45K, tape play 150mV 45K. S/N: phono 70dB aux and tape play 90dB (IHF-A curve). Output: 25W per channel into 8 ohms, 27W per channel into 4 ohms both at 1kHz. THD: 0.5% at rated power into 8 ohms. Power bandwidth: 10Hz-30kHz. Size: 48 × 137 × 344mm. Price: £142 (plus VAT).

#### KR-5400

FM/AM stereo receiver. Bands: 88-108MHz (FM) plus AM/MW. Sensitivity: 1.9µV (IHF) (FM), 18µV (AM) Manual tuning. Aerial: 75 and 300 ohms. Inputs: phono (1&2) 2.5mV 50K, aux 150mV 80K, tape play A & B 150mV 80K, mic 2.5mV 50K. S/N: phono 70dB, aux and tape play 90dB, mic 60dB. (IHF-A curve). Output: 35W per channel into 8 ohms, 47W per channel into 4 ohms at 1kHz. THD: 0.5% at rated power into 8 ohms. Power bandwidth: 10Hz-30kHz. Size: 480 × 151 × 344mm. Price: £169.50 (plus VAT).

#### KR-6400

FM/AM stereo receiver. Bands: 88-108MHz (FM) plus AM/MW. Sensitivity: 1.9µV (IHF) (FM), 18µV (AM). Manual tuning. Aerial: 75 and 300 ohms. Inputs: phono (1&2) 2.5mV 50K, aux 150mV 80K, tape play A & B 150mV 80K, mic 2.5mV 50K. S/N: phono 70dB, aux and tape play 90dB, mic 65dB. (IHF-A curve). Output: 45W per channel into 8 ohms, 65W per channel into 4 ohms at 1kHz. THD: 0.3%

at rated power into 8 ohms. Power bandwidth: 10Hz-30kHz. Size: 480 × 151 × 344mm. Price: £201.50 (plus VAT).

#### KR3200

AM/FM stereo tuner/amplifier. Range: FM 86-108MHz, MW 187-556m. Variable tuning. Usable sensitivity: (FM) 2.3µV. Tuning meter. Aerial input: 75 ohms coaxial and 300 ohms balanced twin. Stereo decoder fitted. Inputs: mag PU 3mV 50K, aux 180mV 30K, tape 200mV 45K. Noise level: (mag PU input) -63dB, (other inputs) -75dB. Output: 18.5W RMS per channel. Output impedance: 4-16 ohms. FR: 25Hz-35kHz. Mains: 110, 230V AC. Two sets of speaker outlets. Controls: bass ±10dB at 100 Hz, treble ±10dB at 10kHz, loudness +10dB at 100Hz. Size: 17 $\frac{1}{8}$  × 5 $\frac{3}{4}$  × 13 $\frac{5}{8}$  in. Weight: 20 $\frac{1}{2}$  lb. Finish: walnut case with aluminium fascia. Price: £99 (plus VAT).

#### ■ WHARFEDALE

Rank Radio International Ltd, PO Box 596, Power Road, Chiswick, London, W4 5PW. Tel: 01-994 6491.

#### Denton

AM/FM stereo tuner/amplifier. Range: FM 88-108MHz, MW 187-555m. Sensitivity: FM 4µV, AM 30µV. Variable tuning. Meter tuning indicator. Capture ratio: 5dB typical. Inputs: mag PU 2mV, ceramic PU 200mV, tape 200mV. H and N: -60dB all inputs. Tone controls: bass +14dB -12dB at 50Hz, treble ±11dB at 10kHz. Output: 9W RMS per channel (both channels driven). FR: 30Hz-30kHz -3dB at 1W. HD: 0.5%. Headphone socket. Outlets for two pairs of speakers. Loudness control. Stereo decoder and beacon. Mains: 100, 120, 200, 240V 50-60 Hz. Size: 14 $\frac{1}{4}$  × 4 × 8 $\frac{1}{4}$  in. Weight: 11lb. Finish: teak, walnut or white. Price: £95 (including VAT).

#### Denton Mk 2

FM/AM stereo receiver. Bands: 87.5-108MHz (FM), 535-1605kHz (AM). Manual tuning, tuning meter. Sensitivity: 6µV (IHF) (FM), 350µV/m (AM). S/N: 65dB (FM). Inputs: phono 5mV (high), 2.5mV (low), tape 280mV, aux and cassette 120mV. FR: 40Hz-40kHz ±2dB. H & N: 65dB ref rated output. Crosstalk: -40dB. Power output: 12W per channel into 6 ohms. THD: 0.5% at rated output at 1kHz. Damping factor: 30 at 1kHz. Price: £99.50 (including VAT).

#### Linton Mk 2 ★

FM/AM stereo receiver. Bands: 87.5-108MHz (FM), 535-1605kHz (AM). Manual tuning, tuning meter. Sensitivity: 4µV (IHF) (FM), 350µV/m (AM). S/N: 60dB (FM). Inputs: phono 5mV (high), 2.5mV (low), tape/cassette/aux inputs 120mV. H & N: 60dB. Power output: 20W per channel into 6 ohms at 1kHz. FR:



Wharfedale Linton Mk 2

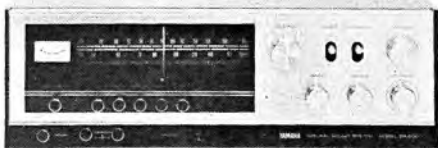

Yamaha CR500

40Hz-40kHz  $\pm$  2dB. THD: 0.5% at rated power and 1kHz. Damping factor: 20 at 1kHz. Price: £115.60 (including VAT).

#### Triton

AM/FM stereo tuner/amplifier. Range: FM 88-108MHz, MW 188-600m. Variable and preset tuning. Sensitivity: FM 4 $\mu$ V, MW 30 $\mu$ V typical. Tuningmeter. AFC. Capture ratio: 8dB. Inputs: mag PU 2.5mV 47K, ceramic PU 80mV 100K, tape 130mV 100K. Noise level: (PU input) -65dB, (tape input) -70dB. Tone controls: bass  $\pm$  12dB at 50Hz, treble  $\pm$  12dB at 10kHz. Output: 25W RMS per channel into 6 ohms. FR: 25Hz-70kHz -3dB. HD: 0.3% at 1W, 0.5% at 20W. Damping factor: 30 at 6 ohms. Scratch filter: -9dB at 10kHz. Five preset FM stations. Headphone socket. Outlets for two pairs of speakers. Quiet tuning facility. Loudness control. Stereo decoder with beacon. Mains: 100, 120, 200, 240V 50-60Hz. Size: 17 $\frac{3}{8}$   $\times$  5  $\times$  12 $\frac{1}{2}$ in. Weight: 44lb. Price: £160 (including VAT).

#### YAMAHA

Natural Sound Systems Ltd, Strathcona Road, North Wembley, London, HA9 8QL. Tel: 01-904 0141.

#### CR500 ★

AM/FM stereo tuner/amplifier. Range: FM 88-108MHz, MW 186-560m. Variable tuning. AFC. Meter tuning indicator. Usable sensitivity: AM 20 $\mu$ V, FM 2 $\mu$ V. Aerial input: 300 ohms balanced. Stereo decoder included. Output: 22W RMS per channel. Two mic inputs with separate volume control. Auto stereo beacon. Mains: 110-240V AC. Finish: steel grey cabinet with brushed chrome facia. Size: 17  $\times$  12  $\times$  6in. Price: £133.15 (plus VAT). Wood cabinet available extra.

#### CR700

AM/FM stereo tuner/amplifier. Range: 88-108MHz, MW 186-560m. Variable tuning. Auto-touch AFC switching. Meter tuning indi-

icator. Usable sensitivity: AM 15 $\mu$ V, FM 1.7 $\mu$ V. Aerial input: 300 ohms balanced. Auto-touch FM tuning. Two-stage RF circuit. High-pass and low-pass filters. Output: 40W RMS per channel. Finish: walnut cabinet with brushed chrome facia. Size: 16 $\frac{1}{2}$   $\times$  6  $\times$  12in. Price: £180.72 (plus VAT).

#### CR400

FM/AM stereo receiver. Bands: 88-108MHz (FM), 550-1600kHz (MW). Sensitivity: 2.5 $\mu$ V (IHF) (FM). Auto-touch AFC (off when tuning knob touched) signal strength and tuning meters. Aerial: 75 and 300 ohms. Inputs: phono 3mV 50K, mic 3mV 50K, tape A & B 150mV 100K. S/N: phono 72dB, mic 65dB, tape 85dB. Outputs: 16W per channel into 8 ohms, 20Hz-20kHz. Damping factor: 40. THD: 0.07% at any power up to full rated power. FR: 20Hz-50kHz +0.5dB -3dB. Size: 17 $\frac{1}{2}$   $\times$  6 $\frac{1}{2}$   $\times$  11 $\frac{3}{4}$ in. Price: £148.28 (including VAT).

#### CR1000

VHF/FM stereo receiver. Bands: 88-108MHz. Manual tuning, auto-touch AFC (off when tuning knob touched), signal strength and tuning meters. Sensitivity: 1.7 $\mu$ V (IHF) (FM). Aerial: 75 and 300 ohms. Inputs: phono (1&2) 3mV 50K, mic 3mV 50K, tape 150mV 40K. S/N: phono 80dB, mic 70dB, tape 90dB. Outputs: 70W per channel into 8 ohms, 20Hz-20kHz. Damping factor: 70. THD: <0.04% at any power up to rated output. FR: 10Hz-50kHz +0.5dB -1dB. Size: 20  $\times$  6 $\frac{3}{4}$   $\times$  13 $\frac{1}{2}$ in. Five gang front end, variable muting and loudness. Price: £379.54 (including VAT).

#### CR800

FM/AM stereo receiver. Bands: 88-108MHz (FM), 550-1600kHz (MW). Manual tuning, auto-touch AFC (off when tuning knob touched), signal strength and tuning meters. Sensitivity: 1.7 $\mu$ V (IHF) (FM). Aerial: 75 and 300 ohms. Inputs: phono (1&2) 3mV 50K, mic 3mV 50K, tape A & B 150mV 45K. S/N: phono 75dB, mic 70dB, tape 90dB. Output: 45W per channel into 8 ohms, 20Hz-20kHz. THD: <0.06%. FR: 10Hz-50kHz +0.5dB -1dB. Size: 18 $\frac{3}{4}$   $\times$  6 $\frac{1}{4}$   $\times$  11 $\frac{3}{4}$ in. Price: £269.62 (including VAT).

#### CR600

FM/AM stereo receiver. Bands: 88-108MHz (FM), 550-1600kHz (MW). Manual tuning, auto-touch AFC (off when tuning knob touched), signal strength and tuning meters. Sensitivity: 2.0 $\mu$ V (IHF) (FM). Aerial: 75 and 300 ohms. Inputs: phono (1&2) 3mV 50K, mic 3mV 50K, tape A & B 150mV 100K. S/N: phono 72dB, mic 70dB, tape 90dB. Output: 16W per channel into 8 ohms at 1kHz. Damping factor: 70. THD: 0.06%. FR: 10Hz-50kHz +0.5dB -1dB. Size: 18 $\frac{3}{4}$   $\times$  6 $\frac{1}{4}$   $\times$  11 $\frac{3}{4}$ in. Price: £214.14 (including VAT).



## THE LENCO GL85. FOR PEOPLE WHO DON'T TAKE THE GOOD THINGS FOR GRANTED.

It's perfectly true that at the price you pay for a turntable even remotely as good as the Lenco GL85, you expect to take quality of the sound for granted.

What you can't be sure of is that you'll get all the special features and refinements that make the difference between technical competence and real accomplishment.

It's the vital difference that puts

the GL85 in a class of its own.

It has a 16 pole low-speed synchronous motor. An illuminated stroboscope skillfully set in the turntable. Electronically-controlled fine speed adjustment.

And an automatic electronic shut-off mechanism which stops the turntable at the end of play and gently raises the arm from the record. Wow and flutter are both fantastically low. Rumble is an

astonishingly low 60 dB weighted

And the whole unit is housed in a style in keeping with its status.

From its handsome plinth to the precision-fitting dust cover with friction hinge it is clearly one of the great Hi-Fi turntables.

For full-colour brochure write to: Goldring Limited, 10 Bayford St. Hackney E8 3SE.

**Goldring** 

The more you know about Hi-fi, the more you'll appreciate Goldring-Lenco.

# simplicity!



- \* Single Point Bearing
- \* 24 Pole Synchronous Motor
- \* Belt Drive
- \* 9lb (4.1 Kg) Non-magnetic Platter
- \* Precision Engineering
- \* Stainless Steel Chassis

Simplicity itself ... that's the Linn Sondek LP12 (Patents Pending)

Available through Authorised Stockists



# LINN SONDEK

LINN PRODUCTS LIMITED

Sondek Division, 235 Drakemire Drive, Glasgow G45 9SZ, UK  
Tel: 041-634 3860 Cables: EURODECK



# Maybe your new hi-fi amplifier should also be a radio?

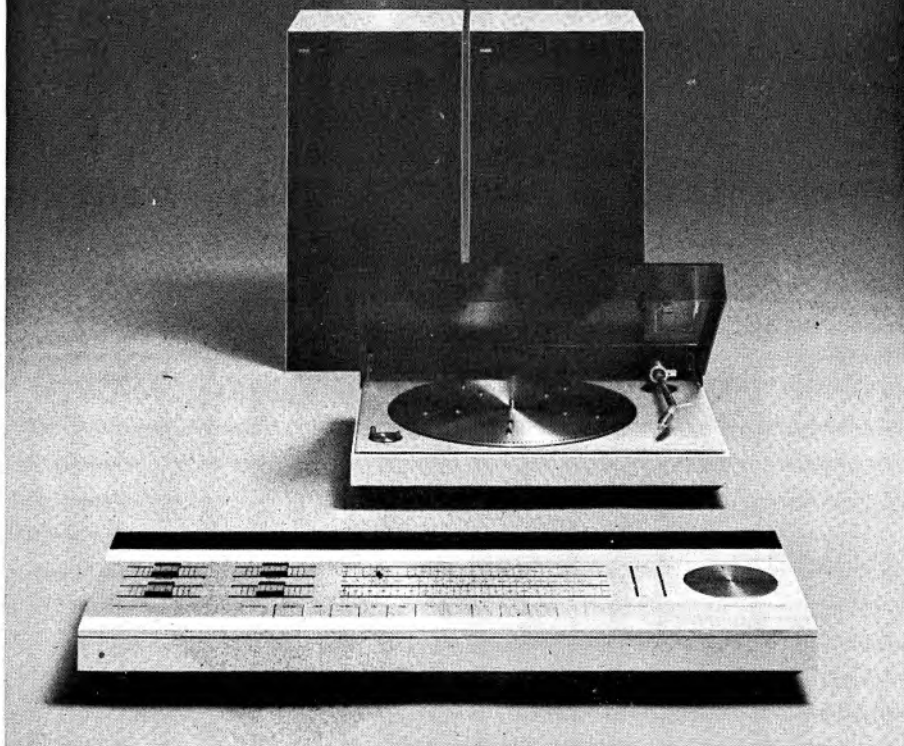

Beomaster 2000 is a good hi-fi amplifier. It has all the essential features and qualities which a modern amplifier ought to have. It provides the excellent, highly faithful amplification of sound that a radio tuner – or any other sound source requires. So to save you the trouble of finding a tuner that will do justice to this good hi-fi amplifier, we have included one.

That makes the Beomaster 2000 a radio – a single unit that does the work of a tuner and an amplifier, and does it very well.

The FM section has five pre-set stations plus manual tuning on a clearly calibrated scale. A phase-lock loop decoder ensures excellent channel separation, and muting circuits eliminate that irritating between-station noise. The IF stages have separate integrated circuits for optimising reception on AM and FM. The amplifier has a powerful 2 x 40 watts sinus power output into 4 ohms. (That's equal to a total of 130 watts peak power). The

output stages have a split-supply Darlington integrated circuit directly coupled to the speakers using separate positive and negative supply, a development which results in an incredibly low distortion figure – <0.06% at 50mW, or <0.1% at full power. With super-smooth press button controls for all the usual functions, plus double stereo speaker outputs, loudness control and two tape sockets – one with AB facility – the Beomaster 2000 is a really practical unit.

In fact we could have said "Maybe your new radio should also be a hi-fi amplifier!"

Beomaster 2000 available in teak, rosewood or white finish. Team it up with Beogram 2000 and a pair of Beovox 3702 and you have the Beosystem 2000. Full details are available from the Public Relations Department (7429), Bang & Olufsen U.K. Limited, Eastbrook Road, Gloucester GL4 7DE. Tel 0452 21591

# Record Decks

★ Indicates entry is illustrated

Abbreviations used in this section are given on page 20.

## ■ ACOS

Cosmocord Ltd, Eleanor Cross Road, Waltham Cross, Herts, EN8 7NF. Tel: Waltham Cross (97) 27331.

### Rega

Turntable with pickup arm, plinth and cover. Speeds:  $33\frac{1}{3}$  and 45rpm. W and F: 0.08%. Rumble: typically -43dB unweighted, 65dB weighted. Motor: 24-pole synchronous, 200-250V AC 50Hz, or 90-120V AC 60Hz. Belt drive. Platter: planetoid design giving maximum mass with lower total weight. Tonearm: fitted with Acos lustre tonearm. Overall length 330mm, effective length 237mm, overhang 15mm. Adjustable up to 3gm. Direct reading magnetic repulsion bias compensation. Recommended cartridges: Acos M6, M6E, M6EX. Price: on application.

## ■ ACOUSTIC RESEARCH INTERNATIONAL

High Street, Houghton Regis, Beds, LL15 5QJ. Tel: Dunstable (0582) 603151. Telex: 825467.

### AR Universal ★

Two-speed turntable, pickup arm, plug-in cartridge shell, plinth and transparent plastic cover. Speeds:  $33\frac{1}{3}$  and 45rpm. W and F: <0.1% (combined wow and flutter measured to NAB standards). Rumble: at least 35dB below 1cm/second (measured to NAB standards). Speed accuracy:  $\pm 0.3\%$  of absolute speed. Turntable: 12in non-magnetic. Belt drive. Miniature synchronous motor. Adjustable playing weight. Decoupled turntable isolated from plinth. Adjustable stylus pressure with built-in gauge. Finish: walnut. Performance guaranteed to exceed NAB broadcast equipment standard for three years after purchase. Price: £60 (including VAT).

## ■ ALBA (Radio & Television) LTD

Bull Lane, Edmonton, London, N18 1RA. Tel: 01-803 4451.

### UA200A

Shelf-mounting cabinet with lift-up lid containing Garrard SP25 Mk III record deck and pickup arm. Stereo magnetic cartridge. Diamond stylus. Cueing device. Teak finished cabinet. Supplied complete with leads and plugs. See

Garrard entry for complete specification of motor unit. Price: £30.10 (including VAT).

## ■ A/R/D

Audio Research and Development Ltd, PO Box 73, Hounslow, Middlesex, TW3 1RD. Tel: 01-570 0471.

### 2000 ★

Contemporary table-top player unit designed to match A/R/D tuner and amplifier. Fitted with Garrard SP25 Mk III or Dual 1216/M75. Lid will lift up or lift off. Size:  $12\frac{3}{4} \times 16\frac{1}{2} \times 6\frac{3}{4}$ in. Finish: stove enamel silver, solid teak sides, dark grey tinted plastic lid. Price: (cabinet only) £13 (plus VAT); (with Garrard SP25 Mk III) £25.50 (plus VAT); (with Dual 1216/M75) £59 (plus VAT).

## ■ ARISTON AUDIO LTD

PO Box 13, Irvine, Ayrshire Scotland, KA12 8JL. Tel: 0294 75211.

### RDII ★

Single-speed transcription motor unit available as chassis only, with plinth and cover, and com-



Acoustic Research Universal



A/R/D 2000



Ariston RD II Record Deck

★ Indicates entry is illustrated

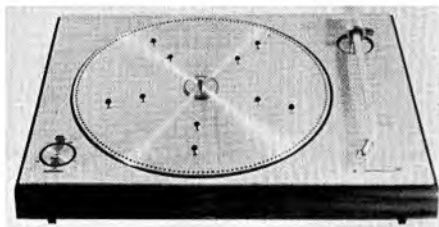

Bang & Olufsen Beogram 1202



BSR McDonald 610 Autochanger

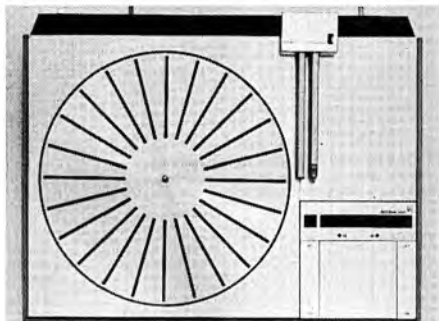

Bang & Olufsen Beogram 4000



BSR 810 Transcription unit

plete with plinth, cover and pickup arm. Speed: 33 $\frac{1}{3}$ rpm. W and F: below meaningful measurement. Rumble: below meaningful measurement. Turntable: 12in diameter, 9lb, made in non-ferrous alloy with single-point bearing in PTFE bushes. Belt drive. Stainless steel chassis. Felt supplied. Motor: 24-pole precision synchronous. Pickup arm (when fitted): Audio Technica 1007. Price: (chassis only RD11) £47 (plus VAT); (chassis with plinth and cover RD11PC) £58.80 (plus VAT); (chassis with plinth, cover and 1007 arm RD11PC) £90.80 (plus VAT).

## ■ BANG & OLUFSEN LTD

Eastbrook Road, Gloucester, GL4 7DE.  
Tel: Gloucester (0452) 21591.

### Beogram 1202 ★

Plinth-mounted motor unit with arm, cartridge and separate dust cover. Speeds: 33 $\frac{1}{3}$  and 45rpm. W and F: < 0.15%. Rumble: better than 55dB (DIN). Turntable: 12in aluminium alloy with conical studs instead of disc mat. Belt drive. Two-pole asynchronous motor. B and O pickup arm with built-in bias compensation and stylus pressure adjustment. Fully automatic operation with single master control. Price: (teak) £65.90 (including VAT); (rosewood or white) £66.90 (including VAT).

### Beogram 3000

Plinth-mounted motor unit with arm, cartridge and hinged-detachable dust cover. Speeds: 33 $\frac{1}{3}$

and 45rpm with  $\pm 6\%$  fine adjustment. W and F: < 0.15%. Rumble: better than 60dB (DIN). Turntable: 12in grooved aluminium. Belt drive. Two-pole asynchronous motor. 110-240V AC switchable. B and O pickup arm with built-in bias compensation. Stroboscopic disc. Fully automatic motor/arm/speed/record size action. Price: (teak) £87.90 (including VAT); (rosewood) £88.90 (including VAT).

### Beogram 4000 ★

Plinth-mounted motor unit with tangential arm and SP-15 integrated cartridge. Hinged translucent dust cover. Servo-driven tone arm plus detector arm for automatic record size and speed sensing. Computer-like data unit gives completely automatic operation. Speeds: 33 $\frac{1}{3}$  and 45rpm with 6% fine speed adjustment available. W and F: better than  $\pm 0.05\%$  DIN ( $\pm 0.025\%$  RMS). Rumble: better than 65dB (DIN B). Turntable: 12in aluminium alloy radially ribbed. Belt drive. Illuminated stroboscope with individual speed indicator lights. Power supply 110-130 and 220-240V AC 50-60Hz. Price: (teak) £198.50 (including VAT); (rosewood) £199.50 (including VAT).

## ■ BLACK KNIGHT RUMBLECURE

Bank Top, Currier Lane, Ashton-under-Lyne, Lancs, OL6 2TA. Tel: 061-330 2836.

### Complete plinth assemblies

See Hi-Fi Cabinets section for full details of the

Black Knight Rumblecure ready-assembled plinths with Garrard 401 units and SME pickup arms.

### ■ BSR McDONALD

(McDonald Division) BSR Ltd.  
Cradley Heath, Warley, Wores, B64 5QH.  
Tel: Cradley Heath 69272.

#### C141R

Three speed automatic turntable unit with provision for interchangeable centre spindles for semi-automatic or manual play. Speeds: 33 $\frac{1}{3}$ , 45, 78rpm. Wow: better than 0.2% RMS. Flutter: below 0.06% RMS. 11in dia deep rim turntable. Capacity up to eight 7in, 10in or 12in dia records with manual selection of record size. Automatic lock. Cue and pause lever. Pickup arm bias compensator. Low mass tubular tone-arm with lightweight cartridge shell with finger lift. Visual stylus pressure indicator with fingertip adjustment. Accepts standard mono or stereo cartridge. Mains: 100-125V 60Hz or 200-250V 50Hz.

#### 610 ★

Automatic three-speed changer. Wow: <0.2% RMS (0.4% peak). Flutter: 0.6%. Speed constant down to 16% reduction in mains voltage. 11in diecast turntable. Pulley drive. Four-pole motor. Double ballrace pickup mounting. Anti-skate device. Counter-balanced. Plug-in head. Viscous damped cue control. Muting switch. Price: (McDonald 610 chassis) £18.19 (plus VAT); McDonald 610 mounted in afrormosia plinth with dust cover fully wired £26.81 (plus VAT); McDonald 610 as above fitted with ADC K8 magnetic cartridge £34.84 (plus VAT).

#### 710

Two-speed transcription player with single-play or automatic facility. Capacity up to six 7in, 10in or 12in diameter records. Speeds: 33 $\frac{1}{3}$  and 45rpm. Mains: 120 or 240V 50Hz or 60Hz AC. Tracking: with high compliance cartridge will track down to  $\frac{1}{2}$ gm. Rumble: better than -55dB relative to 1 kHz at 10cm/sec. Weighting curve has roll-off of 12dB/oct above and below 315Hz. Wow: better than 0.1%. Flutter: better than 0.05%. Pushbutton operation. Low-mass aluminium pickup arm. Pivot to stylus length 8.562in. Ballrace mounting. Resiliently mounted counterweight. Stylus pressure adjustment 0.4 gm. 12in diecast, non-ferrous turntable. Fine speed adjustment of  $\pm 3\%$ . Hydraulic viscous-damped cue and pause control. Bias compensation for spherical and elliptical styli. Slide-in cartridge carrier. Rotating manual stub spindle. Stroboscopic disc speed indicator. Automatic pickup arm lock. Size: 15 $\frac{1}{8}$ in wide, 12 $\frac{1}{8}$ in deep, 5in above motor board, 2 $\frac{3}{8}$ in below motor board. Price: (McDonald 710 two-speed transcription



BSR McDonald HT70

turntable chassis) £35.29 (plus VAT); As above fitted with ADC K5E cartridge £48.29 (plus VAT).

#### 810 ★

Two-speed transcription motor unit fitted with pickup arm. Single player with automatic option. Available in chassis form or plinth mounted. Speeds: 33 $\frac{1}{3}$  and 45rpm. Fine speed control. Wow: better than 0.1%. Flutter: better than 0.05%. Rumble: better than -55dB relative to 1kHz at 10cm/sec (weighting curve has roll-off of 12dB/octave above and below 315Hz). Die-cast turntable weighing 6 $\frac{3}{4}$ lb. Four-pole synchronous motor. Low-mass transcription pickup arm with concentric gimbal mounting. Stroboscopic centre disc to turntable. Rotating centre stub spindle. Dual-range anti-skate device. Stylus position gauge. Stylus brush. Stylus pressure adjustment. Automatic pickup arm lock. Slide-in cartridge carrier. Viscous damped cue and pause. Pushbutton operation. Capacity: up to six 7in, 10in or 12in records. Manual selection of record size and speed. Tracking: down to a minimum of  $\frac{1}{2}$ gm with high compliance cartridge. Size (chassis) 15in wide, 12 $\frac{1}{4}$ in deep, 5in above lower edge of baseplate, 2 $\frac{3}{8}$ in below edge of baseplate. Mains: 105-125V or 210-250V 50 or 60Hz. Finish: Satin black mainplate, black turntable mat, brushed aluminium trim. Price: (McDonald 810 chassis) £43.65 (plus VAT); As above fitted with ADC K3E magnetic cartridge £59.65 (plus VAT).

#### HT70 ★

Three-speed single player. Wow: <0.2% RMS (0.4% peak). Flutter: 0.06%. Speed constant down to 16% reduction in mains voltage. Turntable: 11in diameter diecast alloy weighing 4 $\frac{1}{2}$ lb. Pulley drive. Synchronous dynamically balanced four-pole motor. Double ball-race mounted pickup arm. Plug-in head. Counter-balanced arm. Bias compensator. Tracking control. Viscous damped cue control. Anti-skate device. Muting switch. Adjustment for playing weight. Rotating record stub spindle to combat drag. Price: (HT70 chassis) £19.93 (plus VAT); HT70 mounted in afrormosia plinth with dust cover. Fully wired, £28.33 (plus VAT). As above, fitted with ADC K7E magnetic cartridge £39.42 (plus VAT).

★ Indicates entry is illustrated

### MP60 ★

Three-speed single player. Wow: <math>0.2\%</math> RMS (0.4% peak). Flutter: 0.06%. Speed constant down to 16% reduction in mains volts. 11in die-cast turntable. Pulley drive. Four-pole motor. Double ball-race mounted pickup arm. Plug-in head. Counterbalanced. Bias compensator. Tracking control. Viscous damped cue control. Anti-skate device. Muting switch. Price: (MP60 chassis) £14.53 (plus VAT); MP60 mounted in afromosia plinth with dust cover. Fully wired. £23.49 (plus VAT). Also above fitted with ADC K8 magnetic cartridge £33.16 (plus VAT).

### ■ BUSH-ARENA

Rank Radio International Ltd, PO Box 596, Power Road, Chiswick, London, W4 5PW. Tel: 01-994 6491.



BSR-McDonald MP60



Connoisseur BD1



Connoisseur BD2

### R925

Record deck in plinth to match Bush-Arena Systems. Garrard SP25 Mk III turntable and pickup arm. Goldring G800 Free Field magnetic cartridge. Diamond 0.5 thou stylus. Size:  $15\frac{1}{8} \times 13\frac{3}{4} \times 5\frac{1}{2}$ in. Price: £30.94 (including VAT).

### R76

Record deck in plinth to match Bush-Arena Systems. Garrard AP76 transcription deck and arm. Shure M75 MB magnetic cartridge. Diamond 0.7 x 0.3 thou stylus. Size:  $15\frac{1}{8} \times 15\frac{1}{4} \times 6\frac{3}{8}$ in. Price: £54.24 (including VAT).

### ■ CONNOISSEUR

A. R. Sugden & Co (Engineers) Ltd, Connoisseur Works, Atlas Mill Road, Brighouse, Yorks, HD6 1ES. Tel: Brighouse 2142. Cables: Connoisseur, Brighouse.

### BD1 ★

Two-speed motor unit supplied as motor only. Two fixed speeds,  $33\frac{1}{3}$  and 45rpm. Wow: <math>0.1\%</math>. Flutter: <math>0.1\%</math>. Rumble: -50dB measured at RIAA characteristics ref 7cm/sec at 1kHz. No change in speed for 20% variation in supply voltage.  $10\frac{1}{4}$ in non-ferrous lathe-turned turntable. Precision ground belt drive. Unique drive arrangement eliminates transmission noise. Simple manual speed change. Low hum field. Slimline construction. Only  $1\frac{3}{8}$ in required below mounting platform. Mains: 100-120V and 200-240V 50 or 60Hz. Price: £16.50 (plus VAT).

### BD2 ★

Integrated transcription unit. Includes a BD1 motor unit (mounted on a larger platform and fitted with pressbutton speed change) and a type SAU2 pickup arm. Hydraulic arm lift, operated from front. Anti-vibration springs. Supplied either chassis only or plinth mounted. Perspex cover. Size:  $12\frac{1}{4} \times 14 \times 4\frac{3}{8}$ in (2in below and  $2\frac{3}{4}$ in above the platform). Price: (chassis model) £33.30 (plus VAT); (assembly mounted on plinth complete with transparent plastic cover) £42 (plus VAT).

### ■ DARBY INDUSTRIES

38-42 Chestnut Grove, New Malden, Surrey, KT3 3JW. Tel: 01-942 1596.

#### Slimline 1

Shelf-mounting record deck with hinged lift-off acrylic cover and stay. Fitted with Garrard SP25 Mk IV deck and Audio Technica AT55 cartridge. Wired up with 6ft mains lead and DIN input socket. Finish: eggshell black, white, silver or chrome satellite. Supplied in mail order pack. Price: £24 (plus VAT).

#### Slimline 2

Similar to Slimline 1 but fitted with Garrard



Dual 1229



Dual CS701

6300 changer and Sonotone 9TA/HC cartridge. Supplied in mail order pack. Price: £16 (plus VAT).

#### Large Slimline Mk IV

Record deck mounted in plinth with cover. Incorporates Garrard SP25 Mk IV and Audio Technica AT55 cartridge. Wired up with 6ft mains lead and DIN input socket. Finish: egg-shell black, white, silver or chrome satellite. Supplied in mail order pack. Price: £28.75 (plus VAT).

#### Large Slimline Mk III

Similar to the Large Slimline Mk IV but fitted with Garrard Zero 100SB record deck (less cartridge). Supplied in mail order pack. Price: £52 (plus VAT).

#### Large Slimline Mk II (86B)

Similar to the Large Slimline Mk IV but fitted with Garrard 86B single player record deck (less cartridge). Supplied in mail order pack. Price: £32.50 (plus VAT).

### ■ DENON

Johnsons of Hendon Ltd,  
Colney Street, St Albans, AL2 2EA, Herts.  
Tel: Radlett 4747.

#### Model DP-3700F

Direct drive turntable. Speeds: 33 $\frac{1}{3}$  and 45rpm. Speed control: Servo system through frequency detection. Speed selection: electrically switched. Starting time: 1.8s at 33 $\frac{1}{3}$ rpm. W and F: <0.03% WRMS. S/N: >60dB. Platter: aluminium alloy diecast, diameter 300mm. Weight:

1.1kg. Speed adjustable over  $\pm 3\%$  range. Mains: 220, 230, 240V AC, 50-60Hz. Power consumption: 14W. Fitted with pickup arm, type: static balance. Eff. length: 244mm. Offset angle: 21°. Overhang: 14mm. Tracking error: within  $\pm 2^\circ$ . Vertical tracking force range: 0-3gm. Applicable cartridge weight range: 4-15gm. Price: to be announced.

### ■ DUAL

Audiodecks Ltd, Farnell House, 81 Kirkstall Road, Leeds, LS3 1HR. Tel: Leeds 35111.

#### 1226

Semi-automatic turntable with pickup arm. Speeds: 33 $\frac{1}{3}$ , 45rpm. Speed control: 6% variation. W and F: < $\pm 0.12\%$  DIN. Rumble: (weighted) <57dB, (unweighted) <38dB. Turntable: 270mm diameter, non-magnetic, 1.8kg. Motor: 4-pole dual synchronous with vertically adjustable drive pulley. Torsion-resistant tubular aluminium pickup arm in self-adjusting pivot bearing. Cartridge holder removable, accepting cartridges with  $\frac{1}{2}$ in mounting and a weight from 2-10gm. Price: to be announced.

#### 1229 ★

Fully automatic turntable with pickup arm. Supplied as chassis only or with plinth (not mounted). Speeds: 33 $\frac{1}{3}$ , 45, 78rpm. Speed control: 6% variation. W and F:  $\pm 0.06\%$ . Rumble: (weighted) >63dB, (unweighted) >42dB. Turntable: 12in diameter, non-magnetic, 6 $\frac{3}{8}$ lb. Rim drive. Motor: Dual synchronous, continuous pole. Counterbalanced, gimbal mounted pickup arm. Auto or single play mode selector to maintain correct tracking angle. Illuminated strobe. Continuously variable anti-skating device. Fitted with Shure DM103ME cartridge. Plinth finish: teak or walnut. Price: (1229 chassis only) £74.95; (1229 chassis with Shure cartridge) £90.35; (1229 chassis with Shure cartridge and complete with base and cover) £115.89. All prices include VAT.

#### 601

Two-speed semi-automatic turntable of professional performance. Belt driven new model (optional to the usual edge driven or direct driven Dual models). Specification similar to 1229. Details not available before going to press. Price: approximately £110.

#### 701 ★

Semi-automatic turntable with pickup arm and cartridge. Professional performance. Speeds: 33 $\frac{1}{3}$ , 45rpm. Speed control: 8% variation. Turntable: 12in diameter, non-magnetic. Direct drive. Gimbal mounted arm with resonance reduction. Fitted with Ortofon cartridge. Supplied with plinth and cover. Price: £141 (including VAT).

★ Indicates entry is illustrated

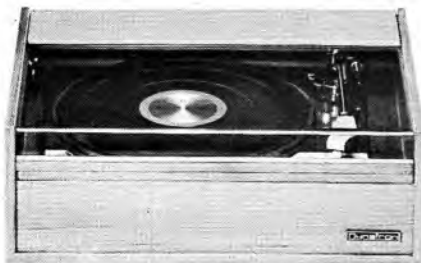

Dynatron P100 teak



Eagle AA18B & AA18W



EMT 930st



EMT 928

### ■ DYNATRON RADIO LTD

St Peter's Road, Maidenhead, SL6 7QY,  
Berks. Tel: Maidenhead (0628) 23331.

#### Dynatron P.100 Teak ★

Plinth unit comprising Goldring-Lenco GL75 mechanism with Goldring G800 cartridge. Four speeds, fully variable. Fitted with mains lead and plug, also audio lead and DIN plug. Price: £54.50 (including VAT).

### ■ EAGLE INTERNATIONAL

Heather Park Drive, Wembley, HA0 1SU.  
Tel: 01-903 0144.

#### AA18B and AA18W ★

Three-speed record deck in plinth with cover. Pickup arm wired for mono or stereo. Motor unit Garrard SP25 Mk III. Speeds: 33 $\frac{1}{3}$ , 45 and 78rpm. Rim drive. Four-pole screened motor. Counterbalanced tubular aluminium arm. Price: £28 (including VAT).

#### AA38

Garrard Zero 100S turntable in stainless steel plinth with dust cover. Fitted with Eagle FF12E cartridge. Price: on application.

### ■ EMT

Franz Vertriebsgesellschaft GmbH.  
Sole UK agents: F. W. O. Bauch Ltd,  
49 Theobald Street, Boreham Wood, Herts.  
Tel: 01-953 0091.

#### EMT 930st ★

Professional transcription turntable fitted with pickup arm and equaliser amplifier, chassis construction. Speeds: 33 $\frac{1}{3}$ , 45 and 78rpm with fine speed control. W and F max: 0.07%. Rumble: referred to a peak velocity  $V=10\text{cm/s}$  at 1kHz 58dB (weighted) (0dB=0.775V). Speed constancy: max  $\pm 0.15\%$ . Turntable: 13in dia heavy cast non-magnetic with light plastic auxiliary turntable on top. Drive: pulley. Motor: EMT manufacture with artificially aged shaft. Pickup arm: EMT type 929. Features: stroboscope, quick start, remote start, pickup illumination, scratch filter and equalisation control on deck, headphone sockets, pickup lowering device. Price: on application.

#### EMT 928 ★

Professional transcription turntable fitted with pickup arm and equaliser amplifier. Speeds: 33 $\frac{1}{3}$ , 45 and 78rpm with  $\pm 2\%$  fine speed control. Rumble: better than  $-65\text{dB}$  weighted (to DIN 45-539). Turntable: 11 $\frac{1}{2}$ in. Belt drive. Three-phase synchronous motor fed by electronic three-phase generator. EMT 929 pickup arm. Statically and dynamically balanced in all directions. Stroboscope. Quick start with muting relay. Pickup illumination. Equaliser amplifier with head phone outlet. Price: on application.



ERA 3033



Garrard Zero 100 Pickup arm

#### ■ ERA

De Banks Electronics Ltd, Market House,  
High Street, Tring, Bucks.  
Tel: Tring (044 282) 2777.

#### Model 444

Turntable unit complete with tonearm, plinth and perspex lid if required. Speeds:  $33\frac{1}{3}$  and 45rpm. W and F: better than 0.04%. Rumble: better than 73dB. Speed constancy: 0.5% 12in diameter, non-magnetic alloy, dynamically balanced platter. Neoprene belt drive. Motor: lightweight 48-pole synchronous. Tonearm, frictionless pivot system, quick change cartridge holder, bias compensation, arm lift and cue. Price: £68.20 (including VAT), cover extra.

#### Model 3033 ★

Transcription unit, complete with tonearm, plinth and tinted, hinged perspex lid. Speeds:  $33\frac{1}{3}$  and 45rpm. W and F: better than 0.04%. Rumble: better than 73dB. Speed constancy: 0.5%. Turntable: 12in diameter. Weight: 2.6lb, dynamically balanced alloy construction. Neoprene belt drive. Motor: lightweight 48-pole synchronous, 250rpm. Tonearm. Tracking error:  $<1.5^\circ$ , head angle  $23^\circ 54'$ . Stylus pressure range: 0.25-4gm. Anti-skate bias correction via graduated ring integral with arm. Built-in arm

lift and cue device, slider controls. Micro-switch actuated auto-stop, internal silent-bloc suspension system. Price: £117.61 (including VAT).

#### Model 5055

Transcription turntable unit, complete with tonearm, plinth and hinged perspex cover. Speeds:  $33\frac{1}{3}$  and 45rpm. W and F: better than 0.04%. Rumble: better than 73dB. Speed constancy: 0.6%. Platter, 12in diameter. Weight: 2.6lb, dynamically balanced, non-magnetic alloy construction. Neoprene belt drive. Motor: 48-pole synchronous. Tonearm. Frictionless pivot and ball bearing support system, bias compensation, tracking error less than  $1.5^\circ$ . Integral arm lift and cue device. Silent-bloc internal suspension system. Price: £93.50 (including VAT).

#### Model 6066

Transcription turntable unit, complete with tonearm, plinth and hinged, lift-off tinted perspex lid. Speeds:  $33\frac{1}{3}$  and 45rpm. W and F: better than 0.04%. Rumble: better than 73dB. Speed constancy: 0.6%. Platter, diameter 12in, Weight: 2.6lb, dynamically balanced, non-magnetic alloy. Neoprene belt drive. Motor: lightweight 48-pole synchronous. Tonearm, frictionless pivot and ball bearing support system, bias compensation, stylus pressure range:  $\frac{1}{8}$ - $2\frac{1}{2}$ gm. Silent-bloc internal suspension system. Price: £100.10 (including VAT).

#### ■ GARRARD ENGINEERING LTD

Newcastle Street, Swindon, Wilts, SN1 1DA.  
Tel: Swindon (0793) 5381.  
Cables: Garrard, Swindon.

#### Zero 100 ★

Two-speed transcription record unit with tangential pickup arm. Speed:  $33\frac{1}{3}$  and 45rpm. Fine speed adjustment giving  $\pm 3\%$ . Stroboscopic neon speed indicator. W and F: better than 0.1% RMS. Rumble: better than -51dB relative to 1.4cm/sec at 100Hz. Garrard Synchro-Lab two-section motor. Tangential pickup head incorporating an automatic pivoting device that keeps the cartridge in precisely the correct attitude and so virtually eliminates tracking error. Stylus angle adjustable for single records or for playing a number of discs on automatic. Provided with gauge for exact positioning of cartridge in head. Magnetic bias compensation calibrated for spherical and elliptical stylus. Adjustable playing weight calibrated in  $\frac{1}{8}$ gm steps from 0.3gm over 3in. Non-magnetic  $11\frac{1}{2}$ in turntable. Pulley drive. Three brass tab keys for controls. Functions provide automatic operation, manual operation, cue, pause and stop. Fluid damped lowering device. Price: £46.88 (plus VAT).

#### Zero 100S

Single play version of Zero 100. Price: (un-





Garrard 401



Garrard SP25 Mk IV



Garrard 86SB



Goldring GL75JP

mounted) £43.13 (plus VAT); (mounted) £50.63 (plus VAT); (fitted with Shure M93 cartridge) £61.13 (plus VAT).

#### Model 401 ★

Transcription motor. Three speeds:  $33\frac{1}{3}$ , 45, 78rpm. Adjustable by eddy current brake. 6lb machined aluminium turntable with gear-cut illuminated strobe markings on rim. Statically balanced. Die-cast aluminium unit plate. Completely screened spring-mounted shaded-pole motor. Styled by Eric Marshall and finished in metallic charcoal with chrome relief. W and F: less than 0.05% RMS. Rumble almost non-existent. Mains: 110-125V and 220-250V 50 or 60Hz according to pulley fitted. Size:  $13\frac{3}{4}$ in wide,  $14\frac{5}{8}$ in front to rear,  $2\frac{1}{2}$ in above and  $3\frac{1}{2}$ in below lower edge of unit plate. Price: £36.75 (plus VAT).

#### SL95B

Transcription turntable with autochange facility and automatic single record play. Combined record size and speed selector.  $11\frac{1}{2}$ in aluminium turntable. Weight-counterbalanced wood and aluminium pickup arm with gimbal type pivots. Calibrated fine stylus force adjustment. Calibrated bias compensator. Slide-in cartridge carrier accepts most makes and types. Cue and pause facility. Wired for mono and stereo. Synchro-Lab constant speed motor. Size (including rear and side overhang of pickup arm):  $15\frac{5}{8}$ in wide,  $14\frac{1}{2}$ in front to rear,  $4\frac{1}{2}$ in above,  $2\frac{1}{2}$ in below edge of unit plate. Plus clearances. Price: £42.18 (plus VAT).

#### AP96

Single-play version of the Garrard SL95B. Price: (mounted) £37.50 (plus VAT); (fitted with Shure 75/6/SM cartridge) £44.70 (plus VAT).

#### SL72B

Transcription turntable with autochange facility and automatic single record play. Combined record size and speed selector. Non-magnetic turntable. Aluminium pickup arm is weight counterbalanced, fitted with slide-in cartridge carrier and features gimbal type pivots. Calibrated stylus force adjustment. Calibrated bias compensator. Cue and pause facility. Wired for stereo and mono. Size (including rear and side overhang of pickup arm):  $14\frac{1}{8}$ in wide,  $12\frac{1}{8}$ in front to rear,  $4\frac{1}{8}$ in above and  $2\frac{1}{8}$ in below lower edge of unit plate, plus clearances. Price: £27.94 (plus VAT).

#### AP76

Single record playing unit complying with DIN 45-500 standards. Manual or automatic play of single records. Combined record size and speed selector.  $11\frac{1}{2}$ in diameter aluminium turntable. Aluminium pickup arm. Counterbalanced. Calibrated fine stylus force adjustment. Calibrated bias compensator. Slide-in cartridge carrier accepts most makes and types. Cue and pause facility. Wired for stereo and mono. Four-pole induction motor. Size (including rear and side overhang of pickup arm):  $14\frac{1}{8}$ in wide,  $12\frac{1}{8}$ in front to rear,  $2\frac{1}{8}$ in above,  $2\frac{1}{8}$ in below edge of unit plate. Plus clearances. Price: (unmounted)

£24.38 (plus VAT); (mounted) £31.88 (plus VAT); (fitted with Shure cartridge) £39.08 (plus VAT).

#### SP25 Mk IV ★

A turntable fitted with own pickup arm, complete with base and cover, automatic. Speeds: 33 $\frac{1}{3}$ , 45 and 78rpm. W and F: typically 0-15% peak. Rumble: typically -57dB (DIN B). Speed constancy:  $\pm 0.75\%$ . Aluminium platter. Motor: 4-pole synchronous. Slide in cartridge carrier, calibrated stylus force and bias compensation. Resiliently mounted counterbalance weight. Price: £38.14 complete with Shure 75/6/SM cartridge (including VAT).

#### Zero 100SB module

Automatic single record playing transcription turntable, base and cover. Speeds: 33 $\frac{1}{3}$  and 45rpm. W and F: typically 0-12%. Rumble: -63dB (DIN B) Platter: diecast aluminium 11.5in diameter. Belt drive from two-step motor pulley. Motor: 4-pole synchronous, 220-240V, 50Hz. Tonearm: as for Zero 100 model. Price: complete with Shure M93E cartridge, £69.72 (plus VAT).

#### 86SB ★

Automatic single record playing transcription turntable fitted with own pickup arm, base and cover. Speeds: 33 $\frac{1}{3}$  and 45rpm. W and F: typically 0-1% peak. Rumble: typically -63dB (DIN B). Speed constancy: synchronous  $\pm 0.75\%$ . Platter: 11 $\frac{1}{2}$ in diecast zinc alloy. Belt drive. Motor: 4-pole synchronous, 220-240V, 50Hz. Tonearm. Aluminium section resiliently mounted counter balance weight. Slide in cartridge carrier. Stylus force calibrated up to 4gm. Bias compensation calibrated for spherical and elliptical styli. Price: £55.83 complete with base, cover and Shure 75/6/SM cartridge (including VAT).

#### ■ GOLDRING LTD

10 Bayford Street, Hackney, London, E8 3SE.  
Tel: 01-985 1152.

#### Goldring-Lenco GL75 ★

Integrated turntable and pickup arm. Four speeds, infinitely variable. Wow: <0.2%. Flutter: <0.2%. Speed change less than 1% for 13% voltage change. 12in diameter diecast zinc turntable, 8lb. Vertical pulley drive. Four-pole 15W induction motor. L75 pickup arm. Counterbalance weight adjustment, knife-edge bearing, plug-in shell. Hydraulic lowering device. Price: £42.90 (plus VAT). Available on plinth as GL75/P £55.50 (plus VAT). Dust cover £5.10 (plus VAT).

#### GL101 P/C Mk II

Two-speed motor unit on plinth with pickup arm. Speeds: 33 $\frac{1}{3}$  and 45rpm. W and F: 0.2% (DIN). Rumble: (weighted) -60dB. Turntable:



Goldring-Lenco GL72/P



Goldring GL78/P/C

steel 10in diameter, 2 $\frac{1}{2}$ lb. Belt drive 16-pole synchronous motor. Counter-balanced pickup arm. Removable shell. Bias compensation. Viscous damped lowering device. Price: £30 (plus VAT).

#### Goldring-Lenco GL72 ★

Turntable unit with pickup. Available in chassis form or with plinth and cover. Speeds: 30-86rpm continuously variable with 'click' stops at 16 $\frac{2}{3}$ , 33 $\frac{1}{3}$ , 45 and 78rpm. W and F: 0-12%. Speed variation: 0.3% for 10% change in mains voltage. Pulley drive. Four-pole motor. Viscous damped lowering device. Removable shell. PU arm type L69. Bias compensation. Price: (motor unit £33.90 (plus VAT); (motor unit on plinth) £45 (plus VAT); (dust cover) £4.50 (plus VAT).

#### Lenco GL85/P/C

Two-speed motor unit with pickup arm on plinth with cover. Speeds: 33 $\frac{1}{3}$  and 45rpm. Electronic fine speed adjustment  $\pm 3\%$ . W and F: (linear)  $\pm 0.16\%$ , (weighted)  $\pm 0.08\%$  (DIN). Rumble: (linear) -45dB, (weighted) -60dB. Turntable: 12.4in alloy. 3 $\frac{1}{2}$ lb. Belt drive. 16-pole synchronous motor. Viscous damped lowering device. Electronic switch-off and pickup raising at end of record. Counter-balanced arm. Bias compensation. Removable shell. Illuminated stroboscope. Price: £96 (plus VAT).

#### GL78P/C ★

Four-speed turntable and pickup arm fitted in

★ Indicates entry is illustrated

plinth with cover. Speeds:  $16\frac{2}{3}$ ,  $33\frac{1}{3}$ , 45, 78rpm (continuously variable between 30-80rpm with 'click' stops). W and F:  $\pm 0.11\%$ , (unweighted)  $\pm 0.06\%$  (weighted to DIN 45-507). Rumble:  $-60\text{dB}$  (weighted to DIN 45-539). Speed constancy:  $\pm 0.2\%$  for 10% change in mains voltage. Turntable:  $12\frac{3}{4}$ in diameter, diecast zinc,  $8\frac{3}{4}$ lb. Idler wheel drive. Motor: four-pole with conical spindle. Pickup arm: Goldring L75 with counterweight, bias adjuster and detachable head shell. Mechanical shut-off at end of record which raises arm, may be disconnected if not required. Price: £75 (plus VAT).

#### ■ GOODMANS LOUDSPEAKERS LTD

Downley Road, Havant, Hants, PO9 2NL.

Tel: Havant (070 12) 6344. Telex: 86296.



Goodmans TD100



Hitachi PS33



ITT DP-1-200

#### TD100 ★

Record deck in plinth with lid. Goldring GL75 motor unit. Infinitely variable speed adjustment with 'click' stops for  $16\frac{2}{3}$ ,  $33\frac{1}{3}$ , 45 and 78rpm. W and F:  $< 0.2\%$ . Speed constancy:  $< 1\%$  change for 13% variation in mains voltage. Turntable: 12in diecast zinc platter. Weight: 8lb. Vertical pulley drive. Four-pole motor. Counter-balanced pickup arm. Plug-in head shell. Hydraulic lowering device. Anti-skate device. Price: (teak) £64.63 (plus VAT); (white) £67.72 (plus VAT).

#### ■ HITACHI

Hitachi Sales (UK) Ltd, New Century Road, Park Royal, London, NW10 7QN.

Tel: 01-965 9861.

#### PS33 ★

Two-speed belt-drive turntable in plinth with arm and cartridge. 12in aluminium alloy turntable. Four-pole outer rotor motor. Speeds:  $33\frac{1}{3}$ , 45rpm. W and F:  $< 0.1\%$ . Plug-in headshell. Magnetic cartridge. Pw: 0.4gm. FR: 20 Hz-20kHz. Stylus: 0.7 thou diamond. Finish: walnut veneer. Size:  $19\frac{1}{4} \times 7\frac{1}{4} \times 15\frac{3}{4}$ in. Price: £94 (including VAT).

#### PS77

Two-speed belt/idler drive turntable in plinth with arm. Four-pole hysteresis synchronous motor.  $12\frac{1}{2}$ in aluminium diecast turntable. Weight of turntable: 5.6lb. Built-in strobe. Zinc diecast motor board. Speeds:  $33\frac{1}{3}$ , 45rpm. W and F:  $< 0.05\%$ . Tubular arm with static balance and cueing device. Plug-in headshell. Finish: oiled walnut. Size  $22\frac{1}{2} \times 11\frac{3}{4} \times 17\frac{3}{4}$ in. Weight: 33lb. Price: £170 (including VAT).

#### ■ ITT

ITT Consumer Products (UK) Ltd, Maidstone Road, Sidcup, Kent, DA14 5HT

Tel: 01-300 7733.

#### DP-1-200 ★

Single-player unit in plinth with smoke grey acrylic lid. Motor unit: BSR P144R. Speeds:  $33\frac{1}{3}$ , 45, 78rpm. Turntable: 11in diameter diecast. Friction drive. Mains: 220-240V 50Hz. Pickup arm: counterbalanced square-section arm with viscous damped cueing. Bias compensation. Slide-in cartridge carrier. Price: £36 (including VAT).

#### ■ JVC (UK) LTD

453 Caledonian Road, London, N7 9BA.

Tel: 01-607 6568.

#### SRP-473

Record turntable in plinth cabinet with pickup arm. Speeds:  $33\frac{1}{3}$  and 45rpm. Belt drive. Four-pole motor. W and F:  $< 0.1\%$ . Turntable:  $12\frac{1}{2}$ in diecast aluminium. Auto return of arm.



## Hi-fi starts here

The quality of the sound you hear  
from your hi-fi depends on the  
quality of transcription from the record  
- so you won't want to skimp on quality.  
When you choose your turntable,  
you'll probably choose Garrard.

*Garrard*

A PLESSEY QUALITY PRODUCT  
Garrard, Newcastle Street, Swindon, Wilts.

---

# 3009 + V15 III + SL110

Can be seen but not heard



## SME

The best pick-up arm in the world

Write to SME Limited  
Steyning · Sussex · England  
Telephone  
Steyning (0903) 814321

LTD/S27



JVC JL-A3 Servo-motor turntable



JVC JL-B44 DC Direct drive turntable



Leak Delta



Leak 2001 transcription unit

Special acoustic isolation. Size:  $18\frac{1}{4} \times 7\frac{3}{8} \times 14\frac{1}{4}$  in. Price: (less cartridge) £71.50 (including VAT).

#### JL-A3 ★

Turntable with plinth, cover, pickup arm and CD-4 cartridge with stereo stylus. Speeds:  $33\frac{1}{3}$  and 45rpm. W and F: 0.08%. Rumble: 55dB. Turntable platter:  $12\frac{1}{2}$ in diecast aluminium. Belt drive. Motor: 4-pole synchronous. No details of pickup arm. Fitted with stroboscope. Price: on application.

#### JL-B44 ★

Turntable with plinth, cover and pickup arm. Speeds:  $33\frac{1}{3}$  and 45rpm. W and F: 0.05%. Rumble: better than 60dB. Speed constancy: adjustable  $\pm 3\%$ . Platter:  $12\frac{1}{2}$ in diecast aluminium. Weight: 1.6kg. Direct drive. Brushless DC servo motor. Fitted with anti-resonance damped arm and neon stroboscope. Price: on application.

#### VLS

Turntable with plinth, cover, pickup arm and CD-4 cartridge with stereo stylus. Speeds:  $33\frac{1}{3}$  and 45rpm. W and F: less than 0.1%. Rumble: better than 50dB. 12in aluminium platter, belt drive. Motor: 4-pole synchronous. Fitted with pickup arm, no further details available. Price: on application.

#### ■ LEAK

Rank Radio International Ltd, Power Road, Chiswick, London, W4 5PW. Tel: 01-994 6491.

#### Delta ★

Turntable with pickup arm, plinth and cartridge. Speed: infinitely variable, 30-86rpm. W and F: 0.06% (DIN). Rumble: -60dB (DIN B). Speed constancy: 0.2% for 10% mains variation, max variation when loaded by pickup playing at 6gm, 0.3%. Motor: 4-pole constant velocity. Tonearm: counter balance weight, knife-edge bearing, stylus pressure adjustable 0.5-5gm with calibrated sliding weight. Removable pickup headshell. Fitted with Shure M75B type 2 magnetic cartridge. Size:  $166 \times 400 \times 371$ mm. Price: £71.30 (including VAT).

#### 2001 ★

Turntable with pickup arm, plinth and cartridge. Unique spherodynamic damped turntable suspension. Isolates against external shock, vibration and acoustic feedback. Speeds:  $33\frac{1}{3}$  and 45rpm. Speed accuracy:  $\pm 0.5\%$ . Wow: typical 0.08%. Flutter: typical 0.02%. Rumble: typical -65dB (DIN B). Platter: 320mm diameter. Weight: 1.6kg. Motor: 10-pole synchronous, 600rpm at 50Hz. Belt drive to turntable rim. Tonearm: static balance, professional, precision engineered. Length: 323mm, effective



Micro MR111



Micro MR711

length: 240mm. Dynamic balancing by counterweight, adjustable stylus pressure 0-3gm, direct reading. Bias compensation. Friction: 18mgm average, lateral and vertical. Remote control, viscous damped arm raise/lower device. Plug-in headshell. Price: to be announced.

#### ■ LINN-SONDEK

Linn Products Ltd, 235 Drakemire Drive, Castlemilk, Glasgow G45 9SZ.  
Tel: 041-634 3860.

#### LP12

Single speed (33 $\frac{1}{3}$ rpm) transcription record deck available as chassis only; with plinth and cover and also with plinth, cover and Grace G-707 arm or SME 3009 Series II arm. Standard plinth finish afrormosia, various other solid timber plinths available. 12in diecast platter driven by ground flat belt from a 24-pole synchronous motor. Patented external bearing assembly for low noise and a patented steel point control bearing running in an oil bath. W and F: 0.04 RMS unweighted. Rumble: -60dB with ref. to 10cm/s at 1kHz unweighted. Price: £67.50 (chassis only), £89.98 (with plinth and cover), £131.74 (with plinth, cover and arm) all including VAT.

#### ■ MICRO

Howland-West Ltd, 3-5 Eden Grove, London, N7 8EQ. Tel: 01-609 0293.

#### MR111 ★

Turntable unit fitted with arm and mounted in plinth with cover. Speeds: 33 $\frac{1}{3}$  and 45rpm. W and F: <0.1% Turntable: 12in diecast alloy, 2lb. Belt drive. Four-pole synchronous motor. Mains: 200-240V. Static balance tubular arm with bias compensation. Counterweight. Direct reading stylus pressure scale. Price: £55 (including VAT).

#### MB300

Turntable unit only. Speeds: 33 $\frac{1}{3}$  and 45 rpm. W

and F: <0.01%. Rumble: >-48dB. Turntable: 12in diecast alloy, 2 $\frac{1}{4}$ lb. Belt drive. Four-pole hysteresis motor. Pushbutton speed selection. Price: £46.20 (including VAT).

#### MR311

Turntable unit fitted with arm and mounted in plinth with cover. Speeds: 33 $\frac{1}{3}$  and 45rpm. W and F: <0.06%. Turntable: 12 $\frac{1}{2}$ in double rim alloy, 3lb. Belt drive. Static balance arm. Bias adjustment. Oil-damped lift. Price: £85.80 (including VAT).

#### MB600

Turntable only. Speeds: 33 $\frac{1}{3}$  and 45rpm. W and F: <0.05%. Rumble: >-52dB. Turntable: 12 $\frac{1}{2}$ in cast aluminium alloy, 3lb. Belt drive. Eight-pole hysteresis synchronous motor. 100-240V AC. Pushbutton speed selection. Price: £55 (including VAT).

#### MR711 ★

Turntable unit fitted with arm and mounted in plinth with cover. Speeds: 33 $\frac{1}{3}$  and 45rpm with electronically controlled adjustment of 6% with meter readout. W and F: <0.04%. Rumble: >-58dB. Turntable: 12 $\frac{1}{2}$ in diecast aluminium, 4.4lb. Motor: DC servo direct drive. 100-240V AC. Static balance arm with lightweight solid headshell. Length: 10in. Electronic switching. Unit mounted on diecast base. Fitted with rubber shock absorbers. Price: £188.10 (including VAT).

#### ■ N. MIERS & CO, LTD

28 Piercing Hill, Theydon Bois, Epping, Essex, CM16 7LE.  
Tel: 037-881 2611. Telex: 897076.

#### C141R

Three-speed turntable unit with low mass tubular tone arm. Lightweight cartridge shell with finger lift. Automatic arm lock. Cue and pause lever, bias compensator etc. Speeds: 78, 45 and 33rpm. Wow below 0.2% RMS. Flutter below 0.06% RMS. Price: £14.99 (plus VAT).

**C129R**

Three-speed turntable unit with pick-up arm. Fitted with stereo crystal cartridge, output 280mV. Speeds: 78, 45 and 33rpm. Wow below 0.35% RMS. Flutter below 0.08% RMS. Price: £10.98 (plus VAT).

**C127R**

Three-speed Mini changer with tubular tone arm 35% smaller than conventional changers. Cue/pause lever. Fitted with stereo cartridge, output 280mV. Price: £10.73 (plus VAT).

**C141/SC5MD**

Four-speed record deck with pickup arm and cartridge. Speeds: 16 $\frac{2}{3}$ , 33 $\frac{1}{3}$ , 45, 78rpm. Stereo ceramic cartridge. Diamond stylus. 11in turntable. Autochanger. Price: £13.49 (plus VAT).

**Plinth and dust cover**

To fit C141. Price: £6.85 (plus VAT).

**■ NATIONAL PANASONIC (UK) LTD**

Whitby Trading Estate, Slough, Bucks.  
Tel: Slough (75) 34522. Telex: 847652.

**SL-1100**

Direct drive turntable with plinth and cover. Full specification on request. Price: £189.50 (including VAT).

**RD7724**

Rim-drive turntable unit with pickup arm and cartridge. Mounted in plinth with cover. Full specification on request. Price: £21.95 (including VAT).

**■ PHILIPS ELECTRICAL LTD**

Century House, Shaftesbury Avenue,  
London, WC2H 8AS. Tel: 01-437 7777.

**GA207**

Two-speed record deck with arm and cartridge mounted in plinth. Finish: silver with clear plastic cover. Speeds: 33 $\frac{1}{3}$  and 45rpm. W and F:  $\leq 0.2\%$ . Rumble:  $-35\text{dB}$  (DIN A),  $-55\text{dB}$  (DIN B). Turntable: 10 $\frac{3}{8}$ in diameter steel. Belt drive. Motor: 24-pole synchronous. Mains: 110, 127, 220, 240V 50Hz. Counterbalanced pickup arm fitted with GP213 ceramic magnetic cartridge. Direct reading stylus pressure gauge fitted. Price: £34 (including VAT).

**GA209**

Turntable complete with pickup arm, GP412 cartridge, plinth and transparent hinged cover. Speeds: 33 $\frac{1}{3}$  and 45rpm. Fine control  $\pm 3\%$ . W and F: better than 0.1%. Rumble:  $-62\text{dB}$  (DIN B). Platter: 11 $\frac{5}{8}$ in steel. Weight: 3lb. Belt drive. DC servo controlled motor. Tone-arm: integral stylus pressure gauge. Aluminium construction with slide in cartridge carrier. Stroboscope, touch control for tonearm lift/lower. Fully automatic. Price: £125 (including VAT).



Philips GA212



Philips GA407

**GA212 ★**

Integrated turntable, pickup arm and cartridge mounted on walnut veneered plinth with hinged tinted plastic lid. Speeds: 33 $\frac{1}{3}$ , 45rpm. Fine speed adjustment:  $\pm 3\%$ . W and F:  $< 0.1\%$ . Rumble:  $< 62\text{dB}$  (DIN B). Turntable: 11 $\frac{1}{4}$ in diameter steel, 2 $\frac{1}{2}$ lb. Belt drive. Motor: DC type with tachogenerator giving electronic control, obviates the need for a heavy flywheel type platter. Lightweight tubular gimbal-mounted pickup arm. Decoupled counterweight. Bias compensation. Stylus pressure adjustment. Standard  $\frac{1}{2}$ in headshell, with slide-in cartridge carrier. Electronic touch controls for speed selection, start and stop. Light beam operated auto-stop. Viscous damped pickup arm raising and lowering device. Supplied complete with Philips GP400 cartridge. Mains: 110, 127, 220, 240V 50-60Hz. Size: 15 $\frac{1}{4}$   $\times$  5 $\frac{1}{2}$   $\times$  13 $\frac{1}{4}$ in. Price: £75 (including VAT).

**GA407 ★**

Two-speed record deck with arm and cartridge mounted in plinth. Finish: walnut base with tinted plastic cover. Speeds: 33 $\frac{1}{3}$  and 45rpm. W and F:  $\leq 0.2\%$ . Rumble:  $-35\text{dB}$  (DIN A),  $-55\text{dB}$  (DIN B). Turntable: 10 $\frac{3}{8}$ in diameter steel. Belt drive. Motor: 24-pole synchronous. Mains: 110, 127, 220, 240V 50Hz. Counterbalanced arm fitted with direct reading stylus pressure gauge. Fitted with GP400 Super 'M' magnetic cartridge. Friction-grip lid hinges. Price: £49 (including VAT).



★ Indicates entry is illustrated

## ■ PHOTAX-CONCERTONE

Photax (London) Ltd, Hampden Park, Eastbourne, Sussex.

### 2000P

Turntable with pickup arm, plinth and cover. Speeds:  $33\frac{1}{3}$  and 45rpm. W and F: less than 0.2% RMS. Platter: aluminium alloy diecast 300mm. Neoprene belt drive. Motor: 4-pole synchronous. Tonearm: static balanced tubular, adjustable counterweight and bias compensation. Cueing device. Optional cartridge, Photax M404C moving magnet. Price: to be announced.

## ■ PIONEER

Distributors: Shriro (UK) Ltd, Shriro House, The Ridgeway, Iver, Bucks, SL0 9JL. Tel: Cedarwood (075 38) 2222.

### PLA35

Two-speed record deck with pickup arm and cartridge mounted in plinth with cover. Speeds:  $33\frac{1}{3}$ , 45rpm. 12in diecast aluminium turntable. W and F: <0.1%. Static balance tubular arm. Induced magnet cartridge. 0.5 thou diamond stylus. Output: 3mV. Price: £91.47 (plus VAT).

### PL12AC

Two-speed record deck with pickup arm on plinth with cover. Speeds:  $33\frac{1}{3}$  and 45rpm. Wow: <0.12%. Flutter: <0.12%. S/N ratio: better than 45dB. 12in aluminium turntable. Belt drive. Four-pole synchronous motor. Static balanced pickup arm, incorporating bias compensation and hydraulic lift device. Price: £47.18 (plus VAT).

### PL15C

Two-speed record deck with pickup arm on plinth with cover. Speeds:  $33\frac{1}{3}$  and 45rpm. W and F: <0.1%. S/N ratio: better than 47dB. 12in diecast aluminium turntable. Belt drive. Four-pole synchronous motor. Static balanced arm incorporating automatic return, bias compensation, hydraulic lift and direct weight calibration. Price: £65.78 (plus VAT).

### PL12D ★

Turntable with pickup arm, plinth and cover. Speeds:  $33\frac{1}{3}$  and 45rpm. W and F: less than 0.1% WRMS. Rumble: 47dB ref. 5cm/s at 1kHz. Speed constancy: 0.1% for 10% mains variation. Turntable: 12in aluminium alloy. Belt drive. Motor: 4-pole synchronous. Pickup arm: static balance, adjustable counterweight, adjustable bias, lateral balance weight. Fitted with overhang indicator, cueing device. Price: on application.

### PL12S

Turntable with pickup arm, plinth and cover. Speeds:  $33\frac{1}{3}$  and 45rpm. W and F: less than 0.08% WRMS. Rumble: 47dB ref. 5cm/s at 1kHz. Speed constancy: 0.1% for 10% mains variation. Platter: 12in diecast aluminium alloy,

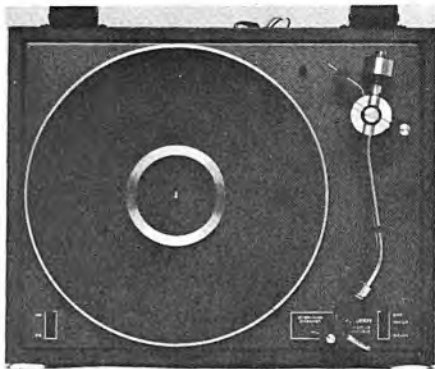

Pioneer PL12D

belt drive. Motor: 4-pole synchronous. Tonearm: static balance, no further details available. Fitted with electronic autostop with Hall element and cueing device. Price: on application.

### PL15D

Turntable with pickup arm, plinth and cover. Speeds:  $33\frac{1}{3}$  and 45rpm. W and F: less than 0.1% WRMS. Rumble: 47dB ref. 5cm/s at 1kHz. Speed constancy: 0.1% for 10% mains variation. Platter: 12in aluminium alloy, belt drive. Motor: 4-pole synchronous. Tonearm: static balanced, tubular. Automatic return function, cueing device, bias compensation. Price: on application.

### PL45D

Turntable with pickup arm, plinth and cover. Speeds:  $33\frac{1}{3}$  and 45rpm. W and F: less than 0.1% WRMS. Rumble: 47dB ref. 5cm/s at 1kHz. Speed constancy: 0.1% for 10% mains variation. Platter: 12in aluminium alloy, belt drive. Motor: 4-pole synchronous. Tonearm: static balance, tubular, adjustable counterweight. Automatic lead in, auto return, auto repeat. Two motor system. Price: on application.

### PL51A

Turntable with pickup arm, plinth and cover. Speeds:  $33\frac{1}{3}$  and 45rpm with speed control  $\pm 2\%$ . W and F: 0.06% WRMS. Rumble: 55dB ref. 5cm/s at 1kHz. Speed constancy: 0.1% for 18% mains variation. Platter: 12½in aluminium alloy. Motor: direct drive, brushless DC servo control. Tonearm: static balance, tubular, lateral balancer, adjustable counterweight, bias compensation, plug-in headshell. Fitted with stroboscope light. Anti-vibration cabinet. Price: on application.

### PL71

Turntable with pickup arm, plinth and cover. Speeds:  $33\frac{1}{3}$  and 45rpm. W and F: less than 0.05%. Rumble: 60dB ref. 5cm/s at 1kHz. Speed constancy: 0.1% for 10% mains variation.

# Connoisseur

## The B.D.2 Turntable Assembly

The famous B.D.2 belt drive turntable with press button speed change has now been developed to feature a newly designed mat and brushed aluminium trim and the perspex cover has an easy "hinged-on, hinged-off" movement. The B.D.2 is available as a chassis unit or spring mounted on a wood plinth, as above.



## B.D.1 Turntable Kit

The B.D.1, well known for its superb performance and quality, is available in kit form. Construction is simplicity itself with no soldering required. Now it's so easy to own the best.

## S.A.U.2 Pick-up Arm

Recognised as one of today's most advanced pick-up arms it features:

- ★ Auto-bias Compensator
- ★ Hydraulic Lowering Device
- ★ Precision Balance
- ★ Adjustable head shell



## S.C.U.1 Stereo Cartridge

This is the cartridge for the person who really cares about his equipment.



# A.R. Sugden & Co. (Engineers) Ltd.

ATLAS MILL RD. BRIGHOUSE, YORKSHIRE HD6 1ER.

Tel: Brighouse (04847) 2142.

Telegrams & Cables: Connoisseur, Brighouse.

# UA6 by Fidelity



## Impeccable precision at £117.82\*

Even by Fidelity's demanding standards, UA6 – the latest of our systems – is exceptional.

Every engineering detail has been taken into account, every component selected for its superiority. The turntable, for example, is the superb 3-speed Garrard SP25 single-play unit with magnetic cartridge and cueing device, and every other aspect of the system – in both radio and record player – matches its sensitivity and precision.

Like any great system, Fidelity's UA6 has to be heard to be appreciated. You'll find it at any discriminating audio dealer; meanwhile, why not listen to other systems at the price? That way, you'll be even better prepared for your next pleasant surprise in sound. For full details of our range write for our colour brochure.

In black leathergrain look with brushed aluminium and teak veneered finish on deck ends and speakers and tinted lid. **Record Player:** ■ Garrard SP25 Mk 1V single play turntable ■ 3 speed with magnetic cartridge and cueing device ■ Individual Volume, Bass and Treble slide controls and rotary control for tuning ■ 2 speakers each with 6½" round drive unit & 3⅜" round tweeter **Radio:** ■ Reception on LW, MW, VHF/FM. ■ Piano key controls for LW, MW, VHF/FM, AFC, Phono & Tape, Mains On/Off ■ Internal ferrite aerial and AFM stereo indicator light Size: Unit with lid lowered 6⅜" x 24⅞" x 14⅞", with lid raised 16½" x 24⅞" x 14⅞" Speakers: 10" x 6" x 15" each Weight: Unit with lid 21lbs. Speakers 9 lbs 2 oz each Sockets: for speakers, tape, FM & AM aerials and stereo headphones Voltage: 200/250 AC Mains 50 Hz Power: 10 watts per channel RMS Power Consumption: 60 watts **Price: £120.00** inc. VAT recommended retail price\*



## FIDELITY RADIO LTD

Olaf Street, London W11 4AY Telephone: 01-727 0131 Cables: Amplify, London  
Service Department: 2 Chase Road, London NW10. Tel: 01-965 9235/6

*Unit Audios, Tuners & Amplifiers, Transistor Radios, Record Players, Stereograms*

\*Manufacturers Recommended Retail Price inc. VAT at time of going to press

Platter: 31cm, 1.7kg diecast aluminium. Motor: direct drive DC servo controlled. Tonearm: new static balance, tubular arm, length 224mm, adjustable height, adjustable counterweight, lateral balance, bias compensation, cueing device. Stroboscopic light. Anti-vibration cabinet. Price: on application.

### ■ RUSSCO ELECTRONICS

Distributors: C. E. Hammond & Co Ltd, Lamb House, Church Street, Chiswick, London, W4 2PB. Tel: 01-995 4551.

#### Russco Studio Pro

Professional two-speed (45 and  $33\frac{1}{3}$ rpm) Turntable. Start-up times:  $\frac{1}{6}$ rev  $33\frac{1}{3}$ rpm,  $\frac{1}{6}$ rev 45rpm. W and F: < 0.2%. Rumble: NAB-38dB. Illuminated speed indicators and electric start—suitable for remote operation. Removable tone arm mounting plate. Neutral position for cueing—felt slip mat. Dimensions:  $15\frac{1}{2} \times 15\frac{1}{2} \times 7\frac{1}{2}$ in below chassis. Weight: 20lb. 50Hz 115V synchronous motor. Price: (including shrouded 115-240V transformer) £153.45 (including VAT).

#### Russco Cue Master

As Studio Pro, except: three-speed (78, 45 and  $33\frac{1}{3}$ rpm). Start-up at 78rpm  $\frac{1}{2}$ rev. W and F: < 0.3%. Rumble: NAB-36dB. No speed indicators or mtg plate. Depth below chassis:  $6\frac{1}{2}$ in. Weight: 16lb. Price: (including transformer) £139.15 (including VAT).

### ■ SABA TELEVISION LTD

6-12 Cornbrook Park Road, Manchester, M15 4EE. Tel: 061-872 7661. Telex: 669131.

#### 735

Three-speed motor unit in plinth with pickup arm and cartridge. Speeds:  $33\frac{1}{3}$ , 45, 78rpm. W and F: < 0.15% (DIN). Rumble: < 56dB (DIN). Turntable: 4lb. Autochanger operation. Four-pole synchronous motor. All-metal pickup arm. Pw: 1-6gm adjustable. Anti-skate device. Shure M71 magnetic cartridge with diamond stylus. Finish: light matt walnut or matt white, clear plastic cover. Size:  $16 \times 7\frac{3}{8} \times 14$ in. Price: £74.26 (including VAT).

#### 745

Three-speed motor unit in plinth with pickup arm and cartridge. Speeds:  $33\frac{1}{3}$ , 45, 78rpm. W and F: < 0.1% (DIN). Rumble: > 57dB (DIN). Turntable: 4lb. Autochanger operation. Four-pole synchronous motor. All-metal pickup arm. Pw: 0.5gm-5.5gm adjustable. Anti-skate device. Shure M91 magnetic cartridge with diamond stylus. Finish: light matt walnut or matt white, clear plastic cover. Size:  $16 \times 7\frac{3}{8} \times 14$ in. Price: £91.50 (including VAT).

#### 780

Three-speed motor unit in plinth with pickup



Sansui SR2050C

arm and cartridge. Speeds:  $33\frac{1}{3}$ , 45, 78rpm. W and F: < 0.06% (DIN). Rumble: > 60dB (DIN). Turntable: 12in diameter, 7lb weight. Autochanger operation. Synchronous continuous pole motor. Anti-skating device. Stroboscopic markings on turntable. All-metal pickup arm. Pw: 0.2gm-5.5gm adjustable. Pickup cartridge and finish the same as for the 745. Size:  $19\frac{1}{2} \times 7\frac{3}{8} \times 14$ in (including storage compartment for accessories). Price: £125 (including VAT).

### ■ SANSUI

Vernitron Ltd, Thornhill, Southampton, SO9 5QF. Tel: Southampton (0703) 444811.

#### SR212

Semi-automatic return turntable complete with pickup arm, plinth and cover. Speeds:  $33\frac{1}{3}$  and 45rpm. W and F: 0.1% WRMS. S/N: 45dB. Platter: aluminium alloy diecast, 300mm. Motor: 4-pole synchronous. Belt drive. Tonearm: statically balanced tubular. Length: 215mm, overhang: 10mm, bias compensation. Cueing device. Fitted with induced magnet cartridge SC-37. Price: on application.

#### SR1050C

Motor unit and pickup in cabinet with clear plastic lid. Speeds:  $33\frac{1}{3}$  and 45rpm. Belt drive. 12in diameter platter. 2.64lb. Mains: 100, 117, 200, 220, 250V AC. Wow: < 0.07%. S/N: better than 40dB. Tubular balanced arm with bias compensation. Cartridge: induced magnet. Output: 5mV. FR: 20Hz-20kHz. Stylus: 0.5 thou diamond. Compliance:  $7 \times 10^{-9}$ cm/dyne. Finish: walnut with smoked acrylic lid. Size:  $17\frac{3}{8} \times 13\frac{3}{4} \times 7\frac{1}{2}$ in. Two years guarantee. Price: £76.17 (plus VAT).

#### SR2050C ★

Motor unit and pickup in cabinet with smoked acrylic dust cover. Speeds:  $33\frac{1}{3}$  and 45rpm. Belt drive: 12in diameter platter. 2.9lb. Mains: 100, 117, 200, 220-240V AC. S/N ratio: better than

★ Indicates entry is illustrated

40dB. Wow: <0.07%. Balanced tubular arm with bias compensation and pressure adjustment. Max tracking error:  $\pm 1.5\%$ . Cartridge: induced magnet. Output: 5mV. FR: 20Hz-20kHz. Stylus: 0.5 thou diamond. Compliance:  $7 \times 10^{-6}$ cm/dyne. Automatic lift-off and stop. Finish: walnut. Size:  $17\frac{1}{2} \times 13\frac{7}{8} \times 7\frac{1}{2}$ in. Two years guarantee. Price: £107.66 (plus VAT).

#### SR4050C ★

Motor unit and pickup in cabinet with smoked acrylic lid. Speeds:  $33\frac{1}{3}$  and 45rpm. Belt drive. 12in diameter platter. 3-3lb. Mains: 100, 117, 200, 220, 240V AC. S/N ratio: better than 45dB. Wow: less than 0.06%. Gimbal supported statically balanced arm with bias compensation. Stylus pressure adjustment. Max. tracking error:  $\pm 1.5\%$ . Cartridge: induced magnet. Output: 5mV. FR: 20Hz-20kHz. Stylus: 0.5 thou diamond. Compliance:  $17 \times 10^{-6}$ cm/dyne. Auto lift-off and stop. Finish: walnut. Size:  $19\frac{5}{8} \times 14\frac{1}{2} \times 7\frac{7}{8}$ in. Two years guarantee. Price: £148.41 (plus VAT).

#### FR3060 ★

Motor unit and pickup arm in plinth cabinet with lid. Speeds:  $33\frac{1}{3}$  and 45rpm. W and F: better than 0.07%. Rumble: signal-to-noise ratio better than 47dB. Turntable: 12in diameter, diecast aluminium, 3-1lb. Belt drive. Four-pole synchronous motor. Statically balanced tubular arm with direct reading stylus pressure gauge. 16-pole timing motor for auto lift and return. Anti-static mat. Automatic and manual control. Facilities for remote control and automatic repeat. Price: £140.93 (plus VAT).

#### ■ SANYO

Sanyo Marubeni (UK) Ltd, Bushey Mill Lane, Watford, WD2 4UQ. Tel: Watford (92) 30421.

#### TP80S ★

Turntable with PU arm in shelf mounting cabinet with tinted lift-up lid. Two speeds ( $33\frac{1}{3}$ , 45 rpm). Belt drive. Four-pole synchronous motor.  $11\frac{7}{8}$ in diecast turntable. S-shaped tubular arm. Lateral balance weight. Accepts all standard cartridges. Tracking force adjustable 0.4gm. Pickup arm returns to rest automatically. Lifting and lowering device. Moving magnet stereo cartridge supplied. Finish: walnut with transparent cover. Price: £74.95 (including VAT).

#### TP92S

Turntable with PU arm in shelf mounting cabinet with lift-up lid. Two speeds ( $33\frac{1}{3}$ , 45rpm). Belt drive. Four-pole synchronous motor. Diecast turntable. Statically balanced pickup arm. Maximum tracking error 1.5°. Arm accepts all standard cartridges. Supplied with moving magnet stereo cartridge with 0.5mm diamond stylus. Pickup arm returns automatically at end of record. Price: £54.95 (including VAT).



Sansui SR4050C



Sansui FR3060



Sanyo Marubeni TP80S

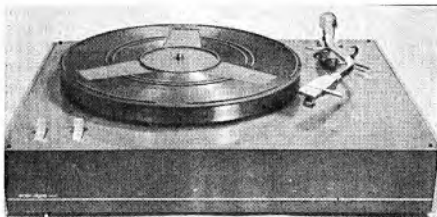

Scan-Dyna 1400

**■ SCAN-DYNA**

Scandinavian Audio Systems Ltd, Sun Alliance Building, 65 London Road, Gloucester, GL1 3HF. Tel: Gloucester (0452) 32791.

**1400 ★**

Two-speed motor unit in plinth with pickup arm. Tinted dust cover. Speeds: 33 $\frac{1}{3}$ , 45rpm. W and F: 0.9%. Turntable: 11 $\frac{1}{2}$ in. Neoprene belt drive. Motor: 2 × 16-pole synchronous. Mains: 220-240V 50Hz. Ortofon AS212 pickup arm fitted with F15 cartridge. Magnetic bias compensation. Price: £69.90 (including VAT).

**■ SCIENTELEC**

35a Beddington Lane, Croydon, Surrey, CR0 4TB. Tel: 01-686 9341/4.

**Club**

Two-speed transcription record deck with arm. Speeds: 33 $\frac{1}{3}$  and 45rpm. Speed accuracy  $\pm 0.2\%$ . W and F:  $< 0.15\%$ . Rumble and noise: -54dB. Non-ferrous tri-pole turntable. Belt drive. Synchronous motor. Knife-edge horizontal pivot to arm, ballrace vertical pivot. Damped lowering device. Bias compensation. Transparent plastic cover with catch. Complete assembly suspended on latex blocks for acoustic isolation. Price: £84 (including VAT).

**■ SIEMENS**

Siemens Ltd, Great West House, Great West Road, Brentford, Middlesex. Tel: 01-568 8281.

**RW444**

Record deck incorporating the PE3012 auto-changer chassis and a Shure M75D cartridge. Size: 162 × 390 × 334mm. Motor: 50-60Hz, 4-pole induction motor. Speeds: 33 $\frac{1}{3}$ , 45 and 78 rpm. Speed:  $\pm 3\%$ . W and F (DIN): 0.15%. Rumble (DIN) 40dB. Turntable: 10.7in. Price: £58.15 (plus VAT).

**RW446**

Similar in styling and specification to RW444, but uses the PE3060 chassis. W and F: 0.08%. Rumble (DIN) 43dB. Price: £85.45 (plus VAT).

**■ SONAB LTD**

PO Box 4, Oldfield Road, Hampton, Middlesex, TW12 2HN. Tel: 01-979 0134.

**85S Mk I**

Transcription turntable unit with improved pickup arm, precision cueing device, bias compensation and cartridge mounted in plinth with transparent plastic dust cover. Speeds: 33 $\frac{1}{3}$  and 45rpm. Wow:  $< 0.08\%$  (DIN). Flutter:  $< 0.08\%$  (DIN). Rumble:  $< 60$ dB (weighted). Speed constancy: better than  $\pm 1\%$ . Turntable: 12in diameter non-magnetic, 2 $\frac{1}{2}$ lb. Belt drive. Four-pole synchronous motor. Lightweight tubular arm balanced statically and dynamically. Adjust-

able for stylus pressures 0.5-3.5gm. Fitted with Shure M75E cartridge with elliptical diamond stylus: Price: £86.35 (plus VAT).

**■ SONY (UK) LTD**

Pyrene House, Sunbury Cross, Sunbury-on-Thames, Middlesex. Tel: Sunbury-on-Thames (76) 87644.

**PS230**

Two-speed motor turntable unit fitted with pickup arm, cartridge, plinth and dust cover. Speeds: 33 $\frac{1}{3}$  and 45rpm. Turntable: 11in diameter. Four-pole synchronous motor. AC mains 100, 120, 220 or 240V. Induced magnetic cartridge. Price: £40 (plus VAT).

**PS5520**

Two-speed auto-manual turntable system in plinth with pickup arm and cartridge. Speeds: 33 $\frac{1}{3}$  and 45rpm. W and F: 0.1%. Turntable: 12in diameter diecast aluminium. Belt drive. Four-pole hysteresis synchronous motor. Statically balanced pickup arm. Pivot to stylus 8 $\frac{1}{2}$ in. Stylus pressure adjustment: 0-3gm. Fitted with induced magnet cartridge. Price: £63 (plus VAT).

**■ TEAC**

Acoustico Enterprises Ltd, Unit 7, Space Way, North Feltham Trading Estate, Feltham, Middx. TW14 OTZ. Tel: 01-751 0141.

**TS-130**

Two-speed record deck with arm. Fitted in plinth with cover. Speeds: 33 $\frac{1}{3}$ , 45 rpm. Flutter: 0.09%. S/N ratio 45dB. Pulley drive. Four-pole synchronous motor. Statically balanced. Price: £72.50 (plus VAT).

**TN-400**

Chassis unit turntable. Speeds: 33 $\frac{1}{3}$  and 45rpm. Direct drive. Mains: 220-240V AC. Fitted with stroboscope and touch sensitive controls. Full details and price on request.

**■ TELEFUNKEN**

AEG Telefunken (UK) Ltd, Bath Road, Slough, Bucks. Tel: Slough (75) 33311. Cables: Allgem, London.

**W215**

Four-speed record deck in shelf-mounting plinth. Speeds: 16 $\frac{2}{3}$ , 33 $\frac{1}{3}$ , 45, 78rpm. Tubular pickup arm with Pickering V15/AC-2 magnetic cartridge. 11in diameter turntable. Tinted dust cover. Size: 14 $\frac{1}{2}$  × 7 $\frac{1}{2}$  × 12in. Price: £61.55 (including VAT).

**W238**

Turntable complete with pickup arm, plinth and cover. Speeds: 33 $\frac{1}{3}$ , 45 and 78rpm. Fine speed adjustment  $\pm 3\%$ . W and F: better than  $\pm 0.15\%$  (DIN). Rumble: better than 58dB (DIN). Platter: zinc pressure moulded, 271mm,

★ Indicates entry is illustrated



Telefunken W258 Transcription Deck

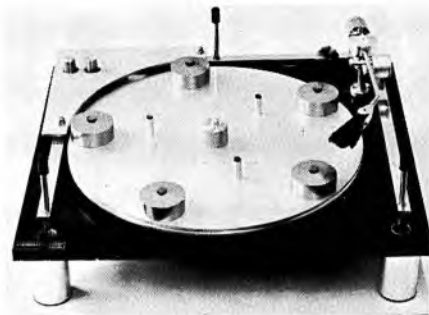

Transcriptors Saturn



Thorens TD125 Mk II



Thorens TD160C

2kg. Pulley drive. Motor: induction, 110-220V. Tonearm: one piece counter balanced diecast girder-type, calibrated counterweight. Fitted with Shure M75-6SM cartridge. Stroboscope, anti-static mat, changer spindle, damped cue device. Price: £89.50 (including VAT).

#### **W258 ★**

Record changer complete with plinth and cover. Speeds:  $33\frac{1}{3}$ , 45 and 78rpm. Fine speed adjustment  $\pm 3\%$ . W and F: better than  $\pm 0.1\%$  DIN. Rumble: better than 59dB DIN. Platter:  $10\frac{3}{8}$  in,  $4\frac{1}{2}$  lb, diecasting. Pulley drive. Motor: induction-type, 110-220V. Tonearm: tubular with cardan mounting and adjustable counterweight, anti-skating device separately calibrated for conical and elliptical styli. Fitted with Shure M91ME cartridge. Stroboscope, anti-static mat, changer spindle, damped cue control, Single and auto changer. Price: £118.50 (including VAT).

### ■ THORENS

Metrosound Audio Products, Ltd,  
Cartersfield Road, Waltham Abbey, Essex.  
EN9 1JF. Tel: Waltham Cross (97) 31933.

#### **TD125 Mk II ★**

Transcription turntable. Three speeds:  $33\frac{1}{3}$ , 45 and  $16\frac{2}{3}$  rpm. With  $\pm 2\%$  electronic speed control. Low speed synchronous motor, belt driven. Motor is transistor governed. Neon-lit strobe.

12in non-ferrous turntable. W and F: 0.09%. Plinth and cover available, also mounting frame if cabinet mounted. Price: £70 (plus VAT).

#### **TD125AB Mk II**

Details as for TD125 but complete with TP16 pickup arm and plinth. Price: £105.50 (plus VAT).

#### **Teak Plinth**

Suitable for TD125 unit. Price: £7 (plus VAT).

#### **Perspex cover TX25**

Suitable for TD125 unit. Price: £7.50 (plus VAT).

#### **TD160C ★**

Transcription turntable with integrated pickup arm. Speeds:  $33\frac{1}{3}$  and 45rpm. TP16 pickup arm. Pw: adjustable 0.5 to 4gm. Magnetic bias compensation device. Complete with smoke grey cover. Price: £59.13 (plus VAT).

### ■ TRANSCRIPTORS LTD

J. H. Nelson Audio, Mycott House,  
Station Road, Boreham Wood, Herts.  
Tel: 01-953 9851.

#### **Saturn turntable ★**

Self-standing turntable unit with pickup arm, cover and anti-feedback legs. Speeds:  $33\frac{1}{3}$  and 45rpm. No fine speed adjustment. Wow: better than 0.03%. Flutter: not measurable. Rumble:

not measurable. Speed remains constant with variation of mains voltage. 12in diecast aluminium turntable. Weight: 6½lb. Belt drive. Mains: 100-110V or 200-240V 50 or 60Hz. Pickup arm has low-friction stabilised unipivot mounting. Hydraulic lowering. Cueing. Full adjustments. Unit fully suspended. Arm and turntable float free at under 5Hz for acoustic feedback damping. Price: approximately £75 (plus VAT).



Trio KP-3022

### ■ TRIO

B. H. Morris & Co (Radio) Ltd,  
Trio House, The Hyde, London, NW9 6JP.  
Tel: 01-205 6411.

#### KP-2022

Two-speed belt-drive turntable unit with pickup arm and cartridge. FR: 20Hz-20kHz. Mounted in plinth with hinged dust cover. Cueing device. Four-pole synchronous motor. Price: £47-50 (plus VAT).

#### KP-2022A

Turntable with arm, plinth and cover. Speeds: 33½ and 45rpm. W and F: less than 0.08% WRMS. S/N: better than 45dB. Platter: 300mm solid diecast aluminium alloy, polyurethane belt drive. Motor: 4-pole induction. Tonearm: static balanced tapered tubular with slide lock EIA plug-in connector and direct reading stylus pressure, 0.4gm. Usable cartridge weight: 5-10gm. Cueing device. Auto-return and auto-reject. Fitted with Type V-39' moving magnet cartridge. Price: £53-50 (plus VAT).

#### KP-3022 ★

Turntable with arm, plinth and cover. Speeds: 33½ and 45rpm. W and F: less than 0.08% WRMS. S/N: more than 48dB. Platter: 300mm, solid diecast aluminium alloy, belt drive. Motor: 4-pole synchronous. Tonearm: as fitted in KP-2022A. Supplied with moving magnet cartridge. Features: auto-in, auto-cut, auto-repeat, auto-return, disc size selector. Cueing device. Pilot lamp for stylus adjustment and 24-pole synchronous motor for arm drive. Price: £85-50 (plus VAT).

#### KP-5022

Turntable with arm, plinth and cover. Speeds: 33½ and 45rpm. W and F: less than 0.05% WRMS. S/N: better than 58dB. Speed control range: ±3% (individual control for each speed). Platter: 300mm solid diecast aluminium alloy. Motor: direct drive DC servo, 8-pole, 24 slot. Tonearm: static balanced tapered tubular, slide locked EIA plug-in connector. Direct reading stylus pressure. Fitted with moving magnet cartridge. Features: as for KP-3022. Price: £138-50 (plus VAT).



Yamaha YP-700

### ■ VALEK LTD

Lark Street, Darwen, Lancs, BB3 2LT.  
Tel: Darwen (0254) 71881.

#### Turntable kits

Kits of parts for home assembly of record turntable units. Full details and prices on request.

### ■ WHARFEDALE

Rank Radio International Ltd,  
Power Road, Chiswick, London, W4 5PW.  
Tel: 01-994 6491.

#### Model W30

Hydraulic arm lowering device. Adjustable arm balance. Bias compensator. Automatic stop/arm return mechanism. Wow: better than 0.2%. Flutter: better than 0.6%. Rumble: better than 35dB. Fitted with Shure M44.7 cartridge. Price: £38-47 (including VAT).

### ■ YAMAHA

Natural Sound Systems Ltd, Strathcona Road,  
North Wembley, HA9 8QL. Tel: 01-904 0141.

#### YP-700 ★

Plinth mounted motor unit with pickup arm, cartridge and tinted hinged dust cover. Speeds: 33½, 45rpm. W and F: <0.05%. Rumble: 58dB. Speed constancy: 0.05%. 12in diecast aluminium turntable. Belt drive. 16-pole outer rotor motor (110 and 240V AC). 9in pickup arm with tracking weight, bias compensation adjustments, and lateral balance weight. Auto-return of pickup arm. Dual hydraulic cueing device. Built-in stylus protractor. Yamaha CG-7000 cartridge. Price: £118-88 (plus VAT).



# ACOS FOR SOUND ENJOYMENT

**Magnificent Martin Speakers**  
These stylish, popular Hi-Fi speakers are available with an attractive wrap around grille and a performance range to suit any system. Brilliance controls are provided which help to fit them into any setting.

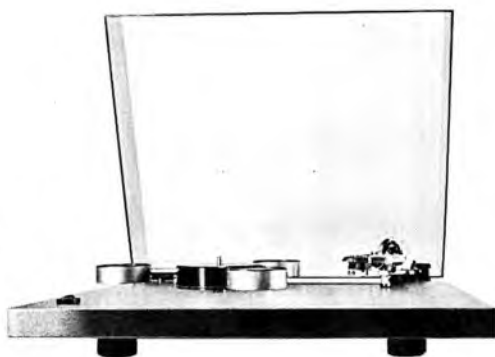

The Acos M6 Range of Magnetic Cartridges are acknowledged to give high performance at low cost for two channel and four channel stereo.



**Acos Rega Record Deck**  
Elegant, modern styling with first-class performance.



**Acos Eleanor Range** of two channel and four channel stereo tuner amplifiers provide a new concept of sound enjoyment in any home setting.

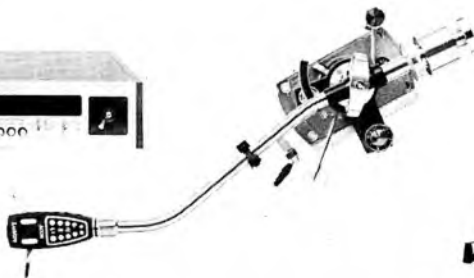

**Acos Lustre Tone Arm**  
Proven quality tone arm for the enthusiast incorporating 'dial-a-magnet' anti-skating.

**Record and Tape Care Accessories**  
Use Acos care accessories for your sound enjoyment.



Cosmocord Ltd, Eleanor Cross Rd, Waltham Cross, Hertfordshire EN6 7HX  
Telephone: Waltham Cross 27331 Telex 24294

Please send me full details of

\_\_\_\_\_  
\_\_\_\_\_  
\_\_\_\_\_



NAME

ADDRESS

\_\_\_\_\_  
\_\_\_\_\_  
\_\_\_\_\_

# Speaker Accessories

★ Indicates entry is illustrated

Abbreviations used in this section are given on page 20.

## ■ RICHARD ALLAN

Richard Allan Radio Ltd, Bradford Road, Gomersal, Cleckheaton, Yorks, BD19 4AZ.

Tel: Cleckheaton (097 62) 2442.

Cables: Acoustics, Bradford.

### CN54 Crossover Unit

Two-way quarter section. Recommended for use with CR5 bass unit and CB4 tweeter. Crossover frequency 5kHz. Impedance: 8 or 15 ohms. Price: (twin) £2.40; (triple) £2.50. All plus VAT.

### CN104 Crossover Unit

A two-way half-section parallel network. Crossover frequency: 5kHz. Impedance: 8 or 15 ohms. Price: £3.55 (plus VAT).

### CN1284 Crossover Unit

A three-way crossover with main crossover operating from half-wave parallel network and subsidiary crossover capacity fed. Crossover frequencies: 1100Hz and 5kHz. Impedance: 8 or 15 ohms. Price: £5.40 (plus VAT).

### CN1220 Crossover Unit

Three-way half-section. Crossover frequencies: 700Hz and 7000Hz. Price: £9 (plus VAT).

## ■ AUDIO PACKS

Audio Packs Ltd, 206-210 Ilderton Road, London, SE15 1NS. Tel: 01-639 7844.

### Sound selector units ★

A range of five units for routing signals to phones, speakers and amplifiers. Four of the units provide for the selection of up to three pairs of stereo headphones or up to three pairs of speakers.

The fifth unit, model HZ793, provides facilities for connecting any three signal sources to any three amplifiers. Particularly suitable for demonstration purposes in showrooms and for comparative tests. Price: on request.

See also entry in Pickup Accessories Section and Tape Recorder Accessories Section.

## ■ CELESTION

Rola-Celestion Ltd, Ditton Works, Foxhall Road, Ipswich, Suffolk, IP3 8JP.

Tel: Ipswich (0473) 73131.

## CO3K crossover

Designed specially for use with Studio 12 and HF1300 Mk 2 units but equally suitable for use with any efficient bass and treble combination. Air-tight terminal assembly with flange mounting. Full half-section filter network. 12dB per octave cut-off at 3kHz. Size: 3 $\frac{3}{4}$ in long, 2 $\frac{3}{4}$ in diameter of body, 3 $\frac{3}{4}$ in diameter of flange. Price: £4.47 (plus VAT).

## ■ DECCA

Decca Special Products, Ingate Place, Queenstown Road, London, SW8 3NT. Tel: 01-622 6677.

### Acoustic Lens

Device for obtaining optimum dispersion of the higher audio frequencies produced by the Decca Mk II ribbon speaker or the Decca DK30 ribbon speaker. Price: £3.30 (including VAT).

### CO/1/8 Crossover

Crossover network specially designed for use with the DK30 ribbon speaker. Ferrite cored inductors and close tolerance capacitors. Low-pass section is constant 12dB/octave, high-pass section is variable slope multi-stage network of novel design. Price: £4.84 (including VAT).

### CO/1000/8

Crossover network designed for use with London ribbon speaker. Mounted on printed circuit board. Close tolerance carbon polyester capacitors and inductors. Low-pass section is standard constant-impedance 6dB/octave filter, high-pass section attenuates at 12dB/octave. Crossover frequency: 1kHz. Negligible inter-modulation distortion. Price: £6.93 (including VAT).

## ■ EAGLE

Eagle International, Heather Park Drive, Wembley, HA0 1SU. Tel: 01-903 0144.

### CN.23, CN.28 and CN.216

Two-way speaker cross-over networks. Crossover frequency 3kHz. CN.23, 3 ohms; CN.28, 8 ohms; CN.216, 16 ohms. Price: £1.38 (including VAT).

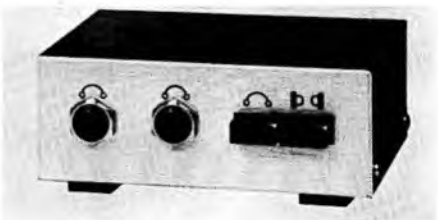

Audio Pack Sound Selector Unit 790—front view

★ Indicates entry is illustrated

### LS.2W

Stereo headphone control unit with provision for two sets of phones A and B channel switching. Price: £5.06 (including VAT).

### JB3

Stereo headphone and speaker switching and attenuation unit. Jack socket for phones. Switch permits phones only, speakers only, or both together. Moulded case with provision for screwing down. Price: £2.09 (including VAT)

### JB3D

Similar specification to the JB3 but fitted with two-pin DIN amplifier plugs. Price: £2.31 (including VAT).

### SN75 ★

Two-way speaker network. LC crossover plus adjustable high frequency control to determine tweeter loading. Spring-loaded terminals for speaker connections. Impedance: 8 ohms. Crossover: 3kHz. Price: £4.18 (including VAT).

### FF30

Three-way speaker network. Comprehensive LC network to split up bass, middle and HF ranges. Mid-range and HF channels incorporate variable attenuators. Spring-loaded colour-coded speaker terminals. Impedance: 8 ohms. Crossover: 1kHz and 5kHz. Price: £7.48 (including VAT).

### FF17 ★

Stereo headphone/speaker control centre. Fitted with two stereo headphone jack sockets. Slide switch for selecting speakers or phones. Four slider volume controls adjust levels in both channels on both headphones. Input: suitable for any amplifier up to 50W output. Output: (headphones) 50mV per channel. Size:  $5\frac{1}{8} \times 2\frac{1}{4} \times 3\frac{3}{8}$  in. Price: £8.80 (including VAT).

### FF5

Three-way crossover network. Frequencies: 1kHz and 5kHz. Impedance: 8 ohms, suitable for systems up to 25W RMS. Price: £3.63 (including VAT).

### AA44

Universal loudspeaker stand. Plated metal stand complete with template and fixing screws. Height: 12in, platform 5in, base extension  $9\frac{3}{4}$  in. Price: £8.80 (including VAT).

## ■ FALCON ELECTRONICS

Components Division,  
33 Station Road, Bexhill-on-Sea, Sussex.  
Tel: Bexhill (0424) 211908.

Inductors and capacitors for crossover networks, BAF wadding for inside enclosures, acoustically transparent micro-porous foam and 'L' pad attenuators.

### Inductors

Wound with self-fluxing, self-bonding wire on



Eagle FF17



Eagle SN75

high permeability ferrite cores. Low values 1in long, large values 2in long. 25 standard values from 0.2mH to 10mH. Special sizes to order. Average DC resistance: 0.25mH 0.25 ohms, 1.8mH 0.8 ohms, 10mH 1.6 ohms. Air cored, high power ferrite, and special tolerances to order. Price list on request.

### Capacitors

Plastic cased, fully sealed, non-polarised electrolytics. 18 values from  $2\mu\text{F}$  to  $100\mu\text{F}$ . Size range:  $2\mu\text{F}$   $\frac{3}{8} \times \frac{1}{4}$  in,  $100\mu\text{F}$   $1\frac{1}{2} \times \frac{3}{8}$  in. Polyester: values from  $0.47\mu\text{F}$  to  $3.3\mu\text{F}$ . Price list on request.

### Resistors

Range of 5 watt and 10 watt wire wound in values from 1 ohm to 100 ohms.

### General Accessories

Input panels, plugs and sockets, matrix boards, crossover printed circuit boards, etc.

### BAF Wadding

In rolls 24in wide and 1in nominal thickness. Cut in multiples of one foot. Price: 53p per linear yard. Enclosures should be lined so that one quarter of the distance between two opposite faces is filled with wadding.

**Long fibre wool**

As per the original specification of Dr Bailey for use in transmission lines, etc.

**Acoustic foam**

Dark grey/black. Thicknesses:  $\frac{1}{8}$ in fine pore,  $\frac{3}{16}$ in medium pore,  $\frac{1}{4}$ in large pore. Prices on request. Negligible attenuation. Any size cut (charged to nearest  $\frac{1}{2}$  sq ft above). Sheet size approximately 7×4ft.

**Attenuators**

'L' pad 8 ohm constant impedance attenuators. Gives change in level without affecting response shape. For use with mid-range and HF units. Supplied complete with knob and recessed flange. Price list on request.

**Potentiometers**

50-ohm wirewound. 2-3W rating. Suitable for attenuating tweeters in systems up to 15W. Price list on request.

**Speaker matching transformers**

15W auto transformers matching 4-8-16 ohms any way. Power response: 30Hz-20kHz. Price list on request.

**Grille fabrics**

Stock range of 10 selected from Danish Silks for whom we are agents in the United Kingdom. These fabrics are of modern appearance and have excellent acoustic transparency. Used by many loudspeaker manufacturers in the U.K. and Europe. Prices and samples, please send 5p stamp. Full price list of Falcon Electronics components available on request with 3½p stamp.

**■ FANE ACOUSTICS LTD**

Hick Lane, Batley, Yorks. Tel: Batley 6431.

Manufacturers of hi-fi and heavy-duty speaker drive units in all sizes and types. Also a range of speaker accessories and crossovers. No product information obtainable as this edition of the Year Book closed for press.

**■ GOODMANS**

Goodmans Loudspeakers Ltd, Downley Road, Havant, Hampshire, PO9 2NL. Tel: Havant (070 12) 6344. Telex: 86296.

**XO/950 Crossover Unit**

A two-way half-section, crossover network, operating at 950Hz. All terminations 15 ohms. Price: £7.77 (plus VAT).

**Attenuator**

12dB, eight steps. Price: £3.73 (plus VAT).

**ARU.172**

For use with 12in range. Price: £4.50 (plus VAT).

**■ HACKER**

Hacker Radio Ltd, Norreys Drive, Cox Green, Maidenhead, Berks, SL6 4BP. Tel: Maidenhead (0628) 22261.



Howland-West Headphone control Mk III



Howland-West Multi-control Mk II

**ST550/ST1100/ST1300 Stands**

Stands for Hacker loudspeakers finished in teak and raise speakers 8in from floor. Price: (ST550) £3.90 (including VAT); (ST1100) £4.10 (including VAT); (ST1300) to be announced.

**■ HOWLAND-WEST LTD**

3-5 Eden Grove, London, N7 8EQ. Tel: 01-609 0293.

**Headphone control Mk III ★**

For operating two sets of stereo headphones simultaneously from the same source. Independent volume controls for each earpiece (four in all). On/off switch and jack sockets on front panel. Amplifier and speaker connections to colour coded terminals at rear. Teak finish. Size: 6×2 $\frac{7}{8}$ ×3 $\frac{1}{8}$ in. Weight: 18oz. Price: £7.81 (including VAT).

**Tri-channel control**

For use with three sets of speakers. Switch allows each pair of speakers to be selected independently, or all together. In the position where all three sets of speakers are on, the Tri-channel control permits the volume of each speaker to be adjusted independently. Finish: teak. Size: 12×3 $\frac{1}{4}$ ×3 $\frac{1}{4}$ in. Weight: 34oz. Price: £11.82 (including VAT).

**Multi-control Mk II ★**

Versatile control unit which caters for almost all domestic listening requirements. Two pairs of stereo speakers may be connected, or one stereo pair and two independent single speakers. Independent volume controls on all four speakers. Two stereo phone sockets are fitted and when switched into circuit, speakers are muted. Finish: teak. Size: 12×3 $\frac{1}{4}$ ×3 $\frac{1}{8}$ in. Weight: 34oz. Price: £10.72 (including VAT).

★ Indicates entry is illustrated

### Remote Control ★

Supplied with 5m of cable. Enables volume of speakers to be controlled individually at this distance from the amplifier. Will also accept headphones which are also individually controlled. Ideal for balancing speakers from central position between speakers. Price: £7.42 (including VAT).

### ■ KEF

KEF Electronics Ltd, Tovil, Maidstone, Kent, ME15 6QP. Tel: Maidstone (0622) 57258. Cables: KEF, Maidstone.

### Crossover networks

DN8 (SP6305) combines B139 and T15. Price: £2. DN12 (SP1004) combines B139, B110 and T27. Price: £5. DN13 (SP1017) combines B110 and T27. Price: £2.50. DN13 (SP1015) combines B200 and T27. Price: £3. All prices shown exclude VAT which must be added.

### 104F Loudspeaker stand

Developed for the KEF Reference Series Model 104 and will locate loudspeaker at the optimum height for domestic listening. Stand is finished in black epoxy and conceals speaker cable within main support. Rubber pads on platform, heel and toes, prevent movement and scratching. Price: on application.

See Constructional Kits section for details of KEF crossover inductors, capacitors, terminals and BAF wadding.

### ■ KOSS

Tape-Music Distributors Ltd, 114 Ashley Road, St Albans, Herts, AL1 5JR. Tel: St Albans (56) 64337. Telex: 28474.

### T10A ★

Chairside listening station. Comprises control box with separate volume controls for two sets of stereo headphones, plus on/off switch for speakers. Wires directly into amplifier. Seven-core flat connecting cable suitable for under-carpet installation. Tinted plastic cover. Price: £11.50 (plus VAT).

### T3

Speaker/headphone switchbox. Incorporates jack socket for stereo headphones, connections for speakers and terminals for connection to stereo amplifier. Switch selects speakers on or off. Price: £4 (plus VAT).

### T-5D

Remote control station suitable for running two pairs of stereo headphones. Speaker on/off switch incorporated, but headphones are always on. The volume of headphones plugged into left-hand jack individually controlled (other set of headphones controlled by volume knob on amplifier). Fitted DIN sockets for amplifier and speaker connections. Matches any amplifier



Howland-West Remote control



Koss Accessories T10A and T4A

with 4, 8 or 16 ohm output. Finish: black with simulated walnut top. Connecting cable seven-core colour-coded 3ft long. Size:  $3\frac{1}{8} \times 3\frac{1}{8} \times 2\frac{5}{8}$  in. Weight: 10½ oz. Price: £8.50 (plus VAT).

See Headphone Section for details of full range of Koss headphones and accessories.

### ■ MAC

Modular Audio Components Ltd, Canterbury Road, Nottingham, NG8 1PQ. Tel: Nottingham (0602) 862647.

### AAU-2

Audio adaptor unit for connecting stereo headphones, plus two pairs of speakers. 3-way switching provides various combinations. Provision for fitting attenuator resistors internally. 4ft connecting cable to amplifier. Size:  $3 \times 3 \times 3$  in. Finish: jaguar silver. Price: £4.84 (plus VAT).

### AAU-2S

Audio adaptor unit. Connects two pairs of speakers to either of two amplifiers selected by toggle switch. 3-way switching gives combination of speakers. Two 4ft connecting cables.

Size: 3 × 3 × 3in. January silver finish. Price: £6.07 (plus VAT).

#### AAU-2X

De-luxe version of AAU-2 housed in solid teak case with pre-set gain controls for earpiece, plus resistive matching networks. Price: £7.57 (plus VAT).

#### AAU-VC

Audio adaptor unit for attenuating extension speakers. Attenuation: total -20dB in 2dB steps. Off position. Headphone jack. 20W per channel. FR: 20Hz-20kHz ± 2dB. Channel balance within 0.1dB. Separation: -85dB. Negligible damping loss. Teak case. Size: 3½ × 3½ × 3½in. Mono and stereo versions available. Prices on application.

Various other combinations of audio adaptor units are offered covering connecting and switching TV sound, headphones, etc. Full details on request.

All MAC AAU units are available in solid teak case at an additional cost of £1.50 (plus VAT).

#### ■ MICRO

Howland-West Ltd, 3-5 Eden Grove, London, N7 8EQ. Tel: 01-609 0293.

#### MSB-1

Micro shock absorber. Microsorber employs air damped high efficiency materials to eliminate acoustic feedback from speaker enclosures to record playing deck (fitted under record deck). Adjustable for height to equalise for unbalanced weight of turntable. Price: (set of four) £4.95 (plus VAT).

#### ■ QAS

Quality Audio Supplies, Wollaton Road, Beeston, Nottingham, NG9 2PB. Tel: Nottingham (0602) 252222 and 256141.

Wide range of audio accessories including phono plugs, DIN plugs and sockets, 4mm and wander plugs, couplers, screw terminals, slider switches, connecting leads with all types of terminations, audio switching units, record cleaner and remote control stations. All items individually blister-packed for over-the-counter or self-service sales.

#### Audio Switch

For use with two sets of stereo speakers and two sets of headphones. Pushbuttons provide any combination of speakers and phones. Headphones attenuated by 100 ohms. Connections by DIN and jack sockets. Size: 5½ × 1¼ × 2¾in. Finish: brushed aluminium. Price: £7.43 (including VAT).

#### De Luxe Audio Switch

Provides for two sets of headphones and two

sets of stereo speakers. Pushbutton switches permit any combination to be used. Monitor socket for adjusting level of remote speakers. Level controls for left and right channels. Headphones attenuated at 100 ohms. Wirewound potentiometers handle up to 35W. Size: 7½ × 1½ × 2¾in. Finish: brushed aluminium. Fixing brackets provided. Price: £9.63 (including VAT).

#### Phone Switch

Designed to cater for two sets of stereo headphones and one set of speakers. Pushbutton switches provide any combination. Headphones attenuated by 100 ohms. Connections by DIN and jack sockets. Size: 5½ × 1¼ × 2¾in. Finish: brushed aluminium. Fixing brackets included. Price: £4.75 (plus VAT).

#### Input Selector

Designed to permit hi-fi enthusiasts to switch instantly between three different inputs and three different amplifiers. Also suitable for retailers carrying out demonstrations. Units can be stacked or lined up. DIN connections and pushbutton switches. Size: 5½ × 1¼ × 2¾in. Finish: brushed aluminium. Fixing brackets included. Price: £7.43 (including VAT).

#### Output Selector

For connecting three sets of stereo speakers from one source. Suitable for retailers showrooms for comparison of speakers. Also for supplying three sets of speakers in different rooms in the home. Units can be stacked to provide additional facilities. Pushbutton switches. Size: 5½ × 1¼ × 2¾in. Finish: brushed aluminium. Fixing brackets included. Price: £7.43 (including VAT).

#### ■ RADFORD

Radford Acoustics Ltd, Ashton Vale Road, Bristol, BS3 2HZ. Tel: Bristol (0272) 662301.

#### FN11

Three-way 17-element crossover network. Impedance: 8 ohms in four types to match various drive unit combinations. HC: 100W. FR: 25Hz-25kHz. Crossover frequencies: 500Hz and 4.2 kHz. Price: £9.50 (plus VAT).

#### ■ ROLA-CELESTION

See Celestion.

#### ■ STENTORIAN

Whiteley Electrical Radio Co Ltd, Radio Works, Victoria Street, Mansfield, Notts, NG18 5RW. Tel: Mansfield (0623) 24762.

#### CX500 Crossover unit

A two-way quarter-section crossover network operating at 500Hz. All terminations 15 ohms. Price: £2.71 (plus VAT).

★ Indicates entry is illustrated

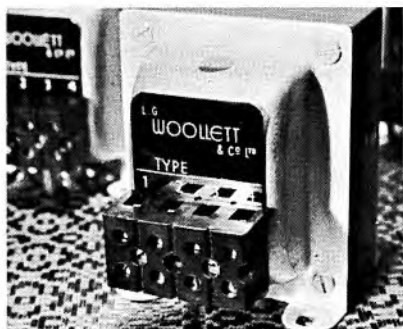

Woollett XSI and XS2

**CX1000 Crossover unit**

Half-section operating at 1kHz. Price: £3.93 (plus VAT).

**CX1500 Crossover unit**

Half-section operating at 1.5kHz. Price: £3.93 (plus VAT).

**CX3000 Crossover unit**

Half-section operating at 3kHz. Price: £3.10 (plus VAT).

**Constant impedance volume control**

T-pad type attenuator having 10 steps of attenuation. Impedance presented by the load remains constant while the volume level is varied. In three versions for 3, 8 or 15 ohms. Price: £2.16 (plus VAT).

■ **TELEFI**

Rola-Celestion Ltd, Ditton Works, Foxhall Road, Ipswich, Suffolk, IP3 8PJ. Tel: Ipswich (0473) 73131.

Sound take-off adaptor for feeding hi-fi from TV. See Tape Recorder Accessories and Radio Tuner Sections.

■ **TTC**

TTC Division, Precision Centre, Heather Park Drive, Wembley, HA0 1SU. Tel: 01-903 0144.

**K4009**

Three-way speaker crossover network. Frequencies: 1kHz and 5kHz. Impedance: 8 ohms. Price: £3.63 (including VAT).

**K4006/K4007/K4008**

Two-way speaker crossovers. Frequency: 3kHz. Impedance: (K4006) 3 ohms, (K4007) 8 ohms, (K4008) 16 ohms. Price: £1.32 (including VAT).

**TK4025**

Panel mounting 3-way crossover. Frequencies: 600Hz and 2.5kHz. High range control. Impedance: 8 ohms. Size:  $6\frac{1}{2} \times 4\frac{3}{4} \times 3$ in. Price: £9.35 (including VAT).

**TK4015**

Panel mounting 2-way crossover. Frequency: 3kHz with high range control. Size:  $6\frac{1}{2} \times 4\frac{3}{4} \times 3$ in. Impedance: 8 ohms. Price: £8.25 (including VAT).

**H1012**

Stereophone junction box connecting to speaker outputs of amplifier. Switchable to speaker, headphone or both. Jack socket for phones. Price: £1.98 (including VAT).

**G1301**

Stereophone junction box. Connects to amplifier speaker socket. Provides output for two stereo headphones, speakers. Switch, speaker/phones. Volume controls for each channel. Price: £3.96 (including VAT).

■ **VITAVOX**

Westmoreland Road, London, NW9 9RJ. Tel: 01-204 4234. Cables: Vitavox, London.

**CN458 Crossover**

Half-section. Crossover: 500Hz. Attenuation: 12dB/octave. Insertion loss 0.9dB. Power handling capacity: 100W RMS. All terminations 15 ohms. Balance control giving 0-8dB HF attenuation incorporated. Price on application.

**CN459 Crossover**

Half-section. Crossover: 1kHz. Attenuation: 12dB/octave. Insertion loss 0.9dB. Power handling capacity: 100W RMS. All terminations 15 ohms. Balance control giving 0-8dB HF attenuation incorporated. Price: on application.

■ **WHITELEY ELECTRICAL RADIO**

See Stentorian.

■ **WOOLLETT AUDIOSTATICS**

21 Anerley Station Road, London, SE20 8PY. Tel: 01-778 9003.

**XS1 ★**

Speaker matching transformer. Converts 16 ohms to 8 ohms, and 8 ohms to 4 ohms. Bifilar wound. Grain orientated laminations. Ratio 1:0.707 auto. FR: 16Hz-30kHz  $\pm 0.6$ dB. Price: £3.87 (plus VAT).

**XS2 ★**

Speaker isolating and matching transformer. Converts 16 ohms to 4 ohms. Bifilar wound. Grain orientated laminations. Ratio 1:1 double wound. FR: 16Hz-100kHz  $\pm 0.6$ dB. May be used to attenuate -6dB and -12dB while maintaining heavy damping on speaker and offering correct load to amplifier. Suitable for operating stereo system comprising two electrostatic high-frequency units with common bass speaker. *Note:* Not suitable for mains isolation in live chassis equipment. Price: £3.87 (plus VAT).

# TANNOY

# THE OUTSTANDING NEW

*Monitor*

## HIGH PERFORMANCE DUAL

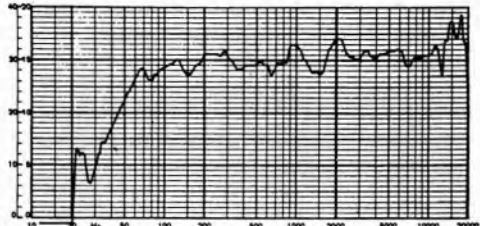

TYPICAL RESPONSE 260 mm HIGH PERFORMANCE DUAL (10")

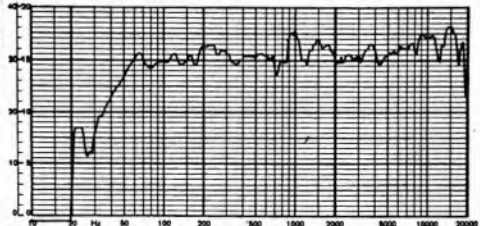

TYPICAL RESPONSE 310 mm HIGH PERFORMANCE DUAL (12")

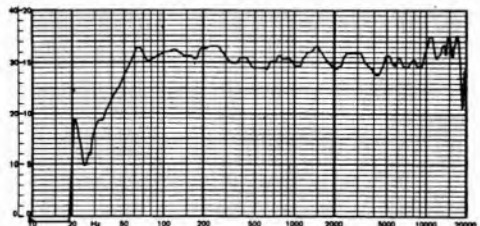

TYPICAL RESPONSE 410 mm HIGH PERFORMANCE DUAL (15")

HIGH POWER  
GIRDAACOUSTIC CONE WITH HIGH TEMPERATURE  
VOICE COIL AND TANOPLAS SURROUND

- \* INCREASED POWER HANDLING CAPACITY
- \* HIGH TEMPERATURE VOICE COILS
- \* GIRDAACOUSTIC CONE FOR SMOOTHER RESPONSE (310 mm and 410 mm models only)
- \* TANOPLAS SURROUND FOR HIGH STABILITY AND LOW BASS RESONANCE
- \* IMPROVED AND UP-RATED CROSS-OVER NETWORK

	260 mm 10"	310 mm 12"	410 mm 15"
Power Handling Capacity*	50W	60W	85W
Frequency Response	27-20,000 HZ	25-20,000 HZ	23-20,000 HZ
Intermodulation Products	less than 2%	less than 2%	less than 2%
Impedance via Crossover network	8 ohms (5 ohms min.)	8 ohms (5 ohms min.)	8 ohms (5 ohms min.)

\* INTEGRATED PROGRAMME MATERIAL

ALL SPECIFICATIONS SUBJECT TO ALTERATION WITHOUT NOTICE



NORWOOD RD. WEST NORWOOD. SE 27.  
01-670 1131



# ATC

Acoustic Transducer Co. Ltd.  
(Acoustic engineers)

for the ultimate  
high quality,  
high power  
loud-speaker  
drive units

14 Ashley Gardens  
Petersham  
Richmond-Upon-Thames  
Great Britain

# Speaker Drive Units

★ Indicates entry is illustrated

Abbreviations used in this section are given on page 20.

## ■ ADASTRA

Adastra Electronics Ltd,  
Unit N22, Cricklewood Trading Estate,  
Claremont Road, London, NW2 1TU.  
Tel: 01-452 6288.

### Peak 100

Heavy-duty full-range speaker unit. 1.5in nominal diameter. Fibre cone. Voice coil diameter: 2in. Voice coil material: aluminium. Impedances: 8 or 16 ohms. Gap flux: 15,000 gauss. HC: 50W RMS (peak 100W). FR: 20Hz-15kHz. Ceramic magnet. Price: £25.15 (including VAT).

## ■ RICHARD ALLAN

Richard Allan Radio Ltd, Bradford Road,  
Gomersal, Cleckheaton, Yorks, BD19 4AZ.  
Tel: Cleckheaton 2442.  
Cables: Acoustics, Bradford.

### CB4

4in tweeter. Paper cone. Doped cambric surround. Ceramic magnet. Voice coil  $\frac{3}{8}$ in. Gap flux 8000 gauss. Total flux 12,000 maxwells. HC: in systems up to 25W. vci: 8 or 15 ohms. FR: 2kHz-17kHz. rcf: 5kHz. Price: £2.40 (plus VAT).

### DT20

20mm dome tweeter. Low mass, plastic foil dome. Ceramic magnet. Voice coil 20mm. Gap flux 12,000 gauss. Total flux 24,500 maxwells. HC: in systems up to 35W. vci: 8 or 15 ohms. FR: 5kHz-25kHz. rcf: 7kHz. Price: £5.60 (plus VAT).

### CF5

5in mid-range unit. Coated paper cone with PVC surround. Ceramic magnet. Voice coil 1in. Gap flux: 8000 gauss. Total flux: 32,000 maxwells. HC: in systems up to 30W. FR: 250Hz-15kHz. vci: 8 or 15 ohms. Price: £3.75 (plus VAT).

### CB5

5in mid-range unit. Coated paper cone with PVC surround. Ceramic magnet. Voice coil 1in. Gap flux: 12,000 gauss. Total flux: 48,000 maxwells. HC: in systems up to 30W. FR: 250Hz-15kHz. vci: 8 or 15 ohms. Price: £4.50 (plus VAT).

### CR5

5in bass/mid-range unit. Paper cone with PVC surround. Ceramic magnet. Voice coil 1in. Gap flux: 14,000 gauss. Total flux: 56,000 maxwells. HC: 10W. vci: 8 or 15 ohms. FR: 30Hz-8kHz. Specially designed for use in small volume infinite baffle enclosure. Price: £5.60 (plus VAT).

### CP8

8in mid-range unit. Paper cone. Doped cambric surround. Ceramic magnet. Voice coil: 1in. Gap flux: 10,000 gauss. Total flux: 40,000 maxwells. HC: 8W. vci: 8 or 15 ohms. FR: 100Hz-12kHz. Price: £3.75 (plus VAT).

### CB8

8in paper cone. Doped cambric surround. Ceramic magnet. Voice coil: 1in. Gap flux: 12,000 gauss. Total flux: 48,000 maxwells. HC: 10W. vci: 8 or 15 ohms. FR: 45Hz-10kHz. Price: £4.50 (plus VAT).

### CB8T

8in paper cone plus tweeter inner. Doped cambric surround. Ceramic magnet. Voice coil: 1in. Gap flux: 12,000 gauss. Total flux: 48,000 maxwells. HC: 10W. vci: 8 or 15 ohms. FR: 45Hz-17kHz. Price: £4.80 (plus VAT).

### CBF8

8in bass/mid-range unit. Paper cone. Moulded polyurethane surround. Ceramic magnet. Voice coil: 1in. Gap flux: 12,000 gauss. Total flux: 48,000 maxwells. HC: 12W. vci: 8 or 15 ohms. FR: 40Hz-10kHz. Price: £4.80 (plus VAT).

### CG8

8in paper cone. Doped cambric surround. Ceramic magnet. Voice coil: 1in. Gap flux: 14,000 gauss. Total flux: 56,000 maxwells. HC: 15W. vci: 8 or 15 ohms. FR: 45Hz-10kHz. Price: £6.45 (plus VAT).

### CG8T

8in paper cone with tweeter inner. Doped cambric surround. Ceramic magnet. Voice coil: 1in. Gap flux: 14,000 gauss. Total flux: 56,000 maxwells. HC: 15W. vci: 8 or 15 ohms. FR: 45Hz-17kHz. Price: £6.75 (plus VAT).

### CF8L

8in bass unit. Coated paper cone. Moulded polyurethane surround. Ceramic magnet. Resonance 25Hz. Voice coil: 1in. Gap flux: 14,000 gauss. Total flux: 56,000 maxwells. HC: 15W. vci: 8 or 15 ohms. FR: 35Hz-2.5kHz. Price: £6.45 (plus VAT).

### CG10

10in paper cone. Doped cambric surround. Ceramic magnet. Voice coil: 1½in. Gap flux: 14,000 gauss. Total flux: 105,000 maxwells. HC: 20W. vci: 8 or 15 ohms. FR: 35Hz-10kHz. Price: £9.75 (plus VAT).

### CG10T

10in paper cone with tweeter inner. Doped cam-

★ Indicates entry is illustrated



Baker 12in Major



Baker Superb Twelve

bric surround. Ceramic magnet. Voice coil: 1½ in. Gap flux: 14,000 gauss. Total flux: 105,000 maxwells. HC: 20W. vci: 8 or 15 ohms. FR: 35Hz-15kHz. Price: £10 (plus VAT).

#### CG12

12in paper cone. Doped cambric surround. Ceramic magnet. Voice coil: 1½ in. Gap flux: 14,000 gauss. Total flux: 105,000 maxwells. HC: 20W. vci: 8 or 15 ohms. FR: 25Hz-9kHz. Price: £11.25 (plus VAT).

#### CG12I

12in paper cone with tweeter inner. Doped cambric surround. Ceramic magnet. Voice coil: 1½ in. Gap flux: 14,000 gauss. Total flux: 105,000 maxwells. HC: 20W. vci: 8 or 15 ohms. FR: 25Hz-15kHz. Price: £11.50 (plus VAT).

#### CG12 Super

12in paper cone. Doped cambric surround. Ceramic magnet. Voice coil: 2in. Gap flux: 14,000 gauss. Total flux: 186,000 maxwells. HC: 25W. vci: 8 or 15 ohms. FR: 25Hz-5kHz. Price: £14.75 (plus VAT).

#### CG15

15in paper cone. Doped cambric surround. Ceramic magnet. Voice coil: 2in. Gap flux: 17,000 gauss. Total flux: 220,000 maxwells. HC: 25W. vci: 8 or 15 ohms. FR: 20Hz-5kHz. Price: £24 (plus VAT).

Richard Allan full-range speaker modules are included in Speaker Enclosure section. Twin



Celestion PS8TC

Assembly, Triple-8 Assembly, Triple-12 Assembly and Super-12 Assembly speaker kits are in the Constructional Kits section.

### ■ BAKER LOUDSPEAKER COMPANY

Bensham Manor Road Passage, Thornton Heath, Surrey. Tel: 01-684 1665.

#### Regent

Full range 12in cone speaker. Paper cone with roll surround. Voice coil: 1½ in. Copper voice coil. vci: 3, 8 or 15 ohms. Gap flux: 12,000 gauss. HC: 15W RMS. FR: 45Hz-13kHz. Price: £9.50 (plus VAT).

#### Major ★

Full range 12in speaker with built-in tweeter cone. 14,000 gauss magnetic gap. FR: 40Hz-14.5kHz. HC: 20W RMS. vci: 3, 8 or 15 ohms. Cast aluminium chassis. Weight: 6lb. Price: £10.50 (plus VAT).

#### Deluxe Mk II

Full range 12in cone speaker. 15W RMS. Bass resonance: 30Hz. Gap flux: 14,000 gauss. Copper voice coil: 1½ in diameter. vci: 8 or 15 ohms. Paper cone with foam plastic surround. Built-in tweeter cone. FR: 25Hz-16kHz. Cast aluminium chassis. Depth: 6in. Weight: 6lb. Price: £12 (plus VAT).

#### Superb Twelve ★

Full range 12in speaker with built-in tweeter cone. Foam plastic surround. Coil diameter:

1½ in. vci: 8 or 15 ohms. Gap flux: 16,500 gauss. HC: 20W RMS. FR: 20Hz-17kHz. Bass resonance: 25Hz. Copper speech coil. Diecast aluminium chassis. Weight: 10lb. Price: £17 (plus VAT).

#### Auditorium 12

Full range 12in cone speaker suitable for bass unit multi-speaker system. HC: 25W RMS. Bass resonance: 35Hz. Gap flux: 15,000 gauss. Copper voice coil: 1½ in diameter. vci: 8 or 15 ohms. FR: 25Hz-16kHz. Paper cone with roll surround. Cast aluminium chassis. Depth: 7in. Weight: 10lb. Price: £16 (plus VAT).

#### Auditorium 15

High power 15in speaker suitable for bass unit in multi-speaker system. HC: 35W RMS. Bass resonance: 35Hz. Gap flux: 15,000 gauss. vci: 8 or 15 ohms. FR: 20Hz-14kHz. 2in diameter voice coil. 35W RMS. Depth: 8in. Weight: 15lb. Price: approximately £22 (plus VAT).

#### Group 25

12in cone speaker with heavy duty suspension for electronic music, guitars, etc. HC: 25WRMS. vci: 3, 8 or 15 ohms. Bass resonance: 55Hz. FR: 30Hz-13kHz. Gap flux: 12,000 gauss. Voice coil: 1½ in. Depth: 6in. Weight: 5lb. Price: approximately £9.50 (plus VAT).

#### Group 35

12in cone speaker with heavy duty suspension for electronic music, guitars, etc. HC: 35WRMS. vci: 3, 8 or 15 ohms. Bass resonance: 55Hz. FR: 55Hz-13kHz. Gap flux: 14,000 gauss. Voice coil: 1½ in. Depth: 6½ in. Weight: 6lb. Price: approximately £10.50 (plus VAT).

#### Group 50

15in cone speaker with heavy duty suspension for electronic music, guitars, etc. HC: 50WRMS. vci: 8 or 15 ohms. Bass resonance: 45Hz. FR: 30Hz-13kHz. Gap flux: 17,000 gauss. Voice coil: 2in. Depth: 8in. Weight: 15lb. Price: approximately £22 (plus VAT).

### ■ CELESTION

Rola-Celestion Ltd, Ditton Works,  
Foxhall Road, Ipswich, Suffolk, IP3 8JP.  
Tel: Ipswich (0473) 73131

#### HF1300 Mk 2

High frequency 3in tweeter. vci: 15 ohms at 10kHz. HC: 5W RMS. Suitable for use with systems up to 20W. FR: 2kHz-15kHz. Rec crossover: 3kHz. Styled with flange to give easy and accurate mounting. Phase correction plate for improved polar response. Self-aligning diaphragm. Contoured polepiece. Damped acoustic cavity to reduce fundamental diaphragm resonance. High flux magnet. Price: £7.14 (plus VAT).



Decca DK30 Ribbon

#### PS8TC ★

8in twin-cone unit. Designed for the home constructor. Impedance: 15 ohms. Resonance: 75Hz. 1in voice coil. Paper cone. Copper voice coil. Gap flux: 10,000 gauss. Total flux: 38,500 maxwells. HC: 6W. FR: 50Hz-12.5kHz. Price: £2.47 (plus VAT).

#### PS12TC

Full-range twin cone unit. 12in diameter. 1½ in voice coil. Impedance: 4-8 ohms or 15 ohms. Gap flux: 11,500 gauss. Total flux: 128,000 maxwells. HC: 20W RMS. FR: 30Hz-12kHz. Price: £10.50 (plus VAT).

#### G12M

Heavy duty 12in unit for electronic musical instruments. HC: 25W RMS. FR: 40Hz-8kHz. Impedance: 8 or 15 ohms. Price: £12.95 (plus VAT).

#### G12H

Heavy duty 12in unit for electronic musical instruments. HC: 30W RMS. FR: 40Hz-8kHz. Impedance: 8 or 15 ohms. Price: £15.75 (plus VAT).

#### G15C

Heavy duty 15in unit for electronic musical instruments. HC: 50W RMS. FR: 30Hz-8kHz. Impedance: 8 or 15 ohms. Price: £26 (plus VAT).

#### G18C

Heavy duty 18in unit for electronic musical instruments. HC: 100W RMS. FR: 25Hz-5kHz. Impedance: 8 or 15 ohms. Price: £34 (plus VAT).

### ■ DECCA

Decca Special Products,  
Ingate Place, Queenstown Road, London,  
SW8 3NT. Tel: 01-622 6677.

#### DK30 Ribbon ★

Horn-loaded high frequency ribbon speaker. Size: 6½ × 3½ × 2in. Aluminium ribbon element. Impedance: 8 ohms constant. HC: 30W maximum. FR: 2.5kHz-25kHz. rcf: 2.5kHz. Price: £17.32 (including VAT).

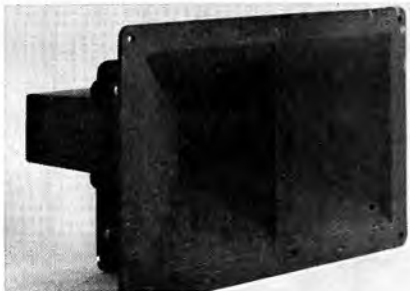

Decca London Ribbon Speaker

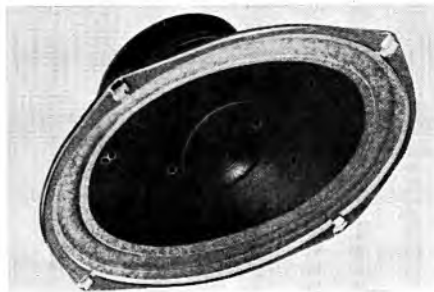

Eagle FF23



Eagle CT10 horn tweeter

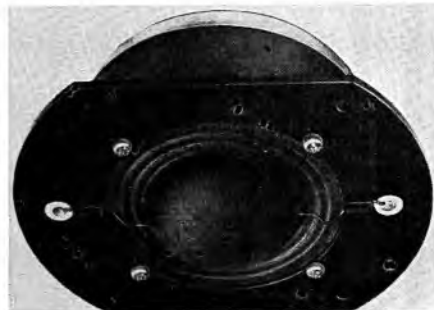

Eagle FF24

**London Ribbon ★**

Horn-loaded high frequency ribbon speaker. Size:  $9\frac{1}{2} \times 4\frac{1}{2} \times 7\frac{1}{2}$  in. Aluminium ribbon element. Impedance: 8 ohms constant. HC: 30W RMS maximum. FR: 1kHz-25kHz. Rec cross-over: 1kHz. Price: £27.50 (including VAT).

**Decca Acoustic lens**

Device for obtaining optimum dispersion of higher audio frequencies produced by Decca Mk II ribbon speaker or the Decca DK30 ribbon speaker. Price: £3.30 (including VAT).

**■ EAGLE**

Eagle International, Heather Park Drive, Wembley, HA0 1SU.  
Tel: 01-903 0144.

**CT5 Cone Tweeter**

Diameter 3in approximately. HC: 5W. Rec crossover 3kHz. Price: £1.76 (including VAT).

**CT10 Horn Tweeter ★**

$3\frac{1}{2}$  in aluminium cone and surround. Voice coil: 1in (aluminium). vci: 8 ohms or 16 ohms. HC: 10W. FR: 1.5-16kHz. rcf: 3kHz. Price: £2.86 (including VAT).

**FR4**

High-compliance full-range 4in unit. FR: 40 Hz-16kHz. Bass resonance 60-70Hz. HC: 5W RMS. Flux density: over 10,000 gauss. vci: 8

ohms. Baffle opening:  $3\frac{1}{2}$  in. Depth: 2in. Price: £6.16 (including VAT).

**FR65**

High-compliance full-range  $6\frac{1}{2}$  in unit. FR: 35Hz-17kHz. HC: 10W. Flux density: over 11,000 gauss. vci: 8 ohms. Baffle opening:  $5\frac{3}{8}$  in. Depth:  $2\frac{3}{4}$  in. Price: £8.25 (including VAT).

**FR8**

High-compliance full-range 8in unit. FR: 30 Hz-17kHz. Bass resonance 30-50Hz. HC: 15W RMS. Flux density: over 12,000 gauss. vci: 8 ohms. Baffle opening:  $6\frac{3}{8}$  in. Depth:  $3\frac{3}{8}$  in. Price: £11 (including VAT).

**FR10**

Dual concentric driver. Nominal cone diameter: 25.5cm and 2.5cm. Nominal impedance: 8 ohms. Gap flux: 12,000 gauss bass, 11,000 gauss tweeter. Paper cone bass, dome tweeter. Peak RMS capacity: 25W. FR: 25Hz-20kHz. Price: £13.20 (including VAT).

**HT15**

High Frequency horn unit. FR: 2kHz-18kHz. vci: 8 ohms. HC: 15W music. rcf: 3kHz. Flux density: 13,000 gauss. Baffle hole required  $2\frac{1}{8}$  in. Price: £4.40 (including VAT).

**HT21**

Horn tweeter using centre stabiliser to improve efficiency and loading. FR: 2.5-20kHz. Cross-over: 3kHz. Impedance: 8 ohms. Flux density:

14,000 gauss. HC: 20W. Price: £6.82 (including VAT).

**DT33**

Heavy duty horn tweeter. FR: 2-18kHz. Crossover: 3kHz. Impedance: 8 ohms. Flux density: 14,000 gauss. HC: 30W. Front mounted dome to give wide listening angle. Price: £6.27 (including VAT).

**FF23 ★**

Full-range elliptical speaker. 9 × 6in. Paper cone. Plastic surround. Copper voice coil. Impedance: 8 ohms. Total flux: 11,500 gauss. HC: 15W RMS. FR: 36Hz-16kHz. Price: £11 (including VAT).

**FF24 ★**

Dome mid-range unit. 2in diameter. Treated fabric dome. Fabric sprung surround. Aluminium voice coil. Impedance: 8 ohms. Total flux: 10,000 gauss. HC: 20W RMS. FR: 400Hz-9kHz. Crossover: 1kHz and 5kHz. Price: £11.55 (including VAT).

**FF25 ★**

Dome mid-range unit. 1½in diameter. Plastic dome. Aluminium voice coil. Impedance: 8 ohms. Total flux: 9200 gauss. HC: 30W RMS. FR: 700Hz-5kHz. Crossover: 1kHz and 5kHz. Price: £10.45 (including VAT).

**FF26**

Cone mid-range unit. 5½in diameter. Paper cone. Treated fabric surround. Aluminium voice coil. Impedance: 8 ohms. Total flux: 10,300 gauss. HC: 20W RMS. FR: 300Hz-5kHz. Crossover: 1kHz and 5kHz. Price: £7.70 (including VAT).

**FF27**

Dome tweeter. Aluminium voice coil. Nominal impedance: 8 ohms. Gap Flux: 10,000 gauss. Peak RMS capacity 5W FR 2kHz-20kHz. Recommended crossover: 3kHz. Price: £5.28 (including VAT).

**FF28 ★**

Horn tweeter. Plastic diaphragm. Aluminium voice coil. Impedance: 8 ohms. Total flux: 10,000 gauss. HC: 15W music. FR: 3kHz-20kHz. Crossover: 3kHz. Price: £9.02 (including VAT).

**AA12 ★**

Mid-range drive units. Nominal cone diameter 12.7cm. Paper cone fabric surround. Nominal impedance: 8 ohms. Gap Flux: 9,000 gauss. Peak RMS capacity: 15W. FR: 800Hz-8kHz. Recommended crossover: 1kHz and 5kHz. Price: £4.84 (including VAT).

**MHT10**

Horn tweeter. Nominal diameter: 5.2cm. Metal horn. Nominal impedance: 8 ohms. Gap flux: 13,000 gauss. Peak RMS capacity 4W. FR:

2kHz-18kHz. Recommended crossover: 3kHz. Price: £4.40 (including VAT).

■ **ELAC**

Electro Acoustic Industries Ltd, Stamford Works, Broad Lane, Tottenham, London, N15. Tel: 01-808 0505.

Manufacturers of hi-fi speaker units and enclo-

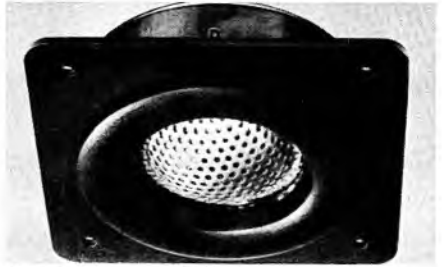

*Eagle FF25*

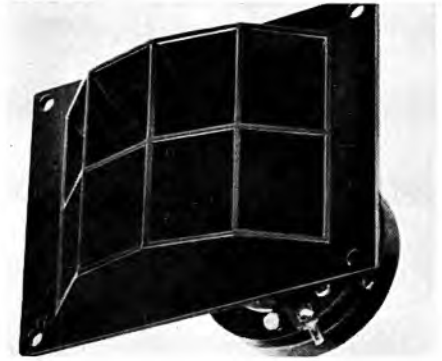

*Eagle FF28*



*Eagle AA12*



*Goodmans Twin Axiom 8*

tures. No product information or prices obtainable as this edition of the Year Book closed for press.

#### ■ ELECTRO-VOICE

Gulton Europe Ltd, Special Products Division, The Hyde, Brighton, Sussex, BN2 4JU. Tel: Brighton (0273) 66271.

#### **EVM158**

Bass driver. Nominal cone diameter: 38.13cm. Paper cone. Cloth surround. Voice coil diameter: 6.5cm. Nominal impedance: 8 ohms. Nominal RMS capacity: 100W. Resonance frequency: 40Hz. Price: £75.90 (including VAT).

#### **EVM15L**

Bass driver. Nominal cone diameter: 38.13cm. Paper cone. Cloth surround. Voice coil diameter: 6.35cm. Nominal impedance: 8 ohms. Nominal RMS capacity: 100W. Resonance frequency: 50Hz. Price: £75.90 (including VAT).

#### **EVM12L**

Bass driver. Nominal cone diameter: 30.95cm. Paper cone. Cloth surround. Voice coil diameter: 6.35cm. Nominal impedance: 8 ohms. Nominal RMS capacity: 100W. Resonance frequency: 50Hz. Price: £67.64 (including VAT).

#### **EMV18B**

Bass driver. Nominal cone diameter: 47.72cm. Paper cone. Cloth surround. Voice coil diameter: 6.35cm. Nominal impedance: 4 ohms. Nominal RMS capacity: 100W. Resonance frequency: 40Hz. Price: £87.45 (including VAT).

#### **12TRXB**

Full range integrated 3-way driver. Nominal cone diameter: 30.95cm. Paper cone. Cloth surround. Voice coil diameter: 6.35cm. Nominal impedance: 8 ohms. Peak RMS capacity: 60W FR: 35Hz-20kHz. Price: £68.75 (including VAT).

#### **SP12**

Full range unit. Nominal cone diameter:



*Goodmans Axent 100*

30.95cm. Paper cone. Cloth surround. Voice coil diameter: 6.35cm. Nominal impedance: 8 ohms. Peak RMS capacity: 80W. FR: 30Hz-15kHz. Price: £64.35 (including VAT).

#### **SP8B**

Full range unit. Nominal cone diameter: 20.3cm. Paper cone. Cloth surround. Voice coil diameter: 5cm. Nominal impedance: 8 ohms. Peak RMS capacity: 40W FR: 35Hz-15kHz. Price: £30.25 (including VAT).

#### **30W**

Bass driver. Nominal cone diameter: 76.26cm. Polystyrene cone. Cloth surround. Voice coil diameter: 6.35cm. Nominal impedance: 8 ohms. Nominal RMS capacity: 60W. Resonance frequency: 15Hz. Recommended crossover: 100Hz. Price: £211.20 (including VAT).

#### **T35**

VHF tweeter. Voice coil diameter: 2.6cm. Nominal impedance: 8 ohms. FR: 3.5kHz-20kHz. Recommended crossover: 3.5kHz. Price: £23.65 (including VAT).

#### **T350**

VHF tweeter. Voice coil diameter: 2.6cm. Nominal impedance: 8 ohms. FR: 3.5kHz-23kHz. Recommended crossover: 3.5kHz. Price: £51.15 (including VAT).

#### ■ EMI

EMI Sound & Vision, EMI Pathé Division, 252 Blyth Road, Hayes, Middlesex, UB3 1HW. Tel: 01-573 3888. Telex: 22417.

#### **Enthusiast's Range**

A comprehensive range of speaker chassis covering all requirements from bass drivers, through mid-range units to HF tweeters. Fully illustrated literature, specification data and prices on request.

#### ■ FANE ACOUSTICS LTD

Hick Lane, Batley, Yorks. Tel: Batley 6431.

Manufacturers of hi-fi and heavy duty speaker drive units in all sizes and types. Also a range of speaker accessories and crossovers. No product information obtainable as this edition of the Year Book closed for press.

## ■ GOODMANS

Goodmans Loudspeakers Ltd, Downley Road, Havant, Hants, PO9 2NL.  
Tel: Havant (070 12) 6344. Telex: 86296.

### Twin Axiom 8 ★

8in full-range twin-cone driver. Paper cone. Rubber surround. Voice coil: 1in diameter copper wound. Impedance: 8 or 15 ohms. Gap flux: 13,500 gauss. Total flux: 53,000 maxwells. HC: 15W (DIN). FR: 40Hz-18kHz. Price: £7-80 (plus VAT).

### Twin Axiom 10

Full-range 10in unit. Paper cone. Latex coated paper surround. Voice coil: 1in diameter (copper). Impedance: 8 or 15 ohms. Gap flux: 13,500 gauss. Total flux: 53,000 maxwells. HC: 10W RMS. FR: 40Hz-18kHz. Price: £8-61 (plus VAT).

### Axent 100 ★

Domed diaphragm high-frequency direct radiator with built-in filter network. Plastic cone. Voice coil: 1in diameter copper wound. Impedance: 8 ohms. HC: for use in systems rated at not more than 30W. FR: typically 2kHz-22kHz. Crossover: cut-off of 12dB/octave from 3kHz down. Price: £6-90 (plus VAT).

### Axiom 401

12in full-range twin-cone driver. Paper cone. Plastic surround. Voice coil: 1½in diameter copper wound. Impedance: 8 or 15 ohms. Gap flux: 15,500 gauss. Total flux: 179,000 maxwells. FR: 30Hz-11kHz. HC: 40W (DIN). Price: £17-68 (plus VAT).

### Audiom 100

12in bass driver. Paper cone. Plastic surround. Voice coil: 1½in diameter, copper wound. Impedance: 8 or 15 ohms. Gap flux: 10,000 gauss. Total flux: 80,000 maxwells. HC: 30W (DIN). FR: 35Hz-3kHz. Crossover: 3000Hz, recommended for use with Axent 100. Price: £12 (plus VAT).

### Audiom 8P

8in heavy duty. HC: 15W. Impedance: 8 or 15 ohms. Price: £4-70 (plus VAT).

### Audiom 10P

10in heavy duty. HC: 15W. Impedance: 8 or 15 ohms. Price: £5-11 (plus VAT).

### Audiom 12P

12in heavy duty. HC: 50W. Impedance: 8 or 15 ohms. Price: £13 (plus VAT).



Goodmans Audiomax 12AX

### Audiom 15P

15in heavy duty. HC: 50W. Impedance: 8 or 15 ohms. Price: £21 (plus VAT).

### Audiom 18P

18in. Voice coil diameter: 3in. vci: 8 or 15 ohms. HC: 100W. Fundamental resonance: 45Hz. Flux density: 13,500 gauss. Baffle hole diameter: 16½in. Depth: 8½in. Weight: 26lb. Recommended sealed enclosure (per speaker): 7000 cu in. Price: £35-70 (plus VAT).

### Audiom 12P-G

12in heavy duty. HC: 50W. Impedance: 8 or 15 ohms. Price: to be announced.

### Audiom 12P-D

12in heavy duty. HC: 50W. Impedance: 8 or 15 ohms. Price: to be announced.

### Audiomax 12AX ★

Bass drive unit. Nominal diameter: 10in. (312mm). Nominal impedance: 8 or 15 ohms. Nominal power handling: 100W. Resonance frequency: 55Hz. Sensitivity (96dB at 1m): 0-12W. 10cm diameter edge wound voice coil. Price: on application.

### Audiomax 15AX

Bass drive unit. Nominal diameter: 15in. (395mm). Nominal impedance: 8 or 15 ohms. Nominal power handling: 100W. Resonance frequency: 55Hz. Sensitivity (96dB at 1m): 0-25W. 10cm diameter edge wound voice coil. Price on application.

### Hifax 750P

High power HF horn unit. Nominal impedance: 8 or 15 ohms. Designed for systems rated at 50W. FR: 1kHz-10kHz. Recommended crossover: 2kHz. Price on application.



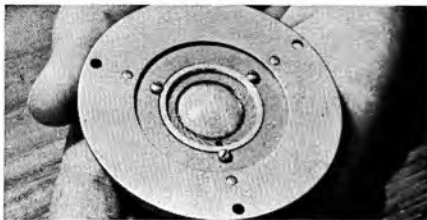

ITT 4001G HF unit

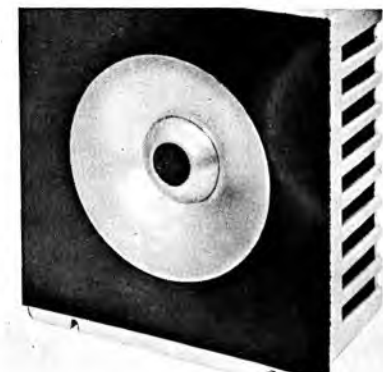

Jordan-Watts speaker drive module

#### ■ ITT

ITT Component Group Europe, Standard Telephones & Cables Ltd, Electrical Products Division, Edinburgh Way, Harlow, Essex. Tel: Harlow 26811.

#### Type 4001G, High Frequency Unit ★

High frequency pressure unit. FR: 6kHz-20kHz. Substantially omni-directional. vci: 15 ohms. Flux density: 14,000 gauss. Size: approximately  $2\frac{3}{8} \times 1$ in. Price on request.

#### ■ JORDAN-WATTS

Benlow Works, Silverdale Road, Hayes, Middlesex, UB3 3BW. Tel: 01-573 6928.

#### Jordan-Watts Module Mk II ★

6in square frame. Aluminium diaphragm with plastic surround. Voice coil:  $1\frac{1}{2}$ in. Ceramic magnet. vci: 4, 8 or 16 ohms. HC: 15W. FR: 25Hz-20kHz. Price: £15.62 (including VAT).

#### ■ KEF

KEF Electronics Ltd, Tovil, Maidstone, Kent, ME15 6QP. Tel: Maidstone (0622) 57258. Telex: 96140. Cables: KEF, Maidstone.

#### B139

$13 \times 9\frac{1}{2} \times 3$ in. 10lb. HC: 30W. Resonance: 20Hz.

Impedance: 8 ohms. FR: 20-1000Hz. Price: £13.75 (plus VAT).

#### B200

$8\frac{3}{4}$ in dia  $\times$  4in.  $3\frac{3}{4}$ lb. HC: 25W. Resonance: 25Hz. Impedance: 8 ohms. FR: 25-3500Hz. Price: £8.50 (plus VAT).

#### B110

$5\frac{1}{2}$ in dia  $\times$   $3\frac{1}{4}$ in. 3.6lb. HC: 15W. Resonance: 30Hz. Impedance: 8 ohms. FR: 30-5000Hz. Price: £7.20 (plus VAT).

#### T15

$3\frac{3}{4}$ in dia  $\times$   $1\frac{1}{8}$ in. 2lb. HC: 6W. Resonance: 550Hz. Impedance: 8 ohms. FR: 800Hz-20kHz. Price: £6.50 (plus VAT).

#### T27

$4\frac{1}{4}$ in dia  $\times$   $1\frac{3}{8}$ in. 1.4lb. HC: 6W. Resonance: 900 Hz. Impedance: 8 ohms. FR: 3500-40,000Hz. Price: £5.50 (plus VAT).

See also entry in Constructional Kits section and Speaker Accessories section.

#### ■ LOWTHER

Lowther Acoustics Ltd, Lowther House, St Mark's Road, Bromley, Kent, BR2 9HQ. Tel: 01-460 5225. Cables: Lowther, Bromley.

#### P.M.2 Mk I ★

6in. Selected paper cone. Roll foam rubber surround. Voice coil: 39mm. Gap flux: 21,000 lines per sq cm. Total flux: 281,000 maxwells. HC: 6W; 20W programme material. vci: 15 ohms. FR: 30Hz-20kHz. Price £40 (plus VAT).

#### P.M.2 Mk II

6in. Selected paper cone. Roll foam rubber surround. Voice coil: 39mm. Gap flux: 23,000 gauss. Total flux: 350,000 maxwells. HC: 6W; 20W programme material. vci: 15 ohms. FR: 25Hz-22kHz. Price: £55 (plus VAT).

#### P.M.4

6in. Selected paper cone. Roll foam rubber surround. Voice coil: 37mm. Gap flux: 24,000 gauss. Total flux: 385,000 maxwells. HC: 6W; 20W programme material. vci: 16 ohms. FR: 25Hz-24kHz. Price: £65 (plus VAT).

#### P.M.6

6in. Selected paper cone. Roll foam rubber surround. Voice coil: 39mm. Gap flux: 17,500 gauss. Total flux: 196,000 maxwells. HC: 6W; 20W programme material. vci: 16 ohms. FR: 30Hz-20kHz. Price: £24 (plus VAT).

#### P.M.6 Mk I

P.M.6 magnet assembly with a new diaphragm assembly: Lowther Special Silver speech coil, roll surround and back centring providing an improved performance: P.M.6 will still be available as a replacement unit. Price: £26 (plus VAT).

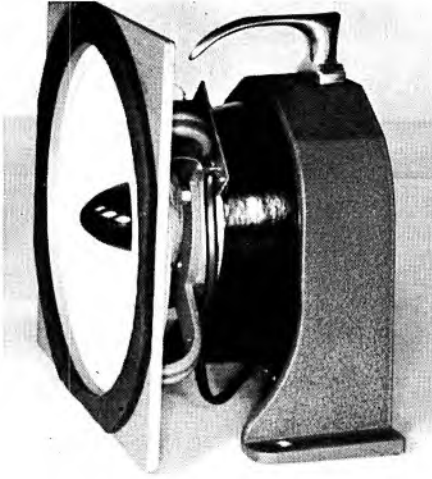

*Lowther PM2 Mk 1*



*Lowther PM7 Drive Unit*

#### **P.M.7 ★**

6in. Selected paper cone. Roll foam rubber surround. Voice coil: 39mm. Gap flux: 19,650 gauss. Total flux: 250,000 maxwells. HC: 6W; 20W programme material. vci: 16 ohms. FR: 30Hz-20kHz. Price: £36 (plus VAT).

Full stabiliser for any of Lowther drive units. Price: £2.50 (plus VAT).

#### ■ **KEITH MONKS**

Keith Monks Audio Ltd,  
26-28 Reading Road South, Fleet,  
near Aldershot, Hants.  
Tel: Fleet (025 14) 7316 and 3566.

#### **Hypertone ★**

Titanium cone speaker module. 6in titanium piston with cantilever suspension. 1½in dia voice coil. Total flux: 160,000 maxwells. Mean hemispherical power response substantially level to 15kHz. vci: 8 or 15 ohms at 400Hz. HC: 15W RMS at and above the lower system limit (dependent upon loading conditions), 30W music rating, i.e. under normal use. Price: £21.45 (including VAT).

#### ■ **PEERLESS**

Distributor: Helme Audio Products Ltd,  
Summerbridge, Harrogate, Yorks, HG3 4DR.  
Tel: Darley (042 372) 279.

All units are 8 ohms impedance, but some tweeters have 16 ohm alternatives.

#### **MT 20 HFC**

Tweeter, 2 × 2in. HC: 5W. FR: 2.5-18kHz. Price: on application.

#### **MT 225 HFC**

Tweeter, 2¼ × 2¼in. vci: 16 ohms. HC: 5W. FR: 1.5-20kHz. Price: on application.

#### **MT 25 HFC**

Tweeter, 2½ × 2½in. vci: 16 ohms. HC: 5W. FR: 1.5-18kHz. Price: on application.

#### **B65 WG**

Woofer, 6½in. HC: 10W. Maxwells: 54,000. Resonant frequency: 50Hz. Price: on application.

#### **P 825 W**

Woofer, 8in. HC: 12W. Maxwells: 90,000. Resonant frequency: 45Hz. Price: on application.

#### **L 825 WG**

Woofer, 8in. HC: 50W. Maxwells: 64,000. Resonant frequency: 25Hz. Price: on application.



*Keith Monks Hypertone*

★ Indicates entry is illustrated

### **L 100 WG**

Woofers, 10in. HC: 50W. Maxwells: 64,000. Resonant frequency: 20Hz. Price: on application.

### **D 120 WL(Sp)**

Woofers, 12in. HC: 40W. Maxwells: 115,000. Resonant frequency: 25Hz. Price: on application.

### **D 150 WL(Sp)**

Woofers, 15in. HC: 50W. Maxwells: 115,000. Resonant frequency: 20Hz. Price: £25 (plus VAT).

### **GT 50 MRC**

Mid-range unit. 5in dia. HC: 6W. FR: 800Hz-7kHz. Maxwells: 21,500. Price: £2.50 (plus VAT).

### **G 50 MRC**

Mid-range unit. 5in dia. HC: 10W. FR: 750Hz-6kHz. Maxwells: 42,000. Price: £3.70 (plus VAT).

### **E.396 M**

Full-range 6 × 4in unit. Price: £4.40 (plus VAT).

### **B 65 FM**

Full-range. 6½in. HC: 6W. FR: 35Hz-15kHz. Maxwells: 57,000. Price: £4.10 (plus VAT).

### **P 825 FM**

Full-range. 8½in. HC: 10W. FR: 30Hz-16kHz. Maxwells: 90,000. Price: £7.10 (plus VAT).

### **CM 120 FM**

Full-range. 12in. HC: 12W. FR: 30Hz-14kHz. Maxwells: 57,000. Price: £5.80 (plus VAT).

### **D 120 FM**

Full-range. 12in. HC: 12W. FR: 30Hz-14kHz. Maxwells: 115,000. Price: £11.30 (plus VAT).

### **Coax 825-20**

Full-range. 8½in. HC: 12W. FR: 30Hz-18kHz. Maxwells: woofer 90,000; tweeter 12,000. Price: £12.40 (plus VAT).

### **Coax 120-20-20**

Full-range 12in unit. HC: 12W RMS. FR: 25Hz-18kHz. Maxwells: (bass unit) 90,000; (two tweeters) 120,000 each. Price: £17 (plus VAT).

### **■ RADFORD**

Radford, Ashton Vale Road, Bristol, BS3 2HZ. Tel: Bristol (0272) 662301.

### **TD3**

Dome pressure-type high frequency unit. 1in diameter. Impedance: 4 or 8 ohms. HC: up to 50W system with correct network. FR: 4kHz-20kHz. Crossover: 4.2kHz. Price: £7.50 (plus VAT).

### **MD9/0B/8**

Open back mid-range unit. 3in diameter. Paper cone. Plastic surround. Copper voice coil. Impedance: 8 ohms. HC: up to 50W system

with correct network. FR: 500Hz-5kHz. Crossover: 500Hz and 4.2kHz. Price: £8.50 (plus VAT).

### **MD9/CB/4 ohms MD0/CB/8**

Closed back mid range unit with high flux density magnet. 3in diameter. Paper cone. Plastic surround. Copper voice coil. Impedance: 4 ohms. HC: up to 50W system with correct network. FR: 500Hz-5kHz. Crossover: 500Hz and 4.2kHz. Price: £9.50 (plus VAT).

### **BD25/8BD/25/4**

Bass driver. 12in diameter. Plastic cone and surround. Copper voice coil. Impedance: 4 or 8 ohms. HC: 50W RMS. FR: 20Hz-1kHz. Crossover: 500Hz. Price: £14.50 (plus VAT).

### **FN11**

Three-way 17 element crossover network. Impedance: 8 ohms in four types to match various drive unit combinations. HC: 100W. FR: 25Hz-25kHz. Crossover frequencies: 500Hz and 4.2kHz. Price: £9.50 (plus VAT).

### **■ ROLA-CELESTION**

See Celestion.

### **■ STENTORIAN**

Whiteley Electrical Radio Co Ltd, Radio Works, Victoria Street, Mansfield, Notts, NG18 5RW. Tel: Mansfield (0623) 24762.

### **Stentorian HF.812**

8in. Composite (paper and cambric) cone. Cambric surround. Voice coil: 1in. Gap flux: 12,000 gauss. Total flux: 47,400 maxwells. HC: 5W. vci: universal 3, 7.5 and 15 ohms. FR: 50Hz-12kHz. Price: £6.13 (plus VAT).

### **H.F.816**

8in. Composite (paper and cambric) cone. Cambric surround. Voice coil: 1in. Gap flux: 16,000 gauss. Total flux: 63,000 maxwells. HC: 6W. vci: universal 3, 7.5 and 15 ohms. FR: 50Hz-14kHz. Price: £10.08 (plus VAT).

### **H.F.912/67**

9in die cast. Speech coil: aluminium. Pole dia: 1in. Magnet system: 1.2 Webers/m<sup>2</sup>. vci: 15 ohms. HC: 10W. Price: £7.63 (plus VAT).

### **H.F. 1012**

10in. Composite (paper and cambric) cone. Cambric surround. Voice coil: 1in. Gap flux: 12,000 gauss. Total flux: 47,400 maxwells. HC: 10W. vci: universal 3, 7.5 and 15 ohms. FR: 30Hz-14kHz. Price: £7.36 (plus VAT).

### **H.F. 1016**

10in. Composite (paper and cambric) cone. Cambric surround. Voice coil: 1in. Gap flux: 16,000 gauss. Total flux: 63,000 maxwells. HC: 10W. vci: universal 3, 7.5 and 15 ohms. FR: 30Hz-15kHz. Price: £11.75 (plus VAT).

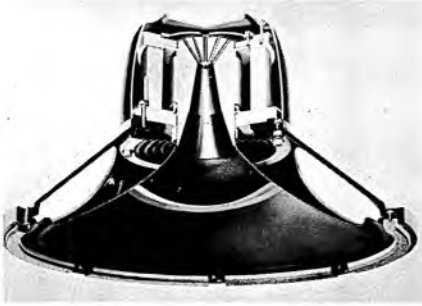

*Tannoy Monitor Gold 12ins*



*Tannoy Monitor Gold 'Twelve'*

**H.F. 1214**

12in. Composite (paper and cambric) cone. Cambric surround. Voice coil: 1.5in. Gap flux: 14,000 gauss. Total flux: 106,000 maxwells. HC: 15W. vci: 15 ohms. FR: 25Hz-14kHz. Price: £20-13 (plus VAT).

**H.F. 1214/67**

12in bass loudspeaker. Speech coil: copper. Pole dia: 1½ in. Magnet system: 1.4 Webers/m<sup>2</sup>. vci: 15 ohms. Price: £22-28 (plus VAT).

**H.F. 1216**

Composite (paper and cambric) cone. Cambric surround. Voice coil: 1½ in. Gap flux: 16,000 gauss. HC: 15W. FR: 20Hz-16kHz. Price: £30-87 (plus VAT).

**T.359**

3½in. Paper cone and surround. Voice coil: 0.635in. Gap flux: 9000 gauss. Total flux: 14,900 maxwells. HC: 15W with crossover. vci: 5 or 15 ohms. FR: 3-17kHz. rcf: 3kHz. Price: £2-57 (plus VAT).

**T.812/67**

8in middle and high frequency loudspeaker. Speech coil: aluminium. Pole dia: 1in. Magnet system: 1.2 Webers/m<sup>2</sup>. vci: 15 ohms. ¼ section. Crossover unit: 1kHz. Price: £7-30 (plus VAT).

**■ TANNOY**

Tannoy Products Ltd, Norwood Road, West Norwood, London, SE27 9AB. Tel: 01-670 1131. Cables: Tannoy, London.

**Direct radiator**

12in. Moulded fibre cone. Plastic treated surround. Voice coil. 2in. Gap flux: 14,000 gauss. HC: 15W. vci: 8 ohms. FR: 40Hz-16kHz. Price: £22 (plus VAT) to special order.

**Monitor Gold III LZ ★**

12in dual concentric. Moulded fibre cone. Plastic impregnated surround. Gap flux: (LF) 10,000, (HF) 15,000 gauss. HC: 25W. FR: 23Hz-20kHz. Recommended crossover (supplied): 1kHz. vci: 8 ohms. Price: £31 (plus VAT).

**Monitor Gold 'Twelve' ★**

12in. Moulded fibre cone. Plastic treated surround. Voice coils: (HF and LF) 2in. Gap flux: (LF) 11,500, (HF) 15,000 gauss. HC: 35W. FR: 25Hz-20kHz. Recommended crossover (supplied): 1kHz. Price: £36-50 (plus VAT).

**Monitor Gold 'Fifteen'**

15in. Moulded fibre cone. Plastic treated surround. Voice coils: (HF and LF) 2in. Gap flux: (LF) 13,500, (HF) 18,000 gauss. HC: 50W. FR: 23Hz-20kHz. Recommended crossover (supplied): 1kHz. Price: £43-25 (plus VAT).

**■ TTC**

TTC Division Precision Centre, Heather Park Drive, Wembley, Middlesex, HA0 1SU. Tel: 01-903 0144.

**K2009**

Bass driver. Nominal cone diameter 29cm. Paper cone. Aluminium voice coil. Nominal impedance: 8 ohms. Gap flux: 10,000 gauss. FR: 30Hz-5kHz. Recommended crossover: 600Hz. Price: £16-72 (including VAT).

**K2008**

Bass driver. Nominal cone diameter: 20cm. Paper cone. Aluminium voice coil. Nominal impedance: 8 ohms. Gap flux: 9,000 gauss. FR: 40Hz-16kHz. Price: £8-36 (including VAT).

**K2010**

Mid range unit. Nominal cone diameter: 12cm. Paper cone. Aluminium voice coil. Nominal impedance: 8 ohms. Gap flux: 9,000 gauss. FR: 1kHz-10kHz. Recommended crossover 1kHz and 5kHz. Price: £3-08 (including VAT).

**FHT6**

Horn tweeter. Nominal diameter: 5.5cm metal horn. Aluminium voice coil. Nominal impedance: 8 ohms. Gap flux: 10,000 gauss. Recommended crossover: 3kHz. Price: £6-38 (including VAT).

**■ VITAVOX**

Westmoreland Road, London, NW9 9RI. Tel: 01-204 4234. Cables: Vitavox, London.

★ Indicates entry is illustrated

### **AK123 Heavy Duty**

12in paper cone. Paper surround. Voice coil: 1-78in. Gap flux: 16,000 gauss. Total flux: 180,000 maxwells. vci: 15 ohms. FR: 50Hz-8kHz. Replaceable cone. Price: on application.

### **AK124**

12in paper cone. Paper surround. Voice coil: 1-78in. Gap flux: 16,000 gauss. Total flux: 180,000 maxwells. vci: 15 ohms. FR: 30Hz-13kHz. Replaceable cone. Price: on application.

### **Cone Kit**

Spare cone kit AK123, DU121, AK124. Price: on application.

### **AK154**

15in paper cone. Treated paper surround. Bass resonance: 30-35Hz. Voice coil: 2-25in. Gap flux: 14,000 gauss. Total flux: 260,000 maxwells. HC: 25W nominal. FR: 30Hz-5kHz nominal. (HC and FR determined by enclosure.) vci: 15 ohms. Replaceable cone. Price: on application.

### **AK155**

Driver for bass horn of dual channel system. 15in paper cone, paper surround. Bass resonance: 40-50Hz. Voice coil: 2½in. Gap flux: 14,000 gauss. Total flux: 260,000 maxwells. DC resistance of voice coil: 5-5-6-5 ohms. HC and FR determined by associated horn characteristics. Replaceable cone. Price: on application.

### **Cone Kit**

Spare cone kit for AK154 and AK155. Price: on application.

### **AK156**

High-power high-efficiency bass driver. Bass resonance: 30-35Hz. Voice coil: 2½in. Gap flux: 15,000 gauss. Total flux: 260,000 maxwells. vci: 15 ohms. HC: 100W music. Replaceable cone. Price: on application.

### **AK157**

High-power high-efficiency bass driver. Specification as for AK156 except vci: 7-5 ohms. Price: on application.

### **S3 HF pressure unit**

High frequency pressure unit. 3in voice coil. Copper wound voice coil. Impedance: 15 ohms. Gap flux: 18,000 gauss. Total flux: 250,000 maxwells. HC: 70W RMS above 500Hz. FR: 200Hz-16kHz. Recommended crossover: 500-1000Hz. Price: on application.

### **High frequency horn**

Designed for use with S2, S3 and GP1 pressure units. Cast in aluminium alloy. Non-resonant. Cut-off frequency 300Hz. Price: on application.

### **GP1 pressure unit**

Diaphragm formed from lightweight aluminium alloy. Voice coil: 1-96in diameter. Gap flux: 15,000 gauss. Total flux: 80,000 maxwells. HC:

above 200Hz 20W. Nominal FR: 200Hz-14kHz. vci: 15 ohms. Price: on application.

### **GP2 pressure unit**

Compact and light HF pressure unit. Voice coil: 1-5in diameter. Gap flux: 14,000 gauss. Total flux: 40,000 maxwells. HC: above 200Hz 15W. Nominal FR: 300Hz-10kHz. vci: 15 ohms. Price: on application.

### **1kHz horn**

High frequency horn designed for use with the GP2 series and GP1 pressure units. With directional swivel and simple two-point mounting. Price: on application.

### **WHARFEDALE**

Rank Radio International Ltd, PO Box 596, Power Road, Chiswick, London, W4 5PW. Tel: 01-994 6491.

### **Bronze 8/RS/DD**

Full-range 8in unit. Paper cone with double diaphragm. Fabric roll surround. Voice coil: 1in (aluminium). vci: 8-15 ohms. Gap flux: 10,500 gauss. Total flux: 41,000 maxwells. HC: 4W RMS. FR: 50Hz-20kHz. Price: £4-44 (including VAT).

### **Super 8/RS/DD**

Full-range 8in unit. Paper cone with double diaphragm. Fabric roll surround. Voice coil: 1in (aluminium). vci: 8-15 ohms. Gap flux: 14,500 gauss. Total flux: 60,000 maxwells. HC: 6W RMS, 12W peak. FR: 40Hz-20kHz. Price: £7-95 (including VAT).

### **Super 10/RS/DD**

Full-range 10in unit. Paper cone with double diaphragm. Fabric roll surround. Voice coil: 1in. Gap flux: 16,000 gauss. Total flux: 85,000 maxwells. HC: 10W RMS. vci: 8-15 ohms. FR: 30Hz-20kHz. Price: £13-11 (including VAT).

### **WHITELEY ELECTRICAL RADIO**

See Stentorian.

### **WOOLLETT AUDIOSTATICS**

21 Anerley Station Road, London, SE20 8PY. Tel: 01-699 5296.

### **12in Type 1**

Low resonance 12in dynamic unit. Paper cone with foam surround. HC: 16W RMS. FR: 20Hz-5kHz. Special unit for use with Woollett electrostatic treble speakers. Price: £14-75 (plus VAT).

### **Type C**

Constant charge push/pull electrostatic. Impedance: 16 ohms. HC: 20W RMS. FR: 1-6kHz-20kHz. Integral crossover. Attenuator, mains polariser. Rear sealed for mounting in bass cabinet behind horizontal 9×6½in aperture. Price: £24 (plus VAT).



## ***So responsive!***

The brilliant new CLR Cirrus is so responsive that we are afraid you are going to hate us, for we have just made your existing loudspeakers obsolete! A full range electrostatic doublet that outdates nearly all current designs. Its beautifully elegant slimline cabinet conceals what is probably the most important British loudspeaker for two decades!

At CLR we want you to listen to your music not your hi-fi, so we have tried to make the Cirrus sound invisible – if you don't believe us, drop into your nearest selected dealer, we think you will realise that at last you have found a 'speaker that won't let your music down'. Available from only the very finest hi-fi dealers in a variety of finishes from £99 + VAT.

### ***You will hear more from us!***

*Please complete the coupon for further details and the address of your nearest dealer.*

---

#### ***Colne Loudspeaker Research***

*51 Lion Road, Twickenham, Middlesex  
Tel: 01-891 1837*

*Name* \_\_\_\_\_

*Address* \_\_\_\_\_



# spendor



The Spendor BCIII illustrated above is an extension and refinement of the BCI and BCII. Both the BCI (widely acknowledged as setting a new standard in loudspeaker design) and the BCII are used extensively by professionals where quality of reproduction is the prime requirement.

## Spendor Audio Systems Limited

Kings Mill · Kings Mill Lane · South Nutfield · Redhill · Surrey · England · RH1 5NF  
Telephone: Nutfield Ridge 2554

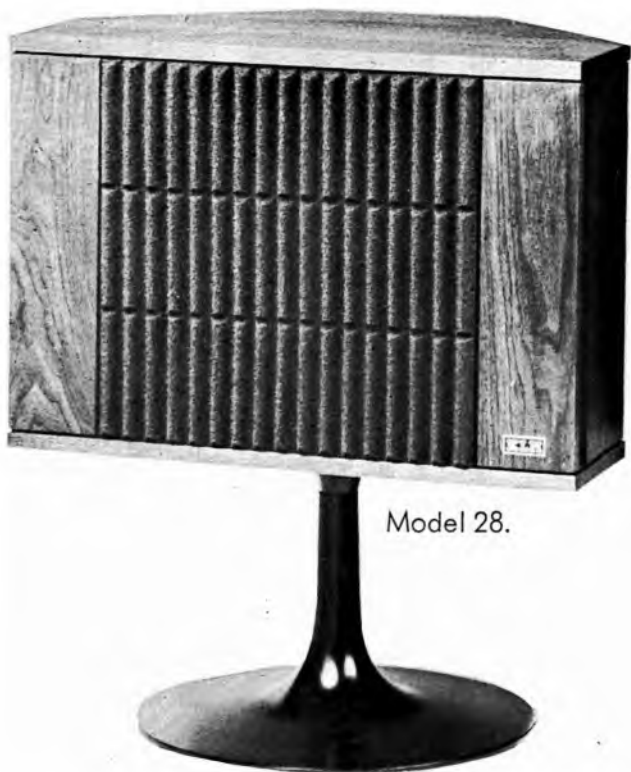

## THE PENULTIMATE

£179 each—plus VAT.

The ultimate is our own model KLH 9—which is slightly more expensive.



Webland International Ltd., P.O. Box 826, London W.2.  
Phone 01-402 9809/402 9410.



# Celestion



## Loudspeakers for the Perfectionist

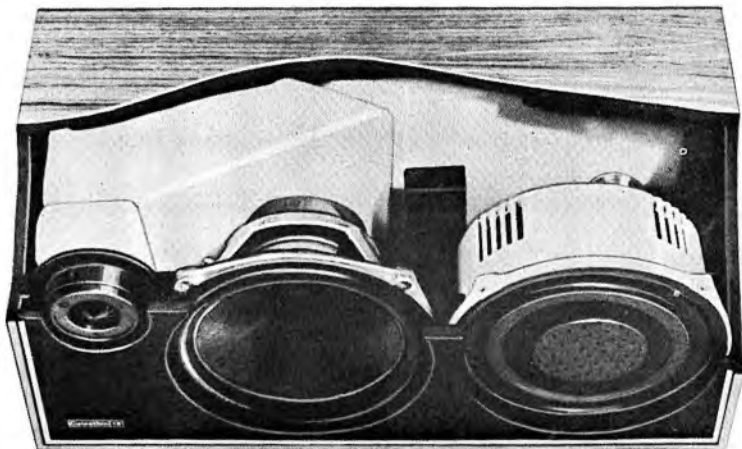

Celestion High Fidelity Loudspeakers are justly famous for their superb musical performance... the illustration shows the interior of the remarkable Ditton 15 of which many thousands are enjoyed by musically aware enthusiasts throughout the world.

Since the conception of the Ditton 15 and the unique ABR principle, Celestion have developed a whole family of these superb reproducers.

Now there is a loudspeaker to suit your precise requirements. Whether it be the Ditton 66 Studio Monitor right through the Celestion range to the miniature Ditton 10.

**Rola Celestion Ltd.**

**Ditton Works, Foxhall Road, Ipswich, Suffolk, IP3 8JP**

# Speaker Enclosures

★ Indicates entry is illustrated.

Abbreviations used in this section are given on page 20.

## ■ ACOUSTICAL MANUFACTURING

See Quad.

## ■ ACOUSTIC RESEARCH INTERNATIONAL

High Street, Houghton Regis, Beds. LL15 5QJ.  
Tel: Dunstable (0582) 603151. Telex: 825467.

### AR-2ax

Infinite baffle enclosure with units and crossover. One 10in bass driver, one 3½in mid-range unit, one ¾in tweeter. Crossovers: 1.5kHz, 5kHz. FR: 30Hz-20kHz (45Hz-20kHz±3dB). HC: 20W minimum power. 50W music power. Impedance: 8 ohms. Mid-range and treble attenuators on rear of unit. Size: 13½×24×11½in. Weight: 36½lb. Finish: teak or walnut. Five-year guarantee. Price: £59.50 (including VAT).

### AR-3a

Infinite baffle enclosure with units and crossover. One 12in bass driver, one 1½in mid-range unit, one ¾in tweeter. Crossovers: 600Hz, 5kHz. FR: 20Hz-20kHz. HC: 25W RMS. Impedance: 4 ohms. Size: 14×25×11½in. Weight: 53lb. Treble/mid-range adjustment on rear of unit. Finish: teak or walnut. Five-year guarantee. Price: £110 (including VAT).

### AR-4xa

Infinite baffle enclosure with units and crossover. One 8in bass driver, one 1½in cone tweeter. Crossover: 1.5Hz. FR: 30Hz-20kHz (45Hz-20kHz±5dB). HC: 15W minimum, 60W music power. Impedance: 8 ohms. Adjustment provided for treble. Size: 10×19×9in. Weight: 18½lb. Finish: teak or walnut. Price: £32 (including VAT).

### AR-5

Infinite baffle enclosure with units and crossovers. One 10in bass driver, one 1½in mid-range unit, one ¾in dome tweeter. Crossovers: 600Hz, 5kHz. FR: 30Hz-20kHz (45Hz-20kHz-3dB). HC: 20W minimum, 60W music power. Impedance: 8 ohms. Separate adjustments on rear of cabinet for treble/mid-range. Size: 13½×24×11½in. Weight: 39lb. Finish: teak or walnut.

Five-year guarantee. Price: £80 (including VAT).

### AR-6 ★

Infinite baffle enclosure with units and crossover. One 8in bass driver with acoustic suspension, one 1½in tweeter. Crossover: 1.5kHz. FR: 25Hz-25kHz (35Hz-20kHz±5dB). HC: 20W minimum, 100W music power. Impedance: 8 ohms. Treble adjustment on rear of cabinet. Size: 19½×12×7in. Finish: teak or walnut. Weight: 20lb. Five-year guarantee. Price: £39.90 (including VAT).

### AR-7

Infinite baffle enclosure with units and crossover. One 8in bass driver, one 1½in tweeter. Crossover: 2kHz. FR: 30Hz-20kHz. HC: 50W music. Impedance: 8 ohms. Independent tweeter control. Size: 15⅞×9¼×6½in. Weight: 10½lb. Finish: teak or walnut. Price: £55 per pair (including VAT).

### AR-LST ★

Acoustic suspension enclosure with units and crossover. One 12in bass driver, four 1½in mid-range units, four ¾in tweeters. FR: choice of six energy output characteristics (special energy profiles) by means of switch mounted on front

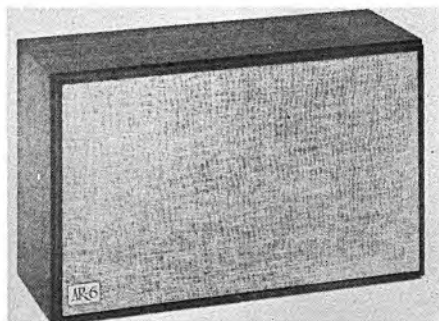

AR-6

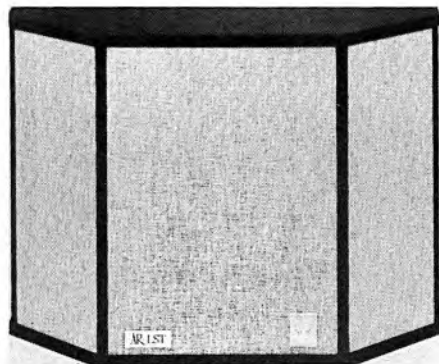

AR-LST

★ Indicates entry is illustrated

of cabinet. Crossovers: 575Hz, 5kHz. Impedance: 4-16 ohms, depending on switch position. HC: details on request. Size:  $27\frac{1}{8} \times 20 \times 9\frac{3}{4}$  in. Weight: 90lb. Price: on application.

#### ■ ADASTRA

Adastra Electronics Ltd, Unit N22, Cricklewood Trading Estate, Claremont Road, London, NW2 1TU. Tel: 01-452 6288.

#### K1425

Infinite baffle enclosure. FR: 100Hz-20kHz  $\pm$  3dB vci: 8 ohms. HC: 8 ohms. Size:  $5\frac{1}{2} \times 5\frac{1}{4} \times 4\frac{1}{2}$  in. One drive unit. Finish: globe speaker available in black, white, red or green. Price: £6.82 (including VAT).

#### Sonata ★

Speaker enclosure without units. Removable sub-baffle suitable for all speakers up to  $10 \times 6$  in, plus tweeter. Finish: straight grained teak with contrasting front edges and matching grille material. Size:  $16 \times 8 \times 6$  in. Price: (per pair) approximately £13.40 (including VAT).

#### La Scala

Speaker enclosure without units. Removable sub-baffle suitable for all speakers up to  $13 \times 8$  in, plus tweeter. Finish: polished grained teak with satinwood surround, black/grey flecked Vynair grille. Size:  $14 \times 21 \times 8\frac{1}{4}$  in. Price: (each) approximately £11.30 (including VAT).

#### ■ AKAI

Rank Audio Visual Ltd, PO Box 70, Great West Road, Brentford, Middlesex, TW8 9HR. Tel: 01-568 9222. Telex: 24408.

#### SW155

Reflex enclosure with units and crossover. One 12in roll-edge bass driver, one 5in cone mid-range unit, one 2in horn tweeter, one  $2\frac{1}{2}$  in horn super tweeter. Crossover: (6dB/octave and 12dB/octave) 1.2kHz, 5kHz, 15kHz. FR: 25Hz-21kHz. HC: 35W RMS. Impedance: 8 ohms. Size:  $25 \times 16 \times 13\frac{3}{4}$  in. Weight: 40lb. Finish: walnut. Pipe ducted reflex cabinet. Price: £70.95 (including VAT).

#### CSS8

Bookshelf speaker system. Price: (per pair) £25.85 (including VAT).

#### ■ ALBA

Alba (Radio & Television) Ltd, Bull Lane, Edmonton, London, N18 1RA. Tel: 01-803 4451

#### UA300 Pair of Speaker Enclosures

Infinite baffle enclosure with units and crossover. Each enclosure has: one  $6\frac{1}{2}$  in bass driver, one 3in tweeter. Impedance: 8 ohms. Finish: teak with silver trim. Size:  $8\frac{3}{4} \times 16\frac{3}{4} \times 7$  in. Price: £31.24 (including VAT).

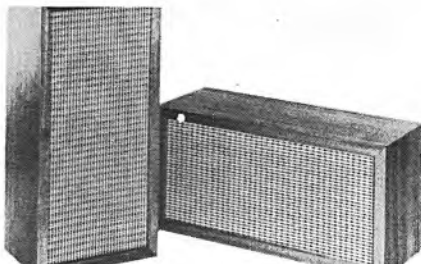

Adastra Sonata

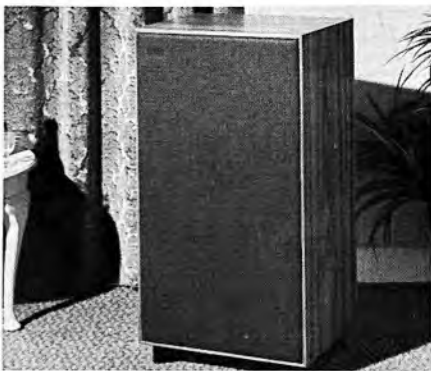

Richard Allan Academy

#### ■ RICHARD ALLAN

Richard Allan Radio Ltd, Bradford Road, Gomersal, Cleckheaton, Yorks, BD19 4AZ. Tel: Cleckheaton (097 62) 2442. Cables: Acoustics, Bradford.

#### Minette series II

Infinite baffle bookshelf enclosure. 5in bass unit, 4in tweeter. FR: 50Hz-17kHz. HC: 10W. Size:  $11\frac{1}{2} \times 7 \times 6\frac{1}{2}$  in. Weight: 11lb. Price: £16 (plus VAT).

#### Chaconne series II

Full range two-way system comprising 8in bass unit and 4in tweeter. FR: 45Hz-17kHz. HC: 12W. Size:  $20 \times 12 \times 8\frac{1}{2}$  in. Weight: 19lb. Price: £19.75 (plus VAT).

#### Flamenco series II

Full range three-way system. One 8in bass driver, one 5in mid-range unit, one 4in tweeter. FR: 40Hz-17kHz. HC: 15W. Size:  $20 \times 12 \times 8\frac{1}{2}$  in. Weight: 21lb. Price: £28.50 (plus VAT).

#### Pavane series II

Full range three-way system comprising 12in bass driver, 8in mid-range unit and 4in tweeter. FR: 30Hz-17kHz. HC: 20W. Size:  $27 \times 15\frac{1}{2} \times 12$  in. Weight: 39lb. Price: £40.75 (plus VAT).

#### Sardana

Full range three-way system comprising 12in bass driver, 8in mid-range unit and 4in tweeter.

FR: 30Hz-17kHz. HC: 25W. Size:  $27 \times 15\frac{1}{2} \times 12$ in. Weight: 43lb. Price: £49.50 (plus VAT).

#### Academy ★

Full range three-way system comprising 12in long-throw bass unit, 5in mid-range and 20mm dome treble unit. FR: 25Hz-25kHz. HC: 35W (25W minimum). Size:  $31\frac{1}{2} \times 16\frac{3}{4} \times 13\frac{1}{2}$ in. Weight: 70lb. Price: Approximately £75 (plus VAT).

#### Richard Allan Kits

See Constructional Kits section for details of Twin Assembly, Triple-8 Assembly, Triple-12 Assembly and Super-12 Assembly speaker kits.

#### ■ ALPHA

Highgate Acoustics, 38 Jamestown Road, London, NW1 7EJ. Tel: 01-267 4937.

#### HT7 Mk II

Infinite baffle enclosure with units and crossover. One 8in bass driver, one  $2\frac{1}{2}$ in tweeter. Crossover: 3.5kHz. FR: 40Hz-18kHz. HC: 20W. Impedance: 8 ohms. Finish: teak. Size:  $17\frac{3}{4} \times 11\frac{1}{2} \times 6\frac{3}{4}$ in. Weight: 15lb. Price: £23.65 (including VAT).

#### HT16

Infinite baffle enclosure with unit,  $8\frac{1}{2}$ in full-range dual-cone driver. FR: 50Hz-18kHz. HC: 10W RMS. Impedance: 4 or 8 ohms. Finish: teak. Size:  $15\frac{1}{2} \times 11 \times 7$ in. Price: £12.10 (including VAT).

#### HT17 Mk II ★

Infinite baffle enclosure with units and crossover.  $7 \times 5$ in bass driver, two  $2\frac{1}{2}$ in tweeters. Crossover: 3.5kHz. FR: 60Hz-1.8kHz. HC: 10W RMS. Impedance: 8 ohms. Finish: teak or walnut. Size:  $13 \times 10 \times 4\frac{3}{4}$ in. Weight: 7lb. Price: £15.95 (including VAT).

#### HT20 Mk II

Infinite baffle enclosure with units.  $8\frac{1}{2}$ in bass driver, 5in mid-range unit,  $2\frac{1}{2}$ in tweeter. Crossovers: 750Hz, 4kHz. FR: 40Hz-20kHz. HC: 20W. Impedance: 8 ohms. Finish: teak or walnut. Size:  $17\frac{3}{8} \times 11\frac{1}{8} \times 9\frac{1}{8}$ in. Weight: 18lb. Price: £28.99 (including VAT).

#### HT30

Infinite baffle enclosure with units and crossover. One 8in bass driver, one  $2\frac{1}{2}$ in tweeter. Crossover: 3.5kHz. FR: 50Hz-20kHz. HC: 15W. Impedance: 8 ohms. Finish: teak or walnut. Size:  $14\frac{1}{2} \times 9\frac{3}{8} \times 5\frac{3}{8}$ in. Price: £17.99 (including VAT).

#### HT50

Infinite baffle loudspeaker. Impedance: 8 ohms. Power handling 25W RMS. Two drivers. Crossover frequency: 3000Hz. Size:  $14\frac{1}{2} \times 10 \times 8$ in. Weight: 12lb. Finish teak. Price: £19.47 (including VAT).

#### HT60

Infinite baffle loudspeaker. Impedance: 8 ohms.

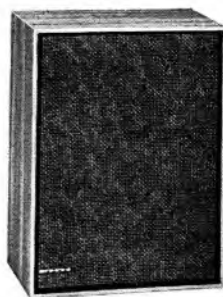

Alpha HT17 Mk II

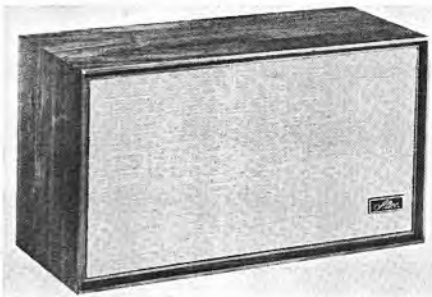

Altec Lansing 893B Corona

Power handling: 60W RMS. Four drivers. Crossover frequency: 300Hz. Size:  $24\frac{1}{4} \times 14\frac{1}{2} \times 11\frac{3}{4}$ in. Finish: teak. Price: £53.90 (including VAT).

#### ■ ALTEC LANSING (domestic)

D.E.S. Wholesale Ltd, 10-12 High Street, Colliers Wood, SW19. Tel: 01-540 9684.

#### 887A Capri

Infinite baffle enclosure with units and crossover. One 8in bass driver, one 3in tweeter. Crossover: 2.5kHz. FR: 50Hz-18kHz. HC: 45W. Impedance: 8 ohms. Size:  $19 \times 10 \times 9$ in. Weight: 23lb. Finish: walnut. Price: £36 (plus VAT).

#### 893B Corona ★

Infinite baffle enclosure with units and crossover. One 10in bass driver, one 3in tweeter. Crossover: 2.5kHz. FR: 50Hz-18kHz. HC: 45W. Impedance: 8 ohms. Size:  $22 \times 12\frac{1}{4} \times 9\frac{1}{2}$ in. Weight: 22lb. Finish: walnut. Price: £56 (plus VAT).

#### 890C Bolero ★

Infinite baffle enclosure with units and crossover. One 10in bass driver, one 10in passive radiator, one horn tweeter. Crossover: 2kHz. FR: 40Hz-20kHz. HC: 50W. Impedance: 8 ohms. Size:  $25\frac{5}{8} \times 14\frac{5}{8} \times 11\frac{7}{8}$ in. Finish: walnut. Weight: 52lb. Price: £65 (plus VAT).

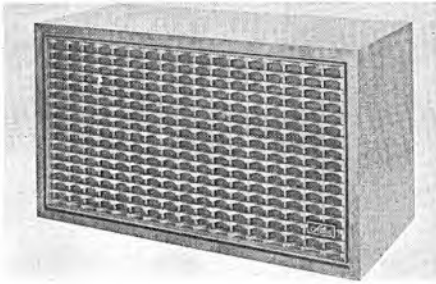

Altec Lansing 890C Bolero



Amstrad Acoustra 2500

### 891A Bookshelf

Infinite baffle enclosure with units and crossover. One 12in bass driver, one 3in tweeter. Crossover: 1-6kHz. FR: 35Hz-20kHz. HC: 50W. Impedance: 8 ohms. Size:  $25\frac{1}{2} \times 14\frac{1}{2} \times 12\frac{1}{8}$ in. Weight: 38lb. Finish: walnut. Price: £65 (plus VAT).

### 874A Segovia

Infinite baffle enclosure with units and crossover. One 12in bass driver, one 4in mid-range unit and one dome tweeter. Crossover: 500Hz-4kHz. HC: 50W. Impedance: 8 ohms. FR: 30Hz-20kHz. Size:  $26 \times 15 \times 12$ in. Finish: walnut. Price: £140 (plus VAT).

**886A Bookshelf.** Price: £79-50 (plus VAT).

**879A Sautana** Price: £159 (plus VAT)

**819A Stonehenge** Price: £215 (plus VAT)

**846B Valencia** Price: £285 (plus VAT)

**873A Barcelona** Price: £475 (plus VAT)

### AMSTRAD

AMS Trading (Amstrad) Ltd, 89 Ridley Road, London, E8 Tel. 01-249 5237

### Acoustra 1500

Infinite baffle enclosure with units. One  $6\frac{1}{2}$ in long-throw bass driver, one  $3\frac{3}{8}$ in tweeter. Crossover: four-element unit 1-2kHz. FR: 45Hz-

17kHz. HC: 15W RMS. Impedance: 8 ohms. Size:  $14\frac{1}{2} \times 10\frac{1}{2} \times 8\frac{3}{8}$ in. Weight: 15lb. Finish: teak cabinet with black front and silver trim. Special vacuum formed front panel. Price: £48 per pair (including VAT).

### Acoustra 2500 ★

Infinite baffle enclosure with units. One 8in long-throw bass driver, one  $3\frac{3}{8}$ in tweeter. Crossover: four-element unit 1-2kHz. FR: 35Hz-17kHz. HC: 25W RMS. Impedance: 8 ohms. Size:  $19\frac{1}{4} \times 10\frac{1}{8} \times 9\frac{1}{2}$ in. Weight: 20lb. Finish: teak cabinet with silver trim. Special front panel design. Price: £60 per pair (including VAT).

### AUDIO DEVELOPMENTS

B. H. Morris & Co (Radio) Ltd, Trio House, The Hyde, London, NW9 6JP. Tel: 01-205 6441.

### AD15

Infinite baffle bookshelf speaker with unit. One  $7 \times 5$ in full-range driver. HC: 10W music. Impedance: 8 ohms. FR: 70Hz-18kHz. Finish: walnut. Size:  $15\frac{3}{4} \times 5\frac{7}{8} \times 8\frac{1}{4}$ in. Weight: 5lb. Price: £15 per pair (plus VAT).

### AD30

Three-way bookshelf or free-standing enclosure with units. One 8in bass driver, one 5in mid-range unit, one  $2\frac{1}{2}$ in tweeter. HC: 20W music. Impedance: 8 ohms. FR: 40Hz-20kHz. Finish: walnut. Size:  $18\frac{3}{4} \times 9\frac{7}{8} \times 9\frac{7}{8}$ in. Price: £32 per pair (plus VAT).

### AUDIO SERVICES LTD

82 East Barnet Road, New Barnet, Herts. Tel: 01-449 6605.

### Dynasonic Monitor

Reflex enclosure with units and crossover. One 12in bass driver, one 4in mid-range unit, one 3in tweeter. Crossover: 2kHz and 8kHz. FR: 35Hz-20kHz. HC: 25W. Impedance: 8 ohms. Height: 27in. Finish: teak or walnut. Weight: 55lb. Price: £39-60 (including VAT).

### Dynastic ASI

Reflex enclosure with units and crossover. One 12in bass driver, one electrostatic mid-range and HF unit. Crossover: 1kHz  $\frac{1}{2}$ -section. FR: 35Hz-20kHz. HC: 25W. Impedance: 8 ohms. Height: 27in. Weight: 60lb. Finish: teak or walnut. Feature: arcuated electrostatic unit. Price: £59-40 (including VAT).

### Dynastic AS100

Reflex enclosure with units and crossover. One 12in bass driver, one electrostatic mid-range and HF unit. Crossover: 600Hz  $\frac{1}{2}$ -section. FR: 35Hz-20kHz. HC: 35W. Impedance: 8 ohms. Height (overall): 35in. Weight: 75lb. Finish: teak or walnut. Feature: arcuated electrostatic unit. Price: £110 (including VAT).

**BANG & OLUFSEN**

Bang & Olufsen (UK) Ltd, Eastbrook Road,  
Gloucester, GL4 7DE.

Tel: Gloucester (0452) 21591.

**Beovox 1702**

Pressure chamber enclosure with units and crossover. One 6in bass driver, one 1in dome tweeter. Crossover: 5kHz. FR: 50Hz-20kHz. HC: 20W RMS. Impedance: 4 ohms. Spec exceeds DIN 45 500. Size:  $13\frac{3}{4} \times 7\frac{1}{8} \times 7\frac{1}{8}$ in. Weight:  $8\frac{3}{4}$ lb. Finish: teak or rosewood. Sold in matched pairs. Price: (per pair) in teak £59.90; in rosewood £62.90 (including VAT).

**Beovox 1802**

Pressure chamber enclosure with units and crossover. One 6in bass driver, one 1in dome tweeter. Crossover: 5kHz. FR: 50Hz-20kHz. HC: 20W RMS. Impedance: 4 ohms. Spec exceeds DIN 45 500. Size:  $13 \times 7\frac{3}{8} \times 4$ in. Weight:  $13\frac{1}{4}$ lb. Finish: teak, rosewood or white. Sold in matched pairs. Price: (teak) £65.90; (rosewood or white) £68.90 (including VAT).

**Beovox 2702**

Pressure chamber enclosure with units and crossover. One 7in bass driver, one 1in tweeter. Crossover: 3kHz. FR: 45Hz-20kHz. HC: 25W RMS. Impedance: 4 ohms. Spec exceeds DIN 45 500. Size:  $16\frac{1}{4} \times 8\frac{1}{8} \times 8\frac{1}{8}$ in. Weight: 12lb 2oz. Finish: teak, rosewood, or white. Sold in matched pairs. Price: (per pair) in teak £69.90; (rosewood or white) £73.90 (including VAT).

**Beovox 3702**

Pressure chamber enclosure with units and crossover. One 8in bass driver, one 3.75in mid-range unit and one 1.5in tweeter. Crossover: 800Hz and 5kHz. FR: 40Hz-20kHz. HC: 40W RMS. Impedance: 4 ohms. Spec exceeds DIN 45 500. Size:  $19\frac{3}{8} \times 9\frac{3}{8} \times 9\frac{3}{8}$ in. Weight:  $18\frac{3}{8}$ lb. Finish: teak, rosewood or white. Sold in matched pairs. Price: £92.90 (per pair) in teak, £98.90 (per pair) in rosewood or white (including VAT).

**Beovox 3800**

Pressure chamber enclosure with units and crossover. One 12in bass driver, one 3.5in mid-range unit. One 1.5in tweeter. Crossover: 800Hz and 5kHz. FR: 35Hz-20kHz. HC: 50W RMS. Impedance: 4 ohms. Spec exceeds DIN 45 500. Size:  $23 \times 11\frac{1}{2} \times 11\frac{1}{2}$ in. Weight: 31lb. Finish: teak or rosewood. Sold in matched pairs. Price: (per pair) in teak £109.50; in rosewood £117.50 (including VAT).

**Beovox 5700 Mk II**

Enclosure incorporating passive radiator, three driver units and crossover. One 10in bass driver, one  $2\frac{1}{4}$ in mid-range unit, one  $\frac{3}{4}$ in tweeter, one 10in passive radiator. Crossover: 650Hz and 6kHz. FR: 25Hz-20kHz. HC: 60W RMS. Im-

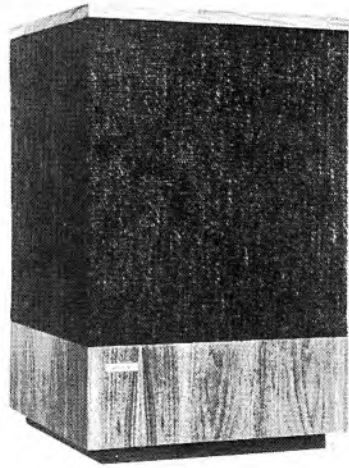

Bose 501



Bose 901

pedance: 4-8 ohms. Spec exceeds DIN 45 500. Size:  $26 \times 14\frac{1}{4} \times 11\frac{1}{4}$ in. Weight:  $49\frac{1}{2}$ lb. Sold in matched pairs. Finish: teak or rosewood. Price: to be announced.

**BOSE**

Importers: Expotus Ltd, 10 Museum Street,  
London, WC1. Tel: 01-836 3747.

Distributors: Acoustico Enterprises Ltd.

**501 ★**

Infinite baffle enclosure with units and crossover. One forward-facing 10in bass driver, two rear-angled  $3\frac{1}{2}$ in mid-range and HF units. FR: 40Hz-20kHz. HC: 100W RMS. Impedance: 4 ohms. Size:  $14\frac{1}{2} \times 14\frac{1}{2} \times 24$ in. Weight: 38lb. Finish: walnut. Sold in matched pairs. Price: (per pair) £150 (plus VAT).

**901 ★**

Infinite baffle enclosure with units. Nine 4in high-compliance paper cone speakers (one forward-facing, eight on rear baffles). No crossover network. FR: 25Hz-20kHz. HC: > 100W RMS.



*Brahms Regency*

Impedance: 8 ohms. Active equaliser corrects response shape and adjusts for room acoustics. Size:  $20\frac{3}{8} \times 12\frac{3}{4} \times 12\frac{3}{4}$  in. Weight: 33lb. Finish: walnut. Sold in matched pairs with equaliser. Price: (per pair) £250 (plus VAT).

## ■ BRAHMS

Brahms Manufacturing & Development Co, Unit E, Rochester Airport, Maidstone Road, Rochester, Kent, ME1 3QJ.  
Tel: Medway (0634) 48816.

### Sandringham series 2

Infinite baffle enclosure with units and crossover. One 8in rubber-edged bass driver, one dome HF unit. Crossover: 2.5kHz LC unit. FR: 45Hz-20kHz. HC: 20W RMS. Impedance: 8 ohms. Size:  $19 \times 10\frac{1}{2} \times 10$  in. Finish: teak. Front loaded with removable brown reticulated foam front. Cabinet mounted on plinth. Price: £26.50 (plus VAT).

### Buckingham series 2

Infinite baffle enclosure with units and crossover. Two 8in rubber-edged bass drivers, one dome HF unit. Crossover: 2.5kHz LC unit. FR: 40Hz-20kHz. HC: 40W RMS. Impedance: 8 ohms. Size:  $31\frac{1}{2} \times 12 \times 12$  in. Finish: teak. Front loaded with removable brown reticulated foam front. Cabinet mounted on plinth. Price: £42 (plus VAT).

### Balmoral series 2

Infinite baffle enclosure with units and crossover. One 12in rubber-edged bass driver, one 5in mid-range unit, one dome HF unit. Crossover: 1.5kHz and 6kHz (LC unit). FR: 35Hz-

20kHz. HC: 35W RMS. Impedance: 8 ohms. Size:  $28 \times 16 \times 12$  in. Weight: 50lb. Finish: teak. Front loaded with removable brown reticulated foam front. Cabinet mounted on plinth. Price: £46 (plus VAT).

### Queen Anne series 2

Infinite baffle enclosure with units and crossover. One 12in bass driver, one 5in mid-range unit, one dome HF unit. Crossover: 1.5kHz and 6kHz. FR: 35Hz-20kHz. HC: 35W RMS. Impedance: 8 ohms. Size:  $28 \times 16\frac{1}{2} \times 12$  in (plus 6in legs). Weight: 48lb. Finish: mahogany, walnut. Front loaded with removable brown reticulated foam front. Connector block with DIN and Continental sockets at rear. Price: £61 (plus VAT).

### Regency series 2 ★

Infinite baffle enclosure with units and crossover. Specification identical to Queen Anne model except cabinet styling. Price: £61 (plus VAT).

### Military series 2

Infinite baffle enclosure with units and crossover. Specification identical to Queen Anne model except cabinet styling. Price: £61 (plus VAT).

### SAL 3000

Infinite baffle loudspeaker. Impedance: 4 ohms. Power handling: 30W RMS. Two drivers. Crossover frequency: 2.5kHz. Size:  $48 \times 26.7 \times 25.4$  cm. Finish teak with brown reticulated foam front. Price: £33 (including VAT).

## ■ BUSH-ARENA

Rank Radio International Ltd, PO Box 596, Power Road, Chiswick, London, W4 5PW.  
Tel: 01-994 6491.

### L810

Infinite baffle shelf-mounting enclosure with units and crossover. One 6 $\frac{1}{2}$ in bass driver, one 4in mid-range unit, one 1 $\frac{1}{8}$ in tweeter. Crossover: 2kHz and 6kHz. Impedance: 4 ohms. HC: 25W (DIN). Size:  $14 \times 9\frac{3}{4} \times 8\frac{3}{8}$  in. Finish: teak veneer. Price: (per pair) £36.72 (including VAT).

### L820

Infinite baffle floor-standing enclosure with units and crossover. One 7 $\frac{1}{8}$ in bass driver, one 4in mid-range unit, one 1 $\frac{1}{8}$ in tweeter. Crossover: 1.8kHz and 7kHz. Impedance: 5 ohms. HC: 25W (DIN). Size:  $17 \times 11 \times 9\frac{3}{8}$  in. Finish: teak veneer. Price: (per pair) £56.49 (including VAT).

### L830

Acoustic suspension enclosure. FR: 50Hz-19kHz  $\pm 3$ dB. vel: 4 ohms nominal. HC: 35W (DIN). Size:  $20 \times 13 \times 11$  in. Weight: 26lb. Three drive units. Crossover: 800Hz and 5kHz. Sensitivity: 12.5W for 95dB SPL. Finish: teak. Price: (per pair) £80.75 (including VAT).

**■ BUSH NELSON**

Bush Nelson Ltd, Bush House,  
6 Yattendon Road, Horley, Surrey.  
Tel: Horley (029 34) 5983.

**12/8**

Pressure chamber system. One 13×8in bass unit, one 3in tweeter. Impedance: 8 ohms. FR: 20Hz-20kHz. Power capacity: 20W. Flux density: bass unit 11,000 gauss. HF unit 10,000 gauss. Bass resonance: 20-30Hz. Crossover frequency: 5kHz. Teak. Size: 23×12×11in. Price: £65 (plus VAT).

**■ B & W**

B & W Electronics, Meadow Road,  
Worthing, Sussex, BN11 2RX.  
Tel: Worthing (0903) 205611. Telex: 87342.

**DM2**

Eighth-wave acoustic line enclosure with units and crossover. One 8in bass driver with Bextrene cone, one Celestion HF1300 mid-HF unit, one  $\frac{3}{4}$ in low-mass plastic dome tweeter. Crossover: 3·5kHz, 9kHz. FR: 30Hz-25kHz(±2dB 300Hz-6kHz, ±3dB 65Hz-20kHz). HC: 50W RMS. Impedance: 8 ohms at 400Hz. Size: 14×25 $\frac{1}{2}$ ×13 $\frac{3}{4}$ in. Weight: 52lb. Finish: teak, rosewood, walnut or satin white. Every model individually pen tested and calibration certificate supplied. Price: £59·90 (plus VAT).

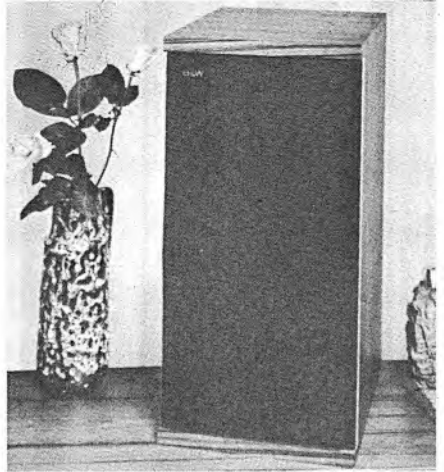

B &amp; W DM4

**DM4 ★**

Three-unit monitor speaker system suitable for bookshelf or wall mounting. One DW200/4 bass/mid-range driver with Bextrene cone, one Celestion HF1300 upper mid-frequency unit, one  $\frac{3}{4}$ in low-mass plastic dome tweeter. FR: 30Hz-25kHz (±3dB 140Hz-14kHz, ±5dB 80



## YOU CAN COUNT ON OUR SUPPORT!

No matter how good your speakers may sound, raising them above the floor invariably improves reproduction. How?

- (a) There is a cleaner bass and mid-range.
- (b) There is a reduction of floor resonances.
- (c) The highly directional treble units are brought nearer to listening height – giving an improved stereo image.

Sabre Speaker Supports have been carefully designed to improve sound quality effectively – with looks to match! Hand made in high quality steel, Sabre will handle speakers of 100 lbs and over comfortably.

Superbly finished in matt black nylon, Sabre Speaker Supports are a magnificent way to enhance your system.

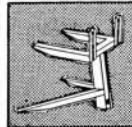

**PRICE PER PAIR**  
£18·03 inc. VAT  
plus 75p P. & P.

To H. M. B. Engineering,  
Fort Works, Pelham Street, Wolverhampton. Tel: 772831/2/3.

- Please send me ..... pairs of Sabre Speaker Supports.  
 Please send me your literature. (Tick as appropriate).

My Cheque/P.O. enclosed for £.....  
(Make payable to H. M. B. Engineering).

Name \_\_\_\_\_

Address \_\_\_\_\_



★ Indicates entry is illustrated

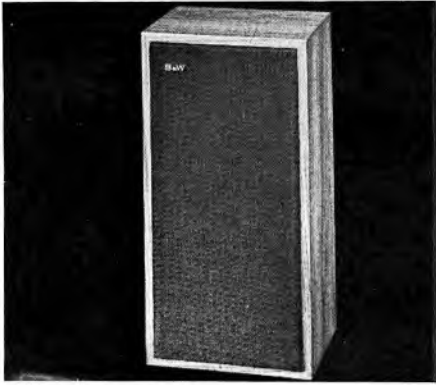

B & W Electronics D5

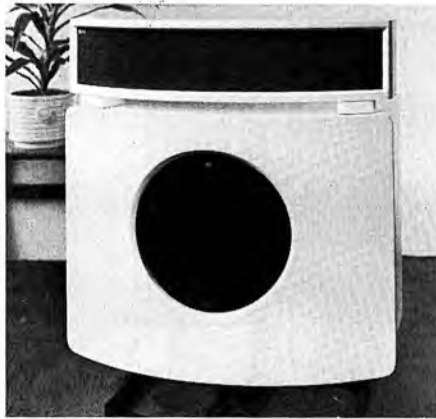

B & W Electronics DM70

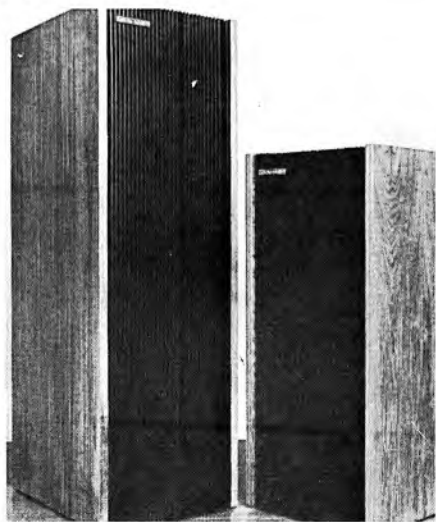

Cambridge Audio R50 (Left) R40 (Right)

Hz-20kHz). HC: 30W RMS. Impedance: 8 ohms at 400Hz. Size: 21 × 10 × 10in. Weight: 24lb 6oz. Finish: teak, walnut, rosewood or satin white. Every model individually pen tested and calibration certificate supplied. Price: £42.50 (plus VAT).

**D5 ★**

Two-unit bookshelf speaker system. One DW150/5 bass/mid-range driver with Bextrene cone, one 1in upper mid-frequency and HF unit. FR: 40Hz-25kHz ( $\pm 3$ dB 150Hz-3kHz,  $\pm 5$ dB 80Hz-20kHz). HC: 25W RMS. Impedance: 8 ohms at 400Hz. Size: 18 × 9 × 7in. Weight: 14lb. Finish: teak, walnut, satin white. Every model individually pen tested and calibration certificate supplied. Price: £25.45 (plus VAT).

**DM70 ★**

Infinite baffle and electrostatic speaker system. One nominal 13in diameter bass radiator with laminated and reinforced cone, one eleven-module wide-dispersion electrostatic HF unit type 701. Power supply unit, high- and low-pass filter assembly mounted on separate board. Infinite baffle loading on bass unit with multiple bracing and synthetic fibre absorbents. Electrostatic unit free-standing plug-in assembly with removable rear polar distribution. Impedance: nominal 8 ohms, not greater than 30 ohms or less than 4 ohms. HC: suitable for high quality amplifiers with outputs of 25-100W RMS. FR: 50Hz-15kHz better than  $\pm 4$ dB, 40Hz-20kHz better than  $\pm 5$ dB. System resonance: 40Hz  $\pm 1\%$ . Finish: oiled American walnut or white. Size:  $32\frac{3}{8} \times 26\frac{7}{8} \times 15\frac{3}{8}$ in. Weight: (with stand) 100lb. Price: £159.50 (plus VAT).

**DM70 Improved**

Free-standing system (stand included) measuring  $32\frac{1}{2} \times 27 \times 15\frac{1}{2}$ in. Units: DW13/70 low impedance bass unit with 2in voice coil operating via level-controlling transformer; 702 11-element wide dispersion electrostatic treble unit with output extending beyond audibility and with built-in protection devices against overload. HC: suitable for 25-100W RMS amplifier. Cabinet: rigid construction finished in white or walnut. Price: £198.40 (plus VAT).

**■ CAMBRIDGE AUDIO**

Cambridge Audio Ltd, The River Mill, St Ives, Huntingdon, PE17 4EP.

Tel: St Ives (0480) 62901. Telex: 32223.

**R50 ★**

High quality transmission line enclosure with units and crossover. Bass driver in damped tapered labyrinth, HF driver in damped tapered pipe. Two HF pressure drivers. FR: 25Hz-25kHz. Crossover: 400Hz, 3kHz, 10kHz. HC: 25W RMS, 50W music. Impedance: 8 ohms

(nominal). Size:  $41\frac{1}{2} \times 17\frac{5}{8} \times 13$ in. Price £112 (plus VAT).

**R40 ★**

High quality enclosure incorporating three drive units in a damped tapered labyrinth. HC: 25W RMS, 40W music. Impedance: 8 ohms (nominal). Size:  $31\frac{1}{4} \times 13 \times 12\frac{3}{4}$ in. Price: £75 (plus VAT).

**■ CANTERBURY AUDIO**

4 Station Road West, Canterbury, Kent.  
Tel: Canterbury (0227) 60431.

**CA215**

Infinite baffle enclosure with units. HC: 15W. FR: 37Hz-19kHz. Impedance: 6 or 15 ohms. Finish: teak veneered bonded chipboard. Size:  $21 \times 13\frac{1}{2} \times 13\frac{1}{4}$ in. Price: £19-60 (plus VAT).

**CA315**

Infinite baffle enclosure with units. HC: 35W.

FR: 35Hz-22kHz. Impedance: 6 or 15 ohms. Finish: teak veneered bonded chipboard. Size:  $31 \times 13\frac{1}{2} \times 13\frac{1}{4}$ in. Price: £39-60 (plus VAT).

**■ CELESTION**

Rola-Celestion Ltd, Ditton Works,  
Foxhall Road, Ipswich, Suffolk, IP3 8JP.  
Tel: Ipswich (0473) 73131.

**County ★**

Infinite baffle shelf mounting enclosure with units. One 8in bass driver, one HF1300 treble unit. HC: 25W RMS. Impedance: 4-8 ohms. Size:  $19 \times 10 \times 9\frac{1}{2}$ in. Finish: teak or walnut. Price: £22-02 (plus VAT).

**Ditton 10 Mk II ★**

Infinite baffle compact system. Long-throw 5in bass unit. HF1300 Mk 2 HF unit. Built-in half-section crossover 3-5kHz. FR: 35Hz-15 kHz. HC: 10W. Size:  $12\frac{3}{4} \times 6\frac{3}{4} \times 8\frac{1}{4}$ in. Weight:

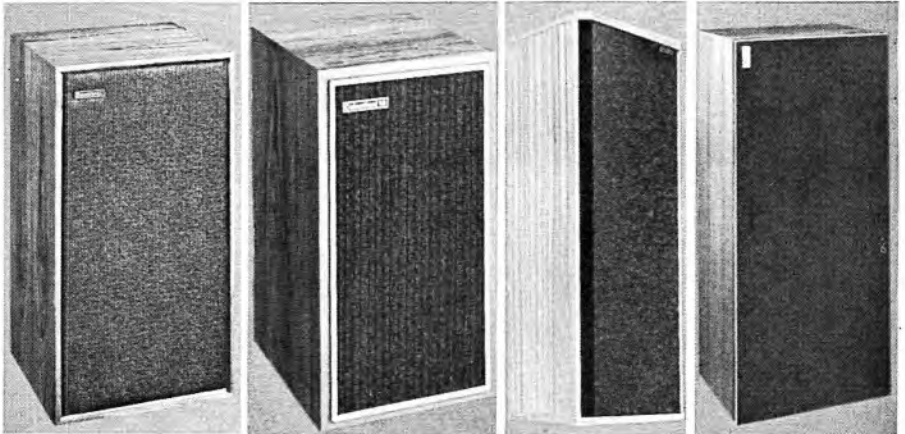

*Celestion County*

*Celestion Ditton 10 11*

*Celestion Ditton 66 monitor*

*Celestion Ditton 25*

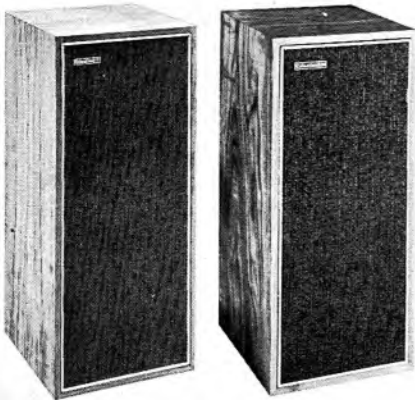

*Celestion Ditton 15*

*Celestion Ditton 120*



*Celestion Dittons 10/County/15/44/25/66*



*Celestion Ditton 66*

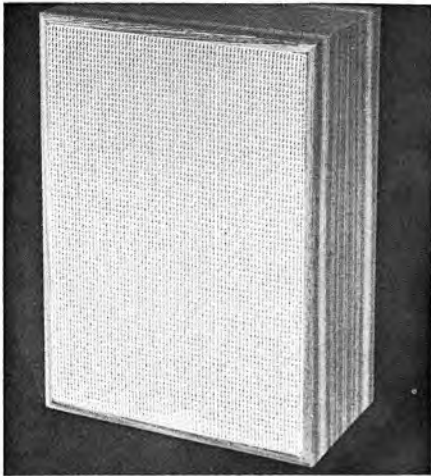

City Audio CA/15

13lb. Available in teak and walnut. vci: 4-8 ohms. Price: £21.42 (plus VAT).

**Ditton 15 ★**

Compact infinite baffle enclosure incorporating auxiliary bass radiator. Units: 8in middle/bass speaker. HF1300 Mk 2 treble radiator. FR: 30Hz-15kHz. HC: 15W RMS. vci: 4-8 ohms. Size:  $21 \times 9\frac{1}{2} \times 9\frac{1}{4}$ in. Weight: 20lb. Finish: walnut or teak. Price: £33.60 (plus VAT).

**Ditton 25 ★**

Studio monitoring quality speaker enclosure with five drive units. 12in long-throw bass driver, two pressure type mid-range and HF units, pressure type ultra high frequency unit, 12in auxiliary bass radiator. HC: 25W RMS. vci: 4-8 ohms. Size:  $32 \times 14 \times 11$ in. Weight: 48lb. Finish: teak or walnut. Price: £65 (plus VAT).

**Ditton 44 ★**

Floor-standing enclosure with units. One 12in bass driver, one 6in HF unit and HF2000 tweeter. HC: 44W RMS. Impedance: 4-8 ohms. Size:  $30 \times 14\frac{1}{2} \times 10$ in. Finish: teak or walnut. Price: £54 (plus VAT).

**Ditton 66 ★**

Floor-standing enclosure with units. One 12in bass driver, one 12in passive radiator (ABR), one dome HF unit, one dome tweeter. HC: 80W RMS. Impedance: 4-8 ohms. Size:  $40 \times 15 \times 11\frac{1}{2}$ in. Finish: teak or walnut. Price: £99 (plus VAT).

**Ditton 120 ★**

Infinite baffle enclosure with two active units and one passive radiator. One 5in long-throw bass driver, one pressure type  $1\frac{1}{2}$ in tweeter, one 5in auxiliary bass radiator. Crossover: low-loss L/C network. FR: 35Hz-15kHz. HC: 20W (DIN).

Impedance: 4-8 ohms. Finish: natural teak or walnut. Size:  $17\frac{1}{4} \times 9 \times 7\frac{3}{4}$ in. Price: £22.02 (plus VAT).

**Hadleigh**

Compact shelf-mounting speaker system. Price: £19.70 (plus VAT).

■ **CHARTWELL**

Acoustico Enterprises Ltd, Unit 7, Space Way, North Feltham Trading Estate, Feltham, Middlesex, TW14 0TZ. Tel: 01-751 0141.

**DM400**

Ported enclosure. FR: 45Hz-22kHz  $\pm$  3dB. HC: 25W RMS. vci: 8 ohms. Size:  $34 \times 15 \times 13$ in. Weight: 55lb. Three drive units. Sensitivity: 3W for 95dB SPL. Finish: teak, rosewood or walnut. Choice of grilles. Price: (per pair) £198 (including VAT).

■ **C.A.S.**

City Audio Services Ltd, 144 Lavender Hill, London, SW11 5RA. Tel: 01-223 2496.

**CA/15 ★**

Infinite baffle enclosure with units and crossover. One  $13 \times 8$ in bass driver, two  $2\frac{1}{2}$ in mid-range and HF units. Crossover: half-section 8-5kHz. FR: 50Hz-14kHz. HC: 10W RMS. Impedance: 8 ohms. Size:  $18\frac{1}{2} \times 11\frac{1}{2} \times 8$ in. Weight: 14lb. Finish: teak. Price: £18.50 (plus VAT).

**Super 30**

Infinite baffle enclosure with units and crossover. One 8in long-throw bass driver with rubber cone suspension, one  $3\frac{1}{2}$ in mid-range unit, one 2in tweeter. Crossover: L/C at over 4-5kHz. FR: 40Hz-19kHz. HC: 12W RMS. Impedance: 8 ohms. Size:  $18\frac{1}{2} \times 11\frac{1}{2} \times 8$ in. Weight: 16lb. Finish: teak. Price: £23.30 (plus VAT).

**D25**

Infinite baffle enclosure. FR: 55Hz-14kHz. Impedance: 8 ohms. HC: 12WRMS. Three drivers. Size:  $18\frac{1}{2} \times 11\frac{1}{2} \times 8$ in. Weight: 28lb. Finish: teak. Price: £19.80 (including VAT).

**M60**

ABR enclosure. FR: 35Hz-18kHz. Impedance: 8 ohms. HC: 20W RMS. Four drivers. Size:  $22 \times 12 \times 8$ in. Weight: 40lb. Finish: teak. Price: £42.90 (including VAT).

■ **CLARK SPEAKERS**

122 Hull Road, Anlaby, Hull, HU10 6UV. Tel: Hull (0482) 656706.

**System A1/1**

Transmission line enclosure with units and crossover. One Richard Allan CF8 8in bass/mid-range driver, one Peerless MT25  $2\frac{1}{2}$ in tweeter. HC: 10W RMS. Impedance: 8 ohms.

FR: 25Hz-20kHz. Crossover: 3kHz  $\frac{1}{2}$ -section two-element. Size:  $30\frac{3}{4} \times 18 \times 15$ in. Finish: teak or mahogany. Also available with extension shelf unit to left or right to accommodate equipment, records, etc. Also available in kit form for home assembly. Full details and prices on request. Price: (kit) £26.50 (including VAT); (ready assembled) £32.32 (including VAT).

#### System A1/1 (KEF)

Similar to A1/1 above but fitted with KEF B200 bass driver. HC: 25W RMS. Price: (kit) £28 (including VAT); (ready assembled) £33.82 (including VAT).

#### System A1/2

Transmission line enclosure with units and crossover. One Richard Allan CF8 8in bass driver, one Fane 501 5in mid-range unit, one Peerless MT25  $2\frac{1}{2}$ in tweeter. HC: 15W RMS. Impedance: 8 ohms. FR: 25Hz-20kHz. Crossover: 500Hz and 3.5kHz,  $\frac{1}{2}$ -section nine element crossover. Size:  $35 \times 18 \times 15$ in. Finish: teak or mahogany. Also available with shelf unit to left or right to accommodate equipment, records, etc. Also available in kit form for home assembly. Full details and prices on request. Price: (kit) £39.94 (including VAT); (ready assembled) £46.76 (including VAT).

#### System A1/2 (KEF)

Similar to A1/2 above but fitted with KEF B200 bass driver. HC: 25W RMS. Price: (kit) £41.44 (including VAT); (ready assembled) £48.26 (including VAT).

#### ■ CROWN

Crown Radio Company Ltd,  
128-129 Shoreditch High Street,  
London, E1 6JE. Tel: 01-739 2382.

#### CSP-12

Infinite baffle enclosure with unit. One  $13\frac{1}{4} \times 8\frac{1}{4}$ in bass driver with integral HF unit. Size:  $7\frac{1}{4} \times 17\frac{1}{2} \times 9\frac{3}{8}$ in. Finish: walnut cabinet with black grille. Price: (per pair) £32.45 (including VAT).

#### CSP-13

Infinite baffle enclosure with unit. One  $13\frac{1}{4} \times 8\frac{1}{4}$ in bass driver with two integral HF units. Impedance: 8 ohms. Size:  $10\frac{1}{2} \times 21 \times 9$ in. Finish: walnut cabinet with black grille. Price: (per pair) £43.45 (including VAT).

#### ■ A. DAVIES & CO

56 Wellesley Road, London, NW5.  
Tel: 01-485 5775.

#### Bass reflex

Suitable for 12in speakers. Cabinets lined with 1in acoustic felt. Finish: sapele, walnut, oak, teak. Full polish or satin finish. Dimensions:  $34 \times 17\frac{1}{2} \times 15\frac{1}{2}$ in. Price: £18.15 (ex works).

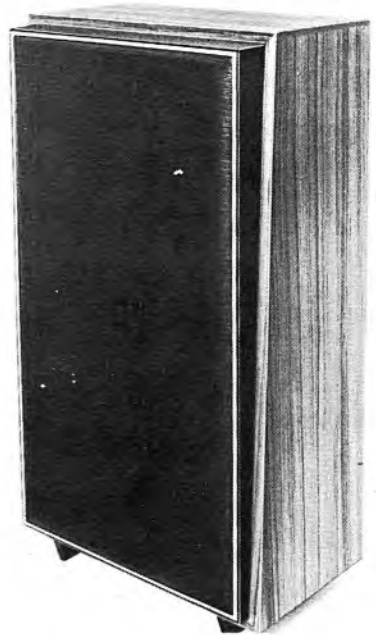

Decca Deram

#### A.D. Sealed Folded Horn

Designed to house full-range 12in driver, or 12in bass unit plus middle and tweeter units to choice. Size:  $31\frac{1}{2}$ in high, 18in wide, 18in deep. Finish: teak or veneer to colour of choice. Front baffle sealed with black laminate (other colours to order), with neutral colour open-weave Tygan grille covering. Price: (12in speaker version) £30.25 ex-works; (15in speaker version) £35.75 ex-works.

#### ■ DECCA

Decca Special Products, Ingate Place,  
Queenstown Road, London, SW8 3NT.  
Tel: 01-622 6677.

#### Decca Deram Enclosure ★

Two units:  $13 \times 8$ in bass driver, 3in tweeter. HC: 8-10W. Size:  $25 \times 13\frac{1}{4} \times 8$ in. Impedance: 8 ohms. Finish: teak or white. Price: £21 (plus £2.10 VAT).

#### ■ DERWENT

Nichols Acoustic Fitments, Church Street,  
Bubwith, Selby, Yorks.  
Tel: Bubwith (075 785) 206.

Manufacturers of a range of competitively priced speaker enclosures to suit most popular drive units. No product information or prices obtainable from the makers as this edition of the Year Book closed for press.

★ Indicates entry is illustrated

## ■ DUAL

Audiodecks Ltd, Farnell House,  
81 Kirkstall Road, Leeds, LS3 1HR.  
Tel: Leeds (0532) 35111.

### CL112

Speaker system in walnut finish. New model and full specification not available as this edition of the Year Book closed for press. Price: £22-64 (including VAT).

### CL142

Speaker system in walnut or white finish. New model and full specification not available as this edition of the Year Book closed for press. Price: (walnut) £36-02 (including VAT); (white) £37-49 (including VAT).

## ■ DYNASTATIC

See Audio Services Ltd.

## ■ DYNATRON

Dynatron Radio Ltd, St Peter's Road,  
Maidenhead, Berks, SL6 7QY.  
Tel: Maidenhead (0628) 23331.

### LS1034

Shelf mounting infinite baffle enclosure with units. One 6½in bass driver, two 3⅜in tweeters. Impedance: 4 ohms. Size: 13⅞ × 7½ × 10¼in. Price: £16-59 (including VAT).

### LS1434 ★

Shelf mounting infinite baffle enclosure with units. One 8in bass driver, two 3⅜in tweeters. Impedance: 4 ohms. Size: 19¾ × 11⅞ × 10¼in. Price: £18-48 (including VAT).

### LS1638

Infinite baffle enclosure with units. One 8in bass driver, one 3in mid-range unit and one 3⅜in

tweeter. HC: 15W RMS. FR: 30Hz-18kHz. Impedance: 8 ohms. Finish: teak. Size: 19¾ × 11 × 9½in. Price: £27-49 (including VAT).

### LS1734

Infinite baffle enclosure with units and crossover. One 8in bass driver, two 3⅜in tweeters. Choke/capacitor crossover. FR: 40Hz-16kHz. HC: 10W RMS. Impedance: 4 ohms. Finish: white spray finish. Matches Dynatron HFC36 and fits stand ST21. Size: 19¾ × 11⅞ × 10¼in. Price: £18-48 (including VAT).

### LS2034

Reflex enclosure with units. One 8in bass driver, two 3⅜in tweeters. FR: 35Hz-18kHz. HC: 10W RMS. Impedance: 4 ohms. Floor-standing design in teak with padded front. Size: 26⅞ × 10¼ × 15½in. Price: £24-64 (including VAT).

### LS3034 ★

Infinite baffle enclosure with units. One 8in bass driver, two 3⅜in tweeters. Impedance: 4 ohms. Size: 26½ × 14⅜ × 12in. Price: £27-49 (including VAT).

### LS4038

Infinite baffle enclosure with units and crossover. One 12in bass driver, one 5in mid-range unit, one 1in tweeter. FR: 30Hz-20kHz. HC: 40W RMS. Impedance: 4-8 ohms. Size: 26½ × 14½ × 12in. Finish: teak veneer. Designed to match all units in Dynatron audio separates range. Price: £49-50 (including VAT).

### LS2528

Infinite baffle enclosure with units and crossover. One 8in bass driver, one 3in HF unit. FR: 30Hz-18kHz. HC: 15W RMS. Impedance: 4-8 ohms. Size: 23 × 15½ × 10in. Finish: selected walnut



Dynatron LS1434



Dynatron LS3034

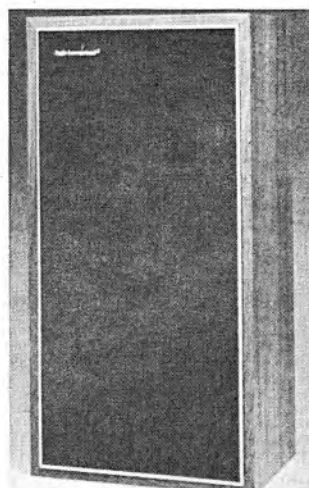

Eagle Int. AA20



## The Ultimate Draws a Little Closer

How can the qualities of the new Gale GS401A be conveyed? Not in words, certainly. To assess this new speaker, there's nothing for it but to go along to a dealer. He will tell you first that the GS401A carries a *seven* year guarantee. Then, when you've admired the handsome exterior created by Jon Bannenberg in matt black and chrome, we suggest you use some test equipment. All you have to do is take a good pair of ears. This delicate apparatus will tell you that, for a speaker only 23¼ x 13 x 10¼ inches, the GS401A combines an unusually high power handling with breathtaking clarity.

You will also need a favourite record. Preferably the one you use to impress your friends with the quality of your existing equipment. The one with prominent percussion and a wide dynamic range. We have only one serious anxiety. With the GS401A being the breakthrough it is, we worry that you simply won't believe the evidence of your ears.

# GALE

Gale Electronics & Design Limited  
39 Upper Brook Street London W1Y 1PE

# You can't have one without the other.

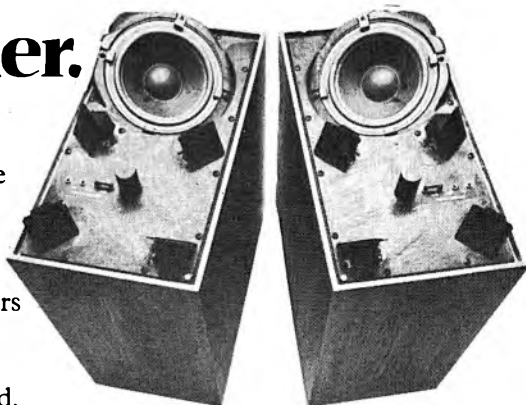

Stig Carlsson's unique Sonab speakers.

The only true ortho-acoustic speakers ever made.

They took him 16 years of research at Stockholm University. They've earned him ecstatic reviews all over the world.

You'd think Stig would have been satisfied at that.

He wasn't.

Stig reasoned that if your ears aren't identical, your speakers shouldn't be. And so he designed his new speakers in properly aligned pairs, to direct the sound.

But unlike conventional speakers, they don't just direct the sound straight at you. They reflect it off every surface, surrounding you with stereo.

So if you move towards one speaker, it doesn't drown the other. And every instrument stays exactly where it should be.

Even then, Stig wasn't happy. He wanted the frequency response curve as flat as possible, but no existing bass unit was up to it.

So he designed his own. Then he widened the frequency range and cut down the distortion . . . until he was satisfied that his new speakers were as good as they looked.

And to keep them that way, he now has each speaker electronically matched with its twin. Before they're packed together at the factory.

And now, after all the research, the testing, the quality control, Stig is finally satisfied.

At least, for the time being.

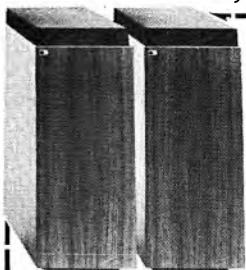

I'd like to know more about the Sonab range.  
And the name of my nearest Sonab dealer.

Name \_\_\_\_\_

Address \_\_\_\_\_

**Sonab** of Sweden

Sonab Limited, P.O. Box No. 4, Oldfield Road, Hampton, Middlesex TW12 2HN. Telephone: 01-979 0134.

veneers. Period style cabinet to match Dynatron HFC46 combination unit. Price: £36.01 (including VAT).

#### LS2638 ★

Infinite baffle enclosure with units and crossover. One 12in bass driver, one 5in mid-range unit, one 1in tweeter. FR: 30Hz-20kHz. Impedance: 4-8 ohms. Size:  $27\frac{1}{4} \times 18 \times 12\frac{1}{2}$ in. Finish: selected walnut veneer. Period style cabinet to match Dynatron HFC103 combination unit. Price: £60.50 (including VAT).

#### LS2828

Infinite baffle enclosure with units and crossover. One 8in bass driver, one 3in HF unit. FR: 30Hz-18kHz. HC: 15W RMS. Impedance: 4-8 ohms. Size:  $23 \times 14\frac{1}{2} \times 10$ in. Finish: selected walnut veneer. Period style cabinet to match Dynatron HFC47. Price: £36.01 (including VAT).

#### LS1018

Infinite baffle shelf mounting enclosure. FR: 60Hz-18kHz. Impedance: 8 ohms. HC: 15W (DIN). Size:  $7\frac{1}{4} \times 5 \times 8\frac{1}{2}$ in. Weight:  $5\frac{1}{4}$ lb. Finish: teak veneer. Price: £12.75 (including VAT).

#### LS1428

Infinite baffle enclosure. FR: 40Hz-20kHz. Impedance: 8 ohms. HC: 50W (DIN). Two drivers. Crossover: 2500Hz. Size:  $17\frac{1}{2} \times 9\frac{1}{4} \times 7$ in. Weight: 13lb. Finish: teak or walnut veneer. Price: £19.10 (including VAT).

#### LS3038

Infinite baffle enclosure. FR: 35Hz-20kHz. Impedance: 8 ohms. HC: 50W (DIN). Three drivers. Size:  $19\frac{3}{8} \times 10\frac{1}{8} \times 7\frac{3}{4}$ in. Weight:  $16\frac{1}{2}$ lb. Finish: teak veneer. Price: £29.75 (including VAT).

#### LS4138

Infinite baffle floor standing enclosure. Impedance: 8 ohms. HC: 50W (DIN). Three drivers. Finish: teak veneer. Price: £54 (including VAT).

#### LS2628

Infinite baffle enclosure in Queen Anne style. FR: 40Hz-20kHz. Impedance: 8 ohms. HC: 50W (DIN). Two drivers. Size:  $17\frac{3}{4} \times 12\frac{1}{2} \times 8$ in. Weight:  $18\frac{1}{2}$ lb. Finish: walnut with selected burr veneers. Complements period style audio separates. Price: £38.45 (including VAT).

#### LS2728

Infinite baffle enclosure in Regency style. FR: 40Hz-20kHz. Impedance: 8 ohms. HC: 50W (DIN). Two drivers. Size:  $17\frac{3}{4} \times 12\frac{1}{2} \times 8$ in. Weight: 17lb. Finish: curled mahogany veneer. Complements period audio separates. Price: £38.45 (including VAT).

#### LS3138.

Infinite baffle enclosure in Queen Anne style. Impedance: 8 ohms. HC: 50W (DIN). Three drivers. Finish: walnut with selected burr

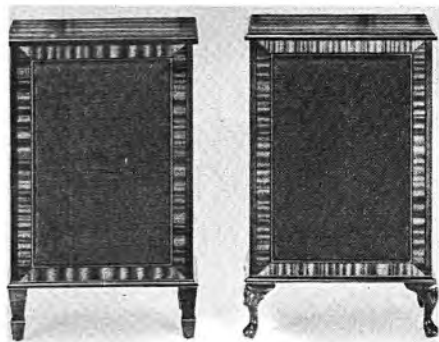

Dynatron LS2638

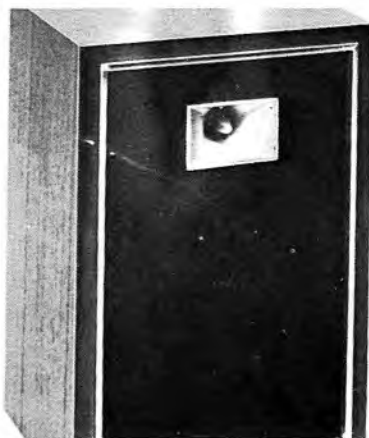

Eagle DL.67

veneers. Designed to complement HFC71 Dorchester Music Centre. Price: £83 (including VAT).

#### ■ EAGLE

Eagle International, Heather Park Drive, Wembley, Middx, HA0 1SU. Tel: 01-903 0144.

#### DL.42

Infinite baffle enclosure. FR: 40Hz-20kHz. HC: 5W RMS. One 4in high compliance unit and one cone tweeter. vci: 8 ohms. Size:  $10 \times 6 \times 6\frac{1}{2}$ in. Finish: teak and black front. Price: £17.60 (including VAT).

#### DL.67 ★

Infinite baffle enclosure. FR: 35Hz-20kHz. HC: 10W RMS. One  $6\frac{1}{2}$ in high compliance unit and one horn tweeter. vci: 8 ohms. Size:  $11\frac{1}{2} \times 8\frac{3}{8} \times 6\frac{3}{4}$ in. Finish: teak and black front. Price: £24.20 (including VAT).

#### AA16

Ported reflex enclosure. FR: 40Hz-19kHz. HC:



★ Indicates entry is illustrated

8W RMS, 16W peak. Impedance: 8 ohms. Size:  $14\frac{1}{4} \times 8\frac{3}{4} \times 6\frac{1}{2}$ in. Finish: oiled teak with charcoal grey grille. Price: (per pair) £26-40 (including VAT).

#### AA14

Infinite baffle enclosure with units and crossover. Two 8in bass drivers, two  $3\frac{3}{8}$ in mid-range units, two  $3\frac{3}{8}$ in tweeters. LC crossover: FR: 30Hz-20kHz. HC: 25W RMS. Impedance: 8 ohms. Price: £48-40 (including VAT).

#### AA20

Infinite baffle enclosure. FR: 35Hz-20kHz. Impedance: 8 ohms. HC: 15W. Two drivers. Size:  $24 \times 12 \times 8\frac{3}{4}$ in. Finish: oiled teak. Price: £33 (including VAT).

#### AA22

Infinite baffle enclosure with units and crossover. One 8in bass/mid-range driver, one 2in tweeter. Crossover: 2kHz LC network. FR: 35Hz-20kHz. HC: 15W RMS. Impedance: 8 ohms. Size:  $15\frac{1}{4} \times 10 \times 7$ in. Finish: oiled teak with stone colour grille cloth. Price: £19-80 (including VAT).

#### AA24 ★

Infinite baffle enclosure with units and crossover. One 8in bass/mid-range unit, one 2in tweeter. Crossover: 2kHz LC network. FR: 35Hz-20kHz. HC: 15W RMS. Impedance: 8 ohms. Size:  $15\frac{1}{4} \times 10 \times 7$ in. Finish: oiled teak and woven material grille cloth. Price: £19-80 (including VAT).

#### AA42 ★

Infinite baffle enclosure. FR: 25Hz-20kHz. Impedance: 8 ohms. HC: 30W. Six drivers including two 8in bass units, two  $3\frac{1}{2}$ in mid-range and two  $3\frac{1}{2}$ in tweeters. Size:  $26 \times 15\frac{1}{2} \times 11\frac{1}{2}$ in. Finish: oiled teak. Price: £59-40 (including VAT).

#### ■ EATON AUDIO FITMENTS

Leopold Street, Long Eaton, Nottingham, NG104QF. Tel: Long Eaton (060 76) 2662/2818.

##### Eaton Economy range

See Constructional Kits section for full details of Economy range of loudspeaker enclosure kits. Also details of kits to Wharfedale specifications, including Pipe kits.

Cabinets and enclosures built to customer's own designs and quotations given. Standard models can be modified to suit individual requirements where such alterations are practical.

#### ■ EDWARD MICHELSEN CUSTOM CABINETS

'Sound Ideas', 216 Brampton Road, Bexleyheath, Kent. Tel: 01-303 9272.

Manufacturers of hi-fi equipment cabinets and speaker enclosures in ready built or kit versions.

Full details on request. No product information or prices obtainable as this edition of the Year Book closed for press.

#### ■ EDWARDUS

J. R. Edwards Electronics.  
696-698 Romford Road, Manor Park,  
London, E12. Tel: 01-353 4349.

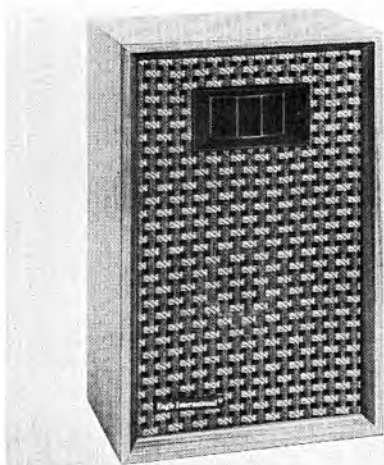

Eagle AA24

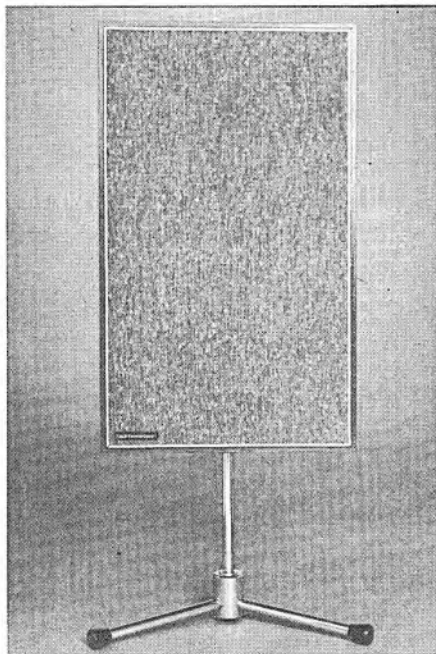

Eagle AA42

**LS 150**

Power handling capacity: 15W RMS. FR: 45Hz-17kHz. Units: Goodmans 6½in long-throw bass unit, Goodmans 3¾in mid-range treble unit. Impedance: 8 ohms. Cabinet size: 14 × 10 × 8¾in. Price: (per pair) £32.30 (including VAT).

**LS 300**

Power handling capacity: 30W RMS. FR: 30Hz-17kHz. Units: Goodmans 10in long-throw bass unit, two Goodmans 3¾in mid-range treble units. Impedance: 8 ohms. Cabinet size: 22 × 12 × 10¼in. Price: (per pair) £71.50 (including VAT).

**LS 200**

Power handling capacity: 20W RMS. FR: 35Hz-17kHz. Units: Goodmans 8in long-throw bass unit, Goodmans 3¾in mid-range treble unit. Impedance: 8 ohms. Cabinet size: 19 × 10 × 9½in. Price: (per pair) £46.20 (including VAT).

**■ FLAC**

Electro Acoustic Industries Ltd,  
Stamford Works, Broad Lane, Tottenham,  
London, N15. Tel: 01-808 0505.

Manufacturers of hi-fi speaker units and enclosures. No product information or prices obtainable as this edition of the Year Book closed for press.

**■ FLGAR**

English Audio (1970) Ltd, North Station Road,  
Colchester, Essex. Tel: Colchester(0206) 73467.

**Flgar**

Infinite baffle enclosure with units. One 12in bass driver, one 4in HF unit. HC: 25W RMS. Finish: teak. Size: 14¾ × 21¾ × 9½in. Price: approximately £35 (plus VAT).

**■ FMI**

EMI Sound & Vision Equipment Ltd.  
EMI Pathé Division,  
252 Blyth Road, Hayes, Middlesex, UB3 1HW.  
Tel: 01-573 3888. Telex: 22417.

**LF.1**

Bass reflex enclosure with unit. One 8 × 5in full range driver. Impedance: 8 ohms nominal. HC: 10W RMS. Finish: teak. Price: £33.80 (including VAT).

**LF.2**

Infinite baffle enclosure with units and crossover. One 13 × 8in bass/mid-range driver, one 3¼in tweeter. Impedance: 8 ohms. HC: 15W RMS. Finish: teak. Price: £29.50 (including VAT).

**LF.3ss**

Infinite baffle enclosure with units and crossover. Special 13 × 8in bass/mid-range driver incorporating double-wound voice coils for use in surround systems, two 3¼in tweeters. Imped-

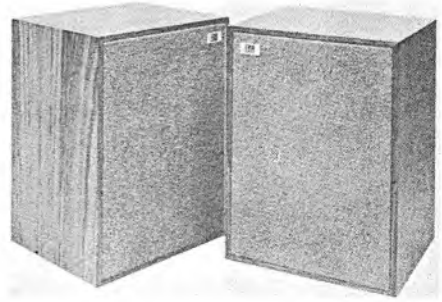

*Era High Fidelity Speaker Systems*

ance: 8 ohms nominal. HC: 15W RMS. Finish: teak. Price: £41.30 (including VAT).

**LF.4**

De luxe infinite baffle enclosure with units and crossover. One 14 × 9in bass driver, one 8 × 5in mid-range unit, two 3¼in tweeters. Impedance: 8 ohms nominal. HC: 25W RMS. Price: £63.20 (including VAT)

**■ EMPHASIS**

50a The Avenue, Kilburn, London, NW6.  
Tel: 01-451 0517.

**DB9**

Matched cube-shaped speaker enclosures. Choice of Tannoy Monitor Gold 12in or Altec Lansing 604E driver units. Size: (each cube) 24 × 24 × 24in on 6in chrome pillar. Finish: teak, rosewood, coloured lacquers or hessian. Prices: according to specification.

**■ ERA**

De Banks Electronics Ltd, Market House,  
High Street, Tring, Herts.  
Tel: Tring (044 282) 2777.

**M70**

Enclosure with crossover and units. FR: 18Hz-40kHz-3dB. Impedance: 8 ohms. HC: 20W. Two drivers. Size: 15¾ × 10 × 8½in. Finish: veneer with fabric grille. Price: (per pair) £88 (including VAT).

**M80**

Enclosure with crossover and units. FR: 20Hz-35kHz-3dB. Impedance: 8 ohms. HC: 30W. Three drivers. Size: 21¾ × 12¾ × 10in. Finish: veneer with fabric grille. Price: (per pair) £116.16 (including VAT).

**M2**

Enclosure with units and crossovers. FR: 22Hz-35kHz-3dB. Impedance: 8 ohms. HC: 30W. Three drivers. Size: 16¾ × 12¾ × 10½in. Finish: veneer with fabric grille. Price: (per pair) £102.30 (including VAT).

★ Indicates entry is illustrated

### ■ EUROTRONIC

50 Oldfield Circus, Northolt, Middlesex.  
Tel: 01-864 2254.

#### RT12

Swivel mounting enclosure with units and crossover. One 6½in bass driver, one 3½in tweeter. FR: 65Hz-20kHz. Crossover: half-section with air-cored inductors. Impedance: 8 ohms. HC: 12W RMS (20W peak). Finish: spun aluminium in natural finish. Removable front bezel to permit integrating the speaker with any decor by inclusion of materials or finish as required. Price: £16 (plus VAT).

#### RT8

Speaker system with unit. No details of price or specification as this edition of the Year Book closed for press.



Executive Audio Hi-Ball 750

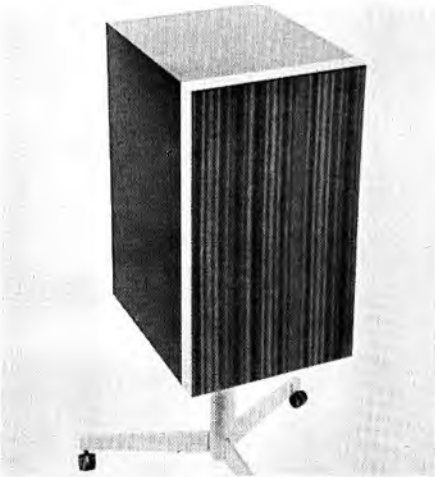

Ferrograph S1

#### RT15

Speaker system with units. No details of price or specification as this edition of the Year Book closed for press.

### ■ EXECUTIVE AUDIO

Quality Audio Supplies,  
Wollaton Road, Beeston, Notts, NG9 2PB.  
Tel: 0602 256141.

#### Hi-Ball ★

Spherical sealed enclosure. FR: 50Hz-18kHz. vci: 8 ohms. HC: 35W music. Size: 10in diameter. One drive unit, 4.5in diameter. Finish: red, orange, yellow or white with black trim, or black with silver trim. Price: (per pair) £31.35 (including VAT).

### ■ FERROGRAPH

The Ferrograph Company Ltd,  
Auriema House, 442 Bath Road, Cippenham,  
Slough, Bucks, SL1 6BB.  
Tel: Burnham (062 86) 62511. Telex: 847297.

#### Model S1 ★

Reflex system enclosure with units and crossover. One LF driver, one mid-range unit and one tweeter. 18-element steep-cutting crossover network. Impedance: 8 ohms nominal. HC: 25W RMS. FR: 45Hz-20kHz ± 3dB. Crossover: 400Hz, 3.5kHz. Size: (cabinet) 25in high, 14in wide, 17½in deep; (stand) 14½in high. Weight: (cabinet) 56lb, (stand) 6lb. Finish: simulated walnut with aluminium trim, white surround and folk weave fabric grille. Connections via recessed press terminals in rear. Price: £95 (plus VAT).

### ■ FISHER

Ideal Computer Processors Ltd,  
Breamish House, Bilton Road, Erith, Kent.  
Tel: Erith (38) 41327.

Completely new range of Fisher tuner/amplifiers, amplifiers and speakers being imported for the 1974/1975 season. No product details obtainable at the time this edition of the Year Book closed for press.

### ■ GABRAPHONE

Modern Engineering & Technology Ltd,  
4 Station Road West, Canterbury, Kent.  
Tel: Canterbury 60431.

#### 138R

Speaker enclosure with units. HC: 15W RMS. FR: 30Hz-19kHz. Full specification and details of finish not obtainable as this edition of the Year Book closed for press. Price: (per pair) £42.68 (including VAT).

#### 138S

Speaker enclosure with units. HC: 7W RMS. FR: 35Hz-17kHz. Full specification and details

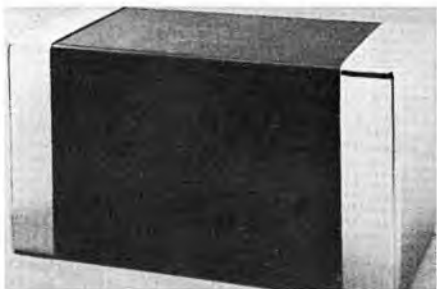

Gale GS401A

of finish not obtainable as this edition of the Year Book closed for press. Price: (per pair) £31.68 (including VAT).

**138G2**

Speaker enclosure with units. HC: 20W RMS. FR: 25Hz-20kHz. Full specification and details of finish not obtainable as this edition of the Year Book closed for press. Price: (per pair) £66.44 (including VAT).

■ **GALE**

Gale Electronics & Design Limited,  
39 Upper Brook Street, London, W1Y 1PE.  
Tel: 01-499 9966.

**GS401A**

Infinite baffle speaker system with units and crossover. Two acoustically coupled 8in bass drivers, one 4in mid-range unit, one 3/4in dome tweeter. Crossover: 475Hz, 5kHz. FR: 35Hz-25kHz  $\pm$  5dB. HC: 100W music. Impedance: 4 ohms. Mid-range and treble balance controls. Fuse protected against amplifier malfunction. Recommended for use with amplifiers of 25-100W RMS per channel. Size: 13  $\times$  23 3/4  $\times$  10 3/4 in. Weight: 52lb. Finish: black and chrome. Seven year guarantee. Price: £115 (plus VAT).

■ **GOODMANS**

Goodmans Loudspeakers Ltd,  
Downley Road, Havant, Hampshire, PO9 2NL.  
Tel: Havant (070 12) 6344. Telex: 86296.

**Double Maxim**

Infinite baffle enclosure with units and crossover. Two 4in bass drivers, one 1in dome HF tweeter. Crossover: 5kHz. FR: 40Hz-22kHz (DIN 45:500). HC: 30W (DIN). Interior volume: 9 litres. Impedance: 4 ohms. Finish: teak, walnut or white. Size: 17 3/4  $\times$  6 3/4  $\times$  7 1/2 in. Weight: 11lb. DIN connector with cable. Price: (teak or walnut) £28.84 (plus VAT); (white) £31.44 (plus VAT).

# We're old fashioned...

... we've been in business 30 years.. Selling the very best in Sound Equipment. We may not give the best discounts, but who else will give you a five year parts and labour guarantee. ... who else will install the equipment Free of charge ... who else will call at your home and offer free advice without obligation. Whoelse..?

**TYSONS**

41 Russell St., Leamington Spa, Warwickshire  
Telephone:-  
Showrooms (0296) 24935  
Workshops (0296) 35273  
After hours service (0296) 25758  
After hours sales (0203) 593727

**TYSONS**  
(Leamington)

for sound advice.



Open 10 - 5p.m. Mon to Sat.

Demonstrations (Only) by appointment Sundays.

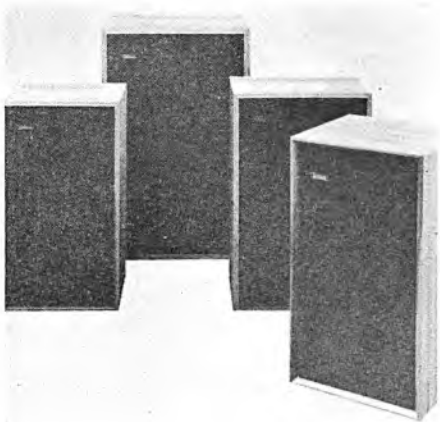

*Goodmans Havant SL, Magnum SL, Mezzo SL and Minister SL*

**Havant SL ★**

Reflex enclosure with units and crossover. One 8in bass driver, one 3 $\frac{3}{8}$ in mid-range unit, one 1in dome tweeter. Crossovers: 2kHz and 8kHz. Interior volume: 18 litres FR: 45Hz-22kHz (DIN 45:500). HC: 20W (DIN). Impedance: 8 ohms. Finish: teak, walnut or white. Size: 19 × 10 $\frac{1}{2}$  × 9 $\frac{3}{4}$ in. Weight: 18 $\frac{3}{4}$ lb. DIN connector with cable. Price: (teak or walnut) to be announced.

**Mezzo SL ★**

Reflex enclosure with units and crossover. One 10in bass driver, one 1 $\frac{1}{2}$ in dome tweeter. Crossover: 2kHz. FR: 40Hz-22kHz. HC: 60W (DIN). Impedance: 4-8 ohms. Size: 24 $\frac{1}{2}$  × 15 × 11 $\frac{3}{8}$ in. Finish: teak or walnut. Price: to be announced.

**Magnum SL ★**

Infinite baffle enclosure with units and crossover. One 12in bass driver, 4in back-loaded mid-range unit, 1in dome tweeter. Crossover: 2kHz and 6kHz. FR: 35Hz-22kHz. HC: 60W (DIN). Impedance: 4-8 ohms. Size: 24 $\frac{1}{2}$  × 15 × 11 $\frac{3}{8}$ in. Finish: teak or walnut. Price: to be announced.

**Magister**

Infinite baffle enclosure with three units and crossovers. One 15in bass driver, one 4in mid-range unit, one 1in dome tweeter. Crossovers: 800Hz and 5kHz. FR: 26Hz-22kHz. HC: 50W (DIN). Impedance: 4-8 ohms. Finish: teak or walnut. Size: 27 × 20 × 14 $\frac{1}{4}$ in. Price: £65-63 (plus VAT).

**Minister SL**

Bookshelf enclosure with units and crossover. 8in bass driver with plastic coated diaphragm, dome type tweeter. HC: 20W (DIN). Impedance: 4-8 ohms. FR: 45Hz-22kHz. Finish: teak or walnut. Size: 19 × 10 $\frac{1}{2}$  × 9 $\frac{3}{4}$ in. Supplied in matched pairs. Price: to be announced.

**Dimension 8 ★**

Mass-loaded reflex enclosure with units and crossover. One slave radiator, four 5in bass drivers, two 4in mid-range units, two 1in dome tweeters. Crossovers: 80Hz, 800Hz, 4kHz. FR: 30Hz-22kHz (DIN 45:500). HC: 60W. Minimum amplifier power: 10W. Interior volume: 40 litres. Impedance: 4 ohms. Finish: teak, walnut or white. Size: 30 $\frac{1}{2}$  × 14 × 12 $\frac{1}{2}$ in. Weight: 44lb. Price: (teak or walnut) £72-44 (plus VAT); (white) £78-76 (plus VAT).

**Dimension 8 Series 2**

Reflex enclosure of same shape as original version with additional drive units. No further details at time of going to press. Price: on application.

**Achromat 400**

Infinite baffle producing optimum performance when mounted on separate stand (CS3). FR: (DIN) 40Hz-22kHz. Impedance: 8 ohms. Size: 26 × 11 $\frac{3}{4}$  × 13in. Weight: 36lb. Three drivers. Crossovers: 900Hz and 3-5kHz. Sensitivity for 96dB: 12W. Teak, walnut or white finish. Price: to be announced.

**Goodwood**

Floor-standing infinite baffle enclosure with units and crossover. One 12in bass driver, one 4in mid-range unit, one 1in dome tweeter. Crossover: 600Hz, 4kHz. FR: 40Hz-22kHz. HC: 50W (DIN). Impedance: 4-8 ohms. Size: 30 × 14 $\frac{1}{2}$  × 10 $\frac{3}{4}$ in. Finish: teak, white or walnut. Price: (teak or walnut) £72-44 (plus VAT); (white) £78-76 (plus VAT).

■ **GRIFFIN**

H. K. Griffin & Co (Electronics), Siddons Factory Estate, Howard Street, West Bromwich, Staffs. Tel: (021 556) 0559/0752.

**Type 15C**

Reflex enclosure. Units: KEF B110, STC 4001. Crossover: 5-4kHz. FR: 55Hz-18kHz (±4dB). Sensitivity: 10W pink noise for 96dB. HC: 20W. Impedance: 8 ohms. Cylindrical shape 11 $\frac{1}{2}$ in diameter. Finish: brown leatherette. Price: £52-60 (including VAT).

**Type 15**

Description as for type 15C but sensitivity: 8W pink noise for 96dB. FR: 48Hz-18kHz (±4dB). HC: 20W.

**Type 25**

Reflex enclosure. Units: KEF 3200, modified T15, STC 4001G. Crossover: 1-8kHz and 5-8kHz. FR: 35Hz-22kHz (±4dB). Sensitivity: 10W pink noise for 96dB. HC: 30W. Impedance: 8 ohms. Size: 18 $\frac{3}{4}$  × 10 $\frac{3}{8}$  × 9 $\frac{3}{8}$ in. Weight: 23lb. Finish: teak, walnut, white or black. Price: (teak) £88-44; (walnut and white) £94-60; (black) £88-44 (including VAT).

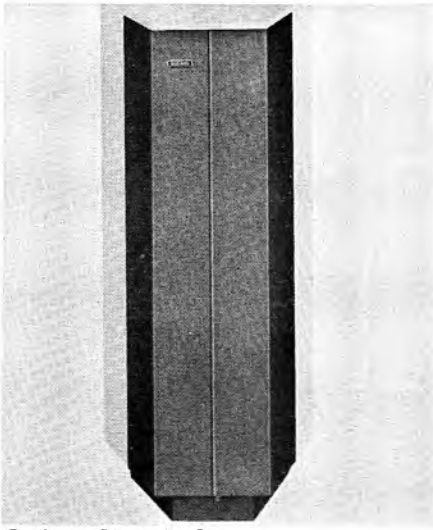

Goodmans Dimension 8



Grundig Troika 7301

**Type 27**

Twin-port reflex, mirror matched. Units as for Type 25. Crossover: 1.8kHz and 6.2kHz. FR: 30Hz-25kHz  $\pm$  3dB. Sensitivity: 4.5W pink noise for 96dB. HC: 35W. Impedance: 8 ohms. Size: 24  $\times$  12  $\times$  10in plus stand. Weight: 35lb. Finish: teak or walnut. Price: (less stand) £122.68 (including VAT).

**Type 85**

Tandem line system (Patented). Units: low resonance KEF B200 infra-bass unit, KEF B139 bass, Celestion HF 500 or Griffin titanium dome 2in unit, STC 40019. Active crossover using ICs. FR: 100Hz-20kHz  $\pm$  1.5dB. Size: 31  $\frac{1}{2}$   $\times$  13  $\times$  12in. Stand: 12in high. Weight: 110lb. Finish: teak. Price: (per pair) £436 (including VAT).

**■ GRUNDIG**

Grundig (Great Britain) Ltd, Hi-Fi Division, Newlands Park, London, SE26 5NQ. Tel: 01-659 2468.

**Troika 7301 ★**

Comprises two separate omni-directional tweeter systems and one bass enclosure. Two drivers in bass enclosure, six tweeters in each

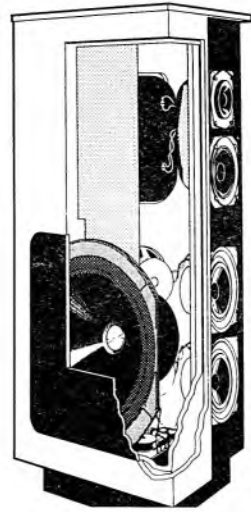

Goodmans Dimension 8 (cut-away)

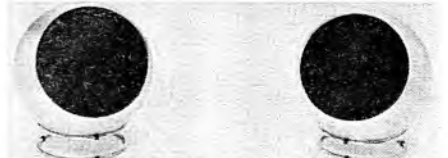

Grundig Speaker System 210a

treble cube. HC: 25W RMS. FR: 40Hz-20kHz. vci: 5 ohms. Finish: matt walnut. Sizes: bass enclosure 21  $\times$  13  $\frac{3}{4}$   $\times$  5in; treble cubes 5  $\frac{1}{2}$   $\times$  5  $\frac{1}{2}$   $\times$  5  $\frac{1}{2}$ in. Price: (complete system) £121.40 (including VAT).

**Troika 3012**

Infinite baffle enclosure with units and crossover. One "Box 301" bass unit, Sphere 300 mid-range and treble unit. Crossover: 400Hz. FR: 40Hz-20kHz. HC: 25W. Impedance: 4-5 ohms. Size: (bass unit) 21  $\times$  13  $\frac{3}{4}$   $\times$  5in, (HF Sphere) 5  $\frac{1}{2}$ in diameter. Weight: (bass unit) 25  $\frac{1}{2}$ lb, (HF Sphere) 3lb. Finish: (bass unit) light matt plus fabric grille, (HF Sphere) black with four circular grilles. Sphere 300 stands on a tripod, total height 10in. Price: £113.15 (including VAT).

**106M**

Infinite baffle enclosure with unit. One full-range 5in driver. FR: 70Hz-12kHz. HC: 6W. Impedance: 4 ohms. Size: 11  $\frac{3}{8}$   $\times$  7  $\frac{1}{2}$   $\times$  4in. Weight: 5  $\frac{1}{2}$ lb. Finish: light matt wood effect. Supplied in pairs. Price: £39.70 per pair (including VAT).

**210a ★**

Infinite baffle enclosure with units and cross-

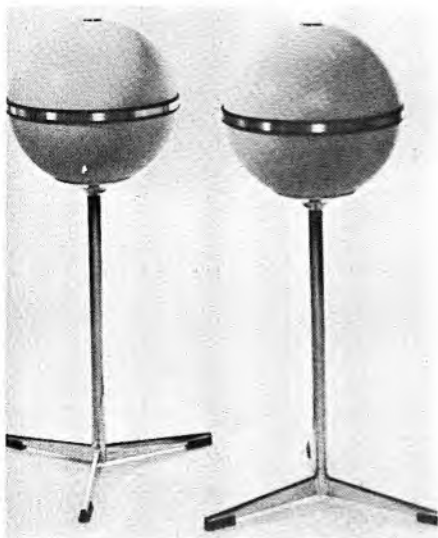

Grundig System Audiorama 7000

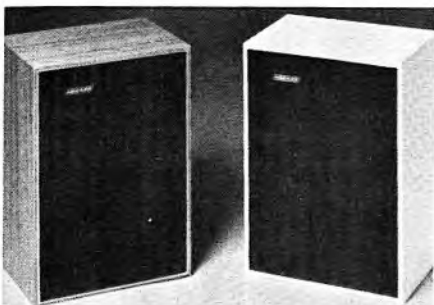

Hacker LS250

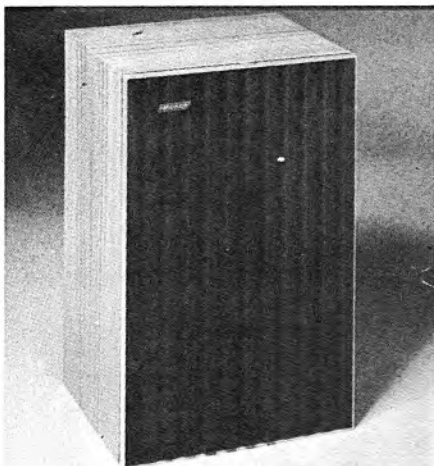

Hacker LS1100

over. One bass/mid-range driver, one tweeter. Crossover: 4.5kHz. FR: 50Hz-20kHz. HC: 15W RMS. Impedance: 4 ohms. Size: 7½ in diameter. Weight: 5½ lb. Finish: satin metal with black grille. Supplied in pairs. Optional free-standing, wall mounting or ceiling suspended. Price: £51.10 per pair (including VAT).

**303M**

Infinite baffle enclosure with units and crossover. Two bass/mid-range drivers, one tweeter. Crossover: 4kHz. FR: 45Hz-20kHz. HC: 25W RMS. Impedance: 4 ohms. Size: 20 × 13⅜ × 3½ in. Weight: 19lb. Finish: white with fabric front. Slim-line cabinet, ideal for wall mounting. Supplied in pairs. Price: £84.95 per pair (including VAT).

**Audiorama 7000 ★**

Infinite baffle enclosure with units and crossover. Four bass drivers and eight treble units in each enclosure. Crossover: 3.5kHz. FR: 40Hz-20kHz. HC: 50W RMS. Impedance: 4 ohms. Size: 12¼ in. diameter. Weight: 30lb. Finish: white sphere with chrome stand (black sphere to special order). Omni-directional sound radiation. Supplied in pairs and with optional ceiling suspension chains. Price: £281.25 per pair (including VAT).

**■ HACKER**

Hacker Radio Ltd, Norrey's Drive, Cox Green, Maidenhead, Berks, SL6 4BP.  
Tel: Maidenhead (0628) 22261.

**LS250 ★**

Infinite baffle enclosure. FR: 100Hz-17kHz ± 3dB. Impedance: 8 ohms. HC: 10W. Two drivers. Crossover: 2.8kHz. Res. frequency: 96Hz. Finish: teak or white. Size: 14½ × 10 × 7⅛ in. Price: (teak) £21; (white) £22 (including VAT).

**LS550**

Infinite baffle enclosure. FR: 85Hz-17kHz ± 3dB. Impedance: 8 ohms. HC: 15W. Two drivers. Crossover: 2.5kHz. Res. frequency: 85Hz. Size: 16½ × 10⅞ × 8½ in. Finish: teak. Price: £25.50 (including VAT).

**LS1100 ★**

Infinite baffle enclosure. FR: 78Hz-17kHz ± 3dB. Impedance: 8 ohms. HC: 25W. Crossover: 1.7kHz and 4.7kHz. Res. frequency: 55Hz. Size: 20¼ × 13⅜ × 11¼ in. Finish: teak. Price: £35 (including VAT).

**LS1300**

Infinite baffle enclosure. FR: 38Hz-21kHz ± 2dB. Impedance: 8 ohms. HC: 35W. Three drivers including dome tweeter and pressurised mid-range speaker. Crossover: 550Hz and 3.5 kHz. Res. frequency: 48Hz. Size: 24½ × 15⅜ × 12in. Finish: teak. Price: to be announced.

**LE.3ss**

Infinite baffle enclosure and units designed for surround sound from standard stereo equipment. Incorporates special 13 × 8in bass driver with double-wound voice coil to give simulated four-channel sound. Two 3½in tweeters. Impedance: 8 ohms. HC: 15W RMS. Finish: teak. Price: £41.30 (including VAT).

**HANIMEX**

Hanimex (UK) Ltd, Hanimex House, Dorcan, Swindon, Wilts, SN3 5HW. Tel: Swindon (0793) 26211.

New range of hi-fi speaker systems to be introduced under the Hanimex brand name. No details of models available as this edition of the Year Book closed for press.

**HEATHKIT**

See Constructional Kits Section.

**HELME**

Helme Audio Products Ltd, Summerbridge, Harrogate, Yorks, HG3 4DR. Tel: Darley (042 372) 279.

Restyled high-fidelity speaker systems finished in teak. 3 systems also available in kit form. All systems are infinite baffle and have 8 ohms impedance.

**Firecrest ★**

Houses 6½in bass driver with two 2in tweeters. Crossover: 2.4kHz. FR: 45Hz-22kHz. HC: 20W RMS. Dimensions: 14 × 9 × 7½in. Price: £48.80 per pair (plus VAT).

**Swallow ★**

Houses an 8in bass unit and two 2½in tweeters. Crossover: 2.5kHz. HC: 50W. FR: 35Hz-22kHz. Dimensions: 20 × 11 × 9in. Price: £67.80 per pair (plus VAT).

**Helme XLS-25**

Houses 8in bass driver and 3in tweeter. Crossover: 4kHz. HC: 25W (DIN). FR: 45Hz-40kHz. Dimensions: 22½ × 12½ × 10in. Speaker drive units and crossover also offered as a kit under reference XLK-25. Prices: (XLS-25) £63.18 per pair (plus VAT); (XLK-25) £23.18 per pair (plus VAT).

**Helme XLS-30**

Houses 8in bass driver with plastic treated cone and 4in tweeter. Crossover: 5.5kHz. HC: 30W (DIN). FR: 55Hz-18kHz. Dimensions: 20 × 11 × 9in. Price: (per pair) £48.18 (plus VAT). Also available as kit under reference XLK-30 at £13.59 per pair (plus VAT).

**Helme XLS-50**

Houses 13 × 8in bass driver with Bextrene cone and 3in tweeter. Crossover: 5kHz. HC: 50W (DIN). FR: 30Hz-45kHz. Dimensions: 22½ ×

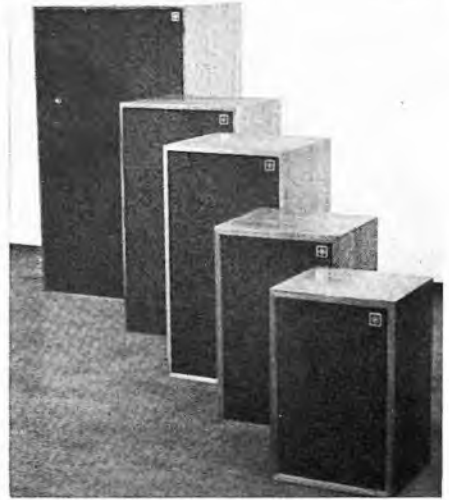

*Helme Speaker Systems*

12½ × 10in. Speaker drive units and crossover also offered as a kit under reference XLK-50. Prices: (XLS-50) £81.36 per pair (plus VAT); (XLK-50) £41.36 per pair (plus VAT).

**HITACHI**

Hitachi Sales (UK) Ltd, New Century House, Coronation Road, Park Royal, London, NW10 7QN. Tel: 01-965 9861.

**HS-220T**

Infinite baffle enclosure with units and crossover. One 8in bass driver, one 2½in tweeter. FR: 40Hz-20kHz (-15dB). Crossover: 4kHz. Impedance: 8 ohms. HC: 8W RMS. Size: 11 × 19½ × 9½in. Weight: 15¼lb. Price: (per pair) £55 (including VAT).

**HS-320**

Reflex enclosure with units and crossover. One 8in bass driver, one horn-type tweeter. Crossover: 4kHz. FR: 35Hz-20kHz (-15dB). Impedance: 8 ohms. HC: 8W RMS. Size: 12¾ × 22¼ × 9¾in. Weight: 24lb. Price: £39.90 (including VAT).

**HS-420**

Reflex enclosure with units and crossover. One 9¾in bass driver, one 5in mid-range unit, one horn-type tweeter. Crossover: 2kHz, 8kHz. FR: 30Hz-20kHz (-15dB). Impedance: 8 ohms. HC: 15W RMS. Size: 14½ × 26½ × 9¾in. Weight: 33lb. Price: £52 (including VAT).

**HS-350**

Ducted port two-way speaker system with units and crossover. One 8in bass driver, one tweeter. Crossover: 3.5kHz. Impedance: 8 ohms.



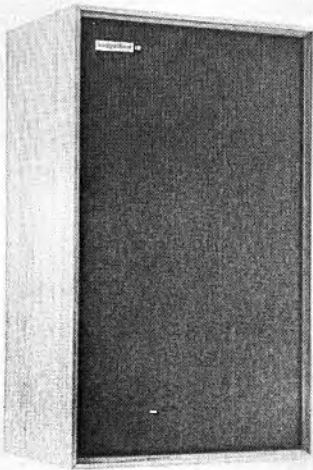

Howland-West Budgetline 12

FR: 40Hz-20kHz. HC: 20W RMS. Size:  $14\frac{3}{8} \times 23\frac{3}{8} \times 9\frac{3}{8}$ in. Weight: 33lb. Finish: walnut veneer. Price: £79 (including VAT).

#### HS1400W

Four-way speaker system with units and crossover. One 8in super bass driver, one 8in bass driver, one 5in mid-range unit, one horn type tweeter. Crossover: 100Hz, 1.5kHz, 5kHz. FR: 35Hz-20kHz. Impedance: 8 ohms. HC: 8W RMS. High-level three-position attenuator, mid-level two-position attenuator. Size:  $17\frac{1}{2} \times 45\frac{1}{2} \times 14\frac{1}{2}$ in. Weight: 62lb. Finish: walnut veneer. Price: £129 (including VAT).

#### HS500

Reflex enclosure with units and crossover. One 8in bass driver, one horn tweeter. Crossover: 3kHz. Impedance: 8 ohms. FR: 25Hz-20kHz. HC: 20W RMS. Size:  $14\frac{1}{2} \times 24 \times 13\frac{3}{4}$ in. Weight: 48lb. Price: £139 (including VAT).

#### ■ HOWLAND-WEST

Howland-West Ltd, 3-5 Eden Grove, London, N7 8EQ. Tel: 01-609 0293.

#### Budgetline 12 ★

Infinite baffle enclosure with units. One 12in bass driver, one  $3\frac{3}{8}$ in coaxially mounted tweeter. Crossover: 5kHz. FR: 40Hz-18kHz. HC: 20W RMS. Impedance: 8 ohms. Size:  $20 \times 12 \times 8\frac{1}{2}$ in. Finish: teak. Price: £19.80 (including VAT).

#### ■ IMF

IMF Electronics Ltd, Westbourne Street, High Wycombe, Bucks. Tel: High Wycombe (0494) 35166.

#### ALS40

Active line enclosure with units and crossover. One 8in foam-surround bass driver, one 8in

sub-bass driver, one 5in impregnated cone mid-range unit, one soft dome tweeter. Crossover: 180Hz, 375Hz and 3kHz. FR: 28Hz-20kHz. HC: 25-60W (40W pink noise for 100dB). Impedance: 8 ohms. Size:  $13\frac{1}{2} \times 13\frac{1}{2} \times 26\frac{1}{2}$ in high. Weight: 46lb. Finish: teak or walnut. Price: (per pair) £165.04 (including VAT).

#### Studio TLS50

Transmission line enclosure with units and crossover. One 8in bass driver, one 5in mid-range unit, one  $1\frac{1}{8}$ in soft dome tweeter, one  $\frac{3}{4}$ in chemical dome super tweeter. Crossover: 375Hz, 3kHz, 13kHz. FR: 23Hz to beyond audibility. HC: 25-60W RMS (50W pink noise for 100dB). Impedance: 8 ohms. Size:  $36 \times 14 \times 15$ in. Weight: 72lb. Finish: teak or walnut. Price: (per pair) £203.28 (including VAT).

#### Professional Monitor

Transmission line enclosure with units and crossover. One  $13 \times 9\frac{1}{2}$ in flat polystyrene bass driver, one 6in plastic cone mid-range unit, one  $1\frac{1}{4}$ in chemical diaphragm tweeter, one  $\frac{3}{4}$ in chemical dome super tweeter. Crossover: 375Hz, 3.5kHz, 13kHz. FR: 17Hz to beyond audibility. HC: 25-100W RMS (25W pink noise for 100dB). Impedance: 8 ohms. Size:  $42 \times 17\frac{1}{2} \times 19\frac{1}{2}$ in. Weight: 140lb. Finish: Formica laminates in woodgrain and plain colours. Fitted with castors. Price: (per pair) £423.50 (including VAT).

#### ■ IMHOFS

Imhofs Ltd, 112-116 New Oxford Street, London, WC1A 1HJ. Tel: 01-636 7878.

#### Junior Mk II

Infinite baffle enclosure with units.  $13 \times 8$ in bass driver, 3in treble unit. Crossover: 5kHz. FR: 50Hz-20kHz. HC: 10W RMS. Impedance: 8 ohms. Finish: teak veneer with forest green grille. Size:  $12\frac{1}{2} \times 24 \times 9\frac{1}{2}$ in. Weight: 15lb. Price: £18 (including VAT).

#### IM.50

Infinite baffle enclosure with unit. One  $6\frac{1}{2}$ in dual-cone full-range driver. FR: 55Hz-16kHz. HC: 10W RMS. Impedance: 8 ohms. Size:  $10\frac{3}{4} \times 8 \times 5\frac{1}{2}$ in. Weight:  $6\frac{1}{2}$ lb. Finish: teak veneer with forest green grille. Price: (per pair) £25 (including VAT).

#### IM.100 ★

Infinite baffle enclosure with units.  $13 \times 8$ in bass driver,  $1\frac{1}{2}$ in treble unit. Crossover: 1kHz. FR: 50Hz-20kHz. HC: 25W. Impedance: 8 ohms. Finish: teak veneer with forest green grille. Size:  $11\frac{3}{4} \times 19 \times 7\frac{1}{2}$ in. Weight: 15lb. Price: £27 (including VAT).

#### IM.200

Infinite baffle enclosure with units.  $13 \times 9$ in bass driver,  $1\frac{1}{2}$ in treble unit. Crossover: 1kHz. FR:

## SPEAKER ENCLOSURES

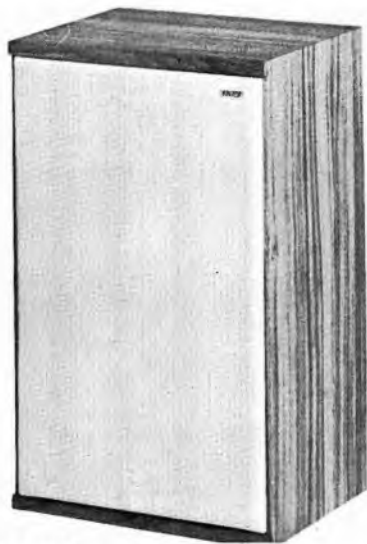

Imhof 1M.100



Isophon-Werke Isonetta



Isophon-Werke HSB6001

40Hz-20kHz. HC: 25W. Impedance: 8 ohms. Finish: teak with forest green grille. Size:  $15\frac{1}{4} \times 24\frac{1}{4} \times 10\frac{1}{4}$  in. Weight: 28lb. Price: £40 (including VAT).

### ■ INTERAUDIO

Expotus Ltd,  
10 Museum Street, London, WC1.  
Tel: 01-836 3747.

#### 1000

Infinite baffle bookshelf enclosure. Impedance: 4 ohms. HC: 40W RMS. Crossover: 2200Hz. Two drivers. Size:  $14 \times 9 \times 7$  in. Finish: walnut. Price: (per pair) £56.10 (including VAT).

#### 2000

Infinite baffle bookshelf enclosure. Impedance: 8 ohms. HC: 60W RMS. Crossover: 1900Hz. Two drivers. Size:  $20 \times 12 \times 8$  in. Finish: Walnut. Price: (per pair) £78.70 (including VAT).

#### 3000

Infinite baffle shelf/floor enclosure. Impedance: 8 ohms. HC: 75W RMS. Crossover: 1800Hz. Three drivers. Size:  $21\frac{1}{2} \times 13\frac{1}{2} \times 9$  in. Finish: walnut. Price: (per pair) £139.92 (including VAT).

#### 4000

Infinite baffle enclosure. Impedance: 4 ohms. HC: 100W RMS. Crossover: 1700Hz. Three drivers. Size:  $25\frac{1}{2} \times 15\frac{1}{2} \times 11\frac{1}{2}$  in. Finish: walnut. Price: (per pair) £139.92 (including VAT).

### ■ ISOPHON-WERKE

Hayden Laboratories Ltd, Hayden House,  
17 Chesham Road, Amersham, Bucks,  
HP6 5AG. Tel: Amersham (0240 3) 5511.

#### Isonetta ★

Spherical enclosure with unit. One full-range  $2\frac{5}{8}$  in unit. FR: 200Hz-20kHz. HC: 5W. Impedance: 5 ohms. Size:  $3\frac{1}{2}$  in diameter. Weight: 12oz. Finish: white, black, red, orange. Scratch resistant finish. Price: £8.50 (plus VAT).

#### Hi-Fi Ball

Spherical enclosure housing high-frequency unit. Designed for use with other speaker systems. One  $3\frac{1}{2}$  in tweeter unit. FR: 3kHz-20kHz. For use with up to 50W systems. Impedance: 8 ohms. Size:  $3\frac{1}{2}$  in diameter. Weight:  $1\frac{3}{4}$  lb. Finish: white or black with white base. Price: £12.55 (plus VAT).

#### KSB1801

Bookshelf enclosure with units and crossover. One  $5\frac{1}{8}$  in bass driver, one  $3\frac{1}{4}$  in tweeter. FR: 48Hz-20kHz. HC: 10W. Impedance: 5 ohms. Size:  $6\frac{3}{4} \times 9\frac{5}{8} \times 7\frac{1}{4}$  in. Weight: 7lb. Finish: walnut. Price: £18.80 (plus VAT).

#### Luna 2000 ★

Spherical enclosure housing six high-frequency units. Six  $2\frac{5}{8}$  in tweeters. FR: 2kHz-20kHz.

★ Indicates entry is illustrated

HC: with systems up to 100W. Impedance: 6 ohms. Size: 6½ in diameter. Weight: 4lb. Finish: white with black metal grille. Works with TMB4501 as part of speaker system. Each half of drum can be rotated for optimum results. Price: £44.88 (plus VAT).

#### **Prominent 2002**

Speaker enclosure with units and crossover. 12in bass driver, 8in mid-range unit and two tweeters. FR: 25Hz to over 20,000Hz. HC: 70W. Impedance: 8 ohms. Size: 15 × 19½ × 16½ in. Weight: 60lb. Finish: walnut or matt black. Price: to be announced.

#### **HSB5001 ★**

Speaker enclosure with units and crossover. One 8in bass driver, one 4in mid-range unit, one dome tweeter. FR: 35Hz to over 20kHz. HC: 30W. Impedance: 8 ohms. Size: 18½ × 13¼ × 8¾ in. Weight: 23lb. Finish: walnut or white with black metal grille. Price: (walnut) £66.68 (plus VAT); (white) £68.51 (plus VAT).



*Isophon-Werke Luna 2000*



*Isophon-Werke HSB5001*

#### **FSB5002**

Speaker enclosure with units and crossover. One 8in bass driver, one 4in mid-range unit, one dome tweeter. FR: 45Hz to over 20kHz. HC: 30W. Impedance: 8 ohms. Size: 18½ × 13¼ × 5¾ in. Weight: 19lb. Finish: walnut or white with black metal grille. Price: (walnut) £63.93 (plus VAT); (white) £65.76 (plus VAT).

#### **HSB6001 ★**

Speaker enclosure with units and crossover. Three 5½ in bass drivers, one 7 × 5in mid-range unit. FR: 35Hz-20kHz. HC: 40W. Impedance: 8 ohms. Size: 20½ × 9¾ × 9in. Weight: 24lb. Finish: walnut or white lacquer, with metal grille. Price: (walnut) £61.65 (plus VAT); (white) £63.08 (plus VAT).

#### **HSB7501**

Speaker enclosure with units and crossover. One 12in bass driver, one 7 × 5in mid-range unit, two 2½ in tweeters. FR: 25Hz to over 20kHz. HC: 50W. Impedance: 8 ohms. Size: 26⅝ × 13¼ × 10⅝ in. Weight: 41lb. Finish: walnut with metal front grille. Price: £97.90 (plus VAT).

#### **HSB9001**

Speaker enclosure with units and crossover. 12in bass driver, 8in mid-range unit and two tweeters. FR: 25Hz to over 20,000Hz. HC: to 70W. Impedance: 8 ohms. Size: 26¼ × 17 × 12in. Weight: 54lb. Finish: walnut. Price: to be announced.

#### **HSB3504**

Speaker enclosure with units and crossover. One 6½ in bass driver, one dome tweeter. FR: 48Hz to over 20kHz. HC: 20W. Impedance: 8 ohms. Size: 16½ × 8½ × 8¼ in. Weight: 12lb. Finish: walnut with black metal grille. Price: £45.43 (plus VAT).

#### **TMB4501**

Speaker enclosure with bass driver. One 9¾ in bass driver unit. FR: 35Hz-2kHz. HC: 30W. Impedance: 5 ohms. Size: 18½ × 13¼ × 8¾ in. Weight: 23lb. Finish: white or orange with black metal grille. Works in conjunction with Luna 2000 as part of a complete system. Price: £64.30 (plus VAT).

#### **FSB4502**

Speaker enclosure with units and crossover. One 9¾ in bass driver, one 7 × 5in mid-range unit. FR: 40Hz-20kHz. HC: 30W. Impedance: 8 ohms. Size: 21⅝ × 12⅝ × 5¼ in. Weight: 21lb. Finish: walnut with metal grille. Price: £60.94 (plus VAT).

#### **■ ITT**

ITT Consumer Products (UK) Ltd,  
Maidstone Road, Sidcup, Kent, DA14 5HT.  
Tel: 01-300 7733.

**KS 662**

4in round unit, in simulated wood bookshelf-type cabinet with slots running vertically down front. Handles 6W. Available in teak or rose-wood finish. Price: £12 (including VAT).

**KS 661**

4in round unit, 4 or 16 ohms, 12W handling capacity, in teak-grain appearance cabinet 382mm high. Impedance change-over switch incorporated. Price: £22.50 (including VAT).

**KS658W ★**

White-finished cabinets. 456mm high house 6½in bass unit and a treble speaker. Power handling is 15W, with 8 ohms impedance. Control for treble response incorporated. Price: £27.94 (including VAT).

**KS 665**

Teakgrain appearance cabinets, 456mm high house 6½in bass unit and a treble speaker, for which a separate control is fitted. Of 8 ohms impedance, the KS 665 handles 15W. Price: £31.50 (including VAT).

**KS 666**

A three-unit combination, this latest addition to the ITT speaker range, with modern thin-edge-front styling, has an impedance of 4 ohms and handles 18W. The teak-appearance cabinet is

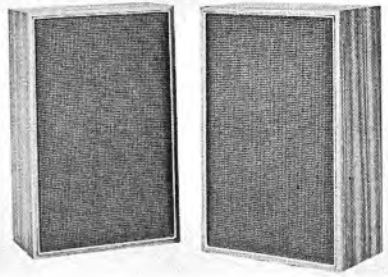

ITT KS658W

698mm high and accommodates a 6½in bass unit, another for mid-range measuring 6 × 4in, and a 3½in tweeter. Price: £57 (including VAT).

**KS 660**

Largest and most powerful in the ITT loud-speaker range, the KS 660 stands 705mm high and the teakgrain-appearance cabinet houses a 12in bass unit, a 6 × 4in mid-range speaker, and a 3½in tweeter, with a combined impedance of 4 ohms and handling power of 20W. Price: £74.80 (including VAT).



**Perfect performance every time**

If you demand the finest sound reproduction, you can't afford to skimp on speakers.

K.F. produce a range of hand-made hi-fi speakers to the highest technical specifications, designed with good looks very much in mind, yet modestly priced.

But the true test of any hi-fi system is how close it comes to reproducing the original sound. K.F. speakers are made to complement amplifiers and transcription decks or tape recorders of the highest quality to give you performance as perfect as is technically possible.

Ask an audio specialist for a K.F. demonstration. You'll hear what we mean.

**The ultimate in contemporary sound.**



RF20.  
A two-unit speaker system with MF balance control. 40 watts music power. Impedance 8 ohms.



For further information and address of your local stockist write to:  
K.F. Products Ltd., Ashton Road, Bredbury, Stockport, Cheshire.



Jordan-Watts Juno



Jordan-Watts Gemini

## ■ JORDAN-WATTS

Jordan-Watts Ltd, Benlow Works,  
Silverdale Road, Hayas, Middlesex, UB3 3BW.  
Tel: 01-573 6928.

### GT

Reflex enclosure. One Jordan-Watts module and HF dome tweeter. Treble control fitted. FR: 30Hz-22kHz. HC: 15W. Finish: teak. Price: £42.24 (including VAT).

### Jodrell

Reflex enclosure. Twin Jordan-Watts module. Treble control fitted. FR: 40Hz-22kHz. HC: 30W. Finish: teak. Weight: 56lb. Price: £60.72 (including VAT).

### Jumbo

Infinite baffle. Power handling 12W. Forward facing. Shelf or wall mounting. Incorporates one Jordan-Watts modular unit. FR: 70Hz-20kHz. Size: 16½ × 8 × 3½ in. Weight: 13lb. Finish: teak. Price: £26.07 (including VAT).

### Janet

Infinite baffle. One full-range Jordan-Watts module. FR: 70Hz-20kHz. HC: 12W RMS. Compact shelf-mounting full range speaker system. Finish: teak with green Vynair. Size: 12 × 8 × 6½ in. Weight: 13lb. Price: £26.07 (including VAT).

### Juno ★

Reflex enclosure. Power handling 12W. Forward facing. Incorporates one Jordan-Watts modular unit. FR: 40Hz-20kHz. Size: 24½ × 12½ × 6½ in. Weight: 27lb. Price: £34.65 (including VAT).

### Juliet

Reflex cabinet. One full-range Jordan-Watts module. FR: 40Hz-20kHz. HC: 12W RMS. Compact shelf-mounting full range speaker system. Finish: teak with green Vynair. Size:

16 × 10 × 9 in. Weight: 28lb. Price: £33.99 (including VAT).

### Gemini ★

Reflex enclosure. Power handling 25W. Forward facing. Incorporates two Jordan-Watts modular units. FR: 40Hz-20kHz. Size: 30 × 13½ × 7½ in. Weight: 50lb. Price: £52.80 (including VAT).

### Jupiter

Reflex enclosure. Power handling 25W. Forward facing. Incorporates two Jordan-Watts modular units. FR: 20Hz-20kHz. Size: 34 × 15 × 10½ in. Weight: 70lb. Price: £79.52 (including VAT).

### Jupiter TLS/ABR

Transmission line speaker system. HC: 30W. Forward-facing. Incorporates two Jordan-Watts modular units. Treble control incorporated. Enclosure lined with sheet lead. FR: 30Hz-22kHz. Size: 34½ × 15 × 10½ in. Weight: 80lb. Price: £108.90 (including VAT).

### Flagon

Ceramic infinite baffle loudspeaker. 65Hz-20kHz. HC: 15W. Exclusive decorative pottery enclosure. Size: 14½ in diameter. Weight: 16lb. Price: £41.25 (including VAT).

## ■ JVC

JVC (UK) Ltd, 453 Caledonian Road,  
London, N7 9BA. Tel: 01-607 6568.

### GB-1ED

Omni-directional speaker system suitable for suspension from a ceiling or fitted to a floor stand. Infinite baffle enclosure. Four 5in free-edge bass drivers, four horn tweeters. Crossover: 5kHz. FR: 20Hz-20kHz. HC: 40W RMS. Impedance: 8 ohms. Dimensions: 13½ in diameter approximately. Weight: 26½ lb. Finish: per-

forated black metal case. Price: £75.28 (including VAT).

**SX3**

Speaker enclosure with units and crossover. One 10in bass driver, one tweeter. HC: 25W RMS. Impedance: 8 ohms. Size:  $20\frac{1}{2} \times 12\frac{3}{4} \times 11\frac{1}{2}$ in. Price: £54.81 (including VAT).

**SX5**

Enclosure with units and crossover. FR: 30Hz-20kHz. Impedance: 8 ohms. HC: 30W RMS. Crossover: 1000Hz l.f., 5000Hz mid. Size:  $22 \times 13 \times 12$ in. Weight: 37.5lb. Price: to be announced.

**5321**

Enclosure with units and crossover. FR: 37Hz-20kHz. Impedance: 8 ohms. HC: 30W RMS. Crossover: 5000Hz l.f., 10,000Hz mid. Size:  $21\frac{1}{2} \times 13 \times 9\frac{3}{4}$ in. Weight: 19.8lb. Price: to be announced.

**5399**

Speaker enclosure with units and crossover. Four drive units. HC: 15W RMS. Impedance: 8 ohms. Size:  $27\frac{1}{2} \times 7\frac{7}{8} \times 7\frac{7}{8}$ in. Finish: walnut. Price: £38 (including VAT).

**5396**

Speaker enclosure with units and crossover. Two drive units. HC: 20W RMS. Impedance: 8 ohms. Size:  $10\frac{1}{2} \times 8\frac{1}{2} \times 18\frac{1}{2}$ in. Finish: walnut. Price: £36.18 (including VAT).

**5391**

Speaker enclosure with units and crossover. Two drive units. HC: 15W RMS. Impedance: 8 ohms. Size:  $16 \times 9\frac{1}{4} \times 7\frac{1}{2}$ in. Finish: walnut. Price: £31.06 (including VAT).

### ■ KEF

KEF Electronics Ltd, Tovil, Maidstone, Kent, ME15 6QP. Tel: Maidstone (0622) 57258. Cables: KEF, Maidstone.

**Coda ★**

Two-way miniature shelf enclosure. One B110 6in bass unit, one T27 1in tweeter. Crossover: 3.5kHz. FR: 45Hz-40kHz. HC: 20W. Impedance: 8 ohms. Size:  $13 \times 9 \times 5\frac{3}{4}$ in. Weight: 10 $\frac{3}{4}$ lb. Finish: teak, walnut or white with brown or grey grille cloth. Price: £22.50 (plus VAT).

**Cantor**

Two-way shelf or wall-mounting enclosure. One B200 8in bass unit, one T27 1in tweeter. Crossover: 3.5kHz. FR: 40Hz-40kHz. HC: 25W. Impedance: 8 ohms. Size:  $18\frac{1}{2} \times 4\frac{3}{4} \times 11$ in. Weight: 13 $\frac{1}{2}$ lb. Finish: teak, walnut or white with brown or grey grille cloth. Price: £25 (plus VAT).

**Chorale**

Compact model in choice of walnut, teak or white. Size:  $18\frac{1}{2} \times 11 \times 8\frac{3}{4}$ in. B200 and T27 units.

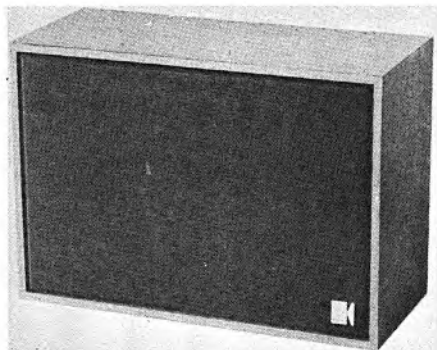
*KEF Coda*

HC: 25W. FR: 35Hz-40kHz. Impedance: 8 ohms. Price: £32.50 (plus VAT).

**Cadenza**

Reflex design in walnut, teak or white with brown or grey grille cloth. Size:  $24 \times 14 \times 12$ in. B200, BD139 and T27 units. HC: 30W. FR: 30Hz-40kHz. Impedance: 8 ohms. Price: £47.50 (plus VAT).

**Concerto**

Reflex design in walnut or teak. Size:  $28 \times 17 \times 12$ in. B139, B110 and T27 units. HC: 50W. FR: 25Hz-40kHz. Impedance: 8 ohms. Price: £60 (plus VAT).

See also Constructional Kits section for Kefkits.

### ■ KELETRON

K & K Electronics Ltd, 60 St Mark's Rise, London, E8 2NR. Tel: 01-254 9941/4.

**KS10**

Speaker enclosure with units and crossover. One 10in bass driver, two 3in HF units. HC: 10W. Impedance: 8 ohms. Size:  $23 \times 11 \times 13$ in. Finish: teak. Price: £23.43 (plus VAT).

**KS15**

Speaker enclosure with units and crossover. One 13 × 8in bass driver, one 4in mid-range unit. HC: 15W. Impedance: 8 ohms. Size:  $27 \times 11 \times 13$ in. Finish: teak. Price: £34.92 (plus VAT).

**KS20**

Speaker enclosure with units and crossover. One 13 × 8in bass driver, two 4in HF units. HC: 20W. Impedance: 8 ohms. Size:  $31 \times 11 \times 13$ in. Finish: teak. Price: £39.38 (plus VAT).

### ■ KF

KF Products Ltd, Brookfield House, Hopes Carr, Stockport, Cheshire. Tel: 061-480 7428/1761.

**PF8-S**

Infinite baffle enclosure with single unit. One

★ Indicates entry is illustrated

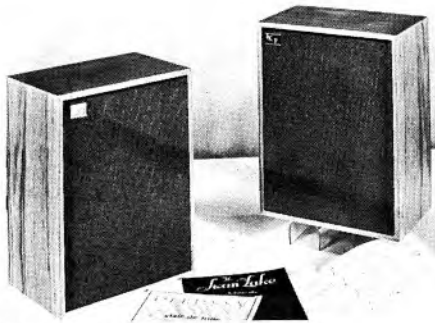

KF Products EI385

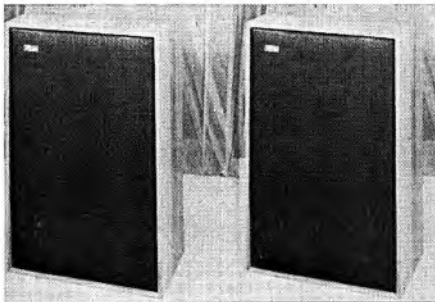

KF KR20

8in dual-cone, high-flux full-range unit with ceramic magnet and long-throw bass driver. FR: 80Hz-17kHz. HC: 8W RMS. Impedance: 8 or 15 ohms. Finish: teak veneer with matching Vynair front grille. Size:  $15 \times 10\frac{1}{2} \times 5\frac{3}{4}$ in. Price: £8.04 (plus VAT).

#### **EI385 ★**

Infinite baffle enclosure with single unit. One EMI 13 × 8in dual-cone driver. FR: 75Hz-13 kHz. HC: 10W RMS. Impedance: 3, 8 or 15 ohms. Finish: teak veneer with matching Vynair front grille. Size:  $18 \times 13\frac{1}{2} \times 9$ in. Packed in matching pairs for stereo. Price: (each speaker) £13.40 (plus VAT).

#### **KR8**

Infinite baffle enclosure with units and crossover. One  $6\frac{1}{2}$ in dual-cone bass driver, one 4in tweeter. Crossover: 6.5kHz. FR: 65Hz-16kHz. HC: 8W RMS. Impedance: 8 ohms. Size:  $17 \times 10 \times 9$ in. Finish: teak veneer. Sold in pairs with matched veneer. Price: (per speaker) £15.43 (plus VAT).

#### **KR10**

Infinite baffle enclosure with units and crossover. One 8in bass driver with ceramic magnet, one 4in tweeter. Crossover: 6.5kHz. FR: 55Hz-16kHz. HC: 10W. Impedance: 8 ohms. Size:  $21\frac{1}{2} \times 11\frac{1}{2} \times 10\frac{1}{2}$ in. Finish: teak veneer. Sold in

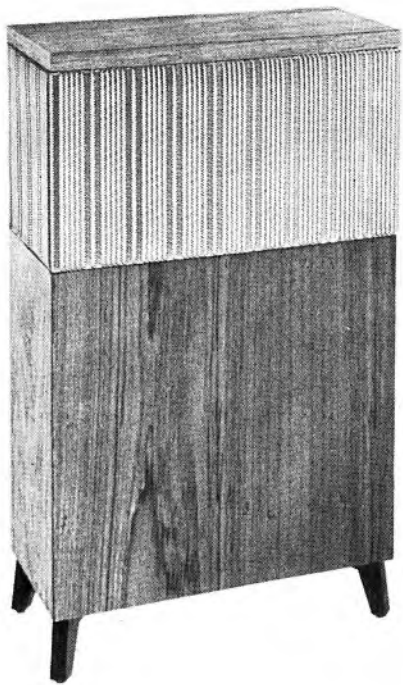

Kirkman Home Concert Hall Mk 2

pairs with matched veneer. Price: (per speaker) £18.86 (plus VAT).

#### **KR20 ★**

Infinite baffle enclosure with units and crossover. One  $13\frac{1}{2} \times 8\frac{1}{2}$ in bass driver with ceramic magnet, one  $3\frac{1}{4}$ in tweeter. Crossover: 5kHz. FR: 40Hz-20kHz. HC: 20W RMS. Impedance: 8 ohms. Size:  $24 \times 15 \times 11\frac{1}{2}$ in. Finish: teak veneer. Aluminium centre to bass driver and curved cone to tweeter. Price: £37.75 (plus VAT).

#### **KR25**

Infinite baffle enclosure with units and crossover. One  $14 \times 9$ in bass driver, two 5in mid-range units, one  $3\frac{3}{4}$ in tweeter. HF response switches on crossover panel. FR: 35Hz-20kHz. HC: 30W. Impedance: 8 ohms. Size:  $28 \times 17 \times 11$ in. Finish: teak veneer. Price: £59.20 (plus VAT).

#### **■ KIRKMAN (Crawley) LTD**

40 The Broadway, Crawley, Sussex.  
Tel: Crawley 26670.

#### **Home Concert Hall Mk 2 ★**

Isothermal tapered reflex enclosure with speakers and crossover. Two Richard Allan CR5 bass units and STC 4001E tweeter. Two  $\frac{1}{4}$ -section crossovers at 3kHz and 4kHz. FR: 28Hz -6dB; 20kHz -3dB. HC: 20W music.

Omni-directional throughout frequency range in horizontal plane. Inside and outside of enclosure employed to maintain non-resonant closely controlled acoustic load. Finish: teak with bronze or black grille. Size:  $31 \times 18 \times 8\frac{1}{2}$  in. Weight: 44lb. Price: £52 (plus VAT).

#### ■ KLEIN & HUMMEL

Sole UK agents: F. W. O. Bauch Ltd,  
49 Theobald Street, Boreham Wood, Herts,  
WD6 4RZ. Tel: 01-953 0091.

#### OY

Studio monitor speaker enclosure comprising two separate built-in 30W solid state bass and treble amplifiers and 3-unit drive system. Input: 0.775V and 1.55V at 4.7K to 500Hz dividing network filter. Speakers: 9in bass unit, one 5in mid-lift unit and a 'top' horn. FR: 30Hz-20 kHz. Complete equalisation controls for room and position matching. Dimensions:  $19 \times 12 \times 9$  in. Weight: 45lb. Finish: grey formica or walnut. Price: on application.

#### OZ

Full-range studio monitoring speaker system including two built-in 30W amplifiers. Two 12in Altec bass drivers, one Altec mid-range and treble pressure system with horn. Inputs: 0 or +6dB for 110 phon at one metre. Size:  $27\frac{3}{4} \times 35\frac{1}{2} \times 16\frac{1}{2}$  in. FR: 30Hz-20kHz (40Hz-16kHz  $\pm 2$ dB). Crossover frequency: 800Hz. Price: on application.

#### ■ KLH

Distributed by: Webland International Ltd,  
PO Box 826, London, W2.

#### Model 31

Two drive units with acoustic suspension loading for 8in bass driver.  $1\frac{7}{8}$ in direct radiating HF unit. Impedance: 8 ohms nominal. Amplifier requirements: minimum 10W RMS per channel. Power handling: short duration peak 100W. Size:  $17\frac{1}{2} \times 11 \times 8\frac{1}{2}$  in. Finish: oil walnut. Price: £29.95 (plus VAT).

#### Model 32

Two way system incorporating 8in bass driver and  $1\frac{7}{8}$ in direct radiating HF unit. Impedance: 8 ohms nominal. Amplifier requirements: minimum 10W RMS per channel. Power handling: short duration peak 10W. Size:  $19\frac{3}{8} \times 10\frac{7}{8} \times 7\frac{7}{8}$  in. Weight: 17lbs. Finish: oiled walnut. Price: £36.59 (plus VAT).

#### Model 38

Two way system incorporating 10in bass driver and  $1\frac{7}{8}$ in direct radiating HF unit. Impedance: 8 ohms nominal. Amplifier requirements: 12 to 18W RMS per channel minimum. Power handling: 150W short duration peak. Size:  $21\frac{1}{4} \times 12\frac{5}{8} \times 8\frac{1}{2}$  in. Finish: oiled walnut. Weight: 23lb. Price: £47.50 (plus VAT).

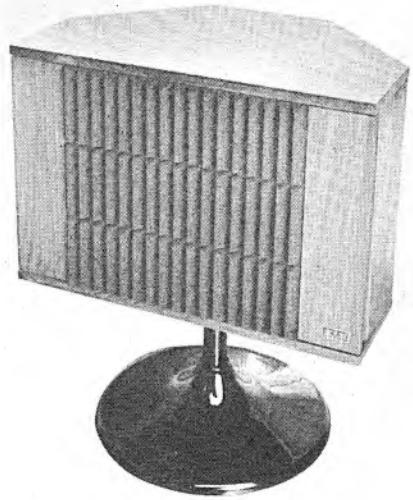

KLH Model 28

#### Model 17

Two way system incorporating 10in bass driver and  $1\frac{3}{4}$ in direct radiating HF unit. Impedance: 8 ohms nominal. Amplifier requirements: 10W RMS per channel minimum. Power handling: 100W short duration peak. Size:  $23\frac{3}{8} \times 11\frac{3}{4} \times 9$  in. Finish: oiled walnut. Weight: 24lb. Price: £54.50 (plus VAT).

#### Model 33

Two way system incorporating 10in bass driver and direct radiating HF unit. Impedance: 8 ohms nominal. Amplifier requirements: 10W RMS per channel minimum. Power handling: 100W short duration peak. Size:  $23\frac{3}{8} \times 12\frac{3}{4} \times 10\frac{7}{8}$  in. Finish: oiled walnut. Weight: 25lb. Price: £75 (plus VAT).

#### Model 23

Two way system incorporating 12in bass driver and  $1\frac{3}{4}$ in direct radiating HF unit. Impedance: 8 ohms nominal. Amplifier requirements: 18W RMS per channel minimum. Power handling: 150W short duration peak. Size:  $12\frac{3}{4} \times 14\frac{1}{4} \times 11\frac{1}{2}$  in. Finish: oiled walnut. Weight: 39 $\frac{1}{2}$ lb. Price: £79.95 (plus VAT).

#### Model 6

Two way system incorporating 12in bass driver and  $1\frac{3}{4}$ in radiating HF unit. Impedance: 8 ohms nominal. Amplifier requirements: 15W RMS per channel minimum. Power handling: 120W short duration peak. Size:  $23\frac{1}{2} \times 12\frac{5}{8} \times 11\frac{7}{8}$  in. Finish: oiled walnut. Weight: 34lb. Price: £89.75 (plus VAT).

#### Model 5

Three way system incorporating four drive units;



★ Indicates entry is illustrated

12in bass driver, two high efficiency mid-range units, 1 $\frac{3}{4}$ in direct radiating HF unit. Impedance: 8 ohms nominal. Amplifier requirements: 18W RMS per channel minimum. Power handling: 150W short duration peak. Size: 26 × 13 $\frac{3}{4}$  × 11 $\frac{1}{2}$ in. Finish: oiled walnut. Weight: 44lb. Price: £132 (plus VAT).

#### Model 28 ★

Two way omnidirectional radiating system incorporating three bass drivers and three HF units. FR: 35Hz-18kHz. Impedance: 8 ohms nominal. Amplifier requirements: 18W RMS per channel minimum. Power handling: 400W RMS short duration peak. Size: 18 $\frac{1}{8}$  × 25 $\frac{1}{2}$  × 16 $\frac{3}{8}$ in. Finish: oiled walnut. Price: £179 (plus VAT); Stands: (per pair) £24 (plus VAT)

#### Marlboro 101

Two way system. Impedance: 8 ohms nominal. Amplifier requirements: 8W RMS per channel minimum. Power handling: 75W RMS short duration peak. Size: 21 $\frac{1}{8}$  × 12 × 7 $\frac{7}{8}$ in. Weight: 20lb. Finish: oiled walnut. Price: £42.50 (plus VAT).

#### Marlboro 102

Two way system. Impedance: 8 ohms nominal. Amplifier requirements: 10W RMS per channel minimum. Power handling: 75W RMS short duration peak. Size: 24 $\frac{1}{2}$  × 12 $\frac{3}{4}$  × 9 $\frac{3}{8}$ in. Weight: 29lb. Finish: oiled walnut. Price: £59.50 (plus VAT).

#### Marlboro 103

Three way system. Impedance: 8 ohms nominal. Amplifier requirements: 15W per channel minimum. Power handling: 100W RMS short duration peak. Size: 26 $\frac{3}{8}$  × 14 $\frac{1}{2}$  × 11 $\frac{1}{8}$ in. Finish: oiled walnut. Weight: 47lb. Price: £89.75 (plus VAT).

### ■ KLINGER

Klinger Controls Ltd, Spencer Court,  
7 Chalcot Road, London, NW1 8LU.  
Tel: 01-586 2922.

#### S35

Infinite baffle enclosure with units and crossover. One 8 × 5in bass driver, one 2 $\frac{1}{2}$ in tweeter. Crossover: 5kHz (capacitor). FR: 55Hz-12kHz. HC: 6W RMS. Impedance: 8 ohms. Size: 13 × 7 × 8in. Weight: 8lb. Finish: teak with black/gold woven front grille. Price: £9 (plus VAT).

#### S42

Infinite baffle enclosure with units and crossover. One long-throw 6 $\frac{1}{2}$ in bass driver with rubber surround, one 3 $\frac{1}{2}$ in mid-range unit, one 2 $\frac{1}{2}$ in tweeter. Crossover: 5kHz (L/C). FR: 40Hz-18kHz. HC: 12W RMS. Impedance: 8 ohms. Size: 17 $\frac{1}{2}$  × 10 × 8in. Weight: 11lb. Finish: teak cabinet with gold/black woven grille. Price: £16.65 (plus VAT).

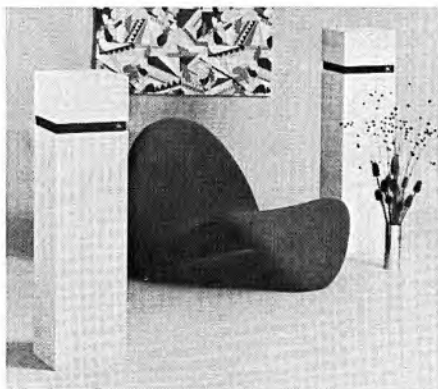

JB Lansing Aquarius 4 (white)

#### S50 Mk II

Infinite baffle enclosure with units and crossover. One 8in long-throw bass driver with rubber surround, two 3 $\frac{1}{2}$ in solid-back tweeters. Crossover: 5kHz (L/C). FR: 40Hz-18kHz. HC: 15W. Impedance: 8 ohms. Size: 18 × 13 × 7in. Weight: 14lb. Finish: teak cabinet with brown basket weave grille and silver trim. Price: £19.50 (plus VAT).

#### S90

Infinite baffle enclosure with units. One 12in long-throw bass driver, one 5in mid-range unit, one 2 $\frac{1}{2}$ in tweeter. Crossover: 1kHz and 5kHz. Output level adjustment for mid-range and tweeter units. FR: 40Hz-20kHz. HC: 50W RMS. Impedance: 8 ohms. Size: 24 × 13 $\frac{1}{2}$  × 10in. Finish: teak cabinet with brown basket weave front grille and silver trim. Price: (per pair) £81 (plus VAT).

### ■ KORTING

Europa Electronics Ltd, 9 Howard Place,  
Shelton, Stoke-on-Trent, ST1 4NW.  
Tel: Stoke-on-Trent (0782) 29316.

#### KUB10

Spherical enclosure with unit. One 6 $\frac{1}{8}$ in full-range driver with dual-cone. FR: 130Hz-13kHz. HC: 10W DIN. Impedance: 4 ohms. Finish: brushed aluminium. Size: 9 $\frac{1}{2}$ in diameter. Price: £21.17 (including VAT).

#### I.SB5

Enclosure with unit. One 6 $\frac{1}{8}$ in full-range driver. FR: 70Hz-15kHz. HC: 5W approx. Impedance: 4 ohms. Finish: walnut, satin finish or white. Size: 10 × 7 $\frac{1}{2}$  × 5 $\frac{1}{8}$ in. Price: £11.82 (including VAT).

#### I.SB12

Enclosure with units and crossover. One 5 $\frac{1}{8}$ in bass driver, one 4in tweeter. HC: 15W DIN.

# read what they say about B&W Loudspeakers

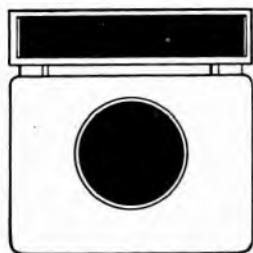

DM70 IMPROVED



DM2A



DM4



D5

## B&W DM70 IMPROVED

“I was really astounded when I heard the new 70's. They are indeed a major step forward,”  
John Freestone, RECORD REVIEW

“What has been achieved with the new loudspeaker combination '70 can be construed as a master work in the field of modern electro-acoustics and a milestone of development for the next decade,”  
H. H. Klinger, FUNK-TECKNIC (Germany)

## B&W DM2A

“The DM2 Monitor passed all tests with outstanding results . . . I have no hesitation in placing this speaker in the top echelon of modern high quality systems,”  
John Gilbert, GRAMOPHONE

“The measured performance shows one of the smoothest mid-range frequency responses that we have ever seen,”  
ELECTRONICS TODAY INTERNATIONAL (Australia)

## B&W DM4

“The DM4 is right at the top of the heights of quality small speakers in our opinion,”  
HI-FI ANSWERS

“Uncorrected, the DM4 reproduces the violin as it is heard at reference level,”  
Jean-Marie Marcel, REVUE DU SON (France)

## B&W D5

“These units have an exceptionally clean overall response for their size and price,”  
Geoffrey Richards, HI-FI ANSWERS

“A well integrated and smooth sound . . . with much detail being reproduced . . . the D5 was fully comparable with certain far more expensive speakers,”  
Martin Colloms, POPULAR HI-FI

hear them for  
yourself at your B&W  
Appointed Dealer



# LOWTHER



towards perfection

- THE AUDITORIUM-ACOUSTA OFFERS an entirely new conception of sound from your existing amplifying system whether it be mono or stereo. Complete absence of point source.
- LOWTHER the first name for:
- High flux drive units.
- Horn loading enclosures.
- Highest efficiency.
- Highest fidelity.
- Actual designers and manufacturers of units and enclosures.
- We do not tell you how to listen but provide a choice of designs to choose from.

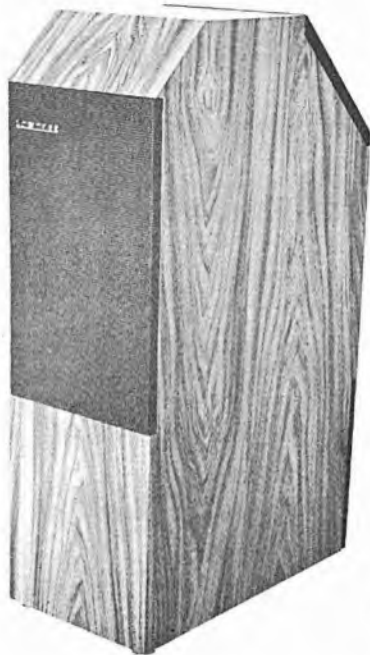

*Auditorium  
Acousta  
Enclosure*

**LOWTHER  
ACOUSTICS  
LTD**

ST. MARK'S ROAD,  
BROMLEY, KENT.  
Telephone: 01-460 5225

# Philips invent a loudspeaker enclosure that beats others four times its size.

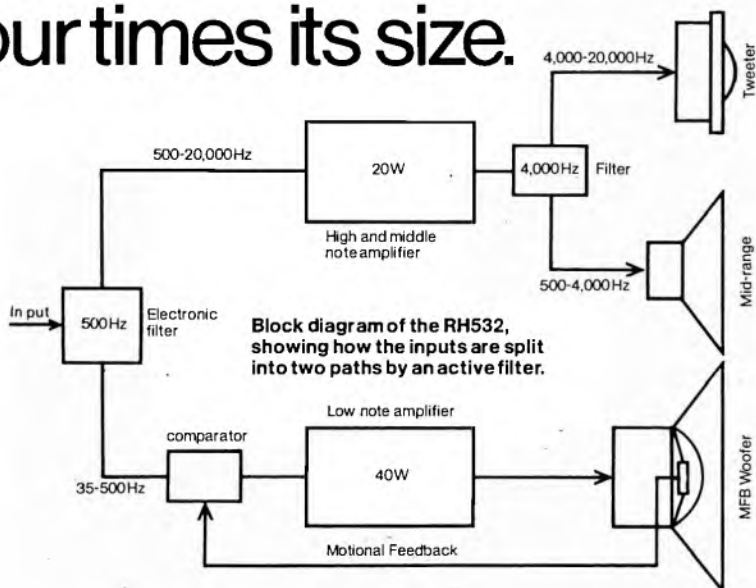

**Block diagram of the RH532, showing how the inputs are split into two paths by an active filter.**

**Philips RH532 'Motional Feedback' enclosure. The first bookshelf speaker with true bass response. Beats bulky floor-standing speakers four times its size. And upgrades the output of your system to 60 watts RMS per enclosure.**

## What is 'Motional Feedback'?



Low notes have always been a problem for loudspeakers, since large amounts of electrical power have to be translated into air pressure variations. The speaker cone can easily go wrong - especially in enclosures compact enough for domestic rooms.

Philips Motional Feedback system solves the problem - by actually making the cone correct itself.

As a ceramic sensing device on the cone vibrates, an electrical signal is generated. This is fed back and compared with the signal that made the cone vibrate in the first place. If there's any difference, corrective action is instantly taken.

In the RH 532 enclosure, you get not only a Motional Feedback woofer for virtually distortion-free bass response, but also excellent transient response from tweeter and mid-range units.

**Result:** Astonishingly faithful reproduction of all frequencies from 35Hz to 20,000Hz, with bass response in true proportion to the rest of the tonal range. Yet the enclosure measures only 15" x 11 1/4" x 8 3/4" (378 x 283 x 220 mm) - and total volume is only 15 litres.

## Power amplifiers built-in

For Motional Feedback, power amplifiers have to be built into the enclosure.

So, in a separate compartment the RH532 has a 40 watt amplifier for the woofer and a 20 watt amplifier for the other two speakers. A total of 60 watts RMS per enclosure!

A separate amplifier is therefore unnecessary. All you really need is a pre-amp and control unit! And you can even link speakers together - for mono, stereo or quad in 15 different rooms!

The RH532 gives Philips a world lead in Hi-Fi sound. For full details, write to Philips Electrical Limited, Dept. SP, Century House, Shaftesbury Avenue, London WC2H 8AS.

**PHILIPS**  
Simply years ahead.



# Richard Allan

## HIGH FIDELITY ENCLOSURES

*For* CONCERT HALL PERFORMANCE

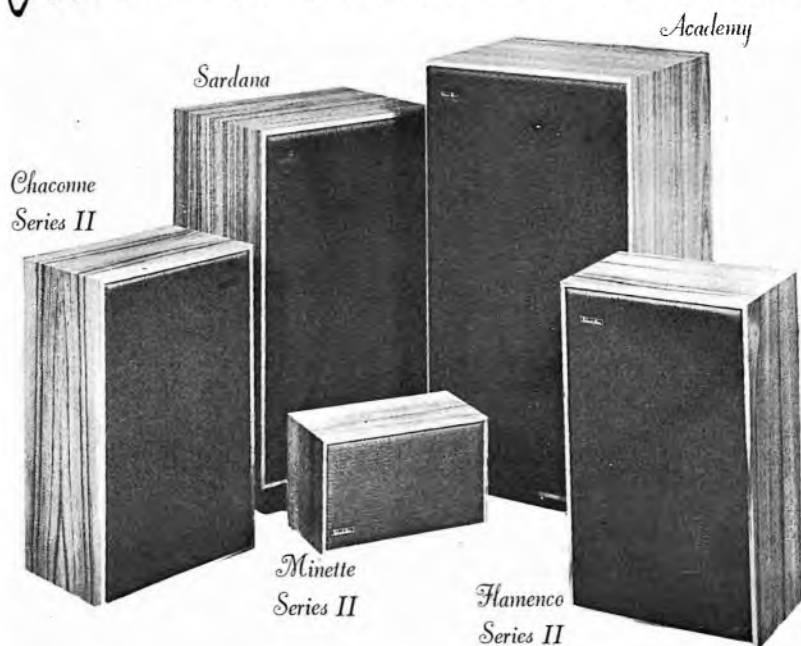

- The enclosures designed with the requirements of the High Fidelity enthusiast in mind.
- This illustration represents a selection from our range of craftsman-built enclosures.
- Richard Allan means Quality and Performance at the right price.

*Write now for latest leaflets.*

### Richard Allan



**Richard Allan Radio Limited**, Bradford Road, Gomersal,  
Cleckheaton BO19 4AZ Yorkshire, England.  
Telephone Cleckheaton 2442/3 Cables: Acoustics Bradford.

FR: 50Hz-16kHz. Impedance: 4 ohms. Finish: walnut, satin finish or white. Price: £18.70 (including VAT).

#### LSB42

Enclosure with units and crossover. One 8in bass driver, one 3 $\frac{3}{4}$ in tweeter. HC: 25W DIN. FR: 30Hz-18kHz. Impedance: 4 ohms. Finish: walnut, satin finish or white. Size: 21  $\times$  10 $\frac{5}{8}$   $\times$  6 $\frac{3}{4}$ in. Price: £29.15 (including VAT).

#### LSB65

Enclosure with units and crossover. Two 9 $\frac{3}{4}$ in bass drivers, one 7  $\times$  5in mid-range unit, one 3 $\frac{3}{4}$ in tweeter. FR: 18Hz-26kHz. HC: 45W DIN. Impedance: 4.5 ohms at 150Hz. Finish: walnut, satin finish or white. Price: £54.72 (including VAT).

#### ■ JAMES B. LANSING (JBL)

Distributors: Feldon Audio Ltd, 126 Great Portland Street, London, W1N 5PH. .  
Tel: 01-580 4314.

#### JBL Decade L26

Reflex enclosure with units and crossover. One 10in long-throw bass driver, one 1in wide dispersion mid-range/HF unit. Crossover: 1500 Hz (12dB/octave variable). FR: 40Hz-18kHz. HC: 20W RMS. Impedance: 8 ohms. Size: 19  $\times$  15 $\frac{1}{2}$   $\times$  14 $\frac{5}{8}$ in. Weight: 35lb. Finish: veneered. Available also as complete system with spaces for equipment and record storage. Price: (standard model) £97 (plus VAT).

#### JBL Aquarius 4 ★

Combination reflex and horn enclosure with units and crossover. One 8in extended range high power main driver, one 2in HF unit. Crossover: 12dB/octave variable. FR: 40Hz-16kHz omni-directional. HC: 35W RMS. Impedance: 8 ohms. Size: 10  $\times$  10  $\times$  40in high. Weight: 52lb. Finish: satin white or walnut. Phase corrected omni-directional speaker, said to be particularly suitable for quadrasonic sound systems. Price: £129 (plus VAT).

#### JBL Century L100

Reflex enclosure with units and crossover. One 12in linear efficiency bass driver, one 5in extended range mid-frequency unit, one 2in wide dispersion HF tweeter. Crossover: 1.5kHz and 6kHz (variable 12dB/octave). FR: 40Hz-16kHz  $\pm$  3dB. HC: 50W RMS. Impedance: 8 ohms. Size: 12  $\times$  24  $\times$  14in. Weight: 55lb. Finish: walnut with sculptured air grille in orange, blue or brown. This speaker system is acoustically identical to the JBL Professional Control Monitor 4310. Price: £184 (plus VAT).

#### JBL Studio Master L200 ★

Reflex enclosure with units and crossover. One 15in linear efficiency bass driver, one extended range horn loaded compression unit with

acoustic lens. Crossover: 1.2kHz 12dB/octave constant impedance, variable. FR: 30Hz-18kHz  $\pm$  3dB. HC: 75W RMS. Impedance: 8 ohms. Size: 33  $\times$  24  $\times$  21in. Weight: 145lb. Finish: walnut case with sculptured air grille in smoke, black, blue or dark red. This speaker system is acoustically identical to the JBL Studio Monitor 4325. Price: £398 (plus VAT).

#### ■ LARSON

Cole Electronics Ltd, Church Road, Croydon, CR0 1SG. Tel: 01-686 7581.

#### LP720 Pyramid ★

Infinite baffle enclosure with units and crossover. One 10in long-throw bass driver with Neoprene suspension, one 1 $\frac{1}{2}$ in dome tweeter. Both drive units to DIN specification. Crossover: 1kHz. FR: 37Hz-20kHz. HC: 40W RMS. 1m-

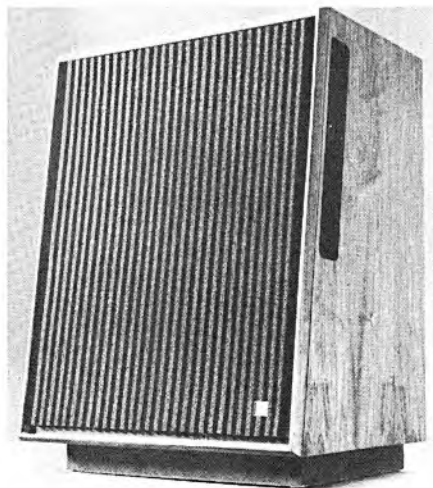

JBL Lansing Studio Master L200



Larson Pyramid LP720

★ Indicates entry is illustrated

pedance: 8 ohms. Size: (pyramid shape) 25in high, 12 $\frac{3}{4}$ in square at base, 5in square at top. Weight: 20lb. Finish: teak, whitelac or jacaranda. Design claims to provide omni-directional sound dispersion. Price: £57 (plus VAT).

#### ■ LEAK

Rank Radio International Ltd, PO Box 596, Power Road, Chiswick, London, W4 5PW. Tel: 01-994 6491.

#### Sandwich 150 ★

Infinite baffle enclosure with 6 $\frac{1}{2}$ in sandwich bass driver and 2 $\frac{1}{2}$ in cellulose acetate butyrate treble unit. Impedance: 8 ohms nominal. FR: 60Hz-18kHz. HC: 18W DIN. Finish: teak or walnut. Size: 15 $\frac{3}{4}$  × 10 × 8 $\frac{1}{2}$ in. Price: £23.41 (including VAT).

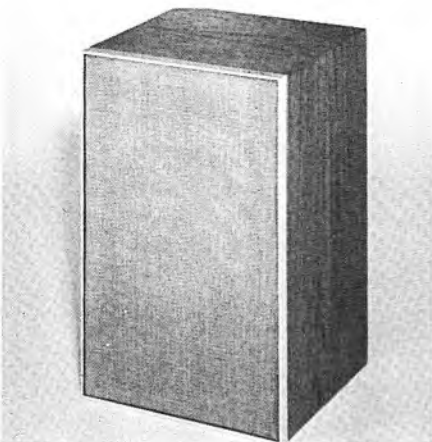

Leak Sandwich 150

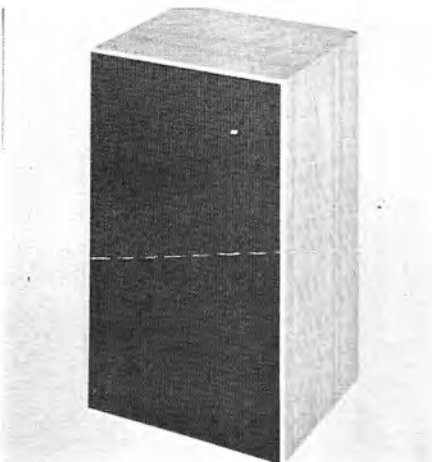

Leak Sandwich 600

#### Sandwich 250

Infinite baffle enclosure with units and cross-overs. 8in sandwich bass driver with 2 $\frac{1}{2}$ in multi-directional tweeter. Floor-standing or book-shelf system. Impedance: 8 ohms nominal. FR: 50Hz-18kHz. HC: 18W DIN. Finish: teak or walnut. Size: 19 $\frac{3}{4}$  × 11 × 10in. Price: £30.43 (including VAT).

#### Sandwich 600 ★

Infinite baffle free-standing speaker with 12in bass driver, 4in sandwich mid-range unit and 1in multi-directional treble unit. Three-way 10-element crossover at 1kHz and 4kHz. FR: 40Hz-20kHz. Impedance: 8 ohms nominal. HC: 40W DIN. Finish: teak or walnut. Size: 26 × 15 × 11 $\frac{3}{4}$ in. Price: £54.45 (including VAT).

#### 2020

Acoustic suspension enclosure. FR: 55Hz-20kHz ± 3dB. vci: 6 ohms nominal. HC: 25W (DIN). Size: 15 $\frac{3}{4}$  × 9 $\frac{7}{8}$  × 9 $\frac{1}{4}$ in. Weight: 15lb. Two drive units. Crossover: 3500Hz. Finish: teak. Price: (per pair) £59.06 (including VAT).

#### 2030

Reflex enclosure. FR: 52Hz-20kHz ± 3dB. vci: 6 ohms nominal. HC: 35W (DIN). Size: 19 $\frac{3}{4}$  × 11 × 10 $\frac{1}{4}$ in. Weight: 24 $\frac{1}{2}$ lb. Three drive units. Crossover: 700Hz and 3.5kHz. Finish: teak. Price: (per pair) £79.55 (including VAT).

#### 2060

Acoustic suspension. FR: 50Hz-20kHz ± 3dB. vci: 6 ohms nominal. HC: 50W (DIN). Size: 25 $\frac{1}{2}$  × 15 × 13in. Weight: 51lb. Three drive units. Crossover: 600Hz and 3.5kHz. Finish: teak. Price: £68.70 (including VAT).

#### 2075

Transmission absorber. FR: 45Hz-20kHz ± 3dB. vci: 6 ohms nominal. HC: 100W (DIN). Size: 47 × 19 $\frac{3}{4}$  × 14 $\frac{1}{4}$ in. Weight: 112lb. Four drive units. Crossover: 450Hz, 2kHz and 5kHz. Finish: teak. Price: £131.75 (including VAT).

#### ■ LECSON

Lecson Audio Ltd, Burrel Road, St Ives, Hunts, PE17 4LE. Tel: St Ives (0480) 64124.

#### HL1 ★

Horn loaded speaker system. Two 13 × 8in bass drivers, one 5in mid-range unit, one tweeter. Crossover: 380Hz (12dB/octave) and 5kHz (18dB/octave). FR: 30Hz-20kHz. HC: 100W peak programme. Impedance: 8 ohms. Size: 15in wide, 37in high, 17 $\frac{1}{2}$ in deep. Weight: 73lb. Designed to stand against a wall or across a corner for correct bass performance. Mid-range horn adjustable for best stereo image. Finish: black or cream fabric with teak or rosewood top panels as standard. Special colours to order. Price: £98 (including VAT).

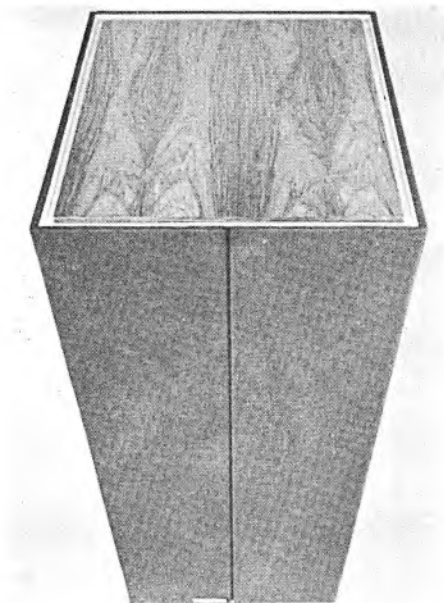

Lecson HLI

### ■ LINN-ISOBARIK

Linn Products Ltd, 235 Drakemire Drive, Castlemilk, Glasgow, G45 9SZ.  
Tel: 041-634 3860.

### DMS

Infinite baffle enclosure with units and crossover. HC: 100W. Impedance: 4 ohms nominal. Size: 15 × 16 × 30in. Suitable for amplifiers delivering over 60W per channel into 4 ohms, and up to 100-250W per channel. FR: 20Hz-20kHz ± 1.5 dB. Employs new bass generator concept (Patent pending). Weight: (approx) 100lb. Price: (per pair) £550 (including VAT).

### ■ L.N.B.

L.N.B. Audio Ltd, The Factory, Duke Street, Loughborough, Leics. Tel: (050 93) 61229.

### Para-Tran 6

Infinite baffle enclosure with speakers and crossover. One special 6½in bass driver plus one 3½in tweeter. Crossover: 3kHz. FR: 50Hz-17kHz. HC: 15W music. Impedance: 8 ohms. Special membrane compensator. Long fibre wool damping material. Size: 15½ × 11 × 8in. Weight: 15lb. Finish: teak cabinet with complementary grille. Price: £38-50 per pair (including VAT).

### Para-Lab Super

Labyrinth enclosure with speakers and crossover. One special 6½in bass driver plus KEF T27 tweeter. Crossover: ½-section at 3kHz. FR: 40Hz-25kHz. HC: 20W music. Impedance: 8

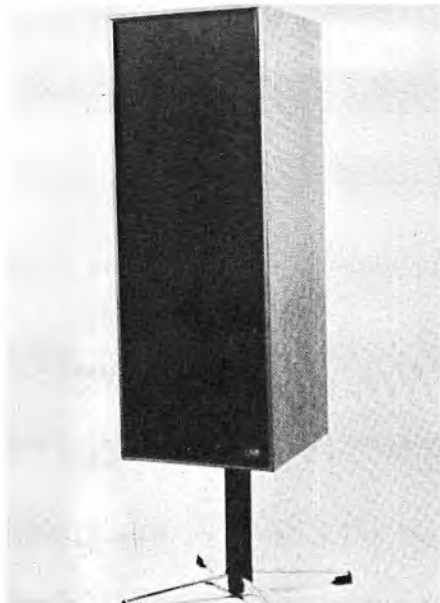

LNB Para-Lab 20 on stand

ohms. Size: 23½ × 10¼ × 9in. Weight: 24lb. Finish: teak cabinet with Vynair front and black trim. Labyrinth acoustic line. Price: £70-40 per pair (including VAT).

### Para-Lab 20 ★

Labyrinth enclosure with speaker and crossover. One KEF B200 bass driver, one KEF T27 mid-range and HF unit, one STC 4001G super HF tweeter. Crossovers: ½-section at 3kHz and 9kHz. FR: 30Hz-25kHz. HC: 30W music. Impedance: 8 ohms. Size: 31 × 11 × 11¼in. Weight: 40lb. Finish: teak cabinet with black Vynair front and black trim. Labyrinth acoustic line. Price: £110 per pair (including VAT).

### Speaker stands

Height approximately 13in. Finish: chrome/black. Will accommodate any speaker with a base larger than 8in square. Price: £13-20 per pair (including VAT).

### ■ LOCKWOOD & CO (Woodworkers) LTD

63 Lowlands Road, Harrow, Middlesex.  
Tel: 01-422 3704/0768.

### Mini-slim

Reflex, forward facing, 12in units. Rec. Tannoy 12in dual concentric, Tannoy III LZ dual concentric. Size: 27½ × 19 × 9½in. Price (with specified units): from approximately £45 (plus VAT).

### Minor Slim

Reflex, forward facing, 12 or 15in units. Rec. Tannoy 12 or 15in dual concentric, and units





Lowther Auditorium Acousta

listed for Mini-slim. Size:  $33\frac{1}{2} \times 20 \times 11\frac{1}{4}$  in. Price (with specified units): from approximately £50 (plus VAT).

#### Major Slim

Reflex, forward facing. 12 or 15in units. Rec. Tannoy 12 and 15in dual concentric. Size:  $38 \times 24 \times 11\frac{1}{4}$  in. Price: from approximately £64 (plus VAT).

#### ■ LOEWE OPTA

Joint distributors: SED Television Ltd, Salisbury, Wilts. Tel: 0722 4201. Hokushin Audio Visual Ltd, 2 Ambleside Avenue, London, SW16. Tel: 01-677 9919.

New range of speaker systems being introduced under the Loewe Opta brand name. No details of products available as this edition of the Year Book closed for press.

#### ■ LOWTHER

Lowther Acoustics Ltd, Lowther House, St Mark's Road, Bromley, Kent, BR2 9HQ. Tel: 01-460 5225. Cables: Lowther, Bromley.

#### Corner Reproducer TPI

Folded bass horn/direct HF horn type. One specially designed 6in pressure unit PM3. Acoustical crossover. FR: 40Hz-22kHz. Size:  $47 \times 32 \times 31$  in from corner. Weight: 70lb. Price: (Standard Model) £180; (Model B) £200; (Model D) £150. All plus VAT.

#### Acousta Cabinet

Model FH/V. Folded horn type, forward facing, with rear folded horn. Vertical on runners. Designed for use with single 6 or 8in unit. Rec. Lowther PM6. FR: 40Hz-18kHz. Size:  $32 \times 18\frac{1}{4} \times 14\frac{1}{2}$  in. Weight: 60lb. Price: (without unit): £32 (plus VAT).

#### Mini Acousta

Model FH/V (vertical). Folded horn type. Forward facing with rear folded horn. Veneered all round. Designed for use with one 6-8in unit.

Rec. Lowther PM6 or PM7. FR: 40Hz-20kHz. Size:  $27 \times 15 \times 13$  in. Price (without unit): £32 (plus VAT).

#### Audiovector

Compound horn. Upward facing mid- and high-frequency horn with rear folded horn. Designed for use with single 6in unit. Acoustic crossover. FR: 40Hz-22kHz. Rec. PM2, PM2 Mk II or PM4. Size:  $26\frac{1}{2} \times 19 \times 34$  in. Weight: 75lb. Price (Model A without unit): £80 (plus VAT); (Model B without unit) £70 (plus VAT).

#### Dual Position Acousta

Folded horn. Rearward facing into corner or along wall at 45°. Bass outlets coupling into corner of room or along wall. Designed for use with single 6in high flux unit. Rec. Lowther PM6 or PM7. FR: 40Hz-18kHz. Size:  $32 \times 9\frac{1}{2} \times 18$  in. Price (without unit): £32 (plus VAT).

#### L.I.B. Acousta

Lowther Ideal Baffle is a special enclosure in the Lowther range of folded rear and compound horn designs. It has closed back with anti-phase slave membrane to overcome resonance. Membrane is coupled to drive unit by compliance and matched via a short labyrinth. Effect is that drive unit frequency response, say 30Hz-20kHz, such as PM6, becomes 25Hz-30kHz. Veneered teak, walnut or sapele finish. Grille cloth: grey. Dimensions:  $19 \times 14 \times 7\frac{1}{2}$  in. Price (without unit): £15 (plus VAT).

#### Auditorium Acousta ★

Twin channel enclosure. Based on design of Dual Position Acousta with forward-facing drive unit. Variable preset level control. Rear unit only using folded horn. Designed for use with two 6-8in units (Lowther PM6, PM6 Mk I and/or PM7). Size:  $32 \times 9\frac{1}{2} \times 19$  in. Weight: (less units) 39½lb. Price (without units): £50 (plus VAT).

#### Auditorium Audiovector

Twin channel enclosure. Improved version of Audiovector with forward-facing drive unit (PM2 Mk I). Variable preset level control. Size:  $34 \times 25\frac{1}{2} \times 19$  in. Weight: 108lb. Price: (Model A) £185 (plus VAT 1); (Model B) £175 (plus VAT).

#### ■ LUX

Howland-West Ltd, 3-5 Eden Grove, London, N7 8EQ. Tel: 01-609 0293

#### LX77

Infinite baffle enclosure with units and crossover. One free-edge 12in bass driver, one 1.6in dome HF unit, one 1.3in tweeter. Crossover: 700Hz, 8kHz (12dB/octave) HC: 60W RMS Impedance: 8 ohms. FR: 30Hz-22kHz. Size:  $26\frac{1}{4} \times 15\frac{3}{8} \times 12\frac{1}{4}$  in. Weight: 50lb. Finish: rosewood. Level controls for mid-range and HF units. Price: £90.20 (including VAT).

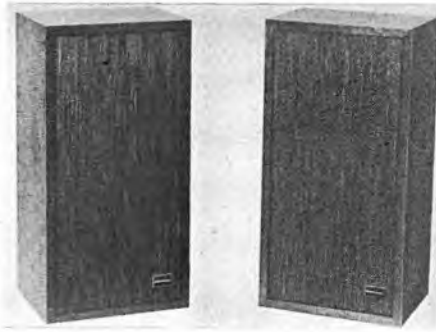

Marantz Imperial 5

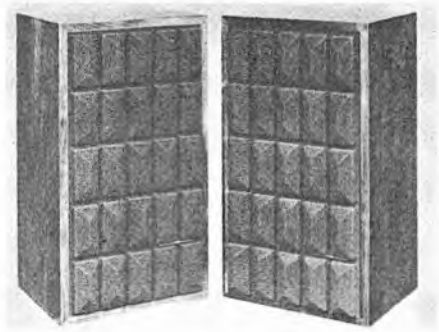

Marantz Imperial 6

## ■ MARANTZ

Pyser Ltd, Fircroft Way, Edenbridge, Kent,  
Tel: Edenbridge (073 271) 4111.

### Imperial 4B

Enclosure with units and crossover. One  $8\frac{1}{4}$ in bass driver, one  $\frac{3}{4}$ in tweeter. L/C crossover. FR: 60Hz-15kHz  $\pm 5$ dB. HC: 40W music. Impedance: 8 ohms. Size:  $11\frac{1}{4} \times 19\frac{3}{8} \times 8\frac{1}{2}$ in. Weight: 20lb. Finish: oiled walnut. Price: £35.75 (including VAT).

### Imperial 5 ★

Enclosure with units and crossover. One 8in bass driver, one  $3\frac{1}{2}$ in tweeter. L/C crossover (12dB/octave from 2kHz). FR: 50Hz-15kHz  $\pm 3$ dB. Impedance: 8 ohms. Three-position high-frequency level selector switch. HC: 40W music. Size:  $12 \times 23 \times 9\frac{1}{2}$ in. Finish: oiled walnut. Price: £49.50 (including VAT).

### Imperial 6 ★

Enclosure with units and crossover. One 10in bass driver, one 2in dome tweeter. L/C crossover (12dB/octave from 3kHz). FR: 40Hz-18kHz  $\pm 5$ dB. HC: 100W music. Impedance: 8 ohms. Size:  $14\frac{1}{4} \times 25\frac{1}{2} \times 11\frac{1}{2}$ in. Three-position high-frequency level selector switch. Finish: oiled walnut. Price: £66 (including VAT).

### Imperial 7

Enclosure with units and crossover. One 12in bass driver, one  $3\frac{1}{2}$ in mid-range unit, one  $1\frac{1}{4}$ in tweeter. L/C three-way crossover. FR: 40Hz-20kHz  $\pm 5$ dB. HC: 100W RMS music. Impedance: 8 ohms. Controls: three-position high-frequency level selector switch, three-position mid-range level selector switch. Foam grille. Size:  $14\frac{1}{4} \times 25\frac{1}{2} \times 11\frac{1}{2}$ in. Weight: 45lb. Finish: oiled walnut. Price: £88 (including VAT).

## ■ MARSDEN HALL

Marsden Hall Manufacturing Co. Ltd,  
High March, Long March Industrial Estate,  
Daventry, Northants.  
Tel: Daventry (032 72) 4011.

### Annexe 100

Infinite baffle enclosure with units and crossover. One  $6\frac{1}{2}$ in bass driver, one  $2\frac{1}{2}$ in tweeter. Crossover: 7kHz L/C network. FR: 50Hz-20kHz. HC: 10W RMS. Impedance: 8 ohms nominal. Size:  $16 \times 9\frac{1}{2} \times 8$ in. Weight: 9lb 6oz. Finish: teak or white. Price: (per pair) £30 (plus VAT).

### Annexe 150

Infinite baffle enclosure with units and crossover. One 8in rubber roll surround bass driver, one  $2\frac{1}{2}$ in tweeter. Crossover: 7kHz L/C network. FR: 40Hz-20kHz. HC: 15W RMS. Impedance: 8 ohms nominal. Size:  $17 \times 11 \times 8$ in. Weight: 12lb. Finish: teak or white. Price: £39 each (plus VAT).

### Annexe 200

Infinite baffle enclosure with units and crossover. One  $12\frac{3}{4} \times 8\frac{1}{4}$ in rubber roll surround bass driver, two  $2\frac{1}{4}$ in tweeters. Crossover: 7kHz L/C network. FR: 40Hz-22kHz. HC: 20W. Impedance: 8 ohms nominal. Size:  $21\frac{1}{2} \times 12\frac{1}{2} \times 10$ in. Weight:  $14\frac{3}{4}$ lb. Finish: teak or white. Price: £49 each (plus VAT).

### Annexe 300

Infinite baffle enclosure with units and crossover. Two 8in rubber roll surround bass drivers, two  $2\frac{1}{4}$ in tweeters. Crossover: 4kHz L/C network. FR: 30Hz-20kHz. HC: 30W RMS. Impedance: 8 ohms nominal. Size:  $34 \times 15 \times 12$ in. Weight: 41lb. Finish: teak or white. Price: £90 each (plus VAT).

## ■ MARTIN

Distributed by Cosmocord Ltd, Eleanor Cross  
Road, Waltham Cross, Herts, EN8 7NX.  
Tel: Waltham Cross (97) 27331. Telex: 24294.

### Signature (Model 1)

Miniature two-way system with units and crossover. One 6in bass driver, one 4in tweeter. HC: 40W music. FR: 40Hz-18kHz. Size:  $12 \times 8\frac{3}{8} \times$

★ Indicates entry is illustrated

9in. Weight: 15lb. Price: (per pair) £30.29 (plus VAT).

#### **Micro-Max (Model 110)**

Shelf-mounting two-way speaker system with units and crossover. One 8in bass driver, one 2in mid-range and tweeter. HC: 45W. FR: 38Hz-18kHz. Rear-mounted balance control. Size:  $18 \times 10\frac{3}{4} \times 9\frac{3}{4}$ in. Weight: 23lb. Finish: walnut

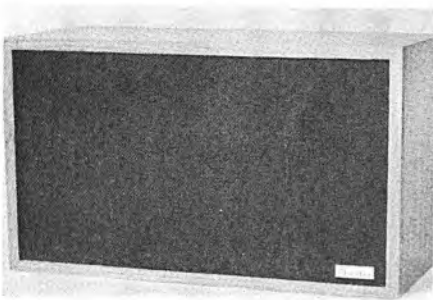

*Martin Laboratory Mk II*

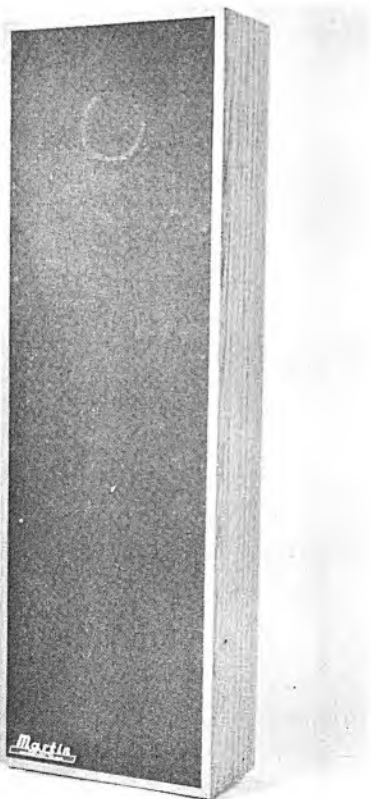

*Martin Sound Tower*

effect laminate on all sides. Price: £44 (plus VAT).

#### **Super Max (Model 120)**

Infinite baffle enclosure system with units and crossover. One 10in bass driver, one 2in tweeter. Rear-mounted control for balance. HC: 50W. FR: 36Hz-18kHz. Size:  $21\frac{1}{2} \times 12\frac{1}{2} \times 10$ in. Weight: 27lb. Price: £60.57 (plus VAT).

#### **Laboratory Mk II (Model 230) ★**

Three-way shelf-mounting speaker system with units and crossover. One 10in bass driver, 4in mid-range unit, 2in tweeter. Two balance controls. HC: 50W. FR: 34Hz-18kHz. For use with amplifiers with output of 20W or over. Size:  $21\frac{1}{2} \times 12\frac{1}{2} \times 10$ in. Weight: 30lb. Price: £76.32 (plus VAT).

#### **Spectrum Slope (Model 330)**

Three-way four-speaker system with units and crossover. Two 8in bass drivers,  $3\frac{1}{2}$ in mid-range unit and 2in tweeter. HC: 60W. FR: 30Hz-18kHz. Mid-range and HF balance control. Size:  $21\frac{1}{2} \times 12\frac{1}{2} \times 10$ in. Weight: 35lb. Price: £104.21 (plus VAT).

#### **ppff (Model 430)**

Bookshelf or floor-standing three-way system with units and crossover. One 12in bass driver, one  $3\frac{1}{2}$ in mid-range unit, one  $2\frac{1}{2}$ in tweeter. HC: 60W. FR: 30Hz-18kHz. Two balance controls for mid- and high-frequency levels. Size:  $25\frac{1}{2} \times 15 \times 12$ in. Weight: 45lb. Price: £110.22 (plus VAT).

#### **Super Spectrum Slope (Model 440)**

No technical details available as this edition of the Year Book closed for press. Price: £117.08 (plus VAT).

#### **Krypton (Model 470)**

Floor-standing four-way speaker system with units and crossover. One 12in bass driver, one 10in mid-bass unit, one  $3\frac{1}{2}$ in mid-range unit, one 2in tweeter. Two controls for mid-frequency and HF balance. HC: 75W. FR: 30Hz-20kHz. Size:  $25\frac{1}{2} \times 15 \times 12$ in. Weight: 49lb. Price: £148.39 (plus VAT).

#### **Magnificat (Model 830)**

Floor-standing five-unit speaker system with units and crossover. Two 12in bass units, one 5in mid-range unit, two 2in tweeters. Two controls for mid-frequency and HF balance. HC: 80W. FR: 28Hz-20kHz. Cabinet braced with 14 struts plus patented pre-stressed arrangement. Size:  $37\frac{1}{2} \times 18 \times 14\frac{3}{4}$ in. Weight: 90lb. Price: £221.06 (plus VAT).

#### **Sound Tower (Model 840) ★**

Floor-standing seven-unit speaker system with units and crossover. Four 8in bass drivers, one 5in mid-range unit, two  $2\frac{1}{2}$ in tweeters. Two controls provide mid-frequency and HF balance. HC: 100W. FR: 28Hz-20kHz. Size:  $52 \times 16\frac{1}{4} \times$

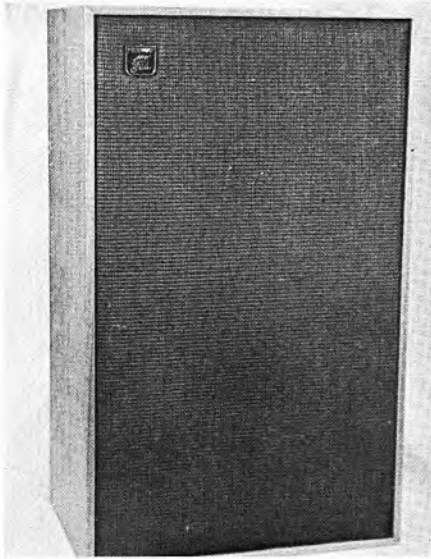

Medway BT75

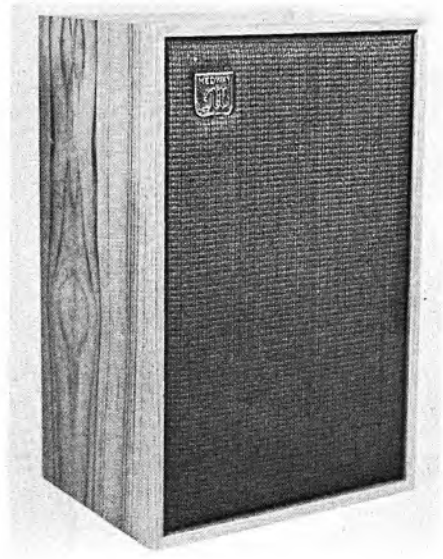

Medway BT50

7 $\frac{3}{4}$  in. Weight: 85lb. Price: £248.33 (plus VAT). All Martin-Eastman speaker systems are unconditionally guaranteed for five years.

#### ■ MEDWAY

Brahms Manufacturing and Development Co, Unit E, Rochester Airport, Maidstone Road, Rochester, Kent, ME1 3QJ.  
Tel: Medway (0634) 48816.

#### BT75 ★

Infinite baffle enclosure with unit. One 8in full-range driver. FR: 70Hz-13kHz. HC: 8W RMS. Impedance: 8 ohms. Size: 13 $\frac{3}{8}$  × 10 × 6 $\frac{1}{2}$  in. Weight: 10lb. Finish: teak or walnut. Price: £18-70 per pair (including VAT).

#### BT100

Infinite baffle enclosure with units and crossover. One 8in doped cone bass driver, one 4in HF unit. Crossover: 3-5kHz. FR: 50Hz-20kHz. HC: 10W RMS. Impedance: 8 ohms. Size: 17 × 10 $\frac{1}{2}$  × 7 $\frac{1}{2}$  in. Weight: 14lb. Finish: teak or walnut. Price: £26-40 per pair (including VAT).

#### BT150

Infinite baffle enclosure with units and crossover. One 8in rubber surround bass driver, one 4in HF unit. Crossover: 3-5kHz. FR: 45Hz-20kHz. HC: 15W RMS. Impedance: 8 ohms. Size: 20 × 12 × 8 $\frac{1}{2}$  in. Weight: 16lb. Finish: teak or walnut. Price: £34-10 per pair (including VAT).

#### ■ METROSOUND

Metrosound Audio Products Ltd, Audio Works, Cartersfield Road, Waltham Abbey, Essex, EN9 1JF.  
Tel: Waltham Cross (97) 31933.

#### HFS103

Infinite baffle enclosure with units and crossover. One 10 $\frac{3}{4}$  × 6 $\frac{1}{2}$  in bass driver, two 2 $\frac{1}{2}$  in tweeters. Crossover: 5kHz. FR: 50Hz-15kHz. HC: 10W RMS. Impedance: 8 ohms. Size: 14 × 9 × 7 in. Weight: 9lb. Finish: teak veneer cabinet and slatted grille, silver trim. Price: (per pair) £25 (plus VAT).

#### HFS202

Infinite baffle enclosure with units and crossover. One 13 $\frac{1}{2}$  × 8 $\frac{1}{4}$  in bass driver, one 3 $\frac{1}{2}$  in tweeter. Crossover: 5kHz. FR: 40Hz-18kHz. HC: 20W RMS. Impedance: 8 ohms. Size: 23 × 11 $\frac{1}{2}$  × 11 in. Weight: 22 $\frac{3}{4}$  lb. Finish: teak veneer cabinet ( $\frac{3}{4}$  in thick) with slatted grille and silver trim. Price: £21-50 (plus VAT).

#### Duplex 25

Duplex electrostatic speaker. HC: 25W. Impedance: 8 ohms. FR: 40Hz-18kHz. Crossover: 2-5kHz. Size: 16 $\frac{1}{2}$  × 27 $\frac{1}{2}$  × 12 in. Weight: 40lb. Finish: crown grain teak. Electrostatic unit energised by mains supply (90-250V 50-60Hz). Price: £52 (plus VAT).

★ Indicates entry is illustrated

### ■ MILLBANK

Millbank Electronics Group, Bellbrook Estate,  
Uckfield, Sussex, TN22 1PS  
Tel: Uckfield (0825) 4166

#### MLS1000

Heavy duty infinite baffle speaker enclosure with units and crossover. One 18in bass driver, four horn-loaded pressure units. Crossover: (electrical) 800Hz. FR: 30Hz to above 12kHz. Designed for high quality high level music reproduction. HC: 150W (from built-in amplifier). Impedance: 10K input to amplifier. Size: 42 × 21½ × 36in. Weight: 180lb. Finish: vynide-covered wood cabinet, satin chrome speaker grille, matt black anodised aluminium HF unit housing. Preset controls for HF and LF units. Particularly suitable for discotheques. Price: £399.89 (plus VAT).



MMG Emperor 101, 102

### ■ MMG ASSOCIATES LTD

8 Station Road, Marlow, Bucks, SL7 1EH.

#### Emperor 101 ★

Infinite baffle type enclosure. 13 × 8in elliptical driver with coaxially mounted high frequency unit. Crossover: 5kHz choke-capacitor network. FR: 50Hz-16kHz. HC: 20W. vci: 8 ohms. Adjustable high frequency balance. Finish: teak effect in Melamine plastic, with other finishes to order. Size: 31 × 17 × 9in. Weight: 39½lb. Price: £33 (plus VAT).

#### Emperor 102 ★

As Emperor 101 but vci is 16 ohms. Price: £33 (plus VAT).

#### Emperor Mk III

FR: 50Hz-18kHz. HC: 25W. vci 8 or 16 ohms. Finish: teak, mahogany or to order. Size: 35 × 17 × 19in. Weight: 42lb. Price: £60 (plus VAT).

#### Emperor Studio Monitor

Full specification and prices of the Emperor Studio Monitor systems available on request.

#### Emperor Custom Series

Speaker systems manufactured to customer's own design and specifications. Full details of service on request.

### ■ MONITOR AUDIO

Monitor Audio, 4 Thulborn Close,  
Teversham, Cambridge, CB1 5AU.  
Tel: (0223) 852031.

#### MA1 Loudspeaker ★

Reflex enclosure with units and crossover. One 13 × 9in reinforced polystyrene wedge bass driver; one 7in plastic cone mid-range; one soft dome tin tweeter. Crossovers: 4000Hz and 2.9kHz. FR: 40Hz-19kHz ± 3.5dB. HC: 60W programme. Programme: minimum power 15W. Impedance: 8 ohms. Size: 30 × 13½ × 15in deep. Weight: 60lb. Stand: 10in high steel frame with



Monitor Audio-Model MA1

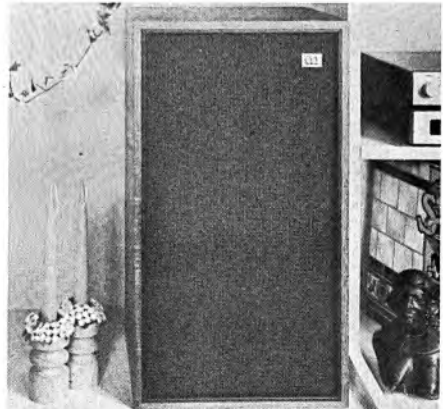

Monitor Audio-Model MA5

castors. Cabinet finish: teak standard, walnut or white to order. Price: (from) £95 (including VAT). Stands extra.

#### MA5 Loudspeaker ★

Infinite baffle enclosure with units and crossover. One plastic cone bass/mid-range driver, 8in in diameter; one soft dome 1in tweeter. Crossover: 2.9kHz. FR: 55Hz-19kHz $\pm$ 3dB. HC: 40W programme. Minimum amplifier programme: 15W continuous rating. Impedance: 8 ohms. Size: 22 $\times$ 12 $\times$ 10in deep. Weight: 26lb. Finish: teak standard, walnut, or white to order. Price: (from) £47.50 (including VAT). Floor stand available.

#### MA3 Loudspeaker

Provisional at time of going to press. Reflex enclosure with units and crossover. One 13.5 $\times$ 9.2in bass driver; one 7in plastic cone mid-range driver; one damped mylar dome 1in tweeter. Crossovers 400Hz and 3kHz. FR: 45Hz-20kHz $\pm$ 3dB. HC: 100W programme. Impedance: 8 ohms. Size: 27 $\frac{3}{4}$  $\times$ 13 $\frac{3}{4}$  $\times$ 12 $\frac{1}{2}$ in deep. Highly damped enclosure with above average translation efficiency. Stand available. Price: (from) £125 (inclusive of VAT). Stands extra.

#### MA7 Loudspeaker

Provisional at time of going to press. Compact reflex enclosure with units and crossover. One 6 $\frac{1}{2}$ in bass driver; one mylar dome 1in tweeter. Crossover: 3kHz. FR: 70Hz-20kHz $\pm$ 4dB, 40Hz-22kHz overall. HC: 25W programme. Minimum power 8W. Impedance: 8 ohms. Size: 16 $\times$ 9 $\times$ 8in deep. Price: (from) £30 (including VAT).

#### ■ KEITH MONKS

Keith Monks (Audio) Ltd, 26-28 Reading Road South, Fleet, near Aldershot, Hants.  
Tel: Fleet (025 14) 7316/3566.

#### Elf ★

Bookshelf reflex enclosure with three units. Built-in filter system, 6 $\frac{1}{2}$ in bass driver, two 3in tweeters. HC: 12W RMS. FR: 40Hz-16kHz. Finish: teak, walnut, pine, white, laurel. Price: £25.30 (including VAT).

#### Super Elf ★

Bookshelf enclosure with units and crossover. One 8in long-throw bass driver, two 4in-high response tweeters. FR: 40Hz-18kHz. Impedance: 8 ohms. HC: 15W RMS. Size: 17 $\frac{1}{2}$  $\times$ 11 $\times$ 8 $\frac{1}{4}$ in. Finish: hard waxed teak veneer with Vynair grille. Price: £31.35 (including VAT).

#### ■ MORDAUNT-SHORT

Mordaunt-Short Ltd, The Causeway, Petersfield, Hampshire, GU31 4JT.  
Tel: Petersfield (0730) 4631.

#### MS079 ★

Infinite baffle enclosure with units. One 6 $\frac{1}{2}$ in

bass driver, one 1in dome tweeter. Crossover: 4.5kHz. FR: 45Hz-20kHz. HC: 20W continuous programme. Impedance: 8 ohms. Finish: teak or walnut veneer (including rear of cabinet), special finishes to order. Size: 15 $\frac{3}{4}$  $\times$ 9 $\frac{1}{2}$  $\times$ 8in. Weight: 14lb. Price: (per pair) £67.10 (including VAT).

#### MS235

Infinite baffle enclosure with units. One 8in bass driver, one 1in dome-type mid-range unit, one STC HF tweeter. Crossover: 3.5kHz and 12kHz. FR: 40Hz-25kHz. HC: 25W continuous pro-

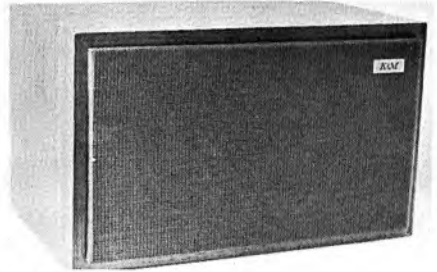

Keith Monks Elf



Keith Monks Super Elf



Mordaunt-Short MS079



Mordaunt-Short MS Festival

gramme. Impedance: 8 ohms. Finish: teak or walnut veneer (including rear of cabinet), special finishes to order. Size: 21 × 13 × 9in. Weight: 25lb. Matching stand optional extra. Price: (per pair) £119.90 (including VAT).

#### MS400

Infinite baffle enclosure with units. One 13 × 8in bass driver, one 1½in dome-type mid-range unit, one STC HF tweeter. Crossover: 2.25kHz and 12kHz. FR: 35Hz-25kHz. HC: 30W continuous programme. Impedance: 8 ohms. Finish: teak or walnut veneer (including rear of cabinet), special finishes to order. Size: 27 × 15 × 9in, with 1½in plinth. Weight: 39lb. Price: (per pair) £143 (including VAT).

#### MS737

Infinite baffle enclosure with units. Two 8in bass units, one London ribbon. Crossover: 3.5kHz. FR: 25Hz-25kHz. HC: 45W continuous programme. Impedance: 8 ohms. Finish: teak or walnut veneer (including rear of cabinet), special finishes to order. Size: 33 × 17 × 12in (with 1½in plinth). Weight: 62lb. Price: (per pair) £216.70 (including VAT).

#### Carnival

No. of drive units: two, 165mm and 68mm. Power-handling capacity: 18W, continuous programme. Impedance: 8 ohms nominal. Weight: 11.5lbs (5.3kg) approx. Frequency range: 50-18,000Hz. Size: 15½in high × 9½in wide × 5½in deep (400 × 241 × 145mm). Finish: teak or walnut veneer; rear of cabinet inset with glass-plates enabling horizontal or vertical wall mounting. Price: (per pair) £45 (plus VAT).

#### Festival ★

No. of drive units: two, 200mm and 68mm.

Power handling capacity: 20W, continuous programme. Impedance: 8 ohms nominal. Weight: 15.5lb (7kg) approx. Frequency range: 45-18,000Hz. Size: 17½in high × 11in wide × 7½in deep (454 × 279 × 185mm). Finish: teak or walnut veneer, rear of cabinet inset with glass-plates enabling horizontal or vertical wall-mounting. Price: (per pair) £54 (plus VAT).

#### ■ NORDMENDE

Distributors: H. Vesshof & Co Ltd (Vessco Vision & Radio), 62 Woodbridge Road, Guildford, Surrey, GU1 4RD. Tel: Guildford (0483) 77877.

#### LB31

Bookshelf type in natural walnut or white. HC: 15W RMS. FR: 45Hz-20kHz. vci: 5 ohms. Size: 6¼ × 7 × 10½in approx. Price: on request.

#### LB34

Enclosure with unit. HC: 5W nominal. FR: 70Hz-14kHz. Impedance: 4 ohms. Size: 10 × 6 × 6¼in approx. Finish: walnut. Price: on request.

#### LB44

Enclosure with units and crossovers to DIN specification. Two 5½in bass drivers, one dome tweeter. Impedance: 8 ohms. HC: 30W nominal. FR: 45Hz-25kHz. Size: 12½ × 21½ × 3¼in approx. Finish: light walnut or white. Price: on request.

#### LB61

Enclosure with units and crossover to DIN specification. Three bass drivers, one dome tweeter. Impedance: 8 ohms. HC: 30W nominal. FR: 30Hz-25kHz. Size: 10 × 20 × 7½in. Finish: white, red, green, dark grey, walnut or teak. Price: on request.

#### LB62

Enclosure with units and crossover to DIN specification. Two bass drivers, one tweeter. Impedance: 5 ohms nominal. HC: 25W. FR: 30Hz-25kHz. Size: 8¼ × 17 × 7¼in approximately. Finish: white, teak or walnut. Price: on request.

#### LB66

Enclosure with units and crossover to DIN specification. One 12in bass driver, two 4in mid-range units, two dome tweeters. HC: 60W nominal. FR: 35Hz-22kHz. Impedance: 8 ohms. Size: 14½ × 27½ × 7½in. Finish: walnut or white. Price: on request.

#### LB67

Enclosure with units and crossover to DIN specification. One 12in bass driver, one 5½in mid-range unit, one 1½in HF unit, one 1in dome tweeter. HC: 60W nominal. FR: 20Hz-25kHz. Impedance: 8 ohms. Size: 28½ × 14¼ × 10½in. Finish: walnut or white. Price: on request.

## ■ PHILIPS

Philips Electrical Ltd, Century House,  
Shaftesbury Avenue, London. WC2H 8AS.  
Tel: 01-437 7777. Cables: Phillamps, London.

### RH422

Infinite baffle. FR: 50Hz-20kHz (DIN 45500).  
vci: 4 ohms. HC: 20W RMS. Size:  $10\frac{1}{2} \times 10\frac{1}{2} \times 4\frac{1}{4}$  in. Weight:  $8\frac{1}{2}$  lb. Two drive units: 7in and 1in. Crossover: 2kHz. Resonant frequency: 95Hz. Finish: walnut. With leads and DIN plugs. Price: £22 (including VAT).

### RH426

Infinite baffle enclosure with three units and crossover. One 8in bass driver, one 5in mid-range unit, one 1in tweeter. Crossover: 500Hz, 5kHz. FR: 35Hz-20kHz. HC: 30W RMS. Impedance: 4 ohms. Size:  $13\frac{1}{2} \times 18 \times 9$  in. Weight: 21lb. Finish: walnut. Price: £39.50 (including VAT).

### RH427 ★

Infinite baffle enclosure with four units and crossover. Two 8in bass drivers, one 5in mid-range unit, one 1in tweeter. Crossover: 500Hz, 5kHz. FR: 30Hz-20kHz. HC: 40W. Impedance: 4 ohms. Size:  $16\frac{1}{2} \times 21\frac{1}{2} \times 9$  in. Weight: 29lb. Finish: walnut. Price: £57.50 (including VAT).

### RH532

Infinite baffle. FR: 35Hz-20kHz (DIN 45500). Inputs: 1V at 3K or 7.5V at 25 ohms switchable. Total output from internal amplifiers: 60W RMS. Size:  $15 \times 11\frac{1}{2} \times 8\frac{3}{4}$  in. Weight: 27lb. Three drive units: 8in MFB, 5in. 1in. Crossovers: 500Hz (active) and 4kHz (passive). Distortion: bass amp: 0.1% at 30W; treble amp: 0.1% at 15W. Finish: walnut. Electronic "motion feedback" enclosure incorporating a 40W bass amplifier and a 20W mid-range/treble amplifier. Price: £125 (including VAT).

## ■ PHOTAX

Photax, Eastbourne, Sussex.

### 1000S

Bass reflex enclosure. FR: 35Hz-21kHz. vci: 8 ohms. HC: 15W RMS. Size:  $11\frac{5}{8} \times 20\frac{1}{4} \times 9\frac{7}{8}$  in. Weight: 24.2lb. Three drive units: 8in,  $5\frac{1}{2}$  in, 3in. Crossover: 1kHz and 5kHz. Price: on application.

### 2000S

Infinite baffle enclosure. FR: 30Hz-21kHz. vci: 8 ohms. HC: 17W RMS. Size:  $13\frac{3}{8} \times 22\frac{3}{4} \times 11\frac{3}{8}$  in. Weight: 33lb. Two drive units: 10in and 1in dome. Crossover: 2.5kHz. Price: on application.

### 3000S

Infinite baffle enclosure. FR: 27Hz-21kHz. vci: 8 ohms. HC: 22W RMS. Size:  $15 \times 22\frac{3}{8} \times 11\frac{3}{8}$  in. Weight: 41.8lb. Three drive units: 12in,  $5\frac{1}{2}$  in and 1in dome tweeter. Crossover: 700Hz and 5kHz. Price: on application.

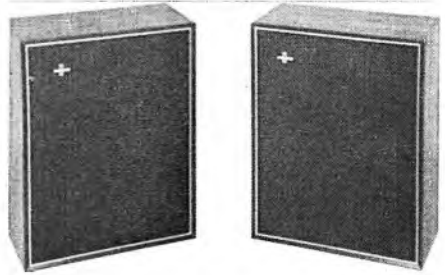

Philips RH427

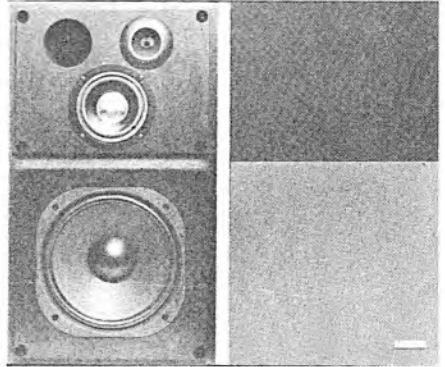

Pioneer CS-R500

## ■ PIONEER

Distributors: Shiro (UK) Ltd, Shiro House,  
The Ridgeway, Iver, Bucks. SL09JL.  
Tel: Cedarwood (07538) 2222.

### CS-R100

Bass reflex enclosure. FR: 50Hz-20kHz  $\pm$  3dB. vci: 8 ohms. HC: 20W RMS. Size:  $18\frac{1}{2} \times 10\frac{1}{8} \times 8\frac{1}{2}$  in. Weight: 11-11lb. Two drive units. Crossover: 5kHz. Resonant frequency: 87Hz. Distortion: 5% at 1kHz. Sensitivity: 1W for 92dB at 1m  $\pm$  1.5dB. Finish: walnut. Price: on application.

### CS-R300

Bass reflex enclosure. FR: 45Hz-20kHz  $\pm$  3dB. vci: 8 ohms. HC: 40W RMS. Size:  $22 \times 13 \times 10$  in. Weight: 26.7lb. Two drive units. Crossover: 4.2kHz. Resonant frequency: 81Hz. Distortion: 3.5%. Sensitivity: 1W for 92dB at 1m  $\pm$  1.5dB. Finish: walnut. Price: on application.

### CS-R500 ★

Bass reflex enclosure. FR: 35Hz-20kHz  $\pm$  3dB. vci: 8 ohms. HC: 60WRMS. Size:  $24 \times 13 \times 12$  in. Weight: 38.9lb. Three drive units. Crossover: 650Hz and 6kHz. Resonant frequency: 65Hz. Distortion: 3%. Sensitivity: 1W for 91dB at 1m  $\pm$  1.5dB. Finish: walnut. Price: on application.



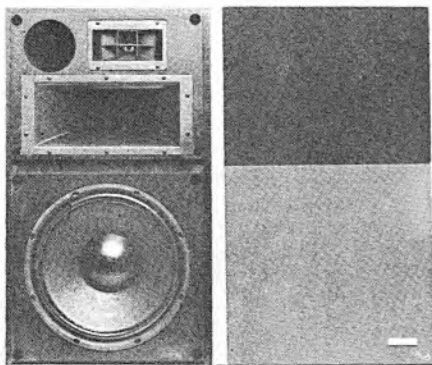

Pioneer CS-R700

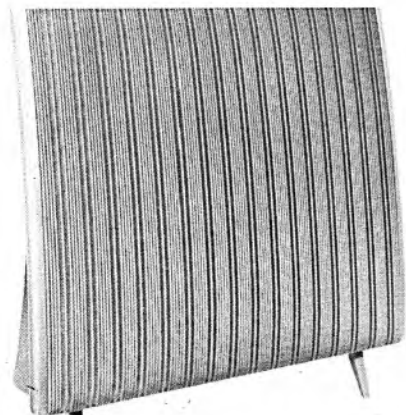

Quad Electrostatic

**CS-R700 ★**

Bass reflex enclosure. FR: 35Hz-20kHz. vci: 8 ohms. HC: 75W RMS. Size: 26 × 14 × 13½ in. Weight: 50-11lb. Three drive units. Crossovers: 700Hz and 14kHz. Distortion: 5%. Sensitivity: 1W for 91dB at 1m ± 1.5dB. Finish: walnut. Price: on application.

**CS-E220**

Air suspension. FR: 50Hz-20kHz. vci: 4-8 ohms. HC: 20W RMS. Size: 17 × 9 × 8 in. Weight: 13-4lb. Two drive units. Crossover: 2-75kHz. Resonant frequency: 90Hz. Distortion: 3% at 1kHz. Sensitivity: 1W for 86dB at 1m. Finish: walnut. Price: on application.

**CS-E320**

Air suspension. FR: 50Hz-20kHz. vci: 4-8 ohms. HC: 30W RMS. Size: 17 × 9 × 8 in. Weight: 19-13lb. Two drive units. Crossover: 1-85kHz. Resonant frequency: 73Hz. Distortion: 3% at

1kHz. Sensitivity: 1W for 86dB at 1m. Finish: walnut. Price: on application.

**CS-E420**

Air suspension. FR: 35Hz-20kHz. vci: 4-8 ohms. HC: 40W RMS. Size: 19 × 10¼ × 9 in. Weight: 26-7lb. Two drive units. Crossover: 1-6kHz. Resonant frequency: 60Hz. Distortion: 2% at 1kHz. Sensitivity: 1W for 87dB at 1m. Finish: walnut. Price: on application.

**CS-E530**

Infinite baffle. FR: 35Hz-20kHz. vci: 8 ohms. Size: 22 × 13 × 11 in. Weight: 36-6lb. Three drive units. Crossover: 800Hz. Resonant frequency: 53Hz. Distortion: 2% at 1kHz. Sensitivity: 1W for 88dB at 1m. Finish: walnut. Price: on application.

**CS-E730**

Infinite baffle. FR: 35Hz-20kHz. vci: 8 ohms. HC: 60W RMS. Size: 26 × 14 × 12 in. Weight: 47-6lb. Three drive units. Crossover: 650Hz and 5kHz. Resonant frequency: 53Hz. Distortion: 2%. Sensitivity: 1W for 91dB at 1m. Finish: walnut. Price: on application.

**CS-E830**

Infinite baffle. FR: 35Hz-20kHz. vci: 8 ohms. HC: 75W RMS. Size: 26 × 14 × 12 in. Weight: 48-8lb. Three drive units. Crossover: 750Hz and 5-6kHz. Resonant frequency: 55Hz. Distortion: 5% at 1kHz. Sensitivity: 1W for 90-5dB at 1m. Finish: walnut. Price: on application.

**CS-3000A**

Infinite baffle. FR: 30Hz-20kHz. vci: 8 ohms. HC: 100W RMS. Size: 26 × 14 × 12 in. Weight: 33kg. Three drive units. Crossovers: 620Hz and 4kHz. Resonant frequency: 45Hz. Distortion: 1% at 1kHz. Sensitivity: 1W for 89dB at 1m. Finish: walnut. Price: on application.

■ **QUAD**

Acoustical Manufacturing Co Ltd,  
St Peter's Road, Huntingdon, PE18 7DB.  
Tel: Huntingdon (0480) 52561.  
Cables: Acoustical.

**Quad Electrostatic ★**

Full range doublet covering 45Hz-18kHz. Attenuation outside band asymptotic to 18dB/8ve. Total integrated radiation at max output equivalent to 95 phons in rooms of up to 5000 cu ft with average reverberation. Dispersion approx 70° horizontal, 15° vertical. Imp: 30-15 ohms, 40Hz to 8kHz, falling above 8kHz. Designed for use with standard Quad 303 Amplifier. Suitable for AC supplies 100-120 or 200-250V 50-60Hz. Free-standing unit requires no enclosure or cabinet. Weight: 35lb. Price: £106-70 (including VAT).

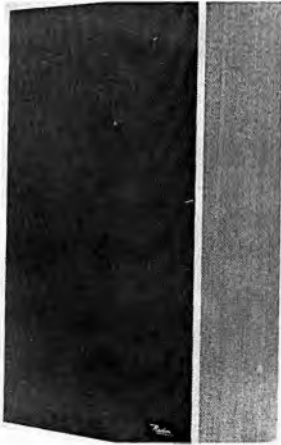

Radon Sapphire

### ■ QUASAR

Quasar Division, Precision Centre,  
Heather Park Drive, Wembley, HA0 1SU.  
Tel: 01-903 0144.

#### QSI Studio

Ported enclosure. FR: 45Hz-20kHz $\pm$ 3dB. vci: 8 ohms nominal. HC: 50W RMS. Size: 26 $\times$ 15 $\frac{1}{2}$  $\times$ 11 $\frac{1}{2}$ in. Weight: 44lb. Four drive units. Crossovers: 750Hz, 6kHz and 16kHz. Resonant frequency: 60Hz. Distortion: 0.16% at 1kHz. Doppler distortion: 0.007%, 90dB at 1m (measured with simultaneous frequencies of 100Hz and 3kHz). Efficiency: 0.55%. Sensitivity: 3.1W for 95dB at 1m. Finish: teak with solid afrormosia trim. Price: £92.40 (including VAT).

#### QS2 Monitor

Ported enclosure. FR: 55Hz-18kHz $\pm$ 3dB. vci: 8 ohms nominal. HC: 50W RMS. Size: 24 $\frac{1}{2}$  $\times$ 13 $\times$ 11 $\frac{1}{2}$ in. Weight: 40lb. Three drive units. Crossovers: 750Hz and 6kHz. Resonant frequency: 64Hz. Distortion: 0.16% at 1kHz. Doppler distortion: 0.007%, 90dB at 1m. Efficiency: 0.55%. Sensitivity: 3.1W for 95dB at 1m. Finish: teak with solid afrormosia trim. Price: £74.80 (including VAT).

#### QS3 Compact Monitor

Infinite baffle enclosure. FR: 60Hz-16kHz $\pm$ 3dB. vci: 8 ohms nominal. HC: 30W RMS. Size: 23 $\frac{1}{2}$  $\times$ 12 $\times$ 8 $\frac{1}{2}$ in. Weight: 26lb. Three drive units. Crossovers: 750Hz and 6kHz. Resonant frequency: 64Hz. Distortion: 0.16% at 1kHz. Doppler distortion: 0.013%, 90dB at 1m. Efficiency: 0.55%. Sensitivity: 3.1W for 95dB at 1m. Finish: teak with solid afrormosia trim. Price: £59.40 (including VAT).

### ■ RADON

Radon Industrial Electronics Co Ltd,  
Brooklands Trading Estate, Orme Road,  
Worthing, Sussex. Tel: Worthing (0903) 34904.

#### Jewel Range

Range of five speakers in hand-built teak enclosures. Finished in satin lacquers and charcoal-coloured fronts. Brass key plates for wall mounting. Impedances: 8 or 15 ohms.

#### Amethyst SC/1

Infinite baffle. HC: 10W maximum. FR: 60Hz-17kHz $\pm$ 6dB. System comprises 6 $\frac{1}{2}$ in woofer with ceramic magnet of 10,000 gauss and lin voice coil; and 4in tweeter with crossover. Size: 19 $\times$ 10 $\times$ 6in. Price: approximately £14 (including VAT).

#### Emerald SC/2

Infinite baffle. HC: 12W maximum. FR: 50Hz-10kHz $\pm$ 5dB. 10 $\times$ 6in woofer with aluminium centre cone and high compliance PVC suspension; tweeter and crossover. Price: approximately £19 (including VAT).

#### Opal SC/3

Infinite baffle. HC: 15W maximum. FR: 20Hz-20kHz $\pm$ 8dB. Speakers: 13 $\times$ 8in woofer using ceramic magnet of 11,000 gauss, high compliance PVC surround, aluminium centre cone; tweeter with 10,000 gauss ceramic magnet, driven from crossover network at 5kHz. Dimensions: 23 $\times$ 12 $\times$ 11in. Price: approximately £27.50 (including VAT).

#### Sapphire SC/4 ★

Enclosure with 12in woofer using ceramic magnet of 15,500 lines and 1 $\frac{3}{4}$ in speech coil. 4 $\times$ 4in tweeter assembly on heavy diecast alloy frame for non-directional sound. HC: 25W maximum. FR: 20Hz-18kHz $\pm$ 2dB. Cabinet size: 30 $\times$ 16 $\times$ 9in. Price: approximately £38.50 (including VAT).

#### Topaz SC/5

Infinite baffle enclosure with units. 14 $\times$ 9in bass driver, 5in mid-range unit, 3 $\frac{3}{8}$ in tweeter. FR: 50Hz-20kHz. HC: 20W RMS. Impedance: 8 ohms. Size: 28 $\times$ 16 $\times$ 13in. Weight: 32lb. Finish: natural teak satin lacquer. Special crossover provides control to mid-range and HF frequencies. Bass unit fitted with laminated glass fibre cone and diecast chassis. Price: approximately £70 (including VAT).

### ■ RANK DOMUS

Rank Audio Products Ltd,  
PO Box 70, Brentford, Middlesex.  
Tel: 01-568 9222.

#### RD150

Infinite baffle enclosure: vci: 8 ohms. HC: 15W RMS. Size: 14 $\frac{1}{2}$  $\times$ 9 $\frac{3}{4}$  $\times$ 9 $\frac{1}{2}$ in. Weight: 14lb. Two

★ Indicates entry is illustrated

drive units. Crossover: 2.5kHz. Resonant frequency: 40Hz. Distortion: <2% at 50Hz. Sensitivity: 5W for 90dBA. Finish: teak. Price: £42.50 (including VAT).

#### **RD175**

Infinite baffle enclosure. vci: 8 ohms. HC: 15W RMS. Size:  $19 \times 9\frac{3}{4} \times 9\frac{1}{2}$  in. Two drive units. Crossover: 2.5kHz. Resonant frequency: 30Hz. Distortion: <1.5 at 50Hz. Sensitivity: 5W for 90dBA. Finish: teak. Price: £54.50 (including VAT).

#### **RD250**

Infinite baffle enclosure. vci: 8 ohms. HC: 30W RMS. Size:  $23\frac{1}{4} \times 12\frac{1}{4} \times 10\frac{1}{2}$  in. Weight: 30lb. Three drive units including dome mid-range. Crossovers: 1.5kHz and 8kHz. Resonant frequency: 30Hz. Distortion: <1% at 50Hz. Sensitivity: 12.5W for 90dBA. Finish: teak. Price: £85.50 (including VAT).

#### **RD350**

Infinite baffle enclosure. vci: 8 ohms. HC: 50W RMS. Size:  $25\frac{1}{2} \times 14 \times 11\frac{3}{4}$  in. Weight: 41lb. Three drive units including dome mid-range. Crossovers: 700Hz and 12kHz. Resonant frequency: 25Hz. Distortion: <1.7% at 50Hz. Sensitivity: 10W for 90dBA, 40W for 96dBA. Finish: teak. Price: £124.50 (including VAT).

#### **RD450**

Infinite baffle enclosure. vci: 8 ohms. HC: 50W RMS. Size:  $26\frac{3}{8} \times 14\frac{3}{4} \times 12\frac{1}{4}$  in. Weight: 45lb. Three drive units including dome mid-range. Crossovers: 700Hz and 12kHz. Resonant frequency: 20Hz. Distortion: 1.7% at 50Hz. Sensitivity: 10W for 90dBA, 40W for 96dBA. Finish: teak. Price: £179.50 (including VAT).

#### ■ **RGD**

ITT Consumer Products (UK) Ltd, Maidstone Road, Sidcup, Kent, DA14 5HT.  
Tel: 01-300 7733.

#### **KS661**

Infinite baffle enclosure with unit. Single 4in full range driver. Impedance: 4 or 16 ohms (switched). HC: 12W peak. Finish: teak grain appearance. Size:  $9\frac{1}{4} \times 7 \times 15\frac{1}{8}$  in. Price: £22.50 (including VAT).

#### **KS665**

Infinite baffle enclosure with units and crossover. One  $6\frac{1}{2}$ in bass driver, one  $3\frac{3}{8}$ in or  $2\frac{1}{2}$ in tweeter. Impedance: 8 ohms. HC: 15W peak. Treble control. Finish: teak grain appearance. Size:  $18 \times 11\frac{1}{2} \times 6\frac{3}{4}$  in. Price: £31.50 (including VAT).

#### **KS659**

Infinite baffle enclosure with units and crossover. One  $6\frac{1}{2}$ in bass driver, one  $6 \times 4$ in mid-range unit, one  $3\frac{3}{8}$ in treble unit. Impedance: 4 ohms. HC: 18W peak. Finish: teak grain appearance.

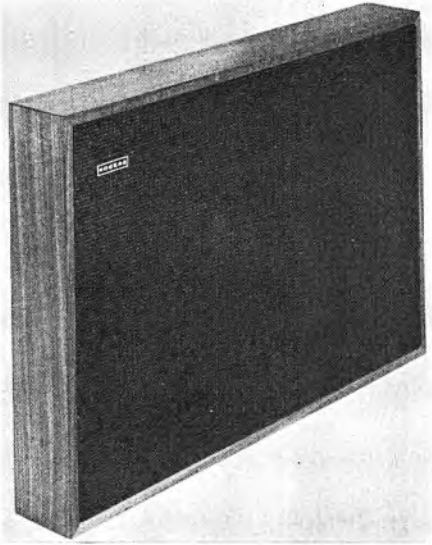

Rogers Wafer

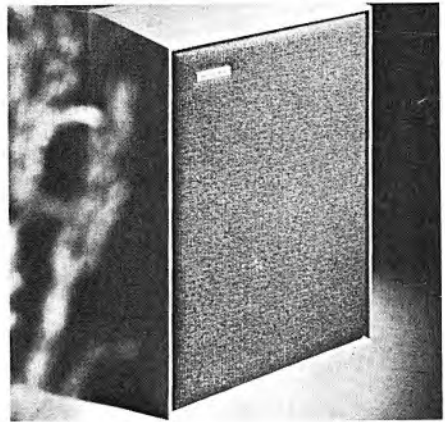

Rogers Ravensbourne Compact

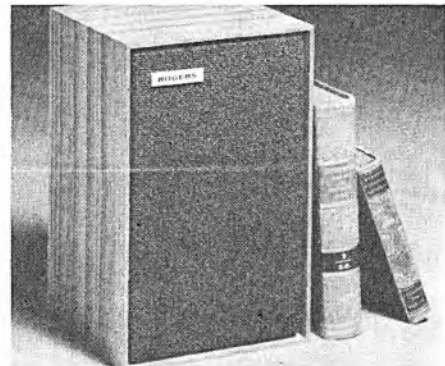

Rogers BBC Monitor LS3/5A

Size:  $27\frac{1}{2} \times 11\frac{1}{8} \times 9\frac{7}{8}$  in. Price: £46.44 (including VAT).

#### KS660

Infinite baffle enclosure with units and crossover. One 12in bass driver, one  $6 \times 4$ in mid-range unit, one  $3\frac{3}{8}$ in square tweeter. Impedance: 4 ohms. HC: 20W peak. Finish: teak grain appearance. Size:  $27\frac{3}{4} \times 16 \times 9\frac{1}{2}$  in. Price: £74.80 (including VAT).

#### ROGERS

Rogers Developments (Electronics) Ltd,  
4-14 Barmeston Road, London, SE6 3BN.  
Tel: 01-698 7424/4340.  
Cables: Rodevco, London, SE6.

#### Wafer System Mk II ★

Infinite baffle enclosure with two units. One 5in bass driver plus tweeter. FR: 40Hz-20kHz. HC: 15W. Impedance: 15 ohms. Finish: solid afrormosia frame with black fret material. Includes volume control for third or fourth channel use. Size:  $13\frac{1}{8} \times 16\frac{3}{8} \times 2\frac{1}{2}$  in. Price: £22 (including VAT).

#### Ravensbourne Compact ★

Complete system including units. One 8in bass driver, one  $2\frac{1}{2}$ in tweeter. Crossover: 2.75kHz at 18dB per octave. FR: 40Hz-20kHz. HC: 35W music rating. Impedance: 8-16 ohms. Size:  $19 \times 13 \times 8\frac{3}{4}$  in. Weight:  $17\frac{1}{2}$  lb. Finish: teak standard, other finishes, including rosewood and walnut, available to order at extra cost. Price: per pair £61.60 (including VAT).

#### BBC Studio Monitor

Three-way system based on a design by the BBC research department and produced under license. Conforms to BBC specification LS3/6, but with the addition of a third unit. Three drive units comprise bass driver, mid-range unit and tweeter. Bass and tweeter unit efficiencies are matched by low-loss auto transformer with 1dB tapplings. Sophisticated crossover using 5 per cent tolerance inductors and low loss capacitors. FR: 40Hz-25kHz  $\pm 3$ dB. HC: 25W (makers recommend amplifier having output of at least 20W, but caution is necessary with equipment over 40W output as overheating of the speech coil may occur). Impedance: 15 ohms standard, 8 ohms and 25 ohms made to order. Size:  $12 \times 25 \times 12$  in deep. Height with stand: 37in. Finish: teak. Price: (Standard Model—LS3/6, two drive units) £79.75 (including VAT); (Special Model, three drive units) £90.75 (including VAT); Tripod stand £9.90 (including VAT).

#### Wafer

Infinite baffle enclosure. FR: 40Hz-20kHz. vci: 8 ohms. HC: 15W speech and music. Size:  $18 \times 12\frac{3}{4} \times 2\frac{1}{2}$  in. Weight:  $10\frac{1}{2}$  lb. Two drive units. Crossover: 3kHz. Finish: teak with Declon grille. Price: £26.40 (including VAT).

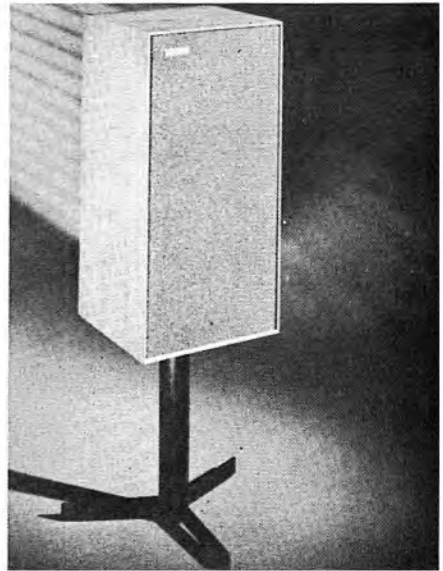

Rogers BBC Monitor LS3/6

#### BBC Monitor LS3/6 Standard

Reflex enclosure. FR: 40Hz-14kHz  $\pm 3$ dB. vci: 15 ohms. HC: 25W speech and music. Size:  $12 \times 12 \times 25$  in. Weight: 34lb. Two drive units. Made under licence from the BBC. Finish: teak. Price: £79.75 (including VAT).

#### BBC Monitor LS3/6 Special ★

Reflex enclosure. FR: 40Hz-20kHz  $\pm 3$ dB. vci: 15 ohms. HC: 25W speech and music. Size:  $12 \times 12 \times 25$  in. Weight: 34lb. Three drive units. Finish: teak. Made under licence from the BBC. Price: £90.75 (including VAT).

#### BBC Monitor LS3/5A ★

Infinite baffle enclosure. FR: 80Hz-20kHz  $\pm 3$ dB. vci: 8. ohms. Size:  $7\frac{1}{4} \times 6\frac{1}{2} \times 11\frac{1}{2}$  in. Weight:  $9\frac{1}{2}$  lb. Two drive units. Crossover: 3kHz. Finish: teak. Made under licence from the BBC. Price: (per pair) £114.40 (including VAT).

**NOTE:** Distribution of the Rogers BBC Monitor speaker system is through a very limited number of selected audio retailers. Full list of appointed retailers available from the manufacturers.

#### ROLA-CELESTION

See Celestion.

#### SABA

Saba Television Ltd, 6-12 Cornbrook Park Road, Manchester, M15 4EE.  
Tel: 061-872 7661.

★ Indicates entry is illustrated

#### **FL15G**

Speaker enclosure with units. One bass driver, one HF unit. FR: 50Hz-20kHz. Size:  $15\frac{3}{4} \times 9\frac{7}{8} \times 3\frac{1}{2}$ in. Finish: light walnut or white. Price: £27.50 (including VAT).

#### **15G**

Speaker enclosure with units. One bass driver, one HF unit. FR: 45Hz-20kHz. Size:  $15\frac{3}{8} \times 8\frac{5}{8} \times 8\frac{1}{4}$ in. Finish: fabric with wood grille. Price: £27.50 (including VAT).

#### **FL40G**

Speaker enclosure with units. Two bass drivers, one HF unit. FR: 40Hz-20kHz. Size:  $20\frac{1}{2} \times 12\frac{7}{8} \times 4\frac{1}{8}$ in. Price: £48.50 (including VAT).

#### **40G**

Speaker enclosure with units. Two bass drivers, one tweeter. FR: 35Hz-22.5kHz. Size:  $19\frac{1}{2} \times 11 \times 9\frac{7}{8}$ in. Price: £48.50 (including VAT).

#### **FL60G**

Speaker enclosure with units. One bass driver, one mid-range unit, two tweeters. FR: 30Hz-22.5kHz. Size:  $23 \times 14\frac{1}{4} \times 4\frac{3}{8}$ in. Price: £63.95 (including VAT).

#### **60G**

Speaker enclosure with units. One bass driver, one mid-range unit, two tweeters. FR: 25Hz-25kHz. Size:  $22\frac{3}{4} \times 12\frac{1}{2} \times 10\frac{1}{4}$ in. Price: £63.95 (including VAT).

### ■ SANSUI

Vernitron Ltd, Thornhill, Southampton, SO9 5QF. Tel: Southampton (0703) 444811.

#### **SP1700 ★**

Enclosure with units and crossover. One 12in bass driver, two 4in mid-range units, two 2in tweeters. HC: 70W music power. Impedance: 8 ohms. FR: 50Hz-20kHz. Crossover: 700Hz, 6.5kHz. Size:  $16\frac{3}{4} \times 25\frac{1}{4} \times 10\frac{3}{4}$ in. Weight: 46 $\frac{3}{4}$ lb. Finish: walnut cabinet with convex Kumiko fretwork grille. Price: £89.03 (plus VAT).

#### **SP2500**

Enclosure with units and crossover. One 12in bass driver, two 5in mid-range units, two 2in horn tweeters. HC: 80W music power. Impedance: 8 ohms. FR: 30Hz-20kHz. Crossover: 700Hz, 6.5kHz. Size:  $16\frac{3}{4} \times 10\frac{7}{8} \times 25\frac{1}{4}$ in. Weight: 56 $\frac{1}{4}$ lb. Finish: walnut cabinet with convex Kumiko fretwork grille. Price: £93.68 (plus VAT).

#### **SP3500**

Enclosure with units and crossover. One 14in bass driver, two 4in mid-range units, one  $4\frac{1}{2} \times 2$ in HF unit, two 2in horn tweeters. HC: 100W music power. Impedance: 8 ohms. FR: 25Hz-20kHz. Crossover: 700Hz, 2kHz, 6.5kHz. Size:  $17\frac{3}{4} \times 11\frac{1}{2} \times 25\frac{1}{4}$ in. Weight: 58lb. Finish: walnut



Sansui SP1700

cabinet with convex fretwork grille. Price: £113.57 (plus VAT).

#### **FS100**

Reflex enclosure with units and crossover. One 10in bass driver, one 1 $\frac{3}{8}$ in dome tweeter. Crossover: two-way 18dB/octave at 3kHz. FR: 45Hz-20kHz. HC: 45W RMS. Impedance: 8 ohms. Size:  $12\frac{1}{4} \times 20\frac{5}{8} \times 9\frac{5}{8}$ in. Weight: 24lb. Finish: walnut. Price: to be announced.

#### **ES200**

Reflex enclosure with units and crossover. One 10in bass driver, one 1 $\frac{3}{8}$ in dome mid-range unit, one  $\frac{3}{4}$ in dome tweeter. Crossover: three-way 12dB/octave and 18dB/octave at 1.5kHz and 6kHz respectively. FR: 45Hz-20kHz. HC: 50W RMS. Impedance: 8 ohms. Size:  $12\frac{3}{8} \times 22\frac{1}{2} \times 11\frac{5}{8}$ in. Weight: 32lb. Finish: walnut. Price: to be announced.

### ■ SANYO

Sanyo Marubeni (UK) Ltd, Sanyo House, Bushey Mill Lane, Watford, Herts, WD2 4UQ. Tel: Watford (92) 30421.

#### **RW15**

Price: £19.75 (including VAT).

#### **RW30**

Price: £26.75 (including VAT).

#### **RW40**

Price: £44.75 (including VAT).

No further details available at time of going to press.

### ■ SCAN-DYNA

Scandinavian Audio Systems Ltd, Sun Alliance Buildings, 65 London Road, Gloucester, GL1 3HF. Tel: Gloucester (0452) 32791.

#### **M2**

Infinite baffle enclosure with unit. One full-range  $6 \times 4$ in unit with double membrane and pneumatic suspension. FR: 70Hz-18kHz. HC:

10W RMS. Impedance: 4 ohms. Size:  $9\frac{3}{4} \times 4\frac{1}{4} \times 8\frac{1}{2}$  in. Finish: teak or rosewood. Price: £13.95 (including VAT).

#### M5

Infinite baffle enclosure with unit. One  $8\frac{1}{2}$  in bass unit, one 2 in tweeter. FR: 60Hz-20kHz. HC: 15W RMS. Impedance: 4 ohms. Finish: teak or rosewood. Price: £22.95 (including VAT).

#### A10

Enclosure with units. One 7 in bass unit, one  $1\frac{1}{2}$  in dome tweeter. FR: 45Hz-20kHz. HC: 30W RMS. Finish: teak, rosewood or black. Impedance: 4 and 8 ohms. Price: £29.95 (including VAT).

#### A20

Twin chamber enclosure with units and crossover. One 8 in bass driver, one  $1\frac{1}{2}$  in dome tweeter. FR: 32Hz-20kHz. HC: 35W RMS. Impedance: 4 ohms. Finish: teak or rosewood. Size:  $17 \times 9\frac{3}{4} \times 9\frac{3}{4}$  in. Weight: 18lb. Price: £35.95 (including VAT)

#### A25

Reflex enclosure with units and crossover. One  $9\frac{1}{2}$  in bass driver, one  $1\frac{1}{2}$  in dome tweeter. Crossover: 1.5kHz. FR: 30Hz-20kHz. Impedance: 4 or 8 ohms. HC: 45W RMS. Size:  $21\frac{1}{2} \times 12\frac{1}{2} \times 9\frac{3}{4}$  in. Finish: teak, rosewood, black or white. Price: £42.95 (including VAT).

#### A30

Twin chamber enclosure with units and crossover. One 10 in bass driver, one  $1\frac{1}{2}$  in dome tweeter. FR: 25Hz-20kHz. HC: 45W RMS. Impedance: 4 ohms. Finish: teak or rosewood. Size:  $22\frac{1}{2} \times 12\frac{1}{2} \times 9\frac{3}{4}$  in. Price: £49.95 (including VAT).

### ■ SENNHEISER

Distributed by Hayden Laboratories Ltd, Hayden House, 17 Chesham Road, Amersham, Bucks, HP6 5AG. Tel: Amersham (0240 3) 5111.

#### VKL 304-1

Infinite baffle enclosure. FR: 40Hz-16kHz. Size:  $24 \times 40 \times 65$  cm. Weight: 22kg. Finish: walnut. Contains a 30W amplifier with 50K input impedance. Price: on application.

#### VKL 304-4

Infinite baffle enclosure. FR: 40Hz-16kHz. Size:  $24 \times 40 \times 65$  cm. Weight: 22kg. Finish: light grey Hornitex. Contains a 30W amplifier with 50K input impedance. Price: on application.

### ■ SERVO-SOUND

(Cybernetic Hi-Fi), Lamb House, Church Street, London, W4 2PB. Tel: 01-995 4551.

#### SL20 ★

Infinite baffle enclosure incorporating drive unit

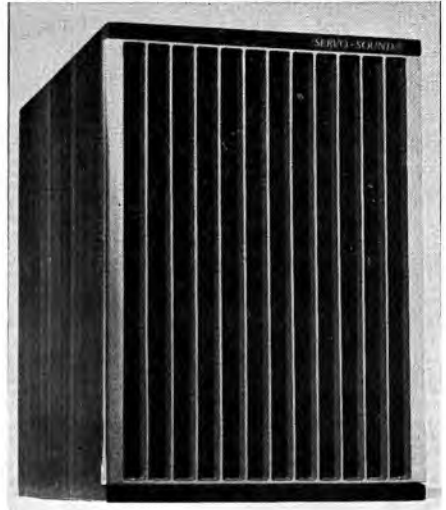

Servo-Sound SL20

and power amplifier. One  $9\frac{1}{2} \times 6\frac{1}{2}$  elliptical full-range drive unit. FR: (power amplifier and speaker system) 35Hz-20kHz. HC: 20W RMS. Impedance: 4 ohms. Includes built-in 15W RMS power amplifier incorporating patented 'Cybernetic' circuit to provide servo control of speaker cone. Circuit is designed to monitor speaker cone movement, compare with input to amplifier and apply correction signal to amplifier. Size:  $7 \times 10 \times 11$  in. Weight:  $12\frac{1}{2}$  lb. Finish: wood cabinet finished in walnut or white, chrome grille. Designed for use with Servo-Sound SC100BEE preamplifier (see Amplifier section). Price: (speaker and amplifier) £58.90 (plus VAT).

### ■ SIEMENS

Siemens Ltd, Great West House, Great West Road, Brentford Middlesex. Tel: 01-568 8281.

#### RL602

Speaker enclosure using four drivers rated for 60W. No further details available. Price: £126 (including VAT).

### ■ SINCLAIR

Sinclair Radionics Ltd, London Road, St Ives, Huntingdonshire, PE17 4HJ. Tel: St Ives (0480) 4311.

#### Q16

Slim shelf-mounting enclosure with unit. High compliance full-range driver with aluminium speech coil and ceramic magnet. 11,000 gauss.

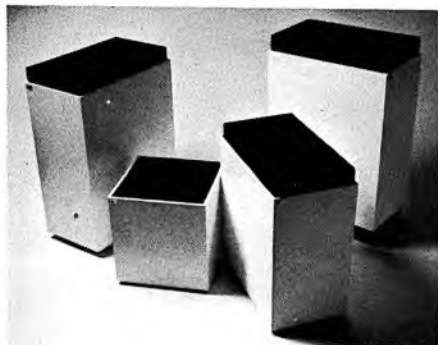

Sonab Enclosures



Sonab Enclosures

HC: 14W RMS. Impedance: 8 ohms. FR: 60 Hz-16kHz. Infinite baffle construction. Size:  $9\frac{3}{4} \times 9\frac{3}{4} \times 4\frac{3}{4}$  in. Finish: natural solid teak surround with black cellular foam front. Price: £7-70 (plus VAT).

#### ■ SMC

Monitor Distribution Co Ltd, 76 Bedford Road, Kempston, Beds, MK42 8BB. Tel: Kempston (023 05) 2694.

#### AL12

Acoustic labyrinth system, 8in bass unit and  $\frac{3}{4}$ in tweeter FR: 50Hz-40kHz (DIN) 45-500 HC25W, 8 ohms, efficiency 20W pink noise -96dB at 1 metre. Size:  $23\frac{1}{2} \times 11\frac{1}{2} \times 11\frac{1}{2}$  in. finish teak. Pedestal stand S12 or trolley T12 available. Prices: (per pair) AL12 £96-26 (including VAT), S12 £13-68; T12 £19-80.

#### A122

Acoustic labyrinth system, 8in bass unit and  $\frac{3}{4}$ in tweeter. FR: 35Hz-40kHz (DIN) 45-500 HC: 30W, 8 ohms efficiency 20W pink noise -96dB at 1 metre. Size:  $32\frac{1}{2} \times 13\frac{1}{2} \times 13\frac{1}{2}$  in finish teak, supplied on plinth or floor standing. Price: (per pair) £130-90 (including VAT).

#### AL30

Acoustic labyrinth system, bass unit and two HF units. FR: 33Hz-40kHz (DIN) 45-500 HC: 40W, 8 ohms efficiency 16W pink noise -96dB at 1 metre. Size:  $35\frac{1}{2} \times 14\frac{1}{2} \times 13\frac{1}{2}$  in finish teak Formica. Price: (per pair) £173-80 (including VAT), other finishes are available to order.

#### ■ SONAB

Sonab Ltd, PO Box 4, Oldfield Road, Hampton, Middlesex, TW12 2HN. Tel: 01-979 0134.

#### V-1 ★

Enclosure with one upward-facing  $8\frac{1}{2}$ in unit. FR: 49Hz-17kHz (DIN). HC: 35W (DIN). Impedance: 8 ohms. Size:  $12 \times 12 \times 12\frac{1}{2}$  in. Weight: 10lb. Finish: rosewood, teak, white, red, yellow or blue. Price: £78-18 per pair (plus VAT).

#### OA-4 ★

Enclosure with upward-facing  $8\frac{1}{2}$ in bass/middle driver and three 2in tweeters. Crossover: 3-5 kHz. FR: 44Hz-18kHz (DIN). HC: 35W (DIN). Impedance: about 7 ohms. Size:  $11\frac{1}{2} \times 17 \times 17\frac{1}{2}$  in. Weight: 20lb. Finish: rosewood, teak, walnut, oak or white. Price: £148-14 per pair (plus VAT).

#### OA-5 ★

Enclosure with  $8\frac{1}{2}$ in upward-facing bass/middle driver and four 2in tweeters. Crossover: 2-7 kHz. HC: 40W (DIN). FR: 37Hz-18kHz (DIN). Impedance: about 7 ohms. Size:  $9\frac{1}{2} \times 17 \times 24$  in. Weight: 22lb. Finish: rosewood, teak, walnut, oak, pine or white. Price: £172-69 per pair (plus VAT).

#### OA-6 Monitor ★

Enclosure with six units and built-in bass amplifier. Units:  $8\frac{1}{2}$ in bass driver,  $8\frac{1}{2}$ in mid-range unit, four 2in tweeters. Bass speaker driven by 26W RMS built-in amplifier. Adjustable environmental controls on mid-range and bass frequencies. Distortion: 0.1%. Crossover: 200Hz and 2.7kHz. FR: 26Hz-18kHz (DIN). HC: 50W (DIN). Impedance: about 7 ohms. Size:  $9\frac{1}{2} \times 17 \times 27$  in. Weight: 44lb. Finish: rosewood, walnut, teak, oak, deal or white. Price: £400 per pair (plus VAT).

#### OA-12

Bass reflex enclosure. FR: 29Hz-15kHz  $\pm$  3dB. vci: 8 ohms. HC: 40W (DIN). Size:  $23 \times 57 \times 42$  cm. Weight: 11.5kg. Five drive units; one SC163 bass and midrange; 50W 5cm treble units. Sensitivity: input for 0-022 acoustic watts (DIN). Finish: teak, oak, walnut, rosewood, white and black lacquer. Price: (per pair) £163-16 (plus VAT).

#### OA-14

Bass reflex enclosure. FR: 42Hz-15kHz  $\pm$  3dB. vci: 8 ohms. HC: 40W (DIN). Size:  $20 \times 46 \times$



**25 Watts  
from a 6 $\frac{1}{2}$ " cube?**

Microdan loudspeakers manufactured in England to an American design concept give an incredible performance with a frequency response from 60 Hz to 16 kHz and provide 25 watts of music power from a rigid, infinite baffle, critically damped cabinet.

These units have been used in discotheques; six units in series parallel give 100 Watts output and yet because of their small size, Microdans are ideal for two or four channel stereos and easily blend into any room setting.

The Popular — 4 range and other superb Martin speakers are also available from Acos.

*Complete the coupon for details of your nearest dealer.*



**Acos for Sound Enjoyment**

**COSMOCORD**

Cosmocord Ltd., Eleanor Cross Road, Waltham Cross, Herts EN8 7NX  
Telephone: Waltham Cross 27331 Telex: 24294

*Please send me your new Martin Speakers Leaflet giving details of the Minidan and Microdan.*

Name: \_\_\_\_\_

Address: \_\_\_\_\_



# New EDWARDUS speakers take you through the sound/price barrier

With sound matching their looks, these new British-made Edwardus loudspeakers have power handling capacities of 20 and 30 watts respectively. Enclosures are of the acoustic suspension type, and speaker units are front mounted to produce tunnelling effect. All models employ a crossover unit consisting

of highly accurate wound coils and electrolytic capacitors. Ideal for vertical and horizontal floor or shelf mounting.

Now take a long, cool look at the specifications of each Edwardus loudspeaker. Then the low, low prices!

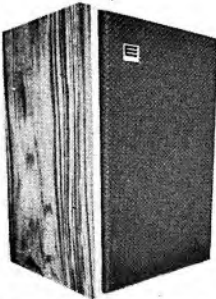

Recessed moulded connections at the back for either DIN socket or screw terminals - Allows flush wall mounting of the loudspeaker.



## LS 150

**Power handling capacity:**  
20 watts RMS

**Frequency response:**  
45-17,000 Hz

### Units:

Goodmans 8" long-throw bass unit  
Goodmans 3 3/8" mid-range treble unit

**Impedance:** 8 ohms

### Cabinet size:

14"(H) x 10"(W) x 8 1/2"(D)

**Recommended retail price:**

£32.30 inc. VAT per pair

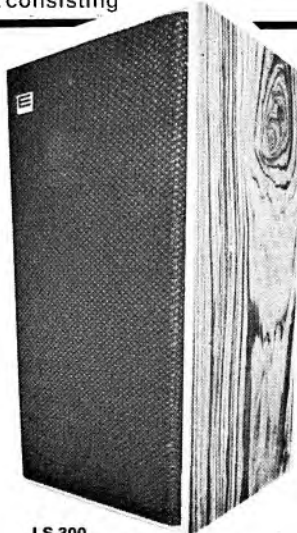

## LS 300

**Power handling capacity:**  
30 watts RMS

**Frequency response:** 30-17,000 Hz

### Units:

Goodmans 10" long-throw bass unit  
Two Goodmans 3 3/8" mid-range treble units

**Impedance:** 8 ohms

### Cabinet size:

22"(H) x 12"(W) x 10 1/2"(D)

**Recommended retail price:**

£71.50 inc. VAT per pair

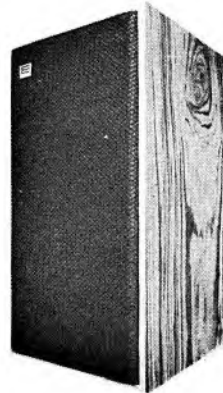

## LS 200

**Power handling capacity:**  
20 watts RMS

**Frequency response:**  
35-17,000 Hz

### Units:

Goodmans 8" long-throw bass unit  
Goodmans 3 3/8" mid-range treble unit

**Impedance:** 8 ohms

### Cabinet size:

19"(H) x 10"(W) x 9 1/2"(D)

**Recommended retail price:**

£46.20 inc. VAT per pair

**12 MONTHS  
GUARANTEE**



**J.R. EDWARDS**

**ELECTRONICS**

**LTD**

HEAD OFFICE: 783, ROMFORD ROAD, MANOR PARK, LONDON, E.12  
TELEPHONE: 01-553 4349

Stocked by most leading hi-fi dealers

# Klipsch SPEAKERS

*KLIPSCH HAVE BEEN MAKING  
SPEAKERS FOR 25 YEARS, AND  
ARE ACCEPTED AS ONE OF  
THE WORLD'S 'GREATS'*



THE BELLE KLIPSCH  
IS TOTALLY HORN LOADED  
GIVING ONLY ONE TENTH  
THE TOTAL DISTORTION  
OF DIRECT RADIATOR  
SPEAKERS

SEND FOR  
DETAILS



The electrostatic radiator is acknowledged by audiophiles the world over as the most accurate acoustic transducer. RTR has been committed from the inception of the corporation to the furtherment of the electrostatic state-of-art.

What is that unique attribute which indelibly separates electrostatic transducers from all others? Simply, it is the near absence of moving mass. It is this attribute that magnetic types seek to achieve.

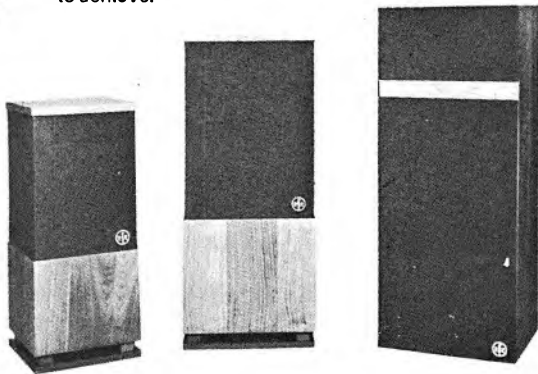

**RTR BROCHURE AVAILABLE**



**MACINNES LABORATORIES LTD.**

MACINNES HOUSE, GARLTON PARK INDUSTRIAL ESTATE,  
SAXMUNDHAM, SUFFOLK IP17 2NL  
TEL: (0728) 2262 2615

## Two new speaker systems from Acoustic Research

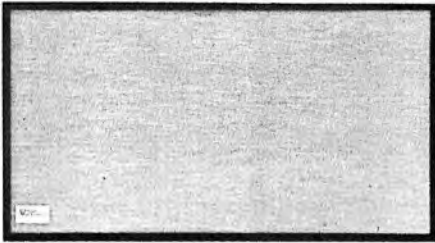

### AR-3a/Improved

Seven years of research and development have produced notable improvements in one of the world's most respected loudspeaker systems.

The AR-3a/Improved embodies all the virtues of the AR-3a, in combination with the latest concepts from AR regarding spectral energy output, as well as further reduced coloration.



### AR-MST

For the first time, AR offers a loudspeaker system of moderate cost with all the accuracy of AR's home speaker systems, but with the increased power-handling capability of the AR-LST.

The new AR Miniature Studio Transducer is the answer for anyone who does not want to sacrifice accuracy of reproduction for the high sound levels normally required for pop music.

**Acoustic Research International**  
High Street, Houghton Regis, Beds  
Telephone: (0582) 603151



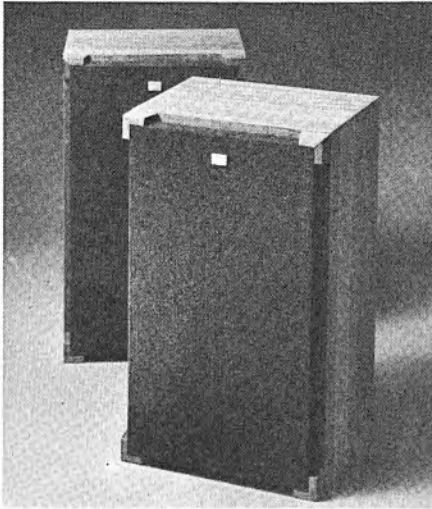

Sony SS7200

34cm. Weight: 7kg. Three drive units; one SCI 65 bass and midrange; two 5cm treble units. Sensitivity: W input. 0.022 acoustic watts (DIN). Finish: teak, oak, walnut, rosewood, white and black lacquer. Price: (per pair) £136.32 (plus VAT). Delivered as stereo pairs.

### ■ SONY

Sony (UK) Ltd, Pyrene House, Sunbury Cross, Sunbury-on-Thames, Middlesex.  
Tel: Sunbury-on-Thames (76) 87644.

#### SS510

Two-unit speaker system. One 8in bass driver, one 2in tweeter. FR: 70Hz-15kHz. HC: 10W RMS. Size:  $10\frac{5}{8} \times 17\frac{3}{8} \times 9\frac{1}{2}$ in. Weight:  $11\frac{3}{4}$ lb. Finish: oiled walnut. Price: £14.50 (plus VAT).

#### SS1005

Infinite baffle enclosure with units and crossover. One  $5\frac{1}{2}$ in bass driver, one  $2\frac{3}{4}$ in tweeter. FR: 75Hz-18kHz. HC: 15W RMS. Impedance: 8 ohms. Size:  $18\frac{3}{8} \times 9\frac{1}{2} \times 7\frac{1}{8}$ in. Weight: 16lb. Finish: walnut grain. Price: £30 (plus VAT).

#### SS7100

Infinite baffle enclosure with units and crossover. One 8in bass driver, one 1in tweeter, with ultra linear magnetic circuits TM. Crossover: 3500Hz. FR: 60Hz-20kHz. HC: 50W. Impedance: 6 ohms. Weight: 18lb 1oz. Finish: walnut with detachable front grille. Rear-mounted tweeter control. Spring-loaded terminals. Price: £37.50 (plus VAT).

#### SS7200 ★

Infinite baffle enclosure with units and crossover. One 10in bass driver, one 5in mid-range,

one 1in tweeter, with ultra linear magnetic circuits TM. Crossover: 450Hz, 4500Hz. FR: 50Hz-20kHz. HC: 70W. Impedance: 6 ohms. Size:  $13\frac{3}{4} \times 23\frac{1}{8} \times 11\frac{3}{8}$ in. Weight: 35lb 5oz. Finish: walnut with detachable front grille. Front mounted mid-range and tweeter controls. Spring loaded terminals. Price: £52.50 (plus VAT).

#### SS5088

Infinite baffle enclosure with units and crossover. One  $6\frac{1}{2}$ in bass driver, one 2in tweeter. Crossover: 6.5kHz. FR: 80Hz-20kHz. HC: 12W. Impedance: 8 ohms. Size:  $9\frac{1}{16} \times 15 \times 5\frac{5}{16}$ in. Weight: 7lb 11oz. Finish: walnut with front grille cloth. Price: £20 (plus VAT).

#### SS70

Infinite baffle enclosure with two units. One  $5\frac{1}{2}$ in bass driver, one  $2\frac{1}{2}$ in tweeter. FR: 95Hz-18kHz DIN. HC: 10W. Impedance: 8 ohms. Size:  $6\frac{3}{8} \times 10\frac{5}{16} \times 9\frac{1}{16}$ in. Weight: 4lb 3oz. Finish: teak cabinet with front grille cloth. Price: £8 (plus VAT).

### ■ SOUND STUDIO

The Sound Studio Ltd,  
33-35 Camden Road, Tunbridge Wells, Kent.  
Tel: Tunbridge Wells (0892) 32153/30314.

#### Cavalier SSC-15

Enclosure with units and crossover. One  $6\frac{5}{8}$ in bass driver, one 2in tweeter. HC: 15W DIN. FR: 60Hz-18kHz. Size:  $13\frac{3}{4} \times 7\frac{3}{4} \times 8\frac{5}{8}$ in. Price: £14.95 (plus VAT).

#### Cavalier SSC-20

Enclosure with units and crossover. One  $11 \times 6\frac{3}{8}$ in bass driver, one 2in tweeter. HC: 20W DIN. FR: 50Hz-18kHz. Size:  $15\frac{5}{8} \times 9\frac{3}{8} \times 9\frac{3}{4}$ in. Price: £21.95 (plus VAT).

#### Cavalier SSC-25

Enclosure with units and crossover. One  $11 \times 6\frac{3}{8}$ in bass driver, one  $2\frac{1}{2}$ in tweeter. HC: 25W DIN. FR: 45Hz-20kHz. Size:  $21\frac{5}{8} \times 12\frac{1}{2} \times 9\frac{3}{4}$ in. Price: £24.95 (plus VAT).

### ■ SPENDOR

Spendor Audio Systems Ltd,  
Kings Mill, Kings Mill Lane, South Nutfield,  
Redhill, Surrey, RH1 5NF.  
Tel: Nutfield Ridge (682) 2554.

#### BC1

Reflex enclosure with units and crossover. One 8in plastic cone bass driver, one Celestion HF1300 mid-range unit, one STC 4001G tweeter. Crossover: 3kHz and 13kHz. FR: 45Hz-25kHz ( $\pm 3$ dB 60Hz-14kHz). HC: 40W peak programme. Impedance: 8 ohms. Main driver based on BBC design with resin-bonded voice coil. Size:  $25 \times 11\frac{1}{4} \times 12$ in. Weight: 31lb. Finish: teak standard (rosewood, walnut or

★ Indicates entry is illustrated

white to order). Price: from £66 (plus VAT). Trolley optional extra.

#### BCII

Reflex enclosure with units and crossover. One 8in plastic cone bass driver, one Celestion HF1300 mid-range unit, one STC 4001G tweeter. Crossover: 3kHz, 13kHz. FR: 45Hz-25kHz (60Hz-14kHz  $\pm$  3dB). HC: 50W peak programme. Impedance: 8 ohms. Bass driver developed by Spendor with 1½in diameter resin-bonded voice coil. Size: 25 × 11½ × 12in. Weight: 33lb. Finish: teak standard (rosewood, walnut or white to order). Price: from £73.50 (plus VAT). Trolley optional extra.

#### BCIII ★

Reflex enclosure with units and crossover. One Spendor 12in bass driver, one 8in mid-frequency unit, one Celestion HF1300 HF unit, one Celestion HF2000 tweeter. Crossover: 700 Hz, 3kHz and 13kHz. FR: 30Hz-20kHz (50Hz-14kHz  $\pm$  2½dB). HC: 70W peak programme. Impedance: 8 ohms nominal. Size: 31½ × 15½ × 15½in. Weight: 75lb. Finish: teak (white, walnut, rosewood to order). Price: £136 (plus VAT). Trolley optional extra.

Spendor speakers also supplied with 20W or 50W power amplifier built-in (Models BCIA and BCIIA). Amplifier inputs balanced or unbalanced. Designed for professional market. Prices and specifications on request.

#### ■ STENTORIAN

Whiteley Electrical Radio Co Ltd, Radio Works, Victoria Street, Mansfield, Notts, NG18 5RW. Tel: Mansfield (0623) 24762.

#### LC93

Infinite baffle enclosure with unit. One 9in HF912-67 speaker unit. FR: 60Hz-20kHz. HC: 10W RMS. Impedance: 15 ohms. Acoustically loaded cabinet. Speaker has graded melaminated cone with silicon rubber-over-cambric suspension. Size: 19 × 12½ × 8½in. Weight: 20lb. Finish: teak or rosewood veneer. Price: (teak) £19.44 (plus VAT); (rosewood) £20.94 (plus VAT).

#### LC94

Labyrinth enclosure with unit. One 9in HF912-67 speaker unit. FR: 45Hz-20kHz. HC: 10W RMS. Impedance: 15 ohms. Acoustic labyrinth with acoustic resistance incorporated in pipe. Special 9in speaker as fitted in LC93. Size: 29½ × 23¾ × 6½in. Weight: 39lb. Finish: oiled teak or rosewood veneer. Price: (teak) £29.92 (plus VAT); (rosewood) £31.88 (plus VAT).

#### LC95

Reflex enclosure with units. One 12in HF1214-67 bass driver, one 8in T812-67 mid- and upper-frequency speaker. Crossover: ¼-section L/C 1kHz. FR: 27Hz-20kHz. HC: 15W RMS. Impe-



Spendor BCIII

dance: 15 ohms. Acoustically loaded bass reflex cabinet. 12in unit melamine treated paper cone with cambric surround, 8in unit melamine treated paper ribbed cone and surround. Size: 31½ × 20¾ × 13½in. Weight: 62lb. Finish: oiled teak or rosewood veneer. Price: (teak) £67.67 (plus VAT); (rosewood) £70.51 (plus VAT).

#### ■ STEREOSTAGE

Nucleus, 22 Hyde Green, Marlow, Bucks.  
Tel: Marlow (062 84) 3787.

#### Sterestage

Labyrinth enclosure fitted with drive units. Ten Astec speaker motor units. FR: 30Hz-20kHz. HC: 60W per channel. Impedance: 8 ohms. Comprises phase delay stereo system integrated in long-line enclosure. Size: 9ft long, 31in high, 10in deep. Finish: to order. Weight: 200lb. Price: £295 (plus VAT).

#### ■ STUDIO CRAFT

Acoustico Enterprises Ltd, Unit 7, Space Waye, North Feltham Trading Estate, Feltham, Middlesex, TW14 0TZ. Tel: 01-751 0141.

#### 110

Infinite baffle enclosure. vci: 4 ohms. HC: 50W RMS. Size: 14 × 9 × 7½in. Two drive units. Crossover: 2.2kHz. Price: (per pair) £56.10 (including VAT) in walnut; £60.50 in white. Choice of two grille cloths.

#### 220

Infinite baffle enclosure. vci: 8 ohms. HC: 60W RMS. Size: 20 × 12 × 8in. Two drive units. Crossover: 1.9kHz. Price: (per pair) £78.10 (including VAT) in walnut; £84.60 in white. Choice of two grille cloths.

**330**

Infinite baffle enclosure. vci: 8 ohms. HC: 75W RMS. Size:  $21\frac{1}{2} \times 13\frac{1}{2} \times 9$ in. Three drive units. Crossover: 1.8kHz. Price: (per pair) £102.13 (including VAT) in walnut; £121 in white. Choice of two grille cloths.

**440**

Infinite baffle enclosure. vci: 4 ohms. HC: 100W RMS. Size:  $25\frac{1}{2} \times 15\frac{1}{2} \times 11\frac{1}{2}$ in. Three drive units. Crossover: 1.7kHz. Price: (per pair) £139.92 (including VAT) in walnut; £148.50 in white. Choice of two grille cloths.

**SYKES+HIRSCH**

Sykes+Hirsch Ltd, Templewood House, Templewood Lane, Stoke Poges, Slough, Bucks, SL2 4AP. Tel: 01-850 4127.

**Sphera 10 ★**

Spherical enclosure with units and crossover. One  $6\frac{1}{2}$ in bass/mid-range driver, one tweeter. HC: 10W RMS. Impedance: 8 ohms. Size: 10in diameter. FR: 45Hz-20kHz. Finish: white GRP standard, other colours available to order. Supplied with shelf mount; wall and ceiling mountings extra. Price: £20.10 (including VAT).

**Sphera 165**

Spherical enclosure with units and crossover. One 8in long-throw bass/mid-range driver, one pressure cone tweeter. HC: 15W RMS. FR: 35Hz-20kHz. Impedance: 8 ohms. Size:  $16\frac{1}{2}$ in diameter. Finish: white GRP standard, other colours to order. Price: £35.50 (including VAT).

**Sphera 24 ★**

Spherical enclosure with units and crossover. One 12in bass/mid-range unit, one high efficiency tweeter. HC: 25W RMS. FR: 25Hz-20kHz. Impedance: 8 ohms. Size: 24in diameter. Finish: white GRP standard, other finishes to order. Price: £70 (including VAT). Also available as cabinet only.

**SYMPHONY**

J. W. (Wholesale) Co Ltd, 26 Rosoman Street, London, EC1. Tel: 01-837 3041.

**Symphony Monitor**

Reflex enclosure with units and crossover. One KEF B139  $13 \times 9\frac{1}{2}$ in bass driver, one KEF B110  $5\frac{1}{2}$ in mid-range unit, one KEF T27 1in tweeter. Crossover: DN12 (400Hz, 3.5kHz). FR: 30Hz-20kHz. HC: 30W. Impedance: 8 ohms. Size:  $30 \times 15\frac{1}{2} \times 12\frac{1}{4}$ in. Weight: 58lb. Supplied direct to user and offered on 14-day home trial. Price: £43.56 (including VAT).

**TANDBERG**

Farnell-Tandberg Ltd, Farnell House, 81 Kirkstall Road, Leeds, LS3 1HR. Tel: Leeds (0532) 35111.

**TAN11 ★**

Infinite baffle enclosure with units and crossover. One  $6\frac{1}{2}$ in bass driver, one 2in tweeter L/C crossover network. FR: 50Hz-26kHz. HC: 20W music power. Impedance: 4 ohms. Size:  $12\frac{5}{8} \times 8\frac{3}{4} \times 6$ in. Weight:  $8\frac{1}{4}$ lb. Finish: teak or rosewood. Vertical or horizontal mounting (swivel name plate). Wall mounting fittings available. Price: (teak) £22.58 (including VAT); (rosewood) £24.84 (including VAT).

**TL12-10 ★**

Infinite baffle enclosure with units and crossover. One  $6\frac{1}{2}$ in bass driver, one  $2\frac{1}{2}$ in tweeter L/C crossover network. FR: 40Hz-25kHz. HC:

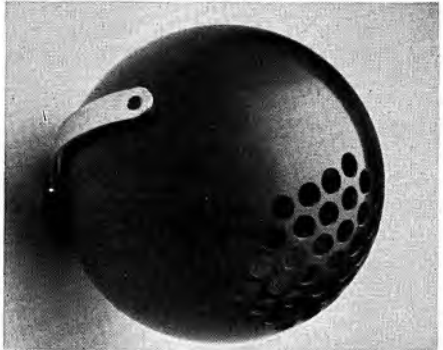

Sykes+Hirsch Mini Sphera

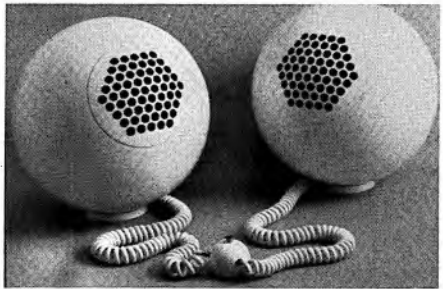

Sykes+Hirsch Super Sphera

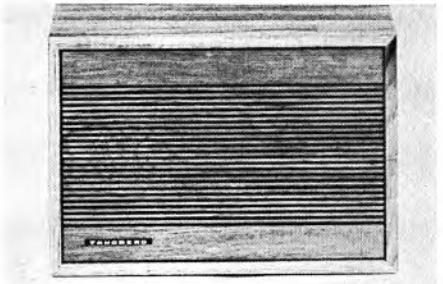

Tandberg TAN11

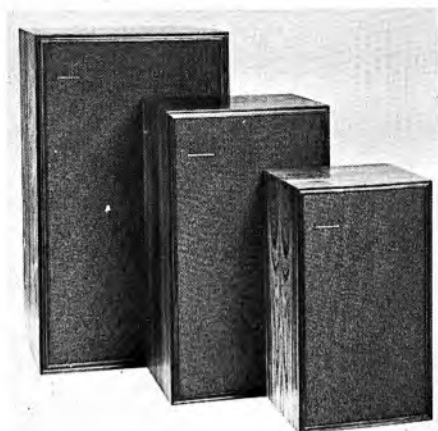

Tandberg TL12, TL25, TL50

25W RMS. Impedance: 4-8 ohms. Size:  $16\frac{3}{8} \times 9\frac{1}{4} \times 7\frac{1}{2}$  in. Weight: 10 $\frac{3}{4}$  lb. Finish: teak or rosewood. Horizontal or vertical operation (swivel name plate). Wall-mounting fittings available. Price: (teak) £32.88 (including VAT); (rosewood) £35.27 (including VAT).

#### TL25-10 ★

Infinite baffle enclosure with units and crossover. One 8in bass driver, one 1in dome tweeter. L/C crossover network. FR: 30Hz-25kHz. HC: 35W. Impedance: 4-8 ohms. Size:  $20\frac{3}{4} \times 11\frac{5}{8} \times 8\frac{3}{4}$  in. Weight: 18lb. Finish: teak or rosewood. Horizontal or vertical operation (swivel name-plate). Wall-mounting fittings available. Price: (teak) £41.95 (including VAT); (rosewood) £47.08 (including VAT).

#### ■ TANNOY

Tannoy Products Ltd, Norwood Road, West Norwood, London, SE27 9AB.  
Tel: 01-670 1131. Cables: Tannoy, London.

#### III.LZ Mk II

Infinite baffle forward facing. Monitor Gold III LZ dual concentric unit with crossover network. FR: 30Hz-20kHz. Size:  $14 \times 10\frac{3}{4} \times 23\frac{3}{4}$  in. Price: £41 (plus VAT).

#### Lancaster

Reflex (single port) forward facing. Free-standing. One Monitor Gold 12in with crossover network. Size:  $33\frac{1}{2} \times 21\frac{1}{2} \times 12\frac{1}{2}$  in (including 2in plinth). Price: £63 (plus VAT).

#### Lancaster

Reflex (single port) forward facing. Corner placing. One Monitor Gold 12in with crossover network. Size:  $33 \times 25 \times 16\frac{3}{4}$  in (including 2in plinth). Price: £63 (plus VAT).

#### Lancaster

Aperiodic free-standing enclosure. One Monitor Gold 15in with crossover network. Size:  $13\frac{1}{2} \times 21\frac{1}{2} \times 12\frac{1}{2}$  in (including 2in plinth). Price: £69 (plus VAT).

#### Lancaster

Aperiodic corner-standing enclosure. One Monitor Gold 15in unit with crossover. Size:  $33 \times 25 \times 16\frac{3}{4}$  in (including 2in plinth). Price: £69 (plus VAT).

#### Rectangular York

Reflex (single port) enclosure. Forward facing. Complete with Monitor Gold 15in dual concentric unit with crossover. Crossover: 1kHz. FR: 23Hz-20kHz. Size:  $15 \times 23\frac{1}{2} \times 42$  in. Price: £86 (plus VAT).

#### York

Reflex enclosure. Forward facing unit. Dual throated ports. Corner placing. One Monitor Gold 15in dual concentric unit with crossover. FR: 35Hz-20kHz. Size:  $45\frac{1}{2} \times 32 \times 22\frac{1}{2}$  in. Price: £86 (plus VAT).

#### Rectangular GRF

Single folded horn. Forward facing with front exits. Complete with one Monitor Gold 15in dual concentric unit. Crossover: 1kHz. FR: 23Hz-20kHz. Size:  $17\frac{1}{4} \times 23\frac{1}{2} \times 42$  in. Price: £123 (plus VAT).

#### Corner GRF ★

Folded horn. Rear loaded horn, forward facing unit. Corner placing. One Monitor Gold 15in dual concentric unit. FR: 20Hz-20kHz. Size:  $48 \times 38 \times 29$  in. Price: £140 (plus VAT).

#### Guy R. Fountain Autograph

Folded horn. Front and rear horn loaded unit. Corner placing. One Monitor Gold 15in unit with crossover. FR: 20Hz-20kHz. Size:  $58\frac{1}{2} \times 43 \times 26\frac{1}{2}$  in. Price: £195 (plus VAT).

#### Chatsworth R.T. ★

Infinite baffle enclosure with dual-concentric unit. One 12in Monitor Gold dual-concentric full-range driver with Tanoplas surround. Eight-section filter with controls for roll-off and level. FR: 30Hz-20kHz. HC: 35W RMS. Impedance: 8 ohms. Designed for domestic high quality where space is limited. Finish: selected teak veneers with melamine finish. Size: 15 $\frac{1}{2}$  in wide, 33 $\frac{1}{4}$  in high, 10 $\frac{1}{4}$  in deep. Weight: 50lb. Price: £57 (plus VAT).

Tannoy III. LZ Mk II and Lancaster speakers are also available in teak and mahogany. York, GRF and Autograph available in teak, mahogany and walnut.

#### ■ TATE

Tate Audio Transmission Equipment Ltd, 5-7 Covent Garden, Cambridge, CB1 2HS.  
Tel: Cambridge (0223) 67873.

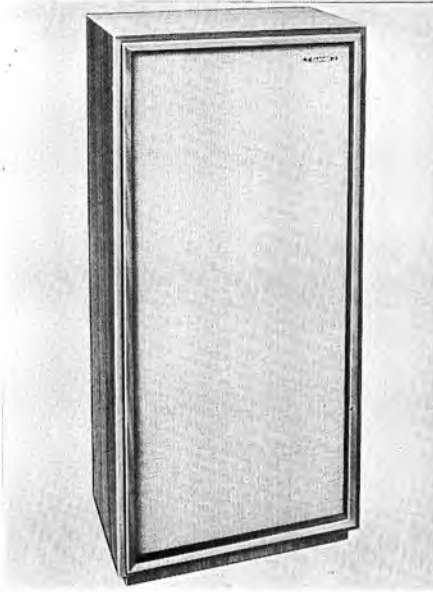

Tannoy Chatsworth R.T.

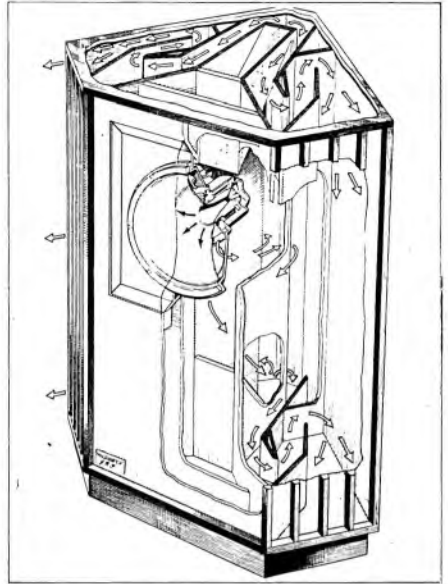

Tannoy Corner GRF

**Global 360**

Acoustic chamber. vci: 8 ohms. HC: 20W RMS. Size:  $12\frac{1}{2} \times 36$ in diameter. Weight:  $7\frac{1}{2}$ lb. One twin cone drive unit. Internally illuminated. Finish: white or silver. Price: (per pair) £47.50 (including VAT).

**TEAC**

Acoustico Enterprises Ltd, Unit 7, Space Way, North Feltham Trading Estate, Feltham, Middlesex TW14 0TZ. Tel: 01-751 0141.

**LS80**

Infinite baffle enclosure with units and crossover. One 12in bass driver, one 5in mid-range unit, one horn tweeter. Crossover: 600Hz, 5kHz. FR: 30Hz-20kHz. HC: 30W RMS. Impedance: 8 ohms. Size:  $26\frac{3}{4} \times 16 \times 11\frac{3}{4}$ in. Weight: 42lb. Finish: walnut, fretwork front. Price: £69.73 (plus VAT).

**TECHNICS**

Building 63, Whithy Road, Trading Estate, Slough, Bucks, Tel: Slough (75) 34522. Telex: 847652.

**SB30**

Speaker system. Full details on request. Price: £18 (including VAT).

**SB120**

Speaker system. Full details on request. Price: £23 (including VAT).

**SB160**

Speaker system. Full details on request. Price: £28.50 (including VAT).

**SB310**

Speaker system. Full details on request. Price: £72.15 (including VAT).

**SB410**

Speaker system. Full details on request. Price: £85 (including VAT).

**SB610**

Speaker system. Full details on request. Price: £99.95 (including VAT).

**TELEFUNKEN**

Distributors: AEG Telefunken (UK) Ltd, Bath Road, Slough, Bucks. Tel: Slough (75) 33311.

**WB60/61**

Enclosure comprising two units:  $5\frac{1}{8}$ in bass driver and  $5 \times 3$ in mid/treble unit. HC: 15W. FR: 45Hz-18kHz. Finish: teak. Dimensions:  $18\frac{1}{2} \times 6\frac{1}{2} \times 10$ in. Price: £20.21 (including VAT).

**TL41**

FR: 44Hz-20kHz. HC: 15W RMS; 30W music power. Size:  $10\frac{1}{2} \times 6\frac{1}{2} \times 8$ in. Two drive units: 5in woofer,  $3 \times 5$ in mid-range and tweeter. Price: (per pair) £49 (including VAT).

**I.55**

Spherical enclosure with unit. One full-range



★ Indicates entry is illustrated

5in driver. FR: 50Hz-15kHz. HC: 15W RMS. Impedance: 4 ohms. Size:  $8\frac{1}{2}$ in diameter. Finish: brushed aluminium. Fitted with special acoustic damping. Stands on plexiglass base or can be suspended. Price: £17.05 (including VAT).

#### TL70

Three-way enclosure with units and crossover. One 8in bass driver, one 5in mid-range unit, one  $1\frac{1}{2}$ in tweeter. FR: 25Hz-20kHz. HC: 50W RMS. Impedance: 4 ohms. Size:  $21\frac{1}{4} \times 11\frac{1}{2} \times 9\frac{1}{2}$ in. Finish: light matt walnut. Price: £42.46 (including VAT).

#### TL90

Three-way enclosure with units and crossover. One 12in bass driver, one 5in mid-range unit, one 1in tweeter. FR: 25Hz-20kHz. HC: 50W RMS. Impedance: 4 ohms. Size:  $13\frac{3}{4} \times 27\frac{1}{2} \times 12$ in. Finish: light matt walnut. Price: £77.11 (including VAT).

#### TL400

FR: 44Hz-20kHz. HC: 20W RMS; 30W music power. Two drive units;  $6\frac{3}{4}$ in woofer,  $3 \times 5$ in mid-range and tweeter. Finish: light matt walnut softline. Price: (per pair) £68 (including VAT).

#### TL500

FR: 40Hz-20kHz. HC: 35W RMS; 50W music power. Size:  $14 \times 10\frac{1}{2} \times 7$ in. Two drive units: 8in woofer,  $1\frac{7}{8}$ in tweeter. Crossover: 2kHz. Finish: light matt walnut softline or anthracite softline. Price: (per pair) £108 (including VAT).

#### TL600

FR: 40Hz-20kHz. HC: 35W RMS; 50W music power. Size:  $18 \times 12\frac{1}{2} \times 5$ in. Three drive units: 8in woofer,  $4\frac{1}{2}$ in mid-range, 1in tweeter. Crossovers: 800Hz and 1500Hz. Finish: light matt walnut softline. Price: (per pair) £138 (including VAT).

#### TL700

FR: 30Hz-20kHz. HC: 45W RMS; 60W music power. Size:  $18 \times 13 \times 9\frac{1}{4}$ in. Three drive units: 8in woofer,  $4\frac{1}{2}$ in mid-range,  $1\frac{1}{2}$ in tweeter. Crossovers: 600Hz and 3kHz. Finish: light matt walnut softline. Price: (per pair) £148 (including VAT).

#### TRIO

B. H. Morris & Co. (Radio) Ltd, Trio House, The Hyde, London, NW9 6JP. Tel: 01-205 6441.

#### KL-220

FR: 70Hz-16kHz. vci: 8 ohms. HC: 18W (DIN). Size:  $14 \times 9\frac{3}{4} \times 8\frac{3}{4}$ in. Weight: 16lb each. Two drive units: 8in bass and 2in treble. Finish: teak. Price: (per pair) £37.50 (plus VAT).

#### KL-440

FR: 60Hz-16kHz. vci: 8 ohms. HC: 18W (DIN). Size:  $19 \times 10 \times 9\frac{1}{2}$ in. Weight: 20lb each.

Two drive units: 8in bass and 2in treble. Finish: teak. Price: (per pair) £46.75 (plus VAT).

#### TTC

TTC Division Precision Centre, Heather Park Drive, Wembley, Middlesex, HA0 1SU. Tel: 01-903 0144.

#### System 3

Three-way speaker system with units and crossover. One 8in bass driver, one 5in mid-range unit, one  $2\frac{1}{2}$ in tweeter. Cabinet lined with glass wool. HC: 20W RMS. FR: 40Hz-20kHz. Impedance: 8 ohms. Size:  $18\frac{7}{8} \times 10 \times 10$ in approximately. Weight: 11lb. Finish: oiled walnut. Price: £24.75 (including VAT).

#### VAN DER MOLEN

Van der Molen Ltd, 1 Mildmay Road, Romford, Essex, RM7 7DA. Tel: Romford (70) 41904.

#### S10

Shell-mounting enclosure with unit. One full-range dual cone driver. FR: 80Hz-18kHz. Size:  $16 \times 10 \times 4\frac{1}{2}$ in. Impedance: 4 or 8 ohms. Price: (per pair) £14 (including VAT).

#### S20

Picture frame enclosure with unit. One full-range drive unit. Impedance: 4 ohms. HC: 10W. FR: 70Hz-18kHz. Size:  $11\frac{1}{2} \times 11\frac{1}{2} \times 3\frac{3}{4}$ in deep. Price: (per pair) £18.50 (including VAT).

#### S40

Floor or shelf enclosure with units. One bass driver, one HF unit. Impedance: 4 ohms. HC: 10W. FR: 60Hz-18kHz. Price: £31.89 (including VAT).

#### S50

Floor-standing enclosure with units. One  $6\frac{1}{2}$ in bass driver, one  $2\frac{1}{2}$ in tweeter. Four-element crossover. FR: 50Hz-18kHz. Impedance: 8 ohms. Size:  $16 \times 10 \times 7\frac{1}{2}$ in. Price: (per pair) £45 (including VAT).

#### VIDEOTON

Distributors: Oscar Radio Company, 55-63 Goswell Road, London, EC1. Tel: 01-253 1802.

#### D131E Minimax 1

Bookshelf enclosure with unit. One 5in full-range driver. HC: 20W RMS. FR: 50Hz-12.5kHz. Impedance: 8 ohms. Finish: teak. Size:  $10\frac{1}{4} \times 8\frac{3}{4} \times 6$ in. Weight:  $8\frac{1}{2}$ lb. Price: £13.10 (plus VAT).

#### D132E Minimax 2

Bookshelf enclosure with units. One  $5\frac{1}{8}$ in bass driver, one 4in tweeter. HC: 15W RMS. FR: 45Hz-20kHz. Impedance: 8 ohms. Finish: teak. Size:  $10\frac{1}{4} \times 8\frac{3}{4} \times 6$ in. Weight: 9lb. Price: £16.87 (plus VAT).

**DP202E Saphir I**

Bookshelf enclosure with units. One 8in bass driver, one 4in tweeter. HC: 20W RMS. FR: 40Hz-20kHz. Impedance: 8 ohms. Finish: teak. Size:  $14 \times 9\frac{1}{2} \times 8\frac{3}{4}$ in. Weight: 17lb. Price: £21.38 (plus VAT).

**DF202E Saphir 2**

Wall mounting enclosure with units. One 8in bass driver, one 4in tweeter. HC: 20W RMS. FR: 45Hz-20kHz. Impedance: 8 ohms. Finish: teak. Size:  $21 \times 13 \times 4\frac{3}{4}$ in. Weight: 17lb. Price: £22.37 (plus VAT).

**D252E Brilliant**

Floor-standing enclosure with units. Screw-on legs. One 10in bass driver, one 4in tweeter. HC: 20W RMS. FR: 35Hz-20kHz. Impedance: 8 ohms. Finish: teak. Size:  $23\frac{1}{2} \times 13\frac{3}{4} \times 12\frac{3}{4}$ in. Weight: 35lb. Price: £38.94 (plus VAT).

**D253E Diadem**

Floor-standing enclosure with units. Screw-on legs. One 10in bass driver, two 4in tweeters. HC: 25W RMS. FR: 35Hz-20kHz. Impedance: 8 ohms. Finish: teak. Size:  $23\frac{1}{2} \times 13\frac{3}{4} \times 12\frac{3}{4}$ in. Weight: 35lb. Price: £44.49 (plus VAT).

**■ VITAVOX**

Vitavox Ltd, Westmoreland Road, London, NW9 9RJ.  
Tel: 01-204 4234. Cables: Vitavox, London.

**System 191 Corner Horn**

Double channel horn system. Folded LF horn with AK155 drive unit. Forward-facing HF horn with S3 pressure unit. Filter network incorporated. Crossover: 500Hz. FR: 30Hz-15kHz. High translational efficiency. Size:  $51 \times 30 \times 27$ in. Price: on application.

**Bitone Series 3200**

Double channel sound system comprising three-cell horn (distribution  $60^\circ$  wide  $\times$   $20^\circ$  high) with 12in LF driver in vented enclosure. Filter network: 1kHz crossover, attenuation 12db per octave. HF balance control 0-8dB attenuation. HC: 20W. FR: 50Hz-15kHz. Size:  $24 \times 20 \times 19$ in. Price: on application.

**Bitone Series 6200**

Similar specification to 3200 but with six-cell horn giving distribution  $60^\circ$  wide  $\times$   $40^\circ$  high. Size:  $29 \times 20 \times 20$ in. Price: on application.

**Bitone Major**

Double channel sound system comprising HF dispersive horn and S3 HF pressure unit (distribution  $90^\circ$  wide  $\times$   $20^\circ$  high) with 15in LF driver in special reflex enclosure. Filter network 500kHz. Crossover attenuation 12dB/octave. HF balance control 0-8dB attenuation. HC: 30W. FR: 35Hz-16kHz. Size:  $42 \times 30 \times 24$ in. Finish: whitewood or studio. Price: on application.

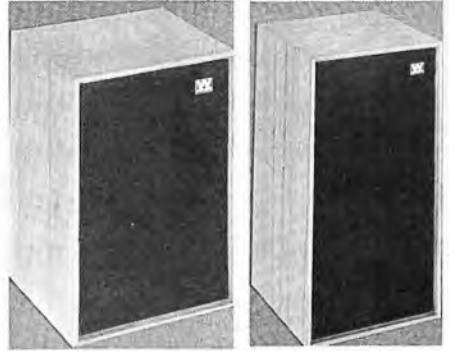

Wharfedale Denton 2

Wharfedale Linton 2

**■ WHARFEDALE**

Rank Radio International Ltd, PO Box 596, Power Road, Chiswick, London, W4 5PW.  
Tel: 01-994 6491.

**Denton 1**

Acoustic suspension enclosure. FR: 70Hz-22kHz  $\pm$  3dB. vci: 6 ohms nominal. HC: 18W (DIN). Size:  $13 \times 9 \times 6\frac{3}{4}$ in. Weight: 7lb. One drive unit. Sensitivity: 6W for 95dB SPL. Finish: white. Price: (per pair) £32 (including VAT).

**Denton 2 ★**

Acoustic suspension enclosure. FR: 70Hz-17kHz  $\pm$  3dB. vci: 6 ohms nominal. HC: 20W (DIN). Size:  $14 \times 9\frac{3}{4} \times 8\frac{3}{4}$ in. Weight: 16lb. Two drive units. Crossover: 1200Hz. Sensitivity: 6W for 95dB SPL. Price: (per pair in teak) £43.09 (including VAT); (in white) £45.25 (including VAT).

**Linton 2 ★**

Acoustic suspension enclosure. FR: 70Hz-17kHz  $\pm$  3dB. vci: 6 ohms nominal. HC: 20W (DIN). Size:  $19 \times 10 \times 9\frac{1}{2}$ in. Weight: 20lb. Two drive units. Crossover: 1200Hz. Sensitivity: 6W for 95dB SPL. Price: (per pair in teak) £53.35 (including VAT); (in white) £56.01 (including VAT).

**Glendale 3**

Acoustic suspension enclosure. FR: 50Hz-19kHz  $\pm$  3dB. vci: 6 ohms nominal. HC: 30W (DIN). Size:  $22 \times 12 \times 10\frac{1}{2}$ in. Weight: 28 $\frac{1}{2}$ lb. Three drive units. Crossover: 800Hz and 5kHz. Sensitivity: 12.5W for 95dB SPL. Finish: teak. Price: (per pair) £79.55 (including VAT).

**Dovedale 3 ★**

Acoustic suspension enclosure. FR: 50Hz-20kHz  $\pm$  3dB. vci: 6 ohms nominal. HC: 50W (DIN). Size:  $24 \times 14 \times 12$ in. Weight: 43lb. Three drive units. Crossover: 600Hz and 5kHz. Sensi-

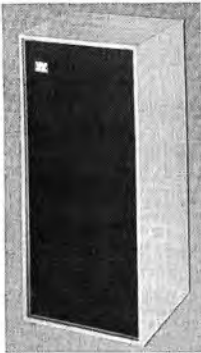

Wharfedale Triton 3

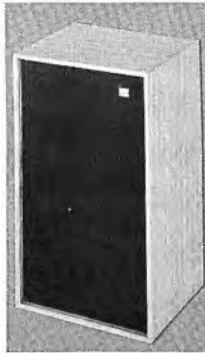

Wharfedale Dovedale 3

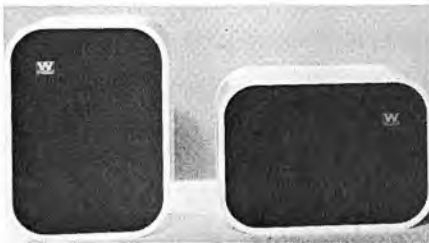

Wharfedale Denton 2

tivity: 20W for 95dB SPL. Finish: teak. Price: £57.25 (including VAT).

### Kingsdale 3

Acoustic suspension enclosure. FR: 45Hz-20kHz  $\pm 3$ dB. vci: 6 ohms nominal. HC: 60W (DIN). Size:  $24\frac{1}{2} \times 17\frac{1}{2} \times 14$ in. Weight: 59lb. Three drive units. Crossover: 700Hz and 3kHz. Sensitivity: 16W for 95dB SPL. Finish: teak. Price: £81.96 (including VAT).

### Triton 3 ★

Infinite baffle enclosure with units and crossover. One 8in bass driver, one 5in mid-range unit, one 1in CAB dome multi-directional tweeter. All units forward facing. Crossover: Seven-element three-way. FR: 55Hz-20kHz  $\pm 3$ dB. HC: 25W DIN. Impedance: 4-8 ohms. Finish: teak or walnut. Floorstanding or bookshelf system. Size:  $21\frac{3}{4} \times 9\frac{3}{4} \times 9$ in. Price: (sold in pairs only) £60.85 (including VAT).

### Melton 2

Infinite baffle enclosure. 2in tweeter and 12in bass driver. Crossover: 1500Hz. FR: 45Hz-17kHz  $\pm 3$ dB. HC: 30W DIN. vci: 4-8 ohms. Size:  $21 \times 14\frac{1}{2} \times 10$ in. Finish: teak or walnut. Price: £38.50 (including VAT).

## ■ WHITELEY ELECTRICAL RADIO

See Stentorian.

## ■ WILKINSON/FORM

Wilkinson/Form Electronics,  
1-2 Low Quay, Blyth, Northumberland,  
NE24 3AL. Tel: Blyth (067 06) 3575.

### WF25

Infinite baffle enclosure with units and crossover. One  $6\frac{1}{2}$ in bass driver, one  $2\frac{1}{2}$ in tweeter. Crossover: 5kHz L/C network. FR: 60Hz-18kHz. HC: 14W RMS. Impedance: 8 ohms. Size:  $17 \times 10 \times 9$ in. Weight: 16lb. Finish: teak with satin aluminium trim and black grille. Price: £25.41 (including VAT).

### WF40

Resistive reflex enclosure with units and crossover. One 8in bass driver, one 2in tweeter. Crossover: multi-element L/C network at 2.5kHz. FR: 35Hz-18kHz. HC: suitable for amplifiers of 15-50W RMS. Impedance: 8 ohms. Size:  $22 \times 12 \times 10$ in. Weight: 30lb. Finish: teak with satin aluminium trim and black grille. Price: £40.30 (including VAT).

## ■ WOOLLETT AUDIOSTATICS

21 Anerley Station Road, London, SE20 8PY.  
Tel: 01-699 5296.

### Claremont ★

Electrostatic mid-range and HF system. Constant charge push-pull electrostatic unit. Crossover: 1.6kHz, -6dB/octave. FR: 1.6kHz-20kHz. HC: 20W RMS. Impedance: 16 ohms. Cabinet contains mains polarising unit, crossover, phase corrector for transistor amplifiers, depolarising circuit, pre-set treble attenuator (12dB range) Mains 200-250V (100-125V to order). Finish: veneered wood, with Vynair. Size:  $11\frac{1}{2} \times 8\frac{3}{4} \times 8\frac{3}{4}$ in. Weight: 4lb 12oz. Price: £26.90 (plus VAT).

### Kelsey Bass

Infinite baffle frontal-loaded enclosure intended for use as a bass speaker. Small/large room middle switching. Unit 12in foam surround. FR: 20Hz-5kHz. HC: 20W. vci: 16 ohms. Finish: veneered wood. Size:  $33\frac{3}{4} \times 13 \times 14$ in. Weight: 52lb. Price: £48 (plus VAT).

### Frensham Bass

Similar specification to Kelsey Bass but in horizontal cabinet on 6in legs. Small/large room middle switching. Cabinet size:  $31 \times 14\frac{3}{4} \times 16$ in. Price: £48 (plus VAT).

### Leven

Similar specification to Claremont but in bow-fronted cabinet  $10 \times 8\frac{1}{2} \times 8\frac{1}{2}$ in. Price: £26.90 (plus VAT).

### Grasmere Moderna ★

Infinite baffle enclosure with frontal-loading 12in bass driver plus push/pull constant charge electrostatic. Crossover: 1.6kHz ( $\frac{1}{4}$ -section). FR: 20Hz-20kHz. HC: 20W RMS. Impedance:

16 ohms (8-ohm transformer available). Variable treble and middle range. Size: 34×18×14in. Weight: 52lb. Finish: matt white, wood veneer and black fabric. Price: £66.75 (plus VAT).

#### Grasmere Futura ★

Similar size and specification to the Moderna but with white front, wood veneer and black fabric. Price: £68.75 (plus VAT).

#### Como Moderna

Enclosure with units, 12in low-resonance bass driver, 2in treble, short horn loaded. FR: 60Hz-16kHz. HC: 16W. Finish: wood veneer and black. Size: 19½×14½×12in. Weight: 24lb. Suggested for rear speakers in quadraphonic systems. Equalised duo-dynamic system. Price: £35.75 (plus VAT).

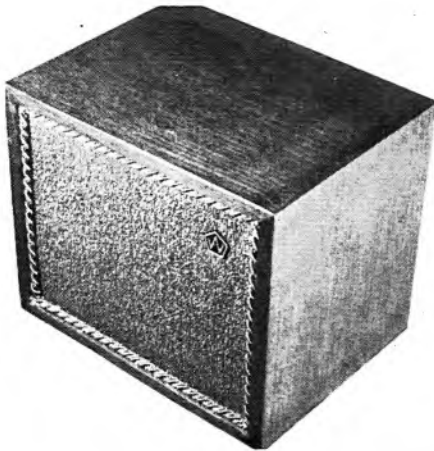

Woollett Claremont



Woollett Grasmere  
Moderna



Woollett Grasmere  
Futura

#### Como Futura

As Como Moderna but finished in wood veneer with white front and black fabric. Price: £37.75 (plus VAT).

#### Como Futura, Bass

Standard Como but without treble system. For use with electrostatic treble as central bass speaker in common bass system, or as rear ambience speaker in derived quadraphonics. Price: £32.90 (plus VAT).

#### Como Moderna, Bass

As Como Futura Bass but with wood veneer front. Price: £30.90 (plus VAT).

#### Addabass

Add-on bass chamber for use with Como system. Gives large-speaker bass and serves as floor stand. Price: £12.80 (plus VAT).

#### Esdiyn

A 'do-it-yourself' constant-charge electrostatic and 12in low-resonance dynamic driver supplied in-the-white for customer to finish to own requirements. FR: 40Hz-20kHz. HC: 20W RMS. Size: 31×18×14¾in. Weight: 48lb. Impedance: 16 ohms (transformer available for other impedances). Price: £51 (plus VAT).

### ■ WORDEN AUDIO DEVELOPMENTS LTD

54 Chepstow Road, London, W2.  
Tel: 01-229 4996.

#### Panosona Reproducer

Double horn with diffusing chamber. Corner reproducer, designed for near plane-wave distribution from single speaker unit. Available in three versions: (Model A) Size: 54in high, 24in wide, 14½in to corner. FR: (with Lowther PM6 or PM7) 20Hz to over 18kHz. (Model B) Size: 48in high, 21½in wide, 12½in to corner. FR: (with Richard Allan CG8T) 30Hz-17kHz. (Model C) Size: 27in high, 24in wide, 13in to corner. FR: (with Richard Allan CG8T) 30Hz-17kHz. Prices: Model A (speaker enclosure only) £65; Model B (enclosure only) £56; Model C (enclosure only) £44. Lowther PM6 Mk I £26 (plus VAT); PM7 £35 (plus VAT); Richard Allan CG8T £6 (plus VAT).

#### Panosona Bookshelf Speaker

Designed in accordance with the principles of the Panosona Corner Reproducers. Size: 16×9×9½in. Recommended drive unit: Richard Allan CG8T. Standard finish: teak. Other finishes to order. Contrasting Tygan or Vynair front covering. Price: £29.50 complete (including VAT).

### ■ WYE ELECTRONICS LTD

Queen Street North, Whittington Moor,  
Chesterfield, Derbyshire.  
Tel: Chesterfield (0246) 51 116.

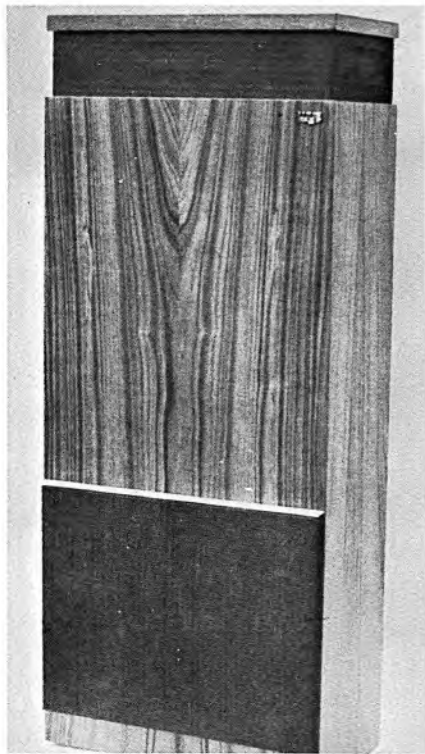

Wye Electronics 1300 column

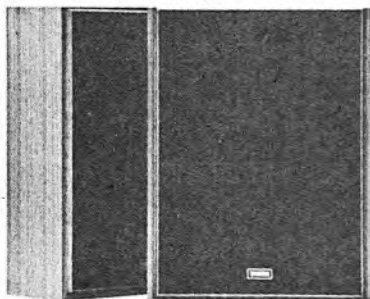

Yamaha NS-250E

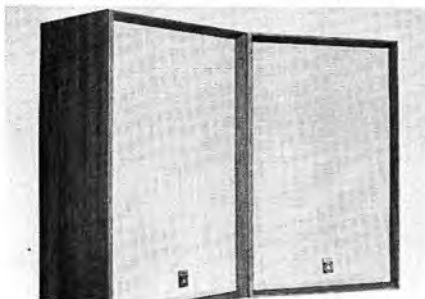

Yamaha NS-410

### Stereo 525

Two-unit enclosure. 13×8in bass with aluminium centre cone and 3½in HF tweeter. FR: 25Hz-18kHz. HC: 10W RMS. vci: 4 ohms. Crossover: 5kHz. Size: 19¼×12×8½in. Price: £21-95 (including VAT).

### 1300 Hi-Fi ★

Two-unit column enclosure speaker with 12in bass unit and HF 1300 3in tweeter. FR: 25Hz-15kHz. vci: 4, 8, 16 ohms. Crossover: 3kHz. Size: 36×15×7½in. Price: £40-88 (including VAT).

## ■ YAMAHA

Natural Sound Systems Ltd, Strathcona Road, North Wembley, London, HA9 8QL.  
Tel: 01-904 0141.

### NS-230

Two-way speaker system. One 18×12½in bass/mid-range driver, one 2½in tweeter. Plastic and aluminium cone. Impedance: 8 ohms. HC: 10W. FR: 45Hz-18kHz. Price: (per pair) £80-97 (plus VAT).

### NS-250 ★

Two-way speaker system. One 20×15in bass/mid-range driver, one 2¼in horn tweeter. Plastic and aluminium cone. Impedance: 8 ohms. HC: 15W. FR: 40Hz-18kHz. Price: (per pair) £95-14 (plus VAT).

### NS-410 ★

Two-way speaker system. One 8in bass/mid-range driver, one 2in horn tweeter. Paper cone. Impedance: 8 ohms. HC: 10W. FR: 45Hz-18kHz. Price: £53-57 (plus VAT).

### NS-25

Speaker enclosure with units and crossover. One 8in bass driver, one 1½in tweeter. Impedance: 4 ohms. HC: 40W RMS. FR: 45Hz-20kHz. Size: 11×10×19½in. Price £104 (plus VAT).

### NS-645

Speaker enclosure with units and crossover. One 10in bass driver, one 1½in tweeter. Impedance: 4 ohms. HC: 40W RMS. FR: 45Hz-20kHz. Size: 11½×10¼×21½in. Price: £147-56 (plus VAT).

### NS-670

Speaker enclosure with units and crossover. One 10in bass driver, one 1½in soft-dome mid-range unit, one 1½in tweeter. Impedance: 8 ohms. HC: 50W RMS. FR: 40Hz-20kHz. Size: 12½×10½×22½in. Price: £200 (plus VAT).

### NS-690

Speaker enclosure with units and crossover. One 12in bass driver, one 2in mid-range unit, one 1½in tweeter. Impedance: 8 ohms. HC: 60W RMS. FR: 35Hz-20kHz. Size: 13½×11½×24½in. Price: £272-72 (plus VAT).

# da

## HI-BALL 750

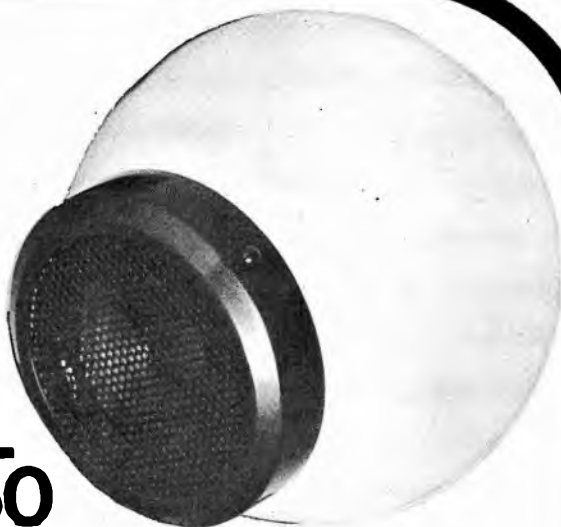

### LOOKS DOWN ON SPEAKERS TEN TIMES ITS SIZE

Tucked away near the ceiling, Hi-Balls take up no floor space, look good, yet produce sounds which you would expect only from speakers ten times their size-and five times their price....

- will handle the output of a 35W RMS amplifier
- available in white, black, purple, orange and red with matt black rim
- 8 $\Omega$  impedance
- £30 per pair
- packed in pairs in handy 'carry-home' carton

10 Goldsmith Street Nottingham

**Executive Audio Limited**

# VHF RADIO TRANSMITTING STATIONS



## B.B.C. Local Radio Stations

Station	Frequency (MHz)	Maximum E.R.P.	Station	Frequency (MHz)	Maximum E.R.P.
Birmingham	95.6	5.5kW	Medway	97.0	5.5kW
Blackburn	96.4*	1.5kW	Merseyside	95.85	2.5kW
Brighton	95.8	500W	Newcastle	95.4	3.5kW
Bristol	95.1	5kW	Nottingham	94.8*	200W
Derby	96.5*	5.5kW	Oxford	95.0	4.5kW
Durham	94.5	2.6kW	Sheffield	88.6	30W
Humberside	95.3	4.5kW	Rotherham†	95.05	9W
Leeds	94.6	140W	Solent	96.1	5kW
Leicester	95.2	140W	Stoke-on-Trent	94.6	2.5kW
London	95.3	16.5kW	Teesside	96.6	5kW
Manchester					

\*Slant polarization; all other transmissions use horizontal polarization

†Relay.



# Griffin Speakers

for the  
discriminating  
listener

## Griffin 85 Studio Electronic

**Tandem Line Bass System**  
 22 Hz — 30 kHz — 4 dB + 2 dB

**Amplifier Dividing Network**

**Treble** 30W R.M.S.: 6 kHz — 50 kHz  
**Middle** 30W R.M.S.: 750 Hz — 6 kHz  
**Bass** 85W R.M.S.: 10 Hz — 750 Hz

**Damping Factor greater than 100 over entire range**

£218 each including V.A.T.

Also illustrated:  
**Griffin Automatic Touch Control Unit T.O.C.80**  
 a comprehensive pre amplifier.

**Type 27** loudspeakers £123 per pair  
**Type 25** " £89 per pair  
**Type 15** " £52 per pair



For further details write to  
**H. K. GRIFFIN & CO. (ELECTRONICS)**  
 High fidelity Equipment Manufacturers, Siddons Factory Estate, Howard Street, West Bromwich, Staffs. Tel: 021-556 0559/0752



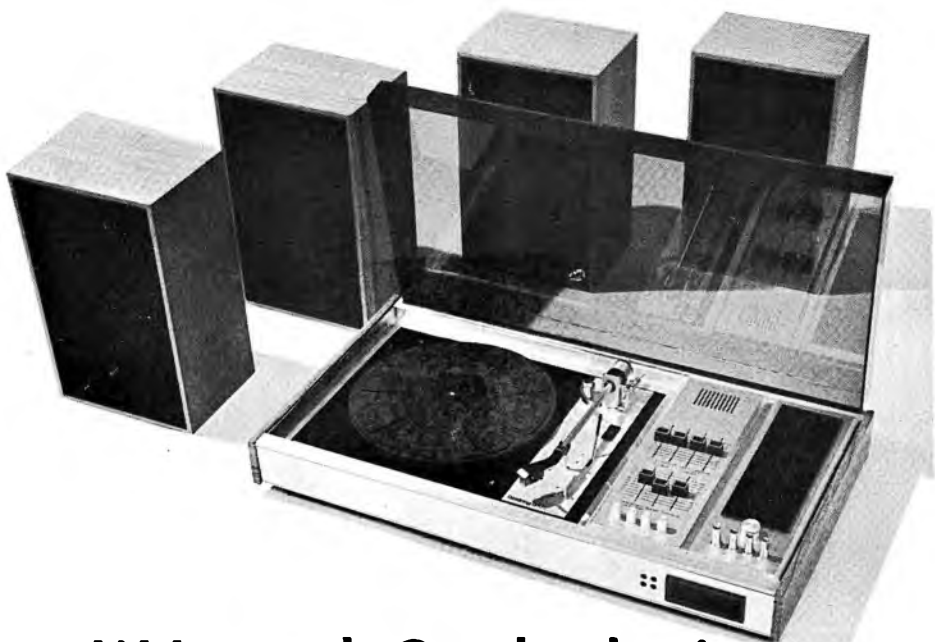

## We've made Quadraphonic breathtakingly simple.

With more and more 4-channel records being produced (mostly the CBS SQ system), this exciting new way of listening is really coming into its own.

Three things have held people back so far. The enormous, complex nature of most quadraphonic equipment. The uncertainty as to which of the three major systems will be universally adopted. And the extremely high cost. Quadrasonics have solved all these problems.

We have produced a true quadraphonic compact unit using all 3 major systems — CBS SQ with Regular QS and CD4 capability. The fully integrated unit includes an advanced FM tuner, 4x20 watts RMS output, top quality belt-drive transcription unit with magnetic cartridge. Complete with 4 superb quality speakers, each speaker comprising 2 bass drive units and 2 tweeters. Selling price? **Under £200!**

Write for full literature or visit our demonstration studio at the address below. We are holding demonstration concerts of quadraphonic music on Thursday evenings at 7 p.m. and Saturday mornings at 10 a.m.

Designed and manufactured by:

# ●● Quadrasonics

Spencer House, Brettenham Road, Edmonton, London N.18.  
Tel: 01-807 5999

# Surround Sound

★ Indicates entry is illustrated

Abbreviations used in this section are given on page 20.

## ■ AKAI

Rank Audio Visual Ltd, PO Box 70, Great West Road, Brentford, Middlesex, TW8 9HR.  
Tel: 01-568 9222.

## SSI ★

Universal quadrasonic synthesiser. Input: tape four-channel 250mV, PU 5mV. FR: 10Hz-100kHz - 2dB. Signal-to-noise ratio: better than 65dB. HD: <0.05%. With this synthesiser unit any two-channel or four-channel stereo source can readily be converted and played back in four-channel stereo. Continuous variable matrix controls for front and rear channels. Spare AC mains outlet socket. Size:  $11\frac{3}{8} \times 5\frac{1}{2} \times 12\frac{5}{8}$ in. Weight: 9 $\frac{1}{4}$ lb. Price: £60.50 (including VAT).

## ■ BANG & OLUFSEN

Bang & Olufsen UK Ltd, Eastbrook Road, Gloucester, GL4 7DE.  
Tel: Gloucester (0452) 21591.

## Ambio Control Unit

Ambiphonic adaptor for use with most conventional amplifiers to facilitate the use of two side loudspeakers in conjunction with main stereo loudspeakers. Enables greatly enhanced reproduction to be obtained from stereo programme sources. Features 6kHz filter switch to eliminate ambiphonic signals above this frequency. Size: 1.4 x 1.9 x 4.3in. Price: £7.90 (including VAT).

## ■ EAGLE

Eagle International, Heather Park Drive, Wembley, HA0 1SU. Tel: 01-903 0144.

## AA10 ★

Four-channel quadrasonic synthesiser. The AA10 plus two extra speakers provides two additional information channels from ordinary two-channel stereo. Self-contained matrix system with level controls and speaker check switches. Rating: 35W RMS per channel. Input impedance: 8 ohms. Output impedance: 8 ohms. Size:  $8\frac{3}{4} \times 2\frac{3}{4} \times 5\frac{5}{8}$ in. Finish: teak cabinet. Price: £19.80 (including VAT).

## AA26

Four-channel quadrasonic synthesiser. Similar to the AA10 but with output jacks for four-channel headphones. Price: £22 (including VAT).

## ■ EMI

EMI Sound & Vision,  
EMI Pathé Division, 252 Blyth Road, Hayes,  
Middlesex, UB3 1HW.  
Tel: 01-573 3888. Telex: 22417.

## 1500 SQ Decoder

SQ decoding bandwidth ( $90^\circ \pm 10^\circ$ ) 20Hz-17kHz. Input impedance: 40K. FR: (all channel controls set flat) 5Hz-100kHz  $\pm 1$ dB. HD: <0.8%. Signal-to-noise: better than 80dB. Front separation: 60dB. Rear separation: 20dB. Designed to operate with EMI 1515 stereo amplifier. Price: on application.

## ■ GRAMPIAN REPRODUCERS LTD

Hanworth Trading Estate, Feltham,  
Middlesex. Tel: 01-894 9141.

## 666 Ambiphonic unit

Enables from one to four speakers to be fed with amplified and delayed signal from main amplifier output. Delay device comprises two transducers and parallel springs as used in Grampian reverberation unit. Volume of delayed signal controlled by listener. Twin high-impedance line-bridging connections. Output: 2 $\frac{1}{2}$ W into 5 ohms and 600 ohms. Mains: 200-250V AC. Size:  $18 \times 4\frac{3}{4} \times 5\frac{1}{4}$ in. Weight: 7lb. Price: on application.

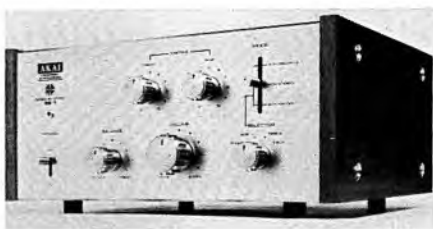

Akai SSI



Eagle AA10

★ Indicates entry is illustrated



Howland-West Four-channel adaptor

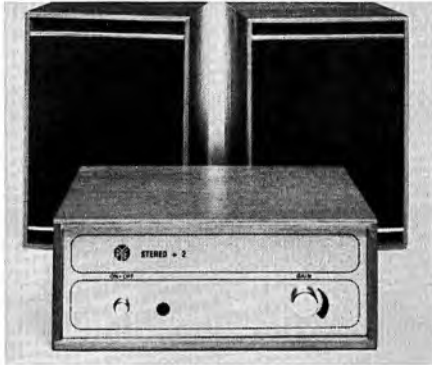

Pye Model 5551 Stereo Plus Two



Sanyo DCA1700X



Sony SQD2020

## ■ HOWLAND-WEST

Howland-West Ltd, 3-5 Eden Grove,  
London, N7 8EQ. Tel: 01-609 0293.

### Four-channel adaptor ★

Dematrixing system to provide four-channel ambience effects from both existing stereo and the new four-channel recordings. Connects to amplifier speaker outlet terminals. Suitable for any unit utilising common speaker earth connections. Price: £12.65 (including VAT).

## ■ PYE

Pye Radio and Television Ltd,  
St Andrews Road, Cambridge, CB4 1DS.  
Tel: Cambridge (0223) 58985.

### 5551 Stereo Plus Two ★

Converter kit comprising add-on amplifier, decoder and two speakers. For use with existing stereo equipment (players, tape recorders, radio). Output: 10W RMS connected to two speakers in series giving 5W RMS per channel into 4 ohms. Mains: 240V AC. Controls: on/off push-button with indicator light, volume. Size: 10 $\frac{3}{4}$  × 4 $\frac{1}{2}$  × 9in. Speakers: 6 × 4in high flux speaker unit. Impedance: 4 ohms. HC: 4W. Size: 10 × 7 × 7 $\frac{1}{2}$ in. Finish: teak veneers. Price: £38.24 (including VAT).

## ■ SANYO

Sanyo Marubeni (UK) Ltd, Sanyo House,  
Bushey Mill Lane, Watford, Herts.  
Tel: Watford (92) 30421.

### DCA1700X ★

Quadrasonic stereo synthesiser. Output: 20W RMS per channel. Inputs: two PU, two aux, radio, tape. Rotary controls for volume, bass and treble. Slider control for balance. Switches for two-channel and four-channel tape recorder. Loudness control. Quadrasonic effect selector. Mains: 120-240V AC. Price: £73.95 (including VAT).

## ■ SCAN-DYNA

Scandinavian Audio Systems Ltd,  
Sun Alliance Building, 65 London Road,  
Gloucester, GL1 3HF.  
Tel: Gloucester (0452) 32791.

### SD4/100

Four-channel sound adaptor for producing rear ambience from two-channel stereo programmes. Suitable for use with most stereo amplifiers. Price: £9.95.

## ■ SERVO-SOUND

Lamb House, Church Street, London, W4 2PB.  
Tel: 01-995 4551.

### DSQ1

Quadraphonic SQ decoder. Contains all input, output and control elements to reproduce four-



Tate 8

channel sound from SQ records or tape. Performs the decoding of SQ encoded material from disc, tape or FM broadcasts. Will also enhance stereo programmes by adding ambience. Input: 250mV 40K. Output: 1.5V max 300 ohms impedance. Phase shift networks: (SQ decoding bandwidth)  $90 \pm 10^\circ$  20Hz-18kHz,  $90 \pm 3^\circ$  at spot frequencies. FR: (all channels flat) 5Hz-100kHz  $\pm 1$ dB. HD: 0.025% at 250mV output. S/N ratio: better than -80dB at 250mV with 20kHz bandwidth. Front separation: 60dB. Rear separation: 20dB. 17 transistors. Mains: 220-240V AC. Price: £46 (plus VAT).

#### ■ SONY

Sony (UK) Ltd, Pyrene House, Sunbury Cross, Sunbury-on-Thames, Middx. Tel: Sunbury-on-Thames (76) 87644.

#### SQD2020 ★

SQ decoder with logic circuitry. Inputs: SQ, regular matrix, stereo, discrete 250mV 100K, two-channel or four-channel tape 750mV 100K. Outputs: front, 500mV 5K, rear (high) 2V, (low) 500mV 5K, tape 250mV 5K. Controls: mains on/off, volume, front left, front right, rear left, rear right balance, mode, system selectors, rear channel bass  $\pm 10$ dB at 100Hz, rear channel treble  $\pm 10$ dB at 10kHz, four-channel/two-channel tape monitor. HD: 0.1%, 250mV at 2kHz. FR: SQ, matrix, stereo 20-20kHz  $\pm 3$ dB, others 10-100kHz  $\pm 3$ dB. S/N ratio: 80dB. Mains: 110, 127, 220, 240V AC. 69 transistors, 84 diodes.  $15\frac{3}{4} \times 5\frac{7}{8} \times 12\frac{7}{8}$ in. Finish: brushed aluminium front panel, metal cabinet. Price: £90 (plus VAT).

#### ■ TATE

Tate Audio Transmission Equipment Ltd, 5-7 Covent Garden, Cambridge, CBI 2HS. Tel: Cambridge (0223) 67873. Telex: 81640.

Ready-built SQ quadraphonic decoders complete with integrated power supply and housed

in neat shelf-mounting cabinet. Full specification is given in the Constructional Kits section.

#### Tate 8 ★

High definition SQ quadraphonic decoder in cabinet ready for use. Wide-band decoding circuitry designed to provide low harmonic distortion and articulate quadraphonic separation. Price: £34 (plus VAT).

#### ■ TRIO

B. & H. Morris, Trio House, The Hyde, London, NW9 6JP. Tel: 01-205 5244.

#### KCD 2

Plug in CD-4 demodulator suitable for use with Trio Two-four receivers (except the KR-5340). Unit plugs into slot at rear of receiver. Power supplied from receiver, 24V DC. FR: 20Hz-16kHz. Phono input level: 1.2-5mV at 11Hz and 1-7mV. Channel separation: front-rear better than 25dB at 1kHz, left-right better than 50dB at 1kHz. Controls: left and right front/rear separation. Left and right carrier level controls. Supplied with 7in CD-4 test record. Price: £42.50 (plus VAT).

## NAMEPLATES CONTROL PANELS LABELS BADGES ENGRAVING

OF ALL DESCRIPTIONS  
IN ALL MATERIALS

Cast in metal, injection moulded in any plastic, silk screen printing on aluminium (and other materials), hot blocking, engraving. Industrial gifts, advertising, novelties, trade promotion articles available and can incorporate your trade emblem or other details.

CATALOGUE ON REQUEST:

**I. MARKOVITS LTD**

1, 2, 3 COBBOLD MEWS, LONDON, W.12

Telephone: 743 1131/2, 743 1313

# Bib<sup>®</sup>

## GROOV-KLEEN modern automatic record cleaners



▲ Model 42

▼ Model 60

▼ Model 45

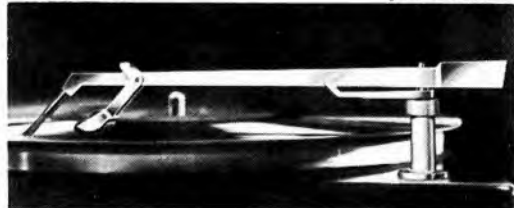

### Stylus and Turntable Cleaning Kit

Anti-static cleaner, stylus brush on free-standing base and absorbent cleaning cloth.

**REF B**  
**34p**



### Stylus Balance

Precision built. Calibrated. Measures stylus pressure within  $\frac{1}{4}$  gramme.

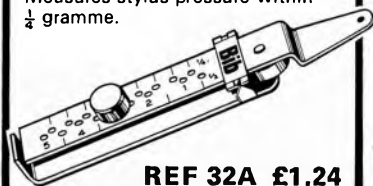

**REF 32A £1.24**

All GROOV-KLEENS remove and collect dust whilst records are played. Improve reproduction. Reduce record and stylus wear. Models 42, 50 and 60 have arm-rests and counterweights to ensure lightweight tracking and operate silently. Brush and velvet are cranked for correct tracking.



**Model 42** Finished in chrome, bright anodised aluminium and shiny black.

**£1.76** (42L for low turntables.)

**Model 50**

Finished in white and matt black. **£1.08**

**Model 60** All chrome finish. **£1.36**

**AUTO-CHANGER GROOV-KLEEN** Finished in chrome—fits most units with flat top cartridge housings.

**Model 45 98p** Pat. App. No. 38099/72  
Reg. Des. No. 958457

Read John Borwick's 56 page book **REF 56**  
"Hi-Fi Stereo Hints and Tips." **38p**

Please write for fully illustrated catalogue showing comprehensive range of over 60 Hi-Fi Accessories.

All prices shown are recommended retail, excluding VAT.

# Bib

**Bib Hi-Fi Accessories Ltd.,**

*P.O. Box No. 78, Hemel Hempstead, Herts HP2 7EP.*

# Tape Accessories/ Components

★ Indicates entry is illustrated

Abbreviations used in this section are given on Page 20.

## ■ ADASTRA

Adastra Electronics Ltd, Unit N22,  
Cricklewood Trading Estate,  
Claremont Road, London, NW2 1TU.  
Tel: 01-452 6288.

### Imp-Verta

Matches low impedance tape heads. PU cartridges and microphones into high impedance amplifier inputs. Solid state printed circuit device using silicon transistor. Automatically switched 9V internal battery. Negligible drain. Conversion factor approximately 20 (depending on load). Virtually no hum or signal loss. Metal case, finished black crackle. Size:  $5 \times 1\frac{1}{2} \times 1\frac{1}{2}$  in. Price: £3.75 (including VAT).

### Tape Editing Kit

See entry under Synchronotape.

### R100 Cassette Carrying Case

Designed to hold 15 compact cassettes in rigid drop-front case. Finished in padded simulated leathercloth. Snap-fast closing. Carry handle. Finish: red, tan or black. Size:  $11\frac{1}{4} \times 3\frac{1}{2} \times 4\frac{3}{4}$  in. Price: £1.90 (including VAT).

### R101 Cassette Carrying Case

30 cassette version of above with double opening front and individual moulded tray holders. Size:  $14\frac{1}{2} \times 3\frac{1}{2} \times 9$  in. Price: £3.30 (including VAT).

### R51/I. 1001

Tape splicer. Self-contained with instant cut and trim action. Spring-loaded arms secure tape to padded cutting block. Price: £1.25 (including VAT).

### R52/I. 1003

Tape head defluxer. AC mains. For removing residual magnetism from tape heads, capstan, guides and other parts of recorders. Hand-shaped moulded body with  $1\frac{3}{4}$  in probe. 3ft mains lead. 200-250V. Price: £2.25 (including VAT).

## ■ AGFA-GEVAERT

Agfa-Gevaert Ltd, Great West Road,  
Brentford, Middlesex.  
Tel: 01-560 2131. Telex: 28154.

### Editing Accessory Kit ★

Price: £2.52½ (including VAT).

### Splicing Tape Outfit

Price: 51p (including VAT).

### Splicing Tape

33ft  $\frac{1}{4}$  in wide. Price: 31½p (including VAT).

### Leader Tape

80ft  $\frac{1}{4}$  in tape in red, green, white. Price: 28p (including VAT).

### Silver Stop Foil

33ft  $\frac{1}{4}$  in. Price: 46p (including VAT).

### Plastic library boxes

No. 13 (5in) 44½p; No. 15 (5¼in) 57½p; No. 18 (7in) 71p. All prices include 10% VAT.

### Plastic spools

No. 13 (5in) 31½p; No. 15 (5¼in) 31½p; No. 18 (7in) 34½p; No. 26 (10½in) £1.40. All prices include 10% VAT.

### Cassette head cleaner

Price: 73p (including VAT).

### Empty album

Price: £1.21 (including VAT).

### Publications

"Tape Recording Technique". Price: 45p+7p (p & p).

"Tape Recorder Manual". Price: 35p+7p (p & p).

"Recording with Compact Cassettes". Price: 65p+7p (p & p).

## ■ ALPHA

Distributors: Highgate Acoustics,  
38 Jamestown Road, London, NW1 7EJ.  
Tel: 01-267 4937.

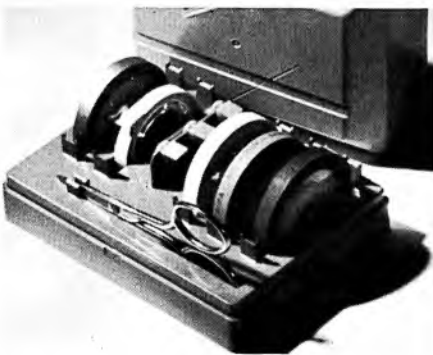

Agfa Tape Editing Kit

★ Indicates entry is illustrated

## **DB6**

Noise reducing unit for use between any tape recorder or tape deck and main hi-fi amplifier. Phono and DIN sockets for inputs and outputs. Inputs: two line inputs (>20K) with level control. Input sensitivity: 30mV for Dolby level (0 VU). Slider type level controls. Two VU meters. Outputs: 580mV for 0 VU at 1K impedance. HD: <0.5% at Dolby level at any frequency 20Hz-20kHz. Noise reduction: 8dB at 2kHz, 10dB at 5kHz. With noise reduction switched out the unit becomes a unity gain amplifier. MPX 19kHz filter, response <1dB down at 15kHz, >30dB down at 19kHz and >20dB down at 38kHz. Mains: 117, 220, 230, 250V AC. Price: £59.40 (including VAT).

## ■ **AUDIO PACKS**

Audio Packs Ltd, 206-210 Ilderton Road, London, SE15 1NS. Tel: 01-639 7844.

### **Audio Packs**

Pre-packed spares and audio accessories.

### **Connecting Cords**

Cables of various types with plugs, sockets and other terminations covering all equipment in use for domestic audio.

### **Adaptors**

Convert from any type of plug or socket termination to any other type.

### **Audio Spares**

Plugs, sockets, chassis-mounted components, fuses and audio accessories. Pre-packed for counter or showroom display.

### **Mains Units**

Three different 6-12V battery eliminators complete with connecting leads for use with all standard battery-operated tape recorders and radios. Full specifications on request.

### **Sound Selector Units**

A range of five units for routing signals to phones, speakers and amplifiers. Four of the units provide for the selection of up to three pairs of stereo headphones or up to three pairs of speakers.

The fifth unit, model HZ793, provides facilities for connecting any three signal sources to any three amplifiers. Particularly suitable for demonstration purposes in showrooms and for comparative tests. Prices: on request.

## ■ **AVEL-LINDBERG**

Avel-Lindberg Ltd, 13-16 Ayron Road, South Ockendon, Essex, RM15 5TD. Tel: South Ockendon 2263.

### **MP3 DC/AC inverters**

A range of four DC to AC electronic inverters. Suitable for operating tape recorders and other similar equipment from DC supplies. Input

voltages: 20-30V DC, 41-60V DC, 100-125V DC, 200-250V DC. Output: 217-227V 50Hz for first two models, 215-225V 50Hz AC for second two models. Efficiency: greater than 70%. Output frequency 50Hz sinewave  $\pm 1\%$ . No moving parts. Electrically and mechanically robust. Protected against overload, short circuit and incorrect polarity. Full details and prices on request.

## ■ **BASF**

BASF United Kingdom Ltd, Audio/Video Tapes Division, PO Box 473, Knightsbridge House, 197 Knightsbridge, London, SW7 1SA. Tel: 01-584 5080. Telex: 267574/5.

### **Technical look spools**

Standard sizes: 2½in 14p; 3in 19p; 3½in 21p; 4in 21p; 4½in 25p; 5in 29p; 5½in 34p; 7in 35p; 8½in 68p; 8½in £1; 10in £1.20; 10½in £1.67. All prices exclude VAT.

### **Metal spools**

7in £1.60; 8½in £2.85; 10in £2.95. All prices exclude VAT.

### **Profi NAB adaptor**

Price: £3.30. Price excludes VAT.

### **Leader Tape**

Green, red or white. Plastic centre spools. 984ft £2.10; 80ft 80p. All prices exclude VAT.

### **Leader Tape Set**

Containing red and green leader tapes, 25 strips of metallized foil and spare spool labels. Price: 76p. Price excludes VAT.

### **Splicing Tape**

¼in × 80ft, £1; ½in × 80ft, £2; ¾in × 32ft, £1.10. All prices exclude VAT.

### **Splicing Set**

Plastic box with bonding groove and 33ft of splicing tape. Price: 45p. Price excludes VAT.

### **Metallized foil**

¼in × 80ft. Price £1.22. Price excludes VAT.

### **Plastic Clips**

Box of 10. Price 20p. Price excludes VAT.

### **Hobby Box (reel-to-reel)**

Contains splicer, marking pencil, 33ft splicing tape, 80ft each of red, white and green leader tapes, 50 pieces of metallized foil, 25 spool labels, 3 tape clips. Price £2.40. Price excludes VAT.

### **Hobby Box (Cassette)**

Contains splicing block, scissors, tweezers, Philips screwdriver, flat-blade screwdriver, 5m splicing tape-dispenser, 10m leader tape, 3 clips, pressure springs and screws. Price £3.65. Price excludes VAT.

### **BR Reel-to-reel cleaning tape**

Price £1.80. Price excludes VAT.

**CR Cleaning Cassette**

Price: £1.80. Price excludes VAT.

**Cassette Library Box**

Price: 45p. Price excludes VAT.

**Head Alignment Tape**

Price: £1.50. Price excludes VAT.

■ **BIB**

Bib Hi-Fi Accessories Ltd, PO Box 78, Hemel Hempstead, Herts, HP2 7EP. Tel: Hemel Hempstead (0442) 3636.

**51 Cassette case kit**

Contains: head cleaner, cassette salvage and re-record kit, editing and joining kit. Price: £3.08 (including VAT).

**26A Cassette Tape Recorder Care Kit**

Contains: ¼in splicer, splicing tape, tape piercer, 9 cassette labels, 3 tape winders, 2 tape cutters, polishing cloth and head cassette cleaner. Price: £2.16 (including VAT).

**53 Stereo Test Cassette**

Devised by BIB and recorded by Decca the cassette contains: channel identification, balance control, speaker phasing, adjusting record volume controls, reducing tape hiss and eliminating hum, wow and flutter. Also includes music: brass band, Grand Organ, etc. Price: £2.12 (including VAT).

**58 8-Track Test Cartridge**

Includes practical tests for channel identification, balance control, speaker phasing, wow and flutter and cleaning tape heads. Also includes high quality music. Price: £2.12 (including VAT).

**31 Cassette Head Cleaner**

Special cleaning tape incorporated in cassette for cleaning tape heads in one operation. Suitable for all cassette machines. Price: 57p (including VAT).

**34 Cassette Case**

High quality black padded PVC case, with carrying handle. For 12 cassettes. Price: £1.76 (including VAT).

**D/2 Flex Tidies**

Shortens without cutting inter-unit cables, speaker leads and mains flex. Price: (pack of 5) 23p (including VAT).

**20 Recording Tape Splicer**

For use with ¼ tape. Fitted with clamps for holding tape for diagonal or both splices. Price: £1.36 (including VAT).

**24 ½in Cassette Editing and Joining Kit**

Complete kit to enable cassette tapes to be edited and joined. Price: £1.80 (including VAT).

**29 Cassette Salvage Kit**

Enables a welded cassette to be opened and joined. Price: 51p (including VAT).

■ **BRADMATIC LTD**

338 Aldridge Road, Streetly, Sutton Coldfield, West Midlands. Tel: 021-353 3171.

Magnetic recording heads manufactured to order. Enquiries welcomed and full details of service offered provided on request.

■ **B & J PHOTOGRAPHIC IMPORTS**

305 Kenton Road, Kenton, Harrow, Middlesex, HA3 0HP. Tel: 01-907 6667.

**Stereo stamp**

Small rubber stamp to enable tape enthusiasts who record in stereo to label their tapes, making them instantly visible. Price: 40p including postage.

■ **CALYX**

Calyx Shelving Systems Ltd, Stanley Works, Belgrave Road, London, SE25 5AN. Tel: 01-771 1221.

**P7 Cassette Rack**

An all acrylic product holding 18 cassettes, or stereo cartridges, or 5¼in tapes. 13¼in long. Price: on application.

Full range of specialist audio products from small cassette rack listed above to a full modular wall system (see also Hi-Fi Cabinets Section). Colour brochure available on receipt of 6p in stamps (not s.a.e. please).

■ **CAROL CINESOUND**

Cresta Electronics Ltd, 72 Loom Lane, Radlett, Herts, WD7 8PA. Tel: Radlett (779) 5342.

**Carol cinepulse cassette**

With its own built-in pulse head, this Compact type cassette offers location lip-sync recording facilities using most cassette recorders without costly adaptation to same. Cassettes can be dubbed to ¼in tape for easy editing, after which they can be erased and re-used. Completed sound tracks of up to twelve minutes duration can be dubbed onto Cinepulse cassettes for ease of storing and lightness of transportation. Price: £6.15 (including VAT).

**Sprocket indicator Unit**

Enables manual transfer from pulsed sound track to sprocket tape without the necessity of recording tone over sprocket holes. This means that tape recorders with duo-play facilities can use both tracks one and three for sound without the need to tie up a track for reading sprocket holes. Price: £9.05 (including VAT).

**Tape Head and Guide Assembly**

Used to add an extra track, on which pulses can be recorded, to an existing mono or four track tape recorder, thus allowing duo-play facilities to be used for sound. Can also be used to read pulses recorded over sprocket holes whilst



★ Indicates entry is illustrated

using duo-play. Price: £11 (including VAT).

#### **Lenshood Assembly**

Produces once per frame pulses from one, two or three bladed projectors without adaptation to projector. Price: £7.15 (including VAT).

#### **$\frac{1}{4}$ in Editing Block**

Price: £1.10 (including VAT).

#### **Leader Tape**

$\frac{1}{4}$ in. 160ft. Price: 60p (including VAT).

#### **Splicing Tape**

$\frac{1}{4}$ in. 33ft. Price: 35p (including VAT).

#### **Tape spools**

3in 10p; 5in 20p (including VAT).

#### ■ **EAGLE**

Eagle International, Heather Park Drive, Wembley, HA0 1SU. Tel: 01-903 0144.

#### **TD.79 Tape Head Demagnetiser**

250V mains operation. Price: £2.42 (including VAT).

#### **T.635 Tape Splicer**

Complete with cutting and trimming blades. Price: £1.54 (including VAT).

#### ■ **EMI TAPE**

EMI Tape Ltd, Tape House, Dawley Road, Hayes, Middlesex, UB3 1BT. Tel: 01-573 3888. Telex: 22417.

#### **AP123 Jointing Block**

Professional non-magnetic jointing block for precision splicing at 45° or 90°. Price: 53p (plus VAT).

#### **AP38 Coloured Leader Tape**

Approximately 150ft in plastic dispenser. Range of five colours as follows: white, red, blue, green, grey. Price: (per reel) 23p (plus VAT).

#### **Jointing Tape**

Adhesive polyester tapes specially prepared for splicing. Approximately 30ft in plastic dispenser. Type AP102 ( $\frac{3}{4}$ in wide) 24p; type AP103 ( $\frac{1}{2}$ in wide) 37p. All prices exclude VAT.

#### **AP125 Stop Foil**

Metallic stop foil on 50ft reels in plastic dispenser. Sufficient for 50 tapes. Price: 32p (plus VAT).

#### **AP124 Accessory Kit**

Kit for splicing and editing. Contains three dispensers of leader tape, one of stop foil, one of jointing tape, jointing block and two cutters. In plastic tray with two spare compartments for additions. Price: £1.88 (plus VAT).

#### **Plastic Spools**

In cartons; 4in 14p; 5in 15p; 5 $\frac{1}{2}$ in 16p; 7in 18p. In self-standing dust-proof plastic library boxes with index: 3in 12p, 4in 20p, 5in 25p; 5 $\frac{1}{2}$ in 25p; 7in 30p. All prices exclude VAT.

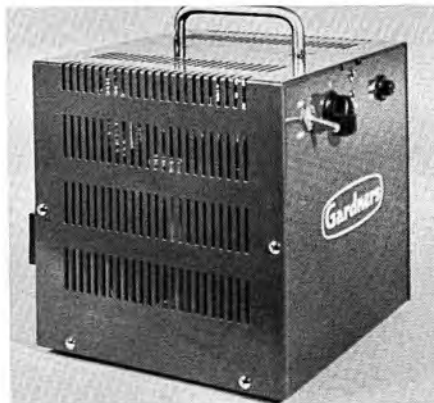

*Gardners 107 inverter*

#### ■ **FERROGRAPH**

Ferrograph Co Ltd, Auriema House, 442 Bath Road, Cippenham, Slough, SL1 6BB. Tel: Burnham (062 86) 62511. Telex: 847297.

#### **Defluxer**

For depolarising heads, capstans and guides. Ensures maximum signal/noise ratio. Prevents hiss and protects tapes from cumulative background noise. Price: £3.98 (plus VAT).

#### **Carrying case for Series 7 recorders**

Waterproof canvas case with zip fastener. Price: £6 (plus VAT).

#### **Plugs**

JPS-401 screened plug with aluminium body and cable clamp. Price: 40p (plus VAT).

#### **Endless loop cassette**

Permits Ferrograph to be operated continuously on an endless loop of 8 min duration at 7 $\frac{1}{2}$ i/s. Price: £8 (plus VAT).

#### **Ferrotape spools**

Aluminium, anodised grey. Prices: 7in 93p (plus VAT); 8 $\frac{1}{2}$ in £1.04 (plus VAT).

#### ■ **GARDNERS TRANSFORMERS LTD**

Christchurch, Hampshire, BH23 3PN. Tel: Christchurch (0201 5) 2284. Telex: 41276.

#### **DC/AC Inverters 107 (A, B and D) ★**

Provide 240V AC squarewave output from DC input. Output: 300VA and 400VA (107D) at 220-240V nominal. Frequency: 50Hz  $\pm$  1Hz. Efficiency: >80% at full load. Input: (107A) 11-15V DC; (107B) 22-30V DC; (107D) 22-30V DC. Size: 9 $\frac{1}{2}$   $\times$  8 $\frac{1}{4}$   $\times$  8 $\frac{1}{2}$ in. Weight: 28 $\frac{1}{2}$ lb. Full specification sheet on request. Price: 107A and B £67 (plus VAT), 107D £85 (plus VAT).

■ **GRAMPIAN REPRODUCERS LTD**  
 Hanworth Trading Estate, Hampton Road  
 West, Feltham, Middx.  
 Tel: 01-894 9141. Cables: Reamp, Feltham.

**Grampian G.7 ★**  
 Matching units, consisting of double-wound transformer in a Mu-metal case with jack socket on the primary and a screened lead on the secondary. Dimensions:  $3\frac{3}{8} \times 1\frac{1}{4}$ in diameter. Versions available for matching 15/30 ohms, 600 ohms and 50,000 ohms or greater. Price: on application.

**Grampian Parabolic Reflector**  
 Diameter 24in, depth 5in. Gain: 14dB over range of 500Hz-5kHz. To take Grampian DP4 and DP6 mics. Weight:  $4\frac{3}{4}$ lb. Price: on application.

**Grampian Reverberation Unit**  
 Self-contained portable unit, transistorised and operated from internal dry batteries. Independent input channels, low level and high level. Output: 1V, 600 ohms. Size (including detachable lid):  $17\frac{1}{2} \times 5\frac{1}{2} \times 6\frac{1}{4}$ in. Weight: 12lb. Price: on application. Mains unit available.

■ **IMPEX**  
 F. I. R. McArdle Ltd, 15 Queen Street,  
 Newcastle-upon-Tyne, NE1 3UG.

**MS7 and MS24**  
 Stereo pickup preamplifiers. See Construction Kit section.

■ **LEEVERS-RICH**  
 Leever-Rich Equipment Ltd, 319 Trinity  
 Road, Wandsworth, London, SW18 3SL.  
 Tel: 01-874 9054.  
 Cables: Leemag, London, SW18. Telex: 923455.

**Leeraser LR70, LR71 ★**  
 Bulk tape demagnetisers. Model LR70 for tapes up to  $8\frac{1}{4}$ in diameter. Price: £22 (plus VAT). Model LR71 for tapes up to  $11\frac{1}{4}$ in diameter. Price: £34 (plus VAT).

■ **LENNARD DEVELOPMENTS LTD**  
 205 Chase Side, Enfield, Middlesex, EN2 0QX.  
 Tel: 01-363 8238.

**Dry-splice**  
 Precut adhesive tape for splicing and mending without the aid of a splicing block. Envelopes of 24. Price: 19p.

**Playfair antistatic cleaning fluid**  
 30cc polythene bottle. Price: 23p.

**Playfair cassette cleaners**  
 Further details and price to be announced.

■ **LYRICHORDS**  
 N. Miers & Co Ltd, 28 Piercing Hill,  
 Theydon Bois, near Epping, Essex, CM16 7LE.  
 Tel: 037-881 2611.



Grampian G7 matching unit

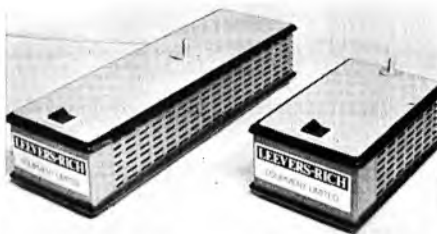

Leever-Rich LR71

Leever-Rich LR70

**Test Tape**  
 8-track cartridge demonstration and test tape. Price: £1-93 (plus VAT).

**Head cleaners**  
 8-track cartridge tape head cleaner. Price: 85p (plus VAT). Reel-to-reel and cassette recorder tape head cleaning kit. Price: 46p (plus VAT).

**Test cassette**  
 Hi-Fi stereo demonstration and test cassette. Price: £1-93 (plus VAT).

**Editing kit**  
 $\frac{1}{8}$ in cassette splicing and editing kit. Price: £1-56 (plus VAT).

**Salvage kit**  
 Cassette salvage kit. Price: 46p (plus VAT).

■ **MAC**  
 Modular Audio Components Ltd,  
 Canterbury Road, Nottingham, NG8 1PQ.  
 Tel: Nottingham (0602) 862647.

**AAU-1**  
 Audio adaptor unit providing connections for tape recorders. Provision for fitting attenuator resistors internally. 24in connecting leads fitted with either phono or DIN plugs (AAU-1Q). Panel fitted with two DIN sockets for record/play. One stereo or two mono recorders can be connected to cabinet mounted hi-fi system. Size:  $3 \times 3 \times 3$ in. Finish: jaguar silver. Price: (AAU-1) £4-18 (plus VAT); (AAU-1Q) £4-26 (plus VAT).

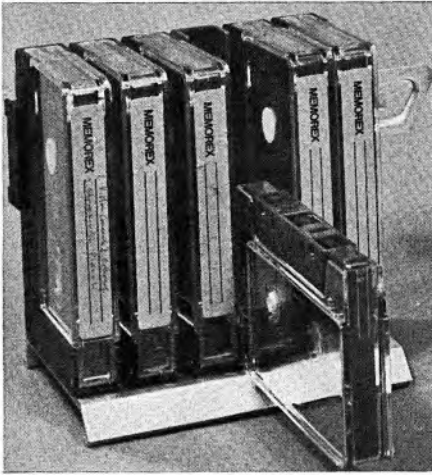

Memorex library holder

#### AAU-4

As previous model, but with provision for connecting two stereo recorders to one amplifier for record/replay, one via rear phono sockets, the other via front DIN socket. 3-way switching gives various combinations for copying, etc. Price: £5.50 (plus VAT).

#### AAU-4M

As AAU-4, but fitted with additional replay leads and extra switching for use with amplifiers incorporating special tape monitor circuits. Price: £8.10 (plus VAT).

#### AAU-TV

Audio adaptor unit provides a ready means of connecting various hi-fi equipments to a TV receiver. Built-in isolating transformer tapped 3.8-15 ohms for matching external speakers. switchable output attenuator for matching input of tape recorder or amplifier. 3-way switching enables TV speakers to be switched on or off. (Remote control switch available with 10ft lead to switch speakers off/on from chair.) Size:  $3\frac{1}{4} \times 3\frac{1}{4} \times 3\frac{1}{2}$  in. Solid teak case. Finish: jaguar silver. Price: £9.45 (plus VAT).

#### AAU-Box

Connector box with facilities for various combinations of audio leads fitted with the plugs in common use. Two independent channels of: 4mm sockets, co-ax,  $\frac{1}{4}$  in jack, miniature jack, 3-pole jack, 5-pin DIN, two pairs of phono. DIN pins selected by slide switch. Screw terminals underneath for fitting attenuator and load resistors, which can be switched in or out. Size:  $4\frac{1}{2} \times 3\frac{1}{2} \times 1\frac{1}{2}$  in. Finish: jaguar silver. Price: £5.70 (plus VAT).

All MAC AAU units are available in solid teak case at an additional cost of £1.32 (plus VAT).

#### ■ MARRIOTT MAGNETICS LTD

Penryn, Cornwall. Tel: Penryn (032 67) 2267.

#### Magnetic Heads

Manufacturers of a wide range of competitively-priced high quality magnetic record/playback and erase heads. Included in the range are versions for two-track and four-track open-reel and cassette recorders, also eight-track cartridge types. Full details and prices on application.

#### ■ MEMOREX

Memorex (UK) Ltd, 50 Salisbury Road, Hounslow West, Middlesex. Tel: 01-570 7716.

#### Cassette cleaner

Price: 57p (including VAT).

#### Cartridge cleaner

Price: 90p (including VAT).

#### Cassette Library Holder ★

Without cases. Price: 75p (including VAT).

#### Cassette Library Holder ★

Complete with cases. Price: £1.95 (including VAT).

#### Audio Training Cassette kits

Available in boxes of 50 in C30, C45, C60, C90 and C120 sizes. Further details and prices on application.

#### ■ METROSOUND

Metrosound Audio Products Ltd, Audio Works, Cartersfield Road, Waltham Abbey, Essex, EN9 1JF. Tel: Waltham Cross (97) 31933.

#### M.4 Klenzatabe kit

Patented head cleaner. Kit comprises ribbed cleaning tape, two special spools and bottle of Klenzatabe fluid. Price: 75p (plus VAT).

#### M.12 Metro-Strobe

Stroboscope for checking accuracy of tape recorders on all speeds at 50Hz and 60Hz. Price: 65p (plus VAT).

#### M.17 Metro-Splicing Block

Professional precision metal splicing block for  $\frac{1}{4}$  in tape, supplied with non-magnetic cutter blade. Price: 60p (plus VAT).

#### M.18 Leader tapes

Choice of six colours, approximately 40ft of leader tape, wound on to plastic mini-spool. Price: 25p (plus VAT).

#### M.19 Stop foil

Metallic tape for actuating electronic auto stop mechanisms for tape recorders. Approximately 15ft on mini-spool. Price: 25p (plus VAT).

**M.20 Jointing tape**

$\frac{1}{4}$ in wide, approximately 12ft on mini-spool.  
Price: 25p (plus VAT).

**M.24 Lubricating Kit**

Suitable for tape recorders and mechanical moving parts. Comprises small bottle of each of R.O.B. and R.O.G. oil and container of Starfax. Price: 40p (plus VAT).

**M.32 Cassette Head Cleaner**

Same size as Philips Compact Cassette. Non-abrasive. Cleans and polishes record and erase heads. For all recorders and tape players using Philips type cassettes. Price: 50p (plus VAT).

**M.30 Accessory Rack**

For radio and audio retailers. Wire display rack with assortment of MetroSound accessories in packs. Full details and prices on request.

**M.33 C60 Blank Cassette**

Price: 60p (plus VAT).

**M.34 Ioniser fluid**

Price: 25p (plus VAT).

**M.39 Cartridge Head Cleaner**

Designed for cleaning heads on eight-track cartridge tape players and recorders. Price: £1 (plus VAT).

**M.46 Test Cassette and Sampler**

Compact cassette containing directions for cassette tape recorder maintenance and setting up procedure. Includes test music and recorded stereo works. Price: £2.25 (plus VAT).

**MUSONIC**

Musonic Ltd, 34-38 Verulam Road, St Albans, Herts, AL3 4DF. Tel: St Albans (56) 50611.

**MT5**

Cassette cleaner in library box. Price: 53p (including VAT).

**MT6**

Cartridge head cleaner. Price: 98p (including VAT).

**MT7**

Cartridge head and capstan cleaner. Price: £1.42 (including VAT).

**MT8 Case set**

Case for 16 cassettes. Price: £1.91 (including VAT).

**MT9 Cartabout**

Case for 15 cartridges. Price: £2.34 (including VAT).

# MIERS *for* B.S.R.

## "THE NEW MIERS LYRICHORD" 8-TRACK CARTRIDGE TAPE PLAYER and PREAMPLIFIER

**FIT ONE TO YOUR**

Mains operated mono or stereo record player, radiogram, unit audio and play 8 track pre-recorded tapes as well.

A completely new dimension to listening, removing most of the difficulties common to disc records.

The LOGICAL addition, the sensible, simpler, FUTURE way to listen to GOOD recorded music.

We have a Bulletin describing the NEW MIERS LYRICHORD, and listing the BSR units and cartridges we keep here in stock. If you would like it, please send for a copy. Better still, GO TO YOUR RADIO RETAILER AND ASK FOR THE NEW MIERS LYRICHORD.

*R.R.P. £26.00  
excl. VAT.*

**N. MIERS & COMPANY LTD.**

28 Piercing Hill, Theydon Bois, Epping, Essex CM16 7LE

Tel. Theydon Bois 2611/2/3 (STD 037 881) Telex 897076

★ Indicates entry is illustrated

#### **MT10**

Cassette library for 30 cassettes. Price: £3-16 (including VAT).

#### **MT11**

Cassette library for 15 cassettes. Price: £2-27 (including VAT).

#### **MT12**

Add 'N' stack for 8 cassettes. Price: 69p (including VAT).

#### **MT13**

Add 'N' stack for 6 cartridges. Price: 69p (including VAT).

#### **MT14**

Cassette carousel for 32 cassettes. Price: £8 (including VAT).

#### **MT15**

Cartridge carousel for 24 cartridges. Price: £8 (including VAT).

#### **MT16**

Empty cassette library box. Price: 12p (including VAT).

#### **MT17**

Cartridge library for 24 cartridges. Price: £3-65 (including VAT).

#### **MT18**

Cassette cleaner without library box. Price: 45p (including VAT).

#### **■ OSMABET LTD**

46 Kenilworth Road, Edgware, Middlesex, HA8 8YG. Tel: 01-958 9314.

#### **'Instant' Bulk Tape Eraser and Recording Head Demagnetizer**

Operates from AC mains to provide rapid and complete erase of tapes and cassettes prior to making quality recordings. Weight: 18oz. Price: £3-25 (plus VAT).

#### **■ PD CONNECTORS**

Parry Electronic Developments Ltd, Assay House, 28 Greville Street, London, EC1N 8SU. Tel: 01-242 1100.

#### **DIN plugs**

New design of DIN plug which requires no soldering or screw connections. Pins interchangeable to match any DIN configuration. Space inside housing to accommodate matching or attenuating resistors. Ratchet-type cable clamp adjusts to all sizes of connecting lead. Designed for home constructors and hi-fi enthusiasts. Price: 28p.

#### **■ PHILIPS**

Philips Electrical Ltd; Century House, Shaftesbury Avenue, London, WC2H 8AS. Tel: 01-437 7777. Cables: Philamps, London.

#### **N6400 Slide Synchroniser**

For use with most tape recorders and automatic slide projectors (max voltage 30V, max current 1A). Supply: 9V battery. Price: £16-16 (including VAT).

#### **N6502**

Mains supply unit. Inputs: 110-245V (switchable). Outputs: 6V, 7.5V and 9V (switchable). For use with Philips battery tape recorders and radios fitted with appropriate socket. Price: £6-75 (including VAT).

#### **SK10 Splicing Kit**

Contains white, green, red and blue leader tape, switching foil, adhesive tape, adhesive labels, cutting blade, splicing jig and instructions. Contained in plastic case. Price: £1-70 (including VAT).

#### **Mono headphones**

For use with Philips recorders. Price: (N6308) £3-96 (including VAT).

#### **Empty spools in cardboard boxes**

5in 23p; 5½in 27p; 7in 29p; 10½in cine centre £1-09. All prices include VAT.

#### **Library cases**

5in 19p; 5½in 20p; 7in 21p. All prices include VAT.

#### **Cassette Cleaning Tape**

Price: 76p (including VAT).

#### **N6705**

Car mounting unit for models EL3300, 3301, 3301T, 3302, N2202 tape recorders. 6V or 12V, positive or negative earth (negative earth only with N2202). Price: £14-54 (including VAT).

#### **EL/1900 Leader Tape**

LT10 (white), LT20 (green), LT30 (red). Price: 17p per reel (including VAT).

#### **EL3880/50 Switch foil**

Price: 20p (including VAT).

#### **EL3916/10 Jointing tape**

Price: 40p (including VAT).

#### **N6719**

Remote control unit for stereo tape recorders N4450, N4418 and N4510. Illuminated 'tip-touch' controls for; pause, record, fast-forward, fast-rewind, start and stop. Supplied complete with 22½ft cable. Price: £15 (including VAT).

#### **N6720 DNL**

Dynamic noise limiter designed to improve signal-to-noise ratio of existing recordings. Connects between recorder or tape deck and main amplifier. Operates only during playback. Price: £18-50 (including VAT).

#### **N6302**

Stereo headphones designed for use with Philips recorders. Stereo 'sound dimension' control permits listener to adjust stereo effect to personal



Ross Cassette Carry Case



Ross RE527K Tape Head Demagnetiser

taste. FR: 16Hz-20kHz. Impedance: 600 ohms. Price: £22 (including VAT).

**N8500**

Hyper-cardioid electret microphone designed for use with Philips cassette and open reel recorders. FR: 100Hz-16kHz (DIN 45 500). Impedance: 1K. Power supply: 1.5V Penlight battery. Price: £16 (including VAT).

**QAS**

Quality Audio Supplies, Wollaton Road, Beeston, Nottingham, NG9 2PB. Tel: Nottingham (0602) 252222/256141.

Wide range of audio accessories including phono plugs, DIN plugs and sockets, 4mm and wander plugs, couplers, screw terminals, slider switches, connecting leads with all types of terminations, audio switching units and remote control stations. All items individually blister-packed for over the counter or self-service sales.

See Pickup Accessories and Speaker Accessories Sections for details of other QAS equipment.

**ROSS ELECTRONICS**

Ross Marks Ltd, 32 Rathbone Place, London, W1P 1AD. Tel: 01-580 7112.

**Cassette Head Cleaner**

Lint-free cleaning tape in a Compact Cassette package removes oxide residue and dirt from record and erase heads. Price: 47p (including VAT).

**Cassette Carry Case ★**

Tough, attractive PVC construction with carry-

ing handle and fastening clip. Holds 12 cassettes in library cases. Packs flat for storage. Colour red. Price: £1.55 (including VAT).

**8-Track Cartridge Carry Case**

Similar to above. Holds 10 cartridges. Price: £1.65 (including VAT).

**RE527K Tape Head Demagnetiser ★**

Removes gradual build-up of residual magnetism from tape heads by briefly applying tip to heads in cassette and reel-to-reel recorders. Operates from mains supply. Totally enclosed and insulated. Price: £2.07 (including VAT).

**SCOTT**

Jacrex Marketing Ltd, 40 Bell Street, Reigate, Surrey, RH2 7BA. Tel: Reigate (74) 40540.

**Cassette Bar**

Storage unit for cased and uncased tape cassettes. Rotates on base. One unit can be stacked upon another. Each tape location incorporates latch-in device to prevent accidental spillage. Holds 20 cased or 32 uncased cassettes. Three different colour combinations available. Colours: black and white, black and yellow, black and orange. Price: £4.95 (including VAT).

**SCOTCH**

3M (UK) Ltd, 3M House, Wigmore Street, London, W1. Tel: 01-486 5522.

**No. 41 Splicing Tape**

A white pressure sensitive adhesive tape specifically designed for splicing magnetic tape.  $\frac{1}{2} \times 150$  in 39p;  $\frac{1}{2} \times 66$ in 73p;  $\frac{3}{4} \times 66$ in 64p. All prices include VAT.

**Tape a Letter**

Send a letter on tape. You can talk for up to thirty minutes on a SCOTCH Tape a Letter. The 3in reel fits all spool type tape recorders. Handy pack is specially designed for easy posting. Price: 42p (including VAT).

**Accessory Kit**

A slim pocket-size kit for outside work or 'on-the-spot' editing. The accessory kit contains: splicer, No. 41 splicing tape on a dispenser. No. 24 white leader tape, in handy pack with cutter, ten tape clips. Price: £2.64 (including VAT).

**Tape Clips**

For holding tape secure on a spool and preventing spilling or tangling in storage, handling and shipment. Available in packets of ten. Price: (per packet) 14p (including VAT).

**Empty Spools**

Made of strong, high-quality plastic except 10 $\frac{1}{2}$ in which is metal. Available in all popular reel sizes each individually boxed and with a slot to allow easy tape threading. In larger sizes the slot is calibrated. Price: 3in 17p; 4in 21p;

★ Indicates entry is illustrated

5in 22p; 5½in 25p; 7in 29p; 10½in £2.09. All prices include VAT.

#### No. 24 Leader Tape

Used to identify ends of tape and sections within a reel. Supplied in red, yellow, white, green and blue. ¼in × 50ft. Price: 15p (including VAT).

#### ■ SONY

Sony (UK) Ltd, Pyrene House, Sunbury Cross, Sunbury-on-Thames, Middlesex. Tel: Sunbury-on-Thames (76) 87644.

#### HE-2

Tape head demagnetiser. Size: 2½ × 1½ × 5in. Weight: 13oz. Price: £4.60 (plus VAT).

#### CSS-4

Sound-on-sound adaptor for recorders and tape decks without suitable facilities. Inputs for microphone and line, outlets for feeding into low impedance mic sockets. Price: £5.20 (plus VAT).

#### BE-7

Bulk eraser for compact cassettes. Permanent magnet. Size: 4½ × 4½ × 1¾in. Weight: 2½lb. Price: £5.70 (plus VAT).

#### ■ SYNCHROTAPE

Sole Distributors: Adastra Electronics Ltd, Unit N22, Cricklewood Trading Estate, Clarendon Road, London, NW2 1TU. Tel: 01-452 6288.

#### Synchrotape Editing Kit

Instant cut and trim splicer, four reels coloured leader tape, one reel metallic stop foil, one reel adhesive tape, six coloured tape-securing clips and 28 self-adhesive titling labels. Presented in see-through crush-proof carton. Complete with 12-page instruction and information booklet. Price: £2.89 (including VAT).

#### ■ TDK

TDK Tape Distributor (UK) Ltd, 341 Brighton Road, South Croydon, Surrey, CR2 6EQ. Tel: 01-688 7372.

#### HC-1

Cassette head cleaner. Price: 79p (including VAT).

#### AR7D

7in plastic reel. Price: 81p (including VAT).

#### AR7HD

7in plastic reel, large hub. Price: 89p (including VAT).

#### AR7M

7in metal reel. Price: £3.14 (including VAT).

#### AR7HM

7in metal reel, large hub. Price: £4.40 (including VAT).

#### AR10M

10½in metal reel, NAB hub. Price: £4 (including VAT).

#### ■ TELEFI

Rola-Celestion Ltd, Ditton Works, Foxhall Road, Ipswich, Suffolk, IP3 8JP. Tel: Ipswich (0473) 73131.

#### Telefi

Special adaptor to permit sound channel output to be taken from most UHF 625-line television receivers. Easy fitting. No connections or modifications to TV. Usually operates without even removing cabinet back. Special probe picks up stray 6MHz inter-carrier sound signal, prior to TV sound detector, and processes the signal to provide a high quality audio output for feeding hi-fi system. Finish: teak. AC mains. Output: typically 100mV-1V adjustable. Output impedance: 2K. Distortion: <1%. FR: 30Hz-20kHz. Two screened leads 6ft long. Price: £30 (including VAT).

#### ■ THORN

Thorn Consumer Electronics Ltd, 284 Southbury Road, Enfield, Middlesex. Tel: 01-366 1155.

#### Foot switch TA/19

Facilitates use of recorder as dictating machine. Recorder runs when switch is depressed. For models with remote pause facility. Price: £2.99 (including VAT).

#### Monitoring Stethoset TA/29

Stethoscope type earpiece to monitor programme during recording. Fitted with Continental speaker plug. Price: £1.60 (including VAT).

#### Stereo headphones TA/39

General purpose stereo headphones. Fitted with ¾in standard jack plug. Price: £8.91 (including VAT).

#### Stereo headphones TA/41

Stereo headphones. High impedance. High quality performance. Price: £10.97 (including VAT).

The tape recorder accessories listed above are primarily for use with machines marketed under the Thorn brand names Ferguson and Marconiphone.

#### ■ TTC

TTC Division Precision Centre, Heather Park Drive, Wembley, Middx, HA0 1SU. Tel: 01-903 0144.

#### T1003

Tape head de-magnetiser. Probe length 1½in. Mains: 240V AC. Price: £2.20 (including VAT).

**UHER**

Uher (UK) Ltd, 15 Broomhills Estate,  
Braintree, Essex, CM7 7RQ.  
Tel: Braintree 23192.

**W212 Stethoset**

Stethoscope earphones. Price: £3.60 (plus VAT).

**Uher A401 Timer**

Self-starting synchronous clock mechanism with hour and minute hands. A third hand indicates time over a 24-hour period (i.e. operates at half speed of normal hour hand). This third hand operates switch striker.

72 selectors round perimeter of clock, spaced at 20-minute intervals, permit on/off on/off switching in sequence, i.e. up to 36 on and 36 off operations within every 24-hour period. Accuracy is  $\pm$  two minutes of the set time. Price: £16.80 (plus VAT).

**Z124**

Mains unit/charger designed to operate models 1200 Report Stereo, 4000L, 4200/4400 from 110-240V AC mains, or to recharge Dryfit battery (Z212) or nickel cadmium battery (Z214). Price: approximately £18 (including VAT).

**Z212, Z214**

Lead acid accumulator (Z212) and nickel cadmium battery (Z214). Designed to fit into models 1200 Report Stereo, Pilot, 4000L, 4200/4400. Capacity: approx 2.5Ah. Running time per charge: approx 4-5 hours. Prices: on application.

**Z213, Z215**

Lead acid accumulator (Z213) and nickel cadmium battery (Z215) for Uher Compact Report Stereo. Capacity: 1.5Ah. Running time per charge approximately 5 hours. Price: on application.

**VALRADIO LTD**

Browells Lane, Feltham, Middx, TW13 7EN.  
Tel: 01-890 4837/4242.  
Service Agents: Vibro Supply, 57 Fortress Road,  
London, NW5. Tel: 01-485 5165.

**DC converters**

Designed for operating tape recorders, video recorders and similar mains equipment from ship's supply or car battery. Input voltage from 12V to 220V DC. Output from 30W to 1000W AC. Prices from £21.

**Transvertor C12/30S**

Input 12V DC. Output 50Hz  $\pm$   $\frac{1}{4}$  Hz sine wave at 30W. Suitable for positive or negative earthed input. Built-in switch and socket. Supplied complete with input lead. Size: 8  $\times$  6  $\times$  6in. Weight: 8lb. Price: approximately £32.

**Transvertor C12/120S**

Input 12V DC. Output: 115-230V 50Hz  $\pm$   $\frac{1}{4}$  Hz sine wave at 120W. Price: approximately £57.

**Transvertor C12/200S**

Input 12V DC. Output: 115-230V 50Hz  $\pm$   $\frac{1}{4}$  Hz sine wave at 200W. Price: approximately £81.

**Transvertor C12/400S**

Input 12V DC nominal. Output 115-230V 50Hz  $\pm$   $\frac{1}{4}$  Hz sine wave at 400W. Price: approximately £197.

**Frequency changer**

AC-DC. Suitable for records, films, television programme special effects. Price: (200W) from about £71.

**WAL**

Sole distributor: A. C. Farnell Ltd,  
Kenyon Street, Sheffield, S1 4BD.  
Tel: Sheffield (0742) 78901.

**WAL D-Mag**

Pinpoint eraser for striped film, tapes and tape heads. Nylon-cushioned probes. Weight: 9 $\frac{1}{2}$  oz. Size: 2in sq  $\times$  1in wide. Psn: 200-250V 50-100Hz. Consumption: 110mA at 240V. Price: £3.98 (plus VAT).

**WAL professional tape eraser**

Will erase both sides of a 7in tape reel in 30 sec and sound from 16mm 10in aluminium reels. Weight: 7lb. Size: 6 $\frac{1}{2}$   $\times$  4 $\frac{3}{4}$   $\times$  3 $\frac{1}{2}$  in. Psn: 200-250V 50Hz, or 110-125V 60Hz. Finish: oyster hammer grey. Price: £9.50 (plus VAT).

**WEIRCLIFFE**

Amos of Exeter Ltd, Weircliffe Court, Exwick,  
Exeter, Devon. Tel: Exeter (0392) 72132.  
Cables: Amos, Exeter.

**Weircliffe Bulk Erasers**

Models 6, 7 and 8. Model 6 accepts reels up to 8 $\frac{1}{2}$ in diameter of  $\frac{1}{4}$ -1in tape. Capacity 180-400 reels per hour. Model 7 accepts 8  $\times$  8in cassettes of  $\frac{1}{4}$ in tape. Model 8 accepts reels of up to 14 $\frac{1}{2}$ in diameter containing tape from  $\frac{1}{4}$ in audio up to 2in video including  $\frac{1}{2}$ in and 1in instrument tape and 16 and 35mm film. Capacity 100-400 reels per hour (NATO catalogue No. 5835-99-972-5371). Model 9 now takes reels of 2in wide video tape on 16in reels as against 35mm only. Sizes: (Models 6 and 7) 11 $\frac{1}{2}$   $\times$  12 $\frac{1}{4}$   $\times$  7 $\frac{1}{2}$  in. Weight: 43lb. Size: (Model 8) 20 $\frac{1}{2}$   $\times$  20 $\frac{1}{2}$   $\times$  10 $\frac{1}{2}$  in. Weight: 92lb. Prices: (Models 6 and 7) £56.75; (Model 8) £179.56; (Model 9) £310. Models available for 115V 60Hz.



# **Who but UHER could ask nearly five hundred pounds for a cassette recorder**



## **AND GET IT!**

Uher tape recorders are well-known in professional and broadcasting circles; keep abreast of the best in recorder developments by asking your dealer for copies of the latest Uher technical literature, or write to:

**UHER(UK) LTD PO Box 30 Braintree  
Essex CM7 7YF Tel: Braintree 23192**

# Tape Amplifiers and Mixer Units

★ Indicates entry is illustrated  
Abbreviations used in this section are given on page 20.

## ■ ADASTRA

Adastra Electronics Ltd, Unit N22, Cricklewood Trading Estate, Claremont Road, London, NW2 1TU. Tel: 01-452 6288.

### M103/B2004

Transistorised stereo/mono microphone mixer. Power supply: 9V. Two stereo channels (with independent gain controls) or four mono channels. Input jack sockets, output phono sockets. Mono/stereo mode switch. On/off switch. Input impedance: 100K. Max input signal: 1V. Gain: 3dB. Free-standing case. Price: £9.30 (including VAT).

### M101/B2005

Transistorised mono microphone mixer. Power supply: 9V. Four channels with individual gain controls. Input jack sockets, output phono sockets. Input impedance: 100K. Max input signal: 1V. Gain: 3dB. Free-standing case. Price: £5.75 (including VAT).

### M104/B2006

Six-channel stereo mixer/preamplifier. Enables multiple combinations of high and low impedance microphones, pickup cartridges and other signal sources to be controlled by slider type gain controls. Low-noise transistorised circuit. Special RIAA 50K socket. Power supply: internal battery. Weight: 3½lb. Price: £34 (including VAT).

## ■ BIAS ELECTRONICS LTD

572 Kingston Road, London, SW20 8DR. Tel: 01-540 8808

### BE106 ★

Professional six-way mono mixer. 17 transistors, six diodes. Inputs: (six) 600 ohms - 80dB or - 20dB. Output: 600 ohms 0dB. Controls: six gain controls (one for each channel), on-off and master gain. Indicator lamp. VU level meter. Mains operated. Size: 17¾ × 6 × 3½in (also available in rack mounting version). Finish: blue stove enamel. Price: £107.96 (including VAT).

### BE206 ★

Professional six-way stereo mixer. 38 transistors, two ICs, 11 diodes. Inputs: (four) 600 ohms - 80dB, (two) 100K - 20dB. Outputs: (two) 600 ohms 0dB (max + 20dB). Controls: six slider gain controls, one talkback gain, two slider master gain, one push-to-talk button, six PFL, six preset gain. One indicator lamp. PPM level meter. Mains operated. Size: 19 × 7½ × 7in. Finish: blue stove enamelled front panel with black anodised chassis. Switchable monitor to either output or PFL. Monitor switches PPM meter. PFL on each channel. Price: £355.74 (including VAT).

## ■ BRENNEL ENGINEERING CO LTD

231-235 Liverpool Road, London, N1 1LY. Tel: 01-607 8271.

### Hi-Fi Tape Link ★

Stereo tape preamplifier and oscillator unit. Connects between tape deck and hi-fi system. Twin transistorised recording amplifiers, bias/erase oscillator, twin transistorised playback amplifiers. Designed for use with three-headed stereo tape deck (i.e. separate erase, record and playback heads). ¼-track or ½-track. Mono and stereo recording facilities provided. Monitoring. Immediate comparison of recorded and original signal. Individual gain controls for each amplifier. Frequency correction for four tape speeds.



Bias Electronics BE106

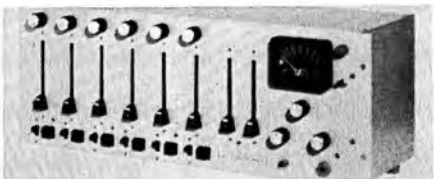

Bias Electronics BE206



Brennell Tape Link

★ Indicates entry is illustrated

Inputs: mic 200 $\mu$ V 200 ohms, aux 8mV 50K, aux 8mV 50K. Cross-fade mixing between inputs. Two illuminated level meters. Output: 1.4V (2V at 2% distortion level). FR: (when used with specified heads) 7 $\frac{1}{2}$ i/s 40Hz-20kHz $\pm$ 3dB, 3 $\frac{3}{4}$ i/s 50Hz-14kHz  $\pm$ 3dB, 1 $\frac{3}{4}$ i/s 60Hz-7kHz ( $\pm$ 3dB), 15i/s 40Hz-22kHz  $\pm$ 3dB. S/N: 56dB. Size: (tapelink) 15  $\times$  7  $\times$  4 $\frac{1}{2}$ in; (power unit) 5 $\frac{1}{2}$   $\times$  5 $\frac{3}{4}$   $\times$  4 $\frac{1}{2}$ in. Weight: (tape link) 9lb; (power unit) 5lb. Price: (complete with PU) £88.50 (plus VAT).

### ■ DEIMOS

Deimos Ltd, 8 Corwell Lane, Hillingdon, Middlesex. Tel: 01-573 3561.

Manufacturers of high quality and custom built mixers. No product information or prices obtainable as this edition of the Year Book closed for press.

### ■ EAGLE

Eagle International, Heather Park Drive, Wembley, HA0 1SU. Tel: 01-903 0144.

#### MP12 ★

Six-channel stereo/mono mixer and preamplifier. Studio type slider controls. Mic inputs can be individually switched between high and low impedance. Inputs: four microphone 1mV 600 ohms or 2mV 50K, two pickup 3.5mV at 47K RIAA. S/N: better than 50dB. Output: (switched stereo/mono) two 250mV. Low profile desk console. Price: £37.40 (including VAT).

#### FF1

Transistorised five-channel mono mixer. Slider type controls. Microphone inputs: 0.5mV at 600 ohms, switchable for 4mV 50K. Aux input: 180mV 100K. Two outputs: (low) 200mV 50K-500K, (high) 2V 50K-500K. Controls: on/off switch, slider control for each input, overall master gain control. Power: two PP3 batteries. Size: 10  $\times$  7  $\times$  1 $\frac{7}{8}$ in. Monitoring facilities included. Price: £28.60 (including VAT).

#### FF10 ★

Stereo seven-channel mixer/preamplifier. Inputs: mic 3mV 50K, stereo PU (1) 3mV 47K, stereo PU (2) 3mV 47K, stereo tape 100mV 100K. Output: two 250mV 50K (switchable stereo/mono). Controls: master gain, mic gain, PU (1) gain, PU (2) gain, tape gain, on/off, stereo/mono mode switch. Power supply: internal 9V battery. Size: 9 $\frac{3}{4}$   $\times$  7 $\frac{1}{4}$   $\times$  1 $\frac{3}{8}$ in (sloping down to 1 $\frac{1}{8}$ in). Finish: black and silver trim. Price: £37.40 (including VAT).

#### FF32

Tape mixer unit. Inputs: phono, stereo 3mV 47K (x2), mic 3mV 50K, stereo tape 100mV 100K. Outputs: 2 stereo outputs 250mV 50K. Pre-fade headphone monitor. Controls: master



Eagle MP12



Eagle FF10



Eagle International AA46 Dolby Processor

volume, tape level, phono 1 level, phono 2 level, mic level, prefade monitor switch, stereo/mono switch, on/off switch. Power: 9V DC (2  $\times$  PP3). Size: 9 $\frac{7}{8}$   $\times$  7 $\frac{1}{8}$   $\times$  1 $\frac{7}{8}$  (sloping to 1 $\frac{1}{8}$ in). Price: £39.60 (including VAT).

#### AA46 ★

Dolby "B" noise reduction unit. Input: 0.580mV variable into 50K. FR: 20Hz-15kHz  $\pm$ 1dB. Two level meters. H & N: better than -70dB ref. 580mV unweighted. Controls: separate stereo level controls, rec/replay switch, MPX switch, cal. switch, Dolby on/off switch, MPX switch, tape monitor switch. Power 240V AC. Size: 16  $\times$  8 $\frac{1}{2}$   $\times$  3 $\frac{1}{2}$ in. Supplied complete with calibration tapes for reel-to-reel and cassette machines. Price: £70.40 (including VAT).

### ■ GRUNDIG

Grundig (Great Britain) Ltd, Newlands Park, Sydenham, London, SE26 5NQ. Tel: 01-659 2468.

**422 ★**

Transistorised stereo mixer for four inputs. Three coarse level controls, directional control and control for reverburation unit. Four microphone preamplifiers fitted. Channel separation: 50dB (mic), 35dB (PU). Response: 40Hz-20kHz  $\pm$  2dB. Powered by two 9V batteries. Size  $13\frac{1}{4} \times 2\frac{1}{4} \times 7\frac{1}{2}$ in. Price: £49.24 (including VRT).

**420**

Mono version of 422 mixer above. Price: £33.74 (including VAT).

**■ H/H ELECTRONIC**

Industrial Site, Cambridge Road, Milton, Cambridge, CB4 4AZ.

Tel: Cambridge (0223) 65945.

**MA100S**

High quality mixer/amplifier. Inputs: 10 inputs (five mono channels) all 50mV 68K also aux input 500mV 100K. Controls: bass +17dB -12dB at 30Hz, treble +17dB -30dB at 10kHz, volume on each input, master volume, master presence +12dB at 1.5kHz. Output: 100W continuous into 7.5 ohms. 130W continuous into 4 ohms. Peak power output: 180W. FR: (power) 20Hz-20kHz  $\pm$  0.5dB. HD: (mixer and power amplifier) < 0.2% 20Hz-20kHz (typically < 0.05% at 1kHz at 100W. Open circuit and short circuit protection. Mains: 115, 210, 220, 230, 240V 50-60Hz. Power consumption: (quiescent) 20VA, (full power) 220A. Finish: electro-luminescent front panel. Size:  $26\frac{3}{8} \times 4\frac{1}{2} \times 11\frac{1}{2}$ in. Weight: approximately 24½lb. Price: £100 (plus VAT).

**MA100 ★**

High quality mixer/amplifier with same specification and dimensions as the MA100S, but with the addition of reverb facilities. Price: £119 (plus VAT).

**H/H console**

Chromium plated steel tubular stand designed to accommodate up to four mixer/amplifiers. Is also useful as means of carrying amplifiers and mixers. Full details on request. Price: £25 (plus VAT).

**■ MILLBANK**

Millbank Electronics Group, Bellbrook Estate, Uckfield, Sussex, TN22 1PS.

Tel: Uckfield (0825) 4166.

**MEX-6**

Six-way mains operated mono mixer. 11 transistors. Range of plug-in modules to suit all standard signal sources, also tone and alarm circuits, etc. Output: Nominal 0.77V 10K (0dB). Tape record output before or after tone controls. Controls: six independent gain controls, bass  $\pm$  12dB at 60Hz, treble  $\pm$  12dB at 12kHz. Indicator light integral with on/off switch. Peak

reading level meter. Mains: 220, 250V 50-60Hz. Size:  $19 \times 3\frac{1}{2} \times 8$ in. Price: £69.12 (plus VAT).

**Disco III ★**

Four-way stereo mains-operated mixer. 52 transistors and 16 diodes. Inputs: mag PU 5mV 68K, ceramic PU 90mV 1M, mic (1) 100µV at 200 ohms, mic (2) 3mV at 30K, tape 55mV 47K. Output: 0.775V 5K (0dB) each channel. Pre-set gain and tone controls on gram and tape inputs. Controls: treble  $\pm$  12dB at 12kHz, bass  $\pm$  12dB at 80Hz, crossfade between PU (1) and PU (2) Mains indicator lamp in on/off switch. Two peak reading VU meters. Full monitoring facilities. Size:  $13 \times 8 \times 6\frac{1}{2}$ in. Mains: 220-250V 50-60Hz. Price: £169.34 (plus VAT).

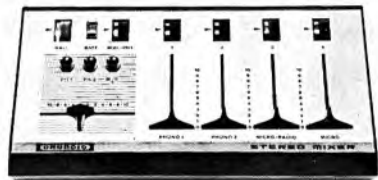

Grundig 422 stereo mixer

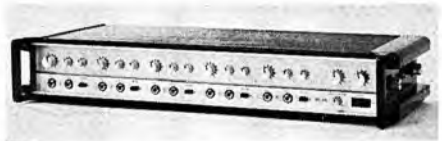

H/H Electronic MA100

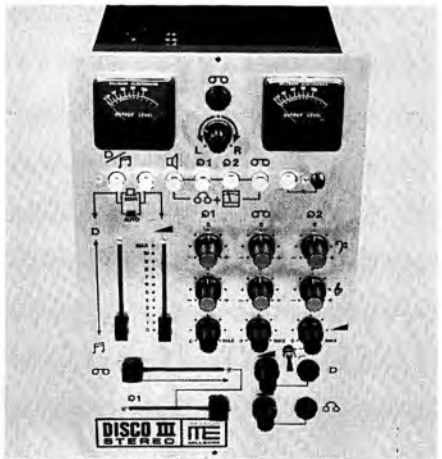

Millbank Disco III

★ Indicates entry is illustrated

### MCC Mk III XLR

Mono or stereo 10-way mixer. Range of input modules to suit all signal sources, also signal and alarm inputs available. Outputs: 0-775V 0dBm each channel, 50 ohms 2V monitoring output. Controls: two master linear faders, independent gain controls, bass  $\pm 12$ dB at 100Hz, treble  $\pm 12$ dB at 12kHz. Pre-fade listen switches under input faders. Mains indicator lamp in on/off switch. Meters: PPM, standard or peak-reading level meters. Mains: 220-250V 50-60Hz. Full monitoring facilities. Size:  $19 \times 5\frac{3}{8} \times 8\frac{1}{8}$  in. Price: £216 (plus VAT).

### MUSICMASTER II ★

Mono or stereo eight-way mixer. 28 transistors, one diode. Eight channels arranged in two groups of four to accept low Z mics (30-200 ohms), high Z mics (3-5mV input) and a range of other high Z inputs. Outlets: 0-775V at 10K per channel. Eight input faders. Preset gain controls. Input selector. Controls: bass  $\pm 10$ dB at 100Hz, treble  $\pm 10$ dB at 10kHz. Mains indicator lamp in on/off switch. Mains: 220-250V 50-60Hz. Size:  $19 \times 7 \times 5\frac{3}{8}$  in. Finish: colour-coded identification on knobs. Price: £207.36 (plus VAT).

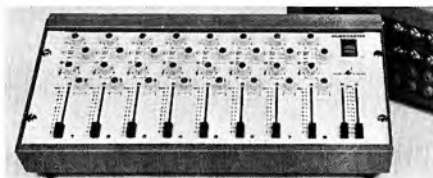

Millbank Musicmaster II



Sennheiser M101

### SENNEHEISER ELECTRONIC

Distributors: Hayden Laboratories Ltd, Hayden House, 17 Chesham Road, Amersham, Bucks, HP6 5AG.

Tel: Amersham (0240 3) 5511.

Audio equipment showroom service department and despatch department: 6 Bendall Mews, Bell Street, London, NW1.

### M101 ★

Battery operated portable mixer. Inputs: four microphone inputs switchable for 200 ohm dynamic and 12V powered capacitor (MKH series of Sennheiser mics). Output: unbalanced +6dB at 60 ohms. Pre-fade listening using ML101 mixer monitoring unit PPM. Slider-type faders. Separate bass and treble controls switchable to one channel or to mixed output. Treble control:  $\pm 12$ dB at 15kHz, bass control +10dB -14dB at 40Hz. Power supply: two 9V Ever-Ready cells type 276 or equivalent, or 18V from other equipment. Price: on application.

### SONY

Sony (UK) Ltd, Pyrene House, Sunbury Cross, Sunbury-on-Thames, Middlesex.

Tel: Sunbury-on-Thames (76) 87644.

### MX10K/MX600M

Three-input mono mixer. Inputs: mic (3) 10K or 600 ohms. One outlet. Output impedance: (MX10K) 13.5K, (MX600M) 300 ohms. Three level controls. Passive system. Size:  $9\frac{1}{2} \times 2\frac{1}{2} \times 4$  in. Price: £8.25 (plus VAT).

### MX12M

Mono/stereo mixer with six inputs. Inputs: mics (3) 0-195mV 600 ohms, aux (3) 61-5mV 100K. DIN connector 0-775V 10K. Two outlets plus headphone socket. Outlets: (high) 245mV 100K, (low) 0-775mV 10K. Controls: power on/off, battery check, six level controls, selector, attenuate on/off. Twin VU meters. Power: six HP11 batteries or 12V DC source. Size:  $15\frac{3}{4} \times 7\frac{7}{8} \times 7$  in. Monitoring facilities by 8-ohm phones. Price: £49.50 (plus VAT).

### MX6S

Six-input stereo mixer. Inputs: mic (3) 0-775mV low Z, aux 0-245mV high Z. Two outlets. Outlets: 0-245mV low Z. Six-level controls plus channel selector. Passive system. Size:  $13\frac{7}{8} \times 2\frac{7}{8} \times 4\frac{5}{8}$  in. Price: £12.10 (plus VAT).

### TEAC

Acoustico Enterprises Ltd, Unit 7, Space Way, North Feltham Trading Estate, Feltham, Middlesex, TW14 0TZ. Tel: 01-751 0141.

### AN60

Dolby noise reduction unit. Stereo. Inputs: line 100mV 35K. Output: tape 300mV, line 580mV. HD: 0.5%. FR: 20Hz-15kHz  $\pm 2$ dB. Mains: 100, 117, 220, 240V AC. Size:  $3\frac{3}{4} \times 6\frac{1}{2} \times 10\frac{3}{8}$  in. Finish: black anodised. Price: £45.50 (plus VAT).

### AN180

Dolby noise reduction unit. Inputs: mic 0-25mV

50K. line 100mV 100K. Noise level: >65dB. Controls: mic and line inputs, record cal, Mpx filter, Dolby switch, play cal R and L, monitor, output level. Two VU meters. HD: <0.3%. Output impedance: 50K or higher. FR: 20Hz-15kHz±1.5dB. AC mains 100-240V. Size: 16½ × 5½ × 12¾ in. Black and chrome finish. Test tape supplied. Price: £145 (plus VAT).

**AN80**

Dolby noise reduction unit. Inputs: line 0.03V 35K. Output: 0.58V. HD: <0.5%. Output impedance: 50K or higher. FR: 20Hz-15kHz ±2dB. Mains: 100, 117, 220, 240V AC. Size: 16½ × 3½ × 10¾ in. Test tape supplied. Finish: black. Price: £77.50 (plus VAT).

**AN300**

Four-channel Dolby noise reduction unit. Input: line 100mV 70K, tape 100mV 70K. Outlets: (record) 300mV, (monitor) 300mV. HD: <0.2%. Output impedance: 50K. FR: 20Hz-20kHz±1.5dB. Mains: 100, 117, 220, 240V AC. Finish: metal cabinet with brushed aluminium trim. Size: 6¾ × 16½ × 10½ in. Price: £204 (plus VAT).

■ **TTC**

Division Precision Centre, Heather Park Drive, Wembley, Middlesex, HA0 1SU. Tel: 01-903 0144.

**B2004 ★**

Transistorised stereo/mono microphone mixer. Power supply: 9V. Two stereo channels (with independent gain controls) or four mono channels. Input jack sockets, output phono sockets. Mono/stereo mode switch. On/off switch. Input impedance: 100K. Max input signal: 1V. Gain 3dB. Free-standing case. Price: £8.80 (including VAT).

**B2005**

Transistorised stereo/mono microphone mixer. Power supply: 9V. Four stereo channels with individual gain controls. Input jack sockets. Input impedance: 100K. Max input signal: 1V. Gain 3dB. Free-standing case. Price: £5.50 (including VAT).

■ **UHER**

Uher (UK) Ltd, 15 Broomhills Estate, Braintree, Essex, CM7 7RQ. Tel: Braintree 23192.

**A122**

Mixer unit for five channels: two stereo plus one mono or five mono channels. Inputs available for 200 ohms microphone, radio or pickup. Outputs: one 40mV nominal, one 500mV nominal. FR: 20Hz-20kHz. Slider faders with directional control, muting switches and 1kHz generator. Powered by PP3 battery. Price: approximately £55 (including VAT).



TTC Mike Mixer B2004

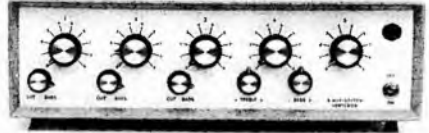

Vortexion 50/70

■ **UNIMIXER**

Soundex Ltd, 18 Blenheim Road, London W4 1ES. Tel: 01-995 1661.

**Studio 4 and Studio 6**

Mixers for studio or portable use. Studio 4 has four channels, Studio 6 has six. Outputs: Four in two groups. Inputs per channel for 25-60 ohms floating mic, 150-600 ohms floating mic, line 1.5M ohms unbalanced, high sensitivity, 50K and 150-300 ohms capacitor mic, phantom working. Specifications and price on application.

■ **VORTEXION**

257-263 The Broadway, Wimbledon, London, SW19 1SF. Tel: 01-542 2814/6242.

**50/70 ★**

All-silicon transistor amplifier with built-in four-channel mixer. Amplifier circuit similar to 100W model described in Amplifier Section. Mixer portion arranged for three 30-60 ohms balanced line inputs and one high impedance input. Separate bass and treble controls. Balanced line 100V output. Sensitivity: 100µV on low impedance inputs, 100mV 100K on high impedance input. 15-ohm output model available. Size: 14 × 11½ × 4½ in. Weight: 22lb. Price: £105.87 (including VAT).

**50/70 plus 5-way mixer**

Similar specification to 50/70 with four-channel mixer, but with additional bass-cut controls on three low impedance inputs. Inputs: three 100µV 30-60 ohms balanced, 100mV 10M, 100mV 100K. Size: 14 × 11½ × 2½ in. Weight: 22lb. Price: £113.13 (including VAT).

**FET mixers and PPMs**

Various types of mixers available. Three-, four-, six- and eight-channel with peak programme meter. Four-, six-, eight- and ten-way mixers. 1win three-, four- and five-channel stereo. Twin four- and five-channel stereo with two PPMs. Price: on application.

# Meet the creators.

A TEAC reel-to-reel deck is more than just a machine. It's a creative tool. A partner in the creative process itself.

Every member of the TEAC reel-to-reel family is designed to expand your imagination and enhance your creativity. Like the classic A-1230 with its reliable 3-motor, 3-head transport system and the A-1250S which is the same but better with automatic reverse/ repeat function.

Our A-4300 with cue-out connection jack, two-position level meter and full reverse circuitry, our A-5300 with centre capstan drive, DC reel motors, dual-scale VU

meters and plug-in electronic boards, our A-5500 with dual-function Dolby<sup>®</sup> circuitry are examples of TEAC creative engineering in the service of creative use.

Think of your TEAC as an extension of yourself. Then open your head and explore your personal world of sound.

You'll be surprised at the beauty that's there. Or maybe you won't be.

TEAC'S A COMMITMENT TO  
AUDIO EXCELLENCE

**TEAC**  
The sound of perfection



Sole UK Distributors  
**ACOUSTICO ENTERPRISES LTD**  
*The Hi-Fidelity People*

Unit 7, Space Way, North Fetham Trading Estate,  
Fetham, Middlesex. Tel: 01-751 0414 (inc)

# Tape Decks and Recorders

★ Indicates entry is illustrated.

Abbreviations used in this section are given on page 20.

## AKAI

Rank Audio Visual Ltd, PO Box 70, Great West Road, Brentford, Middlesex, TW8 9HR.  
Tel: 01-568 9222.

### GX221D

Stereo open reel tape deck.  $\frac{1}{4}$ -track two-channel stereo. Max spool: 7in. Speeds:  $7\frac{1}{2}$ ,  $3\frac{3}{4}$ ,  $1\frac{7}{8}$ i/s. W and F:  $7\frac{1}{2}$ i/s <0.08%,  $3\frac{3}{4}$ i/s <0.12%,  $1\frac{7}{8}$ i/s <0.20%. FR:  $7\frac{1}{2}$ i/s 30Hz-25kHz  $\pm$  3dB,  $3\frac{3}{4}$ i/s 30Hz-20kHz  $\pm$  3dB,  $1\frac{7}{8}$ i/s 30Hz-10kHz  $\pm$  3dB. Signal-to-noise: better than 50dB. Bias freq: 100kHz. Three heads. Three motors. Fast rewind: 60-75 seconds for 1200ft. Output: line (2) 1.23V 20K, phones 30-40mV 8 ohms. Input: mic (2) 0.2mV 10K, line 50mV 150K. 24 transistors, 14 diodes, two ICs. Mains: 100-240V 50-60Hz. Size:  $17\frac{3}{8} \times 16\frac{3}{4} \times 8\frac{3}{4}$ in. Weight: 44 $\frac{1}{2}$ lb. Price: to be announced.

### GX370D

Stereo open reel tape deck.  $\frac{1}{4}$ -track two-channel stereo. Max spool: 7in. Speeds:  $7\frac{1}{2}$ ,  $3\frac{3}{4}$ i/s. W and F:  $7\frac{1}{2}$ i/s <0.07%,  $3\frac{3}{4}$ i/s <0.1%. Playback char: NAB. FR:  $7\frac{1}{2}$ i/s 20Hz-26kHz  $\pm$  3dB,  $3\frac{3}{4}$ i/s 30Hz-22kHz  $\pm$  3dB. Signal-to-noise: 58dB. Bias frequency: 100kHz. Three heads. Three motors. Fast rewind: 60-75 seconds for 1200ft. Output: line (2) 1.23V 20K, phones 30-40mV 8 ohms. Inputs: mic (2) 0.8mV 10K, line (2) 100mV 150K. 65 transistors, 49 diodes, two ICs. Mains: 100-240V 50-60Hz. Size:  $18\frac{1}{4} \times 20\frac{1}{2} \times 10\frac{3}{8}$ in. Weight: 56lb. Price: to be announced.

### GX1900D

Combined open reel/cassette stereo tape deck.  $\frac{1}{4}$ -track two-channel stereo on reels and cassettes. Speeds: (reel)  $7\frac{1}{2}$ ,  $3\frac{3}{4}$ i/s, (cassette)  $1\frac{7}{8}$ i/s. Max spool: 7in. W and F: (reel)  $7\frac{1}{2}$ i/s <0.12%,  $3\frac{3}{4}$ i/s <0.15%, (cassette)  $1\frac{7}{8}$ i/s <0.2%. Replay char: NAB. FR: (reel)  $7\frac{1}{2}$ i/s 30Hz-22kHz  $\pm$  3dB,  $3\frac{3}{4}$ i/s 30Hz-15kHz  $\pm$  3dB, (cassette)  $1\frac{7}{8}$ i/s 40Hz-15kHz  $\pm$  3dB. Signal-to-noise: better than 50dB. Heads: two for open reel, two for cassette. One two-speed motor. Output: line (2) 1.23V 20K, phones 30mV 8 ohms. Inputs: mic (2) 0.5mV 5K, line (2) 50mV 200K. 16 transistors, 12 diodes, two ICs. Mains: 100-240V 50-60Hz. Size:  $15 \times 17\frac{3}{8} \times 10$ in. Weight: 40 $\frac{1}{2}$ lb. Price: to be announced.

### X201D

Stereo open reel tape deck.  $\frac{1}{4}$ -track two-channel stereo. Max spool: 7in. Speeds:  $7\frac{1}{2}$ ,  $3\frac{3}{4}$ ,  $1\frac{7}{8}$ i/s. W and F:  $7\frac{1}{2}$ i/s <0.08%,  $3\frac{3}{4}$ i/s <0.12%,  $1\frac{7}{8}$ i/s <0.2%. FR:  $7\frac{1}{2}$ i/s 40Hz-22kHz  $\pm$  3dB,  $3\frac{3}{4}$ i/s 40Hz-18kHz  $\pm$  3dB,  $1\frac{7}{8}$ i/s 40Hz-9kHz  $\pm$  3dB. Signal-to-noise: better than 50dB. Bias frequency: 100kHz. Three heads. Three motors. Fast rewind: 60-75 seconds for 1200ft. Output: line (2) 1.23V 20K, phones 30mV 8 ohms. Inputs: mic (2) 0.5mV 5K, line 60mV 180K, 14 transistors, 17 diodes, two ICs. Mains: 100-240V 50-60Hz. Size:  $14\frac{3}{4} \times 14 \times 9\frac{3}{8}$ in. Weight: 36 $\frac{1}{2}$ lb. Price: to be announced.

### X1810D

Combined open reel and cartridge stereo tape deck. Tracks:  $\frac{1}{4}$ -track two-channel stereo with open reels, eight-track two-channel stereo with cartridges. Max spool: 7in. Speeds: (reel)  $7\frac{1}{2}$ ,  $3\frac{3}{4}$ ,  $1\frac{7}{8}$ i/s, (cartridge)  $3\frac{3}{4}$ i/s. W and F: (reel)  $7\frac{1}{2}$ i/s <0.08%,  $3\frac{3}{4}$ i/s <0.12%,  $1\frac{7}{8}$ i/s 0.2%, (cartridge)  $3\frac{3}{4}$ i/s <0.25%. FR: (reel)  $7\frac{1}{2}$ i/s 30Hz-22kHz  $\pm$  3dB,  $3\frac{3}{4}$ i/s 30Hz-18kHz  $\pm$  3dB,  $1\frac{7}{8}$ i/s 30Hz-9kHz  $\pm$  3dB, (cartridge) 50Hz-16kHz  $\pm$  3dB. Signal-to-noise: (reel) better than 50dB, (cartridge) better than 45dB. Bias frequency: 65kHz. Heads: (reel) three, (cartridge) two. Three motors. Fast forward: (reel) 60-75 seconds for 1200ft, (cartridge) 230 seconds for 300ft. Output: line (2) 1.23V 20K, phones 150mV 8 ohms. Inputs: mic (2) 0.5mV 100K, line (2) 60mV 150K. 17 transistors, 15 diodes. Mains: 100-240V 50-60 Hz. Size:  $17\frac{3}{8} \times 18 \times 9\frac{3}{8}$ in. Weight: 47lb. Price: to be announced.

### X2000SD ★

Three-speed stereo recorder with facilities for cassettes, cartridges and reel-to-reel recording and playback. Speeds:  $7\frac{1}{2}$ ,  $3\frac{3}{4}$ ,  $1\frac{7}{8}$ i/s. Max spool 7in. W and F:  $7\frac{1}{2}$ i/s 0.09%,  $3\frac{3}{4}$ i/s 0.14%,  $1\frac{7}{8}$ i/s 0.20%. H and N: reel-to-reel all speeds 50dB,



Akai X2000SD





Akai 1721L



Amcron 800

cassettes and cartridges 45dB. FR:  $7\frac{1}{2}$ i/s 30Hz-23kHz  $\pm 3$ dB,  $3\frac{3}{4}$ i/s 30Hz-18kHz  $\pm 3$ dB,  $1\frac{7}{8}$ i/s 30Hz-9kHz  $\pm 3$ dB, cassettes 30Hz-16kHz  $\pm 3$ dB, cartridges 30Hz-18kHz  $\pm 3$ dB. Replay char: NARTB. Rewind time:  $2\frac{1}{2}$  min for 1200ft, 80 sec for cassette. VU meters. Inputs: mic 0.15 mV, line 25mV. Outlet: line. Output: 8W RMS per channel. Speakers: 4  $\times$  2in monitoring. Two-speed capacitor motor. Own deck. Cross-field head. Monitoring. Transfer facilities from reel to cassette or cartridge. Size:  $10\frac{3}{8} \times 13\frac{3}{4} \times 18\frac{3}{8}$ in. Weight: 49 $\frac{1}{2}$ lb. Mains: 100-240V 50-60Hz. Price: £280.96 (including VAT).

#### 1721L ★

$\frac{1}{4}$ -track stereo tape recorder. Speeds:  $7\frac{1}{2}$ i/s and  $3\frac{3}{4}$ i/s. Max spool size:  $7\frac{1}{2}$ in. W and F: 0.15% ( $7\frac{1}{2}$ ), 0.20% ( $3\frac{3}{4}$ ). H and N: less than 10mV at minimum tone control. FR: 50Hz-20kHz ( $7\frac{1}{2}$ ), 50Hz-18kHz ( $3\frac{3}{4}$ ), using SD tape. 50Hz-18kHz ( $7\frac{1}{2}$ ), 50Hz-10kHz ( $3\frac{3}{4}$ ), using regular tape. Rewind time: 80-100 sec for 1200ft tape. Level indicator: VU. Inputs: mic 0.5mV 100K, line 150mV 330K, DIN 7mV. Outputs: line 12V,

DIN 1V, phones 100mW/8 ohms. Speaker output: 6W. Speaker size: 8 ohms. Motors: 204 pole induction. Size: 358  $\times$  360  $\times$  284mm. Weight: 13.2kg. Mains: 100/240V AC 50-60Hz. Price: £120.75 (including VAT).

#### ■ AMCRON

Macinnes Laboratories Ltd,  
Macinnes House, Carlton Park Industrial  
Estate, Saxmundham, Suffolk, IP17 2NL.  
Tel: Saxmundham (0728) 2262/2615.

#### 800 Series ★

Stereo tape deck,  $\frac{1}{4}$ - or  $\frac{1}{2}$ -track. Three-speed 15i/s or  $1\frac{7}{8}$ i/s optional. Max reel 10 $\frac{1}{2}$ in. W and F: 15i/s 0.06%;  $7\frac{1}{2}$ i/s 0.09%;  $3\frac{3}{4}$ i/s 0.18% (RMS). H and N: 15i/s -60dB;  $7\frac{1}{2}$ i/s -60dB;  $3\frac{3}{4}$ i/s -55dB (below peak level). FR ( $\pm 2$ dB): 15i/s 30Hz-30kHz;  $7\frac{1}{2}$ i/s 30Hz-25kHz;  $3\frac{3}{4}$ i/s 30Hz-15kHz. Replay char: CCIR. VU meter. Rewind time: 58 seconds for 2400ft, 38 seconds for 1200ft. Inputs: 2 mixable inputs per channel, mic or line. Sensitivity: 45mV for 0 level (line), 0.4mV for 0 level (mic); impedance 100K, balanced or unbalanced 600 ohms, or 50/200 ohms. Output: 600 ohms. Three motors, magnetic brakes, logic circuitry for tape handling, all tape commands can be remote. A-B monitoring, source and tape mixing, echo, individual bias adjustment and metering. Size: 17 $\frac{1}{2} \times 19 \times 8$ in. Weight: 50lb. Price: £700 to £2,300.

#### ■ AMPEX

Amplex G.B. Ltd, Acre Road, Reading,  
Berks, RG2 0QR. Tel: Reading 84411.

#### AG-440B ★

Full range of professional and semi-professional tape decks, tape units and complete recorders. Typical specification includes following facilities. Full-, half- or quarter track on  $\frac{1}{4}$  in tape. Up to 15in spools. Speeds: selectable pairs from  $\frac{1}{2}$ ,  $1\frac{7}{8}$ ,  $3\frac{3}{4}$ ,  $7\frac{1}{2}$ , 15. Unidirectional or bi-directional operation. FR: 15i/s 30Hz-18kHz  $\pm 3$ dB,  $1\frac{7}{8}$ i/s 40Hz-10kHz. Crosstalk rejection: better than 60dB at 1kHz. Bias/erase frequency: 100kHz. W and F: 15i/s 0.1%,  $1\frac{7}{8}$ i/s 0.25%. Start time: operating speed obtained in 0.1 sec or less. Stop time: at 15i/s tape moves 3in. S/N: 15i/s half-track 63dB,  $7\frac{1}{2}$ i/s half-track 63dB,  $3\frac{3}{4}$ i/s half-track 58dB.

Full specification and prices on request.

#### ■ BIAS ELECTRONICS LTD

572 Kingston Road, London, SW20 8DR.  
Tel: 01-540 8808.

#### BE100M/RR/C ★

Professional tape deck with preamplifiers. Mains operated. Mono. Full-track recording and playback. Speeds:  $7\frac{1}{2}$  and 15i/s. Max spool: 11 $\frac{1}{2}$ in. W and F: ( $7\frac{1}{2}$ i/s) <0.08% RMS, (15i/s) <0.06%

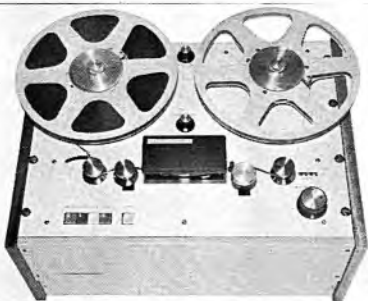

Bias Electronics BE1000M/RR/C



Bias Electronics BE1000S/RR/console



Ampeg AG-440B

RMS. H and N: ( $7\frac{1}{2}$ i/s) - 58dB, (15i/s) - 60dB. FR: ( $7\frac{1}{2}$ i/s) 40Hz-16kHz  $\pm 2$ dB, (15i/s) 40Hz-18kHz  $\pm 2$ dB. Replay char: switchable NAB/CCIR. Variable speed spooling. Rewind time: < 100 seconds for 2400ft. VU meter extra. Clock type tape indicator (driven by tape) calibrated in minutes and tenths. Inputs: line - 20dB - 0dB 10K floating (bridging). Output: 0dB 600 ohms (max +20dB). Motors: two Papst ROT, one Papst HSK2. Size: 20 x 14 $\frac{1}{2}$  x 10 $\frac{1}{2}$ in. Weight: 56lb. Price: (in transportable case) £597.40 (plus VAT): (with rack mounting) £546 (plus VAT).

**BE1000S/RR/C ★**

Professional tape deck with preamplifiers. Mains operated. Stereo.  $\frac{1}{2}$ -track recording and playback. Speeds: 7 $\frac{1}{2}$  and 15i/s. Max spool: 11 $\frac{1}{2}$ in. W and F: ( $7\frac{1}{2}$ i/s) < 0.08%, (15i/s) < 0.06%. H and N: ( $7\frac{1}{2}$ i/s) - 56dB, (15i/s) - 58dB. FR: ( $7\frac{1}{2}$ i/s) 40Hz-16kHz  $\pm 2$ dB, (15i/s) 40Hz-18kHz  $\pm 2$ dB. Replay char: switchable NAB/CCIR. Variable speed spooling. Rewind time: < 100 seconds for 2400ft. VU meters extra. Clock type tape position indicator (driven by tape) calibrated in minutes and tenths. Inputs: (two) line in - 20dB - 0dB at 10K bridging. Output: 0dB 600 ohms (max +20dB at 600 ohms). Motors: two Papst motors ROT, one Papst motor HSK. Size: 20 x 14 $\frac{1}{2}$  x 10in. Weight: 56lb. Price: (in transportable case) £637 (plus VAT): (with rack mounting) £597 (plus VAT).

■ **CHILTON**

Magnetic Tapes Ltd, Chilton Works, Garden Road, Richmond, Surrey. Tel: 01-876 7957.

**Mk 3 Version**

Three-speed,  $\frac{1}{4}$  or  $\frac{1}{2}$ -track recorder. Speeds: 19, 9 $\frac{1}{2}$ , 4 $\frac{3}{4}$ cm/sec  $\pm 1\%$ . W and F: 19cm/s 0.05%, 9 $\frac{1}{2}$ cm/s 0.1%, 4 $\frac{3}{4}$ cm/s 0.15% weighted. FR: 19cm/s 20Hz-22kHz  $\pm 3$ dB, 9 $\frac{1}{2}$ cm/s 30Hz-15kHz  $\pm 3$ dB, 4 $\frac{3}{4}$ cm/s 50Hz-8kHz  $\pm 3$ dB. Max tape distortion: 2% at 0dB (19 and 9 $\frac{1}{2}$ ), 5% at 0dB (4 $\frac{3}{4}$ ). S/N ratio: (19 and 9 $\frac{1}{2}$ ) - 52dB  $\frac{1}{4}$ track, unweighted; -55dB  $\frac{1}{2}$ -track, unweighted. Replay char: NAB. Rewind time within 150 sec 550m I.P tape. Mains: 205-245V AC 50Hz. Weight: 13.6kg. Size: 406 x 406 x 165mm. Price: 100s/CW (chassis in teak surround) £176; 100s/CAWs (as CW with power amplifier) £192.50; 100s/CAP (portable with in-built speakers) £203.50; Dual operation (vertical and horizontal) £17; Lid for CW/CAW (lockable teak and perspex) £8.80. All prices include VAT.

■ **BRENNELL ENGINEERING CO LTD**

231-235 Liverpool Road, London, N1 1LY. Tel: 01-607 8271.

**Mk 6 Stereo Unit**

Stereo tape deck with preamplifiers. Twin 2/2 or quarter 2/4 track system. Speeds: 15, 7 $\frac{1}{2}$ , 3 $\frac{3}{4}$ ,

★ Indicates entry is illustrated

1 $\frac{7}{8}$ i/s. Max spool: 8 $\frac{1}{2}$ in. (10 $\frac{1}{2}$ in NAB reel version available). W and F: 15i/s 0.05%, 7 $\frac{1}{2}$ i/s 0.08%, 3 $\frac{1}{2}$ i/s 0.1%, 1 $\frac{7}{8}$ i/s 0.12%. S/N: 56dB below 2% distortion levels of recording. FR: 15i/s 40Hz-22kHz $\pm$ 3dB, 7 $\frac{1}{2}$ i/s 40Hz-20kHz $\pm$ 3dB, 3 $\frac{1}{2}$ i/s 50Hz-14kHz $\pm$ 3dB, 1 $\frac{7}{8}$ i/s 60Hz-7kHz $\pm$ 3dB. Two illuminated edge-scale meters. Rewind time: less than 60 seconds for 1200ft. Inputs: mic 200 $\mu$ V 200-600 ohms, aux (1) 8mV 50K, aux (2) 8mV 50K. Output: two at 1.4V from tape recorded to 0dB meter level. Two output jack sockets on front panel, two phono sockets on rear. Horizontal or vertical operation. Three motors (all outer rotor). Three heads. Pause control (lockable). Four-digit tape indicator. Auto-stop. A/B switching. A/B balance. Mains: 115, 210, 240V AC 50Hz. Size: 17 $\frac{1}{2}$   $\times$  16 $\frac{3}{4}$   $\times$  8in. Weight: 33lb. Price: £185 (plus VAT). Industrial version with 10 $\frac{1}{2}$ in. NAB reels available. Prices: on application.

### Mk 6 Type M

Mains mono recorder.  $\frac{1}{2}$ -track (full-track version available). Speeds: 15, 7 $\frac{1}{2}$ , 3 $\frac{1}{2}$ , 1 $\frac{7}{8}$ i/s. Max spool: 8 $\frac{1}{2}$ in (10 $\frac{1}{2}$ in NAB version available). W and F: 1 $\frac{7}{8}$ i/s 0.12%, 3 $\frac{1}{2}$ i/s 0.1%, 7 $\frac{1}{2}$ i/s 0.08%, 15i/s 0.05%. H and N: 1 $\frac{7}{8}$ i/s 50dB, 3 $\frac{1}{2}$ i/s 54dB, 7 $\frac{1}{2}$ i/s 56dB, 15i/s 56dB. FR: 1 $\frac{7}{8}$ i/s 60Hz-8kHz, 3 $\frac{1}{2}$ i/s 50Hz-15kHz, 7 $\frac{1}{2}$ i/s 40Hz-20kHz, 15i/s 40Hz-22kHz, all  $\pm$ 3dB. Replay char: CCIR. Rewind time: under 60 sec for 1200ft. Illuminated edge-scale VU meter. Inputs: mic 0.1mV 200-250 ohms, aux 5mV 250K, PU mag 4mV 47K, PU ceramic 160mV 1.5 megohms. Outlets: external amplifier 200mV into 10K, external speaker 15W into 8 ohms or 8W into 15 ohms. Speaker: 7  $\times$  5in. Output: 15W RMS into 8 ohms, 8W into 15 ohms. Transistorised. Own deck. Horizontal or vertical operation. Three motors (Papst outer rotor). Pause control. Straight-through amplifier. Monitoring. Input mixing. Accepts pickups direct. A/B switching. Size: 16 $\frac{1}{2}$   $\times$  7  $\times$  18in. Weight: 35lb. Mains: 110, 210, 240V AC. Price: £150 (plus VAT).

### Multi-channel recorders

A new range of master recorders for sound recording studios and industrial and scientific applications. Series A, full-track on  $\frac{1}{4}$ in tape; Series B, half-track on  $\frac{1}{4}$ in tape; Series C, four-track on  $\frac{1}{2}$ in tape; Series D, four-track on 1in tape; Series E, eight-track on 1in tape; Series F, 16- and 24-track on 2in tape.

Each series comprises four basic self-contained units; (1) tape transport, (2) record/play amplifier (one per channel), (3) master oscillator unit, (4) power supply unit, (5) optional remote control unit for all deck functions. Suitable for 19in rack mounting. Consoles available. Full specifications and prices on request.

### ■ FERROGRAPH

The Ferrograph Company Ltd, Auriema House, 442 Bath Road, Cippenham, Slough, Bucks, SL1 6BB.  
Tel: Burnham (062 86) 62511. Telex: 847297.

#### Ferrograph 713

Semi-professional mains mono recorder.  $\frac{1}{2}$ -track. Speeds: 7 $\frac{1}{2}$ , 3 $\frac{1}{2}$ , 1 $\frac{7}{8}$ i/s. Max spool 8 $\frac{1}{2}$ in. W and F: 7 $\frac{1}{2}$ i/s 0.08%, 3 $\frac{1}{2}$ i/s 0.15%, 1 $\frac{7}{8}$ i/s 0.2%. H and N: 7 $\frac{1}{2}$ i/s better than 55dB. FR: 7 $\frac{1}{2}$ i/s 30Hz-17kHz $\pm$ 2dB, 3 $\frac{1}{2}$ i/s 40Hz-14kHz $\pm$ 3dB, 1 $\frac{7}{8}$ i/s 50Hz-7kHz $\pm$ 3dB. Replay char: DIN. VU meter. Rewind time less than one minute for 1200ft. Inputs: mic 300 $\mu$ V to 15mV at 250-2000 ohms, line 50mV to 10V at 2M. Outlets: 600 ohms, 300mV 10K, 8-16 ohms 10W. Output: 10W RMS. One 6  $\times$  4in speaker. Transistorised. Three motors (synchronous hysteresis capstan motor and shaded pole spool motors). Pause. Four-digit belt driven tape indicator. Straight-through amplifier. Monitoring. Input mixing. Vertical or horizontal operation. Single knob control. Fast wind continuously variable in either direction. Remote start/stop of tape, also time-switch operation. Removable head block. Straight line tape loading. Automatic stop. Reel retainers. Retractable carrying handle. A-B comparison switch. Separate bass and treble controls with cut or lift. Meter indicates signal level on record and playback. Meter switchable to indicate bias. Bias continuously adjustable. Supplied in two styles. Suffix P: portable wood case leathercloth covered; Suffix W: wooden case, natural wood finish. Mains: 200-250V 50Hz; (Suffix A) 117V 60Hz. Price: £182 (plus VAT).

#### Ferrograph 713H

Similar specifications to 713 except tape speeds 15, 7 $\frac{1}{2}$ , 3 $\frac{1}{2}$ i/s. FR at 15i/s: 30Hz-20kHz $\pm$ 2dB. Price: £192 (plus VAT).

#### 7502

$\frac{1}{2}$ -track stereo tape unit with preamps only. Speeds (cm/sec): 19, 9 $\frac{1}{2}$ , 4 $\frac{1}{2}$ . Max spool size: 10 $\frac{1}{2}$ in. W and F: 0.08% (19), 0.15% (9 $\frac{1}{2}$ ), 0.20% (4 $\frac{1}{2}$ ). S/N ratio: better than 60dB (CCIF weighted). FR: 30Hz-17kHz $\pm$ 2dB (19), 40Hz-14kHz $\pm$ 3dB (9 $\frac{1}{2}$ ), 40Hz-14kHz $\pm$ 3dB. Replay char: DIN. Rewind time: variable up to 1 $\frac{1}{2}$ min for 360m tape. Level indicator: VU. Inputs: mic 300 $\mu$ V-15mV 10K, line 50 $\mu$ V-10V/2M ohms. Outputs: line 2V/600 ohms, low level 300mV 10K, low level adjustable up to 300mV 10K. Motors: one synchronous and two constant torque. Three leads, PB multiplay, AB comparison, adjustable tape tensioning. Mains: 200-250V or 117V (suffix A). Size: 20 $\frac{1}{4}$   $\times$  17 $\frac{1}{2}$   $\times$  10in. Weight: 55lb. Price: £269.50 (including VAT).

**7502D**

Same specification as 7502 but includes Dolby 'B'. Price: £322-30 (including VAT).

**7522**

Same specification as 7502 but with power amps. Speaker output up to 10W per channel into 8-16 ohms. Speaker size: 7 × 4in. Price: £299-20 (including VAT).

**7522D**

Same specification as 7502 but includes Dolby 'B' and power amps. Speaker output up to 10W per channel into 8-16 ohms. Speaker size: 7 × 4in. Price: £352 (including VAT).

**7504**

¼-track stereo tape unit with preamps only. Specification same as 7502. Price: £269-50 (including VAT).

**7504D**

¼-track stereo tape unit with preamps only. Specification same as 7502 but with Dolby 'B'. Price: £322-30 (including VAT).

**7524**

¼-track stereo tape unit with power amps. Same specification as 7502. Output up to 10W per channel into 8-12 ohms. Speaker size: 7 × 4in. Price: £299-20 (including VAT).

**7524D**

¼-track stereo tape unit with Dolby 'B' and power amps. Same specification as 7502. Speaker output up to 10W per channel into 8-16 ohms. Speaker size: 7 × 4in. Price: £352 (including VAT).

**7502H**

½-track, high speed stereo tape unit, with pre-amp only. Speeds (cm/sec): 38, 19, 9½. Max spool size: 10½in. W and F: 0-08% (38), 0-10% (19), 0-15% (9½). S/N ratio: better than 60dB (CCIF weighted). FR: 30Hz-20kHz ± 2dB (38), 30Hz-17kHz ± 2dB (19), 40Hz-14kHz ± 3dB (9½). Replay char: DIN. Rewind time: Variable up to 1¼ min for 360m tape. Level indicator: VU. Inputs: mic 300µV-15mV 10K, line 50µV-10V/2M ohms. Outputs: line 2V/600 ohms, low level 300mV 10K, low level adjustable up to 300mV 10K. Motors: one synchronous and two constant torque. Mains: 200-250V AC or 117 (suffix A). Three leads, PB multiplay, AB comparison, adjustable tape tensioning. Size: 20¼ × 17½ × 10in. Weight: 55lb. Price: £269-50 (including VAT).

**7502DH**

Same specification as 7502H, but includes Dolby 'B'. Price: £322-30 (including VAT).

**7522H**

Same specifications as 7502H but with power amps. Speaker output up to 10W per channel

into 8-16 ohms. Speaker size: 7 × 4in. Price: £299-20 (including VAT).

**7522DH**

Same specifications as 7502H but with power amps and Dolby 'B'. Speaker output up to 10W per channel into 8-16 ohms. Speaker size: 7 × 4in. Price £352 (including VAT).

**7504H**

¼-track, high speed stereo tape unit with pre-amps only. Same specifications as 7502H. Price: £269-50 (including VAT).

**7504DH**

¼-track, high speed stereo tape unit with Dolby 'B' and preamps. Same specifications as 7502H. Price: £322-30 (including VAT).

**7524H**

¼-track, high speed stereo tape unit with power amps. Same specification as 7502H. Speaker output up to 10W per channel into 8-16 ohms. Speaker size: 7 × 4in. Price: £299-20.

**7524DH**

¼-track, high speed stereo tape unit with Dolby 'B' and power amps. Same specification as 7502H. Speaker output up to 10W per channel into 8-16 ohms. Speaker size: 7 × 4in. Price: £352 (including VAT).

■ **GRUNDIG**

Grundig (Great Britain) Ltd, Newlands Park, Sydenham, London, SE26 5NQ. Tel: 01-659 2468. Telex: 22854.

**TK745**

¼-track stereo tape recorder. Speeds (cm/sec): 19, 9½, 4½. Max spool size: 7in. W and F: 0-07% (19, 0-12% (9½), 0-2% (4½). S/N ratio: > 54dB (19), > 52dB (9½), > 750dB (4½). FR: 40Hz-18kHz (19), 40Hz-15kHz (9½), 40Hz-8kHz (4½). Level indication: VU. Inputs: mic 1mV 100K, radio diode 3mV 30K, phono 100mV/1M ohms. Outputs: line 800mV 20K, speakers 7W/4 ohms, phones 2V/100 ohms. Facilities for synchronous, multiplay and echo recordings. Automatic or manual recording level control. Mains: 110-240V. Size: 17 × 14 × 16½in. Weight: 27½lb. Price: £154-40 (including VAT).

■ **HANIMEX**

Hanimex (UK) Ltd, Hanimex House, Dorcan, Swindon, Wilts, SN3 5HW. Tel: Swindon (0793) 26211.

New range of tape recorders to be introduced under the Hanimex brand name. No details of models available as this edition of the Year Book closed for press.

■ **HITACHI**

Hitachi Sales (UK) Ltd, New Century House, Coronation Road, Park Royal, London, NW10 7QN. Tel: 01-965 9861.

★ Indicates entry is illustrated



Leavers-Rich E200

#### TRQ730D

Open reel stereo tape deck. Max spool: 7in. Speeds:  $7\frac{1}{2}$ ,  $3\frac{3}{4}$ ,  $1\frac{7}{8}$ i/s. FR:  $7\frac{1}{2}$ i/s 20Hz-23kHz. S/N ratio: better than 52dB. W and F: <0.12%. Dual VU meter. Inputs: mic 300 $\mu$ V 10K, line 40mV 100K. Outputs: line 775mV 10K, headphones 8 ohms. Separate record and playback heads. Monitoring. Easy load facility. Auto shut-off. Four-digit tape indicator with PB reset. Slider volume controls. Size:  $16\frac{1}{4} \times 7\frac{1}{2} \times 13\frac{1}{2}$ in. Weight: 24 $\frac{1}{4}$ lb. Price: £87.05 (including VAT).

#### JVC

JVC (UK) Ltd, 453 Caledonian Road, London, N7 9BA. Tel: 01-607 6568.

New range of open reel and cassette tape recorders available but no product information obtainable as this edition of the Year Book closed for press.

Full specifications and prices on request.

#### LEEVEES-RICH

Leavers-Rich Equipment Ltd, 319 Trinity Road, Wandsworth, London, SW18 3SL. Tel: 01-874 9054. Cables: Leemag, London, SW18. Telex: 923455.

#### Model E200 ★

Speeds:  $7\frac{1}{2}$ , 15i/s,  $3\frac{3}{4}$ ,  $7\frac{1}{2}$ i/s or 15/30i/s to special order. Max spool 11 $\frac{1}{4}$ in. Three motors. Full-track, twin-track or stereo. FR: 40Hz-18kHz. Noise: full track -62dB, twin track -58dB.



Nagra Model 4.2

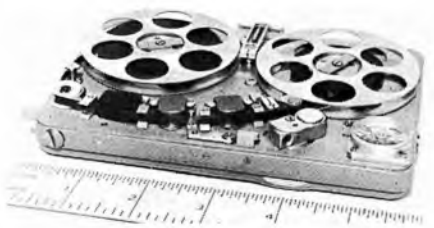

Nagra Miniature SN

W and F: better than 0.1% at all speeds. VU level meter. PPM to special order. Fully transistorised amplifiers. Modular construction throughout. Price: from £1,080 (plus VAT).

#### NAGRA

Distributed by: Hayden Laboratories Ltd, Hayden House, 17 Chesham Road, Amersham, Bucks, HP6 5AG.

Tel: Amersham (0240 3) 5511.

Audio equipment showroom, service department and despatch department: 6 Bendall Mews, London, NW1.

#### Model 4.2 ★

Professional battery-operated portable tape recorder. Speeds: 15i/s,  $7\frac{1}{2}$ i/s,  $3\frac{3}{4}$ i/s. Size:  $12\frac{1}{2} \times 8\frac{3}{4} \times 4\frac{1}{2}$ in. Weight: (excluding batteries) 11 $\frac{1}{2}$ lb. Max spool: (lid closed) 5in, (lid open) 7in. Power supply: 12 type SP2 batteries fitted internally, or external mains unit. Switchable auto-level control. Switchable input filters. Two-stage overload filter. Modular construction. Preamplifiers to suit all types of microphones. Built-in monitoring speaker. Single DC servo-controlled motor. Monitoring headphones switchable to tape or direct. Reference tone generator. Separate record and playback amplifiers. Electro-magnetic indication of speed stability, battery level and tape jamming. W and F: 15i/s 0.05%,  $7\frac{1}{2}$ i/s 0.07%,  $3\frac{3}{4}$ i/s 0.15%. Overall speed stability: better than 0.05%. Temperature range -55degC to +77degC. FR: 15i/s 30Hz-20kHz  $\pm$ 2dB,  $7\frac{1}{2}$ i/s 30Hz-15kHz  $\pm$ 2dB,  $3\frac{3}{4}$ i/s 30Hz-10kHz  $\pm$ 2dB. Rewind time: 600ft/min. Details and prices of various models as follows.

**Model 4.2L.**

Full-track mono version with piloton. Inputs from two mics and line. Line output: 4.4V 600 ohms. S/N ratio: -67 to -70dB depending on speed and tape. Visual piloton indicator. Piloton input level 0.5-25V. Price: £1,005 (plus VAT).

**Model 4.2LSP**

As Model 4.2L but excluding piloton facility. Price: £936 (plus VAT).

**Model IV-SL**

$\frac{1}{2}$ -track model with piloton. Preamplifiers switchable to suit all types of microphone. Output: 1V 600 ohms. Special Nagramaster recording position. Coaxial PPM with two needles to indicate record level and groove cutting depth. S/N ratio: -65dB to -72dB depending on speed and tape. Frequency modulated piloton channel to permit piloton and cue speech recording. Piloton level 2V. Price: £1,192 (plus VAT).

**Model IV-S**

As Model IV-SL but excluding piloton facility. Price: £1,053 (plus VAT).

Special models for industrial sound level recording available.

**Miniature Nagra SN ★**

Full-track battery-operated professional stereo recorder. Speeds: (model SNN-2)  $3\frac{3}{8}$ ,  $1\frac{7}{8}$ i/s; (model SNS-2)  $1\frac{7}{8}$ ,  $\frac{1}{2}$ i/s. Spool capacity: 154m standard tape, 308m 12.5 micron tape. W and F:  $3\frac{3}{8}$ i/s  $\pm 0.1\%$ ,  $1\frac{7}{8}$ i/s  $\pm 0.15\%$  (both to DIN 45 507). S/N ratio:  $3\frac{3}{8}$ i/s 60dB (ASA 'A' with tape);  $1\frac{7}{8}$ i/s 55dB (ASA 'A' with tape). FR: 80Hz-15kHz  $\pm 2$ dB. Replay char: CC1R. Rewind time: (hand winding) 60 sec. Meter level indicator. Inputs: microphone, current input from 200 ohms or greater (3 $\mu$ A RMS, max level 100 $\mu$ A RMS). Alternative line input for normal modulation level from 100 ohms source -160 mV RMS. Outlets: line 600mV across 1K, headphones. One DC series commutator motor. Own deck. Compression indicator and battery check meter. Remote control start/stop. Piloton version available. Size:  $5\frac{3}{8} \times 4 \times 1\frac{1}{8}$ in approximately. Weight: 1.3lb (including batteries and tape). Supply: two manganese cells (Mallory Mn1500 or equivalent). Price: £557 (plus VAT).

**■ PHILIPS**

Philips Electrical Ltd, Century House, Shaftesbury Avenue, London, WC2H 8AS. Tel: 01-437 7777.

**N4308**

Mains operated  $\frac{1}{4}$ -track mono recorder. Speeds:  $3\frac{3}{8}$ ,  $1\frac{7}{8}$ i/s. Max spool: 7in. W and F: <0.25%. H and N: >-45dB. FR:  $3\frac{3}{8}$ i/s 60Hz-14kHz.  $1\frac{7}{8}$ i/s 80Hz-8kHz. Replay char: CC1R. Rewind



Philips N4414



Philips N4416

time: <3 minutes for 1200ft. Meter level indicator. Inputs: mic 0.25mV 2K, radio 2mV 20K, PU 100mV 1M. Outlets: diode 1V 20K, headphones 0.1-5V 1K, speaker 4W 8 ohms. Output: 4W RMS. Speaker: 6 x 4in. Transistors. Own deck. One motor. Pause. Straight-through amplifier. Monitoring. Input mixing. Parallel track replay. Size:  $16\frac{1}{2} \times 11\frac{3}{8} \times 5\frac{3}{8}$ in. Weight: 17 $\frac{3}{8}$ lb. Mains: 200-250V 50Hz. Price: £61.50 (including VAT).

**N4414 ★**

Mains operated stereo  $\frac{1}{4}$ -track recorder. Speeds:  $3\frac{3}{8}$ ,  $7\frac{1}{2}$ i/s. Max spool: 7in. W and F:  $7\frac{1}{2}$ i/s  $\leq 0.15\%$ ,  $3\frac{3}{8}$ i/s  $\leq 0.2\%$  (DIN 45 500). FR: (overall)  $7\frac{1}{2}$ i/s 40Hz-18kHz.  $3\frac{3}{8}$ i/s 40Hz-15kHz. H and N:  $7\frac{1}{2}$ i/s 48dB,  $3\frac{3}{8}$ i/s 15dB. Replay char: DIN 45 500. Rewind time: 180 sec for 1800ft. Meter recording level indicator. Four-digit tape position indicator with PB reset. Inputs: mic 0.2mV 2K, PU 100mV 1M, radio/line 2mV 20K. Outlets: line 1V 50K, speaker 8 ohms. Output: 3W RMS per channel. Speakers: 6 x 4in. Three DC motors. Own deck. Size:  $19\frac{1}{2} \times 13 \times 7\frac{1}{8}$ in. Pause control. Straight-through amplifier. Monitoring on record. Parallel track replay. Solenoid controlled operation. Price: £125 (including VAT).

**N4416 ★**

Mains operated stereo  $\frac{1}{4}$ -track recorder. Speeds:  $7\frac{1}{2}$ ,  $3\frac{3}{8}$ ,  $1\frac{7}{8}$ i/s. Max spool: 7in. W and F:  $7\frac{1}{2}$ i/s  $\leq 0.15\%$ ,  $3\frac{3}{8}$ i/s  $\leq 0.2\%$ ,  $1\frac{7}{8}$ i/s  $\leq 0.35\%$  (all to

★ Indicates entry is illustrated

DIN 45 500). H and N:  $7\frac{1}{2}$ i/s -45dB,  $3\frac{3}{4}$ i/s -45dB,  $1\frac{7}{8}$ i/s -45dB. FR:  $7\frac{1}{2}$ i/s 40Hz-18kHz  $\pm$  3dB,  $3\frac{3}{4}$ i/s 40Hz-15kHz  $\pm$  3dB,  $1\frac{7}{8}$ i/s 60Hz-8kHz  $\pm$  3dB. Replay char: DIN. Rewind time: 180 sec for 1800ft. Meter level indicator. Four-digit tape position indicator with PB reset. Inputs: mic 0.2mV 2K, PU 100mV 1M, line 2mV 20K. Outlets: line 1V 50K, headphones 3V 400-600 ohms, speakers 4-8 ohms. Output: 5W RMS per channel. Speakers: 6  $\times$  4in (2). Three DC motors. Own deck. Size:  $20\frac{1}{4}$   $\times$  15  $\times$   $7\frac{3}{4}$ in. Weight: 22lb. Pause control. Straight-through amplifier. Monitoring. Input mixing. Parallel track replay. Solenoid controlled operation. Price: £151.50 (including VAT).

#### N4418

Mains operated stereo  $\frac{1}{4}$ -track recorder. Speeds:  $1\frac{7}{8}$ ,  $3\frac{3}{4}$ ,  $7\frac{1}{2}$ i/s. Max spool: 7in. W and F: < 0.15%. H and N: > 45dB. FR:  $7\frac{1}{2}$ i/s 40Hz-20kHz,  $3\frac{3}{4}$ i/s 40Hz-15kHz,  $1\frac{7}{8}$ i/s 60Hz-8kHz. Replay char: CCIR. Rewind time: < 180 sec for 1800ft. Two meter level indicators. Inputs: mic 0.15mV 2K, mag PU 1.5mV 47K, aux 2mV 20K, aux 100mV 1M, diode 2mV 20K, diode 100mV 1M, radio 100mV 1M. Outlets: diode 1V 50K, monitor 1V 50K, headphones 3V 400-600 ohms. Output: 10W RMS per channel. Output impedance: (speakers) 4-8 ohms. Speakers: (built-in monitor type) 6  $\times$  4in. Three motors. Three heads. A-B monitoring. Slider controls. Track transfer. Illuminated tip-touch buttons for tape transport. Size:  $20\frac{1}{4}$   $\times$  15  $\times$   $7\frac{3}{4}$ in. Weight: 26 $\frac{1}{2}$ lb. Mains: 110, 127, 220, 240V AC. Price: £208.50 (including VAT).

#### N4450

Mains operated stereo  $\frac{1}{4}$ -track recorder with automatic reverse facility. Speeds:  $1\frac{7}{8}$ ,  $3\frac{3}{4}$ ,  $7\frac{1}{2}$ i/s. Max spool:  $10\frac{1}{2}$ in. W and F: 0.15%. H and N: > 48dB. FR:  $7\frac{1}{2}$ i/s 40Hz-20kHz,  $3\frac{3}{4}$ i/s 40Hz-15kHz,  $1\frac{7}{8}$ i/s 60Hz-10kHz. Replay char: CCIR. Rewind time: < 150 sec for 1800ft. Inputs: mic 0.1mV 2K, PU 1.5mV 47K, aux 2mV 20K, aux 100mV 1M, diode 2mV 20K, diode 100mV 1M, radio 100mV 100K. Outlets: diode 1V 50K, monitor 1V 50K, headphones 3V 400-600 ohms. Output: 20W per channel. Output impedance: 4-8 ohms. Six heads. Three motors. A-B monitoring. Echo. Track transfer. 24-hour timer. Illuminated tip-touch buttons for tape transport. Two VU meters. Winding speed control. Cueing. Size:  $21\frac{1}{2}$   $\times$  20  $\times$   $9\frac{1}{4}$ in. Weight: 44lb. Mains: 110, 127, 220, 240V AC. Price: £308 (including VAT).

#### N4510

Mains operated stereo  $\frac{1}{4}$ -track tape deck. Speeds:  $7\frac{1}{2}$ ,  $3\frac{3}{4}$ ,  $1\frac{7}{8}$ i/s. Max spool: 7in. W and F: (DIN 45 500)  $7\frac{1}{2}$ i/s 0.15%,  $3\frac{3}{4}$ i/s 0.2%,  $1\frac{7}{8}$ i/s 0.35%. Noise:  $7\frac{1}{2}$ i/s -50dB,  $3\frac{3}{4}$ i/s -50dB,  $1\frac{7}{8}$ i/s -48dB. Hum:  $7\frac{1}{2}$ i/s (all speeds) -45dB. FR:  $7\frac{1}{2}$ i/s 40Hz-20kHz  $\pm$  3dB,  $3\frac{3}{4}$ i/s 40Hz-15kHz



Revox Series 77

$\pm$  3dB,  $1\frac{7}{8}$ i/s 60Hz-8kHz  $\pm$  3dB. Replay char: DIN. Rewind time: 180 seconds for 1800ft. Two level meters. Four-digit tape position indicator with PB reset. Inputs: mic 0.15mV 2K, radio 100mV 100K, line 2mV 20K, PU 1.5mV 47K. Outlets: line 1V 50K, headphones 3V 400-600 ohms, monitor 1V 50K. Three DC motors. Own deck. Size:  $20\frac{1}{4}$   $\times$  15  $\times$   $7\frac{3}{4}$ in. Weight: 24lb. Pause control. Monitoring on record. Input mixing. Parallel track replay. Solenoid controlled operation. Full remote control operation using Philips unit N6719. Price: £193 (including VAT).

#### ■ PIONEER

Shriro (UK) Ltd. Shriro House, The Ridgeway, Iver, Bucks, SL0 9JL. Tel: Cedarwood (075 38) 2222.

#### RT1020L

Two-speed,  $\frac{1}{4}$ -track stereo tape deck. Speeds (cm/sec): 19 and  $9\frac{1}{2}$ . Max spool size:  $10\frac{1}{2}$ in. W and F: 0.08% (19), 0.1% ( $9\frac{1}{2}$ ). FR: 40Hz-20kHz  $\pm$  3dB (19), 40Hz-12kHz  $\pm$  3dB ( $9\frac{1}{2}$ ). Motors: One 4/8-pole two speed synchronous and two 6-pole inner rotor special induction. Rewind time: 110 secs for 740m ( $10\frac{1}{2}$ in reel). Solenoid controlled operation, 3 position bias and 2 position equalisation. Independent line and microphone level controls. 2 or 4 channel playback stereo record. Hyperbolic heads, monitoring facility and 4 track monophonic recording. Record mode shown by LED's. Price: on application.

#### ■ PLANET PROJECTS LTD

Goodman Works, Belvue Road, Northolt, Middlesex. Tel: 01-845 1775.

#### C.D.2

Tape deck. Speed:  $3\frac{3}{4}$ i/s ( $1\frac{7}{8}$ i/s to special order). W and F: less than 0.2% at both speeds. Mini-

flux heads,  $\frac{1}{2}$ -track mono or  $\frac{1}{4}$ -track stereo. Two heads, one for each track. FR: dependent on speed and heads. Papst hysteresis motor. Spool size 7in. Automatic track change and reversal of tape direction at end of spool, no fast rewind required. Uses standard  $\frac{1}{4}$ in tape. Single knob control. Provides over 8 $\frac{1}{2}$  hours uninterrupted playing at 1 $\frac{7}{8}$ i/s. Mains: 220-230V 50Hz. Size: 14 $\frac{3}{4}$  × 11 $\frac{3}{4}$  × 6in. Weight approximately: 10lb. Price: on application.

### ■ REPS

Reps (Tape Recorders) Ltd, 11-13 Regina Road, Southall, Middlesex. Tel: 01-574 3645.

HW10 tape recorder no longer in production but spares and service available for all Reps machines from above address.

### ■ REVOX

Distributors: C. E. Hammond & Co Ltd, Lamb House, Church Street, London, W4 2PB. Tel: 01-995 4551. Telex: 9334047.

#### Series 77 ★

Stereo tape recorder. All figures quoted are minimum performance values as measured with Revox 601 tape normally exceeded by all units. Tape speed: 3 $\frac{3}{4}$ i/s and 7 $\frac{1}{2}$ i/s max, deviation from nominal  $\pm 0.2\%$ . W and F: total RMS, weighted 0.04% at 7 $\frac{1}{2}$ i/s and 0.05% at 3 $\frac{3}{4}$ i/s. Weighted peak to peak flutter as per DIN 0.08% at 7 $\frac{1}{2}$ i/s and 0.1% at 3 $\frac{3}{4}$ i/s. Tape slip: not exceeding 0.2%. Max spool size: up to 10 $\frac{1}{2}$ in (minimum hub diameter 2 $\frac{3}{8}$ in). Operating position: horizontal, vertical or inclined. Semiconductor complement: 54 transistors, 32 diodes, 4 silicon rectifiers, 1 CdS-cell. FR (via tape): at 7 $\frac{1}{2}$ i/s 30Hz-20kHz + 2 (-3dB), 50Hz-15kHz  $\pm 1.5$ dB; at 3 $\frac{3}{4}$ i/s 30Hz-16kHz + 2 (-3dB), 50Hz-10kHz  $\pm 1.5$ dB. Equalisation: record NAB, playback NAB and IEC (switchable). Distortion: measured via tape at 1kHz peak level and at OVU respectively; 7 $\frac{1}{2}$ i/s less than 2% or 0.6% respectively; 3 $\frac{3}{4}$ i/s less than 3% or 1% respectively. S/N ratio: weighted as per ASA-A, readings via tape; 7 $\frac{1}{2}$ i/s better than 66dB (4-track 62dB). 3 $\frac{3}{4}$ i/s better than 63dB (4-track 59dB). Cross-talk (at 1kHz): mono better than 60dB, stereo better than 45dB. Inputs (per channel): mic, low impedance 50-600 ohms, 0.15mV, high impedance up to 100K, 2.5mV; radio 2.5mV; aux 35mV. All inputs have an overload margin of 40dB (1:100). Outputs (per channel): amplifier max 2.5V; internal impedance 600 ohms; radio max 1.2V; internal impedance 2.5K; headphones, volume adjustable, load impedance 200 ohms or more. Power amplifier: optional plug-in amplifiers, 2 × 8W continuous RMS power, 2 × 10W music power as per IHFM. Power requirements: voltage selector for 110-250V, 50-60Hz operation without need for conversion,

consumption 70-100W. Various versions as follows:

#### Model 1302 or 1304

Chassis in metal encasement for rack mounting, no output amplifier,  $\frac{1}{4}$ - or  $\frac{1}{2}$ -track. Price: £324.50 (including VAT).

#### Model DL 1332 or DL 1334

As 1302 and 1304 but with Dolby B noise reduction system. Price: £427.90 (including VAT).

#### Model 1322 or 1324

As 1302/4, but with 10W output amplifiers,  $\frac{1}{2}$ - or  $\frac{1}{4}$ -track. Price: £361.90 (including VAT).

#### Model 1102 or 1104

Chassis in teak surround, no output amplifiers,  $\frac{1}{2}$ - or  $\frac{1}{4}$ -track. Price: £324.50 (including VAT).

#### A700

Stereo tape recorder. All figures quoted are minimum performance values as measured with Revox 601 (type Low Noise/High Output), normally exceeded by all units. Tape speed: 15i/s, 7 $\frac{1}{2}$ i/s and 3 $\frac{3}{4}$ i/s. Weighted peak flutter: at 15i/s less than  $\pm 0.06\%$ , at 7 $\frac{1}{2}$ i/s less than  $\pm 0.08\%$ , at 3 $\frac{3}{4}$ i/s less than  $\pm 0.1\%$ . Timer: read-out in minutes and seconds (4 digits), reel-time indication for 7 $\frac{1}{2}$ i/s tape speed. Accuracy 0.5%. Tape-reel dimension: up to 10 $\frac{1}{2}$ in outside diameter with automatic tension change down to a minimum hub diameter of 1 $\frac{1}{2}$ in. Tape tension: electronically regulated during all operating modes, including stop sequence. FR (via tape): 15i/s 50Hz-18kHz  $\pm 1.5$ dB; 7 $\frac{1}{2}$ i/s 50Hz-15kHz  $\pm 1.5$ dB; 3 $\frac{3}{4}$ i/s 50Hz-10kHz  $\pm 1.5$ dB. Equalisation: NAB. Peak recording level: 514nWb/m (corresponds to +6 VU). Level indication: VU meter. Overload indication (trigger level): +6 VU (514nWb/m). Response time: approximately 10m/sec. Storage time: approximately 0.2sec. S/N: (ASA-A) referred to peak recording level (+6 VU), 15i/s better than 65dB, 7 $\frac{1}{2}$ i/s better than 66dB, 3 $\frac{3}{4}$ i/s better than 63dB. Inputs: mic stereo, balanced 50-6000 ohms; position Low: 0.15mV 6K; position High: 1.8mV 6K. Phono 2.5mV 50K; radio 3mV 33K, 2 × 40mV 100K. All inputs have an overload margin of 40dB (1:100). Outputs: output-level from a peak-level recording at +6 VU. Line A and B 1.55V 5K. 1 × radio (DIN): 0.775V, 10K; 2 × headphone: max 4.9V 100 ohms; 1 × power amplifier: max 3.1V 100 ohms, including remote mains switching for A722/A724. Power requirements: voltage selector for 110-220V 50-60Hz. Price: (code 1372 2-track, code 1374 4-track) £647.90 (including VAT).

#### Model DL1132 or DL1134

As 1102 and 1104 but with Dolby B noise reduction system. Price: £427.90 (including VAT).



★ Indicates entry is illustrated

**Model 1122 or 1124**

Chassis in teak surround with output amplifiers,  $\frac{1}{2}$  or  $\frac{1}{4}$ -track. Price: £361-90 (including VAT).

**Model 1222 or 1224**

Complete recorder in suitcase with amplifiers and four speakers,  $\frac{1}{2}$  or  $\frac{1}{4}$ -track. Price: £379-50 (including VAT). All available in High Speed series ( $7\frac{1}{2}$ /15i/s).

**Model 1302 or 1304**

Chassis in metal encasement for rack mounting, no output amplifiers.  $\frac{1}{4}$  or  $\frac{1}{2}$ -track. Price: £324-50 (including VAT).

**Model DL1332 or DL1334**

As 1302 and 1304 but with Dolby B noise reduction system. Price: £427-90 (including VAT).

**Model 1322 or 1324**

As 1302/4, but with 10W output amplifiers,  $\frac{1}{2}$  or  $\frac{1}{4}$ -track. Price: £361-90 (including VAT).

**Model 1102 or 1104**

Chassis in teak surround, no output amplifiers.  $\frac{1}{2}$  or  $\frac{1}{4}$ -track. Price: £324-50 (including VAT).

**Model DL1132 or DL1134**

As 1102 and 1104 but with Dolby B noise reduction system. Price: £427-90 (including VAT).

**Model 1122 or 1124**

Chassis in teak surround with output amplifiers.  $\frac{1}{2}$  or  $\frac{1}{4}$ -track. Price: £361-90 (including VAT).

**Model 1222 or 1224**

Complete recorder in suitcase with amplifiers and four speakers.  $\frac{1}{2}$  or  $\frac{1}{4}$ -track. Price: £379-50 (including VAT).



Saba 544G



Sansui SD3030



Sansui SD5050S

■ RICHARDSON ELECTRONICS LTD

57 Jamestown Road, London, NW1 7EJ.

Tel: 01-267 0723/4874.

**Modular tape amplifiers**

System of pluggable tape record/playback modules. Each module is 7in high and designed to fit into 19in rack. Silicon transistors. Remote electronic switching for four separate equalisations. Modules include: record preamplifier, playback preamplifier, PPM, oscillator, self-sync switching unit, power supply. Full specifications on request. Prices: on application.

**Mixer units**

Full range of plug-in mixer modules available separately or in banks of units. Full specifications and prices on request.

■ SABA

Saba Television Ltd,

6-12 Cornbrook Park Road,

Manchester, M15 4EE. Tel: 061-872 7661.

**544G ★**

Two-speed four-track stereo tape recorder. Speeds:  $3\frac{3}{4}$  and  $7\frac{1}{2}$ i/s. Output: 10W music

power per channel. Automatic or manual level control. Four internal speakers. Multiplay. 31 transistors. 11 diodes. Inputs: mic (2), radio, stereo PU, aux. Outputs: aux, speakers or headphones. FR:  $7\frac{1}{2}$ i/s 40Hz-18kHz. Size:  $19\frac{1}{2} \times 6\frac{1}{2} \times 13$ in. Finish: light walnut with tinted plastic cover. Horizontal or vertical operation. Four-digit tape position indicator with PB reset. Slider controls. Twin level meters. Price: £99.95 (including VAT).

## ■ SANSUI

Vernitron Ltd, Thornhill, Southampton,  
SO9 5QF. Tel: Southampton (0703) 444811.

### SD3030 ★

Stereo and four-channel  $\frac{1}{4}$ -track tape deck. Speeds:  $3\frac{3}{4}$ ,  $7\frac{1}{2}$ i/s. Max spool: 7in. W and F:  $7\frac{1}{2}$ i/s 0.09%,  $3\frac{3}{4}$ i/s 0.14%. H and N: better than 60dB. FR:  $7\frac{1}{2}$ i/s 20Hz-20kHz  $\pm 3$ dB,  $3\frac{3}{4}$ i/s 30 Hz-10kHz  $\pm 3$ dB. Rewind time: 90 sec for 1200ft. Four VU meters. Inputs: mic 0.5mV 50K, line 70mV 100K, DIN 14mV 100K. Outlets: two-channel 470mV, DIN/two-channel 470mV, four-channel 470mV, headphones (front and rear) 8 ohms. 26 transistors, 14 diodes. Size:  $16\frac{5}{8} \times 19\frac{3}{8} \times 9\frac{3}{4}$ in. Weight: 47 $\frac{1}{2}$ lb. Superimpose. Pause. Monitoring. Input mixing. Auto reverse. Auto shut-off. Mains: 100, 110, 117, 200, 220, 240V 50-60Hz. Price: to be announced.

### SD5000

Stereo reel-to-reel tape deck. Speeds:  $3\frac{3}{4}$ ,  $7\frac{1}{2}$ i/s. Max spool: 7in. Forward-play head and reverse-play head. Tape speed accuracy: within 0.5%. Two eight-pole motors, one six-pole motor. Capstan drive: belt. W and F:  $3\frac{3}{4}$ i/s < 0.12%,  $7\frac{1}{2}$ i/s < 0.08%. Rewind time: 120 sec for 1800ft. FR:  $3\frac{3}{4}$ i/s 15Hz-15kHz  $\pm 3$ dB,  $7\frac{1}{2}$ i/s 15Hz-25 kHz  $\pm 3$ dB. S/N ratio: better than 60dB. Distortion: (amplifier) < 0.15%, (tape) < 1.2%. Inputs: mic 0.5mV 50K, line 70mV 100K, DIN 14mV 100K. Two VU meters. Size:  $16\frac{1}{2} \times 10 \times 19\frac{1}{8}$ in. Finish: walnut cabinet. Two year guarantee. Price: £281.11 (plus VAT).

### SD5050S ★

Stereo and four-channel  $\frac{1}{4}$ -track tape deck. Speeds:  $7\frac{1}{2}$ ,  $3\frac{3}{4}$ i/s. Max spool: 7in. W and F:  $7\frac{1}{2}$ i/s 0.07%,  $3\frac{3}{4}$ i/s 0.12%. H and N: better than 60dB. FR:  $7\frac{1}{2}$ i/s 20Hz-20kHz  $\pm 3$ dB,  $3\frac{3}{4}$ i/s 30 Hz-12kHz  $\pm 3$ dB. Rewind time: 90 sec for 1200ft. Four VU meters. Inputs: mic 0.5mV 50K, line 70mV 100K, DIN 14mV 100K. Outlets: two-channel 470mV, DIN/two channel 470mV, four-channel 470mV. 34 transistors, 21 diodes. Size:  $16\frac{5}{8} \times 20\frac{3}{8} \times 9\frac{3}{8}$ in. Weight: 46 $\frac{1}{4}$ lb. Superimpose. Pause. Monitoring. Input mixing. Auto reverse. Remote control. Mains: 100, 110, 117, 200, 220, 240V 50-60Hz. Price: to be announced.

### QD5500S

Stereo and four-channel  $\frac{1}{4}$ -track tape deck. Speeds:  $7\frac{1}{2}$ ,  $3\frac{3}{4}$ i/s. Max spool: 7in. W and F:  $7\frac{1}{2}$ i/s 0.07%,  $3\frac{3}{4}$ i/s 0.12%. H and N: better than 60dB. FR:  $7\frac{1}{2}$ i/s 20Hz-20kHz  $\pm 3$ dB,  $3\frac{3}{4}$ i/s 15 Hz-15kHz  $\pm 3$ dB. Rewind time: 90 sec for 1200 ft. Four VU meters. Inputs: mic 0.5mV 50K, line 70mV 100K, DIN 14mV 100K. Outlets: two-channel 470mV, DIN/two-channel 470mV, four-channel 470mV, headphones (front and rear) 8 ohms. 38 transistors, 19 diodes. Size:  $15\frac{5}{8} \times 21\frac{7}{8} \times 10\frac{3}{8}$ in. Weight: 53 $\frac{1}{2}$ lb. Superimpose. Pause. Monitoring. Input mixing. Auto reverse. Facilities for remote control. Auto shut-off. Mains: 100, 110, 117, 200, 220, 240V 50-60Hz. Price: to be announced.

## ■ SCOPETRONICS

Crown Works, Church Road, Kingston-upon-Thames, Surrey. Tel: 01-546 1275 and 4135.

### 1150

Stereo tape deck. Speeds:  $7\frac{1}{2}$ , 15i/s. Max spool capacity: 11 $\frac{1}{2}$ in. W and F: 0.08% (both speeds). H and N: -57dB. FR:  $7\frac{1}{2}$ i/s 40Hz-15kHz  $\pm \frac{1}{2}$ dB; 15i/s 40Hz-15kHz  $\pm \frac{1}{2}$ dB. Replay char: NARTB, CCIR. Level indicator: meter. Rewind time: 2400ft in < 1 min 45 sec. Inputs: line in, 2V 100K. Line out, 1mV 600 ohms. Valves. Motors: 3 Papst Ext. Rotor. Tape deck: own. Superimpose, pause and inching facilities. Straight-through amplifier. Variable spooling. Removable plug-in head block. Mains: 250V 50Hz. Price: (mono) from approximately £400 (plus VAT); (stereo) from approximately £600 (plus VAT); (console versions) approximately £100 (plus VAT) extra.

### 1151

Stereo tape recorder. Speeds:  $7\frac{1}{2}$ , 15i/s. Max spool capacity: 11 $\frac{1}{2}$ in. W and F: < 0.08% both speeds. H and N: -57dB. FR: 40Hz-15kHz  $\pm \frac{1}{2}$ dB (either speed). Replay char: CCIR. Level indicator: meter. Rewind time: 2400ft in 1 min 45 sec. Inputs: microphone, -75dB 600 ohms. Line bridging, -14dB 50K. Outlets: line, up to 18dBm, 50 ohms or 600 ohms line. Monitor amp, 2W at 15 ohms. Transistorised. 3 Papst motors with ext rotor. Tape deck: own. Superimpose, pause and inching facilities. Straight-through amplifier. Optical stop. Mains: 250V 50Hz. Price: from approximately £500 (plus VAT).

## ■ SHARP

Sharp Electronics (UK) Ltd, 107 Hulme Hall Lane, Manchester, M10 8HL.  
Tel: 061-205 7321.

### RD708V

Mains operated stereo  $\frac{1}{4}$ -track recorder. Speeds:  $7\frac{1}{2}$ ,  $3\frac{3}{4}$ ,  $1\frac{1}{8}$ i/s. Max spool: 7in. W and F:  $7\frac{1}{2}$ i/s

★ Indicates entry is illustrated

0.15%,  $3\frac{3}{4}$ i/s 0.2%,  $1\frac{7}{8}$ i/s 0.2%. H and N: -45 dB. FR:  $7\frac{1}{2}$ i/s 40Hz-16kHz,  $3\frac{3}{4}$ i/s 40Hz-8kHz,  $1\frac{7}{8}$ i/s 40Hz-4kHz. Replay char: DIN. Rewind time: less than 2 min for 1200ft. Meter level indicator. Inputs: mic 0.2mV 200 ohms, aux (DIN) 5mV 15K. Outlets: line (DIN) 500mV 2K, speaker 8 ohms. Output: 3.5W RMS per channel. Speakers: 6 $\frac{1}{4}$ in bass driver, 2 $\frac{3}{8}$ in tweeter. Transistors. One motor. Sharp deck. Straight-through amplifier. Monitoring. Parallel track replay. Size: 15 $\frac{3}{8}$  × 15 $\frac{3}{8}$  × 10 $\frac{1}{2}$ in. Weight: 34lb. Mains: 110, 200, 220, 240V 50-60Hz. Price: £112.96 (including VAT).

#### RT727

Mains operated stereo  $\frac{1}{4}$ -track tape deck. Speeds:  $7\frac{1}{2}$ ,  $3\frac{3}{4}$ i/s. Tracks: 4-track 2-channel stereo. Max spool: 7in. Fast forward wind: 115 sec for 1200ft. Fast rewind: 65 sec for 1200ft. Vertical or horizontal operation. Mains: 110, 220, 240V AC 50Hz. One capacitor-start motor. One record/playback head, one erase head. AC bias and erase. Price: £85.95 (including VAT).



Sony TC 377 and TC 280

#### ■ SONY

Sony (UK) Ltd, Pyrene House, Sunbury Cross, Sunbury-on-Thames, Middx. Tel: Sunbury-on-Thames (76) 87644.

#### TC 270

Stereo tape recorder:  $\frac{1}{4}$ -track stereo and  $\frac{1}{4}$ -track mono. Speeds:  $7\frac{1}{2}$ ,  $3\frac{3}{4}$ ,  $1\frac{7}{8}$ i/s. Max spool 7in. W and F:  $7\frac{1}{2}$ i/s 0.12% RMS DIN;  $3\frac{3}{4}$ i/s 0.15% RMS DIN;  $1\frac{7}{8}$ i/s 0.2% RMS. FR:  $7\frac{1}{2}$ i/s 60Hz-13kHz ± 3dB, 30Hz-16kHz DIN;  $3\frac{3}{4}$ i/s 40Hz-12.5kHz DIN. S/N: 50dB. Bias frequency: 85kHz. THD: < 3%. Two heads. Power: 5W × 2 into 8 ohms. Speaker: 120mm diameter, 8 ohms × 2. Input: diameter 8 ohms × 2. Input: mic low 0.2mV; line 0.06V 160K; rec/PB 3.9K. Output: line > 10K 0.43V at 100K; external speaker 8 ohms; phones 8 ohms; rec/PB 80K 0dB 0.775V. Mains: 110, 127, 220 and 240V AC 50-60 Hz (factory set 240V, 50Hz). Size: 513 × 260 × 387mm. Supplied accessories: two microphones F25, one connecting lead RK74, one reel R7E5, one mains lead, one set of head cleaning tips. Price: £119.95 (including VAT).

#### TC 280 ★

Stereo tape deck:  $\frac{1}{4}$ -track stereo and  $\frac{1}{4}$ -track mono. Max spool: 7in. Speeds:  $7\frac{1}{2}$ ,  $3\frac{3}{4}$ ,  $1\frac{7}{8}$ i/s. W and F:  $7\frac{1}{2}$ i/s 0.1% RMS;  $3\frac{3}{4}$ i/s 0.15% RMS;  $1\frac{7}{8}$ i/s 0.2% RMS. FR: "normal" tape,  $7\frac{1}{2}$ i/s 40Hz-18kHz ± 3dB, 30Hz-18kHz DIN;  $3\frac{3}{4}$ i/s 40Hz-12.5kHz DIN. "SLH" tape,  $7\frac{1}{2}$ i/s 40Hz-21kHz ± 3dB, 30Hz-20kHz DIN;  $3\frac{3}{4}$ i/s 40Hz-14kHz DIN. S/N: "normal" tape 52dB, "SLH" tape 55dB. Bias frequency: 160kHz. Heads: F & F rec/PB, erase head. Input: mic low 0.2mV; line 0.06V 100K; rec/PB 3.8K. Output: line 0.775V 100K; phone 8 ohms, rec/PB 3.3K.

Mains: 110, 127, 220 and 240V AC 50-60Hz (factory set 240V, 50Hz). Size: 394 × 184 × 353 mm. Weight: 9.6kg. Supplied accessories: one reel R7E5, two connecting leads RK74, one head cleaning tip, one mains lead. Price: £99.95 (including VAT).

#### TC 330

Open reel/cassette stereo tape recorder:  $\frac{1}{4}$ -track, two channel. Speeds:  $7\frac{1}{2}$ ,  $3\frac{3}{4}$ ,  $1\frac{7}{8}$ i/s and  $1\frac{7}{8}$ i/s cassette. Max spool 7in. W and F:  $7\frac{1}{2}$ i/s 0.12% RMS;  $3\frac{3}{4}$ i/s 0.15% RMS;  $1\frac{7}{8}$ i/s 0.2% RMS. Cassette 0.2% RMS. FR:  $7\frac{1}{2}$ i/s 30Hz-18kHz (-15dB);  $3\frac{3}{4}$ i/s 30Hz-13kHz (-15dB);  $1\frac{7}{8}$ i/s 30Hz-7kHz (-15dB); cassette 50Hz-10kHz (-15dB). S/N: 50dB, cassette 45dB. Bias frequency: 85kHz. THD: 2.5%. Power: for lid speakers, 5W × 2 into 8 ohms. Speaker: lids, 130mm diameter 8 ohms × 2. Inputs: mic 0.2mV 600 ohms; line 0.06V 100K; phono 1.1mV 65K; phones 8 ohms DIN 10K. Mains: 100, 110, 117, 125, 220 and 240V AC 50-60Hz (factory set 240V, 50Hz). Size: 538 × 300 × 362mm. Supplied accessories: two microphones F25, one reel, one connecting lead RK74, one mains lead. Price: £159.95 (including VAT).

#### TC 377 ★

Stereo tape deck:  $\frac{1}{4}$ -track stereo and  $\frac{1}{4}$ -track mono. Max spool 7in. Speeds:  $7\frac{1}{2}$ ,  $3\frac{3}{4}$ ,  $1\frac{7}{8}$ i/s. W and F:  $7\frac{1}{2}$ i/s 0.09% RMS;  $3\frac{3}{4}$ i/s 0.12% RMS;  $1\frac{7}{8}$ i/s 0.17% RMS. FR: "normal" tape,  $7\frac{1}{2}$ i/s 30Hz-20kHz ± 3dB, 30Hz-20kHz DIN;  $3\frac{3}{4}$ i/s 40Hz-13kHz DIN. "SLH" tape, 30Hz-25kHz ± 3dB, 30Hz-24kHz DIN;  $3\frac{3}{4}$ i/s 40Hz-16kHz DIN. S/N: "normal" tape 52dB, "SLH" tape

55dB. Bias frequency: 160kHz. Heads: F & F Rec, F & F PB erase head. THD: 1.2%. Input: mic low 0.2mV; line 0.06V 100K. Rec/PB -33dB 3-8K. Output: line 0.775V 100K; phones 8 ohms, rec/PB -dB 3-3K. Mains: 110, 127, 220 and 240V AC 50-60Hz (factory set 240V, 50Hz). Size: 418 × 210 × 392mm. Weight: 11.5 kg. Supplied accessories: one reel R7ES, two connecting leads RK74, one head cleaning tip, one mains lead. Price: £129.95 (including VAT).

#### TC 45R

Stereo tape deck:  $\frac{1}{4}$ -track stereo and  $\frac{1}{4}$ -track mono. Continuous playback, forward and reverse recording. Max spool 7in. Speeds:  $7\frac{1}{2}$ ,  $3\frac{3}{4}$ i/s. W and F:  $7\frac{1}{2}$ i/s 0.06% RMS;  $3\frac{3}{4}$ i/s 0.1% RMS. FR: "normal" tape,  $7\frac{1}{2}$ i/s 30Hz-20kHz  $\pm$  3dB, 30Hz-20kHz DIN;  $3\frac{3}{4}$ i/s 20Hz-17kHz -15dB; 40Hz-13kHz DIN. "SLH" tape,  $7\frac{1}{2}$ i/s 30Hz-25kHz  $\pm$  3dB, 30Hz-24kHz DIN;  $3\frac{3}{4}$ i/s 20Hz-20kHz -15dB, 40Hz-16kHz DIN. S/N: "normal" tape 53dB, "SLH" tape 56dB. THD: <1.2%. Heads: F & F, one record, one playback, two erase. Input: mic low 0.2V; line 0.06V 100K DIN 10K. Output: line 0.775V 10K, phones 8 ohms DIN 50K. Mains: 240V AC 50Hz. Size: 403 × 413 × 203mm. Weight: 15kg. Supplied accessories: two RK74 connecting leads, lead cleaning tips, 7in plastic reel. Price: £239.95 (including VAT).

#### TC 630

Stereo open reel tape recorder:  $\frac{1}{4}$ -track two channel and  $\frac{1}{4}$ -track mono. Max spool 7in. Speeds:  $7\frac{1}{2}$ ,  $3\frac{3}{4}$ ,  $1\frac{7}{8}$ i/s. W and F:  $7\frac{1}{2}$ i/s 0.09% RMS;  $3\frac{3}{4}$ i/s 0.12% RMS;  $1\frac{7}{8}$ i/s 0.16% RMS. FR:  $7\frac{1}{2}$ i/s 30Hz-22kHz (-15dB);  $3\frac{3}{4}$ i/s 30Hz-13kHz (-15dB);  $1\frac{7}{8}$ i/s 30Hz-10kHz (-15dB). S/N: 50dB. Bias frequency: 160kHz. Three heads. Power: 15W × 2 into 8 ohms. Lid speaker 7.5W × 2 (16 ohms). Inputs: mic low 0.2mV; line 0.06V 560K; tuner 0.06V 100K; phono 2mV 14K; rec/PB 7.7mV 10K. Output: line 0.775V 100K. Extension speaker 16 ohms. Monitor output: 8 ohms; phones 8 ohms; rec/PB 0.775V 100K. Mains: 100, 110, 117, 125, 220 and 240V AC 50-60Hz (factory set 240V, 50Hz). Size: 454 × 506 × 294mm. Supplied accessories: two F26 microphones, one demonstration tape, one reel, one connecting lead RK74, two reel caps, one head cleaning ribbon. Price: £174.95 (including VA1).

#### TC 755

Stereo tape deck:  $\frac{1}{4}$ -track stereo and  $\frac{1}{4}$ -track mono. Max spool 10 $\frac{1}{2}$ in. Speeds:  $7\frac{1}{2}$ ,  $3\frac{3}{4}$ i/s. W and F:  $7\frac{1}{2}$ i/s 0.05% RMS;  $3\frac{3}{4}$ i/s 0.08% RMS. FR: "normal" tape,  $7\frac{1}{2}$ i/s 30Hz-20kHz  $\pm$  3dB, 30Hz-20kHz DIN;  $3\frac{3}{4}$ i/s 20Hz-17kHz -15dB, 40Hz-13kHz DIN. "SLH/CrO<sub>2</sub>" tape,  $7\frac{1}{2}$ i/s 30Hz-25kHz  $\pm$  3dB, 30Hz-24kHz DIN;  $3\frac{3}{4}$ i/s 20Hz-20kHz -15dB, 40Hz-16kHz DIN. S/N:

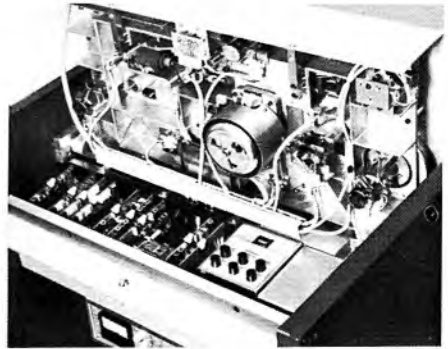

Studer A80 (Underside)

"normal" tape 53dB, "SLH/CrO<sub>2</sub>" tape 56dB. THD: <1.2%. Heads: F & F, one record, one playback, one erase. Three motors. Inputs: mic low 0.2mV; line 0.06V 100K DIN 3-9K. Output: line 0.43V 10K; phones 8 ohms, DIN 0.43V 2K. Mains: 110, 127, 220 and 240V AC 50Hz (factory set 240V, 50Hz). Size: 435 × 451 × 221mm. Weight: 24kg. Supplied accessories: two RK74 connecting leads, head cleaning tips, 10 $\frac{1}{2}$ in plastic reel. Price: £299.95 (including VAT).

#### TC 756-2

Stereo tape deck:  $\frac{1}{2}$ -track stereo and  $\frac{1}{2}$ -track mono. Max spool 10 $\frac{1}{2}$ in. Speeds: 15,  $7\frac{1}{2}$ i/s. W and F: 15i/s 0.04% RMS;  $7\frac{1}{2}$ i/s 0.06% RMS. FR: "normal" tape 15i/s 30Hz-22kHz  $\pm$  3dB, 30Hz-30kHz DIN;  $7\frac{1}{2}$ i/s 30Hz-15kHz  $\pm$  3dB, 30Hz-20kHz DIN. "SLH" tape, 15i/s 30Hz-30kHz  $\pm$  3dB, 30Hz-35kHz DIN;  $7\frac{1}{2}$ i/s 30Hz-25kHz  $\pm$  3dB, 30Hz-25kHz DIN. S/N: "normal" tape 56dB, "SLH" tape 59dB. THD: 1.2%. Heads: F & F, one record, one playback, one erase. Three motors. Input: mic low 0.2mV; line 0.06V 100K. Output: line 0.435V 100K; phones 8 ohms. Mains: 110, 127, 220, 240V AC 50-60 Hz (factory set 240V, 50Hz). Size: 435 × 450 × 221mm. Weight: 24kg. Supplied accessories: 10 $\frac{1}{2}$ in plastic reel, RK74 connecting lead, head cleaning tips, mains lead. Price: £329.95 (including VA1).

#### STUDER

Studer-Franz AG, Switzerland.  
Distributors: F. W. O. Bauch Ltd,  
49 Theobald Street, Boreham Wood, Herts,  
WD6 4RZ. Tel: 01-953 0091. Telex: 27502.

#### Studer A80 ★

Professional tape deck with preamplifiers. Mono or stereo on  $\frac{1}{4}$ in tape, four-track on  $\frac{1}{2}$ in tape, four-track or eight-track on 1in tape. 16-track on 2in tape, 24-track on 2in tape. Speeds:  $7\frac{1}{2}$  and 15i/s. Max spool: 12in. W and F: 15i/s  $\pm$  0.04%,

★ Indicates entry is illustrated



Tandberg 11-2M



Tandberg 1500 Series



Tandberg 3300X Series



Studer B62

$7\frac{1}{2}$ i/s  $\pm 0.06\%$ . H and N: 15i/s 62dB;  $7\frac{1}{2}$ i/s 60dB. FR: 15i/s 30Hz-18kHz  $\pm 1$ dB;  $7\frac{1}{2}$ i/s 60Hz-12kHz  $\pm 0.75$ dB. Replay char: switchable NAB/CCIR. Rewind time: 2 min for 1000m. Separate VU meter for each channel. Inputs: 0.3V to 10V ( $-8$ Bm to  $+22$ Bm) adjustable. Balanced input with impedance higher than 8K between 30Hz-18kHz. Outputs:  $-8$ Bm to 24dBm adjustable. Output balanced with impedance less than 30 ohms between 30Hz-18kHz. Servo-controlled capstan motor, two high-torque asynchronous spooling motors. Tape deck control by eight printed circuit cards equipped with logic circuits, giving constant tape tension throughout all operating modes. Five-digit counter indicating hours, min and sec (accuracy 0.2%). Mains: 240V AC. Prices and further details to professional users on request.

#### Studer B62 ★

Professional tape deck with preamplifiers. Mono, stereo or twin-track on  $\frac{1}{4}$  in tape. Speeds:  $7\frac{1}{2}$  and 15i/s. Max spool: 10 $\frac{1}{2}$  in. W and F: 15i/s 0.05%,  $7\frac{1}{2}$ i/s 0.08%. H and N: 15i/s 61dB,  $7\frac{1}{2}$ i/s 58dB. FR: 15i/s and  $7\frac{1}{2}$ i/s 30Hz-18kHz

$\pm 2$ dB. Replay char: CCIR or NAB by quick-change equaliser printed circuit cards. Rewind time: 100 sec for 700m. Servo-controlled capstan motor, two high-torque asynchronous spooling motors. Size: 19  $\times$  14  $\times$  8 $\frac{1}{2}$  in. Accurate tape timer indicating min and sec. Mains: 240V AC. Prices and further details to professional users on request.

#### ■ TANDBERG

Farnell-Tandberg Ltd, Farnell House, 81 Kirkstall Road, Leeds, LS3 1HR. Tel: Leeds (0532) 35111.

#### 3300X Series ★

Mains-operated stereo tape deck.  $\frac{1}{4}$ -track (3321X) or  $\frac{1}{2}$ -track (3321X). Speeds:  $7\frac{1}{2}$ ,  $3\frac{3}{4}$ ,  $1\frac{7}{8}$ i/s. Max spool: 7in. W and F:  $7\frac{1}{2}$ i/s 0.07%,  $3\frac{3}{4}$ i/s 0.14%,  $1\frac{7}{8}$ i/s 0.28%. H and N:  $7\frac{1}{2}$ i/s ( $\frac{1}{4}$ -track)  $-64$ dB, ( $\frac{1}{2}$ -track)  $-66$ dB. FR:  $7\frac{1}{2}$ i/s 30Hz-22kHz  $\pm 2$ dB,  $3\frac{3}{4}$ i/s 40Hz-16kHz  $\pm 2$ dB,  $1\frac{7}{8}$ i/s 40Hz-9kHz  $\pm 2$ dB. Replay char: NARTB. Rewind time: 2 min 10 sec for 1800ft. Two meter level indicators. Four-digit tape position indicator with PB reset. Inputs: mic 0.05mV at

less than 700 ohms, line 30mV 200K, radio 5mV 50K. Outlets: line 1V 100 ohms, radio 1V 100 ohms, headphones 1V 100 ohms. 36 transistors. One motor (Papst asynchronous). Size:  $15\frac{3}{4} \times 7 \times 16\frac{1}{8}$ in. Weight: 20 $\frac{1}{4}$ lb. Straight-through amplifier. Pause. Monitoring on record. Parallel track replay. Crossfield recording technique. Four sound heads. Photo-electric end stop. Front-mounted jack for headphones. Slider level controls. AC mains. Price: (teak) £137.38 (including VAT); (rosewood) £140.68 (including VAT).

**1521 ★**

Mono tape recorder.  $\frac{1}{2}$ -track. Speeds:  $1\frac{7}{8}$ ,  $3\frac{3}{4}$  and  $7\frac{1}{2}$ i/s. Max spool capacity: 7in. W and F: 0.1%  $7\frac{1}{2}$ i/s, 0.4%  $1\frac{7}{8}$ i/s. H and N: 52dB at  $3\frac{3}{4}$  and  $7\frac{1}{2}$ i/s. FR: ( $\pm 2$ dB) 40Hz-18kHz  $7\frac{1}{2}$ i/s, 50Hz-12kHz  $3\frac{3}{4}$ i/s, 60Hz-6.5kHz  $1\frac{7}{8}$ i/s. Rewind time: 2 min 1200ft. Meter level indicator. Inputs: mic 0.1mV 200 ohms, radio 10mV 100K, PU 100mV 1M. Output: 10W into 8 ohms. 4  $\times$  7in speaker. Outlets: preamp 0.9V 20K, ext speaker 10W 4 ohms, free head 2mV 20K. Features: pause, inching, straight-through amp, monitoring, input mixing, auto end stop, bass and treble controls. Weight: 19lb. Dimensions:  $15\frac{3}{8} \times 11\frac{3}{4} \times 6\frac{1}{2}$ in. Price: £110.36 (including VAT).

**1522**

Portable-case version of above. Price: £122.15 (including VAT).

**1541**

$\frac{3}{4}$ -track version of 1521. Extra feature: parallel track replay. Price: £115.87 (including VAT).

**1542**

Portable-case version of 1541. Price: £130 (including VAT).

**1521F**

As 1521 but remote stop/start and rewind control. Price: £149.16 (including VAT).

**1541F**

As 1521F but  $\frac{1}{4}$ -track. Price: £157.21 (including VAT).

**11-2M ★**

Battery-operated mono recorder.  $\frac{1}{2}$ -track. Speeds:  $1\frac{7}{8}$ ,  $3\frac{3}{4}$  and  $7\frac{1}{2}$ i/s. Max spool capacity: 7in. W and F: 0.1%  $7\frac{1}{2}$ i/s, 0.2%  $3\frac{3}{4}$ i/s, 0.3%  $1\frac{7}{8}$ i/s. H and N: 58-52dB. FR ( $\pm 2$ dB): 40Hz-16kHz  $7\frac{1}{2}$ i/s, 50Hz-10kHz  $3\frac{3}{4}$ i/s, 50Hz-5.2kHz  $1\frac{7}{8}$ i/s. Meter indicator. Rewind time: 2 min 1200ft. Inputs: mic 100mV 200 ohms, music (1) 5mV 10K, music (2) 125mV 200K. Output:  $\frac{1}{4}$ W into 2  $\times$  3in speaker. Outlets: line 1.55V 200 ohms, speaker 20 ohms. Own pulse-excited motor. Features: off-tape monitoring, cueing in fast forward rewind, pause, inching, straight-through amp, monitoring, input mixing. Weight: 11.3lb. Dimensions: 13  $\times$  10  $\times$  4in. Mains unit

available. Lip synchronisation with Super 8mm cameras. Accessories include variable speed unit, pulse generator and projector synchroniser. Price: on application.

**11-1**

Similar to above but full track and available with or without new pilot tone facility. Price: on application.

**3400X**

Stereo mains-operated tape recorder.  $\frac{1}{4}$ - or  $\frac{1}{2}$ -track. Speeds:  $7\frac{1}{2}$ ,  $3\frac{3}{4}$ ,  $1\frac{7}{8}$ i/s. Max spool: 7in. W and F:  $7\frac{1}{2}$ i/s 0.07%,  $3\frac{3}{4}$ i/s 0.14%,  $1\frac{7}{8}$ i/s 0.28%. H and N:  $7\frac{1}{2}$ i/s ( $\frac{1}{2}$ -track) -66dB, ( $\frac{1}{4}$ -track) -64dB. FR:  $7\frac{1}{2}$ i/s 40Hz-22kHz  $\pm 2$ dB,  $3\frac{3}{4}$ i/s 50Hz-16kHz  $\pm 2$ dB,  $1\frac{7}{8}$ i/s 50Hz-9kHz  $\pm 2$ dB. Replay char: DIN. Rewind time: two minutes for 1800ft. Meter level indicator. Four-digit tape position indicator with PB reset. Inputs: mic 0.4mV 200 ohms, radio 5mV 50K, mag PU. Outlets: line/radio, headphones 8 ohms, speakers 4 ohms. Output: 15W RMS per channel. Twin speakers. One Papst motor (asynchronous). Size:  $15\frac{3}{4} \times 7 \times 16\frac{1}{8}$ in. Superimpose. Pause. Straight-through amplifier. Monitoring during recording. Input mixing. Parallel track replay. Flying start with photo-cell stop. Cross-field recording technique. Price: £189.71 (including VAT).

**Series 9100X**

Available in two versions, the 9121, 2-track stereo and the 9141 4-track stereo. Max reel size: 7in. W and F: 0.07% at 19cm/s, 0.14% at 9.5cm/s and 0.28% at 4.75cm/s. S/N: 67dB (2-track), 65dB (4-track). FR: 30Hz-26kHz at 19cm/s, 30Hz-18kHz at 9.5cm/s, 30Hz-11kHz at 4.75cm/s. Inputs: mic 0.25mV 200 ohms, line 30mV 330K, radio 8mV 50K. Outputs: line 1.5V 200 ohms, radio 0.75V 5K, phone 5mW 8 ohms. Three motors. Mains: 115, 230, 240V 50-60Hz. Solenoid deck operation, function indicated by lamps behind press buttons. Servo braking and tape tension. Input mixing, cue and editing facility. Price: £263 (plus VAT).

**■ TAPE RECORDER DEVELOPMENTS LTD**

Hall Lane, Walsall Wood, Staffs.  
Tel: Brownhills (054 33) 5351.

**TRD Series 700**

Mono/stereo  $\frac{1}{2}$ -track tape recorder. Speeds: 15,  $7\frac{1}{2}$ ,  $3\frac{3}{4}$ ,  $1\frac{7}{8}$ i/s or 30, 15,  $7\frac{1}{2}$ ,  $3\frac{3}{4}$ i/s. Max spool: 10 $\frac{1}{2}$ in. W and F: 15i/s 0.05%,  $7\frac{1}{2}$ i/s 0.08%,  $3\frac{3}{4}$ i/s 0.12%,  $1\frac{7}{8}$ i/s 0.2%. H and N: 15i/s -64dB,  $7\frac{1}{2}$ i/s -62dB,  $3\frac{3}{4}$ i/s -60dB,  $1\frac{7}{8}$ i/s -58dB. FR: 15i/s 40Hz-18kHz,  $7\frac{1}{2}$ i/s 40Hz-16kHz,  $3\frac{3}{4}$ i/s 40Hz-12kHz,  $1\frac{7}{8}$ i/s 40Hz-6kHz (all  $\pm 1$ dB -2dB). Replay characteristics switchable. Rewind time: 80 sec for 2400ft. Peak programme meters or VU meters. Four-digit footage indi-

★ Indicates entry is illustrated

cator with PB reset. Inputs: mic 600 ohms -70dB balanced floating, line 10K bridging 0dB balanced floating. Outlets: line +20dB 600 ohms balanced, 2W into 15 ohms (monitor). Three motor deck. Size:  $18\frac{1}{2} \times 19 \times 8$ in. Weight: 60lb. Monitoring. Self-sync facility. Mains operated. Price: £425 (plus VAT).

#### A-2520

Two-speed  $\frac{1}{2}$ -track stereo reel-to-reel tape deck. Max spool 7in. Speeds:  $3\frac{3}{4}$ ,  $7\frac{1}{2}$ i/s. W and F:  $3\frac{3}{4}$ i/s 0.1%,  $7\frac{1}{2}$ i/s 0.08%. H and N:  $3\frac{3}{4}$ i/s -45dB,  $7\frac{1}{2}$ i/s -48dB. FR:  $3\frac{3}{4}$ i/s 40Hz-10kHz  $\pm 3$ dB,  $7\frac{1}{2}$ i/s 40Hz-18kHz  $\pm 3$ dB. Replay char: NAB. Rewind time: 90 sec for 1200ft. Two VU meters. Inputs: mic 0.3mV 10K, line 0.1V 100K. Outlets: line 0.3V 10K, headphones 0.3mW 8 ohms. Three motors: one dual-speed, two eddy current. Superimpose. Pause. Input mixing. Monitoring. Parallel track replay. Two-channel recording, four-channel playback. Size:  $17\frac{3}{8} \times 15\frac{3}{8} \times 8\frac{3}{8}$ in. Weight: 37 $\frac{1}{2}$ lb. Mains: 100, 117, 200, 220, 240V AC. Price: £272 (plus VAT).

#### A7010-GSL

Two-speed  $\frac{1}{2}$ -track stereo tape deck. Speeds:  $3\frac{3}{4}$ ,  $7\frac{1}{2}$ i/s. Max spool:  $10\frac{1}{2}$ in. W and F:  $3\frac{3}{4}$ i/s 0.09%,  $7\frac{1}{2}$ i/s 0.06%. H and N:  $3\frac{3}{4}$ i/s -46dB,  $7\frac{1}{2}$ i/s -48dB. FR:  $3\frac{3}{4}$ i/s 40Hz-7.5kHz  $\pm 2$ dB,  $7\frac{1}{2}$ i/s 30Hz-20kHz  $\pm 2$ dB. Replay char: NAB. Rewind time: 200 sec for 3600ft. VU meter. Inputs: mic -7dB (0.25mV) 600 ohms, line 0.1V 50K. Outlets: line 0.3V 10K, headphones 8 ohms. Three motors. Superimpose. Pause. Input mixing. Monitoring. Parallel track replay. Auto reverse. Bias level switch. Size:  $20\frac{7}{8} \times 17\frac{1}{2} \times 8\frac{1}{4}$ in. Weight: 62lb. Mains: 100, 117, 200, 220, 240V AC. Price: £500 (plus VAT).

#### A7030-GSL

Two-speed  $\frac{1}{2}$ -track stereo tape deck. Speeds:  $7\frac{1}{2}$ , 15i/s. Max spool:  $10\frac{1}{2}$ in. W and F:  $7\frac{1}{2}$ i/s 0.06%, 15i/s 0.04%. FR:  $7\frac{1}{2}$ i/s 30Hz-20kHz  $\pm 3$ dB, 15i/s 30Hz-22kHz  $\pm 3$ dB. Replay char: NAB. Rewind time: 90 sec for 1200ft. Two VU meters. Inputs: mic 0.25mV 600 ohms to 10K, line 0.1V 50K. Outlets: line 0.3V 10K, headphones 8 ohms. Three motors. Superimpose. Pause. Input mixing. Monitoring. Parallel track replay. Size:  $17\frac{3}{8} \times 21\frac{1}{8} \times 9\frac{1}{2}$ in. Weight: 62lb. Mains: 100, 117, 200, 220, 240V AC. Price: £500 (plus VA1).

#### R720

Three-speed  $\frac{1}{4}$ - or  $\frac{1}{2}$ -track stereo tape deck. Speeds:  $3\frac{3}{4}$ ,  $7\frac{1}{2}$ , 15i/s. Max spool:  $10\frac{1}{2}$ in. W and F:  $3\frac{3}{4}$ i/s 0.06%,  $7\frac{1}{2}$ i/s 0.03%, 15i/s 0.02%. FR:  $3\frac{3}{4}$ i/s 25Hz-10kHz  $\pm 3$ dB,  $7\frac{1}{2}$ i/s 25Hz-20kHz  $\pm 3$ dB, 15i/s 25Hz-22kHz  $\pm 3$ dB. Replay char: NAB. Rewind time: 120 sec for 2400ft. Two VU meters. Inputs: mic 600 ohms, line 50K. Outlets: line 10K, headphones 8 ohms. Three motors. Full specification and prices on request.



Teac A-3300S



Teac A-3340S

#### A-4300

Mains-operated stereo tape deck,  $\frac{1}{4}$ -track. Speeds:  $3\frac{3}{4}$ ,  $7\frac{1}{2}$ i/s. Max spool: 7in. W and F:  $7\frac{1}{2}$ i/s 0.08%,  $3\frac{3}{4}$ i/s 0.1%. S/N ratio: 55dB. FR:  $7\frac{1}{2}$ i/s 30Hz-22kHz,  $3\frac{3}{4}$ i/s 30Hz-16kHz. Replay char: NAB. Rewind time: 100 sec for 1200ft. Two VU meters. Four-digit time indicator with PB reset. Inputs: mic 0.25mV 600 ohms-10K, line 100mV 10K. Outlet: 300mV 10K. One hysteresis synchronous capstan motor, two eddy current reel motors. Superimpose. Pause control. Input mixing. Monitoring on record. Parallel track replay. Auto-reverse and repeat. Solenoid controls. Size:  $19\frac{1}{4} \times 17\frac{3}{8} \times 8\frac{1}{2}$ in. Weight: 50 $\frac{1}{2}$ lb. Price: to be announced.

#### A-5300

Mains-operated stereo tape deck.  $\frac{1}{4}$ -track. Speeds:  $3\frac{3}{4}$ ,  $7\frac{1}{2}$ i/s. Max spool: 7in. W and F:

7½i/s 0.08%, 3¾i/s 0.1%. S/N ratio: 55dB. FR: 7½i/s 30Hz-22kHz, 3¾i/s 30Hz-16kHz. Replay char: NAB. Rewind time: 100 sec for 1200ft. VU meter. Four-digit tape indicator with PB reset. Inputs: line 100mV 50K, mic 0.25mV 600 ohms-10K. Outlet: 300mV 10K. One direct drive DC servo capstan motor, two coreless rotor type DC reel motors. Superimpose. Pause control. Input mixing. Monitoring. Parallel track replay. Solenoid operation. Remote control microphone. Auto-reverse and repeat. Size: 21 × 18 × 8½in. Weight: 35¼lb. Price: to be announced.

**A-5500**

Mains operated stereo tape deck. ¼-track. Speeds: 7½, 3¾i/s. Max spool: 7in. W and F: 7½i/s 0.08%, 3¾i/s 0.1%. FR: 7½i/s 30Hz-22kHz ±3dB, 3¾i/s 30Hz-16kHz ±3dB. Replay char: NAB. Rewind time: 100 sec for 1200ft. VU meter. Four-digit tape indicator with PB reset. Inputs: mic 0.25mV 600 ohms-10K, line 100mV 50K. Outlets: 300mV 50K. One direct drive DC servo capstan motor, two coreless rotor type DC reel motors. Superimpose. Pause. Input mixing. Monitoring. Parallel track replay. Dolby noise reduction system. Auto-reverse. Solenoid operation. Size: 21 × 18 × 8½in. Weight: 35¼lb. Price: to be announced.

■ **TEAC**

Acoustico Enterprises Ltd, Unit 7, Space Way, North Feltham Trading Estate, Feltham, Middlesex, TW14 0TZ. Tel: 01-751 0141.

**A2340**

Mains-operated two-speed tape deck. Four-channel with simultaneous sync. Multi-track recording. Speeds: 3¾, 7½i/s. Max spool: 7in. W and F: 3¾i/s 0.1%, 7½i/s 0.08%. S/N ratio: 55dB. FR: 3¾i/s 40Hz-10kHz ±3dB, 7½i/s 40Hz-18kHz ±3dB. Rewind char: NAB. Rewind time: 90 sec for 1200ft. VU meters. Four-digit tape indicator with PB reset. Inputs: mic 0.25mV 600 ohms-10K, line (5) 100mV 50K. Output: line 300mV 10K. One hysteresis synchronous motor, three eddy current motors. Superimpose. Pause control. Input mixing. Monitoring on record. Parallel track record. Size: 18¾ × 17¾ × 8½in. Weight: 46¼lb. Mains: 100, 117, 220, 240V AC. Price: £382 (plus VAT).

**A2420**

Four-channel, two-channel stereo tape player. Speeds: 7½ and 3¾i/s. W and F: 7½i/s 0.08%, 3¾i/s 0.1%. FR: 7½i/s 40Hz-18kHz ±3dB, 3¾i/s 40Hz-10kHz ±3dB. S/N ratio: 55dB. HD: 1% at 1kHz at normal operating level. Rewind time: 90 sec for 1200ft. Output: line 0.3V for load impedance of 10,000 ohms or more. Mains: 100-240V AC 50-60Hz 140W. Motors: one dual speed hysteresis synchronous capstan



Telefunken 3002 hi-fi

and two eddy current induction reel motors. Automatic reverse and repeat control automatic shut off. Size: 383 × 440 × 203mm. Weight: 37½ lbs. Price: to be announced.

**2300S**

7in reel 3¾/17½i/s 3 head ¼-track stereo machine. Full remote control facilities. Mic/Line mixing. Switchable bias plus equalisation for standard or low noise tapes. Off tape monitoring.

**A-3300S ★**

10½in reel 3¾/7½i/s ¼-track. Otherwise as above.

**3300S/2T**

10½in reel 7½/15i/s ½-track. Otherwise as above.

**A-3340S ★**

10½in reel 7½/15i/s ¼-track 4 channel machine. Three heads. Off tape monitoring. Mic/Line mixing. Full remote control facilities. Switchable bias plus equalisation. Two headphones outlets enabling use of quadraphonic phones. Two or four-channel play switch. Simul-Sync facility enables four separate recordings to be made on different tracks in synchronisation with one another.

**6100**

Details on request.

**7300**

Direct drive capstan 10½ reel 2 track stereo semi-pro machine.

**7340**

Semi-pro 4 track channel master record with separate transport and electronics. Eight input mixing, Simul-Sync VU meter and three level LED peak reading display on each channel.

■ **TELEFUNKEN**

AEG Telefunken (UK) Ltd, Bath Road, Slough, Bucks. Tel: Slough (75) 33311.

**M3002 ★**

¼-track stereo tape recorder. Speeds: 1¾i/s, 3¾i/s, 7½i/s. Max spool size: 7in. W and F:



★ Indicates entry is illustrated

(measured to DIN 45 405): less than 0.2% ( $1\frac{1}{2}$ i/s), less than 0.15% ( $3\frac{3}{4}$ i/s), less than 0.1% ( $7\frac{1}{2}$ i/s). S/N ratio (measured to DIN 45 405): less than 48dB ( $1\frac{1}{8}$ i/s), less than 52dB ( $3\frac{3}{4}$ i/s), less than 55dB ( $7\frac{1}{2}$ i/s). FR: 30Hz-12 $\frac{1}{2}$ kHz ( $1\frac{1}{8}$ i/s), 30Hz-15kHz ( $3\frac{3}{4}$ i/s), 30Hz-20kHz ( $7\frac{1}{2}$ i/s). Replay char: DIN 45 500. Rewind time: approximately 2 $\frac{1}{2}$  min. with 720m tape. Level indication: VU. Inputs: tuner 4mV 40K, mic 0.15mV 2K, pickup/tape 100mV/1M ohm. Outputs: line 0.7V 12K, monitor 0.7V 3.3K, phones 2 $\frac{1}{2}$  400K, speakers 35W per channel into 4 ohms. Motors: Cut out switch for motor when unit is used as amplifier. Size: 21 × 6 $\frac{1}{4}$  × 13 $\frac{3}{4}$  in. Weight: 16kg. Mains: 110-240V AC 50Hz. 117 AC 60Hz. Price: £264 (including VAT).



Uher Royal de Luxe

## ■ UHER

Distributors: Uher (UK) Ltd,  
15 Broomhills Estate, Braintree, Essex,  
CM7 7RQ. Tel: Braintree 23192.

### Royal de Luxe ★

Transistor semi-professional mains recorder. Mono/stereo.  $\frac{1}{4}$ -track or  $\frac{1}{2}$ -track. Speeds:  $7\frac{1}{2}$ ,  $3\frac{3}{4}$ ,  $1\frac{7}{8}$ ,  $\frac{1}{2}$ i/s. Max spool 7in. W and F:  $7\frac{1}{2}$ i/s 0.05%;  $3\frac{3}{4}$ i/s 0.1%;  $1\frac{7}{8}$ i/s 0.20%. H and N:  $7\frac{1}{2}$ i/s -52dB/4 tracks (54dB/2 tracks);  $3\frac{3}{4}$ i/s -51dB/4 tracks (53dB/2 tracks);  $1\frac{7}{8}$ i/s -51dB/4 tracks (53dB/2 tracks). FR:  $7\frac{1}{2}$ i/s 20Hz-20kHz;  $3\frac{3}{4}$ i/s 20Hz-15,000kHz;  $1\frac{7}{8}$ i/s 20Hz-90kHz. Replay char: NARTB. Level indicators: two meters. Inputs: mic 0.12mV-70mV 200 ohms; radio 1.2 mV-110mV 47K; Phono (1) 40mV-2.8V, phono (2) 200mV-18V. Outlets: line 775mV 15K; speakers 4 ohms. Output: 10W RMS per channel. One Papst motor. Pause. Inching. Straight-through amplifier. Horizontal or vertical operation. Monitoring. Input mixing. Parallel track replay. Interchangeable head assemblies available as optional extra. Dia-pilot. Multiplay. Echo. Weight: 29 $\frac{1}{2}$ lb (13.9kg). Price: ( $\frac{1}{4}$ -track version) £385 (plus VAT); ( $\frac{1}{2}$ -track version) £380 (plus VAT).

### Royal de Luxe C

Stereo unit without power amplifier or speakers. Specification as for Royal de Luxe.

### Uher 1200 Report Synchro

Transistorised professional mains/battery mono recorder. Full track. Speed:  $7\frac{1}{2}$ i/s. Max spool 5in. W and F: 0.07%. H and N: -52dB. FR: 40Hz-20kHz +0dB -5dB. Replay char: CCIR or NARTB. Meter level indicator. Rewind time: 3 min for 900ft. Inputs: mic (2) 0.2mV 200 ohms balanced, line 40mV-1.55V. Output: 1W RMS. 600 ohms balanced line, pilot tone to synchroniser. Brushless DC motor. Pause. Digit tape indicator. Straight-through amplifier. A/B monitoring. Neo-pilot tone input for synchronising



Uher 4200 Stereo

sound with film camera. Optional automatic level control, pilot tone indicator, mixing of two mic channels. Supply: internal dry cells, rechargeable accumulator, or from 6V, 12V, 24V car battery, 110-240V AC mains with additional adaptor units. For supply only to industrial or scientific users. Size: 11 × 3 × 8in. Weight: 7lb. Price: approximately £260 (including VAT).

### Accessory

Scene marker module No. Z521. Price: £3.80.

### 1721

Professional open reel tape recorder. Mains operated.  $\frac{1}{4}$ -track. Speeds:  $7\frac{1}{2}$ ,  $3\frac{3}{4}$ i/s. Max spool 7in. W and F:  $7\frac{1}{2}$ i/s <0.14%,  $3\frac{3}{4}$ i/s <0.18%. Replay char: NAB. FR:  $7\frac{1}{2}$ i/s 30Hz-21kHz ±3dB,  $3\frac{3}{4}$ i/s 40Hz-15kHz ±3dB. Output: 3W RMS per channel into 8 ohms. S/N ratio: better than 50dB. Bias frequency: 63kHz. Two heads. One two-speed induction motor. Fast rewind: 80-100 sec for 1200ft. Inputs: mic 0.5mV 100K, line (2) 150mV 330K. Speakers: two 7 × 5in. 16 transistors, four diodes. Mains: 100-240V 50-60Hz.

Size:  $14\frac{1}{8} \times 14\frac{3}{8} \times 9\frac{3}{4}$  in. Price: £93.87 (including VAT).

#### 4000 Report L ★

Transistorised mono battery portable recorder.  $\frac{1}{2}$ -track. Speeds:  $7\frac{1}{2}$ ,  $3\frac{3}{4}$ ,  $1\frac{7}{8}$ ,  $\frac{1}{2}$  i/s. W and F:  $7\frac{1}{2}$  i/s,  $\pm 0.2\%$ . H and N:  $-55$  dB. FR:  $7\frac{1}{2}$  i/s 40Hz-20 kHz,  $3\frac{3}{4}$  i/s 40Hz-16kHz,  $1\frac{7}{8}$  i/s 40Hz-10kHz,  $\frac{1}{2}$  i/s 40Hz-4.5kHz. All  $\pm 3$  dB. Replay char: NARTB. Inputs: mic 0.1mV 200 ohms, radio 2mV 47K; gram 30mV 1M. Outlet direct from pre-amp. One motor. 5in spool. Supply: internal batteries, rechargeable accumulator, or from 6V, 12V, 24V car battery or 110-240V AC mains with additional adaptor units. Size:  $11 \times 3 \times 8$  in. Weight: approx 7lb. Price: approximately £140 (including VAT). Combined mains unit and battery charger type Z124. Price: £18.06 (including VAT).

#### 4200 Report Stereo IC ★

Transistor mains/battery stereo tape recorder.  $\frac{1}{2}$ -track. Speeds:  $7\frac{1}{2}$ ,  $3\frac{3}{4}$ ,  $1\frac{7}{8}$ ,  $\frac{1}{2}$  i/s. Max spool 5in. W and F:  $7\frac{1}{2}$  i/s 0.2%;  $3\frac{3}{4}$  i/s 0.25%;  $1\frac{7}{8}$  i/s 0.35%;  $\frac{1}{2}$  i/s 0.56%. H and N:  $7\frac{1}{2}$  i/s  $-57$  dB;  $3\frac{3}{4}$  i/s  $-55$  dB;  $1\frac{7}{8}$  i/s  $-53$  dB. FR:  $7\frac{1}{2}$  i/s 35Hz-20kHz;  $3\frac{3}{4}$  i/s 35Hz-16kHz;  $1\frac{7}{8}$  i/s 35Hz-8kHz;  $\frac{1}{2}$  i/s 35Hz-5kHz (all to DIN 45-500). Replay char: NARTB. Level indicator: two meters. Rewind time: 3 min for 900'. Inputs: mic 0.1mV 200 ohms; radio 2mV 47K; PU 30mV 1M. Outlets: line 1V 15K, speaker 4 ohms. One motor. Pause. Digital position indicator. Monitoring. Parallel track replay. Size:  $11 \times 3 \times 8$  in. Weight: (approx) 7lb (3.8kg). Supply: internal dry cells, rechargeable accumulator, or from 6V, 12V, 24V car battery; 100-240V AC mains with additional adaptor units. Price: £249.50 (plus VAT).

#### 4400 Report Stereo IC

$\frac{1}{4}$ -track versions of 4200. Specification almost identical. Price: £252.50 (plus VAT).

#### Variocord 263 Stereo

Transistor stereo mains recorder.  $\frac{1}{4}$ -track or  $\frac{1}{2}$ -track. Speeds:  $7\frac{1}{2}$  i/s,  $3\frac{3}{4}$  i/s,  $1\frac{7}{8}$  i/s. Max spool 7in. W and F:  $7\frac{1}{2}$  i/s 0.05%;  $3\frac{3}{4}$  i/s 0.1%. H and N:  $7\frac{1}{2}$  i/s  $-55$  dB/4 track (57dB/2 track);  $3\frac{3}{4}$  i/s  $-53$  dB/4 track (55dB/2 track);  $1\frac{7}{8}$  i/s  $-53$  dB/4 track (55dB/2 track). FR:  $7\frac{1}{2}$  i/s 30Hz-20kHz;  $3\frac{3}{4}$  i/s 30Hz-15kHz;  $1\frac{7}{8}$  i/s 30Hz-8kHz. Inputs: mic 0.16mV max 30mV; radio 1.8mV max 600mV; phono (1) 80mV max 7V, phono (2) 250mV max 25V. Outlets:  $2 \times 0.8$  V into 15K 2-track,  $2 \times 0.6$  V into 15 ohms 4-track. Output:  $2 \times 6$  W (sinusoidal),  $2 \times 9$  W (music). Level indicator meter. Interchangeable head assemblies. Input mixing. Horizontal or vertical operation. Price: ( $\frac{1}{4}$ -track version £233 (plus VAT)); ( $\frac{1}{2}$ -track version) £230 (plus VAT).

#### Uher 714L

Mains mono  $\frac{1}{2}$ -track recorder. Max spool 7in. Speed:  $3\frac{3}{4}$  i/s. W and F: 0.3%. S/N:  $>48$  dB. Inputs: mic 200 ohms, radio 47K, PU 1M. Output: 2W. Meter level indicator. Monitor facility. Auto shut-off at end of tape. Vertical or horizontal operation. Price: approximately £65 (including VAT).

#### Uher 5000 Universal

Mains  $\frac{1}{2}$ -track mono recorder. Speeds:  $3\frac{3}{4}$ ,  $1\frac{7}{8}$ ,  $\frac{1}{2}$  i/s. FR: 40Hz-15kHz  $\pm 3$  dB at  $3\frac{3}{4}$  i/s. Max. spool:  $5\frac{1}{2}$  in. W and F:  $3\frac{3}{4}$  i/s  $\pm 0.2\%$ . Inputs: mic 200 ohms, radio 47K, PU 1M. Solenoid operation for remote control working. All metal case. Large range of dictation and transcription accessories available. Price: approximately £135 (including VAT).

#### 5000 Language Tutor

Specification as for 5000 Universal except double  $\frac{1}{2}$ -track heads and  $3\frac{3}{4}$  i/s speed only. Top track playback only, lower track record and playback. Price: approximately £140.

#### 724 Stereo

Transistor stereo mains recorder.  $\frac{3}{4}$ -track. Speeds:  $3\frac{3}{4}$ ,  $7\frac{1}{2}$  i/s. W and F:  $7\frac{1}{2}$  i/s 0.2%;  $3\frac{3}{4}$  i/s 0.25%. FR:  $7\frac{1}{2}$  i/s 50Hz-20kHz;  $3\frac{3}{4}$  i/s 00Hz-15kHz. Inputs: mic 0.25mV 200 ohms; radio 4.7mV 47K; phono 130mV 1M. Outputs: line 0.7V 4.75K; speaker (2) 4W each into 4 ohms. Level indicator meter. Monitoring by phones or speakers. Vertical horizontal operation. Price: £176 (plus VAT).

# Test Tapes and Discs

Abbreviations used in this section are given on page 20.

## ■ AGFA-GEVAERT

Agfa-Gevaert Ltd, Great West Road, Brentford, Middlesex.  
Tel: 01-560 2131. Telex: 28154.

### Calibration Test Tape 38-25

Full-track recording. Speed: 15i/s. NARTB core. Magnetic coating out. 1in tape. Reference frequency: 1kHz. Gap adjustment frequency: 1kHz and 10kHz. Equalisation: 35µs. Gliding tone: 31.5Hz-18kHz. Blank sections as per DIN 45 513. Price: £39.60 (including VAT).

### Calibration Test Tape 38-12

Same specification as Tape 38-25 above but on ½in tape. Price: £20.90 (including VAT).

### Calibration Test Tape 38

Same specification as Tape 38-25 above but on ¾in tape wound on AEG core. Price: £11.33 (including VAT).

### Stereo Reference Tape 38

Recordings for both stereo channels and the separation track. Speed: 15i/s. Wound on AEG core. ¾in tape. Reference frequency: 1kHz. Gap adjustment recording: random noise. Equalisation: 35µs. Gliding tone: 63Hz-10kHz. Price: £11.30 (including VAT).

### Reference Tape 19-25

Full-track recording. Speed: 7½i/s. 1in tape. Wound on NARTB core. Reference frequency: 1kHz. Gap adjustment frequency: 1kHz and 10kHz. Equalisation: 70µs. Gliding tone: 31.5kHz-18kHz. Price: £39.60 (including VAT).

### DIN Reference Tape 19S (Studio)

Same specification as Reference Tape 19-25 but on ¾in tape. Price: £11.33 (including VAT).

### DIN Reference Tape 19H (Amateur)

Full-track recording. Speed: 7½i/s. ¾in tape type PE31. Spool with 3½in diameter. Magnetic coating in. Reference frequency: 1kHz. Gap adjustment frequency: 1kHz and 10kHz. Equalisation: 50/1590µs. Gliding tone: 31.5Hz-18kHz. Price: £11.33 (including VAT).

### DIN Reference Tape 9-5

Similar to Tape 19H above except speed 3¾i/s and reference frequency 333Hz. Gliding tone: 31.5Hz-12.5kHz. Price: £11.33 (including VAT).

### Magnetic Symmetry Tape

Available as tape or film in various widths. Full data and application sheet available on request.

## ■ AMPEX

Ampex G.B. Ltd, Magnetic Tape Division, Acre Road, Reading, Berks. RG2 0QR.  
Tel: Reading (0734) 84411.

For all pro audio tapes, including CCIR and NAB test tapes ¼in to 2in. Prices and details of specifications on request.

## ■ A.P.A.E.

Association of Public Address Engineers Ltd, 47 Windsor Road, Slough, Bucks.  
Tel: Slough (75) 31560.

### A.P.A.E. Test Disc

7in 45rpm double-sided mono disc for testing sound systems, particularly public address and sound reinforcement installations.

Side One consists of three minutes of male speech followed by three minutes of female speech. At end of male speech there is a period of 30 seconds of 'off-mic' speech to illustrate correct microphone technique.

Side Two starts with 60 test phrases selected for phonetic balance. The next two bands are 1000 Hz tone and warble tone, for equipment line-up and measurement with sound level meters. Final two bands are white noise and pink noise. Produced primarily for A.P.A.E. members the record is now available generally. Price: 70p (plus VAT) plus 12p postage.

## ■ BASF

BASF (UK) Ltd, PO Box 473, Knightsbridge House, 197 Knightsbridge, London, SW7 1SA.  
Tel: 01-584 5080. Telex: 267574/5.

### Calibration Tape 9

3¾i/s (9cm per second) full-track tape recorded to 90µs+3780µs characteristic. Range: 30Hz-16kHz in steps, also for azimuth alignment.

### Calibration Tape 19H

7½i/s (19cm per second) full-track tape recorded to 50µs+3780µs characteristic. Range: 30Hz-18kHz in steps, also section for azimuth alignment.

### Calibration Tape 19S

7½i/s (19cm per second) full-track tape recorded to 70µs characteristic. Range: 30Hz-18kHz in steps, also section for azimuth alignment.

### Calibration Tape 38

15i/s (38cm per second) full-track tape recorded to 35µs characteristic. Range: 30Hz-18kHz in steps, also gliding tone from 30Hz-16kHz and section for azimuth alignment.

### Calibration Tape 4-75

1¾i/s (4.75cm per second) full-track tape recorded to 120µs characteristic. Range: 30Hz-10kHz in steps, also section for azimuth alignment.

★ Indicates entry is illustrated

### **Stereo Test Tape 38**

15i/s (38cm per second) test tape used in conjunction with Calibration Tape 38 for aligning stereo recorders. Contains: (1) tone level section of 1kHz for 15 seconds on each channel, (2) track position section of 1kHz, (3) azimuth alignment section of noise containing frequencies from 5-6kHz to 16kHz across the full tape width, (4) cross-talk section of 63Hz for 8 seconds on each channel 1kHz for 8 seconds on each channel and 10kHz for 8 seconds on each channel.

### **Alignment Tape**

3 $\frac{3}{4}$ i/s (9cm per second) tape used for adjusting replay heads. Noise is recorded full-track, with track 3 erased. Frequency 5-6kHz to 16kHz.

### **Azimuth Test Tape**

Used for aligning replay heads at tape speeds of 7 $\frac{1}{2}$ i/s, 15i/s, and 30i/s. A high frequency is recorded on two 2.75mm edge tracks, and their phase relationship is switched alternately from +45° -45° every second at 15i/s. The replay head is correctly adjusted when there is maximum output without level variations. In stereo both replay channels must be phase-correct.

### **Calibration Tape**

Speed: 1 $\frac{7}{8}$ i/s. Equalisation: 120 $\mu$ s+1590 $\mu$ s. Range: 30Hz-10kHz in steps. Section for azimuth alignment. In cassette or on spool.

### **Calibration Tape**

Speed: 1 $\frac{7}{8}$ i/s. Equalisation: 70 $\mu$ s+1590 $\mu$ s. Range: 30Hz-12.5kHz in steps. Section for azimuth alignment. In cassette or on spool.

### **Speed Test Tape**

Speed: 1 $\frac{7}{8}$ i/s. For control of speed on compact cassette tape machines.

### **Wow and Flutter Test Tape**

Speed: 1 $\frac{7}{8}$ i/s. For control of wow and flutter on compact cassette tape machines.

### **Service Cassette**

Speed: 1 $\frac{7}{8}$ i/s. For fast control of compact cassette machines. Tests for level, speed, wow and flutter, azimuth and frequency response. Equalisation: 120 $\mu$ s+1590 $\mu$ s.

### **Dolby-B Cassette**

Speed: 1 $\frac{7}{8}$ i/s. Frequency: 400Hz. For alignment of compact cassette recorders with Dolby-B system.

Prices of calibration and test tapes available on request.

### **DEUTSCHE GRAMMOPHON**

Polydor Ltd, 17 Stratford Place, London, W1N 0BL. Tel: 01-499 8686.

### **101497**

Stereo 7in 45rpm record providing tests for balance, phase, music, voice and effects. Price: on application.

### **EMI RECORDS**

EMI Records Ltd, EMI House, 20 Manchester Square, London, W1. Tel: 01-486 4488.

### **TCS102**

12in stereo record at 33 $\frac{1}{3}$ rpm. 30Hz-20kHz gliding tone.

### **TCS101**

12in stereo record at 33 $\frac{1}{3}$ rpm. 30Hz-20kHz in bands.

### **TCS104**

12in mono record (lateral) at 33 $\frac{1}{3}$ rpm.

### **TCS105**

12in mono record (vertical) at 33 $\frac{1}{3}$ rpm.

Prices and further details of EMI test records available on request.

### **EMI SERVICE DIVISION**

EMI Sound and Vision Equipment Ltd, 252 Blyth Road, Hayes, Middlesex, UB3 1HW. Tel: 01-573 3888.

### **SRT19**

Test tape at 3 $\frac{3}{4}$ i/s with 90+3180 $\mu$ s characteristic. Full-track recording. Spoken announcements followed by 30Hz-14kHz in bands. Section of 3kHz tone for checking wow and flutter, also strobe markings for checking speed.

### **SRT18**

Test tape at 7 $\frac{1}{2}$ i/s with 70 $\mu$ s characteristic. Full-track recording. Spoken announcement followed by 30Hz-16kHz in bands. Section of 3kHz tone for checking wow and flutter, also strobe markings for checking speed.

### **SRT17**

Test tape at 15i/s with 35 $\mu$ s characteristic. Full-track recording. Spoken announcement followed by 30Hz-20kHz in bands. Section of 3kHz tone for wow and flutter check also strobe markings for checking speed.

### **TBT.1A**

Test tape at 7 $\frac{1}{2}$ i/s with 100 $\mu$ s characteristic for domestic recorders. Full-track recording 8kHz section for azimuth adjustment, followed by 40Hz-12kHz.

### **TBT.2A**

Test tape at 3 $\frac{3}{4}$ i/s with 120 $\mu$ s characteristic for domestic recorders. Full-track recording. 6kHz section for azimuth adjustment, followed by 40Hz-8kHz.

### **SRT.18C**

Test tape at 7 $\frac{1}{2}$ i/s with 70 $\mu$ s characteristic. Full-track recording spoken announcement followed by 30Hz-16kHz in bands. Wound into broadcast type cartridge.

Prices and further details of EMI test tapes available on request.

## ■ HI-FI SOUND

Distributors: Howland-West Ltd,  
3-5 Eden Grove, London, N7 8EQ.  
Tel: 01-609 0293.

### Test record HFS69

Side 1. Test 1, channel recognition, phasing and balance using transient random noise bursts with spoken announcements recorded in free-air conditions. Test 2, white noise (monophonic) for subjective evaluation of pickups and speakers and for setting up tape recorder bias and heads. Test 3, determination of side-thrust adjustment and minimum tracking weight of pickup by means of lateral and vertical modulations in four different bands. Test 4, applause—for identifying greatest possible number of individual sounds. Test 5, music.

Side 2. Test 1, reference level and channel separation at 1kHz 5cm/sec 45 degrees. Test 2, pink noise producing constant energy per octave. Test 3, tone bursts—eight bands of 1kHz tone in bursts on separate channels at 7 or 10 cm/sec. Test 4, wow and flutter, lateral cut 5cm/sec 3kHz for use with wow and flutter meters, also concentricity check. Test 5, rumble, lateral cut 10cm/sec 1kHz tone followed by unmodulated grooves. Price: £1.22 (including VAT).

## ■ PYE

Pye Business Communications,  
Cromwell Road, Cambridge, CB1 3HE.  
Tel: Cambridge (0223) 45191.

7in 45rpm record. Side One: (mono) For the Love of Mike—information on use and installation of microphones. Side Two: (stereo) stereo tests. Sent free on request.

## ■ DECCA

The Decca Record Co Ltd, Decca House,  
9 Albert Embankment, London, SE1 7SW.  
Tel: 01-735 8111.

### How to give yourself a stereo check-out

Stereo SKL-4861. The record is designed to provide a means for the exacting listener to check the performance of his equipment without the need for expensive and complicated instruments. Side One starts with a short explanation of the purpose of the record and there is a detailed account of each band and how the information should be used on the sleeve. Side One: (1) Introduction, (2) left-right channel identification, speaker balance, channel phasing, (3) mono music, (4) tone controls, (5) sound colouration, (6) stereo music, (7) groove-jumping and distortion, (8) silent grooves. Side Two: (1) live versus recorded sound, (2) wow and flutter, (3) anti-skating band, (4) crosstalk, (5) musical show-piece. Price: approximately £2.15 (including VAT).

## ■ TUTCHINGS ELECTRONICS LTD

14 Rook Hill Road, Friars Cliff, Christchurch,  
Hants, BH23 4DZ.  
Tel: Highcliff (042 52) 72019.

### Test Tape No. 1

Pure tones 40Hz-10kHz with voice identification of each band. Recorded to IEC 70 plus 3180 microsecond characteristic at  $7\frac{1}{2}$ i/s. Track 2 carries continuous 7.5kHz tone for azimuth alignment.

This tape is used to measure the playback frequency response of  $\frac{1}{4}$ -track and  $\frac{1}{2}$ -track recorders. 3in spool. Price: £2 (including VAT and postage).

### Test Tape No. 2

Pure tones 40Hz-7.5kHz with voice identification of each band. Recorded to NAB 90 plus 3180 microsecond characteristic at  $3\frac{3}{4}$ i/s. Track 2 carries continuous 7.5Hz tone for azimuth alignment.

This tape is used to measure the playback frequency response of  $\frac{1}{4}$ -track and  $\frac{1}{2}$ -track recorders. 3in spool. Price: £2 (including VAT and postage).

### Test Cassette No. 1

Track 1. Frequency run 7500Hz to 40Hz followed by 7500Hz azimuth alignment tone.

Track 2. 50Hz speed test. Set recorder speed for zero beat with 50Hz mains supply. Price: £2 (including VAT and postage).

### Test Tape No. 3

One third octave bands of filtered white noise covering range 40Hz-10kHz with voice identification of each band. Recorded to IEC 70 plus 3180 microsecond characteristic at  $7\frac{1}{2}$ i/s.

This tape is used to measure acoustic responses of recorders, microphones and loudspeakers. On 3in spool. Price: £2 (including VAT and postage).

### Test Tape No. 4

One octave bands of filtered white noise with centre frequencies 100Hz-6.4kHz with voice identification of each band. Recorded to IEC 70 plus 3180 microsecond characteristic at  $7\frac{1}{2}$ i/s. Track 2 carries full range of unfiltered white noise.

This tape is used for reverberation and transmission tests of rooms, studios, etc. It can also be used for subjective testing of room acoustics and listening tests on loudspeakers and enclosures. On 3in spool. Price: £1.50 (plus 5p packing and postage).

### Test Tape No. 5

Azimuth and vertical head alignment tape. Full track white noise with track 3 blank. Allows accurate setting of height and azimuth of  $\frac{1}{4}$ -track heads by ear, using no test equipment at all. On 3in spool. Price: £2 (including VAT and postage).

# Aerialite's new range of Stereo Aerials for perfect stereo reception!



Model FMS 100



Model FMS 200

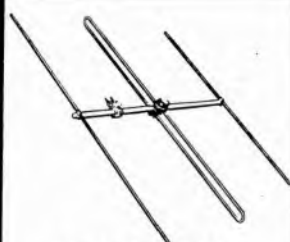

Model FMS 300



Model FMS 400



Model FMS 600



Loft Mounting Kit

For the precise subtlety of stereo radio reception which today's audio equipment can provide, a top quality stereo aerial is an absolute necessity. With a good VHF/FM aerial, both the strength and quality of the incoming signal are considerably improved, eliminating back-ground noise, interference and poor reception in general. All that remains is pure stereo sound, distinct yet sophisticated. Aerialite's extensive research and experience in this field have produced an unparalleled range of stereo aerials. Constructed to the most advanced design specifications, Aerialite's stereo aerials incorporate all those qualities which are vital for flawless stereo radio reception.



Perfect stereo reception demands top quality low loss coaxial cables. Insist on the best - insist on Aerialite!



## Aerialite's great new range is available NOW!



**Aerialite Aerials Ltd. DELTA**

Radnor Park Trading Estate, West Heath, Congleton, Cheshire  
CW12 4PX. Telephone: Congleton 3892. Telex: 669640.

# Antiference Excel...

## Advanced Mushkillers

Superlative quality in FM aerials. Antiference gives you the critical all-round performance that stereo demands. Unique Tru-match dipole on higher gain models gives wider, more even bandwidth response, low VSWR... a stronger, cleaner signal.



## NEW Rotenna aerial rotators

Latest winner from Antiference...bringing in more FM stations, opening up TV options. Handsome solid state control unit, with a knob you simply set to a bearing and press. A rotor unit turns your aerial to 'zero in' on a transmitter. Choice of mast-clamping or heavy duty in-line rotor units.

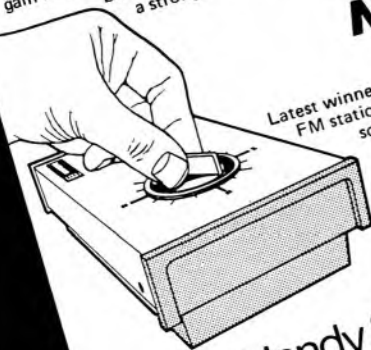

## NEW Handy Stereopacks

Carrying that Antiference excellence through the whole range of aerial aids you need. Cable connectors, plugs, wall sockets, flyleads, in-line attenuators... all packed with instructions complete. See and choose them from the Stereopacks dispenser in your local electrical or hi-fi dealer.



**NEW Masthead amplifier.** Another new FM aid. Widening your horizons with even higher gain... a low-noise amplifier and power unit tuned for top performance over FM band.

in  
**FM Stereo  
Reception**

# Antiference

Antiference Limited Aylesbury Bucks HP19 3BJ Tel 82511



# FM/VHF Aerials

★ Indicates entry is illustrated

Abbreviations used in this section are given on page 20.

## ■ AERIALITE

Aerialite Aerials Ltd, Radnor Park Trading Estate, West Heath, Congleton, Ches, CW12 4PX. Tel: Congleton (026 02) 3892.

Aerialite also manufacture a range of vertical rod-type aerials and anti-static systems.

### FMS100

FM/stereo single dipole with straight stand-off arm and 1-2in bracket. Price: £2.42 (plus VAT).

### FMS200

FM/stereo dipole and reflector array with 1-2in mast attachment bracket. Price: £3.25 (plus VAT).

### FMS300

FM/stereo three-element array with 1-2in mast attachment bracket. Price: £4.84 (plus VAT).

### FMS400

High power stereo four-element array with 1-2in mast attachment bracket. Price: £5.28 (plus VAT).

### FMS600

Six-element extra high power (array only) stereo/FM, with 1-2in mast attachment bracket. Price: £8 (plus VAT).

## ■ ANTIFERRENCE

Antiferrence Ltd, Bicester Road, Aylesbury, Bucks. Tel: Aylesbury (0296) 82511. Telex: 83666.

### FM214/1A

Single dipole complete with 7in stand-off arm and universal clamp for easy attachment to existing masts. For areas close to a transmitter. Price: £2.10 (plus VAT).

### FM214/EM

Single dipole aerial complete with Easimount bracket for surface mounting on wall, window frame or under eaves. Suitable for good reception areas close to a transmitter. Price: £2.20 (plus VAT).

### FM224 Mushkiller

Dipole and reflector 'H' type array. Complete with universal mast/boom clamp. For use in good reception areas. Price: £2.80 (plus VAT).

### FM233 (loft) Mushkiller ★

Three-element folded dipole array complete with loft mounting arm, bracket and clamp. Useful for locations where outdoor arrays are not permitted. Price: £2.95 (plus VAT).

### FM234T Mushkiller

Three element array with tru-match dipole, complete with universal mast/boom clamp, for medium range FM stereo reception. Price: £4.70 (plus VAT).

### FM224T Mushkiller

Four element array with tru-match dipole, complete with universal mast/boom clamp. The most popular FM stereo array. Price: £5.10 (plus VAT).

### FM244 Mushkiller

Four-element folded dipole array. Complete with universal mast/boom clamp. Suitable for medium and long-distance reception. Price: £4.60 (plus VAT).

### FM264T Mushkiller ★

Six element array with tru-match dipole, complete with universal mast/boom clamp. The ultimate for medium and long-range FM stereo reception. Price: £7.75 (plus VAT).

### TRR/V/SP Receiver Transformer

Matches 75 ohms coaxial input feeder into 300 ohms aerial sockets on continental and Japanese tuners and tuner/amplifiers. Price: £1.18 (plus VAT).

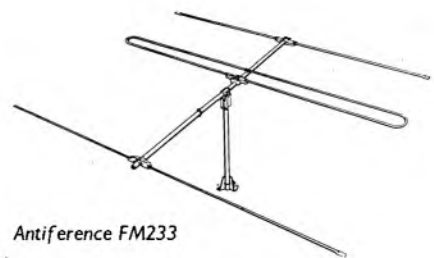

Antiferrence FM233

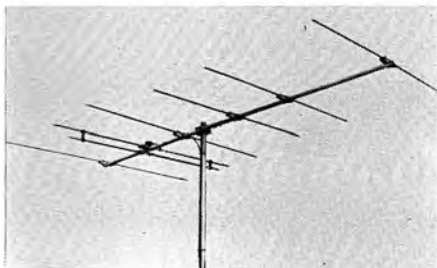

Antiferrence Mushkiller FM264T



# Our gain is your loss!

Achieving high gain with our Stereobeam aerial is the sure way to lose the annoying background noise which interferes with stereo reception. You expect quality reproduction from your hi fi equipment, yet may be accepting poor radio sound. Until you know the difference a Stereobeam aerial can make. However sophisticated the tuner may be, it can only provide peak performance when supplied with the right signal. And that means Stereobeam. The way to better stereo reception. Ask your hi fi stockist.



Associate member  
N.F.A.C.



**Jaybeam Limited**

Moulton Park Industrial Estate,  
Northampton NN3 1QQ.  
Tel: 0604 46611.

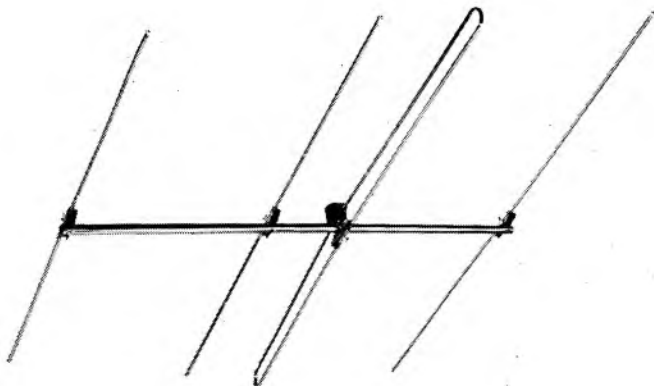

★ Indicates entry is illustrated

### ■ BEN NEVIS AERIALS

Belmont Works, Belmont Site, Lewis Street,  
Stranraer, Scotland, DG9 7AS.  
Tel: Stranraer 2677/8.

#### Ben Nevis TM902-1

Band II single dipole with stand-off arm and  
universal mast clamp for 1-2in masts. Price:  
£2.73 (including VAT).

#### Ben Nevis TM902-2

Band II dipole and reflector with boom and  
stand-off arm and universal mast clamp. Price:  
£3.65 (including VAT).

#### Ben Nevis TM902-3

Band II three-element array comprising direc-  
tor, folded dipole and reflector, with stand-off  
arm and universal mast clamp. Price: £5.45 (in-  
cluding VAT).

#### Ben Nevis TM902-4

Band II four-element array comprising two  
directors, folded dipole and reflector, with  
stand-off arm and universal mast clamp. Price:  
£5.94 (including VAT).

VHF aerials custom-built to individual cus-  
tomer's specification.

### ■ EAGLE

Eagle International Ltd, Heather Park Drive,  
Wembley, Middlesex, HA0 1SU.  
Tel: 01-901 0144.

#### FMA 20

Band II FM Aerial Outdoor or left mounting  
3dB gain. Price: £2.75 (including VAT).

#### FMA 10

Band II dipole for left mounting. Price: £1.65  
(including VAT).

### ■ JAYBEAM

Jaybeam Ltd,  
Sandfield Close, Moulton Park  
Industrial Estate, Northampton, NN3 1QQ.

#### Stereobeam SBM1 ★

Band II folded dipole with 6in stand-off arm f.c.  
attaching to existing mast. Suitable for local  
service areas. Price: £2.58 (including VAT).

#### Stereobeam SBM2 ★

Band II folded dipole and reflector on boom.  
Supplied complete with fixing clamp for masts  
up to 2in diameter. Gain: 3dB. Reduces inter-  
ference from rear. Price: £3.47 (including VAT).

#### Stereobeam SBM3 ★

Band II aerial comprising folded dipole, reflector  
and director on boom. Supplied complete with  
clamp to fit masts up to 2in diameter. Gain:  
6dB. Gives protection against signals more than  
40° off bearing. Price: £5.17 (including VAT).

#### Stereobeam SBM4 ★

Band II aerial comprising folded dipole, reflector



Jaybeam Stereobeam SBM1



Jaybeam Stereobeam SBM2



Jaybeam Stereobeam SBM3

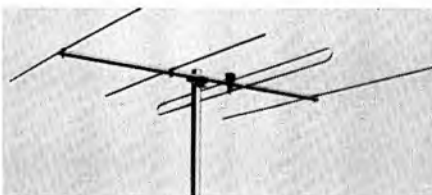

Jaybeam Stereobeam SBM4

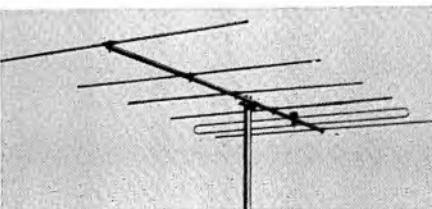

Jaybeam Stereobeam SBM6

and two directors on boom. Supplied complete with clamp to fit masts up to 2in diameter. Suitable for medium fringe areas where large input signal is required for optimum performance. Gain: 7dB. Price: £5.66 (including VAT).

#### **Stereobeam SBM6 ★**

High-gain Band II aerial comprising folded dipole, reflector and four directors on boom. Supplied with clamp to fit masts up to 2in diameter. Suitable for use over the whole of the FM/VHF band, including the more powerful continental stations in favourable locations. Gain: 8.5dB. Price: £8.52 (including VAT).

#### **Stereobeam room aerial ★**

Band II compressed dipole using inductive loading. Suitable for areas of high signal strength. Can be stood on base or fixed to wall. Supplied complete with lead and plug. Price: £2.75 (including VAT).

#### **Stacking kit PM3**

For extreme long range reception two SBM4 or SBM6 arrays can be stacked together using phasing and matching harness PM3. Price: £2.58 (including VAT).

#### **2010/220 Aerial Rotator**

Control unit with position selector knob, plus motor unit for driving aerial. Operation indicated by signal lamps. Motor 20V 65W. 360° rotation. Suitable for 220-240V AC only. Speed: one revolution in 50 sec. Magnetic disc brake and self-restraining worm-gear drive hold aerial in chosen position. Five-core control cable available separately (see below). Price: £34.10 (including VAT).

#### **2030/220 Multimatic Aerial Rotator**

Control unit with position selector knob, direction indication shown by flashing light that follows to position set. Motor 20V 65W. 360° rotation, suitable for 220-240V AC only. Speed: one revolution in 50 secs. Magnetic disc brake and self-restraining work gear drive hold aerial in chosen position. Four-core control cable available separately (see below). Price: £35 (plus VAT).

#### **Control cable**

Five-core colour-coded control cable available in 20 metre or 50 metre lengths. Price: C5/20 £3.85; C5/50 £9.62 (both including VAT).

#### **RZ100**

Alignment bearing suitable for use with the above-mentioned equipment. Price: £8.36 (including VAT).

#### **■ K.V.A. ELECTRONICS**

40 Monarch Parade, London Road, Mitcham, Surrey. Tel: 01-648 4884.

#### **FML**

Band II loft dipole. Two-screw fixing bracket,

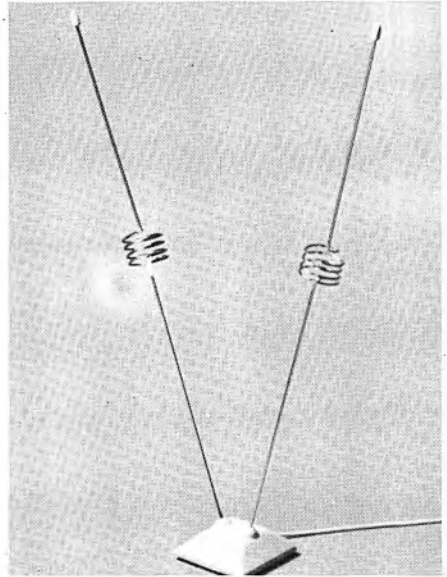

*Jaybeam Stereobeam room aerial*

rotatable base, arms of dipole adjustable to V for optimum results or to clear obstructions. Price: £1 (plus VAT).

#### **FM/SD/W**

Band II wall-mounting single dipole with fixing bracket, stand-off arm and provision for swivelling aerial for optimum results. Price: £2 (plus VAT).

#### **FML/H**

Band II loft-type H aerial comprising dipole, reflector, mounting boom and stand-off arm. Fixing bracket permits aerial to be orientated for best results. Price: £2 (plus VAT).

#### **FML/Y3**

Band II three-element loft array comprising director, folded dipole and reflector with stand-off arm and fixing bracket. Particularly suitable in areas where signal strength is poor or where 'ghosting' causes distortion. Price: £3.25 (plus VAT).

#### **FML/Y4**

Similar to FML/Y3 but with two directors. Price: £3.50 (plus VAT).

#### **■ MAXVIEW**

Maxview Aerials Ltd, Maxview Works, Setch, King's Lynn, Norfolk.  
Tel: Watlington (055 381) 376.

#### **Maxview D/DW**

Band II wall-mounting dipole with stand-off arm and adjustable swivel fitting. Price: £2.15 (plus VAT).

★ Indicates entry is illustrated

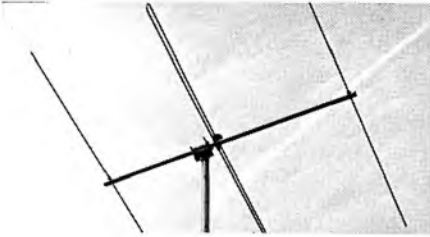

Maxview D/FD3

#### Maxview D/DM

Band II dipole array with bracket for mast fitting. Price: £1-83 (plus VAT).

#### Maxview D/HM

Band II array comprising dipole and reflector on boom. Bracket for mast mounting. Price: £2-54 (plus VAT).

#### Maxview D/S3

Band II three-element array comprising director, dipole and reflector. Bracket for mast mounting. Price: £2-94 (plus VAT).

#### Maxview D/FD3 ★

Band II three-element array comprising director, folded dipole and reflector. Bracket for mast mounting. Price: £3-67 (plus VAT).

#### Maxview D/STB

Band II Twig stub add-on units for TV aerials to boost Band II reception. Price: 67p (plus VAT).

#### ■ PREMIER

Premier Industries Ltd, 343/345 High Street, Cheltenham Spa, Gloucestershire GL50 3HS. Tel: Cheltenham (0242) 27782/52999.

#### Clarity C4

Four-element Band II array comprising two directors, folded dipole and folded reflector. Price: £5-78 (including VAT).

#### Clarity C6

Six-element Band II array comprising four directors, folded dipole and folded reflector. Price: £9-54 (including VAT).

#### Clarity PH/ST

Phasing harness for coupling two C4 or two C6 arrays for extra long distance reception. Price: £1-89 (including VAT).

#### Vorta Mk VI

Dome Antenna. Omni-directional stereo enclosed aerial. Price: £17-93 (including VAT).

#### ■ SPECTRUM AERIALS LTD

Thirsk Place, Osmaston Park Industrial Estate, Derby, DE2 8JJ. Tel: Derby 32094/362936.

#### Dipole

Band II VHF radio dipole. Price: £1-20 (plus VAT).

#### H Array

Band II VHF radio H array. Price: £1-88 (plus VAT).

#### Three-element dipole

Band II VHF radio array comprising director, dipole and reflector. Price: £3 (plus VAT).

#### Three-element folded dipole

Band II VHF radio array comprising director, folded dipole and reflector. Price: £3-20 (plus VAT).

#### Four-element

Band II VHF radio array comprising two directors, dipole and reflector. Price: £4 (plus VAT).

#### ■ VISTA GAIN

Vista Gain Sales Co, 123-124 Newgate Street, London, EC1A 7AA. Tel: 01-600 3030.

#### K.2

Band II indoor dipole. Heavily-plated three-step telescopic dipole adjustable for optimum results. Capacity coupled elements for complete safety. Heavy base. Supplied with three yards low-loss coaxial cable. Price: approximately £2-70 (plus VAT).

#### ■ WOLSEY ELECTRONICS

Cymmer Road, Porth, Rhondda, Glamorgan, CF39 9BT. Tel: Porth (044 361) 2711.

Telex: 49606.

#### FM/DD

Band II single dipole for loft or room mounting. Price: £1-90 (plus VAT).

#### FM/DU

Band II single dipole for outside masthead mounting. Supplied with fixing clamp. Price: £2-20 (plus VAT).

#### FM/HU

Band II dipole with reflector for outside mounting. Supplied with fixing clamp. Price: £3-20 (plus VAT).

#### FM/4U

Band II four-element array comprising folded dipole, two directors, one reflector. Supplied with fixing clamp. Price: £5-20 (plus VAT).

#### Clearsound FM Amplifier

Signal booster for use with FM/4U four element array to boost wanted weak station without introducing distortion from strong unwanted stations. Designed to be fitted to aerial mast, weatherproofed. Supplied with power unit. Price: £22 (plus VAT).

# Vorta

## SYSTEMS (UK) INTRODUCE THE

# NEW

### Quinphonic & Octaphonic

5 & 8 Element

## STEREOPHONIC / QUADRAPHONIC AERIALS for

# FM

## RECEPTION

- ★ SUPERBLY BUILT
- ★ 25mm SQUARE BOOM
- ★ 12mm dia ELEMENTS
- ★ ALL PLATED STEEL FITMENTS
- ★ 75/300ohm BALUN INCORPORATED IN THE LARGE INSULATOR
- ★ TILT CLAMP FOR UP TO 50mm MAST DIAMETERS
- ★ TOTALLY COLLAPSES TO LESS THAN 59" x 7" x 7"
- ★ ASSEMBLED IN MINUTES
- ★ FULLY GUARANTEED

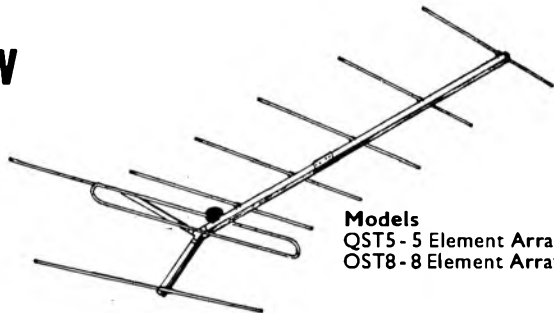

**Models**  
QST5 - 5 Element Array  
OST8 - 8 Element Array

SOLE DISTRIBUTORS

**Premier Industries (Cheltenham) Ltd.**

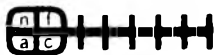

343-345 HIGH STREET, CHELTENHAM, GLOUCESTERSHIRE, ENGLAND.

Tel: CHELTENHAM 27782 also 52999 or 3116

# WIRELESS WORLD ANNUAL

A new publication from Wireless World contains three new constructional projects; design articles on loudspeakers, aerials, features on quadraphony, broadcasting, electronics in space and many other topics of interest. Available now from leading bookstalls Price £1 or direct from General Sales Manager, IPC Electrical-Electronic Press Ltd, Room 11, Dorset House, Stamford St., London SE1 9LU, Price £1.35 inc. p.p.

# Stop Press

This section comprises product details that arrived too late for inclusion in the main text. For addresses, refer to the manufacturers' directory. Abbreviations, page 20.

## Amplifiers & Control Units

### ■ DENON

*See Johnsons of Hendon Ltd.*

**PMA-500** integrated amplifier. Output: 40W/channel into 8 ohms. THD: < 0.03% at -3dB of rated output. Power Bandwidth: 5Hz-35kHz, -1dB. Inputs: power amp 1V 100K, phono (1&2) 2mV 60K, mic 1mV 100 ohms, aux (1&2) 100mV 60K, tape PB 500mV 100K. S/N: phono 65dB, mic 55dB all others 75dB. Price: to be announced.

**PMA-350Z** integrated amplifier. Output: 27W/channel into 8 ohms. THD: < 0.1% at rated output. Power bandwidth: 30Hz-30kHz±0, -1dB. Inputs: power amp 1V 90K, phono (1&2) 2mV 60K. Tuner 100mV 100K, aux 100mV 100K, tape PB 320mV 100K. S/N: phono better than 62dB, all others better than 73dB. Price: to be announced.

### ■ FERROGRAPH

*See Ferrograph Co. Ltd.*

**F208** integrated stereo amplifier. Output: 20W/8 ohms per channel. Size: 18 × 5 × 8 $\frac{3}{4}$  in. Teak, walnut or white finish. Price: £78 (plus VAT).

## Cassette Recorders

### ■ AIWA

*See Johnsons of Hendon Ltd.*

**Model AD1500** Stereo cassette deck. Fitted with Dolby noise reduction. No further details available at time of going to press. Price: £167.86 (including VAT).

### ■ N·E·A·L

*See North East Audio Ltd.*

**Model 102** transcription cassette recorder. Dolby "B". 3M Wollensak deck. Two peak programme meters. Chrome and ferric tape equalisation and bias. Controlled headphone output. Separate input amplifiers for mic. W & F: less than 0.15% RMS (DIN). Rec. amp. distortion: less than 0.1% at 0dB. Inputs: mic 250 $\mu$ V 2.5K, high level 80mV 2M, low level 2.25mV 5K. Rep. amp distortion: less than 0.1% at 0dB. Equalisation: CrO<sub>2</sub>: 70/3180 $\mu$ s. Ferric oxide: 120/3180 $\mu$ s.

Outputs: Mon 110mV 4.7K, line (DIN) 2V 1K, phones 2V 50 ohms, output levels referred to 220nWb/m flux density: FR: (ferric tape) 35Hz-12kHz+1dB, -3dB. CrO<sub>2</sub> tape 35Hz-15kHz+1dB, -3dB. S/N: (CrO<sub>2</sub>, Dolby off) 55dB, (ferric LH, Dolby off) 53dB. Price: on application.

## Headphones

### ■ MARANTZ

*See Pyser Ltd.*

Electrostatic Headphones, model **SE-15**. FR: 20Hz-20kHz±3dB. Distortion: 0.5% at all frequencies from 40Hz-20kHz and up to 100dB SPL. Automatic limiting of very loud passages. Impedance: 30 ohms. Weight: 14oz. Supplied with EE-1 energiser which has built-in speaker/headphone switching and will accept up to two headphones. EE-1 switches off if severely overdriven. Price: £59.50 (plus VAT).

### ■ SCINTREX HEADPHONES

*See Impo Hi-Fi*

Model numbers and prices only available at time of going to press. Model 88, £12 (including VAT); Model 98, £18 (including VAT); Model Mk IV £24 (including VAT); Model PRO-500, £32 (including VAT); Model HQ-4, £34 (including VAT); Model Supra £16 (including VAT).

## Magnetic Tape

### ■ MUSONIC

*See Musonic Ltd.*

**MT1** C60 professional low noise cassette. Price: 70p (including VAT).

**MT2** C90 professional low noise cassette. Price: 92p (including VAT).

**MT3** C120 professional low noise cassette. Price: £1.17 (including VAT).

**MT4** 8-track cartridge. Eighty minutes. Price: £1.96 (including VAT).

### ■ NAKAMICHI

*See Natural Sound Systems Ltd.*

Chrome Dioxide cassettes in snap packs. Price: C60 £3.06 (including VAT); C90 £3.69 (including VAT).

### ■ RACIAL ZONAL

*See Cinesound*

**Low Noise Cassettes** C60 Price: 55p (including VAT); C90 Price: 75p (including VAT); C120 Price: £1.10 (including VAT).

★ Indicates entry is illustrated

## Radio Tuners

### ■ SHARP

See *Sharp (UK) Ltd.*

**ST-511H** FM/AM stereo tuner. Bands: 88-106MHz FM, 520-1620kHz AM. Manual tuning, centre zero meter. Sensitivity: 1.6V IHF (FM), 100 $\mu$ V AM. Aerial: 300ohms. S/N: 75dB. Distortion: 0.3% mono, 0.5% stereo. Output: 0.4-1.2V (aux) 30-90mV (tape), into 100 ohms 100K. Mains: 110, 220, 240V AC. Size: 360 $\times$ 240 $\times$ 130mm. Teak finish. Price: £87.95 (including VAT).

## Receivers

### ■ ALPHA

See *Highgate Acoustics*

**FR5000** Stereo VHF/AM receiver. VHF 88-108MHz, MW 535-1605kHz. Variable tuning. AFC. Sensitivity: VHF (IHF) 3 $\mu$ V, AM 25 $\mu$ V. Aerial impedance: 300(75) ohms. S/N ratio: (VHF) IHF 50dB. Output voltage: 250mV. Load impedance: 100K. Mains: 110-240V AC. Loudness control, low filters, high filters. Size: 16 $\frac{3}{8}$  $\times$ 11 $\frac{3}{8}$  $\times$ 5 $\frac{1}{2}$ in. Finish: teak with brushed aluminium front. Price: £97.90 (including VAT).

**FR6000** Same specifications as FR5000 except sensitivity for VHF is 2 $\mu$ V. Size: 17 $\frac{1}{2}$  $\times$ 11 $\frac{3}{8}$  $\times$ 6 $\frac{3}{8}$ in. Price: £108.90 (including VAT).

### ■ HARMON KARDON

See *Highgate Acoustics*

**Citation 15** Stereo FM receiver. Bands: 88-105MHz. Manual tuning, meter. Sensitivity: 2.0 $\mu$ V IHF. Aerial: 75 or 300 ohms. S/N: -70dB THD: mono 0.25%, stereo 0.35%. Output voltage: 2V fixed and 2V variable into 100K. Mains: 110-240V. Size: 16 $\times$ 13 $\frac{3}{8}$  $\times$ 4 $\frac{7}{8}$ in. Fitted with a patented signal-to-noise ratio meter. Price: £306.90 (including VAT).

### ■ K.L.H.

See *Webland International*

**Model 55** Stereo AM/FM receiver. Range: FM 87-109MHz. MW 182-571m. Variable tuning. Signal strength meter. Usable sensitivity: FM 2.0 $\mu$ V. MW 300 $\mu$ Vm. Built in FM and AM aeriels. Stereo decoder, 3 gang. FM FET front end. Inputs: phono, 2.5 $\mu$ V 47K, aux 330 $\mu$ V 55K, tape mon. 330 $\mu$ V 55K. S/N ratio: phono 55dB, aux 67dB. Tape mon 67dB, FM 60dB, AM 40dB. Tone controls: bass  $\pm$ 10dB at 100Hz, treble  $\pm$ 10dB at 10kHz. HI filter: -3dB at 4.2kHz. 6dB/octave slope. Loudness:

+10dB 100Hz, +3dB 10kHz. Balance and volume controls: output 13W RMS per channel, both driven into 8 ohms. THD <0.1% at 1W. IMD <0.5% at 1W. Power bandwidth: 20Hz-20kHz. FR: 15Hz-22.5kHz. Damping factor: >20. Walnut case included. Size (max): 5 $\frac{1}{4}$  $\times$ 16 $\frac{1}{2}$  $\times$ 19 $\frac{5}{8}$ in. Weight: 16 $\frac{1}{4}$ lb. Price: £109.50 (plus VAT).

**Model 52** Stereo AM/FM receiver. Range: FM 87-109MHz. MW 182-571m. Variable tuning. Signal strength and tuning meters. Usable sensitivity (FM) 1.8 $\mu$ V, (MW) 300 $\mu$ V/m. Built in FM and AM aeriels. Stereo decoder. 4 gang FM FET front end. Inputs: phono, 3.5 $\mu$ V 47K, aux 500 $\mu$ V 47K. Tape monitor, 500 $\mu$ V 47K. S/N ratio: phono 69dB, aux 75dB. Tape mon 75dB, FM 70dB, AM 50dB. Tone controls: bass  $\pm$ 10dB at 100Hz. treble  $\pm$ 10dB at 10kHz. HI filter -3dB at 3.5kHz, 6dB/octave slope. Loudness +10dB 100Hz, +3dB 10kHz. Balance and volume controls. Output 33W RMS per channel, both channels into 8 ohms. THD <0.1% at 1W. IMD <0.3% at 1W. Power bandwidth 15Hz-30kHz. FR: 15Hz-22.5kHz. Damping Factor: >20. Unconditionally stable. Walnut case included. Size (max): 5 $\frac{1}{4}$  $\times$ 18 $\times$ 18 $\frac{1}{2}$ in. Weight: 22 $\frac{1}{2}$ lb. Price: £159.50 (plus VAT).

### ■ TRIO

See *B & H Morris*

**KR7400** AM/FM stereo receiver. Bands: 88-108MHz plus AM/MW. Sensitivity: 1.7 $\mu$ V IHF (FM), 15 $\mu$ V (AM). Manual tuning. Aerial 75 and 300 ohms. Inputs: phono (1&2) 2.5mV 50K, aux 150mV 80K, tape play A & B 150mV 80K, mic 2.5mV 50K. S/N: phono 70dB, aux 90dB, tape play 90dB mic 65dB (IHF-A). Output: 63W/channel into 8 ohms, 75W/channel into 4 ohms at 1kHz. THD: 0.3% at rated power into 8 ohms. Power bandwidth: 10Hz-35kHz. Size: 480 $\times$ 151 $\times$ 344mm. Price: £227 (plus VAT).

**KR8340** Two-four receiver. FM/AM stereo and quadraphonic receiver. Bands: 88-108MHz FM, 540-1600kHz AM. Sensitivity: 1.9 $\mu$ V IHF (FM), 25 $\mu$ V (AM). Manual tuning. Signal strength meter. Aerial: 75 or 300 ohms. Inputs: phono (1&2) 1.5mV 100K, mic 2mV 15K, aux (1&2) 150mV 50K, tape play (A & B) 150mV 50K. Outputs: tape (A & B) 150mV 100K, DIN 40mV. S/N: phono 60dB, all other inputs 75dB ref full power. Damping factor: 30 at 1kHz into 8 ohms. Output power: 25W (4 channel) into 8 ohms, 60W (2 channel) into 8 ohms. Power bandwidth: 10Hz-45kHz. Size: 21 $\times$ 6 $\frac{3}{8}$  $\times$ 14in. All regular matrix and SQ sources decoded. CD-4 demodulator plugs in on rear panel. Price: £285 (plus VAT).

**KR6340 Two-four receiver.** FM/AM stereo and quadraphonic receiver. Bands: 88-108MHz FM, 540-1600kHz MW. Sensitivity: 2.0µV IHF (FM), 25µV (AM). Manual tuning. Signal strength meter. Aerial: 75 of 300 ohms. Inputs: phono 1.5mV 100K, aux 150mV 50K, tape play 150mV 50K. THD: 0.8% at rated power into 8 ohms. S/N: phono 60dB all others 75dB. Damping factor: 20 at 8 ohms (4 channel). Output power: 15W (4 channel) into 8 ohms. Power bandwidth: 20Hz-40kHz. Size: 19 × 6 × 14in. All regular matrix and SQ sources decoded. CD-4 demodulator plugs in on rear panel. Price: £199.50 (plus VAT).

### Cassette Recorders

#### ■ GOODMAN'S

*See Goodmans Loudspeakers Ltd.*

Cassette recorder **Model SCD-100.** No details available at time of going to press except it is a high quality machine with Dolby "B" noise reduction. Price to be announced.

### Tape Accessories

#### ■ AGFA-GEVAERT

*See Agfa-Gevaert Ltd.*

**DIN Reference tape 38** Full track recording. \*Tape speed 38cm/s (15i/s)  $\frac{1}{4}$ in Magnetron tape PER 525. Wound on to AEG core (=CCIR core =European core), magnetic coating out (=emulsion out=EO). Price: on application.

**Short-reference tape 38 (Kurztestband = KTB38)** Abbreviated version of the DIN reference tape 38. Full track recording\*. Tape speed 38cm/s (15i/s)  $\frac{1}{4}$ in Magnetron tape PER 525. Wound on to AEG core (=CCIR core =European core), magnetic coating out\* (=emulsion out=EO). Price: on application.

**DIN Reference tape 19S (for Studio equipment)** Full track recording. Tape speed 19cm/s ( $7\frac{1}{2}$ i/s)  $\frac{1}{4}$ in Magnetron tape PER 525. Spool with core of 80mm diameter. Magnetic coating in (=emulsion in = EI). Price: on application.

**DIN Reference tape 19H (for amateur recorders)** Full track recording. Tape speed 19cm/s ( $7\frac{1}{2}$ i/s)  $\frac{1}{4}$ in Magnetron tape PE31. Spool with core of 80mm diameter. Magnetic coating in (=emulsion in = EI). Price: on application.

**DIN Reference Tape 9:5** Full track recording. Tape speed 9.5cm/s ( $3\frac{3}{4}$ i/s)  $\frac{1}{4}$ in Magnetron tape PE31. Spool with core of 80mm diameter. Magnetic coating in (=emulsion in = EI). Price: on application.

#### ■ TOSHIBA

Toshiba (UK) Ltd, Toshiba House, Great South West Road, Feltham, Middlesex. Tel: 01-751 1281.

### Amplifiers and Control Units

#### SB-300

Stereo integrated amplifier with pseudo-quadraphonic loudspeaker matrixing. Power output 17W/channel. Price: £72.69 (plus VAT).

#### SB-500

Stereo integrated amplifier with speaker matrix circuit. THD: 0.4%. Output: 35W/8 ohms. Special condenser cartridge pre-amplifier for Toshiba cartridge plus additional phono (mag) input. Price: £159.54 (plus VAT).

#### SB404S

Four channel integrated amplifier. Output: 15W/8 ohms (4-channel). THD: 0.4%. Condenser cartridge pre-amplifier. RM system plus CD-4 adaptor terminals. Price: £145 (plus VAT).

#### SC-4105

Four channel SQ/RM decoder-amplifier. Power amplifier for rear channel speakers. Connects to any type of stereo amplifier with DIN socket and phono pre-out/in sockets. Price: £90.46 (plus VAT).

### Cassette Decks

#### KT403D

Cassette deck with noise suppression switch, 4 pole hysteresis motor, tape counter and twin VU meters. Slider volume controls. FR: 50Hz-10kHz. Price: £50.88 (plus VAT).

#### PT415

Cassette deck with DNL. FR: 50Hz-12kHz. Two VU meters, slider controls. Price: £81.76 (plus VAT).

#### PT470

Cassette deck with Dolby noise reduction, two VU meters, slider controls. FR: 40Hz-13kHz. Choice of 3 bias settings by selector switch, mechanical shut-off, tape counter. Price: £122.69 (plus VAT).

#### PT490

Cassette deck with same specification as PT470 but includes auto-reverse. Price: £140.88 (plus VAT).

### Headphones

#### HR50

Stereo headphone with channel changeover switch for binaural and cross-field stereo sounds. Price: £16.34 (plus VAT).



★ Indicates entry is illustrated

#### **HR40**

Four channel/2-channel compatible stereo headphone. Price: £29.95 (plus VAT).

#### **HR80**

Cross-field stereo headphone with removable, washable ear pieces. Price: £8.15 (plus VAT).

#### Pick-ups and arms

##### **C401S**

Direct electret transducer cartridge. FR: 20Hz-35kHz. Modulator and demodulator unnecessary. Used with SZ-200Y equalization amplifier where required. Price: (C401S) £54.44, (SZ-200Y) £22.64 (all plus VAT).

#### Radio Tuners

##### **ST-500**

FM/MW stereo tuner. Hi-blend switch, signal strength and centre channel meters, AFC switch, FM muting, output terminal for 4-channel broadcast decoder. Price: £99.54 (plus VAT).

#### Record Decks

##### **SR-300**

Record deck fitted with arm, plinth and cover. Four pole hysteresis motor, belt drive. Cueing and auto-return/stop facility. Price: £63.61 (plus VAT).

##### **SR-870**

Record deck fitted with arm, plinth and cover. Sixteen pole hysteresis motor, 31cm aluminium diecast platter. Fitted with C401S cartridge. Price: £113.19 (plus VAT).

##### **SR-510C**

Record deck fitted with arm, plinth and cover. Direct drive AC motor, electronic speed control through touch sensitive pads. Fitted with Toshiba C-404X electret cartridge with CD-4 stylus. Price: £199.54 (plus VAT).

##### **SA-304**

Stereo receiver with 4-channel decoder for RM/SQ and CD-4 adaptor terminals. Output: 15W/8 ohms (4-channel). THS: 0.8% FM/AM-MW bands. Price: £108.66 (plus VAT).

##### **SA-504**

Four channel stereo receiver, 35W/8 ohms (4-channel). THD: 0.4%. Condenser cartridge equaliser built-in. Includes RM/SQ decoder plus CD-4 adaptor terminals. FM/AM-MW bands. Price: £159.54 (plus VAT).

#### Receivers

##### **SA-300L**

FM/MW/LW receiver. Output 12W/8 ohms. THD: 0.8%. Price: £108.66 (plus VAT).

#### **SA500**

FM/MW receiver. Output: 35W/8 ohms. THD: 0.4%. Equalisation pre-amplifier for condenser cartridge. Price: £159.54 (plus VAT).

#### Tape Recorders and Decks

##### **PT862**

Stereo tape deck. 3 heads. Tape speeds: 4.75cm/s, 9.5cm/s and 19cm/s. FR at 19cm/s: 20Hz-25kHz. Sound-on-sound and echo, bias control and tape selector switch. Price: £113.61 (plus VAT).

##### **PT884**

Four channel playback, two channel record tape deck FR and facilities as for PT862. Price: £272 (plus VAT).

#### Speaker Enclosures

##### **SS-24**

Infinite baffle enclosure: 2 drive units. FR: 50Hz-20kHz. P.H.: 30W (max) 15W RMS. Impedance: 8 ohms. Size: 308 × 439 × 193mm. Price: £49.07 (plus VAT).

##### **SS-17**

Infinite baffle enclosure. 2 drive units. FR: 50Hz-20kHz. PH: 30W (max) 15W RMS. Impedance: 8 ohms. Size: 270 × 440 × 220mm. Price: £60 (plus VAT).

##### **SS-37**

Infinite baffle enclosure. 3 drive units. FR: 40Hz-20kHz. P.H.: 40W (max) 20W RMS. Impedance: 8 ohms. Size: 342 × 590 × 295mm. Price: £150 (plus VAT).

##### **SS-47**

Infinite baffle enclosure. 3 drive units. FR: 35Hz-20kHz. P.H.: 50W (max) 25W RMS. Impedance: 8 ohms. Size: 400 × 680 × 330mm. Price: £219.19 (plus VAT).

# You've asked for it!

Time and again we are asked for reprints of Wireless World constructional projects: tape, disc, radio, amplifiers, speakers, headphones. Demand continues long after copies are out of print. To meet the situation we have collected fifteen of the most sought after designs and put them in one inexpensive book. And we've updated specifications where necessary to include new components which have become available. A complete range of instruments is presented, from the Stuart tape recorder and Nelson-Jones f.m. tuner, through the Bailey, Blomley and Linsley Hood amplifiers, to the Bailey and Baxandall loudspeakers – some of which have been accepted as standard in the industry.



## high fidelity designs

£1 from newsagents and bookshops. A book from

### Wireless World

## Table of Tape Playing Times

Length of Tape (Feet)		3600	2400	1800	1700	1200	900	850
Size of Spool		8 $\frac{1}{4}$ DP	7 DP 8 $\frac{1}{4}$ LP	5 TP 7 LP 8 $\frac{1}{4}$ S	5 $\frac{3}{4}$ DP	5 DP 5 $\frac{3}{4}$ LP 7 S	4 TP 5 LP	5 $\frac{3}{8}$ S
Maximum Playing Times		H M	H M	H M	H M	H M	H M	H M
1 Track	15 i/s	48	32	24	22	16	12	11
	7 $\frac{1}{2}$ i/s	1 36	1 4	48	47	32	24	22
	3 $\frac{3}{4}$ i/s	3 12	2 8	1 36	1 30	1 4	48	45
	1 $\frac{7}{8}$ i/s	6 24	4 16	3 12	3 1	2 8	1 36	1 30
2 Tracks	15 i/s	1 36	1 4	48	45	32	24	22
	7 $\frac{1}{2}$ i/s	3 12	2 8	1 36	1 30	1 4	48	45
	3 $\frac{3}{4}$ i/s	6 24	4 16	3 12	3 1	2 8	1 36	1 30
	1 $\frac{7}{8}$ i/s	12 48	8 32	6 24	6 2	4 16	3 12	3 1
4 Tracks	15 i/s	3 12	2 8	1 36	1 30	1 4	48	45
	7 $\frac{1}{2}$ i/s	6 24	4 16	3 12	3 1	2 8	1 36	1 30
	3 $\frac{3}{4}$ i/s	12 48	8 32	6 24	6 2	4 16	3 12	3 1
	1 $\frac{7}{8}$ i/s	25 36	17 4	12 48	12 5	8 32	6 24	6 2
Length of Tape (Feet)		600	450	400	300	200	150	
Size of Spool		4 DP 5 S	3 TP 4 LP	3 $\frac{1}{2}$ LP	3 $\frac{1}{2}$ LP 4 S	3 $\frac{1}{4}$ S	3 S	
Maximum Playing Time		H M	H M	H M	H M	H M	H M	
1 Track	15 i/s	8	6	5	4	2 $\frac{1}{2}$	2	
	7 $\frac{1}{2}$ i/s	16	12	10	8	5	4	
	3 $\frac{3}{4}$ i/s	32	25	21	16	10	8	
	1 $\frac{7}{8}$ i/s	1 4	48	42	32	21	16	
2 Tracks	15 i/s	16	12	10	8	5	4	
	7 $\frac{1}{2}$ i/s	32	24	21	16	10	8	
	3 $\frac{3}{4}$ i/s	1 4	48	42	32	21	16	
	1 $\frac{7}{8}$ i/s	2 8	1 36	1 25	1 4	42	32	
4 Tracks	15 i/s	32	24	21	16	10	8	
	7 $\frac{1}{2}$ i/s	1 4	48	42	32	21	16	
	3 $\frac{3}{4}$ i/s	2 8	1 36	1 25	1 4	42	32	
	1 $\frac{7}{8}$ i/s	4 16	3 12	2 50	2 8	1 25	1 4	

**Note:** The 4 tape thicknesses are listed as S (Standard), LP (Long Play), DP (Double Play) and TP (Triple Play).

# The golden age of loudspeakers

By Basil Lane

I recently came across a book which was not only fascinating, in as much as it documented the products of a bygone era, but also I found quite funny in some of the concepts which failed to capture public imagination. If you want a good laugh and at the same time learn something of the early days of hi-fi, read *Loudspeakers* by C. M. R. Balbi, published in 1926 by Sir Isaac Pitman and Sons Ltd, originally sold for the grand sum of three shillings and sixpence net!

Some of the loudspeakers illustrated in this article are dealt with in this book and rather demonstrate the maxim that there is nothing new in this world! If you thought the combination of electric lamp and loudspeaker, shown at last year's Audio Fair was new, then look at the 'Eastern Idol' model shown in **Fig 1** which was also first shown at a bygone 'Radio Show' at Olympia—I wonder if it sold really well?

The second chapter of the book goes into some detail about the types of loudspeaker commercially available in 1926 and introduces the section with a prophetic statement '... it is believed that progress will not be made by minor improvements on standardised lines, but on the development of one of the lesser known forms described, or of some form not yet discovered.'

## Electromagnetic Speakers

Under electro-magnetic systems, nine types of loudspeaker are described including the then fairly standard moving-iron loudspeaker. This was a simple development from the conventional telephone receiver, the 'receiver unit' having exactly the same convention of a soft iron disc diaphragm, held a short distance above the pole pieces of an electro-magnet. The vibrations of the diaphragm produced sound which was acoustically amplified by an artistically curved horn fitted over the diaphragm (see **Fig 2**).

Another loudspeaker, the Standard, made

by Standard Telephones and Cables had a transducer very similar to the most modern and recently introduced telephone receiver. It employed a thin flexible diaphragm actuated by a lever connected to a rocking bar armature pivoting between the poles of an electro-magnet.

The oddly named Gigantaphone developed by Marconi and marketed by Magnavox was based on a principle expounded by Sir Oliver Lodge. It is in fact a moving-coil loudspeaker with an electro-magnet separately energised from a six-volt battery. The diaphragm was coupled to a horn—as in most loudspeakers of the time, but even so, it did represent the precursor to one of the most popular methods of



**Fig 1** Highlight of a bygone 'Radio Show' at Olympia described as an 'Eastern Idol' loudspeaker.



**Fig 2** *The Amplion wireless loudspeaker and for 3/6d extra would be supplied with a polished mahogany trumpet!*

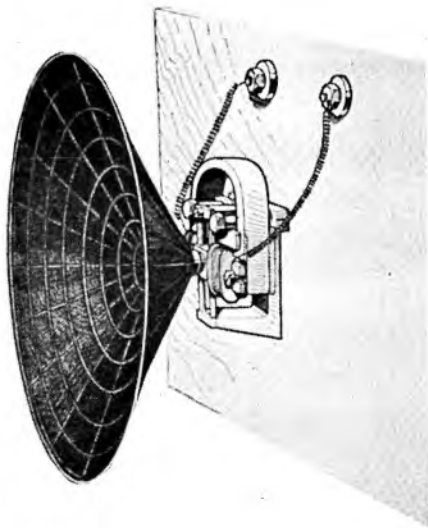

**Fig 3** *One of the most popular electro-magnetic cone speakers ever produced around 1925-6 and by a manufacturer still well known today, namely Celestion.*

operating a loudspeaker in use today. Just to complete the elements of modern loudspeakers, the Celestion loudspeaker of 1926 used a vibrating armature to drive a large diameter cone shaped 'piston' as shown in Fig 3.

### Friction Loudspeakers

Under the remarkable section 'Friction and Semiconductor Types' come a series of designs which were obviously destined not to see too much light of day. The first to be described illustrates the principle of the friction type. The drawing reproduced from the original (Fig 4) shows the 'Edison Loudspeaker'. The unit is based on a curious fact said to be discovered by Edison, that the friction between a metal and a substance subject to electrolytic action varies in proportion to the strength of the current passing through the points of contact.

The operation of the design shown is described as follows: 'A diaphragm of mica *M* is mounted over an opening in the box as shown and a strip of platinum *C* (only the end of which is shown) is attached to its centre and projects at right angles from it. The end of *C* lies flat on the surface of a chalk cylinder *A* which is moistened with a solution of some easily decomposed electrolyte such as potassium iodide.

The platinum strip *C* and the metal supports of *A* are connected to the input. On turning the cylinder by handle *W* so that the top moves away from the mica disc, the friction (which can be regulated by the screw *E*) will cause the centre of the disc to be pulled inward. When the current passes, the friction at the contact will be reduced in proportion to the strength of the current and the disc will partly recover its position'. The cylinder was moistened by raising an absorbent roller (*R*) from a tank of electrolyte (*T*) to bring it into contact with the chalk roller. The loudspeaker was said to be very powerful but had a rather nasal quality and this together with the need to rotate a handle during use led to it being dropped.

### Air Loudspeakers!

'We now come to a heterogeneous collection of loudspeakers which although under no particular section are nevertheless considered as being of great potential importance, as from this miscellany of half-tried experiments it is probable that the perfect loudspeaker of the future will be evolved'. This was Balbi's introduction to the somewhat weird collection of

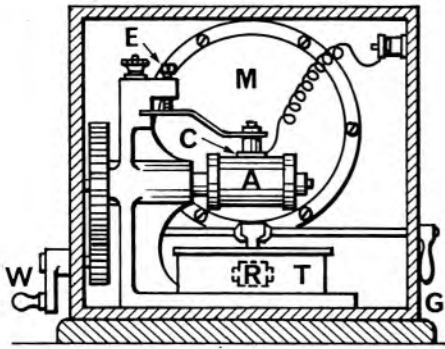

**Fig 4** Original drawing of the Edison loudspeaker. How it works is explained in the text.

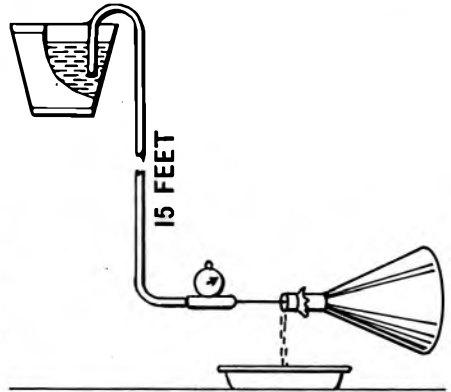

**Fig 6** Suitable for home constructors? The 'Jet of water' loudspeaker. Its principle of operation is explained in the text.

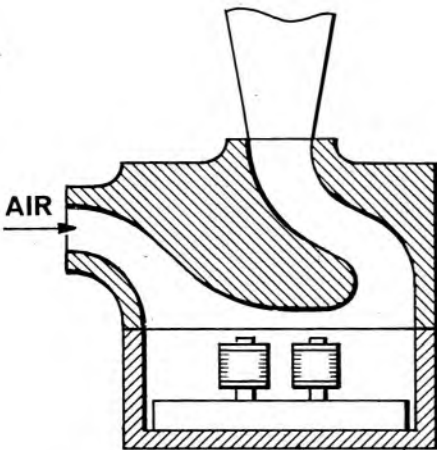

**Fig 5** The principle of the 'Air blast' loudspeaker. The sound was blown out!

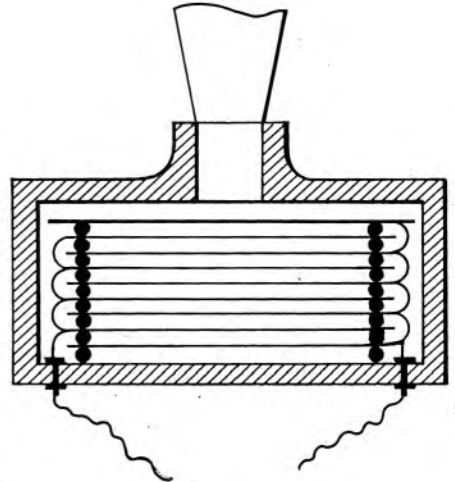

**Fig 7** The 'Condenser' loudspeaker virtually a reverse of the principle of modern condenser microphones.

devices described in his book.

A brief description is given of a *compressed air* loudspeaker. Air under pressure was modulated by an electromagnetic valve, the escaping air then being fed into a horn to acoustically amplify the sound. Air under pressure also appeared as a feature of another design—called appropriately, the *Air Blast Loud Speaker*. 'The principle consists of moving the standing waves formed in the horn by the modulated vibrations of the diaphragm, by means of a continuous

stream of air passing up the horn; or putting it in a less technical way the sound is blown out of the horn'. A diagram illustrating the idea is given in **Fig 5**.

**Water Speakers Too!**

This is the intriguing introduction to a device that was mind boggling in its consequences. **Fig 6**, reproduced from the book, illustrates the principle. 'A tank of water, fifteen feet above the horn has a pipe siphoning water down to a



**Fig 8** *The original Rice Kellogg moving-coil loudspeaker. The field coil power supply and driving amplifier are built in (circa 1925).*



**Fig 9** *A typical domestic moving armature cone speaker of around 1925 made by S. G. Brown.*

very small jet, diameter 1/50th to 1/70th of an inch in diameter. The resulting fine jet of water is made to strike a thin rubber membrane stretched over the end of a horn. Tiny sound sources held against the end of a nozzle (a watch is shown) are then reproduced loudly by the horn. The nozzle to diaphragm distance was said to be critical, too close and no sound would be heard, too far away and a loud singing noise occurred. Greatest sensitivity was obtained when the nozzle-to-diaphragm distance was adjusted to make the singing just audible!

Other, rather more practical designs are described, such as the carbon arc loudspeaker, the piezo electric loudspeaker, the hot wire loudspeaker and a variant of this called the Thermophone. However, the last is the most significant and is the condenser loudspeaker, an unlikely precursor to the electrostatic loudspeaker of this age. This early model Fig 7 consisted of a number of metal plates separated by thin rubber rings. As the applied potential was varied, the rubber rings were compressed or released, the top plate acting as a diaphragm. With a polarising voltage of 150 volts, mechanical resonance was said to be absent, but although results were good, the output appeared to be weak.

#### **Public Address**

Although two chapters of the book deal with the design of diaphragms and horns, there is also one chapter on public address and a piece of equipment worthy of mention is the Western Electric No. 1 Public Address Installation. The system consisted of a specially constructed microphone, sensitive to someone speaking six feet from it, which was mounted on the roof of the amplifier. This had a 'magnification factor of several hundred million' and occupied a floor space of 125 square feet! Finally the loudspeakers mounted on a tower above this were capable (it was claimed) of projecting the spoken voice to an audience of from 700,000 to over one million every one of whom would be able to hear clearly and naturally, every word with perfect comfort.

#### **Valid Advice**

The concluding chapter is entitled *Advice to intending purchasers and other notes*. It contains some useful hints, many of which are equally as valid now, as they were then. For example, 'The different factors in choosing a loudspeaker

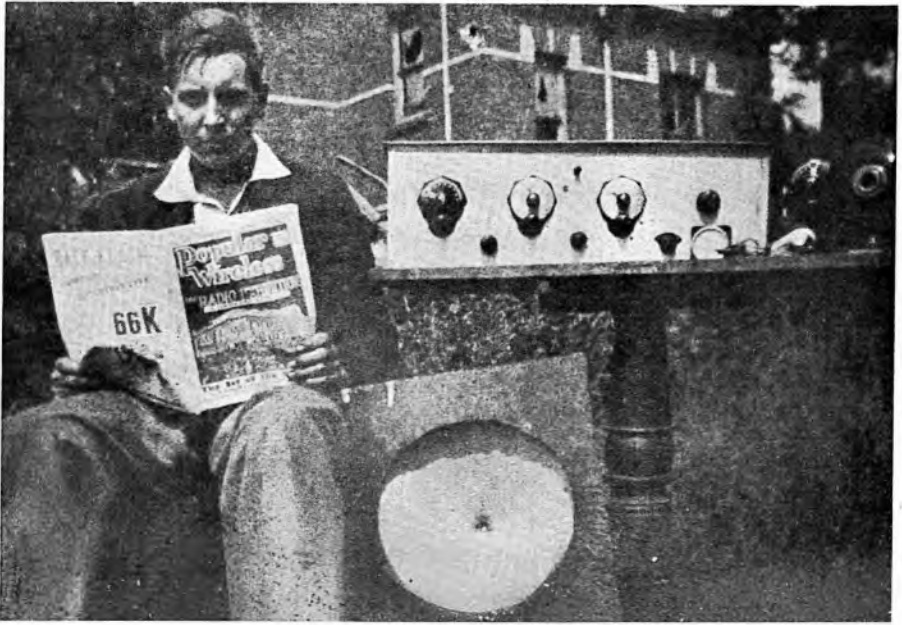

**Fig 10** Fred Judd, with neutrodyne radio receiver and balanced armature cone speaker using the Celestion unit in Fig 3.



**Fig 11** Considered as a typical frequency for a loudspeaker in the 1920s. Note the amplitude scale in 'alternating air pressure' instead of the now more familiar dBs.

should be considered in the following order— (1) The room. (2) The purpose of reception. (3) The wireless set. (4) The type of loudspeaker. The selection of the room is the first problem that an intending purchaser has to consider. This is usually not a difficult task, as in most cases the selection is limited to a choice of one or two rooms, but it must be remembered that the size of the room has a direct bearing on the cost of the installation. If economy has to be taken into consideration, the choice should be a small room in which case it is possible to install a baby loudspeaker'.

This gives some idea of the gems to be found on some secondhand bookstalls and apart from a fascinating glimpse at the early history of hi-fi it is surprising just how apposite some of the information still can be.



# Directory of Manufacturers

**Abstracta Construction Ltd**, Unit C, Staples Corner Trading Estate, Edgware Road, London, NW2. Tel: 01-450 2511.

**Acos**, Cosmocord Ltd, Eleanor Cross Road, Waltham Cross, Herts, EN8 7NX. Tel: Waltham Cross (97) 27331.

**Acoustical Manufacturing Co. Ltd**, St Peter's Road, Huntingdon, Hunts, PE18 7DB. Tel: Huntingdon (0480) 52561.

**Acoustico Enterprises Ltd**, Unit 7, Space Way, North Feltham Trading Estate, Feltham, Middx, TW14 0TZ. Tel: 01-751 0141.

**Acoustic Research International**, High Street, Houghton Regis, Beds, LL15 5QJ. Tel: Dunstable (0582) 603151.

**Adastra Electronics Ltd**, Unit N22, Cricklewood Trading Estate, Clarendon Road, London, NW2 1TU. Tel: 01-452 6288.

**ADC (Audio Dynamics Corporation)**, Hisonic Ltd, Tovil, Maidstone, Kent. Tel: Maidstone 57258.

**AEG Telefunken (UK) Ltd**, Bath Road, Slough, Bucks. Tel: Slough (75) 33311.

**Aerialite Aerials Ltd**, Radnor Park Trading Estate, West Heath, Congleton, Ches, CW12 4PX. Tel: Congleton (02602) 3892.

**Agfa-Gevaert**, Unity House, Great West Road, Brentford, Middx. Tel: 01-560 2131.

**Aiwa**, Johnsons of Hendon Ltd, Colney Street, St Albans, Herts, AL2 2EA. Tel: Radlett 4747.

**Akai**, Rank Audio Visual Ltd, PO Box 70, Great West Road, Brentford, Middx, TW8 9HR. Tel: 01-568 9222.

**ARK Equipment Ltd**, Eardley House, 182-184 Campden Hill Road, Kensington, London, W8 7AS. Tel: 01-229 3695.

**Alba (Radio & Television) Ltd**, Bull Lane, Edmonton, London, N18 1RA. Tel: 01-803 4451.

**Richard Allan Radio Ltd**, Bradford Road, Gomersal, Cleckheaton, Yorks, BD19 4AZ. Tel: Cleckheaton (097 62) 2442.

**Allotrope Ltd**, 90 Wardour Street, London, W1V 3LE. Tel: 01-437 1892.

**Alpha**, Highgate Acoustics, 38 Jamestown Road, London, NW1 7EJ. Tel: 01-267 4937.

**Altec Lansing (Domestic Speakers)**, D.E.S. Wholesale Ltd, 10-12 High Street, Colliers Wood, SW19. Tel: 01-540 9684.

**Ameron**, Macinnes Laboratories Ltd, Macinnes House, Carlton Park Industrial Estate, Saxmundham, Suffolk, IP17 2NL. Tel: Saxmundham (0728) 2262/2615.

**Amerex (UK) Ltd**, 96 Piccadilly, London, W1V 9HA. Tel: 01-499 3537.

**Ampex (Domestic)**, Tape Music Distributors Ltd, 114 Ashley Road, St Albans, Herts, AL1 5JR. Tel: St Albans 64337.

**Ampex G.B. Ltd**, Acre Road, Reading, Berks, RG2 0QR. Tel: Reading 84411.

**Amos of Exeter Ltd**, Weircliffe Court, Exwick, Exeter, Devon. Tel: Exeter (0392) 72132.

**Amstrad**, AMS Trading (Amstrad) Ltd, 89 Ridley Road, London, E8. Tel: 01-249 5237.

**Amtron (UK) Ltd**, 4-7 Castle Street, Hastings, Sussex, TN34 3DY. Tel: Hastings 2875.

**Antiference Ltd**, Bicester Road, Aylesbury, Bucks. Tel: Aylesbury (0296) 82511.

**ARD**, Audio Research and Development Ltd, PO Box 73, Hounslow, Middx, TW3 1RD. Tel: 01-570 0471.

**Ariston Audio Ltd**, PO Box 13, Irvine, Ayrshire, Scotland, KA12 8JL. Tel: 0294 75211.

**Armstrong Audio Ltd**, Warlters Road, Holloway, London, N7 QRZ. Tel: 01-607 3213.

**Arnex Products Ltd**, London Road, Daventry, Northants, NN11 4DU. Tel: Daventry (03272) 2231.

**ASA (UK) Television and Radio Ltd**, 31-35 High Street, Shirlhampton, Bristol, BS11 0DX. Tel: Avonmouth 5035.

**Association of Public Address Engineers Ltd**, 47 Windsor Road, Slough, Bucks. Tel: Slough (75) 31560.

**Audiodecks Ltd**, Farnell House, 81 Kirkstall Road, Leeds, LS3 1HR. Tel: Leeds (0532) 35111.

**Audio Developments**, B.H. Morris & Co (Radio) Ltd, Trio House, The Hyde, London, NW9 6JP. Tel: 01-205 6441.

**Audio Magnetics (UK) Ltd**, 12 Fife Road, Kingston-on-Thames, Surrey, KT1 1SZ. Tel: 01-549 3271.

**Audio Packs Ltd**, 206-210 Ilderton Road, London, SE15 1NS. Tel: 01-639 7844.

**Audio Research & Development Ltd**, PO Box 73, Hounslow, Middlesex, TW3 1RD. Tel: 01-570 0471.

**Audio Services Ltd**, 82 East Barnet Road, New Barnet, Herts. Tel: 01-449 6605.

**Audiosonics**, J. Parker & Co (London) Ltd, Parker House, Beresford Avenue, Wembley, Middlesex, HA0 1YX. Tel: 01-903 5211.

**Audio Technica**, Shiro (UK) Ltd, Shiro House, The Ridgeway, Iver, Bucks, SL0 9JL. Tel: Cedarwood (07538) 2222.

**Audio Workshops Ltd**, 29 High Street, Robertsbridge, Sussex. Tel: Robertsbridge (058 088) 580.

**Avel-Lindberg Ltd**, 13-16 Ayron Road, South Oxenden, Essex, RM15 5TD. Tel: South Oxenden 2263.

**Baker Reproducers Ltd**, Bensham Manor Road Passage, Thornton Heath, Surrey. Tel: 01-684 1665.

**Bang & Olufsen UK Ltd**, Eastbrook Road, Gloucester, GL4 7DE. Tel: Gloucester (0452) 21591.

**BASF United Kingdom Ltd**, PO Box 473, Knightsbridge House, 197 Knightsbridge, London, SW7 1SA. Tel: 01-584 5080.

**F.W.O. Bauch Ltd**, 49 Theobald Street, Boreham Wood, Herts, WD6 4RZ. Tel: 01-953 0091.

**Belcaire Trading**, 59 Cheriton High Street, Folkestone, Kent. Tel: Folkestone (0303) 76834.

**Ben Nevis Aerials Ltd**, Belmont Works, Belmont Site, Lewis Street, Stranraer, Scotland, DG9 7AS. Tel: Stranraer 2677.

**Beyer Dynamic (GB) Ltd**, 1 Clair Road, Haywards Heath, Sussex. Tel: Haywards Heath 51003.

**Bias Electronics Ltd**, 572 Kingston Road, London, SW20 8DR. Tel: 01-540 8808.

**Bib Hi-Fi Accessories Ltd**, PO Box 78, Hemel Hempstead, Herts. Tel: Hemel Hempstead (0442) 3636.

**Bigston**, J. Parker & Co (Radio) Ltd, Parker House, Beresford Avenue, Wembley, Middlesex, HA0 1YX. Tel: 01-903 5211.

**Binatone**, J. Parker & Co (London) Ltd, Parker House, Beresford Avenue, Wembley, Middlesex, HA0 1YX. Tel: 01-902 8991.

**B & J Photographic Imports**, 305 Kenton Road, Kenton, Harrow, Middlesex, HA3 0HP. Tel: 01-907 6667.

**Black Knight Rumblecure**, Bank Top, Currier Lane, Ashton-under-Lyne, Lancs, OL6 2TA. Tel: 061-330 2836.

**Bogen**, Cole Electronics Ltd, Church Road, Croydon, Surrey, CR0 1SG. Tel: 01-686 7581.

**Bose**, Expotus Ltd, 10 Museum Street, London, WC1. Tel: 01-836 3747.

**Distributors**: Acoustico Enterprises Ltd.

**Bradmatic Ltd**, 338 Aldridge Road, Streetly, Sutton Coldfield, West Midlands. Tel: 021-353 3171.

**Brahms Manufacturing and Development Co**, Unit E, Rochester Airport, Maidstone Road, Rochester, Kent, ME1 3QJ. Tel: Medway (0634) 48816.

- Brenell Engineering Co Ltd**, 231-5 Liverpool Road, London, N1 1LY. Tel: 01-607 8271.
- Britimpex Ltd**, 8-12 Rickett Street, London, SW6. Tel: 01-385 0883
- Bryan Amplifiers Ltd**, 18 Greencroes Road, Oldham, Lancs, O14 1HA. Tel: 061-624 4074.
- BSR McDonald**. BSR Ltd, Monarch Works, Cradley Heath, Warley, Worcs, B64 5QH. Tel: Cradley Heath 69272.
- Bush-Arena**. Rank Radio International Ltd, PO Box 596, Power Road, Chiswick, London, W4 5PW. Tel: 01-994 6491.
- Bush Nelson Ltd**, Rush House, 6 Yattendon Road, Horley, Surrey. Tel: Horley 5983.
- B & W Electronics**, Meadow Road, Worthing, Sussex. BN11 2RX. Tel: Worthing 205611.
- Calrec Audio Ltd**, Haringroyd Lane, Hebden Bridge, Yorks, HX7 7DD. Tel: Hebden Bridge 2159.
- Calyx Shelving Systems Ltd**, Stanley Works, Belgrave Road, London, SE25 5AN. Tel: 01-771 1221.
- Cambridge Audio Ltd**, The River Mill, St Ives, Huntingdon, Hunts, PE17 4EP. Tel: St Ives (0480) 62901.
- Canterbury Audio**, 4 Station Road West, Canterbury, Kent. Tel: Canterbury 60431.
- Carol Cinesound**, Cresta Electronics Ltd, 72 Loom Lane, Radlett, Herts, WD7 8PA. Tel: Radlett (779) 5342.
- C.A.S. City Audio Services Ltd**, 144 Lavender Hill, London, SW11 5RA. Tel: 01-223 2496.
- Celestion**. Rola-Celestion Ltd, Ditton Works, Foxhall Road, Ipswich, Suffolk, IP3 8JP. Tel: Ipswich (0473) 73131.
- Chadaere Electronics Ltd**, 63 Stratford Broadway, London, E15 4RO. Tel: 01-534 1207.
- Chartwell**. Acoustico Enterprises Ltd, Unit 7, Space Way, North Feltham Trading Estate, Feltham, Middlesex, TW14 0TZ. Tel: 01-751 0141.
- CHB Supplies Ltd**, Oldington Trading Estate, Stourport Road, Kidderminster, Worcs. Tel: Kidderminster (0562) 4861.
- Chilton**. Magnetic Tapes Ltd, Chilton Works, Garden Road, Richmond, Surrey. Tel: 01-876 7957.
- City Audio Services Ltd**, 144 Lavender Hill, London, SW11 5RA. Tel: 01-223 2496.
- Clark**. Sonab Ltd, PO Box 4, Oldfield Road, Hampton, Middlesex, TW12 2HN. Tel: 01-979 0134.
- Clark Speakers**, 122 Hull Road, Anlaby, Hull, HU10 6LW. Tel: Hull (0482) 656706.
- Cleen**. Kirkman (Crawley) Ltd, 40 The Broadway, Crawley, Sussex. Tel: Crawley 26670.
- Cleandis (Mail Order) Ltd**, 7 Trinity Court, Gray's Inn Road, London, WC1X 8JX. Tel: 01-837 9088.
- C.I.R. Speakers**. Colne Loudspeaker Research, 51 Lion Road, Twickenham, Middlesex. Tel: 01-892 7444.
- Colt Electronics**, Church Road, Croydon, Surrey, CR0 1SG. Tel: 01-686 7581.
- Coltes Engineering Ltd**, Pindar Road, Hoddesdon, Herts. Tel: Hoddesdon (61) 66685.
- Colton**. Musonic Ltd, 34-38 Verulam Road, St Albans, Herts, AL3 4DF. Tel: St Albans (56) 50611.
- Comberton**. CHB Supplies Ltd, Oldington Trading Estate, Stourport Road, Kidderminster, Worcs. Tel: Kidderminster (0562) 4861.
- Condor Electronics Ltd**, 100 Coombe Lane, London, SW20 0AY. Tel: 01-946 0033.
- Connoisseur**. A. R. Sugden & Co (Engineers) Ltd, Connoisseur Works, Atlas Mill Road, Brighouse, Yorks, HD6 1FS. Tel: Brighouse (048 47) 2142.
- Cosmocord Ltd**, Eleanor Cross Road, Waltham Cross, Herts, EN8 7NX. Tel: Waltham Cross 27331.
- Cresta Electronics Ltd**, 72 Loom Lane, Radlett, Herts, WD7 8PA. Tel: Radlett (779) 5342.
- Crown Radio Company Ltd**, 128-9 Shoreditch High Street, London, E1 6JF. Tel: 01-739 2382.
- Darby Industries**, 38-42 Chestnut Grove, New Malden, Surrey, KT3 3JW. Tel: 01-942 1596.
- A. Davies & Co**, 56 Wellesley Road, London, NW5. Tel: 01-485 5775.
- Decca Radio & Television**, Neachells Lane, Willenhall, Wolverhampton, Staffs. Tel: 0902 67367.
- Decca Special Products**, Ingate Place, Queenstown Road, London, SW8 3NT. Tel: 01-622 6677.
- Decca Record Co**, Decca House, 9 Albert Embankment, London, SE1 7SW. Tel: 01-735 8111.
- Deimos Ltd**, 8 Corwell Lane, Hillingdon, Middlesex. Tel: 01-573 3561.
- Derwent**. Nichols Acoustic Fittings, Church Street, Bubwith, near Selby, Yorkshire. Tel: Bubwith (070 785) 206.
- Deutsche Grammophon**. Polyord Ltd, 17 Stratford Place, London, W1N 0BL. Tel: 01-499 8686.
- Discwasher**. Wilmex Ltd, Import Division, Compton House, New Malden, Surrey, KT3 4DF. Tel: 01-949 2545.
- Dual**. Audiodecks Ltd, Farnell House, 81 Kirkstall Road, Leeds, LS3 1HR. Tel: Leeds (0532) 35111.
- Duette**. J. J. Silber Ltd, 11 Northburgh Street, London, EC1. Tel: 01-253 8031.
- Dynastatic**. Audio Services Ltd, 82 East Barnet Road, New Barnet, Herts. Tel: 01-449 6605.
- Dynatron Radio Ltd**, St Peter's Road, Maidenhead, Berks, SL6 7QY. Tel: Maidenhead (0628) 23331.
- Eagle International**, Heather Park Drive, Wembley, Middlesex, HA0 1SU. Tel: 01-903 0144.
- Faton Audio Fittings**, Lenpold Street, Long Eaton, Nottingham, NG10 4QF. Tel: Long Eaton (060 76) 2662 and 2818.
- Echo**. A.Jastra Electronics Ltd, Unit N22, Cricklewood Trading Estate, Clarendon Road, London, NW2 1TU. Tel: 01-452 6288.
- Edward Michelsen Custom Cabinets**, "Sound Ideas", 216 Brampton Road, Bexleyheath, Kent. Tel: 01-303 9272.
- Edwardus**. J. R. Edwards Electronics, 696-698 Romford Road, Manor Park, London, E12. Tel: 01-353 4349.
- Ekco**. Pye Ltd, PO Box 49, St Andrews Road, Cambridge, CB4 1DS. Tel: Cambridge (0223) 58985.
- Elac (Speakers and Enclosures)**. Electro Acoustic Industries Ltd, Stamford Works, Broad Lane, Tottenham, London, N15. Tel: 01-808 0505.
- Electronic Manufacturing Co (UK) Ltd**, Devonshire House, High Street, Deritend, Birmingham, B12 0LP. Tel: 021-772 7145/3669.
- Electro-Voice**. Gulton Europe Ltd, Special Products Division, The Hyde, Brighton, Sussex, BN2 4JU. Tel: 0273 66271.
- Elgar**. English Audio (1970) Ltd, North Station Road, Colchester, Essex. Tel: Colchester (0206) 73467.
- EMI Records Ltd**, EMI House, 20 Manchester Square, London, W1. Tel: 01-486 4433.
- EMI Sound & Vision Equipment Ltd**, EMI Pathe Division, 252 Blyth Road, Hayes, Middlesex, UB3 1HW. Tel: 01-573 3338.
- EMI Tape Ltd**, Tape House, Dawley Road, Hayes, Middlesex, UB3 1BT. Tel: 01-573 3888.
- Emphasis**. 50a The Avenue, Kilburn, London, NW6. Tel: 01-451 0517.
- Empire Scientific Corporation**. Rank Audio Visual Ltd, PO Box 70, Great West Road, Brentford, Middlesex, TW8 9HR. Tel: 01-568 9222.
- EMT Franz Vertriebsgesellschaft mGH**. F. W. O. Bauch Ltd, 49 Theobald Street, Boreham Wood, Herts. Tel: 01-953 0091.
- English Audio (1970) Ltd**, North Station Road, Colchester, Essex. Tel: Colchester (0206) 73467.
- ERA**. De Banks Electronics Ltd, Market House, High Street, Tring, Herts. Tel: Tring (044 282) 2777.
- ESS**. Impo Hi-Fi, 22 Buckingham Palace Road, London, SW1. Tel: 01-834 0050.
- Europa Electronics Ltd**, 9 Howard Place, Shelton, Stoke-on-Trent, ST1 4NW. Tel: Stoke-on-Trent 29316.
- Eurotronic**, 50 Oldfield Circus, Northolt, Middlesex. Tel: 01-864 2254.
- Exator**. Audio Workshops Ltd, 29 High Street, Robertsbridge, Sussex. Tel: Robertsbridge (058 033) 580.
- Excel Sound Corporation**. Malher's Photographics Ltd, 35 John Dalton Street, Manchester, 2. Tel: 061-834 6133.
- Excelsior**. Oscar Radio Company, 56-63 Gaswell Road, London, EC1. Tel: 01-253 1802.
- Executive Audio**, 10 Goldsmith Street, Nottingham, NG1 5JR. Tel: Nottingham (0602) 44223.

**Expert Pickups Ltd**, PO Box 3, Ashtead, Surrey, KT21 2QD.

Tel: Ashtead (27) 76504

**FAL**, Futuristic Aids Ltd, 104 Henconner Lane, Leeds, LS13 4LQ. Tel: Pudsey 5478.

**Falcon John Street (Manufacturers) Ltd**, Falcon Works, Barmeston Road, Cattord, London, SE6. Tel: 01-698 1177.

**Falcon Electronics**, Components Division, 33 Station Road, Bexhill-on-Sea, Sussex. Tel: Bexhill (0424) 211908.

**Fane Acoustics Ltd**, Hick Lane, Batley, Yorks. Tel: Batley 6431.

**Fantavox**, Distributors: Adastr Electronics Ltd, Unit N22, Cricklewood Trading Estate, Clarendon Road, London, NW2 1TU. Tel: 01-452 6288.

**A C Farnell Ltd**, Kenyon Street, Sheffield, S1 4BD. Tel: Sheffield (0742) 78901.

**Farnell-Tandberg Ltd**, Consumer Division, Farnell House, 81 Kirkstall Road, Leeds, LS3 1HR. Tel: Leeds (0532) 35111.

**Feldon Audio Ltd**, 126 Great Portland Street, London, W1N 5PH. Tel: 01-580 4314.

**Ferguson**, Thorn Consumer Electronics Ltd, 284 Southbury Road, Enfield, Middlesex, EN1 1J. Tel: 01-366 1155.

**The Ferrograph Company Ltd**, Auriema House, 442 Bath Road, Crippenham, Slough, Bucks, SL1 6BB. Tel: Burnham (062 86) 62511.

**Fidelity Radio Ltd**, 6 Olaf Street, London, W11. Tel: 01-727 0131.

**Film Industries Ltd**, Station Avenue, Kew Gardens, Surrey. Tel: 01-940 8078

**Fisher**, Ideal Computer Processors Ltd, Breamish House, Bilton Road, Erith, Kent. Tel: 38 41327.

**Foster**, Distributors: Adastr Electronics Ltd, Unit N22, Cricklewood Trading Estate, Clarendon Road, London, NW2 1TU. Tel: 01-452 6288.

**A. R. Franklin** (Audio Engineer), 4 Birch House, Howard Road, Penge, London, SE20 8HJ. Tel: 01-659 0912.

**Fuba**, Audio Workshops Ltd, 29 High Street, Robertsbridge, Sussex. Tel: Robertsbridge (058 088) 580.

**Futuristic Aids Ltd**, 104 Henconner Lane, Leeds, LS13 4LQ. Tel: Pudsey 5478.

**Gabraphone**, Modern Engineering & Technology, 4 Station Road West, Canterbury, Kent. Tel: Canterbury 60431.

**Galactron** Distributed by: Goodmans Loudspeakers Ltd, Downley Road, Havant, Hants, PO9 2NL. Tel: Havant (070 12) 6344.

**Gale Electronics and Design Ltd**, 39 Upper Brook Street, London, W1Y 1PE. Tel: 01-499 9966.

**Gardners Transformers Ltd**, Christchurch, Hants, BH23 3PN. Tel: Christchurch (02015) 2284.

**Garrard Engineering Ltd**, Newcastle Street, Swindon, Wilts, SN1 1DA. Tel: Swindon (0793) 5381.

**Gimar Ltd**, 10 Museum Street, London, WC1. Tel: 01-836 3222.

**Global & Tate**, Feldon Audio Ltd, 126 Great Portland Street, London, W1N 5PH. Tel: 01-580 4314.

**Golding Audio Ltd**, Marks Tey, Colchester. Tel: Colchester 210433.

**Golding Ltd**, 10 Bayford Street, Hackney, London, E8 3SE. Tel: 01-985 1152.

**Goodmans Loudspeakers Ltd**, Downley Road, Havant, Hants, PO9 2NL. Tel: Havant (070 12) 6344.

**Grado**, Howland-West Ltd, 3-5 Eden Grove, London, N7 8EQ. Tel: 01-609 0293.

**Grampian Reproducers Ltd**, 19 Hanworth Trading Estate, Hampton Road West, Feltham, Middlesex, TW13 6EJ. Tel: 01-894 9141.

**Groovac**, R. I. Audio, Kernick Road, Penryn, Cornwall, TR10 9DQ. Tel: Penryn (032 67) 2353.

**Grundig (Great Britain) Ltd**, Hi-Fi Division, Newlands Park, London, SE26 5NQ. Tel: 01-659 2468.

**Gulton Europe Ltd**, Special Products Division, The Hyde, Brighton, BN2 4JU. Tel: 0273 66271.

**Gusdorf**, Distributors: C. E. Hammond & Co Ltd, Lamb House, Church Street, London, W4 2PB. Tel: 01-995 4551.

**Hacker Radio Ltd**, Norreys Drive, Cox Green, Maidenhead, Berks, SL6 4BP. Tel: Maidenhead (0628) 22261.



## Crown home stereo units The connoisseurs choice

There are a number of fine Crown home stereo units of which the model CTD-270 is a superb example.



For further details please contact  
**Crown Radio Co. Ltd.,**  
Industrial Estate, Russell Gardens,  
Wickford, Essex SS11 8RT  
Telephone Wickford (037 44) 63414

**CTD-270 Dolby**  
system cassette deck

- G. F. C. Hadcock**, Audio Division, The Old Vicarage, Doveridge, Derby DE6 5NN Tel: Uttoxeter (088 93) 2452.
- C. E. Hammond & Co Ltd**, Lamb House, Church Street, London, W4 2PB Tel: 01-995 4551
- Hampstead High Fidelity**, 91 Heath Street, Hampstead, London, NW3 Tel: 01-435 6377 and 0099
- Haninex (UK) Ltd**, Haninex House, Dorcan, Swindon, Wilts, SN3 5HW Tel: Swindon (0793) 26211
- Harmon-Kardon**, Highgate Acoustics Ltd, 38 Jamestown Road, London, NW1 7EJ Tel: 01-267 4937
- Harris & Russell Ltd**, 124-130 East Road, London, NL Tel: 01-253 7551
- Harrison**, Distributed by Gimar Ltd, 10 Museum Street, London, WC1 Tel: 01-836 3222
- Hayden Laboratories Ltd**, Hayden House, 17 Chesham Road, Amersham, Bucks, HP6 5AG Tel: Amersham (0240 2) 5511.
- Heathkit**, Heath (Gloucester) Ltd, Bristol Road, Gloucester, GL2 6EE Tel: Gloucester (0452) 29451
- Heime Audio Products Ltd**, Summerbridge, Harrogate, Yorks, HG3 4DR Tel: Darley (042 372) 279
- H/H Electronic**, Industrial Site, Cambridge Road, Milton, Cambridge, CB4 4AZ Tel: Cambridge (0223) 65945
- Hi-Fi Sound (Test Record)**, Howland-West Ltd, 3-5 Eden Grove, London, N7 8EQ Tel: 01-609 0293.
- Highgate Acoustics Ltd**, 38 Jamestown Road, London, NW1 7EJ Tel: 01-267 4937
- Hisonic Ltd**, Tovil, Maidstone, Kent, ME15 6QP Tel: Maidstone 57258
- Hitachi Sales (UK) Ltd**, New Century House, Coronation Road, Park Royal, London, NW10 7QN Tel: 01-965 9861
- H. L. Audio Ltd**, 9b Garman Road, Tottenham, London, N17 Tel: 01-808 6127
- HMV**, Thorn Consumer Electronics Ltd, 284 Southbury Road, Enfield, Middlesex, EN1 1JJ Tel: 01-366 1155
- Hokushin Audio Visual Ltd**, 2 Ambleside Avenue, London, SW16 Tel: 01-677 9919
- Holder Pearce Ltd**, 66 Grove Road, Eastbourne, Sussex, BN21 4UH Tel: Eastbourne 26565
- Howland-West Ltd**, 3-5 Eden Grove, London, N7 8EQ Tel: 01-609 0293
- Ideal Computer Processors Ltd**, Bramish House, Bilton Road, Frith, Kent Tel: 38 41327
- IMF Electronics Ltd**, Westbourne Street, High Wycombe, Bucks. Tel: High Wycombe (0494) 35166
- Inhofs Ltd**, 112-116 New Oxford Street, London, WC1A 1HJ Tel: 01-636 7878
- Impex**, F.I.R. McArdle Ltd, 15 Queen Street, Newcastle-upon-Tyne, NE1 3UG
- Impo Hi-Fi**, 22 Buckingham Palace Road, London, SW1 Tel: 01-834 0050
- Interaudio**, Expotus Ltd, 10 Museum Street, London, WC1 Tel: 01-836 3747
- Isophon-Werke**, Hayden Laboratories Ltd, Hayden House, 17 Chesham Road, Amersham, Bucks, HP6 5AG Tel: Amersham (0240 3) 5511
- ITT Consumer Products (UK) Ltd**, Maidstone Road, Sidcup, Kent, DA14 5HT Tel: 01-300 7733
- ITT Component Group Europe**, Standard Telephones and Cables Ltd, Electrical Products Division, Edinburgh Way, Harlow, Essex. Tel: Harlow 26811
- Jacrex Marketing Ltd**, 40 Bell Street, Reigate, Surrey, RH2 7BA Tel: Reigate 40540
- Jaybeam Ltd**, Sandfield Close, Moulton Park Industrial Estate, Northampton, NN3 1QQ
- Jecklin**, Distributors: Helcaire Trading, 59 Cheriton High Street, Folkestone, Kent Tel: Folkestone (0303) 76834
- Johnsons of Hendon Ltd**, Colney Street, St Albans, Herts, AL2 2FA Tel: Radlett 4747
- Jordan-Watts Ltd**, Benlow Works, Silverdale Road, Hayes, Middlesex, UB3 3BW Tel: 01-573 6928
- JVC (UK) Ltd**, 453 Caledonian Road, London, N7 9BA Tel: 01-607 6568
- J. W. (Wholesale) Co Ltd**, 26 Rosoman Street, London, EC1 Tel: 01-837 3041
- Kalimar**, Highgate Acoustics Ltd, 38 Jamestown Road, London, NW1 7EJ Tel: 01-267 4937
- KEF Electronics Ltd**, Tovil, Maidstone, Kent, ME15 6QP Tel: Maidstone (0622) 57258
- KF Products Ltd**, Brookfield House, Hopes Carr, Stockport, Cheshire, Tel: 061 480 7428
- Kingstereo**, Lionel Murray Ltd, 7 West Halkin Street, Belgrave Square, London, SW1 Tel: 01-235 6424
- Kingsway Mills Ltd**, 5 Worship Street, London, EC2 Tel: 01-628 6157
- Kirkman (Crawley) Ltd**, 40 The Broadway, Crawley, Sussex, Tel: Crawley 26670
- Klein and Hummel**, F.W.O. Bauch Ltd, 49 Theobald Street, Boreham Wood, Herts Tel: 01-953 0091
- KLH**, Webland International Ltd, 30 Baker Street, London, W1M 2DS Tel: 01-402 9410
- Klinger Controls Ltd**, Spencer Court, 7 Chalcot Road, London, NW1 8LU Tel: 01-586 2922
- Korting**, Europa Electronics Ltd, 9 Howard Place, Shelton, Stoke-on-Trent, ST1 4NW Tel: Stoke-on-Trent (0782) 29316
- Koss**, Tape Music Distributors Ltd, 114 Ashley Road, St Albans, Herts, AL1 5JR Tel: St Albans (56) 64337
- Koyo**, Kingsway Mills Ltd, 5 Worship Street, London, EC2 Tel: 01-628 6157
- KVA Electronics Ltd**, 40 Monarch Parade, London Road, Mitcham, Surrey Tel: 01-648 4884
- Kyoto**, Harris Overseas Ltd, 120 Ripple Road, Barking, Essex Tel: 01-594 1473
- Thomas Laney Audio**, Elsetronic Manufacturing Co (UK) Ltd, Devonshire House, High Street, Epsom, Birmingham, B12 0LP Tel: 021-772 7145
- James B. Lansing**, Feldon Audio Ltd, 126 Great Portland Street, London, W1N 5PH Tel: 01-580 4314
- Larson**, Cole Electronics Ltd, Church Road, Croydon, Surrey, CR0 1SG Tel: 01-686 7581
- Leak**, Rank Radio International Ltd, PO Box 596, Power Road, Chiswick, London, W4 5PW Tel: 01-994 6491
- Lesson Audio Ltd**, Burrell Road, St Ives, Hunts, PE17 4LE Tel: St Ives (0480) 64124
- Leavers-Rich Equipment Ltd**, 319 Trinity Road, Wandsworth, London, SW18 3SL Tel: 01-874 9054
- Lem**, Douglas A. Lyons and Associates Ltd, 99 Larkhall Lane, London, SW4 Tel: 01-622 0287
- Lennard Developments Ltd**, 206 Chase Side, Enfield, Middlesex, EN2 0QX Tel: 01-363 8238
- L & H Britimex Ltd**, 8-12 Rickett Street, London, SW6 Tel: 01-385 0883
- Linn Products**, Drakemire Drive, Glasgow, Scotland, G45 9SZ Tel: 041-634 3860
- L.N.B. Audio Ltd**, The Factory, Duke Street, Loughborough, Leics. Tel: Loughborough (050 93) 61229
- Lockwood and Co (Woodworkers) Ltd**, 63 Lowlands Road, Harrow, Middlesex, Tel: 01-422 3704
- Loewe Opta**, Joint Distributors SFD Television Ltd, Salisbury, Wilts Tel: Salisbury (0722) 4201
- Hokushin Audio Visual Ltd**, 2 Ambleside Avenue, London, SW16 Tel: 01-677 9919
- Lowther Acoustics Ltd**, Lowther House, St Mark's Road, Bromley, Kent, BR2 9HQ Tel: 01-460 5225
- Lustraphone**, St George's Works, Regents Park Road, London, NW1 8XG Tel: 01-722 8844
- Lustraphone Hi-Fi Ltd**, Unit 2, Brownells Lane, Feltham, Middlesex, TW13 7EL Tel: 01-890 0887
- Lux**, Howland-West Ltd, 3-5 Eden Grove, London, N7 8EQ Tel: 01-609 0293
- Luxor**, Highgate Acoustics Ltd, 38 Jamestown Road, London, NW1 7EJ Tel: 01-267 4937
- Lyrichords**, N. Miers & Co Ltd, 28 Piercing Hill, Theydon Bois, near Epping, Essex, CM16 7LE Tel: 037-881 2611
- Douglas A. Lyons & Associates Ltd**, 99 Larkhall Lane, London, SW4 Tel: 01-622 0287
- MAC**, Modular Audio Components Ltd, Canterbury Road, Nottingham, NGR 1PQ Tel: Nottingham (0602) 862647

**Macinnes Laboratories Ltd**, Macinnes House, Carlton Park Industrial Estate, Saxmundham, Suffolk, IP17 2NL. Tel: Saxmundham (0728) 2262/2615.

**Major**. Distributed by: Impo H-Fi, 22 Buckingham Palace Road, London, SW1. Tel: 01-834 0050.

**Marantz**. Pysler Ltd, Fircroft Way, Edenbridge, Kent. Tel: Edenbridge (073 271) 4111.

**Marconiphone**. Thorn Consumer Electronics Ltd, 284 Southbury Road, Enfield, Middlesex. Tel: 01-366 1155.

**Marriott Magnetics Ltd**, Penryn, Cornwall. Tel: Penryn (032 67) 2267.

**Marsden Hall Manufacturing Co Ltd**, High March, Long March Industrial Estate, Daventry, Northants. Tel: Daventry (032 72) 4011.

**Martin**. Cosmocord Ltd, Eleanor Cross Road, Waltham Cross, Herts. Tel: Waltham Cross (97) 27331.

**Mathers Photographic Ltd**, 35 John Dalton Street, Manchester 2. Tel: 061-834 6133.

**Matsi**. See Teleton.

**Maxell**. Acoustico Enterprises Ltd, Unit 7, Space Way, North Feltham Trading Estate, Feltham, Middlesex, TW14 0TZ. Tel: 01-751 0141.

**Maxview Aerials Ltd**, Maxview Works, Setch, Kings Lynn, Norfolk. Tel: Watlington (055 381) 376.

**McIntosh**. Wilmex Ltd, Thompson House, High Street, New Malden, Surrey. Tel: 01-942 9567.

**Medway**. Brahm's Manufacturing & Development Co, Unit E, Rochester Airport, Maidstone Road, Rochester, Kent, ME1 3QJ. Tel: Medway (0634) 48816.

**Melodium**. Keith Monks (Audio) Ltd, 26-28 Reading Road South, Fleet, Aldershot, Hants. Tel: Fleet (025 14) 7316/3566.

**Memorex (UK) Ltd**, 50 Salisbury Road, Hounslow West, Middlesex. Tel: 01-570 7716.

**Metrocare**. Metrosound Audio Products Ltd, Audio Works, Cartersfield Road, Waltham Abbey, Essex, EN9 1JF. Tel: Waltham Cross (97) 31933.

**Metrosound Audio Products Ltd**, Audio Works, Cartersfield Road, Waltham Abbey, Essex, EN9 1JF. Tel: Waltham Cross (97) 31933.

**Micro**. Howland-West Ltd, 3-5 Eden Grove, London, N7 8EQ. Tel: 01-609 0293.

**N. Miers & Co Ltd**, 28 Piercing Hill, Theydon Bois, Epping, Essex, CM16 7LE. Tel: 037-881 2611.

**Millbank Electronics Group**, Bellbrook Estate, Uckfield, Sussex, TN22 1PS. Tel: Uckfield (0825) 4166.

**Mitsubishi Corporation**, Bow Bells House, Bread Street, London, EC4. Tel: 01-248 3292.

**MMG Associates Ltd**, 8 Station Rise, Marlow, Bucks, SL7 1EH.

**3M (UK) Ltd**, 3M House, Wigmore Street, London, W1. Tel: 01-486 5222.

**Modern Engineering & Technology**, 4 Station Road West, Canterbury, Kent. Tel: Canterbury (0227) 60431.

**Modular Audio Components Ltd**, Canterbury Road, Nottingham, NG8 1PQ. Tel: Nottingham (0602) 862647.

**Monitor Audio Ltd**, 4 Thulborn Close, Teversham, Cambridge, CB1 5AU. Tel: Cambridge (0223) 852031.

**Monitor Distribution Co Ltd**, 76 Bedford Road, Kempston, Beds, MK42 8BB. Tel: Kempston (023 05) 2694.

**Keith Monks (Audio) Ltd**, 26-28 Reading Road South, Fleet, Aldershot, Hants. Tel: Fleet (025 14) 7316/3566.

**Mordaunt-Short Ltd**, The Causeway, Petersfield, Hampshire, GU31 4JT. Tel: Petersfield (0730) 4631.

**B. H. Morris & Co (Radio) Ltd**, Trio House, The Hyde, London, NW9 6JP. Tel: 01-205 6441.

**Motion Electronics Ltd**, Addestead Farm, Tonbridge Road, East Peckham, Kent. Tel: East Peckham (0622) 871354.

**Multicore Solders Ltd**, Bib Hi-Fi Accessories, PO Box 78, Hemel Hempstead, Herts. Tel: Hemel Hempstead (0442) 3636.

**Lionel Murray Ltd**, 7 West Halkin Street, Belgrave Square, London, SW1. Tel: 01-235 6424.

**Musonic Ltd**, 34-38 Verulam Road, St Albans, Herts, AL3 4DF. Tel: St Albans (56) 50611.

**Nagra**. Hayden Laboratories Ltd, Hayden House, 17 Chesham Road, Amersham, Bucks, HP6 5AG. Tel: Amersham (0240 3) 5511.

**Nakamichi**. Natural Sound Systems Ltd, Strathcona Road, North Wembley, London, HA9 8QL. Tel: 01-904 0141.

**National Panasonic (UK) Ltd**, Building No. 63, Whitby Road, Trading Estate, Slough, Bucks. Tel: Slough (75) 34522.

**Natural Sound Systems Ltd**, Strathcona Road, North Wembley, London, HA9 8QL. Tel: 01-904 0141.

**N.E.A.L.** North East Audio Ltd, 5 Charlotte Square, Newcastle-upon-Tyne, NE1 4XF.

**Neumann GMBH**. F. W. O. Bauch Ltd, 49 Theobald Street, Boreham Wood, Herts, WD6 4RZ. Tel: 01-953 0091.

**New Classic J. W. (Wholesale) Co Ltd**, 26 Rosoman Street, London, EC1. Tel: 01-837 3041.

**Nichols Acoustic Fittings**, Church Street, Bubwith, near Selby, Yorks. Tel: Bubwith (075 785) 206.

**Nikko**. Howland-West Ltd, 3-5 Eden Grove, London, N7 8EQ. Tel: 01-609 0293.

**Nordmende**. H. Vesshof & Co Ltd, (Veseco Vision & Radio), 62 Woodbridge Road, Guildford, Surrey, GU1 4RD. Tel: Guildford (0483) 77877.

**North East Audio Ltd**, 5 Charlotte Square, Newcastle-upon-Tyne, NE1 4XF.

**Nucleus**, 22 Hyde Green, Marlow, Bucks. Tel: Marlow (062 84) 3787.

**Onkyo**. J. Parkar & Co (London) Ltd, Parkar House, Beresford Avenue, Wembley, Middlesex, HA0 1YX. Tel: 01-903 5211.

**Orbit**. Highgate Acoustics Ltd, 38 Jamestown Road, London, NW1 7EJ. Tel: 01-267 4937.

**Ortolf**. Metrosound Audio Products Ltd, Audio Works, Cartersfield Road, Waltham Abbey, Essex, EN9 1JF. Tel: Waltham Cross (97) 31933.

**Oscar Radio Company**, 56-63 Goswell Road, London, EC1. Tel: 01-253 1802.

**Osmabet Ltd**, 46 Kenilworth Road, Edgware, Middlesex, HA8 8YG. Tel: 01-958 9314.

**Pageantry Radio & TV Co Ltd**, 104 Felsham Road, Putney, London, SW15 1DQ. Tel: 01-788 5588.

**J. Parkar & Co (London) Ltd**, Parkar House, Beresford Avenue, Wembley, Middlesex, HA0 1YX. Tel: 01-903 5211.

**Parry Electronic Developments Ltd**, Assay House, 28 Greville Street, London, EC1N 8SU. Tel: 01-242 1100.

**PD Connectors**. Parry Electronic Developments Ltd, Assay House, 28 Greville Street, London, EC1N 8SU. Tel: 01-242 1100.

**Pearl**. Allotrope Ltd, 90 Wardour Street, London, W1V 3LE. Tel: 01-437 1892.

**Peerless**. Helme Audio Products Ltd, Summerbridge, Harrogate, Yorks, HG3 4DR. Tel: Darley (042 372) 279.

**Philco Great Britain Ltd**, Philco House, Stirling Trading Estate, Rainham Road South, Dagenham, Essex, RM10 8TX. Tel: 01-593 8613.

**Philips Electrical Ltd**, Century House, Shaftesbury Avenue, London, WC2H 8AS. Tel: 01-437 7777.

**Phoenix**. H. L. Audio Ltd, 9b Garman Road, Tottenham, London, N17. Tel: 01-808 6127.

**Photax Concertone**, Hampden Park, Eastbourne, Sussex.

**Pickering**. Highgate Acoustics Ltd, 38 Jamestown Road, London, NW1 7EJ. Tel: 01-267 4937.

**Pioneer**. Shriro (UK) Ltd, Shriro House, The Ridgeway, Iver, Bucks, SL0 9JL. Tel: Cedarwood (075 38) 2222.

**Planet Projects Ltd**, Goodman Works, Belvue Road, Northolt, Middlesex. Tel: 01-845 1775.

**Playfair**. Lennard Developments Ltd, 206 Chase Side, Enfield, Middlesex, EN2 0QX. Tel: 01-363 8238.

**Polydor Records Ltd**, 17-19 Stratford Place, London, W1N 0BL. Tel: 01-499 8686.

**Precision Tapes Ltd**, ATV House, 17 Great Cumberland Place, London, W1. Tel: 01-262 5502.

**Premier Industries Ltd**, 343-345 High Street, Cheltenham Spa, Glos, GL50 3HS. Tel: Cheltenham (0242) 27782.

- Pye Radio and Television Ltd**, St Andrews Road, Cambridge, CB4 1DS. Tel: Cambridge (0223) 58985.
- Pye Business Communications Ltd**, Cromwell Road, Cambridge, CB1 3HE. Tel: Cambridge (0223) 45191.
- Pyral (UK) Ltd**, Airport House, Purley Way, Croydon, Surrey, CR0 0XZ. Tel: 01-681 2833.
- Pyser Limited**, Fircroft Way, Edenbridge, Kent. Tel: Edenbridge (073 271) 4111.
- QAS**, Quality Audio Supplies, Wollaton Road, Beeston, Nottingham, NG9 2PB. Tel: Nottingham (0602) 252222/256141.
- Quad**, Acoustical Manufacturing Co Ltd, St Peter's Road, Huntingdon, PE18 7DB. Tel: Huntingdon (0480) 52561.
- Quadrasonics**, Spencer House, Brettenham Road, Edmonton, London, N18. Tel: 01-807 5544/5999.
- Quasar Division**, Precision Centre, Heather Park Drive, Wembley, Middx, HA0 1SU. Tel: 01-903 0144.
- Radford Audio Ltd**, Ashton Vale Road, Bristol, BS3 2HZ. Tel: Bristol (0272) 662301.
- Radio and Electrical Distribution Co**, 56-63 Goswell Road, London, EC1. Tel: 01-253 1802.
- Radon Industrial Electronics Co Ltd**, Brooklands Trading Estate, Orme Road, Worthing, Sussex. Tel: Worthing (0903) 34904.
- Rank Audio Visual**, PO Box 70, Great West Road, Brentford, Middlesex, TW8 9HR. Tel: 01-568 9222.
- Rank Radio International**, PO Box 596, Power Road, Chiswick, London, W4 5PW. Tel: 01-994 6491.
- Record Housing Ltd**, Brook Road, London, N22. Tel: 01-888 7487.
- Reps (Tape Recorders) Ltd**, 11-13 Regina Road, Southall, Middlesex. Tel: 01-574 3645.
- Restosound Ltd**, Spring Gardens, London Road, Romford, Essex. RM7 9LJ. Tel: Romford (70) 61926.
- Revox**, C. E. Hammond & Co. Ltd, Lamb House, Church Street, London, W4 2PB. Tel: 01-995 4551.
- RGD**, ITT Consumer Products Ltd, Maidstone Road, Sidcup, Kent, DA14 5HT. Tel: 01-300 7733.
- R.I. Audio**, Kernick Road, Penryn, Cornwall, TR10 9DQ. Tel: Penryn (032 67) 2753.
- Richardson Electronics Ltd**, 57 Jamestown Road, London, NW1 7EJ. Tel: 01-267 0723/4874.
- Rogers Developments (Electronics) Ltd**, 4-14 Barmston Road, London, SE6 3BN. Tel: 01-698 7424/4340.
- Ronette**, Condor Electronics Ltd, 100 Coombe Lane, London, SW20 0AY. Tel: 01-946 0033.
- Ross Electronics**, Ross Marks Ltd, 32 Rathbone Place, London, W1P 1AD. Tel: 01-580 7112.
- Rotel**, Rank Audio Visual Ltd, PO Box 70, Great West Road, Brentford, Middlesex, TW8 9HR. Tel: 01-568 9222.
- Russo Electronics**, Distributors: C. E. Hammond & Co Ltd, Lamb House, Church Street, London, W4 2PB. Tel: 01-995 4551.
- Saba Television Ltd**, 6-12 Cornbrook Park Road, Manchester, M15 4EE. Tel: 061-872 7661.
- SAE**, Distributors: Gale Electronics and Design Ltd, 39 Upper Brook Street, London, W1Y 1PE. Tel: 01-499 9966.
- Sansui**, Verneritron Ltd, Thornhill, Southampton, SO9 5QF. Tel: Southampton (0703) 444811.
- Sanyo Marubeni (UK) Ltd**, Sanyo House, Bushey Mill Lane, Watford, Herts, WD2 4UQ. Tel: Watford (92) 30421.
- Scandinavian Audio Systems**, Sun Alliance Buildings, 65 London Road, Gloucester, GL1 3HF. Tel: Gloucester (0452) 32791.
- Scan-Dyna**, Scandinavian Audio Systems Ltd, Sun Alliance Buildings, 65 London Road, Gloucester, GL1 3HF. Tel: Gloucester (0452) 32791.
- Scansound**, Howland-West Ltd, 3-5 Eden Grove, London, N7 8EQ. Tel: 01-609 0293.
- Schott**, Jaorex Marketing Ltd, 40 Bell Street, Reigate, Surrey, RH2 7BA. Tel: Reigate (74) 40540.
- Scintrex**, Impo Hi-Fi, Buckingham Palace Road, London, SW1. Tel: 01-834 0050.
- Scopetronics Ltd**, Crown Works, Church Road, Kingston-upon-Thames, Surrey. Tel: 01-546 1275/4135.
- Scotch**, 3M (UK) Ltd, 3M House, Wigmore Street, London, W1. Tel: 01-486 5222.
- SED Television Ltd**, Salisbury, Wilts. Tel: Salisbury (0722) 4201.
- S.D.L. Adastral Electronics Ltd**, Unit N22, Cricklewood Trading Estate, Clarendon Road, London, NW2 1TU. Tel: 01-452 6288.
- Sennheiser Electronic**, Hayden Laboratories Ltd, Hayden House, 17 Chesham Road, Amersham, Bucks, HP6 5AG. Tel: Amersham (0240 3) 5511. Showroom, service and despatch dept. 6 Bendall Mews, Bell Street, London, NW1.
- Servo-Sound (Cybernetic Hi-Fi)**, Lamb House, Church Street, London, W4 2PB. Tel: 01-995 4551.
- Sharp Electronics (UK) Ltd**, 107 Hulme Hall Lane, Manchester, M10 8HL. Tel: 061-205 7321.
- Sherwood**, Acoustico Enterprises Ltd, Unit 7, Space Way, North Feltham Trading Estate, Feltham, Middlesex, TW14 0TZ. Tel: 01-751 0141.
- Shriro (UK) Ltd**, Shriro House, The Ridgeway, Iver, Bucks, SL0 9JL. Tel: Cedarwood (075 38) 2222.
- Shure Electronics Ltd**, Eccleston Road, Maidstone, Kent, ME15 6AU. Tel: Maidstone (0622) 59881.
- J. J. Silber Ltd**, 11 Northburgh Street, London, EC1. Tel: 01-253 8031.
- Sinclair Radionics Ltd**, London Road, St Ives, Hunts, PE17 4HJ. Tel: St Ives (0480) 4311.
- Skandia Electronics**, Golding Audio Ltd, London Road, Marks Tey, Colchester, Essex. Tel: Marks Tey (0206 21) 433.
- SMC Products**, Monitor Distribution Co Ltd, 76 Bedford Road, Kempston, Beds, MK42 8BB. Tel: Kempston (023 05) 2694.
- SME Ltd**, Steyning, Sussex, BN4 3LN. Tel: Steyning (0903) 814321.
- Sonab Ltd**, PO Box 4, Oldfield Road, Hampton, Middlesex, TW12 2HN. Tel: 01-979 0134.
- Sonotone**, Verneritron Ltd, Thornhill, Southampton, SO9 5QF. Tel: Southampton (0703) 444811.
- Sony (UK) Ltd**, Pyrene House, Sunbury Cross, Sunbury-on-Thames, Middlesex. Tel: Sunbury-on-Thames (76) 87644.
- Soundcraftsmen**, Distributor: Gale Electronics and Design Ltd, 39 Upper Brook Street, London, W1Y 1PE. Tel: 01-499 9966.
- Soundex Ltd**, 18 Blenheim Road, London, W4. Tel: 01-995 1661.
- The Sound Studio Limited**, 33-35 Camden Road, Tunbridge Wells, Kent. Tel: Tunbridge Wells (0892) 32153/30314.
- Spender**, Kings Mill, Kings Mill Lane, South Nutfield, Redhill, Surrey, RH1 5NF. Tel: Nutfield Ridge (682) 2554.
- Staples and Co Ltd**, Staples Corner, Junction Edgware Road and North Circular Road, London, NW2. Tel: 01-452 1144.
- Stax**, Wilmex Ltd, Import Division, Compton House, New Malden, Surrey, KT3 4DE. Tel: 01-949 2545.
- STC**, Coles Engineering Ltd, Pindar Road, Hoddesdon, Herts. Tel: Hoddesdon (61) 66685.
- Steepleton Products Ltd**, Station Approach, Bicester, Oxon, OX6 7DP. Tel: Bicester (086 92) 42031.
- Stentorian**, Whiteley Electrical Radio Co Ltd, Radio Works, Victoria Street, Mansfield, Notts, NG18 5RW. Tel: Mansfield (0623) 24762.
- Stereosound Productions**, Capital Works, Wakefield Road, Brighouse, Yorks. Tel: Brighouse (048 47) 4355.
- Stereostage**, Nucleus, 22 Hyde Green, Marlow, Bucks. Tel: Marlow (062 84) 3787.
- John Street (Manufacturers) Ltd**, Falcon Works, Barmston Road, London, SE6. Tel: 01-698 1177.
- Studer**, F. W. O. Bauch Ltd, 49 Theobald Street, Boreham Wood, Herts, WD6 4RZ. Tel: 01-953 0091.
- Studiocraft**, Acoustico Enterprises Ltd, Unit 7, Space Way, North Feltham Trading Estate, Feltham, Middlesex, TW14 0TZ. Tel: 01-751 0141.
- A. R. Sugden & Co (Engineering) Ltd**, Connoisseur Works, Atlas Mill Road, Brighouse, Yorks, HD6 1ES. Tel: Brighouse (048 47) 2142.

- J. E. Sugden & Co Ltd**, Carr Street, Cleckheaton, Yorks, BD19 5LA. Tel: Cleckheaton (097 62) 2501.
- Sykes+ Hirsch Ltd**, Templewood House, Templewood Lane, Stoke Poges, Slough, Bucks, SL2 4AP. Tel: 01-850 4127.
- Symphony, J. W. (Wholesale) Co Ltd**, 26 Rosoman Street, London, EC1. Tel: 01-837 3041.
- Synchrotepe**, Adastra Electronics Ltd, Unit N22, Cricklewood Trading Estate, Clarendon Road, London, NW2 1TU. Tel: 01-452 6288.
- Tak Continental Importers**, 16a High Street, Stone, Staffs. Tel: Stone (078 583) 3232.
- Tandberg, Farnell-Tandberg Ltd**, Farnell House, 81 Kirkstall Road, Leeds, LS3 1HR. Tel: Leeds (0532) 35111.
- Tannoy Products Ltd**, Norwood Road, West Norwood, SE27 9AB. Tel: 01-670 1131.
- Tape Music Distributors Ltd**, 114 Ashley Road, St Albans, Herts, AL1 5JR. Tel: St Albans (56) 64337.
- Tape Recorder Developments Ltd**, Hall Lane, Walsall Wood, Staffs. Tel: Brownhills (054 33) 5351.
- Tape Recorder Spares Ltd**, Harmsworth House, 9 Harmsworth Street, London, SE17 3TL. Tel: 01-735 9683.
- Tate Audio Transmission Equipment Ltd**, 5-7 Covent Garden, Cambridge, CB1 2HS. Tel: Cambridge (0223) 67873.
- TDK Tape Distributor (UK) Ltd**, 341 Brighton Road, South Crondon, Surrey, CR2 6EQ. Tel: 01-688 7372.
- Teac**, Acoustico Enterprises Ltd, Unit 7, Space Way, North Feltham Trading Estate, Feltham, Middlesex, TW14 0TZ. Tel: 01-751 0141.
- Technics**, Building 63, Whitby Road, The Trading Estate, Slough, Bucks. Tel: Slough (75) 34522.
- Telefi**, Rola-Celestion Ltd, Ditton Works, Foxhall Road, Ipswich, Suffolk, IP3 8JP. Tel: Ipswich (0473) 73131.
- Telefunken**, AEG Telefunken (UK) Ltd, Bath Road, Slough, Bucks. Tel: Slough (75) 33311.
- Telerenters (London & Provincial) Ltd**, 155-159 Queens Road, Watford, Herts, WD1 2QH. Tel: Watford (92) 24543.
- Teleton Electro (UK) Co Ltd**, Teleton House, Waterhouse Lane, Chelmsford, Essex, CM1 1BD. Tel: Chelmsford (0245) 62442.
- Tellux (Sound Production) Ltd**, Tallon Road, Hutton Industrial Estate, Brentwood, Essex. Tel: Brentwood 214708.
- Thorens**, Metrosound Audio Products Ltd, Cartersfield Road, Waltham Abbey, Essex, EN9 1JF. Tel: Waltham Cross (97) 31933.
- Thorn Consumer Electronics Ltd**, 284 Southbury Road, Enfield, Middlesex, EN1 1LJ. Tel: 01-366 1155.
- TMT**, Tape Marketing Technology Ltd, 8 Green Street, London, W1Y 3RF. Tel: 01-493 4205/4760.
- Toshiba (UK) Ltd**, Toshiba House, Great South West Road, Feltham, Middlesex. Tel: 01-751 1281.
- Transcriptors Ltd**, J. H. Nelson Audio, Mycott House, Station Road, Boreham Wood, Herts. Tel: 01-953 9851.
- Trio**, B. H. Morris & Co (Radio) Ltd, Trio House, The Hyde, London, NW9 6JP. Tel: 01-205 6411.
- TTC Division Precision Centre**, Heather Park Drive, Wembley, Middx, HA0 1SU. Tel: 01-903 0144.
- Tudor Tape**, A. C. Farnell Ltd, Kenyon Street, Sheffield, S1 4BD. Tel: Sheffield (0742) 78901.
- Turner**, Millbank Electronics Group Ltd, Bellbrook Estate, Uckfield, Sussex, TN22 1PS. Tel: Uckfield (0825) 4166.
- Tysons Electronics Ltd**, 14 Rook Hill Road, Friars Cliff, Christchurch, Hants, BH23 4DZ. Tel: Highcliff (042 52) 72019.
- Tyson's Sound Engineers**, 41 Russell Street, Leamington Spa, Warks. Tel: Leamington Spa (0926) 24935.
- Uher (UK) Ltd**, 15 Broomhills Estate, Braintree, Essex, CM7 7RQ. Tel: Braintree 23192.
- Ultra**, Thorn Consumer Electronics Ltd, 284 Southbury Road, Enfield, Middlesex, EN1 1LJ. Tel: 01-366 1155.
- Unimixer**, Soundex Ltd, 18 Blenheim Road, London, W4 1ES. Tel: 01-995 1661.
- Unisonid**, Condor Electronics Ltd, 100 Coombe Lane, London, SW20 0AY. Tel: 01-946 0033.
- Valek Ltd**, Lark Street, Darwen, Lancs, BB3 2LT. Tel: Darwen (0254) 71881.
- Valradio Ltd**, Brownells Lane, Feltham, Middx, TW13 7EN. Tel: 01-890 4837/4242.
- Van der Molen Ltd**, 1 Mildmay Road, Romford, Essex, RM7 7DA. Tel: Romford (70) 41904.
- Vernitron Ltd**, Thornhill, Southampton, SO95QF. Tel: Southampton (0703) 444811.
- Vero Electronics Ltd**, Industrial Estate, Chandler's Ford, Eastleigh, Hants, SO5 3ZR. Tel: Chandler's Ford (042 15) 2952.
- H. Vesshoff & Co Ltd**, (Vessco Vision & Radio), 62 Woodbridge Road, Guildford, Surrey, GU1 4RD. Tel: Guildford (0483) 77877.
- Videosonics**, Phoenix Videosonic Ltd, 15 Broomhills Industrial Estate, Braintree, Essex, CM7 7RQ. Tel: Braintree 23192.
- Videoton**, Oscar Radio Company, 55-63 Goswell Road, London, EC1. Tel: 01-253 1802.
- Vista Gain Sales Ltd**, 123-124 Newgate Street, London, EC1A 7AA. Tel: 01-600 3030.
- Vitavox**, Westmoreland Road, London, NW9 9RJ. Tel: 01-204 4234.
- Vortexion Ltd**, 257-263 The Broadway, Wimbledon, London, SW19 1SF. Tel: 01-542 6242.
- WAL**, A. C. Farnell Ltd, Kenyon Street, Sheffield, S1 4BD. Tel: Sheffield (0742) 78901.
- Waltham**, Telerenters (London & Provincial) Ltd, 155-159 Queens Road, Watford, Herts, WD1 2QH. Tel: Watford (92) 24543.
- Cecil E. Waits Ltd**, Darby House, Sunbury-on-Thames, Middlesex. Tel: Sunbury-on-Thames (76) 3252.
- Webland International Ltd**, 30 Baker Street, London, W1M 2DS. Tel: 01-402 9410.
- Weircliffe**, A. M. of Exeter Ltd, Weircliffe Court, Exwick, Exeter, Devon. Tel: Exeter (0392) 72132.
- Wharfedale**, Rank Radio International Ltd, PO Box 596, Power Road, Chiswick, London, W4 5PW. Tel: 01-994 6491.
- Whiteley Electrical Radio Co Ltd**, Radio Works, Victoria Street, Mansfield, Notts, NG18 5RW. Tel: Mansfield (0623) 24762.
- Wilkinson/Form Electronics**, 1-2 Low Quay, Blyth, Northumberland, NE24 3AL. Tel: Blyth (067 06) 3575.
- Wilmax Ltd**, Import Division, Compton House, New Malden, Surrey, KT3 4DE. Tel: 01-949 2545.
- The Wilson Stereo Library Ltd**, 104-106 Norwood High Street, London, SE27. Tel: 01-670 6394.
- Wolsey Electronics**, Cymmer Road, Porth, Rhondda, Glam, CF39 9BT. Tel: Porth (044 361) 2711.
- Woollett Audiostatics**, 21 Anerley Station Road, London, SE20 8PY. Tel: 01-699 5296.
- Worden Audio Developments Ltd**, 54 Chepstow Road, London, W2. Tel: 01-229 4996.
- Wye Electronics Ltd**, Queen Street North, Whittington Moor, Chesterfield, Derbys. Tel: Chesterfield (0246) 51116.
- Yamaha**, Natural Sound Systems Ltd, Strathcona Road, North Wembley, London, HA9 8QL. Tel: 01-904 0141.

# Advertisers Index

Acoustic Research International	378	J.V.C. (UK) Ltd	3
Acoustic Transducers Co Ltd	304	Jaybeam Ltd	440
Acoustical Mfg. Co Ltd (Quad)	22	K.F. Products Ltd	347
Acoustico Enterprises Ltd	414	Laskys Radio Ltd	464
Aerialite Aerials Ltd	437	Lennard Developments Ltd	198
Agfa Gevaert Ltd	156	Lindair Electronics	216
Alba Radio & Television Ltd	62	Linn Products Ltd	271
Antiference Ltd	438	Lowther Acoustics Ltd	354
B. & W. Electronics	353	M.D.G. Audio Approach	215
Bang & Olufsen (UK) Ltd	272	MacInnes Laboratories Ltd	60
Bib Hi-Fi Accessories Ltd	396	MacInnes Laboratories Ltd (KLIPSCH Speakers)	377
C. H. B. Supplies	95	Markovitz, I. Ltd	395
Colne Loud-speaker Research	317	Miers N.	403
Condor Electronics Ltd	171	Morris B. H. & Co (Radio) Ltd (Trio)	21
Cosmocord Ltd	296, 375	Philips Electrical Ltd	355
Crown Radio Co Ltd	458	Premier Industries (Cheltenham) Ltd	444
Decca Radio & Television	111	Pye Ltd (Ekco)	112-113
Decca Special Products Ltd	188	Quadrasonics	392
Discount Audio Ltd	70	Radford Hi-Fi Ltd	235
Dynatron Radio Ltd	218	Richard Allan Radio Ltd	356
E.M.G. Handmade Gramophones Ltd	50	Rola Celestion	320 <i>Back cover</i>
Eagle International	240, 241	Ross Electronics	150, 181
J. R. Edwards Electronics Ltd	376	SME Limited	284
Executive Audio Ltd	389	Saba Radio & Television Ltd	255
Fidelity Radio Ltd	290	Sanyo Marubeni (UK) Ltd	96, 256
Followfield, Jonathan, Ltd (Yamaha)	48, 49	Shure Electronics Ltd	162
Fountain Press	4	Sonab (of Sweden) Ltd	334
Gale Electronics	30, 69, 200, 236, 333	Spendor Audio Systems Ltd	318
Garrard Engineering Ltd	283	Sugden A. R. & Co (Engineers) Ltd	289
Goldring Ltd	270	Tannoy Products Ltd	303
Goodmans Loudspeakers Ltd	<i>Front cover</i>	Teleton Electro (UK) & Co Ltd	59
Gramplan Reproducers	95	Thorn Consumer Electronics Ltd (H. M. V.)	84
Griffin U.K. & Co (Electronics)	391	Toshiba (UK) Ltd	47
HMB Engineering	327	Tyson's Sound	339
Hampstead Hi-Fidelity Ltd	130	Uher (UK) Ltd	408
Heath (Gloucester) Ltd	120	United Mercantile Co Ltd (Zenith)	114, 217
Hitachi Sales (UK) Ltd	29	Webland International Ltd	319
Imhof-Bedco Ltd	138		





**ASK  
LASKYS**  
and make no mistake

People ask Laskys because of their keenly competitive pricing policy.

People ask Laskys because of their staggering range of choice

People ask Laskys because every item they sell is fully guaranteed for a year including labour and parts.

People ask Laskys because they give advice that can be trusted.

Ask Laskys at any of the following branches

**CENTRAL LONDON**

481 Oxford Street, W1 01-493 8641  
 10 Tottenham Court Rd. W1 01-637 2232  
 27 Tottenham Court Rd. W1 01-636 3715  
 33 Tottenham Court Rd. W1 01-636 2605  
 42/45 Tottenham Ct. Rd. W1 01-636 0845  
 257/8 Tottenham Ct. Rd. W1 01-580 0670  
 3 Lisle St. WC2 01-437 8204  
 34 Lisle St. WC2 01-437 9155  
 118 Edgware Rd. W2 01-723 9789  
 193 Edgware Rd. W2 01-723 6211  
 207 Edgware Rd. W2 01-723 3271  
 311 Edgware Rd. W2 01-262 0387  
 346 Edgware Rd. W2 01-723 4453  
 382 Edgware Rd. W2 01-723 4194  
 109 Fleet St. EC4 01-353 5812  
 152/3 Fleet St. EC4 01-353 2833

**ESSEX**

86 South Street, Romford 20218  
 205/6 Victoria Circus, Southend –  
 Opening September/October 1974

**KENT**

53/57 Camden Road,  
 Tunbridge Wells 0892-23242

**LEICESTERSHIRE**

45 Market Place, Leicester 0533-537678

**NORTHAMPTONSHIRE**

78 Abingdon Street, Northampton –  
 Opening November 1974

**STAFFORDSHIRE**

30 Wulfrum Way, Wolverhampton –  
 Opening October 1974

**SURREY**

1046 Whitgift Centre,  
 Croydon 01-681 3027  
 27 Eden St. Kingston 01-546 7845  
 32 Hill St. Richmond 01-948 1441

**WARWICKSHIRE**

116 Corporation St.  
 Birmingham 021-236 3503

**New branches opening in 1974/75. Watch our advertisements for details**

Head Office: Laskys Customer Services Division - Audiotronic House - The Hyde - London - NW9 6JJ  
 Telephone: 01-200 1321/8

# Directory of Hi Fi Dealers

## IMPORTANT NOTE

The following list is of shops where stocks of equipment are kept, and where facilities for demonstration exist. It is not necessarily a complete list, and we invite new dealers to submit details for future publications.

## LONDON AREA

### AUDIO HOUSE LTD

5 Ashbourne Parade, Temple Fortune, (nr Henly's Corner), NW11.  
Tel: 01-455 4618

### AUDIO SUPPLIES LTD

(The Big Discount House)  
50 Stamford Hill, N15.  
120 Notting Hill Gate, W11

### AUDIO T

130 West End Lane, West Hampstead, NW6 1SQ. Tel: 01-794 7543

### BERRY'S RADIO LTD

319-320 High Holborn, WC1V 6AZ.

### BRAKEFIELD SALES LTD

285-288 Sangley Road, SE5  
Tel: 01-698 7373

### CHAPPELL MUSIC CENTRES LTD

50 New Bond Street, W1. Tel: 01-629 7500

### DAVIS & KAYS PHOTOGRAPHS

159a Fife Street, Edmonton, N18  
Tel: 01-507 2807

### DISCOUNT AUDIO

231 Tottenham Court Road, W1.  
245-247 Tottenham Court Road, W1  
Tel: 01-323 4949  
301 Edgware Road, W2  
Tel: 01-252 2491

### EMG HANDMADE

### GRAMOPHONES LTD

26 Soho Square, W1V 6BB.  
Tel: 01-734 4311

### FRANCIS OF STREATHAM

159-173 Stratham High Road, SW16.  
Tel: 01-769 0192/0456.

### C C GOODWIN (SALES) LTD

7 The Broadway, High Road, Wood Green, N22 6DU. Tel: 01-838 0077

### GRAHAMS ELECTRICAL LTD

35-88 Pentonville Road, N1 9HS

### HAMPSTEAD HIGH FIDELITY

91 Heath Street, Hampstead, NW3  
Tel: 01-435 0999/6377

### HAVEN HI-FI (EALING) LTD

196-198 South Ealing Road, W5.

### THOMAS HEINITZ

### MUSIC IN THE HOUSE

35 Moscow Road, W2 4AH.  
Tel: 01-229 2077

### HENRY'S RADIO LTD

303 Edgware Road, W2  
Tel: 01-723 1008.  
354-356 Edgware Road, W2.  
Tel: 01-402 5854/4736  
120 Shaftesbury Avenue, W1  
Tel: 01-437 9692

### HERMLYN HI-FI

230-232 Eltham High Street, SE9  
Tel: 01-850 9548

### HI-FI AND COMPONENTS LTD

84 Battersea Rise, Clapham Junction, SW11. Tel: 01-223 1110

### HI-FI PRO

22-24 Buckingham Palace Road, SW1

### IMHOF'S (RETAIL) LTD

112-116 New Oxford Street, WC1A 1JH.  
Tel: 01-636 7878

### LASKYS

42-45 Tottenham Court Road, W1.  
Tel: 01-636 0345.  
33 Tottenham Court Road, W1  
Tel: 01-636 2605  
118 Edgware Road, W2. Tel: 01-723 9789.  
193 Edgware Road, W2. Tel: 01-723 6211.  
207 Edgware Road, W2. Tel: 01-723 3271.  
311 Edgware Road, W2. Tel: 01-262 0387.  
382 Edgware Road, W2. Tel: 01-723 4194.  
346 Edgware Road, W2. Tel: 01-723 4453.  
109 Fleet Street, EC4Y 1DJ  
Tel: 01-353 5812.  
378 Harrow Road, W9. Tel: 01-286 9530.  
3 Lisle Street, WC2. Tel: 01-437 8204.  
34 Lisle Street, WC2. Tel: 01-437 9155.  
431 Oxford Street, W1. Tel: 01-493 8641.  
10 Tottenham Court Road, W1  
Tel: 01-637 2232.  
87 Tottenham Court Road, W1  
Tel: 01-580 3738.  
257-8 Tottenham Court Road, W1  
Tel: 01-580 0670.  
21 Old Compton Street, W1  
Tel: 01-437 9369

### LEE ELECTRONICS

400 Edgware Road, W2.

### LEWIS RADIO CO

100 Chiswick, Southgate, N14 5PL

### LINDAIR

227 Tottenham Court Road, W1  
Tel: 01-580 7383.  
149 Fleet Street, EC4  
137 Charing Cross Road, WC2.  
Tel: 01-437 8718.  
241-242 Tottenham Court Road, W1  
Tel: 01-580 2255

### DISCOUNT AUDIO

299-301 Edgware Road, W2  
Tel: 01-262 2491

### MAC'S CAMERA SHOPS LTD

250-252 King Street, Hammersmith, W6.  
Tel: 01-748 8581

### MODERN ELECTRICS (RETAIL)

LTD  
120 Shaftesbury Avenue, W1V 7DJ

### MYERS AUDIO

199 Hoe Street, Walthamstow, E17 9PP  
Tel: 01-520 7277

### NATIONAL RADIO SERVICE

### & TELEVISION CO

82 St John's Wood High Street,  
NW8 7SH.

### NEWBURY RADIO (FOREST GATE)

LTD  
305 Romford Road, Forest Gate, E7

Tel: 01-534 3100

### NICHOLLS HI-FI

432 Lee High Road, Lee Green, SE13

### NUSOUND

228 Bishopsgate, EC2. Tel: 01-247 2609

36 Lewisham High Street, SE13

Tel: 01-852 2399

82 High Holborn, WC1. Tel: 01-242 7401

242-4 Pentonville Road, NW1.

Tel: 01-837 8200

### M O'BRIEN (HIGH FIDELITY

### SPECIALIST)

95 High Street, Wimbledon Village, SW19

### PEAK DISCOUNT AUDIO/HI-FI

### WAREHOUSE

242-244 Pentonville Road, N1.

### PIERCY'S (ELECTRONICS) LTD

58-62 Lupus Street, Pimlico, SW1V 3EE  
Tel: 01-834 5759

### PICTORIALS

459 Upper Richmond Road, East Sheen, SW14. Tel: 01-876 1740

### PREMIER RADIO (CANONDELL)

### LTD

23 Tottenham Court Road, W1.

Tel: 01-636 3451

56 Gorge Street, W1.

### THE RECORDER CO

186-188 West End Lane, West

Hampstead, NW6. Tel: 01-794 4977

### R E W AUDIO VISUAL CO

146 Charing Cross Road, WC2.

Tel: 01-836 3365

### R E W House, High Street, SW19 2BE

Tel: 01-540 9684

266-268 Upper Tooting Road, SW17 0DR.

### ROUNDABOUT RECORDS LTD

8 Parsons Street, NW4

### JAMES RUSSELL & SONS (AUDIO)

### LTD

11 Wimbledon Bridge, SW19

Tel: 01-946 8804

### SANDS HUNTER & CO LTD.

45 Hare Street, SE18

37 Bedford Street, Strand, WC2

19 Ludgate Hill, EC4.

### SHERBOURNE HI-PHONICS LTD

150 Tooting Park, N4 3AD

Tel: 01-272 4327

50 Topsfield Parade, N8 8PT.

Tel: 01-340 1987

256 Muswell Hill Broadway, N8 8SH

Tel: 01-883 3350

### G. W. SMITH & CO (RADIO) LTD

311 Edgware Road, W2

3 Lisle Street, WC2

34 Lisle Street, WC2.

10 Tottenham Court Road, W1.

27 Tottenham Court Road, W1.

87 Tottenham Court Road, W1

257 Tottenham Court Road, W1V 9AD.

118 Edgware Road, W2 2DZ

193 Edgware Road, W2 1ET

382 Edgware Road, W2 1EB

152-153 Fleet Street, EC4A 2DQ.

378 Harrow Road W9 2HU

H. L. SMITH & CO LTD,

287-9 Edgware Road, W2 3RY

Tel: 01-723 5891

### SOUND CENTRE

### (HI-FI EQUIPMENT) LTD

48 London Wall, EC2.

115 Kingsway Holborn, WC2.

857 High Road, Finchley, N12.

152 Rye Lane, Peckham, SE15.

8 Turnpike Parade, N15

61 Seven Sisters Road, N7

105 Lawrence Road, N15 4ES

**SPEAKER SELECTION LTD**  
611 Forest Road, Walthamstow, E11 74QD  
Tel: 01-531 3117.

**STUDIO 99 LTD**  
81 Fairfax Road, Swiss Cottage, NW6.

**TELESONIC LTD**  
92 Tottenham Court Road, W1

**ASHFORD (KENT)**  
**PHOTOGRAPH HI-FI**  
40 High Street. Tel: Ashford 24441.

**AXMINSTER (DEVON)**  
**REG WARD & CO LTD**  
George Street, EX13 5DP.  
Tel: 0297 33163.

**BANSTEAD (SURREY)**  
**RAYLEC LTD**  
43 High Street. Tel: Burgh Heath 51365.

**BARNET (HERTS)**  
**PORTOGRAM RADIO ELEC. IND. LTD**  
175 High Street.

**BARNLSLEY (YORKS)**  
**GEOFFREY BARNARD**  
2 Pitt Street. Tel: Barnsley 84572.

**BARROW-IN-FURNESS**  
**DERHAMS OF KENDAL**  
5 Furness House, Lanes  
Tel: Barrow 22973.

**BASILDON (ESSEX)**  
**KELLEYS RADIO LTD**  
82 Town Square.

**BATH (SOMERSET)**  
**C MILSOM & SONS LTD**  
North Gate.

**BEDFORD**  
**CARLOW RADIO LTD**  
6 St Luyes Street

**BELFAST (N. IRELAND)**  
**LLOYD SOUND LTD**  
11 Havelock Street, B1 / 1EA.  
Tel: 28338/34510.

**BILLINGSHURST (SUSSEX)**  
**HORSHAM AUDIO SYSTEMS LTD**  
60 High Street. Tel: 3466.

**BIRMINGHAM**  
**AUDIO SUPPLIES LTD**  
1536 Tivoli Shopping Centre, Yardley.

**BELMONT RECORDING CO**  
25 Belmont Road, Bearwood.  
Tel: 021-429 4463.

**BIRMINGHAM TAPE RECORDER CENTRE LTD**  
Vehicle & General House, 37 Hurst Street, B5 4BJ. Tel: 021-622 2323.

**GRIFFIN RADIO LTD,**  
94 Bristol Street, Birmingham, 5

**NORMAN H. FIELD HI-FIDELITY CENTRE**  
35 Hurst Street, B5 4BJ. Tel: 021-622 2323.

**W. J. TAYLOR (DOMESTIC SUPPLIES) LTD**  
128 Hawthorn Road, Kingstanding, B44 8QA.

**KEN WHITTLE LTD**  
788 Stratford Road, Sparkhill, B11 4BP.  
Tel: 021-777 5964.

**BISHOP AUCKLAND (Co. DURHAM)**  
**McKENNA & BROWN (PHOTO/ HI-FI) LTD**  
134 Newgate Street

**BLACKBURN (LANCS)**  
**HOLDINGS OF BLACKBURN LTD**  
Photo-Audio Centre,  
39-41 Mining Lane, Darwen Street.

**BLACKPOOL**  
**F. BENFELL LTD**  
78 Westfield Road (Ansdell Road)  
Tel: 49525.

**C. BRADDOCK LTD**  
(The Tape Recorder Centre)  
255 Waterloo Road, FY4 3AF.

**JOHN F. WIGNEY LTD**  
(Cleveland's Hi-Fi Centre)  
2-3 Orion Buildings, Cleveleys.  
Tel: Cleveleys 2627.

**NORMAN WHITELEY (HOBBIES) LTD**  
4 Deansgate. Tel: 28357.

**BOGNOR REGIS (SUSSEX)**  
**SPORTS & RADIO LTD**  
25-29 Aldwick Road. Tel: 5331

**BOLTON (LANCS)**  
**H. D. KIRK (STEREOELECTRICS) LTD**  
203 St Georges Road  
Tel: 23093

**CLEAR TONE HI-FI LTD**  
166 Blackburn Road.

**BOSTON (LINCOLNSHIRE)**  
**ADDYS (BOSTON) LTD**  
9 Wide Bargate. Tel: Boston 2454.

## THE RECORDERIE

the recorderie opened  
stanmore, middx. april 1961

the recorderie opened  
northwood, middx. november 1968

the recorderie opened  
radlett, herts. november 1973

the recorderie are specialist record, hi-fi, colour TV dealers—the shops carry a vast stock of records, tapes and equipment—special emphasis is placed on the classical catalogue and knowledgeable staff are always ready to help—the hi-fi departments carry only the very best quality equipment—and we give a two year guarantee for labour and parts on all Bang and Olufsen, Hacker, Sony, Dynatron, Quad, Tandberg, Sonab.

10, buckingham parade, stanmore, middx. 01-954 2913/2940

3, rowland place, green lane, northwood, middx. northwood 24882

333, watling street, radlett, herts. radlett 6060

all shops open tuesday—saturday  
9 a.m.—6 p.m.

HI-FI  
T/V VIDEO & CCTV  
RECORDS & TAPES

**Russell's**

40 UPPER ST. JAMES'S STREET  
NEWPORT I-O-W 3864

## Millwards (Wolverhampton) Ltd Hi-Fi Consultants and System Builders

AGENTS FOR  
B & O, Sony, Trio, Tandberg, Marantz,  
Yamaha, Armstrong, Sonab, Quad, Dynatron,  
Dual etc.

11, Salop Street, Wolverhampton  
Telephone: 0902 23980

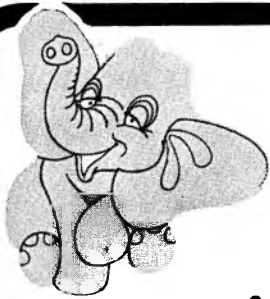

**For the best  
in Hi-Fi**

*it's got to be*  
**HENRY'S**

At Henry's Home Entertainment Centres, you can see and hear the world's leading audio and high fidelity systems. We have superb demonstration facilities, so that you can compare various hi-fi combinations in an ideal listening environment. And here are some more reasons why it's got to be Henry's.

**Unbiased advice.** Every Henry's Home Entertainment Centre gives you unbiased advice. With more than 70 agencies for internationally famous hi-fi manufacturers, we won't be tempted to sell you any particular make.

**Parts and Labour Guarantee.** We give you peace of mind, with every piece of hi-fi equipment! Henry's guarantee is for 12 months - for both parts and labour. And you also get the manufacturer's guarantee, of course.

**Instant Credit for Callers.** Easy credit is available to everyone who visits any Henry's Home Entertainment Centre. But naturally, you can pay cash if you like - or use your Access or Barclaycard.

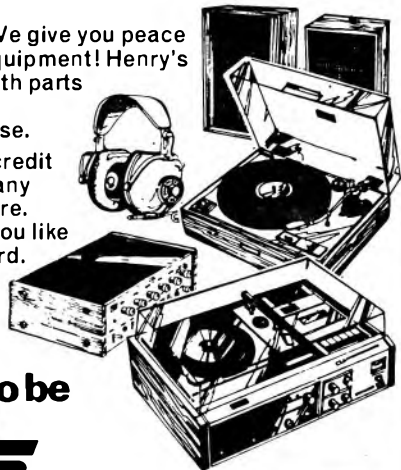

**Call any centre and  
remember - it's got to be**

**HENRY'S** HOME ENTERTAINMENT CENTRES

**London**

354/5 Edgware Rd. W2 01-402 5854  
376/8 Edgware Rd. W2 01-723 0818  
372 Edgware Rd. W2 01-402 8140  
120 Shaftesbury Ave. W1 01-437 9692  
230 Tottenham Court Rd. W1 01-580 1785

144 Burnt Oak B'way, Edgware 01-952 7402  
190/4 Station Rd. Harrow, Middx 01-863 7788

*Out of Town*

256 Banbury Rd. Oxford (0865) 54181  
55 Gloucester Rd. Bristol 7 (0272) 45791

**BOURNEMOUTH**

DAWSONS RADIO LTD  
Seamoor Road, Westbourne.

FORRESTER'S NATIONAL RADIO  
SUPPLIES LTD

70-72 Holdenhurst Road. Tel: 25232.

**MARACK HI-FI**

23 The Hampshire Centre, Castle Lane.

**BRADFORD**

CHRISTOPHER PRATT & SONS LTD  
33 North Parade, BDI 3JJ. Tel: 25894.

CLEAR TONE HI-FI LTD  
Titan Shopping Centre, Wyke.

YORKSHIRE HI-FI CENTRES LTD  
48 Darley Street.

**BRENTWOOD (ESSEX)**

KELLEYS RADIO LTD  
8 High Street.

**BRIDGWATER (SOMERSET)**

P. TAYLOR (BRIDGWATER) LTD  
5 Eastover. Tel: 2142.

**BRIGHTON**

JOHN KING (FILMS) LTD  
Film House, 71 East Street, BNI 1NZ.  
Tel: 25918/27674.

**BRISTOL**

HUSBANDS & SONS LTD  
The Centre, 8 St Augustine's Parade,  
BS1 4UU.

HOUSE OF SOUND LTD  
5 Marsh Street, 1. Tel: 291534.

STEREO CENTRE LTD  
309 Gloucester Road, BS78PE.  
Tel: 421395.

TAPE RECORDER AND HI-FI  
CENTRES LTD.  
82 Stokes Croft, BSI 3RP. Tel: 49677.

**BROADSTAIRS**

THANET MOBILE VISION AND  
AUDIO CENTRE LTD  
78 High Street.

**BURNT OAK (MIDDLESEX)**

HENRY'S RADIO LTD  
144 Burnt Oak Broadway.  
Tel: 01-952 7402/3.

**BURY (LANCS)**

VICTOR WRIGHT ELECTRONICS  
116 The Rock, BL9 0PJ Tel: 061-764 2931.

**BURY ST EDMUNDS (SUFFOLK)**

B. G. RADIO SERVICE  
10 Hatter Street. Tel: 5227.

**BYFLEET (SURREY)**

WEST ELECTRICS  
150 High Street. Tel: 41874.

**CAMBERLEY (SURREY)**

CAMBERLEY CAMERA & HI-FI  
CENTRE  
36 High Street. Tel: 65848.

KENNETH RICHARDS  
24 Grace Reynolds Walk. Tel: 24443.

**CAMBRIDGE**

UNIVERSITY AUDIO  
1-2 Peas Hill. Tel: 54237.

**CANTERBURY (KENT)**

CANTERBURY HI-FI CENTRE  
1-2 The Friars. Tel: Canterbury 65315.

TERRY BURKE (AUDIO) LTD  
64 Windcheap. Tel: 69848.

**CARDIFF**

CITY RADIO LTD  
8 Oxford House, Hills Street.  
Tel: Cardiff 28169.

J. GOUGH & CO LTD  
148-154 North Road. Tel: 28473.

CARDIFF HI-FI CENTRE  
27-30 Oxford Arcade, The Hayes.  
Tel: 40211 and 390853.

**CARLISLE**

MISONS  
11 Warwick Road. Tel: 22620/31481.

TURNERS (NEWCASTLE-UPON-  
TYNE) LTD  
1-5 Lowther Street, CA3 8S3.

**CHANDLER'S FORD (HANTS)**

HAMPSHIRE AUDIO LTD  
8 Hursley Road, SO5 2FU. Tel: 2827.

**CHATHAM (KENT)**

MEDWAY ELECTRONICS  
276 High Street.  
15a Church Square.

**CHELMSFORD (ESSEX)**

RUSH AUDIO DISCOUNTS LTD  
74 Baddow Road. Tel: 64393.

HI-FI CENTRE OF CHELMSFORD  
6 Cornhill. Tel: 57593.

**CHELTENHAM**

RAY ELECTRICAL (CHELTENHAM)  
LTD  
287 High Street.

# AUDIO EQUIPMENT IN THE WEST

BACKED BY OUTSTANDING SERVICE FACILITIES  
from

AT

TAUNTON Phone 2638  
BRIDGWATER Phone 2142  
MINEHEAD Phone 2294  
WELLINGTON Phone 2189  
CULLOMPTON Phone 2202

*J.P. Taylor* LTD

Stockists of  
B & O, DYNATRON, HACKER,  
H.M.V., MORDAUNT-SHORT,  
PHILIPS, QUAD, SONY  
AND OTHERS  
COMPLEMENTED BY  
RECORDED MUSIC ON  
DISC AND TAPES

**WALES**

Leading Hi-Fi Specialists Est. 1930

**J. GOUGH & CO LTD, CARDIFF**

Designers of the "Gough Loudspeaker Cabinet"

Stockists of Quad, Leak, Armstrong, Sony, Trio,  
Bang & Olufsen Main Dealer.

★ Demonstration rooms available ★

148-154 NORTH ROAD

Telephone 28473

Mansfield

Tel: 26315

**SYD. BOOTH, QUEEN ST.**

Comparator Demonstrations of  
Leading Makes

Home Demonstrations - Day or  
Evenings by Appointment



**Colchester's Home of Hi-Fidelity**  
**D.T. WICKS & CO.** Where good equipment costs far less

## **COLCHESTER'S LEADING HI-FI DEALER**

Main agents for :

ACOUSTIC RESEARCH, AKAI  
CELESTION, GOODMAN'S, GARRARD  
GOLDRING, LEAK, MARANTZ,  
NATIONAL PANASONIC, TECHNICS  
THORENS, SCAN-DYNA, TRIO  
SANSUI, ROTEL, TEAC  
PIONEER, J.V.C., KOSS  
and all leading Hi Fi makes.

## **COMPETITIVE PRICES**

**49-51, NORTH STATION ROAD  
COLCHESTER, ESSEX**

Tel: COLCHESTER (0206) 78807 After hours: 42166  
Hours of Business 9 a.m.-6p.m. Mon-Sat. Early Closing Thursday 1 p.m.

**CHESTER (CHESHIRE)**

CHARLESWORTHS HI-FI  
117 Foregate Street. Tel: Chester 25075.

**LLOYD & WYLIE**

42 Bridge Street. Tel: Chester 26704.

**PETERS HI-FI AUDIO**

24 St Michaels Square, Shopping Precinct.

**CHICHESTER**

CHICHESTER TELE-RADIO  
SERVICES LTD

83 East Street.

**COVENTRY**

COVENTRY TAPE RECORDER  
SERVICES

172 Spon Street.

**ELECTRONIC SERVICES**

33 City Arcade, CV1 3HX.  
Tel: Coventry 24632.

**CRAWLEY (SUSSEX)**

KIRKMAN (CRAWLEY) LTD

40 The Broadway, RH10 1HG.  
Tel: 0293 26670.

**THE SOUND STUDIO LTD**

4 Grand Parade, High Street.  
Tel: Crawley 33566.

**SUMMIT AUDIO SYSTEMS LTD**

10 High Street. Tel: Crawley 24316.

**CRAYFORD (KENT)**

COLOURSOUND LTD

33 Crayford High Street, DA1 4HH.  
Tel: 51592.

**CREWE**

CHARLESWORTHS OF CREWE LTD  
14 Hightown. Tel: 56342.

**CROYDON (SURREY)**

F. CAVE LTD  
Trinity Court, Whitgift Centre.

**LASKYS**

1046 Whitgift Centre. Tel: 01-681 3027.

**SPALDING ELECTRICAL LTD**

352-354 Lower Addiscombe Road.  
Tel: 01-654 1231.

**DARLINGTON (Co. DURHAM)**

McKENNA & BROWN (PHOTO/  
HI-FI) LTD

11 Bondgate. Tel: 65990.

**TURNERS (NEWCASTLE-UPON-  
TYNE) LTD**

3 Queen Street.

**DARTFORD (KENT)**

WOODS & PORTER LTD

23 West Hill. Tel: Dartford 20002.

**DERBY**

VICTOR BUCKLAND LTD

41-49 London Road. Tel: 48425.

**DEVIZES (WILTS)**

LOUIS J. RUTTER

Devizes Photo-Audio Centre,  
17 The Brittox. Tel: 0380 2268.

**DONCASTER**

FIELDS RADIO LTD

52 Hallgate, DN1 3PF.

**DORCHESTER**

SUTTONS

2 Hardy Arcade.

**DORKING (SURREY)**

DORKING AUDIO SYSTEMS LTD

23-31 South Street. Tel: Dorking 2897.

**DUBLIN (EIRE)**

CENTRESOUND LTD

2-3 Lincoln Place, 2. Tel: 63466.

**DUNDEE**

LARG'S GROUP

24 Whitehall Street. Tel: 26061.

**DURHAM**

THE HOUSE OF ANDREWS

73-75 Sadler Street.

**EASTBOURNE**

CENTRAL RADIO LTD

15 Langney Road, BN21 3QB.  
Tel: 0323 21989.

**COMPLETE AUDIO SYSTEMS LTD**

32 Grove Road, BN21 4TR.  
Tel: 27362.

**EAST MOLESEY (SURREY)**

MOLESEY SOUND REPRODUCERS

LTD

87 Walton Road. Tel: 01-979 2721.

**EDGWARE**

PLANET HIGH FIDELITY CENTRE

88 High Street, HA8 7HE.

**EDINBURGH**

AUDIO AIDS

20 South Clerk Street, EH8 9PR.

Tel: 031-667 2877.

274 Canongate (Royal Mile), EH8 8AA.

Tel: 031-556 9838.

**ENFIELD (MIDDXX)**

A. T. LABORATORIES

191 Chase Side. Tel: 01-363 7981.



# Kingsons

of Catford and Beckenham  
Appointed Agents  
for

# Bang & Olufsen

# SONY®



Barclaycard and Access facilities.  
No deposit purchase terms

## KINGSONS

Catford Shopping Centre, S.E.6. Tel: 690 3875  
224 High St. Beckenham. Tel: 650 8027



# SWIFT OF WILMSLOW

**HI-FI AND UNIT AUDIO**

Quad, Grundig, Leak, Rogers, Pioneer, Dual  
Goodmans, Wharfedale, Thorens, Goldring,  
Garrard, Philips, Sanyo, Trio, Dynatron,  
Scan Dyna, Fisher, Tandberg etc.

5 Swan Street (nr. traffic lights),  
Wilmslow, Cheshire Wilmslow 26213

TELEPHONE: 061 764 2931

## VICTOR WRIGHT



116 THE ROCK  
BURY, LANCS. BL9 0PJ

HiFi-TAPE-ELECTRONIC COMPONENTS

# There are only three Hi-Fi stores in the North West with such a vast range of equipment

A.D.C.  
ACOUSTIC RESEARCH  
AKAI  
ARISTON AUDIO  
ARMSTRONG AUDIO  
BANG & OLUFSON  
B.S.R. McDONALD  
CAMBRIDGE AUDIO  
CELESTION  
CONNOISEUR  
DOMUS  
DYNATRON  
FERROGRAPH

GARRARD  
GOLDRING  
GOODMANS  
HACKER  
HARMON KARDON  
HITACHI  
HOWLAND WEST  
K.E.F.  
K.L.H.  
KOSS  
LEAK  
LINN SONDEK  
LUX

MARANTZ  
MORDAUNT SHORT  
MICRO  
MONITOR AUDIO  
NEAL  
NIKKO  
PHILIPS  
PIONEER  
QUAD  
REVOX  
ROGERS  
ROTEL  
SANYO

SHURE  
SONY  
SUGDEN  
TANDBERG  
TEAC  
THORENS  
TRANSCRIPTORS  
TRIO  
TECHNICS  
UHER  
WHARFEDALE  
YAMAHA

## YOU GET SO MUCH MORE AT HARDMAN'S

- 2 years free parts and labour
- Lifetime service even after the guarantee is up
- You can exchange any item within two weeks of purchase
- Service department on the premises

LIVERPOOL 33 Dale Street. Tel: 051-236 2828  
MANCHESTER 12 St. Mary's Gate. Tel: 061-832 6087  
PRESTON Guild Hall Arcade. Tel: 59264

**HARDMAN'S**  
A WHOLE WORLD OF HI-FI  
AT SOUND PRICES



**EPPING (ESSEX)**

**CHEW & OSBORNE LTD**  
148 High Street Tel. 4242

**EXETER**

**HOWARDS (EXETER) LTD**  
90-91 Sidwell Street Tel. 58518/9

**FALMOUTH (CORNWALL)**

S R Gear (Falmouth) Ltd,  
The Moor. Tel. 312321

**FARNHAM (SURREY)**

**LLOYD & KEYWORTH LTD**  
26-28 Downing Street. Tel. 5536/6275.

**FLEET (HANTS)**

**KEN ROSE AUDIO LTD**  
282 Fleet Road Tel. 5053

**FOLKESTONE**

**KENT AUDIO**  
22 Guildhall Street. Tel. 55881

**GERRARDS CROSS (BUCKS)**

**THE LEISURE CENTRE**  
Packhorse Road. Tel. 84417.

**GLASGOW**

**ALEXANDER BIGGAR LTD**  
271-275 Sauchiehall Street, G2 3HH.  
Tel: 041-332 8676.

J. D. CUTHBERTSON & CO  
21 Cambridge Street, G2 3DY.

**JAMES KERR & CO LTD**  
98-110 Woodlands Road, G3 6HB.  
Tel: 041-332 0988.

**MCCORMACKS LTD**  
33 Bath Street C2. Tel: 041-332 6644

**JACK LAWSON, B A (HONS)**  
5 Glenpark Avenue, Thornliebank,  
G46 7JE. Tel: 041-638 0648

**TALISMAN HI-FI**  
11 Stockwell Street, G1 4HP

**RSC HI-FI CENTRES LTD**  
326 Argyle Street, G2 8LY.  
Tel. 041-248 4158.

**GOODMAYES (ESSEX)**

**UNIQUE RADIO LTD**  
772 High Road. Tel. 01-590 8277.

**GRAVESEND (KENT)**

**BENNETT & BROWN**  
2 Milton Road. Tel. 3060.

**GREAT YARMOUTH**

**NORFOLK RADIO**  
15 Broad Row.

**GRIMSBY**

**LINCOLNSHIRE INSTRUMENT CO**  
Hi-Fi House, 69-71 Cartergate

**GUILDFORD (SURREY)**

**GUILDFORD HI-FI CENTRE**  
270 High Street. Tel. 71534.

**MERROW SOUND LTD**  
205 Epsom Road, Merrow.

**MERROW SOUND LTD**  
21-22 Tunsgate. Tel: Guildford 33224.

**GUILDFORD HI-FI CENTRE**  
270 High Street.

**HADLEIGH (ESSEX)**

**ESSEX HI-FI CENTRE**  
210 London Road. Tel: Southend 558339.

**HALIFAX**

**TAPE RECORDER CENTRE**  
(HALIFAX)  
30 King Cross Street. Tel. Halifax 66332.

**HARROGATE**

**CAMERA 65 LTD (AUDIO DIV)**  
15 Station Bridge. Tel: 66706

**HARROW (MIDD)**

**HANSPALS AUDIONICS LTD**  
54 StAnns Road. Tel. 01-363 3400

**HENRY'S RADIO LTD**  
190-194 Station Road. Tel. 01-363 7733.

**HASTINGS (SUSSEX)**

**C. P. ABRAHAM LTD**  
192 Queens Road  
484 Old London Road

**HAYWARDS HEATH**

**MASTERSOUND**  
109 South Road.

**HAZEL GROVE (CHESHIRE)**

**CHESTERGATE STUDIOS LTD**  
92 London Road.

**HELSTON (CORNWALL)**

**HYDROVOLT LTD.**  
2 Church Street. Tel: Helston 2545.

**HEMEL HEMPSTEAD (HERTS)**

**HAMILTON SOUND LTD**  
129 Marlowes. Tel: 51718.

**HENLEY-ON-THAMES**

**G. O. MOORHEN**  
190 Reading Road. Tel: Henley 4163

**BLACKPOOL** Tel. Blackpool 49625

# BENFELL

## OF BLACKPOOL

**F. BENFELL LIMITED**

78, WESTFIELD RD.,  
(Ansdell Rd.)

## LOUDSPEAKERS

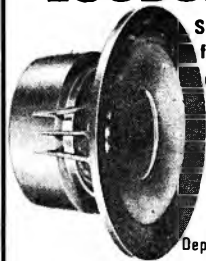

Speakers, kits and cabinets  
for D.I.Y., Hi Fi, P.A., Disco,  
etc. by EMI, Fane, Goodmans,  
Baker, Elac, Richard Allan,  
Wharfedale, etc. Send for  
free booklet, "Choosing a  
Speaker".

### WILMSLOW AUDIO

Dept. HFYB, Swan Works, Bank Square,  
Wilmslow, Cheshire SK9 1HF  
Tel. Wilmslow 29599

PRESTON

## ELECTRA CENTRE

Comparator Demonstrations of  
most leading makes  
B. & O., Sony, A. & R., Quad, etc.

8 Victoria Buildings, Fishergate  
Preston Telephone 55603  
58 Lancaster Road, Preston  
Telephone 58488



ASHFORD

## PHOTOCRAFT HI-FI

OPPOSITE ODEON—  
HIGH STREET

Telephone: Ashford 24441



Agents for:  
A.R., Armstrong, Bang & Olufsen, Dynatron,  
Hitachi, Koss, Leak, Quad, Revox, Sonab,  
Teac, Tandberg, Trio, Toshiba.

# HI-FI PRO

## THE FINEST HI-FI SHOWROOM OF ITS KIND

We've incorporated some revolutionary ideas which will enable you to listen to the world's finest makes in unprecedented luxury and comfort.

Specially aimed at the audiophile, Hi-Fi Pro offers a specialist service to members of the sound industry as well as discerning enthusiasts.

Be sure to come along for a completely new experience in Hi-Fi shopping.

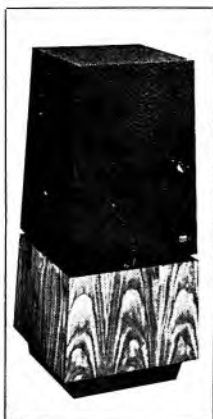

ESS



Harman Kardon

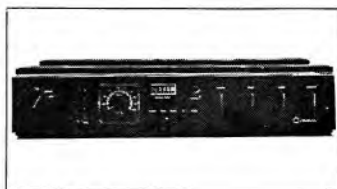

Sonab



Marantz



Technics

AR, Armstrong, B & W, BOSE, Celestion, IMF, KEF, Linn Sondek, Lux, Major, Maxell, Micro, Scintrex, Studiocraft, Tannoy, Transcriptor, Trio, TEAC, Etc,

TEAC SERVICE CENTRE  
FOR THE LONDON AREA

# HI-FI PRO

22-24 Buckingham Palace Road, London, SW1W 0QP  
Telephone 01-834 9382/3

## HEREFORD

WYEVAL LTD  
Wyeval House, 42-43 Bridge Street,  
5 Commercial Road.

## HIGH WYCOMBE (BUCKS)

HUGHES HI-FI  
7 High Street.

M. W. KEEN LTD  
Chantry Studio, Pauls Row,  
HP11 2HH. Tel: 25691.

## HITCHIN (HERTS)

THE RECORD SHOP  
30-31 Hermitage Road, SG5 1BZ.  
Tel: Hitchin 4537.

## HORSHAM (SUSSEX)

HORSHAM AUDIO SYSTEMS LTD  
28-35 Queen Street. Tel: 64962/3110.

## HOUNSLOW (MIDDX)

DELTA (HOUNSLOW) LTD  
50 Bell Road. Tel: 01-572 2285.

MUSICRAFT HI-FI CENTRE  
63 High Street. Tel: 01-570 4640.

## HOVE (SUSSEX)

LANE'S RADIO LTD  
94 Church Road, BN3 2EB.

## HUDDERSFIELD (YORKS)

J. WOOD & SONS LTD  
67 New Street, HD1 2BH. Tel: 27455.

## HULL (YORKS)

A-Z RADIO  
758 Spring Bank West. Tel: 50896/508021.

G. SANDS & SONS  
61 Princes Avenue. Tel: 42118.

## HUNTINGDON

J. V. ROBINSON LTD  
89 High Street.

## ILFORD (ESSEX)

NUSOUND  
87-100 Pioneer Market, Ilford Lane.  
Tel: 01-478 2291.

## ILKLEY

ALLEN & WALKER  
Sedbergh Buildings, 4 Cowpasture Road.  
Tel: Ilkley 3832.

## IPSWICH (SUFFOLK)

R.C.S.  
17 St Nicholas Street, IPI 1TW.  
Tel: Ipswich 55140.

TURNERS PHOTOGRAPHICS  
9 The Walk, IPI 1ED. Tel: (0473) 58551.

## IRVINE (AYRSHIRE)

IAN STRACHAN  
7 Bridgegate.

## KEIGHLEY (YORKS)

KEIGHLEY CAMERA &  
HI-FI CENTRE  
38-40 Cavendish Street. Tel: 2933.

J. S. RAMSBOTTOM & CO LTD  
Coney Lane. Tel: 5444.

## KENDAL (WESTMORLAND)

DERHAM'S OF KENDAL  
Kent Street. Tel: 21995.

## KENTON (MIDDLESEX)

GREENE & COOPER LTD  
211 Kenton Road. Tel: 01-907 9660.

## KETERING (NORTHANTS)

SOUND QUALITY  
2 The Arcade. Tel: 83833.

## KINGSTON UPON THAMES

F. CAVE  
21 Eden Street.

LASKYS  
27 Eden Street. Tel: 01-546 7845.

SOUTHERN AUDIO SERVICES LTD  
43 High Street. Tel: 01-549 3194.

SURBITON PARK RADIO LTD  
48-50 Surbiton Road.

## KNARESBOROUGH (YORKS)

YORKSHIRE HI-FI CENTRE  
32 High Street.

LEAMINGTON SPA  
COVENTRY TAPE RECORDER  
SERVICE  
3 Regent Grove.

## LEEDS

AUDIO PROJECTS  
10 Blenheim Terrace, LS2 9HX.  
Tel: 27139.

R. S. C. HI-FI CENTRES LTD  
5-7 County Arcade.

YORKSHIRE HI-FI CENTRE  
28 Merriion Centre.

## LEICESTER

HI-FI STEREO (SALES) LTD  
206 St Nicholas Circle.

### MAIN DEALERS

**B & O**

**SONY**

**TECHNICS**

**myers**

**audio** SOUND CENTRE

199 HOE STREET, E.17 01-520 7277

**WALTHAMSTOW**

## MICRON AUDIO LTD.

*(Formerly Omicron Electronics)*

**FOR TODAY'S FINEST HI-FI**

ADVICE, SALES, DEMONSTRATIONS  
OF ALL LEADING MAKES, AT:

172 BASLOW ROAD  
(A621) TOTLEY  
SHEFFIELD Tel. 360295

135 SHEFFIELD ROAD  
CHESTERFIELD  
(A61)

### CLEVELAND COUNTY & DURHAM

See, Hear, and Choose your equipment from the North's finest Audio and Tape Centres. We stock the complete range of Bang & Olufsen - Sony - Dynatron - Trio - Mordaunt Short - Sonab - Quad etc. and all good Hi-Fi equipment and television, and back all major products with two years parts and labour guarantee. Part exchange with pleasure plus 6 months credit at cash price.

**McKenna & Brown  
(Photo Hi-Fi) Ltd**

190 Linthorpe Road, Middlesborough.  
135/7 High Street, Redcar.  
11 Bondgate, Darlington.  
134 Newgate Street, Bishop Auckland.

Tel: 48345  
Tel: 3829  
Tel: 65990  
Tel: 2266

### SHOP LATE NITE FRIDAY TILL 8 PM

*Main Agents For:-*

QUAD, UHER, TEAC, SONAB, MORDAUNT-  
SHORT, TANNOY, REVOX, TANDBERG,  
SHERWOOD, BOSE, ARMSTRONG.

*Shop and Home Demonstrations  
Good Cash Discounts*

**Libby's**

021 554 8557

**HI-FI**

**RECORDS**

244 Soho Road, Birmingham B21 9LR

# High Fidelity Specialists

15-24 Gillygate, York 29659

43 Princegate, Waterdale Centre  
Doncaster 63806

18 Market Street  
Scarborough 67081

12 Empire Arcade, Briggate  
Leeds Tel. 446677

## VICKERS·HI·FI·

### WE STOCK

Harman · Kardon · Trio · JBL ·  
Transcriptors · Scan-Dyna ·  
Cambridge · Luxor · Revox ·  
Armstrong · Marantz · National  
Technics · Kef · Koss · Tandberg ·  
Linn · Sondek · Teac · ADC ·  
I.M.F. · Acoustic-Research etc.

### AND GIVE YOU

· 2 years parts and labour  
guarantee · Selected stocks ·  
Expert staff · Home dems ·  
Credit facilities (10% deposit) ·  
Keen prices · Access · Barclay  
card · Package deals ·  
Part exchange.

### HAROLD STOTT LIMITED AUDIO ENGINEERS

*Stockists of all leading makes of Hi-Fi equipment*  
St. Helens 34141

Appointed sole agents for:

**B. & O., B. & W., Dynatron,**  
**Sony, Toshiba,**  
**Mordaunt Short,**  
**Marantz, Kef, Revox,**  
**Tandberg, Philips Video Tape.**

### SOUND SUPPLIES

**(Loughton) CO. LTD.**

#### Stockists for:

SONY, QUAD, HACKER,  
GOLDRING, REVOX, TRIO, BRYAN,  
THORENS, NATIONAL TECHNICS.

#### Speakers:

MORDAUNT-SHORT, JORDAN-WATTS  
**B.&W.**

#### **BROOKLYN PARADE**

309 High Road, Loughton, Essex. 01-508 2715

**STUART BARKER invites you to**  
**His HI-FI CENTRE at**

772, High Road,  
Goodmayes, Essex

### UNIQUE RADIO LTD.

01-590 8277  
Sound Specialist in Hi-Fi or PA.  
M.A.P.A.E.

*The Specialists in*  
*High Fidelity Sound*

**H. D. KIRK**

*Stereolectrics*

Where  
Service  
Matters



203  
St. Georges Rd.

Phone 23093  
**BOLTON**

**LASKYS**  
45 Market Place. Tel: 0533 537678  
**R. S. C. HI-FI CENTRES LTD**  
32 High Street. Tel: 56420.  
**THE TAPE SCENE**  
18 Haymarket. Tel: 50572.

**LEIGH-ON-SEA (ESSEX)**  
**SOUNDTRACK**  
149 Leigh Road.

**LEWES (SUSSEX)**  
**SUMMIT AUDIO SYSTEMS LTD**  
18 High Street. Tel: 3611.

**LINCOLN**  
**LINCOLN HI-FI CENTRE**  
271a High Street. Tel: 20265.

**LIVERPOOL.**  
**ACE AUDIO LTD**  
66 Renshaw Street.  
**ALLERTON RADIO**  
21 Allerton Road, L18 1LG.  
**HARDMAN RADIO**  
33 Dale Street, L2 2HF.  
Tel: 051-236 2828.

**BEAVER RADIO LTD**  
20-22 Whitechapel, L1 6EH.  
Tel: 051-709 9898.

**CLEAR TONE HI-FI LTD**  
New Strand Shopping Centre, Bootle.

**LLANDUDNO (CAERNARVON)**  
**VALLEY RADIO**  
Craig-Y-Don. Tel: 76788.

**LONG EATON (NOTT'M)**  
**C. GILBERT LTD**  
85-89 High Street. Tel: 5621.

**LOSSIEMOUTH (MORAYSHIRE)**  
**JOHN MUNRO**  
26 Seatown. Tel: 2340.  
**LOUGHBOROUGH (LEICS)**  
**RADIO MAINTENANCE (LEICS)**  
LTD  
Wards End.

**LOUGHTON (ESSEX)**  
**SOUND SUPPLIES (LOUGHTON)**  
CO LTD  
309 High Road, IG10 1AH.  
Tel: 01-508 2715.

**LOWESTOFT**  
**JOHN WELLS (PHOTO AUDIO LTD)**  
44 London Road North.  
**LUTON (BEDS)**

**COVENTRY RADIO LTD**  
189-191 Dunstable Road, LUI 1BT.  
Tel: 28201.

**AUDIO VISION**  
38 New Bedford Road. Tel: 38944.  
**D. P. HOBBS LTD**  
11 King Street. Tel: 20907.

**MAIDENHEAD (BERKS)**  
**SOUND SYSTEMS LTD**  
49-51 King Street.

**MAIDSTONE (KENT)**  
**SLOMAN & PETTITT**  
Pudding Lane, ME14 1NB. Tel: 1478

**THE SOUND STUDIO LTD**  
29 Lower Stone Street. Tel: 65097.

**MALVERN LINK (WORCS)**  
**RALPH HALES AUDIO VISION**  
154 Worcester Road. Tel: 4433.

**MANCHESTER**  
**AVGARDE GALLERY LTD**  
42 King Street West, M3 2NY.  
Tel: 061-834 2178.

**CLEAR TONE HI-FI LTD**  
Irlam Shopping Centre, Irlam.  
**GODLEY SPEARS LTD**  
2-10 Shudehill, MA 2AL.

**HARDMAN RADIO LTD**  
12-14 St Mary's Gate, M1 1PX.  
Tel: 061-832 6087.

**LANCS HI-FIDELITY LTD**  
(Home Music Centre)  
248 Wilmslow Road, 14.  
Tel: 061-224 1531.

**LLOYD PATON McGLYNN LTD**  
Ralli Buildings, Stanley Street, Salford,  
M3 5FH.

**MATHERS OF MANCHESTER**  
35 John Dalton Street, 2.

**XLENT ELECTRICS LTD**  
537-539 Wilbraham Road, Chorlton-cum-Hardy, 21. Tel: 061-881 2517.

**MANSFIELD (NOTTS)**  
**SYD BOOTH**  
9-11 Queen Street, NG18 1JL. Tel: 26315

**MARLOW (BUCKS)**  
**CHILTERN SOUND**  
27 Spital Street. Tel: 71588.

**Sight and Sound**

SWINDON  
HI FI & TV  
CENTRE

52 Fleet Street Swindon

TEL  
5498  
25335

**SONY-B & O-SONAB  
SCAN DYNA-KOSS**

**WILTSHIRE**

**AND MANY  
OTHERS**

**TANDBERG-A. R.  
SERVO SOUND-REVOX**

KMAL RECORD CLEANING STATION

**fox radio service ltd**

SWINDON  
HI FI & TV  
CENTRE

5 Milford Street Swindon

TEL  
5498  
25335

**Cleartone Hi-Fi Ltd**

Specialists in Hi-Fi equipment

166, Blackburn Road, Bolton (Reg. Office)  
Tel. 0204 22636/31423  
Irlam Shopping Centre, Irlam, Manchester  
Tel. 061 775 5822  
Titan Shopping Centre, Wyke, Bradford  
Tel. 0274 673966  
Myrtle Parade, Myrtle Street, Liverpool 7  
Tel. 051 709 4570  
Kingstanding Centre, Birmingham 42  
Tel. 021 354 4603  
Unit 18, Grove Market Place, Eltham, London SE9  
Tel. 01-859 3406

Equipment Selected from the Worlds  
Finest in Stock

**CREDIT SALE-CASH SETTLEMENTS  
PERSONAL LOANS**

**LLOYD PATON-MCGLYNN  
LIMITED**

Ralli Buildings  
Stanley Street  
(off Bridge Street)  
Manchester, M3 5FH  
061-834 0563

34, Moorfield Walk,  
Urmston Shopping Centre,  
Urmston,  
Lancashire  
061-747 9722

# HANSPAL'S Audionics



HANSPAL'S GIVE YOU THE TIME YOU NEED TO LOOK, LISTEN AND BE SATISFIED. WE GIVE PROFESSIONAL ADVICE ON ALL ASPECTS OF THE AUDIO AND VIDEO SPECTRUM.

**QUALITY EQUIPMENT FROM LEADING MANUFACTURERS. . .**

Harman Kardon, Hitachi, Sony, Trio, Sansui, Revox, TEAC, Akai, Rotel, Quad, Nikko, Lux, National Panasonic, Pioneer, Tandberg, Sanyo, Scan-Dyna, Sugden, AIWA, Micro, Dual, Saba, JBL, Telefunken, Marantz, B & W, Dynaco, KEF, Koss, Era, Leak,

FREE DEMONSTRATION AND INSTALLATION. WE GIVE CASH DISCOUNTS, AND ACCEPT BARCLAY CARDS, ACCESS CARDS.  
CREDIT FACILITIES CAN BE ARRANGED.

We stock from a 3.5 mm jack plug to a remote control tuner amplifier.

488, LADY MARGARET ROAD,  
SOUTHALL 01-578 2258  
(MIDDX.)

54, ST. ANNS ROAD,  
HARROW 01-863 3400  
(MIDDX.)

## FORRESTER'S NATIONAL RADIO SUPPLIES LTD.

70-72 HOLDENHURST ROAD  
BOURNEMOUTH HANTS

Largest hi-fi and radio component  
store in the south Tel 25232

*For the best in Hi-Fi*

## NOTTINGHAM HI-FI CENTRE

156 ALFRETON ROAD  
NOTTINGHAM  
Telephone 76919

## ELECTRONIC SERVICES

33 City Arcade  
Coventry CV1 3HX

Your central Hi-Fi supplier

Phone Coventry 24632

## SHEFFIELD'S

MAIN DEALERS FOR  
**SONY**<sup>®</sup>

Plus all the latest hi-fi & video equipment

**Hodgsons** 33 & 35 Charles St.  
Tel: 78346

**MIDDLESBROUGH (YORKS)**

McKENNA & BROWN (PHOTO HI-FI) LTD  
190 Linthorpe Road. Tel: 48345

R. S. C. HI-FI CENTRES LTD  
105 Newport Road, TSI 5JF.

TURNERS (NEWCASTLE-UPON-TYNE) LTD  
140 Linthorpe Road

**MINEHEAD (SOMERSET)**

P. TAYLOR LTD  
7 Park Street.

**MOTHERWELL**

R. TALISMAN HI-FI  
211-213 Brandon Street. Tel: 63541

**NEATH**

ELECTROPHONIC  
45a Neath Road, Britton Ferry.  
Tel: Britton Ferry 813494.

**NEWCASTLE-UPON-TYNE**

RICHELY & FREEMAN LTD  
100 Percy Street, NE1 7KZ.

J. G. WINDOWS LTD  
1-7 Central Arcade, NE1 5BP. Tel: 21356.

TURNERS (AUDIO VISUAL) LTD  
Camera House, Pink Lane, NE1 5HT.  
Tel: 0632 25391

TURNERS (NEWCASTLE-UPON-TYNE) LTD

Emerson Chambers, Blackett Street.

YORKSHIRE HI-FI CENTRES  
73 Shields Road.

**NEW HAW (SURREY)**

WEST ELECTRICS  
15 The Broadway. Tel: Byfleet 43784

**NEW MALDEN (SURREY)**

UNILET PRODUCTS LTD  
35 High Street. Tel: 01-942 9567.

**NEWPORT (I.O.W.)**

RUSSELLS TV & RADIO SERVICES  
40 Upper St James Street.  
Tel: Newport 3864.

**NEWPORT (MON)**

HI-FI WESTERN LTD  
48-52 Cambrian Road. Tel: 59602/62790.

**NEWTON ABBOT (DEVON)**

WESTRONICS LTD  
Communications House,  
28 Newton Road, Kingskerswell.  
Tel: 3079.

**NORTHAMPTON**

AUDIOCRAFT  
23-25 Deragate. Tel: 36291.

**NORTHWOOD (MIDDLESEX)**

THE RECORDERIE  
3 Rowland Place, Green Lane.  
Tel: Northwood 24882.

**NORWICH**

YAXLEYS SOUND HIRE  
Sound Centre, Earlham House,  
Earlham Road, NOR 9JH. Tel: 55673.

**NOTTINGHAM**

LINDAIR  
94-96 Upper Parliament Street.  
Tel: Nottingham 40403.

NOTTINGHAM HI-FI CENTRE  
156 Allreton Road. Tel: 76919/74015  
N.S.E.  
64-70 Peveril Street. Tel: 75756.

PETER ANSON LTD  
Bobber's Mill, NG7 5QZ. Tel: 73312.

R. S. C. HI-FI CENTRES  
119-19a Market Street.

**OXFORD**

HORNS  
6 South Parade Tel: 55360

WILL R. ROSE  
119 Pound Way, Cowley Centre

**PAIGNTON**

PAUL PINCH LTD  
7-7a Dartmouth Road. Tel: 59991.

**PLYMOUTH**

ALBERT E. FORD LTD  
84 Cornwall Street, PL1 1NE. Tel: 6319

TOM MOLLAND LTD  
110 Cornwall Street, PL1 1NF  
Tel: 69285

PETER RUSSELL'S HOT RECORD  
STORE LTD  
58 New George Street, PL1 1NE.  
Tel: 0752 69511.

**POOLE (DORSET)**

POOLE CAMERA CENTRE  
91 Arndale Centre. Tel: 6289.

QUALITY HI-FI  
55 North Road. Tel: Parkstone 742706

*For the best in Hi-Fi*

# LINCOLN HI-FI CENTRE

271a HIGH STREET

LINCOLN

Telephone 20265

## GLASGOW'S MAIN DEALER

Trio, Leak, Akai, Garrard, Sony,  
Tandberg, B. & O., Teleton,  
Sansui, Wharfedale, etc.

## VICTOR MORRIS

*We buy, sell and exchange cameras,  
projectors, hi-fi and recorders.*

31 SAUCHIESHALL ST. 041 332 2149  
340 ARGYLE ST. 88 St. VINCENT ST.  
041-221 8958 041-248 7974  
GLASGOW C2.

**High Fidelity & Video  
Specialists**



Hamilton Electronics (Southampton) Ltd  
35 London Road, Southampton Phone 28622 3Lines

# EASTBOURNE

MAIN DEALER FOR

# SONY<sup>®</sup>

All the latest hi-fi and audio systems

## CENTRAL RADIO LTD

15 Langney Road Eastbourne Telephone 21089 / 20139



**audio  
aids**

All Leading Brands of Hi-Fi Equipment  
We have a demonstration studio in both shops and  
an audio consultancy service to assist you  
with your choice.

Suppliers to Universities and Schools.

**AUDIO AIDS**  
20 SOUTH CLERK ST., EDINBURGH  
031-667 2877  
Royal Mile (274 Cannongate)  
031-556 9838

**EDINBURGH'S HI-FI SPECIALIST**

**HI-FI**

CORNER

**HI-FI CORNER EDINBURGH LTD**

1 Haddington Place Edinburgh EH7 4AE  
Telephone 031-556 7901

**mccormack's**  
(MUSIC) LTD

**SCOTLAND'S PREMIER  
HI-FI STOCKISTS**

WIDE RANGE OF —  
**TUNERS - AMPLIFIERS  
SPEAKERS - CASSETTE,  
CARTRIDGE & REEL  
TO REEL TAPE DECKS  
& RECORDERS**

AUTHORISED PHILIPS VIDEO RECORDER DEALER

**SERVICE WORKSHOP  
ON THE PREMISES**

**mccormack's**  
(MUSIC) LTD

**29-33 BATH STREET,  
GLASGOW G2-1HT**

Phone: 041-332 6644

**Talisman Hi-Fi** 

*COMPARATOR DEMONSTRATIONS  
IN COMFORT  
OF THE FINEST SOUNDS IN HI-FI*

AKAI · AR · ARISTON AUDIO  
ARMSTRONG · B&O · B&W  
CELEF · KEF · KENSONIC  
MARANTZ · MONITOR AUDIO  
NATIONAL PANASONIC  
QUAD · PIONEER · ROTEL  
SONY · STANTON · TEAC  
TRIO · TECHNICS  
TRANSCRIPTORS

<b>GLASGOW</b> 111 Stockwell St., 041 552 1043	<b>FALKIRK</b> 44 Cow Wynd 29011
--	--

For  
Hi-Fi in  
Scotland

**JAMES  
KERR  
& CO. LTD.**

■

ARMSTRONG, QUAD  
A. R. HARMAN-KARDON  
TRIO, MARANTZ  
TEAC, SPENDOR  
ROGERS, HITACHI  
S. M. E. SHURE  
MORDAUNT-SHORT  
HACKER, K. E. F.  
UHER, LINN-SONDECIS  
SONY, STAX

■

**98-110 Woodlands Road,  
Glasgow, G3 6HB**



**PORTSMOUTH (HANTS)**

AUDIO SUPPLIES LTD  
12 London Road, North End.  
Tel: Portsmouth 68321.

KENNETH RICHARDS  
106 London Road, North End  
Tel: 692522.

**PRESTON (LANCS)**

ELECTRA CENTRE  
58 Lancaster Road. Tel: 58488.

ELECTRA CENTRE  
8 Victoria Buildings, Fishergate.  
Tel.: 55603.

HARDMAN RADIO LTD  
1-4 Guild Hall Arcade, PR1 1HR.  
Tel: 0772 59264.

**PURLEY (SURREY)**

SURREY SOUND EQUIPMENT LTD  
3-4 Royal Oak Centre, Brighton Road,  
CR2 2BG. Tel: 01-668 4800.

**RADLETT (HERTS)**

THE RECORDERIE  
333 Watling Street. Tel: 6060

**RAMSGATE**

TOM JOYCE  
147 Boundary Road. Tel: Thanet 53193.

**READING**

L.J. GALE LTD  
66 Kings Road. Tel: 51046.

**REDCAR (YORKS)**

McKENNA & BROWN (PHOTO/  
HI-FI) LTD  
135 High Street.

**REDHILL (SURREY)**

MARTYN ELECTRONICS  
36 High Street. Tel: 66858.

RHYTHM AGENCIES LTD  
30 Station Road.

**REIGATE (SURREY)**

ALAN LAURENSEN & CO  
9 Bell Street, RH2 9AH Tel: 46494.

RHYTHM AGENCIES LTD  
19 Church Street.

**RICHMOND (SURREY)**

LASKYS  
32 Hill Street. Tel: 01-948 1441.

**ROMFORD (ESSEX)**

ROMFORD SOUND & VISION  
SERVICES LTD  
78a Brentwood Road. Tel: 41644.

LASKYS  
86 South Street. Tel: 70 20218.

LE CONNOISSEUR SOUND  
160 Heath Park Road, Gidea Park,  
RM2 5XL.

NEWBURY RADIO (FOREST GATE)  
LTD  
120 North Street.

**SALE (CHESHIRE)**

HI-FI STEREO  
47 Washway Road. Tel: 061-973 5577.

**SALISBURY**

J. E. SUTTON  
50 Blue Boar Row. Tel: Salisbury 27171.

**SCARBOROUGH**

SCARBOROUGH HI-FI LTD  
54 Aberdeen Walk.

**SETTLE (YORKSHIRE)**

J. W. GARNETT  
The Market Place.  
Tel: 3558.

**SHEFFIELD**

HI-FI SERVICING  
496 Glossop Road, Broomhill.

HODGSONS LTD  
33-35 Charles Street, S1 1GT.

PHILIP CANN LTD  
Chapel Walk, S1 1GJ. Tel: 29225.

OMICRON ELECTRONICS  
172 Baslow Road, Totley, S17 4DR.  
Tel: 360295.

**SHREWSBURY (SALOP)**

AVON HI-FI LTD  
13 Wyle Cop. Tel: 55166.

**SLEAFORD (LINCS)**

JAMES HUGHES  
10 Westgate. Tel: 2602.

**SOLIHULL (WARKS)**

NORMAN H. FIELD HI-FI  
405 Stratford Road, Shirley.  
Tel: 021-745 2073.

## SOUTH WEST

# BANG & OLUFSEN • SONY • TANDBERG

HUSBANDS OF BRISTOL  
HUSBANDS OF WESTON  
GRAYS CAMERA SHOP  
POOLE CAMERA CENTRE  
WINCHESTER CAMERA CENTRE

The Centre Bristol 293978  
18 High St. Weston-S-Mare 20295  
1 St. James Street Taunton 2986  
91 Arndale Centre Poole 6289  
75 Parchment St. Winchester 3982

**CHESTER**

Est. 40 years

## TAPE RECORDER AND HI-FI SPECIALISTS

Agents for: Ferrograph, Tandberg, Trio,  
Grundig, Philips, Hacker, Armstrong,  
Leak, Quad, Goodmans, Wharfedale, Sony,  
Sanyo, Thorens, S.M.E., Eddystone, A. R.,  
Goldring, Dual

### LLOYD & WYLIE

42 BRIDGE ST., CHESTER Tel: 26704

## NO GIVEAWAY GIMMICKS! NO MASSIVE DISCOUNTS!

We haven't hundreds of units to confuse  
you, only very selected equipment like —  
Sonab, Sony, Bang & Olufsen, Marantz,  
A. R., and one or two other top products  
with our unique before and after sales  
service — Try us! We promise you'll  
never regret it! at

**DAYTRONICS LTD.,**

119a High Street, Teddington, Middlesex.  
TW11 8HG Tel: 01-977 1324

## MARTINS

Largest range in Norfolk

Demonstrations - Guidance - Discounts

Expert repair service

### NORWICH

85-87, Ber St.,  
Tel: 27010

81, Dereham Rd.,  
Tel: 26060

MANCHESTER

## AVGARDE Gallery Ltd.

RECORDS AND FINE SOUND EQUIPMENT

We specialise in the BEST of Hi-Fi and records. No installation too complex for us to undertake.

Cabinets and cabinet modifications a feature.  
HOME DEMONSTRATIONS AT MOST TIMES

King's House, King Street West, M3 2NY  
061-834 2178

LOOK WHAT'S IN  
STORE FOR YOU

AT **IMHOFS**

Specialised showrooms devoted to the following leading manufacturers and, of course, Imofs own hi-fi and record departments

**B & O - Sony - Eddystone - Telefunken  
Tandberg - Dual - Jensen-Dynatron  
Hacker**

Imhofs, 112-116 New Oxford Street,  
London WC1A 1HJ  
Telephone: 01-636 7878

LONDON AREA

*Established 1910*

## H. L. SMITH & CO. LTD.

*Comprehensive stock of equipment  
by leading makers.*

**287-9 EDGWARE ROAD**  
LONDON W2 1BE Tel: 01-723 5891

**HENLEY-ON-THAMES  
AND READING DISTRICT**

## G. O. MOORHEN

**HIGH FIDELITY SPECIALIST**  
190 READING ROAD, HENLEY. Tel. 4163

Appointed Agent for

Tandberg - Revox  
Bang & Olufsen - Sony - Teac

Leak, Quad, Lowther, Rogers,  
K.E.F., Spendor, Wharfedale, etc.

Closed Saturdays from 1 p.m.

## Hi-Fi Centre

**CHELMSFORD**

Every main agency held in stock and on demonstration in 2,400 way comporator room. HFDA MEMBER. Generous Discounts. H.P. or Personal Loan.

**6 CORNHILL, CHELMSFORD, ESSEX**

Opp. Multi-Storey Car Park  
Telephone: Chelmsford 57593

## HI-FI

Stereo Systems and Tape Recorders, Stereo Radio. Quality Equipment for the connoisseur by Bang and Olufsen, Sony, Tandberg, Ferrograph, Leak, Quad, Trio, etc.

Demonstrations any time. Personal Service. Part exchanges. Full Service and Repair facilities with 90-day guarantee.

**C.T.S. AUDIO**  
172 Spon Street, Coventry  
Telephone: Coventry 29668

and **C.T.S. AUDIO**  
3 Regent Grove, Leamington Spa  
Telephone: 29265/6

## \*GUILDFORD HI-FI CENTRE

*have bought you this*

Space

for noting all your hi-fi needs....  
and \*where to get them  
AT THE TOP OF THE HIGH STREET (27D)

**SOUTHALL (MIDDX)**

HANSPAL'S AUDIOSONICS LTD  
488 Lady Margaret Road.  
Tel: 01-578 225R.

**SOUTHAMPTON**

HAMILTON ELECTRONICS LTD  
35 London Road, SO9 2TW. Tel: 28522.

MARACK HI-FI  
48 Commercial Road.  
Tel: 32486.

S. F. SUTTONS  
421 Shirley Road

**SOUTHEND-ON-SEA**

KELLEYS RADIO LTD  
92 High Street.

**SOUTHPORT**

AUDIO CORNER  
117 Portland Street, PR8 6QZ. Tel: 59404.

WAYFARERS RADIO & TELEVISION  
18-20, 29 Burton Arcade, Lord Street,  
PR8 1NU. Tel: 42170.

**SOUTHSEA**

Express Radio, 105-107 Fawcett Road,  
Tel: Portsmouth 22721.

**SOUTH SHIELDS**

TURNERS (NEWCASTLE-UPON-  
TYNE) LTD  
124-126 Fowler Street.

**STAFFORD**

TOM REEKIE LTD  
Tudor House, 10 Bridge Street,  
ST16 2HL. Tel: Stafford 51234.

**STANMORE (MIDDX)**

THE RECORDERIE  
10 Buckingham Parade.  
Tel: 01-954 2940.

**STEVENAGE (HERTS)**

A. & M. SUPPLIES  
123-125 High Street, SG1 3HS.  
Tel: Stevenage 54321.

**STOCKPORT (CHESHIRE)**

AUDIO CENTRE, FAIRBOTHAM &  
CO LTD  
58-62 Hillgate, SK1 3AN.

**STOKE-ON-TRENT**

BRADBURY'S OF STOKE  
20-22 Lonsdale Street, ST4 4DP.

HIGH FIDELITY (S.O.T.) LTD  
(HI-FI CENTRE)  
31 Pall Mall, Hanley.

**STONEHOUSE (GLOS)**

R. LEWIS & CO LTD  
The Green. Tel: Stonehouse 2176.

**STROUD (GLOS)**

MIKE CARWITHEN CAMERAS LTD  
5 London Road. Tel: Stroud 4747.

**ST HELENS (LANCS)**

HAROLD STOTT LTD  
18 Westfield Street. Tel: 34141.

**ST PETER PORT (GUERNSEY)**

LAKERS LTD  
30-34 Commercial Arcade, C.I.

**SUNBURY-ON-THAMES (MIDDX)**

HAVEN HI-FI (EALING) LTD  
8 Sunbury Cross Centre.  
Tel: Sunbury 88963.

**SUNDERLAND**

TURNERS (NEWCASTLE-UPON-  
TYNE) LTD  
Phoenix House, Union Street.

**SUTTON (SURREY)**

HI-FI AND COMPONENTS LTD  
7 Sutton Court Road. Tel: 01-642 2853

**SWANSEA**

HOLT HIGH FIDELITY  
8 Portland Street.

**SWINDON (WILTS)**

FOX ELECTRONIC SERVICES  
40 Fleet Street.

FOX RADIO SERVICES  
5 Milford Street. Tel: 5498/25335

MODERN RADIO, THE HIGH-  
FIDELITY CENTRE  
27 Faringdon Road. Tel: 0793 4917.

**SIGHT & SOUND**

52 Fleet Street.

**TAUNTON (SOMERSET)**

GRAYS CAMERA SHOP  
1 St James Street. Tel: 2985.

P. TAYLOR (TAUNTON) LTD  
2 St James Street.

**TEDDINGTON (MIDDX)**

DAYTRONICS LTD  
119a High Street, TW11 8HG.



**KRAKEN ROSE AUDIO**

283, FLEET ROAD, FLEET, HANTS. Tel: 5053

*Specialists in Sound*

Rush

AUDIO

DISCOUNTS

74 BADDOW ROAD  
CHELMSFORD ESSEX  
Tel Chelmsford 64393

MILSOMS

FOR

Arena, Armstrong, Band W., Ferrograph,  
Garrard, Goldring, Goodmans, Leak, Quad,  
Record Housing, Rogers, Shure, S.M.E.,  
Tandberg, Thorens, Trio, Wharfedale, etc

NORTHGATE BATH

TEL:  
5675

# kent audio

★ TECHNICS      ★ MARANTZ  
★ ACOUSTIC RESEARCH      ★ NIKKO

★ TOSHIBA      ★ TRIO  
AND OTHER LEADING MAKES

Demonstration & service facilities.  
HiFi accessories : also records and tapes

33, Guildhall Street,  
FOLKESTONE  
Tel: Folkestone 55881

# HI FI STUDIO

W. J. TAYLOR

(Domestic Supplies) LTD,

126-128, Hawthorn Road, Kingstanding,  
Birmingham, B44 8QA

Tel: 021-373 2645/6  
021-368 1312

BANG AND OLUFSEN  
Main Dealer and  
all leading makes



## LISTENING TO MUSIC IN THE HOME

We specialise in the final Musical and  
Acoustical result in the Home.

### J. W. GARNETT

THE HI-FI SPECIALISTS OF  
THE NORTH WEST

Please phone Settle 3558  
for an appointment



## HI-FI SALES SERVICE

DEMONSTRATIONS · INSTALLATIONS

Littlehampton Rd. WORTHING Tel. 64141

## TOM MOLLAND LTD

110, CORNWALL STREET,  
PLYMOUTH, S. DEVON

Telephone: 0752 69285



# Technics

MAIN DEALERS FOR:

SONY, B & O, AR, TOSHIBA, KLH, B & W

TECHNICS CENTRE

VTR SPECIALISTS — TANDBERG LANGUAGE LABS

# NSE

Amplifiers by Bang & Olufsen, Marantz, Quad, Revox,  
A&R, Hitachi, National, Sony, Trio, Yamaha.

Turntables etc. by Bang & Olufsen, A&R, National,  
Sony, Thorens, Trio, Yamaha.

Speakers by Bang & Olufsen, A&R, Martin, National,  
Marantz, Mordaunt Short, Sony, Yamaha.

Tape Recorders by Bang & Olufsen, Revox, Sony,  
National.

TVs: B & W and Colour by Hitachi, National, Sony.  
Manager—Doug. Lane. Personal Service Assured—  
Part Exchanges

NOTTINGHAM SCIENTIFIC EXCHANGE,  
Peveril Street. Tel: 75756

## PETER ANSON NOTTINGHAM

A wide range of equipment demonstrated under  
ideal conditions plus full comparator facilities.  
Agents for: B & O, Thorens, Sony, Roberts, Hacker,  
Tandberg, Quad, Revox, Trio, Bowers & Wilkins,  
Koss.

2 YEAR LABOUR AND PARTS GUARANTEE

BOBBERS MILL

0602 73312

## The Sound Studio Ltd.

HEAD OFFICE:  
33-35 Camden Road,  
Tunbridge Wells, Kent.  
Tel: Tunbridge Wells 32153

4 Grand Parade,  
Crawley, Sussex.  
Tel: Crawley 33566

29 Lower Stone St.,  
Maidstone.  
Tel: Maidstone 65097

Half day Wednesdays

Specialists in Hi Fi Stereo for  
Tunbridge Wells, Crawley & Maidstone



**TENTERDEN (KENT)**

POTTER BROS (KENT) LTD  
49 High Street. Tel: 2864.

**TUNBRIDGE WELLS**

GOULDEN & CURRY LTD  
59-63 High Street, TN1 1YD. Tel: 30151.

**LASKYS**

53-57 Camden Road. Tel: 0892 23242.

**THE SOUND STUDIO LTD**

33-35 Camden Road. Tel: 32153.

**UXBRIDGE (MIDDX)**

BUCKELDEE & TAYLOR LTD  
50 Vine Street, UB8 1ST. Tel: 37301/5.

**WALLASEY (CHESHIRE)**

W. H. DOLBY LTD  
266-291 Wallasey Village.  
Tel: 051-689 3005/4260.

**WARRINGTON**

WARRINGTON ELECTRIC  
57-59 Bridge Street. Tel: 30444.

**GEORGE ARNOLD (EC) LTD**

78 Hallfields Road, Orford Green,  
WA2 8DN. Tel: 38851.

**JOHN STOCKTON HI-FI SYSTEMS**

15 Orford Avenue,  
Tel: 32981/67955.

**WATFORD (HERTS)**

K. J. LEISURE SOUND LTD  
101 St Albans Road. Tel: 33011.

**SOUND CENTRE**

(HI-FI EQUIPMENT) LTD  
22 Woodlands Parade, High Street.

**RADIOLUX LTD**

(Watford Hi-Fi Centre)  
108 The Parade, High Street.

**WELLING (KENT)**

H. C. & C. COPPINS  
131-137 Bellegrave Road, DA16 3QS.  
Tel: 01-303 5341.

**WESTHOUGHTON (LANCS)**

MAXTONE HIGH FIDELITY  
31 Lee Bank. Tel: 2088.

**WESTON-SUPER-MARE (SOM)**

HUSBANDS & SONS LTD  
18 High Street. Tel: 20295.

**WHITLEY BAY**

TURNERS (NEWCASTLE-UPON-  
TYNE) LTD  
2 Park View.

**TOM S. FORD LTD**

242 Park View, NE26 4QS.  
Tel: Whitley Bay 24665.

**WIGAN (LANCS)**

H. PLUMB & SON  
52 Standishgate, WNI 1RQ.  
Tel: 44442/45837.

**WILMSLOW (CHESHIRE)**

HI-FI CENTRE  
Green Lane, SK9 1LW.

**SWIFT OF WILMSLOW**

5 Swan Street, SK9 1HF. Tel: 26213.

**WINCHESTER (HANTS)**

SUTTONS  
15 Southgate Street.

**WHITWAMS**

70 High Street, SO23 9DE. Tel: 65253.

**WOKING (SURREY)**

AERCO RECORDS LTD  
22-26 Chapel Ash, WV3 0TS.  
Tel: Woking 4667.

**WOLVERHAMPTON**

M. R. WARNER & SON LTD  
22-26 Chapel Ash, WV3 0TS.  
Tel: Wolverhampton 26581.

**WORCESTER**

JOHNSONS SOUND SERVICE  
43 Friar Street. Tel: 25740.

**WORTHING**

JOHN KING (FILMS) LTD  
Guildbourne Centre. Tel: 35416.

**WREXHAM (DENBIGHSHIRE)**

THE CAMERA SHOP & HI-FI  
CENTRE  
Central Arcade, Hope Street.

**YEOVIL**

THE CAMERA CENTRE.

**YORK**

JOHN SAVILLE & SONS LTD  
7 Goodramgate. Tel: York 25755.

**studio one****A NEW HI-FI DEMONSTRATION STUDIO****WHERE ONLY THE BEST IS AVAILABLE**

Choose from Bang & Olufsen · Sony · Quad · Radford  
Marantz · A.R. · Sonab · Harman Kardon · Toshiba  
K.L.H. · Armstrong · J.V.C. · K.E.F. · Lux · E.R.A.  
Jensen · Cambridge · Revox · Gale · Kenosonic · J.B.L.  
Trio · Teac · Rogers · E.S.S. · Neal · Uher · National  
and most better makes . . .

**the hi-fi centre****GREEN LANE · WILMSLOW · CHESHIRE**

Telephone Wilmslow 24766

■ Personal attention of R. S. Bird ■ Part Exchange  
■ Home demonstrations ■ Evening Demos. by appointment  
■ At least 2 years full guarantee ■ After sales service  
■ Car parking ■ Credit facilities ■ Closed Wednesdays  
■ Open 9 a.m. to 1.0 p.m. and 2 p.m. to 6.0 p.m. ■ Phone Wilmslow 22112 for a studio one appointment . . .

**C. C. GOODWIN (SALES) LTD.**

Agents for:

CAMBRIDGE, LEAK, QUAD, B & O,  
ROGERS, REVOX, TANDBERG, S. M. E.,  
KEF, LOWTHER, CELESTION, TANNAY,  
TRANSCRIPTOR, DECCA, JORDAN-WATTS,  
ETC.

Visit our showrooms - Overseas visitors welcome

For quotes call, write or phone

7, The Broadway, High Road, Wood Green,  
London N22 6DU. Tel: 01-888 0077/8

Open Tues - Sat 9.30 am - 5.30 pm

HOME AND EXPORT



# HI-FI AT 20% DISCOUNT

We supply *everything* for the HI-FI enthusiast—amplifiers, tuners, loudspeakers, cabinets, turntables, pickups, cartridges, tape recorders and so on.

Our associated Hi-Fi Company has been in this field since 1925—and we ourselves were established in 1960 as one of Britain's first Mail Order Discount Agencies.

Since then, we have become known for prompt *personal* service—all enquiries and orders are dealt with on the same day as received—and *immaculate after-sales attention* which is vital when buying at discount.

Only new *unused* branded equipment with manufacturers' guarantees. No Membership charges. Hire purchase if required. Send for free brochure (including full range of domestic appliances, motor cars etc.) to:—

**The DISCOUNT BUYING AGENCY**

111, South Farm Road, Worthing, Sussex  
Tel: (0903)-31415  
Est. 1960

**1975 HIFI YEAR BOOK**

**Celestion** 

Loudspeakers for the Perfectionist

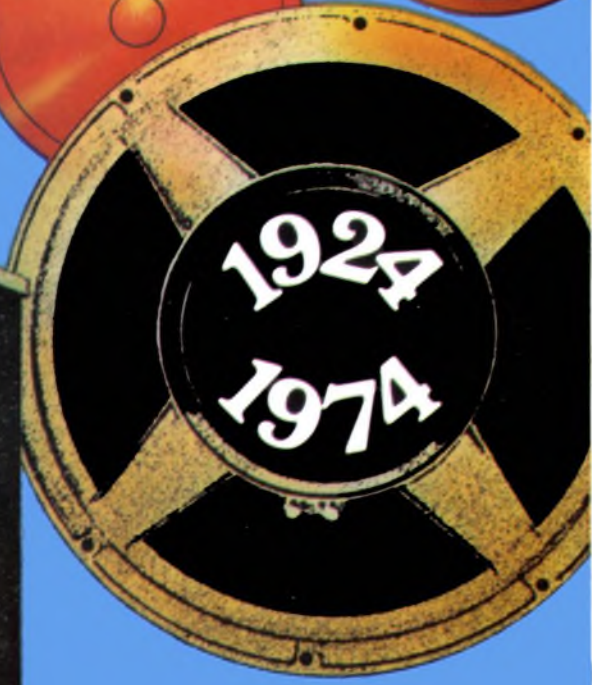
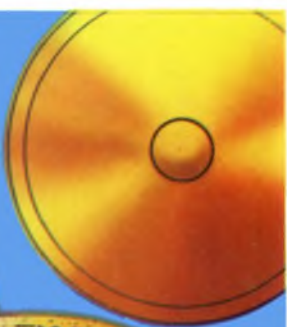

**Half a Century  
of  
Sound Experience**

**ROLA CELESTION LTD, DITTON WORKS, FOXHALL ROAD, IPSWICH**