

# Hi Fi

1962

## YEAR BOOK



**QUAD**

*for the closest approach to the original sound*

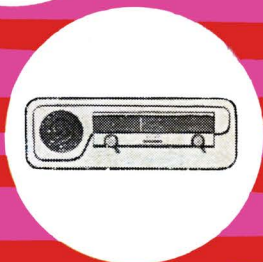
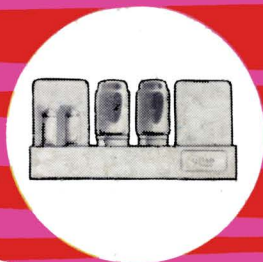

**PICKUPS • MOTORS • TUNERS • SPEAKERS •  
AMPLIFIERS • MICROPHONES • RECORDERS**

10/6

# Hi-Fi Year Book

————— 1962 Edition —————

*Editor* - - MILES HENSLOW



*Published by*

MILES HENSLOW PUBLICATIONS LIMITED,  
99 MORTIMER STREET - - LONDON, W.1

Printed in Great Britain by Portia Press Ltd., London, W.1



# INDEX

	<i>Page</i>
<b>The Dynamic Decibel</b> , by <i>Graham Balmain</i> .. .. .	5
<b>The Disc Stereo Picture 1962</b> , by <i>Stanley Kelly</i> .. .. .	11
<b>Pickups and Arms</b> .. .. <i>DIRECTORY</i> .. .. .	17
<b>Pickup Accessories</b> .. .. <i>DIRECTORY</i> .. .. .	29
<b>Motor Units</b> .. .. <i>DIRECTORY</i> .. .. .	32
<b>Radio Tuners</b> , by <i>Arthur W. Wayne</i> .. .. .	35
”    ” .. .. <i>DIRECTORY</i> .. .. .	41
<b>New Developments in Transistor Amplifiers</b>	
by <i>George S. Tillett</i> .. .. .	47
<b>Amplifiers and Control Units</b> <i>DIRECTORY</i> .. .. .	59
<b>Loudspeakers for 1962-3</b> , by <i>R. L. West</i> .. .. .	83
<b>Speaker Drive Units</b> .. .. <i>DIRECTORY</i> .. .. .	87
<b>Crossover Units</b> .. .. <i>DIRECTORY</i> .. .. .	102
<b>Speaker Enclosures</b> .. .. <i>DIRECTORY</i> .. .. .	103
<b>Microphones</b> , by <i>Stanley Kelly</i> .. .. .	117
” .. .. <i>DIRECTORY</i> .. .. .	123
<b>Time on Tape</b> , by <i>Graham Balmain</i> .. .. .	135
<b>Tape Recorders</b> .. .. <i>DIRECTORIES</i>	
Professional and semi-professional .. .. .	145
General Purpose and Domestic .. .. .	150
Battery operated Portables .. .. .	167
Decks, general purpose and semi-professional .. .. .	171
Decks fitted with Pre-amplifiers .. .. .	173
Tape Amplifiers and Mixer Units .. .. .	174
Tape Accessories and Components .. .. .	181
<b>Magnetic Tape</b> .. .. <i>DIRECTORY</i> .. .. .	189
<b>Constructional Kits</b> .. .. <i>DIRECTORY</i> .. .. .	193
<b>New Products and Late Information</b> .. .. .	199
<b>Hi-Fi Dealers</b> .. .. <i>DIRECTORY</i> .. .. .	209
<b>Advertisers' Index</b> .. .. .	272

# INTRODUCTION

**I**N this seventh edition of **Hi-Fi Year Book** we make two major changes. First, we accept the prodding of our many regular readers, and retrace our steps (more or less) to the point at which we first came in—to 1956, Edition No. 1. In that year book we published a series of very informative articles on almost all the subjects which the book covered in directory form; and we have been asked, annually, ever since, to revert to that original line for future editions.

In point of fact we have often tried to do so, but many things have stood between us and our intentions. For instance, in our second edition (1957) we were caught up in the complications which seemed to envelop the whole business of “hi-Fi”; and reference to our first and second editions will bear this out. 1956 saw the awakening of the general public as a whole to a hobby which had previously been the very personal affair of a limited few. A dozen manufacturers suddenly appeared on the horizon to join company with every one who had, previously, laboured enthusiastically to fill the demand. Scores of items of new equipment demanded attention and recognition.



Then came stereo. Then tape. Then home construction. And so on. And what we had originally planned to be a fairly “leisurely” type of production got out of hand and pulled us along with it. And also, in fairness to our own specialist contributors (who by then were working overtime in order to cope with our demands for a newly established “*Hi-Fi News*”) we were forced to agree with them when they argued with us that they were saying monthly, and in full, what we were urging them to say

again annually. And so it was that the “**Year Book**” developed more and more into a catalogue of the available products, with the addition of occasional informative articles to cover the various sections, as and when the genuine demand made them applicable. Then, two years ago, with the increasing overlap of the interests of audio and cine enthusiasts, we introduced a Cine Section. And that, finally, brought about a drastic change of policy—for cine sound also began to expand to a size and importance that demanded that we must either drop it entirely or do considerably more justice to it.



This year, therefore, we have dropped all cine subjects from the “**Hi-Fi Year Book**”, and have published a completely separate “**Cine Year Book**” in its first edition. And to make full use of the space thus vacated we have endeavoured to cover the present-day scene of Audio and Hi-Fi subjects with full-length articles by experts. Some of the writers are comparatively new to our regular readers: others have been followed for several years in this and our monthly publications. Stanley Kelly has found time to produce two welcome contributions for this edition—on pickups and on microphones; and his knowledge and practical working experience with both need no bouquets from us. George Tillet again contributes a most informative article on amplifiers. Arthur Wayne provides a much needed clarification of the “tuner” position. Ralph West writes once more on speakers. Graham Balmain brings Decibels under control and also strikes a new and unusual line of approach to tape recorders.

Each of these contributions is, in its own way, a unique and valuable essay. There is a gap of some six years between these writings and those which surveyed the Hi-Fi scene as it was when we first published this Year Book. In the intervening period much has happened—not only in the laboratories and the manufacturers' production departments, but also in the art of sound recording and reproduction as a whole. Though the production side of things may truly be said to have "settled down", enormous strides have been made, in terms of thinking and of practical development. "Hi-Fi Year Book" (1962 Edition) summarises all this in its customary Directory Sections, and it also brings its readers the very readable views, discussions and thoughts which link up the unspoken questions of the enthusiast with the practical achievements of the industry.



It is universally accepted that "Hi-Fi" equipment, as made in the factories of England, is the best obtainable. It has been our privilege to list and to present the details of this equipment to the world for several years in this annual. We hope that this seventh edition will be as useful to its readers as its previous editions have proved to be, and that its revised editorial policy will provide its regular followers

with even greater pleasure and valuable reading material. To those readers who have found the "Cine Section" in our 1960 and 1961 editions a useful guide, we apologise for its 1962 omission—but we sincerely recommend to them the newly created "Cine Year Book" which now deals with the whole subject of Cine, in all its sub-sections, far more comprehensively than was ever possible in its previously condensed form in the parent "Hi-Fi Year Book".



In conclusion may we say that, to the best of our ability, this edition carries as complete and as accurate a summary of the available products that a continuous and co-operative association with the many manufacturers has made possible. Also, so far as it has been possible to do so, all details of equipment have been listed and illustrated under their appropriate headings. We do, however, recommend that our readers study the "post script" pages which we have included as an additional service for manufacturers who were unable to provide us with data by the press dates laid down.

Whilst every effort has been made to check all details and prices for accuracy, and to include all items of equipment currently available on the market, no responsibility can be accepted for omissions or inaccuracies.

# THE DYNAMIC DECIBEL

By Graham Balmain

“THE DeciBel is a unit representing electrical power ratio. One-tenth of a Bel, q.v.”.

“The Bel is a dimensionless logarithmic unit representing (originally) the ratio of two electrical powers, and defined by the expression:

$$N = \text{Log}_{10} \frac{P_2}{P_1} \text{ Bels.}$$

It is now used widely of ratios between other electrical quantities and is also applied to analogous relationships in magnetism, acoustics, etc. The unit is named after Alexander Graham Bell, inventor of the telephone, in which industry it was first used (under the name of ‘Transmission Unit’) to replace the ‘standard mile’ as a measure of loss in cables”.

And that, some would say, is all there is to it. Yet it would be wrong and sometimes misleading to consider Bels and deciBels only in terms of the prosaic formula above. Although there is little hint in these imaginary glossary entries of their being anything more than an engineering convenience based on a mathematical device, the logarithm, the more romantic idea that they are an explicit acknowledgement of a natural law does clothe the bare sticks a little by giving some logical background to their use. One can’t always, so to speak, see the wood for the logs. However, let us start at the beginning.

x 10,000,000

By setting up suitable microphones, amplifiers, voltmeters and other acoustical engineering paraphernalia, we can measure the intensity of sounds ranging from the just-audible level at the “threshold of hearing” to an uncomfortable volume at the “threshold of pain”. On the average, the intensity of the latter would be about 10,000,000,000,000 (ten million million) times that from the former, and this evidently represents the possible variation of useful sound level at our ears.

Yet who can say that the loudest bearable noises actually *sound* that much louder than the quietest audible? Or that an orchestral tutti, fortissimo, *sounds* twenty million times louder than the softest



“threshold of pain”.

violin solo, or normal speech one hundred times as loud as a whisper?

It is in fact very difficult to judge loudnesses in terms of ratios at all. One finds it much easier to think of *differences*; thus one can fairly readily say that the *difference* in loudness between sound A: and sound B is about the same as that between B and C, and so on. Various investigators have in this way built up scales of loudness differences covering the whole useful range, a typical example of which is reproduced in the table:

The typical sounds, though interesting and perhaps wryly amusing, are not really very helpful to us. What *is* useful is the arrangement of the two left-hand columns of the table, where the horizontal lines are spaced to represent equal differences in loudness, as detected by the ear. The figures they indicate in the ‘Intensity’ column represent the corresponding measured intensity ratios, expressed as ‘powers of 10’ as well as in clear.

## Add to Multiply

First, you will notice that wherever the intensity is *multiplied* or *divided* by ten, a corresponding constant amount is *added* to or *subtracted* from the loudness. This holds also for other factors, of course;

Intensity	Loudness Scale	Typical Sounds
10,000,000,000,000 = $10^{13}$	— 13 Bels = 130dB	Threshold of pain.
1,000,000,000,000 = $10^{12}$	— 12 Bels = 120dB	Jet Aircraft at 100 ft.
100,000,000,000 = $10^{11}$	— 11 Bels = 110dB	Hammering on steel at 20 ft.
10,000,000,000 = $10^{10}$	— 10 Bels = 100dB	Pneumatic drill at 20 ft.
1,000,000,000 = $10^9$	— 9 Bels = 90dB	Diesel truck at 15 ft.
100,000,000 = $10^8$	— 8 Bels = 80dB	Very loud radio.
10,000,000 = $10^7$	— 7 Bels = 70dB	Busy city street.
1,000,000 = $10^6$	— 6 Bels = 60dB	Noisy office.
100,000 = $10^5$	— 5 Bels = 50dB	Normal speech.
10,000 = $10^4$	— 4 Bels = 40dB	Average house.
1,000 = $10^3$	— 3 Bels = 30dB	Whispered speech.
100 = $10^2$	— 2 Bels = 20dB	Quiet country garden.
10 = $10^1$	— 1 Bel = 10dB	Minimum outdoor noise.
1 = $10^0$	— 0 Bels = 0dB	Threshold of hearing.

in general, equal intensity ratios result in equal loudness differences.

Second, you will see that the powers of 10 for each ratio also change by equal amounts for equal differences in loudness, and they would therefore serve well as units in a loudness-difference scale. In fact they are already used as such; the intervals between them are each one *Bel*, corresponding to an intensity ratio of 10. Thus for instance 2 Bels means a ratio of 100, 4 Bels means a ratio of 10,000, and 13 Bels covers the whole useful intensity range of  $10^{13}$ :1. However, these units are inconveniently large for practical work, so they have been divided each into ten decibels (dB), which have become the familiar working units. This gives us the loudness scale in the middle column of the table.

### Eleven minus one plus

Readers whose school mathematics has not escaped them entirely will probably remember that the power to which 10 is raised to produce a given number is called the *logarithm* of that number. The loudness scale is therefore a logarithmic one, and since it was constructed from listening tests, it follows that the hearing sense itself must have a logarithmic response to changes in sound intensity.

At first sight this may seem a rather odd state of affairs. That the ear, potentially so sensitive to distortion of sound, should itself be a non-linear device is perhaps hard to imagine. Nevertheless, there are sound physiological reasons for its being so, and it is in good company; all the other bodily senses—touch, taste, smell and vision—have logarithmic responses to external stimuli. If they had not, we should

either lead most uncomfortable lives or have a much more massive nervous system. As things are, you will see that it is quite natural to judge the intensity of stimuli such as sound in terms of our logarithmic reactions to them, and to express them in logarithmic units.

Once this idea is accepted, it seems convenient to use the same kind of scale when dealing with physical quantities which are related directly or indirectly to such stimuli, or are analogous to them. The logarithmic sensitivity rating of photographic film is one example, the expression in dB of differences in the electrical output of audio amplifiers another.

### The use of the Db

Thus we refer to the frequency response of a piece of audio gear as being flat within a dB or two over a certain range as a measure of how well the tonal balance of the input is preserved in the output, or as so many dB up or down at some point when it differs. We speak of the gain of an amplifier being so many dB when the output is that much higher than the input which produces it. We say that a pickup is  $x$  dB more or less sensitive than another in terms of output voltage, a recording head  $y$  dB more or less sensitive than another in terms of input current requirements. We can even use decibels to describe variations in the mechanical modulation velocity of a disc groove or the magnetic flux in a tape track.

All this can become rather confusing, and no less so because the decibel seems such an elusive quantity. A volt is a volt, but decibels are jacks-of-all-trades, rootless, shifting and entirely dependent on

circumstances. You cannot reasonably ask "where is a deciBel" any more than "where is an inch"; it all depends on where its ends happen to be, and this in turn depends on what you are measuring. The only constant in either case is the distance between the ends, the difference in position or level between two points.

So every time we use deciBels we must have some point of reference. The phrase "a loudness of 100dB" is meaningless (however much that pneumatic drill annoys you!) unless we add "above the threshold of hearing".\*

We normally avoid the clumsiness of that expression by calling them "*phons*" instead of dB, which immediately refers the measurement to this particular loudness scale. Electrical engineers have similar ways of tying down their reference points; for example, the symbol "dBm" implies a level in dB relative to a power of one milliwatt developed in a 600 ohm resistor. But there is neither the need nor much opportunity for any such device in hi-fi practice; we must see that every deciBel has two ends. Beware of the specification which says: "Noise-60dB". It *should* mean 60dB below maximum useful output—which should in turn also be defined—but it *could* mean almost anything, and, expressed in this way, probably does.

**For power ratios only?**

To return for a moment to the rather severe definition of the unit at the beginning, we have, I think, accounted reasonably well for 'dimensionless' and 'logarithmic', which leaves: . . . . representing (originally) the ratio of two electrical powers. . . . It is better not to dig too deeply here, lest one falls into one's own pit.

The purists would say that deciBels should only be used of power ratios, and even then only when the impedances in which the powers are developed are equal. This idea may have been influenced by

\* Normally assumed to correspond to sound pressure of 0.0002 dynes/cm<sup>2</sup>.



practice in the telephone industry, where transmission levels in lines are perforce measured always across a standardised line impedance of 600 ohms or 75 ohms or whatever, but it certainly has little relevance to general audio work. For one thing, the impedances encountered in a recording or reproducing chain may range from ohms to megohms; for another, the only point at which the actual power developed is of any interest at all is the output of a power amplifier.

We are usually much more interested in voltages (or sometimes currents) because, as well as being proportional at any point in the chain to the sound input, they are directly and usefully comparable from point to point. The latter is not true of power levels; it is quite possible, for instance, to have a pre-amplifier with a power gain of unity (0dB) in which the signal voltage is nevertheless raised by a very useful factor of 100 (40dB) or more, solely because the output load impedance differs from the input impedance.

At this point you are probably complaining loudly that according to the table a factor of 100 converts to 20dB, not 40.

Ratio	0.2	0.25	0.3	0.4	0.5	0.6	0.7	0.8	0.9	1.0
dB	-14	-12	-10	-8	-6	-4½	-3	-2	-1	0
Ratio	1.0	1.1	1.25	1.4	1.7	2.0	2.5	3.0	4.0	5.0
dB	0	+1	+2	+3	+4½	+6	+8	+10	+12	+14

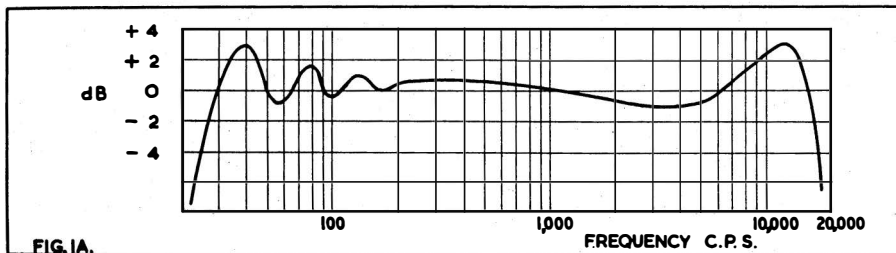

FIG. 1a. Recorder frequency response plotted on log frequency scale and in log output units on linear vertical scale.

So it does, for power ratios. But however much we apply decibels to voltage or current ratios, they remain basically a measure of power ratio. Since power is proportional to the square of the voltage or the current involved, a voltage gain of 100 times implies a power gain of 10,000 times, which gives us our 40dB.

### A point for purists

Here the purists will—quite justifiably—join you in complaining. An amplifier with a power gain of both 0dB and 40dB? It is impossible, of course, and again the differences in impedance are responsible for the anomaly. What we are in fact doing is adopting, quite openly, a convention that voltage ratios are expressed in dB without accounting for impedance differences. It is frankly an expedient for getting the benefits of a logarithmic scale without having to conform to all the rules, but one which has already been made respectable by usage.

Under this convention, then, a voltage or current ratio is represented by twice as many dB as an equal power ratio. Thus a power ratio of two corresponds to 3dB, a voltage ratio of two to 6dB (approximately). Note, however, that there is no basis for the popular misconception of 'power dB' and 'voltage dB' as separate units. If the signal level into a power amplifier increases by 6 dB, the voltage and power fed to the loudspeaker both increase by 6 dB also; the difference is that the voltage is doubled while the power is quadrupled.

### Conversion tables

The table gives a useful range of approximate ratio/decibel conversions for voltages and currents, and analogous quantities such as disc modulation velocity or tape modulation flux.

More accurate and detailed tables are published in various radio and electrical

diaries, most electronic and audio textbooks, and in pamphlet form by the British Sound Recording Association.

There are several incidental advantages in using logarithmic scales, quite apart from their natural relationship to our hearing. The most obvious is that of using logarithms at all, that one can get away with merely adding or subtracting where one would normally have to multiply or divide. Perhaps more familiar to readers of this journal is that it saves paper by compressing unwieldy ratio scales in graphs, frequency-response curves and so on.

### Compressed curves

More than this it saves paper *economically*. If that sounds redundant, or just plain silly, bear with me a moment and look at the curves in Fig. 1. The first shows the frequency response of a medium-priced tape recorder in the usual, familiar form, with a logarithmically proportioned frequency scale on the horizontal axis and a linear dB scale vertically. This recorder is typical of its kind with a slightly uneasy bass quality and a noticeable treble peak: appreciable variations to the critical listener, but by no means intolerable.

Curve (b) shows parts of the same thing plotted on linear frequency and voltage output scales—to draw the whole curve to the approximate scale of the bass end would need about 14 feet horizontally. Finding suitable paper would obviously present problems, and inspecting the curve even more; apart from the length overall, the treble scale is quite ridiculously expanded. And we can certainly do without the exaggerated corrugations in the bass. The recorder just doesn't sound *that* bad. Compress the whole horizontal scale? The treble peak would look reasonable, to be sure, but one couldn't really learn

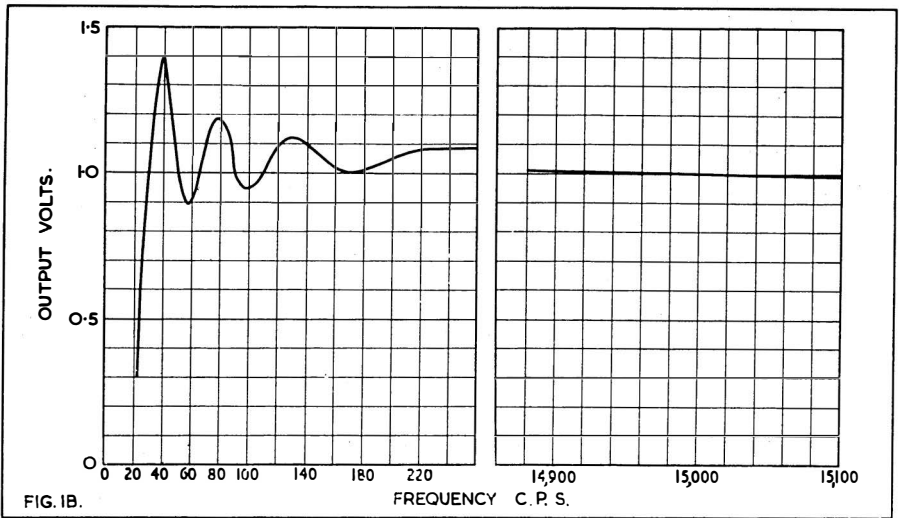

FIG. 1b. Parts of Fig. 1a. plotted in linear units on linear scales.

much from the whiskers at the left-hand end. One wastes paper either way.

On the other hand, the curve based on logarithmic scales shows significant information clearly wherever it occurs (which is often true, incidentally, of other kinds of relationship where large ratios are encompassed). They are equally helpful when one merely tabulates a series of suitably spaced readings, or simply watches a dB meter.

This little exercise in absurdity brings out another point: our sense of pitch is also logarithmic. The curves do not prove it, of course, but they do serve to remind

us that for example, the musical octaves we appreciate as equal intervals of pitch represent 2:1 frequency ratios. Again, as you can see from curve (a), equal ratios correspond to equal differences (of pitch as represented by length, in this case).

However, one must always be careful to see that the scales one uses are compatible if graphs are not to be misleading. Fig. 2 gives an illustration of the danger of not doing so.

Much the same kind of awkwardness can result in a more practical way from so apparently trivial a matter as the wrong

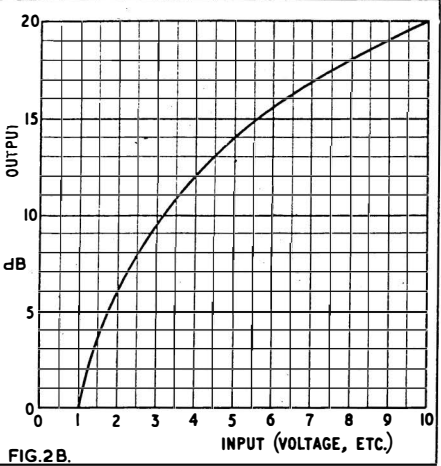
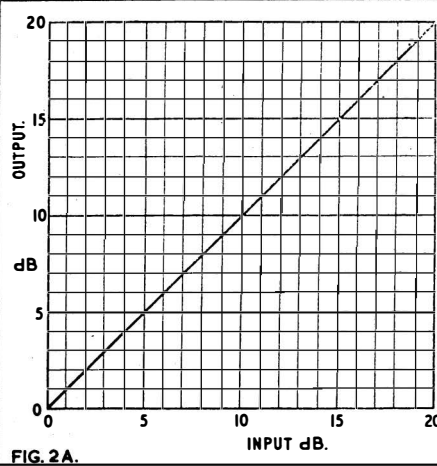

How to make a linear relationship (a) appear non-linear by using incompatible scales (b).



choice of a volume control for an amplifier. Use a linear potentiometer (in which the resistance and voltage tapped-off by the slider is directly proportional to its rotation angle), and the sound leaps out at you suddenly as soon as you begin to turn the knob clockwise from zero, increasing only slightly thereafter.

What is needed is a control whose resistance/rotation characteristic offsets the logarithmic loudness response of the ear by making the voltage rise more slowly at first and then progressively faster and faster as the knob is turned, so that the *loudness* of the output is proportional to rotation; in short, a reversed logarithmic (or 'exponential') law. This kind of control is called 'logarithmic' for reasons which I have yet to discover. Perhaps the man who named it had been reading "Alice Through the Looking-Glass" . . .

Returning to those busy city streets, full of pneumatic drills and diesel trucks, surrounded by noisy offices with jet aircraft at 100 ft. overhead, I find there is one rather obvious loose end to tidy up. Loudnesses have been treated here as though they were always steady values, as from a siren sounding "all clear" or the B.B.C.'s tuning signal, and changes in loudness as though they were clear-cut and discrete; whereas we know from experience that the sounds mentioned above, and most others, vary considerably in loudness from moment to moment and between examples. Change is the essence of informative or entertaining sounds: change of pitch and rhythm as well as of loudness.

The way in which the loudness of everyday sounds changes is usually pretty complicated, but is fairly easy to imagine in terms of fluctuations about an average value. Consider first a steady sound which suddenly changes in loudness to a new steady value. The minimum such change which the average ear can detect in everyday sounds is about 1dB at medium values of pitch, so any change greater than this will be detected almost however quickly it occurs. There is a lower limit, of course; a drift of 1dB in ten seconds or even 6dB in a minute might easily be overlooked, but in general one can readily detect a step in loudness as opposed to a drift.

Now consider the same sound starting at loudness A, stepping to loudness B and returning after a moment to A. In general, this also will be readily detected if A-B is

greater than 1dB, provided that the whole process does not occur too rapidly. However, we find that such a change becomes less and less impressive as its period decreases below about 50 milliseconds, so that a loudness pulse shorter than this, measured at so many dB on fast-acting instruments, might *sound* much less than the measured value.

## Changes of Loudness

Our hard-won loudness scale is obviously in danger of breaking down here, unless we have an instrument for measuring everyday sounds which reacts to their loudness fluctuations in the same way as our ears do. Such an instrument is the 'Volume Unit' (or VU) meter, which is used widely by professional engineers as a modulation indicator in sound systems. The Volume Unit might well be called a 'dynamic deciBel', for the meter has a speed of response approximating to that of the ear; while it will register the true values of loudness steps or slow variations, its response to rapid fluctuations represents their aural effect.

## The VU meter

The VU meter is not, in my view, a good modulation indicator, precisely because it cannot respond fast enough to register even the average value, of the rapid transient loudness peaks which so easily overload a sound system. It is perhaps a pity that the application has been emphasised to the exclusion of any acknowledgement of this limitation, because the meter really is very useful when that limitation is recognised as an intentional design feature.

We have wandered far from the 'dimensionless logarithmic unit' which started us off, but I hope some of the implications of the title will have become clearer along the way. Although the deciBel is indeed a useful practical unit for the engineer, the hi-fi enthusiast and the writer of euphemistic advertising copy, it is far from being the lifeless number which this might suggest. It is a symptom of a natural law, and a fairly precise expression of our personal reactions to one element of sound. It represents change in quantities whose essential interest is in change, in circumstances where Nature works to resist change by compressing its effect. In the widest sense, the deciBel is truly a dynamic unit.

# THE DISC STEREO PICTURE 1962

by Stanley Kelly

THE year 1961 saw no startling innovations but rather a steady consolidation of development and techniques in the art of disc record reproduction. The record companies are now consistently producing magnificent stereo discs which aesthetically and technically are pretty high perfect. At the same time the pickup manufacturers have now thoroughly assimilated the radically new techniques of stereo hill and dale reproduction, as opposed to the lateral "push/pull" reproduction which has existed since Berliner invented the lateral type recording on disc some 70 years ago.

It should be remembered that at the advent of stereo the first pickups available were crystal, and of necessity the techniques were immature and the results crude (by comparison with 1962) in the extreme. The active element of the pickups was Rochelle Salt with concomittent variability with temperature and humidity. With monaural reproduction this not very serious but with stereo reproduction, where there may be a difference in the temperature gradient of the two crystals, variation in sensitivity of each channel and crosstalk would be the inevitable result.



The first serious attempt at producing stable magnetic design was of Continental origin and for a short time it held the field. Some years previously the *Decca* engineers had been working on the problem of reproducing stereo, parallel to their development of the *Teldec* recording system. This is logical because it is foolish to put something on a disc unless you have at the same time the means of getting it off again.

The result of from 7 to 10 years of research was the *Decca ffs* pickup, which at the time was years ahead of anything

produced anywhere in the world. Its frequency response was remarkably extended and smooth, crosstalk was more than adequate and the needle tip impedance remarkably low, and even today it is still in the top three or four pickups available irrespective of price.

In the meantime the *Brush Cleveite Corporation* of America have developed an entirely new crystalline material under the pseudonym of PZT: these letters stand for lead zirconate titanate. This crystal, which is a ceramic material, has a sensitivity several times greater than the original barium titanate elements and due to the novel form of construction known as Multimorph, the mechanical parameters were such as to render the crystal ideally suitable for transducers in stereo pickups. The crystals operate in flexure and by means of suitably proportioning the drive members between the stylus and the crystals it is possible to obtain crosstalk factors in excess of 26 dB over the middle range of the spectrum.



The magnetic pickups have in the meantime developed into two classes, (1) the lateral hill and dale summation system outlined in Blumlein's Master Patent of 1951 and exemplified in the *Decca ffs* and (2) the moving magnet transducers used almost exclusively in America. There is no doubt that the hill-and-dale lateral summation system is capable of giving superior results to any other form of transducer, but it is a difficult and costly pickup to manufacture, requiring precise limits which would normally be outside the capabilities of the average pickup manufacturer. With the moving magnet system considerably wider production tolerances

can be used but with a small reduction in performance, and it is to the credit of the American manufacturers concerned that they have now produced some very fine transducers using the moving magnet system, but there is no difficulty in proving mathematically and demonstrating with suitable test equipment that the English system is capable of lower tip mass and greater consistency of performance both with temperature and other conditions on an individual pickup and from pickup to pickup, under conditions of quantity production. All of which brings us to the measurement of the various parameters.

The starting point of any pickup is record and stylus wear and it is important that these be reduced to an absolute minimum. It can be shown that in order to render the life of a record practically indefinite the playing weight of the pickup should not exceed half a gramme. This at present is an impossibility, but at playing weights of 2 to 3 grammes the life of the stylus is in excess of 2,000 hours and the life of the record (especially when kept clean and static free by means of *Dustbug* or similar device) is certainly many hundreds of playings. Be it noted in parenthesis that the writer has one of the first *ffss* pickups using  $\frac{1}{2}$  thou point and adjusted for  $3\frac{1}{2}$  grammes playing and the flats did not exceed 0.00035 in. diameter until 1,600 playing hours.

It is normally accepted that a flat of the above dimensions is about the maximum that can be expected for high fidelity wide range reproduction. With less stringent requirements the flat could be increased to possibly 0.0005 in. and this would have increased the life of the stylus by several hundred hours.

★

Intimately associated with the playing weight is the restoring force—or as it is usually termed, the compliance of the pickup—and the stylus tip mass; although fundamentally these are static units it is usual to treat them as dynamic values, the compliance being measured at some low frequency usually 30 c/s, and the tip mass at a high frequency generally about 10 k/sc. With modern crystal pickups, where there is a considerable amount of mechanical resistance associated with the systems, in order to render the response substantially flat it is tacitly assumed that the mechanical impedance so measured is purely reactive,

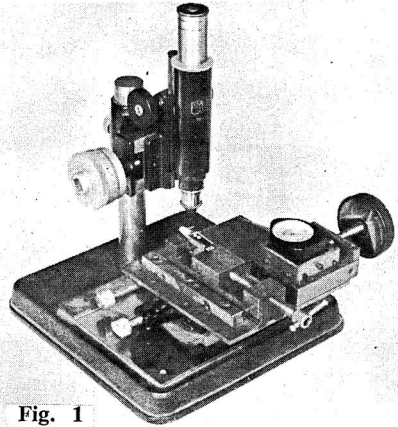

Fig. 1

and it is then equated in terms of compliance or mass. To the purist this is wrong but in practical politics it is not very important because it does relate to the ability of the pickup to satisfactorily trace record, and also it relates these values in terms which are commonly appreciated by the enthusiast.

Generally there are several methods of measuring compliance and mass, and photograph Fig. 1 shows a basic static method of measurement. This consists of a calibrated microscope and a method of playing a known force (actually a spring balance). The balance arm is connected to the stylus by a stiff member and the displacement of the stylus for known forces is measured by the travelling microscope. The micrometer is calibrated in microns (one millionth of a meter) and taking a gramme approximately being equal to 1,000 dynes each micron in displacement of the stylus per gramme of applied force is equal to  $10^{-7}$  cm/dyne, and with average pickups it is possible to measure the compliance of the pickup to two significant decimal places. This method, as stated above, is a static measurement and does not take into account any frictional or other forms of loss resistance associated with the dynamic system of the pickup.

★

Fig. 2 shows a dynamic compliance and mass measuring system by the resonance method. It consists of an electro magnetic drive on to a free armature of known mass (actually 10 grammes). The pickup under test is clamped on to the massive arm which to all intents and purposes is infinitely stiff and cannot move in a lateral direction

because it is supported on knife edges. The coil is driven from a beat oscillator and the velocity of the armature is measured by a capacitive probe. The resonance of the pickup compliance and the free armature is indicated by maximum output from the millivoltmeter connected to the capacitive probe, and the compliance is then calculated from the known driving mass of the armature and the resonant frequency of the system. This gives the true dynamic compliance which is not effected by the resistance associated with the restoring force of the pickup.

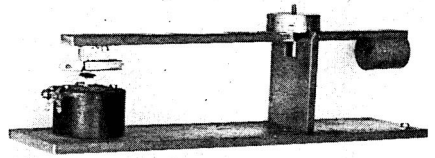

Fig. 2

This latter value is determined by measuring the frequencies at the  $-3$  dB points relative to the peak frequency from which the mechanical losses are then computed. At the same time the pickup is then driven in the high frequency spectrum (10 to 25 kc/s) and the resonances due to the mass of the stylus tip and the stylus recording compliance is shown by the usual rise in output from the pickup associated with this form of resonance. Knowing the record compliance, the mass is easily computed. Unfortunately with extremely highly damped pickups of current crystal variety the resonance is so effectively damped that it cannot be easily detected and recourse to the "non-tracking" method is used. This method consists of playing the pickup at a known frequency and velocity (from standard test records) and then reducing the playing weight until the pickup just does not track as shown by the discontinuities in the sine wave trace on the oscilloscope; from the playing weight and velocity the needle tip impedance can be computed and from that the equivalent compliance and/or mass.

★

The use of these techniques in development during the past two years have enabled designers to produce the very superb pickups which are now available. The *Decca ffs* has now been joined by the *E.M.I. EPU.100* pickup which is of the same general type, namely hill-and-dale lateral summation. A photograph of the assembly is shown in Fig. 3 and the diagrammatic representation in Fig. 4, and the schematic of the connections in Fig. 5. It will be seen that the lateral sensing coils are connected in series and are actually on the two outer poles of the magnet system, and being a balanced system these coils will only respond to impulses in a lateral

direction, whilst the vertical system coils is actually one coil centre tapped, the centre tap being connected to the upper end of the lateral sensing coil and the two outers being the respective left and right hand channels. This is assembled on the centre limb magnet system which is terminated underneath the armature. Provision is made to adjust the spacing between the armature and the vertical sensing pole in order to obtain absolute equality of output between the two channels and reduce crosstalk to a minimum. The response curve of this excellent pickup is shown in Fig. 6.

★

Crystal type of pickups are exemplified by the *Decca Deram*, which is a high fidelity, medium priced, cartridge using the PZT ceramic material. It has a remarkably low effective mass of approximately  $1\frac{1}{2}$  milligrams and a very high compliance and, when used with a suitable arm, will satisfactorily reproduce any stereo record at playing weights below two grammes. The output is equalised to give a flat response without correction in the pre-amplifier, and this type of cartridge will probably be seen on the majority of medium priced, high fidelity reproducers in the future. Because of the versatility of the PZT transducers it is possible to produce a dual purpose cartridge for playing both monaural and stereo records from two separate styli. Photograph Fig. 7 shows the "works" of one such cartridge produced by the *Goldring* Manufacturing Company. This is a relatively high output cartridge rendering the use of expensive pre-amplifiers unnecessary. The compliance and dynamic mass are such that it will satisfactorily play the majority of *lp* records at  $2\frac{1}{2}$  grammes and all that have been produced at present, at 3 to  $3\frac{1}{2}$  grammes when used with the G.60 tone arm. The response is not as smooth as the *Deram* or magnetic type

but this is to some extent compensated for by the very high output and the excellent crosstalk figures obtained, and we can expect to see many more examples of this type of cartridge on general purpose equipment of superior grade to the average run-of-the-mill radiogramophones.

Tone arms are now beginning to get the attention they deserve and the tone arm associated with the EPU 100 pickup is a case in point. *E.M.I.* state this is an integrated stereo pickup and that in their opinion (with which the writer fully concurs) it is not possible to design a high fidelity cartridge to the precise limits required without at the same time designing a tone arm as part of the general system.

### The EPU.100 Integrated Arm

During experimental work on this pickup, it became apparent that conventional arms had several disadvantages when used with a high compliance pickup. Extremely careful adjustment was needed to eliminate rattle at the pivots without introducing excessive friction, and the low frequency resonance of the head and arm were excited by the slightest external disturbance. These resonances, due to the necessary compliances of the pickup and the effective mass of the head and arm, are at 8 to 10 c/s in the lateral direction, and 14 to 16 c/s in the vertical direction. The lateral resonance was particularly easily excited and this caused the pickup head to oscillate violently, often jumping several grooves of the record, while the vertical resonance produced an undesirable increase in sensitivity to motor rumble.

Although the application of a viscous compound to the pivots of the arm had the desired effect of damping the low frequency resonances, considerable difficulty was experienced in preventing the compound flowing from its correct position. A solution to these difficulties was found with a novel design of unipivot arm with built-in damping. This arm has the damping compound, now a viscous silicone fluid, situated away from the pivot, which allows closer control of the damping characteristics and suppression of the undesirable effects due to the low frequency resonances. The offset angle of the head is set to the minimum distortion value, which produces a larger than normal tracking error at the beginning of a record but allows only a small error to occur in the region of the inner grooves. This feature has enabled the production of

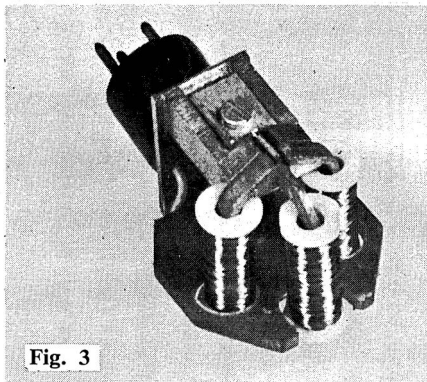

Fig. 3

a compact arm with a pivot to stylus distance of 9 inches.

The arm is largely constructed of aluminium alloy protected by a satin anodized finish. A cylindrical hub contains the unipivot and damping mechanism and from this projects the cranked arm with the pickup socket at its front end. Lateral balance of the arm is ensured by an offset counterweight carried on a spigot projecting from the rear of the hub. At the top of the

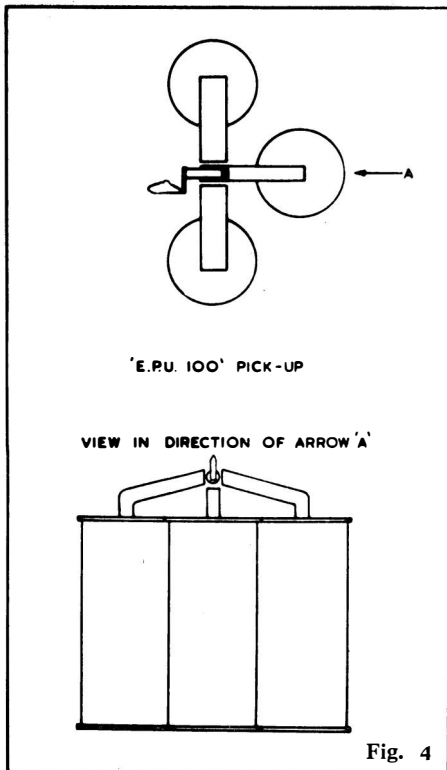
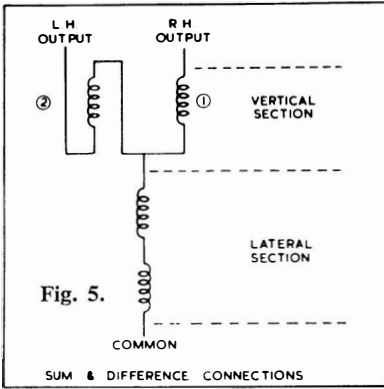

Fig. 4



hub are the precision-finished cone and unipivot; the lower edge of the hub is re-entrant, forming an annular gallery which contains the damping fluid. The stationary part of the damping system is provided by an inverted cup attached to the pivot support. The lip of this cup is immersed in the damping fluid. Vertical movements of the arm cause the hub to rock about the unipivot, thereby displacing the fluid; lateral movements of the arm cause the hub to rotate with respect to the cup, producing a drag. The viscosity of the damping fluid has been carefully selected so that the effects of the low frequency resonances are considerably reduced. To prevent fluid leaking during transport, a plastic washer is inserted between the hub and the pillar, thus raising the hub and

pressing the upper edge of the annular gallery against a rubber sealing washer in the inverted cup.

Incorporated in the supporting pillar is a lever-operated lifting and lowering mechanism which allows a controlled descent of the pickup on to the record. Although the height of the pickup above the base board has been made adjustable over a wide range, the lifting mechanism, being an integral part of the arm, does not need separate adjustment.



Finally, although development is never stationary, and it is extremely difficult to gaze into the crystal ball with any degree of certainty, it would appear that present day high fidelity cartridges and associated equipment are approaching the ultimate in reproduction from disc as we now know it, and without radical rethinking on recording techniques we may well see a static period in innovation for the next few years.

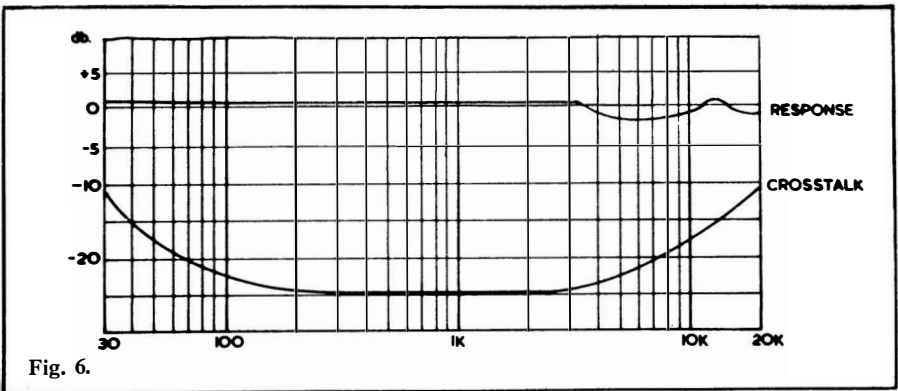
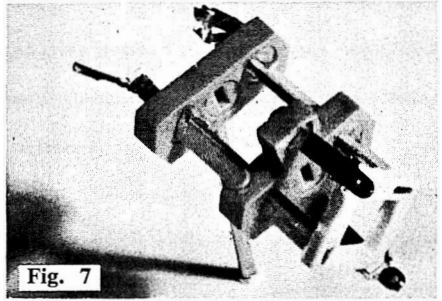

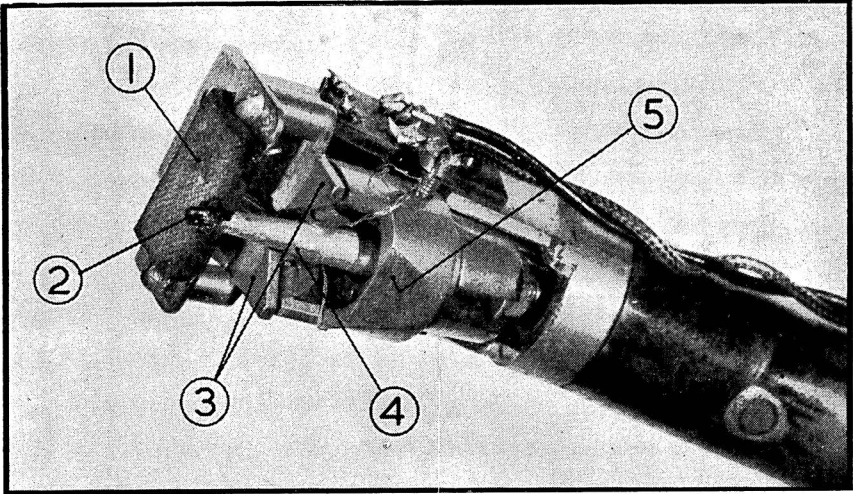

*This photo is of the historic Blumlein stereo pickup. The stylus armature (4) is pivoted at (5) in such a manner that the stylus point (2) can move in the vertical and horizontal directions. The inclined pieces are shown at (3)*

## FLASH BACK

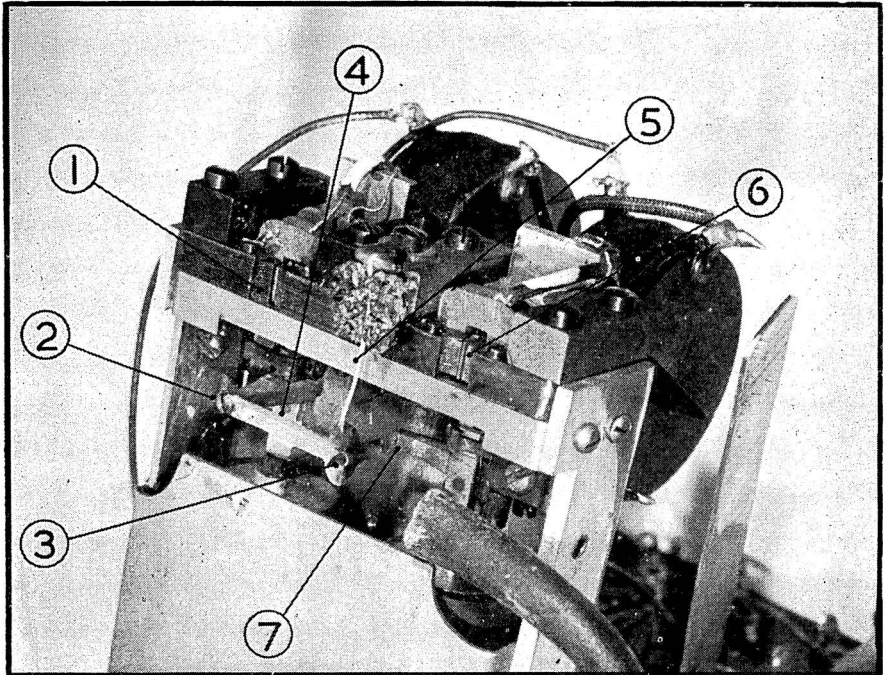

*The experimental "moving iron" complex cutter head used by Blumlein in 1933 for making his stereo discs. The armatures of the two heads are shown in (1) lateral and (6) vertical. The stylus (3) is held by a tie wire (5) and is connected to the vertical armature by the link (7) and to the lateral armature by the links (4) and (2)*

# DIRECTORY OF PICKUPS AND ARMS

★ In the abridged specifications of this directory, the following abbreviations are used for economy of space: **S.p.**—stylus pressure recommended by manufacturer; **Cms**—centimetres per second; ■ denotes stereo equipment.

**Audio Dynamics Corporation**, New York, U.S.A. Sole U.K. agents: **K.E.F. Electronics Ltd.**, Tovil, Maidstone, Kent. Tel.: Maidstone 55761. Cables: Kenteg, Maidstone.

■ **ADC Professional Cartridge.** Stereo cartridge. Moving magnet. Fixed head. Stylus 0.6 thou. diamond. Load imp. 47,000 ohms. Output voltage 1.27 mV. Range 10-20,000 c/s  $\pm$  2 dB. S.p. 0.75-1.5 gm. Price £20 10s. (U.K. purchase tax £6 16s. 9d.)

■ **Pritchard Stereo Pickup Arm.** Details and prices on application.

★

**Bang & Olufsen**, Struer, Denmark. Sole U.K. importers: **Aveley Electric Ltd.**, Ayrton Road, South Ockendon, Essex. Tel.: South Ockendon 3444.

**Orthophonic balanced 8-pole variable reluctance pickup.** Available as single stylus or dual stylus. Sapphire or diamond. Output voltage 1.p. 100 mV; 78 200 mV. Range 20-16,000 c/s. S.p. 1.p. 5-7 gm.; 78 9-12 gm. Load imp. 10-100 K. Price, Cart. only £1 10s. (U.K. purchase tax 10s.). Styli for above: L.p's and Standards, sapphire £1 10s. (U.K. purchase tax 10s.).

■ **Stereodyne 11 stereo magnetic cartridge.** Stylus 0.7 thou. diamond. Output voltage 7 mV per channel at 5 cm/sec. Channel separation > 22 dB. Range 30-15,000 c/s  $\pm$  2 dB. S.p. 2-4 gm. Rec. load 47,000 ohms or higher. Price £5 10s. 3d. (U.K. purchase tax £1 16s. 9d.).

■ **ST/A Arm.** Tone arm with plug-in shell (will take all standard cartridges). Price £9 9s. (U.K. purchase tax £3 3s.)

■ **ST/P.** Professional 12-in. pickup armless cartridge. Accepts only B and O "Stereodyne" ST/L/T2-7 plug-in type cartridge. Price £9 9s. (U.K. purchase tax £3 3s.).

■ **ST/L Arm and moving iron stereo pickup complete.** Diamond stylus 0.7 thou. Load

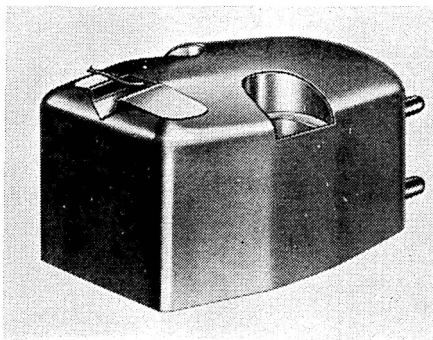

*ADC Stereo Moving Magnet*

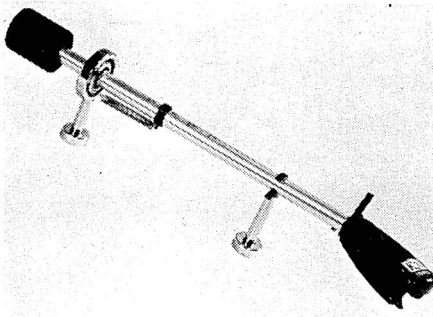

*B & O ST/A Pickup Arm*

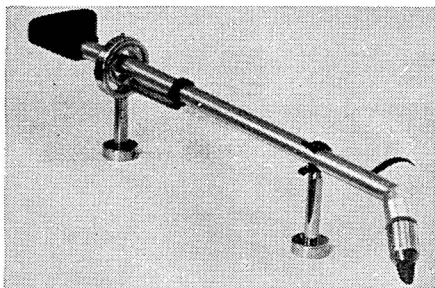

*B & O ST/L arm and Stereodyne Pickup*

imp. 47,000 ohms per channel. Output voltage 1.4 mV per channel. Range 30-15,000 c/s  $\pm$  2 dB. S.p. 3 gm. Price £13 7s. 9d. (U.K. purchase tax £4 9s. 3d.)



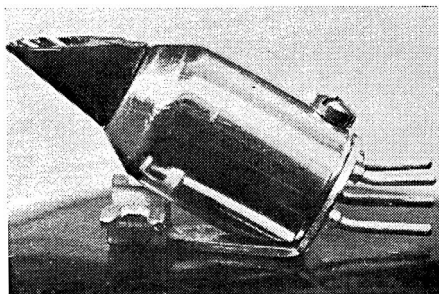

*B & O Stereodyne II Pickup*

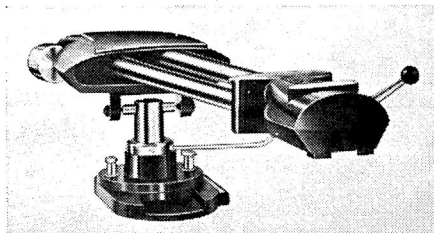

*B.J. Super 90 arm*

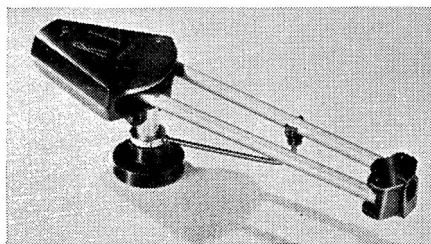

*B.J. TAN/11 arm*

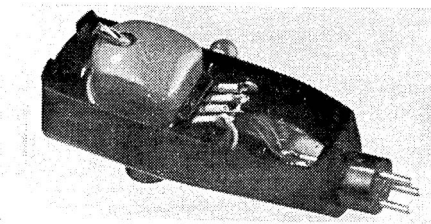

*B.J.-Elac 310 Stereo*

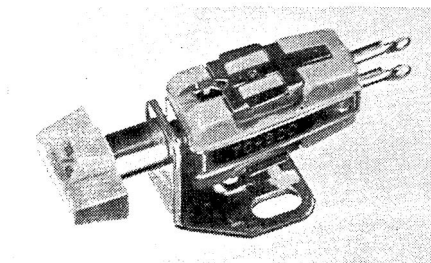

*Collaro TX88 cartridge*

**Burne-Jones & Company Ltd.**, 18 Brunswick Road, Sutton, Surrey. Tel.: Vigilant 5050. Cables: Burjomag, Sutton.

■**B.J.-ELAC210.** Magnetic stereo cartridge. Diamond stylus 0.5-0.7 thou. Output voltage 20 mV for 10 cm/sec. Range 30-15,000 c/s +6 -3 dB. S.p. 4-6 gm. Load imp. 1,500 ohms. Price £13 3s. 9d. (U.K. purchase tax £4 4s. 8d.)

■**B.J.-ELAC310.** Magnetic stereo cartridge. Diamond stylus 0.5-0.6 thou. Output voltage 15 mV for 10 cm/sec. Cross-talk better than 25 dB at 1,000 c/s, and 14 dB at 15 Kc/s. Range 30-15,000 c/s ± 2 bB. S.p. 3-6 gm. Load imp. 1,500 ohms. Price £16 12s. 6d. (U.K. purchase tax £5 6s. 8d.)

**B.J. Tan/11 arm.** Designed to overcome "tracking error". Total tracking error less than 1 degree. Height adjustable. Price £3 3s. (U.K. purchase tax £1 0s. 3d.)

**B.J. Super 90 Mk. II pickup arm.** Two models. 12 in. and 16 in. Price (including two plug-in shells to carry standard cartridges) Super 90/12 in. £11 11s. (U.K. purchase tax £3 14s. 2d.); Super 90/16 in. £12 5s. (U.K. purchase tax £3 18s. 8d.)

**B.J. plug-in shell** for holding cartridges. Price 17s. 3d. (U.K. purchase tax 5s. 9d.)



**Collaro Ltd.**, Ripple Works, By-pass Road, Barking, Essex. Tel.: Rippleway 5533. Cables: Korllaro. Telex: Barking 28748.

**Studio O.** Turnover crystal cartridge. Output voltage 200 mV. Range 50-10,000 c/s ± 5 dB. S.p. 8 gm. Price with two sapphire styli £1 10s. (U.K. purchase tax 9s. 9d.)

**Studio TX88.** Turnover crystal cartridge. Output voltage 1.p. 125 mV/cm/sec. at 1 Kc/s. Range 30-18,000 c/s. Load imp. 1 megohm. Price with two sapphire styli £1 15s. (U.K. purchase tax 11s. 8d.)

■**"Studio" Stereophonic "Type C".** Turnover ceramic cartridge. Output voltage 50 mV. Price £2 5s. (U.K. purchase tax 14s. 8d.)

■**Studio stereophonic Type R.** Turnover crystal cartridge. Output voltage 250 mV per channel ± 10 dB. S.p. 6 gm. Price including two sapphire styli £3 (U.K. purchase tax 19s. 6d.)

**Collel Ltd.**, All Saints Passage, Wandsworth High Street, London, S.W.18. Tel.: Vandyke 4377. Cables: Elcoll, London.

■ **Collel S.C.1.** stereo ceramic turnover cartridge, sapphire or diamond stylus. Output voltage 140 mV. Range 20-20,000 c/s. S.p. 3-4 gm. Load imp. 1 Megohm. Price, with 2 sapphires, £2 8s. 3d. (U.K. purchase tax 15s. 8d.); sapphire and diamond £3 1s. 9d. (U.K. purchase tax £1 0s. 1d.)

■ **Collel SK.1.** stereo crystal turnover cartridge. Sapphire or diamond stylus. Output voltage 170 mv. Range 20-20,000 c/s. S.p. 4-6 gm. Load imp. 1 Megohm. Price, with two sapphires £1 15s. (U.K. purchase tax 11s. 5d.); one sapphire and one diamond £2 10s. 6d. (U.K. purchase tax 16s. 5d.)



**Cosmocord Ltd.**, Eleanor Cross Road, Waltham Cross, Herts. Tel.: Waltham Cross 5206. Cables: Cosmocord, Waltham Cross.

**Acos "The Black Shadow".** Complete arm and slide-on HGP 39.3 head. Output voltage 1.p. 30 mV/cm/sec. Range 40-16,000 c/s  $\pm$  3 dB. S.p. 4-6 gm. Load imp. 100K ohms or higher. Diamond stylus fitted. Price complete £4 13s. 2d. (U.K. purchase tax £1 9s. 11d.). 78 heads available.

**Acos GP67-1.** Turnover crystal cartridge. Output voltage 200 mV. Load imp. 2 Megohms. Range 30-14,000 c/s. S.p. 4-6 gm. Price 18s. (U.K. purchase tax 5s. 9d.)

■ **Acostereo 71-5.** L.p. only.  $\frac{1}{2}$  thou. stylus. Output voltage 140 MV. Load imp. 2 Megohms. Range 40-12,000 c/s. S.p. 3-4 gm. Price with diamond £2 (U.K. purchase tax 12s. 10d.).

■ **Acostereo 73-2.** Turnover crystal stereo/standard. Output voltage 1.p. 150 mV. Load imp. 2 Megohms. Range 40-12,000 c/s. S.p. 3-4 gm. Price with sapphire £1 15s. (U.K. purchase tax 11s. 2d.), diamond £2 13s. 6d. (U.K. purchase tax 17s. 2d.)

■ **Acostereo 81.** Stereo ceramic turnover cartridge, sapphire or diamond styli. Load imp. 2 Megohms. Output voltage 110 mV. Range 50-14,000 c/s  $\pm$  4 dB. S.p. 3-5 gm. dependent upon arm. Price £2 (U.K. purchase tax 12s. 10d.)

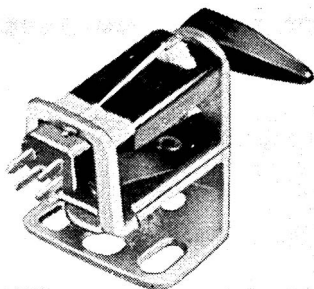

*Collaro Stereo Type C*

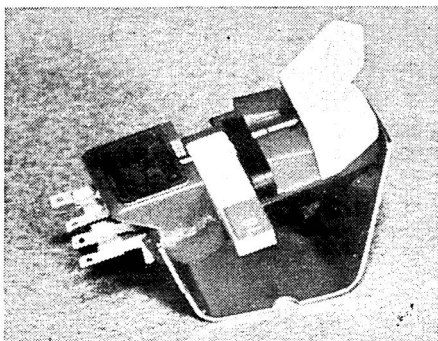

*Collel SK1 Stereo crystal*

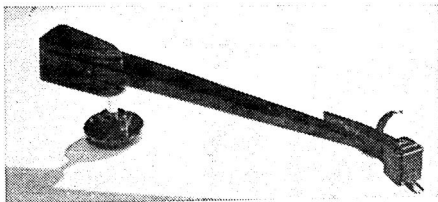

*Acos "Black Shadow"*

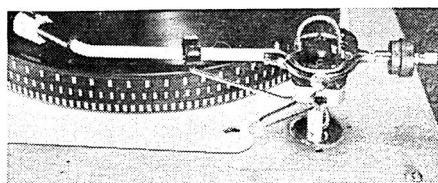

*Acos Hi-Light pickup arm*

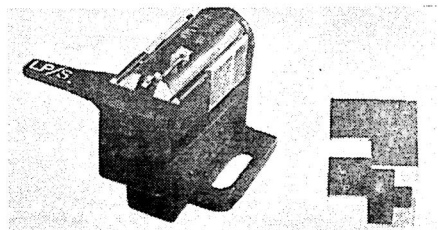

*Acostereo 81-2*

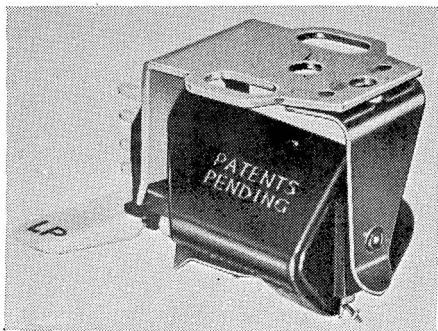

*Acostereo 73-2*

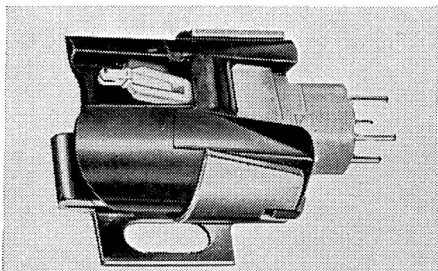

*Decca Deram Stereo ceramic*

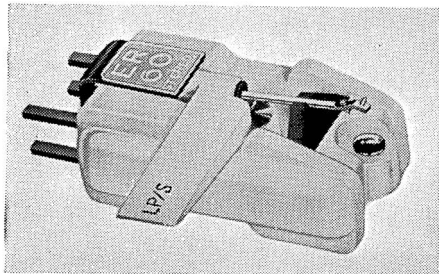

*E.R.60 Ceramic Stereo cartridge*

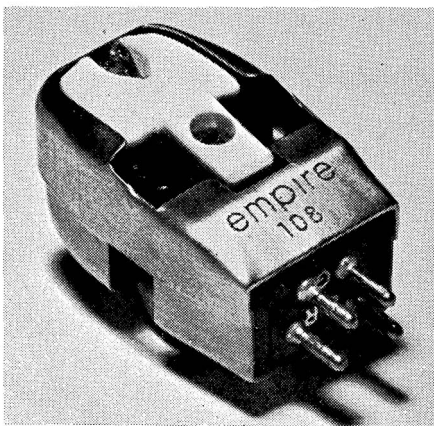

*Audio Empire 108 Stereo*

■ **Acostereo 81-2.** Turnover ceramic cartridge. Output voltage 110 mV. Load imp. 2 Megohms. Range 30-12,000 c/s  $\pm$  4 dB. S.p. 4-6 gm. Price £2 (U.K. purchase tax 12s. 10d.)

■ **Acopoise.** Pickup arm suitable for stereo cartridges. Recommended playing weight 4 gm. Price £1 18s. 6d. (U.K. purchase tax 12s.)

■ **Acos Hi-Light.** Ultra-lightweight adjustable arm for stereo and mono. Plug-in heads. Sapphire styli 0.5 thou. Load imp. 2 Megohms. Output voltage 40 mV (mono and stereo). Range 20-20,000 c/s  $\pm$  3 dB. S.p. 1 gm. (mono), 2 gm. (stereo). Price with both heads £14 6s. 2d. (U.K. purchase tax £4 11s. 10d.)



**Decca Radio & Television**, Ingate Place, Queenstown Road, London, S.W.8. Tel.: Macaulay 6677.

■ **Decca ffs.** Magnetic stereo pickup with slide-on head. Diamond 0.5 thou. stylus. Output 1.4 mV/cm/sec. r.m.s. per channel stereo 1 mV/cm/sec. mono. Response within  $\pm$  1 dB of R.I.A.A. characteristic. S.p. 3.5 gm. Load imp. 50,000 ohms. Price £15 18s. 2d. (U.K. purchase tax £5 2s.)

■ **Decca Deram.** Stereo and mono ceramic cartridge. Diamond stylus. Load imp. 2 Megohms. Output voltage 50 mV per channel. Range 40 c/s to 12 Kc/s  $\pm$  3 dB. S.p. 3.5 gm. Price £4 4s. (U.K. purchase tax £1 1s. 11d.)

Also available: other heads, with 1 thou. diamond for mono L.P.'s; with 2.8 thou. diamond for 78's. Price (each) £8 6s. 4d. (U.K. purchase tax £2 12s. 10d.)



**Dyna-Empire Inc.**, New York, U.S.A. U.K. agent: J. de Villiers, 16/20 Strutton Ground, London, S.W.1. Tel.: Abbey 5960. Cables: Devils, London S.W.1.

■ **Audio Empire 108.** Stereo and mono moving magnet cartridge. Diamond stylus 0.0007, 0.001 or 0.0027. Load imp. 47,000 ohms. Output voltage 8 mV per channel. Range 15-30,000 c/s  $\pm$  2 dB. S.p. 1-5 gm. Price £14 17s. (plus U.K. purchase tax).

**Electronic Reproducers (Components) Ltd.**, Hedley Road, St. Albans, Herts. Tel.: St. Albans 50701. Cables: Saphobear, St. Albans.

**Powerpoint Models 51 & 56** ceramic cartridge. 56 (blue) 1.p/78; 51 (red) 1.p/1.p. plug-in. Sapphire or diamond styli. Load imp. 1 meg-100 pfd. Output voltage 240 mV. Range 40-10,000 c/s. S.p. 7 gm. Price 14s. (U.K. purchase tax 4s. 6d.)

**E.R. 703.** Crystal turnover cartridge. Sapphire or diamond stylus. Load imp. 1 meg-100 pfd. Output voltage nom. 500 mV. Range 30-10,000 c/s  $\pm$  4 dB. S.p. 5 gm. Price 16s. 6d. (U.K. purchase tax 5s. 3d.)

**E.R. 705.** Crystal turnover cartridge. Sapphire or diamond stylus. Load imp. 1 meg-100 pfd. Output voltage 420 mV. Range 30-10,000 c/s  $\pm$  4 dB. S.p. 5-7 gm. Price to be advised.

**E.R.60.** Stereo ceramic cartridge. Turnover. Output voltage 140 mV. Range 40-12,000 c/s. S.p. 5.6 gm. Load imp. 1 Megohm. Price to be announced.



**Expert Pickups Ltd.**, 82 Belsize Lane, Hampstead, London, N.W.3. Tel.: Swiss Cottage 6324.

**Pickups**, moving coil, output 0.75 mV approx., impedance 10 ohms, for use with amplifiers with magnetic input correction requiring transformer or transistorised input. Available complete on Expert Arm (9 $\frac{3}{8}$ -in. centres (base pillar to t/t spindle), with diamond styli 0.0025, 0.003, or 0.001. Price £14 14s. 9d. Also as heads adaptable to most shells having  $\frac{3}{4}$  in. internal clearance, with diamond styli as above. Price £10 10s. 4d. Complete pickups for miniature thorns £12 12s., or head £8 15s. 6d.



**The Garrard Engineering & Manufacturing Co. Ltd.**, Newcastle Street, Swindon, Wilts. Tel.: Swindon 5381. Cables: Garrard, Swindon. Telex: 44-271.

**TPA. 12** Transcription pickup arm with plug-in moulding to take almost all makes of cartridge. Price £3 11s. (U.K. purchase tax £1 3s. 2d.)

**EV26A.** Ceramic turnover cartridge. Sapphire or diamond stylus. Output

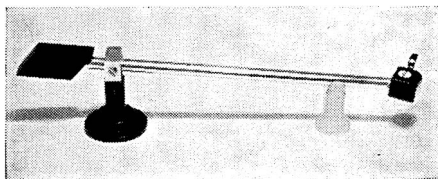

*Decca ffs Stereo pickup*

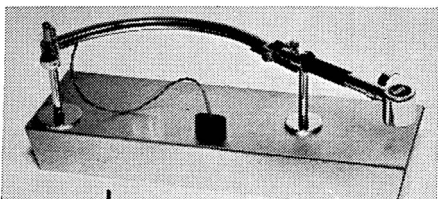

*Expert moving coil pickup and arm*

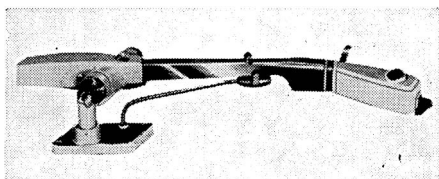

*Garrard TPA 12 pickup arm*

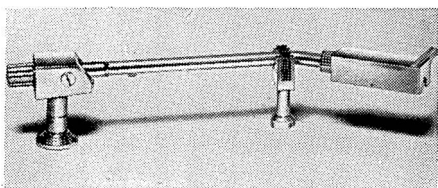

*Goldring Lenco L70 pickup arm*

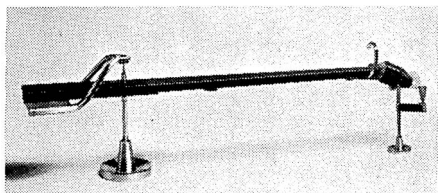

*Pickering Unipoise 198*

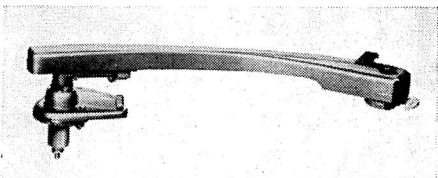

*Goldring G60 pickup arm*

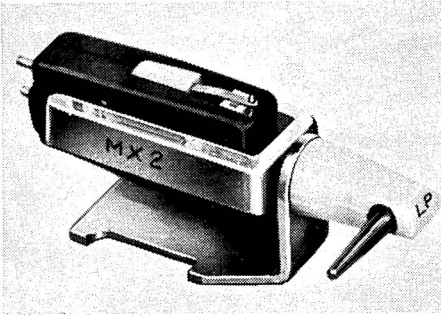

Goldring MX2 crystal

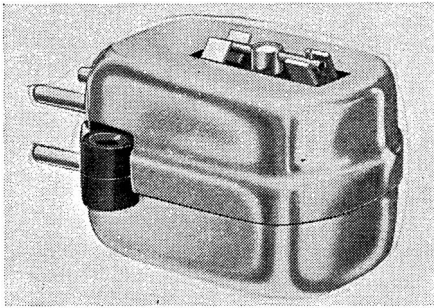

Goldring "700" Stereo cartridge

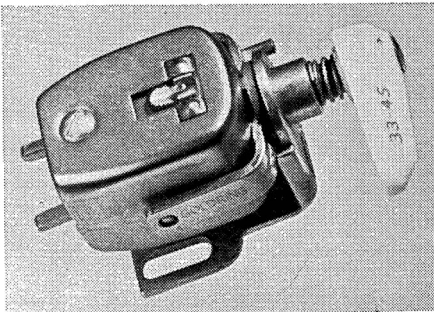

Goldring "600" cartridge

voltage 100 mV. S.p. 3-6 gm. Price £1 15s. 6d. (U.K. purchase tax 11s. 7d.)



**Goldring Manufacturing Co. (Great Britain) Ltd.**, 486/488 High Road, Leytonstone, E.11. Tel.: Leytonstone 8343. Cables: Echovox, London.

■ **MX1/D** Turnover crystal cartridge fitted with diamond l.p. and sapphire 78 styli. Output voltage 500 mV. Range 30-16,000 c/s. S.p. 5.7 gm. Load imp. 1 Megohm. Price £1 17s. 6d. (U.K. purchase tax 12s. 2d.)

■ **SX10/D** stereo turnover cartridge. Fitted with diamond l.p. and sapphire 78 styli. Output voltage 150 mV. Range 30-14,000 c/s. Load imp. 1 Megohm. S.p. 4 gm. Price £2 5s. (U.K. purchase tax 14s. 8d.).

"**600**". Variable reluctance turnover cartridge  $\frac{1}{2}$  in. centre, mounting holes. Diamond stylus for l.p. sapphire for 78. Output voltage 3.2 mV/cm/sec. Range 20-21,000 c/s  $\pm$  2 dB. S.p. 7 gm. Load imp. 68,000 ohms. Price £8 8s. (U.K. purchase tax £2 14s. 7d.)

"**580**". Variable reluctance turnover cartridge. Diamond stylus for l.p. sapphire for 78. Output voltage 3.2 mV. Range 20-18,000 c/s. S.p. 6-7 gm. Load imp. 68,000 ohms. Price £4 4s. (U.K. purchase tax £1 7s. 4d.)

■ **G60**. Transcription arm wired for stereo. Incorporates new slide-in head that will accommodate most cartridges. Height adjustable and S.p. variable from 2 gm. upwards. Price £3 (U.K. purchase tax 19s. 6d.)

**MX2**. Crystal turnover cartridge fitted with diamond or sapphire l.p. and sapphire 78 styli.  $\frac{1}{2}$  in. fixing centre. Load imp. 1 Megohm. Output voltage 500 mV. Range 30-16,000 c/s. S.p. 5-7 gm. Price £1 1s. (U.K. purchase tax 6s. 10d.)

**CM50**. Ceramic turnover cartridge fitted with diamond or sapphire l.p. and sapphire coarse groove styli. Load imp. 1 Megohm. Output voltage 120 mV. Range 30-14,000 c/s  $\pm$  2 dB. S.p. 6-8 gm. Price £1 5s. (U.K. purchase tax 8s. 2d.)

■ **Lenco L70**. Stereo and mono transcription pickup arm. S.p. adjustable. Price £6 6s. (U.K. purchase tax £2 1s.)

■ **Lenco L80**. Stereo and mono transcription pickup arm. 12 in. model for use with 16 in. records. S.p. adjustable. Price £8 8s. (U.K. purchase tax £2 14s. 7d.)

■ **700 Mk 2**. Magnetic variable reluctance stereo cartridge. Diamond 0.0007 in. stylus (replaceable at works only). Load imp. 50 K ohms per channel. Output voltage 3 mV rms per channel. Range 40-16,000 c/s. S.p. 3-4 gm. Price £7 7s. (U.K. purchase tax £2 7s. 9d.)

■ **Pickering 380**. Magnetic stereo cartridge. Diamond red V Guard 0.0007 in. stylus.  $\frac{1}{2}$  in. fixing centres. Output voltage 15 mV per channel, American standard 5 cms.

Range 20-15,000 c/s  $\pm$  2 dB. S.p. 4 gm.  
 Price £12 12s. (U.K. purchase tax  
 £4 1s. 11d.)

■ **Pickering 380A.** Magnetic stereo cartridge. Details as for 380 model but with Diamond yellow V Guard 0.0007 in. stylus and S.p. of 2 gm. Price £28 7s. (U.K. purchase tax £9. 5s. 3d.)

■ **Pickering 381.** Magnetic stereo cartridge. Calibration standard model for recording channel calibration and record evaluation by engineers etc. Diamond yellow V Guard 0.0007 in. stylus. Load imp. 47-100 K ohms. Output voltage 10 mV per channel. American standard 5 cms. Range 20-10,000 c/s  $\pm$  1 dB, 10-15 Kc/s  $\pm$  2 dB. S.p. 2-3 gm. Price £37 16s. (U.K. purchase tax £12 5s. 8d.)

■ **Pickering Unipoise.** Integrated arm and magnetic cartridge for stereo. Employs a single pivot bearing giving almost infinite freedom of tracking. Diamond yellow V Guard 0.0007 in. stylus. Range 20-15,000 c/s  $\pm$  2 dB. S.p. 2-5 gm. Price £44 2s. (U.K. purchase tax £14 6s. 8d.)



**H. J. Leak & Co. Ltd.,** 57/59 Brunel Road, East Acton, London, W.3. Tel.: Shepherds Bush 1173. Cables: Sinusoidal, Ealux, London.

**Dynamic pickup Mk. II.** Moving coil, interchangeable heads, both with diamond stylus. Output voltages l.p. and 78, 8 mV/cm (at transformer secondary). Range 40-20,000 c/s  $\pm$  1 dB. S.p. l.p. 3 gm, 78, 5 gm. Load imp. 50,000-100,000 ohms. Price, with two heads, £16 (U.K. purchase tax £5 19s. 9d.)



**The Long Playing Record Library Ltd.,** Squires Gate, Station Approach, Blackpool.

**Mackie "Delta" parallel tracking arm.** Designed to eliminate tracking error. Side pressure less than 0.1 gm. Groove cueing scale and pickup lowering device. Total moving mass 35-40 gm. depending on cartridge used. Takes all standard cartridges and Decca ffs to special order. Height above turntable 3 in. Price £14 14s.



**The Lowther Manufacturing Co.,** Lowther House, St. Mark's Road, Bromley, Kent.

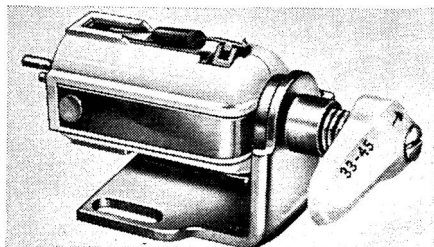

*Goldring SX10 Stereo crystal*

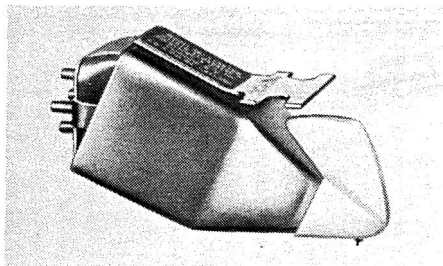

*Pickering 381 Stereo*

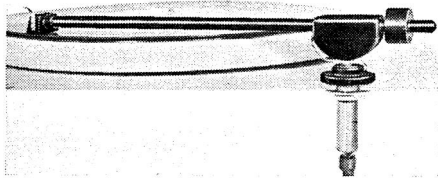

*Leak Dynamic arm and head*

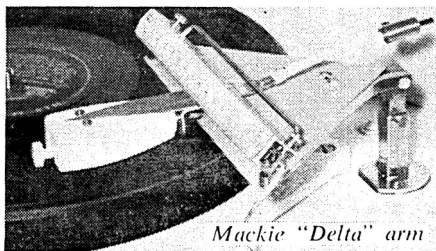

*Mackie "Delta" arm*

Tel.: Ravensbourne 5225. Cables: Lowther, Bromley.

**L.P. pickup.** Moving coil fixed head. Output voltage 10 mV. Range 20-20,000 c/s  $\pm$  2 dB. S.p. 4-6 gm. Imp. 25 ohms. Price, with sapphire stylus, £5 10s. (U.K. purchase tax £2 3s. 10d.): with diamond stylus £12 10s. (U.K. purchase tax £4 19s. 9d.)

**78 pickup.** Moving coil fixed head. Output voltage 18 mV. Range 20-20,000 c/s  $\pm$  2 dB. S.p. 6 gm. Imp. 25 ohms. Price, same as for L.P.



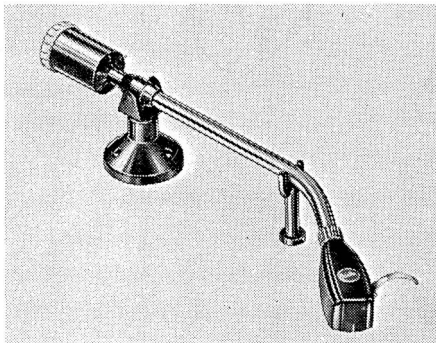

*Ortofon SKG/212 pickup arm*

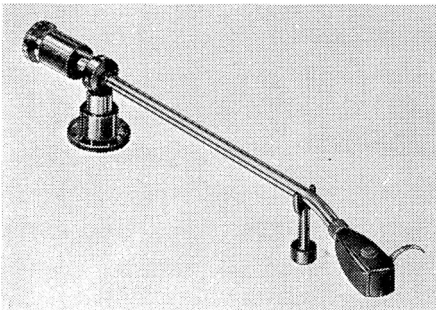

*Ortofon RMG/309 pickup arm*

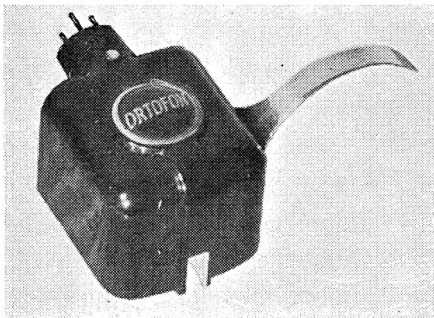

*Ortofon Type C Mono head*

**Ortofon.** Fonofilm Industri A/S Copenhagen. Distributed in the U.K. by Metro-Sound Manufacturing Co. Ltd., 19a Buckingham Road, London, N.1. Tel.: Clissold 8506/7. Cables: Metrosound, London.

**Type A.** Moving coil. Interchangeable head with vertical coils. Diamond stylus. Output voltage l.p. 0.5 mV/cm/sec. Range 20-14,000 c/s  $\pm$  2 dB. S.p. 5-6 gm. Load imp. 2 ohms (transformer required). Price £7 5s. (U.K. purchase tax £2 6s. 6d.)

**Type C.** Moving coil as above. Diamond stylus. Output voltage l.p. 0.3 mV/cm/sec.

Range linear 20-20,000 c/s. S.p. 3.5 gm. Load imp. 2 ohms (transformer required). Price £14 (U.K. purchase tax £4 9s. 10d.)

**Transformer** for use with above pickups. Price £2 7s. 6d.

■ **Type SPU/G.** Moving coil cartridge. Diamond stylus 0.0065 to 0.0007 thou. Output voltage 0.5 mV. Range 20-20,000 c/s. S.p. 3-5 gm. Load imp. 2 ohms. Price £18 (U.K. purchase tax £5 15s. 6d.)

**SPU/GT.** Moving coil cartridge with built-in transformers. Diamond stylus. Channel sep. 20-25 dB. Range 20-20,000 c/s. Load imp. 50 K ohms. S.p. 2 gm. Output voltage 2 ohms. Available with pure stereo 0.0005 and 0.00065 diamond for use with stereo l.p. Price £20 (U.K. purchase tax £6 8s. 4d.)

**SKG/212.** 12 in. pickup arm with adjustable playing weight. Price £4 15s. (U.K. purchase tax £1 10s. 6d.)

■ **SMG/212.** 12 in. pickup arm for stereo cartridges. Playing weight adjustable from 0-12 gm. Price £10 (U.K. purchase tax £3 4s. 2d.)

**RKG/309.** 16 in. pickup arm. Details as for SKG/212. Price £17 (U.K. purchase tax £5 9s. 1d.)

■ **RMG/309.** 16 in. pickup arm. Details as for SMG/212. Price £21 (U.K. purchase tax £6 14s. 9d.)



**Philips Electrical Limited,** Century House, Shaftesbury Avenue, W.C.2. Tel.: Gerrard 7777. Cables: Phillamps.

**AG.3016.** Crystal head fitted with sapphire styli. Output voltage 100 mV. Range 30-15,000 c/s. S.p. 7-10 gm. Load imp. 470,000 ohms. Price 15s. 11d. (U.K. purchase tax 5s. 1d.)

■ **AG.3401.** Stereo magnetodynamic head with diamond stylus. Output voltage 2 mV per channel. Range 20-18,000 c/s. S.p. 3-5 gm. Load imp. 68,000 ohms. Price £7 3s. 1d. (U.K. purchase tax £2 5s. 11d.)

■ **AG.3301.** Crystal stereo pickup cartridge with turnover head. Sapphire styli. Output voltage 120 mV per channel. Load imp. 470,000 ohms per channel. Price £1 6s. 6d. (U.K. purchase tax 8s. 6d.)

■ **AG.3060.** Crystal stereo pickup. Diamond stylus. Output voltage 120 mV per

channel. S.p. 4-6 gm. Load imp. 470,000 ohms per channel. Price £3 3s. 7d. (U.K. purchase tax £1 0s. 5d.)

■ **AG.3063.** Stereo crystal head. Micro-groove only. Sapphire 18 microns stylus. Load imp. 470 K ohms per channel. Output voltage 120 mV. Range 30-12,000 c/s. S.p. 4-6 gm. Price £1 2s. 11d. (U.K. purchase tax 7s. 4d.)

■ **AG.3302.** Stereo crystal turnover head. Sapphire styli, l.p. 18 microns, 78 75 microns. Load imp. 470 K ohms per channel. Output voltages 120 mV. Range 30-12,000 c/s. S.p. 4-6 gm. Price £1 6s. 7d. (U.K. purchase tax 8s. 6d.)

■ **AG.3304.** Stereo crystal turnover head. Styli: 75 microns sapphire for 78, diamond 18 microns for microgroove. Load imp. 470 K ohms per channel. Output voltage 120 mV. Range 30-12,000 c/s. S.p. 4-6 gm. Price £3 8s. 4d. (U.K. purchase tax £1 1s. 11d.)

■ **A.G.3305.** Stereo crystal turnover head. Details as for AG.3302 but with diamond 18 microns stylus for microgroove. Price £3 8s. 4d. (U.K. purchase tax £1 1s. 11d.)



**Ronette.** U.K. distributors: H. K. Harrison & Co. Ltd., 73 Great Titchfield Street, London, W.1. Tel.: Museum 5861. Cables: Empirian, Audley.

**DC-395.** Crystal turnover cartridge. Sapphire stylus. Load imp. 1 meg. 100 pfd. Output voltage 1,000 mV. Range 30-6,000 c/s. S.p. 6-10 gm. Price £1 10s. (U.K. purchase tax 9s. 9d.)

**DC-284-OV.** Crystal turnover cartridge. Sapphire stylus. Load imp. 1 meg. 100 pfd. Output voltage 230 mV. Range 30-10,000 c/s. S.p. 6-10 gm. Price £1 10s. (U.K. purchase tax 9s. 9d.)

**DC-284-T.** Crystal turnover cartridge. Sapphire stylus. Load imp. 1 meg. 100 pfd. Output voltage 600 mV. Range 30-8,000 c/s. S.p. 6-10 gm. Price £1 10s. (U.K. purchase tax 9s. 9d.)

**DC-284-P.** Crystal turnover cartridge. Sapphire stylus. Load imp. 1 meg. 100 pfd. Output voltage 105 mV. Range 30-12,000 c/s. S.p. 4-8 gm. Price £1 10s. (U.K. purchase tax 9s. 9d.)

**DC-395-S.** Crystal turnover cartridge. Sapphire stylus. Load imp. 1 meg. 100



*Ortofon SPU/GT cartridge*

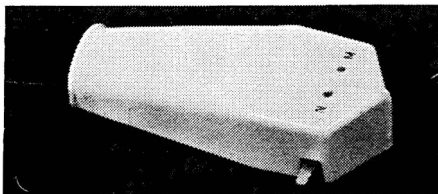

*Philips AG 3301 Stereo crystal pickup*

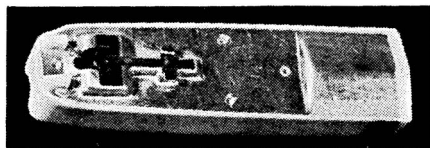

*Philips AG. 3060 Stereo cartridge*

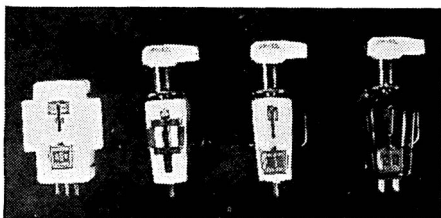

*Ronette Crystal cartridges*

ffd. Output voltage 1,450 mV. Range 30-6,000 c/s. S.p. 10 gm. Price £1 10s. (U.K. purchase tax 9s. 9d.)

**TX-88.** Crystal turnover cartridge. Sapphire stylus. Load imp. 1 meg. 100 pfd. Output voltage 150 mV. Range 30-20,000 c/s. S.p. 2-8 gm. Price £1 15s. (U.K. purchase tax 11s. 8d.)

■ **BF-40.** Stereo single sided crystal cartridge. Sapphire 0.75 mil stylus. Load imp. 1 meg. 100 pfd. Output voltage 180 mV. Range 30-12,000 c/s. S.p. 5-7 gm. Price £2 10s. (U.K. purchase tax 16s. 3d.)



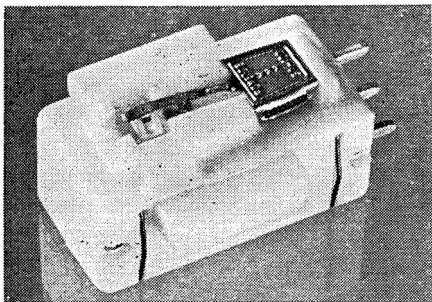

*Ronette Binofluid BF40*

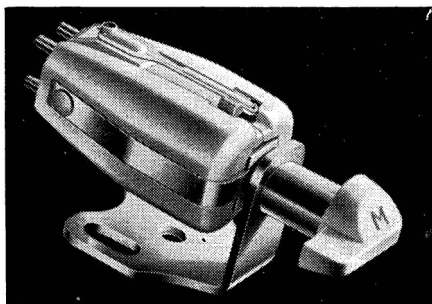

*Schumann-Merula Stereo cartridge*

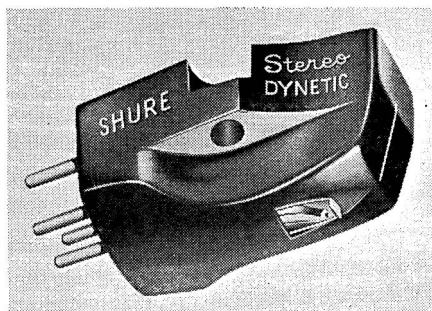

*Shure M3D Stereo Dynetic cartridge*

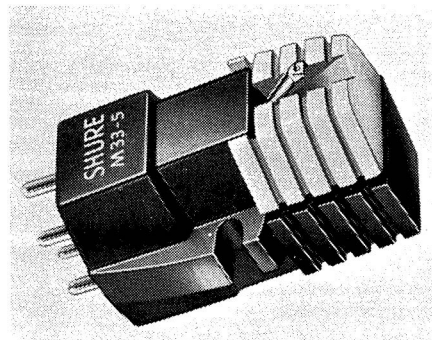

*Shure M33-5 Stereo cartridge*

■ **Stereo 105.** Stereo crystal turnover cartridge. Sapphire stylus. Load imp. 1 meg. 100 pfd. Output voltage 250 mV. Range 30-12,000 c/s. S.p. 3-6 gm. Price £2 11s. (U.K. purchase tax 16s. 9d.)

■ **Stereo 106.** Stereo crystal turnover cartridge. Details as for 105 but output voltage 580 mV.

■ **Stereo 208.** Stereo crystal turnover cartridge. Details as for 105 but output voltage 750 mV. Range 30-6,000 c/s. S.p. 6-10 gm.



F. & H. Schumann, GmbH. Sole U.K. importers: G. A. Stanley Palmer Ltd., Maxwell House, Arundel Street, London, W.C.2. Tel.: Temple Bar 3721/3.

A range of crystal pickups, including the Schumann-Merula stereo cartridge type STK490 and the ceramic stereo cartridge Type STC493.



Shure Electronics Ltd., 84 Blackfriars Road, London, S.E.1. Tel.: Waterloo 6361.

■ **M7D custom stereo dynetic cartridge.** Moving magnet. Diamond stylus 0.7 thou. Load imp. 47,000 ohms. Output voltage 5 mV. Range 20-15,000 c/s. S.p. 5 gm. Price £9 11s. 3d. (U.K. purchase tax £3 1s. 5d.)

■ **M77 professional custom stereo dynetic cartridge.** Moving magnet. Diamond stylus 0.7 thou. Load imp. 47,000 ohms per channel. Output voltage 9 mV. Range 20-17,000 c/s. S.p. 3-6 gm. Price £10 12s. 6d. (U.K. purchase tax £3 8s. 4d.)

■ **M3D professional stereo dynetic cartridge.** Moving magnet. Diamond stylus 0.7 thou. Load imp. 47,000 ohms. Output voltage 5 mV. Range 20-15,000 c/s  $\pm$  3 dB. S.p. 3-4 gm. Price £18 1s. 3d. (U.K. purchase tax £5 15s. 11d.)

■ **M33-5 professional stereo dynetic cartridge.** Moving magnet. Diamond stylus 0.5 thou. Load imp. 47,000 ohms per channel. Output voltage 6 mV. Range 20-20,000 c/s. S.p. 1-3 gm. Price £14 17s. 6d. (U.K. purchase tax £4 15s. 8d.)

■ **M212 studio stereo dynetic pickup.** Complete unit with moving magnet head. Diamond stylus 0.7 or 0.5 thou. Load imp. 47,000 ohms. Output voltage 4.5 mV.

Range 20-20,000 c/s  $\pm$  2.5 dB. S.p. 1.5-2.5 gm. Price £36 2s. 6d. (U.K. purchase tax £11 11s. 2d.)

**M232** and **M236** Precision Tone Arms. Suitable for monaural and stereo heads. S.p. 0.8 gm. Price M232 (12 in.) £12 15s. (U.K. purchase tax £4 1s. 10d.), M236 (16 in.) £13 16s. 3d. (U.K. purchase tax £4 8s. 8d.)



S.M.E. Ltd., Steyning, Sussex. Tel.: Steyning 2228.

**Model 3009** (9-in.) precision pickup arm. Extremely low vertical and lateral friction. Hydraulically damped lowering control. Rapidly adjustable for a wide range of cartridges and heads. Price complete with shell £18 15s. 0d. (U.K. purchase tax £6 5s. 0d.)

**Model 3012** (12-in.) precision pickup arm. Details as above. Price complete with shell £20 12s. 6d. (U.K. purchase tax £6 17s. 6d.)



A. R. Sugden & Co. (Engineering) Ltd., Market Street, Brighouse, Yorkshire. Tel.: Brighouse 2142. Cables: Connoisseur, Brighouse.

**Connoisseur Super Lightweight Pickup Mk. III.** Suitable for monaural and stereo heads. Height adjustable. Heads available: Mk. II monaural, magnetic, with choice of 1, 2.8, 3.5 thou. stylus; stereo ceramic with 0.5 thou. diamond stylus. Price arm only £3 (U.K. purchase tax 19s. 11d.)

■ **Connoisseur stereophonic Pickup Arm CS1.** Also suitable for monaural heads. Height adjustable. Pickup lifting device fitted. Price arm only £3 15s. (U.K. purchase tax £1 4s. 11d.), complete with stereo head £9 15s. (U.K. purchase tax £3 4s. 10d.)

■ **Connoisseur Stereo Head.** Ceramic cantilever system. Diamond stylus 0.0005/6 ins. radius. Output voltage 20 mV. Load imp. 50,000 ohms. Range 20-16,000 c/s  $\pm$  2 dB. Channel separation 20/25 dB. S.p. 3½-4 gm. Price £6 (U.K. purchase tax £1 19s. 11d.) Prices of Mark II heads available. Mark II L.P. Diamond £6 10s. (U.K. purchase tax £2 3s. 3d.) Mark II Std. or L.P. Sapphire £3 10s. (U.K. purchase tax £1 3s. 3d.)

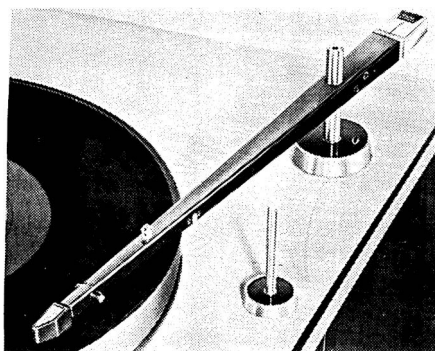

*Shure M212 Stereo Dynetic pickup*

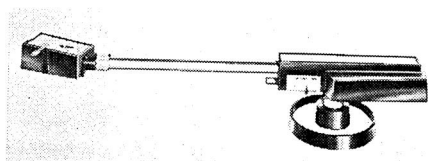

*Shure M232 pickup arm*

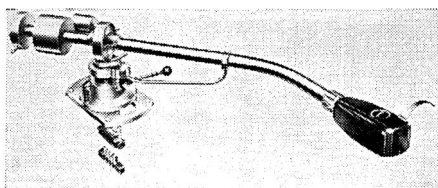

*S.M.E. 3009 pickup arm*

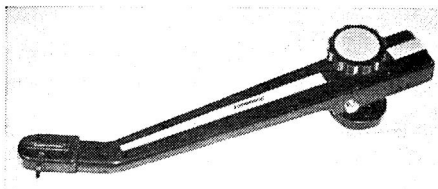

*Connoisseur Stereo CS1*

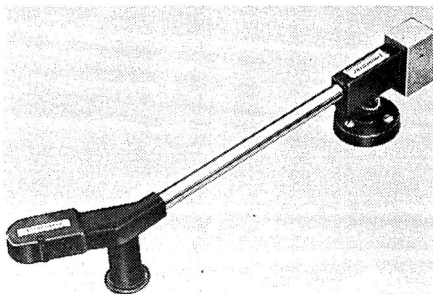

*Connoisseur MK. 111 pickup*

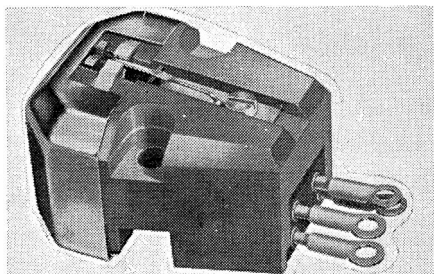

*Tannoy Vari-Twin MK. 11*

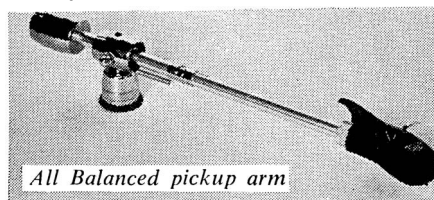

*All Balanced pickup arm*

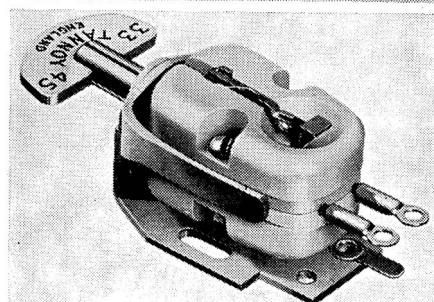

*Tannoy Varilutance cartridge*

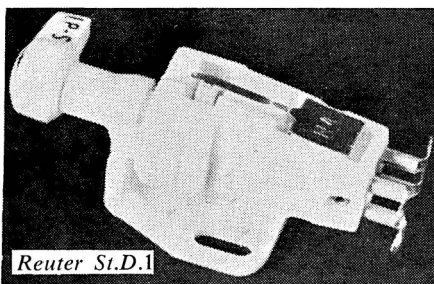

*Reuter St.D.1*

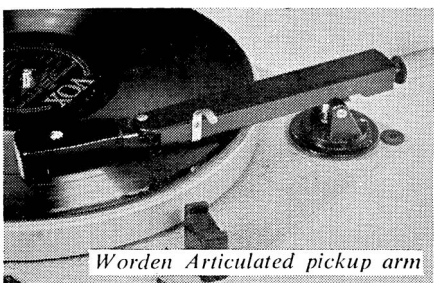

*Worden Articulated pickup arm*

**Tannoy Products Ltd.**, West Norwood, London, S.E.27. Tel.: Gipsy Hill 1131. Cables: Tannoy, London.

**Varilutance turnover cartridge.** Output voltages: 1.p. 10-12mV; 78 18-20 mV. Range 20-16,000 c/s  $\pm 2$  dB. S.p. 5-6 gm. Load imp. 50,000 ohms. Price, with 2 diamonds £12 (U.K. purchase tax £4 17s.); with 1 diamond and 1 sapphire £9 10s. (U.K. purchase tax £3 16s.); with 2 sapphires £7 (tax.. £2 16s. 7d.)

Single stylus version of Varilutance for 1.p. also available. Price with diamond £6 15s. (U.K. purchase tax £2 14s. 7d.)

■ **Vari-twin Mk. II.** Magnetic stereo cartridge. Balance 4-pole system. Diamond stylus 0.5 or 0.7 thou. Output voltage 7 mV per channel. Range 30-15,000 c/s  $\pm 1.5$  dB. S.p. 4 gm. Load imp. 100,000 ohms. Inductance 350 mH. Price £9 19s. (U.K. purchase tax £3 7s.)



**Trianon Electric Ltd.**, 3 Violet Hill, London, N.W.8. Tel.: Maida Vale 2255.

**The All Balanced Pickup Arm 2400.** Suitable for stereo or mono cartridges. Tone arm length 9 ins. Interchangeable heads. Price £10 (U.K. tax £3 4s.)

■ **Reuter St.D.1.** Crystal turnover stereo cartridge sapphire stylus. Range 30-13,000 c/s  $\pm 3$  dB. S.p. 3-5 gm. Load imp. 1 Megohm. Price £1 10s. (U.K. tax 9s. 8d.)

**Reuter St.D.2.** Crystal turnover stereo cartridge. Sapphire stylus. Range 30-16,000 c/s  $\pm 3$  dB. S.p. 3-4 gm. Load imp. 1 Megohm. Price £1 10s. (U.K. purchase tax 9s. 8d.)

■ **Reuter St.D.3.** Crystal stereo cartridge. Sapphire stylus. Range 30-13,000 c/s  $\pm 3$  dB. S.p. 3-5 gm. Load imp. 1 Megohm. Price £1 10s. (U.K. purchase tax 9s. 8d.)



**Worden Audio Developments Ltd.**, 54 Chepstow Road, London, W.2. Tel.: Bayswater 4996.

**Worden Articulated pickup arm.** Radially operated single arm with articulated head piece. Tracking correct to  $\pm \frac{1}{4}\%$ . Moveable counterbalance for weight adjustment. Suitable for stereo and mono heads with adaptors for Decca ffs, Expert, etc. Price complete with one shell £12 5s. (U.K. purchase tax £4 1s. 8d.). Extra shells 13s. 6d. (U.K. purchase tax 4s. 6d.)

## ACCESSORIES

**Auriol (Guildford) Ltd.**, By-Pass Works, Guildford, Surrey. Tel.: Guildford 66712.

**Auriol Pickup Control.** This unit eliminates accidental damage to the record by the stylus, the control provides air cushioned lowering and positive vertical lifting and lowering of the stylus. The supporting arm is serrated and calibrated for accurate positioning of the stylus at any pre-selected position within 1-2 microgrooves. Three cursors are provided to mark starting positions and an indexing clip is supplied to suit any specified pick-up arm. Price £2 11s. (U.K. purchase tax 17s.).

**Auriol Pickup Control Mk. II.** This is dimensionally similar to the above but the arm will swing clear of the turntable to allow its use with the Autochanger/Manual player units. Price £3 1s. 6d. (U.K. purchase tax £1 0s. 6d.).



**Burne-Jones & Co. Ltd.**, 18 Brunswick Road, Sutton, Surrey. Tel.: Vigilant 5050. Cables: Burjomag, Sutton.

**Counterweight Unit.** The addition of this unit to a B.J. pickup arm permits speed and accuracy in weight compensation. Price 12s. (U.K. purchase tax 3s. 11d.).

**Alignment Protractor.** For measuring the tracking accuracy of all pickup assemblies. Made in plastic ivoryne. Price 7s.



**Colton & Co. (Lapidaries) Ltd.**, The Crescent, Wimbledon, London, S.W.19. Tel.: Wimbledon 9401.

**Antistaticloth.** A soft cloth impregnated with an anti-static material, for cleaning records. Price 2s. 6d.



**Cosmocord Ltd.**, Eleanor Cross Road, Waltham Cross, Herts. Tel.: Waltham Cross 25206.

**Acos Changer Dust Bug.** Developed in conjunction with Cecil Watts. Clips on to changer arms. Price 17s. 6d. (U.K. purchase tax 5s. 8d.).



*Auriol pickup control*

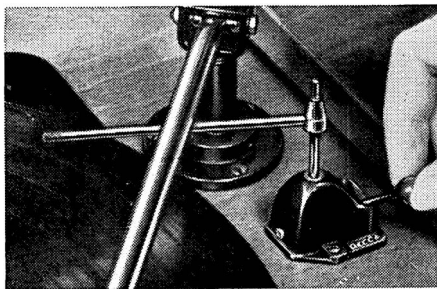

*Decca Microlift*

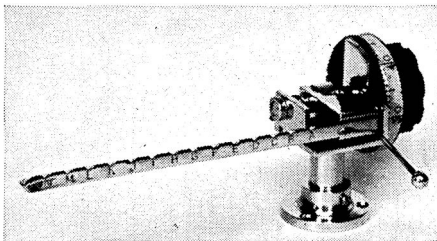

*Hi-Jack Cuematic*

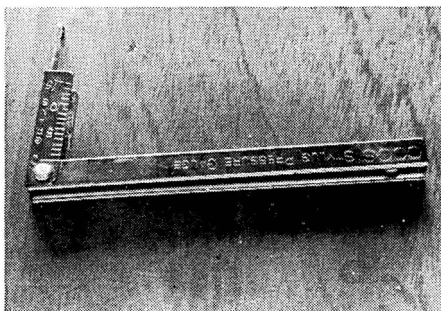

*Cosmocord Stylus pressure gauge*

**Acos Stylus Pressure Gauge.** A spring balanced gauge calibrated 0-15 gm. Accurate to within 0.5 gm. Price 9s. 6d. (U.K. purchase tax 3s.)



**Decca Radio & Television,** Ingate Place, Queenstown Road, London, S.W.8. Tel.: Macaulay 6677.

**Decca Microlift.** A device for raising and lowering a manual pickup arm at any point on the record for minimising risk of damage either to record or stylus through handshake. Easy to fit to any back-pivoted pickup. It does not hinder record handling by over-lapping the turntable. Price £1 2s. 8d. (U.K. purchase tax 7s. 4d.)



**M. B. Fitch,** Distributed by **The Metro-Sound Manufacturing Co. Ltd.,** 19a Buckingham Road, London, N.1. Tel.: Clissold 8506. Cables: Metrosound, London.

**"Hi-Jack" Model "D".** A raising and lowering device specially designed for direct attachment to the Decca ffs pickup pedestal. All metal chrome plated construction, positive stops in gully raised and lowered positions. Price £1 2s. 6d. (U.K. purchase tax 7s. 6d.)

**"Hi-Jack" Universal Model "U".** A raising and lowering device specially suited for use with the Garrard 4HF motor unit for which no extra fixing hole is

required. 1½ in. height adjustment by means of sliding head. All metal chrome plated construction. One 3/16 in. hole needed for fixing. Price £1 2s 6d. (U.K. purchase tax 7s. 6d.)



**Franel Laboratories, Ltd.,** 486 Finchley Road, London, N.W.11. Tel.: Speedwell 7512 (Sole agents for U.K.)

**Rexon.** An automatic record cleaning device which cleans discs as they are being played. A lightweight arm resembling that of a moulded plastic pickup with a head carrying a pad on a self adhesive base. Price 24s.



**The Garrard Engineering & Manfg. Co. Ltd.,** Newcastle Street, Swindon, Wilts. Tel.: Swindon 5381. Cables: Garrard, Swindon.

**S.P.G.3.** Stylus pressure gauge. 0-12 grammes with ½ gram. indication. Price 15s. 3d. (U.K. purchase tax 5s.)

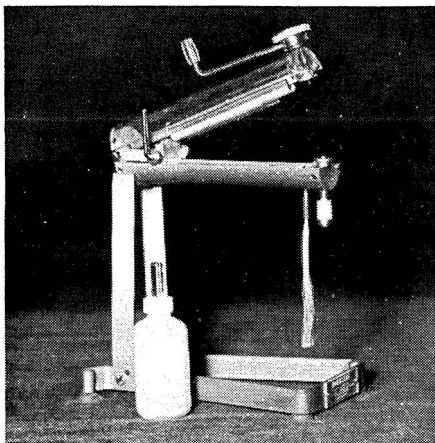

*The Parastat*



*The Dust Bug*

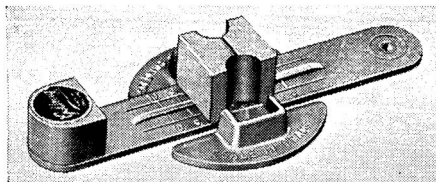

*The Goldring STB1*

W. N. Gay, 14 Tower Road, Worthing.

**Disc-C.** A pure alcohol anti-static cleaner for all l.p. records. Price 6s.



**Goldring Manufacturing Co. (Great Britain) Ltd.**, 486/488 High Road, Leytonstone, E.11. Tel.: Leytonstone 8343. Cables: Echovox, London.

**Anti-static Cleaning Pad.** Removes dust from records and is fitted with a detachable brush for keeping stylus clean. Price 4s. 6d. (U.K. purchase tax 1s. 6d.)

**STB.1.** Stylus balance, a simple yet accurate gauge which operates at record level. Stylus pressure is read directly in grams off the calibrated scale. Price 3s. 6d. (U.K. purchase tax 1s. 2d.)

**Stylus microscope** designed especially for the examination of pickup styli; it has variable magnification from  $\times 50$  to  $\times 150$  providing illumination both under and behind the stylus tip. A clip is fitted to hold any stylus in position under the lens. Price on application. Trade only.



**Q-Max (Electronics) Ltd.**, Napier House, High Holborn, London, W.C.1. Tel.: Holborn 8534.

**Stylovue.** A device for projecting a magnified shadow of a stylus on to a screen facilitating inspection of a stylus in situ. Powered by torch batteries. Price £1 8s. 3d.



**Rimington van Wyck Ltd.**, 42/3 Cranbourn Street, London, W.C.2. Tel.: Gerrard 1171.

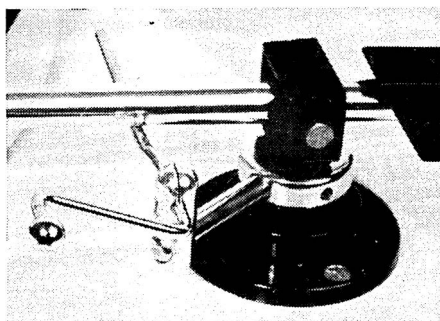

*Hi-Jack Model "D"*

**Clendisc.** An anti-static cleaner and preserver for records. Price 3s. 9d. & 6s.



**M. Tietze**, 25 Castellain Road, London, W.9. Tel.: Cunningham 2846.

**Maey Spring Balances.** A range of spring balances from 1 gm full scale up to 10 Kg. Prices from £1 9s. 6d. to £3 5s.



**Cecil E. Watts Ltd.**, Darby House, Sunbury-on-Thames, Middx.

**The "Dust Bug".** Claimed to be the most efficient method of removing all static and dust from records as they are played. Instantly fitted, suitable for all types of records. Record quality is improved, surface noise and wear reduced. Price 17s. 6d. (U.K. purchase tax 5s. 10d.). Note: A model suitable for use on autochangers is produced in co-operation with Cosmo-cord Ltd.

**The "Parastat".** For cleaning both sides of an l.p. disc simultaneously and making it inert to all static charges. Principally for trade use. Price Mk. II £18 10s. (U.K. purchase tax £6 3s. 4d.)

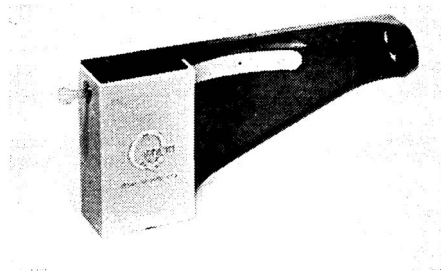

*Q-Max Stylovue*

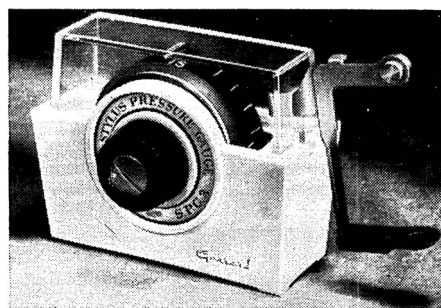

*Garrard S.P.G.3*

# DIRECTORY OF MOTOR UNITS

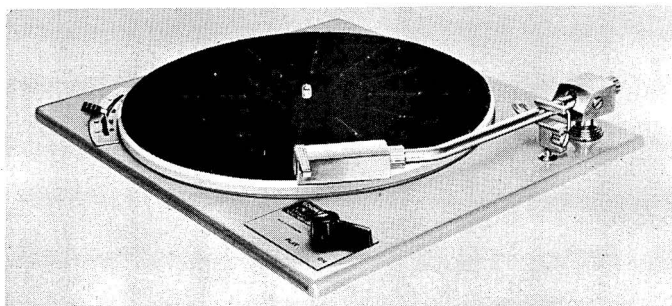

*GOLDRING  
GL-70  
VARIABLE  
SPEED  
TURNTABLE*



*B & O  
MODEL 608  
4-SPEED  
TURNTABLE*



*GARRARD 4HF  
4-SPEED  
TURNTABLE*



**Bang & Olufsen, Struer, Denmark.** Sole U.K. importers: **Aveley Electric Ltd.,** Ayrton Road, South Ockendon, Essex. Tel.: South Ockendon 3444.

**Model 608 transcription turntable.** Four speeds. Belt driven. Stroboscope mat fitted to turntable mounted in teak case complete with B and O ST/L pickup. Price £25 14s. 0d. (U.K. purchase tax £8 11s. 4d.)



**Garrard Engineering & Manufacturing Co. Ltd.,** Swindon, Wiltshire, England. Tel.: Swindon 5381. Cables: Garrard, Swindon.

**Model 301 Transcription Motor.** Three speeds. Variable speed adjustment. Price £17 14s. 6d. (U.K. purchase tax £5 15s. 3d.)

**Stroboscopic Turntable,** extra cost, £1 4s. 9d. (U.K. purchase tax 8s.)

**Garrard 4HF.** Four speed record player complete with pickup arm. 12-in. pressed steel turntable. Rheostat speed control  $\pm 3\%$ . Automatic stop may be disconnected. Price with GC8 cartridge £14 13s. 3d. (U.K. purchase tax £4 15s. 4d.)

**Laboratory Series Type A Turntable.** Transcription type record player with facilities for changing records if required. Heavy sandwich type non-magnetic turntable and weight counter balanced pickup arm. Price, less pickup head, £15 18s. (U.K. purchase tax £5 3s. 5d.)

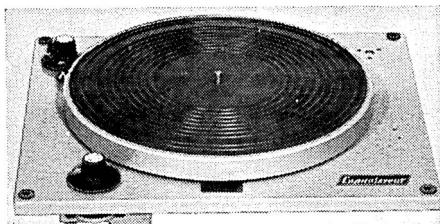

*Connoisseur Type B Transcription motor*

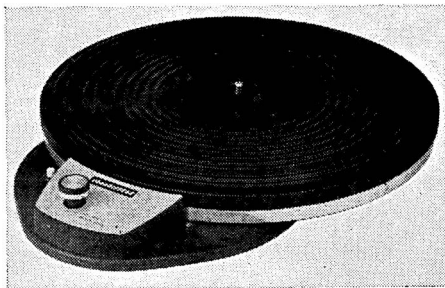

*Connoisseur 2-Speed Turntable*



*Thorens TD 124 Turntable*

**CONNOISSEUR**  
3-SPEED  
**CRAFTSMAN**  
III  
**TURNTABLE**





**Goldring Manufacturing Co. (Great Britain) Ltd.**, 486/488 High Road, Leytonstone, London, E.11. Tel.: Leytonstone 8343.

**Lenco Transcription Unit GL58.** Infinitely variable speed adjustment with pre-selected stops for 16, 33½, 45, and 78 r.p.m. Groove location arm lowers pickup on to record as on/off is operated. Fitted with G.60 arm. Price £13 15s. (U.K. purchase tax £4 9s. 5d.)

**GL70 Transcription Unit.** Non-ferrous turntable, weight 8 lb. Speed may be continuously adjusted from above 80 r.p.m. to below 30 r.p.m. and from 15 to 18 r.p.m. Pre-set standard speeds. 4-pole constant velocity motor. (15 watts). W & F max. 0.2%. Incorporates L.70 pickup arm. Pickup lowering device. Price £22 10s. (U.K. purchase tax £7 6s. 3d.)

**A. R. Sugden & Co. (Engineers) Ltd.**, Market Street, Brighouse, Yorkshire. Tel.: Brighouse 2142. Cables: Connoisseur, Brighouse.

**Connoisseur Transcription Motor Type B.** Three speeds 33½, 45 and 78 r.p.m. with a 4% variation on all speeds. Precision ground and lapped revolving shafts. All bearings adjustable. Large stroboscopic disc beneath the turntable viewed through

mirror with its own internal light source. Price £20 10s. (U.K. purchase tax £7 6s. 1d.)

**Connoisseur "Craftsman" two speed transcription motor.** Operates at 33½ and 45 r.p.m. fixed speeds. Full 12-in. turntable of non-ferrous material. All bearings are adjustable throughout the life of the unit. Synchronous motor. Price £14 (U.K. purchase tax £4 13s. 1d.)

**Connoisseur "Craftsman" three speed transcription turntable.** Requires minimum mounting space. Heavy non-ferrous 12-in. turntable. 33, 45 and 78 r.p.m. 4% variation on all speeds. Neon lit stroboscope fitted. Dynamically and electrically balanced synchronous motor. All bearings are adjustable. Provisional price £18 10s. (U.K. purchase tax £6 11s. 10d.)

**Thorens.** Distributed in the U.K. by Technical Suppliers Ltd., Hudson House, 63 Goldhawk Road, London, W.12. Tel.: Shepherds Bush 2581, 4794. Cables: Teknika, London, W.12.

**Thorens TD124 Transcription Turntable.** Four speeds with "OFF" position of selector switch between each speed. Eddy current speed control ± 3%. Built-in stroboscope for four speeds at 50 and 60 c/s. Price £39 5s. 6d. (tax £11 11s.)

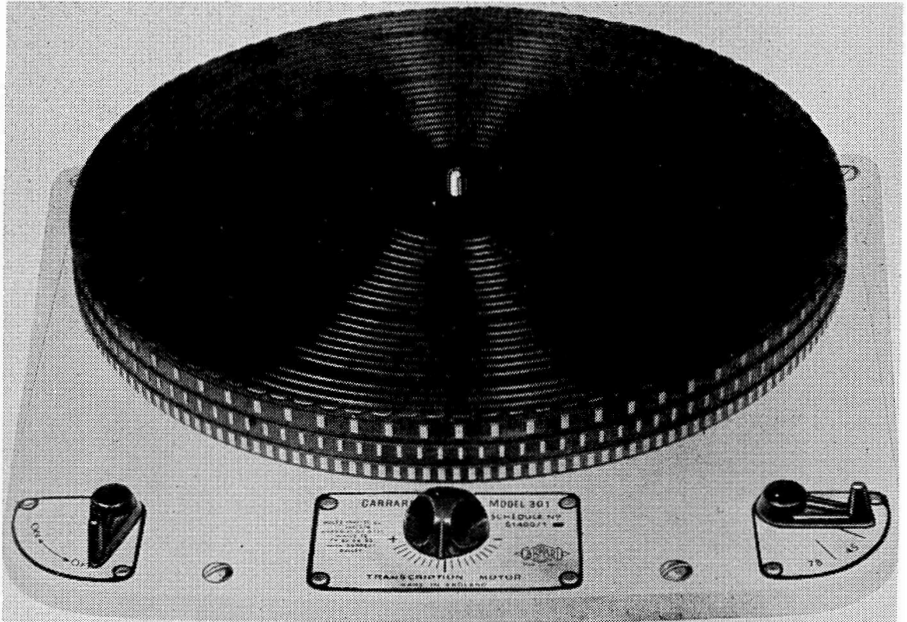

GARRARD 3-SPEED MOTOR WITH STROBO' TURNTABLE

# RADIO TUNERS

by Arthur W. Wayne

THE intending purchaser of a specialized radio tuner as a satisfactory adjunct to a high fidelity system must be sure, before buying, what he really demands, and how much this is worth to him in terms of cash. Firstly, and this is absolutely fundamental to the economics of the whole matter, he must accept that he will get what he pays for, and nothing more; and that all other things being equal, the more expensive specimens in a group are usually better value in terms of lasting satisfaction.

## What programmes?

The second problem is also a personal but, in addition, a technical one. What sort of programmes are wanted? If the requirement is for a limited range of material of the highest possible quality, then, for reasons to be explained, the choice must be VHF/FM; but if a wide choice of programmes is needed, including T.V. sound and the foreign stations, then there is no alternative to AM. Alternatively, both may be wanted, and many kindly manufacturers provide apparatus just for that, with FM as well as the AM bands available at the turn of a switch. But don't be carried away by advertisers' copy-writers! We are now considering *Hi-fi*—by which we understand the best possible sound and performance in our homes; and it is my experience that, in general, combined tuners, well designed as most of them are, offer but a compromise when viewed from the standpoint of the nearest approach to perfection. No doubt there will be many dissenters from this opinion, although it appears to be confirmed by one of the most (justly) respected manufacturers in the Trade, for *Quad* make sure of the best by offering for sale *either* FM or AM tuners, but not both together in

one unit. *Quad*, as we all know, don't compromise.

So here is the point of decision. How much can be afforded? Then, for programmes, is it the best, is it the most, or is it a fair bit of both? (Incidentally, for the benefit of those insomniac persons who spend the small hours listening to Gluk in Upernavich discussing aerial rigs with Wun Lung Tu in Peking, even this depraved taste is catered for.)

For the uncompromising hi-fi listener, there are many makes of purely FM tuners on the market. Some of these take their power supplies from the amplifiers with which they are used, while others, enjoying the appellation "self-powered", come with these facilities built-in. While the advantage of this second sort of unit with its independence of external apparatus is not to be gainsaid, it must not be overlooked that the inbuilt extra has to be paid for, so if tuner "A" complete with integral power-supplies costs the same as tuner "B" without them, it may be assumed with some confidence that "B" is the better job from the point of view of its basic function, i.e. to be a tuner. Small power-packs are available for use in conjunction with non-powered gear at quite reasonable prices, while they are also very simple to construct. A suitable circuit is shown in **Fig. 1**.

## Local Stations

FM tuners are, in effect, local station receivers, as the range of an FM transmitter is comparatively limited; but, provided adequate coverage is provided by a multiplicity of transmitters sited so as to effectively serve the areas in which they are located, this curtailment of range constitutes one of the most valuable features of FM

broadcasting—there is little or no interference from more distant stations, of the kind so distressingly apparent in AM reception. These local station characteristics operate, to the great satisfaction of the discerning listener, in another way, too, as the modulation bandwidth can be considerably extended without encroaching on the preserves of other transmitters.

It is well known that, owing to the large number of powerful AM transmitters of considerable range in Gt. Britain and in Europe, very severe limitations in respect of bandwidth are, by international agreement, imposed, in order to permit some sort of *modus vivendi* among the competing stations. On the medium and long wave-bands, the maximum permissible deviation around the carrier frequencies is 9 Kc/s, i.e.  $\pm 4.5$  Kc/s, a figure far below that demanded for acceptable listening; so it can be seen that AM can hardly achieve high-fidelity standards. But there are other even more serious disadvantages.

### After Dark

After dark, when most listening is done, the effective range of the transmitters increases, and whistles, squeals and monkey-chatter add random distractions to detract from an already inherently unsatisfactory situation. Add the circumstance that most impulse interference, such as is caused by sparking at switch-contacts on refrigerators etc., commutators on vacuum-cleaners and electric shavers, trolley-bus pick-ups and the like is AM in character, and that the demodulation sections of AM tuners are so designed as not to discriminate against AM signals, it will be clearly seen that confusion can become worse confounded at the turn of a knob. (It does too—don't we know!)

Now, an FM demodulator—"demodulator" including the limiter in appropriate circuits—if well-designed, is insensitive to AM signals, so that random interference, which, as we have seen, is largely AM, is rejected at this stage of the tuner circuits, and unwanted background noise due to external causes is virtually eliminated. (The one most serious possible cause of proximal station interference, "capture effect", whereby closely adjacent transmissions with signal strengths above a certain critical ratio to the desired signal will compete to the entire degradation of reception, is rarely troublesome where we are concerned, owing to the comparative sparseness and wide physical separation of the transmitters. Intelligent design helps, too. In America,

however, capture effect sometimes presents quite a problem, as there, many hundreds of broadcasting stations serve small local areas, some of which operate in closely adjacent territories.)

FM offers many advantages additional to those outlined above. Because of the requirements in the way of bandwidth of FM transmissions, these must be located in VHF, Band 2 being allocated for the purpose. (This is the reason for the local-station characteristic of FM broadcast transmitters.) It is thus permissible to allow the greatest possible bandwidth per transmitter—in fact, it is so generous that quality of signal is determined more by economics and engineering limitations than by proximities. That this is so is clear when the medium and VHF (metre) bands are compared.

The medium wave-band extends, in round figures, from 500 Kc/s to 1500 Kc/s, and into this 1 Mc/s are compressed  $x$  transmitters,  $x$  being a fairly large number, so that

available bandwidth =  $\frac{1,000,000}{x}$  (a large number)  
 Now consider Band 2, which extends for well over 10 Mc/s. The equation is:

bandwidth =  $\frac{10,000,000}{3}$ ,  $x$  being the 3 transmitters per district, and the 200 Kc/s bandwidth allowed per station is obviously not going to rub elbows with its neighbours. As a matter of fact, the stations are separated by about 2 Mc/s.

### Pre- and De-emphasis

Another useful feature of FM broadcasting is "pre-emphasis and de-emphasis", which helps very considerably to reduce background noise in the tuner. It must be explained at the outset that much of the noise in any tuner is self-generated, and at VHF can present a quite difficult problem. It is caused to a great extent by the emission and thermal agitation of electrons in conductors, chiefly in the valves themselves, and is generally quoted in the form "equivalent noise resistance" or  $R_{eq}$ .

( $R_{eq}$  is greater in pentodes and other multi-grid valves than in triodes, the relevant equations being:

$$\text{Triode } R_{eq} = \frac{2.5}{gm} \Omega,$$

$$\text{Pentode } R_{eq} = \frac{I_a}{I_a + I_g^2} \left( \frac{2.5}{gm} + \frac{20 I_{g2}}{gm^2} \right) \Omega,$$

which is why VHF tuners use triodes in

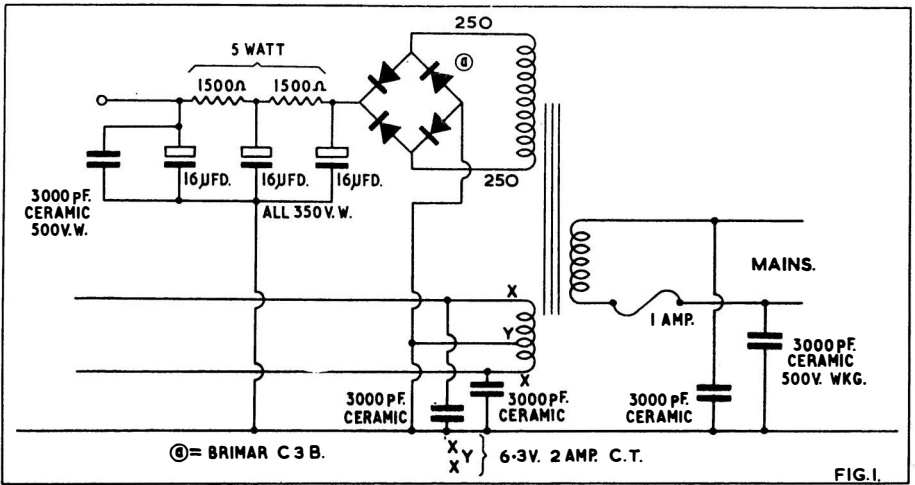

FIG. 1.

R.F. and mixer stages, often to the bewilderment of newcomers to VHF.)

De-emphasis is nothing more than what is done when scratch becomes intolerable on worn records. We turn down the treble control. It is simply a top-cut. Now, ancients like myself may remember, in those far-off 78 days, certain American manufacturers emphasized the upper frequencies on their records, the idea being that, when the tone-control was used to minimize scratch during replay, just about enough top-cut would be brought into effect to reduce the previously recorded emphasized higher frequencies back to normal. In other words, the top was *pre-emphasized* on record, and *de-emphasized* on replay.

The device then wasn't particularly successful, as those who bought pre-war "Orthacoustic" records learned to their sorrow, although it is of course standard practice under the more sophisticated conditions of today; but it works very well in FM radio transmission and reception. All FM transmitters are so designed as to pre-emphasize the upper modulation frequencies by a certain fixed figure, — 50μs in Gt. Britain—and the tuners are arranged to de-emphasize by precisely the same amount, so that hiss and similar noises are dealt with along with the transmitter pre-emphasis (Fig. 2).

As we have already seen, "x" = only 3, i.e. Home, Third and Light, and some means of selecting *only* these programmes without having to chase a pointer over the dial is bound to appeal to lazy folks. Such indolents will gravitate, naturally, to the switched variety of tuner, wherein the

required station is selected at the turn of a knob. It will be appreciated that such tuners must be absolutely stable so that, once correctly adjusted, they will not drift; and stability, at VHF, is no easy matter to achieve. The capacitances and inductances that comprise the tuning circuits of any VHF apparatus are very small indeed, as the following simplified formula demonstrates:

$$f = \frac{159200 \text{ Kc/s}}{LC} \quad \begin{array}{l} L = \text{henrys} \\ C = \text{pf} \end{array}$$

and slight variations in L and C resulting from, say, temperature changes, can cause considerable changes in the *proportions* of these constants; and cyclic and/or permanent mis-tuning can and does result in all but the most carefully designed gear. Various techniques are in common use to counter these possibilities, from most careful disposition and use of temperature com-

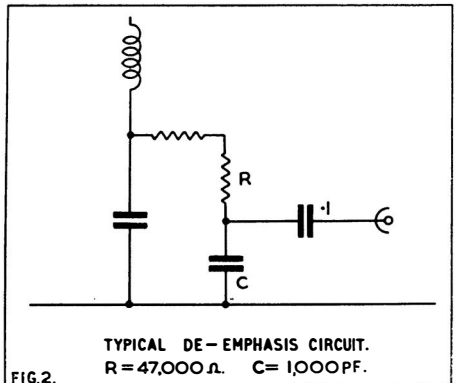

FIG. 2.

TYPICAL DE-EMPHASIS CIRCUIT.  
R = 47,000 Ω. C = 1,000 PF.

pensating components to automatic means of controlling frequency—A.F.C.—whereby  $\pm$  capacitance is added to the drift-prone circuits.

While it is possible to construct circuits that are virtually drift-free without A.F.C.—for example, my own firm uses this method—it is certainly easier and, on a commercial scale, probably cheaper to include it, and switched tuners (and many continuous tuned units) incorporate this type of frequency control. Unless sensibly designed, A.F.C. can, under certain conditions, introduce distortion, and it is possibly significant that it is becoming less popular in U.S.A., where formerly no tuner of any standing would have been without it.

With continuous tuned units, the user is compelled to perform the quite skilled operation of tuning to the centre of a wide pass-band, so some form of tuning indicator is absolutely necessary, and one is almost always incorporated. This may range from the familiar “magic eye” to an elaborate arrangement of two valve-voltmeters, the best in my opinion being the two-neon circuit fitted by *Quad*. The magic eye does well enough, but is not always to be trusted, the phenomenon of maximum signal elsewhere than in the position indicated by the eye being not entirely unknown. The cause is too involved to be discussed in this short essay, but has its roots mainly in misalignment, particularly towards the demodulator sections; and, indeed, with some types of demodulator, the ordinary magic eye is virtually useless.

#### Demodulators

The demodulator's—detector's in O.E.—job is, basically, to convert the amplified FM signal to AM, and two types are in general use, the Foster-Seeley discriminator and the Ratio detector (Fig. 3). There are others, but these cover nearly all FM tuners ordinarily available. It is generally held that the Foster-Seeley is less liable to distortion than the ratio detector, but this is not always true, at least in commercial apparatus. It is certainly easier to set up, but experience proves that, by very careful and painstaking adjustment, the ratio detector can be at least the equal of the other in the way of quality, while it has the indubitable advantage of requiring one previous stage less for efficient working. Both types can be equally effective in rejecting AM interference, but as the Foster-Seeley does not inherently discriminate against AM signals, provision has to be made in the shape of an

extra limiter valve to do the job for it, whereas the ratio detector, when accurately balanced, is a very efficient AM rejector of itself.

A much quoted term in FM tuner specifications is “quieting”, which, from the user's point of view, may roughly be described as signal against background noise. This is not quite the whole truth, but does convey what it usually means from the subjective angle. It is given in the form “ $x$ db quieting for  $y$  microvolts input”,  $y$  being the signal strength at the aerial input, and obviously the greater the ratio  $\frac{x}{y}$  the better; but it is as well to take catalogue figures with a little discretion, as it may be reasonably assumed that quoted figures refer often to what can be done rather than what is done, although of course this is not always true. Caveat Emptor!

#### Good Aerials Help

Should the preceding paragraphs arouse in the reader's breast the feeling that FM provides all the earnest listener desires, it should be pointed out that there *are* some disadvantages too. Some of these are (1) a proper aerial is essential. Here, any old piece of wet string won't do at all. It must be constructed to suit the situation, and, as with all V.H.F., unless the location is close to transmitter, an aerial dimensioned so as to tune to the correct frequency is necessary. On Band 2, the length is just under 5 ft., taking into consideration the effect of adjacent structures on its performance, and it is split to form a dipole. While in good reception areas a piece of lighting flex unravelled to length and tacked round the picture-rail will suffice, in less fortunate homes the dipole must be substantially constructed and mounted as high above its own and neighbours' roofs as possible. Also, in areas towards the limits of transmission, reflectors and directors may be needed as well; but it must be appreciated that a good aerial can quite easily be the equivalent of adding a noise-free valve to the tuner, so the extra cost and trouble involved will be well repaid. Perhaps a short description of “why” may not be out of place.

A straight conductor is, in effect, a resonator similar to a closed pipe—it resonates at a wave-length of twice its own length. Broadly speaking, its self-inductance and summed self-capacitance form a parallel-tuned circuit, with maximum current appearing at a point equi-distant from the

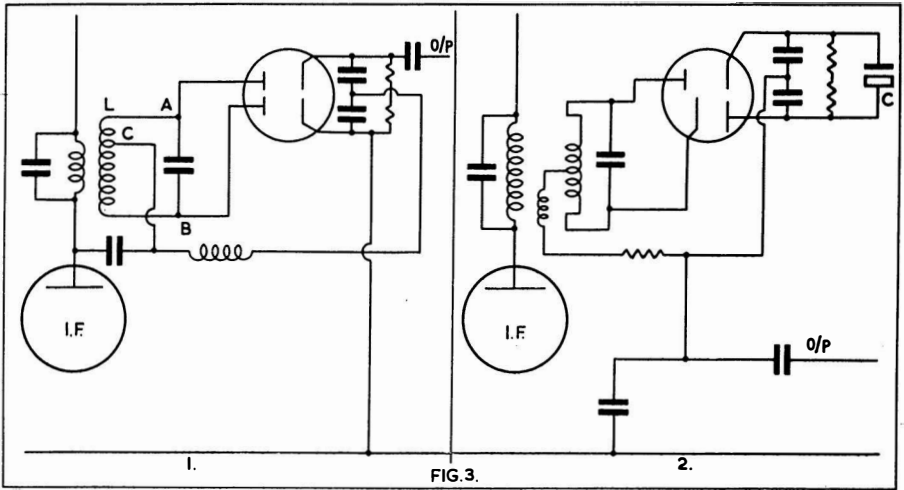

Two types of demodulator— (1) Foster Seeley—(2) Ratio Detector

terminations. This centre-point is clearly the place whence to take the signal, so it is cut to form a dipole—with a characteristic  $z$  of about  $70\Omega$ —and a matching twin feeder of this impedance connects it to the input of the tuner. (Mis-matching to  $300\Omega$  inputs does not, as a rule, seriously affect performance.)

A dipole is directive, and is turned towards the local transmitter, so eliminating interference from programmes emanating from most other directions. However, the response is the same at the back as at the front, but if another conductor, the reflector, be mounted behind it, the response in the forward direction will increase; and for most locations this is a satisfactory arrangement. In poor reception areas a further improvement in gain can be achieved by the addition of yet another element, this time in a forward direction. It is known as the director, and the whole comprises the familiar three-element array.

Fig. 4 shows a plan view of the array, together with dimensions which, although not strictly theoretically precise, do not show any marked inefficiency in practice. There are many other configurations of aerial, most of which are in use in fringe reception areas. It should be noted that, with the most effective of these, gains of up to 5 or 6 dB are possible.

(2) Bound up with (1) is the matter of signal. If this falls below a certain level, background noise— $\frac{1}{\text{quieting}}$ —and distortion increase out of all proportion, whereas with

AM this phenomenon rarely presents serious problems.

(3) The tuned circuits. These *must* be very accurately aligned, with the “ears” of the pass-band unpronounced and absolutely symmetrical about the reference frequency. Admittedly this should also be the case with AM broadcast tuners, but misalignment in this type is not so distressingly obvious, nor is it likely to develop in the same way at the lower frequencies employed. It is always difficult to precisely align and *keep* aligned VHF circuits, and while A.F.C. can and does often help, it can also do the opposite in the way of quality.

(4) Re-radiation from the local (tuner) oscillator. In most commercial tuners intended for the hi-fi market, this particular spectre can be considered as laid; but there was—and possibly still is—one popular make of receiver that was notorious in the

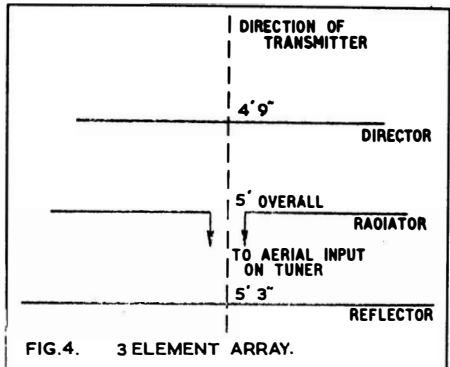

Trade for its transmitting capabilities. The importance of the matter will be apparent when it is realized that second harmonic radiation would fall within Band 3.

### Combined AM-FM tuners

With most of these, an excellent AM performance comparable with that of a purely AM receiver is normal, so that, dependent on the number of wave-bands on the dial, most of the continentals in addition to the usual British broadcasts can be picked up with a reasonably clean background during daylight hours, and with the usual accompaniment of whistles, clicks, bangs, crashes and monkey-chatter at night. FM will usually be average to fairly good, although there are one or two manufacturers who manage to make a little more than the best of both worlds in this direction. Normally VHF/FM together with the long and/or medium bands are offered, but on some makes short-wave bands are available as alternatives or in addition. Outstanding among these latter is the Chapman type S6BS/FM with a truly striking performance on its AM bands—it has nearly the lot—and quite good reception on FM.

One or two tuners include the T.V. Sound programme, which is often considered to be the best quality transmission of all, although here the eye—or ear—of faith is sometimes discernible.

### Purely AM tuners

The *Hi-fi Year Book* for 1961 lists only two, one of these being a 3 wave-band hi-fidelity unit, while the other is of communications type, with 9 wave-bands including the band-spreads. Both are outstanding in their own fields, and are, of course, the Quad AM2 and the Chapman S6BS.

### Things to Come

Obviously there will be considerable developments in FM tuners in the future, as transistors alone are stimulating much thought in all electronic fields. The use of these devices demands much more than simple adaptations of circuits, and their possibilities in the way of stability are obvious, if only for the elimination of the "warming-up period". The probable increasing incorporation of the pulse-counter type of demodulator has its natural counterpart in the substitution of semi-conductors in the earlier sections of the receivers, particularly in view of the lower

I.F. frequencies involved. (Incidentally, it is an interesting fact that a pulse-counter demodulator was described as long ago as 1942, while Scroggie's article describing its adaptation to broadcast receivers was published in 1956.)

### Do-it-yourself tuner kits

There were and probably still are a number of such kits on the market, but the most advanced appears to be the *Heathkit* FMT series, which, as is usual with *Heathkit*, enables the amateur, with an uncanny certainty of success, to produce professional results.

### Advice on Choice

There is such a bewildering variety of excellent commercial tuners on the market that selection, for the newcomer or the man contemplating a change, can cause considerable heart-searching and sleeplessness. It may be stated, at the outset, that all of the tuners described in the Directory section will do their jobs efficiently and well, and any advice that will be given in this invidious situation can be only on the basis that personal prejudice is likely to be a deciding factor.

It is clear that I cannot discuss my own firm's products, but of the few other makes that have passed through my hands, the two *Quad* tuners and the *Lowther* Mark V impressed me most. I liked the *Armstrong* AM/FM and the *HMV* 558/AM/FM also, although the *Armstrong* appeared to suffer some slight curtailment of the upper audio frequencies; but this, I understand, has now been corrected. The *Chapman* S6BS/FM on its AM short-wave bands was a delight to handle, even at 3 a.m.! and although the specimen I tested had had much use over quite a long period without any service attention whatsoever, it might have come direct from the factory, so excellent was its performance. Its FM reception I found average.

The *Goodsell* tuners are very good value, and, as I know from experience extending over some years, most reliable. The *Dulci* FMT/2 and H4T/2 do their work excellently, although the FM performance of the H4T/2 is not quite equal to that of the FMT/2, which has the excellent feature of switchable A.F.C.

It would seem that progress in this field has been steady but unspectacular, with the old favourites proving how well they were designed in the first instance.

# DIRECTORY OF RADIO TUNERS

★ In the abridged specifications of these directory entries the following abbreviations have been used: P.s.n.—Power supply needed; A.F.C.—Automatic frequency control.

**Acoustical Manufacturing Co. Ltd.,** St. Peter's Road, Huntingdon, Hunts. Tel.: Huntingdon 361 and 574. Cables: Acoustical.

**F.M. Tuner.** Variable tuning. Range 87.5-108 Mc/s. Special double neon display ind. P.s.n. 330v at 27 mA; 6.3v at 1.85 amps. Size  $10\frac{1}{2} \times 3\frac{1}{2} \times 6$  ins. Price £21 (U.K. purchase tax £7 17s. 6d.)

**A.M. II Tuner.** Variable tuning. Range 5.8-18.5 Mc/s, 185-588 and 800-2070 metres. Magic Eye ind. P.s.n. 330v at 35mA; 6.3v at 1.2A. Size  $10\frac{1}{2} \times 3\frac{1}{2} \times 6$  ins. Price £24. (U.K. purchase tax £9.)

★

**Armstrong Wireless & Television Co.,** Warlters Road, Holloway, London, N.7. Tel.: North 3213/4.

**F.M. Tuner T4B.** Variable tuning. Range 87-108 M/cs. A.F.C. Ratio disc. Self-powered A.C. 200-250v. Size  $10\frac{1}{2} \times 4\frac{1}{2} \times 7\frac{1}{2}$  ins. Price £17 (U.K. purchase tax £5 9s. 1d.)

**A.M./F.M. Tuner. ST3 Mk. 2.** Variable tuning. Range F.M.: 87-108 Mc/s; A.M.: M.W. 187-570 metres, L.W. 1053-2,000 metres. A.F.C. Ratio disc. Miniature bright line ind. Self-powered A.C. 200-250v. Size  $12\frac{3}{8} \times 5\frac{1}{2} \times 7\frac{1}{2}$  ins. Price £21 1s. 3d. (U.K. purchase tax £6 15s. 3d.)

**A.M./F.M. Jubilee Mk. 2.** Tuner amplifier chassis. Variable tuning. Range F.M.: 87-108 Mc/s; A.M.: M.W. 187-570 metres, L.W. 1053-2,000 metres. A.F.C. Ratio disc. EM. 81 ind. Self-powered A.C. 200-250v. Size  $12 \times 7 \times 8$  ins. Price £23 9s. 3d. (U.K. purchase tax £7 10s. 8d.) Also see Amplifier Section.

**Stereo 12 Mk. 2 A.M./F.M.** Tuner amplifier chassis. Variable tuning. Range 87-108 Mc/s, 187-570, 1053-2,000 metres. A.F.C. Ratio disc. Magic Eye ind. Self-powered. Size  $14\frac{1}{2} \times 9 \times 5\frac{1}{2}$  ins. Price £33 1s. 6d. (U.K. purchase tax £10 12s. 3d.)

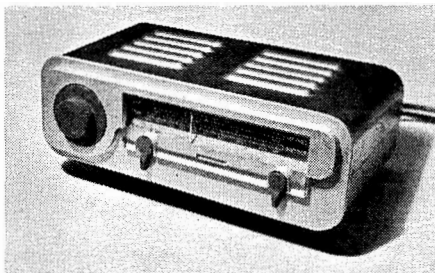

*Quad AM tuner*

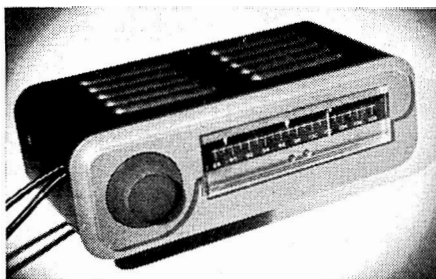

*Quad FM tuner*

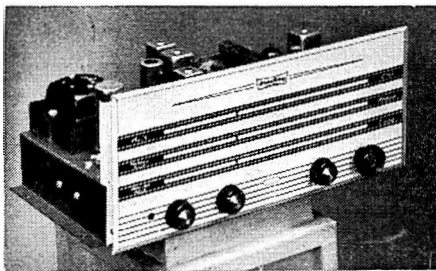

*Armstrong ST3 MK. 2 AM/FM*

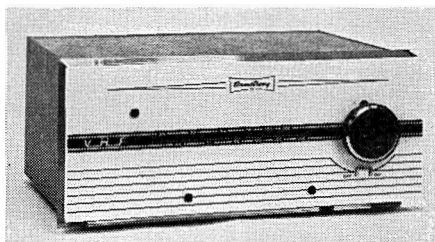

*Armstrong T4B FM tuner*



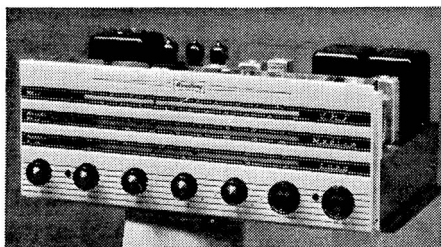

*Armstrong Stereo 12 MK. 2*

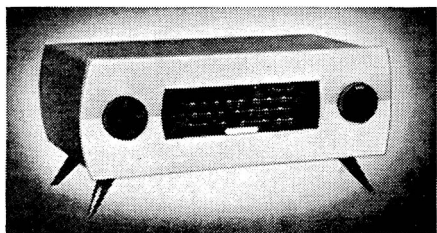

*Chapman FM95*

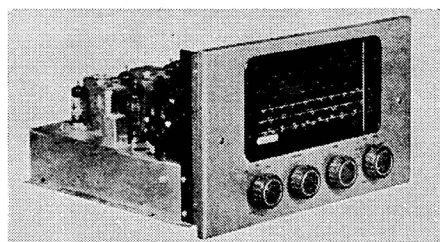

*Chapman S6BS/FM*

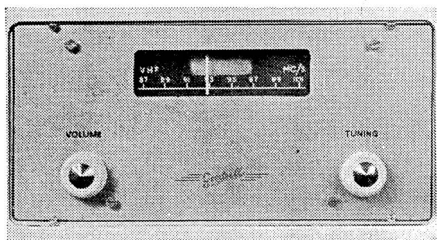

*Goodsell FMT701*

**Aveley Electric Ltd.**, Ayron Road, Aveley Industrial Estate, South Ockendon, Essex. Tel.: South Ockendon 3444. Cables: Telex 24120 Avel Ockendon.

**F.M. Dynatuner FM-1.** Free tuned. Range 88-108 Mc/s. Drift-free design F.C. Balanced bridge discriminator. Magic eye ind. Self-powered. Size  $13 \times 3\frac{3}{4} \times 7\frac{7}{8}$  ins. Price £44 12s. (U.K. purchase tax £16 14s. 6d.) Also available in kit form £38 12s. (U.K. purchase tax £14 9s. 6d.)

**Chapman (Ultrasonics) Ltd.**, Sales Division, 24 Upper Brook Street, London, W.1. Tel.: Hyde Park 2291.

**F.M. Tuner FM90.** Switched, 4 positions. Range 87.5-100 Mc/s. A.F.C. ratio disc. P.s.n. 250v at 40 mA; 6.3v at 2A. Size  $5 \times 4\frac{1}{2} \times 6\frac{1}{2}$  ins. Price £14 9s. (U.K. purchase tax £5 1s.)

**F.M. Tuner FM91.** Free tuned. Range 87.5-100 Mc/s or 88-108 Mc/s. A.F.C. Wide band ratio det. Bright Line tuning ind. P.s.n. 250v at 40 mA; 6.3v at 2A or self-powered. Size  $12 \times 4\frac{1}{8} \times 6\frac{1}{4}$  ins. Price £17 6s. 8d. (U.K. purchase tax £6 1s. 4d.) Self-powered £20 5s. 7d. (£7 1s. 11d.)

**FM95 A.M./F.M. Tuner.** Variable tuning. Range 87.5-100 Mc/s, 195-550 and 800-2,000 metres. A.F.C. Ratio det. EM84 ind. P.s.n. 250v at 30 mA; 6.3v 2 amps. Size  $12 \times 4\frac{1}{8} \times 8\frac{1}{2}$  in. Price £20 1s. 9d. (U.K. purchase tax £7 0s. 9d.) Self-powered version £23 1s. (£8 1s. 6d.)

**A.M./F.M. Tuner S5E/FM.** Free tuned Range (F.M.) 87.5-100 Mc/s or 88-108 Mc/s; (A.M.) 12.5-37, 35-100, 90-250, 190-550 metres. Ratio det. plus limiter. Magic eye tuning ind. P.s.n. 200/250v at 40/50 mA or self-powered.  $13\frac{1}{2} \times 6\frac{1}{2} \times 9$  ins. Price £25 3s. 8d. (U.K. purchase tax £8 16s. 4d.) Self-powered £28 3s. (£9 17s.)

**A.M./F.M. Tuner S5/FM.** Free tuned. Range (F.M.) 87.5 100 Mc/s; (A.M.) 16-50, 195-550, 800-2,000 metres. Ratio det. plus limiter. Magic eye tuning ind. P.s.n. 200/250v at 40/50 mA or self-powered.  $13\frac{1}{2} \times 6\frac{1}{2} \times 9$  in. Price as S5E/FM above.

**A.M./F.M. S6BS/FM.** Free tuned. Range (F.M.) 87.7-108 Mc/s; (A.M.) 6 bandspreads: 11, 13, 16, 19, 25, and 31 metres; also 15-43, 43-140, 175-570 metres wide band ratio det. Magic eye ind. Self-powered. Size  $13\frac{3}{4} \times 13 \times 8\frac{1}{2}$  ins. Price £52 10s. (U.K. purchase tax £19 5s.)

**A.M. Tuner S6BS.** Free tuned. Range 6 bandspread ranges: 11, 13, 16, 19, 25, and 31 metres, also 13-43, 43-140, 175-570 metres. Magic eye ind. P.s.n. 250v at 30/40 mA; 6.3v at 1.5A, or self-powered. Size  $13\frac{3}{4} \times 11 \times 8\frac{1}{8}$  ins. Price £32 19s. 2d. (U.K. purchase tax £11 10s. 10d.) or £37 8s. 2d. self-powered (U.K. purchase tax £13 1s. 10d.)

**Clarke & Smith Manufacturing Co. Ltd.,**  
H.M.V. High Fidelity Components Division,  
Melbourne Works, Wallington, Surrey.  
Tel.: Wallington 9252. Cables: Electronic,  
Wallington.

**A.M./F.M. H.M.V. 558.** Variable tuning.  
Range F.M.: 87.5-108.5 Mc/s; A.M.:  
M.W. 184-575 metres, L.W. 1110-2,050  
metres. EM 84 magic eye ind. Self-  
powered. Size  $14\frac{1}{2} \times 3\frac{3}{8} \times 8\frac{3}{4}$  ins. Price  
£26 4s. 6d. (U.K. purchase tax £8 19s.)



**Goodsell Ltd.,** Gardner Street, Brighton,  
Sussex. Tel.: Brighton 26735.

**F.M. Tuner FMT701.** Manual tuning  
(permeability). Range 85-100 Mc/s. Ratio  
det. Magic eye ind. P.s.n. 250v at 20 mA.  
Price £10 10s. (U.K. purchase tax £3 8s. 3d.)



**Grampian Reproducers Ltd.,** 19 Hanworth  
Trading Estate, Feltham, Middx. Tel.:  
Feltham 2657. Cables: Reamp, Feltham.

**F.M. Tuner 571.** Free tuned. Range  
85-98 Mc/s. Ratio det. Magic eye ind.  
P.s.n. 300v at 35/40 mA, 6.3v at 2.5 amps.  
Size  $10\frac{1}{4} \times 5\frac{1}{2} \times 6\frac{1}{4}$  ins. Price £17 10s.  
(U.K. purchase tax £5 17s. 11d.)



**Jason Electronic Design Ltd.,** Kimberley  
Gardens, London, N.4. Tel.: Stamford  
Hill 5477.

**F.M. Tuner FMT/4.** Variable tuning.  
Range 88-108 Mc/s. Transistor amplified.  
A.F.C. Foster-Seeley disc. Self-powered.  
Size  $11\frac{1}{4} \times 6\frac{3}{8} \times 4\frac{3}{8}$  ins. Better than  $5\mu\text{V}$   
for 40 dB quieting. Price £17 5s. (U.K.  
purchase tax £5 10s. 8d.)

**JTV/2 F.M. and A.M./TV Sound Tuner,**  
Switched turret tuning. Automatic fre-  
quency control. Range 88-96 Mc/s, plus  
all Television channels. Discriminator.  
Self-powered. Size  $11\frac{1}{4} \times 7\frac{1}{2} \times 4\frac{3}{8}$  ins.  
 $10\mu\text{V}$  for 40 dB quieting. Price £19 4s.  
(U.K. purchase tax £6 3s. 3d.)

**Monitor. F.M. and A.M./TV Sound  
Tuner.** Switched tuning. A.F.C. Range  
40-212 Mc/s. Foster-Seeley disc. P.s.n.  
230v at 35 mA; 6.3v at 1.5A. Size  $5 \times 5\frac{1}{2}$   
 $\times 7$  ins. Price £15 (U.K. purchase tax  
£4 16s. 3d.)

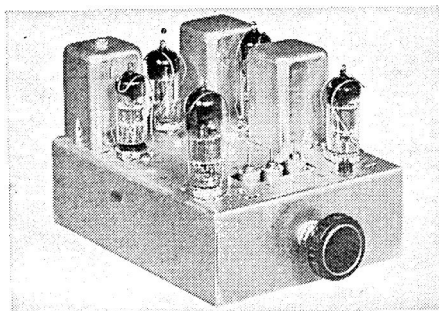

*Chapman FM90 switched tuner*

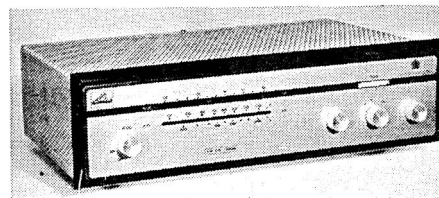

*H.M.V. Model 558 AM/FM*



*Leak Trough-Line 11*

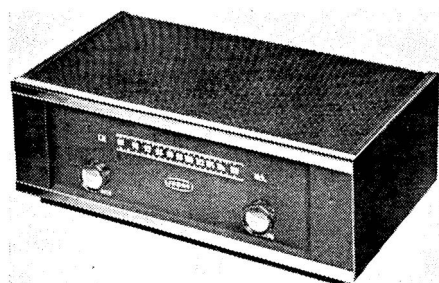

*Jason FMT/4 tuner*

**H. J. Leak & Co. Ltd.,** 57/59 Brunel Road,  
East Acton, London, W.3. Tel.: Shepherds  
Bush 1173. Cables: Sinusoidal, Ealux,  
London.

**F.M. Tuner, Trough-Line 11.** Variable  
tuning. Range 88/108 Mc/s. A.F.C. giving  
tuning stability from the instant of  
switching on. Foster-Seeley disc. Magic  
eye ind. Self-powered. Size  $11\frac{1}{2} \times 4\frac{1}{2} \times$   
 $7\frac{3}{4}$  ins. Price £25 (U.K. purchase tax  
£8 15s.)

**Lee Products (Great Britain) Ltd.**, 10-18 Clifton Street, London, E.C.2. Cables: Leprod, London, E.C.2.

**F.M. Tuner FMT/2.** Variable tuning. Range 88-100 Mc/s. A.F.C. Foster-Seeley disc. Self-powered. Cathode follower output. Size  $12\frac{1}{4} \times 3\frac{1}{2} \times 9\frac{3}{4}$  ins. Price £18 13s. 6d. (U.K. purchase tax £5 19s. 10d.)

**A.M./F.M. Tuner H4T/2.** Variable tuning. Range 87-101 Mc/s, 16-50, 187-540 and 1,100-1,900 metres. Ratio det. Magic eye ind. Self-powered. Size  $12\frac{1}{2} \times 6\frac{1}{4} \times 10$  ins. Price £19 10s. (U.K. purchase tax £6 5s. 2d.)

★

**The Lowther Manufacturing Co.**, Lowther House, St. Mark's Road, Bromley, Kent. Tel.: Ravensbourne 5225. Cables: Lowther, Bromley.

**F.M. Tuner Mk. V Self-Powered.** Twin gang tuning, horizontal scale. Range 87.5-108 Mc/s. A.F.C. Foster-Seeley disc. Switched ind. 50 c/s injection. Self-powered. Size  $13\frac{1}{4} \times 5\frac{1}{2} \times 5$  ins. Price £24.10s. (U.K. purchase tax £8 2s. 11d.)

**F.M. Tuner Mk. V.** Variable tuning. Range 87.5-108 Mc/s. A.F.C. Foster-Seeley disc. Switched A.F.C. and hum check ind. P.s.n. 250v 30 mA; 6.3v 2 amps. Size  $10\frac{1}{4} \times 4\frac{3}{4} \times 7$  ins. Price £22 (U.K. purchase tax £7 6s. 4d.)

**F.M. Tuner Mk. V Crystal.** Switched 3 station tuning. Range Pre-set 87.5-100 M/c A.F.C. Foster-Seeley disc. P.s.n. 200-240v 50 c/s. Size  $10\frac{1}{4} \times 4\frac{3}{8} \times 5\frac{3}{4}$  ins. Price to be announced.

★

**Pamphonic Reproducers Ltd.**, Westmoreland Road, London, N.W.9. Tel.: Colindale 7131.

**640 F.M. Tuner.** Variable tuning. Range 86-103 Mc/s. Ratio sel. Magic eye ind. P.s.n. 200v at 30 mA, 6.3v at 2 amps. Size (panel)  $9\frac{3}{8} \times 3\frac{3}{4}$  ins. Price £15 15s. (U.K. purchase tax £5 5s.)

**F.M. 646.** Manual tuning. Range 88-108 Mc/s. A.F.C. Ratio det. Self-powered. Size  $6 \times 13 \times 4\frac{1}{4}$  ins. Price £21 13s. 3d. (U.K. purchase tax £7 4s. 6d.)

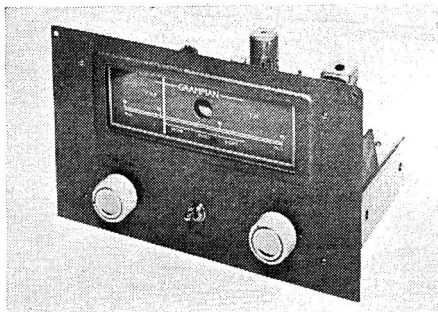

*Grampian FM 571*

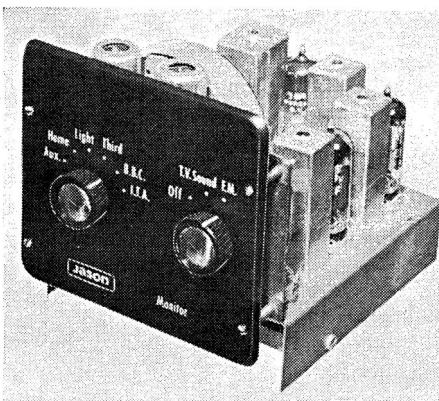

*Jason Monitor*

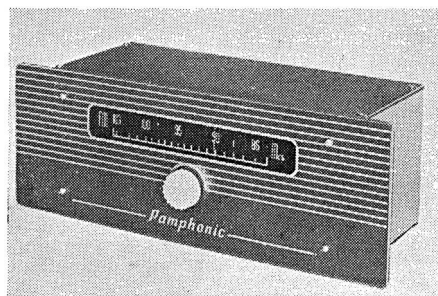

*Pamphonic 640 FM tuner*

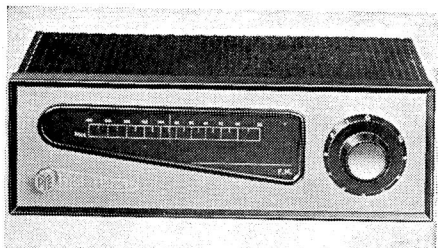

*Pye Mozart HFT 108M*

**Pye Ltd., High Fidelity Division, P.O. Box 49, Cambridge. Tel.: Cambridge 58985. Cables: Pyrad, Cambridge.**

**A.M./F.M. Tuner HFT113.** Variable tuning. Range (F.M.) 88-108 Mc/s (A.M.) 190-550 metres. A.F.C. detect. Self-powered. Size  $10\frac{1}{2} \times 3\frac{3}{8} \times 5$  ins. Price chassis £29 8s., in metal case £31 10s.

**F.M. Tuner Mozart HFT108.** Variable tuning. Range 88-108 Mc/s. A.F.C. Self-powered. Size  $10\frac{1}{2} \times 3\frac{3}{8} \times 5$  ins. Price £17 9s. 9d. (U.K. purchase tax £5 12s. 3d.) chassis only or in metal case £19 1s. 7d. (U.K. purchase tax £6 2s. 11d.) 117v model available.



**Rogers Developments (Electronics), Ltd., "Rodevco Works", 4-14 Barmeston Road, Catford, S.E.6. Tel.: Hither Green 7244 and 4340. Cables: Rodevco, London.**

**R.D. Junior Mk. 11 Variable F.M. Receiver.** Variable tuning. Printed circuit coil pack. Range 87-107.5 Mc/s. A.G.C. Foster-Seeley disc. Twin limiters. Tuning Indicator. Twin Cathode Follower Output. Self-powered. Provision for Multiplex Adaptor. Size:  $8\frac{5}{8} \times 5\frac{3}{8} \times 10\frac{3}{8}$  ins. To operate with any Rogers Control Unit. Available in Teak case to match HG88 Mk. 11. Price to be announced.

**F.M. Tuner R.D. Junior Switched.** Switched tuning. Range 87-96 Mc/s. A.F.C. Foster-Seeley disc. P.s.n. 250v 35 mA; 6.3v 1.7 amps. Size  $9 \times 5\frac{3}{8} \times 5\frac{3}{8}$  ins. Price £11 5s. (U.K. purchase tax £3 16s. 10d.) Also available to match HG88 amplifier without case £11 18s. (U.K. purchase tax £4 1s. 3d.)



**Shirley Laboratories Ltd., 3 Prospect Place, Worthing, Sussex. Tel.: Worthing 30536.**

**F.M. Tuner R/6.** Variable tuning. Standard range. Ratio det. Magic eye ind. P.s.n. 200-300v 30 mA; 6.3v 2.5 amps. Price £27 10s.



**Sound Sales Ltd., Works and Acoustic Laboratories, Farnham, Surrey. Tel.: Farnham 6461/2/3. Cables: Sounsense, Farnham.**

**A-Z F.M. Synchrolock Unit Mk. IV 108.** Variable twin gang tuning. Range 75.8-

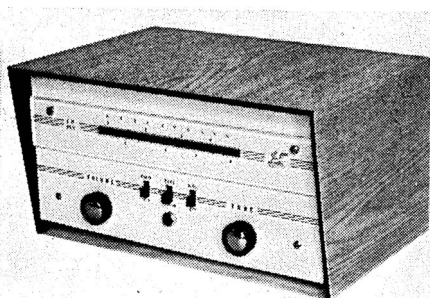

*Lowther FM MK. V tuner*

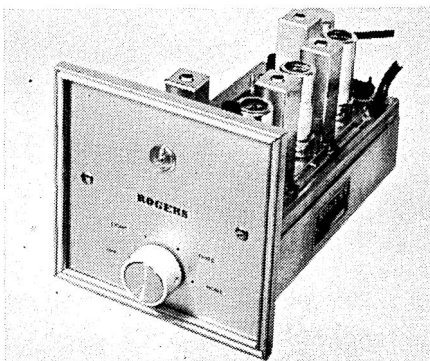

*Rogers RD Junior Switched FM tuner*



*Rogers RD Junior tuner in matching cabinet*

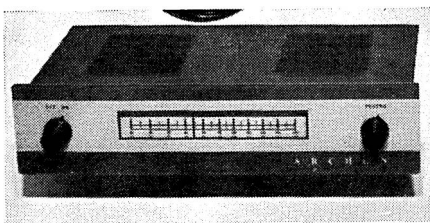

*Tansley-Howard Archon P.F.41*

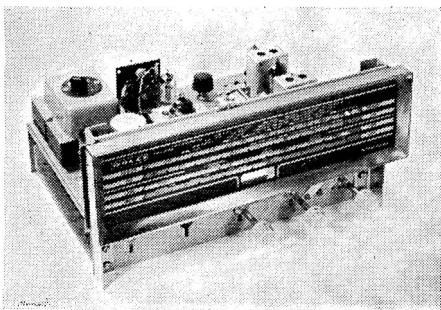

*Dulci H4T/5 AM/FM tuner*

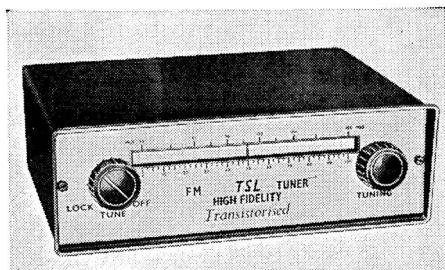

*TSL F.M. tuner*

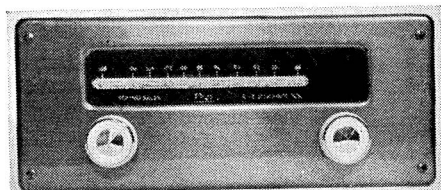

*Sound Sales Synchrolock MK. IV*



*W/B Stentorian F.M. tuner*

**Whiteley Electrical Radio Co. Ltd.**, Victoria Street, Mansfield, Nottinghamshire. Tel.: Mansfield 1762-5. Cables: Whitebon, Mansfield.

108 Mc/s. A.F.C. Foster-Seeley disc. Magic eye ind. Self-powered. Size  $11\frac{1}{2} \times 4\frac{1}{2} \times 6\frac{1}{2}$  ins. Price £22 (U.K. purchase tax £7 1s. 2d.)



**Symphony Amplifiers Ltd.** (Distributors Northern Radio Services (London) Ltd.), 16 Kings College Road, London, N.W.3. Tel.: Primrose 3314/5.

**F.M. Tuner Symphony No. 1.** Variable tuning. Range 87-101 Mc/s. Ratio det. P.s.n. 250v at 40 mA; 6.3v at 1.5A. Size  $9 \times 6 \times 6$  ins. Price £11 1s. 10d. (U.K. purchase tax £3 12s. 2d.) Power pack available. Price £3 7s. 6d. Magic eye available. Price £1.

**A.M./F.M. Tuner Symphony No. 2.** Manual tuning. Range 87-101 Mc/s, 16-50, 190-550, and 1,000-2,000 metres. Ratio det. Self-powered. Size  $13\frac{1}{2} \times 8\frac{1}{2} \times 7\frac{1}{2}$  ins. Price £18 2s. 3d. (U.K. purchase tax £5 17s. 9d.) Magic eye available. Price £1.



**Tansley-Howard Ltd.**, 95 Kensal Road, London, W.10. Tel.: Ladbroke 7195.

**Archon PF41 F.M. Tuner.** Variable tuning. Range 88-108 Mc/s. A.F.C. Self-powered. Size  $12 \times 6 \times 2\frac{3}{8}$  ins. Panel  $12\frac{1}{2} \times 3$  ins. Price £18 15s. (U.K. purchase tax £6 2s.)



**Technical Suppliers Ltd.**, Hudson House, 63 Goldhawk Road, London, W.12. Tel.: Shepherds Bush 2581. Cables: Teknika, London, W.12.

**F.M. TSL.** Fully transistorised. Variable tuning. Range 87.5-108.5 Mc/s. A.F.C. Sensitivity 0.6 mV. Selectivity 350 Kc/s bandwidth. Powered by one 9v and one 3v battery. Size  $8 \times 2\frac{1}{2} \times 7\frac{1}{4}$  ins. Weight 3 lbs. Price £19 9s. 6d. (U.K. purchase tax £6 5s.)



**W/B Stentorian F.M. Tuner Mk. II.** Variable permeability tuning. Range 88-108 Mc/s. Foster-Seeley disc. P.s.n. 200-240v at 45 mA, 6.3v at 2 amps. Size  $11\frac{3}{8} \times 4 \times 7\frac{1}{2}$  ins. Price £16 2s. 5d. (U.K. purchase tax £6 19s. 7d.)

# NEW DEVELOPMENTS IN TRANSISTOR AMPLIFIERS

by George S. Tillett

THIS last year has seen very few noteworthy developments in the amplifier field although there is no doubt that much work is going on behind the scenes—especially with transistors. Before discussing transistor applications, let us take a look at the valve amplifiers. One of the new models released quite recently is the *Armstrong* PCU-25 and A20 combination which was reviewed in the *Hi-Fi News* for April 1962. The most interesting feature of the control unit is the ingenious method of using the treble control in conjunction with the low-pass filter in order to obtain a variation of “cut-off” frequency and attenuation; in other words, as a type of

“slope control”. Fig. 1 shows the circuit in which VR2 is a conventional passive type treble control with a “hinge” around 1,000 c/s. Operation of the switch SI (which short circuits R15) changes its characteristics to those shown in the diagram (Fig. 2). Note that the filter itself is basically a bridged “T” type (R10, II, C7, 8 and 9). The negative feedback loop necessary to make the response asymmetrical is formed by R13 which is connected around V2. A second feedback loop is taken at point X to the output of the 3rd valve.

Obviously this arrangement is not so versatile as a system having both treble and slope controls, but it is a very good com-

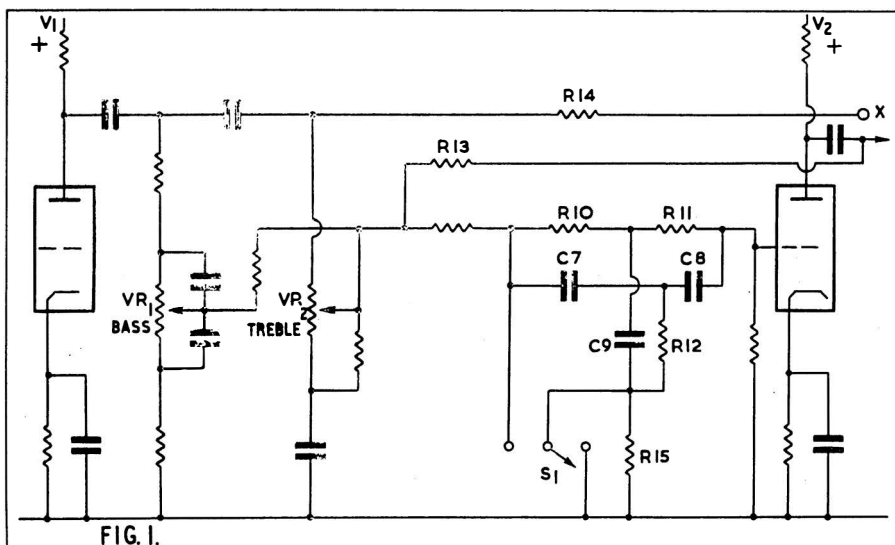

promise. As far as many people in this country are concerned—the fewer the knobs to fiddle with the better! I said as far as *this* country is concerned, because the situation is rather different in America where the designers feel that the more knobs they can cram on the better—and it is not uncommon for an amplifier to have as many as 15 controls, including volume, loudness, centre channel, blend plus tone controls for each channel. Whether this trend is due to the “audiophile’s” pre-occupation with the “mechanics” of the thing, rather than with the end product, is a moot point. In the fullness of time doubtless the reaction will set in, and already it is worthy of note that the new American *Heathkit* amplifier has a hinged cover to hide the non-essential knobs!

### Rogers redesigned

The *Rogers* HG88 has been redesigned and now has an increased power rating of 12 plus 12 watts. The output valves are ECL86’s and the switched step-style volume control has given way to the more conventional close matched variable composition type. Other new models from *Rogers* include the “Cadet” stereo amplifier and control unit. This model has an output of 6 plus 6 watts at a distortion of 0.25% and the input sensitivity of 75mV makes this an ideal combination to use with the *Decca* “Deram” ceramic pickup. Although this is a relatively inexpensive amplifier costing but £27 10s., it is noted that a filter switch is fitted. From *Radford* comes news of further developments in amplifier design technique. Fig. 3 shows the circuit of the latest MA15 amplifier which is claimed to have a phase margin of just under 90 degrees up to 3 Mc/s, with an amplitude

margin of 25 dB. The HF step network (R1, C1) does not attenuate appreciably below 15 Kc/s, thus nearly full feedback is applied up to that frequency and the distortion at 15 watts is only 0.6% at 20 Kc/s. Note that a triode-pentode is used as a phase-splitter instead of a double-triode. R2 and C2 form the low frequency step network to maintain stability at the low end of the scale. Note also that the feedback loop is switched with the change in load impedance. Also to be released is a doubled up version of this power amplifier known as type STA15. Improvements have also been made to the DSM control unit now re-named the SC2. Triodes are used in place of the pentodes with an increase in signal to noise ratio of from 3 to 6 dB. Other features of the DSM, such as the rumble filter cutting at 35 c/s and the cathode follower output stage, have been retained.

### Transistors for Hi-Fi

The advantages of transistors for portable radio receivers are well known, but what is less certain is their suitability for Hi-Fi amplifiers—in other words, just what can we expect to gain? After all, it can be argued that valve amplifiers with their low distortion, wide frequency range etc., can hardly be improved on—or can they? Let us take a look at the transistor claims. (1) Greater efficiency (lower power consumption). (2) Lower heat dissipation. (3) Higher damping factors possible for the output stage. (4) Lower hum level. (5) Lower voltages mean a saving in components. (6) No output transformers needed. (7) Greater compactness. (8) Transistors have a longer life. A formidable list, to which must be added the possible advantage of no warm-

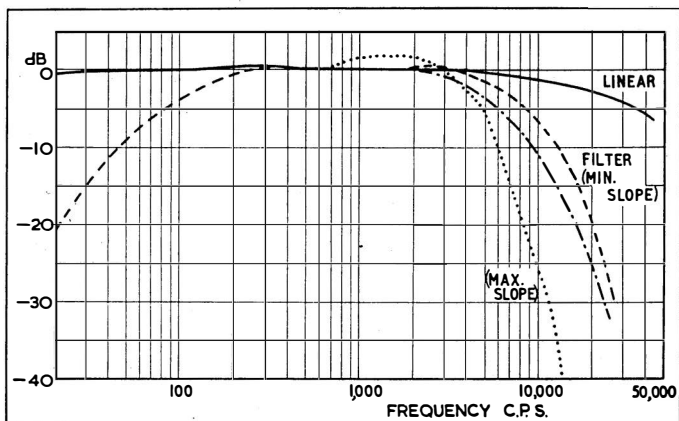

The filter characteristics of the *Armstrong* are shown in the diagram which shows minimum and maximum slopes, plus an intermediate position.

★

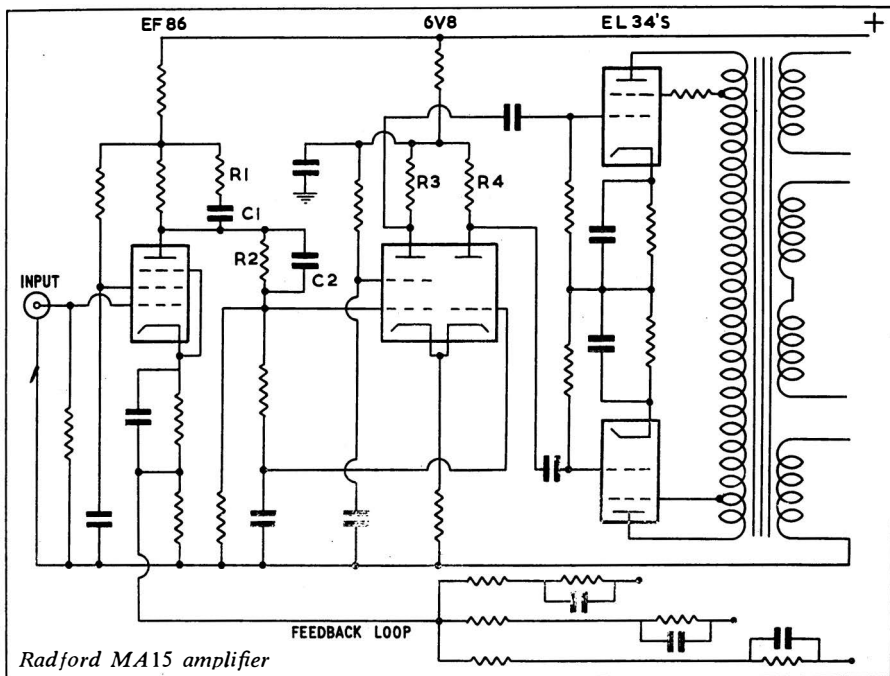

Radford MA15 amplifier

up time (I cannot see that this is important but it *is* quoted by the American adverts!).

The modern valve amplifier is still relatively inefficient and the average 10 plus 10 watt unit would consume some 150 to 200 watts from the mains, thus most of the power is dissipated in the form of heat. In contrast, a transistor amplifier of similar rating would use between 50 and 70 watts. This is partly due to the inherent efficiency of transistors, the absence of heater current and also to the fact that high power transistor output stages are of the "class B" type or similar. The lower heat dissipation is of course a function of the higher efficiency. Higher damping factors are explained by the large amounts of negative feedback necessary to extend the bandwidth and reduce the inherent distortion, as well as for stabilising the operating parameters. Feedback loops of 40 to 60 dB are quite common with resulting damping factors of 100 and over. The lower hum level is mainly due to the absence of a heater supply for the first stages, but the smaller mains transformer means a worthwhile reduction in hum fields which are always a problem with small integrated amplifiers. So what do these claims add up to in practice?

First, the lower power consumption is obviously not too important as it means

but a saving of a few pence per week at the most. (No doubt I will be contradicted by Mr. MacTavish of Aberdeen!) The lower heat dissipation scores a point, for it does enable an amplifier to be mounted quite near to (even underneath) an FM tuner without causing any dire effects. It could also mean that an amplifier could be enclosed in a small wooden free-standing cabinet if so desired. The higher damping factor as such is of no great importance, as any increase over 20 (which equals an output impedance of  $\frac{1}{2}$  ohm) is quite negligible compared with the 15 ohms of the speaker itself.

### Lower Hum Level

Lower hum level is undoubtedly a factor to consider—especially with amplifiers working at inputs of 2 or 3 millivolts. The saving likely to result from the lower voltages used would not be very much, and the reduced cost of the mains transformer may well be offset by the higher costs elsewhere. The inherent low impedance of transistors *does* mean that output-transformerless stages are a practical possibility, and in theory at any rate the scrapping of the output transformers offers better stability, better frequency response and superior transient reproduction. In any



case, transistor output transformers are far less elaborate and costly than valve types; in some circuits simple centre-tapped chokes can be used instead. There is no doubt that smaller, more compact amplifiers will give greater scope for styling and presentation whilst being somewhat easier to install. How about longer life? At present this is certainly true of the ordinary small types of transistor but it is rather less certain of the higher power devices. For Hi-Fi applications a power of 10 plus 10 watts is usually considered necessary, and most valve amplifiers are in this class. If a lower output is acceptable, a transistor amplifier could be operated from batteries and even a 20 watt amplifier could be powered by a car battery. (I should say two car batteries, as most high power transistor amplifiers will use a 24-volt or higher supply.) This may well have applications for those living in remote parts of the world without an electric power supply so I must include battery operation in the possible list of advantages.

**Some disadvantages**

Now let us take a look at the other side of the picture; are there in fact any snags? Yes, here are some of them:

- (1) Transistors are "heat-conscious".
- (2) The spreads in characteristics are much larger than we have become accustomed to with valves.
- (3) The frequency response is restricted at the H.F. end.
- (4) The noise level is higher.

The operating condition of transistors, especially high power types, is related to the working temperature. Furthermore, if the collector current can increase without control, a condition known as "thermal runaway" is reached, when the transistor

will destroy itself. These problems can be overcome by the provision of heat sinks and reasonable ventilation plus the proper stabilising precautions, which take the form of DC feedback loops, potentiometer bias supply, thermistors etc. Variations in gain and other parameters can be dealt with by using large amounts of negative feedback, which will also increase the amplifier bandwidth—provided the right types of transistor are used. As for noise level, again provided that the right types of transistor are used, this is no longer a serious problem. The real difficulty—at the time of writing—centres on the production of suitable types of transistor (low-noise and output types) at a reasonable price. It is now possible to produce a 20-watt transistor amplifier in the laboratory—an all-transistor amplifier which is quite comparable with a valve type but the cost is prohibitive. This situation will of course change, and probably sooner than many people anticipate.

**Transistors versus Valves**

Before considering some design features of transistor amplifiers it will be as well to compare the operation of transistors with valves. The theory of transistors was very ably dealt with by Stanley Kelly in the 1957 Hi-Fi Year Book, and more detailed information is available from a number of publications<sup>1</sup>, so it is not proposed to go very deeply into the mathematical analysis of semi-conductors. However, for those not conversant with transistors the following simple facts must be borne in mind; transistors are low-impedance devices and are *current* operated—unlike valves, which are basically high impedance and nearly always *voltage* amplifiers.

The material used in the making of a

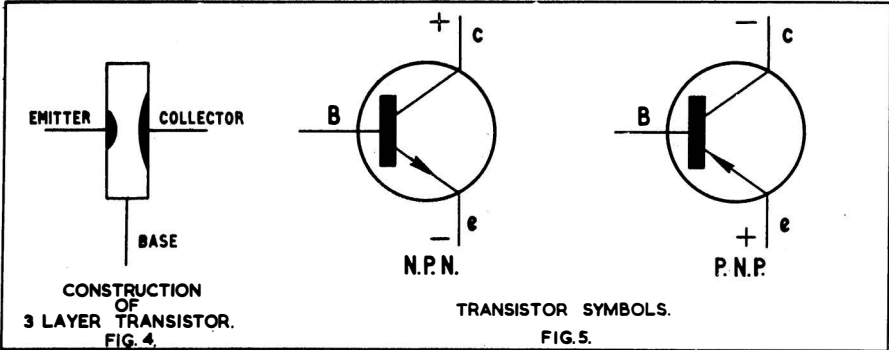

Fig. 4. Construction of 3 layer transistor. Fig. 5. Transistor symbols (NPN and PNP).

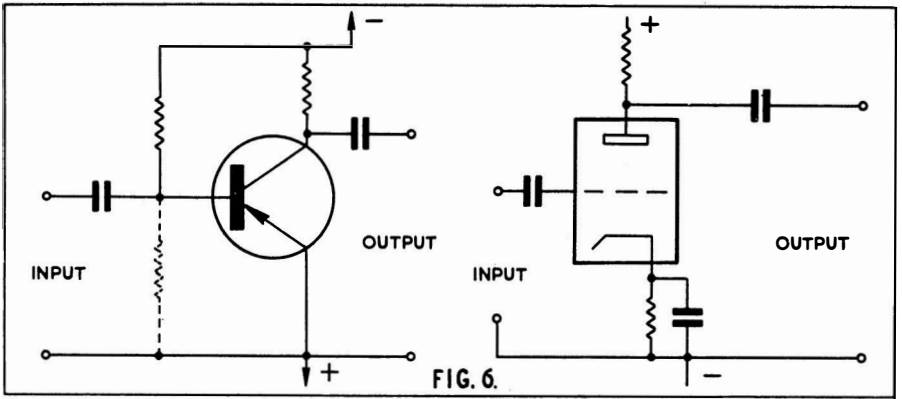

Fig. 6. Transistor, emitter grounded, and valve equivalent.

transistor is known as a "semi-conductor" and is usually of germanium or silicon. Fig. 4 shows the arrangement of a junction type, the middle layer of the "sandwich" is called the *base* and one outside layer is called the *emitter* and the other the collector. Two basic types are made, one PNP and the more common NPN—the letters indicating the kind of germanium used. "P" means that there is an electron *deficiency*, or "hole", in the structure and "N" implying an *excess* of electrons. Fig. 5 shows the symbols for both types, in the *NPN* kind the collector roughly corresponds to the anode of a valve, and provided it is biased positively, with respect to the base, it will absorb electrons therefrom. Varying the base current changes the voltage across the emitter junction, and thus controls the emitter-collector current. PNP types function in reverse, with the collector connected to the negative supply and the emitter to the positive. As mentioned before, most of the transistors used at present are of this

kind. Now for some comparisons, Fig. 6 shows a valve amplifier and a transistor equivalent.

The input is applied to the base (grid), and the output is taken from the collector (anode), with the emitter (cathode) common to both input and output. A typical input impedance would be about 1,000 ohms with an output impedance of some 30 K. The phase relationship would be 180 degrees. Fig. 7 shows a valve cathode-follower stage with its transistor equivalent. Here the collector is grounded and the output is taken from across the load in the emitter circuit. Like the valve cathode-follower, the gain must always be less than unity and the output impedance low. Typical figures are: input impedance 1 megohm (varies with frequency) and output 100 ohms or less.

### Practical Circuitry

Now let us turn to some practical circuits: Fig. 8 shows a low-level pickup input

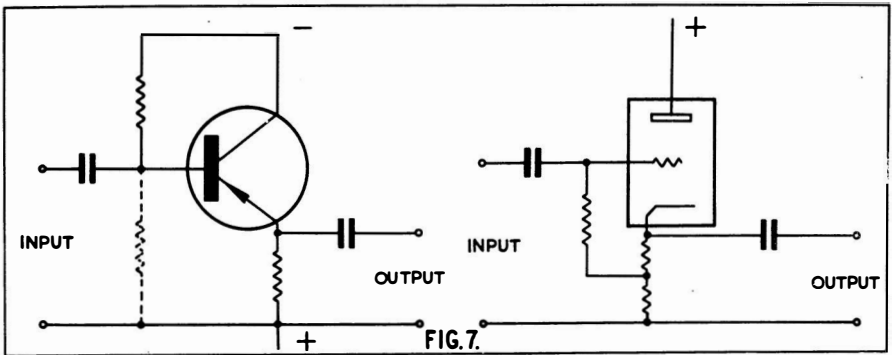

Fig. 7. Transistor collector grounded and valve equivalent.

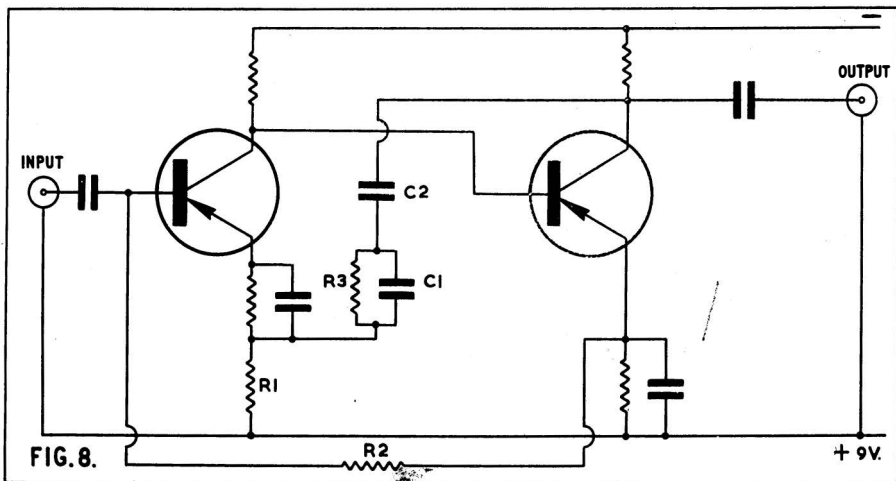

FIG. 8. Input stage using two low-noise transistors.

stage using the new Mullard low-noise AC107 transistors (or equivalent). The two are directly coupled, and equalisation is effected by the selective loop R3, C1 and C2. The omission of the by-pass capacitor across R1 gives a degree of negative feedback for stabilising purposes and increases the input impedance. Further stabilising is provided by the connection of R2 from the emitter of the second transistor to the base of the first, thus forming a DC loop. With an input of 3 millivolts this "front end" will give an output of about 0.5 volts at 1,000 c/s.

Fig. 9 shows another input circuit using two transistors. Here the equalising is effected by a loop in the second stage (R2, C1). Note that feedback is introduced into

both stages by the un-bypassed resistors in the emitter circuits (R3 and R5). With both these circuits the correct equalisation depends to a certain extent on the inductance of the pickup used, and thus the values of the emitter resistors and feedback constants will only suit one particular pickup. A circuit which is effected less by the input characteristics is given in Fig. 10. This is a more elaborate arrangement using 3 transistors.

Note that the second transistor is of the NPN type and that both positive and negative voltage supplies are necessary. Equalisation is obtained by a feedback loop connected between the emitter of the first transistor and the collector of the second (R4, C2 and C3)—rather like the first

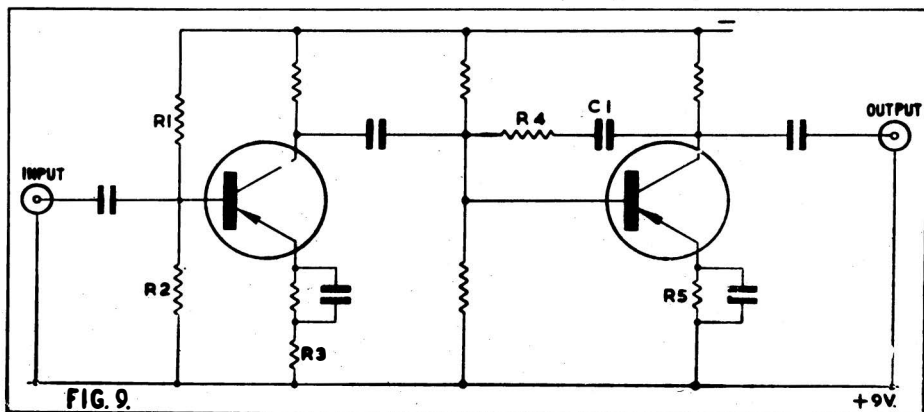

FIG. 9. 2 transistor input circuit with equalising in the second stage (Texas instruments).

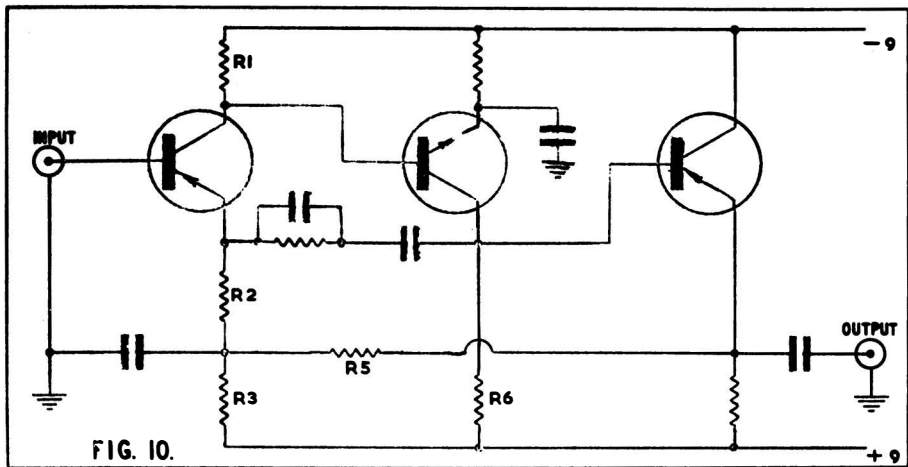

FIG. 10.

Fig. 10. 3 transistor circuit with high input impedance.

circuit, but in this case a larger portion of the emitter resistor of the first stage is left unbypassed. This helps to increase the input impedance to something like 100K. The output transistor is connected as an emitter follower as shown earlier in Fig. 7 and the output impedance is of the order of 100 ohms. C1 and R5 form a DC loop necessary for stabilising purposes.

### Tone Control Systems

After the input stages come the tone control systems. Fig. 11 shows a typical passive network for both bass and treble controls. At first sight this circuit appears to be identical with those used by valve amplifiers, but here they must be considered as current transfer networks rather than voltage networks. V1 is the volume control and V2 is the bass control and V3 the

treble. All these controls would be about 50,000 ohms and C1 would be 0.25 mfd and C2 0.25 mfd. Typical values for C3 and C4 would be 0.1 mfd and 0.01 mfd respectively. These values are considerably larger than those used by the equivalent circuit in valve amplifiers. Several American amplifiers including TEC and KNIGHT use a modified Baxandall tone control circuit and P. J. Baxandall himself has given details of a tone control circuit in an article on transistor amplifiers published recently.<sup>2</sup>

### Output Stages

A straightforward amplifying stage (or stages) which may incorporate a filter brings us to the output section which is associated with the driver stages and phase-splitter. Fig. 12 shows a typical class

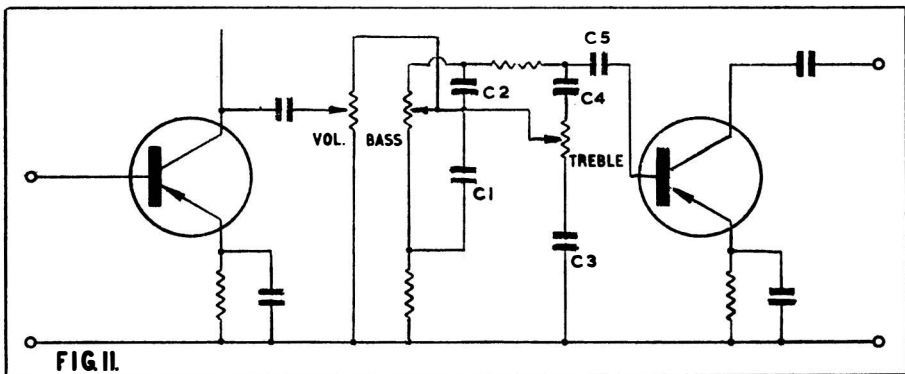

FIG. 11.

Fig. 11. Tone control system using passive network.

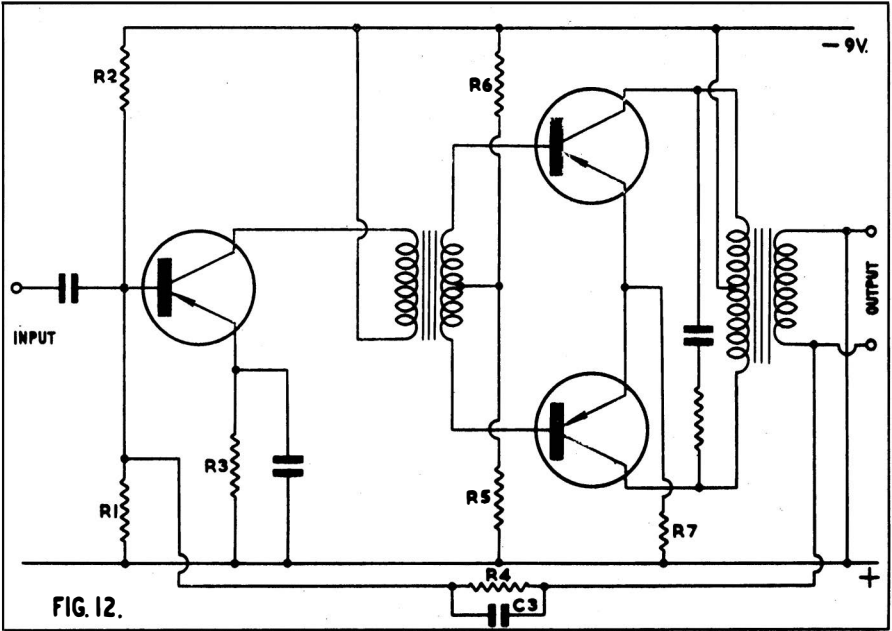

Fig. 12. Class "B" output stage.

B driver and output stage, as used in many portable record players and radio receivers, giving an output up to 1 watt with transistors of the OC81 class. This basic circuit is also used with larger transistors for transmitter modulators and public address amplifiers but is not satisfactory for High-Fidelity applications. In class B push-pull operation one transistor conducts while the other is "cut off", thus the two transistors amplify alternate halves of the waveform.

The three main advantages are (1) greater efficiency—a theoretical 78.5% against 50% for class A; (2) the power handling capacity related to the maximum collector dissipation is much higher, and (3) the amount of current taken from the power supply is related to the signal being amplified and under "no signal" conditions the power taken—the "quiescent current"—is very small.

### Distortion Risks

How about the disadvantages? The answer is that unless immense care is taken with the design a class B stage will have a far greater distortion than a Class A system. The main causes are as follows: (1) "Ringing" can occur when the signal polarity changes at the "cross-over" point. This is most serious in the driver transformer (T1 in

the diagram) and it can be reduced considerably by using a transformer with bifilar windings. (2) As the input swing approaches the point where one transistor takes over from the other, the input resistance of the working transistor increases to

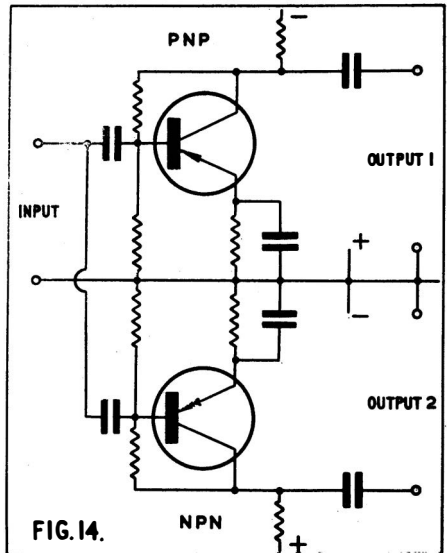

Fig. 14. Phase-splitter using PNP and NPN transistors.

a very high value causing a similar type of distortion to (1). This non-linearity is known as "cross-over" distortion and is very objectionable even when present in quite small percentages. The effect is not unlike that given by a faulty loudspeaker and is particularly noticeable with the reproduction of a piano. It can be reduced by applying a small forward bias so that under quiescent conditions a small amount of emitter current flows. In the diagram this potential is provided by the divider R5 and R6. (3) The current gain factor may vary over the range of applied signal swing. This type of distortion can be reduced by the application of negative feedback. (4) Mismatching the output transistors can cause considerable distortion.

**Single-ended Push-pull**

Apart from the obvious solution, the use of negative feedback will reduce the distortion but the maximum output will be restricted if one transistor overloads before the other. Fig. 13 shows another class "B" output stage, this is known as the single-end push-pull arrangement and offers one or two advantages over the previous circuit. As far as small portable receivers are concerned, naturally the cheaper cost and possible reduction in size are important considerations but the absence of an output trans-

former is the great attraction to Hi-Fi designers. The majority of the American transistor amplifiers use this basic type of circuit known to audiophiles as the OTL (Output Transformerless) amplifier. Looking at the diagram it will be seen that the two transistors are in series across the power supply and in parallel across the load. The load impedance needed to match the transistors is one quarter of that required by the conventional type of circuit shown in the previous diagram. This drastic reduction in load impedance means that direct matching can be made with low impedance speakers. For instance using transistors of the OC81 class the load would be around 25 to 30 ohms falling to 15 ohms or less for high power transistors in the OC23 series. The resistors R8 and R9 set the D.C. stabilisation and help to keep the operating points at levels which are independent of temperature and varying transistor characteristics. The other resistors in the chain (R4, 5, 6 and 7) provide the slight forward bias needed to reduce cross-over distortion.

**Crossover Distortion**

When a signal is fed to T1, equal out-of-phase voltages are applied by the transformer to the bases of the output transistors. These are driven to conduction on alter-

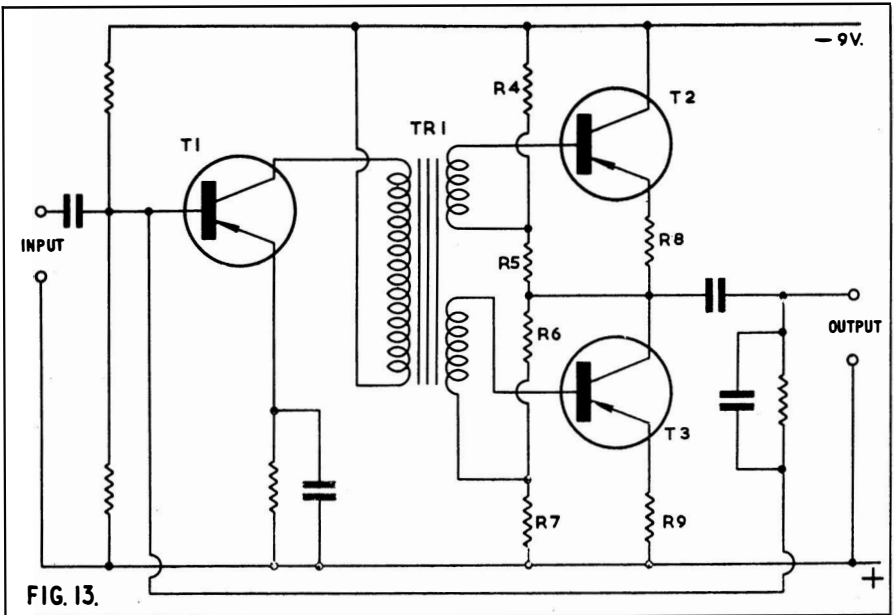
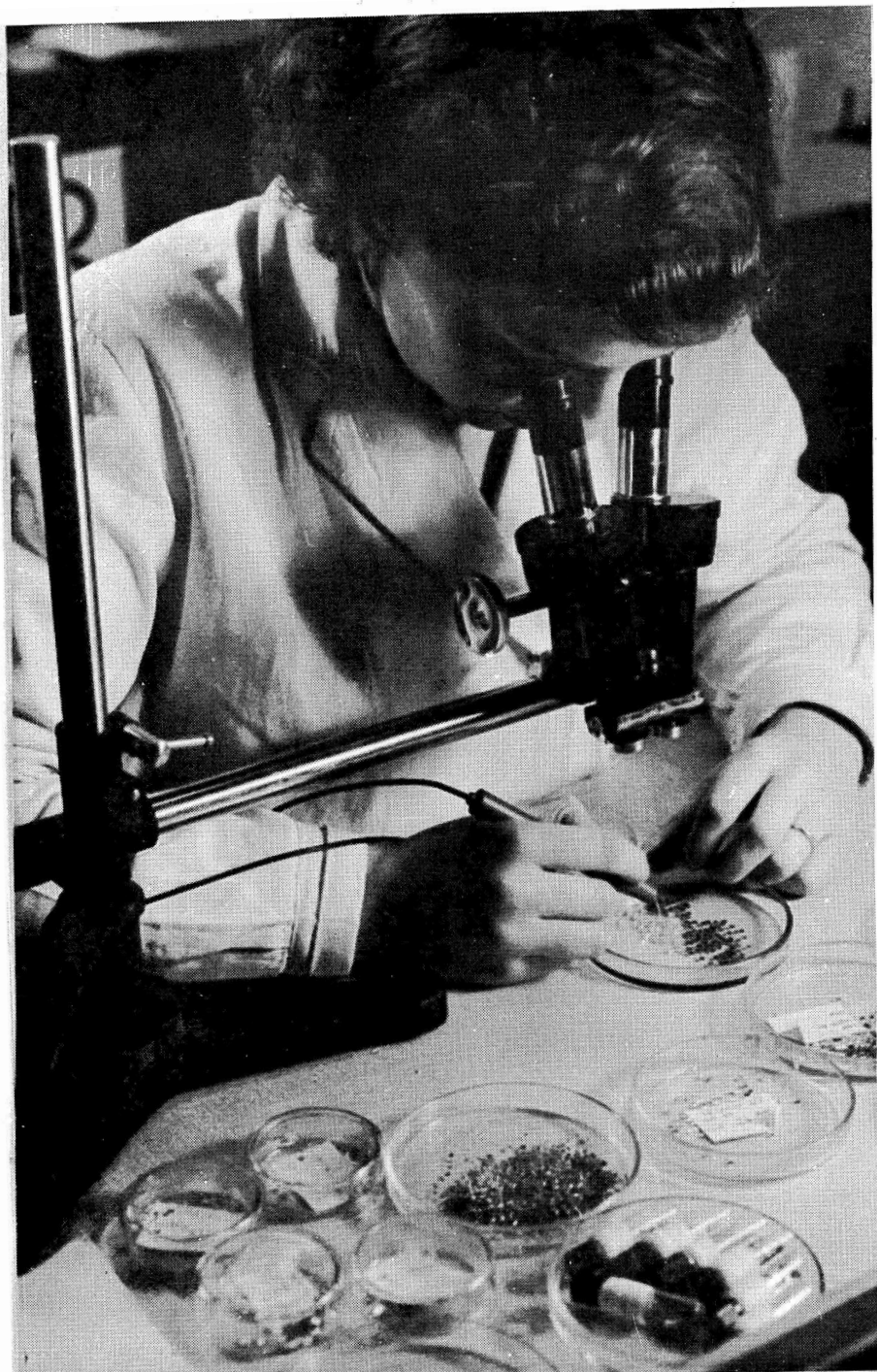

FIG. 13.

Fig. 13. Class "B" stage with single end output.



Transistor manufacture

nate half-cycles and the collector to emitter currents thus flow alternately through the capacitor C1 and the speaker. We have already noted that one source of the unpleasant cross-over distortion is the driver transformer and these components are very rarely used in amplifiers having any pretensions to Hi-Fi. Fig. 14 shows a phase-splitting arrangement using the complementary characteristics of a NPN and PNP transistor. Apart from polarity these have to have very similar parameters and the values in the circuit shown are applicable to the *Sylvania PNP* type 2N34 and the *PNP* 2N35.

★

The same type of complementary circuit is used in the 10 watt amplifier shown in Fig. 15. This is a prototype unit developed by *Texas Instruments* and it must be emphasised that some of the transistors are not available at present. The input transistor VT1 is direct coupled to VT2, the load for this stage being R5 with C2 defining the upper limit of the overall frequency response. The rectifiers MR1 and MR2 are continuously forward-biased and provide temperature compensation for the quiescent current in the driver stage VT3 and VT4. These form the complementary circuit, VT3 being the PNP device and VT4 the NPN. They are directly coupled to the output transistors VT5 and VT6 which

function as a class AB2 stage. Negative feedback is applied from the collectors to the emitter of the input transistor. This loop is no less than 57 dB and together with R12 and C4 helps to define the overall gain and bandwidth of the amplifier. The quiescent current of the output stage is determined by the zener diodes MZ1, MZ2 and the rectifiers MR1 and MR2 which also control the driver stage. Now for some performance figures:

#### Performance Table

Output:	10 watts
Output Load:	15 ohms
Output Impedance:	0.01 ohm in series with 500 mFd
Distortion:	0.02% total harmonic
Bandwidth:	20 cycles to 50,000
Noise:	- 88 dB ref. 10 watts
Power supply:	45 volts at 1.5 A max.

The power output is maintained to 50,000 cycles where the distortion is still less than 0.5%. Truly an amazing specification which is more than comparable with the best valve amplifiers.

A similar amplifier was described recently

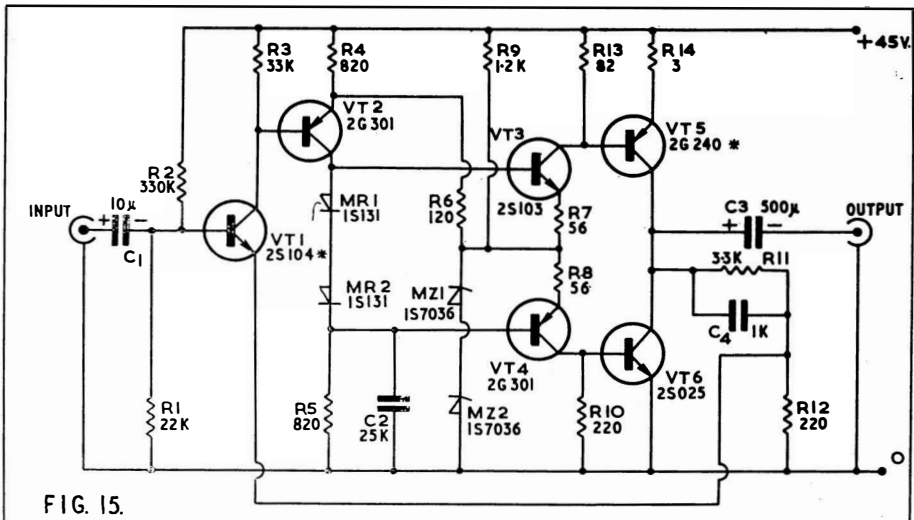

Fig. 15. Complete low distortion 10 watt output stage (*Texas Instruments*).



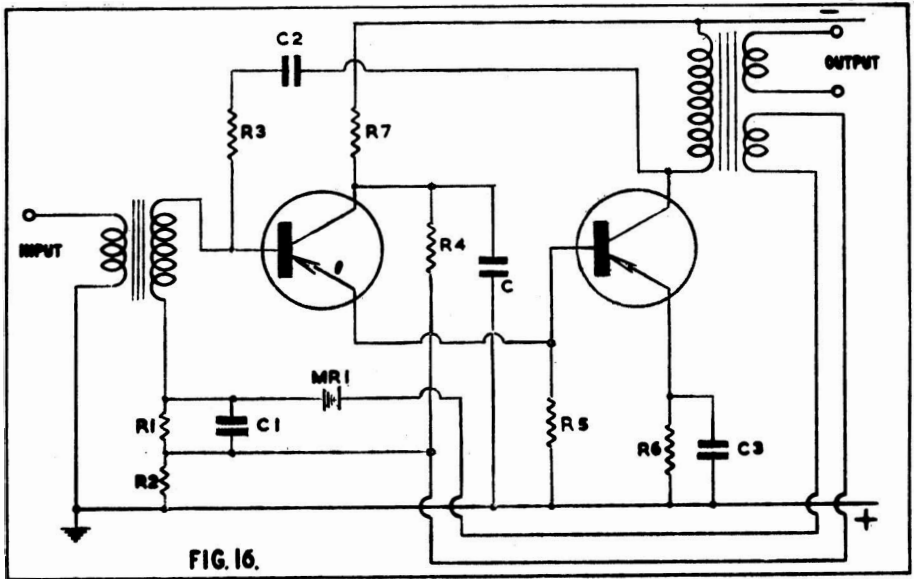

FIG. 16.

in the *Wireless World*<sup>3</sup>. Coming back to a less complicated arrangement, Fig. 16 gives a circuit developed some time ago by *Mullard* and used by *EKCO* in a car radio. It is a very simple circuit which may well have possibilities for low power Hi-Fi amplifiers. The driver transistor is a OC72 and the output is a OC16 giving a power of some 4 to 5 watts. Part of the output signal is passed back and rectified by MR1 and applied to the base of the OC72. This potential is passed back to the output transistor since the first emitter and the base of the second are coupled together;

thus the bias of the transistor is automatically adjusted according to the amplitude of the signal resulting in a gain in efficiency. Negative feedback is applied by C2 and R3 and the direct coupling between the transistors provides excellent D.C. stabilisation.

- (1) Mullard reference manual of transistors 1960. Transistors, circuits and servicing, B. R. Bettridge, Iliffe Books Ltd.
- (2) BSRA Journal, November 1961, Low Distortion Amplifiers, P. J. Baxandall.
- (3) Transistor High-Fidelity Amplifiers, Tobey & Dinsdale, *Wireless World*, November 1961.

# DIRECTORY OF AMPLIFIERS & CONTROL UNITS

★The following abbreviations are used in this directory section: **H.D.**—Harmonic Distortion; <—less than; **H** and **N**—Hum and Noise; **P.a.t.**—Power supplies available for tuner; **R.M.S.**—root mean square; **N.L.**—Noise level; **Sel.**—Selector switch; **■**—Stereo equipment.

**Acoustical Manufacturing Co. Ltd.**, St. Peter's Road, Huntingdon, Hunts. Tel.: H'don 361 and 574. Cables: Acoustical.

**Quad II Q.C. II Control Unit.** Inputs: radio/tape 100 mV; mic. 1.5 mV; gram. to suit pickup. Treble, bass, vol. and on/off, filter slope. Switch filter 5, 7, 10 Kc/s and "out". Tape record socket, switched playback socket. H.D. <0.1%. H and N—70 dB. Size  $10\frac{1}{2} \times 3\frac{1}{2} \times 6\frac{1}{2}$  ins. To operate with Quad II power amp or similar. Price £19 10s.

■**Quad 22 Control unit.** Inputs: Radio/tape 70 mV at 100 K; mic. 1.5 mV at 100 K; pickup dependent on adaptor unit used. Vol. and on/off bass, treble, filter slope, filter switch 5, 7, and 10 Kc/s. Push-button selection of channels, mono-stereo, and record equalisation. H.D. <0.02%. H and N—70 dB total, P.a.t. 330v 35mA each tuner, 6.3v 3 amps. Size  $10\frac{1}{2} \times 3\frac{1}{2} \times 6$  ins. Price £25. To operate with QUAD II amplifiers.

**Quad II Amplifier.** 15 watts. Dist. total 3rd harmonic and higher. <0.1% at 12 watts. Input for spec. output 1.4v. R.M.S. for 15 watts. Response 20-20,000 c/s.  $\pm 0.2$  dB; 10-50,000  $\pm 0.5$  dB. Feedback incorporated in original ultra-linear arrangement. N.L.—80 dB at 15 watts. Out. imp.

7 and 15 ohms. Output KT66's. Original combined anode/screen current circuit. Size  $12\frac{1}{2} \times 4\frac{3}{4} \times 6\frac{1}{2}$  ins. To operate with QCII or Q22 control units. Price £22 10s.

★

**Allegro Sound Equipment Ltd.**, 91a Heath Street, Hampstead, N.W.3.

■**Allegro 66 Integrated Stereo Amplifier.** Inputs mic. 30 mV, tape 30 mV. 7 watts per channel. Dist. 0.5% at 4.3 watts. Response 25-20,000 c/s  $\pm 3$  dB. N.L.—60 dB. Out. imp. 15 ohms. Output ECL82's. Size  $13\frac{1}{4} \times 9\frac{1}{2} \times 5\frac{1}{2}$  ins. Price £29 8s.

★

**Altobass Ltd.**, Percy Road, Aylestone Park, Leicester. Tel.: Leicester 31616. Cables: Altobass, Leicester.

"**High Fidelity 510**" Control Unit. Inputs: tape/radio 100 mV; P/U (I.p.) 50 mV; P/U (78) 60 mV; mic. 10 mV 5-pos. sel., treble, bass vol. and on/off. Tape replay socket. H.D. 0.15%. H and N—64 dB mic.; —71 dB on other inputs. Size  $10 \times 3\frac{1}{2} \times 4\frac{1}{4}$  ins. Price £8 8s. Sold only with 510 power amp.

"**High Fidelity 510**" Amplifier. 10 watts nom., 11 watts max. Dist. 0.1% (10 watts



*ACOUSTICAL QUAD  
II STEREO  
CONTROL UNIT*

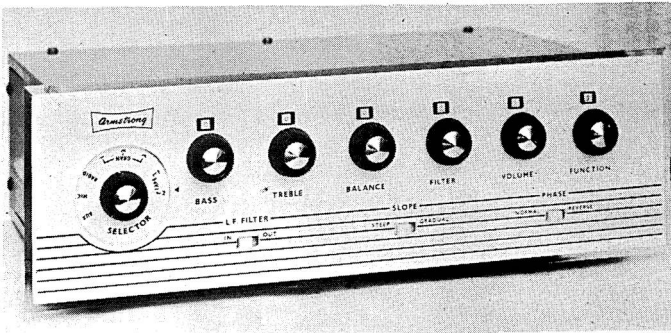

**ARMSTRONG**  
PCU 27  
STEREO  
CONTROL UNIT

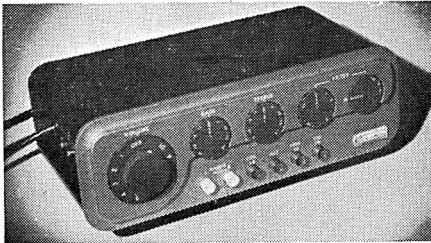

*Quad Q.C. 11 control unit*

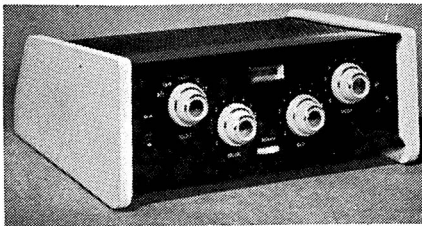

*Allegro 66 integrated stereo*

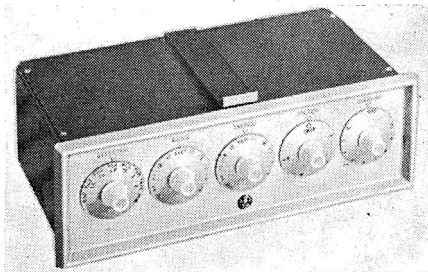

*A.E.I. Mk. 1 control unit*

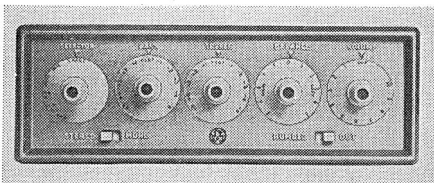

*A.E.I. stereo control unit*

at 400 c/s). Input for spec. output 40 mV. Response 15-20,000 c/s  $\pm 0.6$  dB. Feedback -20.5 dB. N.L. -78 dB relative to 10 watts. Out. imp. 3.75 or 15 ohms output EL84's. Ultra-linear. Size  $13\frac{1}{4} \times 5\frac{1}{2} \times 5\frac{3}{4}$  ins. Price £15 15s.

**Altobass Seventy Control Unit.** Inputs: Pickup 4 and 50 mV; Radio 250 mV; Tape 5 and 250 mV; Aux. 50 mV. 6-position sel., bass, treble, volume and on/off; switched high pass filter 100 c/s, switched low pass filter 5.5 Kc/s. H.D. 0.015%. H and N Tape -52 dB, others -56 dB. Size  $10\frac{3}{8} \times 4 \times 4\frac{1}{2}$  ins. Price £16 16s. To operate with Altobass 510.

■ **Altobass Stereo 70 Control Unit.** Inputs: pickup 4 mV; radio 220 mV; tape 3 mV; mic. 5 mV; aux. 100 mV. 5-position sel., bass, treble, volume, function switch and on/off. H.D. 0.015%. H and N -54 dB. Rumble filter. Size  $13\frac{1}{2} \times 7 \times 3\frac{1}{2}$  ins. Price £24 3s. To operate with Altobass Twin Twelve.

■ **Altobass Twin-Twelve Stereo Amplifier.** 10 watts each channel, 12 watts max. Dist. 0.1% at 10 watts. Input for spec. output 150 mV. Response 20-20,000 c/s  $\pm 0.5$  dB. 20 dB feedback. N.L. -78 dB relative to 10 watts. Out. imp. 4, 8 and 16 ohms. Output EL84's. Ultra-linear. Size  $14\frac{1}{2} \times 7 \times 6\frac{1}{2}$  ins. Price £30 9s. To operate with Altobass Stereo 70 Control Unit.

■ **Altobass Twin II Amplifier and Control Unit.** Inputs: 200 mV for 2 watts per channel. 3-position sel., dual-concentric volume and frequency controls with on/off switch. H and N -56 dB referred to 2 watts. Size: Main amp.  $9 \times 6 \times 5\frac{1}{2}$  ins., Control Unit  $5 \times 3 \times 4\frac{1}{2}$  ins. Price £16 16s. complete.

■ **Stereo 44 Amplifier Kit**—See Kits Section.

Armstrong Wireless & Television Co.,  
Walters Road, Holloway, N.7. Tel.: North  
3213/4.

■**PCU25 Stereo Control Unit.** Inputs:  
Tape 1.100 mV, Tape 2.3 mV. Aux. 100 mV,  
Radio 100 mV; gram. 3.5 mV, mic. 1.8 mV.  
Switched rumble filter, variable treble  
filter. Push buttons. Output 410 mV. 6  
position sel., volume, bass, treble, balance,  
rumble filter, treble filter. H.D. <0.1%  
H and N 61 dB (pickup input of 3.5 mV  
sensitivity). Power supplied by A20 ampli-  
fier. Response 15-22,000 c/s within 1 dB.  
Treble control operates as variable filter  
when filter switched in. To operate with  
A20 power amplifier. Size  $10\frac{1}{2} \times 4\frac{1}{2} \times 7\frac{1}{2}$   
ins. Weight 4 lbs. Price £22 10s.

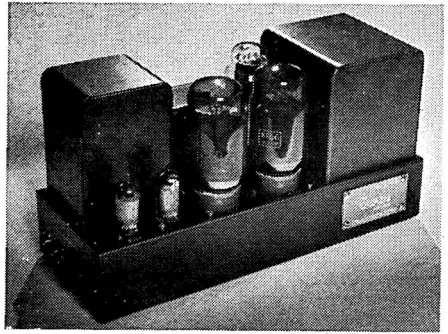

*Quad 11 amplifier*

**Jubilee Mk. 2 Tuner Amplifier Chassis.** 8  
watts. H.D. 0.5%. Input: pickup 180 mV.  
Response 20-30,000 c/s  $\pm 2$  dB. Feedback  
15 dB N.L. 68 dB. Out. imp. 3,  $7\frac{1}{2}$ , 15  
ohms. Output two ECL82's. Self-powered  
A.C. 200-250v. Size  $12 \times 7 \times 8$  ins. Price  
£23 9s. 3d. (U.K. purchase tax £7 10s. 8d.).  
(Also see Tuners Section.)

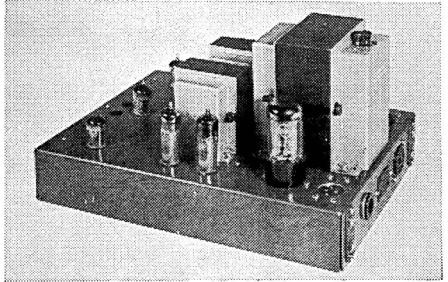

*A.E.I. stereo power amplifier*

■**A20 Stereo Power Amplifier.** 12 watts  
nom. 25 watts max. per channel. H.D.  
< 0.1%. Input for spec. output 410 mV.  
Response 15-22,000 c/s within 1 dB. Feed-  
back 29 dB. N.L. 85 dB. Out. imp. 4, 8  
and 16 ohms. Output two EL84's. Ultra-  
linear. Power supplies required A.C. 100-  
125v and 200-250v. To operate with  
PCU25 stereo control unit. Size  $14 \times 7 \times$   
7 ins. Price £30.

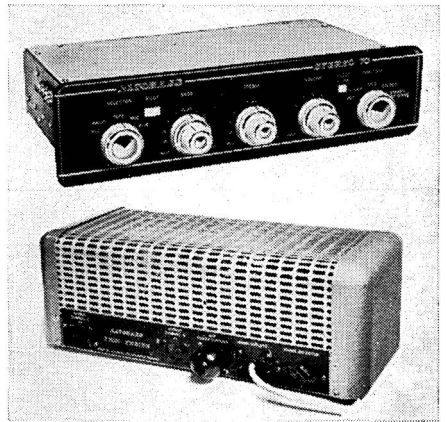

*Altobass stereo 70 C/U and Twin 12 amp.*

■**PCU27 Stereo Control Unit.** Inputs:  
Auxiliary 2 mV. Microphone 2 mV. Radio  
80 mV; Gram 1.80 mV, Gram 2.7 mV;  
Gram 3 3.5 mV; Tape 1 130 mV; Tape 2  
2 mV. 8-position sel., bass, treble, balance  
controls, filter switch, slope switch, rumble  
filter, vol. phase, function. Tape outputs,

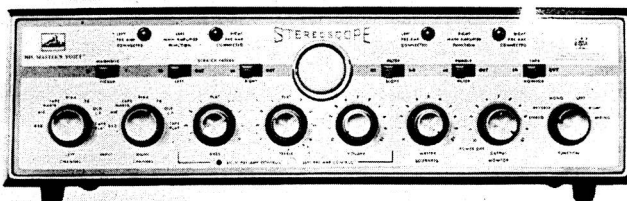

*H.M.V.  
MODEL 556  
STEREOSCOPE  
CONTROL UNIT*

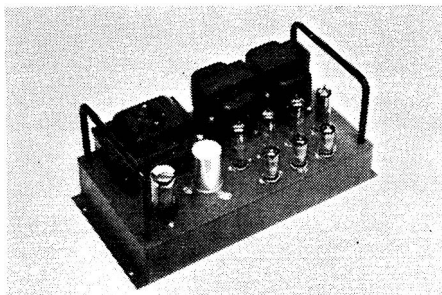

*Armstrong A20 Stereo power amp.*

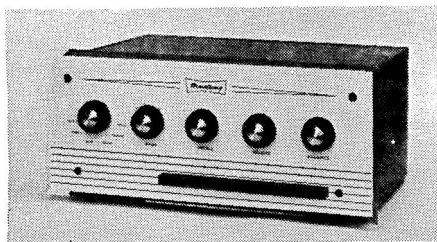

*Armstrong PCU 27 stereo control unit*

stereo and mono. H.D. less than 0.1%. H and N — 62 dB. Power supplies required H.T. 300 volts at 8 mA. L.T. 6.3 volts at 2 amps. Size of front panel  $14\frac{1}{2} \times 4\frac{1}{2}$  ins. To operate with A20 amplifier. Price £28 10s.



**Associated Electrical Industries Ltd., Sound Equipment Group, Crown House, Aldwych, London, W.C.2. Tel.: Temple Bar 8040. Cables: Soundequi, Estrand, London.**



*Altbass Seventy control unit*

**Hi-Fi Control Unit Mk. 1.** Inputs: Mic. 5 mV; tape head 5 mV; pickup 6 and 250 mV; Equalised tape 180 mV; radio 180 mV. 8-position sel., filter, bass, treble, volume and on/off. H.D. <0.05%. H and N — 86 dB. P.a.t. 320v 30 mA, 6.3v 3 amps. Size  $10\frac{1}{4} \times 3\frac{5}{16} \times 5\frac{1}{2}$  ins. Price £17 10s. To operate with BTH Hi-Fi Amplifier, or similar.

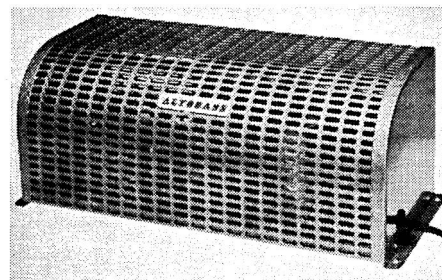

*Altbass 510 amplifier*

**Hi-Fi Power Amplifier Mk. 1.** 20 watts nominal, 30 watts peak. Dist. <0.05%. Input for 20 watts 100 mV. Response 20-20,000 c/s  $\pm 1$  dB. Feedback 24 dB. N.L. — 80 dB. Out. imp. 4, 8 and 15 ohms. Output EL34's. Ultra-linear. Size  $10\frac{3}{4} \times 5\frac{1}{2} \times 6\frac{3}{8}$  ins. Price £24 10s. To operate with BTH Hi-Fi Pre-amp. or as a pair with BTH Stereo Control Unit.



*A.E.I. Mk. 1 power amplifier*

■ **Stereo Hi-Fi control unit.** Inputs: stereo and mono pickup, stereo tape, radio, mic. spare. 6-position sel. bass, treble, balance, vol., on/off. Rumble filter. H.D. less than 0.05% at 10 watts. H and N — 85 dB. P.a.t. 200v 30 mA, 6.3v 3 amps. Size  $10\frac{1}{4} \times 5\frac{1}{2} \times 3\frac{5}{16}$  ins. To operate with BTH stereo amplifier or two mono amplifiers. Price £24 9s.

■ **Stereo Power Amplifier.** 10 watts each channel, 15 watts max. Dist. less than 0.05% at 10 watts. Input for spec. output 100 mV. Response 20-20,000 c/s  $\pm 1$  dB. 24 dB feedback. N.L. — dB relative to 10 watts. Out. imp. 4, 8 and 61 ohms. Out-

put EL84's ultra-linear. Size  $12\frac{3}{4} \times 10 \times 7\frac{3}{4}$  ins. To operate with BTH stereo control or similar. Price £27.



**Associated Electronic Engineers Ltd.,** 10 Dalston Gardens, Stanmore, Middx. Tel.: Wordsworth 4474/5/6. Cables: Astronic, Stanmore.

**Astronic A1332 Control Unit.** Inputs: mic. 20 mV; gram. A.E.S., FFRR, NARTB 10-20 mV; radio/tape 220 mV. 6-pos. sel. treble, bass, vol. and on/off, gram. input attenuator. Tape record and playback socket. H and N - 70 dB. Size  $12 \times 3\frac{3}{8} \times 1\frac{7}{8}$  ins. To operate with A1333 power amp. Price £9 10s. 6d.

**Astronic A1432 Control Unit.** Inputs: mic. 20 mV; radio 120 mV; P/U 4 mV or 20 mV; tape (C.C.I.R.) 1-2 mV. 6-pos. sel (3 record equal.), treble, bass, vol. on/off. Filter 5, 7, 10 Kc/s. Slope 6-30 dB/octave. Loudness - 18 dB max. Presence + 6 dB, 2-3 K/cs. Rumble filter. Variable P/U attenuator. Socket for direct replay from tape head. H.D. not measurable. H and N - 65 dB. Size  $11\frac{1}{2} \times 3\frac{1}{2} \times 5\frac{1}{4}$  ins. To operate with A1333 or A1440 amplifiers. Price £21 19s.

**Astronic A1333 Amplifier.** 10 watts nom., 13 watts max. Dist. 0.1% at 10 watts. Input for spec. output 0.33v R.M.S. Response 20-20,000 c/s  $\pm 0.5$  dB. Feedback 18 dB N.L. - 72 dB. Out. imp.  $3\frac{3}{4}$ ,  $7\frac{1}{2}$  and 15 ohms. Output N709's or EL84's. Ultra-linear. Size  $11\frac{1}{2} \times 6\frac{1}{4} \times 6$  ins. To operate with A1332 control unit. Price £18 19s. 6d.

■ **Astronic A1434 Stereo Control Unit.** Inputs, single channel: tape 1-2 mV; l.p. (Int.) 4 mV; radio 120 mV; mic. 20 mV; aux. 120 mV. Stereo inputs for tape, P/U and radio same sensitivities. 8-pos. sel., bass, treble, vol., on/off, rumble filter, presence switch, channel balance (pre-set). Dist. negligible. H and N - 65 dB. Size  $11\frac{1}{2} \times 3\frac{1}{2} \times 6$  ins. To operate with amplifiers A1333 Mk. I and Mk. II or A1440. Price £22 5s.

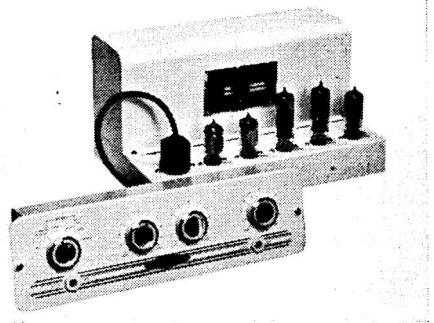

*Astronic A1332 control unit and A1333 amp*

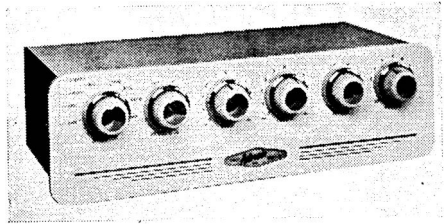

*Astronic A1434 stereo control unit*

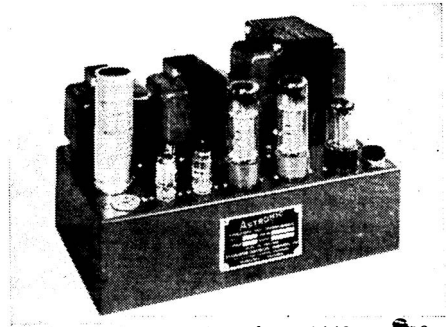

*Astronic Atlas A1440 amplifier*

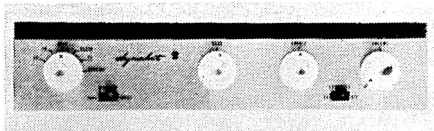

*Dynakit PAM-1 control unit*

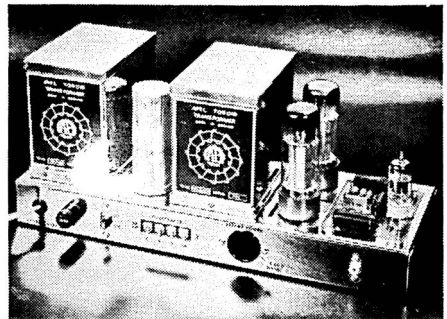

*Avel-Dynaco MK IV amp.*

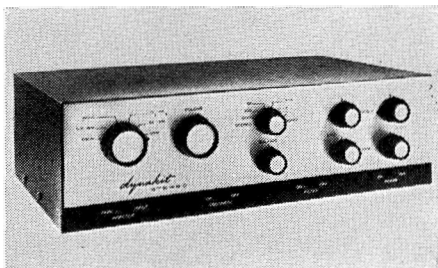

*Dynakit PAS-2 Stereo Control Unit*

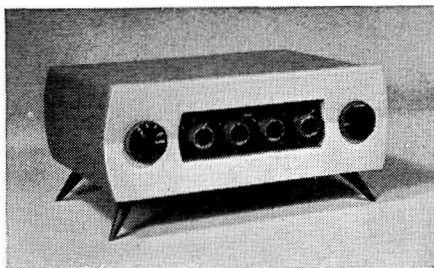

*Chapman 305 stereo control unit*

■ **Astronic A1444. Combined Stereo Unit.** 4 watts. Dist. 2%. Inputs: radio, tape and l.p. discs. 150 mV; 78 discs. 350 mV. 4-position sel., bass, treble, volume and on/off. Out. imp. 3 and 15 ohms. Size  $11\frac{1}{2} \times 8\frac{3}{4} \times 3\frac{1}{4}$  ins. Price £24 3s.

**Atlas A1440.** 20 watts nominal, 35 watts max. Dist. 0.1%. Input for spec. output 0.25 volts. Response 20-20,000 c/s  $\pm 5$  dB. Feedback 30 dB. N.L. - 85 dB. Out. imp.  $3\frac{3}{4}$ ,  $7\frac{1}{2}$  and 15 ohms. Output EL34's. Ultra-linear. Size  $13 \times 7\frac{1}{4} \times 8\frac{1}{2}$  ins. Price £37 16s. To operate with amplifiers A1332, A1432, and A1434.



**Aveley Electric Ltd.,** Ayrton Road, Aveley Industrial Estate, South Ockendon, Essex. Tel.: South Ockendon 3444. Cables: Aveley, Ockendon.

**Dynakit PAM-1 Mono. Free-standing Control Unit.** Inputs: pickup, radio, tape. Output 2v max. 6 pos. sel., bass, treble, volume, tape monitor switch, loudness switch, hum balance. H and N. 70 dB down on 10 mV cartridge. Power supplies required D.C. 200 to 400v at 4 mA, A.C. 6v at 0.75 amp. A.C. Response  $\pm 0.5$  dB

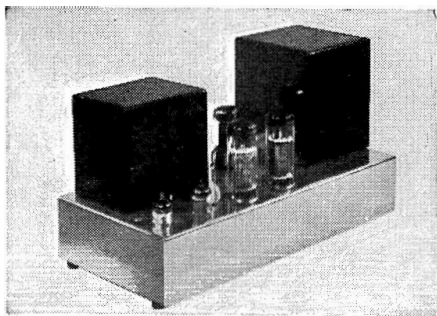

*Chapman 205 amplifier*

10-40,000 c/s. D.C. heater supply. To operate with Avel-Dynaco Mk. IV power amplifier. Size  $12 \times 2\frac{5}{8} \times 6\frac{1}{8}$  ins. Weight  $4\frac{1}{2}$  lbs. Price £22 19s. 11d. Available in kit form £16 19s. 11d.

**Dynakit PAS-2 Stereo Control Unit. Free-standing.** Inputs: mic., tape, radio. Scratch filter. Output 2v max. 6 pos. sel., volume, balance, blend, ind. tone controls for each channel, tape monitor switch, loudness switch. H.D. unmeasurable. I.M. dist.  $< 0.05\%$  at full output. H and D - 70 dB down. Self-powered. Response  $\pm 0.5$  dB 10-40,000 c/s. D.C. heater supply. To operate with two Mk. IV power amplifiers or Avel-Dynaco stereo 70. Size  $13 \times 3\frac{3}{4} \times 7\frac{1}{4}$  ins. Weight 8 lbs. Price £34 19s. 9d. (Also available in kit form £28 19s. 10d.)

**Avel-Dynaco Mk. IV Amplifier.** 30 watts nom., 50 watts max. H.D. L.F. range  $< 0.25\%$ . High range 15,000 c/s  $< 1\%$ , mid range  $< 0.1\%$ . Input for spec. output 1.4v. Response  $\pm 0.5$  dB from 20-60,000 c/s. Feedback 20 dB overall. N.L. 90 dB down on 30 watts. Out. imp. 4, 8, 16 ohms. Output matched EL34's. Ultra-linear. Power supplies required A.C. 0-200/240v. To operate with PAM-1 or PAS-2 Control units. Size  $5 \times 14 \times 6\frac{1}{2}$  ins. Price £35. (Also available in kit form £29 10s.)

■ **Avel-Dynaco "Stereo 70" Amplifier.** 35 watts per channel, 40 watts max. H.D. as for Mk. IV. Input for spec. output 1.4v each channel. Response  $\pm 0.5$  dB 20-60,000 c/s. Feedback 20 dB both channels. N.L. 90 dB below 30 watts. out. Out. imp. 4, 8 or 16 ohms. Output EL34's. Ultra-linear. Power supplies required 200-240v A.C. Size  $10 \times 13 \times 6\frac{1}{2}$  ins. Price £49. (Also available in kit form £42.)

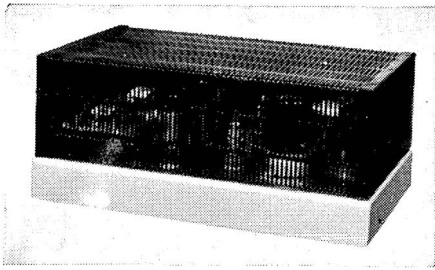

*Chapman 305 stereo amplifier*

**Cape Electrophonics Ltd.**, 43-45 Shirley High Street, Southampton. Tel.: Southampton 74251.

**Cape VL 50.** 50 watts nom. Dist. at 1000 c/s. 0.1%. Input adjustable, from 1 mV. Response 10-50,000 c/s  $\pm$  1 dB. Feedback two loops 20 dB. N.L. - 85 dB. Out. Imp. 3, 7½ and 15 ohms. Output. K.T. 88's Ultra Linear. Size 18 x 9½ x 9½ ins. Weight 55 lbs. Price £75.

**Cape VL 100.** 100 watts. Nom. (Spec. as VL 50). Price £85 (Provisional).

**Cape VL 20.** 20 watts nom. (As VL 50) but with low distortion and noise.



**Chapman Ultrasonics Ltd.**, Sales Division, 24 Upper Brook Street, London, W.1. Tel.: Hyde Park 2291.

**Chapman 205 Amplifier.** 20 watts from 30-20,000 c/s. Dist. <0.05% at 20 watts. Response 2-100,000 c/s  $\pm$  1 dB. Feedback 30 dB. N.L. - 89 dB at 20 watts. Out. imp. 15 ohms. Output EL34's. Ultra-linear. To operate with 205CU. Price £34.

■ **Chapman 305 Stereo Control Unit.** Inputs: Pickup and tape 4.5 mV; radio 100 mV; Aux. 100 mV. 4-position sel., bass, treble, volume, balance, filter. H.D. <0.1%. H and N - 50 dB. Rumble filter. Size 12 x 4½ x 6½ ins. Price £18 18s. To operate with 305 amplifier or 2 x 205 amplifiers.

■ **Chapman 305 Stereo Amplifier.** 8 watts per channel, 15 watts peak. Dist. <0.1%. Input for spec. output 350 mV. Response 30-20,000 c/s  $\pm$  0.2 dB. Feedback 10 dB. N.L. - 80 dB. Out. imp. 3 and 15 ohms. Output EL84's. Ultra-linear. Size 12 x 7 x 5 ins. Price £21. To operate with 305 pre-amplifier.



*H.M.V. 599 stereo control unit*

**Chapman 105 Combined Control Unit and Amplifier.** 10 watts nominal, 20 watts peak. Inputs: pickup 10 and 50 mV; radio and tape 100 mV. Selector, bass, treble, filter, loudness control, volume and on/off. Rumble filter. Dist. <0.1%. Response 30-20,000 c/s  $\pm$  0.2 dB. N.L. - 80 dB. Out. imp. 3 and 15 ohms. Output EL84's. Ultra-linear. Size 12 x 4½ x 8½ ins. Price £29 18s.



**Clarke & Smith Manufacturing Co. Ltd.**, H.M.V. High Fidelity Components Division, Melbourne Road, Wallington, Surrey. Tel.: Wallington 9252. Cables: Electronic, Wallington.

■ **H.M.V. 555 Stereoscope. Integrated Stereo Amplifier.** 10 watts per channel. Inputs: pickup 2 mV magnetic; 60 mV crystal; tape 3 and 150 mV; microphone 2 and 20 mV; tuner 150 mV. H.D. 0.1%. 10 watts at 1,000 c/s. Response 20-20,000 c/s  $\pm$  1 dB. Power amp. 40-5,000 c/s at full output. Feedback 34 dB. N.L. main amp. 80 dB below full output, radio inputs 60 dB below full output. Out. imp. 4 and 16 ohms. Output EL84's. Ultra-linear. Self-powered. Size 4 x 14 x 13½ ins. Price £66 3s.

■ **H.M.V. 556 Stereoscope. Stereo Control Unit.** Inputs: as for 555. Scratch and

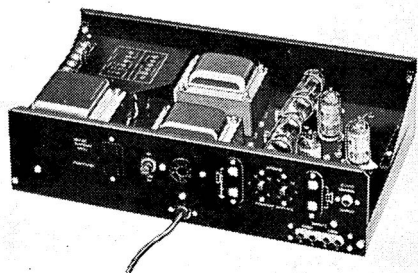

*H.M.V. 577 stereo amplifier*



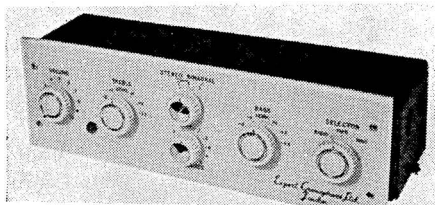

*Expert stereo control unit*

rumble filters. Output cont. variable from 100 mV to 3v for specified input sensitivities. Input selectors: two bass, two treble, two volume, two master loudness, output monitor, junction switch, scratch filters, filter slope, rumble filter, tape monitor, pickup selector. H.D. <0.1% for 6v output. H and N. Low sens. inputs better than 66 dB down. Power supply required 110/250v at 50 or 60 c/s. Response  $\pm 1$  dB 20-20,000 c/s. Size  $4 \times 4 \times 10\frac{1}{2}$  ins. Weight 14 lbs. To operate with H.M.V. 557 amplifier. Price £40 19s.

■ **H.M.V. 557.** Stereo Amplifier. 10 + 10 watts stereo. H.D. 0.1% for 10 watts at 1 Kc/s. Power take off 300v unsmoothed through 100 ohms at 8 mA max. and 6.3v heaters, 2 amps. max. Response 20-20,000 c/s  $\pm 1$  dB. Feedback 22 dB. N.L. 80 dB below full output. Out. imp. 4 or 16 ohms. Output EL84's. Ultra-linear. Self-powered. Size  $4 \times 14 \times 8\frac{1}{2}$  ins. To operate with H.M.V. 556 or 599 Control Units. Price £31 10s.

■ **H.M.V. 599.** Stereo Control Unit. Inputs: pickup, radio, tape. Output 200 mV. 5 pos. sel., bass, treble, balance, function, volume. H and N = 3 microvolts on gram. R.I.A.A. input. Power supply required 5 mA at 300v and 1.2 amps at 6.3v. Response 20-20,000 c/s  $\pm 1$  dB. Size  $11\frac{1}{4} \times 4 \times 5\frac{1}{2}$  ins. Weight 6 lbs. To

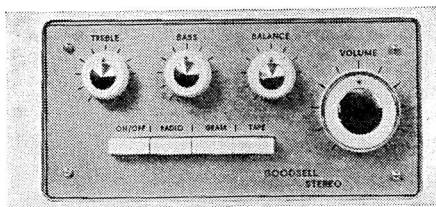

*Goodsell stereo 111 control unit*

operate with H.M.V. 557 amplifier. Price £12 12s.



**Expert Gramophones Ltd.**, 235a Bensham Lane, Thornton Heath, Surrey. Tel.: Thornton Heath 4139. (Showroom: 82 Kensington High Street, London, W.8. Tel.: Western 0037.)

■ **Expert "Standard" Amplifier.** 12 watts nom., 14 watts max. Dist. 0.1%. Input for spec. output 200 mV. Response 20-25,000 c/s  $\pm 0.5$  dB. Feedback 30 dB. N.L. - 80 dB at 8 watts. Out. imp. 15 ohms. Output EL84's. Ultra-linear. Size  $12 \times 9 \times 6\frac{1}{2}$  ins. To operate with Expert control unit or similar. Price £23.

■ **Expert "Master" Amplifier.** 20 watts nom., 26 watts max. Dist. 0.07%. Input for spec. output 200 mV. Response 20-30,000 c/s  $\pm 0.5$  dB. Feedback 30 dB. N.L. - 85 dB at 20 watts. Out. imp. 15 ohms. Output EL34's. Ultra-linear. Size  $12 \times 9 \times 7\frac{1}{2}$  ins. To operate with Expert control unit or any similar. Price £35.

■ **Expert "Standard" Stereo Amplifier.** 10 watts per channel. Dist. 0.1% at 10 watts. Input for spec. output 200 mV. Response 30-20,000 c/s  $\pm 1$  dB. 28 dB feedback. N.L. - 80 dB ref. 8 watts. Out. imp. 15 ohms. Output ECL82's. Size  $12 \times 9 \times 6\frac{1}{2}$  ins. To operate with stereo Mk. I control unit. Price £23.

■ **Expert Stereo Control Unit 62.** Inputs and outputs for pickup, tape and radio. Tape, in and out, front and rear. Inputs: aux. 0.5 - 200 mV. Imp. 100 K ohms - 2 M ohms. Cha. flat, C.C.I.R. & R.I.A.A. Radio 220 mV, tape 4 mV. Pickup 1 variable, pickup 2 3 mV. Treble, bass, filter, balance and focus control. Record. outputs 200mV not affected by vol. Size  $12\frac{1}{4} \times 5\frac{1}{2} \times 4\frac{1}{2}$  ins. To operate with any 200 mV amplifier sensitivity. Price £36 15s.

■ **Expert Stereo Mk. I Control Unit.** Inputs (6) 250 mV sensitivity. Switched bass,



*Expert Standard stereo amplifier*

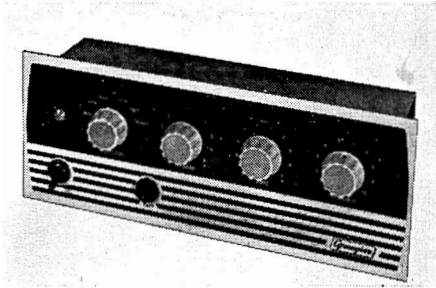

*Grampian 580 control unit*

treble, function controls. H.D. less than 0.1%. P.a.t. Size  $12 \times 3\frac{1}{2} \times 3$  ins. To operate with "Standard" stereo amplifier. Price £18.



**Goodsell Ltd.**, 40 Gardner Street, Brighton. Tel.: Brighton 26735.

■ **Stereo II Control Unit.** Inputs: pickup 7 mV stereo; radio 150 mV; tape 3 mV. Selector switch, vol., bass, treble, on/off. H.D. 0.1%. Size  $13 \times 7\frac{1}{2} \times 3\frac{3}{4}$  ins. Price £27 15s.

■ **Stereo III Control Unit.** Inputs: pickup 60 mV, radio and tape 100 mV. Push-button selector, ganged bass, treble, volume controls. H and N - 65 dB. To operate with Goodsell "Mullard" stereo amplifier. Price £9 15s.

**GW25 Amplifier.** 20 watts. Dist. 0.1%. Input for spec. output 1.5v. Response 20-100,000 c/s. Feedback 20 dB. N.L. better than - 75 dB. Out. imp. 3, 8 and 15 ohms. Output KT66's. Ultra-linear. Size  $14 \times 10 \times 7$  ins. Weight 35 lb. To operate with PFA control unit. Price £33 10s.

■ **"Mullard" Stereo Control Unit.** Details as per Mullard 2-valve design. To operate with Goodsell "Mullard" amplifier. Price £16 15s.



**Grampian Reproducers Ltd.**, Hanworth Trading Estate, Feltham, Middx. Tel.: Feltham 2657/8/9. Cables: Reamp, Feltham.

*Details of New Products are given in a special supplement at the end of the book.*

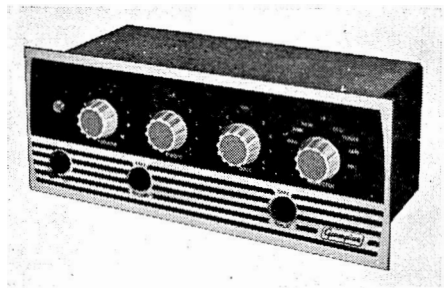

*Grampian 582 control unit*

■ **Grampian 582 Control Unit.** Inputs: pickup 15 mV; radio 200 mV; tape 500 mV. Selector switch, bass, treble, vol. Size  $10\frac{1}{4} \times 4 \times 5\frac{1}{2}$  ins. Price £14. To operate with "Ten Fifteen" Amplifier.

■ **Grampian 580 Control Unit.** Similar to 582, but for crystal pickups. Sensitivity 600 mV, radio 500 mV. Price £8 5s.

■ **Grampian 10-15 Amplifier.** 10 watts nom., 15 watts peak. Dist. 0.1% at 10 watts. Input for spec. output 50 mV. Response 30-20,000 c/s  $\pm 1$  dB. Feedback 20 dB. N.L. - 65 dB below full output. Out. imp. 4, 8, 15 ohms. Output EL84's. Ultra-linear. Size  $11 \times 7\frac{1}{2} \times 6\frac{1}{2}$  ins. To operate with "580" and/or "582" control unit. Price £18.

■ **Grampian 590/2 series.** Stereo Unit. 7 watts per channel, 10 watts peak. Dist. 1%. H and N - 60 dB. Inputs: pickup 0.5v at 1 Megohm, tuner and tape 1v at 0.5 Megohm. Sel., switch, balance, bass, treble. Out. imp. 4 and 15 ohms. Size: chassis  $10\frac{7}{8} \times 3\frac{7}{8} \times 13$  ins., wood surround  $12\frac{1}{2} \times 5\frac{1}{2} \times 13$  ins. Price 590/2 (control unit and two 584 amplifiers), £32, wood surround £2.

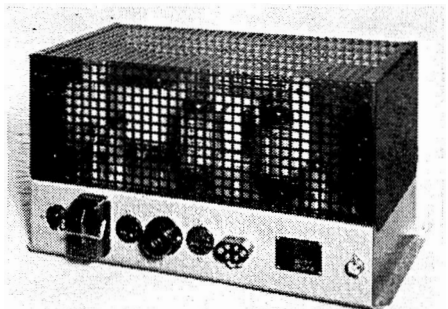

*Goodsell GW 25 amplifier*



Jason Electronic Designs Ltd., Kimberley Gardens, Harringay, London, N.4. Tel.: Stamford Hill 5477.

**J10 Combined Control Unit and Power Amplifier.** Inputs: mic. 1 mV; tape 0.5V; radio 0.4V; P/U 1.0v and crystal P/U. 6-pos. sel., treble, bass, vol. P.a.t. 270v at 10 mA, 6.3v at 0.3 A. Output 10 watts nom., 15 watts max. Dist. 0.1%. Response 30-30,000 c/s  $\pm$  2 dB. N.L. better than 55 dB (mic. input). Out. imp. 15 ohms (other imp. to order). Output EL84's. Ultra-linear. Size  $15 \times 8\frac{1}{4} \times 4\frac{3}{8}$  ins. Price £24.

Jason J2-10 Mk. 111 integrated stereo amp.



■ **J2-10. Integrated Stereo Amplifier, Mk. III.** Inputs: pickup 3 mV and 60 mV; tape 1.5 mV; radio 60 mV; mic. 5 mV. 5-position sel. switch; bass, treble, vol., balance, function, 9 Kc/s and 6 Kc/s filter. H.D. less than 0.1%. H and N - 55 dB Rumble filter. 10 watts per channel, 15 watts max. 18 dB feedback. Out. imp. 4, 8, 15 ohms. Output EL84's. Size  $15 \times 4\frac{3}{8} \times 12$  ins. Price £40 19s.

Leak Varislope 111 control unit



★  
H. J. Leak & Co. Ltd., 57-59 Brunel Road, East Acton, London, W.3. Tel.: Shepherds Bush 1173. Cables: Sinusoidal, Ealux, London.

Leak "Point One Stereo" control unit

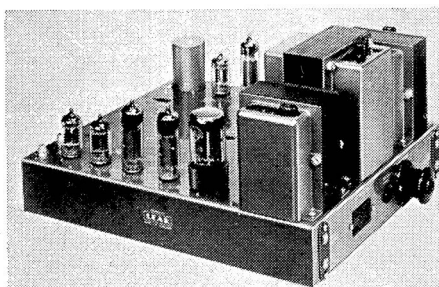

★  
"Point One Plus" Control Unit. Inputs: tape 50 mV or mic. 4 mV; tuner 50 mV; P/U 9.5 mV. 6-pos. sel., 4 record equal, treble, bass, vol., mains on/off. Switch filter 4, 6 and 9 Kc/s. Input level control for P/U, tuner. Tape record and replay sockets on front and rear. H.D. <0.01%. H and N - 66 dB. Size  $11\frac{1}{2} \times 4\frac{7}{16} \times 5$  ins. To operate with TL/12 Plus, TL/25 Plus or TL/50 Plus amplifier. Price £12 12s.

Leak "Point One" Stereo 20 amplifier

★  
"Varislope III" Control Unit. Inputs: tape 50 mV or mic. 4 mV; tuner 50 mV;

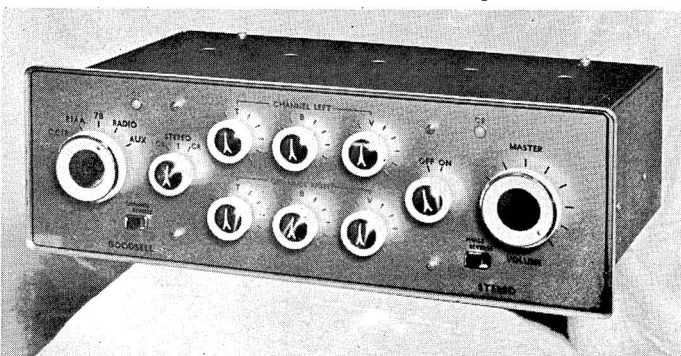

GOODSELL  
STEREO 11  
CONTROL UNIT

pickup I 9 mV; pickup II 9 mV. 6-pos. sel., 4 record equal and change-over switch for pickup I/pickup II. Treble, bass, vol., mains on/off. Switched low pass filter 4, 6 and 9 Kc/s plus Vari-slope control. Rumble filter cut/in. Input level controls for tuner, pickup I, pickup II. Tape input sockets on front and back panels. H.D. <0.01%. H and N - 66 dB. Size  $11\frac{1}{2} \times 4\frac{7}{16} \times 5$  ins. To operate with TL/12 Plus, TL/25 Plus, and TL/50 Plus amp. Price £15 15s.

**“Point One” TL/12 Plus Amplifier.** 12 watts. Dist. 0.1%. Input for spec. output 125 mV. Response 20-20,000 c/s  $\pm 0.25$  dB. Feedback 26 dB. N.L. - 84 dB. Out. imp. 4, 8 and 16 ohms. Output EL84's. Ultra-linear. Size  $10 \times 8 \times 6$  ins. To operate with Varislope III or Point One Plus control units. Price £18 18s.

**“Point One” TL/25 Plus Amplifier.** 25 watts. Dist. 0.1%. Input for spec. output 125 mV. Response 20-20,000 c/s  $\pm 0.25$  dB. Feedback 26 dB. N.L. - 83 dB. Out. imp. 4, 8 and 16 ohms (other imps. to order). Output EL34's. Ultra-linear. Size  $10 \times 8 \times 6\frac{1}{4}$  ins. To operate with Vari-slope III or Point One Plus control units. Price £25 4s.

**“Point One” TL/50 Plus Amplifier.** 50 watts. Dist. 0.1%. Input for spec. output 125 mV. Response 20-20,000 c/s  $\pm 0.25$  dB. Feedback 26 dB. N.L. - 84 dB. Out. imp. 4, 8 and 16 ohms (other imps. to order). Output KT88's. Ultra-linear. Size  $11\frac{1}{2} \times 9 \times 6\frac{1}{4}$  ins. To operate with Vari-slope III or Point One Plus control units. Price £33 12s.

■ **Varislope Stereo Control Unit.** Twin channel inputs: Pickup I 3.5 mV or 35 mV; pickup II 3.5 mV or 350 mV; tape 3 mV; tuner 50 mV or 250 mV; mic. 2 mV; extra 50 mV or 1V (all mono and stereo), sel.

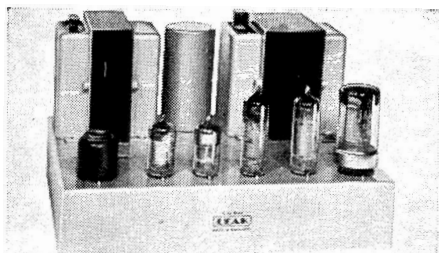

*Leak TL/12 plus amplifier*

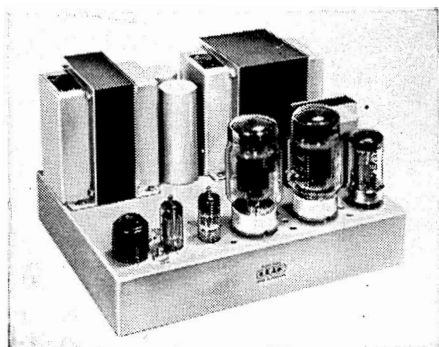

*Leak TL/25 Plus amplifier*

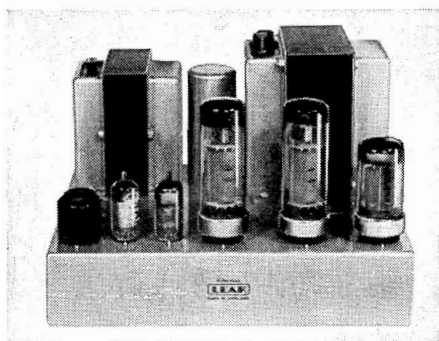

*Leak TL/50 Plus amplifier*

LEAK VARISLOPE  
STEREO CONTROL  
UNIT





*Dulci Stereo 5 control unit*

switch. Function switch. Bass, treble, vol., on/off. Switched low pass filter 4, 6, 9 Kc/s plus Varislope control. Rumble filter cut/in. Balance control. Tape sockets for recording H.D. 0.01%. H and N - 60 dB. Size  $11\frac{1}{2} \times 4\frac{1}{2} \times 6\frac{1}{2}$  ins. To operate with any Leak amplifiers. Price £25.

■ **"Point One Stereo" Control Unit.** Twin channel inputs for P/U, 3.5 mV; tuner 50 mV, auxiliary 50 mV; tape head 3 mV; mic. 2 mV. Function and rumble switches, balance, treble, bass, vol., mains on/off. Input level controls. Tape sockets for recording. H.D. 0.01% on each channel. H and N - 60 dB. Size  $11\frac{1}{2} \times 4\frac{1}{8} \times 5$  ins. To operate with any Leak amplifiers. Price £21.

■ **"Point One" Stereo 20 Amplifier.** 11 watts each channel. Dist. 0.1% on each channel. Input for spec. output 125 mV. Response 20-20,000 c/s. Feedback 24 dB. N.L. - 80 dB. Out. imp. 4, 8 and 16 ohms. Output EL84's. Ultra-linear. To operate with "Point One Stereo" or "Varislope Stereo" control units. Price £30 9s.

■ **"Point One" Stereo 50 Amplifier.** Details as for Stereo 20 but 25 watts each channel. Price £42.

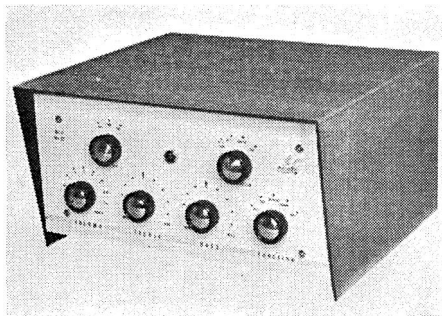

*Lowther MCUMK 1V control unit*

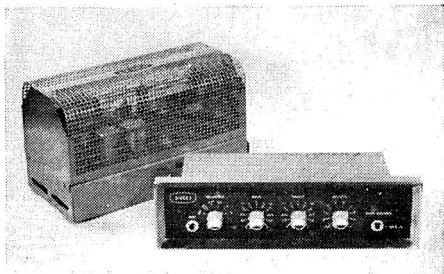

*Dulci DPA 15 control unit and amp.*

**Lee Products (G.B.) Ltd.,** 10-18 Clifton Street, London, E.C.2. Tel.: Bishopsgate 6711. Cables: Leprod, London.

■ **Elpico AC88.** Inputs: mic. 4 mV; radio, pickup and tape 100 mV. 10 watts nom., 16 watts max. Dist. 0.5% at 10 watts. Response 50-20,000 c/s  $\pm 3$  dB. N.L. - 55 dB. Out. imp. 3-15 ohms. Out. EL84's. Ultra-linear. Size  $14 \times 7\frac{1}{2} \times 8$  ins. Price £25 4s.

■ **"Stereo Eight" Control Units.** Inputs: mic. and tape 3 mV; radio 100 mV; pickup 4 to 100 mV; tape 100 mV; aux. 50 mV to 2 volts. 6-position sel., bass, treble, filter, balance, function. H.D. <0.1%. H and N - 50 dB. Rumble filter. Size  $14\frac{1}{2} \times 4 \times 9\frac{3}{8}$  ins. Price £23 2s. To operate with two DPA10, or SP44 amplifiers.

■ **Dulci SP-55 Amplifier.** Input sensitivity: 200 mV for 3 watt output per channel. Output 8 watt peak (4 watts per channel). H.D. better than 0.5% total harmonic content. H and N - 70 dB. Response  $\pm 1$  dB from 40-25,000 c/s. Size  $11\frac{1}{2} \times 6 \times 7\frac{1}{2}$  ins. Weight 13 lbs. 12 oz. To operate with Stereo-Five preamplifier control unit. Price £15 15s.

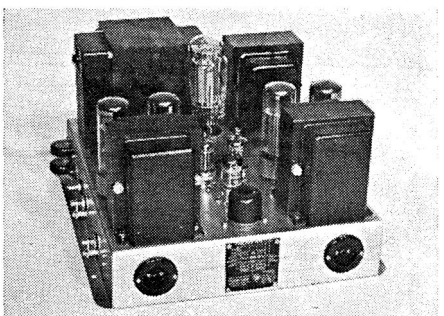

*Lowther LL15S stereo amplifier*



*Dulci GA-505 integrated stereo amp.*

**Dulci DPA-15 Amplifier.** 12 watts nom. 15 watts max. H.D. total harmonic below 0.3% at 10 watts. Response at 1 watt within 1 dB 5-20,000 c/s, at 1 watt within 5 dB 3-50,000 c/s, at 10 watts within 1 dB 30-15,000 c/s. H and N. 75 dB below 10 watts. Out. imp. switchable 3-5, 6-8, 12-16 ohms. Output EL84's. Ultra-linear. Size  $11\frac{1}{8} \times 6 \times 7\frac{1}{2}$  ins. To operate with DPA-15 control unit. Price £15 15s.

■ **Dulci GA-505. Integrated Stereo Amplifier.** 4 watts nom., 5 watts max. H.D. better than 1% at 4 watts per channel. N.L. - 55 dB. Out. imp. 3 or 15 ohms. Output two ECL86's. Power supply required A.C. 230v, 40-60 cycles. Size  $12\frac{3}{4} \times 3\frac{3}{4} \times 6\frac{1}{2}$  ins. Price £18 18s.

Details of DPA 15 control unit and Stereo 5 see New Products supplement.



**Lowther Manufacturing Co.,** Lowther House, St. Mark's Road, Bromley, Kent. Tel.: Ravensbourne 5225. Cables: Lowther, Bromley.

**Lowther No. 2 Control Unit.** Inputs: mic. 15 mV; P/U 15 mV; radio 250 mV. 4-pos. sel., treble, bass, vol., on/off. Mic./tape input socket. H.D. 0.1% on 1v

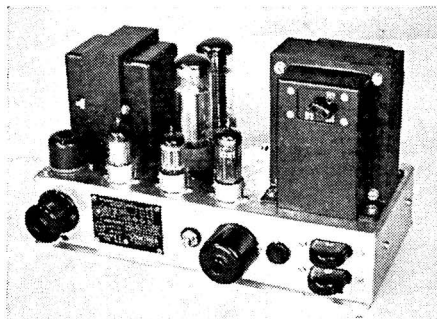

*Lowther LL16 amplifier*

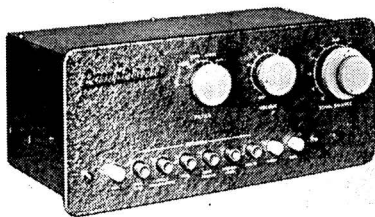

*Pamphonic 1002B control unit*

R.M.S. H and N - 60 dB. Size  $10\frac{1}{4} \times 2\frac{1}{2} \times 3\frac{1}{2}$  ins. To operate with LL15. Price £10 10s.

**Master Control Unit Mk. II.** Inputs: mic., P/U and tape head 3 mV; radio, tape and aux. 100 mV. 6-pos. sel., 5-pos. record equal, treble, bass, vol., on/off. Low pass filter. 18 dB per octave. 35 down to 4 Kc/s. Socket for direct connection to tape playback had. H.D. <0.1%. H and N - 90 dB. Size  $10\frac{1}{2} \times 5\frac{1}{2} \times 7\frac{1}{2}$  ins. To operate with LL15, LL26 and similar power amp. Price £24.

**Lowther LL15 Amplifier.** 16 watts. Dist. <0.1%. Input for spec. output 0.75v. Response 20-40,000 c/s  $\pm 1$  dB. Feedback 20 dB. N.L. - 85 dB. Out. imp. 16 ohms with adjustment. Output EL34's. "Lowther Linear" (screen and anode feedback). P.a.t. Size  $12 \times 6 \times 6$  ins. To operate with MCU Mk. IV or control unit No. 2. Price £27 10s.

**Lowther LL26 Amplifier.** 26 watts. Dist. <0.1%. Input for spec. output 0.75v. Response 20-70,000 c/s  $\pm 1$  dB. Feedback 22 dB. N.L. - 85 dB. Out. imp. 16 ohms with adjustment. Output EL34's. "Lowther Linear". Size  $11 \times 12 \times 7\frac{1}{2}$  ins. Weight 33 lbs. To operate with MCU Mk. IV. Price £47.

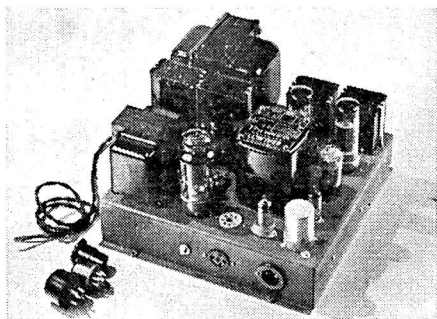

*Lowther LL26 amplifier*



*Pamphonic 3001 integrated stereo amp.*

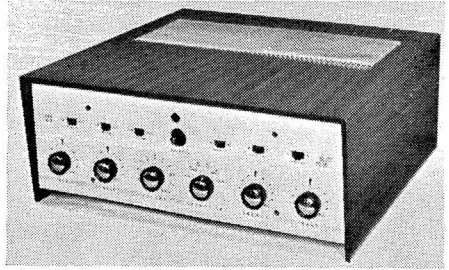

*Lowther integrated stereo amplifier*

**Lowther Mk. IV Control Unit.** Inputs: mic. 3 mV; pickup 3 mV — 300 mV; Radio and aux. 100 mV. 5 pos. sel. vol., bass, treble, filter, equalisation. Filters: 9, 7 and 4.5 Kc/s. H.D. > 0.5% H and N — 65 dB. Output cathode follower 1v r.m.s. To operate with Lowther LL 15 Mk. 1. Size  $10\frac{1}{4} \times 4\frac{3}{8} \times 7$  ins. Price £20.

Pickup 2 mV Tape 100 mV, radio 100 mV, Aux. 100 mV H.D. 0.2% at 10 watts. Response 30-30,000 c/s  $\pm 1$  dB. N.L. — 45 dB. Output Imp. 16 ohms. Price £70.



**Pamphonic Reproducers Ltd.,** Westmoreland Road, London, N.W.9. Tel.: Colindale 7131.

■ **Lowther Mk. I Stereo Control Unit.** Input as for Master Control Unit Mk. IV. Tape input sockets. H.D. 0.1%. Dual low pass filters. Dual output balanced and balance controls between channels. Size as M.C.U. Mk. IV. To operate with LL15S power amp. Price £40.

**1002B Control Unit.** Inputs: mic. 2-3 mV; radio/tape 60 mV; P/U 6-8 mV. Push-button sel. 9 pos. (6 gram.). Cut off filter 4, 7, 12 Kc/s and “out”. Terminals for tape input. H and N 60 dB below 0.5v. P.a.t. Size  $10\frac{1}{4} \times 4\frac{1}{2} \times 7\frac{1}{4}$  ins. To operate with 2001 power amp. Price £25 4s.

■ **Lowther LL15S Stereo Amplifier.** 15 watts output on each channel. Dist. 1%. Input for spec. output 0.75v. Response 20-40,000 c/s  $\pm 1$  dB. N.L. — 85 dB. Out. imp. 8.4 or 16 ohms. Output EL34. “Lowther Linear”. Size  $11 \times 12 \times 7\frac{1}{2}$  ins. To operate with S.C.U. Mk. I control unit. Price £47.

**2001A Control Unit.** Inputs: 3-120 mV depending on input. 6-pos. sel. Pre-set level control for tape/radio. Cut-off filter at 4, 7, 12 Kc/s and “out”. Loudness control. Tape input sockets. H and N 60 dB below 0.5v. P.a.t. To operate with 2001 power amp. Price £12 12s.

■ **Lowther Integrated Stereo Amplifier.** 12 watts per channel, Inputs: mic. 2 mV,

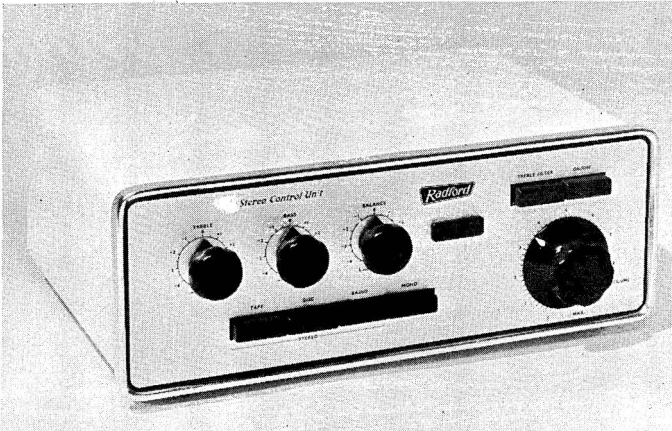

*RADFORD SC2.  
STEREO CONTROL  
UNIT*



**LOWTHER**  
**SCU MK.1 STEREO**  
**CONTROL UNIT**



**2001 Amplifier.** 25 watts. Dist. at 1,000 c/s, 0.05% at 15 watts. Input for spec. output 0.5v. Response substantially flat 2-100,000 c/s. Feedback 28 dB. N.L. 90 dB below full output. Out. imp. 3.75, 6.6, 10 and 15 ohms. Output KT66's. Ultra-linear. To operate with 2001A or 1002B control units. Price £29 8s.

★  
**3000 Stereo Amplifier.** 7.5 watts per channel. Dist. 0.5%. Inputs: radio 1 volt; tape 0.5 volts; pickup crystal stereo. Response. 50-15,000 c/s. Feedback 20 dB. N.L. - 57 dB. Out. imp. 15 ohms each channel. Ultra-linear. Size 14 × 9½ × 4½ ins. Price £31 10s.

**3001 Integrated Stereo Amplifier.** Inputs: pickup 4-6 mV and 150 mV; tape or radio 400 mV and 1 volt. Bass, treble, balance controls. Dist. 0.5% at 6 watts. H and N - 60 dB. 7.5 watts per channel. Out. imp. 15 ohms. Response 40-20,000 c/s ± 1 dB. Crosstalk better than 60 dB. Output ECL82's. Size 13 × 10¼ × 4¼ ins. Price £38 10s.

★

**Period High Fidelity Ltd.,** 14 Mount Street, London, W.1. Tel.: Grosvenor 4686.

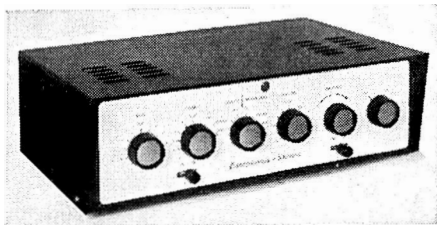

*Pamphonic 3000 stereo amplifier*

**Saville Double Six. Integrated Stereo amplifier.** Inputs: pickup 5 and 100 mV; tape 100 mV, tuner 100 mV, mic. 4 mV. 6-pos. sel., bass, treble, balance, vol. controls. H.D. < 0.25% at 1 Kc/s 4 watts. H and N better than - 55 dB (main amp. better than - 70 dB relative to nominal output. 6 watts per channel. Response 25-25,000 c/s ± 1 dB, ref. 1 Kc/s. Low pass filter 5, 7 and 10 Kc/s. Filter slope control. 12 dB feedback. Out. imp. 15 ohms or to order. Output ECL83's. Ultra-linear. Size 13 × 8 × 3½ ins. Price £38 17s.

★

**Pye Limited, High Fidelity Division.** P.O. Box 49, Cambridge. Tel.: Cambridge 58985. Cables: Pyrad, Cambridge.

**HF10 Mozart Self-contained Control Unit and Power Amplifier.** Inputs: tape 100 mV; radio 100 mV; P/U 15, 8 and 8 mV on each of the 3 curves at 1,000 c/s., special compensation for all makes of P/U. 5-pos. sel., treble, bass, vol., mains on/off, filter at 4, 7, 12 Kc/s and out. Tape replay socket. H.D. 0.3% at 1,000 c/s and 9 watts. H and N main amp. - 70 dB; tape, radio - 60 dB; P/U - 55 dB. Output 10 watts nom. Response 3-70,000 c/s ± 3 dB.

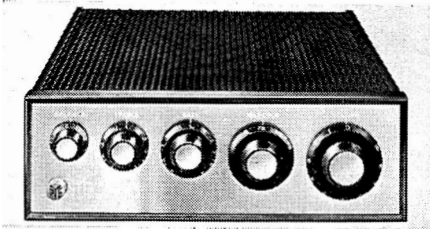

*Pye Mozart integrated stereo HFS20M*



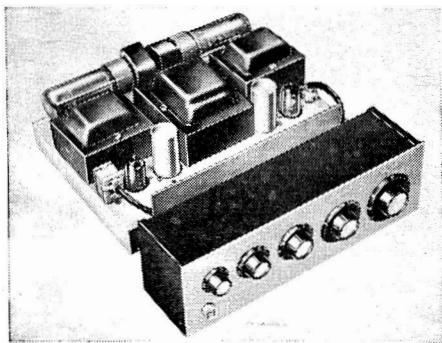

*Pye Stereo Mozart HFS20 amplifier*

Feedback 3 main loops over output stage - 5, 8 and 14 dB. Out. imp. 4, 8 and 15 ohms. Output 1 EL34. Integrated single-ended ultra-linear. Size  $10\frac{1}{2} \times 3\frac{1}{2} \times 5\frac{1}{2}$  ins. Price £23 2s. Also available in metal case for shelf mounting. HF10M £24 13s. 6d. mounted in cabinet with provision for motor. 117v model available.

■ **Mozart Stereo Amplifier and Control Unit. HFS20.** Inputs: Pickup 7 mV; radio and tape 100 mV. Col., bass, treble, balance, on/off, selector switch. H and N - 58 dB. 8 watts per channel nominal, 9 watts max. Dist. 0.2%. Response 5-50,000 c/s  $\pm 2$  dB. Feedback 34 dB. Out. imp. 4, 8 and 15 ohms. Output EL34. Size  $4 \times 10\frac{1}{2} \times 11$  ins. Price Chassis £35, in metal case £36 15s. Mounted in cabinet with provision for motor HFP3, £47 5s.



**Radford Electronics Ltd.,** Ashton Vale Estate, Bristol 3. Tel.: Bristol 662301.

■ **SC3 Stereo Control Unit.** Inputs: pickup 4 mV RIAA; aux. 1, - 100 mV; aux.

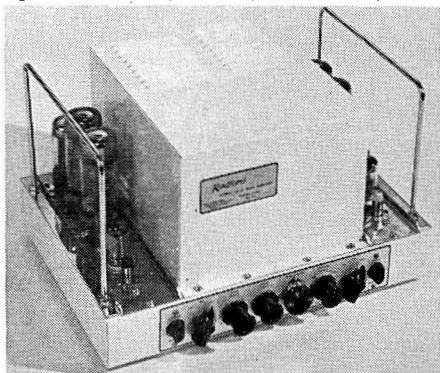

*Radford STA 12 Stereo amplifier*

2, - 500 mV. Rumble and treble filters. Push button sel. Treble, bass, volume controls. Additional independently controlled composite channel for wide angle stereo. Cathode follower outputs on all 3 channels. Requires 3 power amplifiers but also operates on normal pre-amp with 2 channel power amplifiers. Output 0.5 V. H and N better than 70 dB below 5 mV input. P.s.n. 6.3 V 2A, 15-20 mA at 250-350 V.

■ **SC2. Stereo Control Unit.** Inputs: pickup 4 MV RIAA; aux. 1 100 mV; aux. 2 500 mV. Rumble and treble filters. Output 0.5v. Push button sel. treble, bass, vol. and balance controls. H and N better than - 65 dB below 5 mV input, better than - 75 dB on aux. P.s.n. 7-8 mA at 250-350v, 6.3v 1.2A. Response 40-20,000 c/s  $\pm 1$  dB. Complete channel to channel fade on balance control. To operate with STA 12, 2  $\times$  MA 15, 2  $\times$  MA 25. Price on application.

**MA 15 Mk. 2. Amplifier.** 15 watts nom. H.D. 0.05% at 15 watts. Input for spec. output 500 mV. Response 20-20,000 c/s  $\pm 1$  dB. Feedback 25 dB. N.L. better than 90 dB down on nominal output. Out. imp. 4, 8 and 16 ohms. Output EL34. Ultra-linear. Self-powered. Size  $9\frac{1}{2} \times 7\frac{1}{2} \times 6\frac{1}{2}$  ins. To operate with SC2 and SC3 control units. Price on application.

**MA 25 Mk. 2 Amplifier.** Output 25 watts nom. 35 watts max. H.D. 0.5% at 25 watts. Input for spec. output 500 mV. Response 20-20,000 c/s  $\pm 1$  dB. Feedback 26 dB. N.L. - 90 dB in rated output. Out. imp. 4, 8 and 16 ohms. Output KT88. Ultra-linear. Self-powered. To operate with SC2 and SC3 control units. Price on application.

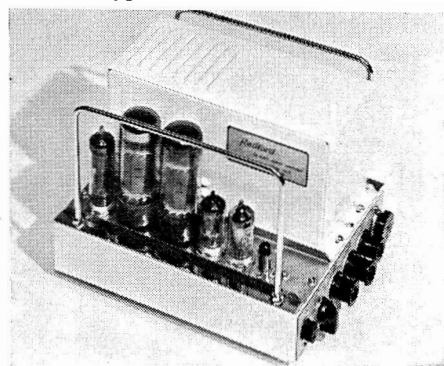

*Radford MA15 amplifier*

■ **STA 12 Mk. 2. Stereo Amplifier.** 12 watts nom. 15 watts max. H.D. <0.05% at 12 watts. Input for spec. output 500 mV. Response 20-20,000 c/s  $\pm 1$  dB. Feedback 26 dB. N.L. better than -80 dB on 12 watts. Out. imp. 4, 8 and 16 ohms. Output EL34. Ultra-linear. Self-powered. Size 12  $\times$  9  $\times$  6 $\frac{1}{2}$  ins. To operate with SC2 and SC3 control units. Price on application.

■ **STA15 Stereo Amplifier.** Identical spec. per channel as MA15 Mk. 2.



**Rogers Development (Electronics) Ltd.,** 4-14 Barmeston Road, Catford, S.E.6. Tel.: Hither Green 7424 and 4340. Cables: Rodeveco, London, S.E.6.

**RD Cadet Mk. II Mono Control Unit.** Inputs: disc. flat 10 & 200 mV, disc. comp. 8 and 160 mV; radio 40 and 200 mV; tape 100 mV; aux. 5 and 20 mV; Push-button selector, bass, treble, filter, volume—On/Off. Tape panel socket. Size: 8 $\frac{1}{2}$   $\times$  5 $\frac{1}{4}$   $\times$  5 ins. To operate with RD Cadet Mk. II mono amplifier. Price £11.

**RD Cadet Mk. II Mono Amplifier.** 7 watts. Harmonic distortion 0.25%. Input sensitivity for 7 watts 600 mV. Feedback, 20 dB. Hum and noise 0.75 dB below 7 watts. P.a.t. 250 V at 40 mA, 6.3 V at 2.2 A. Out. imp. 4, 8 and 16 ohms. Output ECL86's. Size 12 $\frac{3}{4}$   $\times$  4 $\frac{1}{4}$   $\times$  4 $\frac{1}{2}$  ins. To operate with RD Cadet Mk. II mono control unit. Price £12.

■ **RD Cadet Mk. II Stereo Control Unit.** Inputs: disc. 75 mV; radio 75 mV; tape 75 mV. Push-button selector, bass, treble, function and balance. Volume and separate On/Off switch. Size 8 $\frac{1}{2}$   $\times$  5 $\frac{1}{4}$   $\times$  5 ins. To operate with RD Cadet Mk. II Stereo amplifier. Price (including amplifier) £27 10s. 0d.

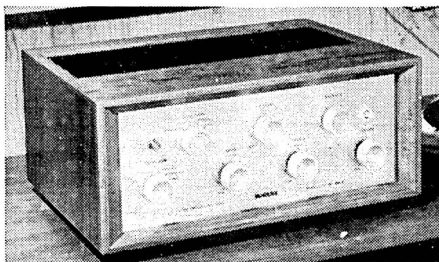

*Rogers HG88 integrated stereo amplifier*

■ **RD Cadet Mk. II Stereo Amplifier.** 6 + 6 watts. Harmonic distortion 0.25%. Peak output 7 + 7 watts. Response 20-20,000 c/s  $\pm 1$  dB. Out. imp. 4 or 16 ohms. Feedback: 18 dB. Hum and noise 75 dB below 6 watts. Output: ECL86's. Size 12  $\times$  6  $\times$  4 $\frac{1}{4}$  ins. to operate with RD Cadet Mk. II Stereo control unit. Price (including control unit) £27 10s. 0d.

■ **RD Junior Mk. III Stereo Control Unit.** Inputs: Disc. 4 or 80 mV. RIAA or flat. Provision second mono pickup. Tape: 4 mV (CCIR) 25 mV (flat) radio: 100 mV, aux. 2.5 or 30 mV. Panel socket for tape record and replay, mic. Push-button selector, bass, treble, filter, function, balance, volume and On/Off. Hi-pass filter. Mono/stereo disc switch. Output: ECC83's. Size 11 $\frac{3}{4}$   $\times$  7 $\frac{1}{4}$   $\times$  5 $\frac{1}{2}$  ins. To operate with RD Junior stereo amplifier. Price £27 10s. 0d.

■ **RD Junior stereo amplifier.** 12 + 12 watts nominal 15 + 15 watts peak. Harmonic distortion 0.2% at 12 watts. Input sensitivity 750 mV for 12 watts. Response, 20-20,000 c/s  $\pm 0.25$  dB. Feedback 20 dB. Hum and noise: 0.85 dB below 12 watts. Out. imp. 4, 8 or 16 ohms. Output: ECC83's. Size 14  $\times$  8  $\times$  5 $\frac{3}{8}$  ins. To operate with RD Junior Mk. III stereo control unit. Price £27 5s. 0d.

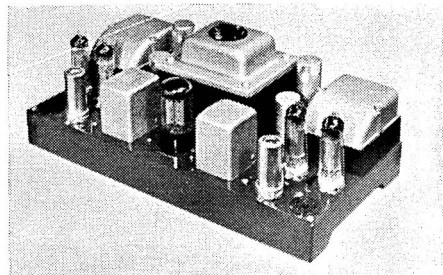

*Rogers RD Junior stereo amplifier*

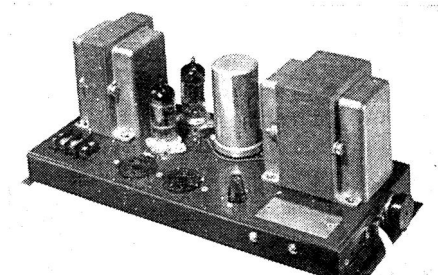

*Rogers RD Cadet amplifier*

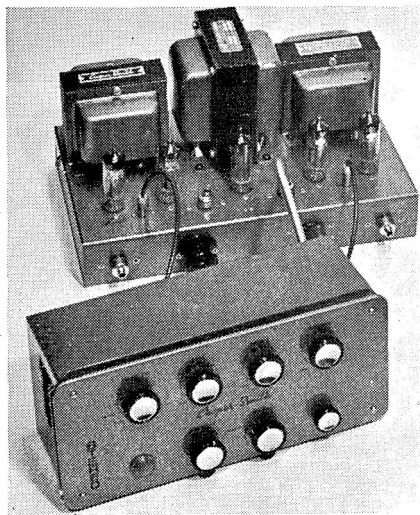

*Cooper-Smith stereo control unit and amp.*

■ **Master Stereo Control Unit.** Inputs: pickup 3-30 mV and 4-40 mV; Tape 1.5-30 mV; radio 30-250 mV. Push-button selector, bass, treble, balance, equalisation. Response, 20-20,000 c/s.  $\pm 1$  dB. Crosstalk - 40 dB. Size  $14 \times 6\frac{1}{2} \times 5\frac{1}{2}$  ins. To operate with RD Junior stereo amplifier. Price £35.

■ **HG88 Mk. II Combined stereo amplifier and control unit.** 12 + 12 watts. 14 + 14 watts peak output. Harmonic distortion 0.25% for 12 watts. Hum and noise: 80 dB below 12 watts. Response, 30-20,000 c/s  $\pm 1$  dB. Feed-back: 16 dB. Out. imp. 4, 8 or 16 ohms. Inputs: disc. 4 or 80 mV (RIAA) 6 or 120 mV (flat) radio 120 mV tape 4 or 20 mV (CCIR) 20 or 120 mV (flat). 5-position selector. Function, bass, treble, filter, volume, On/Off, balance. Size:  $15\frac{3}{8} \times 10\frac{3}{8} \times 7$  ins. Price: Chassis £38 10s. 0d. Teak case model £42 0s. 0d.

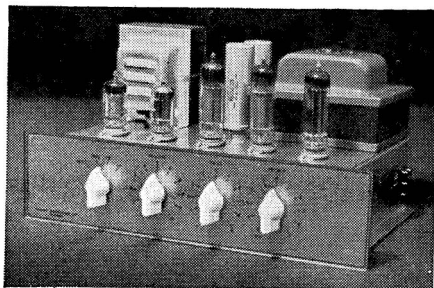

*Shirley Jupiter ampli...*

Shirley Laboratories Ltd., 3 Prospect Place, Worthing, Sussex. Tel.: Worthing 30536.

■ **Jupiter 3B/1-15E Self-contained Control Unit and Power Amplifier.** Inputs: radio, tape, P/U 78 and L.P. Output 15 watts nom. 25 watts max. Input approx. 10 mV for 15 watts. Treble, bass, vol. Response 45-35,000 c/s  $\pm 1$  dB. N.L. - 80 dB. Dist. 0.2% at 10 watts and 1,000 c/s. Out. imp. 15 ohms or as requested. Output EL84. P.a.t. 250v at 35 mA, 6.3v at 2 A. Size  $10 \times 7 \times 6\frac{1}{2}$  ins. Price £23 2s.

■ **Jupiter 3B/1-30E Self-contained Control Unit and Power Amplifier.** Spec. as for 3B/1-15E except output 30 watts nom., 45 watts max. Response 28-35,000 c/s  $\pm 1$  dB. Output EL34's. Price £33 12s.

■ **PA 4/86 Stereo Control Unit.** Inputs: pickup 3 and 50 mV; radio 100 mV; tape 3 mV and 0.5 volts, selector switch, bass, treble, volume, balance. H.D. 0.1%. H and N - 58 dB. Price £21 1s. To operate with SF/10 amplifier, or two SB/7-30.

■ **SB/7-30s Amplifier.** 20 watts nominal, 35 watts max. Dist. 0.1%. Input for spec. output 2.5 volts. Response 34-40,000 c/s  $\pm 0.3$  dB. N.L. - 80 dB. Out. imp. 15 ohms. Output EL34. Ultra-linear. Size  $11 \times 7\frac{1}{2} \times 8$  ins. Price £29 8s. 28 watt version £32 11s. To operate with PA 4/86 Control Unit.

■ **Jupiter SB1-15F Combined Amplifier and Control Unit.** Input 2 mV minimum. Dist. 0.2%. 14 watts nominal, 23 watts max. Response 45-35,000 c/s  $\pm 1$  dB N.L. - 80 dB. Out. imp. 100 ohms line or to order. Size  $10 \times 7 \times 6\frac{1}{2}$  ins. Price £23 2s.

■ **SF/10 Combined Stereo Amplifier and Control Unit.** 12 watts per channel, 18 watts peak. Dist. 0.1%. Control Unit similar details to PA 4/86 above. Price complete £45 3s.

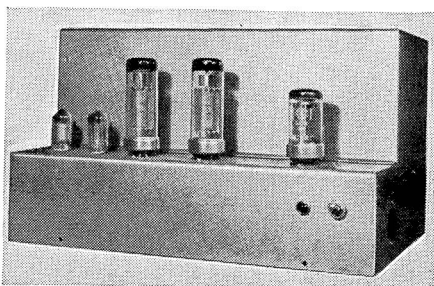

*Shirley Mullard 20-watt amplifier*

**ROGERS MASTER  
STEREO CONTROL  
UNIT**



■ **2SB/10. Integrated Stereo Amplifier.** Inputs: magnetic and crystal pickup; tape direct from high impedance head and from tape recorder; radio. Sel. switch, bass, treble, volume, balance controls. 7 watts per channel. Output ECL86's. Price £45 3s.

■ **2SB/12. Integrated Stereo Amplifier.** 12 watts per channel, 20 watts peak. Output EL84's. Other details as 2SB/10. Price £48 6s.

■ **2SB/50. Integrated Stereo Amplifier.** 25 watts per channel, 40 watts peak. Output KT88's. Response 35-35,000 c/s  $\pm 1$  dB at 25 watts. Dist. 0.05% at 25 watts. Other details as 2SB/10. Price £84.



**H. L. Smith & Co. Ltd.,** 287/289 Edgware Road, London, W.2. Tel.: Paddington 5891/7595.

**Cooper-Smith Mk. II Control Unit.** Inputs: radio 100 mV; P/U 3 mV; mic. 1.5 mV; tape 100 mV. 6 pos. sel. (3 record equal.), treble, bass, vol. on/off. Switch filter 6, 8 and 10 Kc/s. Co-axial tape replay switch. H.D. 0.1% or less at 1,000 c/s. H and N — 80 dB. Rumble filter 12 dB cut at 30 c/s. Size 10  $\times$  3½  $\times$  6½ ins. To operate with B.P.I. power amp. Price kit £7 17s. 6d. Assembled and tested £10 17s. 6d.

**Cooper-Smith B.P.I.** 10 watts nom., 12 watts max. Dist. 0.15% or better at 10 watts. Input for spec. output approx. 1.9 V. Response 20-30,000 c/s  $\pm 1$  dB. Feedback 18 dB. N.L. 90 dB below max. output. Out. imp. 3.75 and 15 ohms. Output 6BQ5's or EL84's. Ultra-linear. Size 12  $\times$  7  $\times$  7½ ins. To operate with Cooper-Smith Mk. II control unit. Price kit £12 5s. Assembled and tested £14 5s.

**Cooper-Smith "Prodigy" Combined Amplifier and Control Unit.** Inputs: pickup 8 mV; radio and tape 10 mV, 6 watts, 9 watts max. Dist. 0.2%. Response 30-25,000 c/s  $\pm 1$  dB. Feedback 15 dB. N.L. — 70 dB. Out. imp. 3½, 7½ and 15 ohms. Output ECL82's. Ultra-linear. Size 10½  $\times$  7  $\times$  5½ ins. Price kit £12 10s. Assembled and tested £15 15s.

■ **Cooper-Smith Stereo Control Unit.** Inputs: pickup 3 mV; tape 100 mV; radio 100 mV. 4 position sel., bass, treble, vol., balance. H.D. 0.15%. H and N — 60 dB. Size 10½  $\times$  4½  $\times$  3½ ins. To operate with Cooper-Smith stereo amplifier. Price kit £12 12s. Assembled and tested £15.

■ **Cooper-Smith Stereo Amplifier.** 6 watts per channel, 9 watts peak. Dist. 0.2% at 6 watts. Input for spec. output 800 mV. Response 40-25,000 c/s at 6 watts. 15 dB feedback. N.L. — 80 dB. Out. imp. 3.75, 7.5, 15 ohms. Output ECL82's. Size 12  $\times$  7  $\times$  6½ ins. To operate with Cooper-Smith stereo control unit. Price kit £13 13s. Assembled and tested £16.



*Cooper-Smith Prodigy control unit and amp.*

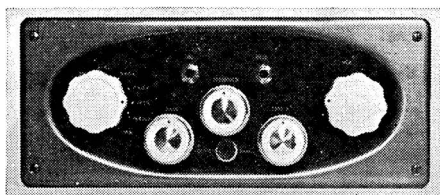

Sound Sales Mk. 111 control unit

**Cooper-Smith Magnum.** 20 watts nom., 30 watts max. Dist. 0.1% at 30 watts. Response 30-30,000 c/s  $\pm$  0.5 dB. Feedback 26 dB. N.L. - 80 dB. Output imp. 3.75, 7.5 and 15 ohms. Output EL34's. Ultra-linear. Size 14  $\times$  8 $\frac{1}{4}$   $\times$  7 $\frac{3}{4}$  ins. To operate with Cooper-Smith Mk. II control unit. Price kit £21 2s. 6d. Assembled and tested £23 12s. 6d.

■ **Smith "Threesome" 3W. Integrated Stereo Amplifier.** Inputs: 300 mV per channel. 3 watts rated, 4 watts max. H.D. < 3% at 3 watts. Response 60-20,000 c/s  $\pm$  3 dB. Feedback 12 dB. N.L. 65 dB down at 3 watts. Out. imp. 3.75 and 15 ohms. On/off and treble cut and volume controls. Sel. switch. Output ECL 82's. Self-powered. Size 8 $\frac{1}{2}$   $\times$  7 $\frac{1}{4}$   $\times$  3 $\frac{1}{2}$  ins. Price £12 12s. (Kit price on application).



Sound Sales Ltd., Works and Acoustic Laboratories, Farnham, Surrey. Tel.: Farnham 6461/2/3. Cables: Sounsense.

**A-Z Wide Range Control Unit Mk. III.** Inputs: pickups 5 and 50 mV; radio 50 mV; mic. 1 mV. 8-position sel., bass, treble, presence. H.D. 0.06%. H and N - 80 dB. Rumble filter. P.a.t. 250v at 40 mA. Size 11 $\frac{1}{4}$   $\times$  4 $\frac{3}{8}$   $\times$  5 $\frac{1}{2}$  ins. To operate with Mk. III Amplifier, and not sold separately.

**A-Z Mk. III Amplifier.** 10 watts nominal, 13.5 watts max. Dist. 0.06%. Input for

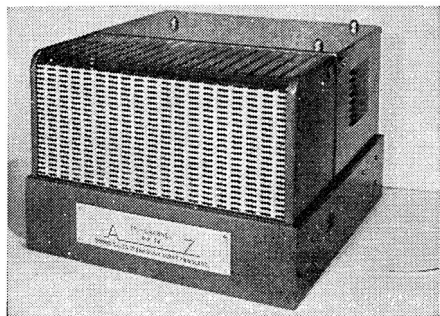

Sound Sales Tri-Channel amplifier

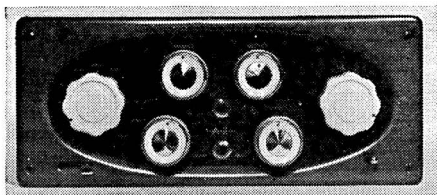

Sound Sales A-Z Twin Twenty control unit

10 watts - 18 dB ref. 1 volt. Response 12-27,000 c/s  $\pm$  1 dB. Feedback 22 dB. N.L. - 80 dB. Out. imp. 3, 6, 15, and 30 ohms. Output EL84's. Ultra-linear. Size 10 $\frac{1}{4}$   $\times$  7 $\frac{1}{4}$   $\times$  6 ins. To operate with Mk. III Control Unit. Price complete £25. Amplifier only £17.

■ **A-Z Twin Twenty Stereo Control Unit.** Inputs: pickup 2-5 mV and 50 mV; radio 3 at 30 mV; tape 14 and 125 mV; mic. 1.4 mV. 11-position sel., balance, bass, treble, filter. Size 11 $\frac{1}{4}$   $\times$  4 $\frac{3}{8}$   $\times$  9 $\frac{1}{2}$  ins. Price £20.

■ **A-Z Twin Twenty Stereo Amplifier.** 10 watts per channel, 13.5 watts peak. Dist. 0.08%. Input for spec. output 0.1 volts per channel. Response 20-20,000 c/s flat. N.L. - 80 dB. Out. imp. 3, 8, and 15 ohms. Output EL84's. Ultra-linear. Size 12 $\frac{1}{2}$   $\times$  10  $\times$  6 $\frac{1}{2}$  ins. Price £30. To operate with Twin Twenty Control Unit, or A-Z Wide Range Control Unit.

**A-Z Senior Control Unit** with transistor input. Inputs: mic. 1 mV; radio 100 mV; tape 250 mV; tape 1 mV (from head) C.C.I.R. and N.A.R.T.B.; P/U variable 1-100 mV. 11 pos. sel. (5 record equal.), treble, bass, vol., presence control, switched filter, 2 pos. and out combined with variable slope. Tape recording in all positions, also jacks for portable recorders. Specially designed for use with M.C. pickups or tape-head without necessity of transformers. Size 11  $\times$  4 $\frac{1}{2}$   $\times$  6 ins. Sold only with A-Z Senior power amp.

**Tri-Channel Control Unit** with transistor input. Inputs: mic. 1 mV; radio 100 mV; tape (from recorder) 250 mV; tape (from head, C.C.I.R. and N.A.R.T.B.) 1 mV; P/U variable 1-100 mV. 11 pos. sel. (5 record equal.). Presence, middle channel response; treble, top channel response; bass, bass channel response. Infinitely variable electronic crossover system, controlling 3 separate amplifying channels to appropriate speakers via master vol. control. Switched filter. Tape recording in all positions also

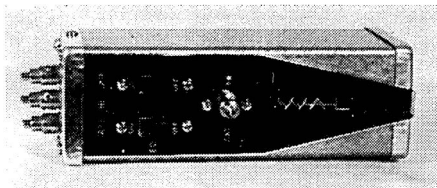

*Wal Hi-Gain pre-amp.*

jacks for portable recorders. H and N better than  $-80$  dB. Dist. not measurable at normal output. Size  $11\frac{1}{4} \times 4\frac{3}{8} \times 6$  ins. Sold only with Tri-channel amp. and speaker enclosure.

**Tri-Channel Amplifier Mk. V.** Bass 20-30 watts, mid channel 8-12 watts, treble channel 4 watts. Total undistorted output approx. 45 watts. Dist. 0.05%. Response infinitely variable on 3 channels. N.L. better than  $-80$  dB. Output LN309, EL84, EL34. Ultra-linear. Size  $18 \times 10 \times 8\frac{1}{2}$  ins. Price complete with control unit and tri-channel speaker enclosure £125.

■ **Tri-Channel Stereo Control Unit and Tri-Channel Stereo Amplifier.** Designed for stereophonic or monaural reproduction using 2 Tri-channel main amps. and 2 labyrinth speakers. Stereo to monaural changeover switch, giving parallel or stereo connection. Price complete with control unit, 2 amps and 2 speaker systems £300.

**A-Z Senior Mk. II Amplifier.** 20 watts nom. 30 watts max. Dist. 0.05% at 20 watts. Response flat 10-30,000 c/s. Feedback 25 dB. N.L.  $-80$  dB at 20 watts. Out. imp. 3, 6, 15 or 30 ohms. Output EL34's. Ultra-linear. Size  $14\frac{1}{2} \times 8\frac{1}{2} \times 8\frac{1}{2}$  ins. Price complete with A-Z Senior control unit £42.



**Stern Radio Ltd.,** 109, 111 and 115 Fleet Street, London, E.C.4. Tel.: Fleet Street 5812/14.

**Mullard Pre-Amplifier Tone Control Unit.** Inputs: pickup 5 mV and 13 mV (Magnetic), 70 mV and 200 mV (Crystal); Radio 300 mV, tape 3 mV, mic. 3 mV, 6-pos. sel., bass, treble, vol. P.s.n. 300v at 3 mA, 6.3v at 0.6 amps. Employs two EF86's. To operate with the 5-10 amplifier. Size  $9\frac{1}{2} \times 4\frac{1}{2} \times 2\frac{3}{8}$  ins. Price £8. Also available in kit form.

■ **Mullard Dual Channel Pre-Amplifier.** Inputs: pickup 5-15 mV and 70-220 mV; tape 4 mV; radio and aux. 330 mV. 5-pos. selector, bass, treble, vol. and balance.

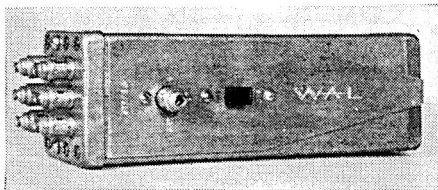

*Stereo Wal Gain pre-amp.*

Output 250 mV per channel. Dist. less than 0.15%. Employs four EF86's. P.s.n. 6.3v at 1 amp., 250/350v at 6 mA. Size  $11 \times 5 \times 4$  in. Price £15. Also available in kit form.

■ **Mullard "10-10" Stereo Amplifier.** 10 watts per channel. H.D.  $< 0.2\%$ . Input for spec. output. 23 mV. Response at 10 watts 20-60,000 c/s  $\pm 3$  dB. Feedback 20 dB. N.L.  $-65$  dB. Out. imp. 15 ohms, alternative 3.75 or 7.5 ohms. Output two ECL86's in each channel. Ultra-linear. Size  $14 \times 6\frac{1}{2} \times 6\frac{1}{4}$  ins. To operate with Mullard Dual Channel pre-amplifier. Price £18. Kit £15 10s. 10d.

■ **Mullard "10-10" Stereo Amplifier with Passive Control Unit.** Output 10 watts per channel. H.D.  $< 0.2\%$ . Input for spec. output, passive unit 250 mV. Response 20-60,000 c/s  $\pm 3$  dB. Feedback 20 dB. N.L.  $-65$  dB. Out. imp. 15 ohms (alternative 3.75 or 7.5 ohms). Output two ECL86's in each channel. Ultra-linear. Size, with passive unit attached,  $14 \times 8\frac{1}{2} \times 6\frac{1}{4}$  ins. Price £21. Kit £18 10s.



**Symphony Amplifiers Ltd.,** 16 Kings College Road, London, N.W.3. Tel.: Primrose 3314/5.

**Symphony No. 1 Amplifier Mk. 3.** 4 watts, 5 watts max. Dist. less than 0.6%. Input for spec. output 140 mV. Response 30-30,000 c/s  $\pm 1$  dB. 24 dB feedback.

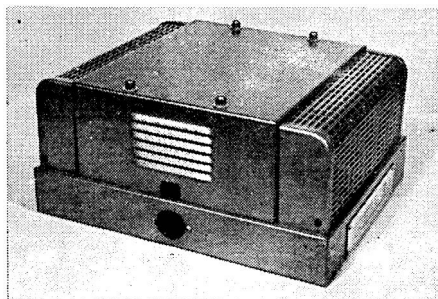

*Sound Sales Twin Twenty stereo amplifier*

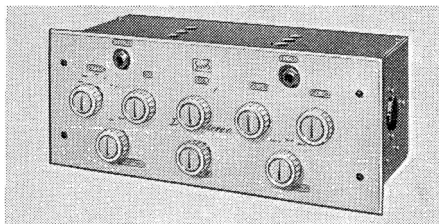

*Stern Mullard stereo control unit*

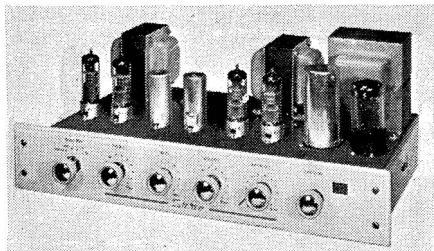

*Stern Mullard 5-10 amplifier*

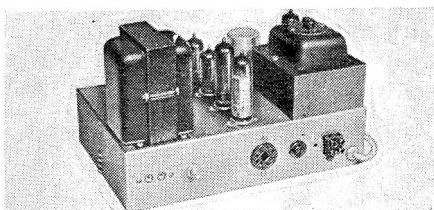

*Stern Mullard 10-10 Stereo amplifier*

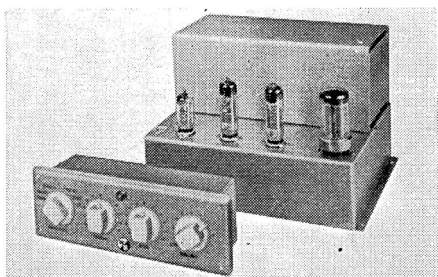

*Stentorian WB12 control unit and amplifier*

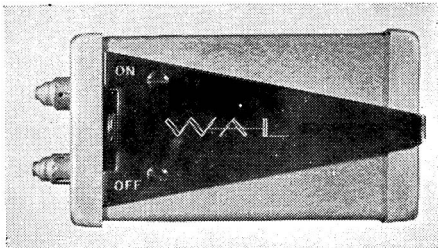

*Wal Gain pre-amp.*

N.L. — 80 dB. Out. imp. 3 or 15 ohms to order. Output 6V6's. Size  $13\frac{1}{2} \times 6 \times 6$  ins. Price £12 12s.

**Symphony No. 2 Integrated Amplifier Mk. 4.** 8 watts, 10 watts max. Dist. less than 0.2% at 6 watts. Input for spec. output 130 mV. Response 20-20,000 c/s  $\pm 1$  dB. 26 dB feedback. N.L. — 85 dB. Out. imp. 3, 7.5 and 15 ohms. Output 6L6's (triode strapped). Size  $12 \times 7 \times 9\frac{1}{2}$  ins. Price £18 18s.

■ **Symphony Integrated Stereo Amplifier.** 5 watts per channel. Dist. 0.3%. Input for spec. output 100 mV. Response 30-20,000 c/s  $\pm 1$  dB. 22 dB feedback. N.L. — 80 dB. Out. imp. 15 ohms. Output 6BW6's. Self-powered. Size  $12 \times 7 \times 9\frac{1}{2}$  ins. Price £23 2s.



**Tansley-Howard Ltd.,** 95 Kensal Road, London, W.10. Tel.: Ladbroke 7195.

■ **Archon SP31. Stereo Control Unit.** Inputs: pickup 1, 7 or 70 mV variable, 2, 7 mV; tape 60 mV; radio 60 mV variable. Sel. balance, treble, bass, filter controls. H.D. 0.05%. H and N — 61 dB. Rumble filter. Size  $12 \times 6 \times 2\frac{3}{8}$  ins. To operate with SL 101 stereo amplifier. Price £20 9s. 6d.

■ **Archon SL101. Stereo Amplifier.** 10 watts per channel. Dist. 0.2% at 10 watts. Input for spec. output 200 mV. Response 3-50,000 c/s  $\pm 1$  dB. 22 dB feedback. N.L. — 80 dB. Out. imp. 3, 7 and 15 ohms. Output EL84's. Size  $12 \times 6 \times 5\frac{1}{2}$  ins. To operate with SP31 stereo control unit. Price £29 8s.



**Tripletone Manufacturing Co. Ltd.,** 241A The Broadway, Wimbledon, S.W.19. Tel.: Liberty 1189.

**Hi-Fi Major. Integrated Amplifier.** Inputs: high imp. pickup or microphone. 12 watts, 15 watts max. Dist. 0.15%. Response 15-20,000 c/s  $\pm 1$  dB. 32 dB feedback. N.L. — 80 dB. Out. imp. 2-3 or 15 ohms. Output EL84's. Size  $12 \times 5\frac{1}{2} \times 6$  ins. Price £15 18s. 9d.

**D.P. 12 Amplifier.** 12 watts nom. 15 watts max. H.L. 0.15%. Input for spec. output 500 mV for 10 watts. Response 10-50,000 c/s  $\pm 0.25$  dB. Feedback 16 dB. N.L. — 80 dB. Out. imp. 2-3 ohms or 15 ohms



switchable. Output EL 84's. P.s.n. A.C. 200-250v 50-60 c/s. To operate with Stereo C.P.1 or Mono C.P.2. Size  $12 \times 6 \times 5\frac{1}{2}$  ins. Price £12 6s.

**C.P.I. Stereo Control Unit.** Inputs: stereo, mic., radio, aux., all 100 mV. Output 12 watts per channel. H and N - 80 dB. F.R. 15-20,000 c/s. H.D. 0.15%. Feedback negative 20 dB. P.s.n. D.C. 250v, A.C. 6.3v. To operate with D.P. 12's or Stereo 5-5. Size  $11 \times 3\frac{1}{2} \times 2\frac{1}{2}$  ins. Price £9 7s. 6d.

■ **Stereo 12-12. Stereo Control Unit and Amplifier Combination.** Inputs; pickup, radio, microphone 100 mV. Sel., bass, middle, treble, vol. controls. H.D. 0.15%. H and N - 80 dB. P.a.t. 300v 50 mA, 6.3v. 12 watts per channel. 15 watts max. Response 15-20,000 c/s  $\pm 1$  dB. 32 dB feedback. Out. imp. 2-3 or 15 ohms. Output EL34's. Size: Control unit  $11 \times 3\frac{1}{2} \times 2\frac{1}{2}$  ins., amplifier  $12 \times 5\frac{3}{4} \times 6$  ins. (two required). Price £33 19s. 6d. (three units).



**Trix Electronics Ltd.,** 1-5 Maple Place, London, W.1. Tel.: Museum 5817. Cables: Trixadio, Wesdo, London.

■ **Trix XT202. Integrated Stereo Amplifier.** Inputs: pickup, tape, tuner, 50/100 mV. 6-pos. sel., bass, treble, balance, vol. H.D. less than 0.5%. H and N - 60 dB. Switched rumble filter. 3.75 watts per channel. Out. imp. 3, 8 and 15 ohms. Output EL84's. Size  $11\frac{1}{4} \times 4\frac{1}{4} \times 7\frac{1}{2}$  ins. Price £23 2s.



**Wellington Acoustic Laboratories Ltd.,** Farnham, Surrey. Tel.: Farnham 6461/4961.

**WAL Gain.** Impedance matching transistor pre-amp, battery operated (3,000-hour life). Noise and distortion too low to measure, gain better than 100. Suitable for use with low output P/U or for direct connection to tape head, mic. etc. Size  $3\frac{3}{8} \times 2\frac{1}{8} \times 2\frac{1}{8}$  ins. Price £5.

■ **Stereo WAL Gain.** Transistorised stereo pre-amplifier. To match pickups, tape or mic., at 50,000 at 3,500 ohms. Battery life 1,000 hrs. Size  $7 \times 2\frac{1}{8} \times 2\frac{1}{2}$  ins. Price £7 10s.

**Wal Hi-Gain, Transistorised pre-amplifier.** Battery operated (1,000 hour battery life).

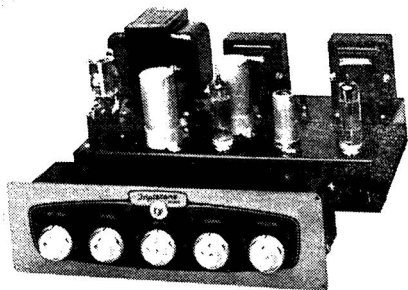

*Tripletone Stereo 12-12*

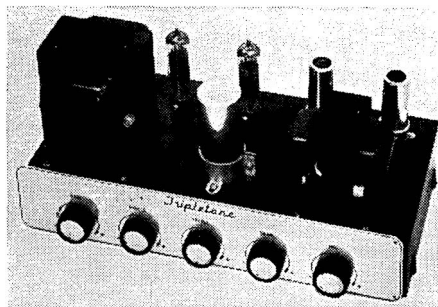

*Tripletone Hi-Fi Major*

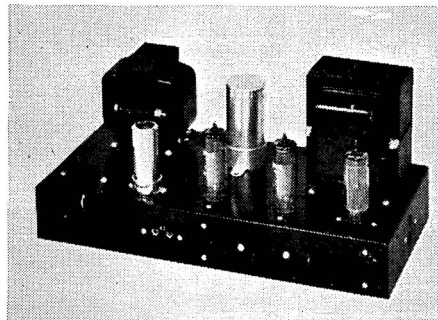

*Tripletone DP12 amplifier*

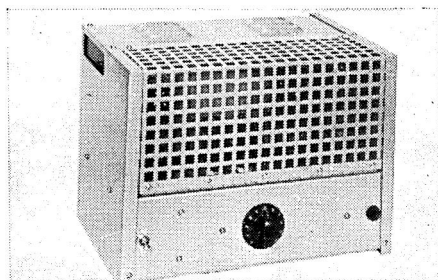

*Westrex 2192 amplifier*



F.R.  $\pm 1$  dB 30-25,000 c/s. Built-in switched CCIR equalisation for monitoring, dubbing, high gain, amplification for moving coil mics. etc. Size  $6\frac{7}{8} \times 2\frac{1}{8} \times 2\frac{1}{2}$  ins. Price £7 16s.



**Westrex Co. Ltd.**, Coles Green Road, London, N.W.2. Tel.: Gladstone 5401/8. Cables: Westelcol, Norphone, London.

**2192 Amplifier.** 30 watts. Dist. 0.1%. Size  $12 \times 9 \times 8\frac{1}{2}$  ins. Designed primarily for use with the Westrex 2241 Loudspeaker Assembly. Price £49.

**2330-A Amplifier.** 30 watts. H.D.  $<1\%$  total at rated output. Input for spec. output  $-10$  dB at 600 ohms. Response 30-18,000 c/s  $\pm 1$  dB. Feedback 10 dB. N.L. better than 80 dB below rated output. Out. imp. 4, 8, 16 ohms or 100v. Output EL34. Ultra-linear. Size  $10 \times 16 \times 11$  ins. Price on application.

**2331-A Amplifier.** 60 watts. H.D.  $<1\%$  total at rated output. Response 30-18,000 c/s  $\pm 1$  dB. Feedback 10 dB. N.L. better than 80 dB below rated output. Out. imp. 4, 8, 16 ohms or 100v. Output EL34. Ultra-linear. Size  $16 \times 10 \times 11$  ins. Price on application.



**Whiteley Electrical Radio Co. Ltd.**, Victoria Street, Mansfield, Notts. Tel.: Mansfield 1762/3/4/5. Cables: Whitebon, Mansfield.

**Stentorian WB12 Standard Control Unit.** Inputs 50 mV. 6-pos. sel. (3 gram.), treble, bass, vol. Tape/Radio input socket. H and N  $-70$  dB at 10 watts. Size  $9 \times 3\frac{1}{2} \times 3\frac{1}{2}$  ins. To operate with WB12 power amp. Price £9.

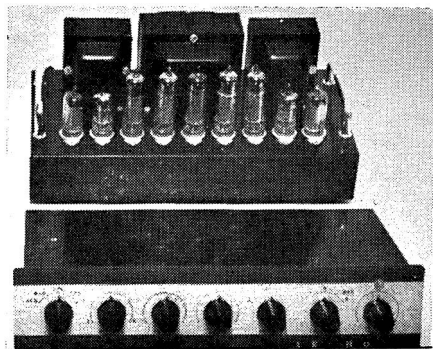

*Tanslev-Howard Archon.*

**Stentorian WB12 Major Control Unit.** Inputs: mic. 2.5 mV; P/U mV; radio 100 mV; tape 100 mV; aux. 50 mV. 9 pos. sel. (5 record equal), treble, bass, vol. on/off switched filter at 5.7 and 11 Kc/s; filter slope. Tape input socket. H.D. 0.3% H and N  $-70$  dB. Size  $11\frac{1}{8} \times 4\frac{1}{2} \times 4$  ins. To operate with WB12 power amp. Price £19 10s.

**WB12 Amplifier.** 12 watts nom., 15 watts max. Dist. at 1,000 c/s. 0.12%. Response 20-20,000 c/s  $\pm 0.15$  dB. Feedback 25 dB. N.L.  $-80$  dB at 10 watts. Out. imp. 3 and 15 ohms. Output EL84's. Ultra-linear P.a.t. 250 V at 50 mA, 6.3 V at 1.5a. Size  $10\frac{3}{8} \times 8 \times 7$  ins. To operate with WB Major or Standard control units. Price £18 10s.

■ **WB Stereo Control Unit.** Inputs: pickup 2.5 and 100 mV; radio and tape 50 mV. Selector switch, bass, treble. H.D. 0.2%. H and N  $-70$  dB. Size  $11\frac{1}{4} \times 4 \times 7\frac{1}{2}$  ins. Price £22 15s. To operate with WB8S, or two WB12.

■ **WB8S Stereo Amplifier.** 6-8 wats per channel. Dist. 0.2%. Input for spec. output 650 mV. Response 40-15,000 c/s  $\pm 0.5$  dB. Feedback 20 dB. N.L.  $-60$  dB. Out. imp. 3 and 15 ohm. Output ECL82's. Ultra-linear. Size  $10\frac{7}{8} \times 6\frac{1}{4} \times 10\frac{1}{2}$  ins. Price £23 15s. To operate with WB Stereo Control Unit.

**WB8 Combined Amplifier and Control Unit.** 6 watts, 8 watts max. Dist. 0.3%. Inputs: pickup 100 mV; radio and tape 50 mV. Response 30-20,000 c/s  $\pm 2.5$  dB. Feedback 15 dB. N.L.  $-60$  dB. Out. imp. 3 and 15 ohms. Output ECL82's. Ultra-linear. Size  $11\frac{1}{4} \times 7\frac{1}{2} \times 4$  ins. Price £19 19s.

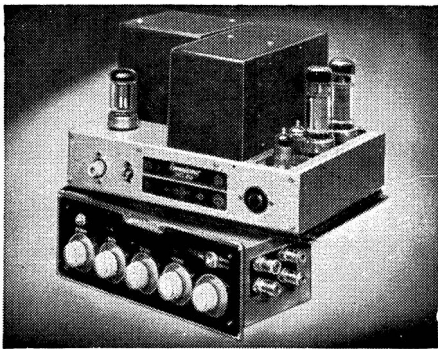

*Connoisseur HQ20 control unit and amp.*

# LOUDSPEAKERS FOR 1962-3

—by R. L. West

AGAIN a twelve-month period has passed without any spectacular developments to report in this country; but there have been several enterprising designs and quite a few newcomers seem to be ready to "have a go". This is all very encouraging, for though the laws of nature cannot be broken, or even bent, we certainly do not yet know all the ways round them!

The foam sandwich cone—a true girder construction—has been in production for a year and it seems to be fulfilling its early promise. There are now two naked foam cones; the more recent one has a really revolutionary shape and it appears to make very pleasant noises. This material is not quite so stiff as the sandwich, but it is much stiffer than paper cones of the same mass. Only time will show whether these will oust the long established paper cone. A second electrostatic tweeter has appeared, but there is still only one full-range electrostatic speaker in the world, as far as is known.



The *Ionophone* and kindred speakers still remain a tantalizing possibility as far as this country is concerned, and it is doubtful whether there are now any of the originals still functioning. One day their problems may be solved.

A really revolutionary design—the *Ortho-phase*—was demonstrated very successfully in France. It is a modern development of the old *Blatthaller* design of the nineteen-thirties and uses ceramic magnets, lots of them. Like the ESL, the whole area of the diaphragm is driven and, size for size, it can handle far more power than the ESL. The

whole assemblage—made of a large number of 5 × 4 in. units—was very costly. The individual units, however, are a commercial proposition and there are other ways of using them. We will no doubt hear more of it.

The one and only ribbon tweeter continues in its seventh year, proving it to be a thoroughly sound design and is now joined by a bass unit from the same stable. There have, of course, been rumours of speakers to end all speakers, but we get used to that and enjoy the fun.



We have talked of compromise before—in the sense that all loudspeakers are a compromise between many conflicting requirements, and an important one of these is cost. We must be careful here and realise that cheap things are seldom a good investment. They are more likely to cause disappointment than more expensive ones. First, they may wear out or become shabby in a very short time; secondly, with increasing experience we may well become dissatisfied with them. This last point is continuously cropping up in high fidelity goods, and while it does provide a steady supply of secondhand equipment for sale, it can become a rather expensive way of gaining experience. In general, if a reasonable price is paid for a loudspeaker from a reputable firm, while it may not be the best in existence, it is not likely ever to be considered a poor buy.

Besides cost, the size and the looks and the performance have also to be considered. Theoretically, performance should come first, but many enthusiasts have to compromise with other members of the family

A GERMAN APPROACH  
TOWARDS THE OMNI-  
DIRECTIONAL IDEAL

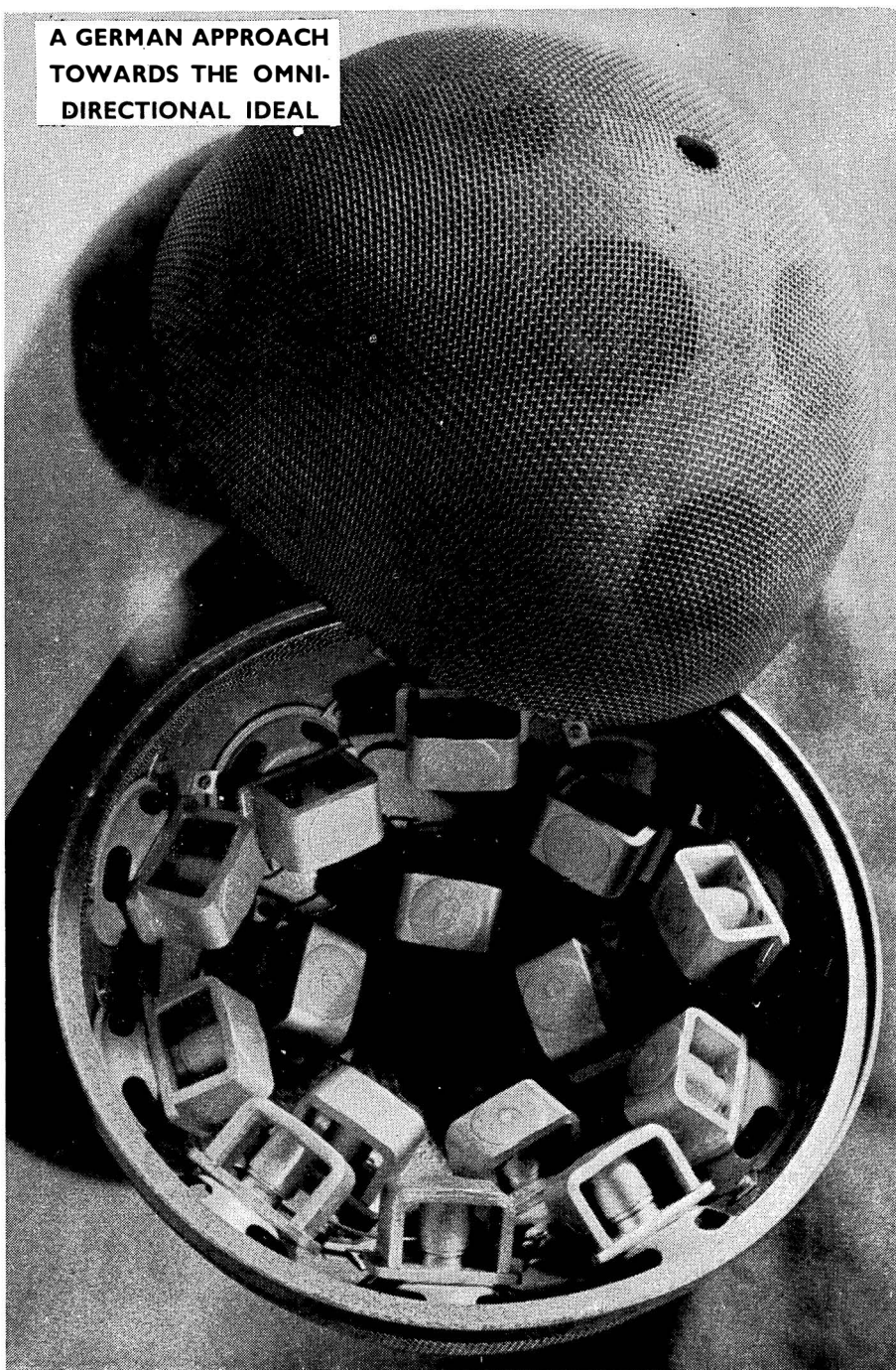

on size and looks. There is no need for a specially good performer to look crude or ungainly. In the past this was sometimes so, but we have largely grown out of that. We do still seem to stick to the very conventional rectangular box with all its openings on one fabric covered side, facing into the room. Maybe this is the cost factor coming in again—it is the cheapest shape to construct. I think we could be more daring if we tried.



Size is a perennial controversy, in the home and in the laboratory. The modern tendency to spend our money on car, fridge, T.V., household gadgets and expensive holidays instead of decent sized living accommodation, naturally leaves us a bit short of room for a pair of loudspeakers. It is amazing what wonders the laboratories have done with overall cabinet dimensions of well under two cubic feet.

While it is quite true to say that really good fidelity can be had with the better versions of such compact loudspeakers—and very reassuring to those who perform must use them—the writer is still unconvinced of the wisdom of this trend. When the best orchestras start using miniature double basses and tympani, and the best organ-builders stop using big pedal pipes, we shall know it is all right. However to be fair to the modern compacts, they do produce a smoother response with less distortion and colouration than many larger and expensive loudspeakers of a few years ago. Now that a much clearer understanding exists of the physical principles involved in the production of sound, this miniaturisation has become possible. The main price to be paid is a reduction in efficiency; *i.e.* we need a few more watts to produce the same amount of sound, but this presents no problem.



Rather more subtle, not yet understood, and certainly as yet unmeasurable, such small speakers in most surroundings tend to sound as though they are small—as though one is listening via a small hole in a large solid wall. A larger, more generously designed speaker system, though measurement may even reveal a less flat response and more bass distortion, etc., may sound better and be preferred to the compact.

So here we are again back to compromise—and we have to choose our own com-

promise, often with a little help from someone more experienced.

Ideally a purchaser should live with his prospective loudspeaker for a week or so, but such a happy arrangement is not available from many dealers. The difficulties are obvious, and yet acceptance tests for larger engineering installations are the normal thing. Failing that, we must get around and hear them demonstrated, preferably several times in *different* places. When a short list has been decided, then we should make sure we hear a selection of material—serious and pop, organ, orchestral and choral, solo instrument and solo voice. If it pleases with *all* of these (musical taste apart!), then it should please for a long time. However, one should insist on hearing it played also at a low level—most demonstrations attempt to impress rather than delight—and one cannot judge properly when standing up—and when three feet away from it!



Strictly speaking, one should alternate listening to a loudspeaker with going to a live concert, as one can so easily develop a perverted taste. This is not being ultra fussy; it is sound advice. Musical performances, as we know them today, have evolved gradually over some 400 years or so and have proved acceptable to our human senses. It is very doubtful whether any other noises will ever give such lasting satisfaction, so our search for something as near the original as possible is nearer the mark than some would have us believe. They will say “it doesn't matter what the noise is if you like it”. Maybe we have not yet found all the noises and combinations that delight our senses, but we must at least avoid being anti-social!

The loudspeaker's style of sound distribution continues to cause argument. Most designs stick to the conventional forward-facing pattern. Depending on the room, its size and furnishings, and seating distance, this traditional arrangement can be very satisfactory. It is certainly the most satisfactory arrangement for a public demonstration in a large hall.

At home, the “stereo seat” will give the most striking results if the head is kept still, but the results tend to alter with quite small changes in position—a mere head movement is enough. This is a disconcerting effect, and one that does not occur when listening to a live performance. It is minimised by *not* sitting on the axis of either

loudspeaker and the effect more or less disappears with the type of speaker that radiates in all directions and thus reflects off the wall surfaces behind it. Stereo pinpointing is not so accurate with this type, but it may be found less tiring to listen to. After all, hardly any musical instruments actually point at us when we hear them played, and the few that might, are on the move all the time, so we only get a small share. Stereo undoubtedly helps, for, at worst, it is better for the sound to come out of two small holes than one. At best, it gives a fair illusion of the real thing and exercises a few more circuits in the ear-combination than mono can!



Two identical speakers are best, even though the room rarely has the symmetry to treat them alike. Dissimilar speakers can work and this has often been demonstrated. It is safe to say that stereo with dissimilar speakers, provided neither is really bad, will be a worthwhile improvement on mono for most people. The same could be said of the "economy systems" which use one bass speaker and two out-rigger tweeters, or a full-range and one tweeter on the other side. Anyway, they are good stepping stones to the ultimate pair.

Building up a high fidelity system, and starting from a domestic FM receiver, the purchase of a good speaker may well be a good start, since the signal from many FM receivers is quite good, *i.e.* if they have low distortion and negligible hum.

Starting with disc playing equipment, however, first must come a good pickup or

the discs will be permanently spoiled for better reproduction later on. They should not be unplayable, but with later and better equipment even slight signs of wear will easily be heard.



Lastly, one does not need a loudspeaker with a response that is flat from zero to infinity—not even from 30 c/s to 18,000 c/s. Thirty cycles per second, yes indeed. We all can hear this and enjoy it; but eighteen thousand?—well, it is nice to know (or think) it is there, but it will not often be used—from the BBC, never; from tape at  $7\frac{1}{2}$ -in. per second, very doubtful—some distortion and tape hiss most probably; from modern LP discs with a good pickup, yes; but how many of us will hear it?

The really important part is all below about 10 Kc/s, and *that* must be smooth and free from vices. Make no mistake, this is not a question of pouring ridicule on all efforts to operate with frequencies above 10 or 12 Kc/s, but rather a warning that the really important part is much lower down, and a smooth response free from distortion and all the other ills that can beset the design (be it loudspeaker, pickup, disc, or tape or tape machine), is far more important than mere bandwidth. It should be remembered that the ear is most sensitive in the range from 500 c/s to about 3,000 c/s, and that it can suffer considerable distress from things we cannot even measure in the laboratory. Nevertheless, our loudspeaker designers do try hard and they produce some very creditable results. May they ever be thus enthusiastic!

# DIRECTORY OF SPEAKERS AND ENCLOSURES

● This directory is divided into two parts. **Part 1** deals with the range of drive units which, by makers' specifications, are within the Hi-Fi classification. **Part 2** deals with complete enclosures. These, as a general rule, embody the drive units of Part 1. For economy of space the following abbreviations are used: **v.c.i.**—voice coil impedance; **r.c.f.**—recommended crossover frequency (and in Part 2) **Rec.**—recommended units; Height by Width by Depth are the order of printed dimensions.

## PART I—DRIVE UNITS

**Richard Allan Radio Ltd.**, Baffle House, Taylor Street, Batley. Tel.: Batley 1123/1308/4033. Cables: Acoustics, Batley.

**Golden Eight.** 8 in. Paper cone. Paper or foam surround. Voice coil 1 in. Gap flux 14,000 gauss. Total flux 56,000 maxwells. H.C. 6 watts. v.c.i. 15 ohms. F.R. foam surround 45-10,000 c/s, paper surround 60-10,000 c/s. r.c.f. Full range unit. With tweeter inner cone and aluminium voice coil, range extends to 17,000 c/s. Price, paper surround £3 7s. 6d. (U.K. purchase tax £1 3s. 10d.); foam surround £3 12s. 6d. (U.K. purchase tax £1 5s. 7d.). Aluminium or copper voice coil available.

**Bronze Eight.** 8 in. Paper cone. Paper or foam surround. Voice coil 1 in. Gap flux 12,500 gauss. Total flux 50,000 maxwells. H.C. 5 watts. v.c.i. 15 ohms. F.R. foam surround 45-10,000 c/s, paper surround 60-10,000 c/s. r.c.f. Full range unit. With tweeter inner cone. Aluminium

voice coil. Range extends to 17,000 c/s. Price, paper surround £2 15s. (U.K. purchase tax 19s. 5d.); foam surround £3 (U.K. purchase tax £1 1s. 2d.)

**Bronze Ten.** 10 in. Paper cone. Voice coil 1½ in. Gap flux 12,500 gauss. Total flux 73,000 maxwells. H.C. 8 watts. v.c.i. 15 ohms. F.R. 40-5,000 c/s (bass cone) or 40-9,000 c/s (wide range cone). Price, standard surround, £4 10s. (U.K. purchase tax £1 11s. 8d.); foam surround £4 17s. (U.K. purchase tax £1 14s. 3d.)

**Golden Ten.** 10 in. Paper cone. Voice coil 1½ in. Gap flux 14,000 gauss. Total flux 82,000 maxwells. H.C. 8 watts. v.c.i. 15 ohms. F.R. 40-5,000 c/s (bass cone) or 40-9,000 c/s (wide range) cone. Price, standard surround, £5 5s. (U.K. purchase tax £1 17s.); foam surround £5 12s. (U.K. purchase tax £1 19s. 6d.)

**Bronze Twelve.** 12 in. Paper cone. Foam surround. Voice coil 2 in. Gap

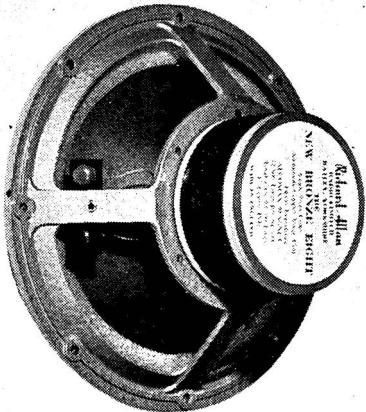

*Richard Allan Bronze Eight*

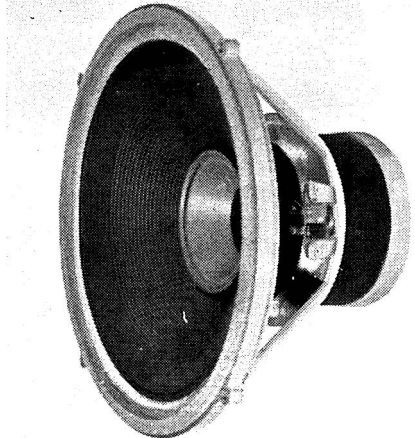

*Richard Allan Golden Twelve*

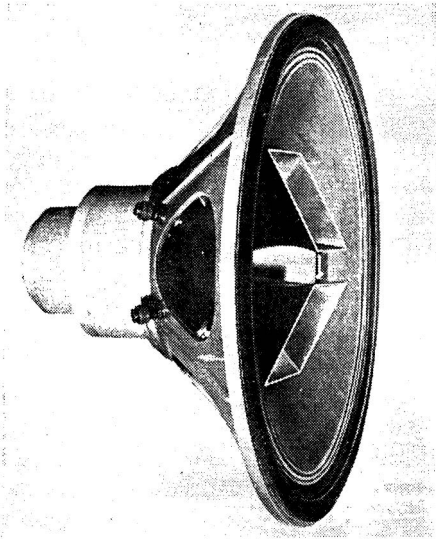

*AEI K10A Dual Concentric*

flux 12,500 gauss. Total flux 162,000 maxwells. H.C. 12 watts. v.c.i. 15 ohms. F.R. 25-5,000 c/s. r.c.f. 1,100 c/s. Price £9 9s.

**Golden Twelve.** 12 in. Paper cone. Foam surround. Voice coil 2 in. Gap flux 14,000 gauss. Total flux 182,000 maxwells. H.C. 15 watts. v.c.i. 15 ohms. F.R. 25-5,000 c/s. r.c.f. 1,100 c/s. Price £12 12s.

**410T. Tweeter.** 4 in. Paper cone and surround. Voice coil 9/16 in. Gap flux 10,000 gauss. Total flux 15,000 maxwells. H.C. 3 watts. v.c.i. 15 ohms. F.R. 2,000-17,000 c/s. r.c.f. 5,000 c/s. Price £1 5s. (U.K. purchase tax 8s. 6d.)



**Altobass Ltd.,** Percy Road, Aylestone Park, Leicester. Tel. Leicester 31616. Cables: Altobass, Leicester.

**2000.** Dual Concentric. 12 in. Moulded paper cone, corrugated surround (L.F.). Duralumin pressure tweeter. Voice coil 1½ in. (L.F.), 1 in. (H.F.). Gap flux (L.F.) 8,000 (H.F.) 13,000 gauss. Total flux (L.F.) 90,000 (H.F.) 50,000 maxwells. H.C. 10 watts. v.c.i. 10 ohms. F.R. 30-20,000 c/s. Built-in crossover at 1,200 c/s. Price £17 17s.



**Associated Electrical Industries Ltd.,** Sound Equipment Group, Crown House, Aldwych, London, W.C.2. Tel.: Temple Bar

8040. Cables: Soundequi, Estrand, London.

**A.E.I. 12A.** 12 in. Paper cone. Fabric surround. Voice coil 1½ in. Gap flux 14,400 gauss. Total flux 122,000 maxwells. H.C. 18 watts. v.c.i. 15 ohms. F.R. 50-10,000 c/s. Price £14.

**A.E.I. 12B.** 12 in. Paper cone. Foam surround. Voice coil 1½ in. Gap flux 14,400 gauss. Total flux 122,000 maxwells. H.C. 12 watts. v.c.i. 15 ohms. F.R. 40-10,000 c/s. Price £14 14s.

**A.E.I. DC12 Dual Concentric.** 12 in. Paper cone. Fabric surround. Voice coils. (L.F.) 1½ in. (H.F.) 1.56 in. Gap flux (L.F.) 10,000 gauss (H.F.) 13,000 gauss. Total flux (L.F.) 85,000 maxwells (H.F.) 49,000 maxwells. H.C. 15 watts v.c.i. 15 ohms. F.R. 50-14,000 c/s. Built-in crssover 1,500 c/s. Price £25.

**A.E.I. K10A.** Dual Concentric. 18 in. Paper cone. Felt surround. Voice coils (L.F.) 2½ in. (H.F.) 1.56 in. Gap flux (L.F.) 14,300 (H.F.) 16,700 gauss. Total flux (L.F.) 285,000 (H.F.) 63,000 maxwells. H.C. 25 watts. v.c.i. 10 ohms. F.R. 30-17,000 c/s. Separate filter unit. 1,700 c/s. Price on application.



**Bakers "Selhurst" Radio,** 523 London Road, Thornton Heath, Surrey. Tel.: Thornton Heath 7798.

**8in. Special.** Fibre cone, bakelised apex. Foam surround. Voice coil 1 in. Gap flux

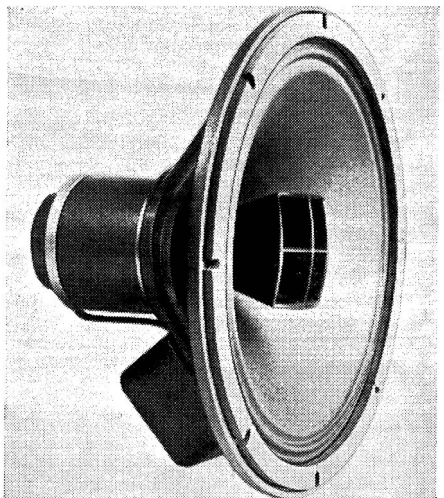

*Altobass 2000*

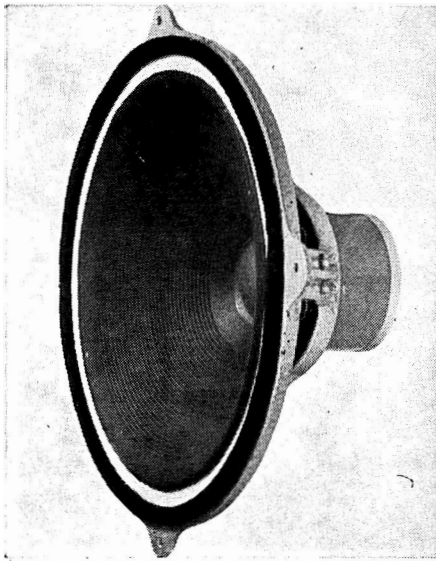

*Bakers Selhurst 15-in./CS Auditorium*

18,000 gauss. H.C. 8 watts. v.c.i. 15 ohms. F.R. 35-20,000 c/s. Price £7 10s.

**12-in. de-luxe fibre curvilinear cone,** bakelised apex. Foam surround. Voice coil  $1\frac{1}{2}$  in. Gap flux 15,000 gauss. H.C. 15 watts. v.c.i. 3 or 15 ohms. F.R. 20-17,000 c/s. Price £9 10s.

**12-in. Ultra de-luxe fibre curvilinear cone,** bakelised apex. Foam surround. Voice coil  $1\frac{1}{2}$  in. Gap flux 17,000 gauss. Peak H.C. 20 watts. v.c.i. 15 ohms. F.R. 18-20,000 c/s. Price £15 15s.

**Ultra Twelve.** 12-in. fibre curvilinear cone, bakelised apex. Foam surround. Voice coil  $1\frac{1}{2}$  in. Gap flux 17,000 gauss. Aluminium voice coil and drive. H.C. 20 watts v.c.i. 15 ohms. F.R. 20-25,000 c/s. Price £17 10s.

**15-in./CS Auditorium.** Fibre cone, bakelised apex. Foam surround. Voice coil 2 in. Gap flux 17,000 gauss. H.C. 15 watts. v.c.i. 8 or 15 ohms. F.R. 20-13,000 c/s. r.c.f. 5,000 c/s. Price £18.

**Ultrasonic  $3\frac{1}{4}$  in. bakelised cone.** Foam surround. Voice coil 1 in. (aluminium). Gap flux 18,000 gauss. H.C. 12 watts above 1,000 c/s. v.c.i. 15 ohms. F.R. 1,000-25,000 c/s. r.c.f. 1,600 or 3,000 c/s or by  $3\mu$ F condenser. Price £6.

**Duode Ltd.,** 523 London Road, Thornton Heath, Surrey.

**Duode 12E.** 12 in. Linen moulded cone. Foamed plastic surround. Voice coil 1.5 in. Gap flux 17,000 gauss. Total flux 190,000 lines. H.C. 30-15 watts. v.c.i. 15-8-5 ohms. F.R. 20-16,000 c/s. Price £15.

**Duode 12D.** 12 in. Linen moulded cone. Foamed plastic surround. Voice coil 1.5 in. Gap flux 14,500 gauss. Total flux 130,000 lines. H.C. 15 watts. v.c.i. 30-15-8-5 ohms. F.R. 20-16,000 c/s. Price £12.

★

**Fane Acoustics Ltd.,** Hick Lane, Batley, Yorks. Tel.: Batley 1578. Cables: Fane, Batley.

**Fane Model 121.** 12 in. Paper cone. Foam surround. Voice coil 2 in. Gap flux 12,000 gauss. Total flux 160,000 maxwells. H.C. 20 watts. v.c.i. 15 ohms. F.R. 30-5,000 c/s. r.c.f. 2,000 c/s. Price £9.

**Fane Model 121A.** Details as above, but aluminium voice coil. F.R. 30-10,000 c/s. r.c.f. 5,000 c/s. Price £9 9s.

**Fane 301 High Frequency Unit.** Aluminium cone. Voice coil  $\frac{3}{4}$  in. Gap flux 17,000 gauss. H.C. 12 watts. v.c.i. 15 ohms. F.R. 1,500-17,000 c/s. r.c.f. 2,000 c/s. Price £3 15s.

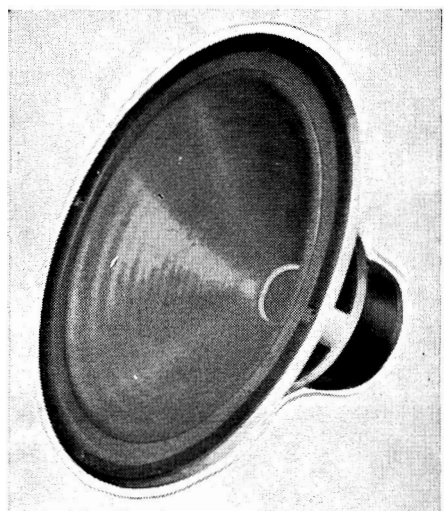

*Duode 12D*



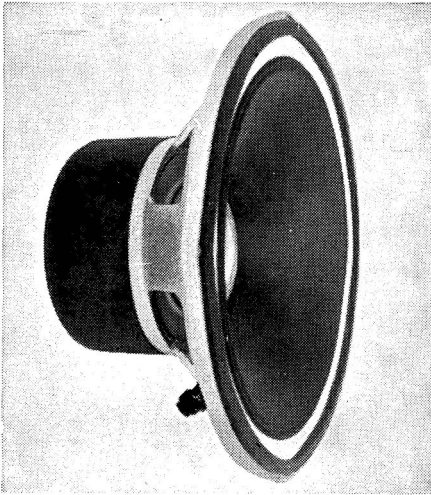

*Fane H.D. 121A*

**Fane Model 151.** 15 in. loudspeaker. Paper cone. Foam surround. Voice coil 3 in. Gap flux 12,000 gauss. Total flux 310,000 maxwells. H.C. 35 watts. V.C. 15 ohms. F.R. 20-3,500 c.p.s. Price £18.



**Goodmans Industries Ltd.,** Axiom Works, Wembley, Middx. Tel.: Wembley 1200. Cables: Goodaxiom, Wembley.

**Axiette 8.** 8 in. Paper cone. Plastic treated surround. Voice coil 1 in. Gap flux 13,500 gauss. Total flux 53,000 maxwells. H.C. 6 watts. v.c.i. 15 ohms. F.R. 40-15,000 c/s. Price £4 1s. 6d. (U.K. purchase tax £1 8s. 6d.)

**Axiom 10.** 10 in. Paper cone. Plastic treated surround. Voice coil 1 in. Gap flux 13,500 gauss. Total flux 53,000 maxwells. H.C. 10 watts. v.c.i. 15 ohms. F.R. 40-15,000 c/s. Price £4 10s. 6d. (U.K. purchase tax £1 12s.)

**Axiom 80.** 9½ in. Twin Diaphragm paper cone, free edge surround. Voice coil 1 in. Gap flux 17,000 gauss. Total flux 62,000 maxwells. H.C. 6 watts. v.c.i. 15 ohms. F.R. 20-20,000 c/s. Price £17 10s. (U.K. purchase tax £6 3s. 7d.)

**Audiom 60.** 12 in. Paper cone. Paper surround. Voice coil 1½ in. Gap flux 14,000 gauss. Total flux 158,000 maxwells. H.C. 15 watts. v.c.i. 15 ohms. F.R. up to 7,000 c/s. r.c.f. 950 c/s. when used as bass speaker in multi-speaker systems. Price £9 12s. 9d.

**Audiom 70.** 12 in. Paper cone. Paper surround. Voice coil 1½ in. Gap flux 17,500 gauss. Total flux 158,000 maxwells. H.C. 20 watts. v.c.i. 15 ohms. F.R. up to 7,000 c/s. r.c.f. 950 c/s when used as bass speaker in multi-speaker systems. Price £15 2s.

**Axiom 300.** 12 in. Twin diaphragm, paper cone. Plastic treated surround. Voice coil 1½ in. Gap flux 14,000 gauss. Total flux 158,000 maxwells. H.C. 15 watts. v.c.i. 15 ohms. F.R. 30-16,000 c/s. Built-in mechanical crossover network at 5,000 c/s. Price £11 5s. 9d.

**Axiom 400.** 12 in. Twin diaphragm, paper cone. Plastic treated surround. Voice coil 1½ in. Gap flux 17,500 gauss. Total flux 195,000 maxwells. H.C. 20 watts. v.c.i. 15 ohms. F.R. 30-16,000 c/s. Built-in mechanical crossover network at 5,000 c/s. Price £16 1s.

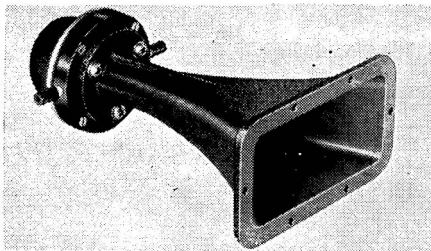

*Goodmans Midax 650*

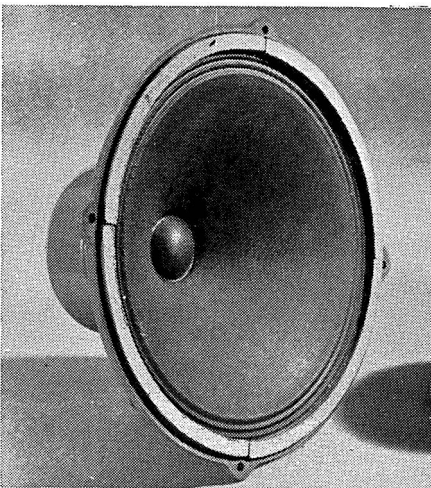

*Grampian 1255/15*

**Audiom 80.** 15 in. Paper cone. Paper surround. Voice coil 2 in. (5 cms.). Gap flux 14,500 gauss. Total flux 215,000 maxwells. H.C. 25 watts. v.c.i. 15 ohms. F.R. up to 7,000 c/s. 950 c/s when used as bass speaker in multi-speaker systems. Price £22 10s.

**Triaxiom 12/20,** 12 in. Paper bass cone. Plastic treated surround. Triple element radiator incorporating H.F. pressure unit and ready wired attenuator. Main voice coil  $1\frac{1}{2}$  in. H.F. 1 in. Gap flux 16,500 gauss. Total flux 185,000 maxwells. H.C. 20 watts. v.c.i. 15 ohms. F.R. 30-20,000-c/s. Price £25.

**Trebax.** Horn-loaded pressure tweeter. Aluminium diaphragm. Voice coil 1 in. H.C. suitable for inclusion in systems of up to 25 watts. v.c.i. 15 ohms at 10 Kc/s. F.R. 2,500-20,000 c/s. r.c.f. 5 Kc/s. Price £6 4s.

**Trebax 5K/20XL.** Horn loaded pressure tweeter. Built in L/C crossover (5,000 c/s) and attenuator. Suitable for inclusion in systems of up to 20 watts. Dispersion angle 90°. Price £7.

**Midax 650.** Horn loaded pressure unit. Resin impregnated linen diaphragm. Die-cast horn. Voice coil  $1\frac{1}{2}$  in. H.C. suitable for systems up to 25 watts. V.c.i. 15 ohms. F.R. 650-8,000 c/s. r.c.f. 950 and 5,000 c/s. Price £9 10s.



**Grampian Reproducers Ltd.,** Hanworth Trading Estate, Middx. Tel.: Feltham 2657/8/9. Cables: Reamp, Feltham.

**Grampian 1255/15.** 12 in. Paper impregnated cone and surround. Voice coil  $1\frac{1}{2}$  in. Gap flux 14,500 gauss. Total flux 130,500 maxwells. H.C. 10 watts. v.c.i. 15 ohms. F.R. 35-15,000 c/s. Price £9 10s.



**KEF Electronics Ltd.,** Tovil, Maidstone, Kent. Tel.: Maidstone 55761. Cables: Kef, Maidstone.

**K1 Baffle.** 16 × 12 in. Exp. polystyrene cone. Double cloth surround. Voice coil 2 in. Gap flux 12,700 gauss. Total flux 165,000 maxwells. 6 × 4 in. Tri-ply cone. Foam surround. Voice coil 1 in. Gap flux 12,000 gauss. Total flux 47,000 maxwells.  $1\frac{1}{2}$  in. Melinex dome. Melinex roll surround. Voice coil  $1\frac{1}{2}$  in. Gap flux

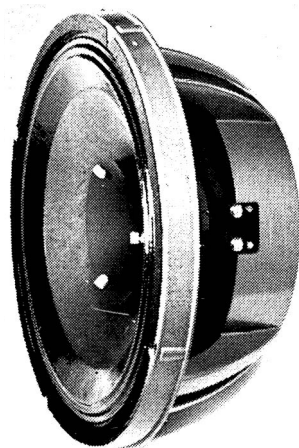

*Goodmans Axiom 301*

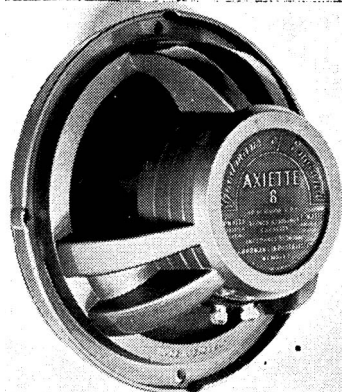

*Goodmans Axiette 8*

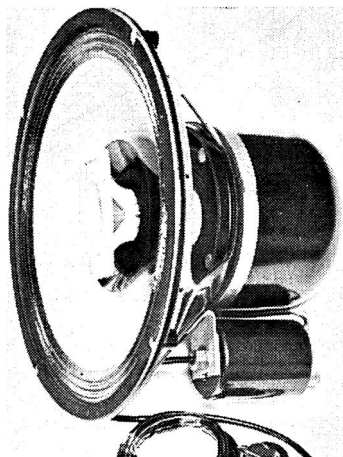

*Goodmans Triaxiom 12/20*

15,000 gauss. Total flux 53,500 maxwells. H.C. 25 watts rms 50 watts peak. v.c.i. 8-16 ohms. F.R. 20-375 c/s; 375-3,000 c/s; 3,000 upwards. r.c.f. 375-3,000 c/s. Price £27 complete.



**The Lowther Manufacturing Co.,** Lowther House, St. Mark's Road, Bromley, Kent. Tel.: Ravensbourne 5225. Cables: Lowther, Bromley.

**P.M.6.** 6 in. Selected paper cone. Plastic surround. Voice coil 37 mm. Gap flux 17,500 gauss. Total flux 196,000 maxwells. H.C. 6 watts. v.c.i. 16 ohms. F.R. 30-18,000 c/s. Price £18 18s.

**P.M.2 Mk. I.** 6 in. Selected paper cone. Plastic surround. Voice coil 37 mm. Gap flux 21,000 lines per sq. cm. Total flux 281,000 maxwells. H.C. 6 watts. v.c.i. 15 ohms. F.R. 30-20,000 c/s. Price £30.

**P.M.2. Mk. II.** 6 in. Selected paper cone. Plastic foam surround. Voice coil 37 mm. Gap flux 23,000 gauss. Total flux 350,000 maxwells, H.c. 6 watts. v.c.i. 15 ohms. F.R. 25-22,000 c/s. Price £40.

**PM2 Mk. III.** Details as PM2 Mk I but with special bracket for securing within Acousta-Twin Enclosure.

**P.M.3.** 6 in. Selected paper cone. Plastic surround. Voice coil 39 mm. Gap flux 22,000 gauss. Total flux 307,750 max-

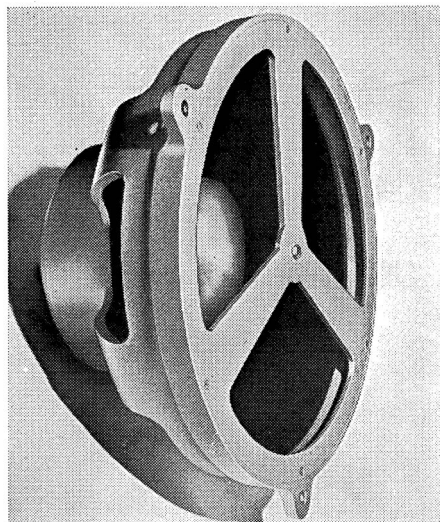

*Romagna L.F. Driver MK I*

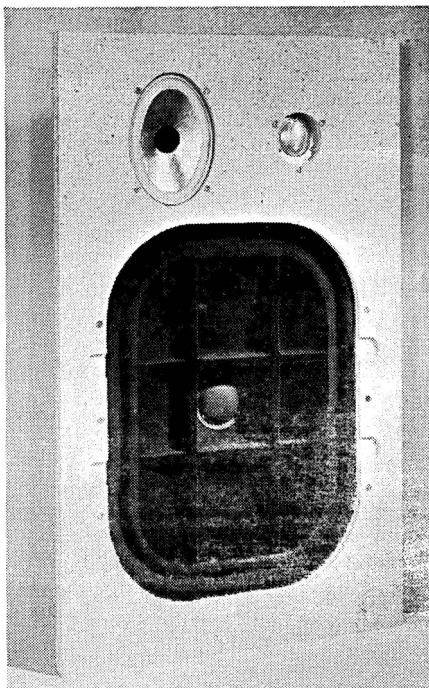

*KEF K1 Baffle*

wells. H.C. 6 watts. v.c.i. 15 ohms. F.R. 20-20,000 c/s. Not sold separately from enclosure type T.P.1.

**P.M.4.** 6 in. Selected paper cone. Plastic surround. Voice coil 37 mm. Gap flux 24,000 gauss. Total flux 385,000 maxwells. H.C. 6 watts. v.c.i. 16 ohms. F.R. 25-24,000 c/s. Price £48.



**Philips Electrical Ltd.,** Century House, Shaftesbury Avenue, W.C.2. Tel.: Gerrard 7777. Cables: Phillamps, London.

**9710.** 8 in. Paper cone. Corrugated surrounds. Voice coil 1 in. Gap flux 8,000 gauss. Total flux 97,000 maxwells. H.C. 10 watts. v.c.i. 7 ohms. F.R. 40-10,000 c/s. r.c.f. 500-1,000 c/s. Price £4 7s. 6d. (U.K. purchase tax £1 8s.)

**9710M.** 8 in. Dual cone. Paper corrugated surround. Voice coil 1 in. Gap flux 8,000 gauss. Total flux 97,000 maxwells. H.C. 10 watts. v.c.i. 7 ohms. F.R. 40-18,000 c/s. r.c.f. 500-1,000 c/s. Price £4 15s. 5d. (U.K. purchase tax £1 10s. 7d.)

**AD5200M.** 12 in. Dual cone. Paper. Corrugated surround. Voice coil 1½ in.

Gap flux 11,000 gauss. Total flux 134,000 maxwells. H.C. 20 watts. Price £10 10s.



**Rola Celestion Ltd.**, Ferry Works, Thames Ditton, Surrey. Tel.: Emberbrook 3402-6.

**Colaudio 1550.** 15 in. Paper cone. Foam surround. Voice coils (L.F.) 3 in. (H.F.)  $\frac{3}{4}$  in. Gap flux (L.F.) 12,500 (H.F.) 14,500 gauss. Total flux (L.F.) 290,000 (H.F.) 73,500 maxwells. H.C. 25 watts. v.c.i. 15 ohms. F.R. 30-15,000 c/s. For use with 3K50 coupling unit. Price £32 10s. Coupling unit £2 19s. 6d.



**Romagna Reproducers Ltd.**, Factory distributors, K. H. Williman & Co. Ltd., Blackford House, Sutton, Surrey. Tel.: Melville 1491.

**Kelly Ribbon H.F. Speaker Mk. 2.** Horn loaded. Ribbon dimensions 6 × 1 cms. H.C. 10 watts. v.c.i. 15 ohms through transformer supplied. F.R. 2,000-20,000 c/s. r.c.f. 2,000 c/s. Price £10 10s.

**L.F. Driver Mk. 1.** 12 in. Metal cone. Free edge. Voice coil 2 in. Gap flux 14,000 gauss. Total flux 250,000 maxwells. H.C. 25 watts. v.c.i. 15 ohms. F.R. 35-2,000 c/s. r.c.f. 2,000 c/s. Price £14 14s.

**L.F. Driver Mk. 3.** Exponential form cone with foam surround. Gap flux 14,000

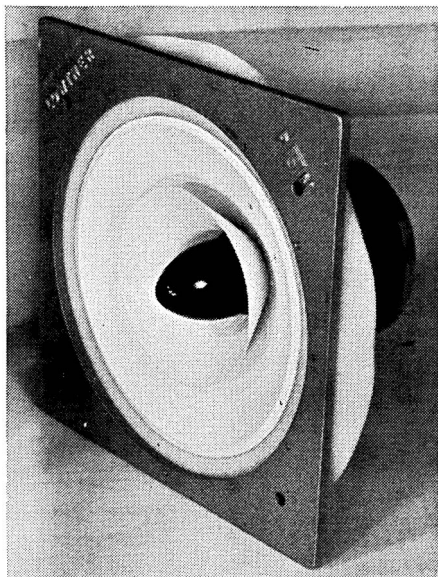

*Lowther PM 6*

gauss. Total flux 95,000 maxwells. H.C. 20 watts. v.c.i. 15 ohms. F.R. 45-18,000 c/s. Price on application.



**Sound Sales Ltd.**, Works and Acoustic Laboratories, West Street, Farnham, Surrey, England. Tel.: Farnham 6461/2/3. Cables: Sounsense,

**Dual Suspension Auditorium.** Models A and B. 12 in. paper cone. Very flexible surround plus dual suspension spider. Voice coil working in 0.06 in. by  $\frac{1}{4}$  in. deep gap, maximum effective travel  $\frac{3}{8}$  in. Gap flux 10,600 gauss. Total flux 95,000 maxwells. H.C. 12 watts in suitable enclosure. v.c.i. model A 15 ohms; model B 3 ohms. F.R. 30-13,500 c/s with suitable mounting. r.c.f. about 3,000 c/s. Price £9 13s. 4d.



**Tannoy Products Ltd.**, West Norwood, London, S.E.27. Tel.: Gipsy Hill 1131. Cables: Tannoy, London.

**Direct radiator.** 12 in. moulded fibre cone. Plastic treated surround. Voice coil 2 in. Gap flux 14,000 gauss. H.C. 15 watts. v.c.i. 20 ohms. F.R. 40-16,000 c/s. Price £14 14s.

**III LZ.** Dual concentric. Moulded fibre cone. Plastic impregnated surround. Gap

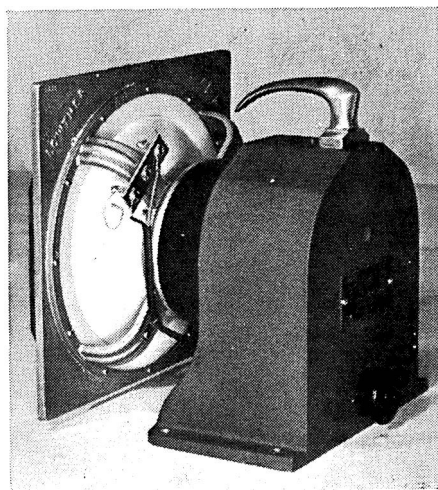

*Lowther PM 4*

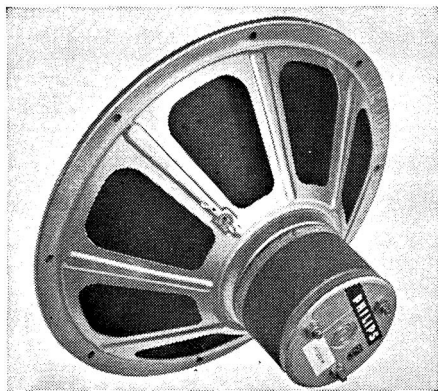

*Philips AD5200M*

flux (L.F.) 10,000 (H.F.) 15,000 gauss. H.C. 10 watts. F.R. 23-20,000 c/s. r.c.f. (supplied) 1,700 c/s. Price £22 10s.

**Monitor "Twelve"**. 12 in. Moulded fibre cone. Plastic treated surround. Voice coils (H.F. and L.F.) 2 in. Gap flux (L.F.) 11,500 (H.F.) 15,000 gauss. H.C. 30 watts. F.R. 25-20,000 c/s. r.c.f. 1,700 c/s. Price £30 15s.

**Monitor "Fifteen"**. 15 in. Moulded fibre cone. Plastic treated surround. Voice coils (H.F. and L.F.) 2 in. Gap flux (L.F.) 13,500 (H.F.) 18,000 gauss. H.C. 50 watts. F.R. 23-20,000 c/s. r.c.f. 1,000 c/s. Price £37 10s.



**Technical Suppliers Ltd.**, Hudson House, 63 Goldhawk Road, London, W.12. Tel.: Shepherds Bush 2581/4794.

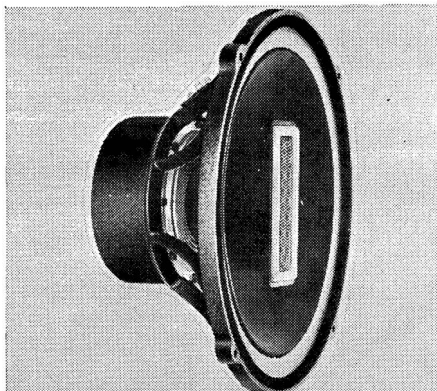

*Rola Celestion Colaudio 1550*

**TSL-Lorenz. LP. 215.** 8 in. Reinforced paper cone. Permaflex surround. Voice coil 1 in. H.C. 8 watts, peak load 12 watts. v.c.i. 4.5 ohms. F.R. 35-12,000 c/s. Price £4 19s. 6d. (U.K. purchase tax £1 12s.)

**LP. 312-2.** 12 in. Reinforced ribbed paper cone. Permaflex surround. Voice coil 1½ in. H.C. 25 watts. (Peak rating in suitable enclosure 40 watts). v.c.i. 15 ohms. F.R. 20 to above 17,000 with 2 type LPH65 treble speakers in a fitted bridge assembly. r.c.f. 3,000-5,000 c/s. Price £14 19s. 6d.

**TSL-Lorenz Tweeter LPH 65.** 2½ in. Special plastic cone. Plastic surround. Voice coil ½ in. H.C. 2 watts (H.F. only). v.c.i. 5.5 ohms. F.R. 2,000 to above 17,000 c/s. r.c.f. 3,000-5,000 c/s. Price £1 8s. 6d. (U.K. purchase tax 9s. 2d.)

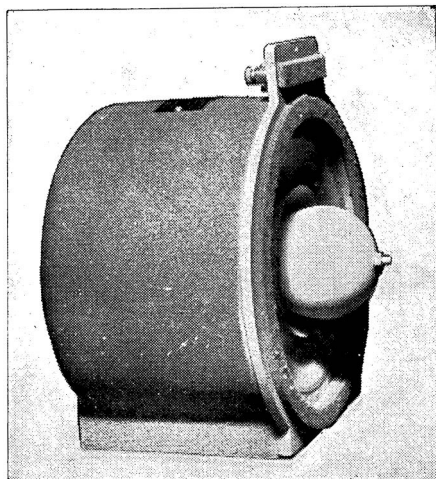

*Lowther P.M.3*

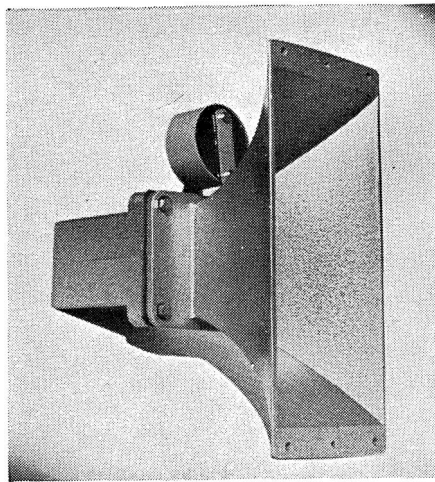

*Kelly Ribbon MK. 11*



*Vitavox DU120 Duplex*

**TSL-Lorenz LP45F.** 1½ in. Special compound cone. Permaflex surround. Voice coil 1½ in. Gap flux 9,500 gauss. H.C. 300 milliwatts. v.c.i. standard low impedance. F.R. 120-14,000 c/s. Price 18s. 8d. (U.K. purchase tax 7s.)

**TSL-Lorenz LP312-2.** 12 in. plus two LPH tweeters mounted on permanent bridge. Special compound cone. Permaflex surround. Voice coil 1½ in. H.C. 29 watts. v.c.i. tapped 4, 8, 16 ohms by taps. F.R. 20 c/s to 17,500 c/s. r.c.f. 2.5 Kc/s. Price £14 19s. 6d.

**TSL-Lorenz LPH65.** 2½ in. Plastic cone. Plastic surround. Voice coil ¾ in. Gap flux 10,000 gauss. H.C. with crossover 30 watts. v.c.i. 5.5 ohms. F.R. 2,000-17,000 c/s. r.c.f. 2,000 c/s. Price £1 8s. 6d. (U.K. purchase tax 10s. 1d.)

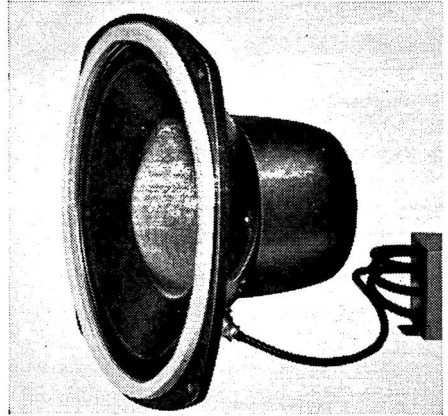

*Tannoy III LZ dual concentric*

**Vitavox Ltd.,** Westmoreland Road, London, N.W.9. Tel.: Colindale 8671. Cables: Vitavox, Hyde, London.

**Duplex Coaxial DU 120.** 12 in. and 3 in. paper and polyester film cones and surround. Voice coil (L.F.) 1.78 in. (H.F.) 0.65 in. Gap flux (L.F.) 14,000 (H.F.) 12,000 gauss. Total flux (L.F.) 160,000 (H.F.) 15,000 maxwells. H.C. 15 watts. v.c.i. 15 ohms. F.R. 40-15,000 c/s nominal. Price £19 10s.

**A.K.120.** 12 in. Paper cone. Paper surround. Voice coil 1.78 in. Gap flux 14,000 gauss. Total flux 160,000 maxwells. H.C. 15 watts. v.c.i. 15 ohms. F.R. 40-12,000 c/s. r.c.f. 1,000 c/s. Price £14.

**K15/40.** 15 in. Paper cone. Paper surround. Voice coil 2.25 in. Gap flux 14,000

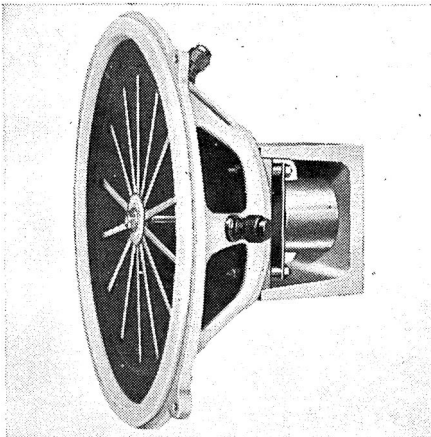

*Sound Sales Auditorium*

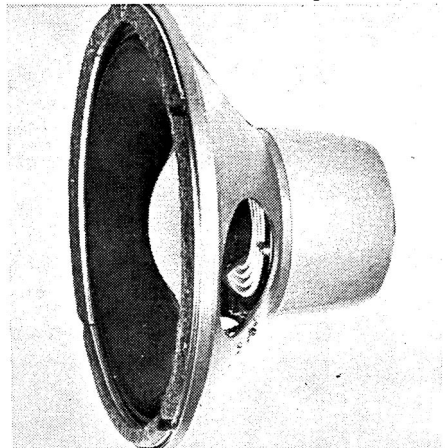

*Tannoy Monitor "Twelve"*



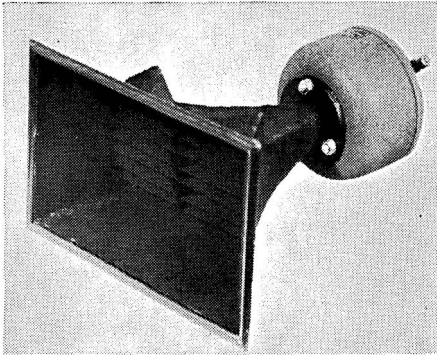

*Westrex High Frequency Unit*

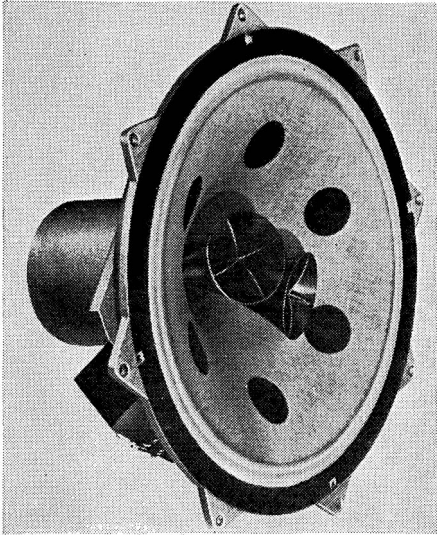

*Whiteley 15-in. Concentric Duplex*



*Vitavox TR30 HF unit*

gauss. Total flux 260,000 maxwells. H.C. 40 watts. v.c.i. 15 ohms. F.R. 50-8,000 c/s. r.c.f. 500 c/s. Price £25.

**T.R. 30.** 3 in. cone. Gap flux 12,000 gauss. Total flux 15,000 maxwells. H.C. 15 watts. F.R. 1,000-15,000 c/s. v.c.i. 15 ohms. Crossover frequency 2,000 c/s. Price £6 10s.



**Westrex Co. Ltd.,** Coles Green Road, London, N.W.2. Tel.: Gladstone 5401/8. Cables: Westelcol, Norphone, London.

**20/80 Low Frequency Unit.** 15 in. Paper cone with damped surround and spider. Voice coil 3 in. of edgewound copper ribbon. Gap flux 13,200 gauss. v.c.i. 16 ohms. H.C. 30 watts. F.R. up to 800 c/s. r.c.f. 675 c/s. Price £33 15s.

**High Frequency Unit,** with Acoustilens coupling unit. Horn loaded. Alloy dome on 3 in. voice coil of edgewound aluminium ribbon. Gap flux 17,500 gauss. H.C. above 500 c/s up to 30 watts. F.R. 500 to over 15,000 c/s. r.c.f. 675 c/s. Speaker includes horn and acoustic lens giving necessary dispersion. Price complete with horn and lens £69 17s.



**Wharfedale Wireless Works Ltd.,** Idle, Bradford. Tel.: Idle 1235-6. Cables: Wharfedel, Idle, Bradford.

**8-in. Bronze/FS/AL.** Paper cone. Foam plastic surround. Voice coil 1 in. (aluminium). Gap flux 10,500 gauss. Total flux 41,500 maxwells. H.C. 4 watts. v.c.i. 2-3 ohms or 10-15 ohms. F.R. 40-12,000 c/s. Price £3 5s. (U.K. purchase tax £1 1s. 7d.)

**Super 8.** 8 in. Paper cone. Surround, paper corrugations. Voice coil 1 in. Gap flux 14,500 gauss. Total flux 60,000 maxwells. H.C. 6 watts. v.c.i. 2-3 or 12-15 ohms. F.R. 60-12,000 c/s. r.c.f. 1,000 c/s. Price £4 10s. (U.K. purchase tax £1 9s. 11d.)

**Super 8/FS.** 8 in. Paper cone. Foam plastic surround. Voice coil 1 in. Gap flux 14,500 gauss. Total flux 60,000 maxwells. H.C. 5 watts. v.c.i. 2-3 or 12-15 ohms. F.R. 40-12,000 c/s. Price £5. (U.K. purchase tax £1 13s. 3d.)

**Super 8/FS/AL.** 8 in. Paper cone. Foam plastic surround. Aluminium voice coil 1 in. Gap flux 14,500 gauss. Total flux 60,000 maxwells. H.C. 4 watts. v.c.i. 2-3

*Wharfedale  
RS/12/DD  
(Right)  
And  
Super  
12/RS/DD*

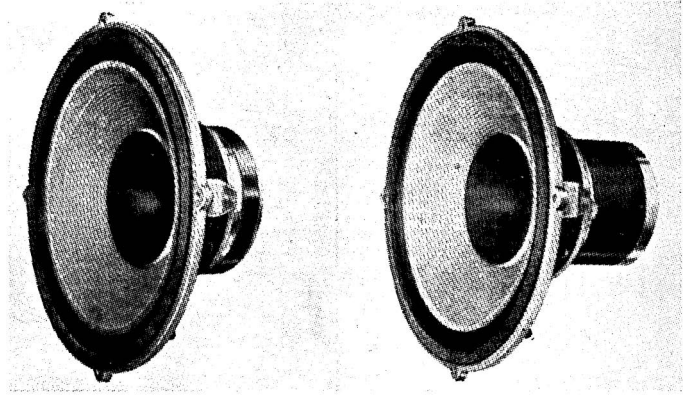

or 10-15 ohms. F.R. 40-14,000 c/s. Price £5 5s. (U.K. purchase tax £1 14s. 11d.)

**10-in. Bronze/FSB.** Paper cone with bakelised apex. Foam plastic surround. Voice coil 1 in. Gap flux 10,500 gauss. Total flux 41,500 maxwells. H.C. 6 watts. v.c.i. 2-3 or 12-15 ohms. F.R. 30-10,000 c/s. Price £3 19s. 6d. (U.K. purchase tax £1 6s. 5d.)

**Golden 10/RS/DD.** 10 in. Double diaphragm assembly. Roll surround. Voice coil 1 in. Gap flux 14,500 gauss. Total flux 60,000 maxwells. H.C. 8 watts. v.c.i. 12-15 ohms. F.R. 30-12,000 c/s. Price £6 15s. (U.K. purchase tax £2 5s.)

**Super 10/RS/DD.** 10 in. Paper (double diaphragm) cone. Roll surround. Voice coil 1 in. Gap flux 16,000 gauss. Total flux 84,000 maxwells. H.C. 10 watts.

v.c.i. 2-3 or 12-15 ohms. F.R. 30-10,000 c/s. Price £3 19s. 6d. (U.K. purchase tax £1 6s. 5d.)

**Super 12/RS/DD.** 12 in. double diaphragm assembly. Roll surround. Voice coil 1½ in. (aluminium). Gap flux 17,000 gauss. Total flux 190,000 maxwells. H.C. 20 watts. v.c.i. 12-15 ohms. F.R. 25-15,000 c/s. Price £17 10s.

**W15/RS.** 15 in. Paper cone. Roll surround. Voice coil 2 in. Gap flux 13,500 gauss. Total flux 180,000 maxwells. H.C. 15 watts. v.c.i. 12-15 ohms. F.R. 25-2,000 c/s. r.c.f. 800 c/s. Price £17 10s.

**Super 3.** 3 in. Bakelised paper cone with integral dome. Foam plastic surround. Voice coil 1 in. (aluminium). Gap flux 14,500 gauss. Total flux 60,000 maxwells. H.C. 6 watts above 1,000 c/s. v.c.i. 2-3 or 8-15 ohms. F.R. 3,000-20,000 c/s. r.c.f.

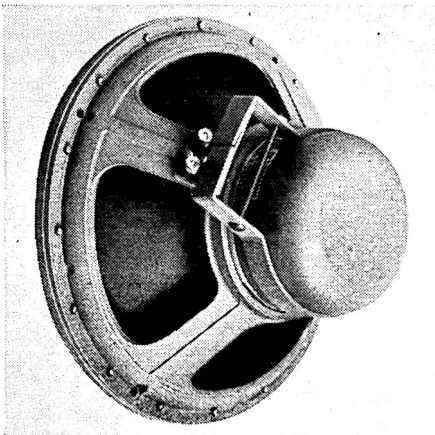

*Westrex 20/80 Low Frequency Unit*

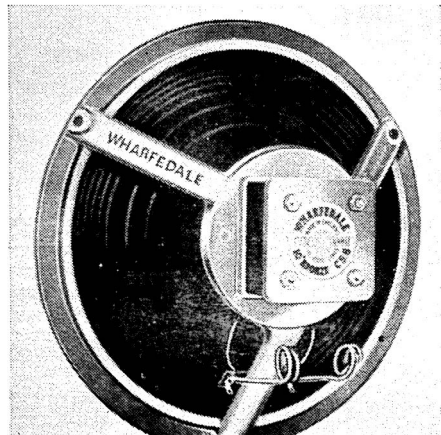

*Wharfedale Bronze/FSB*



# HIGH FREQUENCY UNITS

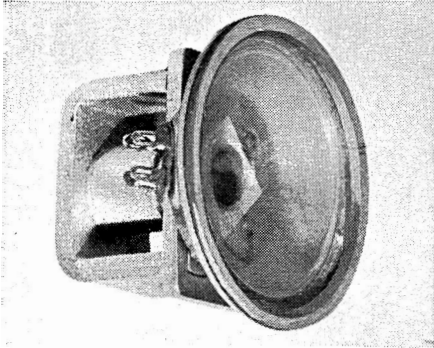

*TSL-Lorenz LPH 65 Tweeter*

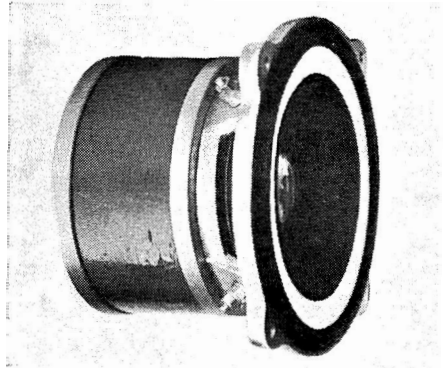

*Bakers Selhurst Ultrasonic*

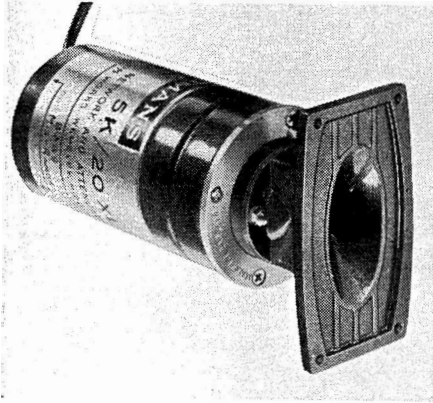

*Goodmans Trebax 5K/20XL*

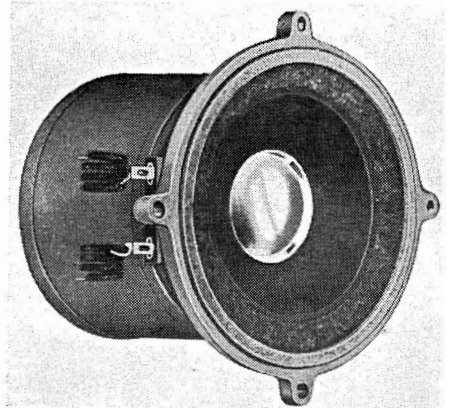

*Wharfedale Super 3*

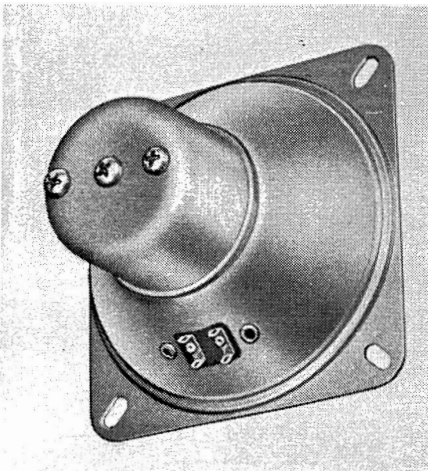

*Richard Allan 410T*

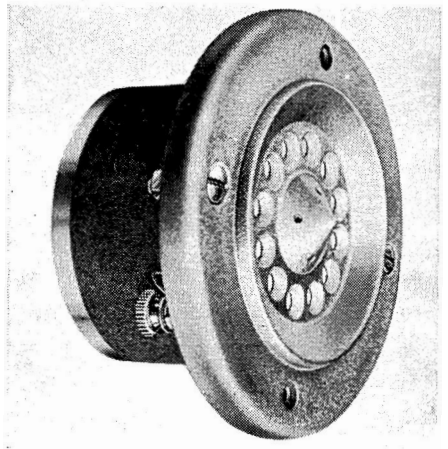

*Fane 301 H.F. Unit*

4,000 c/s. Price £5 (U.K. purchase tax £1 13s. 3d.)

**8/145.** 8 in. Paper cone. Foam surround. Voice coil 1 in. (aluminium). Gap flux 14,500 gauss. Total flux 60,000 maxwells. H.C. 4 watts. v.c.i. 2-3 or 10-15 ohms. F.R. 40-14,000 c/s. Price £5 5s. (U.K. purchase tax £1 14s. 11d.)

**Coaxial 12.** (L.F.) 12 in. (H.F.) 2 in. Paper cone. Roll surround. Voice coils (L.F.) 1½ in. (H.F.) 1 in. Gap flux (L.F.) 14,000 (H.F.) 13,200 gauss. Total flux (L.F.) 155,000 (H.F.) 44,000 maxwells. H.C. 15 watts. v.c.i. 12-15 ohms only. F.R. 25-20,000 c/s. Price £25.



**Messrs. Whiteley Electrical Radio Co. Ltd.,** Victoria Street, Mansfield, Notts. Tel.: Mansfield 1762-5. Cables: Whitebon, Mansfield.

**Stentorian HF.812.** 8 in. Composite (paper and cambric) cone. Cambric surround. Voice coil 1 in. Gap flux 12,000 gauss. Total flux 47,400 maxwells. H.C. 5 watts. v.c.i. universal (3, 7.5 and 15 ohms). F.R. 50-12,000 c/s. Price £3 2s. 5d. (U.K. purchase tax £1 1s.)

**Stentorian Clumber.** 9 in. Paper cone. Paper surround. Voice coil 1 in. Gap flux 12,000 gauss. Total flux 47,400 maxwells. H.C. 9 watts. v.c.i. 15 ohms. F.R. 100-13,000 c/s. Price £11 0s. 2d. (U.K. purchase tax £3 14s.)

**H.F.816.** 8 in. Composite (paper and cambric) cone. Cambric surround. Voice coil 1 in. Gap flux 16,000 gauss. Total flux

63,000 maxwells. H.C. 6 watts. v.c.i. universal 3 ohms, 7.5 ohms and 15 ohms. F.R. 50-14,000 c/s. Price £5 2s. 8d. (U.K. purchase tax £1 14s. 8d.)

**H.F.817.** 8 in. Paper cone. Cambric surround. Voice coil 1 in. Gap flux 17,000 gauss. Total flux 67,000 maxwells. H.C. 10 watts in cabinet. v.c.i. 15 ohms. F.R. 60-22,000 c/s. Price £8 10s. 3d. (U.K. purchase tax £2 17s. 4d.)

**H.F.912.** 9 in. Composite (paper and cambric) cone. Cambric surround. Voice coil 1 in. Gap flux 12,000 gauss. Total flux 47,400 maxwells. H.C. 7 watts. v.c.i. universal (3, 7.5 and 15 ohms), F.R. 40-13,000 c/s. Price £3 6s. 1d. (U.K. purchase tax £1 2s. 3d.)

**H.F.1012.** 10 in. Composite (paper and cambric) cone. Cambric surround. Voice coil 1 in. Gap flux 12,000 gauss. Total flux 47,400 maxwells. H.C. 10 watts. v.c.i. universal 3 ohms, 7.5 ohms and 15 ohms. F.R. 30-14,000 c/s. Price £3 14s. 9d. (U.K. purchase tax £1 5s. 3d.)

**HF.1016.** 10 in. Composite paper and cambric) cone. Cambric surround. Voice coil 1 in. Gap flux 16,000 gauss. Total flux 63,000 maxwells. H.C. 10 watts. v.c.i. 3, 7.5 and 15 ohms. F.R. 30-15,000 c/s. Price £5 19s. 8d. (U.K. purchase tax £2 0s. 4d.)

**10-in. Concentric Duplex:** Composite (paper and cambric) cone. Cambric surround. Voice coil 1 in. Gap flux (L.F.) 12,000 (H.F.) 13,000 gauss. Total flux 47,400 maxwells. H.C. 10 watts. v.c.i. 15 ohms. F.R. 30-14,000 c/s. r.c.f. 3,000 c/s built-in. Price £10 2s. (U.K. purchase tax £3 8s.)

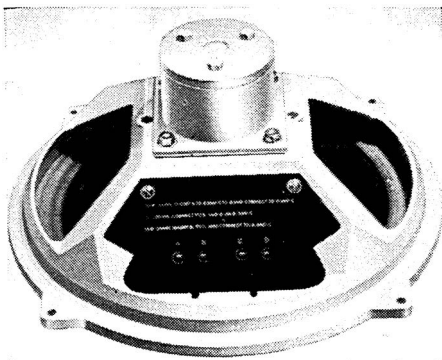

Whiteley HF 1012

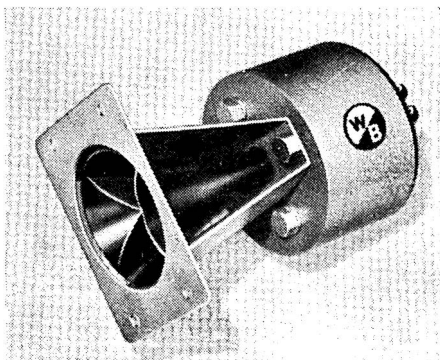

Whiteley T12 tweeter

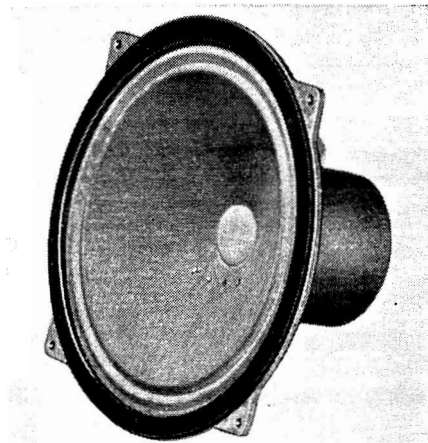

*Whiteley H. F. 816 8-in.*

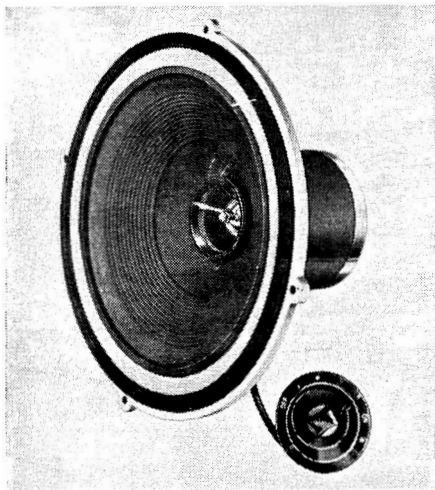

*Wharefdale Coaxial 12*

**HF.1214.** 12 in. Composite (paper and cambric) cone. Cambric surround. Voice coil 1.5 in. Gap flux 14,000 gauss. Total flux 106,000 maxwells. H.C. 15 watts. v.c.i. 15 ohms. F.R. 25-14,000 c/s. Price £10 5s. 6d.

**HF.1216.** Composite (paper and cambric) cone. Cambric surround. Voice coil 1½ in. Gap flux 16,000 gauss. H.C. 15 watts. F.R. 20-16,000 c/s. Price £15 15s.

**15-in. Concentric Duplex.** Composite (paper and cambric) cone. Cambric surround. Voice coil 2 in. Gap flux (L.F.) 14,000 (H.F.) 17,000 gauss. Total flux

350,000 maxwells. H.C. 25 watts, v.c.i. 15 ohms. F.R. 20-18,000 c/s. r.c.f. 3,000 c/s. built-in. Price £45.

**HF.1514.** 15 in. Composite (paper and cambric) cone. Cambric surround. Voice coil 2 in. Gap flux 14,000 gauss. Total flux 178,000 maxwells. H.C. 25 watts. v.c.i. 15 ohms. F.R. 25-5,000 c/s. r.c.f. 1,500-3,000 c/s. Price £26.

**T.10 Tweeter.** Aluminium cone and surround. Voice coil 1 in. Gap flux 14,000 gauss. Total flux: 44,000 maxwells. H.C. 5 watts. v.c.i. 15 ohms. F.R. 2,000-14,000 c/s. r.c.f. 3,000 c/s. Price £4 8s. 3d.

**T.12.** Tweeter. Aluminium cone and surround. Voice coil 1.5 in. Gap flux 17,000 gauss. Total flux 110,000 maxwells. H.C. 12 watts. v.c.i. 15 ohms. F.R. 2,000-17,000 c/s, r.c.f. 3,000 c/s. Price £13 4s. 6d.

**T.816.** 8 in. Paper cone and surround. Voice coil 1 in. Gap flux 16,000 gauss. Total flux 63,000 maxwells. H.C. 15 watts. v.c.i. 15 ohms. F.R. 1,500 to 17,000 c/s. r.c.f. 1,500 c/s. Price £4 17s. 3d. (U.K. purchase tax £1 11s. 2d.)

**T.359.** 3½ in. Paper cone and surround. Voice coil 0.625 in. Gap flux 9,000 gauss. Total flux 14,900 maxwells. H.C. 15 watts with crossover. v.c.i. 5 or 15 ohms. F.R. 3,000-17,000 c/s. r.c.f. 3,000 c/s. Price £1 6s. 1d. (U.K. purchase tax 8s. 10d.).

### ACOUSTIC RESISTANCE UNITS

**Goodmans Industries Ltd.,** Axiom Works, Wembley, Middx. Tel.: Wembley 1200. Cables: Goodaxiom, Wembley.

**ARU Units.** These units combine both reflex port and acoustic resistance in one complete unit. The port area and resistance are calculated to suit a particular cabinet volume and speaker cone resonance, thus being usable with a variety of cabinet designs and driving units. Price £2 19s. 6d. to £4 4s.

*Details of New Products are given in a special supplement at the end of the book.*

## ELECTROSTATIC SPEAKERS

FULL RANGE, MID AND UPPER RANGE  
ELECTROSTATIC LOUDSPEAKER UNITS.

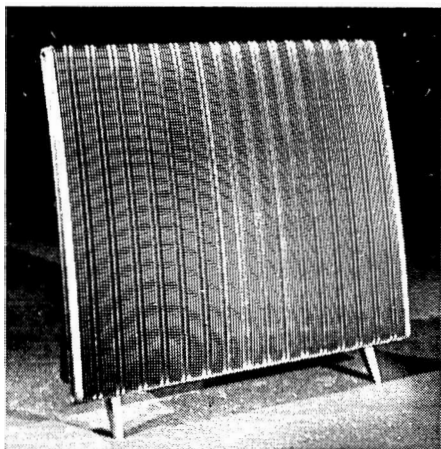

*Quad Electrostatic full range Loudspeaker*

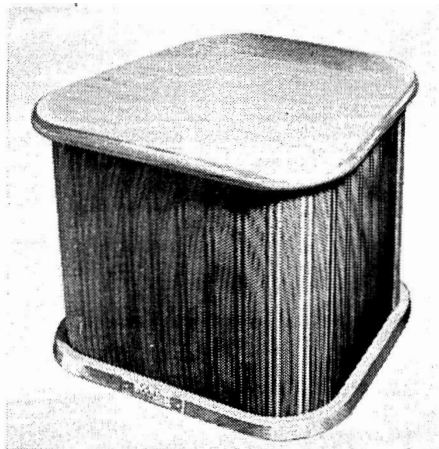

*Woollett Upper Register*

**Acoustical Manufacturing Co. Ltd.,** St. Peter's Road, Huntingdon, Hunts. Tel.: Huntingdon 361 and 574. Cables: Acoustical.

**Quad Electrostatic Loudspeaker.** Full range doublet covering 45 c/s to 18 Kc/s. Attenuation outside band asymptotic to 18 dB/8ve. Total integrated radiation at max. output equivalent to 95 phons in rooms of up to 5,000 cu. ft. with average reverberation. Dispersion approx. 70 deg. horizontal; 15 deg. vertical. Impedance 30-15 ohms, 40 c/s to 8 Kc/s falling above 8 Kc/s. Designed for use with standard Quad II Amplifier or equivalent. Suitable for AC supplies 100-120 or 200-250v. 50-60 c/s. Free standing unit requires no enclosure or cabinet. Weight 35 lb. Price £52 complete.



**Execaphon Ltd.,** 77 Sydenham Park Road, London, S.E.26. Tel.: Forest Hill 9595.

**Audistatic.** Electrostatic, mid and upper frequencies, plastic, curved diaphragm, H.C. maximum 15 watts peak music. v.c.i. 15 ohm. F.R. 100 c/s to limit of hearing. Built-in crossover integrated 1,500 c/s. Price £15 15s. 0d.

**L. G. Woollett & Co. Ltd.,** 21 Anerley Road, Station Road, London, S.E.20. Tel.: Sydenham 9003.

**Electrostatic Upper Register Speaker.** Filter mains polarising and matching. H.C. 15 watts. F.R. from 1,500 c/s upwards. Built-in crossover integrated. Price £15 15s.

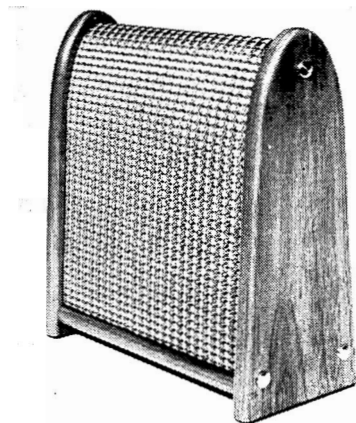

*Audistatic mid & upper frequency unit*

# DIRECTORY OF CROSSOVER UNITS

**Richard Allan Radio Ltd.**, "Baffle House", Taylor Street, Batley. Tel.: Batley 1123/1308/4033. Cables: Acoustics, Batley.

**CN.104 Crossover Unit.** A two-way half-section parallel network. Crossover frequency 5,000 c/s. All terminations 15 ohms. Price £2 2s.

**CN.1284. Crossover Unit.** A three-way crossover with main crossover operating from half wave parallel network and subsidiary crossover capacity fed. Crossover frequencies 1,100 and 5,000 c/s. All terminations 15 ohms. Price £6 5s.



*Goodmans XO/950 crossover unit*

**Goodmans Industries Ltd.**, Axiom Works, Wembley, Middx. Tel.: Wembley 1200. Cables: Goodaxion, Wembley.

**X0/5000-Crossover Unit.** A two-way half-section crossover network, operating at 5,000 c/s. All terminations 15 ohms. Price £1 19s.

**X0/950-Crossover Unit.** A two-way half-section, crossover network, operating at 950 c/s. All terminations 15 ohms. Price £5 5s. 8d.

**X0/950/5000. Crossover Network.** A multiple crossover network comprising four half-section L.C. filters. Crossover frequencies are 950 c/s and 5,000 c/s. All attenuation rates are 12 dB/octave. All terminations 15 ohms. Price £7 0s. 6d.



**Romagna Reproducers**, Factory Distributors, K. H. Williman & Co. Ltd., Blackford House, Sutton, Surrey. Tel.: Melville 1491.

**CO/1/15. Crossover Network.** 3 Kc crossover frequency for 15 ohm loudspeakers and amplifiers. Balance control fitted,  $\frac{1}{2}$  section networks giving 12 dB/octave cut-off. Maximum insertion loss 1 dB in pass band. Potted in cast aluminium case. Price £3 3s.



**Westrex Co. Ltd.**, Coles Green Road, London, N.W.2. Tel.: Gladstone 5401/8. Cables: Westelcol, Norphone, London.

**Dividing Network.** Constant impedance parallel network, using two L-type filter sections, low and high pass, crossover at 675 c/s. For any impedance 16-24 ohms. Price £13 10s.



**Wharfedale Wireless Works Ltd.**, Idle, Bradford, Yorks. Tel.: Idle 1235-6. Cables: Wharfedel, Idle, Bradford.

**Loudspeaker Separators.**  $\frac{1}{4}$ -section type. Operating at 1,000 or 3,000 c/s. 8 units available to cover from 2-16 ohms impedance. Slope 6 dB/octave. Size 7 × 4 × 3 $\frac{3}{4}$  ins. Weight 2-2 $\frac{1}{2}$  lbs. Max. input 30 watts. Price from £2 11s. to £4 17s. 6d. depending on type.

**HS/CR3/2.**  $\frac{1}{2}$ -section 3-way separator unit with crossover at 800 and 5,000 c/s. Max. input 30 watts. Slope 12 dB/octave. Size 9 × 6 × 5 ins. Weight 6 $\frac{1}{2}$  lbs. 2 models. 2-6 ohms, Price £11; 7-16 ohms,

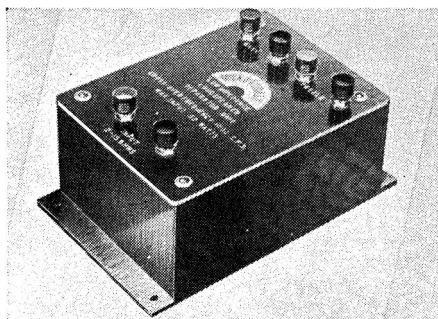

*Wharfedale  $\frac{1}{4}$  section crossover*

Price £8 10s. Also available with crossover at 400 and 5,000 c/s. 7-16 ohms only, Price £10.

**WMT1 Matching Transformer.** Auto transformer for matching 10-16 ohms or 7-9 ohms speakers to sets with 2-5 ohms output or vice versa. Response 20-15,000 c/s  $\pm$  1 dB. Handling capacity 15 watts. Can also match speakers of different imps. to crossover unit in 2 or 3 speaker systems. Size  $2\frac{7}{8} \times 2\frac{3}{4} \times 2\frac{3}{4}$  ins. Weight  $12\frac{1}{2}$  ozs. Price 13s. 6d.

**Stereo Truqual.** Ganged twin vol. control. L-pad type attenuators for stereo speakers. 6 positions. Price £1 10s.



**Whiteley Electrical Radio Co. Ltd.,** Victoria Street, Mansfield, Notts. Tel.: Mansfield 1762-5. Cables: Whitebon, Mansfield.

**CX500. Crossover Unit.** A two-way half-section crossover network operating at 500 c/s. All terminations 15 ohms. Price £1 6s.

**CX1500. Crossover Unit.** As CX500, but operating at 1,500 c/s. Price £1 18s. 3d.

**CX3000. Crossover Unit.** As CX1500, but operating at 3,000 c/s. Price £1 10s.

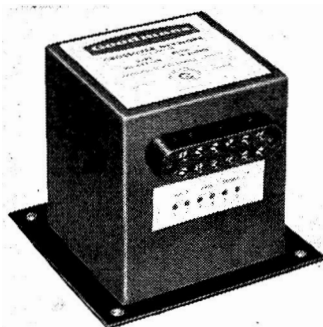

*Goodmans XO/950 crossover unit*

**L. G. Woollett & Co. Ltd.,** 21 Anerley Station Road, London, S.E.20. Tel.: Sydenham 9003.

**Transformer** permitting the use of one bass speaker with two electrostatic upper register speakers. Converts a 3 ohm speaker to 15 ohms or a 3 ohm amplifier to 15 ohms. Enables sensitivity of speaker to be reduced by 6 or 12 dB whilst maintaining a 15 ohm load on amplifier and heavy damping of speaker. F.R. 16-20,000 c/s  $\pm$  0.3 dB. H.C. 15 watts. Size  $3\frac{1}{2} \times 3\frac{1}{4} \times 2\frac{1}{2}$  ins. Weight 2 lbs. 9 ozs. Price £2 18s. 6d.

## PART 2 — SPEAKER ENCLOSURES

**Richard Allan Radio Ltd.,** Baffle House, Taylor Street, Batley, Yorks. Tel.: Batley 1123/1308/4033. Cables: Acoustics, Batley.

**Type 840.** Reflex forward facing unit. Designed for shelf or floor mounting. Two drive units. 8 in. bass and 4 in. tweeter. F.R. 45-17,000 c/s. Size  $25 \times 10 \times 11$  ins. Weight 26 lbs. Price £9.

**Princess.** Reflex forward facing unit. Designed for corner location. One 8 in. drive unit. Rec. Golden Eight. Response 60-10,000 c/s. Size  $28 \times 20 \times 12$  ins. Weight 28 lbs. Price £11 11s.

**Duchess.** Reflex unit designed for corner location. Upward facing tweeter, forward bass. Two drive units. 10 in. bass and 4 in. tweeter. Rec. Golden Ten and 410T. Crossover CN.104. Response 40-17,000 c/s. Size  $30 \times 25 \times 17$  ins. Weight 48 lbs. Price £15 15s.

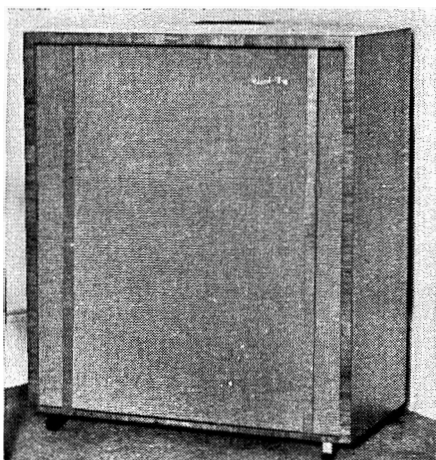

*Richard Allan Empress*

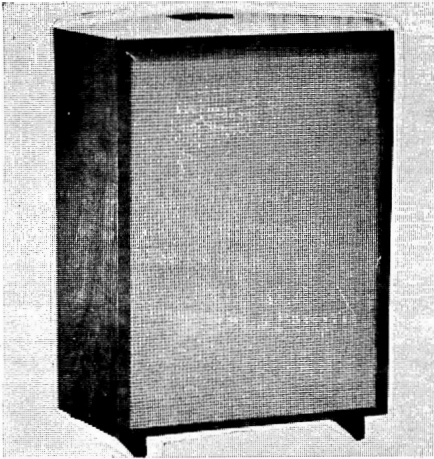

*Richard Allan Duchess*

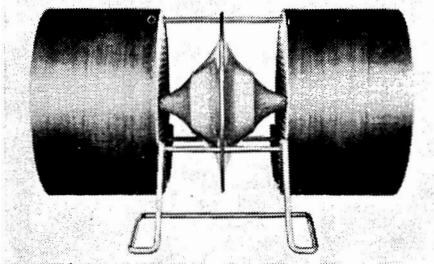

*Burne-Jones Treble Twin*

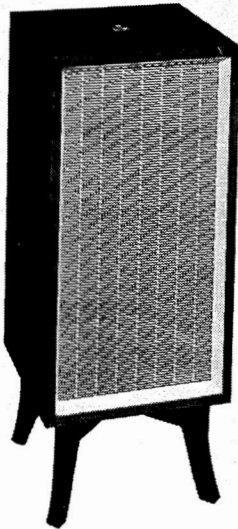

*H.M.V. 519 infinite baffle*

**Empress.** Reflex unit designed for corner location. Upward facing tweeter, forward bass and middle units. Three drive units. 12, 8 and 4 ins. Rec. Golden Twelve, 812F, and 410T. Crossover CN.1284. Response 25-17,000 c/s. Size 33 × 31 × 21 ins. Weight 72 lbs. Price (complete) £37 16s. (without units) £17 17s.



**Bang & Olufsen,** Struer, Denmark. Sole U.K. Importers: Avey Electric Ltd., Ayrton Road, South Ockendon, Essex. Tel.: South Ockendon 3444.

**B & O Toroidal Tweeter.** Omni-directional. Comprising 2 moving coil units facing inwards on a double cone reflector. Response: 2,000-20,000 c/s. Series capacitor incorporated. Size 4½ ins. high, 3 ins. diameter. Price £6 18s. 3d.



**Burne-Jones & Co., Ltd.,** 18 Brunswick Road, Sutton, Surrey. Tel.: Vigilant 5050. Cables: Burjomag, Sutton.

**B.J. Treble 20.** Omni-directional multi-horn. One 4 in. unit. Crossover built-in. Response 1,000-18,000 c/s. Size 6 × 5 ins. Weight 1½ lbs. Price £3 15s. (U.K. purchase tax £1 6s. 6d.)

**B.J. Treble Twin.** Omni-directional horn. Two 4 in. drive units. Crossover included. Response 900-18,000 c/s. Size 9 × 4¾ × 6 ins. Weight 2 lbs. Price £7 2s. 9d. (U.K. purchase tax £2 5s. 10d.)



**Clarke & Smith Manufacturing Co., Ltd.,** H.M.V. High Fidelity Components Division, Melbourne Works, Wallington, Surrey. Tel.: Wallington 9252. Cables: Electronic, Wallington.

**HMV 519.** Infinite baffle. Designed to match equipment console HMV 582. Forward facing. One 13 × 8 in. drive unit, two 3 in. tweeters. DLSU/13/4 13 × 8 in. and DLSU/3/16 3 in. (both E.M.I.) recommended. Crossover XO 4500/4 (E.M.I.). Response 70 c/s-15 Kc/s ± 3 dB. Size, with legs, 31 × 13 × 12¾ ins. Weight approx. 40 lbs. Price £28 7s. each. Units used in the system are available separately. Price, per set £15 4s. 2d. (U.K. purchase tax 19s. 6d.)



Daystrom Ltd., Bristol Road, Gloucester.

Cotswold totally enclosed forward facing. (See Kits section.)



Electronic & Television Industries Ltd.,  
7 Arkwright Road, Poyle Trading Estate,  
Colnbrook, Bucks. Tel.: Colnbrook 2764.

Lansing Rolls. Horn type. 12 in. bass,  
3-2½ in. mid-range, 1-2½ in. H.F. Direct  
radiation front and rear. F.R. 20-20,000 c/s.  
Crossover 2,700 and 6,000. 15 ohms. Size  
31 × 19½ × 16 ins. Price, sapele, £67 10s.



Expert Gramophones Ltd., 235a Bensham  
Lane, Thornton Heath, Surrey. Tel.:  
Thornton Heath 4139 (Showroom: 82  
Kensington High Street, W.8. Tel.:  
Western 0037.)

Acoustic Column. Elongated reflex.  
Vertically mounted 12 in. bass unit and  
3 in. tweeter. Rec. Goodmans Audiom 60  
and Wharfedale Super 3 tweeter. Response  
35-18,000 c/s. Size 44 × 14 × 14 ins.  
Price (complete) £42. Alternative version  
available. Price £33.

Master Speaker. Corner reflex. 15 in.  
dual concentric unit, vertically mounted  
with reflector. 90° distribution. Rec. unit  
15 in. Tannoy dual concentric. Crossover  
1,000 c/s. Response 28-20,000 c/s. Size  
60 × 34 × 24 ins. Price (complete) £110.



Fane Acoustics Ltd., Hick Lane, Batley,  
Yorks. Tel.: Batley 1578. Cables: Fane,  
Batley.

Trio. Cabinet-baffle, forward facing.  
Three drive units. 12 in., 8 in., and H.F.  
unit. Fane units rec. Crossover included.  
Response 40-17,000 c/s. Size 24½ × 24 ×  
8½ ins. Weight 13 lbs. Price £17 10s.

Quartet. Cabinet-baffle, forward facing.  
Four drive units. 12 in., 8 in., and two  
H.F. units. Size 25½ × 25½ × 8¾ ins.  
Weight 32 lbs. Price £35. Cabinet only not  
supplied.



Goodmans Industries Ltd., Axiom Works,  
Wembley, Middlesex, England. Tel.: Wem-  
bley 1200. Cables: Goodaxiom, Wembley.

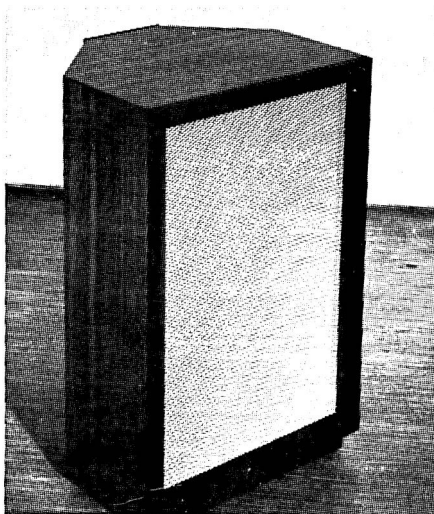

*E.T.I. Lansing Rolls*

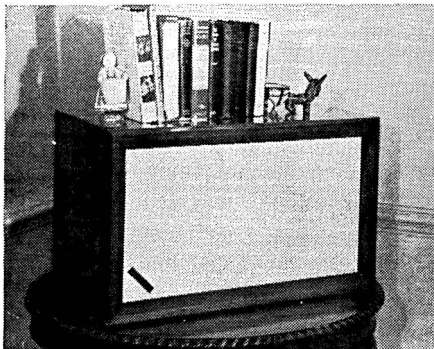

*Goodmans AL 120*

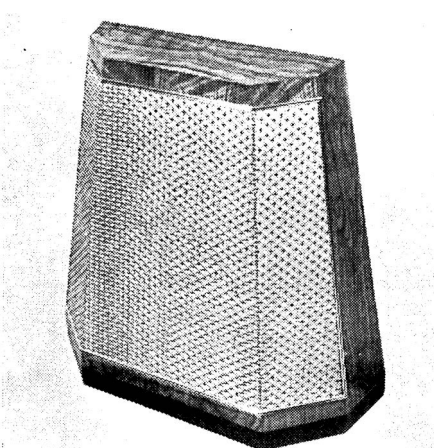

*Fane Quartet*



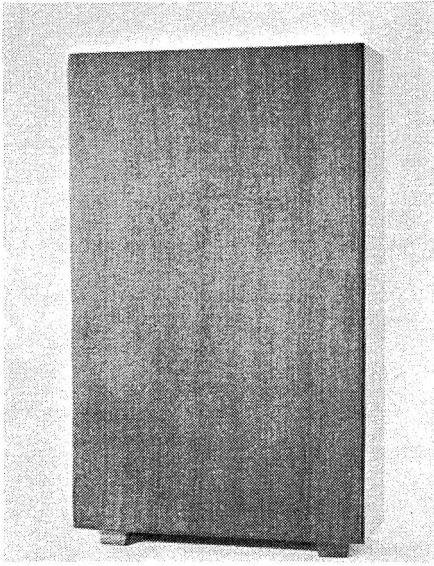

*K.E.F. K1 Slimline*

**AL120. Bookcase Loudspeaker,** forward facing. Baffle ARU loaded. One 12 in. Triaxial Loudspeaker. Crossover at 5,000 c/s built-in. Size  $24 \times 11\frac{1}{2} \times 14\frac{1}{4}$  ins. Price £29 10s. complete.



**Grampian Reproducers Ltd.,** Hanworth Trading Estate, Feltham, Middlesex, England. Tel.: Feltham 2657. Cables: Reamp, Feltham.

**Grampian WS9.** Totally enclosed, forward facing. Fitted with 9 in. drive unit. Handling capacity 7 watts. Size  $23 \times 12 \times 12$  ins. Shaped for corner or wall position. Price £11 2s. 6d. (U.K. purchase tax £3 15s.), legs extra £1 2s. 6d.

**Grampian CE12.** Forward facing reflex, shaped for corner or wall position. One 12 in. unit. Grampian rec. 1255/15. Size  $29 \times 18 \times 12\frac{1}{2}$  ins. Price (complete) £23 10s.



**KEF Electronics Ltd.,** Tovil, Maidstone, Kent. Tel.: Maidstone 55761. Cables: Kef, Maidstone.

**Picture Speaker.** Flexing panel. Forward facing. One drive unit,  $6 \times 4$  ins. Tri-ply K.E.F. recommended. Response 100-15,000 c/s. Size  $18 \times 10\frac{3}{4} \times 2\frac{5}{8}$  ins. Weight 7 lbs. Price £6 10s. (U.K. purchase tax £2 6s. 6d.)

**K1 Slimline.** Pure acoustical resistance load. Forward facing. Three drive units,  $16 \times 12$ ,  $6 \times 4$ ,  $1\frac{1}{2}$  dia. ins. Crossover 375 c/s and 3,000 c/s. Size  $27 \times 17 \times 6\frac{3}{4}$  ins. Weight 40 lbs. Price £37.

**K1 Monitor.** Pure acoustical resistance load. Forward facing. Three drive units,  $16 \times 12$ ,  $6 \times 4$ ,  $1\frac{1}{2}$  dia. ins. Crossover 375 c/s and 3,000 c/s. Response 20-20,000 c/s. Size  $39\frac{1}{2} \times 17 \times 14$  ins. Weight 70 lbs. Price £52.

**K2** totally enclosed. Forward facing. Two drive units  $13 \times 9$  ins. and  $1\frac{1}{2}$  ins. dia. Crossover 1,000 c/s. Size  $18 \times 10\frac{3}{4} \times 6\frac{3}{4}$  ins. Weight 23 lbs. Price to be announced.



**H. J. Leak & Co. Ltd.,** 57/59 Brunel Road, East Acton, London, W.3. Tel.: Shepherds Bush 1173. Cables: Sinusoidal, Ealux, London.

**Sandwich.** Forward facing, two units. Bass 13 in. Treble 3 in. half section crossover cabinet—can be placed in vertical or horizontal position. Size  $26 \times 15 \times 12$  ins. Weight 45 lbs. Price £39 18s.



**Lockwood & Co. (Woodworkers) Ltd.,** 67 Lowlands Road, Harrow, Middlesex. Tel. Byron 3704.

**LE.1.** Reflex, forward facing. Suitable for 15 in. dual concentric unit, or 3-way

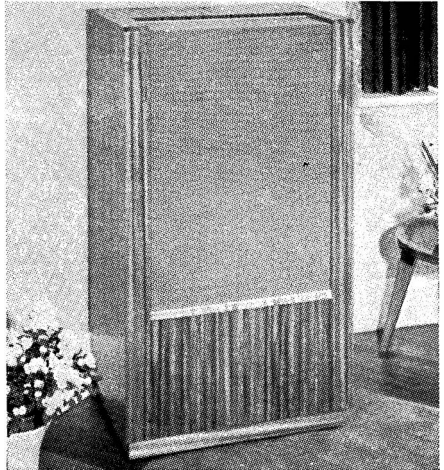

*Lockwood LE.1 reflex*

combination. Size  $44 \times 24 \times 17\frac{1}{2}$  ins. Concealed castors. 18 in. version available. Prices on application.

**LE.2, 3, and 4.** These have a similar outward appearance and design to the LE.1 above, but are progressively smaller in dimension and price, and are suitable for smaller speaker systems. The smallest, LE.4, is  $27\frac{1}{2} \times 17\frac{1}{2} \times 12\frac{1}{4}$  ins. All cabinets fitted with drive unit to individual requirements. Prices on application.



**Lowther Manufacturing Co.,** Lowther House, St. Mark's Road, Bromley, Kent, England. Tel.: Ravensbourne 5225. Cables: Lowther, Bromley.

**Corner Reproducer TPI.** Folded bass horn/direct h.f. horn type. One specially designed 6 in. pressure unit PM3. Acoustical crossover. Response 40-22,000 c/s. Size  $47 \times 32 \times 31$  ins. from corner. Weight 70 lbs. Price of standard Model A £98. Model B £106 approx.

**Acousta Cabinet.** Models FH/V, FH/H. Folded horn type, forward facing, with rear folded horn. Vertical on runners, or horizontal on 12 in. legs. One unit, 6 in. or 8 in. Rec. Lowther PM6. Response 40-18,000 c/s. Size  $32 \times 18\frac{1}{4} \times 14\frac{1}{2}$  ins. Weight 60 lbs. Price without unit £19 19s., walnut, oak, mahogany.

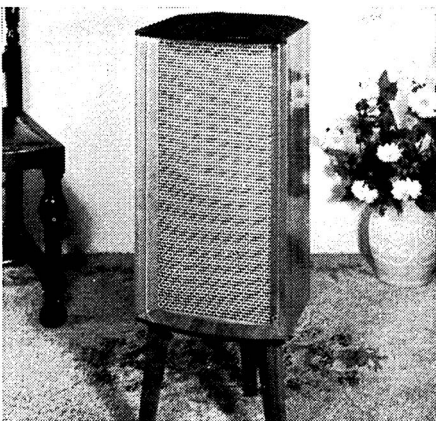

*Grampian WS9*

This enclosure is also available in a "Do-it-yourself" kit form. Price £14 14s. ex works.

**Audiovector.** Compound horn. Upward facing mid- and high-frequency horn with rear folded horn. One 6 in. unit. Acoustic crossover. Range 40-22,000 c/s. Rec. PM2 Mk 11 or PM 4. Size  $26\frac{1}{2} \times 19 \times 34$  ins. Weight 75 lbs. Price with specified units £96, without units £48.

**Acousta-twin.** Dual folded horn. Side facing and rear folded horn system for monaural and stereo reproduction. Two PM6 or PM2 Mk 3 8-in. drive units. Acoustic crossover. Response 40-18,000 c/s. Dimensions  $40 \times 16\frac{1}{2} \times 18$  ins. Price £35 enclosure only. £72 16s. or £95 complete.



**Mordaunt Sound Reproducers,** 32/34 Rupert Street, London, W.1.

**Arundal.** Reflex forward facing two units. Bass 12 in. treble. Ribbon tweeter. Range 30-25,000 c/s. Size  $36 \times 15 \times 12$  ins. Price £39 10s.



**Pamphonic Reproducers Ltd.,** Westmoreland Road, London, N.W.9. Tel.: Colindale 7131.

**Pillar Type 778.** Tuned column. Forward facing H.F. unit and upward facing L.F. unit,  $6\frac{1}{2}$  in. (L.F.), 4 in. (H.F.). Crossover 1,000 c/s single section. Response 35 c/s to 12 Kc/s. Size  $37\frac{1}{2} \times 12 \times 12$  ins. Price £14 6s. (U.K. purchase tax £ 5 3s. 6d.)

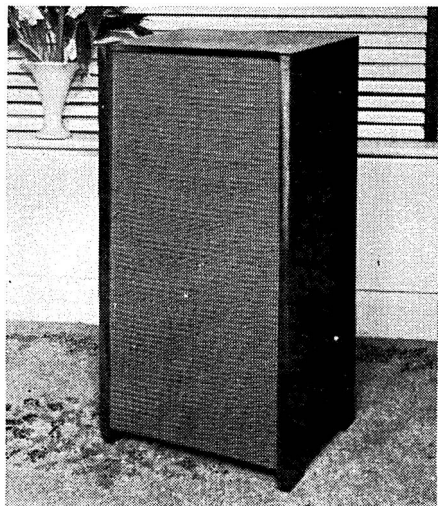

*Grampian CE 12*



*Lowther Audiovector*

**S.1.** Cabinet type, forward facing. Elliptical 10 × 6 ins. concentric cone unit. Size 15 × 12 × 11 ins. Price £10 12s. (U.K. purchase tax £2 14s. 10d.)



**Parman Electronics Ltd.,** Parman House, Balcombe Road, Horley, Surrey. Tel.:

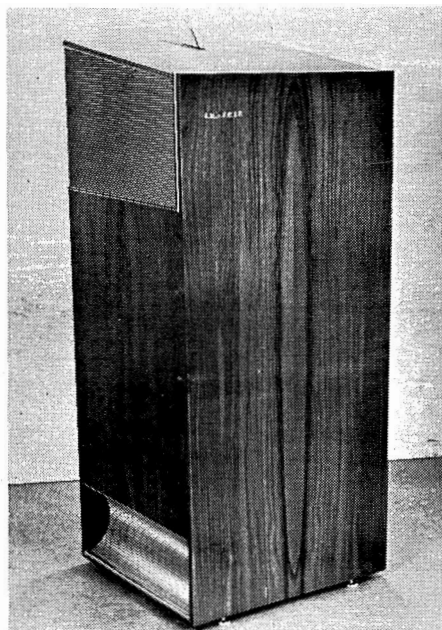

*Lowther Acousta-twin*

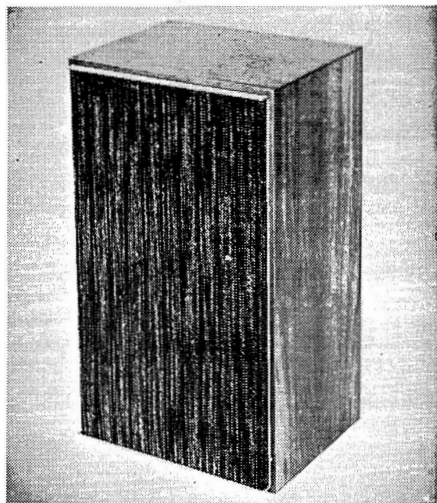

*Leak Sandwich*

**Horley 4344.** Cables: Parmanair, Horley.

**Cygnnet.** Reflex. Table model (upper side of cabinet forming the table top). 13 × 8 ins. and 4-in. tweeter. Crossover unit. Size 21 × 17 × 30 ins. Price £22 1s.



**Pye Limited,** High Fidelity Division, Blue Town, Sheerness, Kent. Tel.: Sheerness 3076. Cables: Faramarine, Sheerness, Kent.

**Mozart Minor HF.8BS.** Distributed vent reflex. Two drive units, 12 in. bass and 10 × 6 ins. elliptical. Air coupled in pat. arrangement. Crossover included. Response 50-15,000 c/s. Size 28 × 13 × 10½ ins. Price £18 18s. complete.

**Mozart Major HF.15 SMT.** Folded labyrinth with forward facing units. One 12-in. and one 4-in. with built-in crossover. Response 45-17,000 c/s. Size 33½ × 17 × 13½ ins. Weight 54 lbs. Price £28 7s.



**Record Housing,** Brook Road, London, N.22. Tel.: Bowes Park 7487.

**Viking.** Reflex forward facing. Three drive units. 8 or 10-in. plus tweeter. Response 40-15,000 c/s. Size 32 × 19 × 12 ins. Price, cabinet only, £10 10s.

**Nordyk.** Reflex forward facing. One drive unit. 8-in. G.E.C. Goodmans and Wharfedale recommended. Response 40-15,000 c/s. Price, cabinet only, £6 15s.

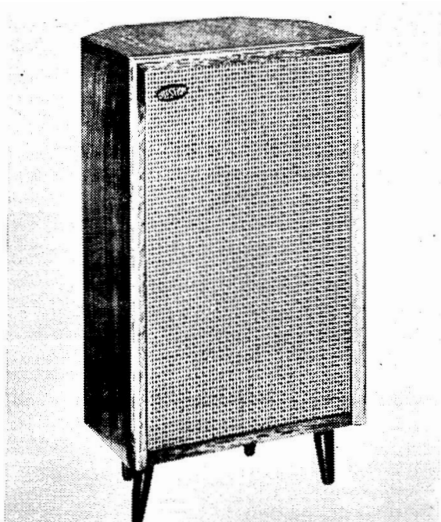

*Rola Celestion Colaudio 11*

**Strauss.** Reflex forward facing. Two drive units. 10 in. plus any tweeter. Response 40-15,000 c/s. Size 32 × 18 × 11 ins. Price £10 19s.



**Rogers Development (Electrical) Ltd.,** 4-14 Barmeston Road, Catford, London, S.E.6. Tel.: Hither Green 7424/4340. Cables: Rodevco, London, S.E.6.

**1284.** 3-way column speaker. Three drive units. 12, 8 and 4 ins. Crossovers included. Response 35-17,000 c/s adjustable. Size 37 × 15 × 14 ins. Price £28 10s. Figured teak £30.

**Mk. 11 Horn Enclosure.** Folded exponential horn housing either the Lowther PM6 or PM2 Mk. 111 Pressure Units. Rear horn loading. Treble diffusor. Power handling capacity: 8 watts (PM6), 10 watts (PM2 Mk. 111). Impedance: 15 ohms. Size 30½ × 12¾ × 29¾ ins. Finish: Figured teak. Price (PM6) £43. (PM2 Mk. 111) £54.



**Rola Celestion Ltd.,** Ferry Works, Thames Ditton, Surrey. Tel.: Emberbrook 3402. Cables: Voicecoil, Thames Ditton.

**Colaudio II.** Bass unit, 12 in. cone. Expanded plastic cone with treated fabric surround. Voice coil 1.75 in. Gap flux 11,500 gauss. Total flux 123,000 maxwells.

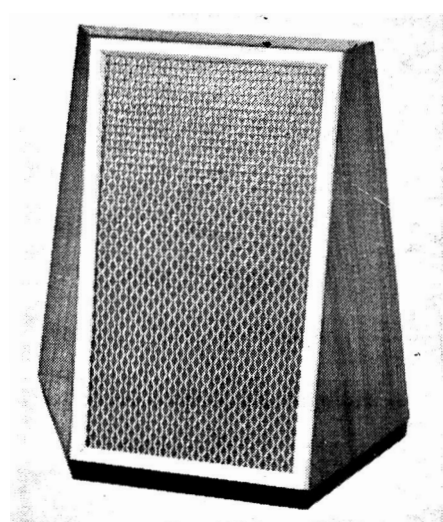

*Fane Trio*

H.C.15 watts peak. V.c.i. 15 ohms. Range 30-15,000 c/s. Enclosed crossover. Price £36 10s.



**Romagna Reproducers,** Factory Distributor, K. H. Williman & Co. Ltd., Blackford House, Sutton, Surrey. Tel.: Melville 1491.

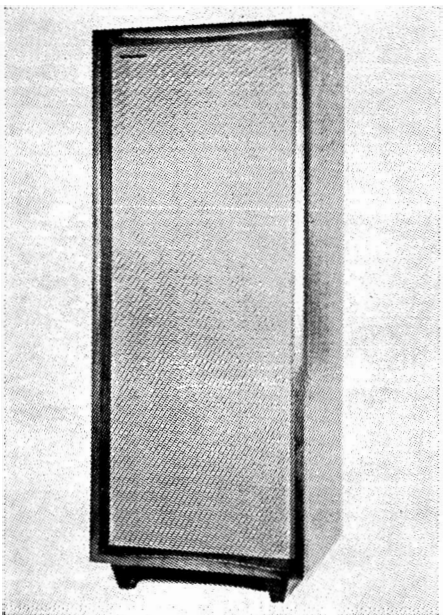

*Mordaunt Arundal*

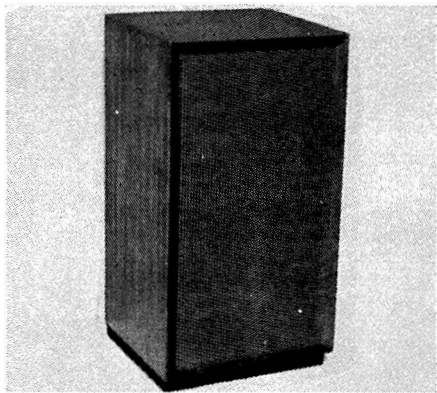

*Lowther Acousta cabinet*

**Mk. 1 Reproducer.** Reflex forward facing. Flat for mid-wall mounting. Two drive units, Kelly Mk. 1 bass unit and Mk. 2 ribbon. Crossover included. Response 35-20,000 c/s. Size 30 × 25 × 12 ins. Weight 55 lbs. Price complete £42.



**The Soundcraft Co.,** 1 Stanley Road, Bromley, Kent. Tel.: Ravensbourne 5673.

**Stanley.** Forward facing folded horn. One 8-in. drive unit. Size 31½ × 12 × 13¾ ins. Price, cabinet only, £13 13s.

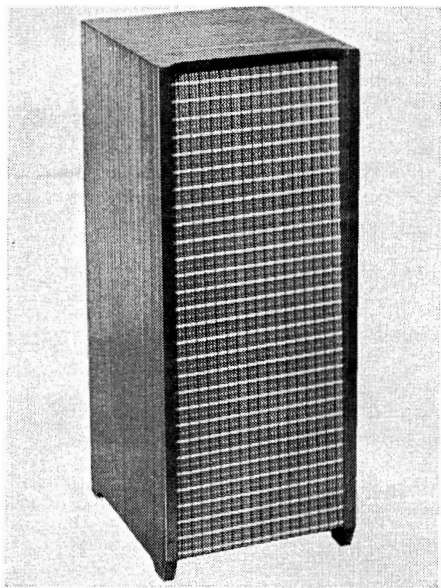

*Soundcraft Stanley*

**Langdon.** Forward facing folded horn. One 8-in. drive unit. Size 33 × 15 × 16 ins. Price, cabinet only, £17 17s.

**FH12.** Forward facing folded horn. Two drive units, 8-in., 10 or 12-in. and tweeter. Size 32½ × 14 ins. Depth according to speaker fitted. Price, approx. £15 15s.



**Sound Sales Ltd.,** Works and Acoustic Laboratories, Farnham, Surrey, England. Tel.: Farnham 6461. Cables: Sounsense.

**Phase Inverter Speaker.** Model A, 15 ohms. Reflex type. Ported cabinet for forward facing. 12 watt handling. 12 in. Sound Sales dual suspension auditorium unit. Response 30-13,500 c/s. Size 29 × 14 × 18½ ins. Weight 44 lbs. Price £20 10s: complete. Stereo pair £37.

**Tri-Channel Mk. 5.** Special labyrinth construction, reflex. Distribution over 90° arc. Three 12 in. Sound Sales Auditorium units, and one tweeter. Response 25-27,000 c/s when used with associated amplifiers. (This equipment is sold complete. Refer to amplifier section.) Size 43 × 31 × 35 ins. Weight 202 lbs. Price, including amplifiers and tone control unit, complete, £125.

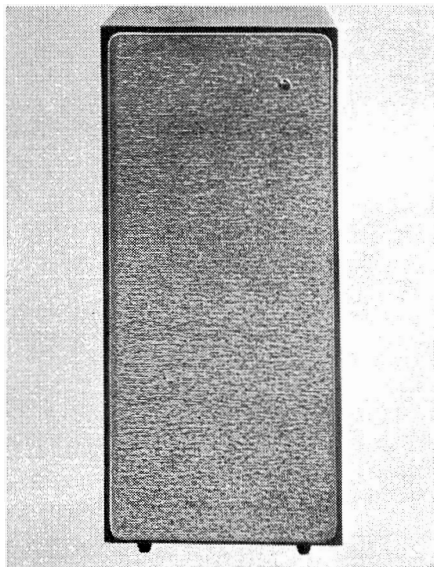

*Pye HF8BS Mozart Minor*

**A. R. Sugden & Co. (Engineers) Ltd.,**  
 Market Street, Brighouse, Yorks. Tel.:  
 Brighouse 2142. Cables: Connoisseur,  
 Brighouse.

**Connoisseur Craftsman Minor.** Column reflex with upward facing ports. Omni-directional 360°. 15 ohms impedance at 400 c/s. One unit, 8 in. foam surround with H.F. dome. 812/FS recommended. Response 40-12,000 c/s. Size 36 × 11½ ins. max. dia. Weight 17 lbs. Price enclosure £9 18s. 9d.; 8 in. unit for above 812/FS £2 1s. 3d. (U.K. purchase tax 14s. 8d.)

**Connoisseur Craftsman Major.** Column reflex with upward facing ports. Omni-directional 360°. 15 ohms impedance at 400 c/s. One 8 in. foam surround unit, one 3 in. tweeter. G8/FS and LPH/65 recommended. Capacitor filter. Response 30-17,000 c/s. Size 43 × 14½ ins. max. dia. Price enclosure only £14 15s.; G8/FS £2 15s. (U.K. purchase tax 19s. 5d.); LPH/65 £1 8s. 6d. (U.K. purchase tax 10s. 1d.)



**Symphony Amplifiers Ltd.,** 16 Kings College Road, London, N.W.3. Tel.: Primrose 3314/5.

**Symphony Column.** One 8-in. drive unit facing vertically. Rec. Wharfedale Super 8/FS/AL. Response approx. 35-15,000 c/s.

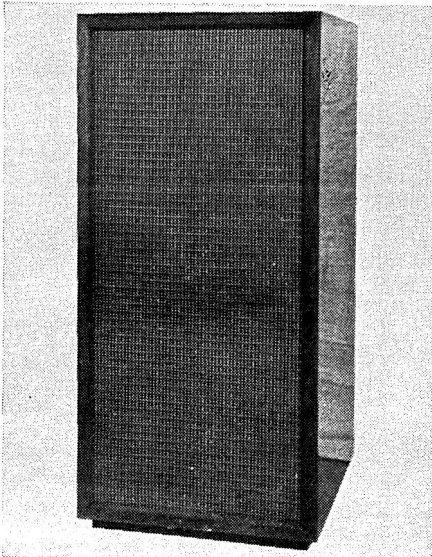

*Sound Sales Phase Inverter*

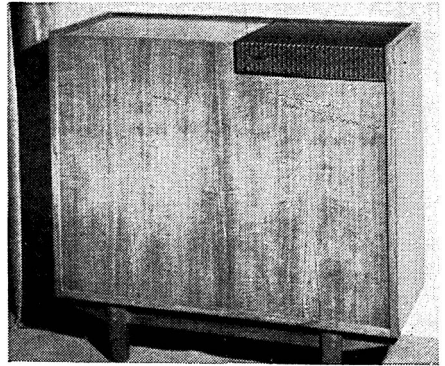

*Rogers MK 11 Horn*

Size 60 × 13 × 13 ins. Weight 50 lbs.  
 Price, cabinet only, £15 15s., Kit £11 11s.

**Symphony Bass Reflex Cabinets.** A range of forward facing systems to take 8, 10 or 12-in. units. Price, ready built, £5 10s. to £11 10s. Also available in kit form.

**Symphony Infinite Baffle.** Forward facing. One 8 in. unit. Wharfedale Super 8/FS/AL or Goodmans Axiette recommended. Response 35-15 Kc/s. Size 24 × 12 × 12 ins. Weight 12 lbs. Price (in white wood) £10 15s. (U.K. purchase tax £1 18s. 6d.) Veneered wood £3 extra; without units (in white wood) £5 10s. Veneered wood £3 extra.

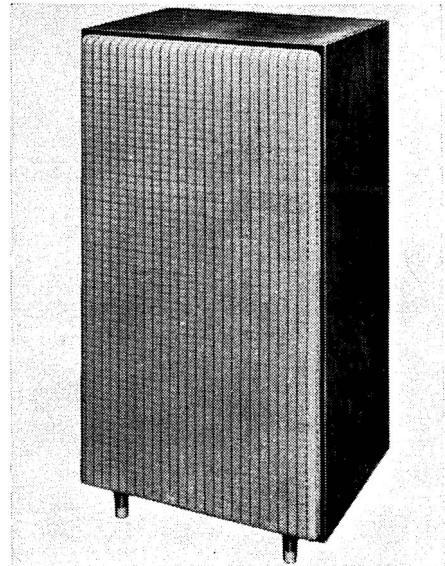

*Pve HF 15/SMT*



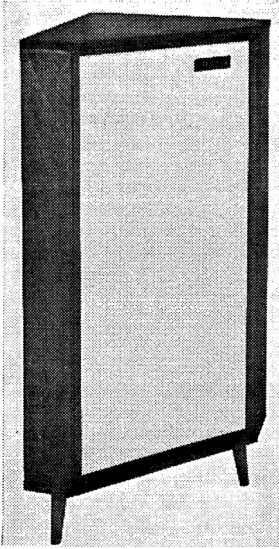

*Tannoy Products  
Chatsworth 11*

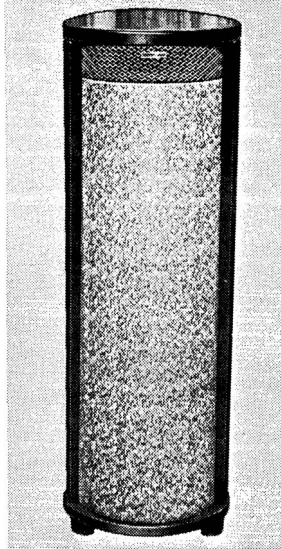

*Connoisseur Craftsman Major*

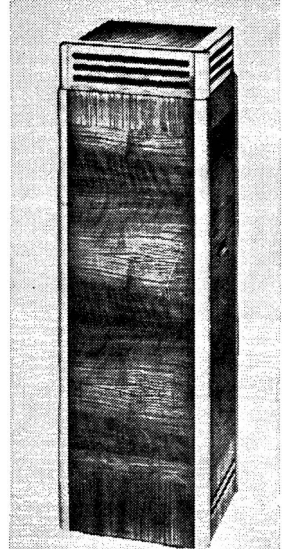

*Wharfedale Wireless  
Column eight*

**Tannoy Products Ltd.**, West Norwood, London, S.E.27. Tel.: Gipsy Hill 1131. Cables: Tannoy, London.

**Chatsworth II.** Aperiodic enclosure for corner placing. One monitor 12 drive unit. Size  $36\frac{1}{2} \times 20 \times 12\frac{3}{4}$  ins. 4-in. legs. Price £49 15s.

**Canterbury.** Reflex, with forward facing unit, dual throated ports, for corner

placing. One 12 in. dual concentric unit, or direct radiator. Size  $37 \times 25 \times 17$  ins. Price, with dual concentric, £57 15s.; with direct radiator, £43 15s.

**York. Reflex.** Forward facing unit, dual throated ports, for corner placing. 12 in. or 15 in. dual concentric unit. Response 35-20,000 c/s. Size  $45\frac{1}{2} \times 32 \times 22\frac{1}{2}$  ins. Price, with 12 in. unit, £66; with 15 in. £75.

**G.R.F.** Folded horn. Rear horn loaded, forward facing unit, for corner. One 15 in. dual concentric unit. Response 20-20,000 c/s. Size  $48 \times 38 \times 29$  ins. Price £122.

**Guy R. Fountain Autograph.** Folded horn. Front and rear horn-loaded unit, forward facing for corner placing. 15 in. dual concentric unit. Response 20-20,000 c/s. Size  $58\frac{1}{2} \times 43 \times 26\frac{1}{2}$  ins. Price £165.

**111 LZC.** Infinite baffle forward facing. Tannoy III LZ dual concentric unit. Response 30-20,000 c/s. Size  $14 \times 10\frac{3}{4} \times 23\frac{1}{2}$  ins. Price £32 10s.



**Truphet & McDonnell Ltd.**, Old School Works, Wrotham, Kent. Tel.: Borough Green 2560.

**Delius 12 & 15. Reflex.** Semi-omni-directional. One bass unit with one or more mid-range or tweeter units. Delius 12 or

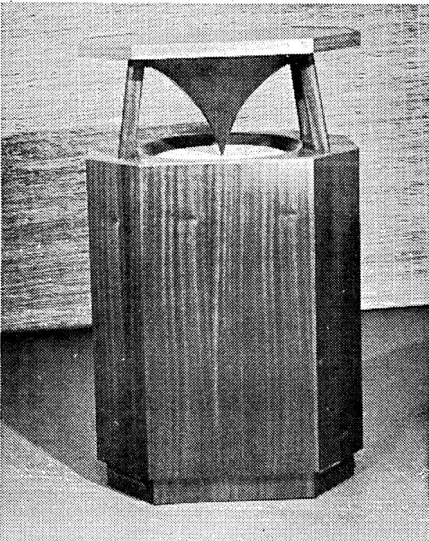

*Delius 12 Reflex*

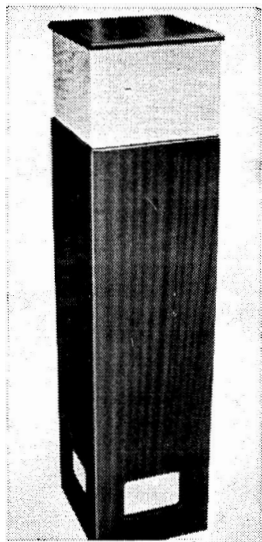

*Whiteley Electrical  
Stentorian WB Column*

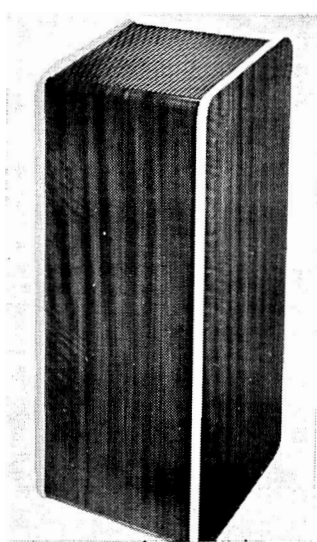

*Rogers Development 1284 3-way  
system*

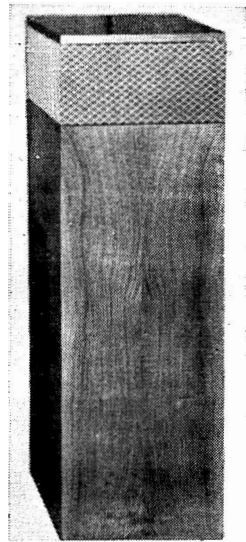

*Expert Gramophones  
Acoustic Column*

15 in. speaker. Tannoy dual concentric recommended. Other units fitted to order. Response 30 c/s to 18 Kc/s. Size 39 × 23 × 15 ins. Weight, Delius 12 approx. 65 lbs.; Delius 15 approx. 82 lbs. Price Delius 12 £63, without units £33 12s.; Delius 15 £75 12s. without units £45 3s.



**Vitavox Ltd.**, Westmoreland Road, London, N.W.9. Tel.: Colindale 8671. Cables: Vitavox, Hyde, London.

**Vitavox Hallmark.** Forward facing acoustically treated reflex enclosure incorporating Vitavox DU120 speaker. Size Model 351 (Tallboy) 27½ × 20 × 16½ ins., Model 352 (Lowboy) 23½ × 24 × 16½ ins. Price, complete, £42 in Oak, Mahogany or Walnut; £45 in Teak.

**Klipshorn.** Double channel horn system. Folded L.F. horn with K15/40 drive unit. Forward facing H.F. horn with S.2 pressure unit. Crossover at 500 c/s with incorporated divided network. Response 30-15,000 c/s. Size 51 × 30 × 27 ins. Weight 210 lbs. Price, complete with drive unit, £165.



**Westrex Co. Ltd.**, Coles Green Road, London, N.W.2. Tel.: Gladstone 5401/8. Cables: Westcol, Norphone, London.

**2326A.** Two-way unit with crossover network. L.F. unit: 15 in., paper cone, voice coil 3 in. Gap flux 13,300 gauss, suspension resonance 45 c/s. H.F. unit: Alu. diaphragm, voice coil 3 in., fitted with slant plate lens. Frequency of crossover 1,500 c/s. Frequency range 40 c/s-18 Kc/s. Will accept output of 30 watts amplifier. Input impedance 16 ohms. Size 37½ × 22½ × 16½ ins. Weight, less transformer, 100 lbs. Price on application.

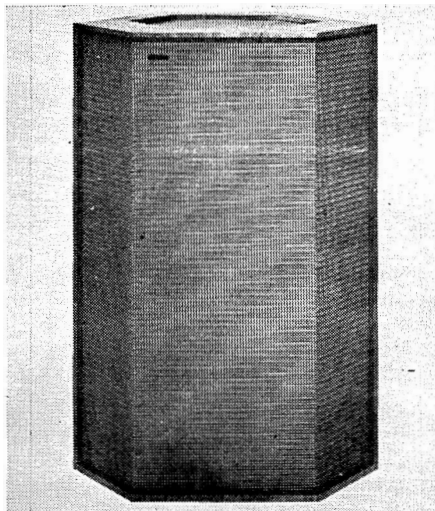

*Wharfedale W4*



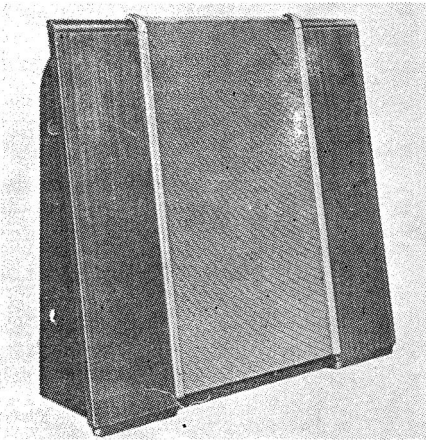

*Wharfedale SFB/3*

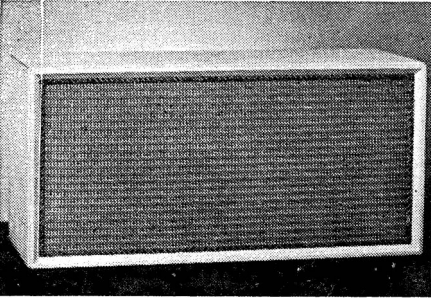

*Wharfedale PST/8*

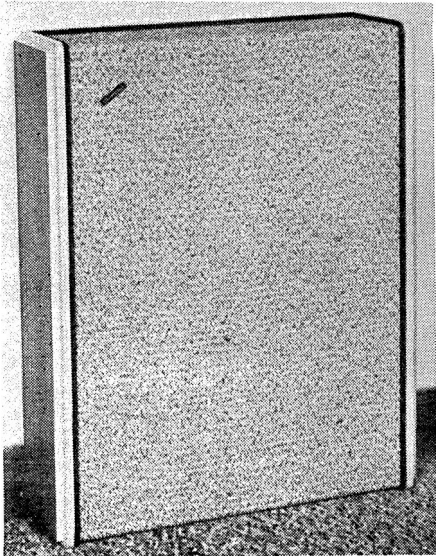

*Wharfedale Slimline 2*

**Wharfedale Wireless Works Ltd.,** Idle, Bradford. Tel.: Idle 1235-6. Cables: Wharfedel, Idle, Bradford.

**PST/8.** Damped reflex, forward facing. One 8 in. drive unit. Rec. Super 8/FS/AL or 8 in. Bronze FS/AL. Response 60-14,000 c/s. Size 24 × 12 × 12 ins. Weight 17 lbs. Price, without unit £7 10s. whitewood, or £10 10s. veneered and polished.

**AF/12/RS.** Reflex, forward facing. One 12 in. drive unit. Rec. Coaxial 12, Super 12/RS/DD, W12/RS. Response 30-20,000 c/s with Coaxial 12. Size 36½ × 23 × 14½ ins. Weight 61 lbs. Price £24 10s. (Whitewood £20).

**SFB/3.** Sandfilled baffle. 3 drive units. 12 and 10 in. units facing forwards. 3 in. H.F. unit facing upwards for omnidirectional treble distribution. Response 35-20,000 c/s. Size 34 × 31 × 12 ins. Weight 64 lbs. Price, with units, £39 10s. (not sold separately).

**"Omni-directional"** 3-speaker corner system. Sandfilled reflex enclosure, bass unit facing forward, separate mid-range and treble unit facing upward. 15 in., 8 in. and 3 in. units. Rec. W15/RS, Super 8/FS, Super 3. Response 20-20,000 c/s. Size 48 × 34 ins. Weight 160 lbs. Price, with specified units, £73 10s.; sandfilled panel only, £31; twin treble cabinet, £8 15s.

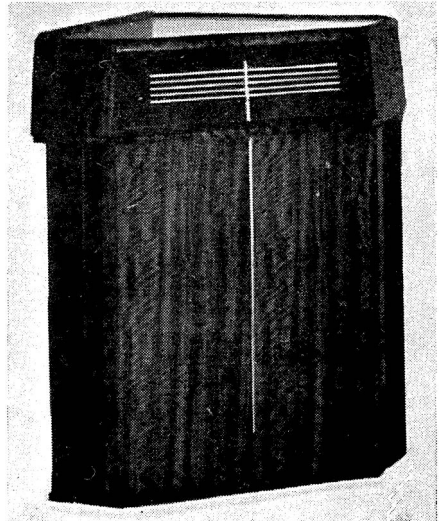

*Vitavox "Klipschorn"*

**Slimline 2.** Reflex. Two speaker system with crossover. 12 in. and 4½ in. units. Size 25 × 20 × 7 ins. Weight 31 lbs. Price £22 10s

**W2.** Two-speaker system, incorporating WLS/12 and Super 5 with vol. control. Crossover 1,000 c/s. Size 23½ × 14 × 12 ins. Price, veneered, complete, £29 10s.

**W3.** Three-speaker system, incorporating WLS/12, a 5-in Bronze, and Super 3. Separate vol. controls for the two H.F. units. Crossover 1,000 c/s. Size 28 × 14 × 12 ins. Price, veneered, complete, £39 10s.

**W4.** Four-speaker system, incorporating WLS/12, two 5 in. Bronze, and Super 3. H.F. units are arranged for omni-directional radiation and have independent mid and treble vol. controls. Size 35 × 24 × 12 ins. Price veneered, complete, £49 10s.



**Whiteley Electrical Radio Co. Ltd.,** Victoria Street, Mansfield, Notts. Tel.: Mansfield 1762/3/4/5. Cables: Whitebon, Mansfield.

**Stentorian Junior Console.** Bass reflex for corner position. 1 or 2 drive units. Rec. HF816 or HF1012 with T10 tweeter, if required. Crossover 3,000 c/s. Response HF816, 50-14,000 c/s; HF1012 and T10 30-14,000 c/s. Size 33 × 22½ × 18½ ins.

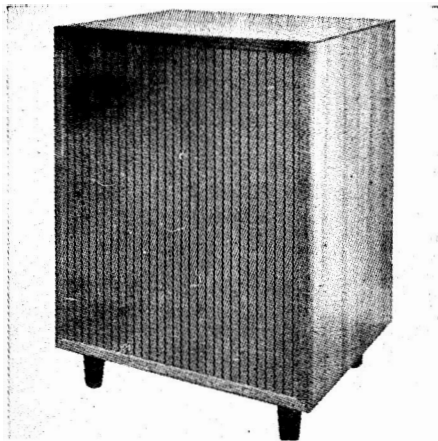

Vitavox Hallmark

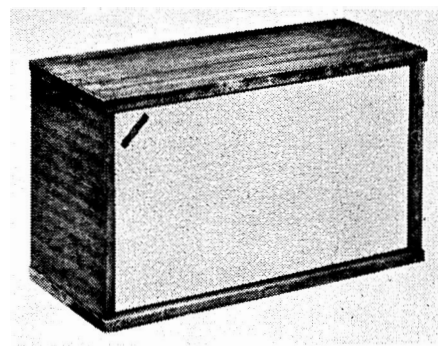

Tannoy 111 LZC

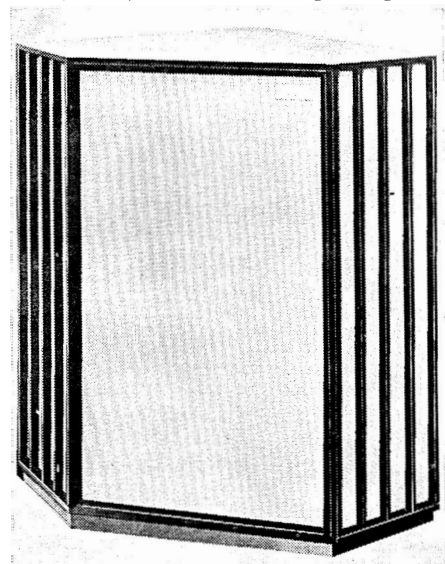

Tannoy G.R.F.

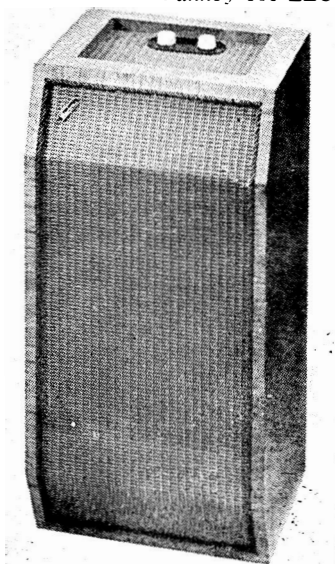

Wharfedale W3

Price, with HF816, £14 6s. 7d. (U.K. purchase tax, £1 19s. 5d.); with HF1012 and T10, £18 14s. (U.K. purchase tax £1 8s. 9d.); without units, £9 9s.

**Stentorian Senior Corner Console.** Bass reflex for corner position. 10 in. or 12 in. drive unit with tweeter, if required. Crossover 3,000 c/s. Response with HF1012 and T10 30-40,000 c/s; with HF1214 and T12 25-17,000 c/s. Size 35 × 30 × 19 ins. Price, with HF1012 and T10, £20 16s. (U.K. purchase tax £1 4s.); with HF1214 and T12, £36 8s. 6d.; without units, £11 11s.

**Stentorian "Prelude".** Bass reflex for corner position. One 18 in. or 10 in. unit with provision for tweeter. Rec. HF812, HF816, or HF1012 and T10. Crossover at 3,000 c/s. Response depending on unit used. Size 33 × 21 × 17 ins. Weight 23½ lb. Price, without units, £10 10s. Model also available for free standing, otherwise as above. Size 33 × 19 × 19½ ins. Weight 27½ lb. Price £11 11s.

**Stentorian Sloping Dual Front.** Tweeter housing, reversible, either forward or rear

facing. One 8 in. unit. Rec. T816. Response 1,000-17,000 c/s. Size 13 × 10½ × 7½ ins. Price, with unit, £8 8s. 11d. (U.K. purchase tax £2 17s. 10d.); without unit, £3 17s. 6d.

**Stentorian Prelude Horn Loaded.** Folded horn, forward facing. One 8 in. drive unit. Rec. HF817. Response 60-22,000 c/s. Size 35 × 18¾ × 16¾ ins. Price (complete) £27 12s. 10d. (U.K. purchase tax £2 14s. 6d.) Price, without units, £19 10s. 10d.

**Stentorian Junior Column.** Reflex upward facing omni-directional. One 6 in. unit. Rec. HF610. Response 100-11,000 c/s. Size 36 × 9 × 9 in. Price (complete) £11 17s. 7d. (U.K. purchase tax 15s. 5d.) Price, without unit, £9 16s. 6d.

**Stentorian Senior Column.** Reflex upward facing omni-directional. One 8 in. unit. Rec. HF816. Response 60-14,000 c/s. Size 57 × 13½ × 13½ ins. Price (complete) £23 15s. 7d. (U.K. purchase tax £1 19s. 5d.) Price, without unit £18 18s.

*Note: All units for the above may be supplied separately.*

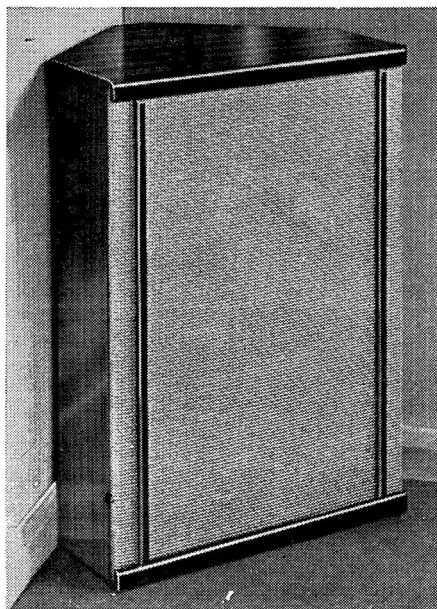

*Stentorian Junior Bass Reflex*

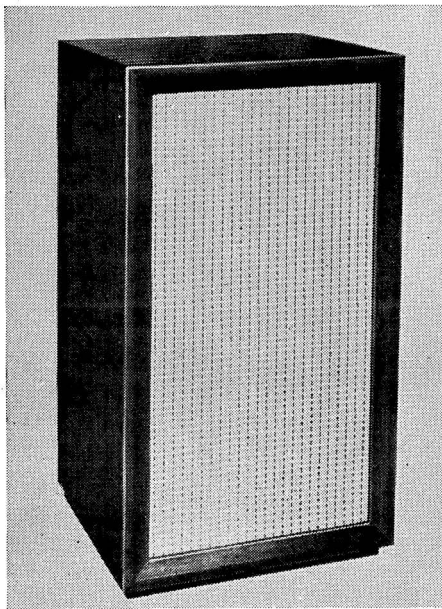

*Stentorian "Prelude" Horn Loaded*

# MICROPHONES

by Stanley Kelly

**M**ICROPHONES, in common with other transducers, convert one form of energy into another. It is unfortunate that some energy is lost in the process, but in terms of electro-acoustic efficiency they are comparable with loudspeakers and considerably more efficient than most gramophone pickups. In some of the latest magnetic types developed for use in hearing aids, conversion efficiencies of the order of 30 per cent over more than one decade of frequency response are obtained. This is quite astounding when one realises that two forms of conversion take place: the first from acoustic to mechanical energy, and the second from mechanical to electrical energy.

The diversification of microphones is considerably greater than other forms of transducers in the reproduction field. With pickups, only two basic forms of unit are used, that is to convert either a lateral modulation or a vertical modulation of the record groove into a corresponding electrical signal; whilst with loudspeakers, with the exception of the electrostatic unit, a mass controlled moving system is used in which the piston either acts as a direct radiator or is connected through some suitable impedance transforming device to the air load. In the case of microphones, although there are two main categories, (a) those in which the polar pattern is spherical, and (b) those in which the polar pattern is either bi-directional or uni-directional, they can be divided into a number of sub classes, dependent on the *modus operandi* of the acoustic-mechanical-electric system.

★

The basic transducer can either be (1) variable resistance (this is the standard form of unit in the majority of the line telephone systems in use throughout the world, but will not be discussed at present); (2) capacitive, in which the instantaneous capacity of the condenser is varied in sympathy with the oncoming sound wave; (3) piezo-electric, in which a force which is

a function of the incident sound wave is applied to a piezo-electric crystal, thereby generating an e.m.f.; (4) varying magnetic field, i.e., balanced armature, in which the magnetic field varies directly with the sound pressure; thus inducing a voltage in the associated coil, and (5) moving conductor or dynamic types of microphone, in which a conductor moves in a linear magnetic field and generates a voltage proportional to its velocity, which in turn is a function of either the incident sound pressure or the particle velocity of the sound wave, according to the acoustic structure associated with the diaphragm. It should be noted that in types (1) (2) and (3) their output is a function of the displacement amplitude of the moving element, whilst in types (4) and (5) the output is proportional to the velocity of the moving element.

★

Let us consider the condenser or capacitive type of microphone. This unit has found widespread use because of its "flat" frequency response. As shown in Fig. 1, the diaphragm of the microphone is a thin membrane. In some structures it is tightly stretched metal, either stainless steel or aluminium between 0.5 and 1.5 thou thick and depending on the upper frequency response; the diameter may be from approximately 1.25 inches (upper limit 10 Kc/s) to 0.4 inch (upper limit 40 Kc/s).

In another form widely used for measurement microphones, the diaphragm consists of a thin quartz or glass membrane approximately one thou thick, half-inch diameter with gold splutter on the outside. In almost all cases the diaphragm is the earthy side of the condenser. Behind the diaphragm and separated about one thou is the fixed plate. Because of the very small spacing between the diaphragm and the back plate, considerable stiffness is applied and this increases the overall resonant frequency of the mechanical structure. At the same time it reduces the sensitivity except at

resonance, where a peak of 20 dB can easily be obtained. In order to reduce the effect of the stiffness narrow grooves or fine holes are bored into the back plate. These add resistance and mass into the circuit and reduce considerably the height of the peak. By correct proportioning the system can be made aperiodic at the high frequency resonance. Where the holes are bored right through the back plate they also form a low frequency resonant circuit below which the response of the microphone will fall at 12 dB per octave, but by suitably proportioning the dimensions of these slots or holes, there is no difficulty in producing a microphone which is flat from 20 c.p.s. to 40 Kc/s.



Fig. 2 shows the analogue; in which  $Md$  = mass of the diaphragm;  $Cs$  = compliance (reciprocal of restoring force of the diaphragm);  $Ca_1$  = stiffness of the air cavity between the backing plate and the diaphragm.  $Ms$  and  $Rs$  = mass and resistance of the slots or holes in the backing plate;  $Ca_2$  = compliance of these slots, but is short-circuited in the case of tubes going right through the backing plate. *Transformer* = transducing element;  $Ce$  = electrical capacitance of the condenser.

The microphone is polarized, usually with a voltage of between 100 and 200 volts and because the capacitance is usually of the order of 50 pf, the feed resistance must be of extremely high value. It is now

common practice to feed the microphone directly into a cathode follower, and if the polarizing resistance is also made the grid resistance it is possible to have input impedances of the order of 300 megohms for a grid resistance of only 20 megohms.



Fig. 3(a) shows a standard head amplifier, and Fig. 3(b) shows a further application where it is necessary to have the microphone at some distance from the head amplifier. Using a double shielded cable, 0.2 inches O.D. with interscreen capacitances of the order of 1000 pfd/s will reduce the overall sensitivity by only 6 dB over medium and high frequencies in this circuit. It is possible to use the microphone as the variable tuning capacitor in a frequency modulated transmitter and commercial units are produced by both R.C.A. and Philips. If the back plate is made reasonably thin and perforated, so that both sides of the diaphragm are effectively in contact with the acoustic wave, a pressure gradient microphone will be produced and the unit will exhibit bi-directional characteristics. Likewise, if a network in the form of an acoustic resistance be applied to the back plate it is possible to produce a microphone having uni-directional (cardioid) characteristics.

A combined non-directional, "figure 8" and cardioid microphone employing a condenser unit as the transducer is shown

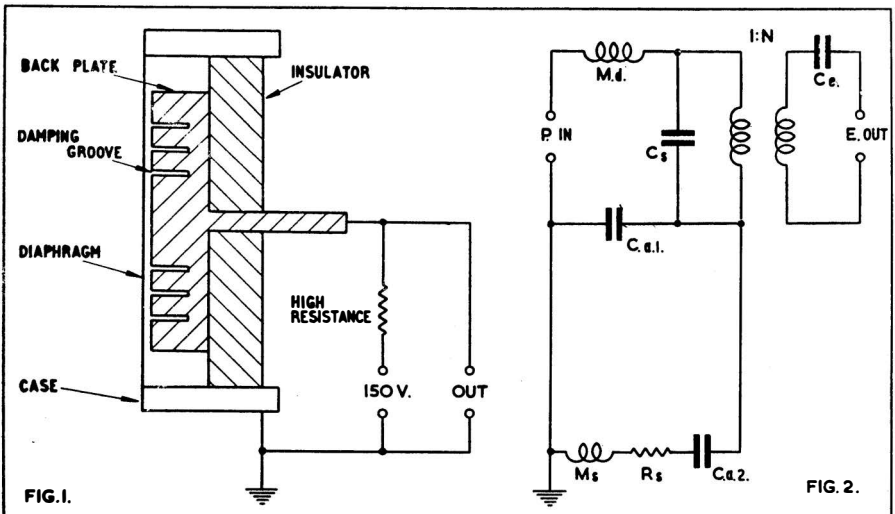

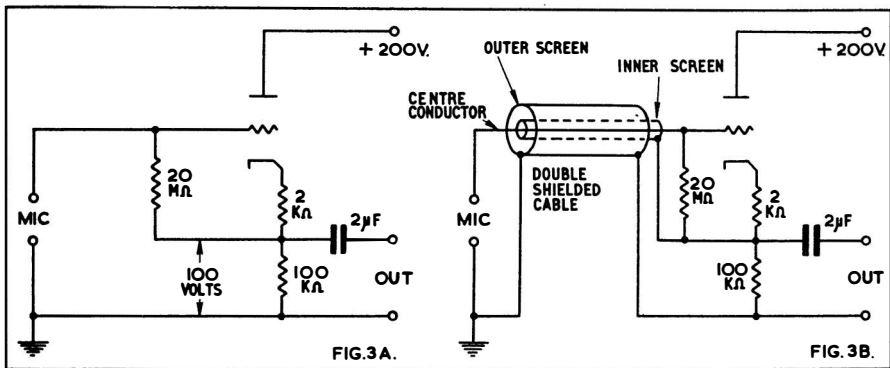

in Fig. 4. The transducer unit consists of two damped diaphragms. The vibrating system consists of the two separate and spaced diaphragms, each diaphragm is spaced at a small distance from the back plate; this damped space provides an acoustical capacitance and acoustical resistance for the diaphragms which are placed back to back. The cavities behind the diaphragm are interconnected by small holes, and the phase shift in the acoustical/mechanical system combined with the electrical polarizing system makes it possible to obtain a variety of directional characteristics as well as a non-directional characteristic. With the potentiometer at the full negative position a bi-directional pattern is obtained; at the zero voltage a cardioid type of directional pattern is obtained. With the potentiometer set at the full positive position a non-directional pattern is obtained.

Messrs *Neumann A.K.G.* and others have produced stereo condenser microphones consisting of two condenser cardioid elements, and by varying the differential polarizing on the two units it is possible to get almost any polar field pattern from completely spherical to bi-directional and middle/side stereophony. The frequency response is flat  $\pm 3$  dB from 40 to 15,000 c/s; sensitivity is approximately one millivolt/dyne/cm<sup>2</sup>; and the residual noise level of the microphone and pre amplifier is 20 phons, that is approximately 53 dB below a dyne/cm<sup>2</sup> and approximately 90 dB below the final crescendo in large symphonic works. It is, of course, this "deafness" or threshold level of noise in a microphone system which ultimately determines the dynamic range of any reproducing equipment.

Condenser microphones used to be temperamental animals, but due to modern techniques they are as reliable as any other

form of transducer. They have, however, to be manufactured to extremely close tolerances and in terms of £ s. d. cannot be considered as cheap items of equipment.

Crystal microphones, on the other hand, are among the cheapest of microphones offered today. They require no polarizing voltage, are comparatively simple to construct, and once the bimorph elements have been produced they do not require close manufacturing tolerances. The majority of crystal microphones use Rochelle Salt made in the form of a bimorph as the activating element, although in the tropics, Titanates, principally lead zirconate (PZT), is being more widely used. It is indeed fortunate that all the close tolerances required for crystal microphones or indeed any form of crystal transducer are built into the crystal element itself, because these units are produced in England alone at a rate in excess of 5,000,000 per year, and the requisite quality control and precision equipment can therefore be applied to the manufacture of crystal elements without

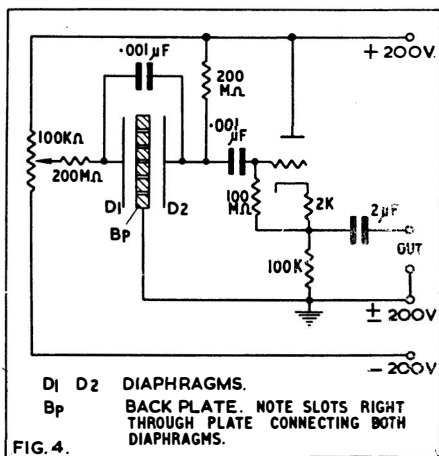

materially increasing the cost of the unit microphone, pickup, etc.

★

Fig. 5 shows in diagrammatic form the normal type of crystal microphone with the analogue beneath it. It behaves purely and simply as a pressure microphone in which the sound pressure vibrates the diaphragm, and the force thus generated is applied to the crystal in series with the stiffness of the cavity and the restoring force (reciprocal of compliance) of the diaphragm. Examining the analogue it will be seen that for wide frequency response  $M_d$  and  $M_x$  (that is the mass of the diaphragm and the mass of the crystal) should be as small as possible, whilst the compliance of the cavity,  $C_c$ , and the diaphragm,  $C_d$ , should be large, and the crystal compliance  $C_x$  as small as possible. This will enable the maximum force to be developed across  $C_x$ , which is in series with the other impedance. Unfortunately, this requirement means a very small crystal with resultant small electrical capacitance, a large thin diaphragm, and a large can. These two latter will limit the upper frequencies that the microphone will respond to and the diaphragm will probably show resonant modes due to break-up of its structure in the mid-upper frequencies.

Because the majority of crystal microphones are today used for domestic tape recorders (which despite the claims of their manufacturers do not have an extended frequency response; and are still further restricted by the small speaker and inadequate loading of same) a frequency response for the microphone of 80 c/s to 6000 or 7000 c/s is considered adequate. Using these parameters, and assuming an electrical load resistance of one megohm gives optimum values of a crystal approximately  $\frac{3}{8}$  inch square and electrical capacitance of 1500 pfd. With a can  $1\frac{1}{2}$  inches

in diameter by  $\frac{1}{16}$  inch deep, the diaphragm cone is approximately 1.25 inches in diameter, giving a surround of about  $\frac{1}{8}$  inch. The diaphragm and crystal masses will be approximately equal, the cavity compliance and crystal compliance will likewise be equal, but the surround compliance will be one order of magnitude less, and this surround compliance is used principally to control the high frequency response.

With the values just stated, the resonant frequency will be of the order of 5 Kc/s, and the sensitivity about -50 dB referred to one volt/dyne/cm<sup>2</sup>. If the surround compliance is made infinite, another 10 dB of sensitivity will be obtained, but the resonant frequency will now be about 1800 c/s dropping at 12 dB per octave above this frequency. In order to reduce the height of the peak (which in the undamped condition is about 20 dB) a rigid perforated grill is fitted in front of the microphone with silk of the proper mesh firmly cemented or clamped to it. The peak can then be controlled to between 4 or 6 dB for a reduction in overall sensitivity of only 2 dB, and in this form the microphone is produced in many thousands each week.

★

The dynamic or moving coil microphone has the same construction as a moving coil loudspeaker in miniature form. The voice coil is usually connected directly to the diaphragm and is located in a strong magnetic field. The e.f.m. generated by the coil is proportional to the velocity of the coil and is given by the well known equation:

$$E = Blv \times 10^{-8}$$

where  $E$  = volts;  $B$  = flux density in gauss;  $l$  = length of the wire of the voice coil in cm;  $v$  = velocity of the coil in cm/sec.

The difficulty is in controlling the last parameter. The absolute value of the velocity will be a function of the acoustic

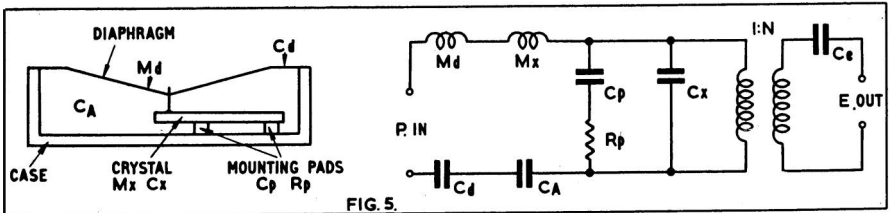
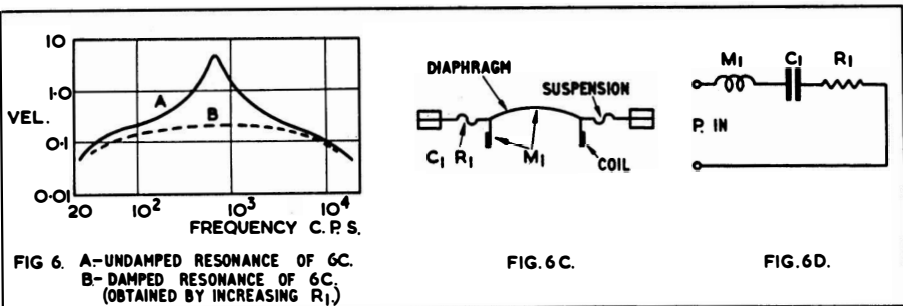

FIG. 5.



field strength, the area of the diaphragm and the mechanical impedance associated with it. In a simple mechanical circuit consisting of the diaphragm, the voice coil and the restoring force, a series resonant circuit will result giving a response of the form shown in Fig. 6(a). As the value of resistance is increased, the height of the peak will be reduced and it is possible to obtain a response as shown in Fig. 6(b). Unfortunately, the sensitivity is reduced rapidly as the frequency response is increased. By applying acoustic resonance to the system approximately an octave can be obtained for only slight discontinuities in the smooth response curve.

Fig. 7 shows one of the simpler methods of obtaining this. In the mechanical network  $M_3$ ,  $Rm_3$ , and  $Cm$  are the mass, mechanical resistance and compliance of the diaphragm and suspension.  $Cm_2$  is the compliance of the air chamber behind the diaphragm whilst  $M_2$  is the effective mass and mechanical resistance of the silk cloth damping the chamber connecting the cavity  $Cm_3$  to the back of the diaphragm. The tube  $M_3Rm_3$  connects to  $Cm_3$  to the

incident wave. It will be seen from the diagram that the extra low frequency response (4, in the curve) is due to the addition of the tube  $M_3Rm_3$ , whilst the upper resonance (5) is due to the compliance  $Cm_2$  resonating with the mass  $M_2Rm_2$  in series with  $Cm_3$ .

More sophisticated microphones are produced with an additional resonance at each end of the frequency band, the microphones are currently produced with a response from 30 to 15,000 c/s  $\pm 3$  dB. The coils are usually wound to an impedance of 25 to 50 ohms and must therefore be used with a matching transformer when fed into high impedance circuits or even normal line impedances of 200 to 600 ohms. An average microphone with a diaphragm diameter of approximately  $\frac{3}{8}$  inch with a voice coil of like dimensions, and a surround of approximately  $\frac{1}{8}$  inch wide, the coil working in a field of approximately 7000 gauss, will produce an open circuit voltage of approximately  $-80$  dB reference 1 volt/dyne/cm<sup>2</sup>; and working with a transformer into a 50,000 ohm load sensitivity of approximately  $-55$  dB per

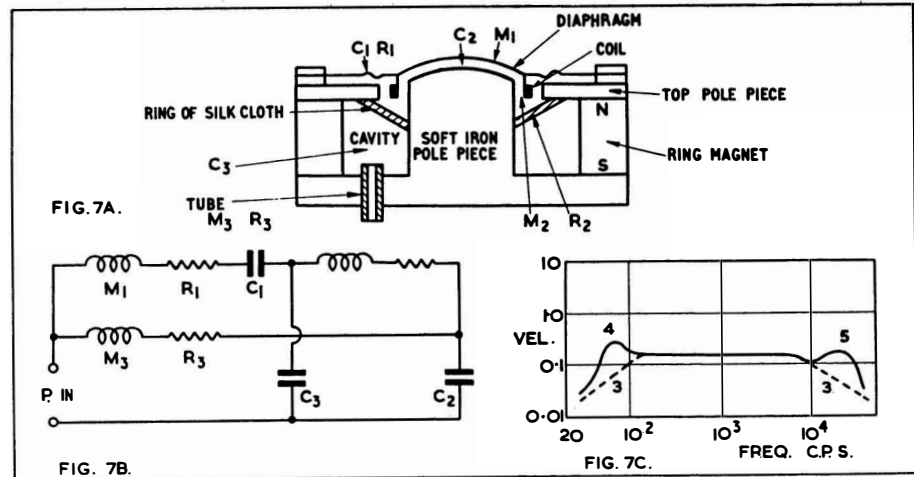



volt/dyne/cm<sup>2</sup> is easily obtained.

The ribbon microphone, in common with the moving coil, is a velocity operated device in so far as the generating system is concerned. Unlike the moving coil unit, however, which has its main resonance in the centre of the audio frequency range, the ribbon unit when used as a pressure gradient microphone is mass controlled, the resonance usually being located below about 50 c/s. At this low frequency, due to the viscous damping of the air, the height of the resonance is not very great, although in high quality microphones extra baffles adding acoustic resistance to the ribbon are employed. The average mass of the ribbon is of the order of  $1\frac{1}{2}$  milligrammes and its length varies between 1 and 2 inches and width between 0.1 and 0.2 inch according to the designer's preference. The difficulty with the ribbon microphone is getting sufficient flux density in the very wide gap. In the old B.B.C. ribbon microphone the flux density was 3200 gauss, whilst in the latest unit the flux density averages 5000 gauss. Commercial ribbon microphones vary between these two figures.

The ribbon is usually constructed of aluminium or aluminium alloy foil between 0.6 and 2 microns thick. The upper limit to the length of the ribbon is determined by the required vertical polar field response. A long ribbon will reduce the response at high frequencies at angles other than perpendicular to the ribbon plane, and for a 3 dB loss at 60° to the horizontal at 10 Kc/s the maximum length of ribbon is of the order of  $1\frac{1}{4}$  inches. The width of the ribbon is determined by a number of contradictory requirements: the wider the ribbon the greater the area and hence sensitivity, also the lower the ribbon impedance, but the gap field strength reduces quite rapidly; a wide ribbon can also result in torsional and cross vibrational nodes at high frequencies, resulting in discontinuities in response, and it must be made wide compared to the gap between the ribbon and the pole pieces; this latter requirement more than anything determines the ultimate ribbon width. Whilst it is possible to make laboratory microphones with a spacing of only 2 or 3 thou between the ribbon and the pole piece, in commercial practice it is usual to have a minimum of 7 to 10 thou and preferably 15 thou of clearance. This gives a minimum width of 1/10th inch for the 7 thou clearance and approximately 0.2 inch for the 15 thou clearance.

In order to obtain a low resonant frequency the ribbon must be corrugated to reduce the stiffness to a minimum. These corrugations, however, introduce transverse resonance modes at high frequencies, and whilst increasing the depth and number of corrugations will reduce the lower resonant frequency they also cause more discontinuities in the 8 to 10 Kc/s region. The optimum seems to be approximately 30 corrugations per inch with a peak to peak value of about 5 thou. The basic peak to peak value is determined empirically and in production is adjusted until the diaphragm resonates at the required low frequency value.

The open circuit sensitivity of the average ribbon unit is between 20 and 30 microvolts from a source impedance of about half an ohm, and sensitivities of the order of 2 millivolts/dyne/cm<sup>2</sup> can be obtained in load impedances of 50 to 100,000 ohms (-54 dB reference 1 volt per dyne/cm<sup>2</sup>).

It is often asked why microphones do not have the same output voltage as gramophone pickups. This disparity will be appreciated when it is realised that a minimum of 2,000 dynes operating force is available on a pickup playing at 3 grammes, whilst the maximum force obtained from acoustic sound wave is very rarely in excess of 20 dynes. Be that as it may, microphones as produced today are precision engineered devices with an overall conversion efficiency at least as high as any other form of generator, and whilst the innovations have not been as startling as in, say, stereo gramophone pickups, the engineering thought applied to modern microphones is at least of the same order. Whilst they are robust they should be treated with the same care as used with a fine watch.



We can expect to see more medium priced dynamic and magnetic microphones in the near future because of the increased use of transistors in tape recorders. The price of transistors has now been reduced to such values as to render them economic in all except the very cheapest instruments and the advantages, freedom from hum, long term stability, and indefinite life, make them a very attractive proposition to the designer. This in turn is putting pressure on the development laboratories of the microphone manufacturers to produce economically priced low impedance devices to match them.

# DIRECTORY OF MICROPHONES

★ In these abridged specifications, the following abbreviations are used: **Source imp.**—microphone source impedance. **Rec. load imp.**—recommended load impedance, and Sensitivity is given in dB with reference to 1 volt/dyne/cm<sup>2</sup>, unless otherwise stated.

■ Stereo.

**AKG (Akustische und Kino-Geräte Ges. m.b.H.).** Sole U.K. agents. **Politechna (London) Ltd.**, 3 Percy Street, London, W.1. Tel.: Langham 6236. Cables: Polindust, London.

**D9.** Moving coil. Response 80-10,000 c/s. Source imp. 200 ohms and 50 K ohms. Fitted with collapsible stand and 5 ft. screened cable. Price £4 14s. 6d.

**D11N.** Moving coil with cardioid directional pattern. Response 80-12,000 c/s. Source imp. 200 ohms or 50 K ohms. Fitted with collapsible stand and 5 ft. screened cable. Price: £6 10s.

**D19.** Moving coil with cardioid directional pattern and bass cut switch. Response 40-16,000 c/s. Source imp. 60,200 ohms and high imp. 50 K ohms with balanced line matching transformer. Price £17 10s. Line transformer £1 19s. 6d.

**D58.** Moving coil. Response 50-12,000 c/s. Sensitivity 0.1 mV/bar. Output imp. 200 ohms. Price £11 10s.

**D12.** Moving coil with cardioid directional pattern. Response 40-12,000 c/s

± 4 dB. Front to back ratio 15 dB. Sensitivity - 77 dB. Source imp. 60 ohms, or to order. Price £34.

**C12.** Professional condenser. Sel. switch gives choice of 9 polar characteristics. Response 30-15,000 c/s ± 3 dB. Sensitivity - 60 dB. Source imp. 50 and 250 ohms. Price £170.

**C60.** Miniature professional condenser. Response 20-30,000 c/s. Source imp. 50 or 200 ohms. Available with mains power unit or re-chargeable battery supply unit. Price (mains) £92 10s.; (battery) £79 10s.

■ **D88.** Moving coil stereo microphone. Response 80-15,000 c/s. Source imp. 200 ohms each channel or 50 K ohms with transformer. Sensitivity - 75 dB low imp., - 52 dB high imp. Double cardioid for stereo, broad cardioid for mono. Price £15 10s. low impedance, £18 high impedance.

■ **C24.** Stereo condenser. Sensitivity 1 mV/bar. Output imp. 200 or 50 ohms. Response 30-20,000 c/s. Omni-directional cardioid; bidirectional; hyper-cardioid. Plus 5 intermediate patterns. Sensitivity

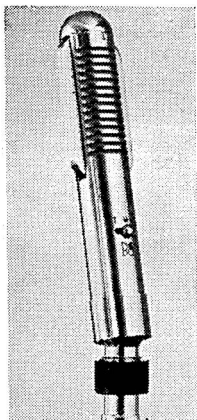

*B & O BM3*

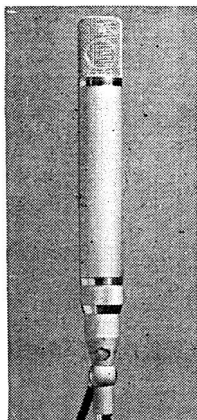

*AKG C12*

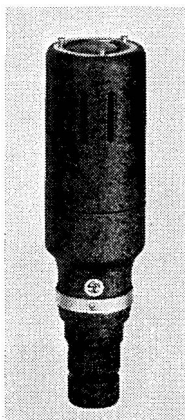

*STC 4106-A*

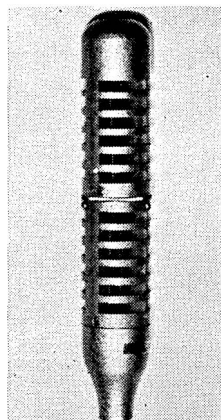

*Lustraphone VR/63*

approx. 1 mV per microbar (at 200 ohms output terminals) — 33 dB re 1 milliwatt at a sound pressure of 10 dynes/cm<sup>2</sup>. Crosstalk between channels < 40 dB throughout entire range. Output imp. < 200 ohms when delivered. 50 ohms by



*Grundig GMC 3*

changing solder connections. N.24 power supply unit. Remote control unit. Twin remote control cable. Price £230.

**ST200.** Microphone floor stand. Telescopic. Height 42 to 77 ins. Three collapsible feet with main support locking device. Anti-vibration characteristics. Microphone may be clamped to face any direction. Price £12 10s.

**K58.** Microphone headset. Incorporates microphone D58 and headset K50 (see Tape Recorder Accessories). Price £13 10s.



*Acos Stereo Mic. 44*

The full range of A.K.G. professional and domestic microphones and accessories is available. Details on request.



**Bang & Olufsen, Struer, Denmark.** Sole U.K. Importers: Aveley Electric Ltd., Ayrton Road, South Ockendon, Essex. Tel.: South Ockendon 3444. Cables: Aersale.

**BM3.** Ribbon. Response: music 30-13,000 c/s  $\pm$  2.5 dB, speed bass cut below 1,000 c/s (2 position switch). Impedance 50 ohms. Price £14 10s.

**BM4.** As BM3 with variable output impedance, 50, 250, and 40,000 ohms. Price £16.

■ **Stereophonic Microphone Assembly.** Comprises two B & O ribbon microphones, plus stereophonic baffle assembly. Price £34 5s., with type BM3. £37 5s., with type BM4.



**Cosmocord Limited, Eleanor Cross Road, Waltham Cross, Herts.** Tel.: Waltham Cross 27331. Cables: Cosmocord, Waltham Cross.

**Acos Mic. 39-1.** Crystal. Response 40-15,000 c/s  $\pm$  6 dB. Sensitivity — 60 dB. Source imp. equals capacity of 800 pF. Rec. load imp. not less than 4.7 megohm. 8 ft. cable. Desk or floor stand adaptor available. Price £3 3s.

**Acos Mic. 40.** Ceramic. Response 30-6,000 c/s. Sensitivity — 60 dB. Source



*AKG D88 Moving Coil Stereo*

imp. 2.5 megohms. Price £2. Crystal details as for Mic. 45. Price £1 15s.

**Acos Mic. 45.** Crystal. Response 30-6,000 c/s. Sensitivity - 50 dB. Source imp. 2.5 megohms. Price £2.

■ **Acos Stereo Mic. 44.** Crystal. Response 50-12,000 c/s. Directional Pattern (Dual Fig. 8) Sensitivity - 70 dB. Source imp. 2.5 megohms. Price £6 6s.



**Elizabethan (Tape Recorders) Ltd.,** Bridge Close, Oldchurch Road, Romford, Essex. Tel.: Romford 64101. Cable address: Elizabethan, Romford.

**Elizabethan.** Ribbon. Response 50-12,000 c/s. Sensitivity - 56 dB. Source imp. 50,000 ohms. Built-in transformer. Price £7 17s. 6d.



**Film Industries Ltd.,** 90 Belsize Lane, London, N.W.3. Tel.: Hampstead 9632/3. Cables: Troosound, London.

**M7.** Moving coil. Response 60-9,000 c/s. Source imp. 20 ohms. 6-ft. twin screened cable standard, other lengths if required. Table, desk and floor stands available. Price £6 5s.

**M8.** Ribbon. Response 50-10,000 c/s  $\pm 2$  dB. Available matched to all impedances up to high. Plug and socket joint between microphone head and flexible, fitted with 12 ft. of twin-screened cable, other lengths if required. Table, desk and

floor stands available. Price, all impedances, £8 15s.

**M8A.** Ribbon microphone complete with 4-in. flexible tubing and desk stand, 12 ft. of cable standard. Available in all impedances. Price £8.



*Simon Cadenza Crystal*

**Fortiphone Ltd.,** Components Division, 124/126 Denmark Hill, London, S.E.5. Tel.: Brixton 8977.

**MI.** Miniature magnetic. Source imp. 2,500 ohms. Omni-direction. Price £1.

**FM-9.** Miniature magnetic. Response 200-4,000 c/s for 6 dB down. Sensitivity - 74 dB at 1,000 c/s. Source imp. 2.5 K ohms at 1,000 c/s. Price 17s.

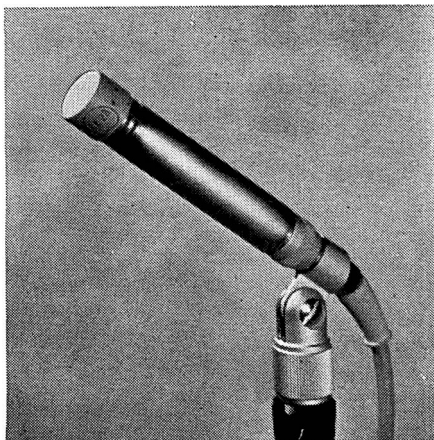

*AKG C60 Miniature Condenser*

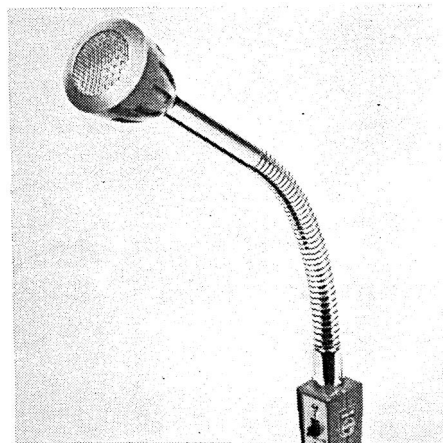

*Philips EL 6031 Moving Coil*

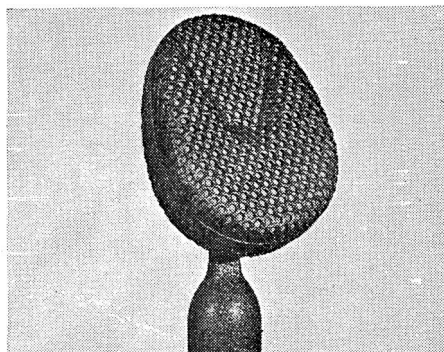

*STC Type 4038 Ribbon*

**M3.** Magnetic. Response 350-4,000 c/s. Sensitivity - 78 dB. Source imp. 3.9 K ohms at 1,000 c/s. Price £1 15s.



**The Gosho Co. Ltd.,** Stone House, Bishopsgate, London, E.C.2. Tel.: Bishopsgate 5901. Cables: Gosho, London.

**Neat.** Omnidirectional dynamic microphones. Models TM1, TM8, TM10. Response, TM1 50-10,000 c/s; TM8 80-10,000 c/s; TM10 50-10,000 c/s. Sensitivity, TM1 - 55 dB; TM8 and TM10 - 57 dB. Source imp. 50 K ohms. Price TM1 £5 15s.; TM8 £3 11s. 6d.; TM10 £3 18s.

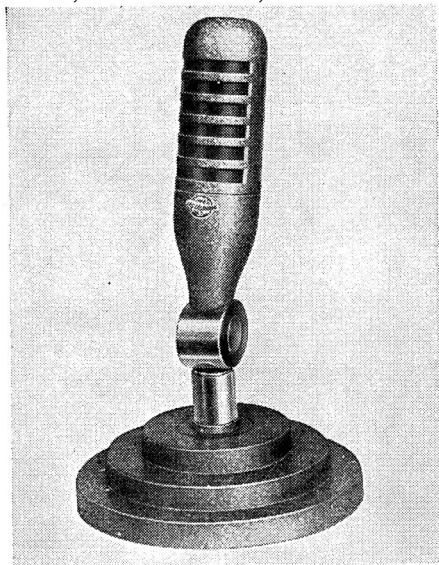

*Lustraphone VR 64 Ribbon*

**Grampian Reproducers Ltd.,** Hanworth Trading Estate, Feltham, Middx. Tel.: Feltham 2657/8. Cables: Reamp, Feltham.

**DP4/H.** Moving coil. Response 50-15,000 c/s. Sensitivity - 52 dB, - 70 dB, - 86 dB, for high, medium and low impedance. 50,000, 600 and 25 ohms. Tubular case. Price, including lead. High or medium impedance £9, low impedance £8.



**Grundig (Great Britain) Ltd.,** Newlands Park, Sydenham, S.E.26. Tel.: Sydenham 2211.

**G.C.M.** Condenser mic. to match range of Grundig recorders. Price £6 6s.

**G.D.M.12 & G.D.M.18.** Moving coil. Response 100-12,000 c/s. Sensitivity - 54 dB. Source imp. 50 K ohms. Built-in transformer. Price G.D.M. 12 £7 7s.; G.D.M. 18, with plastic container, £7 7s.

**GM1L.** Moving coil microphone. Response 100-8,000 c/s. For use with TK1 Tape Recorder. Price £3 3s.



**Lee Products (G.B.) Ltd.,** 10-18 Clifton Street, London, E.C.2. Tel.: Bishopsgate 6711. Cables: Leprod, London.

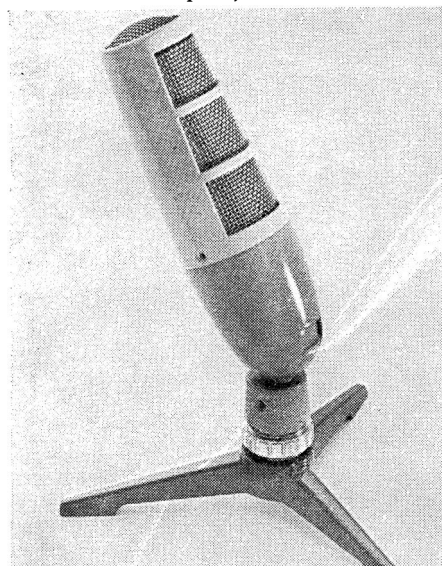

*Simon Ribbon Cadenza*

**M416.** Ribbon. Response 30-13,000 c/s. Source imp. 15-30 ohms. Price £7 15s.

**M63.** Moving coil. Source imp. 15-30 ohms or high. Omni-directional. Price £8 8s.

**B-72/1110.** Crystal. Response 80-16,800 c/s. Source imp. 100 K ohms. Price £5 5s. With Table stand.

**B-92/1110.** As above but with Floor stand. Price £8 8s.



**Lustraphone Ltd.,** St. Georges Works, Regents Park Road, N.W.1. Tel.: Primrose 8844. Cables: Lustraphon, London.

**LX55 Crystal.** Response 30-8,000 c/s. High course imp. 9-ft. cable. Price £2 10s.

**Lustrette LD/61 Series.** Moving coil. Response 70-12,000 c/s. Source imp. low, line and high. Built-in trans. when required. 9-ft. cable. Price £3 7s. 6d.

**Master C51.** Moving coil. Response 50-8,000 c/s. Source imp. low, line and high. Built-in trans. for line and high. 3-pin moulded mic. plug. Stand as required. Price, low, £5 5s.; line and high, £5 15s. 6d.

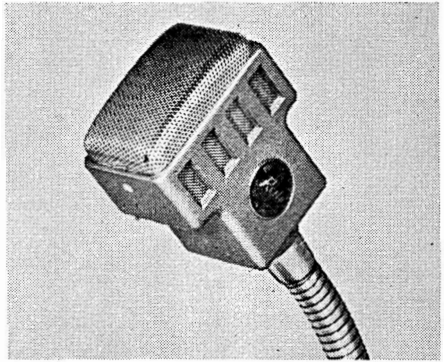

*Reslo Type CR*

**Master C48 and C48/S with Switch.** Moving coil. Response 50-8,000 c/s. Source imp. 20 ohms. 3-pin moulded mic. plug. 6-ft. cable. Price C48, £6 6s.; C48/S, £7 7s.

**Hand Pencil LFV/H59.** Moving coil. Response 150-14,000 c/s. Source imp. low, line and high. Built-in trans. for line and high. 20-ft. cable for low and line. 9-ft. for high. Price £8 8s.

**Full-Vision LFV/59.** Moving coil. Response 150-14,000 c/s. Source imp. low, line and high. Built-in trans. for line and



*Reslosound PR Ribbon*

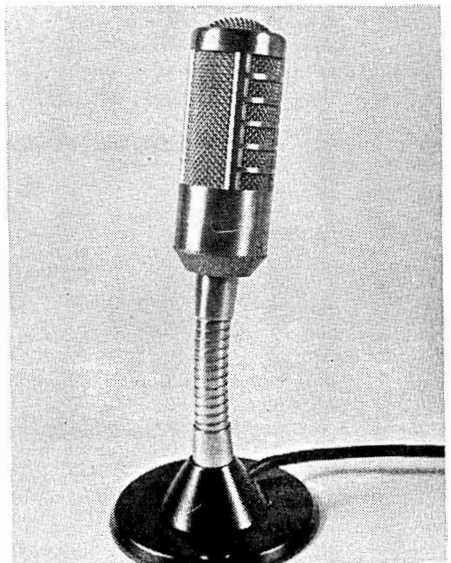

*Film Industries M8A Ribbon*

high. 20-ft. cable with low and line. 9-ft. with high. Stand as required. Price £8 18s. 6d.

**Lavalier LV/59.** Neck halter moving coil. Response 150-14,000 c/s. Low, line and high imp. Price £8 18s. 6d.

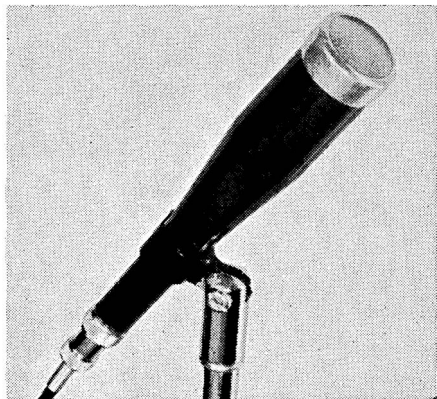

*Grampian DP4/H Moving Coil*

**LD/66.** Moving coil. Response 70-12,000 c/s. Sensitivity - 88, - 75, and - 52 dB, for low line and high imp. respectively. Price £4 2s. 6d., low imp., £4 12s. 6d., line and high imp.

**Tubular Hand TH59/SB.** Moving coil with switch. Response 150-14,000 c/s. Sensitivity - 88 dB at 25 ohms, - 75 dB at 600 ohms, and - 54 dB at 50,000 ohms. Transformer as required. Price £8 18s. 6d.

**Studio VR/53.** Ribbon velocity. Response substantially flat to 14,000 c/s. Source imp. low, line and high. Built-in trans. 3-pin moulded mic. plug. 6-ft. cable. Stand as required. Price £9 19s. 6d.

**Ribbonette VR/64.** Ribbon. Response, substantially maintained up to 13,000 c/s. Source imp. low, line and high. Built-in transformer. 20-ft cable for low and line. 9-ft. for high. Table base. Price £7 17s. 6d.

■ **Stereomic VR/65.** Dual head ribbon. Response 50-13,000 c/s. Sensitivity Stereo - 90 dB at 20 ohms. Source imp. 2 × 300 ohms. Internal transformer. Price £31 10s.

■ **Stereolus VR/65NS.** Dual head ribbon. Response 50-13,000 c/s. Sensitivity stereo - 90 dB at 20 ohms. Price £15 15s.

**Lapel Mic. LP/62.** Electro-Magnetic. Response, substantially maintained up to

6,000 c/s. Source imp. 30 and 1,000 ohms. 6-ft. cable. Price £3 7s. 6d.

**Chest Harness D159/B.S.** Moving coil. Response, substantially flat from 150-14,000 c/s. Source imp., low, line, high. 6-ft. cable. Price £11 11s.

**Velodyne VC52/THSB.** Noise cancelling moving coil with switch. Response rising to 1,700 c/s, flat to 3,500 c/s then falling. Source imp. 25 ohms or as required. Transformer as necessary. Price £8 18s. 6d.



**Philips Electrical Ltd.,** Century House, Shaftesbury Avenue, London, W.C.2. Tel.: Gerrard 7777. Cables: Phillamps, London.

**EL6014/00.** Moving coil. Response 100-10,000 c/s. Sensitivity - 74 dB or - 57 dB. Source imp. 500 ohms or 25,000 ohms. Price £9.

**EL6021.** Moving coil. Response 60-15,000 c/s. Source imp. 50, 500, 10,000 ohms. Price £14.

**EL6031.** Hypercardioid moving coil. Response 70-15,000 c/s. Sensitivity - 74 dB or - 58 dB. Source imp. 500 ohms or 25,000 ohms. Price £19.

**EL6040.** Moving coil. Response 60-20,000 c/s. Source imp. 50, 500 and 25,000 ohms. Price £27.

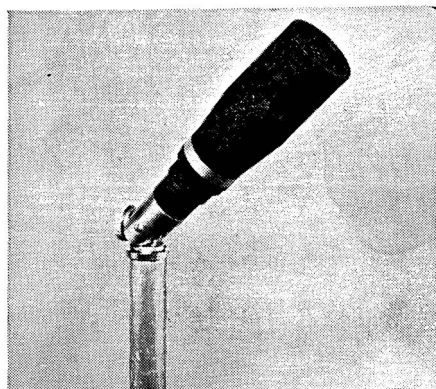

*STC 4105 Moving Coil*

**Reslosound Ltd.,** 24 Upper Brook Street, London, W.1. Tel.: Hyde Park 2291. Cables: Derritron, London.

A range of semi-professional and domestic microphones, including moving coil and ribbon types. The latter are available in



bi-directional or cardioid models, and a range of matching impedances is included. The base fitting incorporates the matching transformer and muting switches may be fitted if required. Details on application.

**Reslo Type PR.** Pencil ribbon. Response (nominal)  $\pm 3$  dB, 70-12,000 c/s. Sensitivity 60 dB below at 40 K ohms. Source



*Elizabethan Ribbon*

imp. PRL 30-50 ohms; PRM 250 and 600 ohms; PRH 30-50 and 35 K ohms. Built-in transformer. (M and H tapped dual impedance.) Price PRL £8; PRM and PRH, £8 10s.

Accessories: Type **GE1.** Transistor coupling unit, for use between medium or low impedance microphone (15 to 1,000 ohms) and the high impedance (nominal 100,000 ohms) microphone input of tape recorder or power amplifier. Response within 1 dB 50-15,000 c/s. Price £6.

Type **LTU1.** Line coupling transformer unit, for use between a low impedance microphone (15 to 50 ohms) and the high impedance (nominal 100,000 ohms) microphone input of tape recorder or power amplifier. Response  $\pm 1$  dB, 50-15,000 c/s. Price £3 15s.

Types **MT101** and **MT102.** Line coupling transformer for chassis or unit mounting, for use between a low impedance microphone (MT101 for 15-50 ohms, MT102 for 250-600 ohms) and the high impedance (nominal 100,000 ohms) microphone input of tape recorder or power

amplifier. Response  $\pm 2$  dB, 50-15,000 c/s. Price, MT101 £2 10s.; MT102 £2 15s.

Microphone stands: **Floor model.** Fixing to base by collar and nut. Min. height 38 ins.; max. height 60 ins. Weight 12 lbs. Price £5 10s. **Table model.** Min. height 16 ins.; max. height 26 ins. Weight 2½ lbs. Price £3 5s. **Desk model (round).** Height 5½ ins. Base dia. 6¼ ins. Weight 22 ozs. Price £1 15s. Desk base model (optional switch). **Type SR.** Pressure Mazak diecasting arranged with cable slot and recessed to accept Reslo standard 3-pin external run plug. Size 4¼ × 3¼ in. Price £1 7s. 6d. **Type SF** supplied with alternative silent cushioning in place of rubber feet fitted to SR model. Price £1 12s. 6d. Slide switch for muting when microphone is permanently fitted to desk base, price 12s. 6d.

Other accessories available include mounting units, cables, reducers, adaptors etc.



**Romagna Reproducers, Factory Distributors,** K. H. Williman & Co. Ltd., Blackford House, Sutton, Surrey. Tel.: Melville 1491.

**HMC/1.** Crystal. Response 80-8,000 c/s. Sensitivity — 54 dB. Source imp. 2,000 p.f. Price £1 5s.



*Lustraphone LD/66 Moving Coil*

**F. & H. Schumann, GmbH.** Sole U.K. importers: G. A. Stanley Palmer Ltd., Maxwell House, Arundel Street, London, W.C.2. Tel.: Temple Bar 3721/3.

A wide range of Microphone inserts and Crystal Microphones.





*Shure 55S Small Unidyne*

**Shure Electronics Ltd.**, 84 Blackfriars Road, London, S.E.1. Tel.: Waterloo 6361.

**55S Small Unidyne.** Cardioid Moving coil. Response 50-15,000 c/s. Sensitivity — 57 dB at high impedance. Sourceimps. 35-50, 150-250 ohms, and high. Switched transformer built-in. Price £27 13s. 4d.

**510C Hercules** Controlled Magnetic. Response 100-7,000 c/s. Sensitivity — 52.5 dB. Source impedance, high. Price £5 13s. 4d.

**535 Slendyne.** Moving coil. Response 60-13,500 c/s. Sensitivity — 61 dB. Sourceimps. 50-250 ohms and high. Switched built-in transformer. Price £24 6s. 8d.

**545 Unidyne III** Cardioid Moving coil. Response 50-15,000 c/s. Sensitivity — 55 dB. Source impedance 25-250 ohms and high. Built-in transformer. Price £28 6s. 8d.



**Simon Equipment Ltd.**, 48 George Street, Portman Square, W.1. Tel.: Welbeck 2371. Cables: Simsale, London.

**Cadenza Ribbon.** Response 50-12,000 c/s. Sensitivity, high impedance — 58 dB, low impedance — 93 dB, or with suitable line transformer — 58 dB. Source imp. 30 ohms and 80 K ohms. Price £8 18s. 6d.; with tripod desk stand and 11-ft. cable, £10 10s.

**Cadenza Crystal.** Response 30-8,000 c/s. Sensitivity — 47 dB. Optimum load 10 megohms. Minimum load 1 megohm. Price £3 13s. 6d.



**Standard Telephones & Cables Ltd.**, Public Address Dept., Esterbrooke Street, London, S.W.1. Tel.: Victoria 7741.

**4021.** Spherical omnidirectional moving coil. Flat response 30-15,000 c/s. Impedance 30 ohms. Sensitivity — 80 dB. Price £24.

**4032.** Moving coil hand microphone. Flat response 40-10,000 c/s. Impedance 30 ohms. Sensitivity — 78 dB. Windshield available. Price £23.

**4033.** Cardioid microphone. Moving coil and ribbon elements which can be

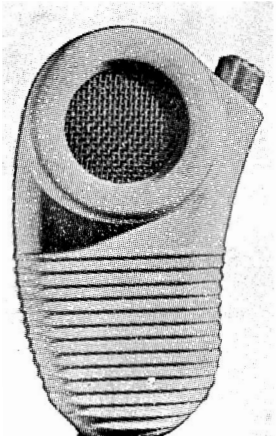

*Vitavox B54*

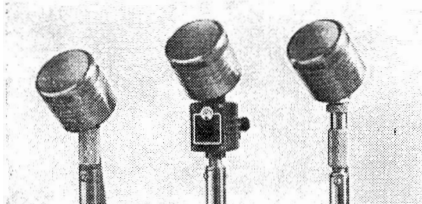

*Trix G7871 Models A, B and C*

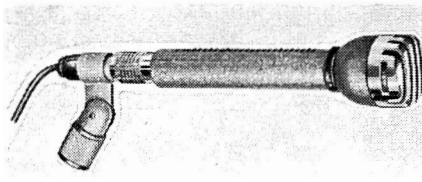

*AKG D19 Moving Coil*



*STC 4033*

used individually or in combination. Flat response 30-10,000 c/s. Impedance 50 ohms. Sensitivity — 80 dB. Front to back ratio 15 to 20 dB. Price £54.

**4035.** Moving coil. As 4032 above, but for stand mounting. Price £23.

**4037.** Moving coil unobtrusive "Pencil" microphone. Flat response 30-15,000 c/s. Impedance 30 ohms. Sensitivity — 84 dB. Price £24.

**4038.** Studio ribbon microphone. Accurate figure-of-eight polar response. Flat response 30-15,000 c/s. Impedance 30 ohms. Sensitivity — 85 dB. Non-linear distortion 0.1%. Controlled transient response. Price £43 10s.

**4104.** Commentator's lip microphone. High degree of noise cancellation. Flat response 70-10,000 c/s. Impedance 30 ohms. Output — 82 dB ref. 1v for 10 dynes/cm<sup>2</sup>. Price £70.

**4105.** Cardioid moving coil. Flat response 60-10,000 c/s. Impedance 30 ohms. Sensitivity — 82 dB. Front to back ratio 15 to 20 dB. Price £22 10s.

**4106-A.** Moving coil. Flat response 40-12,000 c/s. Sensitivity — 85 dB. Source imp. 30 ohms. Price £49 10s.



**Tannoy Products Ltd.,** West Norwood, London, S.E.27. Tel.: Gipsy Hill 1131. Cables: Tannoy, London.

A range of ribbon and moving coil microphones. Details on application.



STC 4104



Shure 535 Slendyne Moving Coil

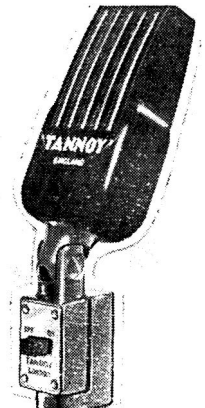

Tannoy MR/425/S

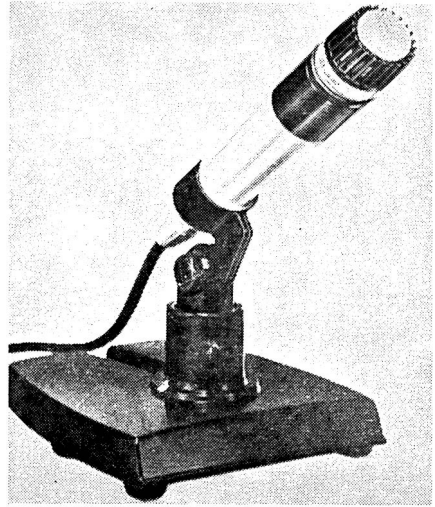

Shure 545 Unidyne III

**Technical Suppliers Ltd.,** Hudson House, 63 Goldhawk Road, Shepherds Bush, London, W.12. Tel.: Shepherds Bush 2581/4794. Cables: Teknika, London.

**M1.** Dual impedance moving coil. Response 60-13,000 c/s. Sensitivity — 72 dB at 200 ohms, — 52 dB at 50,000 ohms. Built-in transformer. Price £4 4s.

**MX3.** Crystal. Response 50-13,000 c/s. Sensitivity — 52 dB. Source imp. 0.5 to 5 meg. Price with stand and cable £2 5s.



**Tellux Ltd.,** 44 Brunel Road, London, W.3. Tel.: Shepherds Bush 0331. Cables:

# CRYSTAL MICROPHONES

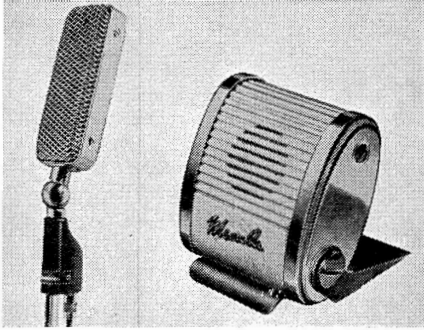

*Shumann-Merula mics.*

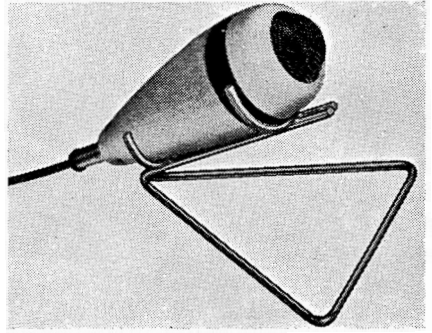

*T.S.L. MX 3*



*Trianon Diana*

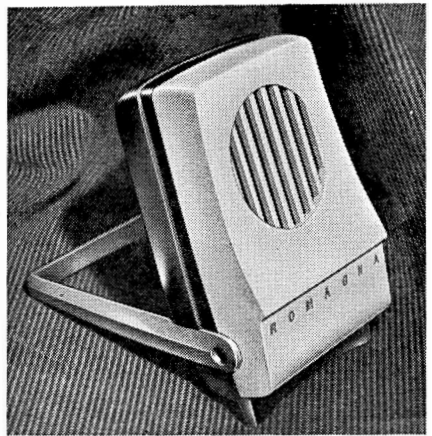

*Romagna HMC/1*

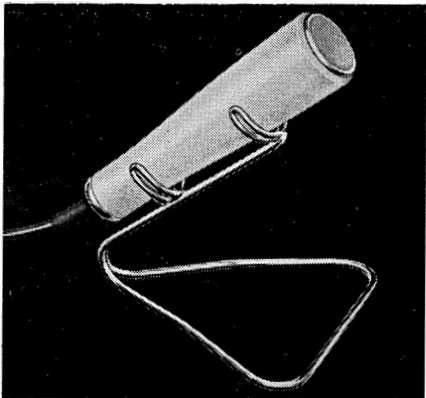

*Acos Mic 39-1*



*Trianon SE 101*

Telite, London. (Sensitivity given in this range is relative to 1 mw/10 dyne/cm<sup>2</sup>.)

**MD21.** Moving coil. Spherical. Response 50-15,000 c/s. Sensitivity — 53 dB. Source imp. 200 ohms. Transformer optional. Price £12 12s.

**MD201.** Moving coil. Near-spherical. Response 50-13,000 c/s. Sensitivity — 53 dB. Source imp. 200 ohms. Transformer optional. Price £18 18s.

**MD3T.** Moving coil. Spherical. Response 50-10,000 c/s. Sensitivity — 61 dB. Source imp. 200 ohms. Price £23 2s.

**MD3M.** Moving coil. Spherical. Response 50-10,000 c/s. Sensitivity — 67 dB. Source imp. 200 ohms. Price £25 4s.

**MD31.** Moving coil. Near-spherical. Response 50-12,000 c/s. Sensitivity — 59 dB. Source imp. 200 ohms. Price £22 1s.

**MD4.** Cardioid moving coil hand mic. Noise cancelling. Response 50-10,000 c/s. Sensitivity—more than 76.5 dB. Source imp. 200 ohms. Price £14 14s.

**MD42.** Cardioid moving coil hand mic. Noise cancelling. Response 100-10,000 c/s. Sensitivity—more than 80 dB. Source imp. 200 ohms. Price £10 10s.

**MD403.** Moving coil. Uni-directional. Response up to 12,000 c/s. Sensitivity — 56 dB. Source imp. 200 ohms or 45,000 c/s. Transformer optional. Price £7 7s.

**MD405.** Cardioid moving coil. Uni-directional. Response 100-14,000 c/s. Sensitivity — 55 dB. Source imp. 200 ohms. Price £14 14s.

**MD408.** Cardioid moving coil. Directional. Response 100-14,000 c/s. Sensitivity — 55 dB. Source imp. 200 ohms. Price £11 11s.

**MD421.** Moving coil directional studio mic. Response 40-16,000 c/s. Source imp. 200 ohms. Transformer optional. Price £15 15s.

**MD43.** Moving coil voice mic. Source imp. 200 ohms. Price £5 15s. 6d.

**MD53.** Moving coil. Spherical. Sensitivity — 53 dB. Source imp. 200 ohms. Transformer optional. Price £5 5s.

**MD7.** Moving coil. Source imp. 200 ohms. Sensitivity—more than 76.5 dB. Transformer optional. Price £4 4s.

**MD82.** Tele-microphone for studio use. Club-shaped. Response 50-13,000 c/s. Sensitivity — 62 dB. Source imp. 200 ohms. Price £48 6s.

■ **MDS1.** Stereo mic. incorporating two dynamic units. Response — 15,000 c/s. Sensitivity — 57 dB. Source imp. 200 ohms. Price £19 19s.



*Acos Mic 45 Crystal*

**Trianon Electric Ltd.,** 3 Violet Hill, London, N.W.8. Tel.: Maida Vale 2255.

**SE101.** Crystal hand mic. Response 50-12,000 c/s. Source imp. 1 meg. ohm. Price £1 15s.

**SE102.** As above but table model version. Price £1 15s.

**Diana.** Crystal. Response 50-12,000 c/s. Price £3 3s. (Moving coil version available.)



*Details of New Products are given in a special supplement at the end of the book.*

**Trix Electronics Company Limited,** 1-5 Maple Place, London, W.1. Tel.: Muséum 5817. Cables: Trixadio, Wesdo, London.

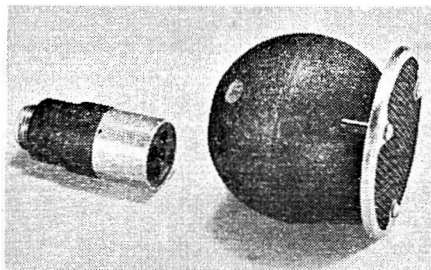

*STC 4021 Moving Coil*

**G7871.** Two models D and C. Moving coil. Response 50-8,000 c/s. Source imp. 30 ohms. G7871/D 18-ft. cable, with switch. G7871/C 18-ft. cable, 3-pin locking type plug. Stands as required. Price: D £7 15s.; C £9 2s. 6d.

**G7823.** Ribbon. Response 50-12,000 c/s. Source imp. 30 ohms. 18-ft. cable, 3-pin locking type plug. Stands as required. Price £9 12s. 6d.

**G7852.** Moving coil. Response 50-9,000 c/s. Source imp. 30 ohms. Cable and connector, G7975/H hand type, or G7976/S stand fitting. G7977/N neck sling attachment. Price, microphone £8 5s.; G7975/H £1 10s.; G7976/S £1 10s.; G7977/N 12s. 6d.

**M88.** Moving coil. Omni-directional. Response 50-17,000 c/s; Source imp. 10 ohms. Price £26 10s.

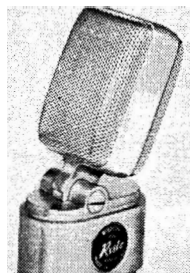

*Reslosound RB Miniature Ribbon*

**Vitavox Limited,** Westmoreland Road, London, N.W.9. Tel.: Colindale 8671. Cables: Vitavox, Hyde, London.

**B50.** Moving coil. Response 60-8,000 c/s. Sensitivity — 85 dB. Source imp. 25 ohms. 6-ft. cable. Price, with control switch, £6 10s.

**B51.** Crystal. Response 60-8,000 c/s. Sensitivity — 50 dB. Source imp. 1 megohm. 6-ft. cable. Price, with control switch, £5 10s.

**B54.** Moving coil. Response 60-8,000 c/s. Sensitivity — 85 dB (excluding transformer). Source imp. according to built-in transformer 200-500-10,000-100,000 ohms. Price, complete with control switch, £8.

**Type A.** Moving coil. Response 60-8,000 c/s. Sensitivity — 68 dB. Source imp. 25 ohms. Rec. load imp. 25 ohms. Price £9 9s.

# TIME ON TAPE

By Graham Balmain

INSTEAD of the far-ranging but necessarily superficial survey of the tape recording field which normally appears here, the writer proposes to take a single theme and to improvise on it in a somewhat more discursive and detailed manner than is otherwise possible. The theme happens to underline most of the necessary peculiarities of tape machines, and this you may perhaps find useful; but the main aim, rather than presuming to instruct, is to present a few ideas which interest the writer and which may possibly also arouse the reader's interest in the subject. So we shall be concerned here with reasons rather than results, with methods more than measurements. Techniques and technicalities are anyway much better learned from the many excellent specialised textbooks and magazine articles on the subject, and above all from the experience of owning and using a tape recorder.

Why is a magnetic recorder—indeed *any* kind of sound recorder—constructed as it is? What (since our theme is Time) makes a tape machine tick?

## Time-Machines

Given the kind of advanced technology imagined by H. G. Wells\* and his successors, we could build ourselves a time-machine which would eliminate the need for separate recorders of the sound variety as any other; a universal four-dimensional reproducer enabling us to return to the actual points in time at which interesting events occurred and re-experience them in sequence. (The reader who thinks that he has trouble now, "getting the kids away from the telly", should try to imagine life with *that* standing

† Charles Eric Maine, "Escapement", published by Hodder & Stoughton.

\* H. G. Wells, "The Time Machine", published by Heinemann.

in the corner. At least we now know where they are!)

One might imagine that no home would be complete without its 4-D Hi-Fi; certainly it would become an essential for, say, students of history and some of the sciences. And yet it is possible that the mere 4-D enthusiast—whose main use for the thing would be entertainment, after all—would be happier with something less fundamental but more sophisticated. However strange truth may be, its impact is transient, and a little rehearsal and polish makes better entertainment. Besides, most real life is too uncomfortable to be relaxing. Who now would prefer medieval squalor to costume romances, or slipshod routine musical performances to the near-perfect ones available on record? Once, perhaps, but not more. Despite our enthusiasm for larger-than-life entertainment, we still prefer it only half as natural and will probably go on doing so.

## A few more frills

If our 4-D reproducer need not actually recall time, it still has much work to do re-creating three-dimensional images in sound and vision, with perhaps smell and a few other tactile sensations thrown in, and it must still reproduce time-sequences, for these are the most important of the dimensions of experience. What form will such a device take? One can hardly guess, but some form of physical movement must be involved in the recording and playback processes (even if only that of electrons in conductors) unless by then we have found some other way of simulating the passage of time. There is also a fair chance that someone will try C. E. Maine's idea for an output stage†: electrodes placed at suitable points on the head to feed the recorded impressions directly to the brain. The storage arrangements in Maine's "*Feelies*"

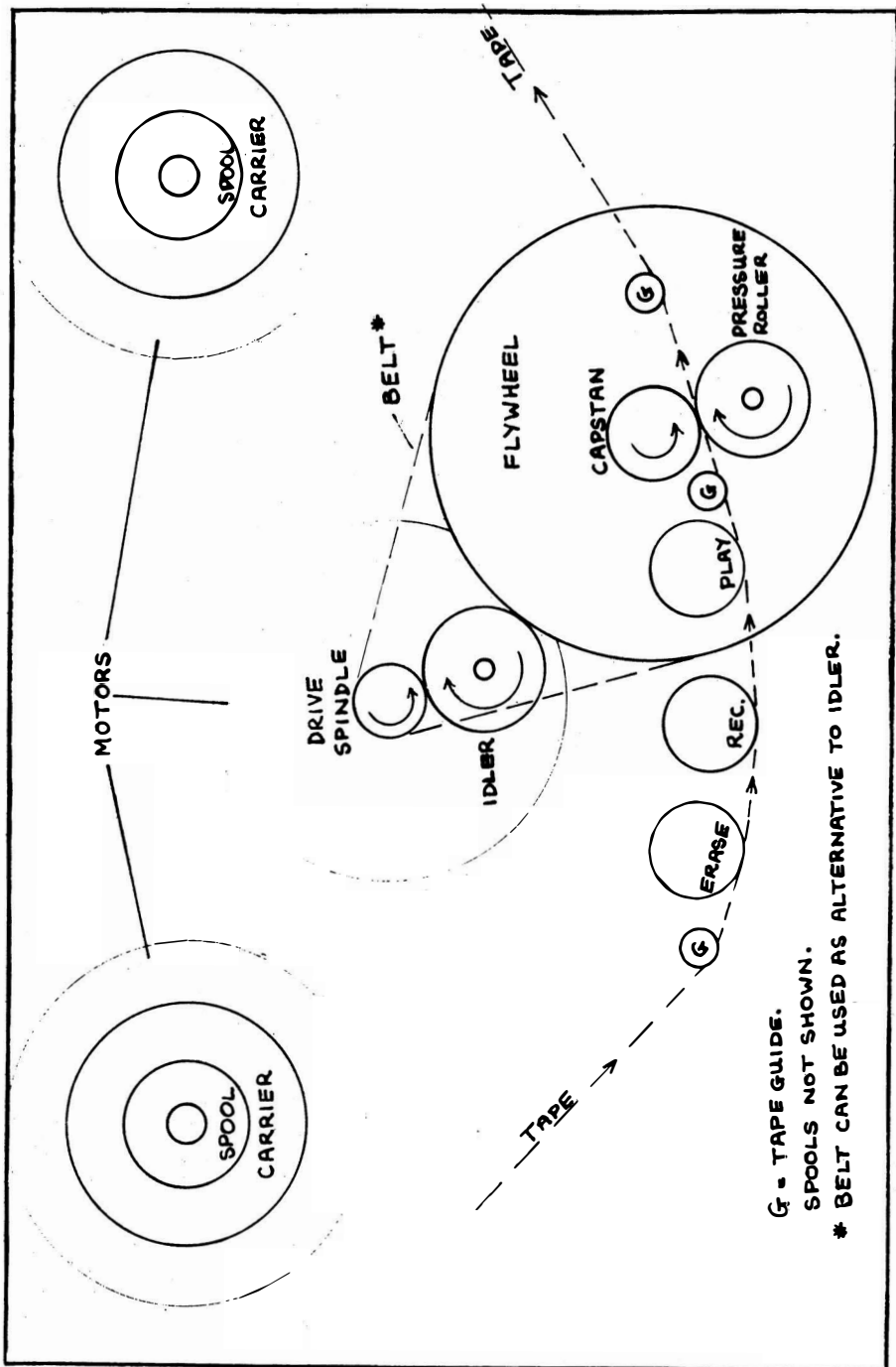

Fig. 1. The basic layout of a typical tape deck. Alternative spool and capstan drives are possible, and many decks have single combination record/playback heads.

were otherwise surprisingly primitive, by the way; tape recorders much as we know them.

And why not? Tape recorders are as near to time-machines as we are likely to get nowadays or at any time until we achieve the real thing; we get no nearer by adding extra dimensions or by combining with film or other effects, but merely increase the range of sensation and the overall satisfaction of the reproduction. Nor is there any strong reason against regarding them as limited kinds of time-machine, for they do all the time-simulating needed for entertainment purposes.

The basic requirement of a recording and reproducing system is clear, then: during recording the signal must either be set in motion in a stationary storage medium (and kept in motion until it is needed again), or transformed into a dimensional pattern of some kind on a moving medium; during playback the signal must move, either of itself or with the medium, relative to the reproducer. The moving signal method is quite feasible in principle, but quite impracticable for sound recording because the capacity of a reasonably small device is no more than a few milliseconds. It is sometimes used for short-term data storage in computers, however. All the familiar sound-recording systems use a moving medium, of course; and the principle is just the same whatever the actual storage method; distances along the medium (or rotation angles for discs) represent time intervals, and its speed (or angular velocity) represents what Wells called the movement of consciousness along the time dimension.

### Recorders as Clocks

Now all this is rather elementary, but it is nevertheless the basis for the logic behind many of the modern applications of tape recording in both the entertainment and industrial fields. It is also a potential source of trouble to the designers of tape machines, who have to make their mechanisms run almost like clockwork (electric clockwork, usually) in order to preserve the original time-relationships on both the long-term and short-term scales. Admittedly, the long term time-keeping required of a tape recorder is pretty sloppy by clock standards. One can reasonably expect even a cheap clockwork movement to be accurate to a minute or so a day (say,  $\pm 0.05\%$ ) and any electric one to be as accurate as the mains supply frequency; but a tape recorder is considered good enough for broadcasting use if it can keep time within 20 seconds in

half-hour ( $\pm 0.5\%$ ), and for domestic use it is given four times this latitude. Which means that the reproducing speed may differ from the recording speed by those percentages, if different machines are used for the one and the other process.

One's ears are tolerant enough on the long-term scale to accommodate such speed differences and (apart from those blessed—or cursed?—with the gift of absolute pitch) also the consequent shifts of pitch. In fact, most people would not be unduly worried by a difference of 5% provided they had not recently heard the original.

A speed accuracy of  $\pm 0.5\%$  is easy enough to achieve in the more expensive machines, because the designer can specify "synchronous" motors whose speed—like that of electric clock motors—depends only on the mains supply frequency under all reasonable mechanical load conditions. Provided the tape drive itself is firm enough, the tape speed should also remain fairly constant throughout the length of a reel. But cheaper machines must perforce have cheaper motors: "induction" or "shaded-pole" types whose speed depends on the mechanical load as well as on the mains frequency. Different examples of such machines, even of the same type, may show differences in average speed because of variations of bearing friction in the motor and tape drive and so on, and all will suffer some speed change from end to end of the tape because of the changing mechanical load. These variations are carefully controlled in well-designed recorders, and their effects should be unobtrusive.

### Wow and Flutter

A greater problem by far is short-term speed accuracy, both because our ears are more sensitive to rapid speed changes ("wow" and "flutter") and because they are more difficult to reduce mechanically than long-term variations. (The terms *wow* and *flutter* mean just what their effects sound like.) Here we generally have to aim at something less than 1% peak to peak fluctuation about the local mean speed (say less than 0.3% *rms*) for general purpose recorders. But one's reactions to wow and flutter are extremely complex, depending on the repetition rate and waveform of the fluctuations, whether they are periodic or irregular, the nature of the programme and the predominant pitches present—even on one's sex, according to a report which claimed female ears to be more critical of their effects. It is thus possible to give



only one rule: "*the less the better*". The best professional machines achieve consistent wow and flutter figures of 0.05% *rms* or less, but in this more than anything else the ear is the best judge.

The *evenness* of the drive must therefore compare well with that of an electric clock (and be much better than that of a clock-work escapement movement which progresses in jerks of anything from one-tenth of a second to a second) even though the mechanical load conditions are much less favourable.

### Tape Drive

To achieve performance of this order, mechanisms such as that sketched in **fig. 1** have been developed. The drive techniques are very similar to those used in disc recorders and players and show the same sort of variations. The one basic feature is the integral flywheel and capstan—equivalent to the turntable and its spindle—which may be driven either directly as an extension of the motor spindle or indirectly through an idler wheel or a belt as shown. The former method has long been favoured in Germany, where the first examples of modern tape recorders were found, although there are now leanings there towards the latter method which is almost always used by British designers. The idler wheel (or "puk") drive seems, incidentally, to have been first used in an early lawn-mower.

### Taking up the slack

Spool-drives, whose purpose is to take up slack in the tape and to wind and unwind it neatly, also vary considerably. At one extreme we have the spool-carriers powered from a single main drive motor, through belts, or idlers, and slipping-clutches under the carriers; at the other we find separate motors for each—apart from the tape drive, as shown. The former is mechanically complex—especially in the latest versions—but makes the machine cheaper; the latter is simpler and more flexible in use but can be expensive. Given good design and manufacture in each case, there is little to choose between them for domestic applications. Apart from treating the tape kindly in a mechanical sense, spool drives must be designed to interfere as little as possible with the tape drive itself and most certainly impose no short term load fluctuations on it.

It will be evident from **fig. 1** that the tape drive must be very carefully arranged to avoid wow and flutter. The possible

causes are obvious enough. For a start, any eccentricities or irregularities in the drive elements will cause speed fluctuations, as will bent spindles, sticky bearings or variations in the elasticity or hardness of rubber wheels or belts. Then the motor itself will contribute periodic fluctuations because of its energising arrangements, although the effects of this and most other drive irregularities should be attenuated considerably by the use of a massive fly-wheel coupled closely to the capstan.

The tape itself may also add flutter by vibrating in various ways against the heads and guides, but this can also be damped by careful design of the tape path and the judicious use of pressure pads. Nevertheless, reducing all these effects to an acceptably low level requires much thought at the design and development stage and considerable precision in the manufacture of the critical parts of the mechanism.

Turning now to the electrical side of recorders, we find we are not yet finished with the time-factor in tape recording, for there are two more ways in which it influences design. One is in setting the basic frequency response of the system, the other in curtailing it at the high-frequency and low-frequency ends.

The first arises from the fundamental law of electro-magnetic induction; the *emf* induced into a coil is directly proportional to the time-rate-of-change of the flux linking it (as well as to the number of turns on the coil and the magnitude of the flux). In tape recording we have the situation shown in **fig. 2**, where our recorded tape passes the playback head at a speed which is sensibly constant and equal to that during recording, and where the flux in that head consequently changes in a way similar to the field which originally produced the recording. The rate-of-change of flux will increase with signal amplitude (larger flux-swings in each given time-period) and with signal frequency (faster flux-swings of given amplitude).

Assuming a constant amplitude or constant flux recording, the output voltage from the playback head should therefore be proportional to frequency, resulting in the familiar 6dB/octave or 20 dB/decade relationship shown in **fig. 3**. Further, the actual output voltage from a particular head at a given signal frequency and amplitude should be independent of tape speed.

However, these basic response conditions hold only over a limited range in practical

systems. The bass response is restricted by the nature of the basic output characteristic itself which, falling at 6dB/octave, will ensure that signals below a certain frequency are simply too small to be useful. The limit frequency is fairly constant for all kinds of recorder (say somewhere between 30 and 60 c/s on average) and is more a function of the general design quality of the recorder than of any particular feature such as the type of head used or the tape speed, though these may have an indirect relationship with it.

The treble response, on the other hand, depends directly on both. This is where the other time-influence is felt, because the dimensional scale of the recording (i.e. how much tape represents so much time) actually modifies the overall output/frequency relationship. As the tape speed, and thus the scale, is reduced, the recorded signal wavelengths become proportionally shorter and those representing high signal frequencies

approach the length of the playback head gap. This causes an increasing loss of signal output which becomes total when the wavelength is equal to the gap length. The situation can obviously be improved when necessary either by increasing the tape speed (and thus the wavelengths at all frequencies) or by decreasing the gap length, subject to technical limitations on the latter and cost restrictions on both.

The recording process also is subject to various wavelength—dependent losses. The two most important are: a virtual part-erasure of the shorter wavelengths by the high-frequency bias field; and a partial self-demagnetisation of recorded signal elements whose wavelengths are comparable to their thickness—their effective depth of penetration into the tape coating, that is. Other losses exist, but they are either avoidable by proper adjustment or have little influence on the general design of a tape recorder.

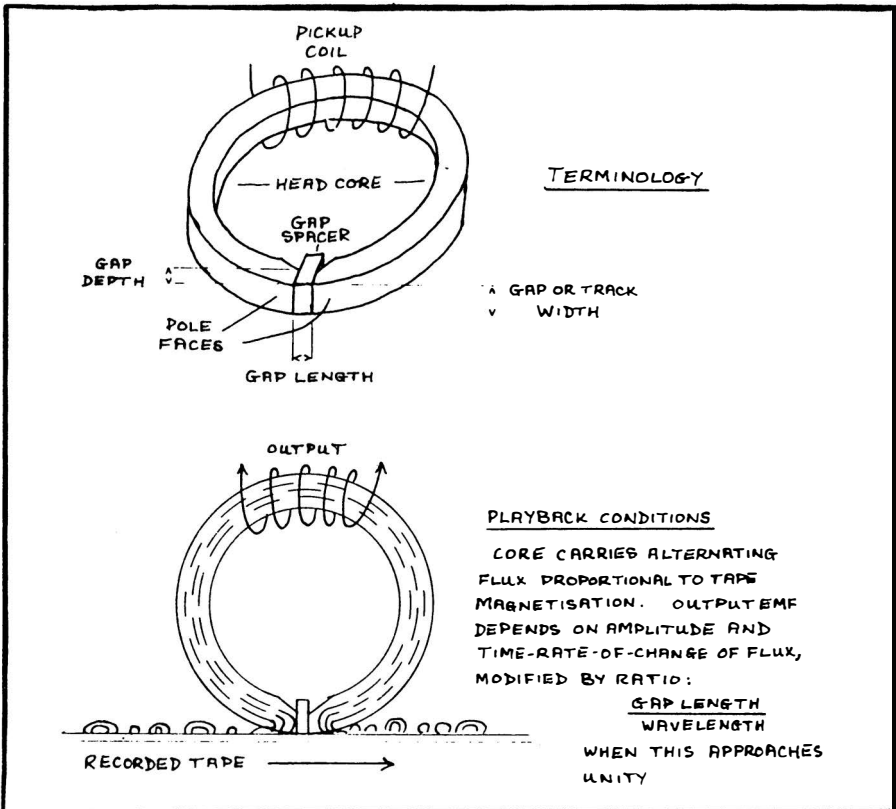

Fig. 2. Magnetic Heads—terminology and conditions on playback.

Adding all these various losses together, we finally obtain a family of curves such as those in **fig. 3**, from which you can see how the available overall frequency response of a tape system depends on the tape speed. Since all these curves depart grossly from the straight horizontal line which we like to think represents the ideal frequency response of a hi-fi unit, we must obviously apply some correction somewhere to restore the tonal balance of the input. The normal practice during the last few years has been to compensate for the known bass fall-off at any given speed by inserting in the playback amplifier a basic equalising network having the kind of frequency response shown in **fig. 4**. This still leaves the h.f. losses, which must be catered for individually at each tape speed according to the type of head and tape used and whether they occur in the recording or the playback process.

Playback losses are equalised by a subsidiary network in the playback amplifier, giving a frequency response such as that shown dashed in **fig. 4**, and recording losses are offset by a similar pre-emphasis network in the recording amplifier. It is pointless to consider the precise shapes of the basic curves in detail at the moment because they are currently under discussion, and although their general shapes are unlikely to be radically changed as a result,

any details given now may be out of date by the time this is in print.

Nevertheless, the fact that they *are* being discussed serves to emphasise their influence on the final results obtainable from a tape recorder. The main troubles to be overcome are in the tape itself; on the one hand it generates a background noise which becomes obtrusive if the recording level is too low or if much playback equalisation is used; on the other hand it overloads and causes harmonic distortion of the signal and other unpleasant effects if the recording level is too high or if there is much recording pre-emphasis in the treble. Both troubles are thus aggravated as the tape speed is reduced, and the noise factor is also increased if the width of the track scanned on the tape (see **fig. 2**) is decreased.

As if this were not enough, hum and noise in the playback amplifier may also make a nuisance of themselves in low speed, narrow-track working. Designers are evidently trapped firmly between several devils and a deep blue ocean as far as the "economy class" recorder is concerned, although they are not too badly off at the higher speeds where little treble boost is needed within the audio range.

At any given speed, one generally reckons the absolute upper limit frequency to be about half that at which a total signal loss occurs (see **fig. 3**). We do not use the

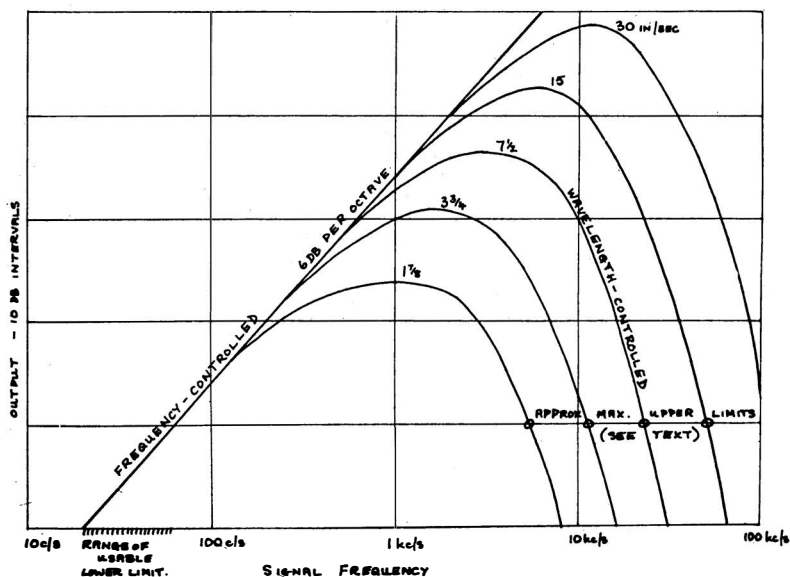

**Fig. 3.** Overall Record/Playback response of typical domestic head at various tape speeds, showing available working limits.

Fig. 4.

General form of present standard playback equaliser response. Typical loss-compensation shown dashed.

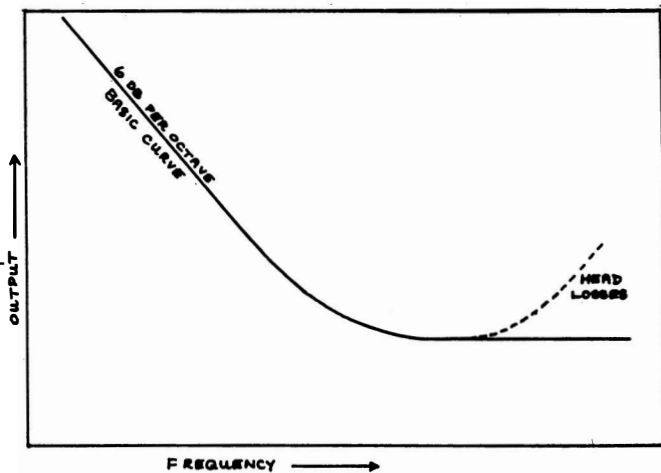

whole range available at the higher speeds, of course, because we do not need it, and it is not always wise (for various reasons connected with distortions) to use all we *think* we need. However, designers are virtually forced to use most or all of the available range at lower speeds, with the inevitable consequences already described above.

Of the various ways of making the best of the situation, using less h.f. bias will improve short wavelength registration, for instance, and shortening the playback gap will improve the output at short wavelengths. But less bias means also more noise and a lower tape overloading point, and a shorter gap results in *less* playback output at middle and low frequencies, so for one step forward there we take half a step backwards somewhere else. The net result of such measures is usually an appreciable (but not large) increase in *either* the high-frequency range *or* the noise factor, but rarely in both together. In short, in reducing tape speeds and track widths as far as we have up to now, we have been able to avoid some of the loss of quality which might have been expected, but not all.

#### Pre-emphasis and Noise

Much more useful improvements could result from the re-shaping of the pre-emphasis and equalisation curves now being discussed. The argument is this; that if more signal can be got on to the tape there will be more output from it, and noise from the tape and playback amplifier will be less obtrusive. We cannot just raise the general recording level, of course, because we should merely overload the tape, but we could take advantage of the fact that,

on the average, music and speech contain less sound power in the treble and the bass than in the middle (see fig. 5). It would therefore seem possible to boost the low and high frequencies relative to the middle during recording, and thus to put more signal on the tape without overloading it. The complementary cut necessary on the playback side to restore the tonal balance would also reduce tape noise at high frequencies and both this and amplifier noise at low frequencies. The extra dynamic range thus gained can either be accepted gratefully or traded, wholly or partly, for an extension of the high-frequency range. A practical pre-emphasis curve might differ somewhat from that shown to give a good compromise for all kinds of programme material.

#### Building-in pre-emphasis

This is by no means a new idea; it was used to advantage in some of the earliest British recorders but was largely dropped later for the sake of standardisation. (It has also been widely used in disc recording for many years, of course.) However, it never really died in America and the development there of narrow-track, low-speed systems made its general revival highly desirable. Standards or not, several British and Continental recorder manufacturers have been building some recording pre-emphasis into their machines for a year or two now.

We have now covered all the features peculiar to tape recorders which arise from the time-factor in the recording process; the method of storage; the general form and some of the requirements of the mechanism; the basic response of the

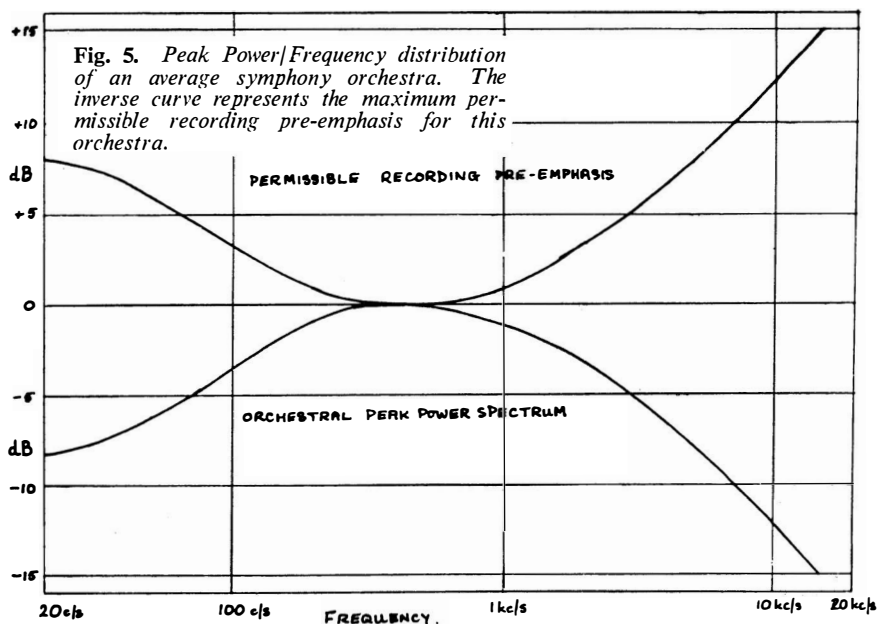

system and its losses; the necessity for equalisation and the desirability of some recording pre-emphasis. One feature remains which has nothing at all to do with time, the use of a high-frequency bias field to obtain optimum sensitivity and distortion conditions on the tape.

### High-Frequency Bias

Fig. 6 shows a sketch of the amplitude response of the tape itself to the magnetic field applied by the recording head. As may be seen, the curve is quite sharply kinked in the middle, and if we try to record with this characteristic as it stands we shall obviously have to put in a fair amount of signal before any impression at all is left on the tape. Even if the general level of the signal is increased until its peaks approach the outer curved parts—the overloading regions—it will still suffer much distortion because the central parts of its waveform are missing, and the lower level signals (the soft passages) will still not register at all.

This is avoided by “bridging the gap”, so to speak; by mixing with the signal field a high-frequency field whose peak amplitude, much as shown in fig. 6, is such as to bring the tape to the threshold of doing something useful without actually doing it. The additional signal field must then register,

however small it is, since the total field swing must overstep the threshold. The effect of the bias is thus to “short-circuit” the central kink and make the central regions of the characteristic approximately a straight line. In practice there is no sharp division between non-registration and registration, because the central kink is curved, not angular, but this merely means that the bias field can be chosen from within a small range to give optimum results according to the particular recording conditions. It does *not* mean that a substantially linear effective characteristic cannot be achieved, as we know from experience.

### Applications and Possibilities

Let us now return for a moment after all this earthy detail to one or two of the rather unearthly ideas put forward earlier, which may turn out to be not so irrelevant as they probably seemed at first. For entertainment, it was said, we want something less fundamental than a real time-machine, but more sophisticated; we want reproduction larger than life, but only half as natural. Otherwise it does not *seem* natural as entertainment, for usually the whole unadulterated truth is so flat and so cluttered with detail and irrelevancies that there is too little for one’s imagination to work on and too much to distract it.

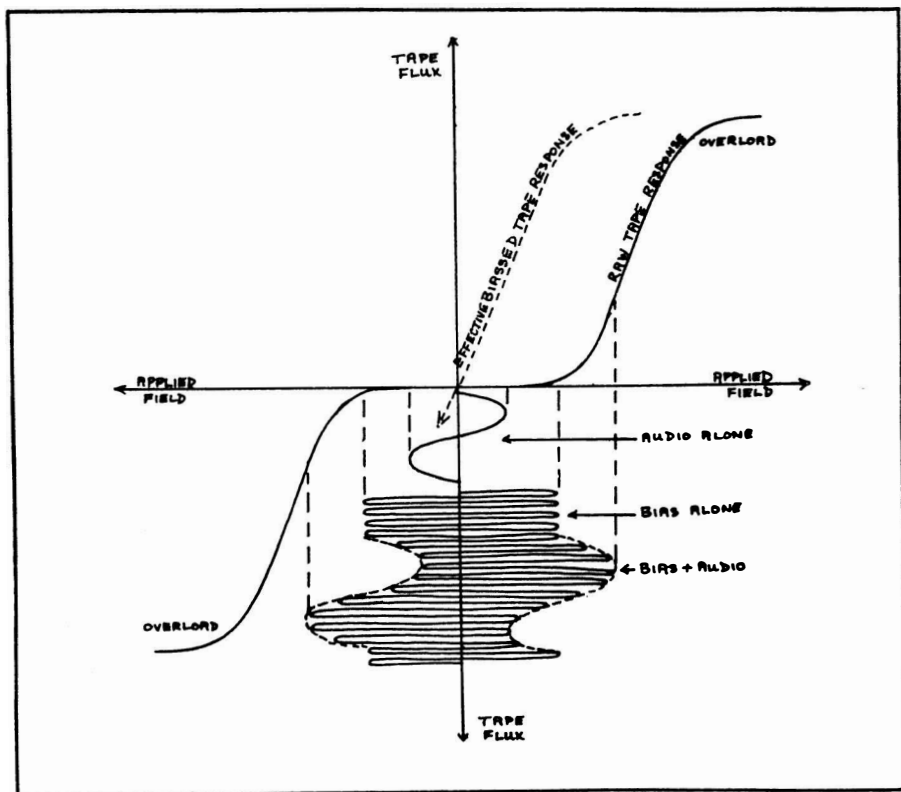

Fig. 6. The effect of high-frequency bias on the raw amplitude response characteristic of magnetic tape.

Every dramatist knows the value of the climax which is seldom so sharply defined in real life; every writer and poet knows the value of the effective phrasing which few of us can achieve in letters, let alone in conversation; every artist exaggerates in some way or other, and all consciously-composed music is in a sense unnatural. A small technical defect in presentation or a slight external distraction can make momentary nonsense of almost any entertainment, but heard once at a live performance, it is forgivable. Transferred permanently to a record it rapidly becomes infuriating.

So our reproduction must necessarily be artificial in presentation as well as in content. No mistakes, no mediocrity, no extraneous matter. Often the lily must even be painted up a bit; artificial reverberation, mixing, weird noises and exaggerations of all kinds are now commonplace and accepted as natural in the context. On no medium is all this so easy to achieve as on tape, and it is probably true to say that no

commercial record company has put anything directly on to a disc for ten years or more.

Tapes can be cut and spliced and doctored so convincingly that it is much cheaper to build a long piece from many short passages, each rehearsed, played and recorded individually, than to have to repeat the whole thing several times to get it right. This is time-simulation indeed! (but in a form already practised by film companies for very much longer, of course). And the result is considered just as artistically satisfying as before (when artistic criteria are relevant) if not more so.

Not only this, but tape has made possible new musical forms—musical, that is, if one's tastes lie that way. *Musique Concrète* would have been technically quite impracticable without the facilities for editing, superimposing, reversing, echoing, speed-changing and all the other various distortions of common sounds practised during its composition, which are easily available

on tape recorders. The newer purely electronic music would have been equally difficult to manage without tape, probably. Here one grows doubtful; time-*dissimulation*, perhaps? This new music certainly has a hypnotic, timeless quality about it, and anyway one can hardly talk of simulating something which is so newly created and has so little basis in common experience. This kind of abstract composition must surely be reckoned the first creative application of tape recording—but again one long anticipated in spirit by the cinema (parts of “Fantasia” for instance) and by the various essays in blending pure colour composition with music. Even speech seems to be amenable to treatment in a way analogous to musical harmony and counterpoint.\* Such trends as these are already firmly established and will undoubtedly expand.

### Tape for Amateurs

One does not have to do all this to enjoy tape recording, of course, but having persuaded oneself to buy a time-machine—sorry, tape recorder—how can one make it justify its existence? A silly question, to which the obvious silly answer is: make it live up to its name; make it *record*. And yet it is surprising how many people buy quite good and expensive tape recorders and then largely use them as gramophones, to play tape records. There is a definite need for tape *players*, to be sure, which manufacturers are now beginning to realise, but it still seems a pity to miss half of the

fun. Apart from the more sophisticated applications, and outside the usual baby-party — wedding — Auntie — Mabel-singing sphere, there is a great deal of enjoyment and solid satisfaction to be had from taking straight recording really seriously. Not merely taping off the BBC, either; this is mostly good, competent, often brilliant stuff of a high technical standard, but nothing like as interesting as trying to make silk purses out of sows' ears at local concerts, for instance, or making up film tracks or programmes for the local hospital or a hundred other really live possibilities.

### Faithful reproduction

Here one learns the real meaning of “faithful” reproduction and how often it is necessary to avoid it in order to make the result convincing, acceptable and even artistic; one finds that high-fidelity is not quite as high-minded as one would have it. But why worry, when one can set one's own standards and make the results still sound consistent with supposed remembrances of the original? To the recordist, tape recording is still an art with all the scope that the word implies. For the engineer and designer it is fast approaching an exact science, to the recordists' benefit. The amateur recording enthusiast, in fact, has never had it so good.

---

\* ‘Audio’ magazine, October 1961, “Audio, etc.,” by E. T. Cauby.

# DIRECTORY OF TAPE RECORDERS

★ The abbreviations used for the specifications in this directory are as follows: F.R.—frequency response; i/s—\_inches per second; P.s.n.—Power supply needed; <, better than; M.E.—Magic eye; W. & F.—Wow and flutter; S-N—signal to noise ratio; ■—Stereo equipment.

## PROFESSIONAL and SEMI-PROFESSIONAL

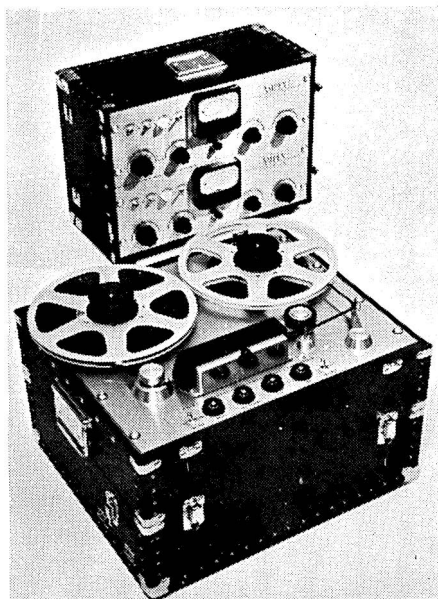

*Ampex 351-2 portable stereo*

**Ampex (Great Britain) Ltd.**, 72 Berkeley Avenue, Reading, Berkshire. Tel.: Reading 55341. Cables: Videotape, Reading.

**Ampex 300 Series.** Prof. recorders. One to eight tracks. Speeds 15 and  $7\frac{1}{2}$  i/s. 3 motors. 14-in. spools up to 1-in. wide. F.R. 15 i/s, 30-18,000 c/s;  $7\frac{1}{2}$  i/s, 40-12,000 c/s, both  $\pm 2$  dB. Large scale V.U. meter. H and N — 60 dB full track, — 55 dB multi-track. W. & F. less than 0.1% at 15 i/s. Prices on application.

**Ampex 351.** Prof. recorder in console, portable or rack-mounted form. Full or half track. Speeds 15 and  $7\frac{1}{2}$  i/s, or  $7\frac{1}{2}$  and  $3\frac{3}{4}$  i/s. 3 motors. 10½-in. N.A.B. spools. F.R.: 15 o/s, 30-18,000 c/s;  $7\frac{1}{2}$  i/s, 40-12,000 c/s;  $3\frac{3}{4}$  i/s, 50-8,000 c/s, all  $\pm 2$  dB. Large scale V.U. meter. H and N — 70 dB full track, — 65 dB half track at 15 i/s. W. & F.

less than 0.15% at 15 i/s. Size (console) 48 × 24 × 28 ins. Weight 168 lbs. Price (15 and  $7\frac{1}{2}$  i/s), £662 portable, £682 console.

**Ampex 352.** Prof. reproducer only in console or rack-mounted form. Full or half track, or stereo. Speeds 15 and  $7\frac{1}{2}$  i/s. 3 motors. 10½-in. N.A.B. spools. F.R.: 15 i/s, 30-18,000 c/s;  $7\frac{1}{2}$  i/s, 40-12,000 c/s, both  $\pm 2$  dB. H and N — 70 dB full track, — 65 dB half track. W. & F. less than 0.15% at 15 i/s. Size (console) 35 × 24 × 24 ins. Weight 109 lbs. Price £503 mono, £635 stereo. Console cabinet extra.

■ **Ampex 354.** Professional console recorder. Speed 15 and  $7\frac{1}{2}$  i/s or  $7\frac{1}{2}$  and  $3\frac{3}{4}$  i/s. 3 motors. 10½ in. N.A.B. spools. F.R. 15 i/s 30-18,000 c/s;  $7\frac{1}{2}$  40-12,000 c/s.  $\pm 2$  dB 2 V.U. meters H and N — 65 dB, W. & F. 0.15% at 15 i/s. Price on application.

**Ampex 601.** Prof. portable recorder. Speed  $7\frac{1}{2}$  i/s. One motor. 7-in spools. F.R.: 40-10,000 c/s  $\pm 2$  dB. Large scale

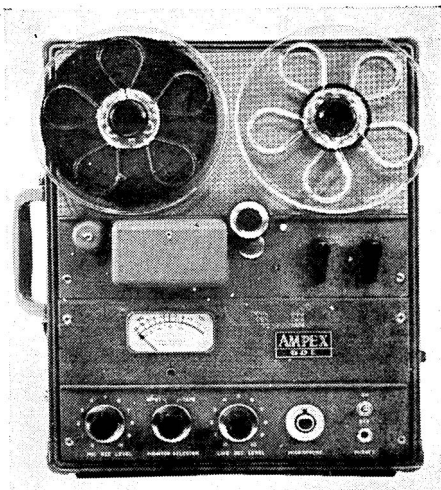

*Ampex 601 portable recorder*



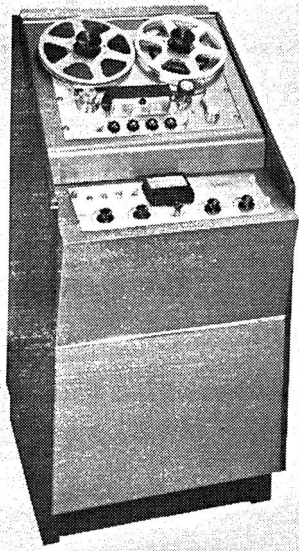

*Ampex Universal 351 console*

V.U. meter. H and N - 55 dB full track, - 50 dB half track. W. & F. less than 0.17%. Size  $16\frac{1}{2} \times 13\frac{3}{4} \times 8$  ins. Weight 28 lbs. Price £295.

■ **Ampex 601-2.** Stereo version of Ampex 601. Size  $24\frac{1}{2} \times 13 \times 8$  ins. Weight 42 lbs. Price £486.

■ **Fine Line Ampex 1200.** Four-track stereo. Speeds  $7\frac{1}{2}$  i/s and  $3\frac{3}{4}$  i/s. One motor. 7-in. spools. F.R.  $\pm 2$  dB.  $7\frac{1}{2}$  i/s 50-15,000 c/s;  $3\frac{3}{4}$  i/s 50-7,500 c/s. Level meter. S-N  $< -55$  dB at  $7\frac{1}{2}$  i/s,  $< -50$  dB at  $3\frac{3}{4}$  i/s. W. & F.  $< 0.2\%$  r.m.s. at  $7\frac{1}{2}$  i/s. Built-in mixing facilities. Built-in pair of amplifier speakers available. Mono or stereo  $\frac{1}{2}$ -track record and replay. Size  $9 \times 15 \times 17\frac{1}{2}$  ins. Weight 36 lbs. Price to be announced.

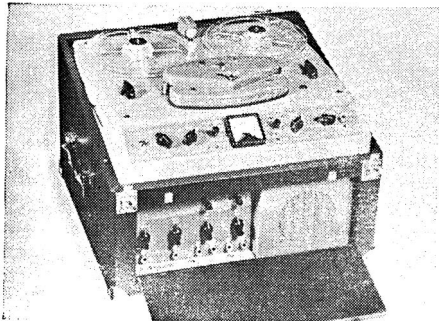

*E.M.I. TR52 stereo portable*

**Elstone Electronics Ltd.** Edward Street, Templar Street, Leeds, 2. Tel.: Leeds 3-5111.

■ **Tandberg Series 6.** Speeds  $7\frac{1}{2}$ ,  $3\frac{3}{4}$  and  $1\frac{7}{8}$  i/s. F.R. 30-20,000 c/s.  $\frac{1}{4}$  track. 7-in. spools. H and N - 55 dB. W. & F. 0.1% M.E. level ind. Outlet from pre-amp. Superimposing. Size  $15\frac{1}{4} \times 11\frac{3}{8} \times 6$  ins. Weight 25 lbs. Price £115 10s. Alternative half-track model also available £115 10s.



**EMI Electronics Ltd.,** Hayes, Middx. Tel.: Hayes 3888. Cables: Emidata, London.

■ **TR52/D.** Prof. portable stereo/mono recorder. Speeds  $7\frac{1}{2}$  and  $3\frac{3}{4}$  i/s. One motor 7-in. spools. F.R.  $7\frac{1}{2}$  i/s, 50-10,000 c/s;  $3\frac{3}{4}$  i/s, 50-6,000 c/s, both  $\pm 2$  dB. W. & F. less than 0.25% at  $7\frac{1}{2}$  i/s. Crosstalk - 45 dB. V.U. meter. Size  $20 \times 17\frac{1}{2} \times 13\frac{1}{2}$  ins. Weight 80 lbs. Price £245.

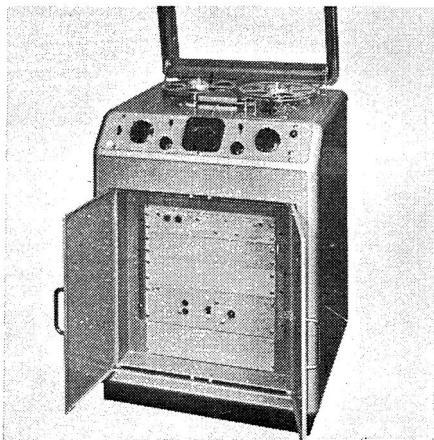

*E.M.I. TR90 in console form*

**EMI Model TR90.** Prof. recorder for rack mounting or as a console on transportable trolley, 30 and 15 i/s or 15 and  $7\frac{1}{2}$  or  $7\frac{1}{2}$  and  $3\frac{3}{4}$  i/s. 4 motors.  $10\frac{1}{2}$ -in. spools. F.r.: 15 i/s, 50-15,000 c/s;  $7\frac{1}{2}$  i/s, 50-10,000 c/s;  $3\frac{3}{4}$  i/s, 50-6,000 c/s. All  $\pm 2$  dB. Level meter. Size (transportable version) 2 cases  $14\frac{1}{2} \times 20 \times 16\frac{1}{2}$  ins. Weight 80 and 58 lbs. Price from £625.



**Leavers-Rich Equipment Ltd.,** 319b Trinity Road, Wandsworth, London, S.W.18. Tel.: Vandyke 9054. Cables: Leemag, London, S.W.18.

**Model E. No. ER141M.** Prof. reproducer console. 15 and  $7\frac{1}{2}$  i/s. 3 motors.  $11\frac{1}{2}$ -in. spools. F.R.: 15 i/s, 50-15,000 c/s;  $7\frac{1}{2}$  i/s, 50-10,000 c/s, both  $\pm 2$  dB on C.C.I.R. test tape. Size  $24 \times 24 \times 36$  ins. Weight 200 lbs. Price £500.

**Model E. 141M.** Prof. recorder console. Speeds 15 and  $7\frac{1}{2}$  i/s. Three motors.  $11\frac{1}{2}$ -in. spools. F.R. 15 i/s 50-15,000 c/s;  $7\frac{1}{2}$  i/s 50-10,000 c/s, both  $\pm 2$  dB. V.U. level meter. H and N  $< -55$  dB unweighted. W. & F.  $< 0.15\%$  at 15 i/s. Outlet from pre-amp. Size  $24\frac{1}{2} \times 23\frac{1}{2} \times 37$  ins. Weight 205 lbs. Price £640.

**Model E. 141P.** Prof. transportable recorder. Details and specifications as for E. 141M. Size, recorder  $21 \times 17 \times 11\frac{1}{2}$  ins.; amplifier  $18\frac{3}{4} \times 14\frac{1}{2} \times 10\frac{3}{4}$  ins. Weight, recorder 71 lbs.; amplifier 25 lbs. Price £615.

**Model E. No. E141R.** Complete rack mounting prof. recorder. 15 and  $7\frac{1}{2}$  i/s. 3 motors.  $11\frac{1}{2}$ -in. spools. F.R.: 15 i/s



*Leevers-Rich ED142K stereo*

50-15,000 c/s;  $7\frac{1}{2}$  i/s, 50-10,000 c/s, both  $\pm 2$  dB. V.U. level meter. Other details as for E. 141M. Size  $19 \times 17\frac{1}{2} \times 10$  ins. Weight 50 lbs. Price £545.

**Model E. No. E121P.** Prof. portable recorder. Spec. as for E141R. In two cases,  $20 \times 17 \times 11\frac{1}{2}$  ins. and  $15 \times 18 \times 10$  ins. Weight 79 lbs. Price £660.

**Model C. Model C621P.** Prof. portable recorder. 15 i/s. 3 motors.  $9\frac{1}{2}$ -in. spools. F.R.: 50-15,000 c/s  $\pm 2$  dB. V.U. level meter. Size  $13 \times 18 \times 10$  ins. Weight 73 lbs. P.s.n. 12v battery or auxiliary mains unit. Price £450.

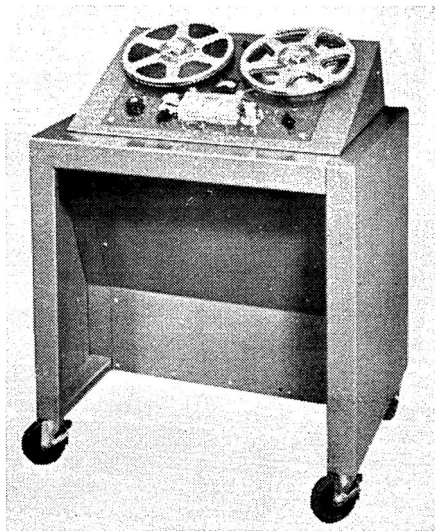

*Leevers-Rich Model No. E141K*

**Model DB. No. DB221P.** Prof. portable recorder. Spec. as for C621P but in two cases,  $13 \times 18 \times 10$  ins. and  $16 \times 20 \times 11\frac{1}{2}$  ins. Total weight 74 lbs. P.s.n. as C621P. Price £500.

**Model CS. No. CS621P.** Syncropulse recorder, for magnetic recording in sync. with cameras, etc. Spec. as for C621P. In two cases both  $13 \times 18 \times 10$  ins. Total weight 73 lbs. P.s.n. as C621P. Price £550.

■ **Model E. No. ED142P.** Complete portable dual channel recorder. 3 motors. 15 and  $7\frac{1}{2}$  i/s. Monitoring off tape, separate V.U. Meter, unit amp. L.R. and H.R. Mic. or line inputs.  $11\frac{1}{2}$ -in. spools. Response at 15 i/s, 50-15,000 c/s  $\pm 2$  dB. Size 2 cases  $16 \times 20 \times 11$  ins. Total weight 80 lbs. Price £696. M console version, £790. All "E" Tape mechanisms are now press button operated.



*Tandberg Series 6*

**Pamphonic Reproducers Ltd.,** Westmoreland Road, London, N.W.9. Tel.: Colindale 7131.

**Reflectograph Model A.** Semi-prof. recorder. Speeds  $7\frac{1}{2}$  and  $3\frac{3}{4}$  i/s. Three motors.  $8\frac{1}{4}$ -in. spools. F.R.  $7\frac{1}{2}$  i/s 35-15,000 c/s;  $3\frac{3}{4}$  i/s 35-9,000 c/s, both  $\pm 2$  dB. Level meter. H and N - 50 dB. W. & F.  $< 0.15\%$ . Outlet from pre-amp. Size  $20 \times 16 \times 10$  ins. Weight approx. 50 lbs. Price £110 5s.

■ **Model B.** Similar specification to Model A but fitted with  $\frac{1}{4}$  track heads and facility

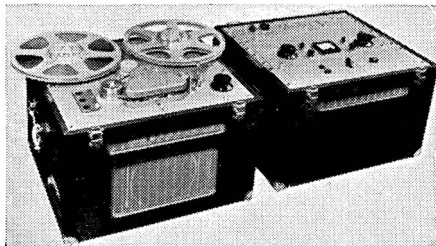

*E.M.I. TR90 in transportable form*

for playing back  $\frac{1}{4}$  track or  $\frac{1}{2}$  track pre-recorded stereo tapes with additional amplifier. Price £120 15s.

■ **Model C.** Half-track semi-prof. recorder. Speeds  $7\frac{1}{2}$  and  $3\frac{3}{4}$  i/s. Three motors.  $8\frac{1}{4}$  in. spools. F.R.  $7\frac{1}{2}$  i/s 35-15,000 c/s;  $3\frac{3}{4}$  i/s 35-9,000 c/s, both  $\pm 3$  dB. H and N - 50 dB. W. & F.  $0.15\%$ . Outlet from pre-amp. Level meter. Size  $20 \times 16 \times 10$  ins. Weight approx. 50 lbs. Price £152 5s.

**Model D Reflectograph.** Half-track tape player. Speeds  $7\frac{1}{2}$  and  $3\frac{3}{4}$  i/s. Three motors.  $8\frac{1}{4}$ -in. spools. F.R.  $7\frac{1}{2}$  i/s 35-15,000 c/s;  $3\frac{3}{4}$  i/s 35-9,000 c/s, both  $\pm 3$  dB. H and N - 50 dB. W and F  $0.15\%$ . Outlet from pre-amp. 250 mV. Size  $20 \times 16 \times 10$  ins. Weight approx. 50 lbs. Price £78 15s.



*Revox*

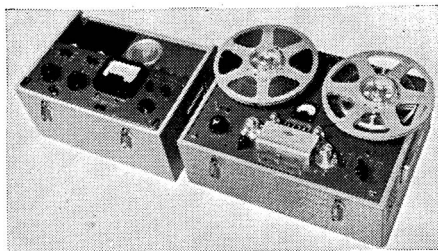

*Leavers-Rich Series E No. E121P*

**Model E Reflectograph.** Half-track tape player. Speeds  $7\frac{1}{2}$  or  $3\frac{3}{4}$  i/s to order. Three motors.  $8\frac{1}{4}$ -in. spools. F.R. to N.A.B. standard. H and N - 50 dB. W and F  $0.2\%$  total. Output from pre-amp 250 mV. Automatic track reversal. Size  $20 \times 16 \times 10$  ins. Weight approx. 50 lbs. Price £99 15s.



**Audiocraft Ltd.,** 296 Kensington High Street, London, W.14. Tel.: Western 4343.

■ **Revox.**  $7\frac{1}{2}$  and  $3\frac{3}{4}$  i/s, Four Track and Two Track. Three Motors. F.R.  $7\frac{1}{2}$  i/s, 40-15,000 c/s.  $3\frac{3}{4}$ , 40-12,000 c/s  $\pm 2$  dB—

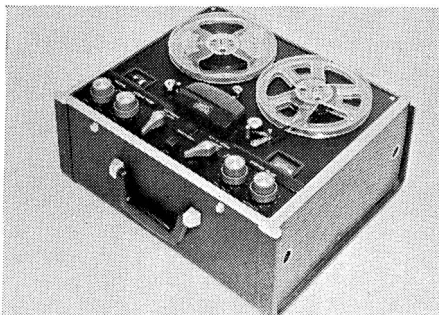

*Ampex 960*

3 dB. 10-in. spools. M.E. level ind. W and F  $0.1\%$ , S-N - 50 dB, Automatic matching for any impedance microphone. Weight 42 lbs. Size  $18 \times 11 \times 13$  ins. Price £110 5s.



**Telefunken—Sole U.K. distributors, Welme Corporation Ltd.,** 147 Strand, London, W.C.2. Tel.: Temple Bar 3357. Cables: Welmcor, London.

**Magnetophon M24.** Studio recorder. Half track. Speeds  $7\frac{1}{2}$  and  $3\frac{3}{4}$  i/s. 3 motors.  $8\frac{3}{4}$ -in. spools. F.R. 30-18,000 c/s.  $7\frac{1}{2}$  i/s, 40-15,000 c/s.  $3\frac{3}{4}$  i/s. H and N - 50 dB. W. & F.  $1.5\%$  at  $7\frac{1}{2}$  i/s. Size according to cabinet. Prices from 159 gns.



Sony 521

**Tellux Ltd.**, 44 Brunel Road, London, W.3.  
Tel.: Shepherds Bush 0331. Cables:  
Telite, London.

■ **Sony 521.** Semi-prof. four-track and twin-track recorder. Speeds  $7\frac{1}{2}$  and  $3\frac{3}{4}$  i/s. One motor. 7-in. spools. F.R.  $7\frac{1}{2}$  i/s 30-18,000 c/s;  $3\frac{3}{4}$  i/s 30-12,000 c/s. Two V.U. meters. S-N < 50 dB. W. & F.  $7\frac{1}{2}$  i/s < 0.15%;  $3\frac{3}{4}$  i/s < 0.25%. Outlet from pre-amp. Size  $16\frac{1}{2} \times 16 \times 8$  ins. Weight 35 lbs. Price £130 4s.

■ **Sony 777.** Transistorised prof. recorder. Speeds  $7\frac{1}{2}$  and  $3\frac{3}{4}$  i/s. Three motors. 7-in.

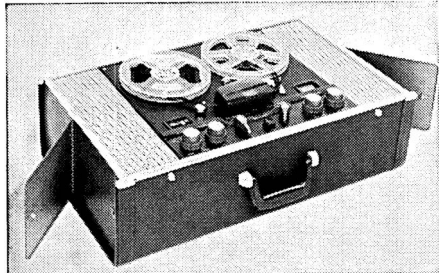

Ampex 970

spools. F.R.  $7\frac{1}{2}$  i/s 30-18,000 c/s;  $3\frac{3}{4}$  i/s 30-10,000 c/s. V.U. meter. S-N < -50 dB. W. & F.  $7\frac{1}{2}$  i/s < 0.15%;  $3\frac{3}{4}$  i/s < 0.2%. Outlet from replay head. Push button remote control. Size  $16\frac{1}{2} \times 16 \times 10\frac{1}{2}$  ins. Weight 42 lbs. 4 ozs. Price £199 10s.



**Uher—Sole U.K. distributors, Bosch Ltd.**,  
205 Great Portland Street, London, W.1.  
Tel.: Langham 1809.

■ **Uher Stereo 1.** Prof. four-track stereo recorder. Speeds  $7\frac{1}{2}$ ,  $3\frac{3}{4}$  and  $1\frac{7}{8}$  i/s. 7-in. spools. F.R.  $7\frac{1}{2}$  i/s 40-20,000 c/s;  $3\frac{3}{4}$  i/s

40-16,000 c/s;  $1\frac{7}{8}$  i/s 40-8,000 c/s. S-N -45 dB. W. & F.  $\pm 0.1\%$  at  $7\frac{1}{2}$  i/s. M.E. level ind. Price £103 19s.

■ **Uher Stereo 2.** Twin-track prof. stereo recorder. Speeds  $7\frac{1}{2}$ ,  $3\frac{3}{4}$  and  $1\frac{7}{8}$  i/s. One motor. 7-in. spools. F.R.  $7\frac{1}{2}$  i/s 40-20,000;  $3\frac{3}{4}$  i/s 40-16,000 c/s;  $1\frac{7}{8}$  i/s 40-9,000 c/s. S-N -45 dB. W. & F.  $0.1\%$  at  $7\frac{1}{2}$  i/s. M.E. level ind. Outlet from pre-amp. Stereo/mono recording. Synchronising. Remote control. Size  $16 \times 15 \times 8$  ins. Weight approx. 34 lbs. Price £142 16s.

■ **Uher Stereo 3.** Four-track prof. stereo



Telefunken M24

recorder. Other details and specifications as for Uher Stereo 2. Price £132 6s.



**Vortexion Ltd.**, 257/263 The Broadway,  
Wimbledon, London, S.W.19. Tel.: Liberty  
6242/3. Cables: Vortex, Wimbledon.

**Model WVA.** Complete semi-pro. portable recorder 15 and  $7\frac{1}{2}$  i/s or  $7\frac{1}{2}$  and  $3\frac{3}{4}$  i/s. Wright and Weaire deck. 3 motors.  $8\frac{1}{4}$ -in. spools. F.r.: 30-17,000 c/s  $\pm 3$  dB at 15 i/s; 30-15,000 c/s  $\pm 3$  dB at  $7\frac{1}{2}$  i/s. S-N < 50 dB unweighted. W. & F., < 0.2%. Meter

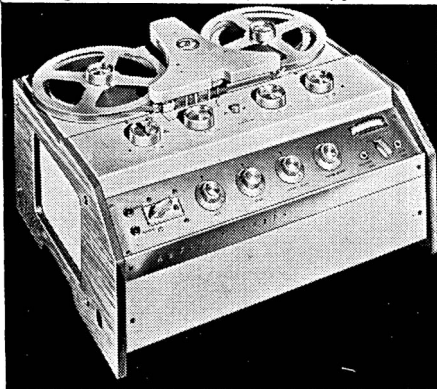

Reflectograph Model A

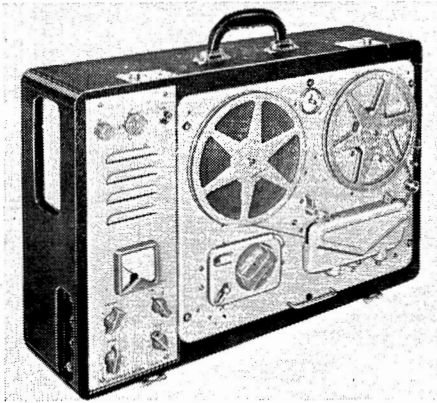

*Vortexion WVA portable*

level ind. Loads 7uV mic. Weight 49 lbs. Price £93 13s. (£5 extra for 15 i/s).

**Model WVB.** Spec. as for WVA, but with extra monitor head and amplifier. Echo facilities. Price £110 3s. (£5 extra for 15 i/s)

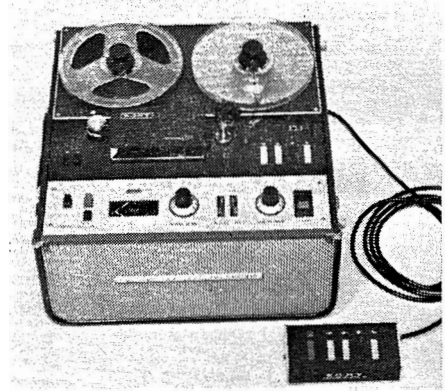

*Sony 777*

**Model WVA/S** Spec. as for WVA with provision for plug-in stereo head, and can be supplied with this and stereo playback pre-amplifiers with equalisation each having an output of 1 volt from a cathode follower. Speeds  $3\frac{1}{2}$  and  $7\frac{1}{2}$  i/s. Price £112 10s.

## GENERAL PURPOSE and DOMESTIC RECORDERS

**Abbey Radiogram Manufacturing Co.,** 1a Compton Terrace, Hoppers Road, London, N.21. Tel. Palmers Green 7492.

**Regent.** Collaro Studio deck.  $7\frac{1}{2}$ ,  $3\frac{3}{4}$ ,  $1\frac{7}{8}$  i/s. 3 motors. M.E. level ind. Variable monitoring. Mixing. Size  $15 \times 18 \times 8$  ins. Weight 32 lbs. Price £40 19s. Legs £2 2s.

**Allegro Sound Equipment Ltd.,** 91a Heath Street, Hampstead, London, N.W.3.

**Contessa.** Collaro Studio deck. F.R.  $7\frac{1}{2}$  i/s, 30-10,000 c/s  $\pm 3$  dB. 3 motors. 7-in. spools. M.E. level ind. W and F 0.15%. H and N - 45 dB. Monitoring. Superimposition. Size  $15\frac{1}{2} \times 15 \times 8$  ins. Weight 25 lbs. Price £44 2s. Four-track version available.

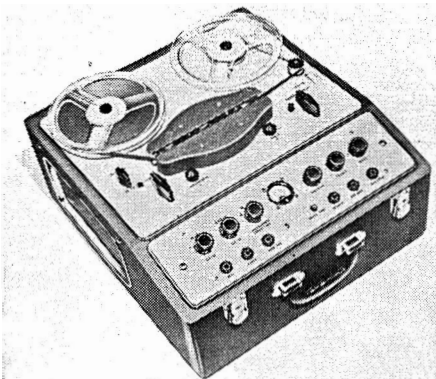

*Brenell MK5 Type M*



*Allegro Contessa*

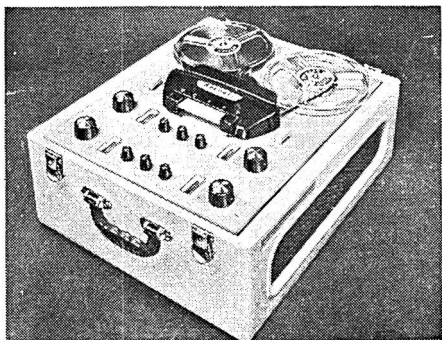

*Brenell Three Star stereo*

**Brenell Engineering Co. Ltd.**, 1a Doughty Street, London, W.C.1. Tel.: Holborn 7358.

**Three Star.**  $7\frac{1}{2}$ ,  $3\frac{3}{4}$  and  $1\frac{7}{8}$  i/s. 1 motor. 7-in. spools. F.R.  $7\frac{1}{2}$  i/s, 60-10,000 c/s  $\pm 3$  dB;  $3\frac{3}{4}$  i/s, 60-6,000 c/s  $\pm 3$  dB;  $1\frac{7}{8}$  i/s, 60-3,000 c/s  $\pm 3$  dB. S-N,  $< -40$  dB. W and F  $< 0.2\%$  at  $7\frac{1}{2}$  i/s. M.E. level ind. Outlet from pre-amp. stage. Straight through amplifier. Adaptable for Stereo. Headphone monitoring. Size  $15 \times 15 \times 7$  in. Weight 30 lbs. Price, with tape and mic., £60 18s. (Quarter track model available at same price.)

■ **Three Star Stereo.** Stereo recorder,  $7\frac{1}{2}$ ,  $3\frac{3}{4}$  and  $1\frac{7}{8}$  i/s. 7-in. spools. Level ind. in each channel. Twin built-in loudspeakers. Bass and treble controls. Straight through amp. Performance details as Three Star. Weight 40 lbs. Price £93 9s. or £99 15s. with two microphones. Quarter-track replay head may be fitted. Price £12.

**Mk. 5.** 15,  $7\frac{1}{2}$ ,  $3\frac{3}{4}$  and  $1\frac{7}{8}$  i/s. 3 motors.  $8\frac{1}{2}$ -in spools. F.R. 15 i/s, 50-16,000 c/s;  $7\frac{1}{2}$  i/s, 60-12,000 c/s;  $3\frac{3}{4}$  i/s, 60-7,000 c/s;

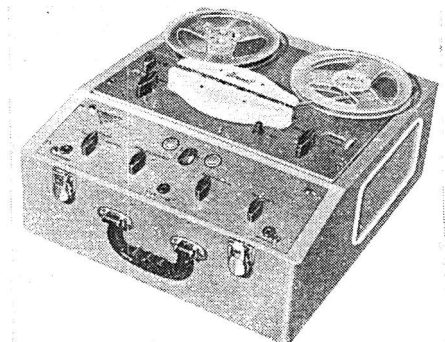

*Brenell MK5*

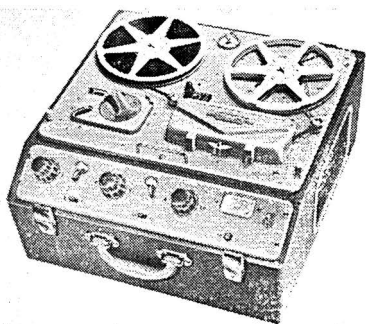

*Ferrograph Series 420*

$1\frac{7}{8}$  i/s, 60-4,000 c/s. All  $\pm 3$  dB M.E. level ind. (Meter available.) H and N  $-45$  dB. W and F 0.05% at 15 i/s. Hi-fi outlet at 200 mV. Straight through amp. Switched frequency correction. Pause control and monitoring. Size  $18 \times 18 \times 8$  in. Weight 43 lbs. Price £67 4s., with meter £72 9s.

**Mk 5. Type M.15.** Speeds  $7\frac{1}{2}$ ,  $3\frac{3}{4}$ ,  $1\frac{7}{8}$  i/s. Three motors.  $8\frac{1}{2}$ -in. spools. F.R. 15 i/s, 40-20,000 c/s;  $7\frac{1}{2}$  i/s, 40-18,000 c/s;  $3\frac{3}{4}$  i/s 40-13,000 c/s;  $1\frac{7}{8}$  i/s, 40-7,000 c/s. Level meter. H and N  $-45$  dB. W and F  $1\frac{7}{8}$  i/s,  $< 0.25\%$ ;  $3\frac{3}{4}$  i/s,  $< 0.15\%$ ;  $7\frac{1}{2}$  i/s,  $< 0.1\%$ . Outlet from pre-amp. Mixing. Superimposing. Tape monitoring. Input monitoring. Size  $18 \times 17 \times 9$  ins. Weight 40 lbs. Price 92 8s.

■ **Mk. 5 Stacked Stereophonic.** Rack mounted. General details as Mk. 5. Records and replays stereo or half-track mono. Alternatively records on one track whilst replaying on other. Price £99 12s.

■ **Brenell Staggered Stereo record and replay.** Mk. 5 deck, 15,  $7\frac{1}{2}$ ,  $3\frac{3}{4}$  and  $1\frac{7}{8}$  i/s.

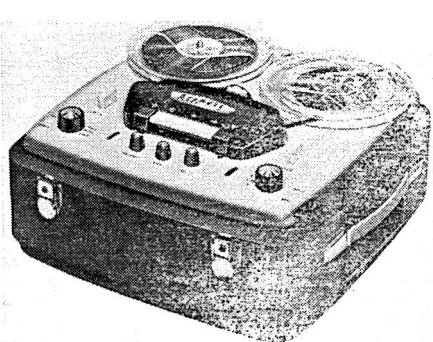

*Brenell Three Star*





*Connaught Console*

Two Mk. 5 amps. F.R. as Mk. 5 portable. Mounted in special rack  $17\frac{1}{2} \times 16\frac{1}{2} \times 11$  ins. Weight 43 lbs. No speakers. Price £93 16s.



**British Ferrograph Recorder Co. Ltd.,** 84 Blackfriars Road, London, S.E.1. Tel.: Waterloo 1981. Cables: Britferro, S.E.

**Ferrograph 4 A/N and 4 A/H.** Complete portable recorder. Any two adjacent speeds from  $3\frac{3}{4}$  to 15 i/s. 3 motors,  $8\frac{1}{4}$ -in. spools. F.R. 15 i/s, 40-15,000 c/s  $\pm 2$  dB;  $7\frac{1}{2}$  i/s 40-14,000 c/s  $\pm 3$  dB, 50-10,000 c/s  $\pm 2$  dB;  $3\frac{3}{4}$  i/s, 50-8,000 c/s  $\pm 3$  dB. Sustained peak signal level meter. Space under the head cover for additional plug-in head for monitoring, lower track working stereo playback or American dual stereo standard. Size  $18\frac{1}{2} \times 17\frac{1}{2} \times 9\frac{3}{4}$  ins.

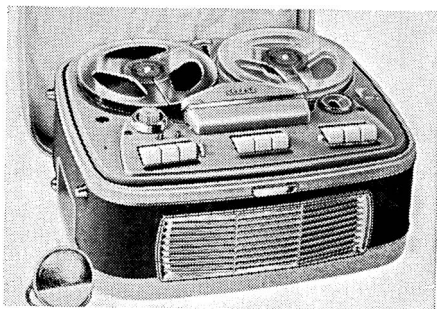

*Cossor CR 1601*

Weight 50 lbs. Prices, 4 A/N ( $7\frac{1}{2}$  and  $3\frac{3}{4}$  i/s) £85 1s.; 4 A/H (15 and  $7\frac{1}{2}$  i/s) £90 6s.

■ **Ferrograph 4 S/N and 4 S/H** as models 4 A/N and 4 A/H, but with stereo replay heads fitted. For the replay of stereo tapes through external amplifiers. Prices, 4 S/N £92 8s., 4 S/H £97 13s.

**Ferrograph 420 series.** See New Products supplement.



**Clarke and Smith Manufacturing Co. Ltd.,** Melbourne Works, Wallington, Surrey. Tel.: Wallington 9252-7. Cables: Electronic, Wallington.

**Model STR/4.** Wright and Weaire deck. F.R.  $7\frac{1}{2}$  i/s, 50-11,000 c/s  $\pm 3$  dB;  $3\frac{3}{4}$  i/s, 50-5,000 c/s  $\pm 3$  dB. S-N - 50 dB. M.E. level ind.  $4\frac{1}{2}$  watts output. Monitoring by headphones. Oak case. Size  $18 \times 14\frac{1}{2} \times 10$  ins. Weight 48 lbs. Price, with tape and mic., £98 13s.



*Cossor CR 1603*

**Connaught (Tape Recorder) Ltd.,** 1 Kings House, 396 Kings Road, London, S.W.3. Tel.: Flaxman 6575/6.

**Console.** Wearite deck. F.R. 30-16,000 c/s  $\pm 2$  dB at  $7\frac{1}{2}$  i/s. Meter. Outlet from pre-amp. stage. 10 watts output. Mounted in a pressure controlled cabinet housing 12-in. drive unit and 2 tweeters. 5 inputs. Price, with tape and moving coil mic., £125.

**Tape-o-gram.** Details as Console plus provision for AM/FM radio and four-speed gram. 15 and 9-in. speakers plus two tweeters. Size  $22 \times 56 \times 45$  ins. Price, with moving coil mic., £210.

**Tape-o-gram Stereo.** Complete stereo system including AM/FM radio, four-speed gram. Price £350.

**Cossor Radio & Television Ltd.**, 233 Tottenham Court Road, London, W.1. Tel.: Gerrard 2931.

**CR1601.** Four track. Speeds  $7\frac{1}{2}$ ,  $3\frac{3}{4}$  and  $1\frac{7}{8}$  i/s. 7-in. spools. F.R.  $7\frac{1}{2}$  i/s, 50-20,000 c/s;  $3\frac{3}{4}$  i/s, 50-15,000 c/s;  $1\frac{7}{8}$  i/s, 50-7,000 c/s. M.E. level ind. S-N better than -40 dB. W and F less than 0.2% at  $7\frac{1}{2}$  i/s. Monitoring, tone and pause controls. Straight amplifier, parallel track feature. Auto tape stop. Stereo outlet socket. Size  $16\frac{1}{2} \times 14\frac{1}{4} \times 7\frac{3}{4}$  ins. Weight 30 lbs. Price with tape and moving coil microphone £61 19s.

**CR1602.** Four track. Speed  $3\frac{3}{4}$  i/s. 7-in. spools. F.R. 50-14,000 c/s. M.E. level ind. S-N -40 dB. W and F < 0.3%. Four track recording/playback. Monitoring, tone and pause controls. Straight amplifier, parallel track feature. Stereo outlet socket. Size  $15\frac{1}{2} \times 12\frac{1}{2} \times 6\frac{3}{8}$  ins. Weight 19 lbs. Price with tape and crystal mic. £38 17s.



*Dynatron Cordova TRP 1*

**CR1603.** Four-track. Speed  $3\frac{3}{4}$  i/s. One motor.  $5\frac{3}{4}$ -in. spools. F.R. 80-13,000 c/s. Level meter. H and N < -36 dB. Diode input/output socket. Price £29 8s.



**Dynatron Radio Ltd.**, St. Peters Road, Furze Platt, Maidenhead, Berks. Tel.: Maidenhead 5150.

**Cordova TRP1.** Speeds  $7\frac{1}{2}$ ,  $3\frac{3}{4}$ ,  $1\frac{7}{8}$  i/s. Three motors. 7-in. spools. F.R.  $\pm 2$  dB.  $7\frac{1}{2}$  i/s, to CCIR; standards  $3\frac{3}{4}$  i/s, 6,000 c/s;  $1\frac{7}{8}$  i/s, 3,000 c/s. M.E. ind. H and N -55 dB on full output. W and F < 0.15% at  $7\frac{1}{2}$  i/s. Outlet from pre-amp. Superimposing. Size  $8\frac{3}{4} \times 16\frac{3}{8} \times 16\frac{3}{8}$  ins. Weight 29 lbs. 8 ozs. Price with mic. £44 2s.



*Sonic V*

**Elizabethan (Tape Recorders) Ltd.**, Bridge Close, Oldchurch Road, Romford, Essex. Tel.: Romford 64101. Cables: Elizabethan, Romford.

**Elizabethan Major.** Collaro Studio deck. F.R.  $7\frac{1}{2}$  i/s, 50-20,000 c/s;  $3\frac{3}{4}$  i/s, 50-14,000 c/s;  $1\frac{7}{8}$  i/s, 50-7,000 c/s, all  $\pm 3$  dB. Level meter. H and N -45 dB. W and F 0.15% at  $3\frac{3}{4}$  i/s. 6 watts push-pull outlet.  $10 \times 6$  in. speaker plus tweeter. Size  $15\frac{1}{2} \times 16\frac{3}{4} \times 9$  ins. Weight 32 lbs. Price, with tape, £68 5s. (4 track version available at same price).

**Elizabethan FT1.** Four track B.S.R. Monardeck. F.R. 50-12,000 c/s. M.E. level ind. Tone control, mixing and superimposing. Size  $15\frac{1}{2} \times 15 \times 7$  ins. Weight 23 lbs. Price £35 14s.

**Elizabethan FT3.** Four track  $7\frac{1}{2}$ ,  $3\frac{3}{4}$  and  $1\frac{7}{8}$  i/s. Collaro deck. Three motors. 7-in. spools. F.R.  $7\frac{1}{2}$ , 50-16,000 c/s. M.E.

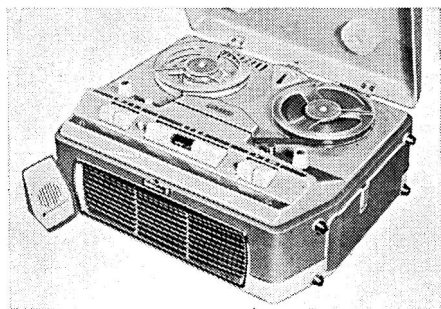

*Cossor CR 1602*



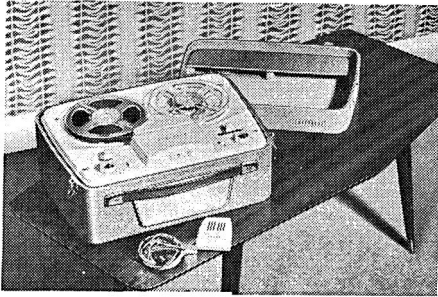

*Ferguson 442 TR*

level ind. Tone control, mixing and superimposing. Stereo recording and playback with additional equipment. Size  $15\frac{1}{2} \times 17\frac{1}{2} \times 7\frac{1}{2}$  ins. Weight 30 lbs. Price £47 5s.

**Elizabethan Popular de Luxe.** B.S.R. Monardeck. Speed  $3\frac{3}{4}$  i/s.  $5\frac{3}{4}$ -in. spools. F.R. 60-10,000 c/s. M.E. level ind. Tone control. Extension speaker socket. Size  $15\frac{1}{4} \times 11\frac{1}{2} \times 6\frac{1}{2}$  ins. Weight  $16\frac{1}{2}$  lbs. Price, with tape and mic. £25 4s. Four-track version £28 7s.

**Elizabethan T.T.3.** Speeds  $7\frac{1}{2}$ ,  $3\frac{3}{4}$  and  $1\frac{7}{8}$  i/s. 7-in. spool. F.R.  $7\frac{1}{2}$  i/s 60-12,000 c/s. M.E. level ind. H and N  $< -40$  dB. W and F not greater than 0.15% at  $7\frac{1}{2}$  i/s. Separate bass and treble controls. Mixing and superimposing. Speaker monitoring. Size  $17\frac{1}{2} \times 15\frac{1}{2} \times 7$  ins. Weight 30 lbs. Price, with tape and mic., £40 19s.



**Elstone Electronics Ltd.,** Edward Street, Templar Street, Leeds, 2. Tel.: Leeds 35111.

**Tandberg 3B.** Speeds  $7\frac{1}{2}$ ,  $3\frac{3}{4}$  and  $1\frac{7}{8}$  i/s. One motor. 7-in. spool. F.R.  $\pm 2$  dB.  $7\frac{1}{2}$  i/s 40-16,000 c/s;  $3\frac{3}{4}$  50-9,000 c/s,  $1\frac{7}{8}$  70-

4,000 c/s. M.E. level ind. H and N  $- 55$  dB. W and F 0.15% at  $7\frac{1}{2}$  i/s. Low impedance outlet. Size  $15 \times 11\frac{5}{8} \times 6\frac{5}{8}$  ins. Weight, with case, 27 lbs. Price £79 16s.



**Ferguson Radio Corporation Ltd.,** Thorn House, Upper St. Martin's Lane, London, W.C.2. Tel.: Temple Bar 2444. Cables: Eleclampo, Lesquare, London.

**441TR.** B.S.R. Monardeck. F.R. 40-10,000 c/s  $\pm 5$  dB. M.E. level ind. H and N  $- 45$  dB. W and F better than 0.2%. Outlet from pre-amp. Size  $14\frac{3}{4} \times 12\frac{1}{4} \times 6\frac{1}{4}$  ins. Weight  $15\frac{1}{2}$  lbs. Price £29 8s.



*Ferguson 441 TR*

**442TR.** Four-track. Speed  $3\frac{3}{4}$  i/s. One motor.  $5\frac{3}{4}$ -in. spool. F.R. 80-10,000 c/s  $\pm 3.5$  dB. M.E. level ind. H and N  $- 45$  dB. W and F  $< 0.4\%$ . Outlet from pre-amp. Superimposing. Straight through amplifier. Size  $14\frac{3}{4} \times 12\frac{1}{4} \times 7$  ins. Weight 17 lbs. Price £31 10s.

**445TR & 5200.** Twin track. Other details as for 442TR. Size  $14\frac{1}{2} \times 13\frac{1}{2} \times 6\frac{1}{2}$  ins. Weight 18 lbs. 4 ozs. Price £25 4s.

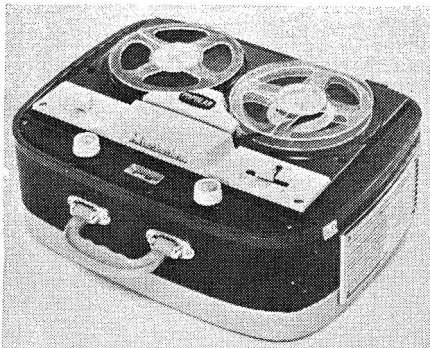

*Elizabethan Popular*

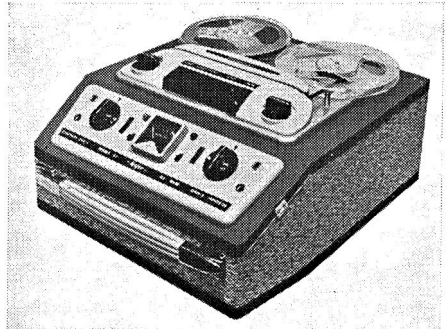

*Elizabethan Major*

**Fidelity Radio Ltd.**, 11/13 Blechynden Street, London, W.11. Tel.: Park 4239/1321.

**Argyll.** B.S.R. Monardeck. F.R. 60-10,000 c/s. H and N - 50 dB. W and F 0.4%. M.E. level ind. Two inputs, mixing, superimposing and monitoring. Size  $17 \times 13\frac{1}{2} \times 7\frac{1}{4}$  ins. Weight 21 lbs. Price, with tape and mic., £30 9s.

**Argyll Minor.** Speed  $3\frac{3}{4}$  i/s. One motor.  $5\frac{3}{4}$ -in. spool. F.R. 60-8,000 c/s. M.E. level ind. H and N - 50 dB down. W and F 0.4%. Size  $14\frac{3}{4} \times 11\frac{1}{2} \times 5\frac{5}{8}$  ins. Weight 16 lbs. Price £23 2s.

**Argyll Major.** Twin track. Speed  $3\frac{3}{4}$  i/s. One motor.  $5\frac{3}{4}$ -in. spool. F.R. 60-10,000 c/s. M.E. level ind. H and N - 50 dB down. W and F 0.4%. Size  $15\frac{1}{2} \times 14\frac{3}{4} \times 7\frac{5}{8}$  ins. Weight 20 lbs. 8 ozs. Price £29 8s.

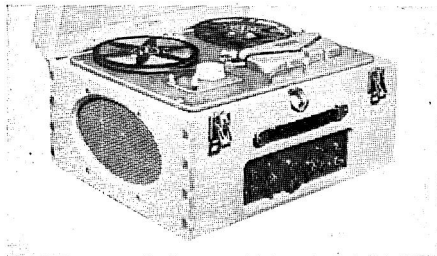

Clarke and Smith STR/4

**Argyll Major 4.** Four track version of Argyll Major, with outlet direct from replay head and socket for stereo adaptor. Price £30 19s. 6d.



**General Sonic Radios**, 92 Caledonian Road, London, N.1. Tel.: Terminus 0322.

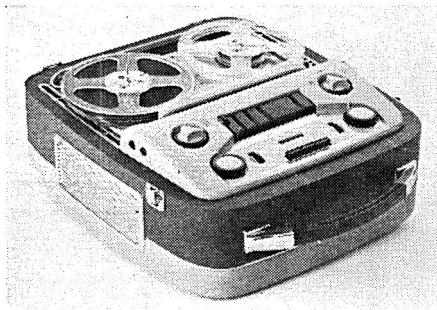

Elizabethan FT3



Tandberg 3B

**Sonic V.** Collaro deck. 3 speeds. 7-in. spools. F.R.  $7\frac{1}{2}$  i/s. 40-12,000 c/s  $\pm$  3 dB. M.E. level ind. W and F 0.15% S-N - 45 dB. Tone controls, superimposition, pause key. Outlet from pre-amp. Two loudspeakers fitted. Output 5.3 watts. Size  $16 \times 16 \times 9\frac{1}{4}$ . Weight 33 lbs. Price £49 7s., two track. £52 10s., four track.



**The Goshco Ltd.**, Stone House, Bishopsgate, London, E.C.2. Tel.: Bishopsgate 5901/5. Cables: Goshco, London.

**Nishikura Model F.** Combination tape recorder and record player. Speeds  $7\frac{1}{2}$  and  $3\frac{3}{4}$  i/s (continuously adjustable  $2\frac{3}{4}$ - $7\frac{1}{2}$  i/s). One motor. 7-in. spools. F.R.:  $7\frac{1}{2}$  i/s 50-13,000 c/s;  $3\frac{3}{4}$  i/s 50-8,000 c/s;  $2\frac{3}{4}$  i/s 50-6,000 c/s. M.E. level ind. W and F  $< 0.2\%$  at  $7\frac{1}{2}$  i/s. Outlet from replay head. Outlet from pre-amp. Built-in MW/SW radio. Plug-in three-speed gram unit. May be used as telephone/P.A. amplifier. Size  $18 \times 13 \times 7$  ins. Price to be announced.

■ **Nicoder 750.** Four-track stereo. Combination tape recorder and record player.

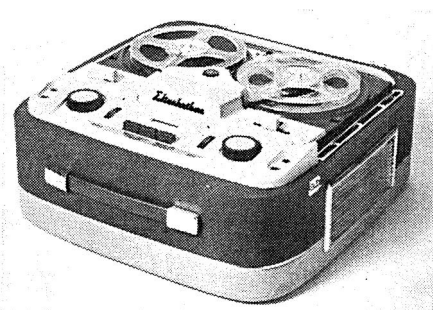

Elizabethan FT1

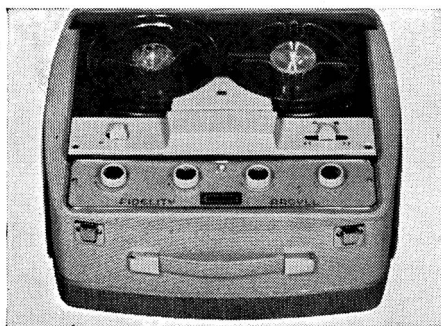

*Fidelity Argyll*

Speeds  $7\frac{1}{2}$  i/s, and  $3\frac{3}{4}$  i/s (continuously variable  $2\frac{3}{4}$ - $7\frac{1}{2}$  i/s). One motor. 7-in. spools. F.R.  $7\frac{1}{2}$  i/s 40-16,000 c/s;  $3\frac{3}{4}$  i/s 50-10,000 c/s. Two V.U. meters. H and N < -45 dB per channel. Crosstalk < -50 dB. W and F 0.2% at  $7\frac{1}{2}$  i/s. Outlet from replay head. Outlet from pre-amp. Plug-in stereo gram unit. Size of unit  $20 \times 17 \times 9$  ins. Weight 48 lbs. Speakers  $15 \times 19\frac{1}{2} \times 12\frac{1}{2}$  ins. Weight 19 lbs. Price to be announced.

**Ricoh Synchrofax Sheet Recorder.** Records and plays back on magnetically coated sheet of paper. Sheet size  $11\frac{3}{4} \times 8\frac{1}{4}$  ins. Maximum recording time 4 minutes. F.R. approx. 100-8,000 c/s. M.E. level indicator. Recordings may be duplicated with printing attachment; the recording can also be erased and the sheet used again. Reverse side of sheet may be used for printed, typed or written notes. Outlet direct from replay head. P.s.n. 100v, 50 or 60 c/s. Size  $15\frac{1}{2} \times 10 \times 6$  ins. Weight 24 lbs. Price £80.

★

**Grundig (Gt. Britain) Ltd.,** Newlands Park, Sydenham, S.E.26. Tel.: Sydenham 2211.

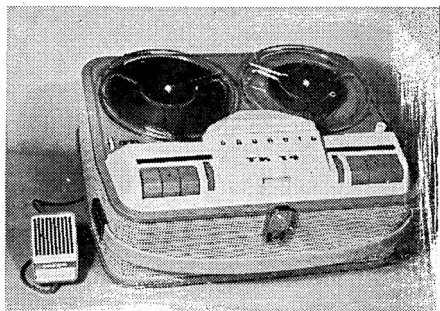

*Grundig TK 14*

**TK14.** Speed  $3\frac{3}{4}$  i/s. One motor.  $5\frac{3}{4}$  in. spools. F.R. 40-12,000 c/s +3 - 5 dB. M.E. level ind. W and F <  $\pm 0.2\%$ . H and N < -50 dB. Size  $14\frac{3}{4} \times 11\frac{1}{2} \times 6\frac{3}{4}$  ins. Weight 20 lbs. Price £36 15s.

**TK40.** 4-track. Speeds  $1\frac{7}{8}$ ,  $3\frac{3}{4}$  and  $7\frac{1}{2}$  i/s. One motor. 7-in. spools with lid off,  $5\frac{3}{4}$ -in. spools with lid on. F.R.  $1\frac{7}{8}$ ; 60 to 10 Kc/s.  $3\frac{3}{4}$ ; 60 to 15 Kc/s.  $7\frac{1}{2}$ ; 60 to 18 Kc/s. S-N < 45 dB. W and F  $\pm 1\%$  at  $7\frac{1}{2}$  i/s. Facilities: Inching, Cine-socket, Built-in tape cleaner, indicator re-set, automatic stop, remote control, mixing facilities, monitoring, synchronous recordings and superimposition. Price £78 15s. (including tape and microphone).

■ **TK60.** Mono/stereo. Speeds  $7\frac{1}{2}$  and  $3\frac{3}{4}$  i/s. One motor. 7-in. spools. F.R.  $7\frac{1}{2}$  i/s, 50-15,000 c/s;  $3\frac{3}{4}$  i/s, 50-10,000 c/s, both  $\pm 3$  dB. M.E. level ind. H and N - 40

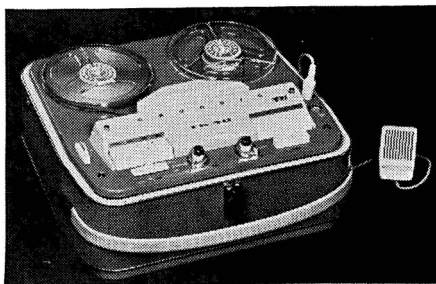

*Grundig TK 40*

dB. W and F less than 0.2% at  $7\frac{1}{2}$  i/s. Outlet from pre-amp. Stereo/mono recording and playback. Detachable loudspeakers. Size  $27 \times 17\frac{1}{2} \times 12$  ins. Weight 54 lbs. Price with tape £134 8s.

★

**Hatfield Radio,** 28 Stroud Green Road, London, N.4. Tel.: Archway 1593.

**Viking.** Motek deck. F.R.  $7\frac{1}{2}$  i/s, 50-11,000 c/s  $\pm 3$  dB. S-N < -45 dB. M.E. level ind. Outlet from pre-amp. stage. Superimposing. Monitoring by headphones from erase head. Size  $16 \times 14\frac{1}{2} \times 8$  ins. Weight 34 lbs. Price, with tape and mic., £48 6s.

*Details of New Products are given in a special supplement at the end of the book.*

**H. E. Kettle Ltd.,** P.O. Box No. 28, Knight-  
rider Street, Maidstone. Tel.: Maid-  
stone 55551. Cables: Kettle Ltd.,  
Maidstone.

**Knightrider.** B.S.R. Monardeck. Speed  
 $3\frac{3}{4}$  i/s. One motor.  $5\frac{1}{2}$ -in. spools. M.E.  
level ind. Size  $13\frac{3}{4} \times 9\frac{1}{2} \times 6$  ins. Weight  
17 lbs. Price £25.



**K.G.M. Electronics Ltd.,** 2/4 Bardolph  
Road, Richmond, Surrey. Tel.: Richmond  
7171. Cables: Kelec, Richmond, Surrey.

**Cinecorder Model A.** Tape recorder  
incorporating tape timing, cueing, sound  
mixing and remote control. B.S.R. tape  
deck. Twin track recording up to  $5\frac{1}{4}$ -in.  
reels. Tape speed  $3\frac{3}{4}$  i/s. Playing time per  
track: standard tape 5-in. reel. 32 mins.;  $5\frac{1}{4}$ -

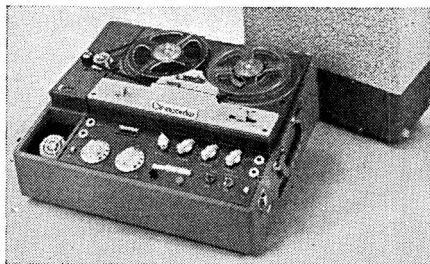

*KGM Cinecorder*

ind. Size  $7\frac{1}{2} \times 16\frac{3}{4} \times 13\frac{1}{4}$  ins. Weight  
22 lbs. Price £28 7s.

**K-B TT40 "Twin Four".** Four track.  
Speed  $3\frac{3}{4}$  i/s. One motor.  $5\frac{1}{2}$ -in. spools.  
F.R. 50-12,000 c/s. M.E. level ind. H and  
N - 40 dB below full output. W and F  
0.2%. Outlet from replay head. Size  
 $13\frac{3}{4} \times 12\frac{1}{4} \times 6\frac{3}{4}$  ins. Weight 20 lbs. 8 ozs.  
Price £40 19s. 6d.



**Lee Products (G.B.) Ltd.,** Elpico House,  
Longford Street, London, N.W.1. Tel.:  
Euston 5754. Cables: Leprod, London,  
N.W.1.

**Elpico TR/702.** B.S.R. Monardeck.  $3\frac{3}{4}$   
i/s. One motor.  $5\frac{1}{2}$ -in. spools. F.R.  
80-8,000 c/s. H and N - 40 dB. W and F  
< 0.25%. M.E. level ind. Outlet from  
pre-amp. stage. Size  $15 \times 12\frac{1}{2} \times 6$  ins.  
Weight 18 lbs. Price £24 13s. 6d.

**Elpico TR/704.** B.S.R. Monardeck.  
Four track.  $3\frac{3}{4}$  i/s. One motor.  $5\frac{1}{2}$ -in.  
spools. F.R. 80-8,000 c/s. H and N - 40  
dB. W and F < 0.25%. M.E. level ind.  
Outlet from pre-amp. stage.  $15 \times 12\frac{1}{2} \times 6$ .  
Weight 18 lbs. Price £30 9s.

**Elpico/Geloso G.256.** Speed  $1\frac{1}{8}$  i/s.  
One motor.  $3\frac{1}{4}$ -in. spools. F.R. 80-6,000  
c/s. DM70 level ind. H and N - 40

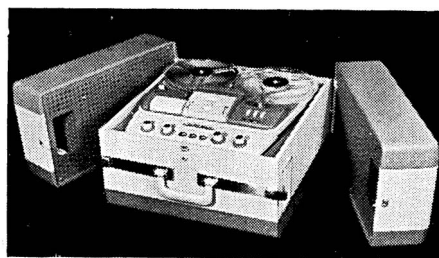

*Grundig TK60 stereo*

in. reel, 45 mins. Amplifier output 4 watts  
15 ohm imp. 10 in elliptical high flux  
speaker housed in detachable lid with 24 ft.  
cable. Frequency response: amplifier 30-  
14,000 c/s. Tape overall 60-10,000 c/s  $\pm$  3  
dB CCIR type recording. Separate bass  
and treble tone controls. Boost and cut.  
Signal/noise ratio 100/1 or better. Wow and  
flutter less than 0.4% peak r.m.s. Bias  
control for superimposition. Two-channel  
mixing with two input sockets for each  
channel. Separate capstan tape time indic.  
reading in seconds. "Shiftrack" tape con-  
trol for dual recordings. Tape lift control  
for cueing and cross-fading. Remote control  
for instantaneous start and stop. Size  
 $16\frac{1}{2} \times 14 \times 8\frac{1}{2}$  ins. Weight 28 lbs. Price  
£59 17s. Accessories: Microphones and  
extension cables.



**Kolster-Brandes Ltd.,** Footscray, Sidcup,  
Kent. Tel.: Footscray 3333. Cables:  
Matchtone; Sidcup.

**RT 20/1.** B.S.R. Monardeck. Speed  $3\frac{3}{4}$   
i/s. One motor.  $5\frac{1}{2}$ -in. spools. M.E. level

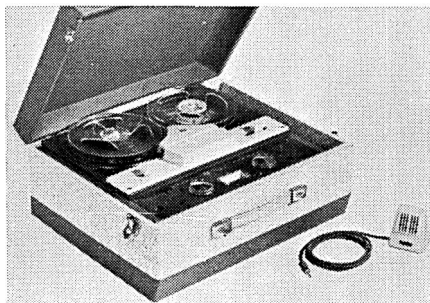

*Kolster-Brandes RT 20/1*



*Kolster-Brandes TT40*

dB. W and F 0.3%. Size  $10 \times 5\frac{1}{2} \times 4$  ins. Weight  $6\frac{1}{2}$  lbs. Price £27 16s. 6d.

**Elpico/Geloso G.257.** Speed  $1\frac{1}{8}$  i/s. One motor. 3 $\frac{1}{2}$ -in. spools. F.R. 80-6,000 c/s. H and N < -40 dB. M.E. level ind. Size  $10\frac{1}{4} \times 6\frac{1}{2} \times 4$  ins. Weight 6 lbs. 14 ozs. Price £25 4s.

**Elpico/Geloso G.258.** 3 $\frac{3}{4}$ ,  $1\frac{7}{8}$  and  $\frac{1}{8}$  i/s. One motor. 5-in. spools. F.R. 50-12,000 c/s. H and N - 40 dB. W and F < 0.2%. M.E. level ind. Size  $13 \times 8\frac{3}{4} \times 6\frac{1}{4}$  ins. Weight  $12\frac{3}{4}$  lbs. Price £44 2s.



**Magnavox Ltd.,** Magnavox House, Alfreds Way, Barking, Essex. Tel.: Rippleway 5533.

**Magnavox Magitape.** Collaro deck. 3 speeds. 7-in. spools. M.E. level ind. W and F 0.15%. Tone controls. Superimposition. Outlet from pre-amp. 4 watts output. Size  $17 \times 17\frac{3}{4} \times 11\frac{1}{4}$  ins. Price £40 19s.

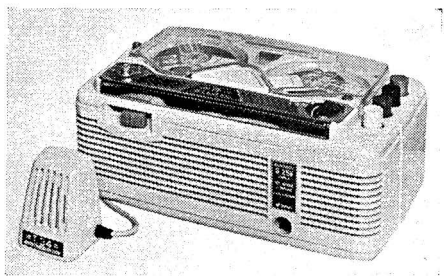

*Elpico Geloso G256*



*Philips EL3542*

**Murphy Radio Ltd.,** Welwyn Garden City, Herts. Tel.: Welwyn Garden 3434.

**TR1.** Garrard magazine loading deck. M.E. level ind. Two inputs, outlet from pre-amp. Size  $12\frac{3}{4} \times 10\frac{1}{4} \times 7\frac{1}{8}$  ins. Weight 21 lbs. Price £29 18s. 6d.



**Parman Electronics Ltd.,** Parman House, Balcombe Road, Horley, Surrey. Tel.: Horley 4344. Cables: Parmanair, Horley.

**Parman "Sixteen" De Luxe High Fidelity Consul Tape Recorder.** Mono and Stereo. Prices to be announced



**Philco (Gt. Britain) Ltd.,** 21 Cavendish Place, London, W.1. Langham 9291.

**Philco 5200.** Speed  $3\frac{3}{4}$  i/s. One motor. 5 $\frac{1}{2}$ -in. spools. F.R. 50-10,000 c/s + 3 - 5 dB. M.E. level ind. H and N - 45 dB. W and F < 0.4%. Outlet from pre-amp. Superimposing. Size  $13\frac{3}{4} \times 11\frac{1}{4} \times 6\frac{1}{4}$  ins. Weight 17 lbs. 8 ozs. Price £26 5s.

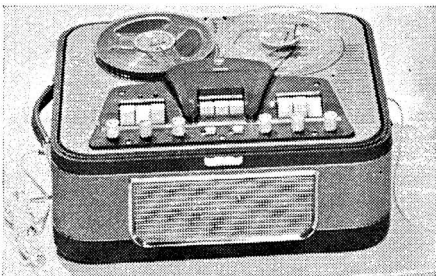

*Philips EL3536*



*Magnavox Magitape*

**Philips Electrical Ltd.,** Century House, Shaftesbury Avenue, London, W.C.2. Tel.: Gerrard 7777. Cables: Phillamps, London,

**EL3514.** Four track. Speed  $3\frac{3}{4}$  i/s. One motor. 5-in. spools. F.R. 80-10,000 c/s  $\pm 3$  dB. M.E. level ind. H and N - 40 dB. Size  $9\frac{3}{4} \times 13\frac{1}{2} \times 4\frac{3}{4}$  ins. Price £28 7s.

**EL3541.** Four track recorder.  $3\frac{3}{4}$  i/s. F.R. 60-13,000 c/s  $\pm 3$  dB. H and N - 40 dB. W and F < 0.3%. M.E. level ind. Parallel track feature, monitoring, straight amp stereo outlet socket. Size  $14\frac{1}{4} \times 12 \times 6\frac{3}{4}$  ins. Weight 18 lbs. Price £35 14s.

**EL3542.** Four track. Speeds  $7\frac{1}{2}$ ,  $3\frac{3}{4}$  and  $1\frac{7}{8}$  i/s. F.R.  $7\frac{1}{2}$ , 50-20,000 c/s;  $3\frac{3}{4}$ , 50-15,000 c/s;  $1\frac{7}{8}$ , 50-7,000 c/s. 7-in. spools. M.E. level ind. Four track mono. record/playback. Parallel track feature; monitoring, straight amp stereo outlet socket. Size  $17\frac{3}{4} \times 13\frac{1}{2} \times 7\frac{3}{8}$  ins. Weight 30 lbs. Price £61 19s.

■ **EL3536.** Stereo recorder. Speeds  $7\frac{1}{2}$ ,  $3\frac{3}{4}$  and  $1\frac{7}{8}$  i/s. F.R.:  $7\frac{1}{2}$ , 50-20,000 c/s;  $3\frac{3}{4}$ , 50-15,000 c/s;  $1\frac{7}{8}$ , 50-7,000 c/s. 7-in.

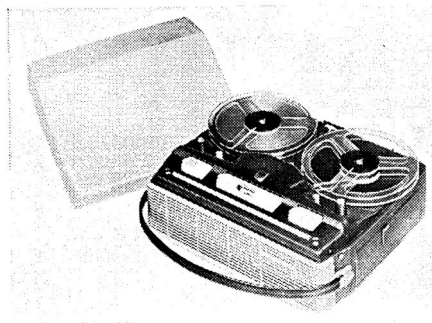

*Philips EL3541*



*Murphy TR1*

spools. M.E. level ind. Four track stereo/mono. recording and playback. Size  $20 \times 16\frac{3}{4} \times 11\frac{1}{2}$  ins. Weight 43 lbs. Price £96 12s.



**Portogram Radio Electrical Industries Ltd.,** Audio Works, Paxton Road, Tottenham, London, N.17. Tel.: Tottenham 7683/4/5.

**Minitape.** Speed  $3\frac{3}{4}$  i/s. One motor.  $5\frac{3}{4}$ -in. spools. F.R. 50-9,000 c/s. M.E. level ind. H and N - 50 dB. W and F 0.2%. 3 watts output. Size  $14\frac{1}{2} \times 12\frac{1}{2} \times 6\frac{3}{4}$  ins. Weight 18 lbs. Price with tape and mic. £24 3s.

**Monotape.** B.S.R. Monardeck. F.R. 30-7,000 c/s  $\pm 3$  dB. M.E. level ind. H and N - 60 dB. W and F < 0.2%. Tone, control and outlet from pre-amp. Size  $14 \times 12\frac{1}{4} \times 8$  ins. Weight 19 lbs. Price, with tape and mic., £30 9s.

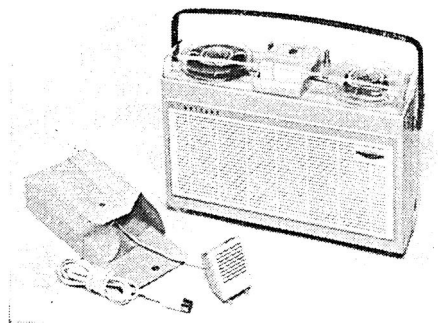

*Philips EL3541*





*Stuzzi Junior 4 M*

**Portotape.** Collaro Studio deck. F.R.  $7\frac{1}{2}$  i/s, 60-10,000 c/s;  $3\frac{3}{4}$  i/s, 60-7,000 c/s;  $1\frac{7}{8}$  i/s, 60-5,000 c/s, all  $\pm 3$  dB. M.E. level ind. H and N - 60 dB. W and F 0.15%. Tone control, and outlet from pre-amp. Size  $17\frac{1}{2} \times 16 \times 9\frac{3}{4}$  ins. Weight 36 lbs. Price, with tape and mic., £40 19s.

**Audiotape.** Speeds  $7\frac{1}{2}$ ,  $3\frac{3}{4}$  and  $1\frac{7}{8}$  i/s. Three motors. 7-in. spools. F.R.  $\pm 3$  dB  $7\frac{1}{2}$  i/s 40-12,000 c/s;  $3\frac{3}{4}$  i/s 40-9,000 c/s;  $1\frac{7}{8}$  i/s 40-7,000 c/s. H and N - 60 dB. W and F 0.15%. Outlet from pre-amp. Mixing. Superimposing. Straight through amplifier. 3 watts output. Size  $18\frac{1}{2} \times 16\frac{1}{4} \times 9\frac{3}{4}$  ins. Weight 38 lbs. Price with tape and mic. £47 5s.



**Recording Devices Ltd.**, 44 Southern Row, Kensington, London, W.10. Tel.: Lad-broke 4775.



*Portogram Audiotape*



*Robuk RK3*

**Stuzzi Tricorder.** Speeds  $3\frac{3}{4}$ ,  $1\frac{7}{8}$  and  $\frac{1}{2}$  i/s. One motor.  $5\frac{3}{4}$ -in. spools. F.R.  $3\frac{3}{4}$  i/s, 40-16,000 c/s;  $1\frac{7}{8}$  i/s, 40-8,000 c/s;  $\frac{1}{2}$  i/s, 40-4,000 c/s. M.E. level ind. H and N - 45 dB. W and F 0.25%. Mixing. Variable Superimposing, Monitoring and remote control. Size  $13 \times 10 \times 6$  ins. Weight 18 lbs. Price £66 3s.

**Stuzzi Junior 4M.** Four track. B.S.R. Monardeck.  $3\frac{3}{4}$  i/s. One motor.  $5\frac{3}{4}$ -in. spools. F.R. 90-9,000. M.E. level ind. H and N  $< -30$  dB. W and F 0.25%. Superimposing. Size  $13\frac{3}{4} \times 14\frac{3}{4} \times 6\frac{3}{8}$  ins. Weight 18 lbs. Price £27 6s.

**Stuzzi 201 de Luxe.** Speeds  $7\frac{1}{2}$  and  $3\frac{3}{4}$  i/s. One Papst motor. 7-in. spools. F.R.  $7\frac{1}{2}$  i/s 40-20,000 c/s;  $3\frac{3}{4}$  i/s 60-15,000 c/s. M.E. level ind. H and N - 50 dB approx. W and F  $3\frac{3}{4}$  i/s 0.15%. Outlet from pre-amp. Price £47 5s. approx.



**Reps. (Tape Recorders) Ltd.**, 118 Park Road North, South Acton, London, W.3. Tel.: Acorn 4141.



*Portogram Monotape*

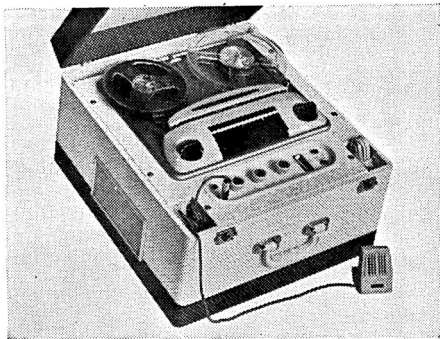

*Portogram Portotape*

**R.10.** Collaro Studio deck.  $7\frac{1}{2}$ ,  $3\frac{3}{4}$  and  $1\frac{7}{8}$  i/s. F.R.  $7\frac{1}{2}$ , 40-16,000 c/s  $\pm 3$  dB;  $3\frac{3}{4}$ , 40-10,000 c/s;  $1\frac{7}{8}$  50-6,000 c/s. Level meter. S-N - 50 dB. W and F 0.1%. Size  $15\frac{1}{2} \times 15 \times 9$  ins. Weight 31 lbs. Price, with tape, crystal mic. and stand, £61 19s. two track, £72 9s. four track.



**Robuk Electrical Industries Ltd.**, 559/561 Holloway Road, London, N.19. Tel.: Archway 1022.

**Robuk RK3.**  $7\frac{1}{2}$ ,  $3\frac{3}{4}$  and  $1\frac{7}{8}$  i/s. Three motors. 7-in. spools. F.R.  $7\frac{1}{2}$ , 60-14,000 c/s  $\pm 3$  dB;  $3\frac{3}{4}$ , 60-7,000 c/s  $\pm 3$  dB;  $1\frac{7}{8}$ , 60-3,500 c/s. M.E. level ind. H and N  $< -40$  dB. W and F  $< 0.2\%$ . Outlet from pre-amp. stage. Size  $16 \times 11\frac{1}{2} \times 7\frac{1}{2}$  ins. Price £37 16s.



**Simon Equipment Ltd.**, 48 George Street, London, W.1. Tel.: Welbeck 2371. Cables: Simsale, London.

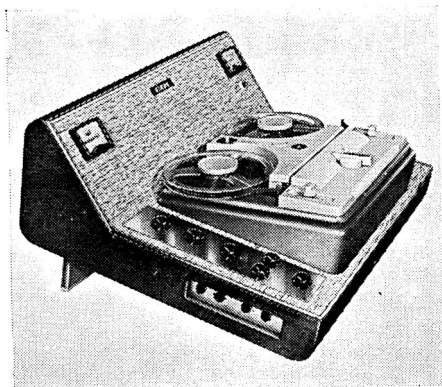

*Simon SP/5*

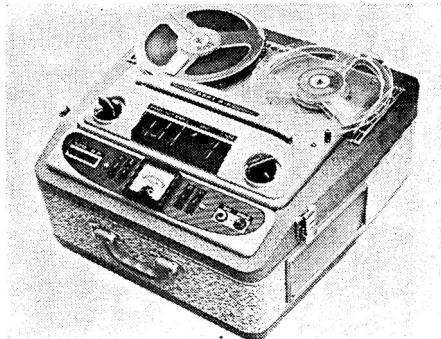

*Reps R10*

**SP/5.** Speeds  $7\frac{1}{2}$  and  $3\frac{3}{4}$  i/s. Three motors. 7-in. spools. F.R.  $\pm 3$  dB.  $7\frac{1}{2}$  i/s 30-20,000 c/s;  $3\frac{3}{4}$  i/s 30-10,000 c/s. Level meter. H and N  $< -50$  dB weighted against frequencies below 50 c/s. W and F  $7\frac{1}{2}$  i/s  $< 0.15\%$ ;  $3\frac{3}{4}$  i/s  $< 0.2\%$ . Monaural, can be converted to stereo. Re-record from one track to another. Monitoring of recorded signal. Outlet from pre-amp. Size  $22\frac{1}{2} \times 20 \times 9\frac{1}{4}$  ins. Weight 45 lbs. Price, monaural £97 13s.; stereo £111 6s.

**Minstrelle 4.** Table portable model. 4 Track. Garrard magazine loading deck. 4-in. spools or magazines. M.E. level ind. Mixing, straight through amplifier. 3 watts push/pull. Built-in mic. Size  $18\frac{1}{4} \times 11\frac{1}{2} \times 8$  ins. Weight  $27\frac{1}{2}$  lbs. Price £43 1s.

■ **Minstrelle 4S.** Stereo record and playback version of Minstrelle 4. Price £66 3s.

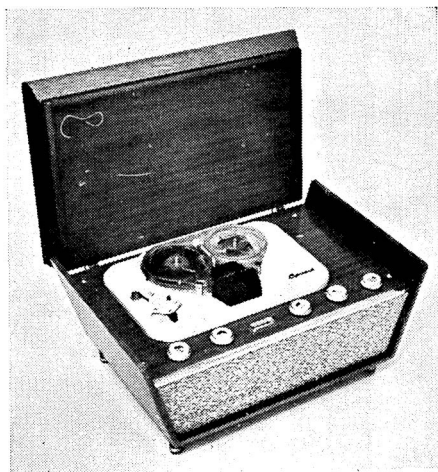

*Simon Minstrelle 4*



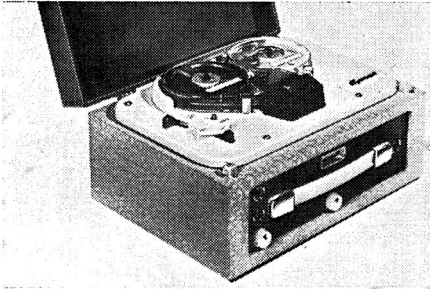

*Simon Cymbal*

**Cymbal.** Garrard magazine loading deck. 4-in. spools or magazines. M.E. level ind. Straight through amplifier. 3 watts output. Size  $13 \times 9\frac{1}{2} \times 6\frac{1}{2}$  ins. Weight 22 lbs. Price with crystal microphone and tape, £25 4s.



**Stella Radio & Television Co. Ltd.,** Astra House, 121/3 Shaftesbury Avenue, London, W.C.2. Tel.: Gerrard 7086.

**ST454.** 4 track.  $3\frac{3}{4}$  i/s 7-in. spools. F.R. 50-14,000 c/s. S-N - 40 dB. W and F < 0.3%. M.E. level ind. Monitoring. Straight amplifier, parallel track feature. Stereo outlet socket. Size  $15\frac{1}{4} \times 12\frac{1}{2} \times 6\frac{1}{4}$  ins. Weight 19 lbs. Price £38 17s.

**ST455.** 4 track recorder. Speeds:  $7\frac{1}{2}$ ,  $3\frac{3}{4}$  and  $1\frac{7}{8}$  i/s. F.R.:  $7\frac{1}{2}$ , 50-20,000 c/s;  $3\frac{3}{4}$ , 50-15,000 c/s;  $1\frac{7}{8}$  50-7,000 c/s. 7-in. spools. M.E. level ind. Mixing, Monitoring. Straight amplifier, parallel track feature. Auto tape stop. Stereo outlet socket. 4 track mono. record/playback S-N - 40 dB W and F < 0.3%. Size  $16\frac{1}{2} \times 14\frac{1}{4} \times 7\frac{3}{4}$  ins. Weight 30 lbs. Price £61 19s.

**ST456.** Mains operated all transistor amplifier. 4 track  $3\frac{3}{4}$  i/s F.R. 80-13,000.  $5\frac{1}{4}$ -in. spools. Meter level ind. Radio

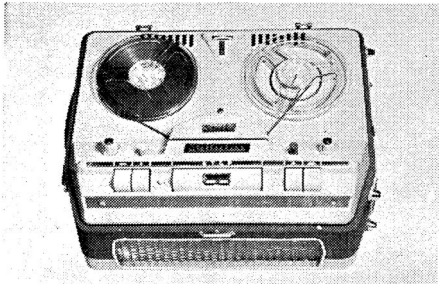

*Stella ST454*

input/output socket. Size  $12 \times 10\frac{1}{2} \times 6$  ins. Weight 11 lbs. Price including m/c mic., tape, spool and connecting lead £29 8s.



**Stereosound Productions Ltd.,** 12-14 Wakefield Road, Brighouse, Yorkshire. Tel.: Brighouse 1755.

**Carousel Junior Radiotape.** Speed  $3\frac{3}{4}$  i/s. One motor.  $5\frac{1}{4}$ -in. spools. 60-9,000 c/s  $\pm 3$  dB. M.E. level ind. H and N - 38 dB. W and F  $\pm 0.25\%$ . Size  $23 \times 20 \times 10\frac{1}{2}$  ins. Weight 27 lbs. 8 ozs. Price £30 9s. AM radio tuner (optional) £8 18s. 6d.



**Symphony Amplifiers Ltd.,** 16 Kings College Road, London, N.W.3. Tel.: Primrose 3314.

**Symphony.** Truvox Mk. VI deck with Truvox type K amplifier.  $7\frac{1}{2}$  and  $3\frac{3}{4}$  i/s

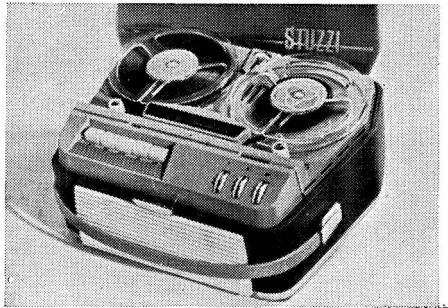

*Stuzzi Tricorder*

F.R. to C.C.I.R. spec.  $\pm 3$  dB. S-N - 45 dB at 4 watts. W and F < 0.2%. M.E. level ind. Output from pre-amp. stage. Available in either portable or table cabinet. Price £54 12s.

**Symphony.** Automatic tape recorder incorporating Telefunken deck and amplifier. Monaural 2- and 4-track or stereo. Price, 2-track, £72 19s.; 4-track, £82 19s.; Stereo, £103 19s.



**Tape Recorders (Electronics) Ltd.,** 784-788 High Road, Tottenham, London, N.17. Tel.: Tottenham 0811-3. Cables: Taperec, London.

**Sound Master.** Collaro deck. Four track.  $7\frac{1}{2}$ ,  $3\frac{3}{4}$  and  $1\frac{7}{8}$  i/s. F.R. 40-15,000 c/s  $\pm 3$  dB at  $7\frac{1}{2}$  i/s. Level meter. H and

N - 45 dB. W and F < - 0.15%. Outlet from pre-amp stage 10 watts output. Mixing, monitoring, superimposing. Size  $20\frac{1}{2} \times 17\frac{1}{2} \times 40\frac{1}{2}$  ins. Weight 105 lbs. Price £110 5s.

**Sound Riviera.** Speed  $3\frac{3}{4}$  i/s. One motor.  $5\frac{3}{4}$ -in. spools. F.R. 80-10,000 c/s  $\pm 3$  dB. H and N - 40 dB. W and F < 0.2%. Outlet from pre-amp. Headphone monitoring. Size  $13\frac{1}{2} \times 11\frac{1}{2} \times 6\frac{1}{2}$  ins. Weight 15 lbs. Price £23 2s.

**Sound Slimline One-Two.** Speed  $3\frac{3}{4}$  i/s. One motor.  $5\frac{3}{4}$ -in. spools. F.R. 80-12,000 c/s  $\pm 3$  dB. M.E. level ind. H and N 40 dB. W and F < 0.2%. Outlet from pre-amp. Monitoring. Mixing. Superimposing. Straight through amplifier. Size  $13\frac{1}{2} \times 13\frac{1}{2} \times 5\frac{3}{4}$  in. Weight 19 lbs. Price £33 12s.

**Sound Slimline One-Four.** Four-track version of Sound Slimline One-Two. Price £38 17s.

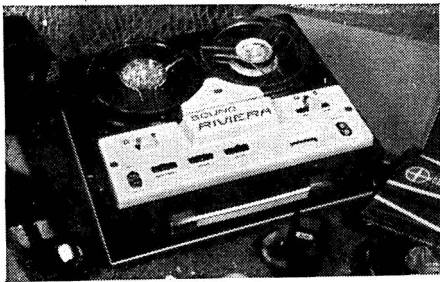

*Sound Riviera*

**Sound Slimline Three-Two.** Speeds  $7\frac{1}{2}$ ,  $3\frac{3}{4}$  and  $1\frac{7}{8}$  i/s. Two motors. 7-in. spools. F.R. at  $7\frac{1}{2}$  i/s  $\pm 3$  dB. Amp. 10-18,000 c/s; Record/replay 80-13,000 c/s. M.E. level ind. H and N - 40 dB. W and F < 0.2%. Outlet from pre-amp. Superimposing. Mixing. Monitoring. Straight through amplifier. Size  $13\frac{1}{2} \times 13\frac{1}{2} \times 6$  ins. Weight 22 lbs. Price £42.

**Sound Slimline Three-Four.** Four-track version of Sound Slimline Three-Two. Price £47 5s.

★

**Technical Suppliers Ltd.,** Hudson House, 63 Goldhawk Road, London, W.12. Tel.: Shepherds Bush 2581 and 4794. Cables: Teknika, London.

**Körting MK128.** Four track  $3\frac{3}{4}$  i/s. One motor. 7-in. spools. F.R. 30-16,000 c/s  $\pm 2$  dB. H and N - 55 dB. W and F 0.08%. M.E. level ind. Stereo/mono

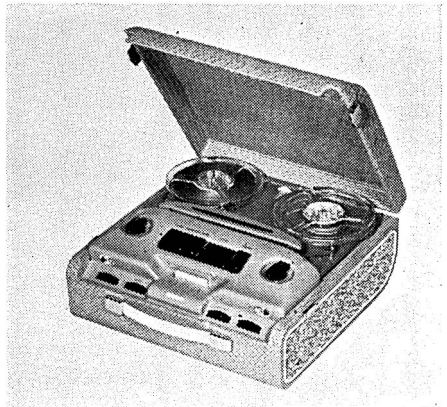

*Sound Slimline Three-Two*

record and playback. Two speakers. Outlet from pre-amp. Size  $12\frac{3}{4} \times 17\frac{1}{2} \times 7\frac{1}{2}$  ins. Weight  $32\frac{1}{2}$  lbs. Price £71 8s.

■ **Körting MT.157.** Four-track. Stereo. Speeds  $7\frac{1}{2}$  and  $3\frac{3}{4}$  i/s. One motor. 7-in. spools. F.R.  $7\frac{1}{2}$  i/s 30-20,000 c/s;  $3\frac{3}{4}$  i/s 40-15,000 c/s. M.E. level ind. W and F < 0.2% at  $7\frac{1}{2}$  i/s. Outlet from pre-amp. Third head for monitoring. Size  $16\frac{1}{2} \times 13 \times 7\frac{3}{4}$  ins. Weight 29 lbs. Price £89 5s.

★

**Telefunken—Sole U.K. distributors,** Welmec Corporation Ltd., 147 Strand, London, W.C.2. Tel.: Temple Bar 3357. Cables: Welmcor, London.

**Magnetophon 75K15.**  $3\frac{3}{4}$  and  $1\frac{7}{8}$  i/s. One motor.  $5\frac{3}{4}$ -in. spools. F.R.: 60-16,000 c/s  $\pm 3$  dB at  $3\frac{3}{4}$  i/s; 60-9,000 c/s  $\pm 3$  dB at  $1\frac{7}{8}$  i/s. W and F 0.4% at  $3\frac{3}{4}$  i/s. S-N, < - 40 dB. Fluorescent bar level ind. Automatic stop at end of tape by foils. Connections for synchronised control of automatic slide projector with Telechron



*Körting MK, 128*



*Telefunken 95*

1 universal unit available as an extra. Connection for remote control. Output from pre-amp. stage. Size  $6\frac{1}{4} \times 12\frac{1}{2} \times 12\frac{1}{2}$  ins. Weight 21 lbs. Price, with tape, £49 7s.

**Magnetophon 85KL.**  $7\frac{1}{2}$  and  $3\frac{3}{4}$  i/s. One motor. 7-in. spools. F.R.: 30-20,000  $\pm 3$  dB at  $7\frac{1}{2}$  i/s; 30-15,000 c/s  $\pm 3$  dB at  $3\frac{3}{4}$  i/s. S-N  $< -50$  dB. W and F  $< 0.2\%$  at  $7\frac{1}{2}$  i/s;  $< 0.4$  at  $3\frac{3}{4}$  i/s. M.E. level ind. Outlet from pre-amp. stage. Straight through amp. 6 watts output. Superimposing. Automatic stop at end of tape by foils.

**Magnetophon 95.** Speeds  $7\frac{1}{2}$ ,  $3\frac{3}{4}$ ,  $1\frac{7}{8}$  i/s. 7-in. spools. F.R.  $7\frac{1}{2}$  i/s 30-18,000 c/s;  $3\frac{3}{4}$  i/s 30-16,000 c/s;  $1\frac{7}{8}$  i/s 30-9,000 c/s. M.E. level ind. W and F 0.15% at  $7\frac{1}{2}$  i/s. H & N  $-40$  dB. Outlet from pre-amp. Straight through amplifier. Size  $16\frac{1}{4} \times 11\frac{1}{2} \times 7\frac{3}{4}$  ins. Weight 24 lbs. Price £61 19s.

**Magnetophon 96.** Four-track. Speeds  $7\frac{1}{2}$ ,  $3\frac{3}{4}$  and  $1\frac{7}{8}$  i/s. One motor. 7-in. spools. F.R.:  $7\frac{1}{2}$  i/s 30-18,000 c/s;  $3\frac{3}{4}$  i/s 30-16,000 c/s;  $1\frac{7}{8}$  30-9,000 c/s. M.E. level ind. H



*Telefunken 85 KL*



*Volmar Vectis*

and N  $< -40$  dB. W and F 0.15% at  $7\frac{1}{2}$  i/s. Outlet from pre-amp via radio socket. May be used with external amplifier for replaying stereo tapes. Size  $16\frac{1}{4} \times 11\frac{1}{2} \times 9$  ins. Weight 24 lbs. Price £72 9s.

■ **Magnetophon 97.** Four-track stereo. Details as for Magnetophon 96. Price £101 17s.



**Tellux Ltd.**, 44 Brunel Road, London, W.3. Tel.: Shepherds Bush 0331. Cables: Telite.

■ **Sony 462.** Four-track stereo. Speeds  $7\frac{1}{2}$  and  $3\frac{3}{4}$  i/s. One motor. 7-in. spools. F.R.  $7\frac{1}{2}$  i/s 60-15,000 c/s;  $3\frac{3}{4}$  i/s 60-10,000 c/s. Two M.E. level inds. Size  $14\frac{3}{4} \times 12\frac{3}{8} \times 6\frac{9}{16}$  ins. Weight 19 lbs. Price £72 9s.

■ **Sony 464.** Details as for Sony 462 but with instant stop lever and 8 mm. synchronising facilities. Price £75 12s.



**Truvox Ltd.**, Neasden Lane, London, N.W.10. Tel.: Dollis Hill 8011. Cables: Truvoxeng.

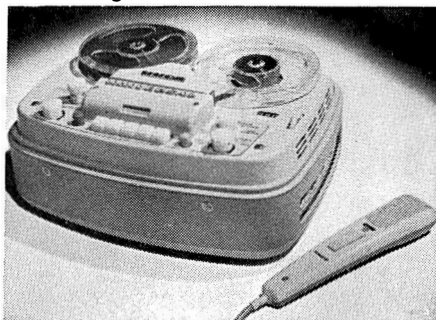

*Uher Universal*

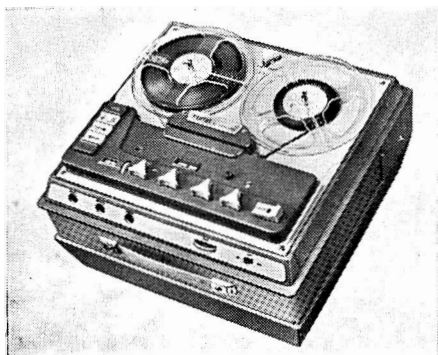

Truvox R82

**R.7.** Speeds  $7\frac{1}{2}$  and  $3\frac{3}{4}$  i/s. 3 motors. 7-in. spools. F.R.  $7\frac{1}{2}$  i/s, 40-15,000 c/s  $\pm 3$  dB.  $3\frac{3}{4}$  i/s 40-10,000 c/s  $\pm 2$  dB W and F 0.1% at  $7\frac{1}{2}$  i/s. Tracks in both directions. Outlet from pre-amp. Size  $16\frac{1}{2} \times 16 \times 10\frac{1}{4}$  ins. Weight 45 lbs. Price £86 2s.

**R.82.** Speeds  $7\frac{1}{2}$  and  $3\frac{3}{4}$  i/s. Three motors. 7-in. spools. F.R.  $\pm 3$  dB.  $7\frac{1}{2}$  i/s 40-20,000 c/s;  $3\frac{3}{4}$  i/s 40-12,000 c/s. M.E. level ind. H and N - 45 dB. W and F  $< 0.15\%$  at  $7\frac{1}{2}$  i/s. Outlet from pre-amp. Mixing. Superimposing. Pause control. Size  $16\frac{1}{4} \times 15\frac{1}{2} \times 10\frac{1}{4}$  ins. Weight 36 lbs. Price £57 15s.

■ **R.84.** Four-track version of R.82. Outlet from replay head and pre-amp. Price £61 19s.



Uher—Sole U.K. distributors, Bosch Ltd., 205 Great Portland Street, London, W.1. Tel.: Langham 1809.

**Uher 524.** Four-track. Speeds  $3\frac{3}{4}$  and  $1\frac{7}{8}$  i/s. 5-in. spools. F.R.  $3\frac{3}{4}$  i/s 40-15,000

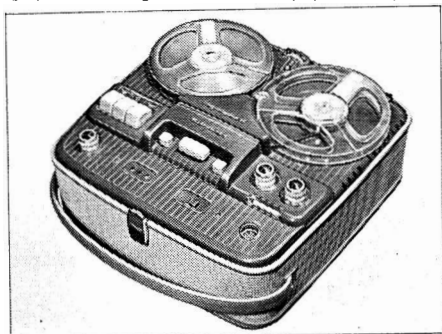

Telefunken 75 K 15

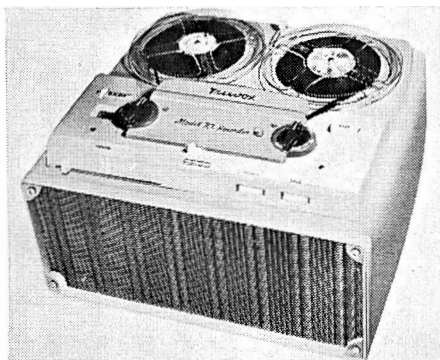

Truvox R.7

c/s;  $1\frac{7}{8}$  i/s 40-8,000 c/s. S-N - 45 dB. W and F 0.2% at  $3\frac{3}{4}$  i/s. M.E. level ind. Size  $12 \times 10 \times 5$  ins. Weight approx. 15 lbs. Price with tape and mic. £80 17s.

**Uher 734.** Four track. Speeds  $7\frac{1}{2}$ ,  $3\frac{3}{4}$ ,  $1\frac{7}{8}$  i/s. F.R.  $7\frac{1}{2}$  i/s. 40-20,000 c/s;  $3\frac{3}{4}$  i/s 40-16,000 c/s.  $1\frac{7}{8}$  i/s 40-80,000 c/s. M.E. level ind. H and N - 45 dB. W and F  $\pm 0.1\%$ . Outlet from pre-amp. Size  $15 \times 14 \times 7$  ins. Weight 26 lbs. Price £93 9s.

**Uher Universal S.** Semi-prof. twin-track recorder. Speeds  $3\frac{3}{4}$ ,  $1\frac{7}{8}$  and  $\frac{1}{8}$  i/s. One motor. 5-in. spools. F.R.  $3\frac{3}{4}$  i/s 40-16,000 c/s;  $1\frac{7}{8}$  i/s 40-8,000 c/s;  $\frac{1}{8}$  i/s 40-4,000 c/s. M.E. level ind. S-N - 45 dB. W. & F.  $\pm 0.2\%$  at  $3\frac{3}{4}$  i/s. Outlet from pre-amp. Remote control. Synchronising. Size  $12 \times 10 \times 5$  ins. Weight 18 lbs. Price, with tape and mic., £87 3s.



Veritone Ltd., 16 Station Close, Potters Bar, Middx. Tel.: Potters Bar 2079.

■ **Veritone 16.** Speeds  $7\frac{1}{2}$  and  $3\frac{3}{4}$  i/s. Three motors.  $8\frac{1}{4}$ -in. spools. F.R.  $\pm 3$  dB:

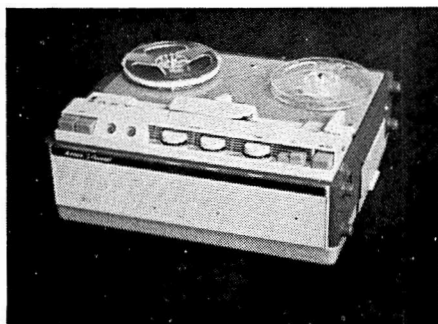

Sony 464



*WyndSOR International*

7½ i/s 50-12,000 c/s; 3¾ i/s 50-7,500 c/s. S-N < -45 dB. Monitoring. Superimposing. Size 17¾ × 20 × 9½ ins. Weight approx. 50 lbs. Price £95 11s.



**Volmar Limited**, 154 High Street, Brentford, Middx. Tel.: Isleworth 1161. Cables: Volmar, Brentford, Hounslow.

**Vega.** Garrard magazine loading deck. F.R. 60-7,000 c/s ± 3 dB. M.E. level ind. Size 13½ × 11 × 7¾ ins. Weight 21 lbs. Price with tape and mic. £35 14s.

**Vectis.** Collaro Studio deck. F.R. 100-10,000 c/s ± 7½ i/s. M.E. level ind. Size 15½ × 13 × 8½ ins. Weight 26 lbs. Price with tape and mic. £37 16s.

**Vista.** Speed 3¾ i/s. One motor. 5¾-in. spools. F.R. 80-8,000 c/s ± 3 dB. M.E. level ind. Size 14½ × 12 × 7¼ ins. Weight 18 lbs. 4 ozs. Price £26 5s.



*WyndSOR Heron*

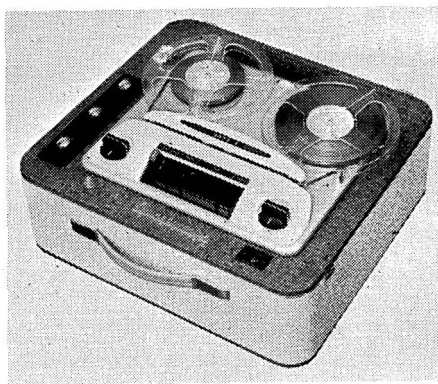

*Volmar Gainsborough*

**Vista-4.** Four-track version of Vista model. Price £29 8s.

**Gainsborough.** Speeds 7½, 3¾ and 1⅞ i/s. Three motors. 7-in. spools. F.R. ± 3 dB: 7½ i/s 80-12,000 c/s; 3¾ i/s 80-8,000 c/s; 1⅞ i/s 80-5,000 c/s. M.E. level ind. Superimposing. Size 17½ × 15½ × 8½ ins. Price £40 19s.



**WyndSOR Recording Co. Ltd.** (inc. Magnetic Recording Co.), 2 Bellevue Road, Friern Barnet, London, N.11. Tel.: Enterprise 2226/7. Cables: Wyndreco.

**International.** Four-track. Speeds 7½ and 3¾ i/s. Three motors. F.R. 40-18,000 at 7½ i/s; 40-12,000 c/s at 3¾ i/s. Level meter. H and N < -45 dB from 3 watts. W and F < 0.15% at 7½ i/s; < 0.2% at 3¾ i/s. Outlet from reply head. Outlet from pre-amp. 8-in. speaker. Ribbon mic. Price approx. £78 15s.



*Elpico TR/400*

## BATTERY OPERATED PORTABLES

**Butoba**—Sole U.K. distributors, **Denham & Morley Ltd.**, Denmore House, 175 Cleveland Street, London, W.1. Tel.: Euston 3656. Cables: Denmorl, Wesdo, London.

**Butoba MT5.** Transistorised battery portable. Speeds  $3\frac{3}{4}$  and  $1\frac{7}{8}$  i/s. M.E. level ind. Two motors. F.R.  $3\frac{3}{4}$  i/s, 50-13,000 c/s;  $1\frac{7}{8}$  i/s, 60-5,000 c/s. H and N - 40 dB. Battery life 20-40 hours. Eight 1.5v batteries. Size  $12 \times 9\frac{1}{2} \times 6$  ins. Weight including batteries, 12 lbs. Price including microphone and tape, £69 6s. Mains converter, £11 11s.



**Challen Instrument Co.**, 4 Stratford Place, London, W.1. Tel.: Mayfair 5054. Cables: Fedstrat, Wesdo, London.

**Minivox Model C.** Battery portable tape recorder  $3\frac{3}{4}$  and  $1\frac{7}{8}$  i/s. F.R. up to 10,000 c/s at  $3\frac{3}{4}$  i/s. Output 600 milliwatts, 5-in. speaker unit. Price £24 3s.



**Cine Accessories (Brighton) Ltd.**, 15 Bond Street, Brighton, Sussex.

**TR100 Transcorder.** Battery operated transistor recorder. Speeds  $3\frac{3}{4}$  and  $1\frac{7}{8}$  i/s. 3-in. spools. Level meter. Weight 4 lbs. Price £40 19s.



**Thomas A. Edison Ltd.**, Victoria House, Southampton Row, London, W.C.1. Telephone: Holborn 9988. Cables: Edison-gram. Westcent, London.

**Mohawk Midgetape 400.** Transistorised battery portable. Speed  $1\frac{7}{8}$  i/s. F.R. 150-5,000 c/s. H and N - 42 dB. W and F less than 0.7%. Special tape cartridge and T50 Mercury battery. Battery life 50 hours. Size  $8\frac{1}{2} \times 3\frac{3}{8} \times 1\frac{7}{8}$  ins. Weight 3 lbs. Price with transistorised speaker, microphone and battery, £129 10s.

**Mohawk Midgetape 500.** Transistorised professional battery portable. Speed  $3\frac{3}{4}$  i/s. F.R. 50-10,000 c/s, H and N - 42 dB. W and F 0.4%. Single battery with indicator. Size  $8\frac{1}{2} \times 3\frac{3}{8} \times 1\frac{7}{8}$  ins. Weight 3 lbs. Price on application.

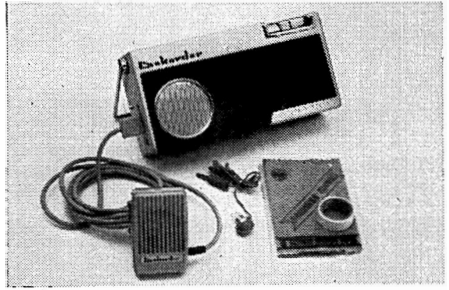

*Dokorder PT-4K*

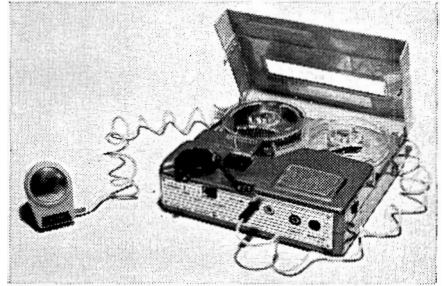

*TR/100 Transcorder*

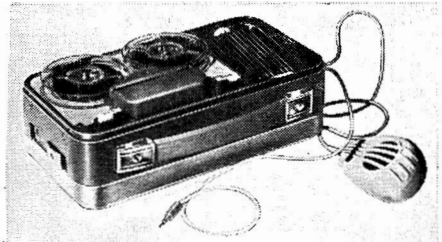

*G.B.C. Clarion*

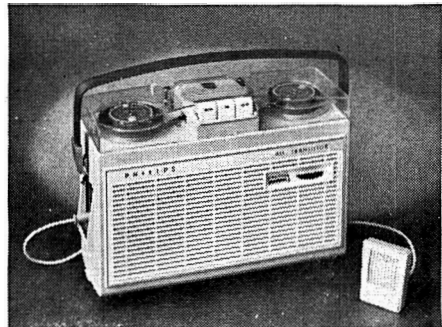

*Philips EL 3585*



*Butoba MT 5*

**EMI Electronics Ltd.**, Hayes, Middx.  
Tel.: Hayes 3888. Cables: Emidata,  
London.

**EMI RE321.** Transistorised, professional battery portable. Speed  $7\frac{1}{2}$  i/s. One motor. F.R. 50-10,000 c/s. H and N - 44 dB. W and F 0.25%. Level meter. Eight 1.5v cells or rechargeable units of equivalent size. Full track recording and playback. CCIR characteristics. Size  $14\frac{1}{4} \times 6\frac{3}{4} \times 8$  ins. Weight  $17\frac{1}{2}$  lbs. Price £124.



**Fi-Cord Ltd.**, 40a Dover Street, London, W.1. Tel.: Hyde Park 3448. Cables: Fi-Cord, London.

**Mark 1A.** Transistorised battery portable.  $7\frac{1}{2}$  and  $1\frac{7}{8}$  i/s. One motor.  $3\frac{1}{4}$ -in. spools. F.R. 50-12,000 c/s  $\pm 3$  dB at  $7\frac{1}{2}$  i/s. W and F 0.4%. S-N, - 35 dB. M.E. bar type



*E.M.I. RE 321*

level ind. Output from pre-amp. stage. Rechargeable batteries, price includes a charger. Battery life,  $1\frac{1}{2}$ -2 hrs. at  $7\frac{1}{2}$  i/s; 3-3 $\frac{1}{2}$  hrs. at  $1\frac{7}{8}$  i/s. Size  $9\frac{3}{8} \times 5 \times 2\frac{3}{4}$  ins. Weight  $4\frac{1}{2}$  lbs. Price, with tape, batteries and mic., £61 19s. £69 6s. with Gramplan DP4/M microphone.



**GBC Electronic Industries Ltd.**, 121/123 Edgware Road, Marble Arch, London, W.2. Tel.: Ambassador 2872.

**Clarion Mk. 1 and 3. Twinset.** Battery powered portable tape recorder with transistorised amplifier. Speed  $3\frac{3}{4}$  i/s. One motor. 3-in. spools. F.R. 200-6,000 c/s.  $7 \times 4$  ins. elliptical speaker. Four 1.5v batteries. Size  $9\frac{1}{2} \times 5 \times 3\frac{3}{8}$  ins. Weight 5 lbs. (incl. batteries). Price £28 7s.

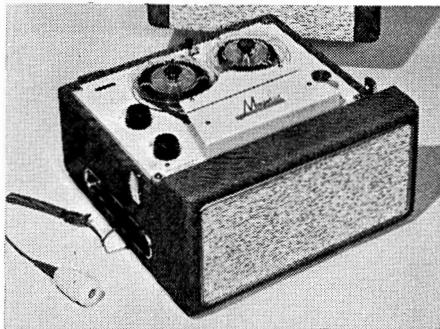

*Minivox Model C*

**Clarion 88. Twintrack.** Battery powered transistor tape recorder. Speed  $1\frac{7}{8}$  i/s. One governed Distler Electromatic motor.  $2\frac{1}{2}$ -in. spools. F.R. 100-6,000 c/s. Playback through microphone. Three C-cell batteries 1.5v and 3 penlight batteries 1.5v. Size  $7\frac{3}{4} \times 4\frac{1}{4} \times 1\frac{7}{8}$  ins. Weight  $2\frac{3}{4}$  lbs. (incl. batteries). Mains adaptor available. Accessories: Stethoscope headphone. Lapel mic. Amplifier/speaker.



**The Goshco Co. Ltd.**, Stone House, Bishopsgate, London, E.C.2. Tel.: Bishopsgate 5901. Cables: Goshco, London.

**Dokorder PT8-D.** Battery operated portable recorder. Speeds  $3\frac{3}{4}$  and  $1\frac{7}{8}$  i/s. One motor. 5-in. spools. F.R.  $3\frac{3}{4}$  i/s 100-7,000 c/s;  $1\frac{7}{8}$  i/s 200-4,000 c/s. V.U.



level meter. Outlet from replay head. Size  $11\frac{3}{4} \times 8\frac{1}{8} \times 3\frac{3}{8}$ . Weight 8.6 lbs. Price £25 15s.

**Dokorder PT-4K Kari-Korder.** Battery operated portable transistorised recorder. Speeds  $3\frac{3}{4}$  and  $1\frac{7}{8}$  i/s. One motor.  $3\frac{1}{4}$ -in. spools. F.R.  $3\frac{3}{4}$  200-7,000 c/s;  $1\frac{7}{8}$  200-3,500 c/s. V.U. level meter. W and F 0.7% max. Outlet from replay head. Size  $3\frac{3}{8} \times 2\frac{1}{4} \times 7\frac{3}{4}$  ins. Weight 3 lbs. Price, with telephone pickup, case, earphone, ext. lead, £51 9s.



**Grundig (Great Britain) Ltd.,** 39/41 New Oxford Street, London, W.C.1. Tel.: Covent Garden 2995.

**TK1.** Transistorised battery portable. Speed  $3\frac{3}{4}$  i/s. One motor. 3-in. spools. F.R. 80-8,000 c/s  $\pm 3$  dB. H and N - 40

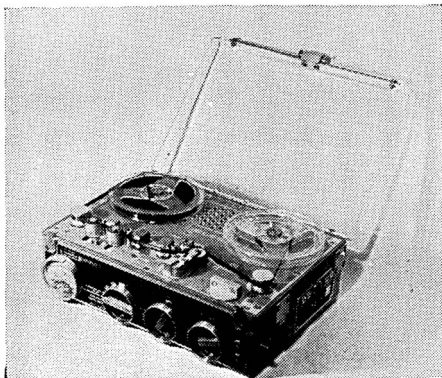

*Nagra 111 B*

dB. W and F 0.2%. Six 1.5v cells. Battery life 20 hours. Size  $11\frac{3}{4} \times 7 \times 4\frac{1}{2}$  ins. Weight 8 lbs. with batteries. Price, with tape and mic., £30 9s. Mains converter available, £7 7s.



**Livingston Laboratories Ltd.,** 31 Camden Road, London, N.W.1. Tel.: Gulliver 8501.

**Nagra IIIB.** Prof. battery portable recorder. 15,  $7\frac{1}{2}$  and  $3\frac{3}{4}$  i/s. One motor. 5-in.

*Details of New Products are given in a special supplement at the end of the book.*



*Fi-Cord 1A*

15,000 c/s  $\pm 1$  dB at 15 i/s; 30-12,000 c/s  $\pm 1.5$  dB at  $7\frac{1}{2}$  i/s; 50-7,000 c/s  $\pm 3$  dB at  $3\frac{3}{4}$  i/s. S-N -51 dB at  $7\frac{1}{2}$  i/s. 53 dB at  $7\frac{1}{2}$  i/s. W and F 0.2% at  $7\frac{1}{2}$  i/s. Meter level ind. Batteries, twelve 1.5v torch batteries, life approx. 20 hours. On alkaline accumulators, approx. 70 hours' life. Mixing on the 3 inputs. 3 heads. Monitor speaker, outlet from pre-amp. stage. Size  $8\frac{3}{4} \times 12\frac{1}{2} \times 4\frac{1}{2}$  ins. Weight approx.  $15\frac{1}{2}$  lbs. Price £307 plus duty.



**Philips Electrical Ltd.,** Century House, Shaftesbury Avenue, London, W.C.2. Tel.: Gerrard 7777. Cables: Phillamps, London.

**EL3585.** Battery operated portable transistorised recorder. Speed  $1\frac{7}{8}$  i/s. One motor. 4-in. spools. F.R. 120-5,500 c/s  $\pm 3$  dB. Level meter. H and N - 40 dB. W and F < 0.5%. Size  $11\frac{1}{8} \times 3\frac{7}{8} \times 7\frac{3}{4}$  i/s. Weight 8 lbs. (incl. batteries). Price, with mic. and tape, £25 4s.

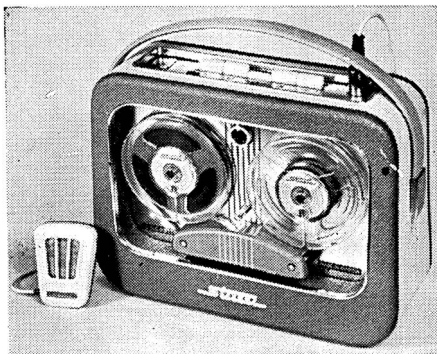

*Stuzzi Magnette*





Grundig TK 1



Steelman Transitaape

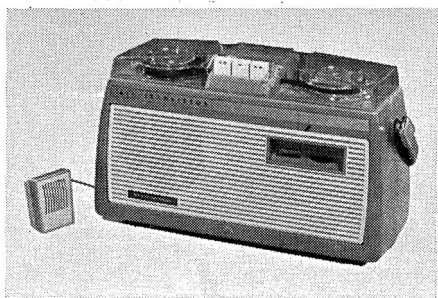

Stella ST 470

**Redifon Ltd.**, Broomhill Road, Wandsworth, London, S.W.18. Tel.: Vandyke 7281. Cables: Redifon, London.

**Steelman Transitaape.** Transistorised battery portable. Speeds  $3\frac{3}{4}$  i/s and  $1\frac{7}{8}$  i/s. One motor. 3-in. spools. F.R.  $3\frac{3}{4}$  i/s 100-6,500 c/s;  $1\frac{7}{8}$  i/s 100-4,000 c/s, both  $\pm 3$  dB. Neon level ind. Thirteen 1.5v batteries. Battery life 50 hours (motor), 300 hours (amplifier). Size  $9\frac{3}{4} \times 6\frac{1}{2} \times 2\frac{7}{8}$  ins. Weight  $6\frac{1}{2}$  lbs. without batteries. Price £29. Accessories: A.C. mains unit; battery charger, foot switch; car battery adaptor.



**Stella Radio & Television Co. Ltd.**, Astra House, 121/3 Shaftesbury Avenue, London, W.C.2. Tel.: Gerrard 7086.

**ST470.** Battery operated transistorised portable recorder. Speed  $1\frac{7}{8}$  i/s. One motor. 4-in. spools. F.R. 120-5,500 c/s  $\pm 3$  dB. Level meter. H and N - 40 dB. W and F < 0.5%. Size  $9\frac{3}{4} \times 12 \times 4\frac{1}{2}$  ins. Weight 8 lbs. (incl. batteries). Price, with tape and mic., £26 5s.



**Stuzzi**—Sole U.K. distributors, **Recording Devices**, 44 Southern Row, Kensington, London, W.10. Tel.: Ladbroke 4775.

**Stuzzi Magnette.** Battery portable.  $3\frac{3}{4}$  and  $1\frac{7}{8}$  i/s. 2 motors. 4-in. spools. F.R. 40-9,000 c/s at  $3\frac{3}{4}$  i/s; 80-4,500 c/s at  $1\frac{7}{8}$  i/s. W and F 0.25% at  $3\frac{3}{4}$  i/s; 0.35% at  $1\frac{7}{8}$  i/s. S-N, - 45 dB. M.E. bar type, level ind. Outlet from pre-amp. stage. Extension speaker socket. Powered by four standard torch batteries; life, 30-100 hours depending on type of use. Battery indicators. Size  $11 \times 4\frac{1}{4} \times 8$  ins. Weight 8 lbs. Price, with tape and mic., £61 19s.

**Stuzzi Magnette Studio.** Battery portable  $7\frac{1}{2}$  i/s. 4-in. spools. F.R. 40-14,500 c/s. W and F 0.2%. H and N - 50 dB. Magic Eye level indicator. Outlet from pre-amp. Extension speaker socket. Price £78 15s.

## DECKS—GENERAL PURPOSE and SEMI-PROFESSIONAL

**Birmingham Sound Reproducers Ltd.,**  
Monarch Works, Powke Lane, Old Hill,  
Staffs. Tel.: Cradley Heath 69272.

**B.S.R. Monardeck TD2.** G.P. deck.  
 $3\frac{3}{4}$  i/s. One motor.  $5\frac{3}{4}$ -in. spools. F.R.:  
with good amplifier equalisation 30-10,000  
c/s  $\pm 3$  dB. 2 heads. W and F 0.2%.  
RMS. Size  $13 \times 8\frac{3}{4}$  ins. Price £12 12s.;  
with 4-track head £14.



**Bradmatic Ltd.,** Station Road, Aston,  
Birmingham, 6. Tel.: East 2881-2. Cables:  
Bradmatic, Birmingham.

**Bradmaster.** Models 5B, 5CS, 5CD,  
5D Semi-prof. tape deck.  $7\frac{1}{4}$  and  $3\frac{3}{4}$  i/s.  
3 motors. Model 5B 7-in. spools; 5CS  
and 5CL  $9\frac{3}{8}$ -in. spools; 5D  $10\frac{1}{2}$ -in. N.A.B.  
spools. F.R.  $7\frac{1}{2}$  i/s, 40-15,000 c/s;  $3\frac{3}{4}$  i/s,  
40-7,500 c/s, both  $\pm 4$  dB (dependent on  
amp. used). Size and weight dependent on  
model. Price 5B £42; 5CS £45 10s.;  
5CL £47 10s.; 5D £50. Available with  
full track or stereophonic heads to special  
order. Prices on application.

**Model 5DF.** Semi-prof. tape deck. 15  
and  $7\frac{1}{2}$  i/s. 3 motors.  $10\frac{1}{2}$ -in. N.A.B.  
spools. F.R. 15 i/s, 30-18,000 c/s;  $7\frac{1}{2}$  i/s,  
30-15,000 c/s, both  $\pm 2$  dB. W and F,  
0.1% at 15 i/s. Variable spooling control.  
Size  $20 \times 14\frac{1}{2}$  ins. Weight 20 lbs. Price  
£62.



**Brenell Engineering Co. Ltd.,** 1a Doughty  
Street, London, W.C.1. Tel.: Holborn  
7358.

**Mark 5.** G.P. tape deck. 15,  $7\frac{1}{2}$ ,  
 $3\frac{3}{4}$  and  $1\frac{7}{8}$  i/s. 3 motors.  $8\frac{1}{4}$ -in. spools.  
W and F 0.1% at  $7\frac{1}{2}$  i/s accommodates  
up to four heads. Size  $15 \times 11\frac{1}{2} \times 5$  ins.  
Weight 16 lbs. Price £29 8s.



**Collaro Ltd.,** Ripple Works, By-Pass Road,  
Barking, Essex. Tel.: Rippleway 5533  
Cables: Korllaro. Telex, Barking.

**Collaro Studio.** G.P. tape deck  $7\frac{1}{2}$ ,  $3\frac{3}{4}$   
and  $1\frac{7}{8}$  i/s. 3 motors. 7-in. spools. F.R.:  
30-10,000 c/s at  $7\frac{1}{2}$  with record/playback  
equalisation 2 heads. Price on application.  
Stereo head available.

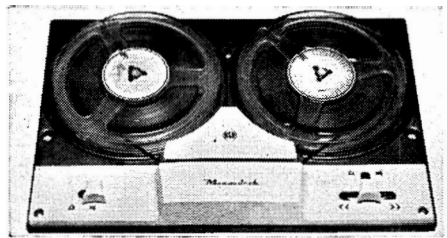

*B.S.R. Monardeck TD1*

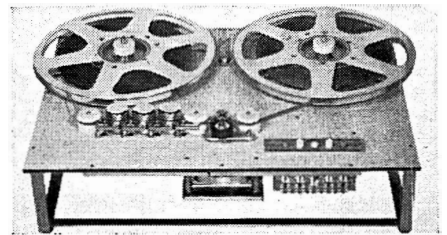

*Bradmaster 5D*

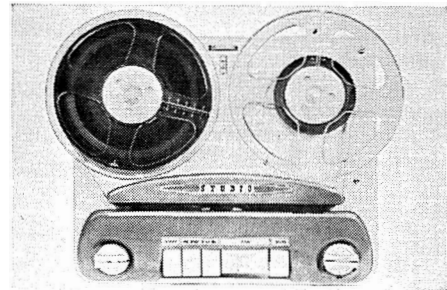

*Collaro Studio*

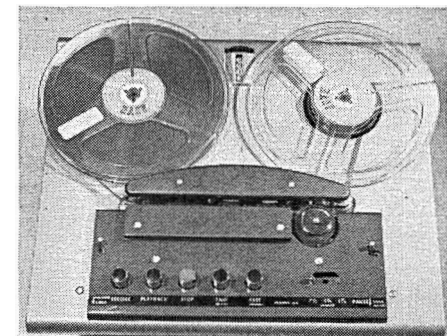

*Planet U1*

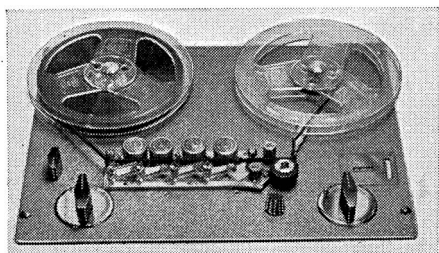

*Brenell Mark 5*

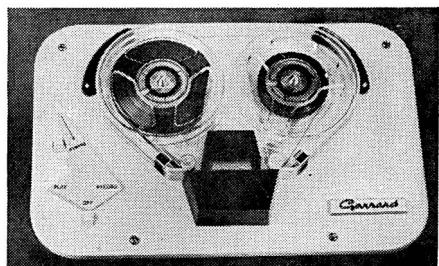

*Garrard Magazine Deck*

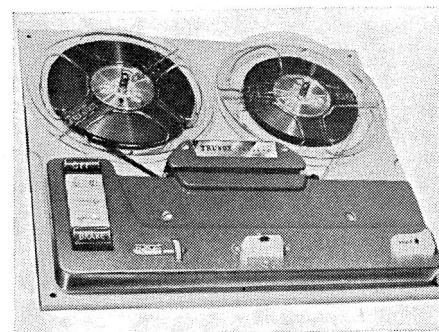

*Truvox D82*

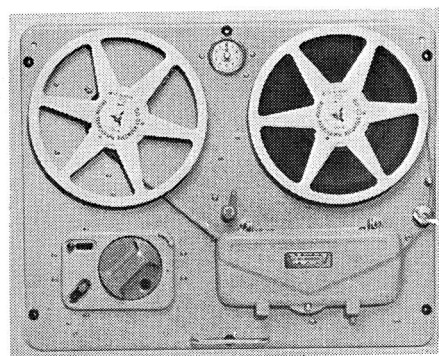

*Wearite 4A*

**Garrard Engineering & Manufacturing Co. Ltd.**, Newcastle Street, Swindon, Wilts. Tel.: Swindon 5381. Cables: Telex 44-271.

**Garrard Magazine Tape Deck.** Half-track.  $3\frac{3}{4}$  i/s. Two motors. 4-in. spools or magazine. F.R. to 10,000 c/s. W and F 0.2%. No threading or spilling of tape. Size  $12\frac{1}{4} \times 8 \times 3\frac{3}{4}$  ins. Price £16 3s. Quarter-track model £19 3s. 9d.



**Modern Techniques**, Wedmore Street, London, N.19. Tel.: Archway 3114.

**Motek K10.** G.P. tape deck.  $7\frac{1}{2}$ ,  $3\frac{3}{4}$ ,  $1\frac{1}{8}$  i/s. 3 motors. 7-in. spools. F.R.: approx. 40-12,000 c/s at  $7\frac{1}{2}$  depending on amplifier used. W and F < 0.2% at  $7\frac{1}{2}$  i/s. 2 heads. High imp. record head. Size  $15\frac{1}{4} \times 10\frac{3}{4}$  ins. Price £22 1s.



**Planet Projects Ltd.**, Planet Works, Conlan Street, London, W.10. Tel.: Ladbroke 0436.

**Planet U.1.**  $7\frac{1}{2}$ ,  $3\frac{3}{4}$  and  $1\frac{7}{8}$  i/s. One Papst Hysteresis synchronous F.R. 30-18,000 c/s at  $7\frac{1}{2}$  i/s. W and F 0.1% at  $7\frac{1}{2}$  i/s.

Autostop using metal foils, lockable pause control. Wrap around Tape guides, no pressure pads used. Size  $14 \times 12\frac{1}{4} \times 4$  ins. Weight  $12\frac{1}{2}$  lbs. Price £39 10s.



**Truvox Ltd.**, Neasden Lane, London, N.W.10. Tel.: Dollis Hill 8011. Cables: Truvoxeng, London, N.W.10.

**D82.** Speeds  $7\frac{1}{2}$  and  $3\frac{3}{4}$  i/s. Three motors. 7-in. spools. F.R. (with suitable amplifier)  $7\frac{1}{2}$  i/s 40-20,000 c/s;  $3\frac{3}{4}$  i/s 40-12,000 c/s, both  $\pm 3$  dB. H and N - 45 dB. W and F < 0.15% at  $7\frac{1}{2}$  i/s. Outlet from replay head. Provision for R/P and speed change switch wafers. Push buttons interlocked. Pause control. Size  $14\frac{1}{4} \times 13 \times 7$  ins. Weight 15 lbs. Price £26 5s.

**D84.** Quarter-track version of D82. Price £29 8s.



**Wright & Weaire Ltd.**, 84 Blackfriars Road, London, S.E.1. Tel.: Waterloo 1981. Cables: Writewea, S.E.

**Wearite Models 4A, 4B, 4C.** Semi-prof. tape deck.  $3\frac{3}{4}$  and  $7\frac{1}{2}$  i/s. Also available  $7\frac{1}{2}$  and 15 i/s, 4AH, 4BH, 4CH.

available  $7\frac{1}{2}$  and 15 i/s, 4AH, 4BH, 4CH. 3 motors.  $8\frac{1}{4}$ -in. spools. W and F 0.2% at  $7\frac{1}{2}$  i/s. Size  $16\frac{1}{2} \times 13 \times 7$  ins. Weight 18 lbs. 4A standard monaural record/replay, Price £42. 4AH, £45. 4B monaural record/replay plus monitor head, Price £47. 4BH, £50. 4C Industrial dual track, Price £51 10s. 4CH, £56 10s.

■ **Models 4SN, 4SH.** Monaural record replay plus stereo replay. Price, 4SN, £49 7s.; 4SH, £52 7s.

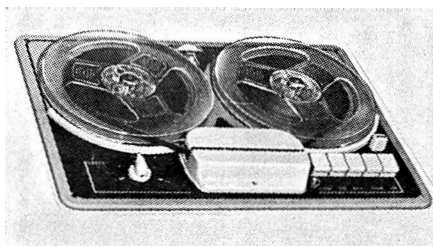

*Motek K10*

## DECKS AND PRE AMPLIFIERS

**Gramdeck.** U.K. distributors, Andrew Merryfield Ltd., 29/31 Wright's Lane, Kensington, London, W.8. Tel.: Western 3603. Cables: Technology, Kens, London.

**Gramdeck.** Head and drive mechanism for attachment to gramophone turntable. Speeds  $7\frac{1}{2}$ , 4.3, 3.2 and 1.6 i/s for the standard disc speeds.  $5\frac{3}{4}$ -in. spools. F.R. 60-10,000 c/s  $\pm 3$  dB at  $7\frac{1}{2}$  i/s. W and F 0.15%. Size  $13\frac{1}{2} \times 6$  ins. Weight approx. 2 lbs. Price including transistor pre-amplifier £11 11s.

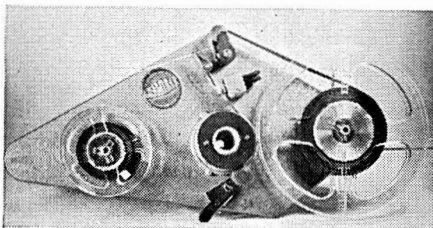

*Gramdeck*



**Grundig (Great Britain) Ltd.,** 39/41 New Oxford Street, London, W.C.1. Tel.: Covent Garden 2995.

■ **TM60.** G.P. tape deck for monaural and stereo use. Includes all pre-amplifier circuitry.  $7\frac{1}{2}$  and  $3\frac{3}{4}$  i/s. One motor. 7-in. spools. F.R.  $7\frac{1}{2}$  i/s, 50-15,000 c/s;  $3\frac{3}{4}$  i/s, 50-10,000 c/s, both  $\pm 3$  dB. M.E. level ind. H and N - 40 dB. W and F less than 0.2% at  $7\frac{1}{2}$  i/s. Size  $14 \times 11\frac{1}{4} \times 8\frac{5}{8}$  ins. Weight 24 lb. Stereo/mono recording and playback through suitable output stages and loudspeakers. Price, with tape, £94 19s.

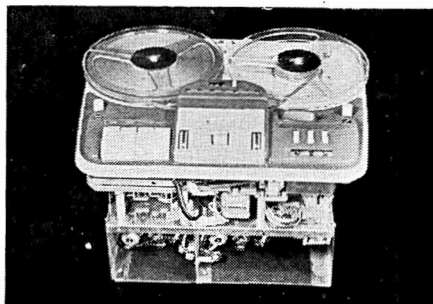

*Grundig TM60*



**Truvox Ltd.,** Neasden Lane, London, N.W.10. Tel.: Dollis Hill 8011. Cables: Truvoxeng, London, N.W.10.

**PD82.** Deck mechanism with pre-amplifier. Self-powered. Specifications as for D82 but with mixing and superimpose facilities. Outlet from pre-amp. M.E. level ind. Size  $14\frac{1}{2} \times 13\frac{1}{4} \times 8$  ins. Weight 29 lbs. Price £42.

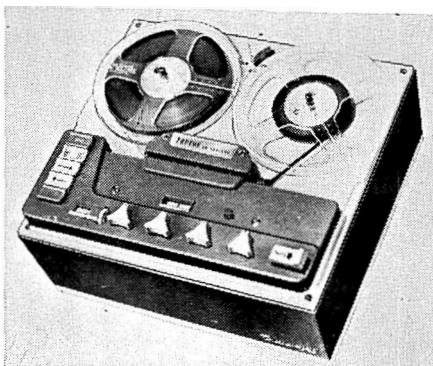

*Truvox PD 84*



*Truvox D82*

**PD83.** Deck mechanism with pre-amplifier. Self-powered. Speeds  $7\frac{1}{2}$  and  $3\frac{3}{4}$  i/s. Three motors. 7-in. spools. F.R.  $7\frac{1}{2}$  i/s 30-20,000 c/s;  $3\frac{3}{4}$  i/s 30-12,000 c/s, both  $\pm 3$  dB. Level meter. H and N - 45 dB. W and F < 0.15% at  $7\frac{1}{2}$  i/s. Outlet from pre-amp. Size  $14\frac{1}{2} \times 15\frac{1}{2} \times 8$  ins. Weight 31 lbs. Price £48 10s.

**PD84.** Deck mechanism with pre-amplifier. Self-powered. Speeds  $7\frac{1}{2}$  and  $3\frac{3}{4}$  i/s. Three motors. 7-in. spools. F.R.  $7\frac{1}{2}$  i/s 40-20,000 c/s;  $3\frac{3}{4}$  i/s 40-12,000 c/s, both  $\pm 3$  dB. M.E. level ind. H and N - 45 dB. W and F < 0.15% at  $7\frac{1}{2}$  i/s. Outlet from replay head. Outlet from pre-amp. Mixing. Superimposing. Quarter-track outlet from head for stereo replay. Pause control. Size  $14\frac{1}{2} \times 13\frac{1}{2} \times 8$  ins. Weight 20 lbs. Price £46.

**PD85.** Quarter-track version of PD83.

■ **PD86.** Deck mechanism with three  $\frac{1}{4}$ -track stereo heads and dual (stereo) pre-amplifier, self-powered. Speeds  $7\frac{1}{2}$  and  $3\frac{3}{4}$  i/s. 3 motors. 7-in. spools. F.R.:  $7\frac{1}{2}$  30-20,000 c/s,  $3\frac{3}{4}$  i/s 40-12,000 c/s, both  $\pm 3$  dB. Level meter. H and N - 45 dB. W and F < 0.15% at  $7\frac{1}{2}$  i/s. Stereo recording, track-to-track recording, input mixing on both channels. Pause control. Size  $14\frac{1}{2} \times 16\frac{1}{2} \times 8$  ins. Weight 33 lbs. Price £63.

■ **PD87.** Half-track version of PD86.

## TAPE AMPLIFIERS AND MIXER UNITS

**Ampex Great Britain Ltd.,** 72 Berkeley Avenue, Reading, Berkshire. Tel.: Reading 55341. Cables: Videotape, Reading. Telex: 84146.

**Ampex 620 Speaker/amplifier.** Comprises 8-in. drive unit in special enclosure. Acoustically flat from 60 to 10,000 c/s. The built-in amplifier has 10 watts output. F.R. 20-20,000 c/s  $\pm 0.5$  dB. Price £88.

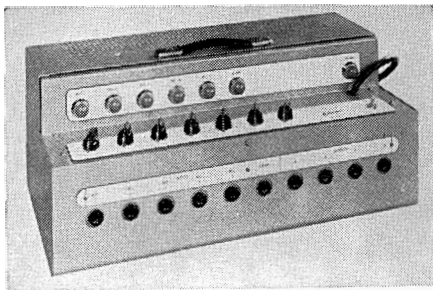

*Astronic A.1446*

**Associated Electrical Industries Ltd.,** Crown House, Aldwych, London, W.C.2. Tel.: Temple Bar 8040. Cables: Soundequi, Lesquare, London.

**A.E.I. Four Channel Electronic Mixer.** Four inputs, one output with master control 20 or 100K ohm and 20 ohm. Preset bass and top cut. Output imp. 500 ohms. sensitivity 75  $\mu$ v. Powered from A.E.I. 30 watt amplifier or from separate power supply. Price £55.



**Associated Electronic Engineers Ltd.,** 10 Dalston Gardens, Stanmore, Middx. Tel.: Wordsworth 4474/5/6. Cables: Astronic, Stanmore.

**Astronic A.1446.** 6 channel electronic mixer unit. Designed for 5 low impedance sources each 10/30 ohms, 0.5 mV; 1 high impedance source 250K ohms, 0.2 volts. There are four output sockets

supplying 0.7 volts into 600 ohms. A master gain fader is incorporated, and each channel has an indicator lamp to show which sources have been faded up. A.C. mains required. Size  $9 \times 11 \times 8\frac{1}{2}$  ins. Price £58 10s.



**Brenell Engineering Co. Ltd.**, 1a Doughty Street, London, W.C.1. Tel.: Chancery 5809 and Holborn 7356.

**Mk.5 Record/playback amplifier.** Inputs: mic. 2.5 mV, radio/gram 100 mV, both high impedance. Outputs: 200 mV



*Jason Tape Pre-Amplifier*

at 50,000 ohms, and 4 watts into 15 ohms for direct connection to loudspeaker. Headphone monitoring M.E. level ind. or meter if required. Price £24. Meter, £5 5s. extra.

**Brenell Mixer Unit.** 3 channel unit. For best results high impedance sources such as crystal microphones and pickups are recommended. There are 4 sockets for jack plugs for the three inputs and the output lead, each input having a volume control. Price £2 18s.



**Cape Electrophonics Ltd.**, 43-45 Shirley High Street, Southampton. Tel.: Southampton 74251.

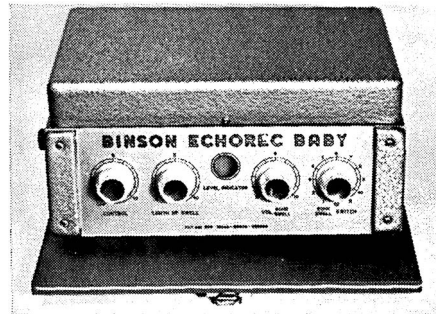

*Binson Baby Echorec*



*Grundig G.M.U.3*

**Cape VLT/2.** Tape recording/replay amplifier suitable for operation with a variety of tape decks. Self-powered. Price £75.



**Grundig (Gt. Britain) Ltd.**, Newlands Park, Sydenham, S.E.26. Tel.: Sydenham 2211. Showroom: 39-41 New Oxford Street, London, W.C.1. Tel.: Covent Garden 2995. Cables: Grundig, London. Telex 22054.

**G.M.U.3.** Four channel mixer and pre-amp. Inputs: Mic 1, 1.2 mV, 100 K ohms; Mic. 2, 4 mV, 100 K ohms. Polarised 100v. D.C. Mic. 3 as Mic. 2. Channel (radio/P.U.). 300 mV, 500 K ohms. Out. imp. approx. 1,000 ohms. Magic eye level ind. Output level 65 mV. Mains-powered. Price £16 16s.

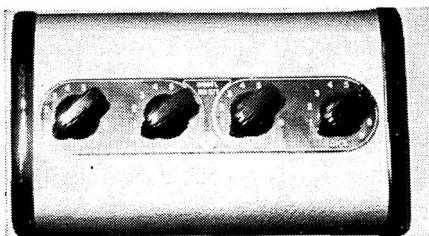

*Lustraphone MU 577*

**Jason Electronic Designs Ltd.**, Kimberley Gardens, Harringay, London, N.4. Tel.: Stamford Hill 5477.

■ **JTL. Stereo tape pre-amplifier.** One input, 100 mV sensitivity. Output 0.5 volt. Equalisation for  $7\frac{1}{2}$  and  $3\frac{3}{4}$  i/s. M.E. level ind. Controls: function, record amplifier, playback amplifier, monitor, playback/record volume, signal/bias. Simultaneous record/replay. Self-powered. Push/pull oscillator. H and N 55 dB down on 2% distortion. Suitable for any deck. To operate with Jason J2-10 amplifier. Size  $15 \times 9\frac{1}{2} \times 4\frac{3}{8}$  ins. Price assembled, £30 9s. Kit £21.

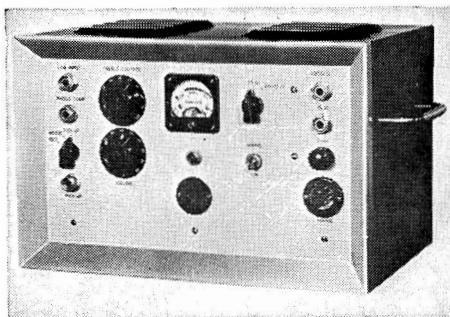

*MSS RA 50 recording amplifier*

**The Lowther Manufacturing Co.,** St. Mark's Road, Bromley, Kent. Tel.: Ravensbourne 5225. Cables: Lowther, Bromley.

**Companion Supply Unit No. 2.** H.T. and L.T. power supply suitable to power radio tuners. Pre-amp and tape bias amplifier. Output 250v at 40 mA, 6.3v at 3 A. Price £5 5s.



**Lustraphone Ltd.,** St. George's Works, Regent's Park Road, London, N.W.1. Tel.: Primrose 8844. Cables: Lustraphon, London.

**M.U.577.** Transistor mixer unit. Inputs: 1 and 2 are unbalanced and are suitable for low imp. mics. (line or highimps. to order). 2 and 3 are high imp. and suitable for radio or P/U. Output is balanced to match that from 1 and 2. F.R. substantially flat 50-14,000 c/s. Power by mercury cell with 1,000 hours life. Alternative input and output impedances to specification. Price, standard model, £19 19s.

A range of transistorised power amplifiers, up to 50 watts, and complete public address systems. Details on application.

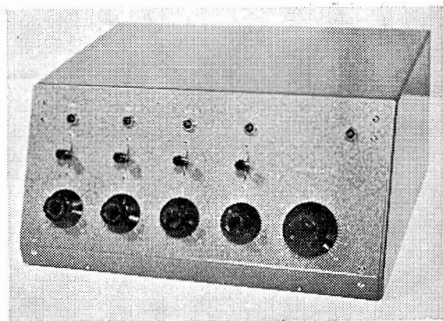

*MSS 4M2 4-Channel Mixer*

**Modern Electrics (Retail) Ltd.,** 120 Shaftesbury Avenue, London, W.C.2. Tel.: Covent Garden 1703. Temple Bar 7587. Cables: Modcharex, London.

**Binson Echorec Mk.1.** Pre-amplifier and magnetic recording unit enabling echoes and other effects to be achieved. Three channels are included and the timing of echoes is variable. Operation from AC mains. Price £147 complete.

**Binson Baby.** Single channel version of above. Price £105.



**M.S.S. Recording Co., Ltd.,** Colnbrook, Bucks. Tel.: Colnbrook 2431. Cables: Emessco.

**4 M 2 or 2 ML.** Microphone mixing and control unit. Up to 4 mics. or line, P/U

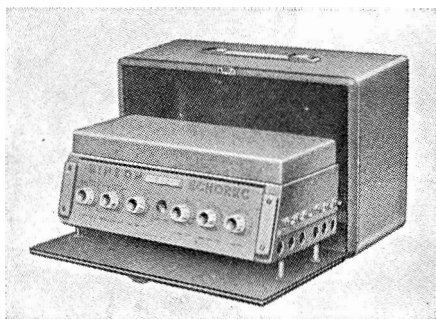

*Binson Echorec*

and 2 mics. Microphone switching and level control. Output sockets for 600 ohm line and headphone monitor. 4 input sockets. H.D. at 1 mW 1,000 c/s. tone, is 0.25%. H and N at normal output level on 1 mV signal to noise ratio -60 dB. Size 14½ × 12 × 7 ins. Price £50.

**RA/50.** Amplifier for recording and playback. 50 watts. Dist. 2.5% at 50 watts. Input for spec. output 1v. Response 30-15,000 c/s. ±2 dB. Feedback 12 dB. N.L. -80 dB at full output. Out. imp. RA50/1 1,800 ohms; RA50/2 200 ohms; RA50/3 15 ohms. Output EL37's. Size 19 × 14 × 8 ins. Power available for pre-amp. Price £70.



**Penco Products,** 36 Coniston Road, Kings Langley, Herts. Tel.: Kings Langley 3134. Cables: Penco, Kings Langley.



**Epigram Mix/3.** 3 channel unit. Incorporates 3 transistors and is designed for 2 low impedance 15/30 ohms and one high impedance input. Power derived from 4 volt Mercury Cell. Output is high impedance. Price £15 15s.

**Epigram Mix/35.** Details as above except that 5 transistors are included, giving extra gain, e.g. to by-pass input stage of recorder. Price £26 5s. Specials to order.

**Epigram Mix/35L.** As Mix 35 but fitted with low noise transistors. Price £29 8s.



**Philips Electrical Ltd.,** Century House, Shaftesbury Avenue, London, W.C.2. Tel.: Gerrard 7777. Cables: Phillamps, London.

**ET 1042/10.** 4-channel mixer unit. Input impedance 50 ohms, 0.2 mV.

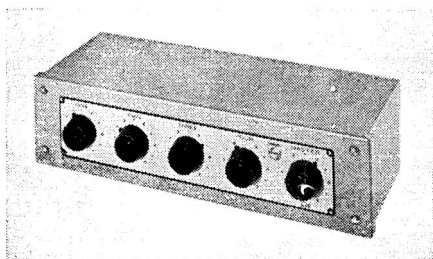

*Philips ET 1042 Mixer*

Outputs: 50,000 ohms at 200 mV or 6,500 ohms at 10 mV. Four individual mic. input controls and master. F.R. 50-12,000 c/s with speech filter giving 6 dB cut at 60 c/s. S-N -70 dB. Self-powered, 200-250v 50 c/s A.C. Suitable for all Philips amplifiers. Size  $13\frac{1}{2} \times 7 \times 3\frac{1}{8}$  ins. Price £35.

**EL 3374.** Tape pre-amplifier. Outputs 5-pin DIN socket, 1 volt across 150 K ohms; 2 pole socket, 200 mV across 1 K ohm. Response 5-pin DIN socket, 60-10,000 c/s; 2 pole socket, 60-4,500 c/s. Powered from tape recorder. Synchronised record/playback. Suitable for use with current models of Philips EL 3541, EL 3542; Stella ST 454, ST 455; Cossor CR 1601, CR 1602. Size  $6\frac{3}{8} \times 3\frac{1}{2} \times 1\frac{3}{8}$  ins. Price £6 10s.

**Philips EL.3989.** 4-channel mixer unit. Incorporating 4 separate potentiometers. Price £4 4s.

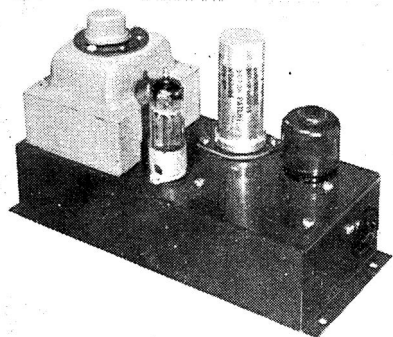

*Rogers Power Pack*

**Rogers Developments (Electronics) Ltd.,** "Rodevco Works", 4-14 Barmeston Road, Catford, S.E.6. Tel.: Hither Green 7424. Cables: Rodevco, London.

**General Purpose Power Pack, Model A.** Suitable for tape units and radio tuners. Output 250v at 45 mA, 6.3v at 2.5A. Size  $7\frac{1}{2} \times 3 \times 5$  ins. Price £4 5s.

**Model C** for switched FM unit. Price £4.



**Shirley Laboratories Ltd.,** 3 Prospect Place, Worthing, Sussex. Tel.: Worthing 30536.

**TW/PA2.** Recording amplifier for use with high quality power amplifier. Inputs: 1.5 mV and 60 mV. Bias and erase oscillator. Full corrections. Valve voltmeter modulations level ind. For use with Wearite tape deck, can be supplied to order for any deck. Size  $10 \times 5\frac{1}{2} \times 5\frac{1}{2}$  ins. P.s.n. from main amp. or power pack can be supplied at £6 16s. 6d. Price £31 10s.

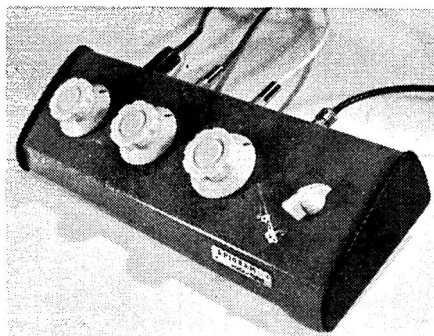

*Penco Epigram Mix/3*



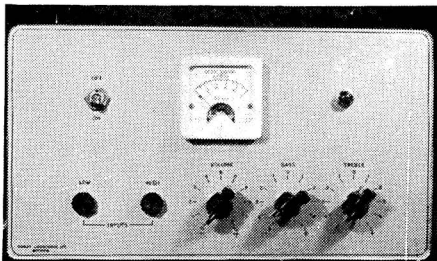

Shirley TWA/15

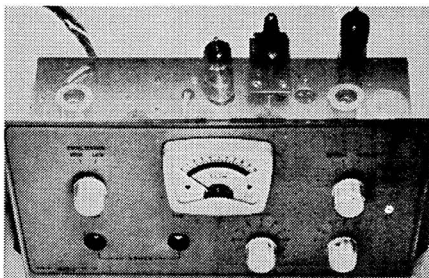

Shirley TW/PA2

**TWA/15.** Tape amplifier for use with most tape decks, also for use with pickup or radio. Inputs: 1-1.5 mV and 40 mV. Output. 15 watts, 20 watts peak. F.R.: as recorder 50-14,000 c/s; as reproducing and gram amp. 20-30,000 c/s. Bass and treble boost and cut. H and N 85 dB down. Valve-Voltmeter level ind. power supply on separate chassis. Price £47 5s.

■ **TWA/1515.** Complete stereo record and replay amplifier. Output 15 watts continuous, 25 watts peak on each channel. Inputs: 1.5 mV and 50 mV. Bass and treble boost and cut. Level indicated by separate sustained peak-reading valve voltmeters. Power supply and oscillator on separate chassis. F.R.: 40-30,000 as ordinary amp.; 40-15,000 as recording amp. Size: control unit  $23 \times 7\frac{1}{2} \times 7$  ins. Power unit  $10 \times 8 \times 7\frac{1}{2}$  ins. Price £100 16s.

Mixer Units supplied to order. Up to 36 inputs. Prices on application.



**Sound News Productions**, 10 Clifford Street, New Bond Street, London, W.1.

**Unimixer 1.** 3-channel unit. Channels 1 and 2 have duplicate sockets for low or

high impedance microphones—30 ohms or 400 K ohms. Recommended load impedance not less than 500 K ohms. F.R. from 30 ohm input 56-10,000 c/s  $\pm 3$  dB. Price £9 9s.

**Unimixer 2.** 3-channel unit. Inputs as above but high impedance is 5 M ohms in channels 1 and 2. Power supply needed 200/300 volts D.C. at 5 mA, 6.3v at 0.3 amps. Special connectors available to obtain power supplies direct from Ferrograph or Vortexion recorders without any alteration. Price £15 15s.



**Sound Sales Ltd.**, Works and Acoustic Laboratories, West Street, Farnham, Surrey. Tel.: Farnham 6461-2-3. Cables: Sounsense.

**A-Z General Purpose Power Pack** for supplying additional units beyond the scope of the main amplifier. Output 250v at 50 mA, 6.3v at 2A. Price £5 10s.

**A-Z Precord Unit.** Designed for use with Wearite or Truvox tape deck. Self-powered. Inputs: mic. or radio/pickup. Sel. switch for record and replay. Green and red ind. lights give add. visual check.

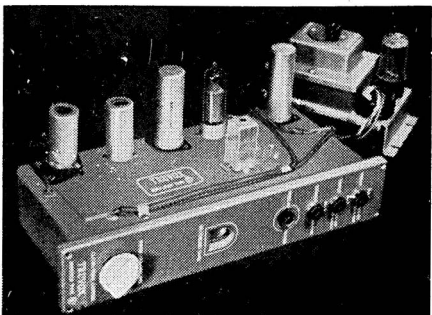

Truvox Type K recording amplifier

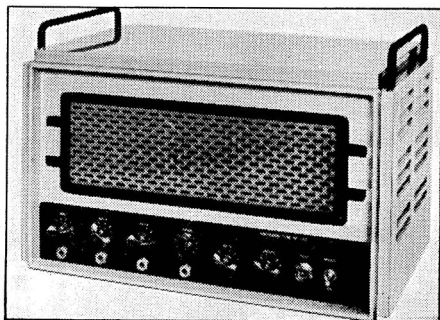

Vortexion S/30/50 mixer and amplifier

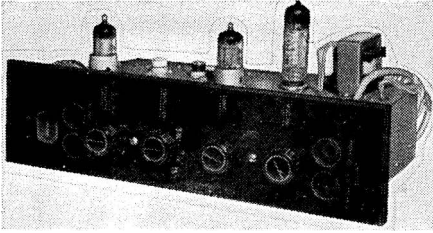

**Stern HF/TR3**

Calibrated recording level indicator. Equalisation for  $3\frac{1}{2}$ ,  $7\frac{1}{2}$  and 15 i.p.s. C.C.I.R. and N.A.R.T.B. characteristics. Variable bias control. Record level and replay gain control. Size  $11\frac{1}{4} \times 9\frac{1}{2} \times 4\frac{3}{4}$  ins. Price £30.



**Stern Radio Ltd.**, 109 and 111 Fleet Street, London, E.C.4. Tel.: Fleet Street 5812-14.

**HF/TR3.** Tape amplifier. Inputs: mic. 2.5 mV, radio/pickup 300 mV. F.R. 35-17,000 c/s  $\pm 3$  dB at 15 i/s. Equalisation available for 15,  $7\frac{1}{2}$  and  $3\frac{3}{4}$  i/s or  $7\frac{1}{2}$ ,  $3\frac{3}{4}$  and  $1\frac{7}{8}$  i/s. 3 watts output into 3,  $7\frac{1}{2}$  or 15 ohms. To Mullard design, suitable for Brenell, Collaro, Motek, Truvox and Wearite decks. Price, with separate power unit, £17. Plus £3 3s. for special matching to Wearite 4A decks. Also available in kit form.

**Type C Tape Pre-amplifier.** Inputs: mic. 0.5 mV, radio/pickup 250 mV. F.R. 30-17,000 c/s  $\pm 3$  dB at 15 i/s. Equalisation available for 15,  $7\frac{1}{2}$  and  $3\frac{3}{4}$  i/s or  $7\frac{1}{2}$ ,  $3\frac{3}{4}$  and  $1\frac{7}{8}$  i/s. 250 mV audio output. To Mullard design, suitable for Brenell, Collaro, Motek, Truvox and Wearite decks. Price, with separate power unit, £17. Plus £3 3s. for special matching to Wearite 4A decks. Also available in kit form.

**Mullard 4-channel Electronic Mixer. Model 2H.** Inputs: 2  $\times$  microphone. High "Z" 3 mV; radio/tape 250 mV;



*Sound News Production Unimixer*

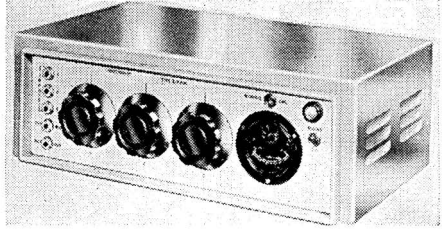

**Vortexion 3-channel Mixer**

pickup 250 mV. Outputs: A: 40 mV; B: 100 mV; C: 250 mV; D: 500 mV. Impedance 600 ohms. Cathode follower. Individual channel controls. Response 15-20,000 c/s  $\pm 2$  dB. S-N -50 dB. Self-powered. Suitable for most machines. Size  $11 \times 4 \times 4$  ins. Price, assembled, £10. Kit £8 8s.

**Model 1L.** Alternative to Model 2H. Incorporates matching transformer in one microphone channel. Suitable for ribbon mics., etc. Price, assembled, £11 17s. Kit £10 5s.

■ **STP-1.** Stereo tape pre-amplifier. Inputs (each channel): radio 250 mV, impedance 500 K ohms; microphone 2 mV, impedance 2 megohms. Outputs: standard 250 mV (alternatives up to 2 volts). Response at  $7\frac{1}{2}$  i/s 40-16,000  $\pm 3$  dB. Equalisation for 15,  $7\frac{1}{2}$ ,  $3\frac{3}{4}$  and  $1\frac{7}{8}$  i/s. 2 in. moving coil meter. Controls: function, equaliser, record level (2), meter, meter set zero. Separate track switch. H and N -55 dB. P.s.n. 290v at 30 milli-amp; 6.3v at 2 amps. Suitable for Brenell and Truvox (quarter-track Miniflux head) and Collaro (quarter-track Reuter head). Size  $14 \times 6 \times 3\frac{3}{8}$  ins. Price £28. Available in kit form, price to be announced.



**Technical Suppliers Ltd.**, Hudson House, 63 Goldhawk Road, London, W.12. Tel.: Shepherds Bush 2581/4794. Cables: Teknica, London.

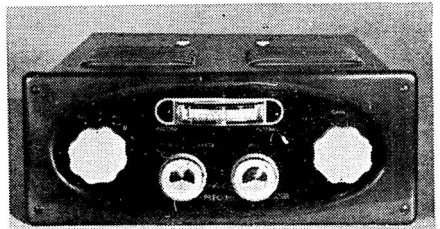

*Sound Sales AZ Precord*

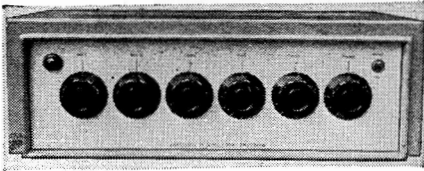

*Vortexion 2MGT 15W*

**3-channel mixer unit.** Designed for high impedance inputs. Jack plug sockets fitted. Size  $4\frac{1}{4} \times 3\frac{1}{8} \times 4\frac{1}{2}$  ins. Price £2 2s.



**Tele-Radio (1943) Ltd.,** 189 Edgware Road, London, W.2. Tel.: Paddington 4455.

**Masterlink M3.** Tape pre-amplifier. Mainly for Wearite series of decks, but suitable for Collaro and Brenell. Inputs: mic. 3 mV, 1 megohm; radio/pickup 100 mV, 1 megohm. Output: approx. 200 mV. Response at  $7\frac{1}{2}$  i/s with Wearite deck 30-14,000 c/s. Equalisation for 15,  $7\frac{1}{2}$ ,  $3\frac{3}{4}$  and  $1\frac{7}{8}$  i/s. EM84 level-ind. Controls: bias, selector, indicator, equaliser, gain. Self-powered (separate power pack). Price £22 1s.



**Truvox Ltd.,** Neasden Lane, London, N.W.10. Tel.: Dollis Hill 8011. Cables: Tru oxeng.

**Type M Recording Amplifier.** Inputs: 1 megohm at 1-2 mV;  $\frac{1}{2}$  megohm at 0.5v. Vol. and on/off. Compensated for  $7\frac{1}{2}$  and  $3\frac{3}{4}$  i/s. Record/replay switch. Tone control. High imp. output. H and N -45 dB. Output 4 watts. Primarily for Truvox tape deck. Price £21.

**Type K Mk. 2 Recording Amplifier.** Similar to Type M. Power available for bias and erase. Price £19 19s.



**Vortexion Ltd.,** 257/263 The Broadway, Wimbledon. Tel.: Liberty 6242/3. Cables: Vortexion, Wimble, London.



*Masterlink M3*

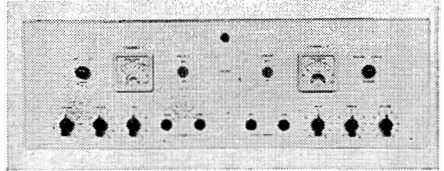

*Shirley TWA/1515*

**3-channel Prof. Mixer.** Built-in mu-metal shielded input transformer, hermetically sealed controls, screened mains transformer. Output 1 m/W, 600 ohm balanced or unbalanced, or float. Peak programme meter calibrated zero level +10 to  $\pm 26$  dB. Size  $18\frac{1}{4} \times 11\frac{1}{4} \times 6\frac{1}{4}$  ins. Price on request.

**4-channel Prof. Mixer.** For 30-50 ohm mic. balanced line or other imps. to order, heavy mu-metal shielded transformers, hermetically sealed controls. Outputs  $\frac{1}{2}$ v on more than 20,000 ohms or 600 ohms, 1 mW. Has own screened power pack for AC mains. Size  $18\frac{1}{4} \times 11\frac{1}{4} \times 6\frac{1}{4}$  ins. Price £40 8s. 6d. 600 ohms output extra. Similar 12 way is also available.

**2MGT.10/15W.** Combined 4-channel mixer and 10/15 watts power amplifier. Distortion 0.1%. F.R. 20-20,000 c/s  $\pm 1$  dB. 24 dB feedback. H and N -80 dB. Out. imp. 4, 8, and 15 ohms. Size  $18\frac{1}{4} \times 11\frac{1}{4} \times 6\frac{3}{8}$  ins. Price £49.

**S/30/50.** Combined 4-channel mixer and 30/50 watts power amplifier. Distortion 0.2%. F.R. 30-20,000 c/s  $\pm 1$  dB. 22 dB feedback. H and N -85 dB. Out. imp. 4, 8, and 15 ohms and 100 volt line. Size  $18 \times 10\frac{3}{4} \times 12\frac{1}{4}$  ins. Price £59.

**120/200 watts power amplifier.** Distortion 0.2%. Input for spec. output 0.775v into 600 ohms. F.R. 30-20,000 c/s  $\pm 1$  dB. 24 dB feedback. H and N -95 dB. Output 110 or 220 volt. Size  $19 \times 12\frac{1}{4} \times 12$  ins. To operate with Vortexion 4-channel mixer or 3-channel plus P.P.M., etc. Price £112.

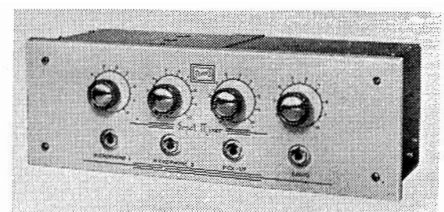

*Stern Model 2H mixer*

**Waverley Electronics Ltd.**, Waverley Road, Weymouth, Dorset. Tel.: Weymouth 1987.

**Waverley Mixer/fader.** Pocket 3-channel mixer. Jack sockets as standard. Input and output. Price £2 5s.

**Waverley Monitor.** Transistorised unit to provide monitoring or act as pre-amplifier. Powered by 2 torch cells. Price £5 5s.

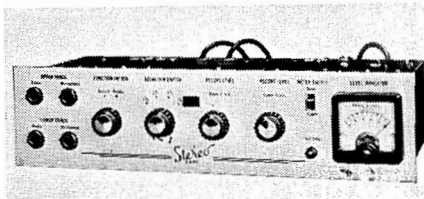

*Stern STP-1 Stereo*

## TAPE ACCESSORIES and COMPONENTS

**Agfa Ltd.**, 27 Regent Street, London, S.W.1. Tel.: Regent 8581. Cables: Telex 23705.

**Tape Accessory Kit.** Three lengths of leader strips in green, red and white. One reel white adhesive tape. One reel of triggering foil. Pair of magnetic scissors. Price £1 7s. 4d.



**AKG (Akustische und Kino-Geräte Ges. m.b.H.)** Sole U.K. and Commonwealth agents, **Politechna (London) Ltd.**, 3 Percy Street, London, W.1. Tel.: Langham 6326. Cables: Polindust, London.

**A.K.G. K50** Dynamic headphones. F.R. 30-20,000 c/s. Impedance 400 ohms per ear piece. Suitable for stereo or mono. Weight 80 grams. Price £7 10s. Ear pads available.



**Bradmatic Ltd.**, Station Road, Aston, Birmingham 6. Tel.: East 2881/2. Cables: Bradmatic, Birmingham.

A range of twin track high impedance sound heads, single hold fixing, pole pieces are cylindrically ground flush with caps. Screening cans available.



*S.G. Brown Super K Headphones*

**Type 5 RP.** Combined record/replay head 0.0004 in. gap. Price £3 5s.

**Type 6 RP.** Super fidelity record/replay head 0.0002 in. gap. Price £3 15s.

**Type 5R.** Record only 0.0007 in. gap. Price £3 5s.

**Type 5E.** Erase head. Price £3 5s.

Full track versions of the above are also available.

■ **Type ST-RP.** Stereo record/replay head. Price with screen can, without fixing stem, £6.



**S. G. Brown Ltd.**, Shakespeare Street, Watford, Herts. Tel.: Watford 27241 Cables: Sidbrownix, Watford.

A range of headphones suitable for recording and dictating equipment, e.g.

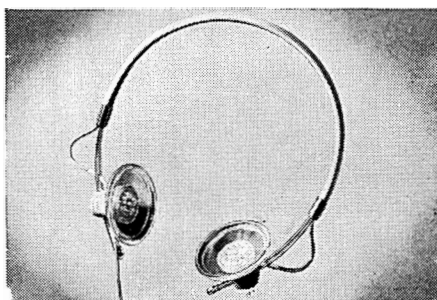

*AKG lightweight headphones, type K50*

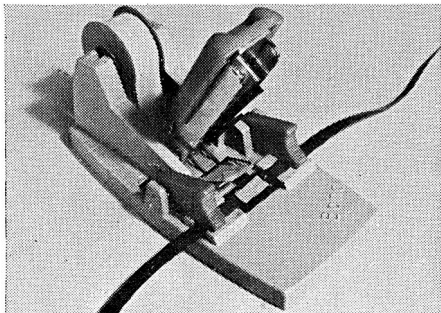

*Bond Tape Splicer*

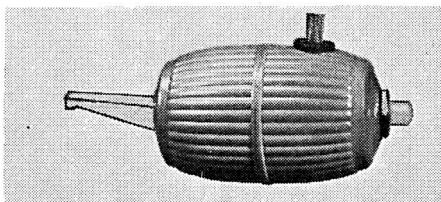

*Cinesmith Depolariser*

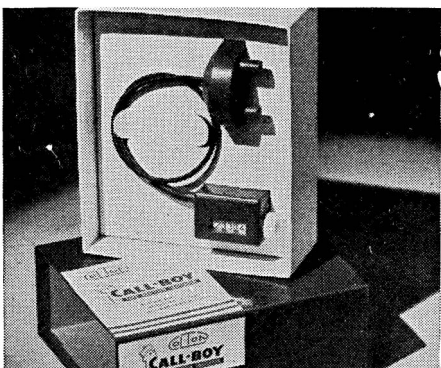

*Colton Call-Boy*

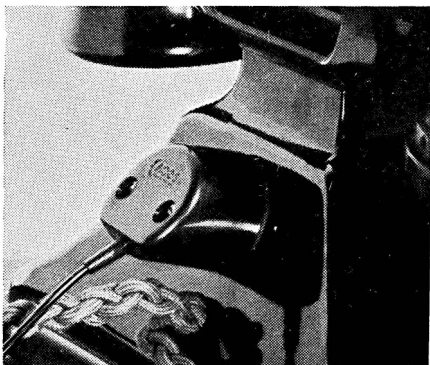

*Acos telephone adaptor*

lightweight miniature model. Prices from £3 5s.

**Super "K"**. Moving coil headphones. Available as monaural or binaural. Price £6 10s.



**Cine Accessories (Brighton) Ltd.**, 15 Bond Street, Brighton, Sussex. Tel.: 27674.

**Bond Tape Splicer**. Semi-automatic; self-contained tape dispenser. Price £1 12s. 6d.



**Cinesmith Products**, Britannic Works, Regent Street, Barnsley. Tel.: Barnsley 4445.

**Cinesmith Depolariser**. For demagnetising record/playback heads in situ. Consists of a plastic moulding with polepiece and push-button switch. Price £1 15s.



**Colton and Co. (Lapidaries) Ltd.**, The Crescent, Wimbledon, London, S.W.19. Tel.: Wimbledon 9401.

**Call Boy**. Counter type position indicator for tape recorders without built-in counter. Price £2 2s.



**Cosmocord Ltd.**, Eleanor Cross Road, Waltham Cross, Herts. Tel.: Waltham Cross 27331.

**Acos telephone adaptor**. Allows recording or amplification of two-way telephone conversations by feeding into mic. or radio input of tape recorder. Price £1 1s.



**Elizabethan (Tape Recorders) Ltd.**, Bridge Close, Oldchurch Road, Romford, Essex. Tel.: Romford 64101.

**Elizabethan Stethoset Headphones**. Lightweight, high impedance. Price £3 13s. 6d.

**Elizabethan Radio/P.U. Connecting Lead**. 3 yards of low loss screen cable fitted with British Standard jack plug coaxial plug. Price 12s. 6d.

**Telephone adaptor**. Price £1 1s.

**E.M.I. Tape Ltd.**, Blyth Road, Hayes, Middx. Tel.: Hayes 3888. Cables: Emitape, London.

**Emiguide.** Comprises six instructional tapes, playing time about 9 minutes, for guidance in using domestic tape recorders.

**Emitape Jointing Compound.** AP35 for C.A. base tape. AP77 for PVC base tape. A jointing fluid for making permanent welded joints in magnetic tape. Price 7s. 6d. per bottle.

**Emitape Jointing Tape.** AP103. Adhesive jointing tape for simple and quick splicing and editing of magnetic tape. Price 7s. 6d. per reel.

**Emitape P.V.C. Leader Tapes.** A range of six coloured tapes to enable colour code references to be inserted in a reel of recorded tape for quick editing and indexing purposes. Packed in plastic dispensers. AP38/1 white; AP38/2 red; AP38/3 yellow; AP38/4 blue; AP38/5 orange; AP38/6 green. Price 4s. 6d. per reel.

**Emitape Plastic Spools** in cartons. AP93 (3-in.) 3s.; AP93N (3½-in.) 3s.; AP85 (5-in.) 4s. 6d.; AP89 (5½-in.) 4s. 6d.; AP87 (7-in.) 5s.

**AP118** (8¼-in. metal spool) 12s. 6d.

**Emitape Jointing Block AP123.** Under-cut channel holds the tape securely enabling a clean cut at 45° or 90°. Price 10s. 6d.

**Emitape Non-magnetic Scissors.** AP39. Made of non-ferrous metal, the scissors may be used for splicing magnetic tape without risk of magnetising, so ensuring a completely noiseless joint. Price 16s.

**Emitape Accessory Kit AP124.** Holds three reels of coloured leader tape, 1 reel of jointing, 1 reel of stop foil, 1 Emitape jointing block, 2 cutters. Packed in plastic rack (to hold 7 spools), designed for the workbench. Price £1 17s. 6d.

**Emitape Metallic Stop Foil.** AP125. Sufficient for 50 tapes. In plastic container. Price 6s. 6d.



**Film Industries Ltd.**, 90 Belsize Lane, Hampstead, London, N.W.3. Tel.: Hampstead 9632. Cables: Troosound, London.

**Microphone Stands.** Desk, table and Floor stands. Grey Hammer finish with

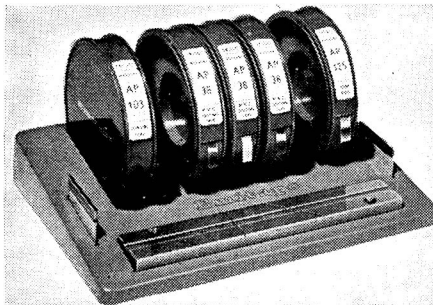

*Emitape Accessory Kit*



*Emitape Plastic Spool Container*



*Grampian G.7 matching unit*



*Grampian Parabolic Reflector*

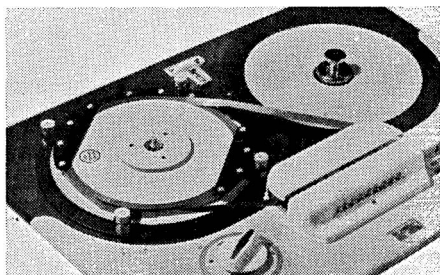

*Guy's Brittape*

cast iron bases, stems in satin chrome. Prices from £1 5s.

**Matching Transformer.** Enclosed in Mu-metal screening case for fitting into microphone lead. Impedance ratio: 30 ohms to 60 K ohms. Price £2 2s.



**Grampian Reproducers Ltd.,** Hanworth Trading Estate, Feltham, Middx. Tel.: Feltham 2657. Cables: Reamp, Feltham.

**Grampian G.7.** Matching units, consisting of double wound transformer in a Mu-metal case with jack socket on the primary and a screened lead on the secondary. Dimensions  $3\frac{3}{8} \times 1\frac{1}{4}$  ins. diameter. Versions available for matching 15/30 ohms, 600 ohms and 50,000 ohms or greater. Price £3 5s.

**Grampian Parabolic Reflector.** Diameter 24 in. depth 5 in. Gain 14 dB over range of 500 c/s to 5,000 c/s. To take Grampian DP4 Microphone. Weight  $4\frac{1}{2}$  lbs. Price £5 15s.



**Guy's Calculating Machines Ltd. (General Engineering Division),** Truro Road, Wood Green, London, N.22. Tel.: Bowes Park 2258. Cables: Guycalc, London..

**Brittape Mk. 2.** Endless tape cassette providing up to 200 ft. of long-play tape and up to 400 ft. of special lubricated double-play tape. Fits all flat topped 7-in. spool tape recorders. Price £6 6s.



**Harvey Electronics Ltd.,** 273 Farnborough Road, Farnborough, Hants. Tel.: Farnborough 1120. Cables: Harvelec, Farnborough, Hants.

A range of bulk erasers for 200-250v or 100-130v mains, 40-60 c/s. Smallest model will take  $3\frac{1}{4}$  to 5-in. spools of  $\frac{1}{4}$ -in. tape, and the largest  $3\frac{1}{4}$  to 12-in. spools of 1-in. tape. Prices, from £6 5s. to £15 10s.



**Leavers-Rich Equipment Ltd.,** 319b Trinity Road, Wandsworth, London, S.W.18. Tel.: Vandyke 9054/6. Cables: Leemag, London, S.W.18.

**LeeRaser.** Junior ER30A; Standard ER31B; Senior ER32B. Ultra rapid de-

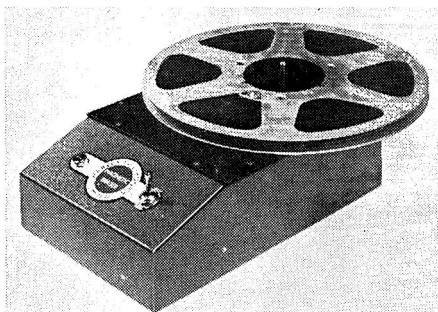

*Harvey Bulk eraser*

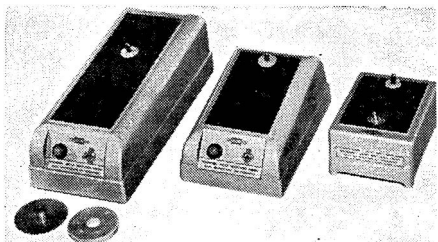

*Leavers-Rich LeeRaser*



*MSS Tape Calculator*



magnetisers for spools of tape and accessories. Price £6 5s.; £9 10s.; £15.



**Metro-Sound Manufacturing Co. Ltd.**, 19a Buckingham Road, London, N.1. Tel.: Clissold 8506/7. Cables: Metro-sound, London.

**Klenzatape.** Cleaning outfit for removing oxide deposits, dirt, etc., from tape heads in situ. Comprises a length of brushed velvet rubber-backed cleaning tape, two 3-in. spools and a bottle of cleaning fluid. Price 12s. 6d.

**Metro-Tabs.** Set of coloured identifying tabs for affixing to recording tape. Visible on the wound spool and may be catalogued on the folder supplied. Price 3s. 11d.

**Metro-Brush.** Made with specially angled Feathersoft Nylon for cleaning inaccessible places on tape decks, ciné cameras, projectors, etc. Price 2s. 6d.

**Metro-Splicer.** Suitable for splicing tape and 8 mm. ciné film. Cuts at any angle. Non-magnetic blade. Price 15s.



**Minnesota Mining and Manufacturing Company**, 3M House, Wigmore Street, London, W.1. Tel.: Hunter 5522. Cables: Minnesota, London.

**Tape Calculator.** Giving playing times of standard, long play and double play tape. Free on request.



**M.S.S. Recording Co., Ltd.**, Colnbrook, Bucks. Tel.: Colnbrook 2431. Cables: Emesco.

**Tape Calculator.** Four speed Tape Calculator giving playing times at a glance. Price 2s. 6d.

**M.S.S. Tape-Rack.** Plastic covered steel rack designed to hold 12 reels of tape, reel sizes from 3 to 7 inches dia. Price 18s. 6d.



**Multicore Solders Ltd.**, Multicore Works, Hemel Hempstead, Herts. Tel.: Boxmoor 3636.

**The "Bib" Tape Splicer.** This splicer enables the tape to be joined easily and to be edited to the accuracy of a syllable.

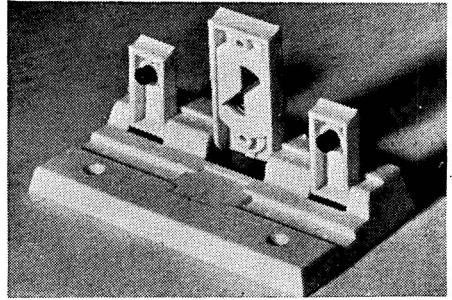

*Metro-Splicer*

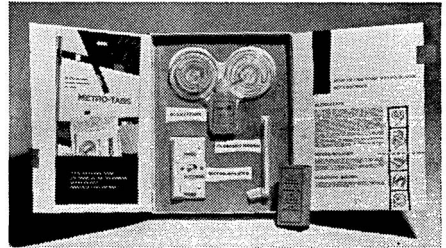

*Metro-Klenzatape*

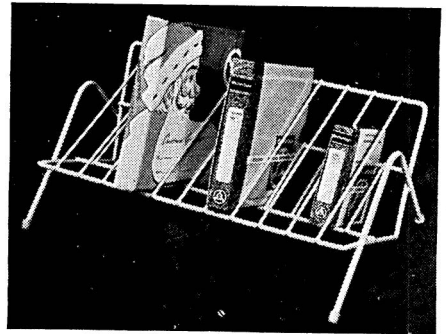

*M.S.S. Tape-Rack*

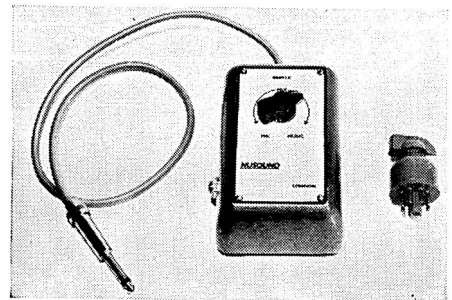

*Nusound Numix and Monitor*



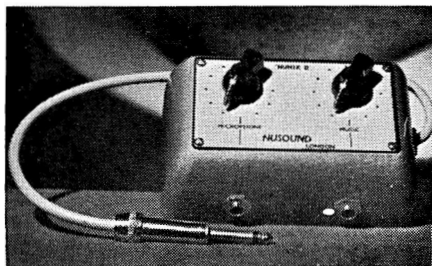

*Nusound Numix 2*

Supplied complete with razor cutter and mounted on flock-covered panel. Price 18s. 6d.

The "Bib" Tape Accessory Kit contains "Bib" tape splicer. Tape reel labels, data card giving tape speeds. Splicing tape and spare cutters. Price £1 8s. 6d.

"Bib" Tape Labels. Suitable for marking tape reels and boxes. Price 2s. 6d.



**Nusound Recording Co.**, 35 Craven Street, London, W.C.2. Tel.: Trafalgar 2080.

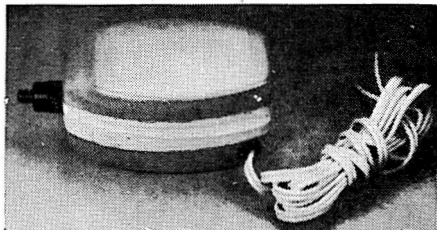

*Osmabet "Instant" Bulk Eraser*

**Nusound Monitor.** Designed for use with Ferrograph recorders Model D, 2A, 3A, 4A and Series 4. Allows monitoring of the recorded signal through the internal loud-speaker. Price, black £1 1s., grey £1 5s.

**Numix 1.** Low impedance two channel mixer. Output: high Z. Single control. For use with Ferrograph Model D, 2A, 3A, 4A. Price £4 7s. 6d.

**Numix 2.** Low or high impedance two channel mixer. Mic. and music control. For use with all tape recorders having a high impedance input microphone stage. Price £6 10s.



**Osmabet Ltd.**, 46 Kenilworth Road, Edgware, Middlesex. Tel.: Stangrove 9314.

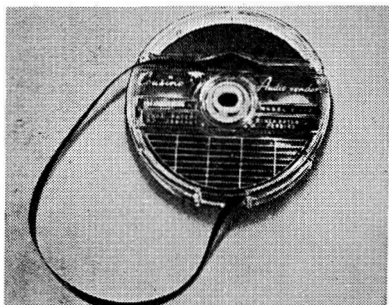

*Philips continuous tape cassette*

"Instant" Bulk Eraser. Operates from A.C. mains to provide rapid and complete erase of tapes prior to making quality recordings. Price £1 7s. 6d.



**Philips Electrical Ltd.**, Century House, Shaftesbury Avenue, W.C.2. Tel.: Gerard 7777. Cables: Phillamps, London.

**Continuous Tape Cassette.** Containing approximately 200 ft. of tape. Allowing continuous playback. Price £5.



**Recording Devices Ltd.**, 44 Southern Row, Kensington, London, W.10. Tel.: Lad-broke 4775.



*Stuzzi Tape Tuner*

**Stuzzi Tape Tuner.** A.M. tuner variable tuning F.R. 190-550m and 1,500m preset. Powered by one PP3 battery. Printed

circuit construction. Size  $5\frac{3}{4} \times 4\frac{1}{4} \times 1\frac{7}{8}$  ins. Price £4 0s. 10d. (U.K. purchase tax £1 8s. 8d.)



**Romagna Reproducers**—Factory distributors, K. H. Williman & Co. Ltd., Blackford House, Sutton, Surrey. Tel.: Melville 1491.

**Romagna Editing Block.** Accurately machined from aluminium and designed to grip the edges of the tape. Diagonal or vertical cuts using razor blade. Price 7s. 6d.



**Simon Equipment Ltd.**, 48 George Street, London, W.1. Tel.: Welbeck 2371. Cables: Simsale, London.

**Stethoscope Head Set.** Operates from ext. L/S socket for monitoring. Price with plug £2 12s. 6d.



**Tape Heads Ltd.**, High Street, Wollaston, Stourbridge, Worcs. Tel.: Stourbridge 6021. Cables: Electronics, Stourbridge. Registered office: Monarch Works, Powke Lane, Old Hill, Staffs.

**Simplex Tape Record Sound Heads.** Complete range of half-track and quarter-track tape record heads. Details and prices on application.



**Tape Recorders (Electronic) Ltd.**, 784/788 High Road, Tottenham, London, N.17. Tel.: Tottenham 0811. Cables: Taperec.

**Sound Stethoset.** Lightweight headphones. Impedance 50 ohms. Weight  $1\frac{3}{4}$  ozs. Price complete with lead and screened plug £2 10s.

**Sound Splicer CM6.** Incorporates strong plastic blades for rapid editing of tapes. Spare blades and guides available. Price £1 12s. 6d.



**Truvox Ltd.**, Neasden Lane, London, N.W.10. Tel.: Dollis Hill 8011. Cables: Truvoxeng, London.

■ **TR2049. Stereophonic Head.** Stacked heads with safety gap for  $\frac{1}{4}$ -in. tape. Azimuth adjustment incorporated—will directly replace Truvox  $\frac{1}{2}$ -track heads. Response 50-15,000 c/s  $\pm 3$  dB with

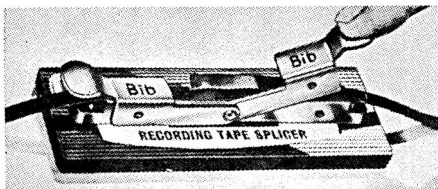

*Multicore "Bib" splicer*

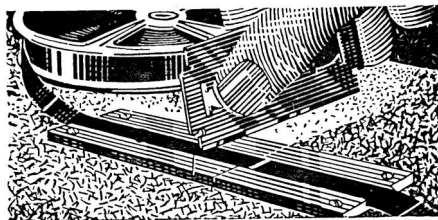

*Romagna Tape Splicing block*

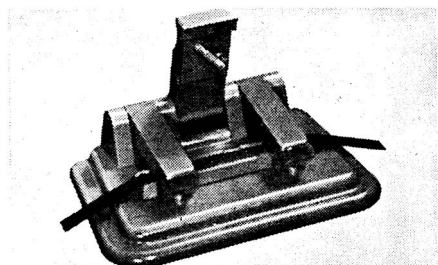

*Sound tape splicer*

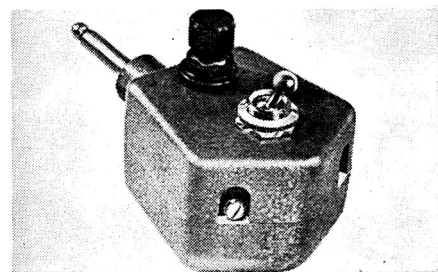

*Truvox Radio Jack*

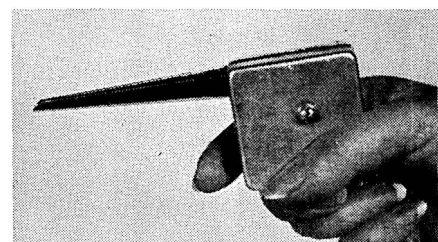

*WAL D-Mag*

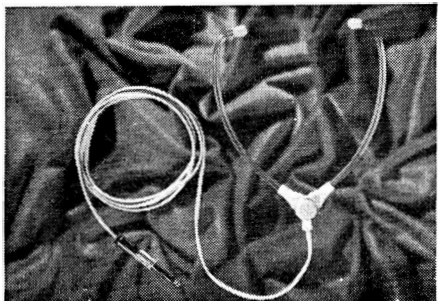

*Sound Stethoset*

suitable amp. Impedance 50,000 ohms at 10 Kc/s. Cross talk better than 45 dB. Price £8 8s.

**Telephone attachment TA 2**, for recording 2-way telephone conversations. Price £1 1s.

**Stethoset TA 2000**, for use with any recorder with low imp. output socket. Price £3 3s.

**Radio Jack TA 3**. Price Standard (M.W. only) £2 10s. (U.K. purchase tax 18s. 4d.).



**Waverley Electronics Ltd.**, Waverley Road, Weymouth, Dorset. Tel.: Weymouth 3721.

**Telecon pickup**. For placing behind telephone (no actual connection) when telephone conversations are to be recorded or amplified. Price £1 7s. 6d.



**Wellington Acoustic Laboratories Ltd.**, Farnham, Surrey. Tel.: Farnham 6461/4961.

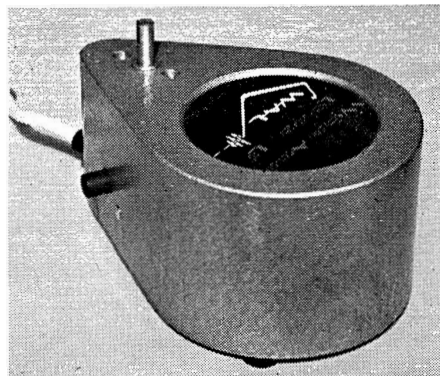

*WAL Tape Eraser*



*Bib Tape Accessory Kit*

**WAL Tape Eraser**. A mains operated tape demagnetiser, accommodates from 5 to 10-in. reels, push button operated. Erases both tracks in a few seconds. Available for 200-250v, 50 c/s or 110-125v, 60 c/s. Price £7 18s. 6d.

**WAL D-MAG**. A mains operated head demagnetiser providing complete de-gaussing circuit. Suitable for erasing short passages from tape or striped film. Price £2 10s.



**Wright & Weaire Ltd.**, 84 Blackfriars Road, London, S.E.1. Tel.: Waterloo 1981. Cables: Writewea, S.E.

**Wearite Defluxer**. For depolarising heads of tape recorders and players. It ensures maximum signal/noise ratio from any tape recorder and protects recorded tapes from cumulative background noise and the gradual attenuation of the higher frequencies. Price £2 10s.

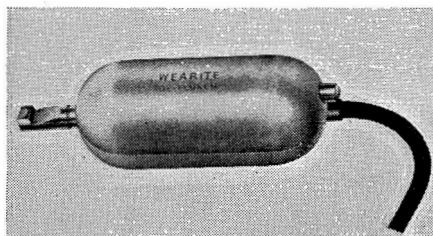

*Wearite Defluxer*

# DIRECTORY OF MAGNETIC TAPE

**Agfa A. G. Leverkusen, W. Germany.**  
**Agfa Ltd., 27 Regent Street, London,**  
**S.W.1. Tel.: Regent 8581.**

**Agfa Magnetonband PE31.** Pre-stressed polyester. Long play. Spool sizes: 3, 5, 5½, 7 in. Price: 9s., £1 8s., £1 15s., £2 10s.

**Agfa Magnetonband PE41.** Pre-stressed polyester. Double play. Spool sizes: 3, 5½, 7 in. Price: 14s., £3, £4.



**BASF Chemicals Ltd., 5a Gillespie Road, London, N.5. Tel.: Canonbury 2011.**  
**Grams.: Forbasf, Phone, London.**

**BASF LGS52.** PVC. Standard play. Spool sizes: 3, 4, 5, 5½, 7, 8½ in. Price: 7s. 6d., 13s. 6d., £1 1s., £1 8s., £1 15s., £2 17s. 6d.

**BASF LGS35.** PVC Long play. Spool sizes: 3, 4, 4½, 5, 5½, 7, 8½ in. Price: 9s., 14s. 6d., £1 1s., £1 8s., £1 15s., £2 10s., £3 12s. 6d.

**BASF LGS26.** PVC. Double play. Spool sizes: 3, 4, 4½, 5, 5½, 7 in. Price: 14s., £1 5s., £1 10s., £2 2s., £2 18s. 6d., £3 17s. 6d.



**C.B.S. International, 12-16 Watling Street, London, E.C.4. Tel.: City 2238.**

**CIP 6 Standard 5-in. 600 ft. 17s. 6d.**  
**CIP 9 5½-in. 900 ft. £1 3s.**

**LP 9 Long play. 5-in. 900 ft. £1 1s. LP 12 5½-in. 1,200 ft. £1 5s. LP 18 7-in. 1,800 ft. £1 15s.**

**CMXP 12 Double play. 5-in. 1,200 ft. £1 8s. CMXP 18 5½-in. £2 7s. CMP 24 7-in. 2,400 ft. £2 16s.**

**CIP-12PR Professional 7-in. 1,200 ft. £1 7s. 6d.**



**Electro-Techno-Dynamics, 101 Leadenhall Street, London, E.C.3. Tel.: Avenue 6982.**  
**Wholesale and retail enquiries to V. L. Dewitt Ltd., 24-26 Hampstead Road, London, N.W.1. Tel.: Euston 5533.**

**Ferrodynamic Brand 5 Acetate.** Spool sizes: 5-in. 600 ft., 16s.; 5-in. 800 ft., 18s. 6d.; 5½-in. 1,200 ft., £1 3s. 6d.; 7-in.

1,200 ft., £1 5s.; 7-in. 1,800 ft., £1 15s.  
**Mylar Dupont:** 3-in. 300 ft., 13s.; 5-in. 1,200 ft., £1 17s. 6d.; 7-in. 1,200 ft., £2; 7-in. 1,800 ft., £2 4s.; and 7-in. 2,400 ft., £3. Super quality Mylar Dupont 7-in. 2,400 ft., £3 10s.



**Electronic World Tapes. J. S. de Villiers, 16/20 Strutton Ground, London, S.W.1. Tel.: Abbey 5960. Cables: Devils, London S.W.1.**

**Standard Play.** Acetate base. Spool sizes: 3, 4, 5, 5½, 7 in. Price: 4 for 18s. (£2 8s. doz.), 4 for £1 5s., 2 for £1 5s., 15s., 17s. 6d.

**Long Play.** Polyester base. Spool sizes: 3, 4, 5, 5½, 7 in. Price: 4 for £1 2s. (£3 doz.), 2 for £1, 2 for £1 13s., £1 2s. 6d., £1 9s.

**Double Play.** Polyester base. Spool sizes: 3, 4, 5, 5½, 7 in. Price: 4 for £1 16s. (£5 doz.), 2 for £1 7s. 6d., £1 5s., £1 13s., £2 2s. 6d.



**E.M.I. Tape Ltd., Blyth Road, Hayes, Middx. Tel.: Hayes 3888. Cables: Emitape, London.**

**"44".** Cellulose acetate. Standard play. Spool sizes: 3½, 5, 5½, 7 in. Price: 6s. 9d., 18s., £1 4s. 6d., £1 10s.

**"77".** PVC. Professional grade. Standard play. Spool sizes: 5, 5½, 7, 8½, 10½, 11½ in. Price: £1 10s., £1 15s. 6d., £2 8s., £3 13s. 6d., £5 4s. 9d., £4 19s. 6d.

**"88".** PVC. Standard play. Spool sizes: 3, 3½, 4, 5, 5½, 7, 8½, 10½, 11½ in. Price: 7s. 6d., 7s. 6d., 10s. 6d., £1 1s., £1 8s., £1 15s., £2 17s. 6d., £3 18s. 9d., £3 13s. 6d.

**"99".** PVC. Long play. Spool sizes: 3, 3½, 4, 5, 5½, 7, 8½, 10½ in. Price 9s. 6d., 9s. 6d., 14s. 6d., £1 8s., £1 15s., £2 10s., £3 12s. 6d., £5 10s.

**"100".** Polyester. Double play. Spool sizes: 3½, 5, 5½, 7 in. Price: 17s., £2 5s., £2 17s. 6d., £4.



**Gevaert Ltd., Great West Road, Brentford, Middx. Tel.: Isleworth 2131. Cables: Artoveg, Brentford Hounslow.**

**Gevasonor Type M.** Acetate. Standard play. Spool sizes: 4, 5, 5½, 7, 10 in. Price: 10s. 6d., 18s., £1 3s. 6d., £1 10s., £2 15s.

**Gevasonor Type LR.** Acetate. Long play. Spool sizes: 3, 4, 5, 5½, 7, 10 in. Price: 7s. 6d., 13s. 6d., £1 4s., £1 8s. 6d., £2 2s., £4.

**Gevasonor Type LRP.** Tensilized polyester. Long play. Spool sizes: 3, 4, 5, 5½, 7, 10 in. Price: 9s., 16s., £1 8s., £1 15s., £2 10s., £4 15s.

**Gevasonor Type DP.** Tensilized polyester. Double play. Spool sizes: 3, 4, 5, 5½, 7 in. Price: 14s., £1 5s., £2 5s., £2 15s., £4.

★

**Kodak Ltd.,** Kingsway, London, W.C.2. Tel.: Holborn 7841.

**Kodak Tape.** Standard. 600 ft., £1 1s. 1,200 ft., £1 15s.

★

**Lee Products (Great Britain) Ltd.**—(Concessionaires of **Audio Devices Inc.** (U.S.A.), Elpico House, Longford Street, London, N.W.1. Tel.: Euston 5754. Cables: Leprod, London.

**Audiotape.** A range of 8 grades and thicknesses for amateur and professional use. Spool sizes: 3, 3½, 4, 5, 5½, 7 in.

★

**Minnesota Mining and Manufacturing Company,** 3M House, Wigmore Street, London, W.1. Tel.: Hunter 5522. Cables: Minnesota, London.

**Scotch 111.** Acetate. Standard play. Spool sizes: 3, 3½, 5, 5½, 7 in. Price: 5s. 3d., 6s. 9d., 18s., £1 4s. 6d., £1 10s.

**Scotch 311.** PVC. Standard play. Spool sizes: 3½, 5, 5½, 7 in. Price: 7s. 6d., £1 1s., £1 8s., £1 15s.

**Scotch 102.** Polyester all-purpose. Spool sizes: 5, 5½, 7 in. Price: £1 2s. 9d., £1 10s. 3d., £1 18s.

**Scotch 150.** Polyester. Long play. Spool sizes: 3½, 5, 5½, 7, 8½ in. Price: 9s. 6d., £1 8s., £1 15s., £2 10s., £3 12s. 6d.

**Scotch 200.** Polyester. Double play. Spool sizes: 3½, 5, 5½, 7 in. Price: 17s., £2 5s., £2 17s. 6d., £4.

**MSS Recording Company Ltd.,** Colnbrook, Bucks. Tel.: Colnbrook 2431.

**MSS Standard.** Spool sizes: 3, 3½, 4, 5, 5½, 7, 8½ in. Price: 5s. 6d., 5s. 6d., 10s., £1, £1 7s. 6d., £1 15s., £2 10s.

**MSS Long Play.** Spool sizes, 3, 3½, 4, 5, 5½, 7, 8½ in. Price: 8s. 6d., 11s., 14s. 6d., £1 8s., £1 15s., £2 10s., £3 10s.

**MSS Double Play.** Spool sizes: 3, 5, 5½, 7 in. Price: 10s. 6d., £2 5s., £2 17s. 6d., £4.

★

**Penco Products,** 36 Coniston Road, Kings Langley, Hertfordshire. Tel.: Kings Langley 3134.

**Orange Line. Standard.** 5, 5½, 7 in. 600, 820, 1,200 ft. Price: 17s. 6d., £1 1s. 6d., £1 7s. 6d. **Long Play.** 5, 5½, 7 in. 885, 1,150, 1,800 ft. Price: £1 1s. 6d., £1 8s. 6d., £1 16s. 6d.

★

**Philips Electrical Ltd.,** Century House, Shaftesbury Avenue, London, W.C.2. Tel.: Gerrard 7777. Cables: Phillamps, London.

**Philips Standard Play.** Green PVC. Spool sizes: 4, 5, 5½, 7 in. Price: 13s. 6d., £1 1s., £1 8s., £1 15s.

**Philips Long Play.** Red PVC. Spool sizes: 3, 4, 5, 5½, 7 in. Price: 9s., 14s. 6d., £1 8s., £1 15s., £2 10s.

**Philips Double Play.** Blue PVC. Spool sizes: 3, 4, 5, 5½, 7 in. Price: 14s., £1 5s., £2 2s., £2 12s. 6d., £3 17s. 6d.

★

**R.C.A. Great Britain Ltd.,** Lincoln Way, Windmill Road, Sunbury-on-Thames, Middx. Tel.: Sunbury-on-Thames 5511.

**R.C.A. Red Seal Professional.** ¼-in tape. **1.0 mil. Long Play.** Acetate base. Spool sizes: 5, 7, 10½ in. Price: £1 7s. 6d., £2 4s. (£4 for NAB hub spool), £5.

**1.5 mil. Professional Grade.** Acetate. Spool sizes: 3, 5, 7, 10½ in. Price: 6s., 19s., £1 10s. (£3 5s. for NABhub), £4 2s. 6d.

**Snap-Load Cartridge Mylar.** Polyester base. 560 ft., £2 2s. 6d.

**0.75 mil. Tensilized Extra-long Play Mylar.** Polyester base. Spool sizes: 3, 5, 7, 10½ in. Price: 14s., £2 5s., £4, £9 10s.

**0.5 mil. Extra-long Play Mylar.** Polyester base. Spool sizes: 5, 7 in. Price: £2, £3 10s.

**1.0 mil. Long Play Mylar.** Polyester base. Spool sizes: 3, 5, 7, 10½ in. Price: 9s., £1 10s., £2 10s. (£4 17s. 6d. for NAB metal hub), £5 17s. 6d.

**1.5 mil. Professional Grade Mylar.** Polyester base. Spool sizes: 5, 7, 10½ in. Price: £1 5s., £2 (£4 5s. for NAB metal hub), £5 5s.

**1.0 mil. Long Play Mylar.** ½ in. Polyester base. 10½-in spool with NAB metal hub. 3,600 ft. Price: £12 15s.

NAB spools have 3-in. centre holes.



**Soundcraft Magnetics Ltd.,** Haddenham, Bucks. Tel.: Haddenham 384 & 422.

**Standard.** Standard play. Tri-acetate base. Spool sizes: 3, 5, 5½, 7 in. Price: 5s., 17s., £1 3s., £1 7s. 6d.

**Standard 50.** Long play. Tri-acetate base. Spool sizes: 3, 5, 5½, 7 in. Price: 7s. 6d., £1 4s. 6d., £1 7s., £1 19s. 6d.

**Plus 50.** Long play. Mylar. Spool sizes: 3, 5, 5½, 7 in. Price: 9s., £1 8s., £1 15s., £2 10s.

**Plus 100X.** Double play. Mylar. Spool sizes: 3, 5, 5½, 7 in. Price: 13s. 6d., £2 2s., £2 12s. 6d., £3 17s. 6d.



**Tape Recorders (Electronics) Ltd.,** 784/788 High Road, Tottenham, London, N.17. Tel.: Tottenham 0811. Cables: Taperec, London.

**Sound Sonocolor W.H.S.** PVC. Standard play. Spool sizes: 3, 3½, 4, 4½, 5, 5½, 7, 9¾ in. Price: 8s., 9s. 6d., 13s. 6d., 16s. 6d., £1 1s., £1 8s., £1 15s., £3 15s.

**Sound Sonocolor W.S.M.** PVC. Long play. Spool sizes: 3, 3½, 4, 4½, 5, 5½, 7, 9¾ in. Price: 9s. 6d., 14s. 6d., 16s. 6d., £1 0s. 6d., £1 8s., £1 15s., £2 10s., £5 5s.

**Sound Sonocolor W.D.T.** PVC. Double play. Spool sizes: 3, 3½, 4, 4½, 5, 5½, 7 in. Price: 14s., £1 1s., £1 5s., £1 11s. 6d., £2 2s., £2 12s. 6d., £3 17s. 6d.

**Sound Sonocolor W.L.4.** PVC. Four track and stereo. Spool sizes: 5, 5½, 7 in. Price: £1 12s. 6d., £2 2s., £2 17s. 6d.

**Super Synchro-Cine.** Black lines printed on yellow backing for synchronizing cine films. 5-in. spool with mirror £2 15s., without mirror £2 10s.



**Telefunken.**—Sole U.K. distributors, **Welme Corporation Ltd.,** 147/148 Strand, London, W.C.2. Tel.: Temple Bar 3357. Cables: Welmecon, London.

**Telefunken Long Play.** PVC. Spool sizes: 5, 5½, 7 in. Price: £1 8s., £1 15s., £2 10s.

**Telefunken Double Play.** PVC. Spool sizes: 5, 5½, 7 in. Price: £2, £2 10s., £3 15s.



**A. C. Farnell Ltd.,** Vicar Lane, Leeds 2. Tel.: Leeds 35111.

**Irish 195.** Acetate. Standard play. Spool sizes: 3, 5, 5½, 7 in. Price: 4s. 11d., 17s., £1 3s., £1 7s. 6d.

**Irish 196.** Acetate. Long play. Spool sizes: 5, 5½, 7 in. Price: £1 4s. 6d., £1 7s., £1 19s. 6d.

**Irish 211.** Acetate. Standard play. Spool sizes: 5, 5½, 7 in. Price: £1 1s., £1 8s., £1 15s.

**Irish 231.** Mylar. Standard play. Spool sizes: 5, 7 in. Price: £1 6s., £2 5s.

**Irish 241.** Mylar. Long play. Spool sizes: 3, 5, 5½, 7 in. Price: 9s., £1 8s., £1 15s., £2 10s.

**Irish 251.** Tensilized Mylar. Double play. Spool sizes: 3, 4, 5, 5½, 7 in. Price: 13s. 9d., £1 5s., £2 5s., £2 12s. 6d., £4.



**Zonal Film (Magnetic Coatings) Ltd.,** Zonal House, Westfields Road, Acton, London, W.3. Tel.: Acorn 6841. Cables: Zonogram, London, W.3.

**Zonatape.** Acetate standard play 3, 5, 5½, 7 in. Price: 5s. 3d., 18s., £1 4s. 6d., £1 10s.

**Zonatape PVC Standard, Extra Play and Double Play** in Standard spool sizes. Price: 5s. 9d., £1 1s., £1 8s., £1 15s.

**Zonatape.** Sprocketed tape ¼ in. Length to order. Price 1¼d. per ft.

Length of tape in feet	Type of spool	Maximum playing times in hours and minutes											
		1 Track			2 Tracks			4 Tracks					
		15 i/s	7½ i/s	3¾ i/s	1½ i/s	7½ i/s	3¾ i/s	1½ i/s	15 i/s	7½ i/s	3¾ i/s	1½ i/s	
3,600	8¼" DP	48	1 36	3 12	6 24	1 36	3 12	6 24	12 48	3 12	6 24	12 48	25 36
2,400	7" DP 8¼" LP	32	1 4	2 8	4 16	1 4	2 8	4 16	8 32	2 8	4 16	8 32	17 4
1,800	7" LP 8¼" S	24	48	1 36	3 12	48	1 36	3 12	6 24	1 36	3 12	6 24	12 48
1,700	5¾" DP	22	47	1 30	3 1	45	1 30	3 1	6 2	1 30	3 1	6 2	12 5
1,200	5" DP 5¾" LP 7" S	16	32	1 4	2 8	32	1 4	2 8	4 16	1 4	2 8	4 16	8 32
900	5" LP	12	24	48	1 36	24	48	1 36	3 12	48	1 36	3 12	6 24
850	5¾" S	11	22	45	1 30	22	45	1 30	3 1	45	1 30	3 1	6 2
600	4" DP 5" S	8	16	32	1 4	16	32	1 4	3 8	32	1 4	2 8	4 16
450	4" LP	6	12	24	48	12	24	48	1 36	24	48	1 36	3 12
400	3¼" DP	5	10	21	42	10	21	42	1 25	21	42	1 25	2 50
300	3¼" LP 4" S	4	8	16	32	8	16	32	1 4	16	32	1 4	2 8
200	3¼" S	2½	5	10	21	5	10	21	42	10	21	42	1 25

Note: The 3 tape thicknesses are listed as S (Standard), LP (Long Play) and DP (Double Play).

# DIRECTORY OF CONSTRUCTIONAL KITS

**Altobass Ltd.**, Percy Road, Aylestone Park, Leicester. Tel.: Leicester 31616. Cables: Altobass, Leicester.

**Altobass Stereo 44 Amplifier.** Inputs: pickup, radio, tape, sensitivity 130 mV. Frequency response 20-20,000 c/s  $\pm$  1 dB.



*Altobass Stereo 44 amplifier*

H and N - 70 dB. Distortion 2.5% at 4 watts (1.5% at 3 watts). Separation better than 40 dB at 1,000 c/s. 4 watts each channel, 8 watts monaural. Output impedance 4, 8 or 16 ohms. Size  $11\frac{1}{2} \times 4\frac{3}{4} \times 9$  ins. Price £18 18s.



**Aveley Electric Ltd.**, Ayrton Road, Aveley Industrial Estate, South Ockendon, Essex. Tel.: South Ockendon 3444. Cables: Telex 24120 Avel, Ockendon.

**F.M. Dynatuner FM-1.** (See tuner section). Price, kit £38 12s. (U.K. Purchase Tax £14 9s. 6d.).

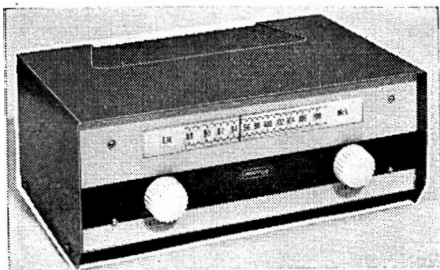

*Jason FM Tuner, FMT3*

**Cossor Instruments Ltd.**, Cossor House, Highbury Grove, London, N.5. Tel.: Canonbury 1234. Cables: Cossor, London.

**1045K.** Single-beam Oscilloscope kit. Printed circuits. 4-in. tube. Y amplifier sensitivity 50 mV/cm, response 5 c/s to

3 Mc/s (30% down), rise-time 0.12 microsec. X amplifier sensitivity 0.75 V/cm, response 2 c/s to 275 Kc/s (30% down), rise-time 1.4 microsec. Intensity modulation. 1 volt calibration source built in. Size  $14\frac{3}{4} \times 9 \times 18\frac{1}{4}$  ins. Weight 18 lbs. Price £34. Assembled £46.



**D.G.C. Ltd.**, 41 High Street, Camberley, Surrey.

**Oakhurst Doric Speaker Enclosure.** To house a single Goodmans Axiette 8-in. speaker. Cabinet available in whitewood or veneered finish. Size  $30 \times 11\frac{1}{2} \times 11\frac{1}{2}$  ins. Price in kit form: £8 whitewood, £11 10s. veneered. Assembled: £10 10s. whitewood, £14 14s. veneered. 10% reduction when ordering stereo pair.

**Oakhurst Ionic Speaker Enclosure** to house a single Wharfedale W10/FSB speaker cabinet. Available in whitewood or veneered finish. Size  $34 \times 13 \times 13$ .

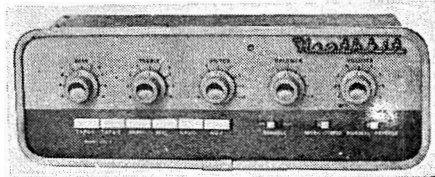

*Heathkit USC-1 stereo pre-amp*

Price in kit form: £10 12s. 6d. whitewood, £14 1s. 3d. veneered. Assembled: £13 whitewood, £17 14s. 6d. veneered. 10% reduction when ordering stereo.

**Oakhurst Corinthian Speaker Enclosure** to house a single Philips AD S200M 12-in. speaker. Size  $34 \times 15 \times 15$  ins. Price in kit form: £13 10s. whitewood, £19 12s. 6d. veneered. Assembled: £17 8s. 9d. whitewood, £21 18s. 9d. veneered. 10% reduction when ordering stereo.

Also the Penfield range of Hi-Fi furniture kits.



**Heathkit.** Manufactured by Daystrom Ltd., Bristol Road, Gloucester, England.

**S-88.** Stereo amplifier kit. 8 watts per channel. Distortion 0.1%. Stability better than 10 dB. Response 30-20,000 c/s  $\pm$  2 dB.



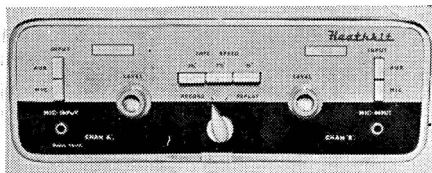

Heathkit TA-1S Stereo tape amplifier



Heathkit S-88 integrated stereo amp

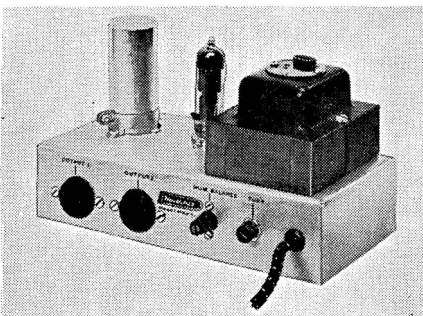

Heathkit MGP-1 power pack

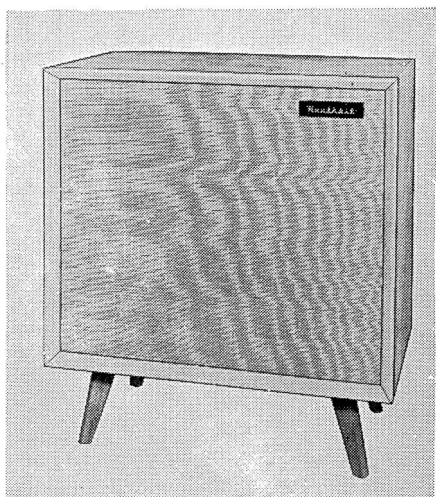

Heathkit Cotswold speaker system

Inputs: pickup 20 mV, radio 200 mV, tape 400 mV. Push-button sel., bass, treble, filter, balance and reversing switch. Size  $13\frac{1}{2} \times 5\frac{1}{2} \times 9\frac{1}{2}$  ins. Price £26 12s. 6d. High sensitivity (4 mV) model S-88B £27.

**S-33.** Stereo amplifier kit. 3 watts per channel. Distortion 0.3%. Input 100 mV at 1 megohm. Bass, treble, balance, volume. Price £12 8s. 6d.

**USC-1.** Stereo pre-amplifier. Inputs: pickup 1, 3-4 mV 50 K; pickup 2, 150 mV 1 megohm; tape 1, 2.5 mV 80K CCIR, tape 2, 150 mV 100K; radio 150 mV; mic. 3 mV 1 megohm; aux., 4-150 mV 1 megohm. Controls: bass, treble, rumble filter, variable low pass filter, balance, volume, function, channel reverse. Power required, 250v 10 mA, 6.3v 1.5 amps. Output voltage 1.3 volts RMS. Price £18 18s. 6d.

**USP-1.** Booster amplifier. Suitable for stereo and monaural sources of low sensitivity, e.g. pickups, tape heads or microphones. Input sensitivity 2-20 mV. Output adjustable from 20 mV to 2 volts. Maximum gain 100. Power requirements 180-250 volts, 3-5 mA; 6.3 volts 0.5 amps. Price £6 17s. 6d.

**SSU-1.** Speaker system kit. Comprises 8-in. and 4-in. matched drive units, and ducted-port bass reflex cabinet. Response 40-16,000 c/s  $\pm 5$  dB, crossover frequency 3,000 c/s. Imp. 15 ohms. Size  $23 \times 11\frac{1}{2} \times 11\frac{3}{4}$  ins. Price complete £11 18s. 6d., without legs, £10 17s. 6d.

**TA-1M.** Pre-amplifier. Inputs. Mic. 0.5mV. Radio 250mV. Switched controls, record/replay, bias, level, mic., radio. H.D.  $<0.1\%$  for 500mV H and N - 60 dB for 500mV. Power supply required 290V 20 mA D.C. 6.3V, 1A per channel. Size  $4\frac{1}{2} \times 13\frac{1}{2} \times 12$  ins. Price £18 2s. 6d.

■ **TA-1S.** Stereo version of TA-1M. Price £23 6s.

**TA-1C.** Conversion Unit for TA-1M to convert to TA-1S. Price £6 10s.

**V-7A.** Valve voltmeter kit. Printed circuit. Measures A.C. volts (0-1.5, 5, 15, 50, 150, 500, 1,500) R.M.S., A.C. volts (0-4, 14, 40, 140, 400, 1,400, 4,000). Peak-to-peak, D.C. volts (0-1.5, 5, 15, 50, 150, 500, 1,500). Ohms (with 10 ohms centre)  $\times 1, 10, 100, 1,000, 10K, 100K, 1$  Meg. 0.1

ohms to 1,000 Megohms with internal battery. Input resistance 11 Megohms. Meter 200 micro-amps. Full scale deflection. Accuracy  $\pm 3\%$  full scale. Price £13.

**MGP-1.** Power supply unit. 200, 250, 270V 120mA; 6.3V, 2.5A. Price £4 16s. 6d.

**OS-1.** Service oscilloscope kit. 2 $\frac{3}{4}$ -in. C.R. tube. Printed circuit. Vertical bandwidth 10 c/s to 2.5 Mc/s. Built-in calibrator. "Y" sensitivity 10 mV R.M.S. per cm. "X" sensitivity 1v R.M.S. per cm. Price £19 10s.

**O-12U.** General purpose oscilloscope kit. 5-in. flat face C.R. tube. Printed circuits. Vertical bandwidth 3 c/s to 5 Mc/s. Built-in 1 volt calibrator. "Y" sensitivity 10 mV R.M.S. per cm. "X" sensitivity 0.12v R.M.S. per cm. Phasing control. Z-axis modulation. Price £36 10s.

**S-3U.** Electronic Switch (oscilloscope trace doubler). Converts a single beam oscilloscope to double beam. Switching rates 150, 500, 1,500, 5,000 and 15,000 c/s. Signal frequency response 0-100 Kc/s  $\pm 1$  dB. Signal input range 0.1 to 1.8 volts R.M.S. Price £10 15s. 6d.

**CM-1U.** Direct-reading capacitance meter. Uses a 4 $\frac{1}{2}$ -in. meter with four ranges as follows: 100 picofarads, 1,000 picofarads, 0.01 microfarads and 0.1 microfarads. Price £14 15s.

**C-3U.** Resistance/capacitance bridge. Self-contained and powered. Capacitance range 0.00001 to 1,000 microfarads. Resistance range 100 ohms to 5 megohms. Power factor and leakage also indicated. Polarising voltages available from 5 to 450 volts. Price £8 6s. 6d.

**AV-3U.** Audio valve millivoltmeter. Measures voltages as low as 1 mV to a maximum of 300 volts at high impedance in 10 ranges. Frequency range 10-400,000 c/s. Uses a 4 $\frac{1}{2}$ -in. meter. Cathode follower output. Price £13 18s. 6d.

**309-CU.** RF probe. Extends the range of a valve voltmeter to 100 Mc/s. Uses a printed-circuit board. Price £1 9s. 6d.

**AW-1U.** Audio wattmeter. Uses external loads or the following internal loads: 3, 8, 15 and 600 ohms. 5 power

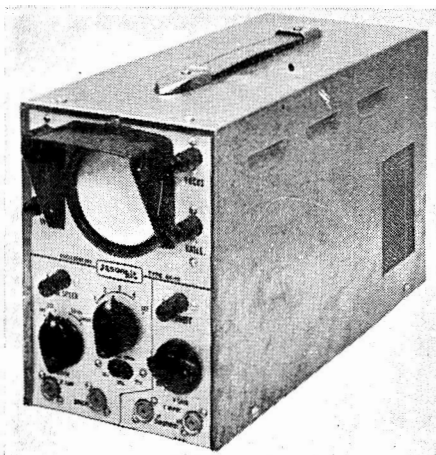

*Jason OG10 oscilloscope*

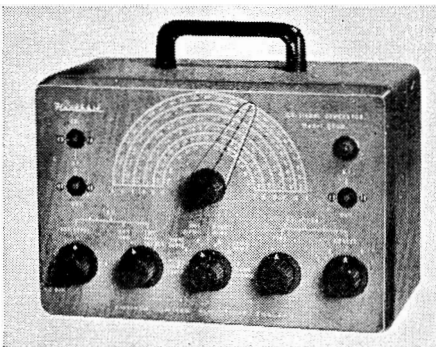

*Heathkit RF-1U R.F. Sig. generator*

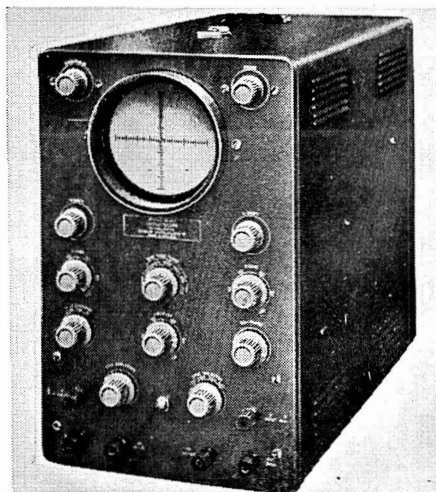

*Cossor 1045K Single-beam oscilloscope*

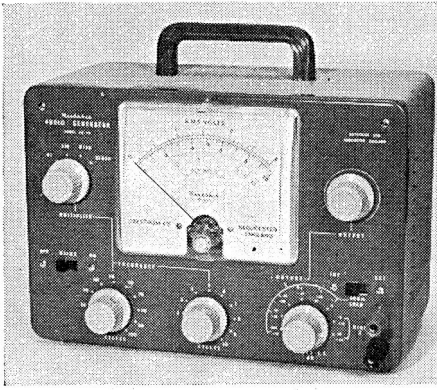

*Heathkit AG-9U Audio generator*

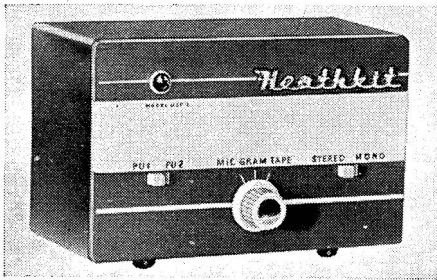

*Heathkit USP-1 booster amplifier*

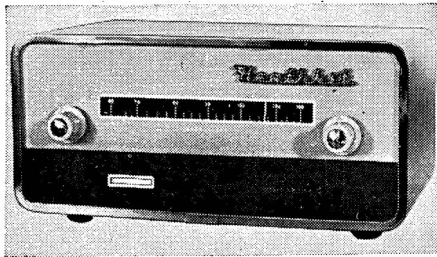

*Heathkit FM Tuner*

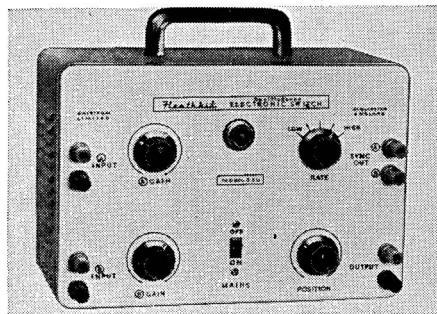

*Heathkit S-3U Electronic Switch*

ranges from 0.5 mW to 50 watts.  $4\frac{1}{2}$ -in. meter calibrated in watts and dB. Price £14 14s.

**AG-9U.** Audio signal generator. Range 10 c/s to 100 Kc/s. Distortion less than 0.1% from 20 c/s to 20 Kc/s. Decade switching over 8 voltage ranges from 3 mV to 10 volts monitored. Uses  $4\frac{1}{2}$ -in. meter. Price £19 19s. 6d.

**AFM/1.** AM/FM tuner. Variable tuning. FM frequency range 88-108 Mc/s. AM frequency range 16-50, 200-550, 900-2,000 metres. Wide band ratio discriminator plus two limiters. Magic eye tuning indicator. Self-powered. Size  $10\frac{1}{2} \times 11\frac{1}{2} \times 4\frac{1}{2}$  ins. Price £24 19s. 6d.

**FM tuner.** Comprises model FMT-4U tuner unit and FMA-4U IF strip and power supply. Flywheel tuning, thermometer tuning indicator, three IF stages with two limiters, printed circuit board and pre-aligned coils. Tuning range 88-108 Mc/s. Sensitivity 2.5 microvolts for 20 dB quieting. Price £14 16s. (for both units).

**Cotswold.** High fidelity three-way loud-speaker. Drive units are 12-in. bass,  $8 \times 5$  ins. elliptical, and pressure tweeter. Range 30-20,000 c/s. Two volume controls. Celotex lined enclosure. In white wood ready cut and drilled. Dimensions  $26 \times 23 \times 14\frac{1}{2}$  ins. Price complete with cross-over unit, etc. £21 19s.

**Chepstow.** Cabinet for hi-fi equipment. Space available for FM tuner, amplifier and record player. Dimensions  $34 \times 32\frac{1}{2} \times 18$  ins. Price £11 5s. 6d.

**Gloucester.** Cabinet for hi-fi equipment. Space available to house records, tapes, etc. Mk. I accommodates tape deck or record player, FM tuner, and stereo amplifier. Mk. II accommodates both tape deck and record player, FM tuner and stereo amplifier. Dimensions: length  $46\frac{1}{8}$ , height 30, depth 21 ins. Price Mk. I £16 13s. 6d., Mk. II £17 18s. 6d.

**Malvern.** Cabinet for hi-fi equipment. Space available for transcription record player, tape deck, radio tuner, audio amplifier (or control unit and separate power amplifiers) and tape record/replay amplifier. Price £17 10s.

Full details of test gear not included in this section can be obtained on application.

Jason Electronic Designs Ltd., Kimberley Gardens, Harringay, London, N.4. Tel.: Stamford Hill 5477.

**F.M.T.1. Standard FM tuner kit.** 4 valves only are used, giving an aerial sensitivity of better than 100 microvolts. A ratio detector is combined with a limiter for low distortion and good noise rejection. Price without valves and power supply £5 19s. Power Pack kit £2 14s.

**F.M.T.2.** This is the same unit as the F.M.T.1, but built into a shelf mounting case. Price, less valves, but with power supply £8 15s.

**F.M.T.3.** A fringe FM tuner with automatic frequency control. Two limiters combat the effects of aeroplane flutter and car interference. Price with case but less seven valves required, £9 19s.

**Argus AM tuner.** Manual tuning. Frequency range 186-530, 1,200-1,800 metres. P.s.n. one 9v battery. Size 9 × 2½ ins. Price £7 10s.

**EM10.** Valve voltmeter. A four valve bridge circuit, gives good stability. May be used as a general purpose meter. 23 ranges including D.C. current range. Price £23.

**AG10.** Audio Generator. A capacity tuned Wien bridge covers from 10 c/s to 100 Kc/s with excellent stability and low distortion while the output is held constant within 1 dB. Output impedance is 600 ohm from a cathode follower and the Attenuator uses resistors of 1% accuracy. The rise time on square waves is better than 2 microseconds. Price kit £15 19s.

**AA10** Audio Attenuator. Nine slide switches give the following attenuation. 40 dB, 20 dB, 20 dB, 10 dB, 10 dB, 5 dB, 2 dB, 2 dB, 1 dB, while the tenth switch allows the addition of a 600 ohm termination resistor. Resistors of 1% accuracy are used. The case measures 13 in. long × 2½ in. wide × 1 in. high. Price kit £7 15s.

**CC10** Crystal Controlled Calibrator. The exact frequency of a generator may be found by connecting the output to this crystal calibrator when the self-contained audio section and loudspeaker allow marker pips to be heard directly. These marker pips are generated at 10 Mc/s, 1 Mc/s, 100 Kc/s and 10 Kc/s so that

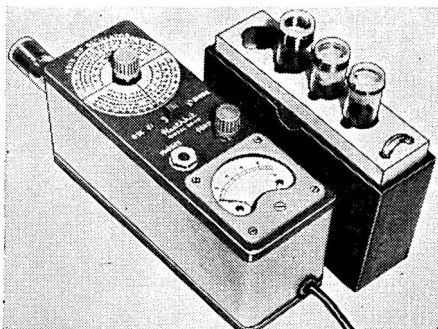

*Heathkit GD-1U Grid Dip oscillator*

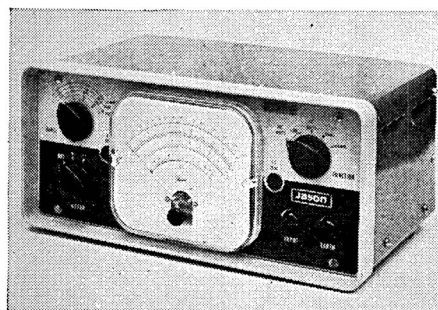

*Jason EM10 Valve Voltmeter*

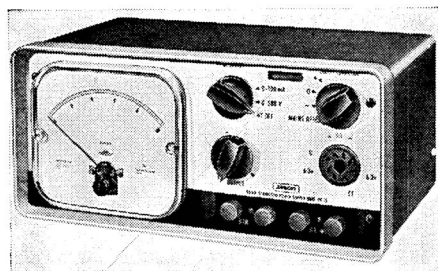

*Jason PP10M stabilised power pack*

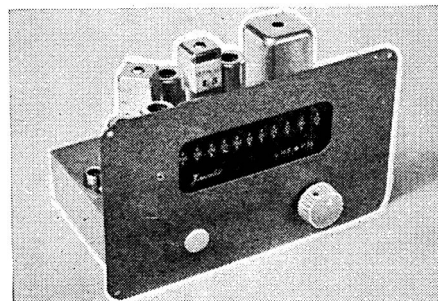

*Jason FMT1 FM Tuner*

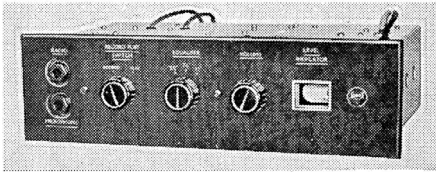

*Stern Type "C" tape pre-amplifier*

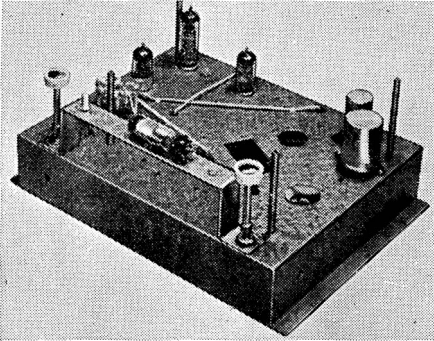

*Stern HF/G3P*

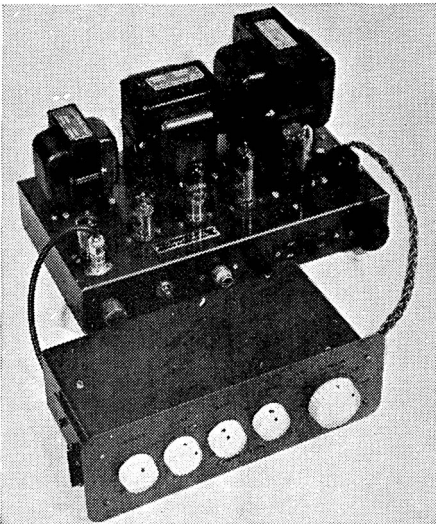

*Cooper-Smith control unit and amplifier*  
generators in the range of 10 Kc/s to 250 Mc/s may be checked. The basic accuracy of 0.01% comes from a 1 Mc/s crystal oscillator. Price kit £19 19s.

**OG10.** 2¼ in. Oscilloscope has a sensitivity of 10 mV/cm with a bandwidth of 2 c/s-2 Mc/s. Sweep linearity is good and push-pull amplifiers are used on both X and Y. Price kit £22 10s.

**JTL.** Stereo tape amplifier kit (see Tape Amplifier section). Price £21.

**Lektra Products,** 118 Gordon Road, London, W.13.

**Gazelle.** Reflex corner kit. One 8- or 10-in. unit, and one tweeter. Size 30 × 23½ × 12½ ins. Weight 20 lbs. Price £6 6s.

**Mayfair.** Reflex corner kit. One 10- or 12-in. unit, and one tweeter. Size 36 × 28 × 16½ ins. Weight 30 lbs. Price £9 9s. Assembled £13 2s. 6d.



**H. L. Smith & Co. Ltd.,** 287/289 Edgware Road, London, W.2. Tel.: Paddington 5891/7595.

See Amplifier Section for details of the following kits:

**Bantam Combined Amplifier and Control Unit.**

**Cooper-Smith 20w Power Amplifier.**

**Cooper-Smith Mk. II Control Unit.**

**Cooper-Smith B.P.I. Amplifier.**

**Prodigy Combined Amplifier and Control Unit.**

**Cooper-Smith Stereo Control Unit.**

**Cooper-Smith Stereo Amplifier.**

**Smith Threesome 3w Integrated Stereo Amplifier.**



**Stern Radio Ltd.,** 109 and 111 Fleet Street, London, E.C.4. Tel.: Fleet Street 5812-14.

**Type C Tape pre-amplifier.** To Mullard design (see Tape Amplifier Section). Price £11 15s., power supply unit £2 15s. extra.

**HF/TR3. Tape amplifier.** To Mullard design (see Tape Amplifier Section). Price, including power supply unit, £13 13s.

**Mullard Pre-amplifier Tone Control Unit.** (See Amplifier Section.) Price £6 6s.

**Mullard "5-10" Amplifier** (See Amplifier Section). Price £10.

**Mullard "10-10" Amplifier** (See Amplifier Section). Price £15 10s.

**Mullard Dual Channel Pre-Amplifier** (See Amplifier Section). Price £12 10s.

**2H Mullard 4-channel electronic mixer** (See Tape Amplifier Section). Price £8 8s. Alternative model 1L, Price £10 5s.

**STP-1 Stereo pre-amplifier** (See Tape Amplifier Section). Price to be announced.

# DIRECTORY OF NEW PRODUCTS

**Bang & Olufsen, Denmark.** Sole U.K. distributors: **Aveley Electric Ltd.**, Ayrton Road, South Ockendon, Essex. Tel.: South Ockendon 3444.

**Belcanto Portable tape recorder.**  $3\frac{3}{4}$  i/s. One motor.  $5\frac{1}{4}$ -in. spools. F.R. 40-11,000 c/s  $\pm 2.5$  dB. S-N - 50 dB. M.E. level ind. Separate tone controls. 6 watts output. Size approx.  $14 \times 12 \times 11\frac{1}{2}$  ins. Weight 25 lbs. Price to be announced.

■ **Type 608 Integrated Stereo Amplifier.** 15 watts per channel. Inputs: pickup, 2 mV; tape 100 mV; radio 100 mV; Bass, treble, balance controls with visual display showing effect of tone controls. Transistorised input stage. Response 20-20,000 c/s  $\pm 1$  dB. Distortion,  $< 0.5\%$  at 10 watts. 16 dB feedback. Crosstalk,  $\pm 50$  dB between channels. N.L. - 60 dB. Output ECL 85's. Out. imp. 15 ohms. Size approx.  $15 \times 9 \times 6$  ins. Price to be announced.



**British Ferrograph Recorder Co. Ltd.**, 84 Blackfriars Road, London, S.E.1. Tel.: Waterloo 1981. Cables: Britferro, S.E.

**Ferrograph Series 420** complete portable stereo/mono recorder.  $7\frac{1}{2}$  and  $3\frac{3}{4}$  i/s. Three motors,  $8\frac{1}{4}$ -in. spools. F.R.  $7\frac{1}{2}$  i/s, 50-15,000 c/s  $\pm 3$  dB;  $3\frac{3}{4}$  i/s, 60-10,000 c/s  $\pm 3$  dB. W and F 0.2% at  $7\frac{1}{2}$  i/s. S-N, - 52 dB. Meter level ind. Outlet from pre-amp. Size  $18\frac{1}{2} \times 17\frac{1}{2} \times 9\frac{3}{4}$  ins. Weight 48 lbs. Price £115 10s.

■ **Ferrograph 424**, spec. and price as the 420 but with provision for 4-track replay mono/stereo.



**Butoba**—Sole U.K. distributors: **Denham & Morley Ltd.**, Denmore House, 175 Cleveland Street, London, W.1. Tel.: Euston 3656.

**Butoba MT7.** Transistorised battery portable. Speed,  $3\frac{3}{4}$  and  $1\frac{7}{8}$  i/s. F.R. 100-12,000 c/s at  $3\frac{3}{4}$ ; 100-5,000 c/s at  $1\frac{7}{8}$ . W and F 0.5%. M.E. level ind. Output 0.8 watts. Four 1.5 V batteries. Weight 8 lbs. Price to be announced. Mains converter available.

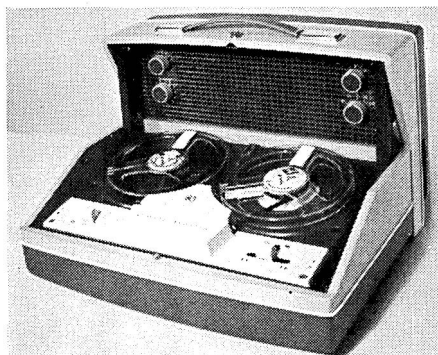

*B. & O. Belcanto*

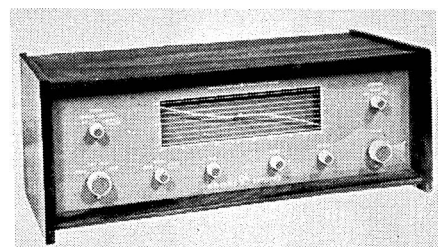

*B. & O. Type 608 integrated amp*

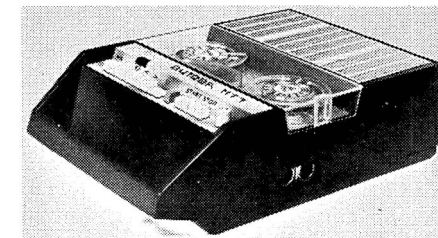

*Butoba MT 7*



*Fi-Cord 202*





Diawa DE-30

**R42.** Cellulose acetate. Standard play. Spool sizes: 3, 3½, 5, 5½, 7 in. Price: 5s. 6d., 8s. 6d., 18s., £1 4s. 6d., £1 10s.

**LD3.** Cellulose acetate. Long play. Spool sizes: 3, 3½, 5, 5½, 7 in. Price: 7s. 6d., 12s. 6d., £1 5s., £1 12s., £2 10s.

**MLD3.** Polyester. Long play. Spool sizes: 3, 3½, 5, 5½, 7 in. Price: 8s. 6d., 12s., £1 8s., £1 15s., £2 10s.

**MDD4.** Polyester. Double play. Spool sizes: 3, 3½, 5, 5½, 7 in. Price: 12s., £1 2s., £2 5s., £2 17s. 6d., £4.

**High Output.** Cellulose acetate. Standard play. Spool sizes: 3, 3½, 5, 5½, 7 in. Price: 7s. 6d., 12s. 6d., £1 5s., £1 12s., £2 10s.

**PR4.** Professional cellulose acetate. Spool size: 10½ in. Price: £4 10s.

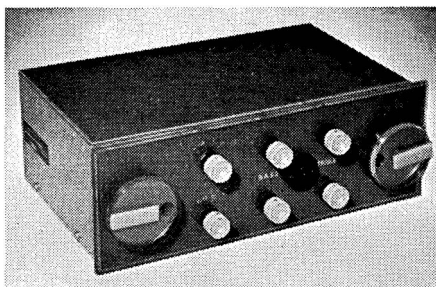

Kerr McCosh DS1 control Unit



**Fi-Cord Ltd.,** 40a Dover Street, London, W.1. Tel.: Hyde Park 3448.

**202 Battery Portable** tape recorder. 7½ and 3¾ i/s. Two motors. 4-in. spools. F.R. 50-12,000 c/s ± 3 dB at 7½ i/s; 50-8,000 c/s ± 3 dB at 3¾ i/s. W and F < 0.3% rms at 7½ i/s; < 0.4% rms at 3¾ i/s. V.U. meter. Mercury batteries. Size 9 × 6½ × 4 ins. Weight 6¾ lbs. inc. batteries. Price inc. tape £69 6s. Mains converter £7 10s. extra.



**Kerr McCosh & Co. Ltd.,** 435 Sauchiehall Street, Glasgow, C.2.

■ **DS1 Stereo control Unit.** Inputs: Pick-up and tape head 4 mV; crystal pickup and tape 75 mV; mic. 1.5 mV. Sel. switch; on/off; separate vol. treble, bass for each channel; flat/tone control. Tape record sockets. Size 12½ × 4½ × 10¼ ins. Price £34.

**C.W.A.10 amplifier.** 10 watts. Dist. 0.1% at 10 watts. N.L. - 85 dB at 10 watts. Response, 25-30,000 c/s ± 0.2 dB, 2-200,000 c/s ± 1 dB. Out. imp. 7 and 15-ohms. Size 11½ × 7¼ × 4½ ins. Price £24.



**Lee Products (GB) Limited,** 10-18 Clifton Street, London, E.C.2. Tel.: Bishopsgate 6711. Cables: Leprod, London, E.C.2.

■ **Stereo-Five Control Unit:** Inputs: Radio & Tape 100 mV; Pick-up: 50 mV - 2

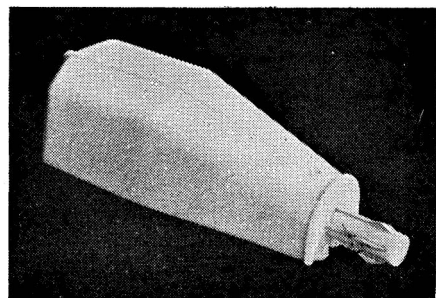

Philips AG 3402 Stereo Pickup

**Cromptons (Manchester) Ltd.,** 29, Minshull Street, Manchester 1.

**Diawa DE-30. Portable recorder.** 7½, 3¾, 1½ i/s. F.R. 70-11,000 c/s at 7½ i/s. 7-in. spools. Price £46 14s. 6d.



**Ferrania, Milan.** Sole U.K. distributors: **Neville Brown & Co. Ltd.,** Electric House, 93/97 New Cavendish Street, London, W.1. Tel.: Langham 7161.

volts (adjustable); Radio & Tape: 250 K ohms; Pick-up: 1 megohm (for low sensitivity pick-ups the TA-6 Transistor Pre-amplifier plugs into the back of the Stereo-Five). Separate bass, treble, balance and volume controls together with six-position selector switch. Size  $12\frac{3}{4} \times 3\frac{1}{2} \times 5$  ins. Price £11 11s. To operate with two DPA-15 or SP-55 amplifier.

**DPA-15 Control Unit.** Inputs: Microphone 1.5 mV, 2 meg.; Tape Replay: 100 mV, 100 K ohms; Radio 1 : 100 mV, 100 K ohms; Radio 2: 300 mV, 560 K ohms. Separate bass, treble and volume control together with six-position selector switch. Size  $11\frac{1}{4} \times 6 \times 7\frac{1}{2}$  ins. Price £9 9s. To operate with DPA-15 amplifier.



**Loewe-Opta.** Sole U.K. Agents, **Highgate Acoustics**, 71/73 Great Portland Street, London, W.1. Tel.: Museum 2901.

**Optacord 403.** Portable tape recorder  $3\frac{3}{4}$  and  $1\frac{7}{8}$  c/s, 5-in. spools, F.R. 40-16,000 c/s at  $3\frac{3}{4}$  i/s; 40-8,000 c/s at  $1\frac{7}{8}$  i/s. M.E. level ind. Size  $14\frac{1}{4} \times 13\frac{3}{4} \times 7\frac{1}{4}$  ins. Weight 21 lbs. Price £45 3s.

**Optacord 404:** Four-track version of the model 403. Price £55 13s.

**Optacord 412.** Mains/battery portable recorder.  $3\frac{3}{4}$  i/s, 4 $\frac{1}{2}$ -in. spools, F.R. 50-12,000 c/s. M.E. level ind. Operates from six 1.5v batteries, car batteries or mains. Size  $14\frac{1}{4} \times 9 \times 4$  ins. Weight 9 $\frac{1}{2}$  lb. Price £47 5s.



**Philips Electrical Limited**, Century House, Shaftesbury Avenue, London, W.C.2. Tel.: Gerrard 7777.

■ **AG-3402 5-contact Stereo Magneto-dynamic pick-up**, microgroove only, 18 micron diamond stylus. Output voltage 2 mV per channel. Range 20-18,000 c/s. S.P. 3-5 gm. Price £7 4s. 1d. (U.K. purchase tax £2 10s. 11d.).



**Radford Electronics Ltd.**, Ashton Vale Estate, Bristol 3. Tel.: Bristol 662301-2.

**Prices of equipment listed in Amplifier Directory.** Stereo Control Unit Type SC2 £24. Stereo Control Unit Type SC3 £30. Power Supply PS1 £8 10s. MA15 Mk. 11 Power Amplifier £19 15s. MA25 Mk. 11

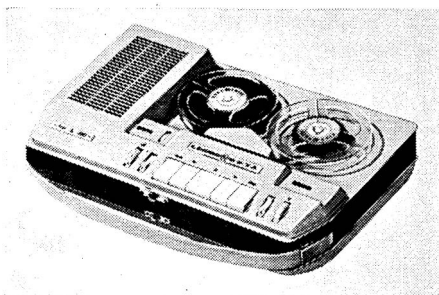

*Loewe-Opta Optacord 403*

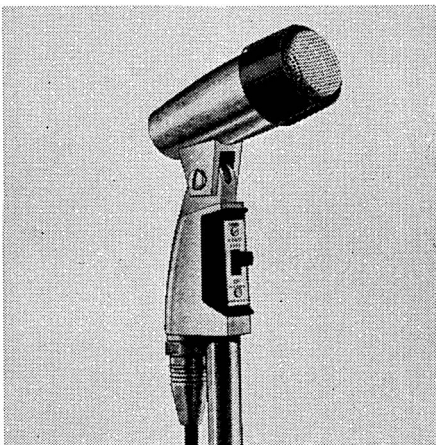

*Shure Sonadyne II*

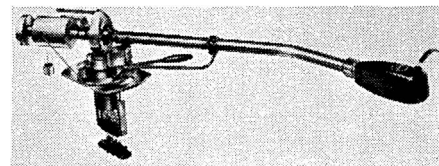

*S.M.E. Models 3009 and 3012 Series II pick-up arm. Decreased mass, extended range of balance, reduced height, bias adjuster standard. Price to be announced. S.M.E. Ltd., Steyning, Sussex.*

Power Amplifier £27 10s. STA12 Mk. 11  
Stereo Power Amplifier £32 10s. STA15  
Stereo Power Amplifier £36 10s.



**Shure Electronics Ltd.**, 84 Blackfriars Road, London, S.E.1. Tel.: Waterloo 6361.

**Sonadyne II Model 540S.** Moving coil microphone. Response 60-10,000 c/s variable. High output. Price £16 13s. 4d.



# stereo decola separates

## turntable unit

Garrard 301 motor unit  
Decca ffs pick-up with Mark I head  
Decca microlift  
Motor and board resiliently mounted  
Housed in walnut Price £55.

## amplifier unit

A twin AF amplifier and power unit  
Power output: 12 W per channel  
Frequency response: flat from 30-25,000 cycles  
Distortion: measured at 10 W  
less than 1% at 1,000 cycles  
less than 1.0% at all other frequencies  
Input: sensitivity 90 mV for full output  
Background: -75 dB referred to 12W  
Output impedance: 15 ohms  
Power supply: input AC 100—110—200—250  
in 10 V steps  
40-60 cycles 200 W consumption Price £45.

## speakers:

1 base unit  
6 HF loudspeakers specially mounted at  
various angles  
Crossover frequency 400 cycles complete  
with built-in crossover units  
Impedance 15 ohms capable of handling  
15 W  
Housed in walnut cabinets with hand-made  
brass grilles Price £53.0.0 each



## radio unit

Magic eye tuning unit  
Fine tuner unit 86-108 megacycles  
Housed in walnut Price £25.

## control unit

Frequency response: 40-25,000 cycles  
(built-in negative feedback rumble-filter)  
Input sensitivity: for 90 mV output  
Gramophone: 14 mV  
Radio: 60 mV  
Auxiliary: 30 mV  
Base and treble controls  
Base: +15 dBs and -9 dBs relative to  
50 cycles  
Treble: +12 dBs and -10 dBs relative to  
10,000 cycles Housed in walnut Price £26.



# *professional* stereo pickup

**Output** 1.2 mV/cm/sec per channel. Suitable for an amplifier system with sensitivity of 5 mVs.

**Impedance** 3,000 ohms at 400 c/s

**Recommended termination** 50,000 ohms

**Diamond stylus radius** 0.0005" to 0.0006"

**Tip mass** Less than 1 milligram

**Compliance** Lateral:  $10 \times 10^{-6}$  cm/dyne Vertical:  $2 \times 10^{-6}$  cm/dyne

**Frequency response** Proportional to recorded velocity.  $\pm 1$ db from 40 to 16,000 c/s

**Cross talk figures** Better than -20 db at 1,000 c/s and -15 db at 50 c/s and 12,000 c/s

**Recommended playing weight** 3.5 grammes

**Dimensions** The overall length of the arm is 12". From the diamond point to the centre axis of rotation of pick-up base 9". From the centre of the turn table pin to the centre axis of rotation of pick-up base 8.375".

Complete 35gns. tax paid Head 16gns. tax paid Arm 19gns. tax paid

**Decca**  
Mark II head  
and  
*Professional*  
arm

From  
DECCA RADIO  
INGATE PLACE  
LONDON S W 8

**Tellux Ltd.**, 44 Brunel Road, London, W.3.  
Tel.: Shepherds Bush 0331.

**Sony 362B Portable Recorder.**  $7\frac{1}{2}$ ,  $3\frac{3}{4}$  and  $1\frac{7}{8}$  i/s. 7-in. spools, F.R.  $7\frac{1}{2}$  i/s, 40-15,000 c/s;  $3\frac{3}{4}$  i/s, 50-9,000 c/s;  $1\frac{7}{8}$  i/s, 50-5,000 c/s. M.E. level ind. H and N - 50 dB. W and F 0.3%. Mixing, Earphone monitoring. Weight 34 lbs. Price £82 19s.

**Sony 262 Portable Recorder.**  $7\frac{1}{2}$  and  $3\frac{3}{4}$  i/s. 7-in. spools. F.R.  $7\frac{1}{2}$  i/s, 70-10,000 c/s;  $3\frac{3}{4}$  i/s, 100-7,000 c/s. M.E. level ind. Earphone monitoring. Size  $15 \times 7 \times 11$  ins. Weight 22 lbs. Price £59 17s.

**Sony III Portable Recorder.**  $3\frac{3}{4}$  and  $1\frac{7}{8}$  i/s. 5-in. spools. F.R.  $3\frac{3}{4}$  i/s, 70-8,000 c/s;  $1\frac{7}{8}$  i/s, 70-4,000 c/s. M.E. level ind. Size  $8\frac{3}{4} \times 4\frac{1}{2} \times 7\frac{3}{4}$  ins. Weight 10 lbs. Price inc. mic., tape, leads and carrying case £30 19s. 6d.

**Sony 101 Portable Recorder.**  $7\frac{1}{2}$  and  $3\frac{3}{4}$  i/s. 7-in. spools. F.R.  $7\frac{1}{2}$  i/s, 50-10,000 c/s;  $3\frac{3}{4}$  i/s, 100-7,000 c/s. V.U. meter. Size  $13 \times 7 \times 10\frac{1}{2}$  ins. Weight 19 lbs. Price £49 7s.

**Sony 1-E.M. Professional Transistorised Battery Portable.**  $7\frac{1}{2}$  i/s. Clockwork 5-in. spools. W and F 1%. F.R. 100-5,000 c/s  $\pm$  5 dB. S-N, - 50 dB. Dist., 3%. Level meter also checks state of batteries. Six dry batteries. Size  $13\frac{1}{2} \times 4\frac{3}{8} \times 6\frac{1}{2}$  ins. Weight approx. 12 lbs. Price £262 10s. complete.

★

**L. G. Woollett & Co. Ltd.**, 21 Anerley Station Road, London, S.E.20. Tel.: Sydenham 9003.

**Electrostatic-Dynamic.** A full range loudspeaker system incorporating a dynamic bass speaker and an electrostatic mid. and upper frequency unit. Response 25-20,000 c/s. Price £46 4s.

**Dynamic Bass drive unit.** Response 25-3,000 c/s. Price £33 12s.

★

**Wyndor Recording Co. Ltd.**, 2 Bellevue Road, Friern Barnet, London, N.11. Tel.: Enterprise 2226.

**Heron Portable Recorder.** B.S.R. deck.  $3\frac{3}{4}$  i/s. 5 $\frac{1}{2}$ -in. spools. M.E. level ind. W and F 0.4%. S-N < - 40 dB. Size  $16\frac{1}{2} \times 14\frac{1}{2} \times 5\frac{1}{2}$  in. Weight 171 lbs. Price, inc. tape and mic., £26 5s.



*Tape Recorder Covers for all popular makes. Prices range from £1 15s. to £3 17s. Further details from A. Brown & Sons Ltd., 24-28, George Street, Hull.*

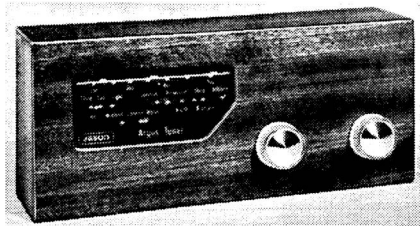

*Jason Argus A.M. Tuner Kit. Transistorised, battery operated, internal ferrite rod aerial. L.W. 1200-1800 metres; M.W. 186-530 metres. Price £7 10s. Jason Electronic Designs Ltd., 2a, Kimberley Gardens, Harringay, London, N.4.*

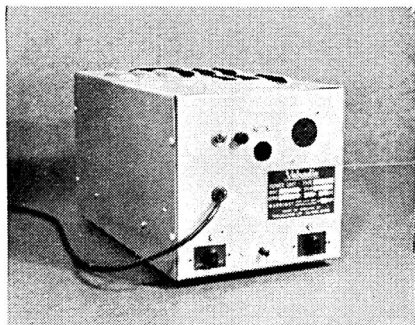

*Valradio Converter for operating mains machines from low voltage or D.C. supply. Prices from £6 10s. Valradio Ltd., Brownells Lane, Feltham, Middlesex.*

# *the* **TAPE RECORDER**

**THE FINEST "TAPE" PAPER**

● Overseas agencies are invited to write to our Distribution Dept. for supply details of this lively magazine.

● Readers in all parts of the world may join our subscription list 12 monthly copies plus annual index, 24/- (U.S.A. and Canada \$3.25).



**PRICE 1/6 MONTHLY**



**THE TAPE RECORDER**  
99 MORTIMER STREET, LONDON, W.1

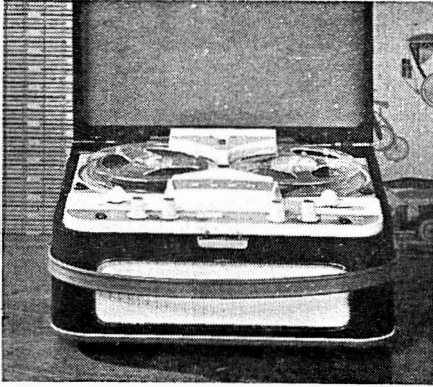

Bush TP50, 4-track portable recorder,  $3\frac{1}{2}$  i/s;  $5\frac{1}{2}$  in. spools; 7 x 4-in. speaker; bass and treble controls. Price £42. Bush Radio Ltd., Power Road, Chiswick, London, W.4.

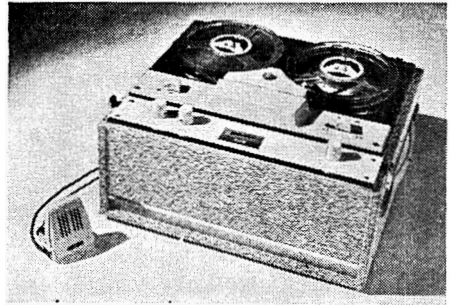

Ekco. RT 366, portable recorder,  $3\frac{1}{2}$  i/s  $5\frac{1}{2}$ -in. spools, M.E. level ind. 7 x 4-in. speaker. Size  $7\frac{1}{2}$  x  $13\frac{1}{2}$  x  $11\frac{1}{2}$ . Weight 22 lb. Price £29 8s. RT 391, 4-track version. Price £33 12s. Ekco Radio & Television Ltd., Southend-on-Sea, Essex.

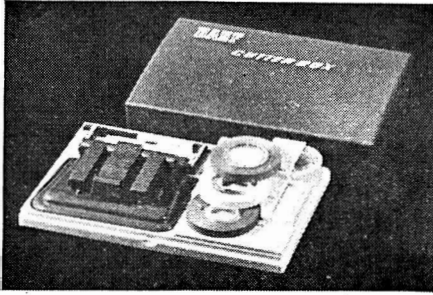

B.A.S.F. Tape Editing Kit contains splicer; spare knife; 4 tape clips, stop foils, splicing tape, 3 leader tapes, spool labels. Price £2 12s. 6d. B.A.S.F. Chemicals Ltd., 5a, Gillespie Road, London, N.5.

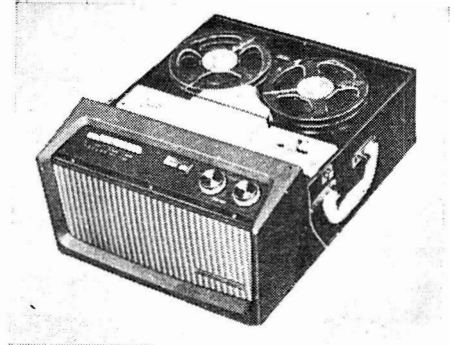

H.M.V. 2202 4-track portable recorder  $3\frac{1}{2}$  i/s;  $5\frac{1}{2}$ -in. spools, 8 x 6-in. speaker. Price £35 14s. The British Radio Corporation Ltd., 21, Cavendish Place, London, W.1.



E.M.I. Voicemaster 4-track portable recorder  $7\frac{1}{2}$ ,  $3\frac{1}{2}$  i/s 7-in. spools, 10 x  $4\frac{1}{2}$ -in. and  $2\frac{1}{2}$ -in. speakers. Price £68 5s. The Gramophone Co. Ltd., E.M.I. Sound Division, Hayes, Middx.



Martin Recordakits, for building complete recorders using B.S.R. or Collaro deck. Martin Electronics Ltd., 155, High Street, Brentford, Middlesex.



# THE ASSOCIATION OF PROFESSIONAL RECORDING STUDIOS LTD.

*Incorporated 1951*

An Association to promote and protect the interests of Members and stimulate interest in the use of electrical recording.

Professional recording studios are invited to apply for Membership—others concerned with recording may be elected as Associates.

**Write for information to the General Secretary,  
34a, Arterberry Road, London, S.W.20**

## DIRECTORY OF MEMBERS AND ASSOCIATES

Studio	Telephone No.	Address
<b>LONDON AREA</b>		
Paul Addinsell Advison Ltd.	LEE Green 2730	13, Pond Road, S.E.3.
Bishop Sound & Electrical Co. Ltd.	GROsvenor 3342/4	82/83, New Bond Street, W.1.
The British Homophone Co. Ltd.	TEmpLe Bar 7484	48, Monmouth Street, W.C.2.
Central Sound Studio	NEw Cross 1353	Excelsior Works, Rollins Street, S.E.15.
Ching & Carey	TEmpLe Bar 6061	6, Denmark Street, W.C.2.
Custom High Fidelity	HAMpstead 8256	38A, Hollycroft Avenue, N.W.3.
T. H. Eaglestone	PALmers Green 5228	371, Green Lanes, Palmers Green, N.13.
Electrical & Musical Industries Ltd. (Retail Division)	CUNningham 0364	162, Shirland Road, W.9.
Fidelity Recording Co.	MAYfair 1240	363, Oxford Street, W.1.
Garland Bros. Ltd.	FINchley 8255	Fidelity House, 6, Grosvenor Road, N.3.
Griffiths Hansen (Recordings) Ltd.	TIDeway 4412	Chesham House, Deptford Broadway, S.E.8.
John Hassell Recordings	MUSEum 2771 & 6375	24/25, Foley Street, W.1.
Keopton Recording Service	RIVERSide 7150	21, Nassau Road, S.W.13.
Levy's Sound Studios Ltd.	LEE Green 3310	1, Knighton House, Manor Way, S.E.3.
Livingston Recordings Ltd.	MAYfair 8521	73 & 104, New Bond Street, W.1.
Magnegraph Recording Co. Ltd.	ARCHway 6251	Rescar Street, N.19.
R. G. Mander Ltd.	LANgham 2156	1, Hanway Place, Oxford Street, W.1.
Mobile Recording Services	TEmpLe Bar 1107	53, Monmouth Street, W.C.2.
Olympic Sound Studios	MITcham 7278	54A, Charlmont Road, S.W.17.
Queensway Recording Studios Ltd.	HUNter 1635	Carton Street, W.1.
Rapid Recording Service	BAWtwater 4992	123 Queensway, Bayswater, W.2.
Recorded Productions (London) Ltd.	COPPermill 3889	The Chestnuts, 21, Bishops Close, Church La., E.17.
Recorded Sound Ltd.	LARKSwood 7889	Morris House, 1, Jermyn Street, S.W.1.
Recording & Transcription Service	TRAFalgar 2618/9	27/31, Bryanston Street, Marble Arch, W.1.
Regent (B. & E.) Sound Ltd.	GROsvenor 4634 & 3726	6, Chiltern Gardens, Cricklewood, N.W.2.
*Ritorna (Mrs. C. E. Jones)	SPEEdwell 5670	Denmark Street, W.C.2.
Leslie Robinson	TEmpLe Bar 6769	55, Redston Road, Hornsey, N.8.
Sonotape Ltd.	MOUnview 1451	120, Barriedale, New Cross, S.E.14.
Sound Enterprise	TIDeway 5028	18, Soho Square, W.1.
Sound News Productions	GERrard 8464	2, Singleton Scarp, Woodside Park, N.12.
Star Sound Studios Ltd.	HILLSide 7612	10, Clifford Street, New Bond Street, W.1.
Toucan Sound Productions	REGEnt 2745	Rodmarton Mews, Blandford Street, W.1.
Universal Programmes Corporation Ltd.	LANgham 2201	122, Fernlea Road, Balham, S.W.12.
Leonard Wadsworth & Co. Ltd.	BALHam 8313	35, Portland Place, W.1.
Warren Recordings	LANgham 2000	Bank Buildings, 47, Wimbledon Hill Road, S.W.19.
	WIMbledon 9871/2/3	59, Hendale Avenue, Hendon, N.W.4.
	SUNNyhill 0306	
<b>HOME COUNTIES</b>		
Cathedral Sound	CHLswick 0739	38, Nutfield Gardens, Northolt, Middlesex.
Conway Sound Recordings	Burnham 381	29A, Kent Road, West Wickham, Kent.
J. R. T. Davies	Sellingde 3195	1, Walnut Tree Cottage, Burnham, Bucks.
Gospel Recordings	CREscent 8947	101, Grange Road, Ilford, Essex.
Hayton Recording Co. Ltd.	Burnham 1208	Hayton Manor, Stanford, Nr. Ashford, Kent.
Ilford Sound Recording Service	MITcham 3668	63, Aintree Crescent, Barking-side, Ilford, Essex.
A. R. Itter	Maidenhead 230	99, Green Lane, Burnham, Bucks.
R. G. Jones (of Morden) Ltd.	Colnbrook 284	Morden Park Sound Studios, London Road, Morden, Surrey.
MJB Recording & Transcription Service	Tring 3135	7, High Street, Maidenhead.
M.S.S. Recording Co. Ltd.	Potters Bar 6428	Poyle Close, Colnbrook, Bucks.
D. R. Neale	ENfild 1179	London Lodge, London Road, Tring, Herts.
Omega Recording Co.	UPLands 7667	112, Sunny Bank Road, Potters Bar, Middlesex.
Sound Snapshots	Pinner 6114	17, River View, Enfield, Middlesex.
Soundwork Services	Princes Risborough 518	Soundwork House, Station Approach, Coulsdon South, Surrey.
Studio Republic Ltd.	Leigh-on-Sea 74752	Church Farm, High Street, Pinner, Middlesex.
Transacord Ltd.		Bledlow Road, Princes Risborough, Aylesbury, Bucks.
Soundtrack		149A, Leigh Road, Leigh-on-Sea, Essex.

Studio	Telephone No.	Address
<b>SOUTH</b>		
Arco Sound Recording Unit Audio Recordings John King Films Ltd. Lawrence Recordings Personal Recordings Ltd.	Crawley 25830 Amesbury 2011 Brighton 5918/9 Portsmouth 31083 Worthing 9160	23, Gosspops Drive, Crawley, Sussex. 65, Solstice Rise, Amesbury, Wilts. Film House, East Street, Brighton. 41, Festing Road, Southsea, Hants. 22, New Broadway, Tarring Road, West Worthing, Sussex. High Fidelity House, 12 Maud Road, Dorchester, Dorset.
Wessex Sound Recordings	Dorchester 1472	
<b>SOUTH MIDLANDS</b>		
Isis Recording Studios Snellgrove's	Oxford 2858 Cum nor 2733	15, Broad Street, Oxford. 3, Third Acre Rise, Botley, Oxford.
<b>EAST</b>		
Jack Bryant Jaybee University Recording Co.	Cromer 2150 Cambridge 57947	Church Square, Cromer, Norfolk. 75, Bramford Road, Ipswich, Suffolk. 16, Burleigh Place, Cambridge.
<b>WEST AND SOUTH-WEST</b>		
Bristol & West Recording Service Ltd. Fidelity Recording Studio Record Centres (Bristol) Ltd. Vincent Roussele	Bristol 20763 Weston-s-Mare 6702 Bristol 28752	6, Park Row, Bristol, I. 49, Westbrook Road, Weston-super-Mare. 5, Denmark Street, Bristol, I. Arcade Chambers, High Street, Newport, Mon.
<b>MIDLANDS</b>		
Benn Radio & Electrical Co. Ltd. B.P.S. Sound Recordings Davlan J. H. Fletcher	Rugby 3347/8 Coventry 75403	39, Albert Street, Rugby. 111, Sewall Highway, Coventry. Craven Street, Coventry. 101, Mulberry Road, Dudley Fields, Bloxwich, Walsall, Staffs.
Hollick & Taylor Recording Co. Ltd. N. Marshall Ltd. Millar Thomson	Birchfields 4246 Nottingham 77077 Hillingbury 1314	16, Grosvenor Road, Handsworth Wood, Birmingham, 20. Maville Works, Beech Avenue, Nottingham. 112, Alcester Road South, King's Heath, Birmingham, 14.
Northampton Sound Recording Services Victor Buckland Ltd.	Northampton 33933 Derby 46292	36A, Spring Gardens, Northampton. 37/39, London Road, Derby.
<b>NORTH-EAST</b>		
*Henry Askwith *Gestrian Sound Services The C.V.S.R. Group Peter Dearden Excel Services Fairbank, Harding Ltd. Fields Radio Ltd. A. J. Glover & Sons Hulland Studio Reproducers Mortonsond (G. L. Morton & Co. Ltd.) Northern Sound Services Ltd. Sound Recording & Equipment Hire Sunderland Sound Services	Leeds 663612 Hebden Bridge 108 Darlington 3989 Shipley 55779 Pudsey 2558/3635 Doncaster 3160 Richmond 2241 Dewsbury 3031 Newcastle 2-6902 Newcastle 26304/5 Leeds 26192 Sunderland 57032	83, Shaftesbury Avenue, Leeds, B. 32, Melville Street, Chester-le-Street, Co. Durham. *Glenbraes, Mytholm, Hebden Bridge, W. Yorks. 19, Post House Wynd, Darlington. 49, Bradford Road, Shipley, Yorks. 6A, Loughton, Pudsey, Yorks. 52, Hall Gate, Doncaster. Finkle Street, Richmond, Yorks. Red Gables, Northfield Road, Dewsbury, Yorks. 12, Oxford Street, Newcastle-upon-Tyne.
Fred W. Wood Ltd.	Grimsby 5021	Broad Chare, Quayside, Newcastle-upon-Tyne. Wade Buildings, 21, Wade Lane, Leeds, 2. 28, Viewforth Terrace, Fulwell, Sunderland, Co. Durham 24A, Bull Ring, Grimsby, Lincs.
<b>NORTH-WEST</b>		
Deroy Sound Service "Eroica" Sound Recording Services Harker & Howarth (Music) Ltd. Jack Michaels Mobile Recordings The Music Box A. Oliver & Son Ltd. Personal Recording Services P. F. Phillips Rendezvous Records R. H. Sound Recording Service W. D., Welsby Western Sound Recorders Ltd.	Hest Bank 2444 Eccles 1624 Bolton 6247 Blackpool 62465 Southport 3778 Cloughton 4023 St. Helens 5752 Anfield 5297 Rusholme 6868 Whitefield 2755 Rainhill 143 Warrington 2553	52, Hest Bank Lane, Hest Bank, Lancaster. 31, Peel Street, Eccles, Manchester. 7, The Arcade, Bradshawgate, Bolton. 219, Westmoreland Avenue, Blackpool. 16, Eastbank Street, Southport, Lancs. 13, Wellington Road, Oxton, Birkenhead, Cheshire. 15, Robin's Lane, St. Helens, Lancs. 38, Kensington, Liverpool, 7. 19, Blackfriars Street, Manchester, 3. 3, Kings Avenue, Whitefield, Manchester. Red Trees, View Road, Rainhill, Lancs. 11, Wilson Patten Street, Warrington.
<b>WALES</b>		
Acoutape Ron Clough Colbeck-Lewis Recordings Glamorgan Recording Services South Wales Recording Services Welsh Recordings	Llandudno 76533 Llanddulas 378 Cardiff 33251 Cardiff 37762 Cardiff 37906 Llanelly 3198	26, St. David's Road, Llandudno. The Groove, Station Road, Llanddulas, Abergelle, Denbighshire. 14, Kyveilog Street, Cardiff. 24, Marlborough Road, Cardiff. 21, Connaught Road, Roath, Cardiff. Marble Hall Road, Llanelly, Carmar.
<b>SCOTLAND</b>		
Alexander Biggar Ltd. Grampian Sound Service Jeffreys (George Jeffrey Ltd.) Larg & Sons (Dundee) Ltd. R. C. Miller	Douglas 8774 BRldgeton 1202 Fou 8389 Dundee 26061	271-5, Sauchiehall Street, Glasgow, C.2. 15, Broompark Drive, Dennistoun, Glasgow. 23, Earl Grey Street, Edinburgh, 3. 16-24, Whitehall Street, Dundee. 136, Crown Street, Aberdeen.
<b>IRELAND</b>		
Audiofare Peter Hunt Recording Studio Ltd. Stapleton Studios	Dublin 62215 Dublin 54011 & 54952 Dublin 66327	59, Merrion Square, Dublin. 130, St. Stephen's Green, Dublin. Merrion Court, Merrion Row, Dublin.

\*Associate

your final choice



**REVOX**

**AUDIOCRAFT LTD**

296 KENSINGTON HIGH ST., W.14  
WESTERN 4343  
89-90 HIGH ST., ETON WINDSOR 1517

*Trade Inquiries Invited*

# DIRECTORY OF HI-FI DEALERS

**IMPORTANT NOTE:** The following list is of shops where stocks of equipment are kept, and where facilities for demonstration exist. It is not necessarily a complete list, and we invite new dealers to submit details for future publications.

## LONDON AREA

AUDIOCRAFT (LONDON) LTD., 296 Kensington High Street, W.14

AUDIO SERVICES, 82 East Barnet Road, New Barnet, Herts.

BERRYS (SHORT WAVES) LTD., 25 High Holborn, W.C.1

CHELSEA RECORD CENTRE LTD., 203 Kings Road, S.W.3

CITY SALES & EXCHANGE LTD., 93 Fleet Street, E.C.4

CLYNE RADIO LTD., 18 Tottenham Court Road, W.1, 162 Holloway Road, N.7, and 9 Camberwell Church Street, S.E.5

CUSTOM HIGH FIDELITY, 371 Green Lanes, Palmers Green, N.13

ELECTRONICS (FLEET STREET) LTD., 152/3 Fleet Street, E.C.4

C. G. GOODWIN LTD., 7 The Broadway, Wood Green, N.22

GRAMOPHONE EXCHANGE LTD., 80-82 Wardour Street, W.1

H. C. HARRIDGE, 8 Moor Street, Cambridge Circus, W.1

THOMAS HEINITZ, 100 Queensway, W.2

ALFRED IMHOF LTD., 112 New Oxford Street, W.C.1

LARGS OF HOLBORN, Hanover House, 76/77 High Holborn, W.C.1

LASKY'S RADIO—LASKY'S (HARROW ROAD) LTD., 207 Edgware Road, W.2, and 33 Tottenham Court Road, W.1

LEE ELECTRONICS, 400 Edgware Road, W.2

LEWIS RADIO CO., 100 Chase Side, Southgate, N.14

MODERN ELECTRICS LTD., 120 Shaftesbury Avenue, W.1

MUSICRAFT HI-FI CENTRE, 20-22 High Street, Southall  
NEWBURY RADIO, 272 Romford Road, Forest Gate, E.7

H. NORMAN DAVIS LTD., 91 The Broadway, Mill Hill, N.W.7

NUSOUND RECORDING CO., 35 Craven Street, W.C.2

RIMINGTON VAN WYCK LTD., 42/43 Cranbourn Street, W.C.2

H. L. SMITH & CO., LTD. 287-9 Edgware Road, W.2

A. L. STAMFORD, 98 Weymouth Terrace, E.2

STERN RADIO LTD., 109 Fleet Street, E.C.4

STUDIO 99, 57 Fairfax Road, Swiss Cottage, N.W.6

TELE-RADIO (1943) LTD., 189 Edgware Road, W.2

TELESONIC LTD., 92 Tottenham Court Road, W.1

WEBB'S RADIO, 14 Soho Street, Oxford Street, W.1

## BANGOR (N. WALES)

JOHN SHINN & SONS LTD., 109 High Street

## BATH (SOMERSET)

C. MILSOM & SON, North Gate

## BEXLEYHEATH (KENT)

Broadway Radio, 228 Broadway

## BIRMINGHAM

GRIFFIN RADIO LTD., 94 Bristol Street

HOLLICK & TAYLOR, 16 Grosvenor Road, Handsworth Wood

JEWKES & CO. LTD., 285 Broad Street

NORMAN H. FIELD, 1 Lodge Road

## BLACKPOOL

F. BENFELL LTD., 17 Cheapside

METCALFE'S RADIO STORES, 121 Whitegate Drive

## BOGNOR REGIS

TANSLEY & COOKE LTD., 3/4 Odeon Buildings, and 46 Aldwick Road

## BOLTON

HARKER & HOWARTH (MUSIC) LTD., 7 The Arcade, Bradshawgate

H. D. KIRK (STEREOELECTRICS), 150 Higher Bridge Street

## BOURNEMOUTH (HANTS)

NATIONAL RADIO SUPPLIES, 66 Holdenhurst Road

## BRACKNELL

PACK'S LTD., High Street

## BRADFORD

SOUND CENTRE, 16 Ivegate

## BRIGHTON (SUSSEX)

LANES, 11 Gardner Street

LYON & HALL LTD., 92 Western Road

## BRISTOL (SOMERSET)

BRISTOL & WEST RECORDING SERVICES LTD., 6 Park Row

HOUSE OF SOUND, 5 Marsh Street

## CAMBRIDGE

ADAMS & DELLAR LTD., 66 Regent Street

H. GEE, 94a Mill Road

K.P. CAMERA SHOP, 12a King's Parade

G. P. REECE, 1 & 2 Peas Hill

UNIVERSITY RECORDING CO., 16 Burleigh Place

## CANTERBURY

GOULDENS, 36 High Street

## CARDIFF

J. GOUGH & CO. LTD., 148-154 North Road

## CARLISLE

MISONS, Citadel Row

## CHELTENHAM

RAY ELECTRICAL, 287 High Street

## CHICHESTER (SUSSEX)

STORRYS OF CHICHESTER LTD., 83 North Street



## LOWTHER

high flux drive units are the finest in their class, and so, are World renowned for their performance and efficiency.

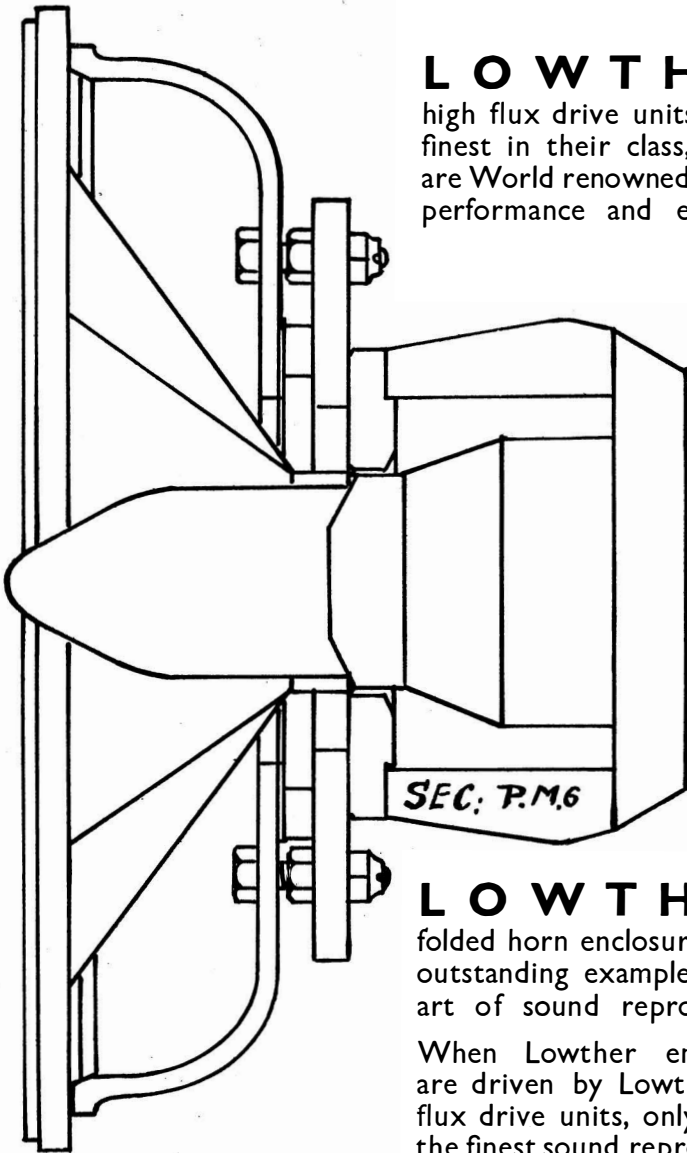

## LOWTHER

folded horn enclosures are all outstanding examples in the art of sound reproduction.

When Lowther enclosures are driven by Lowther high flux drive units, only then is the finest sound reproduction attained.

*Full details of these and Lowther amplifiers, control units, tuner units, etc., gladly sent upon request*

**THE LOWTHER MANUFACTURING COMPANY**  
LOWTHER HOUSE : ST. MARK'S ROAD : BROMLEY : KENT  
Telephone : RAVensbourne 5225

**COVENTRY**

ELECTRONIC SERVICES, 110 Gosford Street  
R.E.S. (COVENTRY) LTD., 128 Far Gosford Street

**DARLINGTON**

PALMERS, 13 Post House Wynd

**DERBY**

DALTONS & SONS LTD., 11 London Road  
DIXONS (DERBY) LTD., Strand Arcade  
VICTOR BUCKLAND LTD., 37/39 London Road

**DORKING**

THE HIGH FIDELITY CENTRE, 61 West Street

**DUNDEE**

LARG & SONS (DUNDEE) LTD., 16/24 Whitehall Street

**EDINBURGH**

GEO. JEFFREY LTD., 23 Earl Grey Street  
J. NICHOLSON, 1 Haddington Place

**ETON (BUCKS.)**

AUDIOCRAFT OF ETON LTD., 89-90 High Street

**EXETER**

FILDEWS (ENGINEERS) LTD., 99 Fore Street

**FARNHAM (SURREY)**

LLOYD & KEYWORTH LTD., The Record Shop, 26/27 Downing Street

**GLASGOW**

JAMES KERR & CO. LTD., 435 Sauchiehall Street

**GRIMSBY (LINCS.)**

JOHN ANGLIN, 385 Cleethorpe Road

**HALIFAX**

TAPE RECORDER CENTRE (HALIFAX) (TREVOR FAWTHROP LTD.), 30 King Cross Street

**HAMPTON HILL (MIDDXX.)**

MELFORD RADIO, 58 Windmill Road, & 181c High Street

**HIGH WYCOMBE (BUCKS.)**

M. W. KEEN, Paul's Row

**HOVE (SUSSEX)**

RECORD ROUNDUP, 154 Portland Road, Hove 3

**HUDDERSFIELD**

GORDON ROBERTS, Yorkshire Sound Centre, 5 Outcote Bank  
J. WOOD & SONS LTD., 67 New Street

**IPSWICH (SUFFOLK)**

R.C.S., 61 Fore Street

**KEIGHLEY (YORKS.)**

J. S. RAMSBOTTOM & CO. LTD., Bow Street

**KIDDERMINSTER**

F. W. LONG, 14 Mill Street

**KINGSTON-ON-THAMES (SURREY)**

R. K. APPELBY, 30 London Road

**LEAMINGTON SPA**

TYSONS, 41 Russell Street

**LEATHERHEAD (SURREY)**

MAURICE RICHARDS LTD., Radio House, The Crescent

**LEEDS**

VALLANCE & DAVIDSON LTD., 20 New Market Street and Headrow House  
P.W.B. AUDIO, 41 Call Lane

**LEICESTER**

DALTON & SONS LTD., 76 Granby Street  
HI-FI RECORD BAR, 13 Applegate Street  
LEICESTER CO-OPERATIVE SOCIETY LTD., High Street

**LEIGH (LANCS.)**

JOHN SHINN & SONS LTD., 23 Market Street

**LITTLEHAMPTON**

TANSLEY & COOKE LTD., 61 High Street

**LIVERPOOL**

BEAVER RADIO LTD., 60-62 Whitechapel  
LAMBDA RECORDING CO LTD., 95 Liverpool Road

**LOWESTOFT**

E.J.P. SOUND SYSTEMS LTD., 118 High Street

**LUTON (BEDS.)**

S. FARMER & CO. LTD., Gonnaught House, 15-17 Upper George Street  
COVENTRY RADIO, 189 Dunstable Road

**MACCLESFIELD (CHESHIRE)**

HI-FI HOUSE, 123 Chestergate

**MAIDENHEAD**

GREVILLES, 7 High Street

**MAIDSTONE (KENT)**

HIGH FIDELITY (MAIDSTONE) LTD., 57 King Street

**MALVERN**

RANFORD RADIO LTD., Barnards Green

**MANCHESTER**

FORSYTH BROTHERS LTD., 126-128 Deansgate  
LANCS HIGH FIDELITY LTD., 8 Deansgate

**MIDDLESBROUGH**

AUSTIN KYME LTD., 67 Corporation Road  
PALMERS OF MIDDLESBROUGH, 106 Newport Road

**MITCHAM (SURREY)**

HOME RADIO (MITCHAM) LTD., 187 London Road

**NEWCASTLE (STAFFS)**

GREEN'S SOUND SERVICES, 11 West Brampton

**NEWCASTLE-UPON-TYNE**

PAYNE & HORNSBY LTD., 3 Andrews House, Gallowgate

**NEWTON ABBOT**

D. O. H. COLES LTD., 13 Courtenay Street

**NORTHAMPTON**

CRYER'S, 220/224 Wellingborough Road

**OXFORD**

HORNS, 6 South Parade  
L. WESTWOOD, 46 George Street

**PAIGNTON**

PAUL PINCH, Foales Corner

**PERTH**

GEORGE G. BROWN, 61 Kinnoull Street

**PETERBOROUGH**

CAMPKIN'S RECORD SHOP, 15 Long Causeway  
ROY SPACKMAN, 42 Cowgate

**PLYMOUTH**

ALBERT E. FORD LTD., 84 Cornwall Street

**READING**

HERBERT & LASCELLES LTD., 22-25 St. Mary's Butts

**RICHMOND (SURREY)**

MUSICRAFT, 13 King Street

*Philips Stereo  
Tape Recorder  
Model EL 3536*

**92**

**GNS**



(Made in Holland)

# Supremacy in Stereo

Anything you want in stereo tape recording you'll get from this superb instrument from Philips. And if you think this is a bold claim, test it at your local Philips dealer's.



**PHILIPS** -the friend of the family

Philips Electrical Ltd., Electro-Acoustics Division, Century House, Shaftesbury Avenue, London, W.C. 2

**SALISBURY (WILTS.)**

J. F. SUTTON, 18 Queen Street

**SLOUGH**

HICKIE &amp; HICKIE LTD., 67/69 High Street

**SHEFFIELD**

PHILIP CANN CO. LTD., Chapel Walk, Fargate

COX RADIOVISION LTD., 687 Attercliffe Road and 2 High Street, Whitwell

**SOUTHAMPTON**

HAMILTON ELECTRONICS (SOUTHAMPTON) LTD., 35 London Road

J. F. SUTTON, 421 Shirley Road

UNIVERSITY CAMERAS, 12 Bargate Street

**STOCKPORT**

FAIRBOTHAM &amp; CO. LTD., 47 Lower Hillgate, Stockport

**STOKE-ON-TRENT**

HIGH FIDELITY SOUND EQUIPMENT, 116 Birches Head Road

MILLER &amp; PALIN LTD., 3 Vale Street

**SUNNINGDALE**

PACK'S LTD., London Road

**THORNTON HEATH (SURREY)**

NUSOUND RECORDING CO., 3-8 Brigstock Parade, London Road

**TRURO**

EDMUND FORD, 9 Pydar Street

**TUNBRIDGE WELLS**

GOULDEN &amp; CURRY LTD., 61 High Street

PERCY POWELL RADIO LTD., 54 High Street

**WALMGATE (YORKS.)**

CUSSINS &amp; LIGHT LTD., Walmgate, York

**WARRINGTON**

WESTERN SOUND RECORDERS LTD., 11 Wilson Patten Street

**WESTHOUGHTON (LANCS.)**

MAXTONE HIGH-FIDELITY, 247 Church Street

**WIGAN**

JOHN SHINN &amp; SONS LTD., "Melody House", 43 Hallgate

**WOLVERHAMPTON**

FENWICK'S, Fenwick Buildings, Great Brickklyn Street

PODMORE LTD., 19/21 Merridale Road

VOLTIC RADIO, Queen's Arcade

**WORCESTER**

JOHNSON SOUND SERVICE, 9 Sidbury

**WORTHING**

CLOUGH SMITH ELECTRICAL LTD., 4 Connaught Buildings, Chapel Road

BOWERS &amp; WILKINS LTD., 1 Becket Buildings, Littlehampton Road

J. W. MANSFIELD LTD., 8-12 Liverpool Road

TANSLEY &amp; COOKE LTD., Chapel Road

## TAPE RECORDER SPECIALISTS

★ The following is a short list of dealers specialising in the sale of tape recorders and associated equipment

**LONDON**

CITY &amp; ESSEX TAPE RECORDER CENTRES, 2 Maryland Station, Stratford, E.15, 205 High Street North, East Ham, E.6 and 228 Bishopsgate, E.C.2

DICKINSONS OF PALL MALL LTD., 11 Royal Opera Arcade, Pall Mall, S.W.1

FRANCIS OF STREATHAM, 169-171 Streatham High Road, S.W.16

HAMPSTEAD HIGH FIDELITY, 91a &amp; 91b Heath Street, N.W.3

MAGNEGRAPH, 1 Hanway Place, W.1

RAPP RADIO LTD., 181 Dalston Lane, E.8

THE RECORDER CO., 188 West End Lane, West Hampstead, N.W.6

R. E. W. EARLSFIELD LTD., 545 Garratt Lane, S.W.18, and 266 Upper Tooting Road, S.W.17

SHEEN TAPE RECORDER CENTRE LTD., 8 Station Parade, Sheen Lane, S.W.14

THE TAPE RECORDER CENTRE LTD. (Head Office), 447 Green Lanes, Harringay, N.4. (Showrooms) 75 Grand Parade, Green Lanes, Harringay, N.4. (West End Showroom) 82 High Holborn

TELETAPE, 33 &amp; 59a Edgware Road, W.2

**BIRMINGHAM**

NORMAN H. FIELD LTD., 1 Lodge Road, Hockley and 68 Hurst Street

HOLLICK &amp; TAYLOR RECORDING CO. LTD., 16 Grosvenor Road, Handsworth Wood

REEVES SOUND SERVICE, 416 Moseley Road

**BLACKPOOL**

TAPE RECORDER CENTRE, (BLACKPOOL) — C. BRADDOCK LTD., 266 Waterloo Road

**BRIGHTON**

JOHN KING (FILMS) LTD., East Street and 1 The Drive, Church Road, Hove, 3

**BROMLEY (KENT)**

HOWARD TAPE RECORDERS, 218 High Street, Bromley

**CHESTER**

MILLER &amp; PALIN LTD., 144-146 Foregate Street

**CREWE**

MILLER &amp; PALIN LTD., 11 Delamere Street

**CROYDON (SURREY)**

CROYDON CINE EXCHANGE LTD., 48 South End

**HUDDERSFIELD**

M. R. W. ELECTRONICS, 222 Wakefield Road, Moldgreen

**HULL (E. YORKS.)**

A. BROWN &amp; SONS LTD., 24/28 George Street

**LANCASTER**

CHRIS. WILLAN LTD., 20 New Street

**LEICESTER**

G. W. GOWLING LTD., 26 Belvoir Street

**LIVERPOOL**

COGHLAN &amp; CO., 88 Lark Lane

**MAIDENHEAD (BERKS.)**

NORMAN GREVILLE, 7 High Street

**NOTTINGHAM**

NOTTINGHAM TAPE RECORDERS LTD., Burton Street

**WORTHING**

JOHN KING (FILMS) LTD., Colonnade House, 1 High Street

# RADFORD

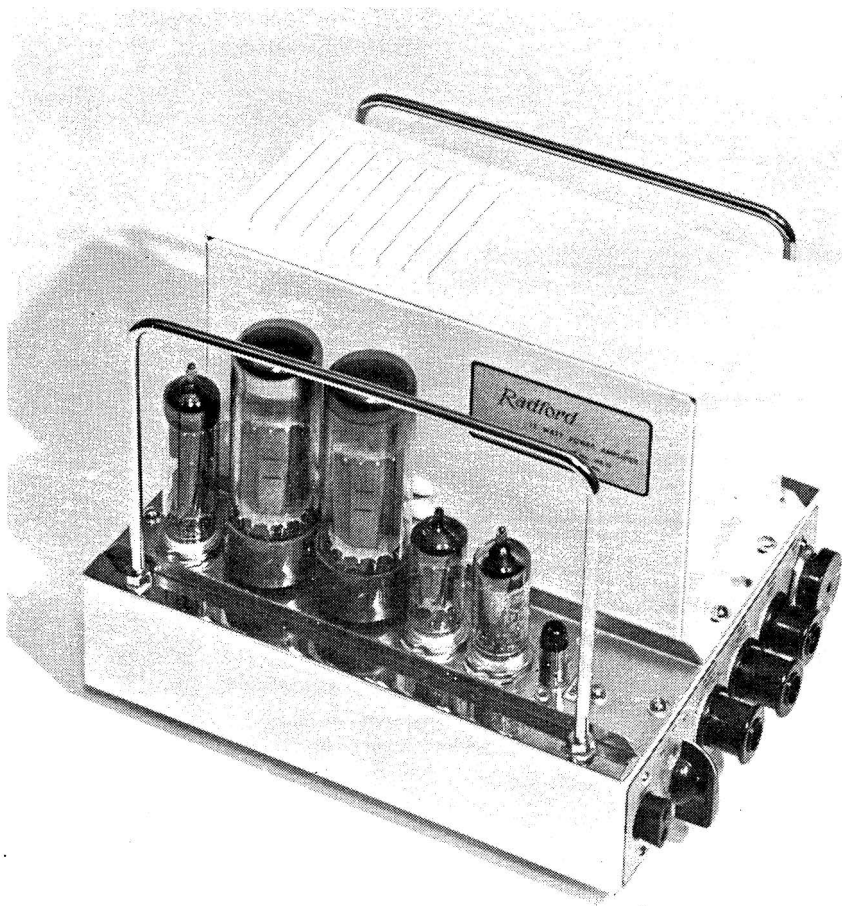

The remarkable new MA 12 Mk. II power amplifier has distortion levels at 15 watts r.m.s. power output of: 40 c/s  $<0.1\%$ , 1 Kc/s  $<0.05\%$ , 15 Kc/s  $<0.5\%$ . Also available with 12 and 25 watts output and in stereo versions.

LITERATURE ON COMPLETE RANGE OF EQUIPMENT AVAILABLE ON REQUEST

## **RADFORD ELECTRONICS LTD.**

ASHTON VALE ESTATE, BRISTOL 3, ENGLAND

TEL. 662301/2

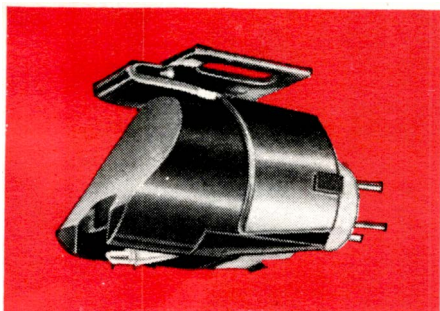

# DECCA Deram

MICROGROOVE 'CERAMIC' CARTRIDGE  
WITH DIAMOND STYLUS FOR  
STEREO OR MONO RECORDS

This is a new 'ceramic' pick-up head resulting from fresh consideration of the problems of record wear in relation to medium-priced equipment. Research has shown that tracking weight and stylus compliance are not the most important factors affecting record wear. To minimise wear—and the resultant deterioration of the superb quality obtainable from the modern LP—the *first essential is a low tip-mass*. No medium-priced pick-up has so far succeeded sufficiently in achieving this necessity. The micrographs show how well the Decca 'Deram' does so. It should be noted that the 'conventional medium-priced pick-up' referred to in the caption of micrograph (c) is in fact markedly superior to the pick-ups fitted to the current medium-priced stereogram.

Micrographs of the groove of the Decca stereo frequency test record, recorded on one channel with a 10 Kc/s signal



UNPLAYED



PLAYED 250 TIMES  
with the Decca Deram—  
note the absence of damage



played ONCE ONLY with a  
conventional medium-priced pick-up  
tracking at 3 grammes  
The arrows point out the damage

#### Specification—changer model

Tip mass—1 milligramme at 45°; compliance— $6 \times 10^{-6}$  cms/dyne (lateral),  $3.5 \times 10^{-6}$  cms/dyne (vertical); tracking weight—3-5 grammes; frequency response— $\pm 3$  dB 40 c/s to 12 Kc/s; output—50 mV/cm/sec (per channel); crosstalk—-20 dB at 1 Kc; stylus—diamond, of tip radius 0.0005/0.0006 in.

Price 4 GNS. tax paid

#### Specification—transcription model

As changer model, except for: compliance— $10 \times 10^{-6}$  cms/dyne (lateral),  $6 \times 10^{-6}$  cms/dyne (vertical); tracking weight—2-4 grammes

Price 5 GNS. tax paid

A 78 rpm cartridge with sapphire stylus is also available at 3 qns. tax paid



# Emitape

magnetic recording tape—  
the finest in the world

USED BY THE BBC 9 TIMES OUT OF 10

TYPE No.	SPOOL SIZE	APPROX. LENGTH		PLAYING TIME PER TRACK				PRICE	
		Feet	Metres	$\frac{1}{16}$ IPS	$1\frac{1}{2}$ IPS	$3\frac{1}{2}$ IPS	$7\frac{1}{2}$ IPS		IN EMI-CASE
<b>44</b> acetate standard-play tape	3½"	175	53	37 20	18 40	9 20	4 40	6.9	—
	5"	600	183	2 8 0	1 4 0	32 0	16 0	18.0	—
	5¾"	850	259	3 1 20	1 30 40	45 20	22 40	£1. 4.6	—
	7"	1200	366	4 16 0	2 8 0	1 4 0	32 0	£1.10.0	—
<b>88</b> standard-play tape, maximum durability for general use	3"	175	53	37 20	18 40	9 20	4 40	7.6	—
	3½"	175	53	37 20	18 40	9 20	4 40	7.6	—
	4"	300	91	1 4 0	32 0	16 0	8 0	10.6	—
	5"	600	183	2 8 0	1 4 0	32 0	16 0	£1. 1.0	£1. 3.6
	5¾"	850	259	3 1 20	1 30 40	45 20	22 40	£1. 8.0	£1.10.6
	7"	1200	366	4 16 0	2 8 0	1 4 0	32 0	£1.15.0	£1.17.6
<b>99</b> long-play tape on thin base. 50% more recording time than standard	8½"	1750	530	6 14 0	3 7 0	1 33 30	46 45	£2.17.6	—
	3"	250	76	53 20	26 40	13 20	6 40	9.6	—
	3½"	250	76	53 20	26 40	13 20	6 40	9.6	—
	4"	450	137	1 36 0	48 0	24 0	12 0	14.6	—
	5"	850	259	3 1 20	1 30 40	45 20	22 40	£1. 8.0	£1.10.6
	5¾"	1200	366	4 16 0	2 8 0	1 4 0	32 0	£1.15.0	£1.17.6
	7"	1800	549	6 24 0	3 12 0	1 36 0	48 0	£2.10.0	£2.12.6
	8½"	2400	732	8 32 0	4 16 0	2 8 0	1 4 0	£3.12.6	—
<b>100</b> Extra-thin double-play tape. 100% more recording time	3½"	400	122	1 25 20	42 40	21 20	10 40	17.0	—
	5"	1200	366	4 16 0	2 8 0	1 4 0	32 0	£2. 5.0	—
	5¾"	1700	518	6 2 40	3 1 20	1 30 40	45 20	£2.17.6	—
	7"	2400	732	8 32 0	4 16 0	2 8 0	1 4 0	£4. 0.0	—

The above figures are calculated times, and do not allow for slow- or fast-running motors or mechanical variations, etc.

## Special Emitape Features

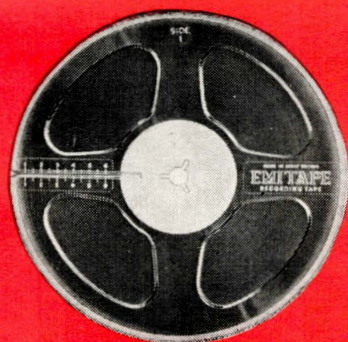

- \* Anti-static
- \* High sensitivity
- \* Low 'print-through' factor
- \* P.V.C. Leader and Trailer strip fitted to all but 'Message' spools
- \* In spool sizes for all tape recorders
- \* Metallic 'Auto Stop' foil fitted to all 44, 88 and 99 spools except 'Message'

Joint and edit your tape the professional way with **EMITAPE** accessories

**JOINTING COMPOUNDS**  
AP 35 for C.A.-base Tape and AP 77 for P.V.C.-base Tape

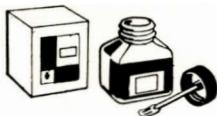

Special jointing fluid to make a permanent welded joint when splicing either P.V.C. or cellulose acetate base magnetic recording tape. 7/6

**EMITAPE**  
**JOINTING BLOCK AP 123**

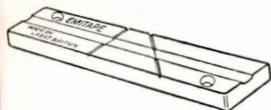

The exclusive undercut channel holds the tape fast, enabling you to cut it cleanly at an angle of 45° or 90°. 10/6

**NON-MAGNETIC SCISSORS**  
AP 39



These scissors, made from non-ferrous metal, enable recorded tape to be cut for splicing or editing purposes without magnetising the tape. This ensures a silent joint. 16/-

**P.V.C. LEADER TAPES**  
AP 38/1 to 38/6

With this range of coloured tapes you can insert colour code references for quick identification and indexing purposes in a reel of recorded tape. Colours: White, Red, Yellow, Blue, Orange, Green. 4/6 a reel.



**JOINTING TAPE AP 103**

Specially prepared adhesive jointing tape for simple and quick splicing and editing of magnetic recording tape. In handy plastic containers. 7/6



**Metallic Stop Foil AP 125**

Sufficient for 50 tapes. In handy plastic container. 6/6

**ACCESSORY KIT AP 124**



Holds 3 spools of leader, 1 spool of jointing tape, 1 spool of stop-foil, Emitape jointing block, two cutters and full instructions. Packed in a plastic rack (room for 7 spools). Specially designed for the workbench. 37/6

**EMICASE**

Polystyrene container. Solves storage problems, protects spools from dust and allows easy identification of leader tapes. 7"—4/-, 5½"—3/6, 5"—3/6



**EMPTY PLASTIC**  
**SPOOLS IN CARTONS**

AP 93 3"	...	...	...	3/-
AP 93N 3½"	...	...	...	3/-
AP 85 5"	...	...	...	4/6
AP 89 5½"	...	...	...	4/6
AP 87 7"	...	...	...	5/-
AP 118 8½"	...	...	...	12/6

**EMIGUIDES**

6 demonstration tapes that pave the way to better recording.  
No 1—Getting the Quality Right  
No 2—Microphone Technique  
No 3—Tape Editing  
No 4—Outdoor Recording  
No 5—Trick Recording and Sound Effects  
No 6—Producing Feature Tapes  
8/6 a reel

**EMI**

E.M.I. TAPE LIMITED, HAYES, MIDDLESEX. TELEPHONE: HAYES 3888



FOR THE **BEST** REPRODUCTION

*install*

# HI-FI EQUIPMENT

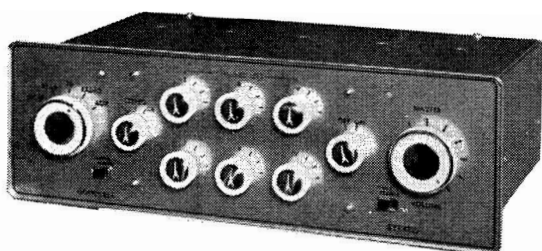

STEREO II  
TONE CONTROL

*and*

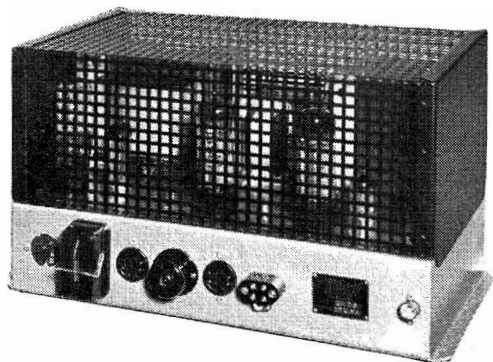

GW 25  
POWER AMPLIFIER

Full details from :—

**GOODSELL LTD.**

**40 GARDNER STREET**

**BRIGHTON 26735**

**BRIGHTON I**

BINSON  
B.J.  
BRENNELL  
CHAPMAN  
COLLARO  
CONNOISSEUR  
COSMOCORD  
DECCA

## EQUIPMENT FOR TAPE, DISC & RADIO

**MODERN  
ELECTRICS**  
(RETAIL) LTD.

DULCI  
ELAC  
FERROGRAPH  
G.E.C.  
GARRARD  
GOLDRING  
GOODMANS  
GRAMPIAN  
GRUNDIG  
KELLY  
LEAK  
LENCO  
LUSTRAPHONE  
ORTOFON  
PHILIPS  
QUAD  
REFLECTOGRAPH  
RESLO  
ROGERS  
RONETTE  
SIMON  
S M E  
TANNOY  
THORENS  
TRUVOX  
VITAVOX  
W.B.  
WHARFEDALE

*WE SEND THE BEST OF  
BRITAIN'S HI-FI AND  
TAPE EQUIPMENT  
EVERYWHERE*

Our service reaches to every part of the world, and extensive selections of our up-to-the-minute stocks appear regularly in our advertisements each month in "Hi-Fi News", "The Gramophone", "Wireless World", etc. If you cannot call, send us your enquiries without obligation. Whatever you order, no matter how small or how large, it is given prompt and personal attention at all times.

**AS EXCLUSIVE DISTRIBUTORS FOR THE BINSON "ECHOREC" MK. 11 ELECTRONIC ECHO UNIT**, we invite enquiries for full information which will gladly be sent on request. This unit, which enables controlled echo to be imposed on a signal costs 160 gns (\$480 U.S.A.) and is widely used by broadcasting, recording and other organisations. Professional and Trade Discounts. ALSO AVAILABLE—"Baby" BINSON ECHOREC single channel Echo Unit. 80 gns (£240 U.S.A.).

**MODERN ELECTRICS (RETAIL) LTD.**

**120 SHAFTESBURY AVENUE, LONDON, W.1**

(Opposite Columbia Cinema and three minutes from Piccadilly Circus)

Telephone: TEM 7587 and COY 1703 Cables: MODCHAREX, LONDON

# SENSITIVITY & RESPONSE

The best circuit must depend for faithful reproduction on the sensitivity and response of the microphone. The BBC recognize this fact and use STC microphones — the most efficient in the world.

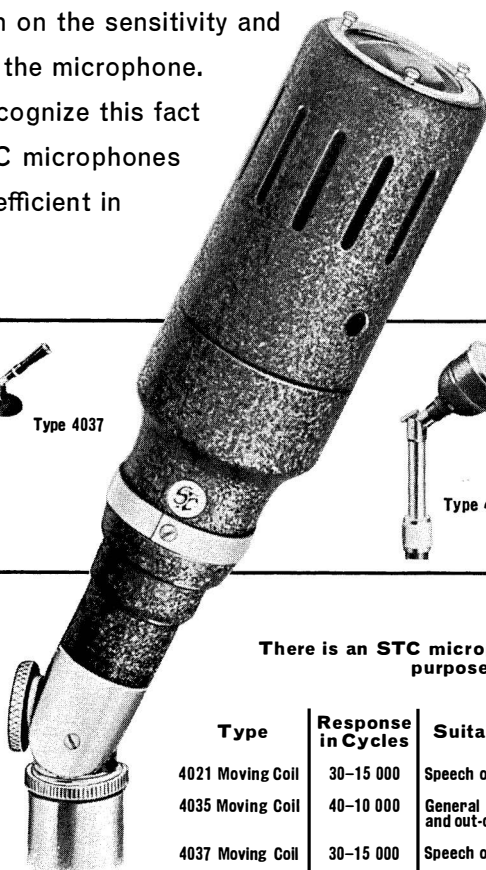
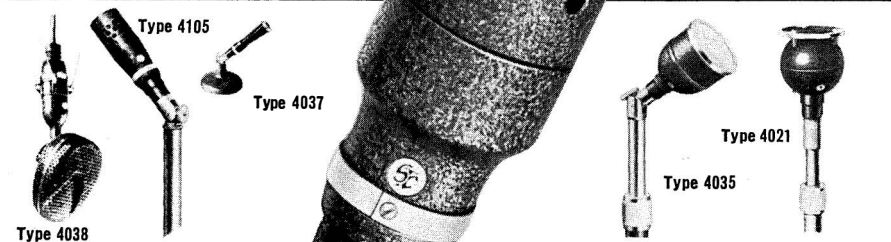

There is an STC microphone for every purpose.

Type 4038

Type 4106

A full range of stands, accessories and cables is also available.

**STC MICROPHONES**—the first step to high quality reproduction.

Type	Response in Cycles	Suitability	Price
4021 Moving Coil	30-15 000	Speech or music	£24. 0.0
4035 Moving Coil	40-10 000	General purpose and out-of-doors	£23. 0.0
4037 Moving Coil	30-15 000	Speech or music	£24. 0.0
4038 Ribbon	30-15 000	Speech or music	£43.10.0
4105 Cardioid (moving coil)	60-10 000	General purpose	£22.10.0
4106 Cardioid (moving coil)	30-15 000	Speech or music	£49.10.0

Generally microphones have an impedance of 30 ohms.



**Standard Telephones and Cables Limited**

PUBLIC ADDRESS DEPARTMENT: ESTERBROOKE STREET · LOND ON S.W.1

Who makes the  
Hi-Finest  
units ?



TYPE A



TPA 12



MODEL  
301



**Garrard**  
of course!

LABORATORY SERIES AUTO TURN-  
TABLE TYPE 'A'. — Designed specially  
to meet the demand for a Transcription  
Record Player with provision for auto-  
matic use if desired.

MODEL TPA12 - Transcription Pick-  
up Arm. Fitted with MPM.4 plug-in  
moulding.

MODEL 301 - Famous Transcription  
Motor used by Broadcasting Stations  
throughout the world.



**GARRARD ENGINEERING AND MANUFACTURING CO., LTD.**

SWINDON - WILTSHIRE

# C 60



## **New Studio Condenser Microphone**

Smooth over entire range (20...18000 cps) with field proven omni and cardioid capsule CK 26 and CK 28. Transistor B 60 power pack makes the C 60 independent of AC mains. Miniaturized for use on shoulder strap. C 60 with B 60 power pack or N 60 power supply and all necessary cables only £79.10.0d. and £92.10.0d.

# K 58



## **New Headphone — Microphone Boom Set**

Combination of the well-known K 50 headphones and the dynamic noise cancelling microphone D 58. Rugged, iron-dust proof, extremely lightweight, no tight coupling to ear necessary. No listening fatigue.

Ideal for switchboard operators, inter-communication, language laboratories, broadcast reporters, etc.

Available also with transistor amplifier for + 6 dbm output: type K 58 T.

---

# **POLITECHNA (LONDON) LTD.**

LONDON W. 1

TELEPHONE: LANGHAM 6236

TELEX: 23894

3 PERCY STREET

CABLES: POLINDUST LONDON



AKG of Vienna has the basic patents on mikes with full-range cardioid response. AKG's cardioids are cardioid down the entire range where you need it most! This is only one of the plus values in an AKG. They are all rugged and smooth in their translation of sound.

From von Karajan to Joe Doakes, AKG is first choice for crisp, full-bodied sound. From £100 to £7, AKG cardioids are the cardioidest mikes you can buy today.



## **MICROPHONES FROM VIENNA**

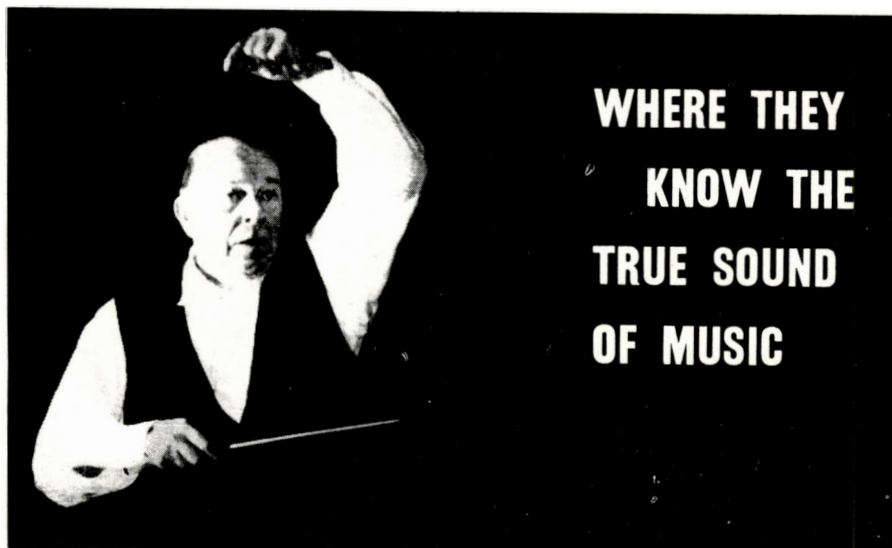

**WHERE THEY  
KNOW THE  
TRUE SOUND  
OF MUSIC**

# PART EXCHANGE

We are always willing to accept your unwanted Hi-Fi equipment, tape recorder or Classical LP records for cash or in exchange for other goods. Let us have full details and we will make an offer.

## ALWAYS IN STOCK

Rogers, Quad, Leak and Armstrong equipment, Lenco, Garrard and Connoisseur motors, Decca ffs and E.M.I. pickups.

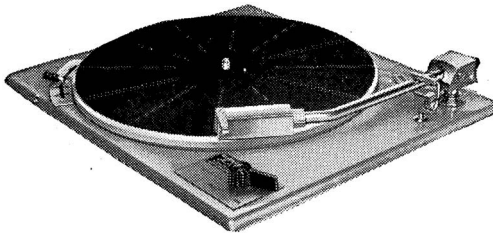

*Goldring G.L. 70 Transcription Motor*

*Send for lists and photographs of new and used items including cabinets.*

25 years of  
buying, selling and exchanging

# H. C. HARRIDGE

8 MOOR STREET, CAMBRIDGE CIRCUS, W.1

*Hours of Business :*

Monday }  
Tuesday } 10 a.m. to 5.30 p.m.  
Wednesday }

Friday 10 a.m. to 7 p.m.  
Saturday 9 a.m. to 5 p.m.  
Thursday CLOSED ALL DAY

**for monophonic  
sound**

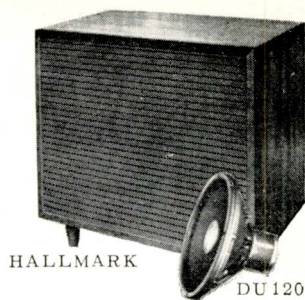

**for  
stereophonic  
sound**

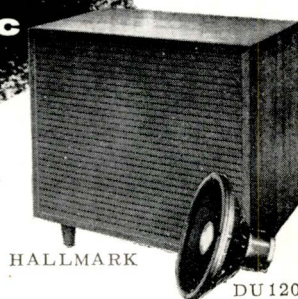
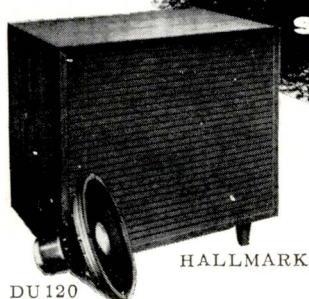

**for exceedingly good sound**

There is no reason at all why any really good dealer in genuine High Fidelity Sound Equipment should not be able to supply you with VITAVOX. If you meet with any difficulty just write to us and we'll see you get exactly what you want.

**PRICES**

DU120 Duplex Coaxial Full Range Loudspeakers	£19: 10s 0d
Hallmark Loudspeaker Systems – Tallboy or Lowboy	
In Teak	£45: 0s 0d
In Mahogany	£42: 0s 0d
In Walnut	£42: 0s 0d

There is no mystery about the superiority of Vitavox Loudspeakers and Loudspeaker Systems. It is all a matter of careful design and attention to details. Vitavox Loudspeakers, installed in suitable enclosures, make excellent companions and do full justice to any first class sound reproducing equipment with which they are used. Vitavox is a "must" if you demand the highest quality and insist on the most perfect performance possible.

**VITAVOX** *Hallmark*  
**LOUDSPEAKER SYSTEMS**  
and **DU120 Duplex Coaxial**  
**FULL RANGE LOUDSPEAKERS**

VITAVOX LIMITED • WESTMORELAND ROAD  
LONDON • N.W.9 Telephone COLindale 8671



The kit-sets\*  which give  
the Best Possible Performance  
at Absolutely Minimum Cost!

★ Also available assembled

*Whether you require  
record player,  
tuner, amplifier,  
tape deck,  
equipment cabinet,  
loudspeaker systems,  
radio or test  
instruments,  
you cannot do better  
than buy a  
HEATHKIT model.*

*send for a free catalogue!*

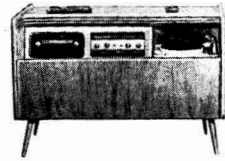

**DAYSTROM LTD.**

DEPARTMENT H.Y.  
GLOUCESTER, ENGLAND

A MEMBER OF THE DAYSTROM GROUP

Manufacturers of

**THE LARGEST SELLING ELECTRONIC KIT-SETS IN THE WORLD**

# 6



## Books by G. A. BRIGGS

### AUDIO BIOGRAPHIES

With contributions by 64 collaborators. 344 pages.  
112 illustrations. 19/6 (20/9 post free)

\* A to Z IN AUDIO

244 pages. 160 illustrations. 15/6 (16/6 post free)

\* STEREO HANDBOOK

146 pages. 88 illustrations. 10/6 (11/6 post free)

\* LOUDSPEAKERS 5th Ed.

336 pages. 230 illustrations. 19/6 (20/9 post free)

SOUND REPRODUCTION 3rd Ed.

368 pages. 315 illustrations. 17/6 (18/9 post free)

PIANOS, PIANISTS & SONICS

190 pages. 102 illustrations. 10/6 (11/6 post free)

\* with R. E. COOKE as technical editor

The above books are sold by many  
radio dealers and bookshops.  
In case of difficulty direct from

**Wharfedale**  
WIRELESS WORKS LTD

**IDLE  
BRADFORD  
YORKS**

Tel.: Idle 1235/6 Grams: "Wharfedel," Idle, Bradford



# Armstrong

## A New Hi-Fi Stereo Amplifier

### PCU25 STEREO PRE-AMPLIFIER

£21.0.0

Six inputs providing for all possible signal sources including the lowest output pick-ups and tape heads. Push button function switching. Bass and treble tone controls. Balance control. Treble filter. Rumble filter. Tape recording outputs. Distortion 0.1%. Hum and noise (high sensitivity pick-up input) 60db below full output. Valves, 2 × EF86, 3 × ECC83. Dimensions 10½" × 4½" × 7½".

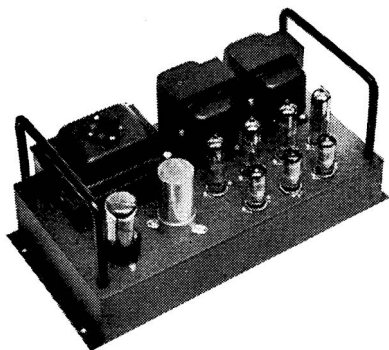
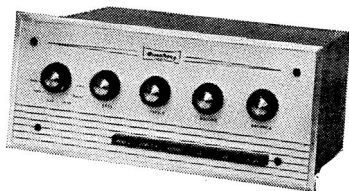

### A20 STEREO POWER AMPLIFIER

£23.12.6

12 Watts push-pull ultra-linear output from each channel. Distortion 0.1%. Hum and noise 80db below full output. Frequency response 15-22,000 c.p.s. within 1db. Power response 20-18,000 c.p.s. within 1db. Negative feedback 29db. Stability factor 18db. Valves, GZ34, 3 × ECC83, 4 × EL84. High Specification output transformers with grain-orientated laminations and multi-sectional winding. Dimensions 14" × 7" × 7".

***More Compact, More Sensitive,  
More Facilities and a Lower hum  
and noise level than any Amplifier  
in its price range***

Choose from the Armstrong T4B FM Tuner (£23. 0. 0d.) and the ST3 Mk. 2 AM/FM Tuner (£28. 10. 0d.) both of which match the new amplifier in styling and performance.

**ARMSTRONG WIRELESS & TELEVISION CO. LTD. WALTERS RD. LONDON, N.7**

**NORTh 3213**

SKETCH BY FELIKS TOPOLSKI



*At LARGS we delight in the "fussy" customer, although we don't call him anything so misleading. We appreciate his love of the superlative, and know that he will take full advantage of our knowledge and practical skill. After all, what is the use of our having a staff of very competent Technicians, French Polishers, Cabinet Makers and Fitters, ready to make Radio-Gramophones for the discerning music lover, if their work is not appreciated.*

*The typical LARGS' customer appreciates how music should sound, and how a well-built cabinet should look. He wants it to give pleasure in every way to himself, his family and his friends. Why does he come to LARGS? Just visit our Showrooms and satisfy your curiosity (and incidentally all your Hi-Fi requirements for some years to come).*

### Our cabinet showrooms

We pride ourselves that the range of cabinets displayed in our showrooms is the finest in the country. Featured below are just two fine examples.



**TRIO, Price 28 gns**



**QUARTETTE, 32 gns**

AVAILABLE ONLY FROM LARGS

**76-77, HIGH HOLBORN, W.C.1**

Telephone: CHAncery 2626  
(Private Branch Exchange)

Near Holborn Tube Station

Buses 7, 8, 22, 23, 25, 32 pass the door.

**LARGS**  
of Holborn for High Fidelity

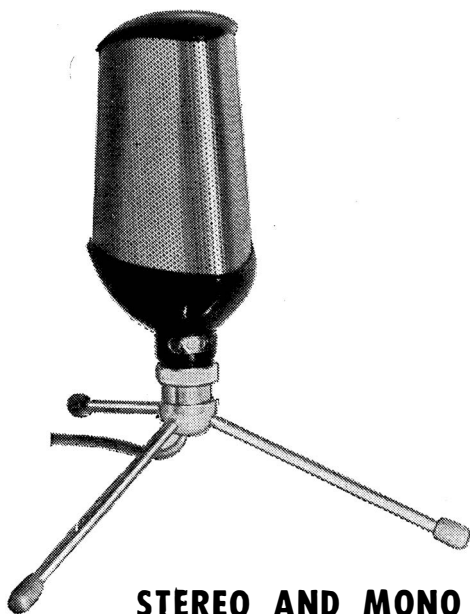

## ACOS

### MIC 44

### STEREO AND MONO MICROPHONE

The Acos MIC 44 stereo/mono microphone, incorporating two separate figure-8 response microphones, makes possible true, life-like stereophonic recording, at the same time eliminating completely the 'hole in the middle' effect sometimes produced by spaced microphones. In addition, the MIC 44 may be used as a high performance mono microphone.

#### Specification

Sensitivity at 1 Kc/s — 68 dB ref. 1 V/dyne/cm<sup>2</sup> (approx.  $\frac{1}{2}$  mV.).

Frequency response 30-12,000 c/s.

Directional characteristic There are two pairs of inserts combined to give a pressure-differential (figure-8) response. On-axis to 90° off-axis ratio: better than 12 dB at 1 Kc/s. Directional characteristic maintained over the range 50-8,000 c/s.

Capacity of each insert .. .. 1,600 pF.

Recommended input impedance Not less than 1 MΩ.

Lead .. .. 2 × 8 feet.

The Acos range also includes:

**Microphones.** MIC 28-2 lapel microphone; MIC 39-1 crystal stick microphone; MIC 40 fold-away microphone; MIC 45 crystal hand microphone.

**Cartridges.** Acostereo 71-5 stereo/mono single-sided cartridge; Acostereo 73-2 universal turnover cartridge for stereo, mono and 78 rpm records.

**Pick-ups.** The Acos range includes the astonishing Hi-Light stereophonic pick-up.

**Styli.** Over 150 types of Acos × 500 replacement styli, individually tested at times - 500 magnification, to fit all makes and models of pick-ups and cartridges in current use.

**Changer Dust Bug.** Clears record surfaces of dust and all harmful particles.

**Stylus Pressure Gauge.** Measures downward pressure to within  $\frac{1}{2}$  gramme.

**acos** ARE DOING THINGS IN STYL!



# FRANCIS OF STREATHAM

*invite all  
Hi-Fi and Recorder  
enthusiasts to their  
South London Showrooms*

**FOR LARGE AND UP-TO-DATE STOCKS  
OF EQUIPMENT BY LEADING  
MANUFACTURERS AS ADVERTISED  
IN HI-FI NEWS, TAPE RECORDER, ETC.**

- |                 |              |
|-----------------|--------------|
| ★ FERROGRAPH    | ★ QUAD       |
| ★ BRENNELL      | ★ LEAK       |
| ★ COSSOR        | ★ GARRARD    |
| ★ GRUNDIG       | ★ Lenco      |
| ★ PHILIPS       | ★ MORDAUNT   |
| ★ TELEFUNKEN    | ★ RESLO      |
| ★ REFLECTOGRAPH | ★ ARMSTRONG  |
| ★ VORTEXION     | ★ DULCI      |
| ★ SIMON         | ★ ORTOFON    |
| ★ AKG           | ★ THORENS    |
| ★ LUSTRAPHONE   | ★ WHARFEDALE |

**NO CHARGES FOR  
CREDIT FACILITIES**  
★  
**LARGEST SELECTION  
OF LATEST MODELS**  
★  
**TAPES • ACCESSORIES**

*Personal attention  
to all enquiries  
without obligation*

**WRITE ★ CALL ★ 'PHONE**

*Please mention Hi-Fi Year Book when writing*

## FRANCIS OF STREATHAM

**169-171 and 181, STREATHAM HIGH ROAD, LONDON, S.W.16**

Between Streatham Station and St. Leonard's Church ★ Phone: STReatham 0466 & 0192

**(Please note this is our only address)**



**PRESENTING THE**

# **SONY 521** *Stereophonic Recorder*



The **SONY 521** has introduced a new achievement in sparkling, stereophonic sound reproduction. Designed for the connoisseur and for professional use, this remarkable instrument is the culmination of years of research and development by the internationally renowned **SONY CORPORATION**.

The **SONY 521** incorporates such notable features as :

- ★ 2 and 4 track monaural stereo recording and playback.
- ★ Built-in stereo pre-amplifiers, stereo recording amplifiers and stereo playback monitor amplifiers.
- ★ Separate level controls for microphone and auxiliary inputs provide professional mixing facilities for recording sound over sound.
- ★ Special tape tension guide automatically shuts off recorder at end of playing time.
- ★ Dynamically balanced flywheel . . . used in advanced "rimdrive" principle . . . no pulleys or belts to wear out.
- ★ Instantaneous stop lever ensures precise editing and cueing.
- ★ Safety lock recording button prevents accidental erasure of pre-recorded tapes.
- ★ Separate channel recording indicator lights.

A full specification has been prepared and is available from the distributors for the United Kingdom — **TELLUX LTD.**

# SONY TAPECORDERS

RESEARCH MAKES THE DIFFERENCE

The **SONY** Corporation have produced a range of recording instruments, catering for the professional and industrial user, for the serious Hi-Fi enthusiast and for the modern family.

Illustrated are a few of the more popular **SONY TAPECORDERS**, engineered to the highest standards but very economically priced.



**SONY III** — A portable tape recorder with outstanding performance. Beautiful 2-tone styling, 2 speeds, simple to operate, complete with smart case. **29½ gns.**



**SONY 101** — An "easy to use" family tape recorder; light, compact, handsome and sturdy, this recorder will delight users with its high fidelity performance. Incorporating transistorised printed circuits and dual speeds. **47 gns.**



**SONY 262** — A compact, high quality instrument designed for serious recording. High performance, dual speed record-playback head assures wide frequency response (70-10,000 c.p.s. at 7.5 ips) and a tape timer will give spot-on relocation. **57 gns.**



**SONY 464** — A high fidelity recorder for the connoisseur with dual speed 4-track stereo/mono recording, sound on sound facilities, instant stop and 8 mm. sync. A beautifully engineered instrument. **72 gns.**



**SONY 362B** — A full fidelity deluxe tape recorder with 3-speed, dual track facilities and push button mixing. Precision built, with transistorised printed circuits **79 gns.**

Illustrated literature with full specifications on these tape recorders are available from leading recorder dealers or from the **SONY CORPORATION'S** sole U.K. Distributors

## TELLUX LIMITED

44 Brunel Road, Acton, London, W.3

Telephone : SHEpherds Bush 0331

A member of the  
K. G. (Holdings) Group of Companies



# **AUDIO SERVICES**

*The specialists with the Hi-Fi know-how*

Accredited Agents for

**MORDAUNT — TANDBERG — ARMSTRONG  
H.M.V. HI-FI EQUIPMENT — SIMON — WOOLLETT**

**SOLE AGENTS FOR THE SHACKMAN DYNA-STATIC LOUDSPEAKER**

**QUAD — LEAK — ROGERS — DECCA  
GOODMANS — W.B. — WHARFEDALE  
GARRARD — CONNOISSEUR — S.M.E.  
ORTOFON — E.M.I. — GOLDRING — ACOS  
K.E.F. — RECORD HOUSING, Etc., Etc.**

*Try us for part exchange, we are extremely generous  
Credit Facilities*

- A unique personal service by Audio engineers of wide experience and trained musicianship.
- Hear the unique Dyna-static Speaker. Natural reproduction from 30 c/s to 20 kc/s.
- A large stock of superior second-hand equipment always available at keen prices.

## **AUDIO SERVICES**

**82, EAST BARNET ROAD, NEW BARNET, HERTS.**

Telephone: BARNET 6605

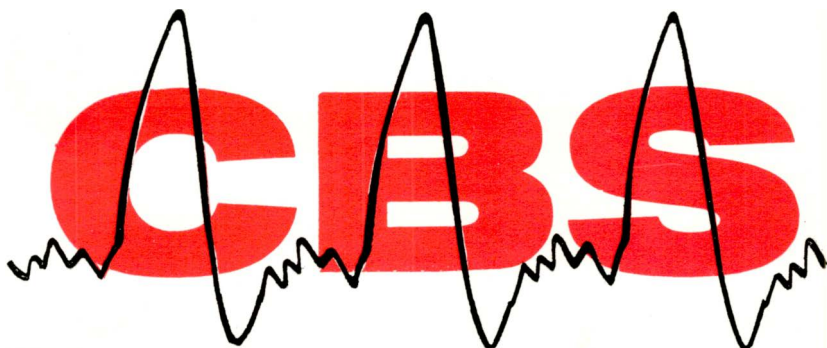

## MAGNETIC RECORDING TAPES **NEW** EXTENDED RANGE OF AUDIO TAPES

STANDARD 1½ MIL	Type	Length	Size	Retail Price
Recommended for most applications where dependable, stable, economical tape is required. Chosen by thousands of users in government and business, and by amateur enthusiasts and professional sound-recording engineers alike. An unusual value in long-wearing, extended frequency range tape.	CIP-1	150ft.	3in.	7/6
	CIP-3	300ft.	4in.	9/6
	CIP-6	600ft.	5in.	17/6
	CIP-9	900ft.	5½in.	23/-
<b>PROFESSIONAL</b>	CIP-12PR	1200ft.	7in.	27/6
A premium tape each reel of which is specially preselected for uniformity. Will more than satisfy the demands of professional sound-recording specialists and discerning audiophiles.				
<b>LONG PLAY 1 MIL</b>  Exceptional tape economy! Provides 50% more footage on same size reel than "Standard" and "Professional" types. Allows 50% more playing time.	LP-9	900ft.	5in.	21/-
	LP-12	1200ft.	5½in.	25/-
	LP-18	1800ft.	7in.	35/-
<b>EXTRA LONG PLAY</b>  Twice the playing time of "Standard"-type tapes. A break-free, long-wearing tape with all the desirable properties of Du Pont's polyester MYLAR film. Incomparable frequency response throughout the entire audio spectrum.	½ MIL (Double Play)			
	CMXP-3	300ft.	3in.	10/-
	CMXP-12	1200ft.	5in.	34/-
	CMXP-18	1800ft.	5½in.	45/-
	CMXP-24	2400ft.	7in.	56/-

**CBS** MAGNETIC RECORDING TAPES are specially designed for use in modern tape recording equipment to satisfy the high-fidelity requirements of 4-track stereo and other advanced professional sound recording techniques. Superior high- and low-frequency characteristics are achieved by precision application of a specially prepared fine magnetic iron oxide dispersion—the result of intensive research and testing. Quality-controlled finishing processes further enhance these characteristics and assure uniform surface properties from tape to tape.

TRADE & WHOLESALE

Enquiries to  
12-16 WATLING ST. E.C.4.  
City 2238

**CBS INTERNATIONAL**  
A Division of Columbia Broadcasting System, Inc.

# HI-FI

**made  
to  
measure**

Most good Hi-Fi equipment doesn't come off the peg. It's custom-built to suit the individual (and his pocket).

Let the Tape Recorder Centre run a tape around *your* requirements.

The Tape Recorder Centre has the largest and finest range of Hi-Fi equipments, components, cabinets in

the country ; unequalled know-how in matching different units ; a reputation for honest and informed advice. Let the Tape Recorder Centre help you to get exactly what you need for top performance and top value. Choose in person — at the London Showrooms ; or choose by post — Send for details.

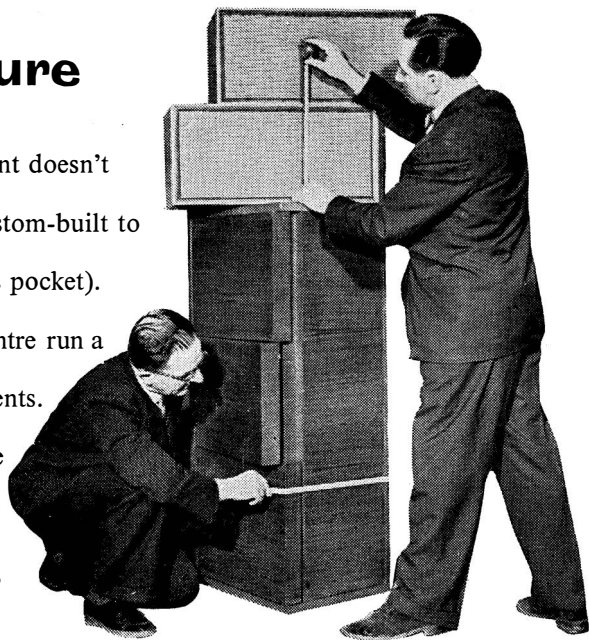

**THE**  
**T C R**  
**TAPE**  
**RECORDER**  
**CENTRE**

82 High Holborn, London, W.C.1. Telephone : CHA 7401

Here's the



range of

# TELEFUNKEN

## *tape recorders*



**NEW**

### TELEFUNKEN MAGNETOPHON 95

Entirely new design in the Telefunken range with attractively styled case. Twin Track. Fully Portable. Three speeds:  $7\frac{1}{2}$ "  $3\frac{1}{2}$ " and  $1\frac{1}{4}$ ". Maximum Spool Size 7". Frequency response: 30-18,000 cps at  $7\frac{1}{2}$  ips; 30-16,000 cps at  $3\frac{1}{2}$  ips; 30-9,000 cps at  $1\frac{1}{4}$  ips. Special trick and "straight through" amplifier facilities. **59 gns** (excluding microphone)



**NEW**

### TELEFUNKEN MAGNETOPHON 96

This new FOUR-TRACK recorder has the same basic style and technical specifications as the Magnetophon 95, but offers all the advantages of the desirable four-track technique. Playing time over 16 hours on 7" DP tape. Multiple transcription from one track to another. Facilities for playback of prerecorded stereo tape through additional amplifier or radio. **69 gns** (excluding microphone)



**NEW**

### TELEFUNKEN MAGNETOPHON 97

The stereo tape recorder which provides not only the outstanding facilities of the four-track system with its manifold possibilities for transcribing and trick effects, but also the twin-channel stereo, four-track technique for recording and playback. Speeds, frequency response and spool size same as Magnetophon 95. Extra speaker in the lid for stereo playback.

**95 gns** (excluding microphone)

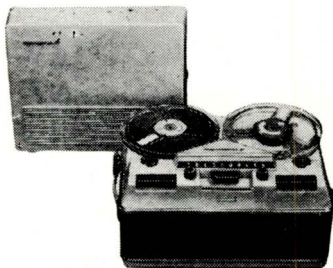

*and of course*

75K-15—Tape speeds  $3\frac{1}{2}$  ips and  $1\frac{1}{4}$  ips; frequency response of 60-16,000 cps and 60-9,000 cps. Playing time of 6 hours on 5 $\frac{3}{4}$ " DP tape. 47 Gns (excl. microphone).

85-KL—Tape speeds  $7\frac{1}{2}$  ips and  $3\frac{1}{2}$  ips; frequency response 30-20,000 cps  $\pm$  3dB and 30-15,000 cps. 79 Gns (excl. microphone)



75K-15

# TELEFUNKEN

Send for illustrated literature to:



WELMEC CORPORATION LIMITED

147/8 STRAND WC2

# *Pamphonic*

## REFLECTOGRAPH

QUALITY WITHOUT COMPROMISE

The primary function of a tape recorder is the accurate reproduction of the original signal. This is the aim and achievement of the REFLECTOGRAPH

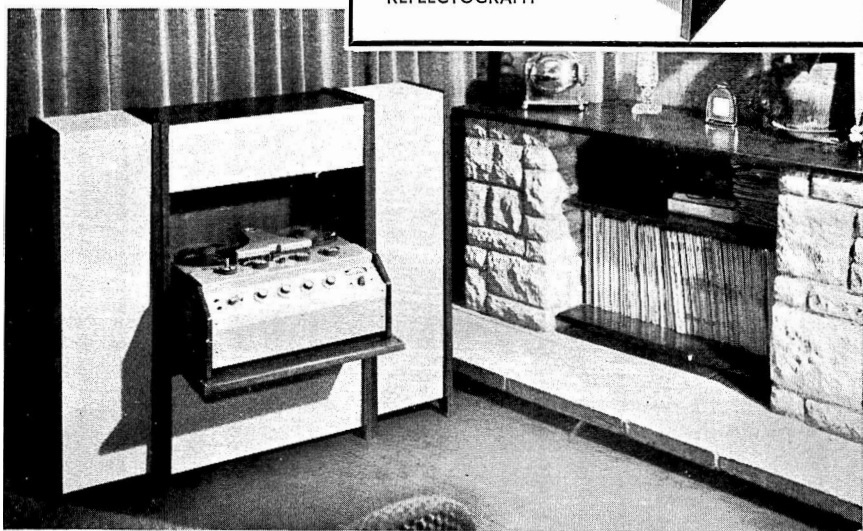
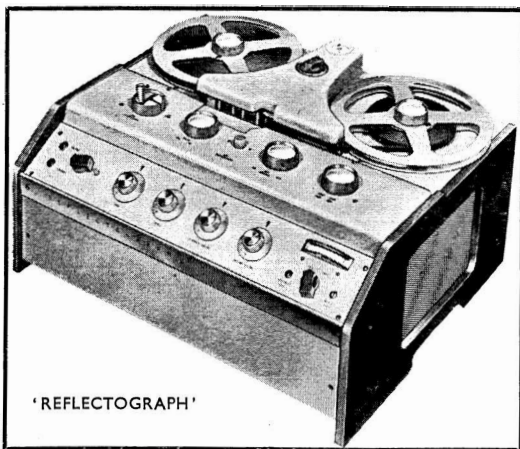

**SOUND GENIUS** and original styling combine in the Cosmonaut Reflectograph cabinet to provide a unit with ability to blend visually and aurally in perfect harmony with all domestic settings.

*Write for further details and full specification*

**PAMPHONIC REPRODUCERS LTD.**  
Westmoreland Road, Queensbury, London, N.W.9. Telephone: COLindale 7131



# LASKY'S RADIO

## for all that's NEW

IN THE REALM OF HI-FI

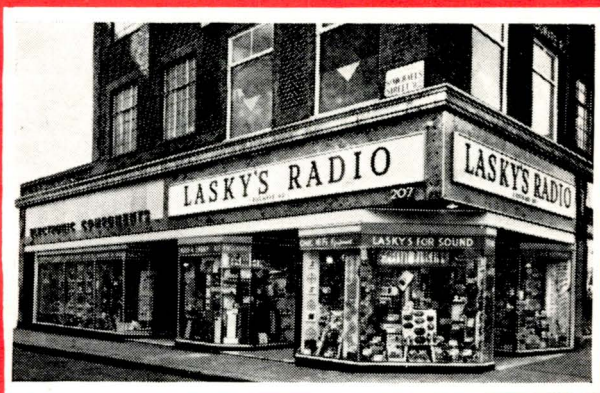

See and hear the latest in hi-fi in our Demonstration Studios or let us serve you by post, as we do many thousands of home and overseas customers. We also operate the purchase tax-free plan for overseas visitors.



Read all about hi-fi equipment of every kind in our superb catalogue of over 100 large pages, 11¼ × 8½ in., in photogravure and colour. Price 5s., part post 6d. (returnable in full on making your first hi-fi purchase from the catalogue).

- ★ AMPLIFIERS
- ★ CONTROL UNITS
- ★ PICKUPS
- ★ LOUDSPEAKERS
- ★ SPEAKER SYSTEMS
- ★ RECORD PLAYERS
- ★ AUTOCHANGERS
- ★ TRANSCRIPTION  
TURNTABLES
- ★ AM/FM TUNERS
- ★ TAPE DECKS
- ★ TAPE RECORDERS
- ★ MICROPHONES
- ★ CABINETS & SPEAKER  
ENCLOSURES

H.P. TERMS AVAILABLE

207 EDGWARE ROAD, LONDON, W.2.

PADdington 3271/2

Few yards from Praed Street

Both open All Day Saturday. Early Closing Thurs.

33 TOTTENHAM COURT ROAD, W.1.

MUSEum 2605

Nearest Station Goodge Street

Mail Orders to Dept. YB, Edgware Road

# H.M.V.

## AUDIO EQUIPMENT



Model 582 Cabinet with matching Loudspeaker system 519 in figured walnut

Cabinet has ample accommodation for all High Fidelity Components and record storage space. Each Loudspeaker Enclosure contains 13" x 8" bass unit, two 3" tweeters and a crossover network.

582: 30 guineas

519: 27 guineas each

... part of a full range of components including

★ MODEL 555: 10 + 10 watt "Stereoscope" integrated stereo amplifier. 63 guineas

★ MODEL 556: "Stereoscope" self-powered stereo pre-amplifier. 39 guineas

★ MODEL 557: 10 + 10 watt stereo power amplifier. 30 guineas

★ MODEL 599: Stereo control unit pre-amplifier. 12 guineas

★ MODEL 558: Self-powered AM/FM radio tuner unit. 33½ guineas plus 17s. 11d. P.T. surcharge



... the expert's choice

EPU/100 pickup by **E.M.I.**

21 gns.  
plus  
11/3 P.T. s/charge.

Full details of all the above components available from:

**CLARKE AND SMITH MFG. CO. LTD.**

HIGH FIDELITY COMPONENTS DIVISION

MELBOURNE ROAD • WALLINGTON • SURREY

Phone  
9252/7





**RECORD IT ON**  
**GEVASONOR**

**MAGNETIC**

**RECORDING TAPE**

*Available in a full range of  
types and sizes*

**GEVAERT**

FOR PRICES, SEE "DIRECTORY OF MAGNETIC TAPE"

**GEVAERT LIMITED · GREAT WEST ROAD · BRENTFORD · MIDDX**

12" Monitor  
Dual Concentric.  
For highest quality  
Home music  
systems.

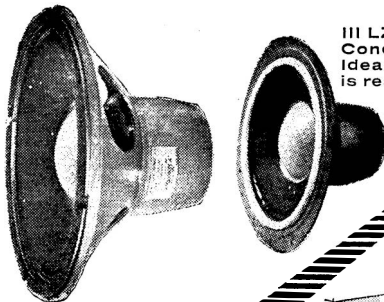

III LZ Monitor Dual  
Concentric.  
Ideal where space  
is restricted.



15" Monitor  
Dual Concentric.  
Used as studio  
monitor by  
recording and  
broadcasting  
companies.

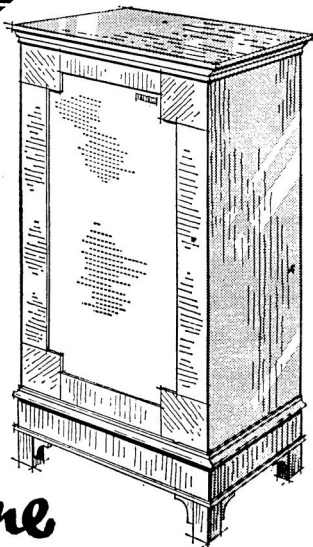
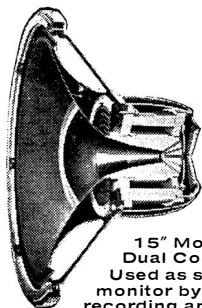

# STUDIO STANDARDS *in your home*

The corner G.R.F. enclosure has for several years been regarded as a quality standard by professional users and music lovers alike. The introduction of a *free-standing model* built to the same exacting standards, not only increases its application to mono systems but makes it an ideal companion to the corner version in stereo systems of the highest quality.

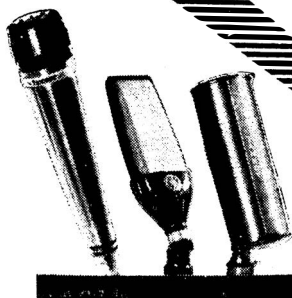

LEFT: NEW—Pressure Operated Moving Coil Microphone. 25 cps-14Kcs. Omni-directional.  
CENTRE: NEW—Velocity Ribbon Microphone. 25 cps-14Kcs. Symmetrical bi-directional characteristic.  
RIGHT: NEW—Single Element Cardioid Microphone. Front to rear discrimination exceeding 15 dB. 25 cps-14Kcs.

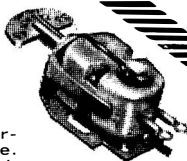

Varilucance  
Turnover  
Mono  
Cartridge.  
As used by  
the B.B.C.



Varitwin  
Stereo Cartridge.  
For high quality  
Home music systems.

One of the  
Tannoy Group  
of Companies

TANNOY PRODUCTS LIMITED, West Norwood, S.E.27. Gipsy Hill 1131

# HI-FI NEWS

Hi-Fi News is the established magazine for the audio and High Fidelity Trade. Read all over the world by Experts, by Beginners and by Enthusiasts. Hi-Fi News is always well-produced, full of interesting material, and essentially readable. On sale at all leading bookstalls, monthly.



## PRICE 2/- MONTHLY

- WELL PRODUCED ON GOOD PAPER AND LIBERALLY ILLUSTRATED
- UP-TO-DATE NEWS AND PICTURES
- INFORMATIVE ARTICLES ON ALL ASPECTS OF THE AUDIO WORLD
- REGULAR DETAILS OF NEW PRODUCTS
- AUTHORITATIVE AND RELIABLE REVIEWS
- SPECIAL FEATURES FOR HOME CONSTRUCTORS
- LIVELY AND USEFUL MONTHLY POSTBAG, DEALING WITH MANY AUDIO PROBLEMS.

### SUBSCRIPTION RATES

The subscription rate to "Hi-Fi News" is 27/6 per annum (U.S.A. \$4.00) from "Hi-Fi News," 99, Mortimer Street, London, W.1.  
Subscription + Index, 30/- (U.S.A. \$4.25).

**MILES HENSLOW PUBLICATIONS LTD.**  
**99 MORTIMER STREET :: LONDON, W.1.**

# Choose them in comfort . . . Hear them at leisure!

*How to get there. From Tottenham Court Road Tube Station go westward along Oxford Street. Soho Street is the first on the left.*

**Make your way**

to

**WEBB'S**  
*Radio*

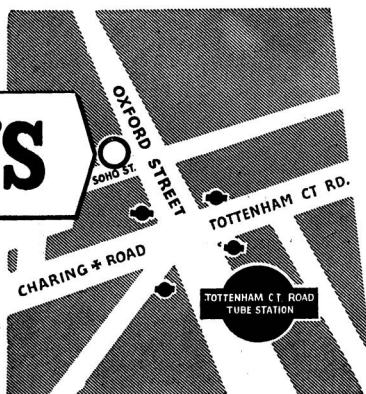

You'll find everybody at Webb's to be cheerful and helpful — without any high pressure sales talk. We have one of the largest selections of the best in hi-fi equipment in London. Come and compare the merits of any combination of Amplifier, Speaker, Pickup and Radio, in comfort and at your leisure.

- **AMPLIFIERS** by  
ACOUSTICAL ROGERS      ARMSTRONG LEAK

- **SPEAKERS** by  
GOODMANS      SOUND SALES  
VITAVOX      ROLA  
TANNOY      CELESTION  
WHARFEDALE      W.B.  
LEAK

- **F.M. & A.M. RADIO UNITS** by  
ACOUSTICAL CHAPMAN  
ARMSTRONG ROGERS

- **PICKUPS and MOTORS** by  
WORDEN      CONNOISSEUR  
TANNOY      LEAK  
GARRARD      EXPERT  
SME      Lenco  
ORTOFON Stereo



Webb's unrivalled stocks cover everything from a replacement stylus to complete de luxe outfits. Attractive Hire Purchase terms available.

**14 SOHO STREET, OXFORD STREET, LONDON, W.1**

Telephone: GERrard 2089 and 7308

Shop hours: 9 a.m. to 5.30 p.m. (7 p.m. Thursday), 9 a.m. to 1 p.m. Saturdays.

# "technically luxurious"

Stereo Deck  
and Pre-amp.

**Model PD 86**

Stereo  $\frac{1}{4}$ -track **£63**

Model PD 87

Stereo  $\frac{1}{2}$ -track **£63**



7" Reels

4 watts

Model R 82

2-Track **55 gns.**

Model R 84

4-Track **59 gns.**



Model D 82

2-Track Deck only **25 gns.**

Model D 84

4-Track Deck only **28 gns.**

Model PD 82

2-Track Tape Deck  
and pre-amp **£42**

Model PD 84

4-Track Deck and  
pre-amp **£46**



## TAPE RECORDERS

BY **TRUVOX**

TRUVOX LTD., NEASDEN LANE, LONDON, N.W.10

# pleasure for the hi-fi eye

DESIGN cabinets for records and hi-fi equipment are solidly built and 100% functional . . . that goes without saying. But they give pleasure to the eye, too; unassumingly handsome and painstakingly finished, they harmonise successfully with any scheme of decoration. Send for our free brochure, and the name of your nearest stockist.

DESIGN FURNITURE LIMITED,  
Carnwath Road, Fulham, London, S.W.6.  
Telephone: RENown 2217.

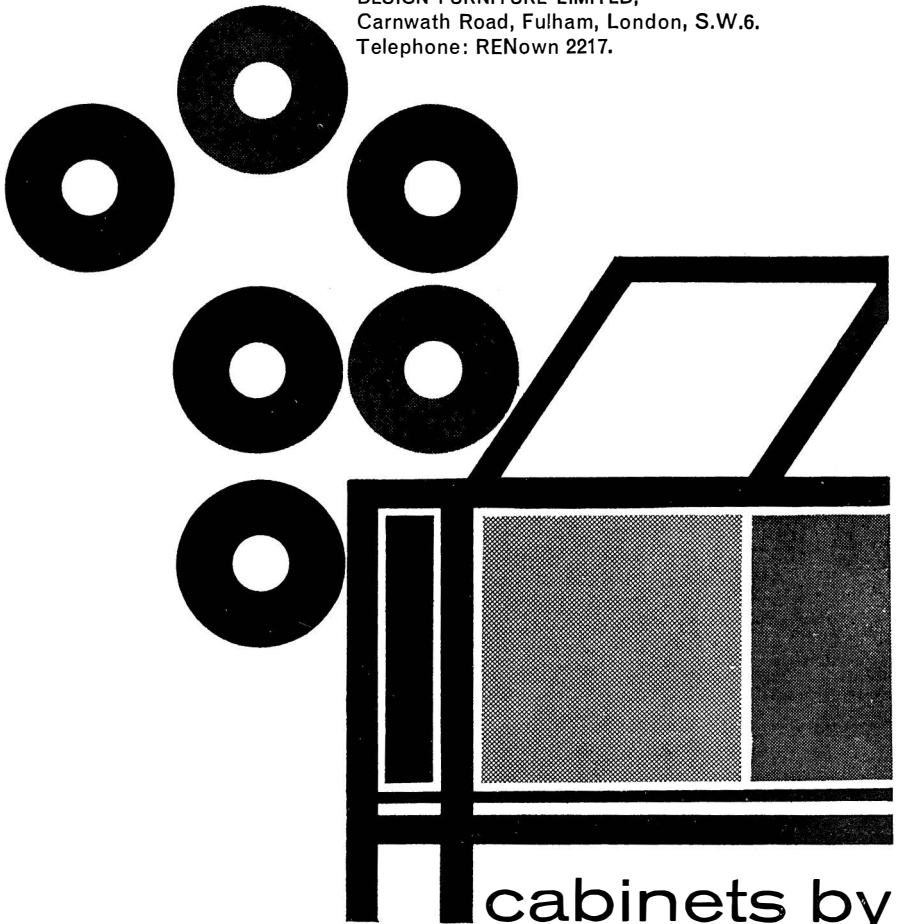

cabinets by

***DESIGN***

**It's the listening test  
that counts**

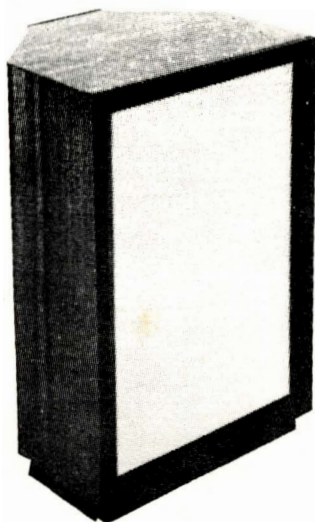

## **THE LANSING ROLLS**

**SPEAKER SYSTEM**

**SOUNDS GOOD**

**LOOKS GOOD**

**E.T.I. LTD., 7 ARKWRIGHT ROAD  
COLNBROOK, BUCKS**



# SANDWICH

## LEAK

### ... an astonishingly improved loudspeaker system

LEAK set a new standard when, in 1945, they marketed amplifiers having a total distortion content as low as 0.1%. This was fifty times better than the then accepted standard for distortion content. Now LEAK have set a new standard in Loudspeakers with their Sandwich System.

#### The group unequivocally voted for the LEAK "SANDWICH"

"An extended series of direct comparison tests with three current designs of commercial loudspeakers, was undertaken with a listening panel of mixed sex and age. Two of the speakers cost approximately the same as the Leak, and the third model was much more expensive. After all tests on speech and music, from records and radio, the group unequivocally voted for the Leak 'Sandwich'. The superiority on speech tests was particularly marked. . . . SUMMARY: We gave the Leak 'Sandwich' loudspeaker the full treatment. It is difficult to fault it. This design must be regarded as a break-through of fundamental and far-reaching importance."

*Quoted from the Test Report by Donald Aldous and David Phillips. "Audio and Record Review."*

#### "LEAK Speakers won the day"

"This occasion proved a most stringent test as we were listening to a stereo recording of a very recent orchestral and operatic performance we had enjoyed either as audience or performer. By way of experiment other pairs of speakers were switched in, but the very smooth response of the Leak speakers won the day."

*Quoted from the Test Report by Ralph West, B.Sc., M.Brit.I.R.E. in "Hi-Fi News."*

#### "Selecting the Equipment"

"Suggestions? The Leak line comes highly recommended on two continents, the pre-amp isn't cursed with superfluous knobs, and it looks good. The mono amp would thus be the TL/12 Plus and the stereo version would be the Point One Stereo 20 Amplifier. Both run about 10-12 watts per speaker, and frankly I think this is plenty. Even with that you can rattle the windows, and the reason is that this 10W is at minimum distortion, 10W sinewave power (which means that it'll put out a lot more on peaks). The price of the Leak is also quite reasonable for uncompromised sound quality."

*Quoted from the article "Frankly Speaking" by John Berridge. "Hi-Fi News."*



Southdown Cabinet  
£21

Point One Stereo pre-amp.  
£21

Stereo 20 power amplifier  
£30·9s.



The revolutionary LEAK "Sandwich" cone diaphragm weighs the same as conventional cones, but is hundreds of times stiffer, and will support the weight of a man. We have thus overcome the major weakness of the moving-coil system—lack of diaphragm rigidity—for there has been no improvement of practical significance in rigidity during the 36 years since Rice and Kellogg introduced the original "R-K" design in 1925.

A loudspeaker diaphragm or cone, in order to follow accurately the signal applied to the speech coil, needs to be light *and* stiff but hitherto materials which of necessity have had to be used for their low mass have suffered from a low stiffness factor, resulting in significantly large areas of the cone vibrating in modes uncontrolled by the speech-coil. When reproducing speech and music these uncontrolled vibrations, or break-up motions, are translated to the listener as a complex mixture of ever-present and unpredictably ever-changing audible distortions—transient distortion or "hang-over", intermodulation distortion and amplitude distortion. The immense stiffness of the new LEAK "Sandwich" cone gives, for the first time in history, a direct-radiator loudspeaker diaphragm which behaves in the theoretically ideal manner of a rigid piston and reproduces the signal applied to the speech coil without flexing and free of break-up distortions.

LEAK "SANDWICH" LOUDSPEAKER . . . Price **£39·18·0d**

**LEAK**

**. . . the first name in High Fidelity**

H. J. LEAK & CO. LTD., BRUNEL ROAD, WESTWAY FACTORY ESTATE, LONDON, W.3.  
Telephone: SHEpherds Bush 1173.      Telegrams: Sinusoidal Ealux, London

# IMHOFS

## EXCLUSIVE hi fi cabinets

IMHOFS have designed an exclusive range of cabinets for every possible hi fi need. These cabinets have been featured at the Design Centre, and at exhibitions in London, New York, and many continental cities... they are built by IMHOF craftsmen... they have an excellence of finish that gives distinction to any home. The fifth floor of IMHOF House is now devoted wholly to cabinets—you are invited to see them at your leisure.

### HFU 10

A three-compartment control cabinet, finished in Sapele Mahogany or Walnut, which will house the most elaborate control equipment including tape decks. 50" wide × 25" high (with legs) × 21" deep—price £39. 18. 0. Also available HFU 9 similar to the above but a two-compartment cabinet. 35" wide × 25" high (with legs) × 21" deep—Price £30. 10. 0.

### Trolley L

A trolley control cabinet which will move with finger-tip ease. Plenty of space for latest equipment—dimensions are 24" high (including castors) × 18½" deep × 35½" wide. Standard finishes are Sapele Mahogany or Walnut—Price £30. 10. 0.

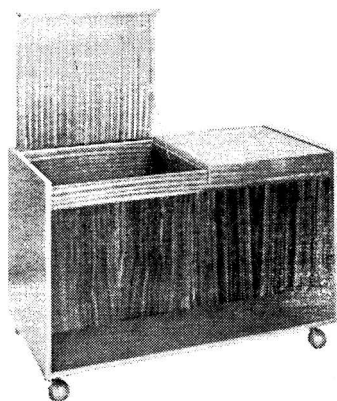

### IM unit III B

A compact, inexpensive cabinet of high quality workmanship and finish for transcription record players. 18" wide 8" high 15½" deep—finish Sapele Mahogany or Walnut—Price £8.8.0

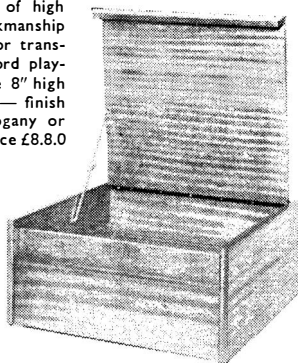

**Special finishes  
for all models to order**



*IMHOFS are the world-acknowledged experts in hi fi and can supply every worthwhile piece of equipment, whether you want a single item (such as a tuner or motor) or an elaborate concealed system designed in conjunction with your architect. With the IMHOF Mono Stereo Comparator you can hear up to 4,000 alternative choices of equipment at the flick of a switch!*

**Have you sent for your FREE copy of "This year of Hi Fi 1962"?**

**Alfred Imhof Limited Dept. 412**

112-116 New Oxford Street, W.C.1 MUSEum 7878

Tape  
never  
had it  
so  
good!

With its unique versatility the UHER UNIVERSAL "S" covers the whole range of audible sound. The simpler needs of the business man dictating a memo—the more particular demands of a discriminating recordist—all can be satisfied by this one brilliant machine with exceptional efficiency and reliability.

At 1½ i.p.s. the UNIVERSAL "S" will give you a frequency response well above average; at 3½ i.p.s. musical quality is superb whilst at the low speed of 15/16 i.p.s. the special features of the UHER make it ideal for speech recording.

Additional UHER accessories available include hand or foot operated remote control units and the Syncro-Akustomat—an acoustic switch which gives you sound operated control and will enable you to start and stop the machine simply by speaking.

*Find out more about this exceptional machine—make a point of seeing it and hearing it for yourself.*

**PRICE 83 gns.**

*(including remote control microphone and tape)*

**UHER**  
**UNIVERSAL 'S'**

**WORLD'S MOST  
VERSATILE  
TAPE RECORDER**

Visit our new London Showrooms, or write for illustrated literature describing the full range of UHER Tape Recorders and accessories.

*London Showroom, Radio and Domestic Appliance Division,*

**BOSCH LIMITED**

205 Gt. Portland St., London, W.1.  
Tel: LAngham 1809/1800

*Head Office:*  
20 Carlisle Rd., The Hyde, Hendon, N.W.9  
Tel: COLindale 0161

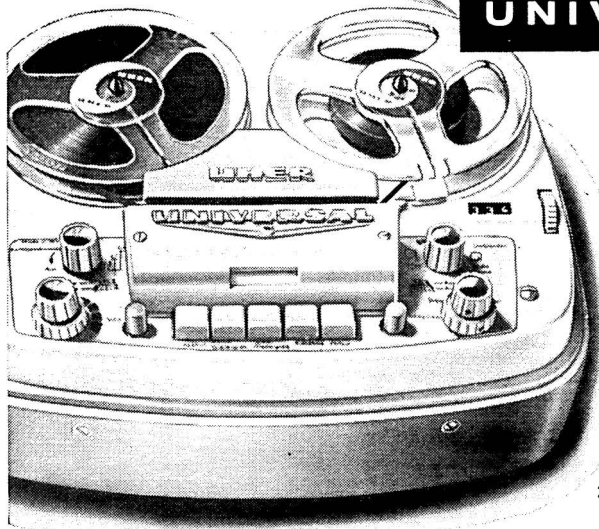



# WELLINGTON ACOUSTIC LABORATORIES LTD.

## The famous WAL GAIN PRE-AMPLIFIERS...

Transistorised, battery operated, the WAL GAIN gives you the EXTRA GAIN you need, without hum, or distortion. Can be connected directly to low impedance microphones, tape heads, or P-U's, and the output taken directly to the input of the main amplifier.

**MONO WAL GAIN, £5. 0. 0.** Size only  $3\frac{3}{4}'' \times 2'' \times 2\frac{1}{4}''$ . Ideal for Reslo ribbon, STC 4021 "ball and biscuit," Lustraphone LD/61, and many others.

**STEREO WAL GAIN, £7. 10. 0.** Many applications for Mics, Tape heads, and also Decca ffss, SPU/G Ortofon, Shure, Grado, etc. High and Low Impedance inputs. Size  $7'' \times 2'' \times 2\frac{1}{2}''$ .

**WAL HI-GAIN, £7. 16. 0.** Invaluable accessory for the second deck, for re-play, dubbing, monitoring or headphones. Also the second channel for stereo on mono tape equipment. CCIR equalisation, High and Low Impedance inputs. Pair for Stereo re-play, special price, **£15.**

All WAL GAINS are supplied complete with phono plugs, battery, screened lead and full connection instructions.

There are many applications in the Industrial, Medical, Scientific, Cine and Audio fields where one of the WAL GAINS will solve the problem.

**WAL D-MAG.** Mains operated, head demagnetiser, that provides a complete degaussing circuit. NYLON COVERED PROBES, designed to reach the heads on most decks. Also "spot" erasers for unwanted sounds on tape or film. **£2. 10. 0.**



WAL HI-GAIN, size  $7'' \times 2'' \times 2\frac{1}{2}''$

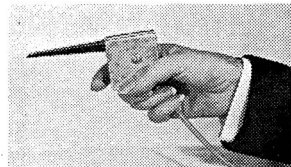

WAL D-MAG head demagnetiser

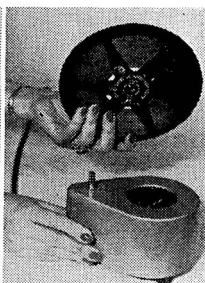
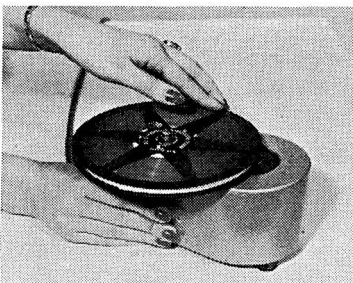
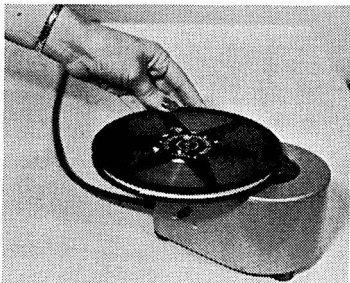

Put a reel of tape on the WAL Eraser, switch on, turn the reel several times, remove the reel, switch off.

**WAL BULK ERASER, £7. 18. 6.** It takes 30 seconds to "clean" both tracks from  $8\frac{1}{2}''$  reel of tape. The ideal accessory for professional enthusiasts.

The WAL Eraser is used in Laboratories, Colleges, Schools, Dealers' demo rooms, Studios, Offices, Tape Clubs—in fact, by anyone who does tape recording.

**WALTRAK, £6. 10. 0.** Output 1000 cps sine wave. Transistorised, battery operated pocket oscillator. Hundreds of applications.

Full technical leaflets available on all our products, which are designed and manufactured by us. We are always pleased to advise customers and dealers, on any technical query on any of our products.

**ALL THE LEADING DEALERS KNOW W. A. L.**



Wholesalers include: Thompson, Diamond & Butcher Ltd., London and A. C. Farnell Ltd., Leeds.



**WELLINGTON ACOUSTIC LABORATORIES LTD.**

FARNHAM, SURREY

Farnham 6461

# Chapman



'Tranquillo'  
105  
Complete  
Amplifier

S6BS/FM  
six stage AM  
bandsread &  
high gain FM

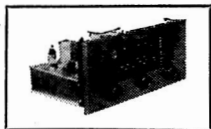

## lead with quality and design

By consistently maintaining the high standard of design, reliability of performance is continued year after year.

The finest of British components are selected and used in relation to stringent quality control and testing, giving confidence to the most discriminating listener throughout the world.

To those who are prepared to spend a little more, initially, the result is a long term sound investment.

FM 95  
AM/FM Tuner



305  
Stereo control  
unit

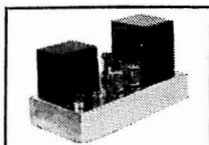

205  
Amplifier

Write for full specifications.

## CHAPMAN ULTRASONICS LTD.



# Reslo

## for high quality sound reproduction

All microphones are backed by over 25 years' experience in the design of ribbon and coil dynamic types.

We have concentrated our design efforts on ribbon type microphones, as these provide the very high standard of reproduction demanded by present-day sound equipment. We now dominate this field in styling and performance.

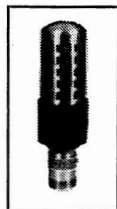

Pencil Ribbon  
(non-swivel)  
type P.R.

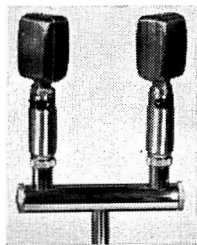

Stereo bar for microphones



Transistor Coupler  
type G.E.I

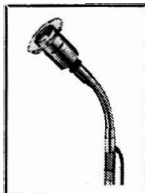

Dynamic  
type C.D.



Miniature  
Ribbon  
type R.D.

## RESLOSOUND LIMITED

Sales Division: 24 Upper Brook Street, London, W.1.

Write for full specifications.

★ All enquiries for either company should be sent to the address below.

Telephone: Hyde Park 2291

## PROVED

The finest method for cleaning records. Already over 200,000 enthusiastic users. All Static and Dust completely removed from Your Records as they are played

THE  
**“Dust Bug”**  
AUTOMATIC GRAMOPHONE  
RECORD CLEANER

PATENT No. 817598

Instantly Fitted. Suitable for all Types of Record. Quality Improved. Surface Noise and Wear Reduced.

**STANDARD MODEL FOR TRANSCRIPTION AND SINGLE RECORD PLAYERS.**

PRICES REDUCED **17/6** (plus 5/10 purchase tax)

From Your Dealer, or

**CECIL E. WATTS LTD.**

(Sound Recording and Reproduction)

**Darby House, Sunbury-on-Thames, Middx.**



The Dust Bug may be placed in any convenient position around the turntable and the adjustable pin of the pillar raised if necessary so that the arm is approximately parallel to the surface of the record.

The use of the fluid dispenser should only provide a trace of dampness to the push pad. It is not intended that any fluid should be transferred to the record. The slightly damp pad provides a leakage path for the discharge of any static in the record and assists in the collection of dust, etc.

The Dust Bug is the only record cleaner capable of thoroughly cleaning the groove without affecting the record surface in any way.

The

# PARASTAT

(Regd.)

## TREATMENT FOR L.P. RECORDS (PATENTS APPLIED FOR)

Buy where there is a “Parastat” service—Used by dealers who have the customer’s interests at heart

This Machine serves three main purposes in the handling of all types of Gramophone Records.

1. It cleans simultaneously both sides of the entire surface of the record (including the label), and removes every particle of dust or foreign matter from the grooves in less than ten seconds.
2. Renders the record permanently inert to all Static charges induced by any means, leaving no trace on either groove or record surface.
3. Reduces the coefficient of friction between stylus and groove wall at all points of violent acceleration reducing tracing distortion wear and surface noise.



**CECIL E. WATTS LTD. - DARBY HOUSE - SUNBURY-ON-THAMES - MIDDLESEX**





NOW... an even wider range  
of transcription equipment  
from **GOLDRING**



**GL. 58**  
Continuously  
variable speed  
control. Wow and  
flutter less than  
0.5%. Transcription  
arm wired for stereo  
or mono. Unique groove  
selection device . . .  
Price £18.4.5.

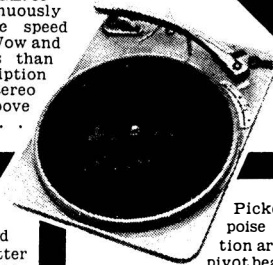

**GL. 70.** 8lb. die cast turntable,  
accurately machine finished and  
dynamically balanced. Wow and flutter  
less than 0.2%. Continuously variable  
speed adjustment. L.70 transcription  
arm, in light alloy with nylon bearings.  
Extremely low tracking error. . . .  
Price £29.16.3

**Pickering Model 198** Uni-  
poise integrated transcrip-  
tion arm and cartridge. Single  
pivot bearing. The variable reluctance  
stereo/mono cartridge has simple  
slide-in stylus changing facilities. Tracking  
weight 2 gms. . . . Price £58.8.8.

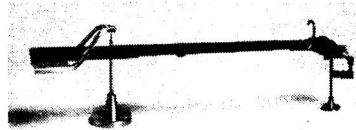

**Pickering**  
variable  
reluctance  
stereo/mono

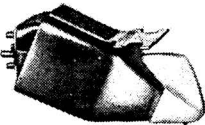

cartridges '380', '380A' and '381'. Sealed  
mu-metal capsule. Simple slide-in stylus  
assembly. '380' tracking 4 gms. . . . Price  
£16.13.11; '380A' tracking pressure 2 gms.  
. . . £37.11.3. '381' (Calibration standard)  
for professional use. . . . Price £50.1.8.

(All prices quoted are subject to 10% P.T. increase)

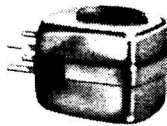

**700 Mk 11** stereo cartridge  
with standard fixing centres.  
Normal tracking weight 3-4  
gms. Frequency response  
40 c/s-12,000 c/s. Channel  
separation-20dB at 1 Kc.  
. . . Price £9.14.9.

**Goldring 600** mono  
cartridge. Wide, level,  
frequency response.  
Higher compliance.  
Minimum effective  
mass at stylus tip.  
Tracking pressure 4-5  
gms. . . . Price £11.2.7.

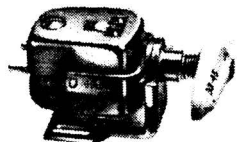

**GOLDRING MANUFACTURING CO. (Gt. Britain) LIMITED**

486-488 High Road, Leytonstone, London, E.11. Telephone: LEYtonstone 8343

# THE BEST OF BOTH WORLDS

## Brenell Mk. 5 Deck

4 recording speeds  $1\frac{7}{8}$ ,  $3\frac{3}{4}$ ,  $7\frac{1}{2}$  and 15 ips. Permits use of  $8\frac{1}{2}$  in. reels (3,600 ft. of D.P. tape at  $1\frac{7}{8}$  ips., plays for over 12 hours); 3 independent motors. Interlocked controls. Pause control. Digital rev. counter. Fast rewind (1,200 ft. in 45 secs.). Provision for extra heads. 28 gns.

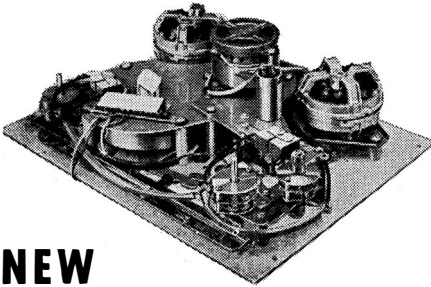

## NEW

### Brenell Mk. 510 Deck

A recent introduction is the modified Mk. 5 Deck which will accommodate  $10\frac{1}{2}$  in. N.A.B. and standard spools. All other features remain as before. It is available in either Hammered Gold or Hammered Grey finish for use on 200/250V 50c/s mains supplies only. The additional cost is 7 gns.

Sole manufacturers:

# Brenell

**BRENELL ENGINEERING CO. LTD., 1a Doughty Street, London, W.C.1**

**Telephone: Holborn 7356 (3 lines)**

That is what you can expect when you buy a Brenell tape deck or recorder—top quality performance and versatility at a reasonable price. The Mark 5 deck at 28 gns., the Mark 5 recorder at 64 gns. or the 3 Star Stereo at 89 gns. are all unbeatable in their class. Mere illustrations can only show the functional appearance of these machines but a practical demonstration will reveal the realism and beauty of recorded sound obtainable from a Brenell recorder. Ask your specialist dealer for a demonstration and you will hear what we mean.

All Brenell tape decks and recorders are fitted with an hysteresis synchronous capstan motor with an outer rotor and a large statically and dynamically balanced flywheel. This drive system is widely regarded as the most efficient for use in tape recorders and 'Wow and Flutter' are reduced to below .1% at  $7\frac{1}{2}$  ips.

### Brenell Mk. 5 Recorder

The professional choice. Has all the remarkable performance features of the Mk. 5 Deck, plus monitoring facilities, complete record/play-back amplifier with power unit, coloured signal lights, selective frequency correction at  $3\frac{3}{4}$ ,  $7\frac{1}{2}$  and 15 ips. 64 gns.



### Brenell Mk. 5 Type "M"

A development of the Mk. 5 giving facilities for mixing, superimposing and tape monitoring. Two separate amplifiers are provided for recording and replay and an accurate Recording Level meter ensures recordings of unvarying quality.

88 gns.

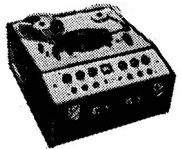

### Brenell 3 Star Stereo

3 speeds. Stacked heads. Records and replays stereo. Extended frequency range. For monaural work, half track erasure is used. Exceedingly low cross talk of -60 db. Plays directly from pick-up—Stereo or Monaural. Two recording level indicators. Two internal speakers. 89 gns. With two microphones 95 gns.



# For High Fidelity Stereo and Monitoring . . .



**S. G. BROWN**

**SUPER**  
**K**  
**HEADPHONES**

The "Super K" Headphones are the newest product of S. G. Brown Ltd. and are designed especially for High Fidelity Stereo requirements. They are attractive in appearance, extremely comfortable to wear and incorporate plastic head band and earpieces.



*Ask for fully detailed and illustrated leaflet from:*

**S. G. BROWN LTD.**  
**SHAKESPEARE STREET, WATFORD, HERTS.**

Telephone : Watford 27241



# QUALITY AMPLIFICATION 1931 — 1962

Since 1931 we have enthusiastically designed and produced equipment built to Laboratory standards, that would create the closest approach to realism under domestic conditions, hence the introduction of the Tone Control, as far back as 1937 when the famous Tri-Channel was first introduced.

Our products include the Twin Twenty Stereo Amplifier, the Mk. III Mono, Professional Recording Amplifiers, F.M. Units, and the well-known Phase Inverter Speaker which incorporates a Laboratory built unit of unique design, with a cast aluminium chassis, plus a very efficient Alcomax magnet giving very low resonance, and consequently smooth reproduction from 30 to 13,500 cps. The Phase Inverter Speaker does not employ a collection of individually inferior units with crossover networks to cunningly dodge their resonant peaks. Thousands of Phase Inverter Speakers are in use at Home and Abroad — they have stood the test of time — and since everything except the attractive Cabinet is produced in our Works, they are reasonably priced; therefore particularly attractive to the Audio enthusiast, and of course our Overseas Department can ship to any part of the World.

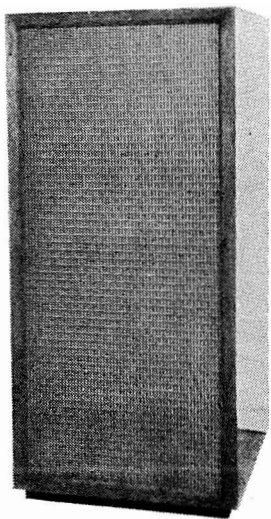

THE PHASE INVERTER  
SPEAKER  
PRICE £20 10 0

R. N. WELLINGTON  
MANAGING DIRECTOR

CONTRACTORS TO THE BBC, GPO, ETC.

---

---

SOUND SALES LTD.

SOUND LABORATORIES

FARNHAM, SURREY

Tel.: FARNHAM 6461-2-3

---

---

U.S.A., CANADA, PARIS, NEW ZEALAND, AUSTRALIA

# Vortexion

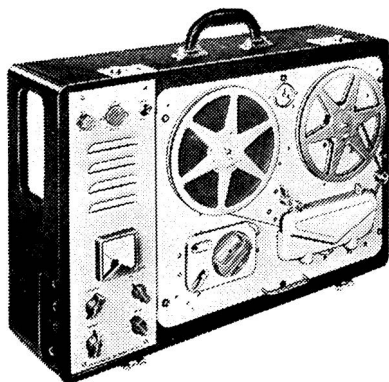

The W.V.B. recorder has an additional amplifier and head with provision for "before" and "after" record monitoring while the recording is in progress, and this also has echo facilities.

The W.V.A recorder has provision for a plug in stereo head and can be supplied with this and stereo playback pre-amplifiers with equalisation each having an output of 1 volt from a cathode follower. This is type W.V.A/S.

## TWELVE-CHANNEL ELECTRONIC MIXER

This is similar to the 4-channel, but is fitted with 12 hermetically sealed controls, 12 balanced line microphone transformers potted in mu-metal boxes, and a mains transformer also potted in mu-metal. All components which can affect noise are tested and selected before insertion. It is supplied in standard steel case or 7 inch rack panel.

## 30/50 WATT AMPLIFIER

Gives 30 watts continuous signal and 50 watts peak Audio. With voice coil feedback distortion is under 0.1%, and when arranged for tertiary feedback and 100 volt line it is under 0.15%. The hum and noise is better than -85 dB referred to 30 watt. It is available in our standard steel case with Baxandall tone controls and up to 4 mixed inputs, which may be balanced line 30 ohm microphones or equalised P.U.s to choice.

## 120/200 WATT AMPLIFIER

Will deliver 120 watts continuous signal and over 200 watts peak Audio. It is completely stable with any type of load and may be used to drive motors or other devices to over 120 watts at frequencies from 20,000 down to 30 cps in standard form or other frequencies to order. The distortion is less than 0.2% and the noise level -95 dB. A floating series parallel output is provided for 100-120 v. or 200-240 v. and this cool running amplifier occupies 12 $\frac{1}{4}$  inches of standard rack space by 11 inches deep. Weight 60 lb.

## VORTEXION LIMITED

257/263, The Broadway, Wimbledon, London, S.W.19

Telephones: LIBerty 2814 and 6242-3

Telegrams: "Vortexion, Wimble, London"

# Stentorian

## HIGH FIDELITY AT REALISTIC COST

The items illustrated are representative of the wide range of W.B. Hi-Fi equipment. A noteworthy recent addition is the "Stentereo" Stereophonic Speaker System embodying many novel features. Our experience in sound reproduction covers 35 years: such a background is a guarantee of quality. Full details of all W.B. products will gladly be sent on request.

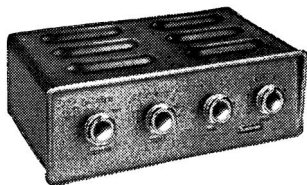

W.B.8 Amplifier £19.19.0.

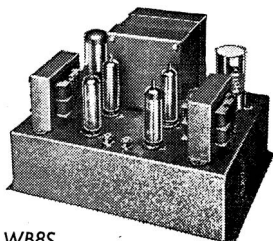

WB8S Stereo Amplifier £23.15.0

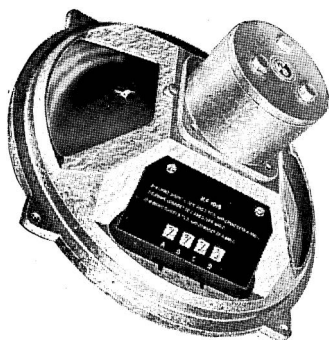

Stentorian Cambric Cone Hi-Fi Units.  
The Famous H.F.1016 at £8.4.0.  
Others from £1.4.0

Ready-to-assemble cabinets in polished walnut from £6.0.0 to £18.10.0

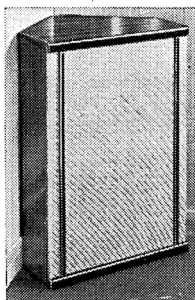

Prelude Horn-Loaded Cabinet £20.0.0

H.F.817 Speaker £11.13.3

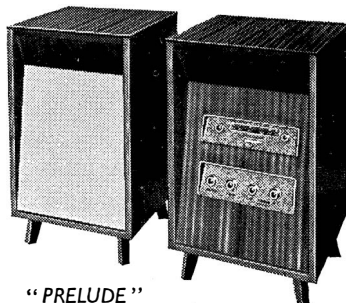

"PRELUDE" ready-to-assemble cabinets in striped sabelle from £10.10.0 to £14.14.0

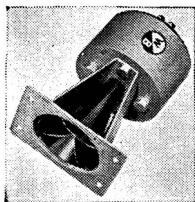

Tweeter Units from 35/10 to £13.4.6

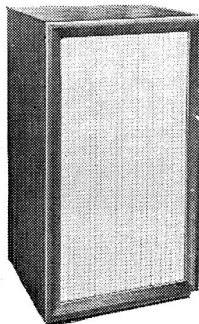

Stentorian Extension Speakers from 64/6

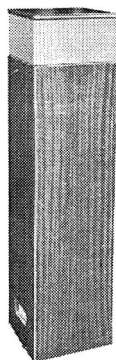

COLUMN LOUDSPEAKERS  
Cabinet for H.F.816 Unit £20.0.0  
Cabinet for H.F.610 Unit £11.0.0

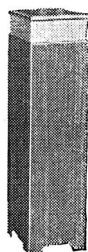

WHITELEY ELECTRICAL RADIO CO. LTD • MANSFIELD • NOTTS

W.B.110

Telephone: MANSFIELD 1762-5

TECHNICAL EXPERTS  
REGARD **ORTOFON** AS  
THE FINEST PICK-UP  
IN THE WORLD

*Ortofon*



MODEL  
SPU-G/T  
(STEREO)  
CARTRIDGE

- "To say I was impressed is to put it mildly . . . have never found such a remarkable range before." Percy Wilson, M.A., The Gramophone.
- "Must be placed without reservation among the select few designs at the top, if not right on the pinnacle." D. W. Aldous, M.Inst.E., MBKS, Audio & Record Review.
- "Must take its place among the few outstanding stereo heads available." B. J. Webb, Hi-Fi News.

Other exclusive  
**METRO-SOUND**  
products include

**HI-JACK PICK-UP  
ARM CONTROLS**

Model 'U' a raise lower device of universal application.  
Model 'D' for direct attachment to Decca ffs Pick-up arm pedestal all Hi-Jack models 30/9 (inc. tax)

**KLENZATAPE**

For cleaning tape recorder heads. Complete kits 12/6; fluid refills 3/11; tape replacements 5/-.

**METRO-SPLICER**

For both recording tape and 8 mm cine film. Complete with film emulsion scraper and spare cutting unit 15/-. Spare scraper 1/-; spare cutting units 2/6.

**METRO-TABS**

For making positive identification of recording at a glance 3/11, complete with index.

**TAPE DECK  
CLEANING BRUSH**

Made from specially feather soft non-scratch nylon 2/6 each.

**MODEL SPU-G/T (STEREO) CARTRIDGE**

A hi-fi stereo cartridge with built-in transformers, will match into virtually all equipment without pre-amplifier, or other stages.

<i>Channel Separation</i>	<b>20-25 dB</b>
<i>Frequency Response</i>	<b>20-20,000 cycles</b>
<i>Stylus pressure</i>	<b>Below 2 gms.</b>
<i>Compliance</i>	<b>10<sup>5</sup> cm/dyne</b>
<i>Fitted low Mass (1 mg) Diamond Stylus.</i>	

Model SPU-G without built-in transformers available.

**MODEL C.G. (MONO) CARTRIDGE**

This World-Famous Cartridge is now available in the type "G" shell for use with ORTOFON Pick-Up Arm SMG 212. All ORTOFON Cartridges in type "G" shell are suitable for use with S.M.E. arm.

**PICK-UP ARM SMG-212**

For exchangeable heads. Due to the special shape of the Pick-up Arm, turntable levelling is unnecessary. The turntable may be up to 30° out of level. Ball bearings are applied for both horizontal and vertical action, assuring trouble-free performance, even at the lowest possible stylus force. Height over mounting plate is adjustable.



**SOLE  
DISTRIBUTORS  
OF ALL ORTOFON  
PRODUCTS IN  
THE U.K.**

Write for 8-page  
descriptive leaflet

Available at your usual  
dealer or write direct to

**METRO-SOUND MFG. Co. Ltd.**, 19a Buckingham Road, London, N.1

Tel.: CL15old 8506/7



# Superb equipment by

## Connoisseur

### STEREO PICKUP MARK III

Will take both stereo and monaural heads.

Arm only £4. 1.11 inc. tax

Stereo Head £8. 3.11 inc. tax

Mark II Diamond Head

£8.17. 7 inc. tax

Mark II Sapphire Head

£4.15. 7 inc. tax

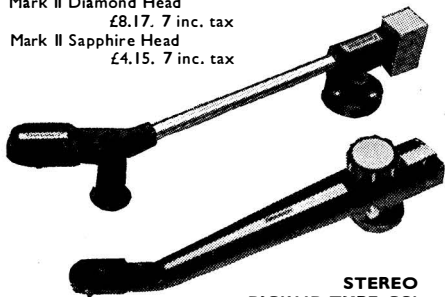

STEREO  
PICKUP TYPE CSI

Frequency range 20-16,000 c.p.s.

Downward Pressure 3½-4 grams

Diamond Stylus.

Price complete as illustrated £13. 6. 4 inc. tax

Pickup Head £8. 3.11 inc. tax

Pickup Arm £5. 2. 5 inc. tax

### VARIABLE 3-SPEED MOTOR

For 33½, 45 and 78 r.p.m. Stroboscope fitted with internal light source. Synchronous motor, dynamically balanced, resiliently mounted. Mechanical speed change giving 4% variation on all speeds.

Price £28.10.8 inc. tax.

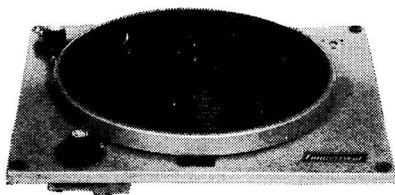

Please write for leaflets

\*All prices include 10% P.T. Surcharge

# Craftsman SERIES

### OMNIDIRECTIONAL SPEAKERS

Finished in Vynair plastic with walnut and black trim.

#### MAJOR

Enclosure only £14.15.0

8" Speaker unit

to suit £3.16.6

inc. tax

and 3" unit £1.19.8

inc. tax

#### Dimensions

43" × 14½" max. dia.

#### MINOR

Enclosure only £9.18.9

8" Speaker unit

to suit £2.17.5

inc. tax

#### Dimensions

36" × 11½" max. dia.

#### ENCLOSURES COMPLETE

WITH SPEAKER UNITS

FITTED

MAJOR £26. 8.10 inc. tax

MINOR £16.14. 0 inc. tax

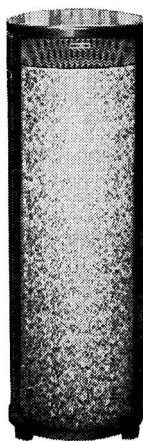

### NEW VARIABLE 3-SPEED TRANSCRIPTION TURNTABLE

33½, 45, 78 r.p.m. Mechanical speed change. Neon light stroboscope. Synchronous motor, dynamically balanced. Styled in black and satin silver.

Provisional Price £18.10.0 plus £7.5.0 P.T.

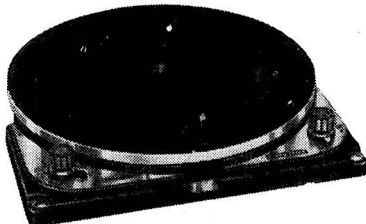

### 2-SPEED TRANSCRIPTION MOTOR

Finished in matt black and silver 33½ and 45 r.p.m. Full 12" turntable is lathe turned. Nylon bearings. Synchronous motor, dynamically balanced. Neon indicator on/off warning light.

Price £19. 2. 5 inc. tax

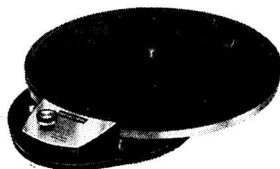

**A R SUGDEN & CO(ENGINEERS) LTD. MARKET STREET, BRIGHOUSE**

BRITISH DESIGNED

BRITISH MADE



# MICROPHONES

## KEEP FAITH WITH SOUND



*Dynamic and Ribbon Velocity  
Microphones to suit all  
Professional and Domestic  
Requirements for Monophonic  
and Stereophonic Reproduction*



also Transistorised Four Channel Mixer,  
Stands, Bases, Accessories, P.A. Equipment

LITERATURE ON REQUEST

**LUSTRAPHONE LTD.,** ST. GEORGES WORKS, REGENTS PARK RD., LONDON, N.W.1  
Phone: PR1mrose 8844 Cables: LUSTRAPHON, LONDON

---

# THIS IS LONDON'S SPECIAL GRAMOPHONE SHOP

When recorded music is listened to to-day, it represents the ultimate in a chain of processes that places the good reproducing equipment virtually in the class of a precision instrument. Certainly that used in the making and playing of records is vastly elaborate.

Not that there is need to understand these processes in detail in order to enjoy a record. Many music lovers may not want to. However, they do want to be able to depend on the supplier from whom they buy. This is precisely the service which E.M.G. Handmade Gramophones Limited, is organised to render in the fullest possible way.

The Company operates in two main streams:

Firstly, there is the record shop where the lover of good music will find a treasure house of records from which to choose, and all records are meticulously examined to ensure their being perfect before sale. If choosing proves difficult, the staff (music enthusiasts themselves) can help. If you cannot call, there is "The Monthly Letter".

This remarkable critique of new record issues has served collectors continuously for over thirty years and occupies a position of trust such as no subsequent publication of its kind has ever attained. A year's subscription costs 14/- post free. Records can also be purchased by post.

Secondly, there is the technical department. Through it, the company sells its well-known Davey equipment in the form of high quality Reflector Loud-speakers and Playing-desks with amplifiers and tuners. Fine cabinet work is a strong feature here. This department deals also with installations to individual requirement and also the conversion and modernisation of existing domestic equipment.

E.M.G. then, offer a unique and comprehensive service to music lovers. It is as modern as the latest transistorised stereophonic techniques; it is backed by a long unbroken tradition of leadership in promoting better standards for listening to good music in the home. This is as true to-day as when the famous E.M.G. acoustic flared horn of pre-war days showed then just how well records should, and could, sound.

*Consult E.M.G. for everything good in sound reproduction.*

**E · M · G**

**HANDMADE  
GRAMOPHONES  
LTD.**

6 NEWMAN STREET, OXFORD ST., LONDON, W.1.

*Telephone: MUSEum 9971*

*The best pick-up arm in the world*

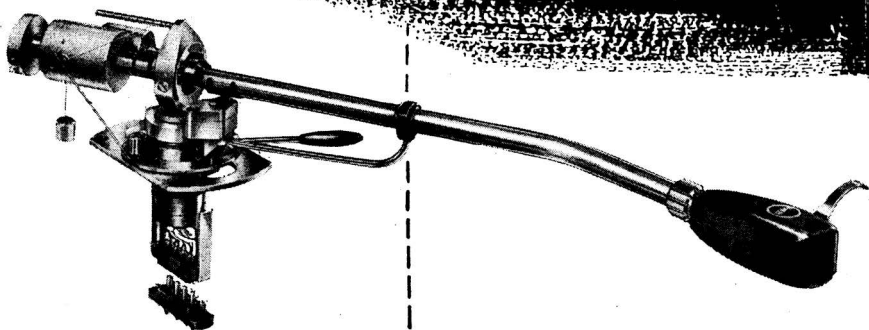

**SME**

SERIES II

These new series II precision pick-up arms embody all the best features of the earlier models to which have been added improvements for still greater ease and flexibility of use. Decreased mass and extended range of balance anticipate lighter, higher compliance cartridges in addition to those of the present day. Reduced height simplifies use with low turntables.

The bias adjuster formerly an accessory is now standard equipment.

*Illustrated brochure will be sent on request.*

**SME LIMITED • STEYNING • SUSSEX • ENGLAND**

ACOS A.D. ARCHON AURIOL BANG & OLUFSEN

BRENELL

CONNOISSEUR

CHAPMAN

DECCA

E.M.I.

GARRARD

GOLDRING-LENCO

GRAMPIAN

GOODMANS

HI-JACK LEAK

KELLY

LOWTHER

LUSTRAPHONE

**FOR ALL THE LATEST**

**'Hi-Fi'**

*developments by  
all the leading  
makers under  
one roof*

*get in touch with*

NEW  
SOUTHDOWN

ORTOFON

PHILIPS

QUAD

RESLO

ROGERS

RONETTE

S.M.E. SHURE

SIMON

STENTORIAN

TRUVOX

WRIGHT & WEAIRE

WATTS

WHARFEDALE

WAL

# **T HOMPSON D IAMOND & B UTCHER LTD.**

**THE LEADING "Hi-Fi" WHOLESALER**

**TRAMWAY AVE., STRATFORD, LONDON. E.15.**

**Telephone: MARYland 5588**

*A Company within*  
**THE RANK ORGANISATION**



# connoisseurs of audio equipment eagerly acclaim Shure components

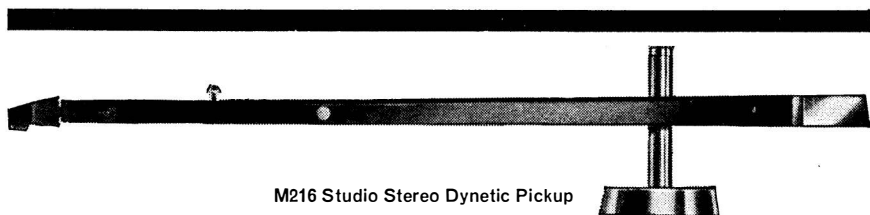

Shure audio components and microphones are world acclaimed for sound reproduction and re-creation of the very highest order. They are made only for the discriminating listener with the experienced ear to appreciate their true quality. If you seek nothing but the finest in audio equipment, you will want to write at once for the current Shure catalogue of pickups, cartridges or microphones.

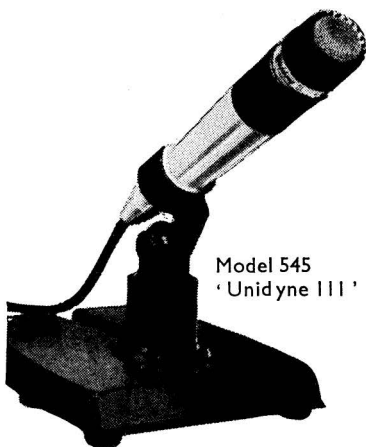

---

**SHURE**

**SETTING THE WORLD'S STANDARD IN SOUND**

SHURE ELECTRONICS LIMITED

84 BLACKFRIARS ROAD • LONDON S.E.1 • Telephone: WATerloo 6361

The **Tandberg Series 6** is a 'no-compromise' instrument capable of delivering consistently fine 'professional' quality when used with comparable amplifier and speaker systems

## **Tandberg** STEREO TAPE DECK

**3 Speeds 3 Heads 4 Amplifiers**

Features include

*Free-Standing or Build-in Teak Cabinet*

*Flawless Technical Specification*

*High and low level mixer inputs & cathode follower outputs*

*Two Recording and Two Playback Amplifiers*

*"On and Off the tape" monitoring*

*Sound-on-Sound Simultaneous record and playback*

**MODEL 6-4  
4 TRACK**

**MODEL 6-2  
2 TRACK**

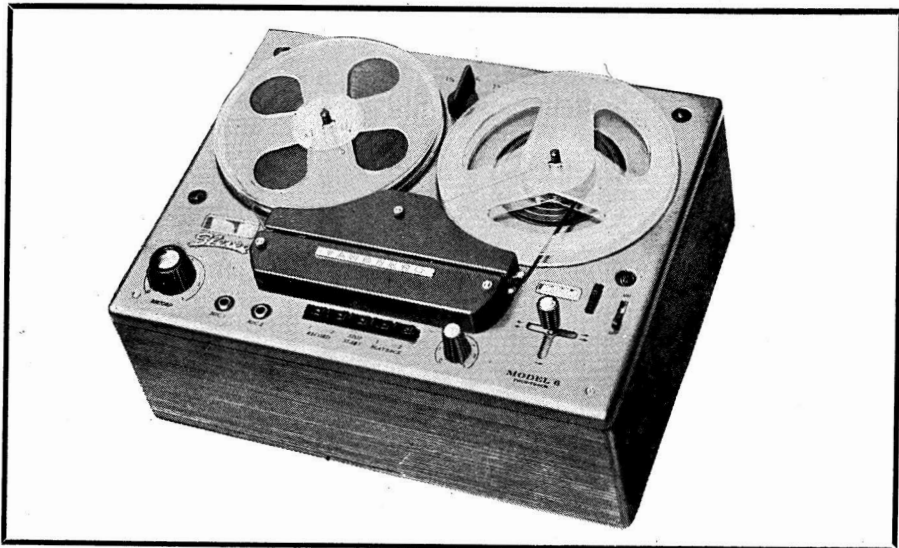

**RETAIL PRICE 110 gns**

**(4 TRACK OR 2 TRACK)**

FROM SPECIALIST TAPE RECORDER & HI-FI DEALERS

**Tandberg** GB · ELSTONE ELECTRONICS LTD  
EDWARD STREET · TEMPLAR STREET · LEEDS 2  
TELEPHONE: LEEDS 3-5111 (7 lines)



THE WORDEN

★ ARTICULATED ★

PICK-UP ARM

PAT. No. 741639

WORLD PATS. PENDING

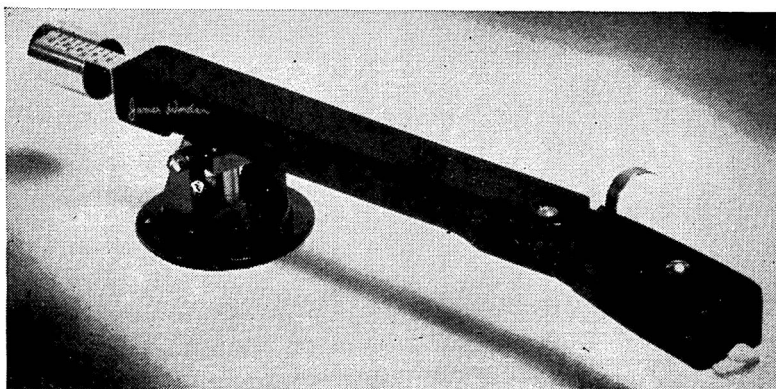

★ A REVOLUTIONARY ADVANCE ★

CORRECT TRACKING —

Plus:— ● Very Low Friction.

● Negligible Side-thrust.

● Arm Dynamically Balanced.

A single arm of conventional appearance, but with articulated head-piece. Movement of pickup head controlled to exceptionally fine limits by means of light linking system passing within the arm, so that the stylus is maintained in correct alignment with the groove ( $\pm\frac{1}{4}^\circ$ ) over whole of playing area.

- ★ "End of side distortion" virtually eliminated; overall sound quality greatly enhanced.
- ★ Inward lateral thrust largely obviated, resulting in more evenly divided weight on groove walls with drastic reduction of record/stylus wear.
- ★ Two main vertical pivots only for torsional and lateral stability incorporating miniature Swiss precision bearings.
- ★ Quieter surfaces.      ★ No groove jumping.      ★ No stylus flutter.

ALLOWS THE CARTRIDGE FULL FREEDOM OF EXPRESSION

Wired for Stereo and Mono, supplied complete with one self-locking slide-on shell (spring-loaded contacts) to accommodate all popular cartridges. Adaptors for integrated pickup heads (e.g. Decca, Expert, etc.). Extra shells available. Polished black finish.

**INSTRUMATIC**  
LD

Grove Works, Elmgrove Road, Weybridge, Surrey

Telephone: Weybridge 6464/2559

# SIMON

## FINEST TAPE RECORDERS AND ACCESSORIES



The brilliant SIMON SP5 — brilliant in design, brilliant in performance with the widest range of facilities: 7 inch spools, twin tracks, two speeds, monitoring of recorded signals, mixing, fade control, re-recording . . . and easy inexpensive conversion from monaural to stereo!

The famous SIMON Cadenza Ribbon microphone gives you studio class performance . . . output flat to close limits over the range 50-12,000 c.p.s. . . for use both in HZ and LZ conditions . . . ribbon four times normal area but with negligible dynamic impedance.

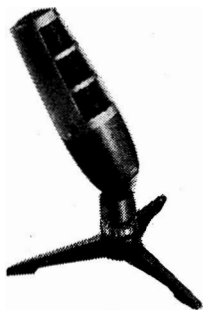

The best selling SIMON Cadenza Crystal microphone is a high quality instrument available at a remarkably low price. Output is flat within close limits over the frequency range 30-8,000 c.p.s.



**There is a SIMON TAPE RECORDER to suit your needs - to suit your purse!**

*For full details of the SP5 and other tape recorders in the SIMON range; and for names of SIMON stockists, please write to:*

**SIMON EQUIPMENT LIMITED**

48 George Street London W 1

# AURIOL

## GRAMOPHONE PICKUP CONTROLS

No matter what combination of equipment is selected for the playing of gramophone records it will not be complete without an AURIOL pick-up control. This piece of precision equipment is designed for use with every model of pick up arm and provides the complete answer to the problem of handling the pick-up without risk of damaging the playing surface of the record, or the pick-up. The stylus can be instantly positioned within an accuracy of 1-2 micro-grooves anywhere across the record including the first groove and the pick-up may then be automatically lowered under pneumatic control at an adjustable preset speed which provides positive, cushioned contact. At any position across the record the pick-up can be raised with the stylus being lifted vertically and cleanly out of the groove. At no time is it possible to drop the pick-up on to the record!

The control is exhibited by the Council of Industrial Design at the Design Centre, London, and has been acclaimed by many leading critics including:—

### Burnett James—Gramophone Record Review

"... This is quite obviously the only sane method yet devised of dealing with the problem of the ubiquitous recital record. I use one with a BJ 'Super 90' arm and I have come to regard it as an essential piece of equipment."

### R. L. West—Hi-Fi News Test Report

"... Although the Connoisseur pick-up is a very easy one to handle, used with an AURIOL it was even easier and it was impossible to damage either pick-up or record."

### P. Wilson, M.A.—The Gramophone

"... For a long time we have all been aware that one of the disadvantages of LP records is the difficulty of picking out any particular passage, and placing the pick-up there positively and gently, or vice versa, of lifting the pick-up from the middle of the record. The AURIOL solves that problem. Is its price such as one can afford? You can answer that yourself bearing in mind that an expensive record can be ruined by a single mishap in placing a pick-up."

**Patented and proved in use throughout the world, these controls are guaranteed to give long, trouble-free service**

**Standard model** for single record players only **£3.9.9** Inc. Tax

**Mk. II model** with swivel arm for auto-changer/manual players **£4.4.0** Inc. Tax

A standard indexing clip is supplied to suit  $\frac{3}{8}$ " (9.6 mm.) round arms. Clips are available to suit all other arms. Please specify when ordering.



DECCA FFSS PICKUP 301 TURNTABLE

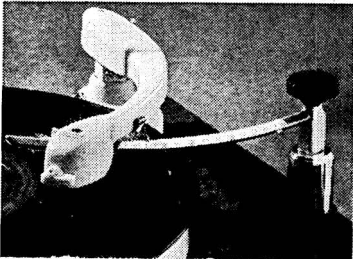

COLLARO AC4/564 UNIT



GOLDRING G60 PICKUP ARM



GARRARD T.A. Mk. II UNIT

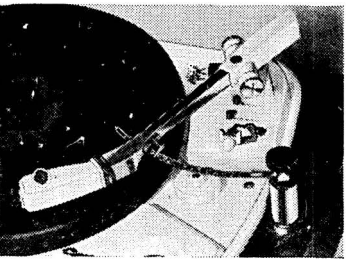

GARRARD 4 HF. UNIT

**AURIOL (GUILDFORD) LIMITED, GUILDFORD, SURREY**

**TELEPHONE : 66712**

# ADVERTISERS' INDEX

	Page		Page
ACOUSTICAL MANUFACTURING CO. LTD.	Front Cover	LEAK, H. J. & CO. LTD. .. .. .	248-249
ARMSTRONG WIRELESS & TELEVISION CO. LTD. .. .. .	228	LOWTHER MANUFACTURING CO. .. .. .	120
ASSOCIATION OF PROFESSIONAL RECORDING STUDIOS .. .. .	206-207	LUSTRAPHONE LTD. .. .. .	263
AUDIOCRAFT LTD. ... .. .	208	METRO-SOUND MANUFACTURING CO. LTD.	261
AUDIO SERVICES .. .. .	234	MODERN ELECTRICS (RETAIL) LTD. .. .. .	219
AURIOL (GUILDFORD) LTD. .. .. .	271	PAMPHONIC REPRODUCERS LTD. .. .. .	238
BOSCH LTD. .. .. .	251	PHILIPS ELECTRICAL LTD. .. .. .	212
BRENNELL ENGINEERING CO. LTD. .. .. .	256	POLYTECHNA (LONDON) LTD. .. .. .	222-223
BROWN, S. G. LTD. .. .. .	251	RADFORD ELECTRONICS LTD. .. .. .	214
CLARKE AND SMITH MANUFACTURING CO. LTD. .. .. .	240	S.M.E. LTD. .. .. .	265
COSMOCORD LTD. .. .. .	230	SAGA SOUND .. .. .	Back Cover
DECCA RADIO & TELEVISION .. .. .	215	SHURE BROS. INC. .. .. .	267
DESIGN FURNITURE LTD. .. .. .	246	SIMON EQUIPMENT LTD. ... .. .	270
E.M.G. HANDMADE GRAMOPHONES LTD. .. .. .	264	SOUND SALES LTD. .. .. .	258
E.M.I. SALES & SERVICE LTD. .. .. .	216-217	STANDARD TELEPHONES & CABLES LTD. .. .. .	220
ELECTRICAL AND TELEVISION INDUSTRIES LTD. .. .. .	247	SUGDEN, A. R. & CO. LTD. .. .. .	262
FRANCIS OF STREATHAM .. .. .	231	"THE TAPE RECORDER" .. .. .	204
GARRARD ENGINEERING & MANUFACTURING CO. LTD. .. .. .	221	TAPE RECORDER CENTRE, THE .. .. .	236
GEVAERT LTD. .. .. .	241	TANNOY PRODUCTS LTD. .. .. .	242
GOLDRING MANUFACTURING CO. (GREAT BRITAIN) LTD. ... .. .	255	TELLUX LTD. .. .. .	232-233
GOODSELL LTD. .. .. .	218	THOMPSON, DIAMOND & BUTCHER .. .. .	266
HARRIDGE, H. C. .. .. .	229	TRUVOX LTD. .. .. .	245
HEATHKIT (DAYSTROM) LTD. .. .. .	226	VITAVOX LTD. .. .. .	225
"HI-FI NEWS" .. .. .	243	VORTEXION LTD. .. .. .	259
IMHOF ALFRED LTD. .. .. .	250	WATTS, CECIL E. LTD. .. .. .	254
LARGS OF HOLBORN .. .. .	229	WEBB'S RADIO .. .. .	244
LASKY'S (HARROW ROAD) LTD. .. .. .	239	WELLINGTON ACOUSTIC LABORATORIES LTD.	252
		WELMEC CORPORATION LTD. .. .. .	237
		WHARFEDALE WIRELESS WORKS LTD. .. .. .	227
		WHITELEY ELECTRICAL RADIO CO. LTD. .. .. .	260
		WORDEN AUDIO DEVELOPMENTS LTD. .. .. .	267

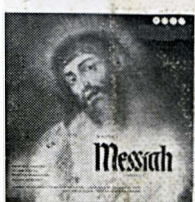
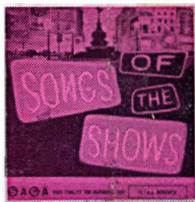

pre-recorded tapes  
are the  
Commonwealth's  
*most accepted*  
tape records

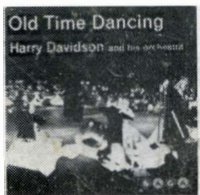

Ask for SAGA  
*by name*



Catalogues available  
on request to

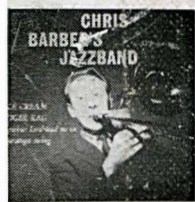

127 KENSAL ROAD  
LONDON W.10

