

HI-FI CHOICE

CARTRIDGES & TURNTABLES

The most comprehensive guide to buying cartridges
and turntables ever published.

**PLUS
COMPLETE
ACCESSORIES
GUIDE**

£2.95 \$8.00

**Best Buys Recommended
Over 150 Tests & Reviews**

MISSION ELECTRONICS

because people like music



PHOTOGRAPHY: STEPHEN ESSBERGER

Consumer Introduction	5
Basics of disc equipment and cartridge principles	
Technical Introduction: Cartridges	13
Cartridge testing: how and why the tests were carried out	
Cartridge Reviews	19
Over 60 full-length reports plus a further 35 Summary Reviews	
Best Buys: Cartridges	94
Overall summing up on models that performed best	
Technical Introduction: Turntables and Tonearms	97
Turntable assessment and how to make use of the test results	
Turntable Reviews	106
Full-length reports plus a further 30 Summary Reviews	
Best Buys: Turntables	151
Overall findings on turntables and arms which performed best	
Accessories Guide	155
Comprehensive guide to manufacturers, products and prices	
Selected Dealer Directory	166
Where to find the best hi-fi advice and demonstrations in your area	
Glossary	172
Guide to technical terms and jargon	
Product Index	175
Lists all products tested in the review sections	

DON'T FORGET

All the current volumes in the Hi-Fi Choice Series are available direct from our Mail Order Service. See page 104

Editor: Steve Harris
Assistant Editor: Jane Hadley
Advertisement Manager: Judith Kelly
Group Art Director: Perry Neville
Production Manager: Sonia Hunt
Publisher: Marianne McNicholas
Photography: Ian McKinnell
Cover: Chris Stevens

Published by Sportscene Publishers Ltd,
 14 Rathbone Place, London W1P 1DE.
 Tel: 01-631 1433.

Distributed by Seymour Press Ltd,
 334 Brixton Road, London SW9 7AG.

Typeset by Instep Ltd,
 33-41 Dallington Street, London EC1 0BB
Printed by Imperial Printers, London

Enquiries regarding the content of this book should be made in writing to Hi-Fi Choice Editorial, 14 Rathbone Place, London W1P 1DE. We regret enquiries cannot be dealt with by telephone. While every care has been taken in the preparation of this book, the publishers cannot be held responsible for the accuracy of the information herein, or any consequence arising therefrom. Readers should note that all judgements have been made in the context of equipment available to Hi-Fi Choice at the time of review, and that 'value for money' comments are based on UK prices at the time of review, which are subject to fluctuation and are only applicable to the UK market. This edition © 1985, Felden Productions.

PURE HI-FI

FROM SANSUI



5

1 TU-D 33XL TUNER £109 inc. vat

"A couple of plays revealed that the TU-D 33XL's ability to prise decent sound stage, with ample depth to convey 3-D presence and base, from musical instruments or sound effects was, at times, near awesome

"The Sansui is a devilish successful solution for those of you who can no longer bear to part with a liver whenever you crave something new"

"And it's pretty to boot"

Ken Kessler, Hi-Fi News, May 1985



6

2 AU-G 55X STEREO AMP. £249 inc. vat

"Altogether a very satisfying stereo amplifier which I could live with for a long time. Well recommended"

John Gilbert, Gramophone, April 1985

"To most people, names such as Sansui enjoy street credibility while other more esoteric names simply cannot match up."

"The Sansui easily won out in the specific area of maximum loudness, which was achieved in a seamless and unstrained manner."

"Like the Sansui, in addition to its superb build, finish and flexibility, it was capable of real quality music making."

Alvin Gold, What Hi-Fi? February 1985.

5 SR-222 MkV BELT DRIVE TURNTABLE £109 inc. vat

"I was very impressed with the sound from this MkV version of the SR-222. It was consistently smooth and even toned, with only a slight lack of subtlety giving away its market position compared to more expensive units. On the whole it gave a consistently revealing sense of atmosphere and plenty of detail, but above all it got the feet tapping and really invited you to participate. For just over £100 that's got to be good value."

Jonathan Kettle, New Hi-Fi Sound, July 1985

6 D-290 CASSETTE DECK £129 inc. vat

"Overall I felt the D-290 turned in a very respectable performance and would provide a good casual listening source even for the owner of above average systems"

John Nicholson, Hi-Fi for Pleasure, March 1985

A full logic cassette deck with Dolby C/B noise reduction systems. Mic. mixing facility with volume control offering the advantage of adding commentary to tapes while recording from another source. The D-290 also offers automatic music programme search for cueing convenience. Precise LED meters, a timer switch, and headphone socket are the finishing touches to this cassette deck.

SANSUI PURE HI-FI DEALERS

ALDERSHOT BRYANT'S HI-FI, 81 High Street, 0252 20728
 BRISTOL RADFORD HI-FI, 52-54 Gloucester Road, 0272 428248
 COLWYN BAY ELECTRO TRADER HI-FI, 19 Colwyn Crescent, Rhos-on-Sea, 0492 48932
 COVENTRY H.S.C., 17 Shelton Square, 0203 25983
 CROYDON ST. GEORGES AUDIO, 36 St. Georges Walk, Croydon Centre, 01-681 1484
 LEEDS SUPER FI, 36 Queen Victoria Street, 0532 449075
 VIRGIN RETAIL LTD., 94-96 The Briggate, 0532 452769
 LONDON AUDIO 1, 25 Tottenham Court Road, London W1P 9RA, 01-631 0129
 BILLY VIFF SOUND SYSTEMS, 74R Lee High Road, Lewisham, 01-13-01 210 5755
 BUDGET SOUND, 242 Tottenham Court Road, W 1, 01-636 5974
 HI-WAY HI-FI, 315 Edgware Road, W 2, 01-402 2441

Also available from selected branches of Laskys

SOUTH LONDON HI-FI, 210 Brixton Hill, S W 2, 01-674 4433
 SPATIAL HI-FI, 29 Tottenham Court Road, W 1, 01-637 8702
 NEWCASTLE-UPON-TYNE HI-FI OPPORTUNITIES, 33 Handy Side Arcade, 0632 32779
 NEW MALDEN UNILET, 35 High Street, 01-942 9567
 NOTTINGHAM NOTTINGHAM HI-FI, 120-122 Alfreton Road, 0602 786919
 PORTSMOUTH VIRGIN RETAIL LTD., 69-73 The Tricorn, Charlotte Street, 0705 81685
 PORTSMOUTH HI-FI, 350-352 Fratton Road, 0705 82034
 SEVENOAKS SEVENOAKS HI-FI, 111 London Road, 0732 459555
 SHEFFIELD AUDIO CENTRE, 284 Glossop Road, 0742 737893
 ST. LEONARUS UNISEA HASTINGS HI-FI, J2 Western Road, 0424 442975
 WESTON-SUPER-MARE PAUL ROBERTS, 203 Milton Road, 0934 414423
 YORK VICKERS HI-FI, 12-24 Gillygate, 0904 29659

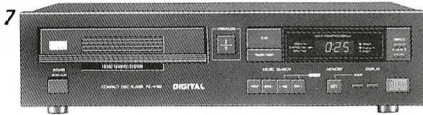

3

AU-G 33X STEREO AMP. £169 inc. vat

"Sansui AU-G 33X is pretty damn good. In fact it's a cracker."

"I have the distinct impression that here, at last is one main stream manufacturer making a concerted stab at closing the gap with the best of the audiophile orientated competition."

"The Sansui does go louder - much louder - than the £100 to £120 models, and it has that rare and precious facility of staying in perfect control of the loudspeakers to which it's presented."

"Recommended"

Alvin Gold, New Hi-Fi Sound, February 1985.

4

TU-D 99X TUNER £229 inc. vat

SANSUI TU-D 99X Best Buy, Hi-Fi Choice, March 1985.

"With a front rank sound quality and a very strong RF performance, this is clearly a fine tuner design. Suited, with the 'local' switch, to both fringe and high strength locations, a versatile performance is offered"

Conclusion. "The TU-D 99X represents very good value in its price sector, and qualifies for a Best Buy rating."

Hi-Fi Choice.

The TU-D 99X incorporates a super linear digital decoder which eliminates beat interference. It does so effectively and without creating its own audible beat since no harmonics are generated.



7

PCV-100 COMPACT DISC PLAYER £339 inc. vat

"This player offers a good sound quality for the money, together with a competent transport, claiming fast access times. In common with other related models, the new PCV-100 has no difficulty in gaining a recommendation in this issue and in view of the latest pricing wins a 'Best Buy' rating."

"Welcome back Sansui! Your PCV-100 player is an excellent product and is warmly recommended."

For: Good looks. Ease of operation. Very quiet running. Against: The third screw along the back was the wrong shade of black!" Stan Curtis, Which Compact Disc? June 1985.



8

AU-G 11X STEREO AMP. £109 inc. vat

The AU-G 11X is an affordable amplifier offering the same technology as models AU-G 33X and AU-G 55X. The X Balanced Amp type II is designed to eliminate all ground related problems so music is reproduced with unbelievable purity and clarity.

In the event of speaker impedance becoming low, the AU-G 11X is equipped to supply ample current to the power output stage and can deliver as much as 75 watts of dynamic power into 2 ohms



Send the coupon today for further details on any of the products shown above and a full list of Sansui Pure Hi-Fi dealers.

NAME _____
(PRINT BLOCK CAPITALS PLEASE)

ADDRESS _____

POSTCODE _____

In recent years the development of hi-fi generally has led to improved sound quality, which in turn, has increased the expectations of the listener for an even better sound from his system. The much acclaimed Rotel range is the result of our on-going research and design programme in the UK to constantly improve the quality, performance and visual appeal of our hi-fi systems whilst maintaining our reputation of value for money. Our concerted effort to optimise sound quality has led to the removal of unnecessary controls and features, which in many cases can degrade the sound of a system, and enabled our designers to include much higher quality components. The result is improved sound quality from visually enhanced products, with cleaner simpler lines, which you will be proud to own.



ROTEL SIMPLICITY

RP830. The RP830 turned in a superlative performance that really made me sit up and listen. Eyes closed, I'd never have thought I was listening to such a reasonably priced machine. **What Hi-Fi.**

RA820BX. This remarkable little amp shows the competition a clean pair of heels. It's a gem that can only further enhance Rotel's reputation. **Hi-Fi for Pleasure.**
Best Buys — **Hi-Fi Choice.** 🏆

RL850. The RL850 fully meets all the criteria for reproducing music in an informative and unobtrusive way. They're essentially uncoloured and smooth with a well controlled and quite powerful bass and an overall lively, forward feel. **Hi-Fi Choice (Best Buy).** 🏆

The System. This system combines individual excellence with the integrity of some of the best in this category to provide a truly stunning system package.

What Hi-Fi Awards 1985 — Winner
'Best System'.



• WINNERS IN 1985 • WINNERS IN 1986
BEST AMPLIFIER UNDER £250 1985 & 1986
 RA820B • RA820BX
BEST SYSTEM FROM ONE MANUFACTURER, 1985 & 1986
 RP830 Turntable • RA820BX Amplifier • RL850 Loudspeakers • RT830L Tuner •
GRAND PRIX AWARD FOR HI FI PRODUCT OF THE YEAR
 • RA820BX Amplifier •

Send A4 SAE for further information on products photography and your local dealer.

ROTEL hi-fi

25 HEATHFIELD, STACEY BUSHES, MILTON KEYNES, MK12 6HR TEL 347707

CONSUMER INTRODUCTION

This edition of *Hi-Fi Choice* is intended as a complete guide to getting the best from your record collection — despite the Compact Disc revolution, the black vinyl disc has much to offer. This introduction covers disc and cartridge principles, alignment and system matching.

Though the smallest separate part of a hi-fi system, the cartridge is in some ways the most important — and it is certainly one of the hardest to manufacture, since inside that small block of plastic attached to the end of the record player arm is some remarkable micro-engineering. The job of the cartridge is to 'read' the undulations of the groove which represent the original sound, and to convert this mechanical representation of music into an electrical signal which can be fed to an amplifier, and finally to a pair of loudspeakers.

All cartridges work on the fundamental principle of 'tracking' or 'tracing' the record groove with a flexibly-mounted stylus. The movements of the stylus in relation to the cartridge body can then be used to generate an electrical signal.

Many people still think of the stylus as the 'needle', this term a hangover from the days of 78s. Today, the stylus is a very tiny, carefully-shaped diamond, mounted on the end of a thin rod or tube called the cantilever, which may itself be only as thick as a pin or needle.

Inside the cartridge body, the other end of the cantilever passes through a compliant synthetic rubber bung, the flexible pivot which allows stylus movement. The exact degree of flexibility or compliance may be very important.

Moving-magnet cartridges

The electrical generating elements are usually behind the pivot, a tiny magnet (or piece of magnetically permeable material) being attached to the back end of the cantilever. Movements of the magnet in relation to the surrounding fixed coil windings produce tiny electrical signals in the latter. There are countless variations on the moving-magnet idea — ADC's induced magnet, Ortofon's 'Variable magnetic Shunt', Grado's 'Flux Bridger' and the Glanz 'Moving Flux' — most of which use a moving element of magnetically permeable material (allowing low moving mass) which is arranged to vary the field of a fixed magnet in proximity to the fixed coils. With some exceptions (Linn, Rega), moving magnet cartridges have user replaceable stylus assemblies, generally at around 80% of the cartridge price.

Moving-coil cartridges

Where the coils are the moving element of the generator, they are usually mounted in front of the pivot block, and their movement in relation to very

powerful fixed magnet produces the musical signal. Owing to the need for wire connections to the moving parts, and the desirability of rigid construction, moving-coils hardly ever have replaceable styli; instead, the maker will usually offer a trade-in deal which probably amounts to a similar proportion of the price. 'High-output' moving coils produce big enough signal voltages (though sometimes only just) to drive normal amplifier disc inputs, while 'low-output' types need an 'mc' input, or alternatively a special 'head-amp' or step-up transformer.

Disc principles

As it traces the groove to convert mechanical movements to electrical signals, the cartridge is performing the reverse function of the cutter which produced the groove on the master disc. In fact some cartridge and turntable manufacturers have made advertising claims to the effect that their product follows the operating principle of the cutter more closely than its competitors. So before discussing cartridges in more detail, we should look very briefly at how the record is cut. Comparison of the recording and replay processes does shed some light on the way the cartridge should work.

Disc cutting

On the cutting lathe, a lacquer master disc, made of relatively soft plastic, is held down very firmly on the platter by vacuum suction. The cutter head carries a tiny, accurately-shaped diamond chisel, or cutting stylus, which is operated by a number of feedback-controlled motors; when electrical signals representing music (and stored on tape) are amplified and fed to the cutter head, the cutting stylus carves an accurately-controlled groove in the master disc. From this master, a series of moulding and electroplating processes yields a negative stamper which is used to press the vinyl discs themselves.

Stereo recording and playback

In the days of mono, the cutter was simply driven from side to side to produce lateral 'wiggles' in the groove. For stereo, two separate sound channels must be recorded in a single groove, and to achieve this the cutter head is driven diagonally as shown in the diagram. If there is sound in one channel only, the groove will undulate at 45 degrees to the record surface, in the direction A-

CONSUMER INTRODUCTION

B for one channel or C-D for the other. This system is called 45/45 stereo. If the sound signal is identical on both channels, the net result will be a horizontal movement — in other words, a mono signal. If the oscillating signals in the two channels are at any given moment moving in opposite directions (that is they are 'out of phase'), the net result will be a vertical movement of the cutter.

In practice, the music signal will be a complex combination of in-phase and out-of-phase components, and on replay it is the presence of the latter that produces the stereo effect of instruments or voices variously positioned across the 'sound stage' between and around the speakers. This is why, in order to play back stereo records, the cartridge pivot has to allow vertical stylus movements as well as horizontal ones.

Cartridge support

In disc mastering, the cutting head is driven radially across the disc with the utmost precision, its position always tightly controlled; unfortunately, the same situation cannot exist for playback. The cartridge cannot be driven across the disc as the cutter was, since it must follow the groove through changes of spiral pitch, eccentricities and warps. So the cartridge must be sup-

ported in a way which allows it to be pulled slowly across the disc by the groove and to climb over warps, while maintaining the steady position of the cartridge body relative to the part of the groove being traced. This is only possible because the vital movements of the stylus relative to the cartridge body (produced by the 'wiggles' in the groove) are actually vibrations at frequencies of above 20Hz (20 cycles per second) while the larger-scale arm movements are at slow speed (hence lower frequencies) and so the two kinds of movement can be more or less prevented from interfering with each other.

Compliance and resonance

However, the cartridge compliance, connected to the mass of the arm, is in mechanical terms a spring and weight arrangement, and as such has a resonant frequency, determined by the values of compliance and arm effective mass. If excited at or near this frequency, the combination will vibrate in an uncontrolled fashion. The answer is to ensure that the resonant frequency lies somewhere near 10Hz — high enough not to be excited by passing record warps, footfalls or turntable suspension movements, but low enough to be clear of the lowest-frequency signals on the record.

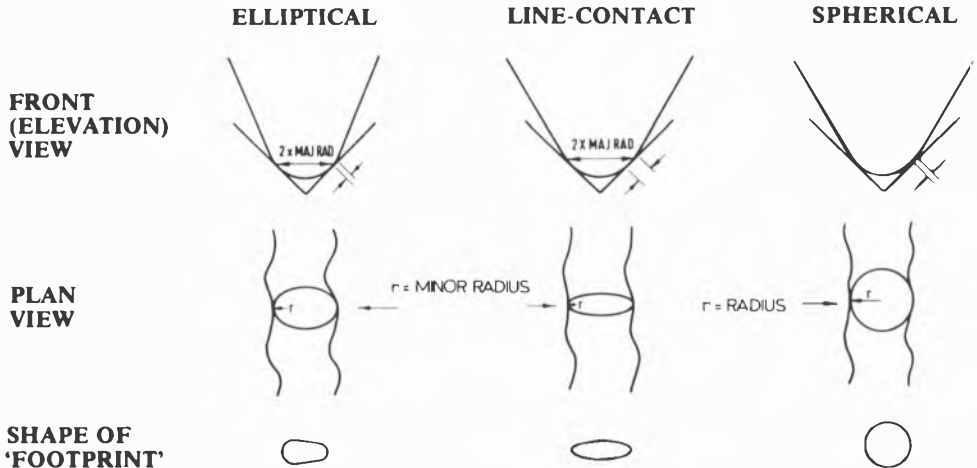

Different stylus types: The three sets of diagrams above attempt to show the difference between the main types of stylus profile, although these two-dimensional views cannot show the 3-D forms accurately. The 'footprint' shows the shape of the tip's contact area on the angled groove wall, and is not drawn to scale.

CONSUMER INTRODUCTION

In this book, the cartridge reviews quote the range of arm effective mass that will be suitable, and of course effective mass is quoted for each arm reviewed — so cartridge/arm matching should be a simple matter. For other combinations, refer to the diagram on page 17, which should give the answer for any possible case. It would seem that ideally, lateral and vertical compliances should be similar, as resonances in both planes should be watched, but sometimes this is not the case; it is interesting to note that the Decca cartridge, which has almost no vertical and quite high lateral compliance, was originally conceived partly for an abortive early stereo technique which did not use the 45/45 idea.

Resonances may be more or less damped by the cartridge suspension system, so that even at non-optimum frequencies their effects will be lessened. The extreme case is the Shure's external damper brush, which suppresses the arm/cartridge resonance so effectively that the cartridge will work in virtually any arm. Lightly-damped cartridges, Paul Messenger concludes, will on the other hand work well only with high-quality turntables and arms, which do not introduce low-frequency problems of their own.

The other important resonance which occurs in cartridges is that of the stylus tip mass and the compliance of the vinyl. Where this occurs in the audio band (below 20kHz) it may be used deliberately to extend the treble response; but the most refined modern cartridges have ultra-low tip mass and therefore a high resonant frequency. But the HF resonance can be an important factor in the sound character and tonal balance of a cartridge.

Tracking angle error and 'linear tracking'

Still the most common, and usually the most effective, arms are of the pivoted type which sweeps the stylus across the disc in an arc (usually of about 230mm radius). This means that during play the axis of the cartridge turns slightly away from the ideal tangent to the groove. In fact, modern arms are designed with a combination of offset, that is, the cartridge is mounted at an angle to a line which joins it and the arm pivot, and overhang, that is, the cartridge is set so that the arc described by the stylus passes not through the centre spindle but beyond, or rather in front of it.

This geometrical trick minimises the lateral tracking angle error, which is held to within a degree or so across the disc and actually reaches zero at points near the inside and outside grooves. To get the cartridge aligned properly, it

is best to use an alignment protractor (Elite, Heybrook etc). If the arm geometry and mounting position on the turntable is correct, it should be possible to get the cartridge in the correct position and straight in the headshell.

'Linear tracking' arms, so called because they purported originally to do away with tracking angle error, move bodily across the disc under servo-motor control; but in practice, well-designed pivoted arm reduce the error and resultant distortions to negligible proportions anyway, and most linear tracking arms in our experience have produced poor sound, due to their lack of rigidity, particularly if the sliding bearings at the back are sloppy.

Vertical tracking angle

The edge or face of the cutter, viewed from the side, cannot for practical reasons be made exactly perpendicular to the surface of the master, but is set at an angle to the vertical which is supposedly held to an international standard of 20 degrees. In theory, the 'reading' edge of the stylus should be set at this same 'vertical tracking angle'; but in practice both cutters and cartridges depart from the standard. Any discrepancy must result in increased distortion on playback. Strictly speaking, the cartridge manufacturer should make sure that the stylus is set at the correct angle to the cantilever; incorrect VTA here can in effect be compensated for by arm height adjustment — but remember that a huge vertical movement at the arm pillar is needed to make a tiny angular change at the cartridge end.

Stylus profiles

For accurate groove tracing the stylus tip ought ideally to resemble the V-shaped cutting edge of the cutter, but of course if it got too close to this it would do some cutting of its own! The simplest stylus tip is the spherical or conical type, which leaves a circular 'footprint' on each groove wall. The length of this footprint limits the tip's ability to get in and out of the shortest modulations. This is fairly unimportant at the outside grooves, where the vinyl is travelling past the tip quite fast, but at the inner grooves, the stylus becomes unable to trace short (high frequency) groove excursions. Because of this, spherical styli may tend to produce noticeably less treble towards the end of a record side.

This problem was first overcome by the introduction of elliptical (often in fact 'bi-radial' rather than true 'swept' elliptical) tips, where a smaller radius 'edge' gave improved high frequency tracing — though the smaller contact area enforced

Now a group of MPs really worth listening to.



MP10 "Very much the baby of the Nagaoka moving magnet range, the MP10 shares the same impressively rigid body structure.

"Separation figures rivalled many cartridges costing many times the price, even showing respectable control at high frequencies."

"The MP10 was very well liked for the 'seamlessness and control of its sound, which showed remarkably good integration for such a low cost design."

"An obvious best buy."

HiFi Choice

MP10 £14.

Styls fully interchangeable for ease and economy of upgrading.

MP11 "In terms of sound quality, the MP11 stood out as the clear winner. Its ability to get the last degree of articulation and control on a bass guitar or synth line could make even the excellent C77 seem a little ponderous at times. Piano and synthesiser chord changes seem to be conveyed more precisely with the MP11, while vocals are open and backing vocals are very well separated and articulated. It has all the detail and delicacy of the C77 with an added power and life that really help to convey a rhythm line."

"Superb sound. Excellent mounting quality. Nothing to criticise at the price."

What Hi-Fi 12 Cartridge super test

"With much improved quality control, the MP11 now offers a superb all round performance for the price."

What Hi-Fi Awards 1985 Best cartridge under £50

MP11 £19.

MP11 Boron "Low mass tips are often expensive to engineer and difficult to align. Nagaoka have come up with a novel solution to reducing moving mass in the popular MP11 design."

"Nagaoka use a shanked diamond, where only the tip is made from diamond, but unlike other shanks which use diamond or a metal alloy this uses Boron. Boron has similar 'strength' properties to sapphire and yet it's nearly a third lighter than diamond."

"The sound quality improvement fully justifies the price difference on the new model. The MP11 Boron shows itself very capably in complex cymbal and percussion passages. It proved more capable of revealing the atmosphere of the recording acoustic."

"The audibly lower distortion of the MP11 Boron gives music a much more confident dynamic quality... it can compete well out of its price category."

What Hi-Fi

MP11 Boron £29.



NAGAOKA

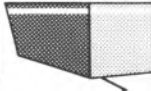

MPs that keep their promise.

PATH LIMITED, 1 BERENS ROAD, LONDON NW10 5DY. TELEPHONE: 01 969 2514. TELEX: 8814198

CONSUMER INTRODUCTION

lower tracking weights (down to 1g) and higher compliance to avoid increasing the pressure on the vinyl to the point of permanent groove damage.

Further development has brought the range of 'line contact' tip types, which extend the 'footprint' of the elliptical stylus up the wall of the groove, increasing contact area and hence allowing higher tracking weights and lower compliances.

The earliest line contact stylus was the Shibata type, introduced in the early 1970s for the ill-fated CD-4 quadrophonic system which demanded a frequency response extended to 38kHz (a requirement which, incidentally, helped to enforce the use of low-capacitance arm leads) but for normal stereo use these tended to an over-bright sound quality. Recent developments have been much more successful and there are now many advanced 'super elliptical' types.

Tracking weight and mistracking

While Shure long ago designed cartridges that could track very well at 1g, other manufacturers have never quite reached this point. Many people still mistakenly believe that lighter tracking forces will automatically mean less groove damage and wear, when in fact the reverse is often true. If a cartridge fails to track (most obviously resulting in momentary treble spittiness or sibilant distortion on loud passages) then the stylus, instead of following the groove closely, is bouncing around and damaging it. The answer is, always stick near the top of the manufacturers' recom-

mended tracking weight range — the lower figure quoted may be rather optimistic !

Bias correction

An outward force applied to the arm by a thread-and-weight, spring or other device, bias correction counteracts the inward pull created by the arm geometry. Usually, the bias calibration on the turntable (related to tracking weight) will be approximately right, but fine-tuning will be well worth it because bias requirements vary according to cartridge design. Too little bias causes mistracking on the right channel, too much, mistracking on the left. A test record such as HFS 81 will be helpful here.

T4P or 'P-Mount' cartridges

Many cartridges have produced turntables which dispense with the conventional cartridge mounting bolts, and indeed with all the fiddly business of wiring and aligning the pickup. A couple of years ago, Technics introduced the T4P standard which specifies arm and cartridge mass as well as the design of the plug-in body, so any 'P-mount' cartridge will give the same 1.25g tracking force with no adjustment whatsoever by the consumer. We have only tested P-mount cartridges which are supplied with an adaptor to allow the use of normal mounting bolts, when unfortunately many sounded unsatisfactory due to the lack of mechanical integrity of the adaptor. But it must be remembered that the T4P idea is primarily applicable to midi- and rack-system turntables, which fall somewhat outside the scope of this book.

Choosing and installing

Turntable and arm design questions are fully covered in the Technical Introduction which precedes the turntable review section later in this book. Suffice it to say here that the turntable and arm have a fundamental effect on the sound quality of a cartridge, and that it is well worthwhile to seek out a balanced combination rather than to plump immediately for one 'super' component at the expense of the others. The reviews in this book should give a helpful guide to subjectively 'right' combinations, as well as making sure that you avoid mechanical or electrical mismatches. But of course the best way is to seek out a helpful dealer, who will introduce you to a range of combinations without exerting undue pressure or bias. And if you are not too confident of your installation abilities, he will be able to make sure everything works perfectly — leaving you to simply enjoy the music.

Steve Harris

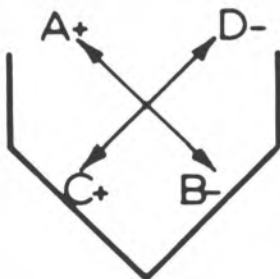

The stereo disc: this diagram represents either cutter or stylus. The lines A+ to B- and C+ to D- show the direction of vibration corresponding to the signals of each channel. A side-to-side vibration of cutter or stylus will cut or read (respectively) two signals of the same size and phase (both channels moving to '+' at the same time). This gives a central mono signal. A vertical cut gives equal size signals but out of phase, so that the two channels when mixed together will cancel.

OUR NEW CARTRIDGE HAS SOMETHING Y A VARIABLE P

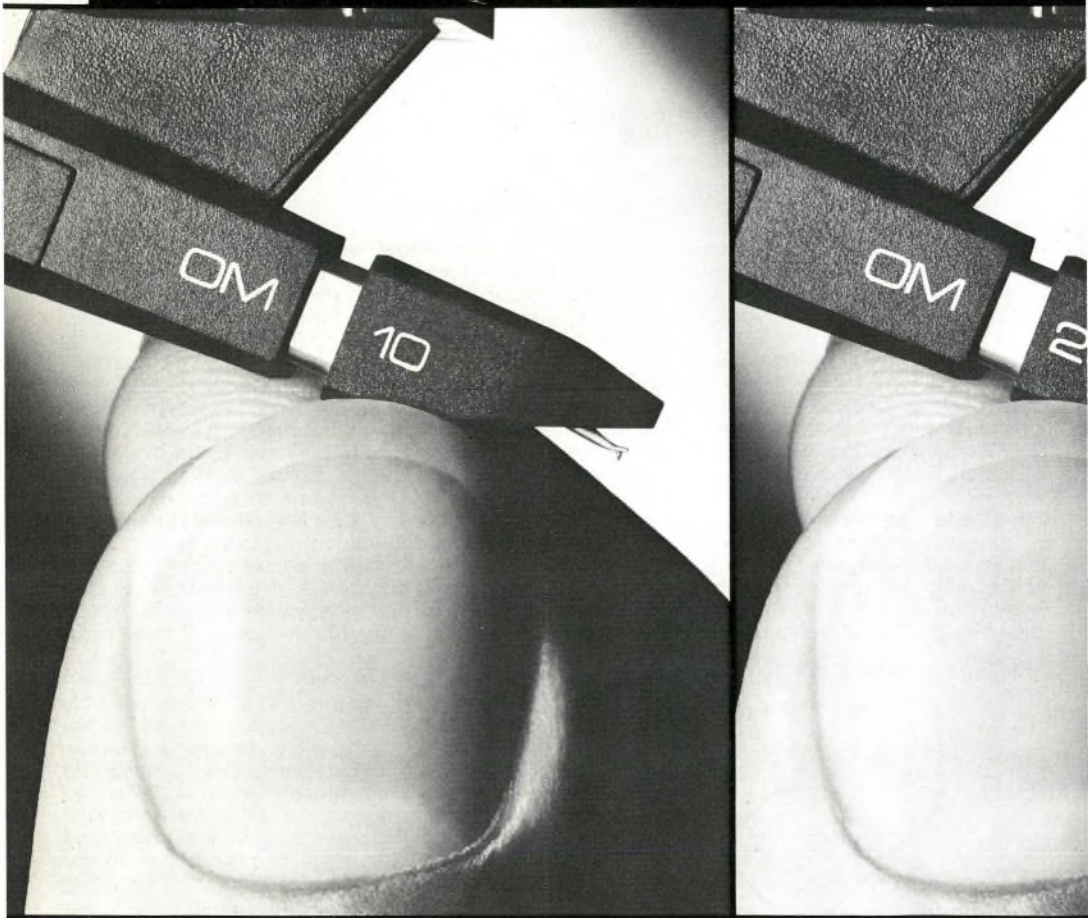

Hi-Fi cartridges (even the more expensive ones) have sometimes had one thing wrong with them.

If you want to upgrade them, you have to throw away the old cartridge. Along with the money it cost you.

Ortofon have found a way round this frustrating dilemma. And we've made it the principle behind our new

series of Optimum Match cartridges.

The OM Range (as it's more catchily known) features two basic cartridges.

Which, between them, will match almost any contemporary tonearm.

The OM, for all standard fittings, complete with removable weight-plate to differentiate between low and medium-mass models.



YOU WOULD NEVER EXPECT FROM ORTOFON. PERFORMANCE.

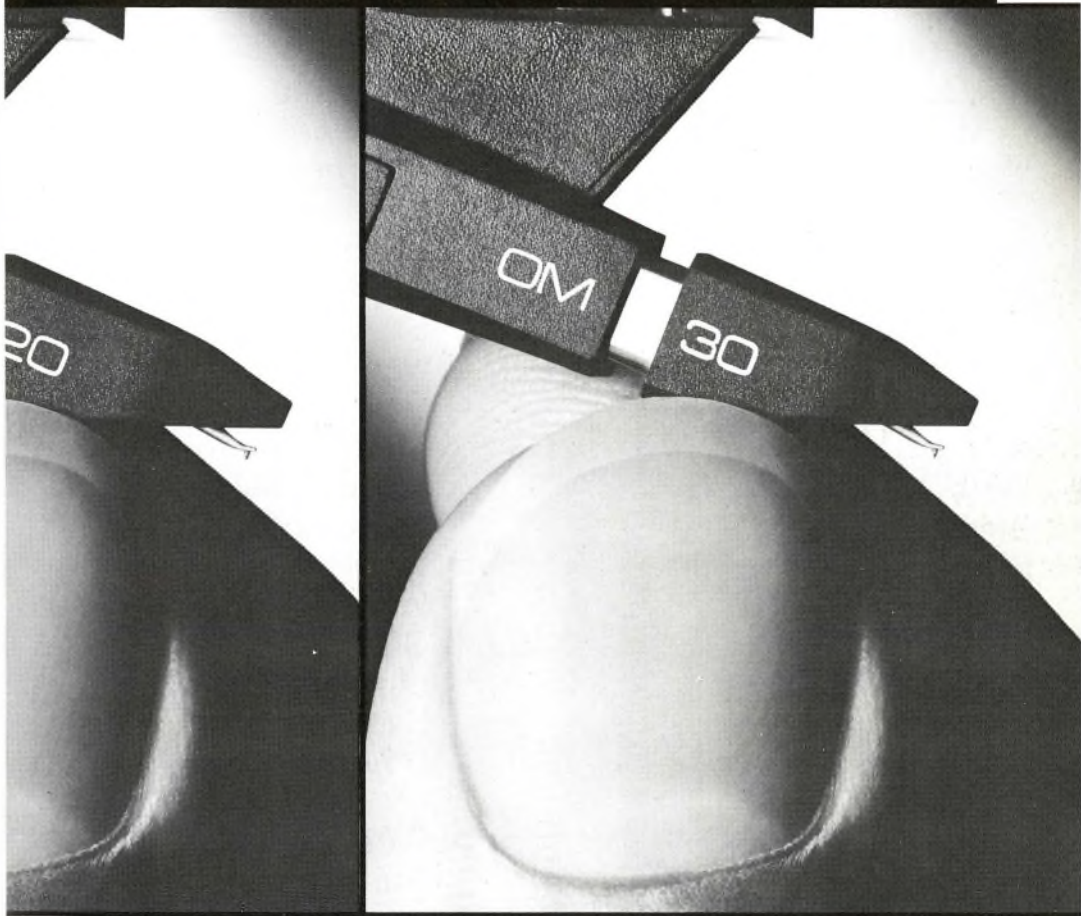

And the OMP for P mount (Plug-in), fittings. Both these cartridges can then be fitted from a choice of three different stylus units, of increasing quality. The 10, an Elliptical diamond. The 20, a nude, highly-polished Elliptical diamond. And the 30, a highly-polished Fine Line diamond.

So, you can improve the performance of your cartridge without actually

changing the whole cartridge unit.

Have a look and listen at the new OM range at your Ortofon stockist. With the OM10 or OMP10 only setting you back around £14, the prices will be something else you never expected from Ortofon.

ortofon
accuracy in sound



FOR MORE INFORMATION CONTACT: ORTOFON LTD., DENMARK HOUSE, TAVISTOCK INDUSTRIAL ESTATE, Nr. TWYFORD, BERKS. RG10 9NJ. TELEPHONE: (0734) 343621.

***Listen to Ariston from
the following dealers:***

AUDIO EXCELLENCE	Cardiff
AUDIO EXCELLENT	Swansea
AERCO	Farnborough
AERCO	Liverpool
BARTLETS	London
BEECHWOOD AUDIO	Braintree
BRENTWOOD MUSIC CENTRE	Brentwood
W. DARBY	St Albans
PETER ELIS	Newark
E.T.S.	Helston
GELSON AUDIO	Middlesbrough
HUDDERSFIELD HiFi	Huddersfield
HUGHES	Lowestoft
KENSINGTON HiFi	London
MIDLAND HiFi	Wolverhampton
MUSIC ROOM	Glasgow
MUSIC ROOM	Manchester
RUTTERS	Salisbury
RUTTERS	Devizes
SOUND SENSE	London
STILTION AUDIO	Peterborough
TARGET ELECTRIC	Dunstable

ARISTON ACOUSTICS
Freeport, Scotland
Prestwick International Airport
Prestwick, Ayrshire KA9 2RB
Tel: 0292 76933

TECHNICAL INTRODUCTION: CARTRIDGES

All the cartridges covered in this book have been subjected to stringent lab tests as well as careful listening tests. This section explains how and why the various tests were carried out.

This is the sixth *Choice* to cover cartridges, and the second by the present author; the reviewing approach and test techniques are substantially unchanged since the last edition, and so do generally allow direct comparison between older models and the new ones included here for the first time.

I should first note my personal preference for subjective rather than measurement-based reviewing. Not that I deny the value of technical results — I for one find them fascinating reading, and lab measurements do frequently offer valuable insights — but they are fundamentally less useful than auditioning and hands-on experience of even the briefest kind.

In its original inception, *Choice* attempted to test everything that was available, but in the early years this may have amounted to only 50 or so components in any product category. More recently, there have been up to 300 cartridges available (to a greater or lesser extent) on the UK market, under around 50 different brands. For the 1984 *Cartridges* edition, we received samples of about 140 different models, covering the great majority of available brands.

To cope with this number of models we took advantage of a recent development in test equipment and evolved a two-part test programme; each cartridge was given a relatively superficial first review, which nonetheless enabled us to accumulate an enormous amount of data, and to make a selection, based on various considerations, of models which would be given extended full reviews. This time round, the number of new models to be covered was somewhat smaller and so all were subjected to full reviews.

Review criteria

There are many possible ways to analyse cartridges. For the purpose of this review exercise, sound quality takes precedence, though a reasonable technical performance is expected to back this up. We also take note of the practicality of the design, in terms of its suitability to commercially available turntables and arms.

We are frankly suspicious of the over-compliant cartridge. The low frequency resonance interaction between arm and cartridge mass and cartridge low frequency compliance is a vital determinant of overall performance. The 'target range' has traditionally been set at 8-12Hz, though our experience suggests that resonance

frequencies below 10Hz are better avoided, provided this is not achieved at the expense of flimsiness in arm construction. Mechanical rigidity in the cartridge structure must be an important ingredient of sound quality, or why would mechanical rigidity play such an important part in the sound of different tonearms? A good tonearm is designed to accommodate the vibrational energy fed to it from the cartridge, so there is no earthly point in its owner fitting a cartridge which absorbs its own energy by sympathetic stator and body vibrations, and consequent loss of signal information.

Initial measurements

One of the more useful hi-fi by-products of the microcomputer revolution has been the introduction by cartridge manufacturer Ortofon of the *TC3000* cartridge test system. A strength of the *TC3000* over traditional techniques is the simplicity with which one can check the total performance of the system when varying parameters such as tracking weight, vertical tracking angle, bias compensation and input capacitance.

By no means a replacement for the careful examination using a variety of test discs in a well-equipped laboratory, it does provide a simple, quick, and impressively repeatable means of gleaning many of the most important parameters of cartridge performance. It therefore provided the foundation for the first series of 'screening' tests which were applied to all cartridges.

Low-frequency resonance

The data on low frequency resonance is invaluable for ensuring good arm mass/compliance compatibility.

Figures for vertical and horizontal resonant frequencies and the resonance rise quoted in the data tables are for the individual cartridges mounted in an arm of 13.5g effective mass (a figure close to the mean of conventional single-pivot arms).

Channel balance

The spot measurements relating to channel balance, separation and tracking abilities also provide useful information on the cartridges, though their 'spotty' nature means that they should not be over-interpreted!

It is better to rely upon response graphs for channel balance, as a variation of this factor across the frequency band is more troublesome

TECHNICAL INTRODUCTION: CARTRIDGES

than a specific constant shift which may be corrected simply enough by a balance adjustment on the amplifier. (*In the published graphs, we have separated left and right channel traces for clarity, but this makes any overall imbalance less obvious — Ed*).

Tracking ability

Most cartridges sailed happily through the tracking ability test provided on the computer system, which provided a maximum test level of 80µm. One might infer that the tracking test was insufficiently severe, but in the author's opinion a sensible maximum has been chosen which indicates those cartridges which may cause problems if used unwisely, while avoiding the unnecessary 'glamorisation' of 'supertrackers'. It is in fact a reflection of the relative lack of importance that need be attached to this parameter nowadays, despite the fact that historically it was for many years accepted as a prime arbiter of cartridge quality.

Over many years the author has extensively used some of the 'worst' tracking cartridges in the book, where 80µm looks like pure self-indulgence, yet scarcely ever encountered mistracking during regular everyday use. Those with a particular penchant for operatic and choral music (or with a peculiar obsession with special audiophile discs) would do well to be a little cautious of the poorest trackers, but many users will no doubt find themselves confirming the author's experiences. Today's best cartridge engineering can give perfectly adequate tracking abilities without compromising performance and sound quality through too high a compliance for sensible arm matching. And again, in the author's opinion and experience, there's no better way to get good tracking from a cartridge than to start with a decent turntable/arm foundation.

Channel separation

As with channel balance, the computer test's single 'figure of goodness' for channel separation is really only a guideline and may often be a substantial oversimplification. Many cartridges comfortably achieved the computer's maximum of 30dB on both channels. The more detailed figures quoted in all full reviews as 'stereo separation', giving both left-on-right and right-on-left crosstalk at three frequencies, obviously give a more complete picture.

Frequency response figures

The frequency response measurements needed to be carefully interpreted in the light of

experience with the machine and discs. We conducted exhaustive statistical analysis of results, and relied upon comparison with various mean values obtained from different samples of the test cartridges. While this approach does not attempt to define an absolute 'flatness' of response, it has the benefit of establishing a cartridge's performance in relation to the norm.

Output level

The final useful computer-derived measurement is that of output level. Not so much because of the actual value, but again because a specific cartridge's output can be related to the mean for the type (low or high output).

As a rough guide, figures twice or half the mean are most unlikely to cause amplifier matching problems, and three times or one-third can generally be accommodated. Mean values recorded (one channel, 1kHz, 5cm/s) were 3.6mV for high output cartridges and 0.29mV for low output models.

Extended Technical Tests

Frequency response graphs for the full reviews were plotted over the range 20Hz-20kHz, using the inner bands of the JVC *TRS-1007 II* test disc. This ultra-thick and ultra-flat disc is widely regarded as an industry standard, and was of good enough quality to enable traces to be made at low and high writing speeds, the former to establish the general trend while the latter provided useful additional information on the mechanical integrity of the cartridge and its general stability in the groove. Temperature was again held as closely as practical to 17-20° C, which is considered by the author to be most appropriate to the British climate, though below the range often specified by manufacturers.

The reference trace is taken with low-capacitance loading at the B&K measurement pre-amplifier (capacitance being 100pF including tonearm wiring and leads), which gets as close as possible to defining the inherent response of the cartridge.

Some moving magnet cartridges are specifically designed to make use of some additional capacitance loading to enhance their response. Usually this is done by providing a tuned electrical resonance to interact constructively with the inherent mechanical losses of the particular design, and so optimise response. Critics of this technique can sagely point out that two wrongs rarely make a right.

It will be noted that there is a discrepancy between these responses and data the

1/2" Mounting Bracket makes the new MMC generation a universal fit. The MMC cartridge weighs only 3.3g with the mounting bracket. Extra weight can be added depending on mounting screws, angles, weight etc

Symmetrical Permalloy Body Shell closes the magnetic circuit of the cartridge, acting as a shield against the effect of external hum fields and makes it possible to design such a small cartridge

Powerful, Samarium Cobalt Ring Magnet forms one of the poles in the air gap, allowing for total symmetry in the magnetic system and no loss of magnetic current giving high output

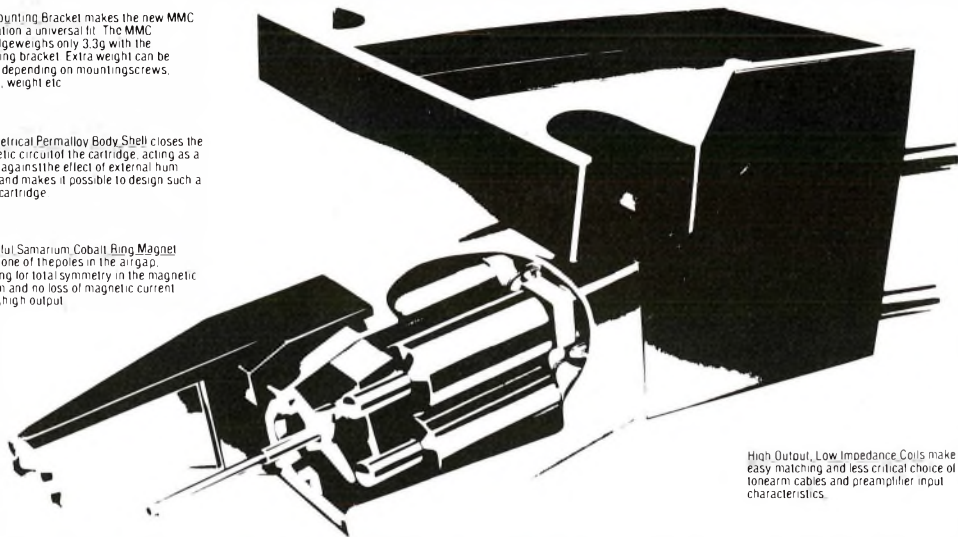

High Output, Low Impedance Coils make for easy matching and less critical choice of tonearm cables and preamplifier input characteristics.

Multi-radial, Contact Line Diamond (MMC 1 & 2) is ensuring you precise high frequency sound reproduction, low ETM and thereby low record wear and perfect tracking

Hollow Tube, Crystal Sapphire Cantilever (MMC 1 & 2) The Sapphire is 5 times stiffer than aluminium and 40% stiffer than beryllium. The sapphire tube cantilever ensures linear transfer of signals since longitudinal vibrations are eliminated

Patented, Computer designed Moving Micro Cross Armature (MMC), which is x-shaped ensures excellent channel separation over the entire frequency range. It is miniaturized to ensure low ETM and thereby minimal record wear and internal resonance control

Specially Formulated Elastomer Suspension together with the precise, symmetrically mounted cantilever, ensures that the stylus has a single, accurate pivot point to obtain better stereo imaging

The MMC series. Cartridges for the digital age.

Every music lover knows the excitement which comes from discovering a new hi-fi component that has suddenly made his music sound decisively better.

You will make that discovery, and experience that excitement, with the Bang & Olufsen MMC Series Cartridges

No longer will you have awareness that a cartridge has interposed itself between the music as it was recorded, and the music you are hearing. On the contrary, you will delight in finding new depth, detail and spatial perspective in even your most familiar recordings.

The cartridge as an electronic component.

The phono cartridge, of course, is by nature an electro-mechanical component. However, Bang & Olufsen has succeeded in virtually removing the performance

limitations placed on the cartridge by its mechanical design. The result is a change in cartridge performance so astounding, you might conclude that the cartridges have become electronic components for the new age of improved software.

You already have the right turntable for an MMC cartridge.

The MMC Series contains a cartridge that will match or exceed the abilities of the turntable you own. In fact, you may well find that your turntable has more potential than you imagined. A correctly matched MMC cartridge simply makes high performance possible where it wasn't before. And at prices starting from around £21, the improvement will be far from expensive!

The use of Samarium Cobalt for the MMC's ring magnet has allowed a significant reduction in the pickup's overall size. Its extreme smallness and lightness (only 3.3g including 1/2" mounting) means that the advantages of the MMC technique can now be enjoyed by users of heavier arms too!

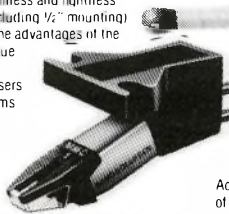

Actual size of cartridge



	MMC 1	MMC 2	MMC 3	MMC 4	MMC 5
Stylus diameter	Unframed contact line	Unframed contact line	Unframed elliptical	Titanium bonded elliptical	Titanium bonded elliptical
Cantilever	Sapphire tube	Sapphire tube	Tapered aluminium tube	Tapered aluminium tube	Straight aluminium tube
Effective tip mass	0.25 mg	0.3 mg	0.35 mg	0.4 mg	0.5 mg
Compliance	30 µm/mN	30 µm/mN	25 µm/mN	25 µm/mN	20 µm/mN
Frequency response	20-20,000 Hz ±1 dB	20-20,000 Hz ±1.5 dB	20-20,000 Hz ±2 dB	20-20,000 Hz ±2.5 dB	20-20,000 Hz ±3 dB
Channel separation	>30 dB/1KHz	>25 dB/1KHz	>25 dB/1KHz	>22 dB/1KHz	>20 dB/1KHz

See and hear these amazing cartridges at your local Bang & Olufsen dealer or send for the free Design Story to us, Bang & Olufsen UK Limited, Dept HC2, Eastbrook Road, Gloucester GL4 7DE. Telephone (0452) 21591

Bang & Olufsen

RECOMMENDED

The van den Hul MC10 cartridge

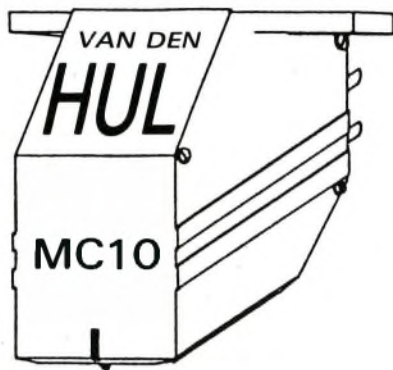

The MC10 cartridge is the first cartridge entirely designed and individually hand-built by A J van den Hul.

It embodies all his knowledge on cartridge design and mono-crystal technology.

It is probably the finest and most complete pick-up cartridge ever made.

Only a small quantity will ever be produced. Appropriately, it is already a collector's item.

Automation Sciences Company
20 Little Gaddesden, Berkhamstead
Herts. HP4 1PA, England
(044284-2786)

HI-FI CARE LTD

We don't stock or sell any hi-fi or video equipment!

But we do stock and specialise in hi-fi audio and video accessories for most leading brands of equipment.

Example: our stylus range begins from steel needles for wind-up gramophones to the very latest moving-coil cartridge for the most advanced turntable.

Why not visit Hi-Fi Care's walk round stores

To see the latest in microphones, headphones, record/tape care, audio/video tapes, switchboxes, plugs and leads, speaker/TV stands and brackets, cartridges and styli, TV/FM aerials and boosters, plus a comprehensive range of video accessories and many difficult to find accessory items too numerous to mention.

Our knowledgeable and helpful staff would be pleased to advise you on your requirements at:

HI-FI CARE LTD

245 Tottenham Court Road, London W1 Tel 01 637 8911/2

7 Tottenham Court Road, London W1 Tel 01 637 0371

SHOP HOURS MON SAT AM 6PM
PHONE ORDER CAN BE ACCEPTED ON ACCESS & VISA

TAX FREE SERVICE FOR OVERSEAS CUSTOMERS

TECHNICAL INTRODUCTION: CARTRIDGES

Ortofon computer, which is also quoted. This is simply because the computer-derived data relates to a carefully chosen mean frequency response, whereas the pen chart assumes that the inherent response of the disc is ruler flat.

One naturally assumes that a flat frequency response is a desirable end in itself, but this is obviously an oversimplification. More important perhaps is the general response evenness, so that if a straight line is drawn through the graph, any departures from the line are small, and more particularly, gradual. Any sharp change in response is more distracting sonically, and indicative of problems, than a gradual one.

A valuable by-product of the response trace is the opportunity to examine channel balance closely and in detail, as this provides further clues to the mechanical integrity of generator and stator. Some discrepancy at high frequencies (above 10kHz) may be deemed acceptable, but variations between channels (as distinct from constant channel differences) are definitely to be avoided.

The other key measurement of cartridge performance is stereo separation. We used the same test disc (different bands), but this time recorded the result using third-octave band averaging on a computing spectrum analyser. Here we used a 50kHz bandwidth, which gave an opportunity to examine the amount of out-of-band spuria produced by the test cartridge.

This averaging technique can be rather flattering to the cartridge, but is still capable of providing useful results on the general trend, and spotlighting any notable anomaly. It is probable that the actual value of separation (recorded at three selected frequency bands in the data table) is less important than the trends and anomalies, which are very sensitive indicators to the mechanical behaviour and internal alignment of the cartridge sample.

Stylus examination

For full reviews, all styli were carefully examined under a high quality stereo microscope. This was certainly capable of weeding out any duff samples, checking alignment, polish, quality of mounting and orientation, and confirming (or denying) the manufacturer's general claim for the tip type and quality.

Listening tests

All the submitted cartridges were run in and auditioned briefly as part of the 'screening' procedures. Further listening involved formal 'blind' panel sessions.

Further extended listening was undertaken daily on specific models across a wide range of programme material.

Acknowledgements

The author would like to express his thanks first and foremost to all the distributors and manufacturers who had sufficient faith to participate!

Special thanks for their support in the domestic listening are due to Exposure Electronics for the use of their facilities and to Jeffries Hi-Fi for much generous assistance throughout.

On the technical side, my thanks to Ortofon, without whose impressive TC3000 computer data gathering would have been very hard work; Alvin Gold, for extended loan of his Neutrik pen-recorder; to Martin Colloms for his Nicolet computing spectrum analyser and a lot of invaluable advice; JVC for assistance with test discs; and Studio 99 for access to their Canon stereo microscope. And finally, by no means least to long-suffering assistant Xavier Wilcox, and to the willing volunteers who made up the listening panel.

Paul Messenger

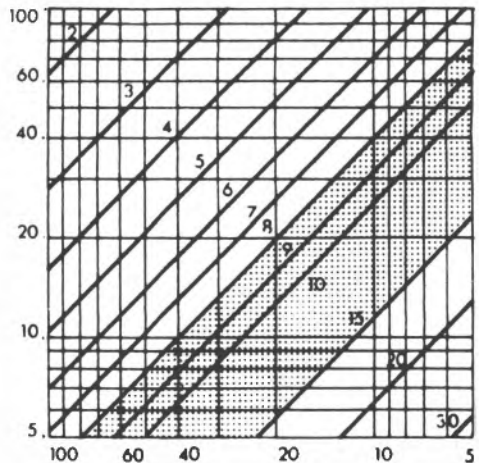

Arm and cartridge resonance matching: the low-frequency resonance of an arm/cartridge combination can be calculated from the arm effective mass, cartridge mass and cartridge compliance. Add together the arm and cartridge masses, and draw in the corresponding vertical line. Then draw in a horizontal line corresponding to cartridge compliance. Where the two lines intersect, the resonant frequency can be read from the diagonal scale. The shaded area is the optimum area within which the lines should intersect.

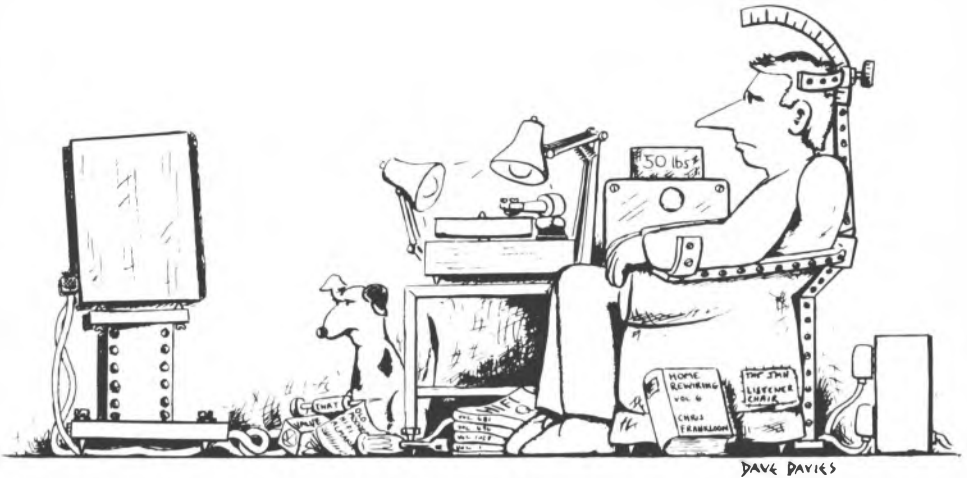

Meanwhile, back in the real world...

...Quite frankly, at Audio T, we really don't mind if you feel the compulsion to align your Hi-fi along the lode-lines, set your room thermostat to 21.4°C and don a white tie and tails, before you pick up your baton to enjoy an informal musical evening at home.

Whilst we specialise in the very best audio equipment available in the world today, we are happy to be able to offer consistently enjoyable real music systems for less than £300.00 (complete with cables etc.).

We stock fine equipment from –

A&R AIWA ALPHASON AUDIOLAB AUDIO RESEARCH BURMESTER CREEK CROFT DENON DUAL
DUNLOP GALE HEYBROOK KOETSU KRELL LINN MAGNUM MICHELL MISSION/CYRUS NAKAMICHI
PINK TRIANGLE PROAC QUAD ROTEL SPENDOR THORENS VAN DEN HUL YAMAHA ZETA

Phone for an appointment in
either of our two demonstration rooms.



Audio T
190 West End Lane
London
NW6 1SQ
01 794 7848



ADC Phase I

Harman (Audio) UK Ltd, Mill Street, Slough, Berks SL2 5DD
Tel (0753) 76911

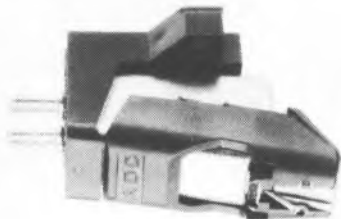

This long established American cartridge manufacturer is best known for using an 'induced magnet' variation on the moving magnet theme. ADC have applied this basic principle at different levels of refinement over many years.

Currently, the *Phase 1* is the cheapest ADC model. The detachable stylus assembly is a bit fiddly to fit properly, but the body is solidly made and can be secured tightly in the headshell.

The stylus has a spherical tip which was quite small and neatly mounted. Tracking weight is a sensible 2g, the compliance quite low (lower than the other ADCs), and the LF resonance well-damped, so the cartridge is suitable for a wide range of arms, with only the lowest mass examples best avoided.

Lab report

The output level and electrical amplifier loading requirements are average, so will suit all amplifiers. Although capacitance change made a minor difference to the response, the value seemed subjectively irrelevant.

Frequency response shows a generally smooth trend with pronounced but gentle treble rolloff. Channel imbalances are slight and confined to the frequency extremes, but there is clear evidence of some mechanical resonances in the midband.

Separation results were reasonable enough for the price, the spectrum analyser confirming the computer readings. Tracking abilities are clearly more than adequate, assisted by the highish tracking weight but impressive enough considering the compliance.

Sound quality

The balance of this cartridge was particularly liked. Considering its low price level, it showed a general midrange integrity which could be

the envy of more expensive designs, and surprisingly good 'focus' for a modest model, though inevitably there was little real impression of stereo depth.

Very much an 'up-front midrange' cartridge, the *Phase 1* offered treble that was inevitably lacking in output and detail. The bass lacked impact while still sounding quite firm and detailed. Though it could be said to lack subtlety, the sound was quite tuneful and involving, and well suited to rock material. The cartridge seemed unusually stable in the groove, which often seems to be associated with a solid coherent sound.

Conclusions

This is an unpretentious cartridge that manages to deliver a rather fine balance of qualities, particularly well-suited to budget turntables. Clearly a Best Buy, it offers almost universal compatibility and a decent sound quality. Even the treble rolloff could well be a positive benefit in the context of a budget system.

TEST RESULTS

Type, mass.....	moving magnet 5.8g
Stylus type.....	spherical
Stylus inspection result.....	well mounted, little polish
Output Level (1kHz, 5cm/s).....	-3.5mV
Relative output (0dB = 1mV/cm/s).....	-1dB
Channel balance.....	0.25dB
Channel separation (L,R).....	21.6, 30dB
Tracking ability (L,R).....	80, 80µm
Frequency response limits 100Hz-5kHz.....	+1, -2dB
Frequency response limits 30Hz-20kHz.....	+1, -7dB
Stereo Separation L on R 100Hz, 3kHz, 10kHz.....	24, 23, 20dB
Stereo Separation R on L 100Hz, 3kHz, 10kHz.....	29, 29, 23dB
Channel diff. from graph, 100Hz, 1kHz, 10kHz.....	0, 0.5, 0dB
Response limits ref computer mean, 1kHz-15kHz.....	+0, -3dB
Response limits ref computer mean, 1kHz-20kHz.....	+0, -6dB
Test tracking weight, loading.....	2g, 275pF
LF resonance frequency, 12.5g arm (vert, lat).....	11, 11Hz
Estimated compliance (vert, lat).....	15, 15cu
Recommended arm effective mass.....	8-18g
LF resonance rise, 12.5g arm (vert, lat).....	11.3, 10dB
Typical selling price.....	£12

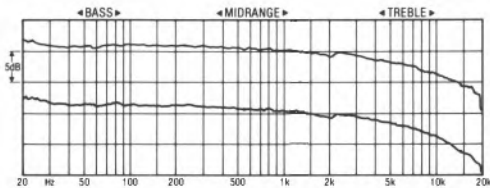

Frequency response, left and right channels

ADC Phase IV

Harman (Audio) UK Ltd, Mill Street, Slough, Berks SL2 5DD
Tel (0753) 76911

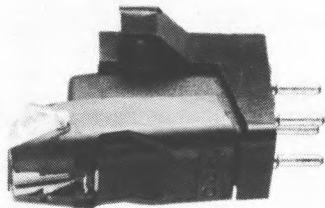

This £41 model is the top of the range for the traditional Phase series ADC induced magnet cartridges. The body construction seems sound, with sensible mounting lugs for firm headshell fixing, though removing or fitting the stylus assembly — in this instance carbon fibre instead of ordinary plastic — was a bit fiddly.

A nude elliptical stylus is specified, and this was confirmed on inspection. Tracking weight is a lowish 1.2g, and the compliance and damping are moderate enough to suit a wide range of low-medium mass arms.

Lab report

Output level and capacitance loading requirements are entirely average, which should ensure good amplifier compatibility. Capacitance adjustment does change response slightly, though not to the extent of being subjectively too distracting.

Frequency response showed a very smooth gently falling treble range with low loading which was rather better maintained but then rolled more sharply with increased capacitance. Channel balance was only fair, with some variation particularly at low frequencies (like *Phase I*). Interestingly, due either to the carbon fibre or the higher compliance, the midrange resonances noted with the *I* were virtually absent.

Channel separation was a touch disappointing considering the price level, being poorest at low frequencies, with some asymmetry. Tracking ability, on the other hand, was fine.

Sound quality

The improvement of high frequency output over the *I* was immediately obvious, though perhaps a trifle too much so. There is a family resemblance about the sound of the *Phases* which preserves fine integrity though the upper

bass and lower mid, but in the case of the *IV* the treble seemed a trifle 'detached'. The bass was rather lacking in 'weight' and 'power', though it was quite tuneful and uncoloured.

Stereo imaging was quite nicely focussed with reasonable depth, if a trifle 'narrow'. Though not the most dynamic of cartridges, it sounded pretty consistent throughout the range and seemed well-suited to all types of music. The cartridge sat reasonably securely in the groove despite the lowish tracking weight, though surface noise seemed a touch emphasised.

Conclusions

This is a pretty well-balanced design, as the *Phase* series generally seem to be. It suits the lower mass arms best, and can sound a touch 'bright', but detail and integrity are pretty good, and the sound betters many at its price.

TEST RESULTS

Type, mass.....	moving magnet 5.8g
Stylus type.....	elliptical
Stylus inspection result.....	adequate nude
Output Level (1kHz, 5cm/s).....	3.48mV
Relative output (0dB = 1mV/cm/s).....	- 1.5dB
Channel balance.....	1.03dB
Channel separation (L,R).....	24.6, 30dB
Tracking ability (L,R).....	.80, 80µm
Frequency response limits 100Hz-5Hz.....	+ 0.5, - 2dB
Frequency response limits 30Hz-20kHz.....	+ 0.5, - 4.5dB
Stereo Separation L on R 100Hz, 3kHz, 10kHz.....	28, 31, 26dB
Stereo Separation R on L 100Hz, 3kHz, 10kHz.....	30, 30, 25dB
Channel diff. from graph. 100Hz, 1kHz, 10kHz.....	0, 0.5, 0.5dB
Response limits ref computer mean, 1kHz-15kHz.....	+ 0, - 2dB
Response limits ref computer mean, 1kHz-20kHz.....	+ 0, - 3dB
Test tracking weight, loading.....	1.5g, 275pF
LF resonance frequency, 12.5g arm (vert, lat).....	9.5, 8Hz
Estimated compliance (vert, lat).....	16, 22cu
Recommended arm effective mass.....	5-14g
LF resonance rise, 12.5g arm (vert, lat).....	13.5, 13.5dB
Typical selling price.....	£41

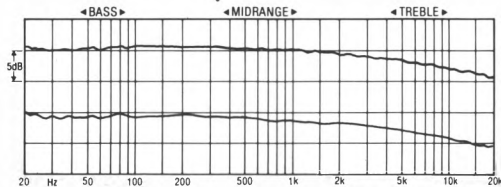

Frequency response, left and right channels

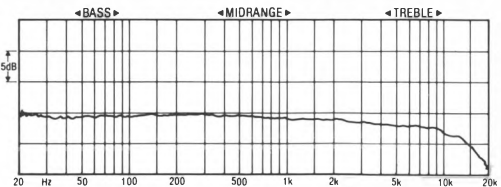

Frequency response with higher load capacitance

A&R C77

A&R Cambridge Ltd, Denny End Industrial Centre, Waterbeach, Cambridge CB6 9PB
Tel (0223) 861550

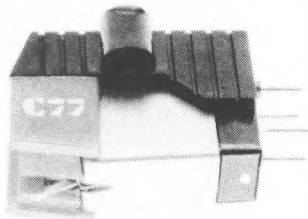
BEST BUY

A&R are best known for their *A60* amplifier, but in recent years they have expanded their activities into the loudspeaker and cartridge markets. Their original cartridge policy was to take a fairly conventional moving magnet design and specify a very high quality stylus (Weinz Paroc on the original *P77*), while keeping the price quite modest.

They have added other models since, and made a number of developmental changes, so there are now three moving magnet cartridges, sharing a common body but differing in styli and cantilevers. The newer *PMX10* is a moving-coil model which applies the original concept to a moving-coil design of Goldring manufacture.

The unassuming *C77* moving magnet model shows good mechanical integrity in body and stylus assembly. The latter has a spherical tip which was small, neat and well-mounted. Compliance is moderate with little damping, suited to the many arms in the effective mass range 7-15g. Tracking weight for this model is a sensible 1.8g, a figure which confers reasonable groove security.

Lab report

Output is conveniently average, and amplifier input capacitance is quite uncritical (250pF increase adding 1dB to treble level).

Frequency response showed a fairly obvious broad 3dB suckout in the mid treble, followed by a mild rise to the 16/17kHz resonance. Channel balance improved steadily towards high frequencies, and the overall trace did in fact manage to look quite 'clean' even at high writing speeds.

The separation analysis showed decent enough figures which were generally pretty consistent down to low frequencies, though reducing somewhat at HF. Tracking abilities were fine.

Sound quality

The measured frequency balance was quite obvious in the sound quality, but this is something of a compliment to an inherently very clear and clean sounding cartridge, which in many respects sounds most impressive considering its price.

The treble peak was a trifle obvious and sounded a little 'detached', perhaps because the extreme HF was not particularly detailed. Elsewhere the balance and dynamics were thoroughly impressive, with plenty of 'bounce' and a genuine attempt to convey stereo depth. Surface noise was not exaggerated, midrange focus was pretty good, and the general integrity was good.

Conclusions

Belying its rather nondescript appearance, the *C77* is the sort of model that gives moving magnets a good name. It offers good compatibility and sound quality at a very sensible price. Clearly a Best Buy, the only question mark lies over the treble peak and how it might interact with a given system and pair of ears.

TEST RESULTS

Type, mass.....	moving magnet 6g
Stylus type.....	spherical
Stylus inspection result.....	confirmed, well mounted
Output Level (1kHz, 5cm/s).....	3.75mV
Relative output (0dB = 1mV/cm/s).....	- 1dB
Channel balance.....	- 0.85dB
Channel separation (L,R).....	28.5, 28.8dB
Tracking ability (L,R).....	80, 80µm
Frequency response limits 100Hz-5kHz.....	+ 1, - 2.5dB
Frequency response limits 30Hz-20kHz.....	+ 1, - 9dB
Stereo Separation L on R 100Hz, 3kHz, 10kHz.....	22, 31, 22dB
Stereo Separation R on L 100Hz, 3kHz, 10kHz.....	28, 24, 22dB
Channel diff. from graph, 100Hz, 1kHz, 10kHz.....	0.5, 0.5, 1dB
Response limits ref computer mean, 1kHz-15kHz.....	+ 2.5, - 1.5dB
Response limits ref computer mean, 1kHz-20kHz + 2.5, - 2dB	
Test tracking weight, loading.....	1.8g, 300pF
LF resonance frequency, 12.5g arm (vert, lat).....	10, 10.3Hz
Estimated compliance (vert, lat).....	16, 15cu
Recommended arm effective mass.....	6-16g
LF resonance rise, 12.5g arm (vert, lat).....	14.5, 12dB
Typical selling price.....	£20

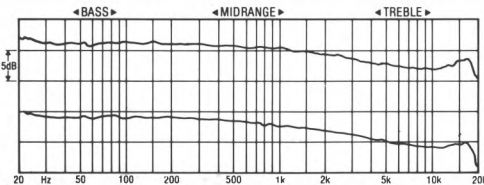

Frequency response, left and right channels

A&R P77

A&R Cambridge Ltd, Denny End Industrial Centre, Waterbeach, Cambridge CB6 9PB
Tel (0223) 861550

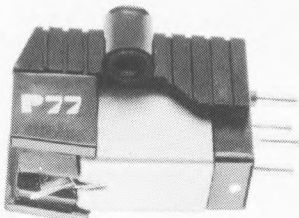

The original '77 started with a Weinz Paroc stylus profile on a conventional Japanese-sourced body/cantilever, chosen for good rigidity and sensible compliance. This stylus is now replaced by a special elliptical/line 'profined' tip, which is fitted in the UK.

The quality of this tiny nude tip was confirmed by inspection, and is fair justification for the moderate £45 asking price. This A&R stylus assembly may be purchased separately, to upgrade any of the other A&R cartridges when the time comes for stylus replacement. Compliance was a touch lower than the other 77s, with rather greater damping, so low-medium effective mass arms are to be preferred.

Lab report

Medium output and uncritical capacitance loading should avoid any compatibility problems with amplifiers. Adding capacitance in fact served merely to fill the upper-mid/treble suckout by less than 1dB.

Frequency response showed a remarkable similarity to the C77, though the extreme HF peak was a trifle more pronounced. Channel balance was much closer — width-of-the-pen-trace stuff in fact — which confirms A&R's claim that they select the closest tolerance bodies for the P model. The trace itself was impressively smooth, with no obvious identifiable mechanical resonances midband.

Separation gave rather variable results, and it was difficult to determine a trend, but the figures were pretty reasonable nonetheless. Tracking abilities seemed fine.

Sound quality

Though the response indicated a less promising result than the C77, in fact the reverse was true. Though still a slightly 'tizzy' cartridge, the definition and 'sweetness' at

high frequencies was improved sufficiently to render the peak somehow less sonically 'isolated'.

In fact clarity, detail and control were impressive throughout, and quite good stereo images were produced, with reasonable depth albeit the occasional anomaly. The bass did sound a touch congested, perhaps the effect of increased damping which certainly made the cartridge very stable in the groove.

Conclusions

Another well balanced A&R cartridge, clearly meriting recommendation, the P77 does a pretty good job of justifying its extra cost over the C. Despite the measured response, it is one of the more listenable moving magnet cartridges around, while offering sensible wide-spread compatibility.

TEST RESULTS

Type, mass.....	moving magnet 6g
Stylus type.....	'profined' line contact
Stylus inspection result.....	fine nude line contact tip
Output Level (1kHz, 5cm/s).....	-3.4mV
Relative output (0dB = 1mV/cm/s).....	-1.5dB
Channel balance.....	0.36dB
Channel separation (L,R).....	25.8, 24dB
Tracking ability (L,R).....	80, 80µm
Frequency response limits 100Hz-5Hz.....	+1, -2.5dB
Frequency response limits 30Hz-20kHz.....	+1, -4dB
Stereo Separation L on R 100Hz, 3kHz, 10kHz.....	21, 30, 22dB
Stereo Separation R on L 100Hz, 3kHz, 10kHz.....	33, 26, 35dB
Channel diff. from graph, 100Hz, 1kHz, 10kHz.....	0, 0, 0.5dB
Response limits ref computer mean, 1kHz-15kHz.....	+2, -1.5dB
Response limits ref computer mean, 1kHz-20kHz + 3.5, -1.5dB	
Test tracking weight, loading.....	1.8g, 300pF
LF resonance frequency, 12.5g arm (vert, lat).....	9, 8.6Hz
Estimated compliance (vert, lat).....	18, 19cu
Recommended arm effective mass.....	6-15g
LF resonance rise, 12.5g arm (vert, lat).....	10.6, 10.6dB
Typical selling price.....	£45



Frequency response (channels identical)

Audio-Technica AT105E

Audio-Technica (UK) Ltd, Hunslet Trading Estate, Low Road, Leeds
Tel (0532) 771441

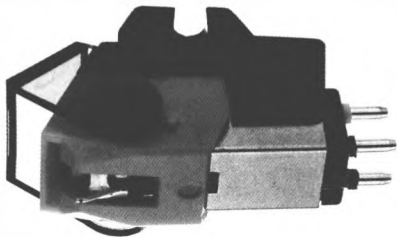

a cartridge at this price level, and the high frequency limitations tended to dominate listeners' reactions. While the sound was described as 'shut in' with the lack of extreme treble emphasising the midband, the bass was praised for tightness, good articulation and integration.

Conclusions

This Audio Technica model provides solid value for money for those seeking a low price cartridge, though it is perhaps worth finding the extra fiver to go one rung further up the ladder. Better suited to medium and high mass arms and the better class of turntable, it is capable of a lively performance and is inherently well engineered.

Cheapest of the Audio Technica branded models tested by *Choice* (though Linn's *Basik* is based on an even less expensive model), this £11.50 magnetic cartridge nevertheless shares A-T's latest tweak, LC-OFC (linear crystal oxygen-free copper) wire, with most of its more expensive stablemates.

It has a fairly rigid body shape, albeit with only half-circle mounting lugs, and a very firmly located stylus assembly and is solidly built; the spherical stylus — which when examined, appeared to carry a mild elliptical profile — tracks at a sensible 2g downforce.

Compliance is well chosen too, indicating compatibility with a wide range of medium and high mass arms, taking account of the highish mass of the cartridge itself. However there is little damping of the LF resonance, so the 105 is likely to work best, when the turntable is of at least reasonable quality.

Lab report

Output level is about average, and low (100-200pF) capacitance is specified. Increasing the capacitance loading did flatten the response up to 10kHz, but curtailed the bandwidth thereafter and sharpened the peak a shade. Sonically, changes in loading seemed more innocuous than the measurements suggest, so pre-amp matching should be fairly uncritical.

Frequency response fell gently and smoothly some 2.5-3dB from 100Hz-10kHz; above 10kHz the treble rolled off quite quickly. The response traces are reasonably smooth, with only a couple of minor midrange 'glitches'.

Separation was quite good, 29dB being a very respectable 'worst case' at high frequencies, with 35dB typical and symmetrical elsewhere. Tracking abilities seemed fine.

Sound quality

One should not perhaps expect a great deal from

TEST RESULTS

Type, mass.....	moving magnet 7.2g
Stylus type.....	conical (spherical)
Stylus inspection result.....	very mild ellipse!
Output Level (1kHz, 5cm/s).....	4.1mV
Relative output (0dB=1mV/cm/s).....	0dB
Channel balance.....	0.5dB
Channel separation (L,R).....	30, 30dB
Tracking ability (L,R).....	80, 80µm
Frequency response from graph, 100Hz-5kHz.....	+1.5, -1.5dB
Frequency response from graph, 30Hz-20kHz.....	+1.5, -6dB
Stereo Separation L on R 80Hz, 3kHz, 10kHz.....	32, 35, 29dB
Stereo Separation R on L 80Hz, 3kHz, 10kHz.....	36, 36, 29dB
Response limits ref computer mean, 1kHz-15kHz.....	+1.5, -0.5dB
Response limits ref computer mean, 1kHz-20kHz.....	+1.5, -2.5dB
Test tracking weight, loading.....	2g, 150pF
LF resonance frequency, (13.5g arm) (vert, lat).....	10, 9Hz
Estimated compliance (vert, lat).....	13, 15cu
Recommended arm effective mass.....	6-16g
LF resonance rise, (13.5g arm) (vert, lat).....	15, 17dB
Typical selling price.....	£11.50

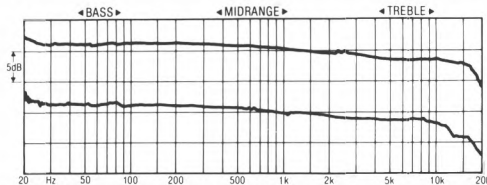

Frequency response, left and right channels

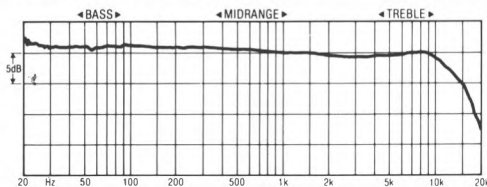

Frequency response with higher load capacitance

BEST BUY

Audio-Technica AT110E

Audio-Technica (UK) Ltd, Hunslet Trading Estate, Low Road, Leeds
Tel (0532) 771441



This conventional low cost (£16) magnetic cartridge shares bodywork and the new LC-OFC (linear crystal) wiring with the *105* and *115E*. The rigid body, mildly compromised by half-circle mounting lugs, accepts a firmly located stylus assembly. It tracks securely enough at a sensible 1.5-2g, though the specified mild-profile elliptical stylus looked suspiciously spherical under the 'scope — a curious juxtaposition with the test *'105*.

Compliance is pretty sensible, suiting a wide range of arms, though better class turntables are to be preferred as there is little damping of the resonance. The highish mass of the cartridge suggests that the lowest mass arms are better avoided.

Lab report

Output level is about average, and although low capacitance is specified, a high capacitance load did flatten the response and extend the bandwidth, not to mention sounding slightly better. Most pre-amps should provide suitable loading, though experimentation with a little extra might pay off in some systems.

Frequency response downtilted quite noticeably until some capacitance was added, when a good overall response to 14kHz was obtained. Channel balance error was a less than impressive 1.1dB, though the match between channels was quite close. Even at the fast writing speed the response traces were pretty smooth, with only a couple of minor 'glitches'.

Separation was very good considering the modest price of this model, only mildly asymmetrical and showing a 5dB improvement at high frequencies over the cheaper *'105*.

Sound quality

The improvement over the cheaper *105* due to the extra treble was immediately apparent in the listening tests, providing a significantly 'livelier'

sound. With high capacitance loading the cartridge could sound rather brittle and aggressive, so the recommendation for low capacitance should be followed. The sound was quite 'fast', 'firm' and 'bouncy', with a good overall balance, but a mild 'steely' coloration was also described.

Conclusions

This exceedingly well balanced budget cartridge is a very capable performer, with few grounds for technical criticism, a sound quality that more than stands up to scrutiny, and performance more than able to do justice to better quality turntables. Whether the LC-OFC wire actually is a worthwhile 'magic ingredient' remains a moot point, but the *'110E* is clearly a very competitive package well deserving recommendation.

TEST RESULTS

Type, mass.....	moving magnet 7.2g
Stylus type.....	elliptical
Stylus inspection result.....	spherical!
Output Level (1kHz, 5cm/s).....	4.0mV
Relative output (0dB=1mV/cm/s).....	0dB
Channel balance.....	1.1dB
Channel separation (L,R).....	30, 30dB
Tracking ability (L,R).....	80, 78µm
Frequency response from graph, 100Hz-5kHz.....	+1.5, -2dB
Frequency response from graph, 30Hz-20kHz.....	+1.5, -7dB
Stereo Separation L on R 80Hz, 3kHz, 10kHz.....	33, 36, 32dB
Stereo Separation R on L 80Hz, 3kHz, 10kHz.....	36, 39, 33dB
Response limits ref computer mean, 1kHz-15kHz.....	+0, -2dB
Response limits ref computer mean, 1kHz-20kHz.....	+0, -5dB
Test tracking weight, loading.....	1.8g, 150pF
LF resonance frequency, (13.5g arm) (vert, lat).....	.9, 9Hz
Estimated compliance (vert, lat).....	.15, .15cu
Recommended arm effective mass.....	.5-16g
LF resonance rise, (13.5g arm) (vert, lat).....	.14, 16dB
Typical selling price.....	£16

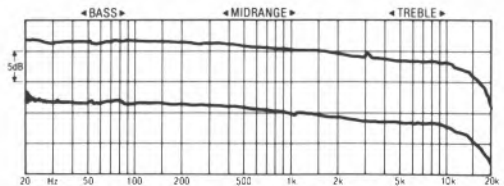

Frequency response, left and right channels

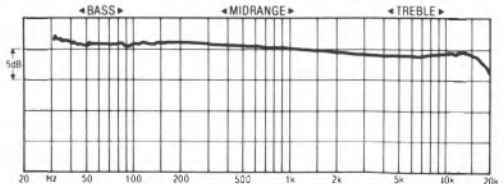

Frequency response with higher load capacitance

Audio-Technica AT115E

Audio-Technica (UK) Ltd, Hunslet Trading Estate, Low Road, Leeds
Tel (0532) 771441

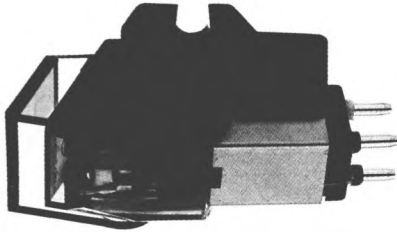

This conventional £25 magnetic cartridge shares generator and LC-OFC wiring with the '105 and '110E. Construction indicates good mechanical rigidity mildly compromised by those half-circle mounting lugs, with a firm stylus assembly fit.

The slightly sharper ellipse stylus profile used in this model suits the reduced tracking pressure, and consequently gives lower tracking ability margins, though these should still be adequate nonetheless.

Compliance is sensible, suiting a wide range of arms, though the highish cartridge mass suggests that medium and high mass arms will provide the better match. Little low frequency resonance damping would suggest that the better class of turntable is to be preferred.

Lab report

Output level is above average, and the responses show that the low capacitance specified does give the flattest response in this instance. However, it is unfortunate that with this stylus the HF resonance occurs half an octave below that of the '110E. Changes in load capacitance produced a fairly mild change in the response.

Though lacking extension, the frequency balance is quite flat. Channel balance was not too impressive, showing significant 1dB discrepancies at high frequencies.

Separation was fair enough considering the price of this model, though below the standard of the '110E nevertheless, which is mildly disappointing.

Sound quality

Described as 'a bit of a thumper', the '115E sounded clear, with quite good detail, but a balance that was a little on the 'heavy' side. Described by one panelist as 'not for the classical buff', this model could well find particular favour amongst rock and reggae enthusiasts. Mild criticism was also directed at the quality of the bass,

described as a little 'slow' and 'sluggish', but the overall sound was regarded as pretty competitive.

Conclusions

While this is an inherently good cartridge design, the balance of different aspects of measured and subjective performance did not seem to have been as finely judged as the cheaper '110E of the same series. The clarity of the well balanced treble may possibly have been assisted by the special LC-OFC coil windings, but the overall 'heavy' character and poorer response and separation than the cheaper model mitigate against recommendation. But for those who want to add a little extra to their bottom end . . .

TEST RESULTS

Type, mass.....	moving magnet 7.2g
Stylus type.....	elliptical
Stylus inspection result.....	simple elliptical
Output Level (1kHz, 5cm/s).....	5.2mV
Relative output (0dB=1mV/cm/s).....	+1.5dB
Channel balance.....	-0.5dB
Channel separation (L,R).....	30, 28dB
Tracking ability (L,R).....	70, 70µm
Frequency response from graph, 100Hz-5kHz.....	+1.5, -1.5dB
Frequency response from graph, 30Hz-20kHz.....	+1.5, -6dB
Stereo Separation L on R 80Hz, 3kHz, 10kHz.....	33, 34, 27dB
Stereo Separation R on L 80Hz, 3kHz, 10kHz.....	33, 32, 25dB
Response limits ref computer mean, 1kHz-15kHz.....	+0.5, -0.5dB
Response limits ref computer mean, 1kHz-20kHz.....	+0.5, -4dB
Test tracking weight, loading.....	1.5g, 150pF
LF resonance frequency, (13.5g arm) (vert, lat).....	9, 9Hz
Estimated compliance (vert, lat).....	15, 15cu
Recommended arm effective mass.....	5-16g
LF resonance rise, (13.5g arm) (vert, lat).....	15, 16dB
Typical selling price.....	£25

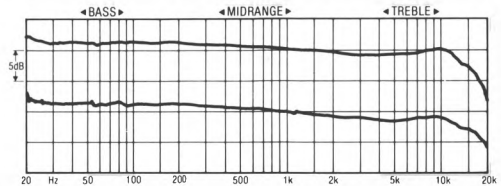

Frequency response, left and right channels

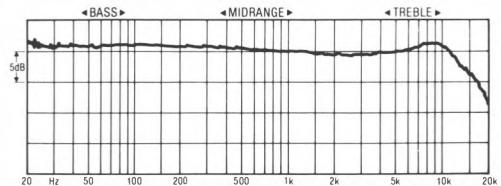

Frequency response with higher load capacitance

RECOMMENDED

Audio-Technica AT3200XE II

Audio-Technica (UK) Ltd, Hunslet Trading Estate, Low Road, Leeds
Tel (0532) 771441

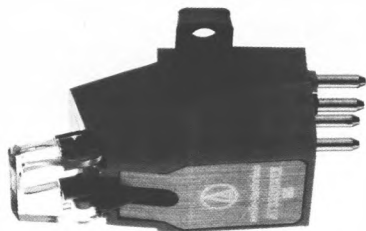

The '3200 XE II' is the latest model in Audio Technica's original series of modestly-priced moving-coil models, following the '30 and '31 but no relation to the pillbox-bodied '32 or '33. None of which makes life any simpler!

This is a high output model, though our computer seemed to become confused and came up with what was presumably a spurious reading indicating a 'mid-output', this was not corroborated in practice. The body is fashioned in a polystyrene regrettably redolent of the unpainted toys which fall out of cereal packets, and the mounting lugs in particular did not feel particularly rigid. In fact the complete generator mechanism can be unplugged from the mounting section, a feature of dubious value which does nothing to preserve mechanical integrity. Furthermore, the mounting plate only contacts the headshell over a comparatively small area.

Sensible and symmetrical compliance ratings suit a wide range of tonearms, while the lack of significant low frequency damping suggests that best results will only be obtained when a respectable quality turntable is being used. Tracking was adequate at a reasonable downforce, though the stylus shape and alignment left something to be desired.

Lab report

Moving coil cartridges, high or low output, are unaffected by pre-amplifier loading differences. The measured response of the '3200 was promisingly even and extended, though significantly downtilted from bass to treble. Inadequate structural rigidity is indicated by the 'glitches' which may be seen at 800Hz and 1200Hz, though the high frequency region looks remarkably well controlled for such a modestly priced m-c design.

Promising results for stereo separation, with an even trend gently reducing either side of the midband, was marred by significant asymmetry

between the channels.

Sound quality

Given that this is perhaps the cheapest moving-coil model generally available, it auditioned better than appearances might have suggested. Results were somewhat inconsistent, but the consensus was only a little below the overall average, which is a more than reasonable result considering the price.

The 'laid back' balance is one notable characteristic, and the ability to convey convincing 'space' was praised. The bass gave good detail and articulation, but could also sound a little 'heavy' and 'detached'. The treble was well controlled, if lacking the fine resolution of some more exotic models.

Conclusions

Sonically the 3200 represents a valiant and at least partly successful attempt to present moving-coil qualities at an affordable price and in a convenient high output form. The mechanical engineering and presentation let it down somewhat, but the generator has become impressively refined after a number of years' development. It faces stiff competition from the best moving magnet designs at the same sort of price, but manages to offer a very credible alternative.

TEST RESULTS

Type, mass.....	high output moving coil 4.3g
Stylus type.....	elliptical
Stylus inspection result.....	indifferent shape/alignment
Output Level (1kHz, 5cm/s).....	0.9mV
Relative output (0dB=1mV/cm/s).....	-13dB
Channel balance.....	0.4dB
Channel separation (L,R).....	30, 24.1dB
Tracking ability (L,R).....	76, 73µm
Frequency response from graph, 100Hz-5kHz.....	+1.5, -2dB
Frequency response from graph, 30Hz-20kHz.....	+1.5, -2dB
Stereo Separation L on R 80Hz, 3kHz, 10kHz.....	32, 52, 39dB
Stereo Separation R on L 80Hz, 3kHz, 10kHz.....	28, 32, 27dB
Response limits ref computer mean, 1kHz-15kHz.....	+1.5, -1.5dB
Response limits ref computer mean, 1kHz-20kHz.....	+1.5, -1.5dB
Test tracking weight, loading.....	1.7g, n.a.pF
LF resonance frequency, (13.5g arm) (vert, lat).....	9, 9Hz
Estimated compliance (vert, lat).....	.18, .18cc
Recommended arm effective mass.....	6.18g
LF resonance rise, (13.5g arm) (vert, lat).....	16, 16dB
Typical selling price.....	£42

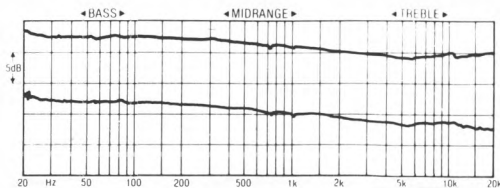

Frequency response, left and right channels

Audio-Technica AT140ML

Audio-Technica (UK) Ltd, Hunslet Trading Estate, Low Road, Leeds
Tel (0532) 771441



The increasing importance of moving-coil models over the past few years has led to a situation where there seem to be precious few £100 moving magnet cartridges on the market, so the AT140ML is a welcome arrival. In many senses it may be seen as a low cost version of the £135 AT160ML (quite favourably reviewed in the last edition), the first to have A-T's LC-OFC (linear crystal) coil windings and their 'ML' ridged' stylus profile.

Though the '140 has more than its fair share of 'hi-tech' features, the body seems less likely than A-T's cheap models to allow really firm mounting in the headshell. That said, the stylus assembly makes a fine rigid and well-located coupling to the bodywork. The stylus itself had an acceptable ridged profile but lacked the stone symmetry which distinguishes the best examples.

Technical performance shows some significant improvements over the older '160 design, notably a more sensibly chosen compliance and reduced body mass. Suitable for use with the majority of separate tonearms, lower mass arms are still to be preferred, the reduced LF damping implies that a good turntable is essential.

Lab report

Output is generous, though there was an unwelcome 0.7dB discrepancy between channels. The recommendation for low capacitance loading still produced a distinctly elevated treble region, with a +2-3dB plateau from 10-18kHz. Increasing the load produced an even more exaggerated response, peaking +4dB at 8-9kHz.

Despite the low tracking weight and reasonable compliance, tracking abilities were fine. The separation data reflects the peaked frequency response, indicating an in-band resonance at high frequencies.

Sound quality

Inevitably the high frequency response aberration featured significantly in the comments of

listeners, though the widespread observation of brightness was not necessarily condemnatory — qualitatively, the treble was liked, though the quantitative by the excess tended to exaggerate surface noise and defects.

Fine stereo space and midrange clarity were praised, but offset by the over-brightness and undistinguished bass reproduction, giving an overall sound which was above average, but more acceptable to some listeners than others.

Conclusions

This cartridge has a number of positive and attractive features which should have a particular appeal to those for whom tracking ability, low coloration and stereo imaging are major priorities. However, the treble elevation in a model competing at this fairly high price is too great to permit recommendation.

TEST RESULTS

Type, mass.....	moving magnet 6.5g
Stylus type.....	microline
Stylus inspection result.....	indifferent profile & stone
Output Level (1kHz, 5cm/s).....	4.7mV
Relative output (0dB=1mV/cm/s).....	+1dB
Channel balance.....	0.7dB
Channel separation (L,R).....	30, 30dB
Tracking ability (L,R).....	80, 80µm
Frequency response from graph, 100Hz-5kHz.....	+1, -0.5dB
Frequency response from graph, 30Hz-20kHz.....	+2, -2dB
Stereo Separation L on R 80Hz, 3kHz, 10kHz.....	31, 35, 24dB
Stereo Separation R on L 80Hz, 3kHz, 10kHz.....	37, 44, 28dB
Response limits ref computer mean, 1kHz-15kHz.....	+3.5, -0dB
Response limits ref computer mean, 1kHz-20kHz.....	+3.5, -0dB
Test tracking weight, loading.....	1.25g, 150pF
LF resonance frequency, (13.5g arm) (vert, lat).....	7, 8Hz
Estimated compliance (vert, lat).....	25, 20cu
Recommended arm effective mass.....	6-12g
LF resonance rise, (13.5g arm) (vert, lat).....	18, 16dB
Typical selling price.....	£96

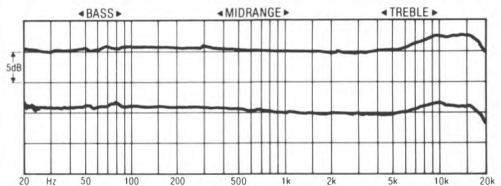

Frequency response, left and right channels

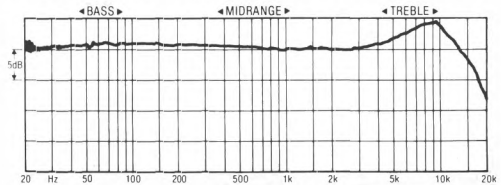

Frequency response with higher load capacitance

Audio Technica AT33ML

Audio Technica UK Ltd, Hunslet Trading Estate, Low Road, Leeds
Tel (0532) 771441

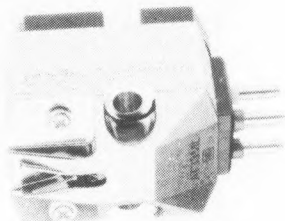

Top model amongst AT's middle range of moving coil cartridges, the low output '33ML is priced at £227 — quite an advance on the £120 asked for the AT32E II, for example. Apart from the Linear Crystal (LC) internal wiring, now used by AT throughout the range, the '33ML also features a beautifully executed MicroLine 'ridged' stylus profile. The longish cantilever is gold plated beryllium tubing.

The body is rather bulky but beautifully (or maybe garishly) finished, using plastic and alloy, and can be firmly and closely mounted in the headshell. Compliance was moderate and lightly damped, suggesting a preference for lowish arm masses.

Lab report

Output level was substantial compared to most low output models, and is probably sufficient to drive some moving magnet input stages, though a proper high gain input is to be preferred.

Fitting a 3dB window across the bandwidth, the frequency response was fairly smooth but dominated by a 2dB peak at 12kHz, which is certainly low enough to be clearly audible. Though absolute channel balance was poor on our sample, the much more important channel matching was very close. The traces were quite smooth, but not without a slight ripple at fast writing speed particularly at high frequencies.

Separation figures were generally reasonable, though slightly asymmetric and far from spectacular considering the price. Some ultrasonic spurious were produced, but tracking was excellent.

Sound quality

The '33ML was an odd mixture, because in part it reflects characteristics of the range from which it comes, yet the additional high-tech design input was also clearly audible. The

result is quite a nice blend, strong on excitement and energy, if a little lacking in control, with fine mid focus, reasonable stereo depth, a marginally 'fat' bass, and slightly 'overblown' top. Though somewhat distracting and inclined to emphasise sibilants and surface noise, the treble was very clear and the dynamic range was most impressive.

Conclusions

Deserving commendation for the sheer gusto of its performance, the '33ML provides good ammunition to support the claims that LC wiring provides improved sound quality. At the same time the 'untidiness' suggests that certain aspects of the design could be better balanced.

Recommended in the last issue, the '33ML has since suffered a substantial price increase, but is still worth considering.

TEST RESULTS

Type, mass.....	low output moving-coil 6.8g
Stylus type.....	ML
Stylus inspection result.....	small square long shank with ridged line contact
Output Level (1kHz, 5cm/s).....	0.47mV
Relative output (0dB = 1mV/cm/s).....	-17dB
Channel balance.....	0.0dB
Channel separation (L,R).....	25.2, 27.7dB
Tracking ability (L,R).....	80, 80µm
Frequency response limits 100Hz-5kHz.....	+1, -0.5dB
Frequency response limits 30Hz-20kHz.....	+1, -2dB
Stereo Separation L on R 100Hz, 3kHz, 10kHz.....	22, 29, 32dB
Stereo Separation R on L 100Hz, 3kHz, 10kHz.....	31, 27, 23dB
Channel diff. from graph, 100Hz, 1kHz, 10kHz.....	1, 1, 1.5dB
Response limits ref computer mean, 1kHz-15kHz.....	+1, -0dB
Response limits ref computer mean, 1kHz-20kHz.....	+1.5, -0dB
Test tracking weight, loading.....	1.5g, n.a.
LF resonance frequency, 12.5g arm (vert, lat).....	9, 9Hz
Estimated compliance (vert, lat).....	16, 16cu
Recommended arm effective mass.....	6-15g
LF resonance rise, 12.5g arm (vert, lat).....	14, 13dB
Typical selling price.....	£227

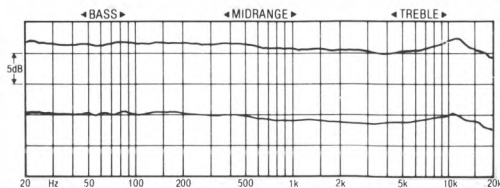

Frequency response, left and right channels

Audionote 102vdH

Audio By Design Ltd, Unit 8, Dyke Road Mews, 74/76 Dyke Road, Brighton BN1 3JD
Tel: (0273) 203277

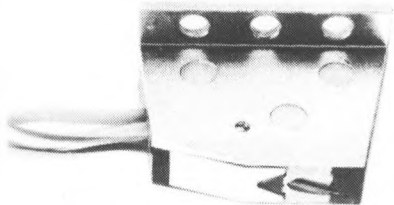

Possibly the most fascinating, certainly the most expensive cartridge tested for the 1984 edition, the van den Hul-tipped *IO2* is now available in the UK via a new distributor, Audio By Design. The cartridge itself is now priced at £695, while a package including a suitable step-up transformer now costs about £975. The *IO2* has internal silver wiring and comes with flying leads for attachment to the arm, the intention being that this should also ideally be silver-wired.

The *IO2* is also twice the weight of any of the opposition, 18g no less, and built to give new meaning to the term rigidity, with four headshell screws to boot. However, compliance is very low, so it suits a wide range of medium and high mass arms. Some asymmetry was apparent in the compliance, with notably heavy damping in the vertical plane.

Lab report

Output is very low (-28dB), so the matching (low impedance) transformer will often be needed, though we found Naim moving-coil boards just about usable directly. Experimenting with different loadings showed that reducing the impedance or adding the transformer seemed to cut down the detail, but also reduced the slightly obtrusive treble,

Frequency response was pretty impressive, albeit with a 3dB downtilt across the band through the midrange, and mild recovery above 6kHz. Channel balance was very good, though with minor departures at the frequency extremes. The trace was smooth through the midband, but uneven below 50Hz on one channel.

Separation was disappointingly asymmetric, but at the same time highly impressive in some respects, especially at low and mid frequencies. Tracking abilities seemed reasonable, particularly in view of the compliance, though there is not much in reserve for difficult discs.

Sound quality

Going some way towards justifying its extravagant price, the *IO2* vdH was obviously one of the very best, and was particularly liked for an extraordinarily relaxing midrange clarity, giving plenty of 'space' around instruments.

Notably clean in the upper bass, it reacted extremely well to panel speakers, and sounded thoroughly romantic via its transformer. Used directly into dynamic speakers the low bass was a bit 'rich' and the extreme top a trifle obvious — detailed, but exaggerating surface noise a little. It was a trifle prone to dust clogging, so records need to be kept clean. Not quite the 'fastest' cartridge, it was always one of the most listenable, though it certainly requires careful system and arm matching.

Conclusions

Very much the sort of product with which one enters into an emotional relationship, it is not for the fainthearted who prefer to fit and forget. Nevertheless it has some unique strengths which may well charm the dedicated enthusiast, and definitely represents one variation on the current state of the art.

TEST RESULTS

Type, mass.....	low output moving coil 18g
Stylus type.....	van den Hul
Stylus inspection result.....	confirmed, superb mounting
Output Level (1kHz, 5cm/s).....	0.03mV
Relative output (0dB = 1mV/cm/s).....	-29dB
Channel balance.....	—
Channel separation (L,R).....	—
Tracking ability (L,R).....	—
Frequency response limits 100Hz-5Hz.....	+1.5, -1.5dB
Frequency response limits 30Hz-20kHz.....	+2, -1.5dB
Stereo Separation L on R 100Hz, 3kHz, 10kHz.....	50 +, 26, 20dB
Stereo Separation R on L 100Hz, 3kHz, 10kHz.....	30, 20, 15dB
Channel diff. from graph, 100Hz, 1kHz, 10kHz.....	0, 0, 0dB
Response limits ref computer mean, 1kHz-15kHz.....	—
Response limits ref computer mean, 1kHz-20kHz.....	—
Test tracking weight, loading.....	2g, n.a.
LF resonance frequency, 12.5g arm (vert, lat).....	12, 10Hz
Estimated compliance (vert, lat).....	6, 14cu
Recommended arm effective mass.....	8-18g
LF resonance rise, 12.5g arm (vert, lat).....	8, 13dB
Typical selling price.....	£695

**requires special transformer, supplied as an extra*

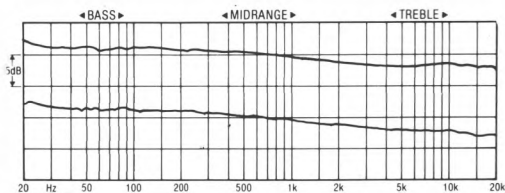

Frequency response, left and right channels

BEST BUY

Bang & Olufsen MMC4

Bang & Olufsen (UK) Ltd, Eastbrook Road, Gloucester GL4 7DE
Tel (0452) 21591

Selected to represent the lower end of the B&O range, this cartridge slots neatly into the hierarchy of five models, which share a common adaptor to provide compatibility with B&O's turntables and their super-light arms.

The cartridge itself is a little miracle of engineering miniaturisation, though the adaptor is slightly flexible and the connection only push-fit. The whole weighs a mere 3.3g, tracks at a low 1.2g, using a tapered aluminium cantilever fitted with a small titanium-bonded elliptical tip, which examination suggested was a little short on polish.

Compliance needs to be high enough to match B&O's own arms, yet is still low enough (with the low cartridge mass) to allow a reasonable range of low-medium mass arms to be used.

Lab report

Output level is rather below average, but this almost certainly only means that users will have the luxury of a wider volume control range! The change in measured response with increased capacitance was very marginal, but the sound was slightly preferred.

Response is most impressive, showing the usual gently falling trace, with a mild recovery to a well-damped resonance at around 10kHz. Channel balance was fine. Much of the class of this cartridge can be gleaned from the remarkably smooth trace even at high writing speed, but the Achilles heel of the adaptor resonance is shown clearly at 900Hz, similar to though less severe (and at a higher frequency) than those encountered with P-mount cartridges, but subjectively significant nonetheless.

Despite the low cost of this model, fine results were obtained for separation, particularly in the midband, bettering 30dB over most of the range. Tracking was (inevitably) impressively secure throughout.

Sound quality

There is a close family resemblance throughout the B&O range. All are handicapped by slight softening and blurring at low frequencies, which gives a relaxed rather than 'punchy' presentation, with fine control.

The '4' was picked out for its particular solidity and overall balance, which seemed remarkably 'seamless' for the price. Midrange clarity, dynamics and focus are excellent, giving fine stereo imaging. The treble is well balanced and controlled for the price, though a touch unrefined. Stability was impressive and surface noise was well under control.

Conclusions

The general standard attained by the B&Os transcends their modest price level, and does much to reinforce their claim that moving magnets sound as good as moving-coils. The mounting bracket problem keeps them from the top class, but its sonic significance will depend on the relative importance the listener attaches to powerful integrated bass.

The level of engineering expertise demonstrated in other respects is mildly awe-inspiring, and an added bonus is the relatively easy time given to the tonearm by such light-tracking cartridges.

TEST RESULTS

Type, mass.....	moving magnet 3.3g
Stylus type.....	elliptical
Stylus inspection result.....	short squat brazed elliptical, little polish
Output Level (1kHz, 5cm/s).....	2.55mV
Relative output (0dB = 1mV/cm/s).....	-4dB
Channel balance.....	0.05dB
Channel separation (L, R).....	30, 30dB
Tracking ability (L, R).....	80, 80µm
Frequency response limits 100Hz-5Hz.....	+1, -1.5dB
Frequency response limits 30Hz-20kHz.....	+1, -3dB
Stereo Separation L on R 100Hz, 3kHz, 10kHz.....	30, 38, 27dB
Stereo Separation R on L 100Hz, 3kHz, 10kHz.....	26, 39, 26dB
Channel diff. from graph, 100Hz, 1kHz, 10kHz.....	0.5, 1, 0.5dB
Response limits ref computer mean, 1kHz-15kHz.....	+0, -1dB
Response limits ref computer mean, 1kHz-20kHz.....	+2, -1dB
Test tracking weight, loading.....	1.2g, 200pF
LF resonance frequency, 12.5g arm (vert, lat).....	9, 9Hz
Estimated compliance (vert, lat).....	24, 24cu
Recommended arm effective mass.....	5-15g
LF resonance rise, 12.5g arm (vert, lat).....	15, 12dB
Typical selling price.....	£25

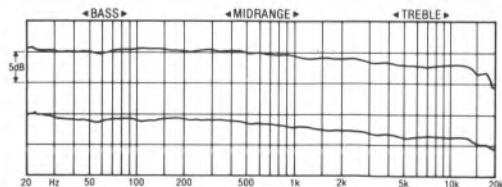

Frequency response, left and right channels

Bang & Olufsen MMC1

Bang & Olufsen (UK) Ltd, Eastbrook Road, Gloucester GL4 7DE
Tel (0452) 21591

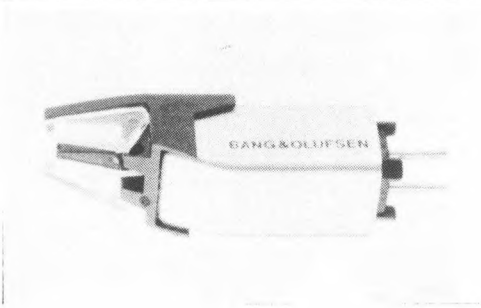

With the top-of-the range *MMC1*, B&O throw all their advanced technology into a miniature cartridge with jewelled cantilever and tiny diamond tip with exquisite line-contact profile (but with a sensible shank long enough to avoid too much dust collection). Regrettably again we have the plug-in adaptor, though the overall mass is still low, and downforce a superlight 1g.

Compliance is pretty sensible, considering it has to accommodate B&O's own ultra-low-mass arms, though 13g arm effective mass represents the top limit for safety.

Lab report

Output is a little on the low side, but should be sufficient for the great majority of amplifier moving magnet inputs. Though specified and measured as insensitive to capacitance loading changes, in fact we found low capacitance inputs substantially superior subjectively.

Response and channel balance were exemplary, save for the 900Hz 'glitch' we attribute to the mounting adaptor. That apart the trace was pretty smooth, gently falling 4-5dB across the band with exemplary high frequency control.

Stereo separation was likewise reference-standard stuff, with outstanding figures throughout the band, and no compromise at high frequencies. Groove stability was decent and tracking ability fine, despite the low downforce, though the cartridge as a whole was rather microphonic.

Sound quality

The extraordinary clarity and detail at high frequencies are almost sufficient to rate this amongst the very top cartridges, and will be sufficient and convincing reason for many purchasers. But one does notice the treble,

inasmuch as it somehow draws attention to itself, while the bass plods along a bit, almost as an afterthought. Focus, midrange dynamics, and stereo imaging were of the highest order.

Conclusions

Probably deserving recommendation for its strengths, the *MMC1* also deserves a better adaptor. (Perhaps GB Engineering can be persuaded to make a clamp, or Mission a special 774 wand!) Even as it stands it is a very satisfying cartridge, possibly with greater appeal to the classical than rock listener. Meanwhile the enthusiast prepared to chance his delicate stylus assembly and start messing around with Superglue and Araldite could well find himself with a true audiophile cartridge on the cheap.

TEST RESULTS

Type, mass.....	moving magnet 3.3g
Stylus type.....	small nude 'line'
Stylus inspection result.....	fine, tiny, long 'pegged' line contact
Output Level (1kHz, 5cm/s).....	2.75mV
Relative output (0dB = 1mV/cm/s).....	- 2dB
Channel balance.....	0.4dB
Channel separation (L,R).....	30, 30dB
Tracking ability (L,R).....	80, 80µm
Frequency response limits 100Hz-5Hz.....	+ 1, - 1.5dB
Frequency response limits 30Hz-20kHz.....	+ 1, - 4dB
Stereo Separation L on R 100Hz, 3kHz, 10kHz.....	29, 38, 32dB
Stereo Separation R on L 100Hz, 3kHz, 10kHz.....	33, 48, 34dB
Channel diff. from graph, 100Hz, 1kHz, 10kHz.....	0.5, 0.5, 0dB
Response limits ref computer mean, 1kHz-15kHz.....	+ 0, - 3dB
Response limits ref computer mean, 1kHz-20kHz.....	+ 2, - 3dB
Test tracking weight, loading.....	1g, 200pF
LF resonance frequency, 12.5g arm (vert, lat).....	9, 8Hz
Estimated compliance (vert, lat).....	24, 21cu
Recommended arm effective mass.....	5-13g
LF resonance rise, 12.5g arm (vert, lat).....	13, 12dB
Typical selling price.....	£95

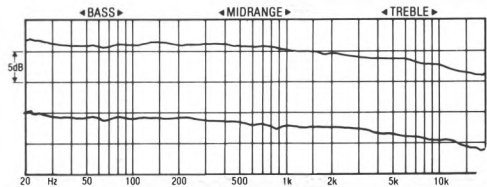

Frequency response, left and right channels

109-113 London Road
SEVENOAKS Kent
 ☎ (0732) 459555

162 Powis Street Woolwich
ONDON SE 18
 ☎ (01) 855 8016

34 Mount Ephraim
TUNBRIDGE WELLS
 ☎ (0892) 31543 Kent



SEVENOAKS HI-FI + VIDEO

If you can buy cheaper elsewhere, tell us - we want to know!

ALL BRANCHES CLOSED WEDNESDAY

4 Railway Street
CHATHAM Kent
 ☎ (0634) 46859

55 Preston Street
BRIGHTON Sussex
 ☎ (0273) 733338

51 Beckenham Road
BECKENHAM Kent
 ☎ (01) 658 3450

Amplifiers

A & R Alpha	£129.95
A & R A60	£199.95
AR THE AMP	£189.95
Cyrus One	£139.95
Cyrus Two	£259.95
Denon PMA717	£189.95
Nad D20	£99.95
Nad 2155	£209.95
Nad 3120	£119.95
Nad 3020B	£139.95
Nad 2150poweramp	£159.95
Nad 3155	£249.95
Nad 1155preamp	£179.95
Nad 2200poweramp	£339.95
Proton P520	£159.95
Proton D540	£239.95
Quad 341/405/2150	P.O.A.
QED	£99.95
Roler RA820	£109.95
Roler RA820B	£139.95
Roler RA840	£169.95
Roler RA840B	£179.95
Roler RA870	£285.95
Sansui AG55X	£249.95
Sansui AUC115	£108.95
Sansui AUC33X	£189.95
Technics Super Quoties	P.O.A.
Trio KA74	£99.95
Trio KA77	£129.95
Yamaha A07	£109.95
Yamaha A30	£89.95
Yamaha A420	£139.95
Yamaha A520	£189.95

Tuners

A & R T21	£199.95
Cyrus Tuner	£199.95
Denon TU17	£89.95
Denon TU10	£109.95
Hitachi FT5500 II	£229.95
Nad A15	£229.95
Nad A020B	£139.95
Pioneer F99X	£199.95
Proton P420	£119.95
Proton P440	£189.95
Quad FM4	P.O.A.
Roler R1820	£79.95
Roler R1830	£109.95
Roler R1850	£139.95
Sansui TU033XL	£109.95
Sansui TU099XL	£139.95
Trio K154L	£99.95
Yamaha T30	£89.95
Yamaha T520	£139.95

Compact Disc Players

Buy your player this month and claim

£30 worth of **FREE DISCS** (except *)

EXTRA SPECIAL OFFER:
 Marantz CD54 Gold ★
 rated "Best Buy"
 free only at £219.95

AWA DX1200	£379.95
Axa CDA 7L *	£399.95
Axa CDMBE *	£399.95
Denon DCD1000	£249.95
Denon DCD1500	£299.95
Denon DCD1600	£399.95
Marantz CD45B	£229.95
Marantz CD 74 *	£279.95
Marantz CD84 *	£319.95
Mission DAD 7000 R	£449.95
Nakamichi	P.O.A.
Philips CD104 *	£239.95
Philips CD150 *	£279.95
Philips CD304 *	£329.95
Philips CD350 *	£399.95
Philips DD500 *	£429.95
Pioneer PD610	£299.95
Pioneer PD7010	£349.95
Pioneer PD8010	£279.95
Pioneer PD5010 *	£239.95
Sansui PCV750	£299.95
Sansui PCV100	£289.95
Sony CD P30 *	£289.95
Sony CD P70	£299.95
Sony CD P102 *	£359.95
Sony CD P302 *	£449.95
Sony CD P502 *	£629.95
Technics SLP 11K	£279.95
Technics SLP3K	£449.95
Technics SLP2K	£399.95
Technics SLP1K	£349.95
Trio DP770	£229.95
Trio DP840	£279.95
Trio DP700	£329.95
Trio DP800	£299.95
Yamaha CD X2 *	£249.95
Yamaha CD3	£349.95

Tuner Amps

Nad 7125	£239.95
Nad 7140	£339.95
Nad 7155	£389.95
Yamaha RJ3	£179.95

Turntables

Acoustic Research/AR	£189.95
Acoustic Research LX	£209.95
Acoustic Research EB101	£189.95
Dual CS505/2	£94.95
Dual CS505/2 deluxe	£109.95
Dual CS505/2	£59.95
Mission T75LCT	£59.95
Nad 1520	£99.95
Qak	£99.95
Pink Triangle	£399.95
QED T21	£129.95
Roler RP830	£179.95
Roler RP850	£199.95
Sansui SR22V	£129.95
Systemdek IX	P.O.A.
Systemdek IX electronic	£125.95
Thorens TD166	£129.95
Thorens TD116	£129.95
Thorens TD318	£239.95
Thorens TD321	£199.95
Thorens TD311LVX	£214.95
Thorens TD321LVX	£277.95

Cassette Decks

Axa Cassette Decks★ "hard to beat" prices thru month	P.O.A.
Denon DR171	£134.95
Denon DR181	£179.95
Denon DR182	£244.95
Denon DRM33HX	£289.95
Denon DRM34HX	£349.95
Dual C808	£124.95
Nad 5130	£119.95
Nad 5050C	£159.95
Nakamichi CBX150	£239.95
Nakamichi RX202	£249.95
Nabamichi - very portable when you buy from us!	£124.95
Pioneer CT1060W	£134.95
Proton P720	£169.95
Roler RD30	£124.95
Trio KX54	£99.95
Yamaha K220	£119.95
Yamaha K320	£149.95
Yamaha K420	£169.95

Video HiFi

Ferguson V148	£549.95
Ferguson V143	£509.95
JVC HR755	£539.95
JVC HR775	£539.95
Panasonic NV810	£649.95
Spesonic N V870	

Rogers LS3/5A	£239.95
Rogers LS30	£209.95
Rogers LS7	£214.95
Rogers Studio 11	£239.95
Rolli R50	£199.95
Spendor Prelude	£245.95
Spendor S P1	£540.95
Spendor S P2	£380.95
Tannoy Triam	£39.95
Tannoy Mercury	£145.95
Tannoy M20 Gold	£199.95
Tannoy Venus	£240.95
Wharfedale Diamond II *	£84.95
Wharfedale 506	£119.95
Wharfedale 508	£159.95
Wharfedale 708	£299.95

Speakers

Present this advert to claim free stands and 6 metres OED Cable with all Loudspeakers listed below except (*) Suggested Systems excluded)

ARBX	£79.95
AR18B	£99.95
AR28B	£129.95
AR33B	£199.95
AR Arcam 200	£189.95
Boston A40	£99.95
B & W DM110	£119.95
B & W DM220	£199.95
Celestion DL4	£99.95
Celestion DL6	£129.95
Celestion DL8	£179.95
Celestion SL6	£279.95
Haybrook H16	£139.95
Haybrook HB2	£189.95
JPW P1	£99.95
JPW P2	£119.95
Kel Coda II *	£199.95
Kel C New Series	P.O.A.
Kel R103 2	£299.95
Kel R104 2	£299.95
Kel R105 2	£899.95
Mission 70H	£99.95
Mission 70L	£119.95
Mission 70T	£149.95
Mission 737 R	£199.95
Mission 770 F	£379.95
Mission 780 A	£599.95
Monitor Audio R100	£109.95
Monitor Audio R25v	£129.95
Monitor Audio R32	£199.95
Monitor Audio R700	£249.95
Monitor Audio R850	£299.95
Monitor Audio R552	£344.95
MordenShort MS10	£79.95
MordenShort MS15	£129.95
MordenShort MS40	£199.95
MordenShort MS100	£159.95
MordenShort MS300	£299.95
Quad EL83	£249.95
Rogers LS2	£154.95

Midi Systems

Awa V850 (ex)	£449.95
Awa V850 (ex)	£449.95
Awa V800 (ex)	£449.95
Awa V800 (ex)	£449.95
Awa V250 (ex)	£349.95
Awa V200 (ex)	£299.95
Awa V150 (ex)	£249.95
Awa V100 (ex)	£299.95
JVC X3	£109.95
JVC X20	£429.95
Pioneer S110	£349.95
Pioneer S330	£349.95
Pioneer S550	£489.95
Pioneer S770	£759.95
Sony Super Quoties	P.O.A.
Technics Super Quoties	P.O.A.
Trio M3 C *	£449.95

Speakers included unless stated

Specials

Ahai GR55	£179.95
CS 505/1	£89.95
JVC S50 System	£649.95
Marantz CD83B	£199.95
Marantz CD54	£249.95
Nad 3150	£179.95
Pioneer In-Car	P.O.A.
Pink Triangle SH	£299.95
Sinclair Spectrum +	£99.95

Prices include VAT and were correct at time of preparation (approximately 5 weeks before publication) but are subject to change without notice. E & O

Each component has been acclaimed "Best Buy" in the UK Hi-Fi Press, and as a system offers unbeatable value for money.

This is an unrepeatable chance to purchase an excellent quality hi-fi at a bargain price.

Dual CSS05-2
TURNTABLE
 (deluxe extra £20)

£244.95
 inc. Cartridge & leads



JPW P1 or
 Celestion DLA
 SPEAKERS

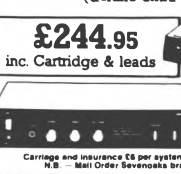

Carriage and insurance £6 per system UK mainland
 N.B. - Mail Order Sevenoaks branch only



Rotel RA820
 AMPLIFIER

Mail order to Sevenoaks Hi-Fi, 109/113 London Rd, Sevenoaks, Kent. 0732 459555

Please send me _____

I enclose cheque/cash/card no. including p. & p.

Name _____

Address _____

All goods fully insured against loss or damage in transit. Please allow up to 10 days for delivery, although it should normally be much less. Carriage & Insurance Extra UK mainland N.B. - Mail Order Sevenoaks branch only

Decca London Blue and London Gold

Presence Audio, Eastland House, Plummers Plain, Horsham, West Sussex RH13 6NY
Tel (044 485) 333

RECOMMENDED

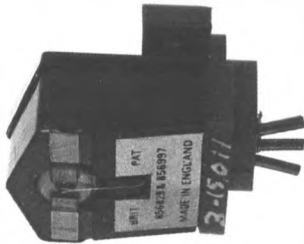

Defying comparison with other cartridges, the Decca is a throwback to the days when record companies carried out much of the technical development. Some regard it merely as a curious British anachronism that can't possibly work. But Decca enthusiasts will contend that it can spit contemptuously on any rivals.

The 'moving-iron' generator with no conventional cantilever, is completely undamped and has wildly differing vertical and horizontal compliances which would suggest there isn't an arm on the market which is really suitable; in practice the more substantial tonearms seem to work best, and some form of damping can be a boon.

Lab report

All Deccas possess steep low frequency rise due to the high Q vertical resonance at around 20Hz; this can add some excess 'weight'. Response from the mid bass up to the lower treble (5kHz) is then remarkably flat, if marred by the mounting bracket decoupling effect at around 350Hz. The main treble resonance around 8kHz is surely the most dominant subjective factor, after which the various models (and samples) tend to do their own thing.

In fact our samples held quite close limits at high frequencies, though the elliptical-tipped *Gold* seemed less smooth than the spherical *Blue* (illustrated). Separation was quite reasonable. There was some tracking uncertainty, particularly on heavy bass transients and sometimes at high frequencies.

Sound quality

The Deccas' unique strength is the sheer 'speed' and dynamics of the midrange, which makes even its most exotic rivals sound comparatively ponderous and 'smeared'. This tremendous 'attack', and the equally impressive notable lack of 'overhang', further spotlighted by the 8kHz resonance, does however tend to leave low bass and high treble sounding like something of an afterthought.

Criticism was made of the mild tracking uncertainty, some midrange coloration and flattening of stereo perspectives, and some exaggeration of surface noise (particularly with the *Gold*), but both models ended up towards the top of panellist's preferences nonetheless.

Conclusions

Deccas seem to look the same but manage to sound better year by year. It is likely that their undamped *modus operandum* reaps increased benefits with the steady improvement in turntables and tonearms.

Despite reservations regarding consistency, fragility and the possibility of record wear due to the stiff vertical compliance, the Deccas' main strength demands recognition. The *Blue* offers exotic performance at a down-to-earth price, and so deserves warm recommendation for those prepared to live with the idiosyncracies.

TEST RESULTS: Decca London Blue

Type, mass.....	moving iron (eff. magnet) 6.7g
Stylus type.....	spherical
Stylus inspection result.....	neat spherical tip
Output Level (1kHz, 5cm/s).....	5.5mV
Relative output (0dB=1mV/cm/s).....	+3dB
Channel balance.....	1.2dB
Channel separation (L,R).....	17, 24dB
Tracking ability (L,R).....	80, 80µm
Frequency response from graph, 100Hz-5kHz.....	+0.5, -0.5dB
Frequency response from graph, 30Hz-20kHz.....	+5, -3dB
Stereo Separation L on R 80Hz, 3kHz, 10kHz.....	25, 26, 21dB
Stereo Separation R on L 80Hz, 3kHz, 10kHz.....	30, 35, 17dB
Response limits ref computer mean, 1kHz-15kHz.....	+3, -0dB
Response limits ref computer mean, 1kHz-20kHz.....	+7, -0dB
Test tracking weight, loading.....	2g, n.a.p.F
LF resonance frequency, (13.5g arm) (vert, lat).....	18, 11Hz
Estimated compliance (vert, lat).....	3.5, 10cu
Recommended arm effective mass.....	see text 8-20g
LF resonance rise, (13.5g arm) (vert, lat).....	25dB
Typical selling price.....	£80 (Gold £138)

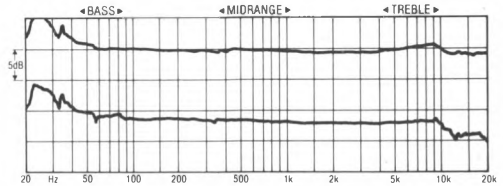

Frequency response, left and right channels ('Blue')

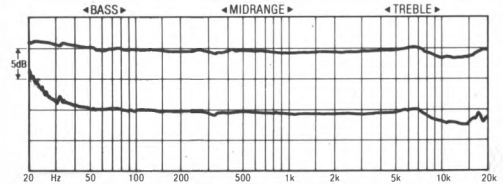

Frequency response, left and right ('Gold')

RECOMMENDED

Decca Super Gold

Presence Audio, Eastland House, Plummers Plain, Horsham, West Sussex RH13 6NY
Tel (044 485) 333



Similar to other Deccas at first sight, close inspection shows that the underside of £250 *Super Gold* body has been chamfered to give a slightly less blunt shape. Closer inspection still revealed a high quality van den Hul stylus.

The classic Decca asymmetric compliance characteristics make arm matching a trifle uncertain, our advice being to avoid the flimsier lightweight models and go for some arm damping if possible. (The skittish behaviour on a suspended subchassis turntable is completely removed with the trough-equipped *Elite Rock* to the point that the combination could be used in a discotheque!)

Marginally increased compliance on the *Super Gold* gives tracking abilities that are quite adequate at a fairly modest 1.6g downforce. Changes in pre-amp capacitance loading has no influence on this 'moving iron' design.

Lab report

Following the same response pattern as all Deccas, our *Super Gold* sample was even flatter in the vital midband from 100Hz to 5kHz. The effect of the mounting bracket seemed minimal in this instance, while the treble resonance was well controlled, but at a slightly lower frequency than the *London* models, around 5.5kHz. The final two octaves showed fine control and channel matching, though distinctly 'bright'.

The past tendency for Deccas to produce substantial ultrasonic spurious seemed somewhat ameliorated, as distortion and crosstalk products were held below -15dB throughout the high frequency region. Separation measurements were acceptable enough by Decca standards.

Sound quality

In a typical display of temperament, the *Super Gold* declined to make proper contact in its mounting block, so the 'blind' listening test had to be aborted. The consistent results obtained for

the *Londons* and careful comparative listening later showed that the *Super Gold* is a very worthwhile refinement of the cheaper models' strengths, but with its own distinct character.

Sounding decidedly 'bright' in balance, more perhaps than might be suspected from the measurements, the *Super Gold* could sound a little 'fierce' and tended to emphasise record surface faults and tape hiss. However, treble detail was exceptionally fine where the cheaper models could sound a little coarse.

Traditional virtues of dramatic 'speed' and lack of 'overhang' were fully — even exaggeratedly — on display, while some coloration was evident and stereo imaging seemed precise but somewhat 'up-front', with reduced depth.

Conclusions

There is probably no cartridge more capable of revealing the excitement and tension of musical performance than the *Super Gold*, though it is kind neither to record and recording defects nor surfaces. Capable of inducing the fiercest and most loyal love/hate relationships in audio, the top Decca is not for the fainthearted. For those who take the trouble to persevere in optimising a system, possibly involving some modification of mounting and body damping, the rewards can be considerable.

TEST RESULTS

Type, mass.....	moving iron (eff. magnet) 6.7g
Stylus type.....	van den Hul
Stylus inspection result.....	fine vdH confirmed
Output Level (1kHz, 5cm/s).....	3.6mV
Relative output (0dB=1mV/cm/s).....	-1dB
Channel balance.....	0.3dB
Channel separation (L,R).....	20, 25dB
Tracking ability (L,R).....	80, 80µm
Frequency response from graph, 100Hz-5kHz.....	+0.5, -0dB
Frequency response from graph, 30Hz-20kHz.....	+2.5, -1dB
Stereo Separation L on R 80Hz, 3kHz, 10kHz.....	22, 21, 21dB
Stereo Separation R on L 80Hz, 3kHz, 10kHz.....	27, 25, 21dB
Response limits ref computer mean, 1kHz-15kHz.....	+2, -1dB
Response limits ref computer mean, 1kHz-20kHz.....	+7, -1dB
Test tracking weight, loading.....	1.6g, n.a.p.F
LF resonance frequency, (13.5g arm) (vert, lat).....	17, 6Hz*
Estimated compliance (vert, lat).....	complex: 4, 30cu*
Recommended arm effective mass.....	complex: 8.20g*
LF resonance rise, (13.5g arm) (vert, lat).....	14, 19dB
Typical selling price.....	£248

*see text

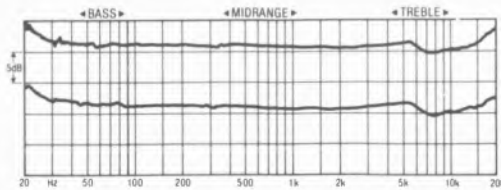

Frequency response, left and right channels

Decca Garrott

Parabolic Stylus Co, PO Box 38, Torquay TQ1 1DW
Tel (0803) 26791

RECOMMENDED

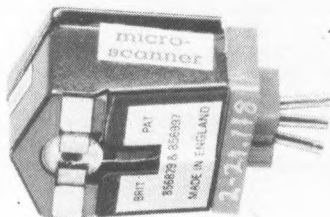

Though Deccas are again available in the UK, the 'Microscanner' version, modified in Australia by the Garrott Brothers, has built a strong reputation among UK audiophiles, and a special clamp made by GB Engineering is included in this very non-standard £325 package.

There is no conventional cantilever, merely a tie-wire holding the vertical moving-iron element with its attached tiny line-contact stylus. The body is thin and of quite flexible metal, so the clamp cannot be tightened hard, nor should it be fixed too firmly in the headshell. Compliance is totally undamped and quite dissimilar in the two planes, so arm and turntable matching is a little unpredictable, with the traditional recommendation for a damped rigid unipivot arm of quite high mass still relevant, while tracking weight is a low 1.3g.

Lab report

Output is more or less sufficient, and the cartridge is insensitive to capacitance; some enthusiasts prefer to load it with lower than standard impedance.

Frequency response is remarkably flat from 100Hz to 5kHz, above which there is some mild untidiness but little of which to complain. Channel balance is very close. Generally very clean, the series of short 'glitches' around 2kHz relate to the suspension tie.

Separation figures are very mediocre, which says as much about the meaningfulness of this measurement than anything else! Tracking tended to be a bit 'edgy', but serious mistracking was in fact rarely encountered.

Sound quality

The midrange clarity and dynamics of this cartridge are so startling that one easily ignores its less impressive characteristics.

Across the broad central band of the response it provides such extraordinary speed of reaction, lack of 'hangover' and signal integrity that one is reminded of electrostatic and horn loudspeakers. There is some coloration here to be sure, and an occasional intimation that things are slightly exaggerated, but the stereo focus and aliveness can be breathtaking.

That said, the treble is a trifle uncomfortable and 'fierce', bass lacks power and energy, and low bass seems almost absent. Surfaces themselves seem extraordinarily quiet, but imperfections are ruthlessly revealed by the rapid rise time. Groove stability and handling sensitivity are the pits!

Conclusions

This is not a cartridge for the casual; it demands as much as it delivers, and can be as tiresome as it can be rewarding. But the enthusiast who encounters the Garrott Decca will have to face two questions. The first is whether or not he can live with its various vicissitudes; the second is whether he can possibly live without it! I'll use mine Mondays to Fridays when there's an R in the month.

TEST RESULTS

Type, mass.....moving iron (high output) 9 including clamp	
Stylus type.....	Garrott Microscanner
Stylus inspection result.....	fine-line profile on tiny rod
Output Level (1kHz, 5cm/s).....	—
Relative output (0dB = 1mV/cm/s).....	—
Channel balance.....	—
Channel separation (L,R).....	—
Tracking ability (L,R).....	—
Frequency response limits 100Hz-5Hz.....	+ 0.5, - 0dB
Frequency response limits 30Hz-20kHz.....	+ 1, - 0.5dB
Stereo Separation L on R 100Hz, 3kHz, 10kHz.....	18, 19, 11dB
Stereo Separation R on L 100Hz, 3kHz, 10kHz.....	21, 22, 12dB
Channel diff. from graph, 100Hz, 1kHz, 10kHz.....	0, 0, 0dB
Response limits ref computer mean, 1kHz-15kHz.....	—
Response limits ref computer mean, 1kHz-20kHz.....	—
Test tracking weight, loading.....	1.3g, n.a.
LF resonance frequency, 12.5g arm (vert, lat).....	12, 6Hz
Estimated compliance (vert, lat).....	.8, 30cu
Recommended arm effective mass.....	8-16g*
LF resonance rise, 12.5g arm (vert, lat).....	both very severe
Typical selling price.....	£325

*some arm damping may be tried if available

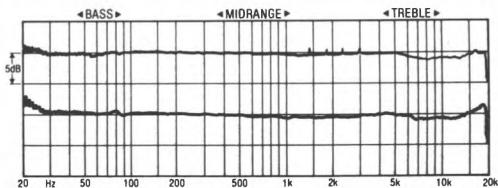

Frequency response, left and right channels

Denon 103

Hayden Laboratories, Hayden House, Chiltem Hill, Chalfont St Peter, Bucks
Tel (0753) 888447

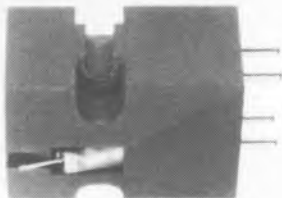

One of the oldest models still in current production, the 103 is the low output moving-coil model which Denon made originally for NHK, the Japanese equivalent of the BBC, and which definitely made a major contribution towards the revival of the genre. Price has been held through the years, and £80 still looks reasonable. Other models in the 103 series, with more sophisticated styli and cantilevers, have been covered in the summaries.

It is a large but quite solid and heavy cartridge, with large headshell contact area but half-circle retaining lugs. Spherical styli may lack status, but that fitted here was very neat. Compliance is quite low, allowing matching with a usefully comprehensive range of arms from 6-16g effective mass.

Lab report

Some high-gain pre-amps (notably certain valve models) should be able to take the 103 directly into moving magnet inputs, but most users will find it provides plenty of urge for m-c inputs.

Frequency response shows a fairly modest 2dB downtilt through the midrange, and a slight flattening out at 7-8kHz. In fact a straight line could be drawn through the response trace from 20-20kHz with deviations of less than 0.5dB, which is very impressive at this (or any) price level. However, the response was 2dB 'brighter' if taken at the outer grooves, a function of the limited scanning radius of the spherical tip. Channel balance was pretty good, and the response was smooth, with just a tiny 900Hz 'glitch' and some bass unevenness.

Separation generally exceeded 30dB across the bulk of the band, reducing somewhat at the extremes, and 2.5g tracking weight (no problem with the large footprint area of a spherical tip) provides adequate tracking abilities and extraordinary groove stability — it is easy to understand its popularity in broadcast studios.

Sound quality

Very well received, the strength of the sound is its fine integration and great liveliness, coupled with a firm and powerful bass. Treble can be inconsistent, and generally sounded a little rolled off, while the midrange extended the good clarity established through the bass.

Conclusions

Spherical styli may be unfashionable, but they have always worked exceedingly well in the 103. Once again this stalwart shines out from the pack, and furthermore offers fine value for money and general (moving-coil) compatibility.

TEST RESULTS

Type, mass.....	low output moving-coil 8.5g
Stylus type.....	spherical
Stylus inspection result.....	small v. short shank, diagonal set
Output Level (1kHz, 5cm/s).....	0.44mV
Relative output (0dB = 1mV/cm/s).....	- 19dB
Channel balance.....	1.0dB
Channel separation (L,R).....	29.7, 28.4dB
Tracking ability (L,R).....	75, 80µm
Frequency response limits 100Hz-5Hz.....	+ 1, - 1dB
Frequency response limits 30Hz-20kHz.....	+ 1.5, - 3dB
Stereo Separation L on R 100Hz, 3kHz, 10kHz.....	32, 31, 26dB
Stereo Separation R on L 100Hz, 3kHz, 10kHz.....	25, 32, 26dB
Channel diff. from graph, 100Hz, 1kHz, 10kHz.....	0, 0, 0.5dB
Response limits ref computer mean, 1kHz-15kHz.....	+ 1, - 0dB
Response limits ref computer mean, 1kHz-20kHz.....	+ 1.5, - 0dB
Test tracking weight, loading.....	2.5g, n.a.
LF resonance frequency, 12.5g arm (vert, lat).....	10, 10Hz
Estimated compliance (vert, lat).....	13, 13cu
Recommended arm effective mass.....	6-16g
LF resonance rise, 12.5g arm (vert, lat).....	15, 13dB
Typical selling price.....	£80

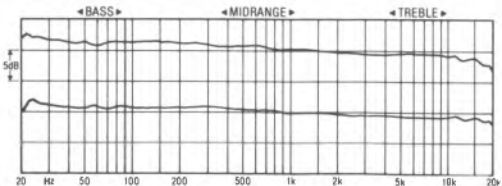

Frequency response, left and right channels

Denon DL110

Hayden Laboratories Ltd, Hayden House, Chiltern Hill, Chalfont St Peter, Bucks
Tel (0753) 888447

BEST BUY



Denon were busy away making '103 moving-coil cartridges for Japanese domestic and broadcast customers while throughout the rest of the world only Ortofon stuck doggedly to the m-c principle of the rest of the world. But more recent Denon models have been high priced items, not always brought into the UK; the very top model has achieved an enviable international reputation, but less exotic versions have had to struggle a bit to justify their extra cost over the 103. Now we have two very competitively priced high(ish) output models which look more than capable.

The £50 *DL110*, finished in an attractive maroon tortoiseshell effect, has a neat rigid four-square body with substantial though only semicircular mounting lugs and a reasonable area of headshell contact. A high quality advanced elliptical tip stylus of low mass was fitted.

Cartridge mass is quite low, so a medium compliance at a sensible 1.8g downforce provides good tracking capabilities in a package which is usefully compatible with a wide range of arms. The quite heavy internal generator damping should help it perform in inadequate turntable systems. Output level is significantly below normal, but most amplifiers will have sufficient reserve gain.

Lab report

The frequency response trace is pretty remarkable by any standards, let alone those of £50 cartridges. Occasional minor unevenness can be detected in the 1-2kHz region, but there is no other ground for criticism apart from noting the normal overall downtit, held to a respectable 3dB.

Separation results were good too, mildly asymmetric but held better than 30dB even at high frequencies, and with reasonable control of ultrasonic spurious besides.

Sound quality

The listening panel seemed to be passing through

a positive phase when the '110 was presented, and were generally enthusiastic, praising the clarity and dynamics, a generally neutral balance, and fine midrange projection. Minor concern was raised at the quality of the bass, which some felt sounded mildly dissociated and detached.

The overall reaction seemed to be that this model offers a fine balance of strengths, while noting that it still falls short of the very highest standards.

Conclusion

To describe a cartridge as lacking character should be praise of a high order. The Denon *110* sailed through our subjective and objective test programme with consummate ease. It deserves firm recommendation as a fine all-rounder which is very likely to perform to a consistently high standard under nearly all circumstances. Provided the lowish output is no problem, our only minor reservation is that other less well-damped models can sound rather more lively.

TEST RESULTS

Type, mass.....	high output moving coil 4.8g
Stylus type.....	advanced elliptical
Stylus inspection result.....	small nude stone, well aligned
Output Level (1kHz, 5cm/s).....	1.5mV
Relative output (0dB = 1mV/cm/s).....	-8dB
Channel balance.....	0.4dB
Channel separation (L,R).....	30, 30dB
Tracking ability (L,R).....	80, 78µm
Frequency response from graph, 100Hz-5kHz.....	+1.5, -0.5dB
Frequency response from graph, 30Hz-20kHz.....	+1.5, -1.5dB
Stereo Separation L on R 80Hz, 3kHz, 10kHz.....	29, 38, 30dB
Stereo Separation R on L 80Hz, 3kHz, 10kHz.....	36, 47, 31dB
Response limits ref computer mean, 1kHz-15kHz.....	+0.5, -1dB
Response limits ref computer mean, 1kHz-20kHz.....	+2, -1dB
Test tracking weight, loading.....	1.8g, n.a.pF
LF resonance frequency, (13.5g arm) (vert, lat).....	10, 9Hz
Estimated compliance (vert, lat).....	15, 19cu
Recommended arm effective mass.....	6 -16g
LF resonance rise, (13.5g arm) (vert, lat).....	11, 12dB
Typical selling price.....	£50

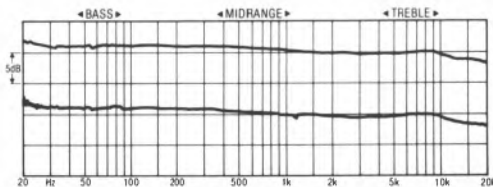

Frequency response, left and right channels

Denon DL160

Hayden Laboratories Ltd, Hayden House, Chiltern Hill, Chalfont St Peter, Bucks
Tel (0753) 888447



This £70 high-output moving-coil cartridge has much in common with the *DL110*, both models representing a renewed Denon assault upon the market for modestly-priced moving-coil models. A sultry 'sapphire tortoiseshell' plastic body replaces the '110's moody maroon. From the instruction leaflet, the only distinguishing detail being downforce and the size of the diamond tip itself; you pay more for the smaller stone. Further, the '160 tip seemed to be mildly asymmetrically shaped, though still representing good quality at this price level.

Low body mass plus sensible compliance will suit a wide range of tonearms, while the substantial damping should assist performance in the poorer turntables. The output is on the low side; though most pre-amps will have plenty in hand to cope, it makes sense to check this is the case in specific instances. Though the tracking force is reduced some 10% below the '110, tracking ability has suffered only slightly.

Lab report

The near copybook frequency response is almost uncannily like the trace obtained for the '110, even down to a shared 'glitch' at 1.4kHz, though there were a couple of extra blips on this more expensive model. Nevertheless, it is a remarkably good performance, which many an exotic model would do well to emulate.

The uncanny similarity between the models extended even to the fine detail of the separation, the '160 turning in a good solid performance with similar asymmetry and levels of ultrasonic spuria. though impressive enough by absolute standards, one does begin to wonder what the extra £20 is supposed to provide.

Sound quality

It is hardly surprising that the auditioning results of the *DL160* should prove similar to those of the *DL110*. This was indeed the case, though with

the mildly unfortunate rider that this more expensive model was consistently rated a little below its sister. As a conjecture, the mild reduction in tracking abilities and downforce might well have contributed.

Highly competent in most respects, the '160 lacked the refinement which distinguishes the best models, and was described as a trifle 'thin' in balance. Criticisms were few, but praise was not effusive either; one described the sound as 'sweet but rather sticky'. Another summarised: 'surprisingly adequate'.

Conclusions

There can be no denying the competence of a design which one participant described as 'a good £100 worth', yet the '160 was firmly undermined by the extremely similar, cheaper, and slightly better *DL110*. It is a fine all-rounder, suited to almost any system providing sufficient output is available for the pre-amp. its only failure was that it failed to provoke much positive enthusiasm amongst the listeners.

TEST RESULTS

Type, masshigh output moving-coil 4.8g
Stylus typespecial elliptical
Stylus inspection resultfair, slightly asymmetric elliptical
Output Level (1kHz, 5cm/s)1.4mV
Relative output (0dB=1mV/cm/s)-8dB
Channel balance-0.8dB
Channel separation (L,R)30, 30dB
Tracking ability (L,R)80, 73µm
Frequency response from graph, 100Hz-5kHz+1, -0.5dB
Frequency response from graph, 30Hz-20kHz+1, -1.5dB
Stereo Separation L on R 80Hz, 3kHz, 10kHz29, 35, 29dB
Stereo Separation R on L 80Hz, 3kHz, 10kHz38, 46, 28dB
Response limits ref computer mean, 1kHz-15kHz+0, -1dB
Response limits ref computer mean, 1kHz-20kHz+2, -1dB
Test tracking weight, loading1.6g, n.a.pF
LF resonance frequency, (13.5g arm) (vert, lat)9, 9Hz
Estimated compliance (vert, lat)18, 18cu
Recommended arm effective mass6-16g
LF resonance rise, (13.5g arm) (vert, lat)11, 13dB
Typical selling price£70

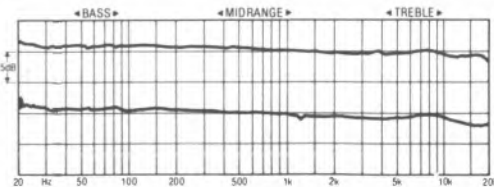

Frequency response, left and right channels

Empire MC-5M

Automation Sciences Company, 20 Little Gaddesdon, Berkhamsted, Herts HF4 1PA
Tel (044284) 2786

RECOMMENDED

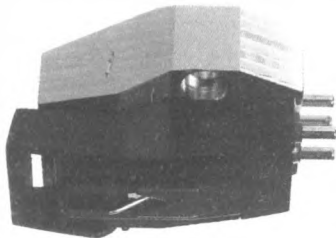

Empire is one of the long established US cartridge manufacturers, though the company's European operation now appears to be autonomous, combining Japanese and European manufacturing with European design skills. Prominent among consultants has been AJ van de Hul, whose *MC10* is a refinement of Empire's *MC1000*.

The *MC5M* is an altogether more affordable item of quite different concept. Though a low-output moving-coil cartridge, this one is made in Japan, is fitted with a detachable stylus assembly/generator, and costs a reasonable £69.

The substantial metal frame with full circular fixing lugs looks a promising start mechanically, despite the minor weight penalty involved. But the headshell contact area is rather small, and a large area of purely decorative trim detached itself rather readily.

Furthermore, all the business bits are fitted into additional plastics mouldings (of admittedly very high quality), and there seems little rational justification for introducing electrical and mechanical interfaces in order to provide a detachable facility that has very little value. That said, the stylus assembly fit was excellent!

Mechanically the cartridge will match well with most arms, and shows a fair degree of internal damping.

Lab report

Frequency balance of the *MC-5M* was a little unusual, showing minimal droop through the 2-5kHz region and distinct recovery beyond, in some respects not unlike the balance shown by Decca cartridges. A minor 'glitch' at 1.2kHz is detectable, and some high frequency uneasiness besides.

Separation was generally good, though distinctly asymmetric between channels, showing the expected reduction towards the treble resonance (above the audible range) and good suppression of ultrasonic spurious.

Output requires the extra boost of moving-coil pre-amplification circuitry, and a high quality advanced elliptical stylus tip provided secure tracking at a sensible 1.8g downforce.

Sound quality

On audition, the Decca analogy proved appropriate, for the *MC-5M* bounced along with lively dynamics and a bright, sometimes aggressive presentation. Providing an impressive sense of scale, some felt the presentation as a whole lacked subtlety, and could become wearing with prolonged listening.

Attempting to summarise varied reaction to this cartridge's individual style is not easy, though the overall reaction was cautiously favourable, with averaged scores that more than justified its price.

Conclusion

Only the name remains the same, for this gutsy, almost fiery-sounding cartridge is quite unlike this author's recollection of the earlier American designs. It represents a new direction which clearly deserves success. The cartridge itself providing an exciting sound in a mechanically well-controlled (if unnecessarily elaborate) package, and as such wins a recommendation.

TEST RESULTS

Type, mass.....	low o/p (detachable) moving-coil 6.2g
Stylus type.....	'paralinear'
Stylus inspection result.....	advanced high quality ellipse
Output Level (1kHz, 5cm/s).....	0.31mV
Relative output (0dB=1mV/cm/s).....	-22dB
Channel balance.....	-0.7dB
Channel separation (L,R).....	30, 23dB
Tracking ability (L,R).....	80, 80µm
Frequency response from graph, 100Hz-5kHz.....	+1, -0.5dB
Frequency response from graph, 30Hz-20kHz.....	+2, -0.5dB
Stereo Separation L on R 80Hz, 3kHz, 10kHz.....	31, 45, 33dB
Stereo Separation R on L 80Hz, 3kHz, 10kHz.....	26, 33, 25dB
Response limits ref computer mean, 1kHz-15kHz.....	+2, -0dB
Response limits ref computer mean, 1kHz-20kHz.....	+5, -0dB
Test tracking weight, loading.....	1.8g, n.a.pF
LF resonance frequency, (13.5g arm) (vert, lat).....	9, 8Hz
Estimated compliance (vert, lat).....	16, 20cu
Recommended arm effective mass.....	6-15g
LF resonance rise, (13.5g arm) (vert, lat).....	12, 12dB
Typical selling price.....	£69

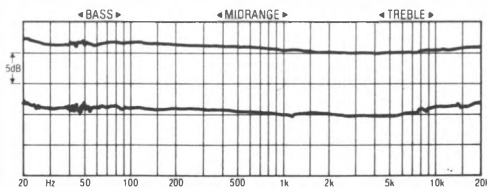

Frequency response, left and right channels

RECOMMENDED

Dynavector DV10X IV

Dynavector UK, 117 Kings Road, Long Ditton, Surbiton KT6 5JE
Tel 01-398 8710



This lightweight high output moving coil from Japanese specialist Dynavector is the latest in a long series of 10X models, which are accustomed to high ratings in *Choice*. Though the transparent bodywork is cantilevered from a plastic mounting plate, rigidity is reasonable. The longish cantilever looks a little vulnerable to accidental damage, and the stylus is a fine quality nude elliptical on a rectangular shank.

Compliance is fairly low and pretty well damped, so medium-to-high mass arms are to be preferred. Tracking abilities fell slightly short of the target despite the reasonable 1.7g downforce.

Lab report

Output level is lower than most models intended for moving magnet inputs, but was still high enough to be most unlikely to cause any difficulties. Capacitance matching is of course irrelevant in a low impedance moving-coil design.

Frequency response followed the familiar downtilted pattern but only dropping some 3dB across the whole band. The high frequency resonance is quite well controlled, but at a lowish 7-8kHz, while there were also a couple of midrange 'glitches' to cope with at 600 and 800Hz. Channel balance showed some 0.5dB variation at different parts of the main frequency spectrum, but was held quite closely at high frequencies.

Separation figures were good for a cartridge at this price level (or any price level, for that matter), albeit with mild channel asymmetry.

Sound quality

In some respects this was the most balanced sounding of the Dynavectors, and certainly delivered a very decent level of quality. Bass was felt to be slightly overdamped, with mild upper bass richness combining to give an

impression of slightly limited extension. The mild treble peak was audible as a slight 'brightness', and emphasised by 'smearing'. Midrange focusing was very good, and this tended to draw attention away from the limitations at the extremes. Stereo seemed a trifle lacking in depth, but was impressively solid and stable, as was the general behaviour of the cartridge in the groove.

Conclusions

This is a fine sounding cartridge at a realistic price, with the added convenience of driving moving magnet stages directly. Tracking ability is less its forte than groove stability, yet damping should be sufficient to ensure successful widespread compatibility, so firm recommendation is clearly indicated.

TEST RESULTS

Type, mass.....	high output moving-coil 4.5g
Stylus type.....	nude elliptical
Stylus inspection result.....	good small rectangular section
Output Level (1kHz, 5cm/s).....	2.35mV
Relative output (0dB = 1mV/cm/s).....	- 4dB
Channel balance.....	- 0.4dB
Channel separation (L,R).....	26.1, 30dB
Tracking ability (L,R).....	80, 77µm
Frequency response limits 100Hz-5Hz.....	+ 1.5, - 1dB
Frequency response limits 30Hz-20kHz.....	+ 2, - 2dB
Stereo Separation L on R 100Hz, 3kHz, 10kHz.....	23, 32, 23dB
Stereo Separation R on L 100Hz, 3kHz, 10kHz.....	35, 35, 30dB
Channel diff. from graph, 100Hz, 1kHz, 10kHz.....	0.5, 0.5, 0.5dB
Response limits ref computer mean, 1kHz-15kHz.....	+ 1, - 1dB
Response limits ref computer mean, 1kHz-20kHz.....	+ 2, - 1dB
Test tracking weight, loading.....	1.7g, n.a.
LF resonance frequency, 12.5g arm (vert, lat).....	11, 12Hz
Estimated compliance (vert, lat).....	12, 10cu
Recommended arm effective mass.....	8-18g
LF resonance rise, 12.5g arm (vert, lat).....	well damped
Typical selling price.....	£60

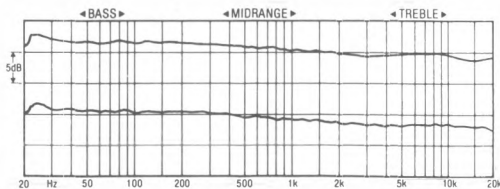

Frequency response, left and right channels

RECOMMENDED

Glanz MFG 110EX

The Music Room, 221 St Vincent Street, Glasgow
Tel 041-248 7221

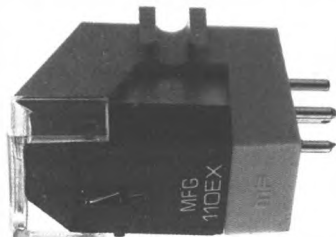

Perhaps less readily available than they were a few years ago, Japanese manufacturer Glanz make a comprehensive range of 'Moving Flux' (loosely, moving magnet) and moving-coil cartridges in the low and medium price ranges. The sole example reviewed here is a £30 moving magnet model, which as it happens is also the first Glanz model to come the way of the reviewer. Our sample was purchased from a London dealer.

Substantial in size, construction seems well-founded, and the stylus assembly fixes in quite precisely. The stylus itself, a simple elliptical, showed an indifferent standard of polish. The semi-circular lugs seem strong enough for rigid fixing, and a reasonable headshell contact can be made despite a superfluous centre trim piece.

Output level is sufficient for all moving magnet inputs, and different loadings have little effect upon response. Mechanically, the 110EX should suit most tonearms, and gave good tracking ability at a sensible 1.75g downforce. The discrepancy between the size of horizontal and vertical resonances is curious as the frequency is identical, though it is impossible to predict cause or effect.

Lab report

Frequency response was gently dntilted in the usual manner, generally very smooth and even though with some variation between channels at high frequencies. Adding capacitance produced a flatter total response at the expense of a slightly more exposed, but effectively ultrasonic, treble peak. The difference amounted to only about 1dB, and may probably be safely ignored.

Separation was rather disappointing by the standards of most of today's cartridges, reaching only 24dB on one channel, 30dB on the other. Ultrasonic spurious were reasonably well down.

Sound quality

Subjectively marginally preferred with

capacitance loading, the Glanz was warmly received by a panel who admittedly appeared to be in a generous mood at the time of its presentation. Tonally described as a little 'bright', not unlike CD, the midrange sounded lively if slightly coloured, the bass detailed if a little slow, and the treble clear with only slight overemphasis at times.

The 'average' ratings were very good considering the modest enough price of this model.

Conclusions

The MFG-110EX designation may be a bit of a mouthful, and it certainly doesn't manage to define any new standards in technical performance, but nevertheless delivers a very competitive sound deserving recommendation. If it is typical of Glanz cartridges in general, the rest of the range should also be worth exploring.

TEST RESULTS

Type, mass.....	moving flux (magnet) 5.5g
Stylus type.....	elliptical
Stylus inspection result.....	simple ellipse, indifferent polish
Output Level (1kHz, 5cm/s).....	3.4mV
Relative output (0dB=1mV/cm/s).....	-1dB
Channel balance.....	0.5dB
Channel separation (L,R).....	20, 16dB
Tracking ability (L,R).....	80, 80µm
Frequency response from graph, 100Hz-5kHz.....	+1, -1dB
Frequency response from graph, 30Hz-20kHz.....	+1, -4dB
Stereo Separation L on R 80Hz, 3kHz, 10kHz.....	24, 24, 22dB
Stereo Separation R on L 80Hz, 3kHz, 10kHz.....	32, 30, 25dB
Response limits ref computer mean, 1kHz-15kHz.....	+1.5, -1.5dB
Response limits ref computer mean, 1kHz-20kHz.....	+3.5, -1.5dB
Test tracking weight, loading.....	1.75g, 100pF
LF resonance frequency, (13.5g arm) (vert, lat).....	9, 9Hz
Estimated compliance (vert, lat).....	16, 16cu
Recommended arm effective mass.....	6-16g
LF resonance rise, (13.5g arm) (vert, lat).....	9, 14dB
Typical selling price.....	£30

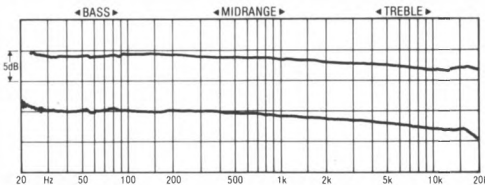

Frequency response, left and right channels

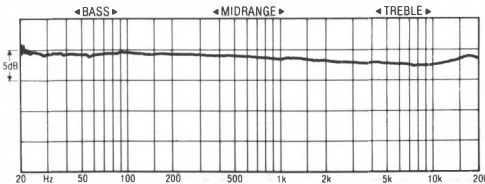

Frequency response with higher load capacitance

RECOMMENDED

Goldring Epic

Goldring Products Ltd, Unit 8, Grey Friar's Rd, Moreton Hall Ind Est, Bury St Edmunds IP32 7DX
Tel (0284) 701101

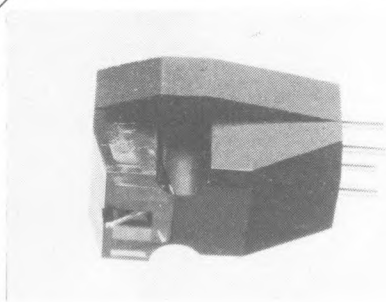

This now well established budget cartridge from Goldring attracted much interest and favourable comment from its introduction, as did the version Goldring build for Russ Andrews, the RATA *RP20*. The body is rather large, though it can be mounted tightly with good contact area; the body is now made of good quality plastic material which allows firm mounting with no problems.

Stylus assembly made a fine tight fit, and the specified elliptical tip was confirmed and neatly mounted. Compliance is moderate and well-damped, so arms of up to 16g effective mass look a safe enough bet. The downforce of 2g helps to give reasonable tracking performance.

Lab report

Plenty of output for the least sensitive amplifiers, plus a response which shows little change in shape with added capacitance will ensure no compatibility problems here. In fact the rather 'dim' response was improved a couple of dB by an extra 250pF without any untoward side effects, so adding a little extra capacitance may be beneficial.

The response trend is determinedly downtilted at high frequencies, falling some 6dB between 1kHz and 20kHz, which is not too promising. But it does follow a smooth and even trend, the final HF region is under fine control, and the curve itself is pretty smooth, with only one minor (750Hz) 'glitch'.

Channel balance was acceptable enough for the price, and separation likewise, at least showing good balance and evenness if not at a particularly exalted level. Tracking abilities are adequate, and groove stability pretty good.

Sound quality

Dominated by the dulled response, the Epic tended to sound bass heavy but was quite

impressive in terms of integration and focus, and was quite liked as a result on the listening tests. One hesitates to call it lively, but 'punchy' is not a bad adjective. Dynamics and coloration were pretty decent throughout, and stereo imaging showed some depth, albeit with some congestion.

Conclusions

This unpretentious cartridge is rather too dull in balance for the standard of ancillary equipment we used during listening, but the tight high frequency control is not ill-suited to the budget equipment it is likely to partner. Providing the body plastic is reinforced, the generally decent performance in other respects indicates cautious recommendation in the right system context.

TEST RESULTS

Type, mass.....	moving magnet 6.5g
Stylus type.....	elliptical
Stylus inspection result.....	neat simple elliptical
Output Level (1kHz, 5cm/s).....	3.8mV
Relative output (0dB = 1mV/cm/s).....	0.3dB
Channel balance.....	0.3dB
Channel separation (L,R).....	28.6, 25.7dB
Tracking ability (L,R).....	70, 69µm
Frequency response limits 100Hz-5Hz.....	+ 1, - 3dB
Frequency response limits 30Hz-20kHz.....	+ 1.5, - 6/7dB
Stereo Separation L on R 100Hz, 3kHz, 10kHz.....	21, 27, 29dB
Stereo Separation R on L 100Hz, 3kHz, 10kHz.....	18, 23, 25dB
Channel diff. from graph, 100Hz, 1kHz, 10kHz.....	0.5, 0.5, 1dB
Response limits ref computer mean, 1kHz-15kHz.....	+ 0, - 3dB
Response limits ref computer mean, 1kHz-20kHz.....	+ 2, - 3dB
Test tracking weight, loading.....	1.8g, 200pF
LF resonance frequency, 12.5g arm (vert, lat).....	10, 10Hz
Estimated compliance (vert, lat).....	13, 13cu
Recommended arm effective mass.....	6-14g
LF resonance rise, 12.5g arm (vert, lat).....	11, 11dB
Typical selling price.....	£16

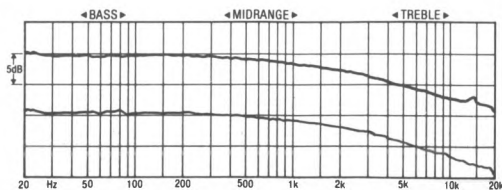

Frequency response, left and right channels

Goldring 1010

Goldring Products Ltd, Unit 8 Greystriars Road, Moreton Hall Industrial Estate, Bury St Edmunds IP32 7DX
Tel (0284) 701101

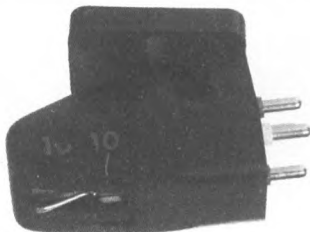

Goldring's new '1000' series provides successors to the long-lived '900' range. Certain similarities remain, but the changes, notably in improving the overall mechanical rigidity of the package, are very obvious.

Cheapest of the series, the 1010 features a simple elliptical stylus of adequate quality. Stylus assemblies are interchangeable, allowing easy upgrading if desired. Full circular mounting lugs and a large flat contact area should ensure good headshell contact. The generator can is firmly located in a substantial moulding which includes the mounting plate, and the stylus assembly is also very firmly and precisely located.

The moderate compliance still provided ample tracking performance at the sensible 1.75g downforce, yet is mechanically suited to a broad range of tonearms — a welcome contrast to some of the earlier '900' series models of a few years ago. Compliance and damping were both somewhat asymmetric, laterally and vertically; electrically, output was ample.

Lab report

Frequency response with low capacitance loading was almost ruler straight up to 18kHz, with very close channel balance and a solitary 1.2kHz 'glitch' — a remarkably impressive result. Higher loading revealed a very different picture, raising the output some 3dB at an 8.5kHz treble peak.

Separation results were very good too, though the discrepancy between channels was quite marked.

Sound quality

Despite the very impressive measured performance, and the frequency response in particular, the results of auditioning were rather disappointing. For whatever reason — it would be foolhardy to speculate as the package undoubtedly 'looks right' — the sound quality was criticised for being comparatively coarse and muddled, conveying

little of the tension of performance and lacking in space and air particularly on complex material.

Furthermore the treble was described as 'spitty', which suggests that the peak revealed when measured with capacitance loading remains audible in practical use, despite the successful attempts to control the output.

Conclusions

Just about everything about this new Goldring model looks positive, from the high standards of design and construction through to the fine technical performance. It was therefore a great disappointment to obtain such indifferent results for sound quality. Though there seems no obvious explanation, we must reserve judgement and defer any recommendation.

TEST RESULTS

Type, mass.....	moving magnet 6g
Stylus type.....	elliptical
Stylus inspection result.....	adequate simple ellipse
Output Level (1kHz, 5cm/s).....	4.3mV
Relative output (0dB=1mV/cm/s).....	+1dB
Channel balance.....	0.1dB
Channel separation (L,R).....	30, 30dB
Tracking ability (L,R).....	80, 76µm
Frequency response from graph, 100Hz-5kHz.....	+1, -1dB
Frequency response from graph, 30Hz-20kHz.....	+1, -2dB
Stereo Separation L on R 80Hz, 3kHz, 10kHz.....	31, 43, 29dB
Stereo Separation R on L 80Hz, 3kHz, 10kHz.....	37, 37, 29dB
Response limits ref computer mean, 1kHz-15kHz.....	+1.5, -0dB
Response limits ref computer mean, 1kHz-20kHz.....	+1.5, -1.5dB
Test tracking weight, loading.....	1.8g, 150pF
LF resonance frequency, (13.5g arm) (vert, lat).....	10, 8Hz
Estimated compliance (vert, lat).....	14, 20cu
Recommended arm effective mass.....	8-16g
LF resonance rise, (13.5g arm) (vert, lat).....	12, 14dB
Typical selling price.....	£30

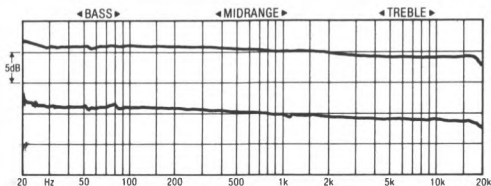

Frequency response, left and right channels

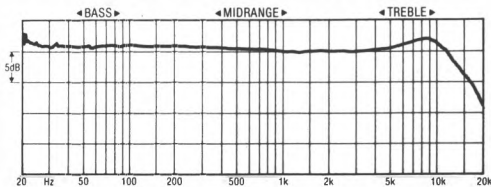

Frequency response with higher load capacitance

Goldring 1020

Goldring Products Ltd, Unit 8 Greyfriars Road, Moreton Hall Industrial Estate, Bury St Edmunds IP32 7DX
Tel (0284) 701101



Middle model of the range which replaces the familiar '900' series, the 1020 has a van den Hul type II tip, similar to that used in the '920. Its high quality and correct mounting was confirmed under the microscope. Stylus assemblies are interchangeable throughout the range.

With this new series the body and stylus assembly construction seem much more rigid and tightly fitting; the mounting area is now a substantial flat plate with circular lugs to give rigid headshell contact.

Output is ample for all pre-amps, with the recommendation for low capacitance loading. Balance between channels was a full dB out. Mechanically, the moderate if somewhat asymmetric compliance suits a wide range of medium-heavy arms, and the cartridge is moderately well-damped. The 1.8g downforce ensured fine tracking.

Lab report

Recording an almost identical but slightly better extended trace than the 1010, the flattest response is clearly only obtained when the load capacitance seen by the cartridge and contributed by arm leads and pre-amp input is low. At higher loading a mild 2.5dB downtilt becomes a 2dB peak at 8.5kHz. The traces showed slightly more mechanical unevenness than the 1010, but separation was rather better, only slightly asymmetrical and reasonably well maintained at high frequencies.

Sound quality

On audition, the 1020 proved something of a disappointment, and was not well received. The sound was described as muddled and congested, 'lumpy' in the upper bass and without conveying any real space, air, or tension. A slightly aggressive balance provided a certain liveliness which was quite well suited to rock material, and the vocal registers sounded quite clear and well

focused, but detail resolution outside the mid-band was judged insufficient by several listeners.

Conclusions

The combination of a high quality stylus and commendably rigid construction with technical performance to an apparently high standard would appear to promise much. But under test conditions, and rather to our perplexity, the sound quality did not quite seem to measure up.

The cause of our difficulties remains obscure. The only sources of mild suspicion are the degree of load sensitivity and the compliance asymmetry. The cartridge is in any case no mean performer and deserves to be given a fair chance by prospective purchasers.

TEST RESULTS

Type, mass.....	moving magnet 6g
Stylus type.....	van den Hul 2
Stylus inspection result.....	good quality vdH confirmed
Output Level (1kHz, 5cm/s).....	4mV
Relative output (0dB = 1mV/cm/s).....	0dB
Channel balance.....	1dB
Channel separation (L,R).....	30, 30dB
Tracking ability (L,R).....	80, 80µm
Frequency response from graph, 100Hz-5kHz.....	+1, -1dB
Frequency response from graph, 30Hz-20kHz.....	+1, -1.5dB
Stereo Separation L on R 80Hz, 3kHz, 10kHz.....	31, 42, 30dB
Stereo Separation R on L 80Hz, 3kHz, 10kHz.....	37, 37, 28dB
Response limits ref computer mean, 1kHz-15kHz.....	+1.5, -0dB
Response limits ref computer mean, 1kHz-20kHz.....	+1.5, -1.5dB
Test tracking weight, loading.....	1.8g, 150pF
LF resonance frequency, (13.5g arm) (vert, lat).....	10, 8Hz
Estimated compliance (vert, lat).....	14, 20cu
Recommended arm effective mass.....	8-16g
LF resonance rise, (13.5g arm) (vert, lat).....	12, 12dB
Typical selling price.....	£45

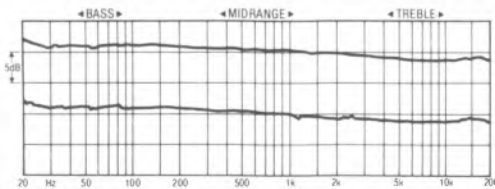

Frequency response, left and right channels

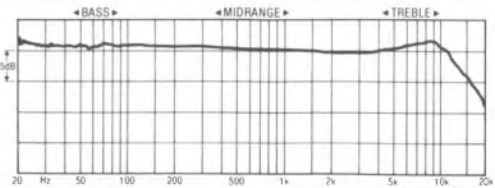

Frequency response with higher load capacitance

Goldring 1040

Goldring Products Ltd, Unit 8 Greyfriars Road, Moreton Hall Industrial Estate, Bury St Edmunds IP32 7DX
Tel (0284) 701101



This is the top model in the newly introduced '1000' series, featuring the most elaborate van den Hul type 1 stylus. There are similarities to its '900' series predecessor in terms of the generator, cantilever and can, but the 1040 offers much improved body rigidity and stylus assembly fit. Furthermore, the mounting plate uses circular fixing lugs and offers a substantial area of proper firm headshell contact.

Mechanically similar to the other models in the series (the stylus assemblies being interchangeable), the 1040 has a sensible though somewhat asymmetric compliance which is best suited to medium and high mass tonearms, the great majority in point of fact. Electrical output is ample, though the recommendation for low capacitance pre-amp loading ought to be followed.

Lab report

Differing somewhat from the cheaper models, frequency response showed a substantial change with low or high capacitance loading. With the former, as recommended, there was a broad -1.5dB trough through the treble with recovery around 18kHz; with additional loading the cartidge started rolling off around 8kHz, ending up -9dB at 20kHz. Neither condition achieved the degree of 'flatness' found with the '10 and '20, and some value in between might well have been optimum.

Separation figures were pretty good, particularly in the bass and midband, and showed commendably close symmetry between channels, which is certainly the exception rather than the rule, and evidence of good cantilever control. Tracking abilities were also good at the sensible 1.8g downforce.

Sound quality

Results of the listening tests were disappointing, with most listeners commenting on a degree of muddle and a rather slow, ponderous and heavy

bass delivery. While there was some praise for overall neutrality and relaxed presentation, and some tracks were better received than others, it was clear from the comments that the 1040 failed to inspire any real enthusiasm in the panel.

Conclusions

While the measured performance seemed very competent, and the package undoubtedly provides a very classy stylus at a comparatively modest price, the results of the listening were rather disappointing. The degree of variation in response with different pre-amps suggests that predicting overall system results will not be easy, so prospective purchasers are advised to try the model for themselves before making a firm commitment.

TEST RESULTS

Type, mass.....	moving magnet 6g
Stylus type.....	van den Hul 1
Stylus inspection result.....	fine top quality vdH
Output Level (1kHz, 5cm/s).....	4mV
Relative output (0dB=1mV/cm/s).....	+1dB
Channel balance.....	0.2dB
Channel separation (L,R).....	30, 30dB
Tracking ability (L,R).....	80, 80µm
Frequency response from graph, 100Hz-5kHz.....	+1.5, -1dB
Frequency response from graph, 30Hz-20kHz.....	+1.5, -1dB
Stereo Separation L on R 80Hz, 3kHz, 10kHz.....	29, 41, 29dB
Stereo Separation R on L 80Hz, 3kHz, 10kHz.....	38, 38, 30dB
Response limits ref computer mean, 1kHz-15kHz.....	+1.5, -1.5dB
Response limits ref computer mean, 1kHz-20kHz.....	+1.5, -1.5dB
Test tracking weight, loading.....	1.8g, 150pF
LF resonance frequency, (13.5g arm) (vert, lat).....	10, 8Hz
Estimated compliance (vert, lat).....	14, 20cu
Recommended arm effective mass.....	8-16g
LF resonance rise, (13.5g arm) (vert, lat).....	11, 13dB
Typical selling price.....	£70

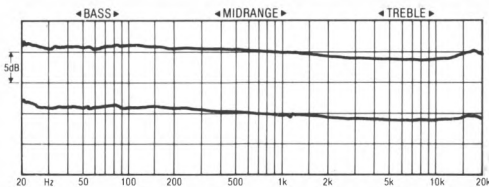

Frequency response, left and right channels

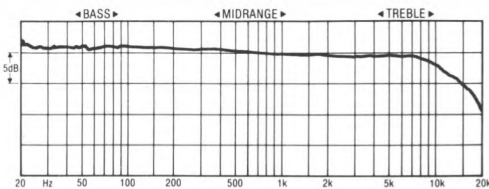

Frequency response with higher load capacitance

Goldring Electro II

Goldring Products Ltd, Unit 8, Greyfriars Road, Moreton Hall Industrial Estate, Bury St Edmunds IP32 7DX
Tel (0284) 701101

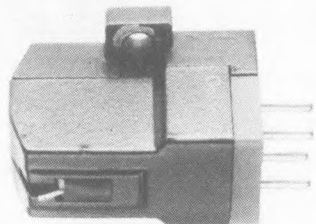

This high-output moving-coil has been around a couple of years now, and is the original model in the *Electro* series. It is a heavy cartridge with a substantial metal mounting plate to ensure close mechanical contact with the arm.

A fine van den Hul tip was fitted, which is unusual in an £80 cartridge. Downforce was a sensible 1.8g, and compliance quite low, though asymmetrical in frequency and damping. The recommended range of arm masses is 8-16g, with the middle of the range preferred.

Lab report

Though nominally a high output type, the *Electro*'s output is somewhat below average for moving magnet inputs, so the individual purchaser would be wise to check there is enough level to get the amplifier up to clipping without background noise problems. An m-c input, if available, should work with no problem.

Frequency response showed a gentle 2.5dB downtilt from 100Hz to 4kHz, a mild (1dB) peak at 8kHz, and then a rather ragged though tolerably balanced rolloff. Channel balance was fair and the trace quite smooth, with just a couple of 'glitches' between 500Hz and 1kHz.

Separation figures were rather disappointing considering the price level, showing a marked deterioration towards high frequencies, though the generation of ultrasonic spurious was at an encouragingly low level. Tracking abilities were reasonable enough, but without a great deal in reserve.

Sound quality

The overall balance was pretty good, if a touch 'bright', giving a pleasant 'airiness', albeit with a touch of surface noise. However, low frequencies were a little lacking in authority and the presence lacked 'punch' and focus to a degree.

Conclusions

Decent enough in most aspects of its performance, quality of the *Electro II* generator doesn't really justify the highish price, despite the fine stylus. It is a pretty decent all-rounder to be sure, but does not excel sufficiently in any respect to warrant recommendation.

TEST RESULTS

Type, mass.....	high output moving-coil 9g
Stylus type.....	van den Hul
Stylus inspection result.....	fine tiny vdH tip
Output Level (1kHz, 5cm/s).....	1.93mV
Relative output (0dB = 1mV/cm/s).....	- 7dB
Channel balance.....	0.4dB
Channel separation (L,R).....	28.1, 27.8dB
Tracking ability (L,R).....	80, 75µm
Frequency response limits 100Hz-5Hz.....	+ 1.5, - 1dB
Frequency response limits 30Hz-20kHz.....	+ 2, - 4/5dB
Stereo Separation L on R 100Hz, 3kHz, 10kHz.....	23, 23, 14dB
Stereo Separation R on L 100Hz, 3kHz, 10kHz.....	31, 25, 16dB
Channel diff. from graph, 100Hz, 1kHz, 10kHz.....	1, 0.5, 0.5dB
Response limits ref computer mean, 1kHz-15kHz.....	+ 0, - 1.5dB
Response limits ref computer mean, 1kHz-20kHz.....	+ 1, - 3dB
Test tracking weight, loading.....	1.8g, n.a.
LF resonance frequency, 12.5g arm (vert, lat).....	13, 10Hz
Estimated compliance (vert, lat).....	7, 13cu
Recommended arm effective mass.....	8-16g
LF resonance rise, 12.5g arm (vert, lat).....	9, 13dB
Typical selling price.....	£82

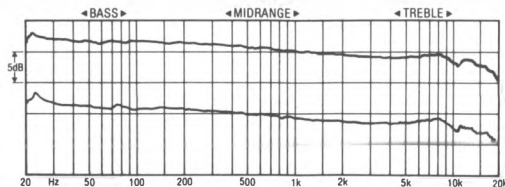

Frequency response, left and right channels

Grace F9E II

Russ Andrews Turntable Accessories, Edgebank House, Skelsmergh, Kendal, Cumbria LA8 9AS
Tel: (053 983) 274

RECOMMENDED

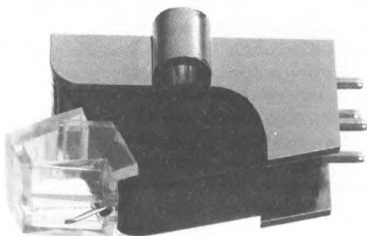

the '9E were again in evidence, combining a slightly 'weighty' balance with an impressively 'lively' presentation.

The majority of comments positively described this as an interesting solid-sounding cartridge. But there were a couple of dissenters, and a general criticism of some 'fizz'.

Conclusions

While this latest version of the F9E can be said to deliver the sonic goods satisfactorily, the excessive compliance of our solitary sample was a disappointment, and could well have been the reason why the II was not regarded as any significant improvement over its predecessor.

While warning against high compliance samples, this still remains a sufficiently fine example of moving magnet technology to retain cautious recommendation.

With a history that seems to stretch back into the mists of time, the F9E has become something of a yardstick for high-quality moving magnet designs, providing a sound competitive with m-c models in a device which offers good tracking abilities at low downforce. Recent refinement justifies the II suffix, with visible changes to the fluorescent stylus assembly moulding.

The manufacturer's family ties with the Supex people can be seen in a similar concern for good mechanical body rigidity with substantial fixing lugs. The new stylus assembly makes a fairly good fit, but was not exceptional in this respect.

Compliance of our Mk II sample was unfashionably high, significantly greater than that of last year's model, and therefore only really suited to low mass arms, though assisted by a fair amount of internal damping. This certainly ensures good tracking at a low 1.2g downforce, but then last year's model was also a good tracker and more sensibly matched to today's tonearms.

Electrical output is ample, and channel balance fair. The fine small advanced elliptical tip had a slightly asymmetric shank.

Lab report

Changing the load capacitance altered the treble response by a fairly substantial 3dB, so attention should be paid to this in a system context. With low capacitance, an almost ruler-flat response downtilted 4dB from 200Hz to 20kHz is punctuated by a broad 2dB peak at 11kHz; higher loading increases the peak by 1dB and rolls off the higher frequencies.

Separation was excellent, particularly through the lower midrange with dB values consistently in the '40s, and with well-suppressed ultrasonics.

Sound quality

Curiously, during 'hands on' listening, the sound was actually preferred with the additional capacitance. The traditional highly regarded virtues of

TEST RESULTS

Type, mass.....	moving magnet 6.1g
Stylus type.....	advanced elliptical
Stylus inspection	result.....tiny, slightly asymmetric advanced elliptical
Output Level (1kHz 5cm/s).....	4mV
Relative output (0dB=1mV/cm/s).....	+1dB
Channel balance.....	-0.6dB
Channel separation (L,R).....	30, 30dB
Tracking ability (L,R).....	.80, 80µm
Frequency response from graph, 100Hz-5kHz.....	+1, -1.5dB
Frequency response from graph, 30Hz-20kHz.....	+1, -3dB
Stereo Separation L on R 80Hz, 3kHz, 10kHz.....	31, 39, 27dB
Stereo Separation R on L 80Hz, 3kHz, 10kHz.....	36, 39, 28dB
Response limits ref computer mean, 1kHz-15kHz.....	+1, -0dB
Response limits ref computer mean, 1kHz-20kHz.....	+1, -0.5dB
Test tracking weight, loading.....	1.2g, 2000F
LF resonance frequency, (13.5g arm) (vert, lat).....	5, 5Hz
Estimated compliance (vert, lat).....	50, 50cu
Recommended arm effective mass.....	5-10g
LF resonance rise, (13.5g arm) (vert, lat).....	11, 13dB
Typical selling price.....	£159

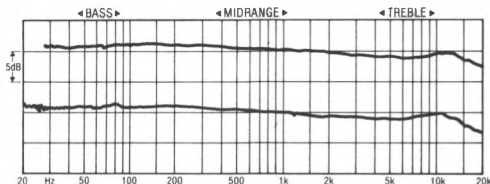

Frequency response, left and right channels

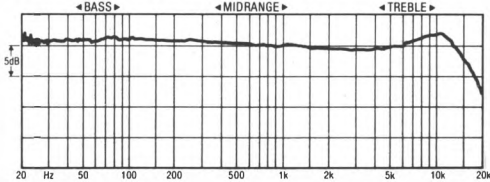

Frequency response with higher load capacitance

READ Hi-Fi CHOICE

LISTEN AND MAKE YOUR CHOICE

Whatever your needs,
the "BEST BUYS" are at
Brentwood Music Centre

Ground and First Floor
2 Ingrave Road, Brentwood,
Essex. Tel: (0277) 221210
Ideally situated — 5 mins. by car from
M25/A12 intersection, 15 mins. from
Dartford Tunnel and M11

★ ★ COMPACT DISC SPECIALIST ★ ★

AGENCIES INCLUDE: AR, AIWA,
ARISTON/QLN, B&W, CASTLE, DENON,
DIESIS, DUAL, HARMAN/KARDON, JBL, LUX,
MARANTZ, MORDAUNT-SHORT, NAKAMICHI,
PHILIPS, PROTON, QED, QUAD, SANSUI,
TEAC, TRIO, WHARFEDALE, YAMAHA.

A WIDE RANGE OF HEADPHONES,
CARTRIDGES AND ACCESSORIES FROM THE
TOP NAMES.

Hi-fi for the discerning

Basically Sound



OLD SCHOOL, SCHOOL ROAD, BRACON ASH
NR NORWICH
TELEPHONE (0508) 70829

OF NORFOLK

A&R CAMBRIDGE • CREEK • HARBETH
HEYBROOK • LINN • MORDAUNT SHORT
MANTRA • NAIM • NIGHTINGALE • ROTEL
REGA • SONDEX • SPENDOR • SUPEX
WHARFEDALE • AND OTHERS

Mon-Sat 9.30-5.30

THE BEST BUYS IN BIRMINGHAM . . .

THE BEST AND WIDEST CHOICE OF
CARTRIDGES AND TURNTABLES
ALL RECORD DECKS ARE
ASSEMBLED AND CAREFULLY ALIGNED

- We cater for a wide range of tastes and budgets by offering carefully selected Hi-Fi products from the finest manufacturers.
- Demonstrations are arranged by appointment in our single Speaker demonstration room, simulating a domestic environment, to ensure the correct choice of equipment.
- Most products are covered by a full two year warranty; repairs and manufactures are carried out in our own service departments.
- Systems can be installed at homes in the West Midlands area at no extra charge.
- AKG, A&R, AR, Ariston, Audiolab, Audio Technica, Beyer, Bose, Celestion, Diesis, Dual, Gale, Glanz, Goldring, Grado, Helius, Heybrook, KEF, Logic, Linx, Maxell, Meridian, Michell, Mission, Mordaunt-Short, Monitor Audio, Musical Fidelity, NVA, Oak, Ortofon, Philips, Pink Triangle, Quad, Revolver, Rogers, Rotel, Sondex, Spendor, Systemdek, Tannoy, TDK, Thorens, Wharfedale.



ALTERNATIVE AUDIO LTD
95 HOBS MOAT ROAD, SOLIHULL, WEST MIDLANDS B92 8JL
TEL: SALES 021 742 0254; SERVICE 021 742 0248
OPEN HOURS: TUESDAY TO SATURDAY 10am to 6pm
CREDIT TERMS AVAILABLE (credit brokers)

Grado MT

Grado Products Ltd, Lynch House, Alwalton, Peterborough PE7 3UY
Tel (0733) 236562

BEST BUY

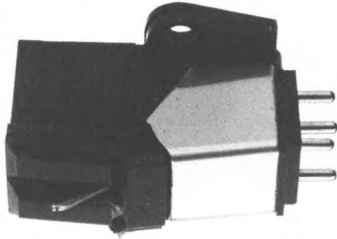

element in the subjective reaction, though 'listening through' the effect revealed a sound of rare quality considering the low price.

The balance was rich and slightly 'heavy', marred by some softness in bass definition and some sibilant and surface noise exaggeration. Inherent good clarity and 'speed', along with the balance, helped to convey impressive scale with good vocal projection and ambient detail.

Conclusions

Despite the odd frequency balance, this Grado produced sufficient of the sound quality goods to indicate recommendation at its very reasonable price. Other aspects of technical performance were decent enough in any case.

However, significant reservations remain regarding the suitability of such a lightly-damped model in the budget turntables it is likely to partner. Good performance in a high quality system does not necessarily imply that the quality will be maintained when the compromises get tough. A fine potential performer, it needs, more than most, to be checked out in the prospective system.

TEST RESULTS

Type, mass.....	moving magnet 5.5g
Stylus type.....	not specified
Stylus inspection result.....	mild elliptical
Output Level (1kHz, 5cm/s).....	3.5mV
Relative output (0dB=1mV/cm/s).....	-1dB
Channel balance.....	0.6dB
Channel separation (L,R).....	24, 25dB
Tracking ability (L,R).....	80, 66µm
Frequency response from graph, 100Hz-5kHz.....	+1.5, -1.5dB
Frequency response from graph, 30Hz-20kHz.....	+2, -3dB
Stereo Separation L on R 80Hz, 3kHz, 10kHz.....	26, 31, 29dB
Stereo Separation R on L 80Hz, 3kHz, 10kHz.....	32, 34, 31dB
Response limits ref computer mean, 1kHz-15kHz.....	+2.5, -3dB
Response limits ref computer mean, 1kHz-20kHz.....	+4, -3dB
Test tracking weight, loading.....	1.5g, n.a.pF
LF resonance frequency, (13.5g arm) (vert, lat).....	11, 11Hz
Estimated compliance (vert, lat).....	12, 12cu
Recommended arm effective mass.....	8-18g
LF resonance rise, (13.5g arm) (vert, lat).....	18, 21dB
Typical selling price.....	£19

Like all Grado models, this is a simple design of unprepossessing appearance, sensibly constructed to couple well with the tonearm mechanically. The mounting lugs are a little flimsy and should not be over-tightened, but they at least provide circular contact with the bolts.

The stylus assembly fit is remarkably tight, with additional mastic-type damping. Indeed those foolhardy enough to attempt removal without the special tool provided risk terminal cantilever damage — as we discovered last time around!

A fairly stiff compliance means that medium and heavy mass arms are to be preferred, while the lack of any cantilever damping (a characteristic Grado trait) implies that tonearm damping could be beneficial if available, and that poorer quality turntables should be avoided. Tracking abilities should be adequate, but in an adequate player could be caught out on the more difficult material (opera, choral etc.).

Output is fine for conventional moving magnet inputs, but the design of the generator means Grados, though entirely unaffected by input capacitance loading, may be somewhat susceptible to hum pickup in the 'wrong' system (glass turntable platters, for example).

Lab report

Frequency response was certainly a little dramatic, suggesting a cartridge stronger on character than neutrality. Dropping a full 3dB through the midrange from 200Hz to 5kHz, there is evidence of slight recovery and then a sharp rise to a +2dB peak at 18kHz.

Separation showed good channel matching and impressive evenness, despite absolute values which were below average. Ultrasonic output was higher than usual, corroborating the high frequency response problem.

Sound quality

The frequency characteristic proved a major

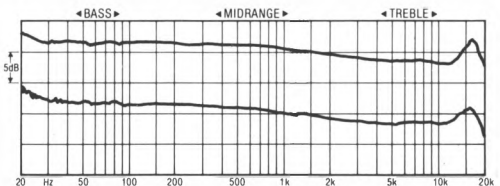

Frequency response, left and right channels

Grado M1

Grado Products Ltd, Lynch House, Alwalton, Peterborough PE7 3UJ
Tel (0733) 236562



This expensive Grado differs little from its cheaper (or still more expensive) brethren in appearance, the hidden value lying presumably in the cantilever engineering, stylus, and quality control. In fact, the *M1*'s stylus appeared to be nothing particularly special.

Overall mechanical construction is simple and sound, with an exceedingly well-fitting stylus assembly necessitating a special tool for its removal. Headshell contact area is fairly good and the mounting lugs are circular, though appear rather thin and fragile.

Slightly greater vertical compliance over the *MT* probably helps produce the improved tracking performance, at the expense of some compliance asymmetry. Once again, medium and high mass arms are to be preferred, and the virtual absence of cartridge damping indicates the need for a good quality player and/or a damped tonearm. Output is on the low side though fully adequate, and channel balance was very good.

Lab report

Low generator inductance means that the *M1* is unaffected by changes in pre-amp loading. The response shows the same general trend as the cheaper model, but with significant high frequency refinement and some extension besides. Showing similar low bass boost and midrange down tilt, the first recovery is slightly stronger but also higher in frequency, while the treble peak has been effectively eliminated, maintaining ± 1 dB with fine channel balance.

Separation was certainly superior to the *T*, but on one channel only unfortunately. Ultrasonic spurious were again apparent at a higher level than usual.

Sound quality

Once again the effects of the response characterised the overall 'rich', 'heavy' sound balance, and despite the apparently smoother

treble, some 'tizz' was again noticed.

While the treble range was an improvement, the *M1* seemed to lose some of the 'liveliness' of the cheaper model. Praise was again given to the mid-range clarity and space, but there was also the impression that the *M1* was tending towards blandness.

Conclusions

While the *M1* does offer a number of improvements over the far cheaper *MT*, these seem insufficient to justify the substantial difference in price. Indeed in some respects the *M1* seemed less effective in creating an integrated whole out of the sum of its parts. In many ways, it is a fine performer, but on the basis of our findings the highish price precludes recommendation.

TEST RESULTS

Type, mass.....	moving magnet 5.5g
Stylus type.....	not specified
Stylus inspection result.....	mild elliptical, indifferent polish
Output Level (1kHz, 5cm/s).....	3.2mV
Relative output (0dB=1mV/cm/s).....	-2dB
Channel balance.....	0dB
Channel separation (L,R).....	26, 30dB
Tracking ability (L,R).....	80, 80 μ m
Frequency response from graph, 100Hz-5kHz.....	+1.5, -2dB
Frequency response from graph, 30Hz-20kHz.....	+2, -3dB
Stereo Separation L on R 80Hz, 3kHz, 10kHz.....	26, 32, 30dB
Stereo Separation R on L 80Hz, 3kHz, 10kHz.....	36, 43, 35dB
Response limits ref computer mean, 1kHz-15kHz.....	+1, -3dB
Response limits ref computer mean, 1kHz-20kHz.....	+3, -3dB
Test tracking weight, loading.....	1.5g, n.aF
LF resonance frequency, (13.5g arm) (vert, lat).....	11, 9Hz
Estimated compliance (vert, lat).....	12, 17cu
Recommended arm effective mass.....	8-16g
LF resonance rise, (13.5g arm) (vert, lat).....	23, 19dB
Typical selling price.....	£125

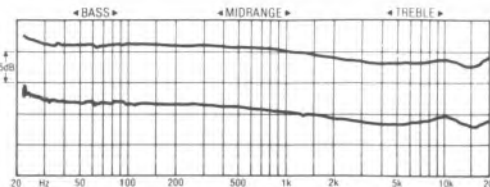

Frequency response, left and right channels

Grado M3

Grado Products UK Ltd, Lynch House, Alwalton, Peterborough PE7 3UY
Tel (0733) 236562

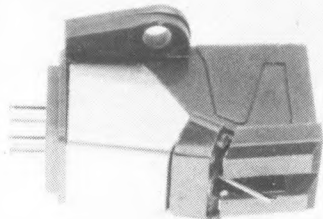

Sound quality

Liked in particular for its lively openness, the M3 was a bit of a lightweight when it came to bass 'slam', but managed to sound remarkably uncongested throughout most of the band.

The midrange showed reasonable focus and stereo was quite promising, while the balance as a whole sounded a touch 'bright' and 'cold', somewhat lacking in richness and mid bass power. Some treble brightness was audible, but the combination of control and detail was good for the price.

Conclusions

A very decent sounding cartridge for the price, not to mention some impressive results in the technical testing, ensures recommendation for this Grado, and the suggestion that other models in the Master series deserve checking out, according to the depth of your pocket. However, it is not a cartridge to use with an inadequate turntable; Grados have a habit of sounding only as good as their players.

Grado cartridges are unusual in several ways, the most obvious being the almost total lack of low frequency damping, which is not so much of a bad thing *per se*, but which does mean that the accompanying turntable needs to be pretty decent. The body is a rather soft blue plastic, and we frankly didn't dare try the recommended three-point mounting spacer for fear of tearing off the lugs, which showed signs of straining when tightened. Stylus was a nicely shaped and mounted special elliptical.

The compliance is beautifully chosen for the test arm, and perfectly symmetrical, so a fair range of arm effective masses should be useable despite the high resonance rise.

Lab report

Output level is round about average and Grados are unaffected by capacitance changes, so there are no amplifier matching problems. Hum susceptibility is a known Grado trait, and will depend upon the turntable, so should be checked out if proposing purchase.

Frequency response sorted out the cheaper *T* and the *M3* quite comfortably, while at the same time showing some significant strengths in both. They were identical from 100Hz to 6kHz, showing impressive channel balance but a gently curving downtilt of 4dB. Whereas the *T* then recovered substantially, showing some channel divergence above 12kHz, the *M3* flattened and then turned down again at 9kHz, smoothly following the original trend under exceptional control. The trace as a whole was devoid of other identifiable resonances.

Separation measurements were fairly unspectacular, if reasonably consistent, and showed quite good control of ultrasonic spurious. Tracking posed no problems, stability was quite impressive despite the 1.5g tracking weight, and surface noise stayed under good control.

TEST RESULTS

Type, mass.....	moving magnet 5.5g
Stylus type.....	elliptical
Stylus inspection result.....	confirmed, small & neat
Output Level (1kHz, 5cm/s).....	3.4mV
Relative output (0dB = 1mV/cm/s).....	- 1.5dB
Channel balance.....	0dB
Channel separation (L,R).....	23.6, 21.8dB
Tracking ability (L,R).....	80, 80µm
Frequency response limits 100Hz-5Hz.....	+ 2, - 2dB
Frequency response limits 30Hz-20kHz.....	+ 2, - 2/3dB
Stereo Separation L on R 100Hz, 3kHz, 10kHz.....	25, 23, 22dB
Stereo Separation R on L 100Hz, 3kHz, 10kHz.....	33, 32, 25dB
Channel diff. from graph, 100Hz, 1kHz, 10kHz.....	0, 0, 0dB
Response limits ref computer mean, 1kHz-15kHz.....	+ 1, - 2dB
Response limits ref computer mean, 1kHz-20kHz.....	+ 3, - 2dB
Test tracking weight, loading.....	1.5g, n.a.
LF resonance frequency, 12.5g arm (vert, lat).....	10, 10Hz
Estimated compliance (vert, lat).....	16, 16cu
Recommended arm effective mass.....	6-14g*
LF resonance rise, 12.5g arm (vert, lat).....	18, 17dB
Typical selling price.....	£49.

*with slight damping if available

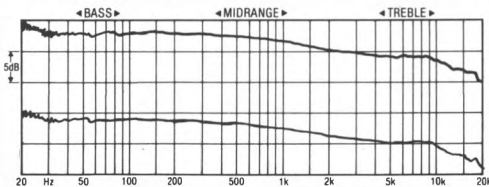

Frequency response, left and right channels

COSMIC

Established
24 Years

HI FI SYSTEM SALE

SYSTEM OF THE MONTH

£299.95 INC VAT & DELIVERY

*Only the turntable can be substituted in this system



CELESTION DL4



ROTEL RA820



DUAL 505-2 INC CARTRIDGE

DUAL CS505-2 + ROTEL RA820	+AR18BX OR CEL DL4 OR MS15 OR MISSION 70II OR CASTLE CLYDE	£269.95
DUAL CS505-2 + ROTEL RA820BX	+AR18BX OR CEL DL4 OR MS15 OR MISSION 70II OR CASTLE CLYDE	£299.95
DUAL CS505-2 + ROTEL RA840	+AR18BX OR CEL DL4 OR MS15 OR MISSION 70II OR CASTLE CLYDE	£329.95
DUAL CS505-2 + ROTEL RA840BX	+AR18BX OR CEL DL4 OR MS15 OR MISSION 70II OR CASTLE CLYDE	£339.95
DUAL CS505-2 + YAMAHA A320	+AR18BX OR CEL DL4 OR MS15 OR MISSION 70II OR CASTLE CLYDE	£259.95
DUAL CS505-2 + YAMAHA A420	+AR18BX OR CEL DL4 OR MS15 OR MISSION 70II OR CASTLE CLYDE	£309.95
DUAL CS505-2 + YAMAHA A07	+AR18BX OR CEL DL4 OR MS15 OR MISSION 70II OR CASTLE CLYDE	£279.95
DUAL CS505-2 + YAMAHA A520	+AR18BX OR CEL DL4 OR MS15 OR MISSION 70II OR CASTLE CLYDE	£349.95
DUAL CS505-2 + CYRUS 1	+AR18BX OR CEL DL4 OR MS15 OR MISSION 70II OR CASTLE CLYDE	£319.95
DUAL CS505-2 + PROTON 520	+AR18BX OR CEL DL4 OR MS15 OR MISSION 70II OR CASTLE CLYDE	£299.95
DUAL CS505-2 + QES A230	+AR18BX OR CEL DL4 OR MS15 OR MISSION 70II OR CASTLE CLYDE	£274.95
DUAL CS505-2 + QED A240	+AR18BX OR CEL DL4 OR MS15 OR MISSION 70II OR CASTLE CLYDE	£319.95
DUAL CS505-2 + DENON PMA717	+AR18BX OR CEL DL4 OR MS15 OR MISSION 70II OR CASTLE CLYDE	£279.95
DUAL CS505-2 + DENON PMA737	+AR18BX OR CEL DL4 OR MS15 OR MISSION 70II OR CASTLE CLYDE	£324.95
DUAL CS505-2 + A&R ALPHA	+AR18BX OR CEL DL4 OR MS15 OR MISSION 70II OR CASTLE CLYDE	£309.95
DUAL CS505-2 + MARANTZ PM54	+AR18BX OR CEL DL4 OR MS15 OR MISSION 70II OR CASTLE CLYDE	£349.95
DUAL CS505-2 + ROTEL RA820	+AR18BX OR CEL DL4 OR MS15 OR MISSION 70II OR CASTLE CLYDE	£269.95

You can substitute AR18BX or DL4 or MS20 or Mission 7011 or Monitor Audio R100 in the above systems with any of the Loudspeakers listed below at the following EXTRA COST OPTION:

DUAL CS505-2 DELUXE.....add £20	MARANTZ CD748 COMPACT DISC.....add £200	PHILIPS CD304 COMPACT DISC.....add £250
ROTEL RP830/AT110E.....add £30	REVOLVER/LVX.....add £115	MISSION DAD700R COMPACT DISC.....add £350
ROTEL RP850/AT110E.....add £100	MARANTZ CD84 COMPACT DISC.....add £250	YAMAHA CDX2 COMPACT DISC.....add £180
AR TURNTABLE/£8101.....add £100	PHILIPS CD1048 COMPACT DISC.....add £180	YAMAHA CD3 COMPACT DISC.....add £250

You can substitute AR18BX or CEL DL4 or Mission 70II or Castle Clyde in the above systems.

B&W DM90DM100.....add £110	Castle Tyn.....add £30	Kel C30.....add £50	A&R22.....add £30	Monitor Audio R352.....add £100
B&W DM110.....add £20	Castle Avon.....add £80	AR33.....add £100	Mordant MS30.....add £30	Tannoy Mercury.....add £70
Castle Trent.....deduct £5	Celestion DL6.....add £25	Kel C20.....add £15	Monitor Audio R252 vinyl.....£20	Wharfedale 50S.....add £20
Haybrook HB1.....add £100	Kel C10.....deduct £10	Mission 700 2.....add £30	Monitor Audio R252 wood.....£30	Wharfedale 50B.....add £80

FREE DELIVERY + LEADS (UK, MAINLAND ONLY) ON ABOVE SYSTEMS.
ALL STOCK IS BRAND NEW, BOXED, AND ALL TURNTABLES SUPPLIED WITH CARTRIDGE.

OPEN SEVEN DAYS A WEEK 9.00AM-6.00PM

★ Prices subject to change without notice

■ Please phone to check that prices still apply

Christmas Opening Times
We are open Sunday 22nd, Monday 23rd, Tuesday
24th. Closed Christmas Day/Boxing Day.
Re-open Dec 27th Open all new year 9-6pm
MERRY CHRISTMAS AND HAPPY NEW YEAR
TO ALL OUR CUSTOMERS

COSMIC

244/256 STATION RD, ADDESTONE,
WEYBRIDGE, SURREY.

Tel: (0932) 54522/51753/43769.

Highphonic MCA3

Esoteric Audio Research Ltd, The Old Chapel, Little Stukeley, Huntingdon, Cambs
Tel (0480) 53791

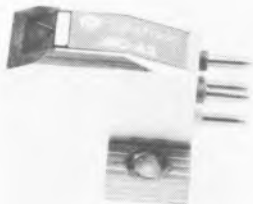

This exquisitely crafted low output moving-coil cartridge costs a fairly substantial £285, and comes from a group of ex-Denon engineers. The hereditary influence from Denon's 300 series is apparent, with the emphasis on low moving mass and also on a low specified tracking weight (1.1g).

The body is a beautifully finished metal casting, and the stylus a tiny line-contact rod. Compliance is very high, though fairly well damped, but this model is really only suitable for low mass arms.

Lab report

Output level is very low. Though not beyond the capabilities of a decent, low-noise, moving-coil pre-amp, this isn't the sort of cartridge to use into the add-on m-c stage of the typical integrated amplifier.

Frequency response is very impressive, while following the familiar trend of a gently falling midrange from 100Hz-5kHz (2dB in this instance), a short shelf to 10kHz, followed by a fairly gentle rolloff thereafter, which was the only evidence of any channel imbalance. A solitary, tiny 800Hz 'glitch' remains unexplained.

Separation figures were mostly outstanding, particularly through the mid/bass, but with the odd inconsistency elsewhere. Out-of-band spurs were exceptionally low at 25kHz, but more normal at 40kHz. Tracking was exemplary, though stability the precise opposite.

Sound quality

One strength of this particular exotic is just about the sweetest treble of them all, a feature which is undeniably seductive after listening to 130 other variations on that particular theme! However, it did sound rather 'bright', as if unable to avoid attracting attention to itself, and one could describe the sound as a little

'cold' or 'clinical'.

The bass as a whole and the upper bass in particular sounded 'lean', and very uncoloured, with good differentiation but lacking a little 'power' subjectively. Dynamics and focus were pretty good, while depth was a little curtailed.

Conclusions

This beautifully engineered cartridge is not too expensive considering its superb tracking abilities at high frequencies, its wide dynamic range and lack of colouration. Ultimately, however, I find myself in close agreement with another reviewer who suggested that it has a sound which is closer to Japanese than UK tastes, but which has its own validity nonetheless.

TEST RESULTS

Type, mass.....	low output moving-coil 6.6g
Stylus type.....	not specified
Stylus inspection result.....	minuscule line profile rod, some glue
Output Level (1kHz, 5cm/s).....	0.12mV
Relative output (0dB = 1mV/cm/s).....	- 30dB
Channel balance.....	0.5dB
Channel separation (L,R).....	30, 30dB
Tracking ability (L,R).....	80, 80µm
Frequency response limits 100Hz-5Hz.....	+ 1, - 1dB
Frequency response limits 30Hz-20kHz.....	+ 1, - 3/5dB
Stereo Separation L on R 100Hz, 3kHz, 10kHz.....	31, 34, 38dB
Stereo Separation R on L 100Hz, 3kHz, 10kHz.....	37, 28, 24dB
Channel diff. from graph, 100Hz, 1kHz, 10kHz.....	0, 0, 0.5dB
Response limits ref computer mean, 1kHz-15kHz.....	+ 1, - 0dB
Response limits ref computer mean, 1kHz-20kHz.....	+ 1.5, - 0dB
Test tracking weight, loading.....	1.1g, n.a.
LF resonance frequency, 12.5g arm (vert, lat).....	8, 6Hz
Estimated compliance (vert, lat).....	20, 38cc
Recommended arm effective mass.....	5.12g
LF resonance rise, 12.5g arm (vert, lat).....	12, 12dB
Typical selling price.....	£285

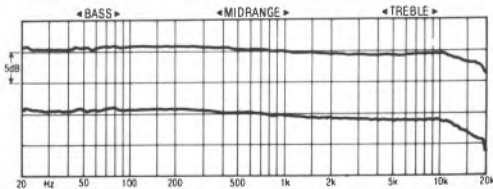

Frequency response, left and right channels

RECOMMENDED

Koetsu Black K

Absolute Sounds, 42 Parkside, London SW19
Tel 01-947 5047

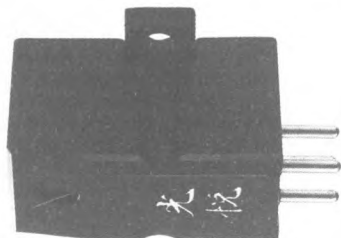

Visually and pricewise similar to the *Black* tested in the last edition, this latest *K* version features a number of detail changes, including the addition of some tasteful gilt to the otherwise featureless body.

Mechanically it appears to be very similar, with a lightly-damped compliance suited to medium and high mass arms. Some additional tonearm damping might be to advantage if available.

Electrical output needs normal moving-coil boost but no more. Though an inherently good quality stylus was fitted, polish was a little lacking and glue rather too much in evidence. Tracking margins were not generous despite the sensible 1.8g tracking weight, and this model should be approached with caution by lovers of grand opera and choral music.

Lab report

An inherently flat and smooth response downtilted a modest 2dB across the band, and held between fine overall ± 1 dB limits. However there were occasional 'glitches' and a mild lack of control at high frequencies was also indicated.

Separation was truly outstanding, maintaining a symmetrical 45dB—plus, right from 250Hz to 5kHz, albeit with slight spurious ultrasonic output.

Sound quality

In our initial 'hands on' work, it was obvious that the *Black K* was a significant sonic improvement over its predecessor, retaining the Koetsu character but with a 'lighter', 'faster' sound overall.

However, in the blind presentation the panel were somewhat less convinced. While praising the impressive 'scale' and dynamics, there was criticism of some bass muddling and excess, and some high treble 'tizz'. Though scoring well enough, it was not as highly rated as might have been expected from the name and reputation. Overall it has a romantic and spacious presentation which has undoubted appeal to some

listeners.

Conclusions

The *Black K* has certainly done enough technically and subjectively to retain recommendation, enhancing the reputation of its illustrious and successful predecessor. However, it is not a sound to everyone's taste, and the panel showed sufficient misgivings to warn that it definitely should be auditioned before purchase. A good turntable and tonearm are mandatory, and the tracking ability may not be quite up to standard for some users.

TEST RESULTS

Type, mass.....	low output moving-coil 9.5g
Stylus type.....	not specified
Stylus inspection	
result.....	gluey super elliptical, indifferent polish
Output Level (1kHz, 5cm/s).....	0.36mV
Relative output (0dB=1mV/cm/s).....	-21dB
Channel balance.....	0.2dB
Channel separation (L,R).....	30, 30dB
Tracking ability (L,R).....	62, 65 μ m
Frequency response from graph, 100Hz-5kHz.....	+1, -0.5dB
Stereo Separation L on R 80Hz, 3kHz, 10kHz.....	+1, -1dB
Stereo Separation R on L 80Hz, 3kHz, 10kHz.....	34, 44, 37dB
Stereo Separation R on L 80Hz, 3kHz, 10kHz.....	37, 45, 38dB
Response limits ref computer mean, 1kHz-15kHz.....	+2, -0dB
Response limits ref computer mean, 1kHz-20kHz.....	+5.5, -0dB
Test tracking weight, loading.....	1.8g, n.a.pF
LF resonance frequency, (13.5g arm) (vert, lat).....	10, 10Hz
Estimated compliance (vert, lat).....	13, 13cu
Recommended arm effective mass.....	6-18g
LF resonance rise, (13.5g arm) (vert, lat).....	15, 17dB
Typical selling price.....	£477

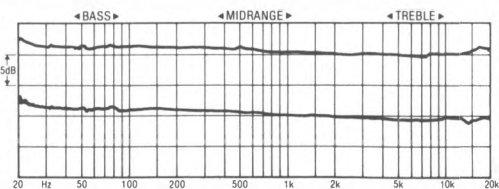

Frequency response, left and right channels

Koetsu Red

Absolute Sounds Ltd, 42 Parkside, London SW19
Tel 01-947 5047

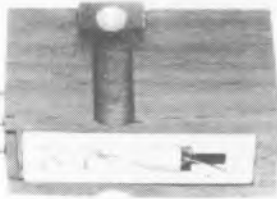

Considerably more expensive than the *Black*, the *Red* Koetsu is by far the prettier model, looking like an expensive Mah Jong tile in its beautifully finished rosewood sleeve. The stator and generator assemblies are built on a solid metal foundation, which can be bolted closely to the headshell.

Stylus type is unspecified, but consisted of an inherently fine small long-shank tip with mildly anomalous super-ellipse/line profile, slightly spoilt by an unsightly 'carbunkle' of adhesive on one side of the shank near the tip. Compliance is low, quite lightly damped, and mildly asymmetric, suited to a wide range of medium-high effective mass arms. Like the *Black*, despite near 2g downforce, margins of tracking ability are not generous, and may be further compromised if not used with the best tonearms.

Lab report

This low output moving-coil packs sufficient 'wallop' for some sensitive low noise moving magnet inputs, though some sort of step up stage will probably be necessary.

Frequency response was a further refinement on the *Black* in straightness: a line drawn between 30Hz and 20kHz would drop 2dB, but show no deviation greater than 0.5dB. Such trends as exist corroborate subjective observation of slight richness and brightness, but the high frequency region is remarkably flat and well controlled.

Channel balance was pretty good, though bettered by others, and there were several minor 'glitches' below 1kHz on the otherwise smooth trace.

Separation was exceptional in the upper mid and lower treble, but rather poorer at low frequencies and in the 16kHz band, and also showed rather higher output of ultrasonic suriae than the *Black*.

Sound quality

The magnificently 'laid back' balance seemed particularly well suited to classical music, and the sound showed a significant improvement in smoothness, control and refinement over the *Black*, further enhancing the stereo soundstage. Suiting panel speakers and valve amplification even better than the *Black*, it was a little less 'fiery' and exciting on dynamics, and sounded a touch 'slower' at low frequencies.

Conclusions

This beautiful cartridge could perhaps have done a little more to justify its very high price in terms of quality control, but is clearly a worthwhile graduation for those already seduced by the charms of the *Black*, with improved detail and control throughout the mid and treble. It is a little less forgiving of arm quality than the *Black*, and, inevitably, requires even more careful selection of ancillaries to make the most of its strengths.

TEST RESULTS

Type, mass.....	low output moving-coil 7.5g
Stylus type.....	specified high quality
Stylus inspection result.....	good superellipse but overglued
Output Level (1kHz, 5cm/s).....	0.34mV
Relative output (0dB = 1mV/cm/s).....	- 22dB
Channel balance.....	0dB
Channel separation (L,R).....	30, 30dB
Tracking ability (L,R).....	.74, .68µm
Frequency response limits 100Hz-5kHz.....	+ 1, - 1dB
Frequency response limits 30Hz-20kHz.....	+ 1, - 1.5dB
Stereo Separation L on R 100Hz, 3kHz, 10kHz.....	21, 36, 31dB
Stereo Separation R on L 100Hz, 3kHz, 10kHz.....	27, 39, 24dB
Channel diff. from graph, 100Hz, 1kHz, 10kHz.....	0.5, 0.5, 0.5dB
Response limits ref computer mean, 1kHz-15kHz.....	+ 2, - 1dB
Response limits ref computer mean, 1kHz-20kHz.....	+ 4, - 1dB
Test tracking weight, loading.....	1.9g, n.a.
LF resonance frequency, 12.5g arm (vert, lat).....	12, 11Hz
Estimated compliance (vert, lat).....	.9, 11cu
Recommended arm effective mass.....	9-18g
LF resonance rise, 12.5g arm (vert, lat).....	15, 15dB
Typical selling price.....	£687

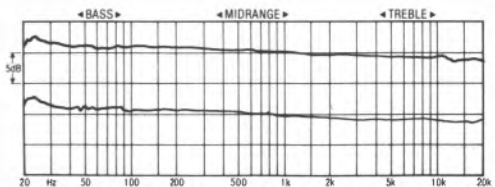

Frequency response, left and right channels

Linn Basik

Linn Products Ltd, 257 Drakemire Drive, Castlemilk, Glasgow G45 9SZ
Tel 041-634 0371

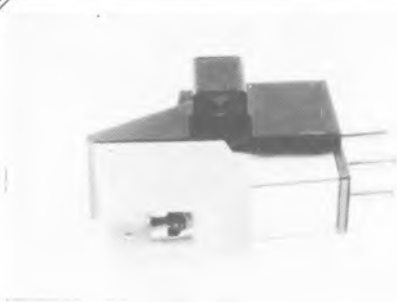

Conceived originally by Linn as a giveaway with the arm of the same name, to drive home the company's view that the arm is infinitely more important than the cartridge, the current model *Basik* is now available as a separate £16 item. It is made in Japan by Audio Technica and based on the *AT93E*, but seems to have acquired something of a cult reputation for itself as a 'giant killer'.

This simple moving magnet design has good mechanical properties in terms of body rigidity and stylus fit, though the stylus itself was rather heavily glued. Compliance is on the high side of medium, which means that arms should be on the low side of medium mass, a category which just about accommodates Linn's own designs!

Lab report

Output is quite sufficient in level, and although it is fairly tolerant of capacitance, there was little doubt that it sounded best well-loaded.

Frequency response actually measured best with low capacitance, where it was very good indeed, holding ± 1 dB from 20Hz-16kHz; increased capacitance emphasised the 10kHz peak a touch and curtailed the bandwidth slightly. Channel balance was poor in terms of absolute error. The high writing speed trace was a little untidy, confirming the slight unevenness on the original chart.

Separation was distinctly uninspiring, lurking around the 20dB mark, due we suspect to the lively highish vertical compliance. Tracking, on the other hand, was pretty good.

Sound quality

Reflecting its low cost in terms of general brashness and unsubtlety, the *Basik* nevertheless did a decent job in conveying detail and dynamics through most of the range, though surface noise tended to be exaggerated and

the sound could occasionally be described as 'fierce'. Definitely preferred on rock rather than classical music, this cartridge tried hard to give a good impression of overall integrity. Groove stability was reasonable.

Conclusions

No cartridge better deserves the epithet 'cheap and cheerful', yet the *Basik* goes much further in delivering the goods than its price level might indicate. It is one of the brightest-sounding amongst the better low cost cartridges, which will either be a blessing or a curse to the prospective purchaser, according to system and taste.

TEST RESULTS

Type, mass.....	moving magnet 5g
Stylus type.....	spherical?
Stylus inspection result.....	rather heavy glueing, small
Output Level (1kHz, 5cm/s).....	3.38mV
Relative output (0dB = 1mV/cm/s).....	- 1.5dB
Channel balance.....	-0.98dB
Channel separation (L,R).....	28.1, 28.5dB
Tracking ability (L,R).....	80, 80 μ m
Frequency response limits 100Hz-5Hz.....	+ 1, - 1dB
Frequency response limits 30Hz-20kHz.....	+ 1.5, - 3.5dB
Stereo Separation L on R 100Hz, 3kHz, 10kHz.....	20, 23, 19dB
Stereo Separation R on L 100Hz, 3kHz, 10kHz.....	20, 19, 16dB
Channel diff. from graph, 100Hz, 1kHz, 10kHz.....	1.5, 1.5, 1.5dB
Response limits ref computer mean, 1kHz-15kHz.....	+ 3, - 0dB
Response limits ref computer mean, 1kHz-20kHz.....	+ 3, - 2dB
Test tracking weight, loading.....	2g, 300pF
LF resonance frequency, 12.5g arm (vert, lat).....	8.8, 8.6Hz
Estimated compliance (vert, lat).....	25, 26 μ c
Recommended arm effective mass.....	6-14g
LF resonance rise, 12.5g arm (vert, lat).....	15.6, 11.2dB
Typical selling price.....	£16

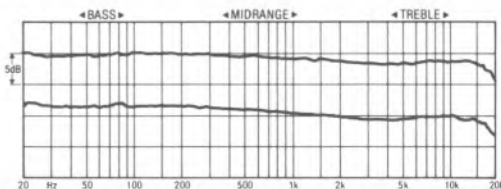

Frequency response, left and right channels

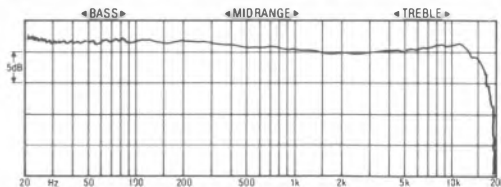

Frequency response with higher load capacitance

Linn K9

Linn Products Ltd, 257 Drakemire Drive, Castlemilk, Glasgow G45 9SZ
Tel 041-634 0371

BEST BUY

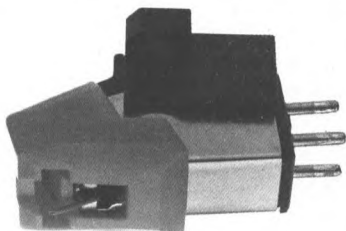

This latest Linn takes the cheap 'n' cheerful *Basik* as a starting point, beefs up the bodywork with a metal casting, improves the stylus assembly fit still further, and slaps on a Vital stylus with the clear intention of transforming something that nobody would describe as a sow's ear (*wouldn't they?* — Ed.) into the proverbial silk purse.

The mechanical improvements seem to be well founded, with plenty of headshell contact area, and inspection confirmed the presence of advanced elliptical Vital tip. Compliance indicates that low- or medium-mass arms will match well.

Electrical output suits normal moving magnet inputs, though capacitance loading will affect the frequency response. Tracking abilities were more than adequate at the sensible 1.8g downforce.

Lab report

With low capacitance loading the response showed a gentle 2dB downtilt between 200Hz and 6kHz, followed by a broad slight recovery and eventual rolloff. At the recommended and subjectively preferred higher loading the treble trough was reduced but a broad treble peak appeared, +1.5dB 10-13kHz.

While the frequency response was quite impressive, the separation betrayed the humble origins of the generator system. Not that the values were particularly poor, just that they were inferior to many others, with significant channel asymmetry.

Sound quality

Very conscious of the need to avoid bias in favour of a cartridge that must inevitably benefit from our use of the maker's own turntable and tonearm, our confidence was boosted by similarly high ratings and good comment consistency in two separate 'blind' panel presentations.

Linn seem to have succeeded in improving further the punchy delivery of the *Basik* while replacing the somewhat aggressive top end of the

cheap model with a much sweeter, more open, yet still slightly bright presentation.

Comments praised bass detail and differentiation, the 'liveliness' of strings, and good stereo staging, while acknowledging that the overall sound did not match the very best.

Conclusions

Even given the probable helpfulness of the ancillary equipment used in the listening tests, the *K9* has clearly succeeded in its goal of adding some extra refinement to the *Basik* package, delivering a lively and highly competitive middle market contender which clearly merits Best Buy status. A relatively lightly damped model, it should really only be considered for use with good quality turntables and tonearms.

TEST RESULTS

Type, mass.....	moving magnet 7.2g
Stylus type.....	'vital' elliptical
Stylus inspection result.....	high quality vital confirmed
Output Level (1kHz, 5cm/s).....	3.3mV
Relative output (0dB=1mV/cm/s).....	-1dB
Channel balance.....	0.4dB
Channel separation (L,R).....	23, 30dB
Tracking ability (L,R).....	80, 80µm
Frequency response from graph, 100Hz-5kHz.....	+1, -1.5dB
Frequency response from graph, 30Hz-20kHz.....	+1, -4dB
Stereo Separation L on R 80Hz, 3kHz, 10kHz.....	36, 34, 30dB
Stereo Separation R on L 80Hz, 3kHz, 10kHz.....	23, 27, 22dB
Response limits ref computer mean, 1kHz-15kHz.....	+3, -0.5dB
Response limits ref computer mean, 1kHz-20kHz.....	+3, -0.5dB
Test tracking weight, loading.....	1.8g, 200pF
LF resonance frequency, (13.5g arm) (vert, lat).....	9, 8Hz
Estimated compliance (vert, lat).....	16, 20cu
Recommended arm effective mass.....	6-15g
LF resonance rise, (13.5g arm) (vert, lat).....	12, 17dB
Typical selling price.....	£59

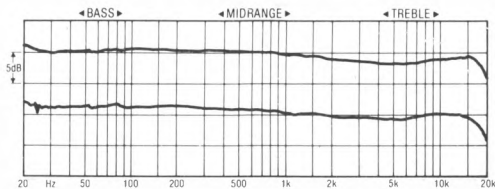

Frequency response, left and right channels

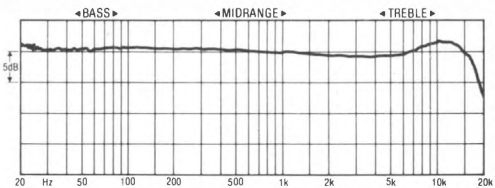

Frequency response with higher load capacitance

Linn Trak

Linn Products Ltd, 257 Drakemire Drive, Castlemilk, Glasgow G45 9SZ
Tel 041-634 0371

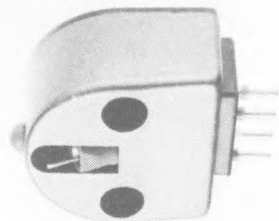

The *Trak* is a low cost version of the well respected and established *Asak*. It is understood to have slightly less stringent production tolerances and to undergo final quality control in Japan, without the automatic Glaswegian inspection applied to the most costly models.

It is a low output moving-coil model of solid construction, with a distinctive metallic blue can. A fine small nude stylus of rectangular section was well fitted. Tracking weight is 2g which helps cope with the low compliance. This is best suited to arms towards the middle of a 10-18g effective mass range, in view of the virtual absence of LF damping.

Lab report

Output is sufficient for any decent moving-coil stage, and the 470ohm recommended loading is pretty widespread, so there are unlikely to be any compatibility problems here.

Frequency response is very similar to all Linn's m-c models, fitting a fairly tight 3dB window across the bandwidth 40Hz-20kHz. The midrange downtilt was some 2.5dB between 200Hz and 5kHz, followed by a well controlled 11kHz peak and gentle rolloff thereafter. Channel balance was very close throughout, though the trace was a little livelier than the other Linn m-cs, with a few small 'glitches' at the low frequency end.

Separation was pretty good, if not quite to *Karma* standards, rarely falling below 30dB except for gentle worsening at high frequencies. Despite the name, tracking abilities were a bit marginal, though the lack of damping will place much of the responsibility on the turntable and arm.

Sound quality

The sound was considered a trifle 'heavy', a little recessed in the lower treble, and then with a slight emphasis at the extreme top. However,

'difficult' distorted treble was handled pretty well, and the sound was reassuringly solid, with fine full-range dynamics, good focus, and plenty of detail. All-in-all a thoroughly impressive result for the price, albeit leaning slightly in the direction of 'boom 'n' tizz'.

Conclusions

Clearly fine value for money in itself, the *Trak's* limitations lie more in the difficulties it can present tonearms than anywhere else, though tracking abilities are also a trifle suspect. The chances are that anyone with a tonearm capable of doing the *Trak* justice may well have set his cartridge sights a little higher than £126, yet at the same time this model definitely delivers the goods, and deserves warm recommendation.

TEST RESULTS

Type, mass.....	low output moving-coil 6g
Stylus type.....	vital
Stylus inspection result.....	confirmed, small nude rectangular special ell
Output Level (1kHz, 5cm/s).....	0.18mV
Relative output (0dB = 1mV/cm/s).....	- 26dB
Channel balance.....	0.25dB
Channel separation (L,R).....	27.2, 28.9dB
Tracking ability (L,R).....	74, 71µm
Frequency response limits 100Hz-5Hz.....	+ 1.5, - 1.5dB
Frequency response limits 30Hz-20kHz.....	+ 2.5, - 1.5dB
Stereo Separation L on R 100Hz, 3kHz, 10kHz.....	32, 24, 25dB
Stereo Separation R on L 100Hz, 3kHz, 10kHz.....	35, 30, 25dB
Channel diff. from graph, 100Hz, 1kHz, 10kHz.....	0, 0.5, 0dB
Response limits ref computer mean, 1kHz-15kHz.....	+ 2.5, - 0dB
Response limits ref computer mean, 1kHz-20kHz.....	+ 3.5, - 0dB
Test tracking weight, loading.....	2g, n.a.
LF resonance frequency, 12.5g arm (vert. lat).....	11.5, 12Hz
Estimated compliance (vert. lat).....	11, 10cu
Recommended arm effective mass.....	10-18g
LF resonance rise, 12.5g arm (vert. lat).....	17.5, 17.5dB
Typical selling price.....	£126

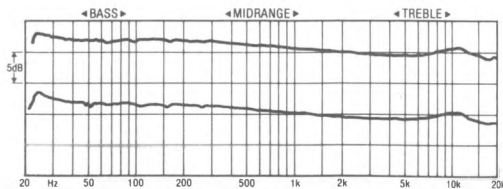

Frequency response, left and right channels

Linn Karma

Linn Products Ltd, 257 Drakemire Drive, Castlemilk, Glasgow G45 9SZ
Tel 041-634 0371

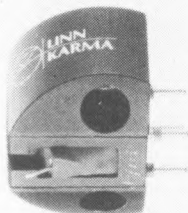

Since the decision to design their own cartridges for Supex to manufacture, rather than merely acting as the latter's distributors, Linn's models have increasingly taken their own path. *Karma* is clearly much more of a Linn cartridge than its predecessors.

The body is a small strong alloy casting. The (short) aluminium alloy cantilever carries a swept elliptical (Vital) tip, which was a tiny well-aligned rectangular section nude stone.

Compliance is low, symmetrical, and with very little damping, so medium-to-high mass arms are the rational choice, with the *Ittok* making an admirable match. Downforce is 1.7g, which gave adequate tracking abilities but left little in hand.

Lab report

Undoubtedly a low output model, the *Karma* still has sufficient output for any decent m-c input, with an easily met impedance recommendation of 470ohms.

Frequency response is smooth but with a fairly large 3dB downtilt, running from 100Hz to 5kHz, then a small, controlled 1dB peak at 10kHz, and a small 'glitch' at 14kHz. Channel balance was very close with fine control at high frequencies. At high writing speed, there was a solitary 'glitch' at 1.2kHz, ironically identical to the Koetsu *Black's* sole blemish!

Separation figures were amongst the best in the book.

Sound quality

With the best will in the world, the author is going to find it impossible to remain entirely dispassionate about the model he has purchased and been using over a thirty month period.

The *Karmasound* is essentially very weighty, powerful and extended in the bass, and slightly bright and brittle in the mid treble. Integration

and control are major strengths, yet there is none of the congestion that often accompanies more heavily damped models — *Karma* is very 'fast' in the manner of the Decca (though not to the same degree), yet extends this subjective speed over a much wider bandwidth. Focus, dynamics and projection in the midband are exceptional, but the sound is a little 'clinical', lacking the warmth, romance and depth of smoother sounding high-end models. Yet because of the fine integration, what seems to be less apparent detail translates into more coherent information.

Conclusions

Capable of superb results in the right system context, *Karma* sets new standards for bandwidth integration, and is uncoloured and fast to boot. But by coupling such a bandwidth of high mechanical energy to the tonearm, it also sets new standards for interface problems. While it may be strongly recommended for use in Linn-based systems, there must be similarly strong note of caution against more general applications, where results will be less predictable.

TEST RESULTS

Type, mass.....	low output moving-coil 6.2g
Stylus type.....	Vital superelliptical
Stylus inspection result.....	confirmed, fine small stone, accurately set
Output Level (1kHz, 5cm/s).....	0.2mV
Relative output (0dB = 1mV/cm/s).....	- 26dB
Channel balance.....	0.25dB
Channel separation (L,R).....	30, 30dB
Tracking ability (L,R).....	.80, 76µm
Frequency response limits 100Hz-5kHz.....	+ 2, - 1dB
Frequency response limits 30Hz-20kHz.....	+ 2, - 2dB
Stereo Separation L on R 100Hz, 3kHz, 10kHz.....	30, 33, 35dB
Stereo Separation R on L 100Hz, 3kHz, 10kHz.....	32, 37, 33dB
Channel diff. from graph, 100Hz, 1kHz, 10kHz.....	0, 0, 0.5dB
Response limits ref computer mean, 1kHz-15kHz.....	+ 1, - 0dB
Response limits ref computer mean, 1kHz-20kHz + 2.5.....	- 0dB
Test tracking weight, loading.....	1.7g, n.a.
LF resonance frequency, 12.5g arm (vert, lat).....	11.5, 11.5Hz
Estimated compliance (vert, lat).....	.12, .12cu
Recommended arm effective mass.....	9-18g
LF resonance rise, 12.5g arm (vert, lat).....	15.5, 14.5dB
Typical selling price.....	£345

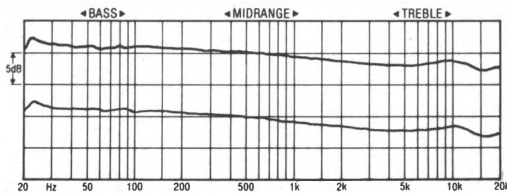

Frequency response, left and right channels

ABBOTT AUDIO

*East Midland Esoteric
Hi-Fi Consultant*

Evening and weekend demonstrations by appointment to hear esoteric Hi-Fi in a relaxing environment air, valve and mosfet amplifiers, audiostatic, electrostatic speakers, Beard amplifiers, Decca cartridges, Oddesey tonearms, Omega point turntables and tonearms. Stad turntables, Vectuer cable, Zarathustra turntable.

Personal attention and North West delivery. All the above equipment individually recommended and used by the proprietor: Alan Abbott.

**27 CHURCH LANE, BALDERTON
NEWARK, NOTTS**
Tel: Newark (0636) 77242

Your Guide to Good Audio in North Buckinghamshire



SELECTED PRODUCTS FROM:
A&R, AUDIOLAB, B&W, CELESTION, CREEK, DENON, DUAL, ELITE, HELIUS, HEYBROOK, KEF, LINN, MAGNUM, MERIDIAN, MISSION/CYRUS, MONITOR AUDIO, MORDAUNT SHORT, MUSICAL FIDELITY, MYST, NAKAMICHI, NYTECH, PINK TRIANGLE, QED, QUAD, RATA, ROGERS, ROTEL, SONDEX, SYSTEMDEK, TANNOY, WHARFEDALE AUDIO INSIGHT,
53 Wolverton Road, Stony Stratford,
Milton Keynes. MK11 1ED
Telephone 0908 61551



LINN K9



ORTOFON MC10 SUPER



KOETSU BLACK

RECOMMENDED BY THIS MAGAZINE

Other agencies include:

A&R • AUDIOLAB • BURMESTER • BRIER • BREUER • CELESTION • CREEK • DUAL • ELITE • TOWNSHEND • GOLDRING • GRADO • GALE • HELIUS • JPW • KOETSU • K.E.F. • KRELL • LINN PRODUCTS • MAGNAPLANAR • MERIDIAN • MISSION • MICHELL • MORDAUNTSHORT • MUSICAL FIDELITY • MYST • NYTECH • NIGHTINGALE • ORACLE • ONYX • PERREAUX • PINK TRIANGLE • PROTOU PS AUDIO • QUAD • REGA • ROGERS • ROTEL • SYSTEMDEK • YAMAHA • SUPEX • ZETA

KEITH MONKS RECORD CLEANING SERVICE AVAILABLE

Reading Hi-Fi Centre

READING HI-FI CENTRE, 6, HARRIS ARCADE,
FRIAR ST. READING, BERKS. RG1 1DN TELE (0734) 585463
Tues Sat 9.30am to 5.30pm (LUNCH 2 to 3pm. EXCEPT SAT
DEMONSTRATION APPOINTMENTS ADVISED)

Closed all day Monday

BADA

Mission Solitaire

Mission Electronics Ltd, Stonehill, Huntingdon, Cambridge PE18 6ED
Tel (0480) 57477



This conventional moving-magnet cartridge is sourced from the Far East and marketed by Mission Electronics as their middle model.

It uses a solid-looking plastic body with a decently fitting stylus assembly, the elliptical stylus itself being fairly substantial and firmly 'pegged' through the cantilever. Compliance and damping are both moderate, so a wide range of arm masses can be accommodated.

Lab report

This model has a substantial output, and is also quite sensitive to changes in capacitance, the graph clearly showing that the addition of 250pF increases the 10kHz level some 2.5dB. Though amplifier sensitivity is clearly no problem, some experimentation with capacitance loading could well pay off.

Frequency response looks impressively smooth and extended, though the midrange downturn with low capacitance is a full 5dB from 200Hz-8kHz. Increased capacitance reduces this to only 2dB, with the corner now turning at 5.5kHz, followed by a gentle 10kHz peak and fairly rapid rolloff thereafter. Channel balance was very impressive, with only very minor blemishes, and the high writing speed confirmed a pretty smooth trace with 'glitches' few and small.

Stereo separation was not too impressive, recording values in the mid twenties fairly consistently. Tracking abilities, on the other hand, were fine.

Sound quality

Described as 'firm' and 'punchy', the *Solitaire* had a touch of moving-coil character about its sound. Definition was limited at high frequencies, yet output was quite generous, so there was a touch of 'smear' which was mildly irritating. The midrange and upper bass were nice and clear with good dynamics, though the bass

proper sounded a touch congested and constrained.

Conclusions

One could be forgiven for overlooking the *Solitaire* because its lack of specific character is its major strength.

In fact it offers a very nice blend of compromises if examined closely, and should match well with turntables in the mid price sector, say from £150-£300, providing in many senses a slightly smoother and sweeter version of the inherently decent sound of leading budget models like the ADC *Phase 1*, Linn *Basik* and Ortofon *OM10*. Furthermore, the sensitivity to capacitance loading can be exploited for system matching.

TEST RESULTS

Type, mass.....	moving magnet 5.7g
Stylus type.....	elliptical
Stylus inspection result.....	substantial 'pegged' elliptical
Output Level (1kHz, 5cm/s).....	2.46mV
Relative output (0dB = 1mV/cm/s).....	-4dB
Channel balance.....	0.4dB
Channel separation (L,R).....	20.4, 30dB
Tracking ability (L,R).....	80, 80µm
Frequency response limits 100Hz-5Hz.....	+1.5, -1.5dB
Frequency response limits 30Hz-20kHz.....	+1.5, -4dB
Stereo Separation L on R 100Hz, 3kHz, 10kHz.....	19, 25, 22dB
Stereo Separation R on L 100Hz, 3kHz, 10kHz.....	22, 29, 25dB
Channel diff. from gr: ph, 100Hz, 1kHz, 10kHz.....	0, 0, 0dB
Response limits ref computer meqr, 1kHz-15kHz.....	+0, -1.5dB
Response limits ref computer mean, 1kHz-20kHz +0, -1.5dB	
Test tracking weight, loading.....	1.8g, 200pF
LF resonance frequency, 12.5g arm (vert, lat).....	10, 10Hz
Estimated compliance (vert, lat).....	15, 15cu
Recommended arm effective mass.....	1.6-1g
LF resonance rise, 12.5g arm (vert, lat).....	13.5, 12.5dB
Typical selling price.....	£40

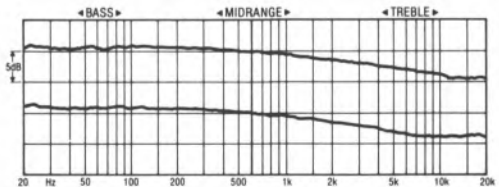

Frequency response, left and right channels

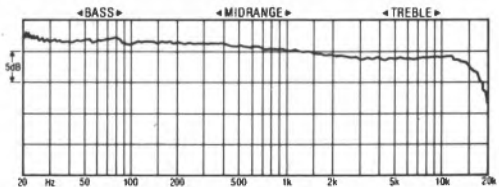

Frequency response with higher load capacitance

Monster Alpha 2

Wilmex Ltd, Compton House, New Malden, Surrey KT3 4DE
Tel: 01-949 2545



Though they are still something of a rarity in the UK, American cable and accessory specialist Monster have had something of a hit in the US with their Japan-sourced moving-coil cartridges.

The *Alpha 2* is an expensive low output m-c model. The good quality of the 'ridged' stylus profile was confirmed under examination, and the body construction looks eminently capable of rigid headshell fixing, despite its semicircular lugs. Though the source of the *Alpha 2* was not revealed, it resembled the *Highphonic* a little in construction, being compact with a substantial (6.5g) alloy body.

Horizontal compliance was theoretically a little high for our medium mass test arm, so low mass arms are generally to be preferred, though the substantial internal damping should permit almost any tonearm to be used without undue difficulty.

Output level is ample for normal moving-coil (low output) amplifier inputs.

Lab report

Response was generally smooth, with just a couple of 'glitches', downtilting quite gently a couple of dB between 200Hz and 4kHz, recovering around 10kHz, whereupon the channels diverged by 4dB — a reasonable but not exceptional result.

Separation was outstanding, maintaining 40dB or better from lowest frequencies until well into the treble, a still impressive 28dB at 20kHz, and no evidence of ultrasonic spurious.

Sound quality

The Monster received a slightly mixed reception during the listening tests, faring well enough to establish its inherently fine quality, if not perhaps to justify its exceptionally high price. The general impression was of good neutrality in relationship to Compact Disc. The sound was open and spacious, though a trifle obtrusive in the treble. Bouncy and lively, the bass was a little 'soft'.

Overall the Monster came over as a fine all-rounder in terms of sound, without particularly excelling in any single respect.

Conclusions

This is a first rate cartridge in many respects, offering fine sound quality and better tracking ability than many top moving-coil models. However, compliance is a little high for many of the best tonearms, and the damping a little high for the sort of turntables such an exotic ought to partner. In the final analysis this fine all-rounder is insufficiently exceptional in any specific respect to justify fully the high UK price.

TEST RESULTS

Type, mass.....	low output moving-coil 6.5g
Stylus type.....	'micro-ridge'
Stylus inspection result.....	fine quality small nude stone
Output Level (1kHz, 5cm/s).....	0.31mV
Relative output (0dB=1mV/cm/s).....	-22dB
Channel balance.....	0dB
Channel separation (L,R).....	30, 30dB
Tracking ability (L,R).....	80, 74µm
Frequency response from graph, 100Hz-5kHz.....	+1.5, -0.5dB
Frequency response from graph, 30Hz-20kHz.....	+2, -2.5dB
Stereo Separation L on R 80Hz, 3kHz, 10kHz.....	39, 48, 32dB
Stereo Separation R on L 80Hz, 3kHz, 10kHz.....	41, 42, 31dB
Response limits ref computer mean, 1kHz-15kHz.....	+2.5, -0dB
Response limits ref computer mean, 1kHz-20kHz.....	+5, -0dB
Test tracking weight, loading.....	1.75g, n.a.pF
LF resonance frequency, (13.5g arm) (vert, lat).....	9, 7Hz
Estimated compliance (vert, lat).....	17, 27cu
Recommended arm effective mass.....	6-14g
LF resonance rise, (13.5g arm) (vert, lat).....	10, 11dB
Typical selling price.....	£479

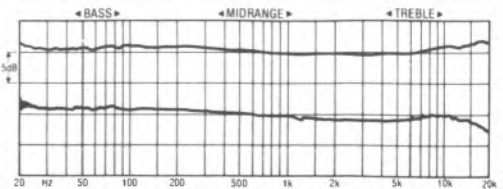

Frequency response, left and right channels

Nagaoka MP10

Three Marketing Ltd, 1 Berens Road, London NW10 5DY
Tel 01-969 2514

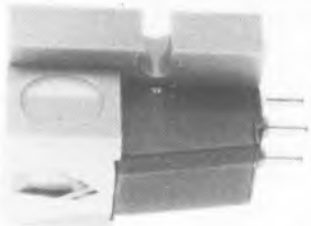
BEST BUY

Very much the 'baby' of the Nagaoka moving magnet range, the *MP10* shares the same impressively rigid body structure, albeit as a plastic moulding in an unattractive dull red colour, with lower mass than the metal models higher up the range. Humbly sporting a spherical tip, which was actually quite small and neatly mounted, a substantial 2.3g downforce ensures good tracking ability and groove stability.

Compliance is lower, nicely symmetrical, and less damped than the other Nagaokas, so although the *MP10* is probably best served by low mass arms, medium mass models are almost as suitable.

Lab report

Substantial enough in output for any moving magnet input, Nagaoka specify low capacitance loading, which should be particularly respected in this instance, as the treble rolloff is already quite severe, and is only made worse by increasing capacitance.

Frequency response shows a pronounced downtilt commencing at 300Hz, increasing in slope a little around 2kHz until levelling out some 5dB down at 13kHz, then finally rolling off at 17kHz. Despite the inaccuracy of this response in absolute terms, the lack of sudden change throughout the band is praiseworthy. Furthermore, channel balance stayed closely within 0.5dB, and 'glitches' were merely minor unevennesses, predominantly below 1kHz.

Separation figures rivalled many cartridges costing many times the price, even showing respectable control at high frequencies.

Sound quality

Despite the treble rolloff, which in the manner of spherical styli becomes more severe towards the end of a side (our response was taken at roughly the middle of a side), the *MP10*

was very well liked for the 'seamlessness' and control of its sound, which showed remarkably good integration for such a low cost design. High frequencies did sound 'shut in', and depth was curtailed, but the bass and mid were satisfyingly energetic, 'bouncy' and 'punchy'.

Conclusions

An obvious Best Buy; spherical tip apart, the *MP10* is clearly substantially better balanced than the other Nagaokas, with much better stability and control than the over-compliant '11 which seems to have been consistently overrated by other magazines. Moreover, the slightly 'dim' balance could well prove to be an ideal partner to the less-than-tidy tonearms, amplifiers and loudspeaker which its price suggests will be frequent partners.

TEST RESULTS

Type, mass.....moving magnet 6.8g
Stylus type.....spherical
Stylus inspection result.....small and neat
Output Level (1kHz, 5cm/s).....3.75mV
Relative output (0dB = 1mV/cm/s).....0.9dB
Channel balance.....0.54dB
Channel separation (L,R).....28.9, 30dB
Tracking ability (L,R).....80, 80µm
Frequency response limits 100Hz-5Hz.....+ 1, - 3dB
Frequency response limits 30Hz-20kHz.....+ 1.5, - 7dB
Stereo Separation L on R 100Hz, 3kHz, 10kHz.....27, 29, 24dB
Stereo Separation R on L 100Hz, 3kHz, 10kHz.....32, 30, 25dB
Channel diff. from graph, 100Hz, 1kHz, 10kHz.....0.5, 0, 0dB
Response limits ref computer mean, 1kHz-15kHz.....+ 0, - 3.5dB
Response limits ref computer mean, 1kHz-20kHz.....+ 0, - 4dB
Test tracking weight, loading.....2.3g, 100pF
LF resonance frequency, 12.5g arm (vert, lat).....9, 8.7Hz
Estimated compliance (vert, lat).....17, 18cu
Recommended arm effective mass.....5-13g
LF resonance rise, 12.5g arm (vert, lat).....11.3, 12.3dB
Typical selling price.....£14

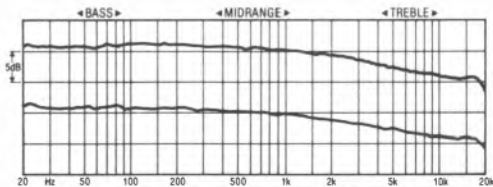

Frequency response, left and right channels

BEST BUY

Nagaoka MP11 Boron

Path Ltd, 1 Berens Road, London NW10 5DY
Tel: 01-969 2514



The *MP11* has been a particular favourite in Nagaoka's range of moving magnet models for some years, though our tests in fact favoured the *MP10*. Nagaoka have now taken the unusual and creative step of introducing a *Boron* version, featuring a cantilever made from this exotic material, usually only found on exotically priced cartridges.

This is a large cartridge which is also on the heavy side, but it has a fairly well-fitting stylus assembly and a good body shape which can be fixed firmly enough in the headshell despite semicircular lugs.

Our original preference for the *MP10* was due to the '11's undesirably high compliance. The *Boron* comes in with a much more sensible compliance, closer to the '10 than the '11 yet high enough to ensure good tracking performance at the sensible 2g tracking weight. Nevertheless low and medium mass arms will match best, and decent quality turntables should be used as internal damping is modest.

Electrical output is fine for any normal input, though capacitance variations do have an influence on the response. Channel balance was a reasonable 0.6dB.

Lab report

Both responses were good by any standards. With the recommended low capacitance a gentle 2dB downtilt from 200Hz to 10kHz was followed by a 2-3dB peak at 18kHz. With higher capacitance the response held within ± 0.5 dB to 12kHz, rolling off thereafter. It is something of a moot point as to which of the two is to be preferred.

Separation was reasonable enough, though decidedly asymmetric between the channels.

Sound quality

Subjectively, the *MP11 Boron* was in fact preferred with additional capacitance, sounding a little 'spitty' with low loading.

Reactions varied somewhat, but were generally very favourable considering the modest price. A major strength was the overall balance, which was 'weighty' and 'powerful', conveying a good sense of scale and space. Low level resolution and dynamics attracted some mild criticism, however, as did some 'thickening' in the bass and midrange.

Conclusions

While this could not be described as a particularly exciting cartridge, it auditioned well and the technical performance was also entirely adequate. It is certainly good enough to respond to good quality ancillaries, and certainly merits a 'Best Buy' rating.

TEST RESULTS

Type, mass.....	moving magnet 6.8g
Stylus type.....	elliptical
Stylus inspection result.....	mild elliptical
Output Level (1kHz, 5cm/s).....	4mV
Relative output (0dB=1mV/cm/s).....	0dB
Channel balance.....	-0.6dB
Channel separation (L,R).....	30, 23dB
Tracking ability (L,R).....	80, 80 μ m
Frequency response from graph, 100Hz-5kHz.....	+0.5, -1dB
Frequency response from graph, 30Hz-20kHz.....	+0.5, -1.5dB
Stereo Separation L on R 80Hz, 3kHz, 10kHz.....	37, 45, 32dB
Stereo Separation R on L 80Hz, 3kHz, 10kHz.....	30, 31, 20dB
Response limits ref computer mean, 1kHz-15kHz.....	+3, -0dB
Response limits ref computer mean, 1kHz-20kHz.....	+3, -5dB
Test tracking weight, loading.....	2g, 100pF
LF resonance frequency, (13.5g arm) (vert, lat).....	8, 8Hz
Estimated compliance (vert, lat).....	20, 20cu
Recommended arm effective mass.....	5-13g
LF resonance rise, (13.5g arm) (vert, lat).....	15, 15dB
Typical selling price.....	£29

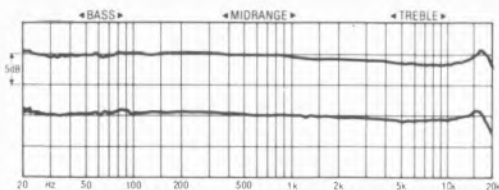

Frequency response, left and right channels

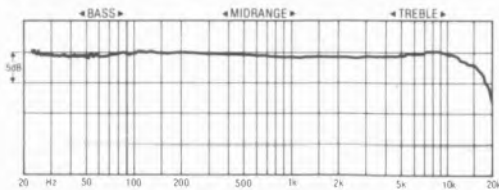

Frequency response with higher load capacitance

Ortofon OM5E

Ortofon (UK) Ltd, Denmark House, Tavistock Industrial Estate, Ruscombe, Twyford, Berks RG10 9NJ
Tel: (0734) 343621



After the success of the £16 *OM10* during the previous project, we wondered how well the even cheaper *OM5E* would perform, and determine whether £10 could be regarded as the new 'lower limit' for a pedigree hi-fi cartridge.

'OM' stands for Optional Mass, and the OM cartridges are of light construction to offer a base of 2.5g, useful in extending compatibility to high mass arms if an appropriate counterweight is available. Alternatively, ballast is added to make up a more conventional 5g total, better to match low and medium mass arms.

This construction leads inevitably to some reduction in rigidity. Compact design helps here, but the integral mounting bracket looks rather flimsy. The stylus assembly fitted quite well, and although it is perhaps a little surprising to find an elliptical tip at such a low price, this proved about as basic as could be.

The optional mass helps take care of wide arm compatibility, but compliance is sensible in any case, with average damping, permitting decent enough tracking ability at the sensible 1.8g downforce.

Electrical output is ample, though a channel imbalance of 1.2dB was recorded.

Lab report

Frequency responses show the substantial effect that pre-amp load changes can have. The recommended low capacitance gives a smooth, extended and determinedly downtilted response, dropping 4-5dB from 200Hz. Higher capacitance reduces the bandwidth an octave to 10kHz, but cuts the downtilt to 1.5dB. The unfortunate consequence of (presumably) the bracket construction can be seen in the harmonic series of 'glitches' starting around 1kHz. Separation was pretty good, if rather uneven and asymmetric.

Sound quality

Unlike its slightly more expensive stablemate, the

OM5E did not generate any particular enthusiasm amongst the listening panel, with adjectives like 'slow', 'murky' and 'nondescript' typical of those appearing in the comments. The vocal range was quite well projected, albeit with some coloration, while definition and 'speed' at the frequency extremes was clearly lacking.

Conclusions

Where the *OM10* is a hi-fi cartridge, on the basis of these results the *OM5E* is not. There had to be a level below which it was inadvisable to go, and it obviously lies between £10 and £16. Competent, yes, in many ways, the '5E failed to make the grade on sound quality.

TEST RESULTS

Type, mass.....	moving magnet 2.5/5g*
Stylus type.....	elliptical
Stylus inspection result.....	very mild elliptical
Output Level (1kHz, 5cm/s).....	4mV
Relative output (0dB=1mV/cm/s).....	0.0dB
Channel balance.....	1.2dB
Channel separation (L,R).....	30, 30dB
Tracking ability (L,R).....	80, 72µm
Frequency response from graph, 100Hz-5kHz.....	+1.5, -1.5dB
Frequency response from graph, 30Hz-20kHz.....	+1.5, -5.5dB
Stereo Separation L on R 80Hz, 3kHz, 10kHz.....	29, 35, 38dB
Stereo Separation R on L 80Hz, 3kHz, 10kHz.....	32, 42, 33dB
Response limits ref computer mean, 1kHz-15kHz.....	+0, -3dB
Response limits ref computer mean, 1kHz-20kHz.....	+1, -3dB
Test tracking weight, loading.....	1.8g, 150µF
LF resonance frequency, (13.5g arm) (vert, lat).....	9, 9Hz
Estimated compliance (13.5g arm) (vert, lat).....	18, 18cu
Recommended arm effective mass.....	5-16g
LF resonance rise, (13.5g arm) (vert, lat).....	12, 14dB
Typical selling price.....	£10

*optional, tested at 5g

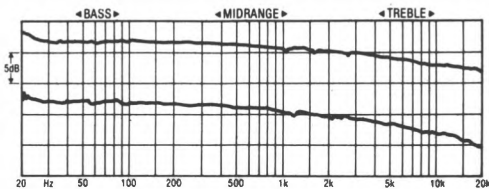

Frequency response, left and right channels



Frequency response with higher load capacitance

BEST BUY

Ortofon OM10

Ortofon UK Ltd, Denmark House, Tavistock Industrial Estate, Ruscombe, Twyford, Berks RG10 9NJ
Tel (0734) 343621

This cartridge is often supplied with the popular Dual 505 budget turntable, and is also available as a separate item. The OM designation refers to an optional mass facility, because the 5g cartridge mass contains 2.5g of ballast, which may be removed if the tonearm is capable of balancing such a low mass.

Experiencing this difficulty ourselves, we elected to retain the ballast, but this option, theoretically at least, should allow a wider range of arm masses to be accommodated.

However, it can be argued that the provision of mass as mere ballast must compromise structural rigidity, and certainly the body mounting was rather skeletal, though the stylus assembly made a good fit. Compliance was moderate enough to suit a wide range of arms, the heavier ones benefitting from ballast removal.

Lab report

With enough output to drive any amplifier, this model is designed to work into a high impedance capacitance to achieve the manufacturer's intended results at the high frequency resonance. Where pre-amp input loading is low, adaptors may be used in the signal line.

Frequency response looks most impressive despite the low cost of the cartridge, dropping quite smoothly 3dB between 100Hz and 7kHz, then rallying to 19kHz. Adding capacitance to the manufacturer's recommendation reduces the treble droop to 1dB at 3kHz, and the response starts rolling gently at 10kHz. Channel balance was found to be quite close, but with a broad 0.5dB error 100-600Hz which cannot be corrected and may be audible. There is also evidence of quite pronounced 'glitches' in response at 500Hz and 1.2kHz, with some general unevenness at high frequencies.

Separation figures were pretty good, albeit asymmetric to a marked degree between

channels and with significant sample variation, while tracking abilities were fine.

Sound quality

Nice but noisy (referring to record surfaces) is a snapshot comment on the OM10 sound. High frequencies were audibly down compared with the more expensive OMs, but were nevertheless clean and well controlled.

The midrange was nicely integrated and open-sounding, while the bass did show a degree of overhang.

Conclusions

Clearly one of the leading 'cheapies', the OM10 gives a decent overall performance, albeit with some sample variation, not to mention a fine level of sound quality for the price.

TEST RESULTS

Type, mass.....	moving magnet 5g*
Stylus type.....	E
Stylus inspection result.....	neatly mounted simple elliptical
Output Level (1kHz, 5cm/s).....	3.6mV
Relative output (0dB = 1mV/cm/s).....	-1dB
Channel balance.....	0.23dB
Channel separation (L,R).....	23.6, 21.6dB
Tracking ability (L,R).....	80, 80µm
Frequency response limits 100Hz-5Hz.....	+1, -5dB
Stereo Separation L on R 100Hz, 3kHz, 10kHz.....	30, 45, 39dB
Stereo Separation R on L 100Hz, 3kHz, 10kHz.....	22, 24, 25dB
Channel diff. from graph 100Hz, 1kHz, 10kHz.....	0.5, 0.5, 0.5dB
Response limits ref computer mean, 1kHz-15kHz.....	+1.5, -0dB
Response limits ref computer mean, 1kHz-20kHz.....	+1.5, -0dB
Test tracking weight, loading.....	1.5g, 400pF
LF resonance frequency, 12.5g arm (vert, lat).....	9, 7.6Hz
Estimated compliance (vert, lat).....	19, 24cu
Recommended arm effective mass.....	5-15g**
LF resonance rise, 12.5g arm (vert, lat).....	7, 11.7dB
Typical selling price.....	£16

*Includes 2.5g ballast

**If arm can be re-balanced with ballast removed

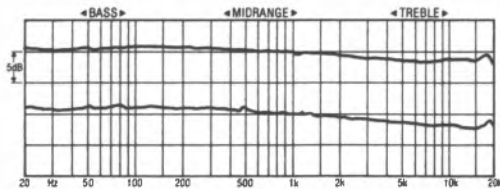

Frequency response, left and right channels

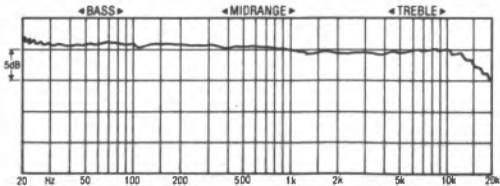

Frequency response with higher load capacitance

Ortofon OM20

Ortofon UK Ltd, Denmark House, Tavistock Industrial Estate, Ruscombe, Twyford, Berks RG10 9NJ
Tel (0734) 343621

RECOMMENDED



This is the £37 middle model in Ortofon's stylish 'optional mass' range of moving magnet cartridges. It is a 2.5g cartridge with 2.5g of removable ballast, the latter necessary more to enable conventional arm counterbalances to work than for any other reason, as it contributes nothing to the structural rigidity. In fact body rigidity is not too bad and stylus fit is quite good.

Even fully laden, the OM20 can match a fair range of arm effective masses, though high mass examples will benefit from ballast removal. Tracking weight is a low 1.25g, but tracking ability was still good.

Lab report

Substantial output avoids any likelihood of amplifier sensitivity mismatch. Ortofon usually specify high capacitance loading, but there was no mention in the instruction leaflet on this occasion. In fact the subjective difference was quite slight, and the measured change not that great either.

Frequency response was very flat with capacitance loading, falling within a 1dB 'window' from 30Hz to 15kHz, while without capacitance the high frequency extension was marginally increased, at the expense of an overall 2dB 'window'. Channel balance was a little disappointing, and 'glitches', relating to the mounting we suspect, are visible either side of 1kHz. The trace as a whole was a little uneven at high frequencies, but not severely so.

Separation figures were reasonable enough, and were well maintained at high frequencies, though they were somewhat asymmetric and uneven throughout the band.

Sound quality

Generally very well balanced tonally, if a touch 'thin' and 'bright', the OM20 succeeds

handsomely as an all-rounder despite a certain lack of excitement. Focus, depth and dynamics were well below the best, but the general level of competence and control were very convincing, with good lateral stereo.

Conclusions

Definitely deserving recommendation, this turned out to be our favourite amongst Ortofon's moving magnet cartridges. While it may not produce one of the most dynamic sounds around, it offers impressive compatibility mechanically and sonically with the fairly modest equipment which one would expect it to partner, and generally delivers the goods in a well-balanced manner.

TEST RESULTS

Type, mass.....	moving magnet 5g*
Stylus type.....	'E'
Stylus inspection result.....	mild elliptical, decent quality
Output Level (1kHz, 5cm/s).....	3.6mV
Relative output (0dB = 1mV/cm/s).....	- 1dB
Channel balance.....	0.23dB
Channel separation (L, R).....	23.6, 21.6dB
Tracking ability (L, R).....	80, 60µm
Frequency response limits 100Hz-5kHz.....	+ 1, - 0dB
Frequency response limits 30Hz-20kHz.....	+ 1.5, - 0dB
Stereo Separation L on R 100Hz, 3kHz, 10kHz.....	30, 26, 25dB
Stereo Separation R on L 100Hz, 3kHz, 10kHz.....	35, 36, 28dB
Channel diff. from graph, 100Hz, 1kHz, 10kHz.....	1, 1, 1.5dB
Response limits ref computer mean, 1kHz-15kHz.....	+ 1.5, - 0dB
Response limits ref computer mean, 1kHz-20kHz.....	+ 1.5, - 0dB
Test tracking weight, loading.....	1.25g, 400pF
LF resonance frequency, 12.5g arm (vert, lat).....	9, 7.6Hz
Estimated compliance (vert, lat).....	21, 25cu
Recommended arm effective mass.....	5-16g**
LF resonance rise, 12.5g arm (vert, lat).....	7, 11.7dB
Typical selling price.....	£37

*includes 2.5g ballast

**if arm balances with ballast removed

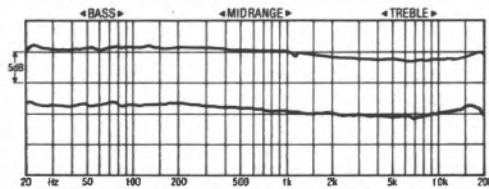

Frequency response, left and right channels

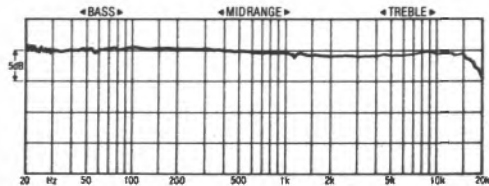

Frequency response with higher load capacitance

BEST BUY

Ortofon MC10 Super

Ortofon UK Ltd, Denmark House, Tavistock Industrial Estate, Ruscombe, Twyford, Berks RG10 9NJ
Tel (0734) 343621

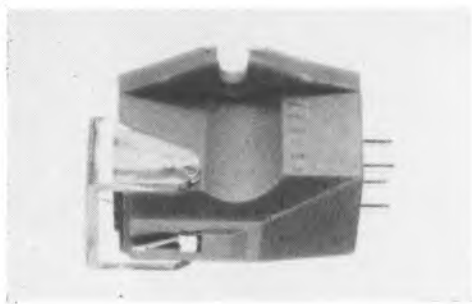

Ortofon deserve considerable respect for their singlehanded bearing of the moving-coil torch through the dark years of moving magnet domination. But when the 'coils became fashionable again, and lots of amplifiers started including provision for low output cartridges (so removing all the hassle of step-up devices), they were left a little out on a limb, with such low outputs that transformers were still almost mandatory.

The new *MC10 Super* sets out to change all that, providing a fully competitive and comparable £50 model in the middle of the popular price bracket. There are still a few of the old oddities around it's true to say, including the unusually 'deep' body, requiring different arm height adjustment from most other models, not to mention the silly hinged stylus guard, and semicircular mounting lugs which are prone to 'distortion'. Stylus was an accurately shaped and aligned small nude elliptical.

Compliance is impressively symmetrical, lightly damped, and very sensibly chosen for low- to-medium mass arms. Although the tracking reserve is not great, it will still be sufficient for all but the most extreme cases.

Lab report

Output level is close to ideal for normal amplifier moving-coil inputs, and the really clever trick is that Ortofon have done this while retaining the sonically superior low impedance coils.

Frequency response shows a fairly pronounced midrange downtilt amounting to some 3dB between 200Hz and 7kHz, whereupon there was a mild and slightly uneven recovery. Channel balance was pretty good throughout. The overall trace showed areas of vague unevenness, but no distinct resonances.

Separation figures were rather average, though quite well balanced and notably well

maintained at high frequencies.

Sound quality

What a delightfully sweet-sounding cartridge this is. There is a touch of the 'boom'n'tizz' which indicates a little loss of control at the frequency extremes, but even these balance each other nicely, while the midrange sounds delightfully clear, open and uncongested, with decent stereo, depth, dynamics and focus, and a pleasantly 'airy' sound. It has much of the delicacy of far more expensive designs, if lacking quite the same degree of control, sophistication and smoothness.

Conclusions

Ortofon's extensive experience has somehow managed to come up with a beautifully judged package which combines the full open, dynamic qualities of moving-coils without resort to overdamping or undue lack of control. The balance errs a trifle on the latter side (indicated by the separation figures perhaps), which may place a premium on the quality of the turntable. But it is hard to envisage a better overall combination of the various parameters within the cost constraints.

TEST RESULTS

Type, mass.....	low output moving-coil 7.2g
Stylus type.....	'E'
Stylus inspection result.....	fine small nude elliptical
Output Level (1kHz, 5cm/s).....	0.32mV
Relative output (0dB = 1mV/cm/s).....	- 22dB
Channel balance.....	0.1dB
Channel separation (L,R).....	30, 30dB
Tracking ability (L,R).....	75, 74µm
Frequency response limits 100Hz-5Hz.....	+ 1.5, - 1dB
Frequency response limits 30Hz-20kHz.....	+ 1.5, - 2dB
Stereo Separation L on R 100Hz, 3kHz, 10kHz.....	22, 26, 20dB
Stereo Separation R on L 100Hz, 3kHz, 10kHz.....	24, 28, 21dB
Channel diff. from graph, 100Hz, 1kHz, 10kHz.....	0.5, 0.5, 0.5dB
Response limits ref computer mean, 1kHz-15kHz.....	+ 3, - 0dB
Response limits ref computer mean, 1kHz-20kHz + 3.5, - 0dB	
Test tracking weight, loading.....	1.5g, n.a.
LF resonance frequency, 12.5g arm (vert, lat).....	9, 9Hz
Estimated compliance (vert, lat).....	15, 15cu
Recommended arm effective mass.....	5-15g
LF resonance rise, 12.5g arm (vert, lat).....	14, 12dB
Typical selling price.....	£49



Frequency response, left and right channels

RATA RP20

Russ Andrews Turntable Accessories, Edgebank House, Skelsmergh, Cumbria LA8 9AS
Tel (05398) 3247

RECOMMENDED

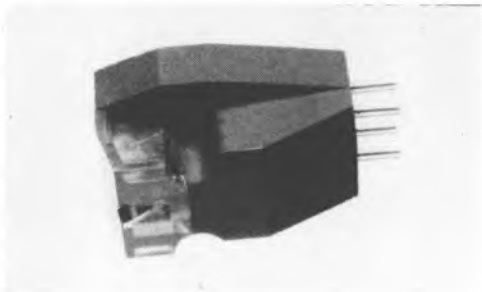

For a number of years now, RATA have been importing and distributing fairly expensive Grace and Supex cartridge models from Japan; more recently they have launched a home-grown range under their own brand name. First of the RATA models to appear was the *RP20*, which is built for Russ Andrews by Goldring, and in fact shares a common body with the Goldring *Epic*. The body design is inherently good, if rather allowing tight mounting with a good contact area. Internal wiring differs from that of the *Epic*, as does the elliptical tip, which has a rather sharper profile. However, the inherent shape is good, if bulky. Stylus fit is pretty secure.

Compliance is close enough to the *Epic* for a similar range of suitable arm masses, but damping is lighter, so the heavier arms are better avoided, particularly as tracking weight is reduced to 1.5g.

Lab report

The healthy output will drive amplifiers most efficiently. Claimed to be independent of loading capacitance, our sample still showed both measured and audible improvement when using high capacitance.

The response trace illustrates the reduced damping at high frequencies, where the treble flattens out at around 5kHz and then regrettably builds up to a substantial peak on one channel, though the other channel is very impressively controlled. Once again the slight 800Hz 'glitch' is visible, though the trace is nice and steady otherwise. Tracking abilities and groove stability seemed much the same, in spite of the lower tracking weight.

Sound quality

Marred by the distinctly audible treble peak on one channel (5dB difference between channels!), the sound was otherwise very promising for the price, with good integration

and low frequency solidity, and a clear dynamic midrange with the beginnings of fine stereo imaging. The 'sparkle' was a bit strong at the top of course, and tended to upset the imaging rather, but hopefully this is merely a sample problem.

Conclusions

Despite the treble problems of our sample, and now that body strength is improved, this model clearly merits recommendation. It offers an inherently rather better balanced sound than the *Epic* which justifies the slightly higher cost.

TEST RESULTS

Type, mass.....	moving magnet 7.6g
Stylus type.....	simple elliptical
Stylus inspection result.....	confirmed neat mounting
Output Level (1kHz, 5cm/s).....	3.55mV
Relative output (0dB = 1mV/cm/s).....	- 1dB
Channel balance.....	0.9dB
Channel separation (L,R).....	28, 26.6dB
Tracking ability (L,R).....	.80, 80µm
Frequency response limits 100Hz-5kHz.....	+ 1, - 2.5dB
Frequency response limits 30Hz-20kHz.....	+ 26, 41, - 27dB
Stereo Separation L on R 100Hz, 3kHz, 10kHz.....	19, 24, 27dB
Stereo Separation R on L 100Hz, 3kHz, 10kHz.....	1, 1, 0dB
Channel diff. from graph, 100Hz, 1kHz, 10kHz.....	+ 3, - 1dB
Response limits ref computer mean, 1kHz-15kHz.....	+ 6, - 1dB
Response limits ref computer mean, 1kHz-20kHz.....	1.8g, 250pF
Test tracking weight, loading.....	9, 9Hz
LF resonance frequency, 12.5g arm (vert, lat).....	15, 15cu
Estimated compliance (vert, lat).....	6-14g
Recommended arm effective mass.....	15, 14dB
LF resonance rise, 12.5g arm (vert, lat).....	.£20
Typical selling price.....	

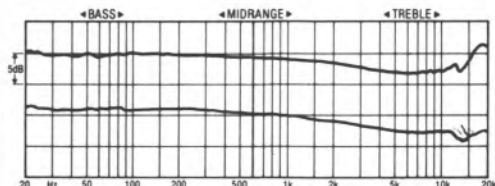

Frequency response, left and right channels

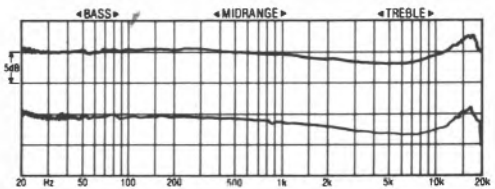

Frequency response with higher load capacitance

RATA RP40

Russ Andrews Turntable Accessories, Edgebank House, Skelsmergh, Kendal, Cumbria LA8 9AB
Tel: (053 983) 247



In the last edition, *Choice* encountered the Goldring *Epic* for the first time, along with a first own-brand model from RATA, based on the *Epic* body but with variations in generator and stylus.

Now RATA have gone a couple of steps further, and the *RP40* is the next stage of refinement up, with a high quality conventional elliptical stylus.

Rather bulky and heavy, the body has full circular lugs and a generous mounting area for proper mechanical coupling to the headshell; the plastic is now strengthened, after our problem with cracking and crumbling last year. Stylus assembly fit is excellently tight.

Mechanically, it suits low and medium mass arms. Compliance is somewhat asymmetrical, and reasonably well-damped. At (1.5g) downforce, tracking abilities were good, and channel balance was close.

Lab report

Frequency responses looked far from promising, falling a full 3.5dB to the 8kHz trough, then rising 5-6dB to an ultrasonic 19kHz peak. The addition of capacitance has little effect with this generator, reducing the trough depth a dB or so. The high quality mechanical design is reflected in the smooth traces with just a single 'glitch'.

Further evidence of this may be seen in the fine separation performance, which was also smooth, unusually well extended, and almost perfectly symmetrical, with values between 33 and 40dB steadily improving to unusually high frequencies.

Sound quality

The *RP40* was quite well received despite the recognised oddities of its response characteristic. Balance was determinedly 'heavy', yet with a slight 'edge' at high frequencies. Focus was quite good, and stereo spread excellent, with an impressive sense of scale. Good midrange and treble detail, and decent dynamic resolution were also noted, as the '40 did a good job of sorting out the layers

and complexity of the mix.

Conclusions

Behind the far from neutral balance, there is a fine cartridge doing its best, showing fine cantilever control at high frequencies, with good stereo and detail as a result. Whether the balance is desirable or tolerable will depend to a degree upon the other bits of a system, but if this aspect works out, the *RP40* is an impressive contender, meriting cautious recommendation.

TEST RESULTS

Type, mass	moving magnet 7.1g
Stylus type	elliptical
Stylus inspection result	good quality elliptical
Output Level (1kHz, 5cm/s)	3.7mV
Relative output (0dB=1mV/cm/s)	-1dB
Channel balance	0.3dB
Channel separation (L,R)	28, 29dB
Tracking ability (L,R)	80, 80µm
Frequency response from graph, 100Hz-5kHz	+1, -2dB
Frequency response from graph, 30Hz-20kHz	+3, -3dB
Stereo Separation L on R 80Hz, 3kHz, 10kHz	34, 39, 39dB
Stereo Separation R on L 80Hz, 3kHz, 10kHz	33, 37, 40dB
Response limits ref computer mean, 1kHz-15kHz	+3, -1.5dB
Response limits ref computer mean, 1kHz-20kHz	+5, -1.5dB
Test tracking weight, loading	1.5g, 4 pF
LF resonance frequency, (13.5g arm) (vert, lat)	10, 8Hz
Estimated compliance (vert, lat)	14, 20cu
Recommended arm effective mass	8-15g
LF resonance rise, (13.5g arm) (vert, lat)	12, 14dB
Typical selling price	£40

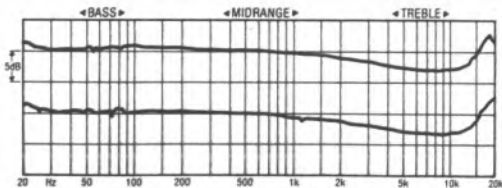

Frequency response, left and right channels

RATA RP70

Russ Andrews Turntable Accessories, Edgebank House, Skelsmergh, Kendal, Cumbria LA8 9AS
Tel: (053 983) 247



This top model of the three-strong RATA range shares basic bodywork with the Goldring *Epic* and internal components with the two cheaper RATAs. The difference is in the stylus, cantilever, and quality control. RATA have followed Linn rather than Goldring in fitting a high-quality Vital swept elliptical tip.

The *Epic*-derived body provides substantial headshell contact area and very tight stylus assembly fit.

Mechanical parameters of the '70 are very close to the '40 (and indeed the latest '20). The somewhat asymmetric compliance suits low and medium mass arms best, and damping is light so a good quality turntable should be used. Tracking ability is quite adequate, but registered a mite down on that of the '40.

Lab report

Response followed the same determined downtilt of its stablemates, falling some 3-4dB from 200Hz to 9kHz. Recovery again followed, though this time by a smaller 3-4dB, the final peak being at a higher frequency. Comparing this final resonance with smoothness of the '40s peak, one cannot help concluding that the treble control of the cheaper model is superior even though the response aberration is mildly greater. Effects of load changes were only slight, with mild preference for the higher capacitance condition.

Separation was again to the highest standards, symmetrical between channels and well maintained from lowest to highest frequencies.

Sound quality

While listeners were able to distinguish the different characters of the top two RATA's (the very respectable) scores awarded came out very close between the two. Inevitably the balance was again a little 'heavy' and 'dull', but the overall sound was still spacious and open. The 'tizz' was less noticeable than before, but the sound also

seemed less lively, more ponderous at the bottom end, and with slightly softer 'focus'.

Conclusions

Frequency balance apart, the *RP70* is a very competent cartridge that was well received by listeners. Though the price differential over the '40 is justified by the construction, it is harder to establish that £30 worth of extra sound has come out at the end of the day.

Though the '70 is cleaner and sweeter, it also seemed heavier and less lively. It merits consideration by those whose systems suit the frequency balance, though doesn't seem to offer quite the value for money of the '40.

TEST RESULTS

Type, mass.....	moving magnet 7.1g
Stylus type.....	Vital advanced elliptical
Stylus inspection result.....	advanced elliptical confirmed
Output Level (1kHz, 5cm/s).....	4mV
Relative output (0dB=1mV/cm/s).....	0dB
Channel balance.....	0dB
Channel separation (L,R).....	25, 26dB
Tracking ability (L,R).....	74, 73µm
Frequency response from graph, 100Hz-5kHz.....	+1, -2.5dB
Frequency response from graph, 30Hz-20kHz.....	+1, -3.5dB
Stereo Separation L on R 80Hz, 3kHz, 10kHz.....	34, 39, 39dB
Stereo Separation R on L 80Hz, 3kHz, 10kHz.....	35, 42, 40dB
Response limits ref computer mean, 1kHz-15kHz.....	+2, -2dB
Response limits ref computer mean, 1kHz-20kHz.....	+5, -2dB
Test tracking weight, loading.....	1.5g, 400pF
LF resonance frequency, (13.5g arm) (vert, lat).....	10, 8Hz
Estimated compliance (vert, lat).....	.14, 20cu
Recommended arm effective mass.....	8-14g
LF resonance rise, (13.5g arm) (vert, lat).....	13, 15dB
Typical selling price.....	£70

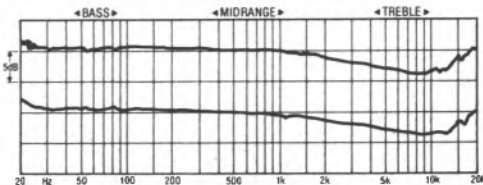

Frequency response, left and right channels

RECOMMENDED

Rega RB100

Rega Research Ltd, 119 park Street, Westcliff-on-Sea, Essex S50 7PD
Tel: (0702) 33071



Rega's original Japan-sourced *R100* cartridge was slow in acceptance but eventually became a firm favourite, a fate which the *RB100* may be destined to repeat. Plain and simple, this £37 model is unusual in having a fixed stylus. In some senses it is a moving magnet built like a moving-coil. The body has proper fixing lugs and decent headshell contact area, so the mechanical integrity of the whole is potentially superior to conventional m-m types.

Compliance on our sample was on the high side, suitable really only for low to medium mass arms, including Rega's own. Internal damping is fairly light, so nasty cheap turntables should be avoided. Some asymmetry was noted in the vertical and horizontal planes.

Electrical output is a little below average, though sufficient to drive any normal amplifier; but anyone attempting shop comparisons will need to advance the volume to avoid a misleading result.

Lab report

Frequency response followed the unashamed downtilt favoured by a number of successful UK cartridges. There the droop was a substantial 5dB from 200Hz to 10kHz, ameliorated by only a single dB with higher capacitance loading. Recovery to the treble resonance was a mild 2dB, at 18kHz. Despite the odd shape the trace was very smooth, showing fine control and channel balance even at high frequencies. An outstanding spectrum of separation was further evidence of excellent cantilever control; the bass started at 35dB and improved to a remarkable 40dB at 10kHz.

Sound quality

The Rega proved the hardest cartridge in the report to tie down subjectively. Our initial 'hands on' experience suggested that the *RB100* could hold its own with m-c models several times its price. But a later try-out in a different system and

with two different samples raised a few doubts; then the 'blind' test results showed contradictory results between panellists and different tracks of the programme. The *RB100* may be unusually system-dependent; the balance is duller than average, and acceptability would seem to depend on how this combines with other components and the musical balances of different discs. At worst, a pleasantly 'laid back' and spacious balance becomes tiresomely dull.

Conclusions

A contrary design in some respects, the *RB100* has a remarkable mechanical performance for its price, with a balance that is as far from average — and 'neutrality' — as it is possible to be. In the right system context it is a potential 'best buy', but the wrong combination could be an absolute disaster. It merits recommendation, but with a stern 'try before you buy' warning.

TEST RESULTS

Type, mass.....	(fixed) moving magnet 5.9g
Stylus type.....not specified
Output Level (1kHz, 5cm/s).....2.8mV
Relative output (0dB=1mV/cm/s).....-3dB
Channel balance.....0.5dB
Channel separation (L,R).....25, 30dB
Tracking ability (L,R).....80, 80µm
Frequency response from graph, 100Hz-5kHz.....+1, -3dB
Frequency response from graph, 30Hz-20kHz.....+1, -4dB
Stereo Separation L on R 80Hz, 3kHz, 10kHz.....36, 45, 40dB
Stereo Separation R on L 80Hz, 3kHz, 10kHz.....35, 37, 39dB
Response limits ref computer mean, 1kHz-15kHz.....+0, -3.5dB
Response limits ref computer mean, 1kHz-20kHz.....+2, -3.5dB
Test tracking weight, loading.....1.8g, 150pF
LF resonance frequency, (13.5g arm) (vert, lat).....8, 6Hz
Estimated compliance (vert, lat).....20, 35cu
Recommended arm effective mass.....5-12g
LF resonance rise, (13.5g arm) (vert, lat).....13, 15dB
Typical selling price.....£37

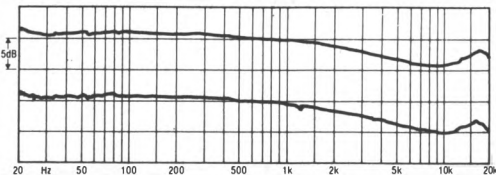

Frequency response, left and right channels

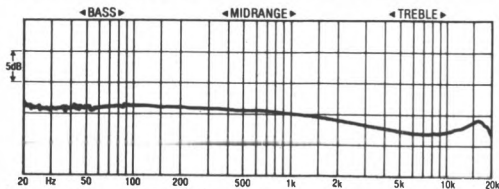

Frequency response with higher load capacitance

Shure M92E

HW International Ltd, 3-5 Eden Grove, London N7 8EQ
Tel 01-609 0293

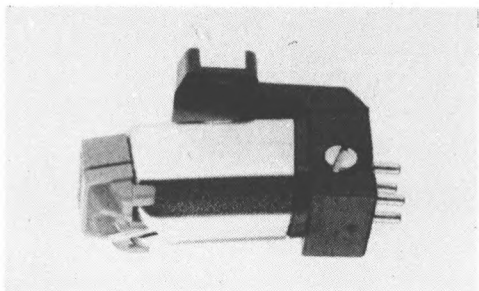

This is the bubble-packed baby amongst Shure's P-adaptable moving magnet cartridges, costing £15.

Stylus is a simple neatly mounted elliptical, and tracking weight is a light 1.25g. Compliance is modest enough, though unusually the vertical figure is higher than the horizontal. The range of arm masses which can ideally be accommodated is therefore quite narrow, but well chosen nonetheless, while heavy damping will assist general compatibility with cheaper equipment.

Lab report

Output level is pretty substantial, so no problems here, but this model is fairly sensitive to capacitance loading, and a high rather than low figure improves the trace 2dB at 9kHz while also suppressing the 20kHz peak.

Frequency response shows yet again the problem of the P-adaptor, yet in other respects is most impressive, particularly with loading where the ruler straight range from 300Hz to 9kHz falls a gentle 2dB, with decent rolloff control beyond. Channel balance is pretty close, and the trace is relatively free from 'glitches' outside the P-mount influence.

Separation figures were unimpressive, with significant channel asymmetry, and tracking abilities were not too impressive either, though they are nevertheless adequate.

Sound quality

As is so often the case with low cost cartridges, the 92E was quite a pleasant surprise, though it showed its limitations nonetheless, particularly in terms of a 'flattened' sound stage with little apparent depth. The balance was very well judged, with no part of the range particularly obtrusive. Though the treble range was under quite good control, there was little real detail here, and some of its

attempts to simulate this were rather obvious. The mid was somewhat recessed, but the bass kept trucking along quite nicely, with little boom or overhang. In all, the 92E gave a rather impressive display of control for the price, though was inclined to make heavy weather of high frequency distortion.

Conclusions

Capable of a respectably decent sound for a respectably low price, the 92E deserves cautious recommendation. And one cannot help feeling that it might have made a Best Buy were it not hampered by the P-mount adaptor, which reduces its competitiveness in its price class. P-mount users would do well to investigate this model if seeking a low cost replacement, as it is a pretty decent performer.

TEST RESULTS

Type, mass.....	moving magnet 6.4g
Stylus type.....	simple elliptical
Stylus inspection result.....	confirmed, neatly mounted
Output Level (1kHz, 5cm/s).....	4.85mV
Relative output (0dB = 1mV/cm/s).....	+ 2dB
Channel balance.....	0.6dB
Channel separation (L,R).....	27.6, 25.1dB
Tracking ability (L,R).....	59, 69µm
Frequency response limits 100Hz-5Hz.....	+ 3, - 3dB*
Frequency response limits 30Hz-20kHz.....	+ 0, - 4dB*
Stereo Separation L on R 100Hz, 3kHz, 10kHz.....	18, 22, 22dB
Stereo Separation R on L 100Hz, 3kHz, 10kHz.....	26, 35, 30dB
Channel diff. from graph, 100Hz, 1kHz, 10kHz.....	0.5, 0.5, 0.5dB
Response limits ref computer mean, 1kHz-15kHz.....	+ 0, - 4dB
Response limits ref computer mean, 1kHz-20kHz.....	+ 0, - 4dB
Test tracking weight, loading.....	1.25g, 250pF
LF resonance frequency, 12.5g arm (vert, lat).....	9, 12Hz
Estimated compliance (vert, lat).....	18, 12cu
Recommended arm effective mass.....	10-15g
LF resonance rise, 12.5g arm (vert, lat).....	10, 7dB
Typical selling price.....	£15
*at low capacitance (c.100pF)	

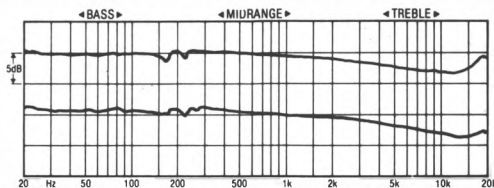

Frequency response, left and right channels

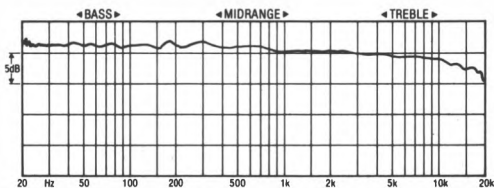

Frequency response with higher load capacitance

RECOMMENDED

Shure ME97HE

HW International Ltd, 3-5 Eden Grove, London N7 8EQ
Tel: 01-609 0293



Shure revived four favourite designs of the past for their 'Encore' series, and on the basis of work carried out in the last (and previous) editions, the '97HE looked to be the 'one most likely to'.

This £40 moving magnet model features Shure's stabiliser/brush, which damps the vertical low frequency resonance completely. The additional stability ensures that the '97E will work stably in virtually any context, even in high mass arms, while the highish compliance provides adequate tracking abilities at the rather low 1g downforce.

Shure's 'Hyperelliptical' stylus profile (hence HE) is a form of swept ellipse. Excessive glue on our sample made it difficult to assess alignment or quality.

Lab report

Response shows substantial variation with capacitance loading above 1kHz. The Shure recommendation of 250pF is about midway between the values we measured, and would appear a good compromise. The traces are quite smooth, with slight ripple but no 'glitches', and the 3dB discrepancy at very high frequencies is the only cause for mild complaint.

Separation was very good, giving high but asymmetric readings in the midband, which were well maintained into bass and treble.

Sound quality

Though regarded as inherently more tidy than exciting, the '97HE acquitted itself very respectably in the listening tests. Several commented on the 'politeness' of the sound and neutrality of the balance, though focus, dynamics and the resolution of low level detail were a little weak. Some of the 'liveliness' of other presentations was missed, but stereo perspectives were clear and stable, and coloration, bar a touch of hardness, was low.

Conclusions

Though there remain reservations about the mechanical construction, the cantilever engineering is to a high standard, and the '97E delivers a very respectable technical and sonic performance at a realistic price. The stabiliser undoubtedly works, acting as a safety net to help the cartridge get the most out of high mass arms. Though it won't turn a sow's ear of turntable into a silk purse, it will at least keep going and produce a respectable result.

By not aiming too high in the first place, the designers have achieved an artful compromise capable of giving a respectable sound in almost any application.

TEST RESULTS

Type, mass.....	moving magnet 6.6g
Stylus type.....	nude hyperelliptical
Stylus inspection result.....	tip obscured by glue
Output Level (1kHz, 5cm/s).....	4mV
Relative output (0dB = 1mV/cm/s).....	0.4dB
Channel balance.....	30, 30dB
Channel separation (L,R).....	80, 72µm
Tracking ability (L,R).....	80, 72µm
Frequency response from graph, 100Hz-5kHz.....	+1, -1.5dB
Frequency response from graph, 30Hz-20kHz.....	+1, -3dB
Stereo Separation L on R 80Hz, 3kHz, 10kHz.....	32, 42, 36dB
Stereo Separation R on L 80Hz, 3kHz, 10kHz.....	38, 51, 37dB
Response limits ref computer mean, 1kHz-15kHz.....	+0, -2.5dB
Response limits ref computer mean, 1kHz-20kHz.....	+0, -2.5dB
Test tracking weight, loading.....	1g*, 250pF
LF resonance frequency, (13.5g arm) (vert, lat).....	9*, 6Hz
Estimated compliance (vert, lat).....	16, 35cu
Recommended arm effective mass.....	5-15g
LF resonance rise, (13.5g arm) (vert, lat).....	10*, 16dB
Typical selling price.....	£40

*excluding stabiliser, see text

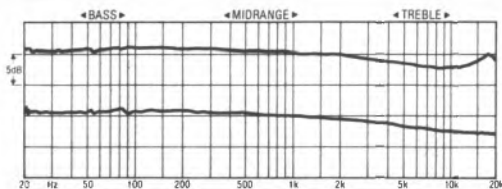

Frequency response, left and right channels

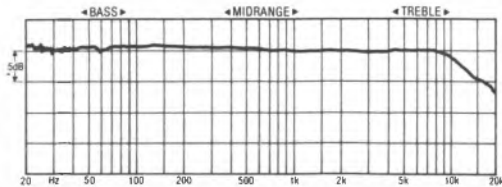

Frequency response with higher load capacitance

Shure ML140HE

HW International Ltd, 3-5 Eden Grove, London N7 8EQ
Tel 01-608 0283

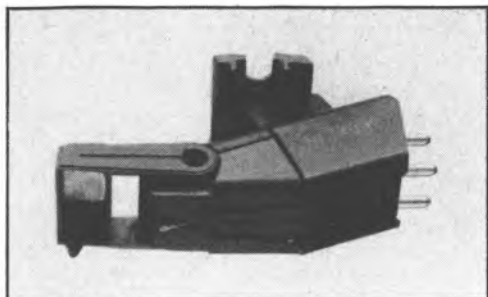

Along with its sister 120 model, this design constitutes a new lightweight body style for Shure's sub-V15 models, including a very neat re-design on the built-in stabiliser/damper brush mechanism.

'HE' is the part of the nomenclature that refers to a Hyperelliptic profile stylus, which proved to be a nicely set nude stone with swept elliptical extended contact. The LF resonance indicates moderate compliance and damping, suitable to a usefully wide range of arms.

Lab report

Output was average, as is the recommendation for capacitance loading, so there are unlikely to be any compatibility problems with this cartridge. In fact the response does show a fair amount of variation with loading, so some experimentation *in situ* may be worthwhile; our subjective preference was for low rather than high capacitance.

Frequency response was almost identical to the V-15 V MR — pretty smooth and flat in either condition, one producing an effectively flat response to 10kHz rolloff, the other a gentle 2dB downtilt between 200Hz and 10kHz, then down a further 2dB at 20kHz. Channel balance was out a surprising amount for such an expensive model, and although correction can be made with the balance control, this leaves a minor discrepancy above 10kHz.

Separation figures were pretty decent in themselves, and were quite well maintained at high frequencies, but also showed some channel asymmetry. Despite the low 1g downforce, tracking was good, and groove stability more than adequate with the stabiliser's assistance.

Sound quality

This cartridge gave a well balanced slightly 'bright' sound which was much better inte-

grated at high frequencies than the '120. There was some bass softening, but extension was good and the overall focus and dynamics were promising.

Upper bass seemed slightly suppressed, so the sound was a little lacking in 'body', but was crisp, clear and informative nonetheless, particularly through the central midband. Qualitatively the treble was a match for many moving coils.

Conclusions

This is a well balanced cartridge, preferred in a number of ways to the more expensive V-15 V MR. Though expensive, it sounds good and has very sensible parameters for matching other equipment, while providing good tracking at low downforce with the help of the stabiliser.

TEST RESULTS

Type, mass.....	moving magnet 4.5g
Stylus type.....	hyperelliptic
Stylus inspection result.....	confirmed, nude stone
Output Level (1kHz, 5cm/s).....	3.75mV
Relative output (0dB = 1mV/cm/s).....	- 1dB
Channel balance.....	0.15dB
Channel separation (L,R).....	30, 30dB
Tracking ability (L,R).....	80, 80µm
Frequency response limits 100Hz-5Hz.....	+ 0.5, - 1dB
Frequency response limits 30Hz-20kHz.....	+ 0.5, - 1.5/3.5dB
Stereo Separation L on R 100Hz, 3kHz, 10kHz.....	33, 35, 31dB
Stereo Separation R on L 100Hz, 3kHz, 10kHz.....	27, 28, 24dB
Channel diff. from graph, 100Hz, 1kHz, 10kHz.....	0.5, 0.5, 1dB
Response limits ref computer mean, 1kHz-15kHz.....	+ 1, - 1dB
Response limits ref computer mean, 1kHz-20kHz.....	+ 1, - 1dB
Test tracking weight, loading.....	1g, 250pF
LF resonance frequency, 12.5g arm (vert, lat).....	10, 9.5Hz
Estimated compliance (vert, lat).....	15, 16cu
Recommended arm effective mass.....	6-16g
LF resonance rise, 12.5g arm (vert, lat).....	14, 11dB
Typical selling price.....	£120

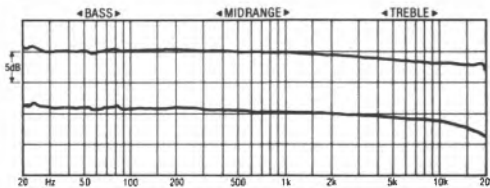

Frequency response, left and right channels

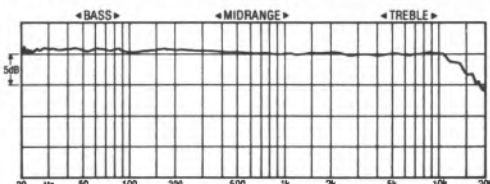

Frequency response with higher load capacitance

Stanton 500E II

Wilmex Ltd, Import Division, Compton House, New Malden, Surrey KT3 4DE
Tel 01-949 2545



Stanton are probably best known as suppliers of cartridges to professional users (broadcast, disco and recording studios), with the sister brand Pickering offering similar domestic models.

The 500 series moving-magnet models offer ultra-rugged construction, and have just been upgraded to *MkII* status. Having examined three the 'E' was chosen ahead of the 'A' and 'EE' as potentially of most interest to hi-fi purchasers.

Horizontal and vertical compliance were markedly different, the latter is stiff enough to suggest that high-mass arms will give best results. The internal generator had little damping.

Output level is relatively low, though perfectly sufficient for all normal amplifiers. If comparing cartridges in a shop, care will be needed to increase the volume with this model to avoid being misled by a level difference.

Lab report

Whereas the 'A' and 'EE' had shown substantial treble peaks at around 15kHz, the *500E* showed much better control at high frequencies: all three designs seemed impervious to changes in loading capacitance. The response itself was strongly downtilted, falling 4dB from 200Hz to 8kHz, whereupon the 14kHz resonance came into play to flatten the final octave before a fairly early rolloff. 'Glitch' at 550Hz, seems likely to be due to resonance between the can and the mounting bracket, and sure to have some audible effect. Separation was decent enough, if a little scrappy in terms of interchannel differences and different parts of the frequency band.

Sound quality

Though lacking some of the drama of the other *500s*, which were marred by pronounced treble peaks, the *500E* was a lively performer with a bouncy character and a balance which was a bit bright and tizzy. The treble was considerably tamed, at the expense of a little less openness.

The sound conveyed plenty of 'space' though little impression of 'scale'.

Conclusions

This is a decent, lively-sounding cartridge capable of withstanding a fair amount of abuse. The substantial cantilever and well-glued brazed shank stylus add moving mass which inevitably restricts bandwidth. The clever trick in the *500E* has been to control the treble resonance so effectively without sacrificing the lively performance unduly. It would be nice to see more, a substantial mounting, but this is certainly a model to take seriously if playing conditions are hazardous.

TEST RESULTS

Type, mass.....	moving magnet 5.5g
Stylus type.....	elliptical
Stylus inspection result.....	gluey elliptical, metal shank
Output Level (1kHz, 5cm/s).....	2.1mV
Relative output (0dB = 1mV/cm/s).....	-5dB
Channel balance.....	0.9dB
Channel separation (L,R).....	28.1, 28.1dB
Tracking ability (L,R).....	80, 80µm
Frequency response from graph, 100Hz-5kHz.....	+1.5, -3dB
Frequency response from graph, 30Hz-20kHz.....	+1.5, -10dB
Stereo Separation L on R 80Hz, 3kHz, 10kHz.....	30, 33, 33dB
Stereo Separation R on L 80Hz, 3kHz, 10kHz.....	34, 28, 22dB
Response limits ref computer mean, 1kHz-15kHz.....	+2.5, -15dB
Response limits ref computer mean, 1kHz-20kHz.....	+2.5, -2.5dB
Test tracking weight, loading.....	2.25g, 275pF
LF resonance frequency, (13.5g arm) (vert, lat).....	14, 9Hz
Estimated compliance (vert, lat).....	7, 18cu
Recommended arm effective mass.....	10-18g
LF resonance rise, (13.5g arm) (vert, lat).....	13, 17dB
Typical selling price.....	£27

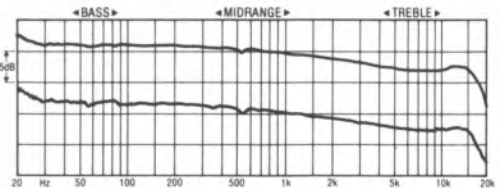

Frequency response, left and right channels

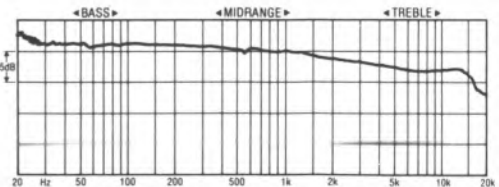

Frequency response with higher load capacitance

Stanton HZ9S

Wilmax Ltd, Import Division, Compton House, New Malden, Surrey KT3 4DE
Tel 01-949 2545

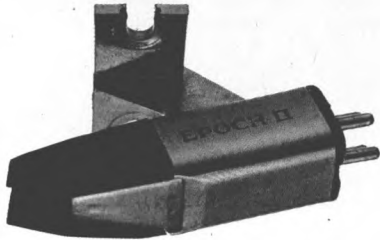

No less than four of the new Stanton *Epoch II* cartridges arrived belatedly, after most of the places in the review programme had been filled. Having given them a brief trial, we settled on the top '9S model for a full review. The 'S' suffix indicates a Stereohedron stylus, an advanced elliptical type, which was found to be of good quality.

The *Epoch II* series of four high-output and two low-output moving magnet cartridges are all based on a basic common body moulding. Pretty and streamlined in appearance this may be, but the thin small plastic mounting plate and flexible central stalk, do not help performance. The stylus assembly gives a pretty good fit, but the can as a whole was easily loosened inside the body moulding.

A fairly high compliance assists good tracking at the lightish 1.25g downforce, but is somewhat asymmetric vertically and horizontal. Low and medium mass arms are therefore to be preferred, and the light level of internal damping suggests that a turntable of good quality should be used.

Lab report

The inadequacy of the support is evident in a discontinuity of almost P-mount proportions in the 600-800Hz region of the responses, and further minor glitches are visible elsewhere. The traces show a steady downtilted trend from 200Hz to -3dB at 4kHz, followed by a gentle recovery supported by a well-disguised 9kHz resonance, and then subsequent rolloff. Increasing capacitance marginally reduced the downtilt by 1dB. Very similar in shape to the 500E, it is odd that the treble resonance should be at a lower frequency for this much more expensive model. Separation was nicely symmetrical, recording generally good values across the band.

Sound quality

Felt to be the liveliest and most interesting of the

Epoch IIs during 'hands on' testing, the '9S had a mixed reception during the 'blind' presentation, ranking slightly below average overall. The most frequently expressed descriptions were of a rather full, well behaved and gentle bass, a general politeness and softening, and a slightly 'obvious' and smeared treble.

Conclusions

The '9S acquitted itself reasonably enough in the listening tests, its mellow sound appealing to some panelists more than others. But the handicap of the bodywork with its inadequate rigidity is a substantial hurdle that it couldn't fully counter, and at its highish price recommendation is not possible.

TEST RESULTS

Type, mass.....	moving magnet 4g
Stylus type.....	stereohedron II
Stylus inspection result.....	good quality stereohedron
Output Level (1kHz, 5cm/s).....	2.7mV
Relative output (0dB=1mV/cm/s).....	-3dB
Channel balance.....	0dB
Channel separation (L,R).....	30, 28.5dB
Tracking ability (L,R).....	80, 80µm
Frequency response from graph, 100Hz-5kHz.....	+1, -1dB
Frequency response from graph, 30Hz-20kHz.....	+1, -6dB
Stereo Separation L on R 80Hz, 3kHz, 10kHz.....	30, 40, 31dB
Stereo Separation R on L 80Hz, 3kHz, 10kHz.....	29, 38, 28dB
Response limits ref computer mean, 1kHz-15kHz.....	+0, -4dB
Response limits ref computer mean, 1kHz-20kHz.....	+0, -6dB
Test tracking weight, loading.....	1.25g, 280pF
LF resonance frequency, (13.5g arm) (vert, lat).....	9, 7Hz
Estimated compliance (vert, lat).....	18, 30cu
Recommended arm effective mass.....	5-14g
LF resonance rise, (13.5g arm) (vert, lat).....	16, 17dB
Typical selling price.....	£112

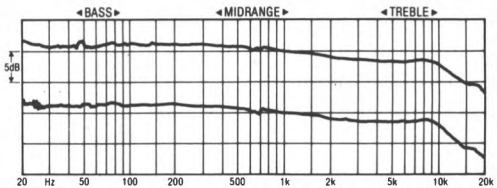

Frequency response, left and right channels

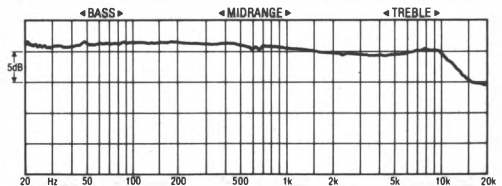

Frequency response with higher load capacitance

Supex SD900 IV

Russ Andrews Turntable Accessories, Edgebank House, Skelsmergh, Kendal, Cumbria LA8 9AS
Tel (053 983) 247



Very much an old favourite, the Supex 900, in early wooden and later plastic-body forms, pioneered the UK moving-coil revival a decade or so ago. It has now been upgraded to Mk IV status, with further improvements to the excellent external finish via a new bottom plate.

This low output moving-coil model needs the full step up of an m-c pre-amp. It is fitted with a fine advanced Vital elliptical tip, on a small rectangular shank.

Substantial headshell contact area and circular fixing lugs enable the 900 to be firmly mechanically coupled to the tonearm, though the amount of energy coupled to the tonearm by a low compliance device such as this will place something of a premium on the arm quality.

The fairly substantial body mass and low compliance suggests that only medium and high mass arms of good rigidity should be used. Tracking abilities are reasonable enough, by virtue of a fairly generous downforce. Little internal damping is used, so only decent-quality turntables need apply.

Lab report

The frequency response keeps within fairly close limits across the band, but wiggles about a bit. A 2.5dB downtilt starts around 200Hz and bottoms out at 5kHz, whereupon a mild 1dB recovery is centred upon 10kHz, with a slightly uneven but well balanced continuation beyond. A single minor 'blip' is seen at 1.2kHz, but outstanding channel balance throughout.

An exceptional series of values for stereo separation indicated that performance was beyond the discrimination of our measurements.

Sound quality

Earlier 900 versions have sailed through listening panel tests often enough and especially in view of the fine results obtained by its high output sister, we were surprised that the new 900 IV was

not better received. Whatever the reason, and listening tests do tend to throw up some anomalous results, the panel were somewhat confused, with comments like 'mixed reactions' and 'cannot compute' taken from the sheets.

The essential Supex sound is romantic, open and spacious, a little heavy and 'laid back', with fine midrange and treble information. Criticisms on this occasion were of a tendency to dullness and slowness, with some bass softening.

Conclusions

The Supex 900 is an inherently fine cartridge, but despite the recent update it does seem to be beginning to show its age. It is expensive and the competition above and below continues to strengthen, so erring on the side of caution we have saved our recommendation for the 901 on this occasion, whilst pointing out that potential purchasers who like what they hear can go ahead with confidence in the fine technical performance.

TEST RESULTS

Type, mass.....	low output moving-coil 8.3g
Stylus type.....	vital elliptical
Stylus inspection result.....	fine super ellipse
Output Level (1kHz, 5cm/s).....	0.19mV
Relative output (0dB = 1mV/cm/s).....	2.2dB
Channel balance.....	0.1dB
Channel separation (L,R).....	29, 29dB
Tracking ability (L,R).....	80, 72µm
Frequency response from graph, 100Hz-5kHz.....	+2, -1.5dB
Frequency response from graph, 30Hz-20kHz.....	+2, -2dB
Stereo Separation L on R 80Hz, 3kHz, 10kHz.....	45, 750, 750dB
Stereo Separation R on L 80Hz, 3kHz, 10kHz.....	750, 47, 750dB
Response limits ref computer mean, 1kHz-15kHz.....	+0, -0.5dB
Response limits ref computer mean, 1kHz-20kHz.....	+2.5, -0.5dB
Test tracking weight, loading.....	2g, n.a.pF
LF resonance frequency, (13.5g arm) (vert, lat).....	10, 10Hz
Estimated compliance (vert, lat).....	12, 12cu
Recommended arm effective mass.....	10-18g
LF resonance rise, (13.5g arm) (vert, lat).....	14, 15dB
Typical selling price.....	£245

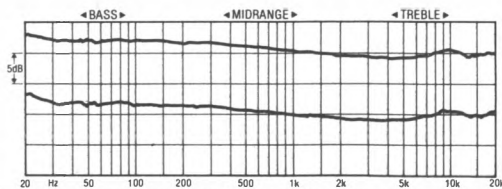

Frequency response, left and right channels

Supex SD901 IV

Russ Andrews Turntable Accessories, Edgebank House, Skelsmergh, Kendal, Cumbria LA8 9AS
Tel (053 983) 247

RECOMMENDED

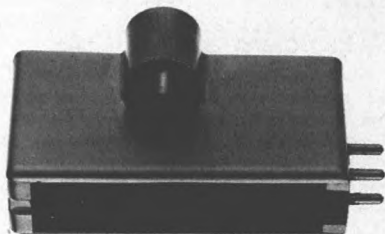

and the ability to maintain resolution well down into the mix. Not everyone was completely convinced, and there was felt room for improvement in the bass, which showed mild tracking problems and was a little 'sluggish', but on balance the 901 gave a fine overall performance.

Conclusions

Expensive, the 901 delivered sufficient objective and subjective performance to justify its price tag, and the (fairly) high output allows it to provide high quality moving-coil performance for systems without m-c gain where a separate step-up would be an intrusion. Good quality ancillaries are mandatory, and this is still not the cartridge for material which places a premium on tracking ability.

TEST RESULTS

Type, mass.....	high(ish) output moving-coil 9.1g
Stylus type.....	vital advanced elliptical
Stylus inspection result.....	quality vital, marred by glue
Channel separation (L,R).....	30, 24dB
Tracking ability (L,R).....	60, 75µm
Frequency response from graph, 100Hz-5kHz.....	+1.5, -1dB
Frequency response from graph, 30Hz-20kHz.....	+1.5, -2dB
Stereo Separation L on R 80Hz, 3kHz, 10kHz.....	30, 51, 39dB
Stereo Separation R on L 80Hz, 3kHz, 10kHz.....	36, 50, 33dB
Response limits ref computer mean, 1kHz-15kHz.....	+1, -0.5dB
Response limits ref computer mean, 1kHz-20kHz.....	+2.5, -0.5dB
Test tracking weight, loading.....	2g, n.a.pF
LF resonance frequency, (13.5g arm) (vert, lat).....	9, 9Hz
Estimated compliance (vert, lat).....	14, 14cu
Recommended arm effective mass.....	8-18g
LF resonance rise, (13.5g arm) (vert, lat).....	18, 18dB
Typical selling price.....	£283

This silver-bodied cartridge is the high output moving-coil sister of the renowned 900, and is also now in Mk IV form.

Past experience has shown that output of the 901 is lower than a normal moving-magnet cartridge (the test computer declined to give us a reading, for reasons which remain obscure), and it is worthwhile checking that a particular pre-amplifier has enough sensitivity. One can usually get away with a 901 without using (and risking overloading) an m-c stage, and its output usefully matches some of the latest valve amplifiers.

Fine rigid construction allows the unit to be bolted firmly into the headshell of the tonearm with good rigidity and coupling. Body mass is high and compliance quite low, so medium and high mass tonearms of high quality are necessary with very little internal damping, turntable quality will be at a premium.

Despite the highish 2g downforce, tracking abilities were a trifle marginal. A good quality Vital advanced elliptical stylus was fitted, but with excessive glue on our sample.

Frequency response was very similar to the 900, though a little brighter and with a more pronounced peak in the treble region. The downtilt was held to around 2dB, and the recovery at 9kHz made up the same amount. Channel balance was outstanding throughout, even above the treble peak, while the right hand channel showed the occasional 'glitch'.

Separation was generally excellent, with good channel conformity and outstanding midrange values, but, at low frequencies, somewhat below the standard set by the 900.

Sound quality

Paradoxically, in view of the 900's problems, the 901 sailed through the auditioning, receiving plaudits like 'exudes authenticity'. A degree of 'boom'n'tizz' was criticised, but there was praise for mid and treble detail, for space and ambience,

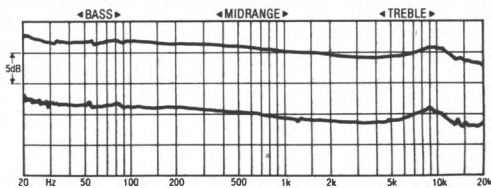

Frequency response, left and right channels

Supex SDX2000 High Output

Russ Andrews Turntable Accessories, Edgebank House, Skelsmergh, Kendal, Cumbria LA8 9AS
Tel (053 983) 247

RECOMMENDED



Lacking the cheerful ruddiness of its stablemate, the sombrely grey-suited high-output 2000 has a quiet dignity nonetheless. It will be necessary to take the precaution of checking there is sufficient output for specific circumstances, as this is well below normal moving magnet level. That said, there are many who have a real need for a state-of-the-art high output moving-coil, notably thermionic disciples.

Fine mechanical construction with solid lugs and a good contact area ensure this model may be securely mounted, necessarily in a good quality arm because substantial energy may be coupled. Stylus is the usual high quality Vital, again rather over-glued in this instance.

Compliance is quite low, but so is the mass, so a fairly wide range of arms may be used, with preference for strong rigid types. Tracking is a little marginal for some tastes in music, and considering the sensible 1.8g downforce. Damping was a little higher than the Supex norm.

Lab report

Response is almost identical to the low output 2000, but with each of the latter's flaws slightly exaggerated. In addition there were a number of response 'glitches', perhaps due to the greater number of internal wire turns. Though inevitably not quite up to the low-output's standard, it is a fine result nonetheless. Paradoxically, the high-output's separation equalled or bettered the other's throughout, with the most notable improvement through the mid-range. (The most likely explanation is a fluke in the spectrum analyser sampling I suspect!)

Sound quality

For some reason the reaction of the listening panel was again more positive towards the high rather than the low output Supex. Treble balance was quite neutral in relation to CD) though sonically substantially preferred). Which means

it is a touch on the bright side, but with additional weight and richness at the bottom end. The treble sounded sweet and fast, the midrange coherent and detailed, surface noise was controlled, but bass definition was not quite right.

Conclusions

Distinguished from the 'low' version by the uniqueness of a high output option within the context of a top up-to-date moving-coil design, this 2000 merits recommendation. It doesn't match the best of the low output designs sonically, and there may be some conventional inputs which need a little more urge than it can provide. But it is a pukka modern m-c, 'faster' than the 907, and therefore has its own unique niche.

TEST RESULTS

Type, mass.....	high output moving-coil 4.8g
Stylus type.....	vital line contact
Stylus inspection result.....	fair quality vital, rather gluey
Output Level (1kHz, 5cm/s).....	1.1mV
Relative output (0dB = 1mV/cm/s).....	-10dB
Channel balance.....	0.4dB
Channel separation (L,R).....	30, 30dB
Tracking ability (L,R).....	79, 66µm
Frequency response from graph, 100Hz-5kHz.....	+1, -0.5dB
Frequency response from graph, 30Hz-20kHz.....	+1, -0.5dB
Stereo Separation L on R 80Hz, 3kHz, 10kHz.....	34, 52, 33dB
Stereo Separation R on L 80Hz, 3kHz, 10kHz.....	36, 48, 33dB
Response limits ref computer mean, 1kHz-15kHz.....	+2, -0dB
Response limits ref computer mean, 1kHz-20kHz.....	+5, -0dB
Test tracking weight, loading.....	1.8g, n.a.pF
LF resonance frequency, (13.5g arm) (vert, lat).....	10, 9Hz
Estimated compliance (vert, lat).....	14, 18cu
Recommended arm effective mass.....	6-16g
LF resonance rise, (13.5g arm) (vert, lat).....	13, 14dB
Typical selling price.....	£475

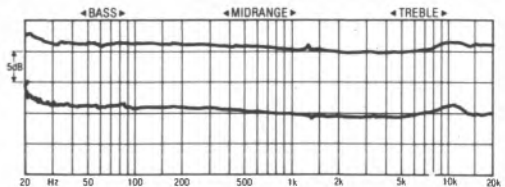

Frequency response, left and right channels

Supex SDX2000 Low Output

Russ Andrews Turntable Accessories, Edgebank House, Skelsmergh, Kendal, Cumbria LA8 9AS
Tel (053 983) 247



Separation was fine, with quite good channel balance, though curiously not quite as good as the older models tested.

Sound quality

Reception to the 2000 was rather mixed, though generally positive. The sound was described as rather on the bright side, notably 'quick' at mid and high frequencies, yet with a heavy slightly 'sluggish' bass, which somehow seemed to lack the expected extension and power. The soundstage was big and open, with good detail and without exaggeration of surface noise. In all it sounded lively, but not entirely integrated across the spectrum.

Conclusions

Though the 2000 low o/p has many sterling qualities, it doesn't quite have the class, nor specific outstanding areas of excellence, to compete with some of the other models in the region approaching £500. The extra damping over other Supex models could prove useful in some circumstances, but the overall performance is not quite up to justifying such an exotic price.

TEST RESULTS

Type, mass.....	low output moving-coil 4.8g
Stylus type.....	vital line-contact
Stylus inspection result.....	rather gluey, vital super-ellipse
Output Level (1kHz, 5cm/s).....	0.2mV
Relative output (0dB=1mV/cm/s).....	-26dB
Channel balance.....	0.4dB
Channel separation (L,R).....	30, 30dB
Tracking ability (L,R).....	30, 69µm
Frequency response from graph, 100Hz-5kHz.....	+1, -1dB
Frequency response from graph, 30Hz-20kHz.....	+1, -1dB
Stereo Separation L on R 80Hz, 3kHz, 10kHz.....	33, 48, 33dB
Stereo Separation R on L 80Hz, 3kHz, 10kHz.....	28, 38, 33dB
Response limits ref computer mean, 1kHz-15kHz.....	+2, -0dB
Response limits ref computer mean, 1kHz-20kHz.....	+5, -0dB
Test tracking weight, loading.....	1.8g, n.a.pF
LF resonance frequency, (13.5g arm) (vert, lat).....	10, 10Hz
Estimated compliance (vert, lat).....	14, 14cu
Recommended arm effective mass.....	6-18g
LF resonance rise, (13.5g arm) (vert, lat).....	13, 13dB
Typical selling price.....	£430

After so much dull hi-tech, the low-output Supex 2000's red and cream has to be a pleasant change — reminiscent of the 'blood and custard' of early BR carriage livery if my memory serves me correctly! Railway nostalgia apart, this is the latest from Supex, featuring a Boron cantilever, costing a substantial £430, and succeeding the 1000 series which never officially made it to the UK.

For historical reasons of distribution, Supexes follow a fairly tortuous path to the UK, which means that the top models carry a premium against the Supex-made Linn models of similar performance.

The engineering has something in common with the Linn *Asak*, including the Vital swept elliptical stylus, which on this sample was suffering from an excess of glue. Output is quite low, definitely needing a step up stage of at least 20dB, preferably a little more.

Construction shows the usual high level of integrity in Supex mechanical engineering, with substantial lugs and fixing area for firm connection to the tonearm.

Fairly low compliance and body mass allow a wide range of arms to be used, though the high energy coupled by such a design means that a well-built tonearm is essential, so medium or high mass types are best suited. Interestingly, the degree of damping is rather higher than on other Supex made cartridges, which should make it a little less fickle about its companions. Tracking margins are not very high, considering the sensible downforce.

Lab report

Showing similarities to, but substantial refinements of, the *SD900* traces, the 2000 frequency response is very flat and quite smooth, showing a less exaggerated downtilt and recovery, with very good control and channel balance up to ultrasonic frequencies. The solitary 1.4kHz 'blip' is still there.

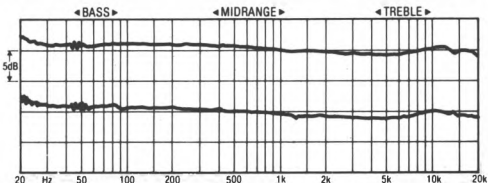

Frequency response, left and right channels

Talisman A

Absolute Sounds, 42 Parkside, London SW19
Tel 01-947 5047



The A is for Aluminium — an excellent material for cantilevers, if less fashionable than the rarer earths — and this is Talisman's base model, a £200 low-output moving-coil of attractive and interesting appearance. Sourced from Japan, the design is American-inspired, by the important US distributor Sumiko.

The attractively shaped body may bear a passing resemblance to an Ortofon OM model, but the mechanical integrity is significantly greater. The substantial alloy castings used in the construction seem most unlikely to flex, and the compactness further aids structural rigidity. While the headshell contact area is mildly restricted, full circular lugs will still enable a firm mechanical coupling.

Compliance is nicely judged to provide fine tracking at 2g downforce, plus compatibility with a wide range of arms, though the heaviest types are better avoided. Damping seems likewise well chosen to provide a good balance between liveliness and turntable tolerance. A good quality line contact stylus was fitted, and the output is sufficient for all normal m-c stages. Channel balance registered 0.5dB out.

Lab report

Frequency response was quite smooth with few irregularities, and an even downtilted characteristic of 2dB followed by the mildest of recoveries. A slight channel imbalance occurred at high frequencies, above 8kHz.

Separation was competent enough, though far from exceptional considering the price, with mild asymmetry between channels.

Sound quality

The comments describing the A were reasonably consistent, though the corresponding value judgements did vary somewhat, indicating the different preferences and tolerances of the individual listeners.

There was general agreement that the balance was heavy: 'a bit of a thumper' in one phrase. The overall sound was spacious, rich and rather 'laid back', though with some top end tizz as well. The lower treble/upper-mid seemed to lack some transparency, and while the overall presentation was on the grand scale, it was also a little lacking in subtlety.

Conclusions

This is a decently engineered cartridge with a selection of well chosen compromises. While it could sound good enough, so could models which cost significantly less. It is a good cartridge, capable of fine results, but we feel that is insufficiently distinctive to merit formal recommendation here.

TEST RESULTS

Type, mass.....	low o/p moving-coil 6.3g
Stylus type.....	not specified
Stylus inspection result.....	good quality line contact
Output Level (1kHz, 5cm/s).....	0.3mV
Relative output (0dB=1mV/cm/s).....	-22dB
Channel balance.....	-0.5dB
Channel separation (L,R).....	30, 30dB
Tracking ability (L,R).....	80, 80µm
Frequency response from graph, 100Hz-5kHz.....	+1.5, -1dB
Frequency response from graph, 30Hz-20kHz.....	+1.5, -1dB
Stereo Separation L on R 80Hz, 3kHz, 10kHz.....	33, 37, 30dB
Stereo Separation R on L 80Hz, 3kHz, 10kHz.....	31, 43, 35dB
Response limits ref computer mean, 1kHz-15kHz.....	+1, -0.5dB
Response limits ref computer mean, 1kHz-20kHz.....	+4, -0.5dB
Test tracking weight, loading.....	2g, n.a.pF
LF resonance frequency, (13.5g arm) (vert, lat).....	9, 9Hz
Estimated compliance (vert, lat).....	18, 18cu
Recommended arm effective mass.....	8-16g
LF resonance rise, (13.5g arm) (vert, lat).....	14, 15dB
Typical selling price.....	£195

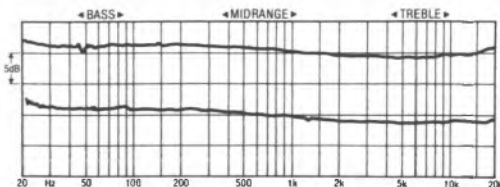

Frequency response, left and right channels

Talisman S

Absolute Sounds, 42 Parkside, London SW19
Tel 01-947 5047

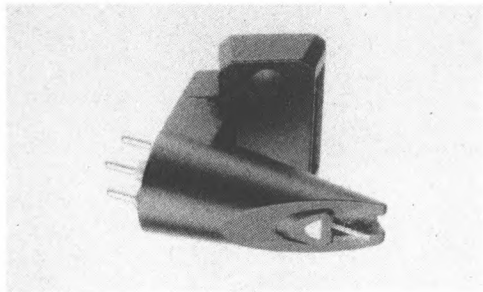

This US-designed low output moving-coil cartridge is one of a series of models based upon a common body but with different cantilevers, styli and generating systems. The body is an attractive alloy moulding of quite low mass and 'cantilevered' shape, not dissimilar to the Ortofon OM series in appearance, which gives good rigidity with limited headshell contact. The sapphire cantilever was fitted with a beautiful, small line-contact tip.

Compliance is moderate and lightly damped, so a useful range of arm masses will give a good match, centred on the medium mass models. Downforce is a fairly substantial 2g, ensuring decent tracking ability.

Lab report

While definitely needing a moving-coil facility on the amplifier, output is close to the average for low output models, so no level incompatibility is likely.

Frequency response is a little unusual, and is dominated by a significant high frequency rise, starting around 5kHz, and reaching an average +4dB by 20kHz. (The more recent *Alchemist III*S high output model showed an even stronger rise.) The rest of the range is relatively flat, fitting within a 1dB window. Channel balance was very close through most of the range, but started to diverge again at around 5kHz, winding up 2dB apart by 20kHz. The trace as a whole was clean below 500Hz but then showed a slight unevenness with several tiny but identifiable 'glitches'.

Separation figures were unexceptional, showing some unevenness and asymmetry, and tailing off towards the HF resonance, with some evidence of ultrasonic spurious.

Sound quality

Though the treble rise dominated in an absolute sense, the Talisman was nevertheless

a pretty good sounding cartridge, satisfyingly 'sweet', relaxing, and easy to listen to. Furthermore, if the treble was rather obvious, it was also quite clean, clear and integrated.

Though it does not deliver the bass 'slam' or 'impact' of some other moving-coils, the bass was nicely controlled and well extended. The midrange was very clear with good detail and stereo presentation, if slightly muted dynamically.

Conclusions

Though somewhat idiosyncratic in a number of ways, the sheer sweetness of the sound remains an important strength. While it is unlikely to appeal to fundamentalists of any particular school of cartridge design, it is a well-judged alternative, unlikely to displease.

TEST RESULTS

Type, mass.....	low output moving-coil 6.3g
Stylus type.....	line contact
Stylus inspection result.....	beautiful small line contact
Output Level (1kHz, 5cm/s).....	0.28mV
Relative output (0dB = 1mV/cm/s).....	- 23dB
Channel balance.....	0.1dB
Channel separation (L,R).....	27.6, 30dB
Tracking ability (L,R).....	80, 80µm
Frequency response limits 100Hz-5Hz.....	+ 1, - 0dB
Frequency response limits 30Hz-20kHz.....	+ 2.5/6, - 0dB
Stereo Separation L on R 100Hz, 3kHz, 10kHz.....	26, 22, 21dB
Stereo Separation R on L 100Hz, 3kHz, 10kHz.....	38, 30, 22dB
Channel diff. from graph, 100Hz, 1kHz, 10kHz.....	0, 0, 1dB
Response limits ref computer mean, 1kHz-15kHz.....	+ 4, - 0dB
Response limits ref computer mean, 1kHz-20kHz.....	+ 7, - 0dB
Test tracking weight, loading.....	2g, n.a.
LF resonance frequency, 12.5g arm (vert, lat).....	9, 10Hz
Estimated compliance (vert, lat).....	18, 15cu
Recommended arm effective mass.....	6-16g
LF resonance rise, 12.5g arm (vert, lat).....	16, 12dB
Typical selling price.....	£295

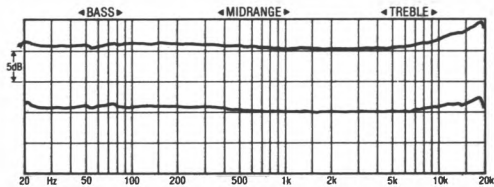

Frequency response, left and right channels

Technics P205C 4

Panasonic (UK) Ltd, 300-318 Bath Road, Slough, Berks
Tel (0753) 34522

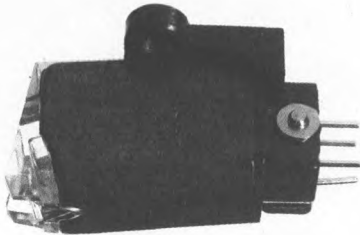

Having developed a dislike of P-mount cartridges — or at least to the effects of their universal mounting brackets — in the last edition, I confess to some lack of initial enthusiasm even for this £130 version. But Technics, originators of the T4P or 'P-mount' plug-in standard, have some remarkable cartridge engineers.

This is a clever cartridge, with a much stronger P-mount adaptor than usual, and with full circular lugs — though one feels it could have been better still with an alloy casting instead of a plastic moulding. The stylus fit is superb — I was struggling to shift it until I noticed the little retaining screw at the front!

The combination of modest compliance and downforce still provides good tracking abilities, which is a tribute to the cantilever engineering. So despite the constraint of T4P's standard 1.25g downforce, a wide range of arms can be accommodated, though the higher mass types are best avoided. Damping is modest, though mildly asymmetric.

Lab report

Further enhancing Technics' reputation as cartridge engineers, the frequency responses were excellent by any standards. The P-mount bracket effect was much smaller than those encountered in last year's project, if not quite entirely eliminated. Capacitance loading added a couple of dB to the treble level, introducing the mildest of peaks around 14kHz. Channel balance was close, with slight variation at high frequencies.

Separation was a mild disappointment after the fine responses. Though the values were adequate enough, the variation between channels was quite large, indicating some alignment asymmetry.

Sound quality

Despite the generally promising technical performance, the auditioning results were a little

disappointing. The bass was fairly unconvincing throughout, so one suspects the mounting adaptor was only partly doing its stuff. On the other hand, the mid and treble were clear, lively, and fairly neutral, if a touch 'bright'. It was not a cartridge that attracted significantly adverse reaction, but neither did it attract enthusiasm.

Conclusions

For the determined P-mount enthusiast this Technics is a comfortable cut above any rivals we have encountered. And even with the handicap of a (better than usual) adaptor bracket, it performed very decently, with clever cantilever control producing fine mid and treble transparency. Outstanding tracking abilities are a further benefit, but in the final analysis it didn't deliver quite enough soundwise to justify its substantial price tag against conventional competitors.

TEST RESULTS

Type, mass.....	moving magnet 'P-mount' 6g
Stylus type.....	elliptical
Stylus inspection result.....	very high quality advanced ellipse
Output Level (1kHz, 5cm/s).....	3.6mV
Relative output (0dB=1mV/cm/s).....	0dB
Channel balance.....	0dB
Channel separation (L,R).....	30, 27dB
Tracking ability (L,R).....	80, 80µm
Frequency response from graph, 100Hz-5kHz.....	+0.5, -1dB
Frequency response from graph, 30Hz-20kHz.....	+1, -2dB
Stereo Separation L on R 80Hz, 3kHz, 10kHz.....	35, 54, 47dB
Stereo Separation R on L 80Hz, 3kHz, 10kHz.....	33, 54, 33dB
Response limits ref computer mean, 1kHz-15kHz.....	+0, -1.5dB
Response limits ref computer mean, 1kHz-20kHz.....	+2, -1.5dB
Test tracking weight, loading.....	1.25g, 150pF
LF resonance frequency, (13.5g arm) (vert, lat).....	9, 18cu
Estimated compliance (vert, lat).....	18, 18cu
Recommended arm effective mass.....	5-15g
LF resonance rise, (13.5g arm) (vert, lat).....	11, 14dB
Typical selling price.....	£133

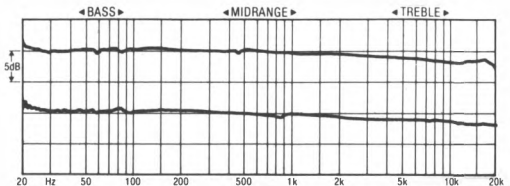

Frequency response, left and right channels

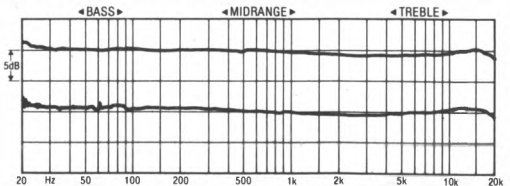

Frequency response with higher load capacitance

van den Hul MC-10

Automation Sciences Co, 20 Little Geddedsen, Berkhamsted, Herts HF4 1PA
Tel (044 284) 2786

RECOMMENDED



Dutchman A.J. van den Hul has become a powerful influence in cartridge design, both through the adoption of his stylus profile by several manufacturers, and his design consultancy work for other manufacturers, notably Empire. His own name has become a brand through the modifications he has performed on existing designs such as EMTs and Deccas; the MC10 represents his handmade version of the Empire MC1000, which he designed.

This expensive low output moving-coil cartridge reportedly uses the latest type of 'monocrystal' wire internally, and was supplied with a set of special silver headshell leads. Though not a complete solid casting, the screwed alloy body looks quite rigid, and rather small tapped lugs take the fixing screws directly.

While this arrangement helps save mass at the headshell, it risks the problem, which we in fact encountered, of the thread stripping, and frankly does not lend itself to confident tight fixing.

Compliance of the first sample was exasperatingly excessive, but a later sample gave a less well-damped resonance at a sensible 9Hz, indicating suitable matching with most tonearms.

Lab report

A very fine-looking frequency response gave a gentle 2.3dB downtilt across the band, and held within 0.5dB of a straight line throughout. There was some evidence of small mechanical resonances here and there, particularly above 5kHz.

Separation showed some mild asymmetry but achieved consistently high values throughout the range, best in the midband but very well maintained towards the frequency extremes, with slight evidence of ultrasonic spuriae.

Sound quality

'High drama' is a phrase lifted from the panel comments to describe a sound favoured by all listeners (but one) for its 'liveliness'; the

exceptional 'space' and 'air', decent 'speed' and fine timing and integration. Treble detail was resolved with consummate ease and lack of 'grain'. And this was the first over-compliant sample; its replacement seemed to bring the bass into better focus.

When re-auditioning, tracking weight was found to be critical in obtaining the best sound, 1.25g giving best sonic results under our conditions, though compromising the tracking margins somewhat.

The one general complaint about the MC10 was a slightly intrusive brightness about the balance. This probably aided its exceptional analytical capabilities, but could be a touch fatiguing, particularly on poorly mixed material.

Conclusions

Though a touch temperamental, the MC10 makes a genuine contribution towards the state of the art, making a strong claim to a 'best bar none' title. Demanding recommendation, it certainly goes a long way towards justifying an admittedly high price, though we must record our irritation over the duff original sample.

TEST RESULTS

Type, make	low output moving coil 7.3g
Stylus type	van den Hul
Stylus inspection result	excellent vdH
Output Level (1kHz, 5cm/s)	0.38mV
Relative output (0dB = 1mV/cm/s)	-20dB
Channel balance	-0.5dB
Channel separation (L,R)	30, 30dB
Tracking ability (L,R)	80, 72µm
Frequency response from graph, 100Hz-5kHz	+1, -1dB
Frequency response from graph, 30Hz-20kHz	+1, -2dB
Stereo Separation L on R 80Hz, 3kHz, 10kHz	35, 42, 38dB
Stereo Separation R on L 80Hz, 3kHz, 10kHz	37, 50, 35dB
Response limits ref computer mean, 1kHz-15kHz	+1, -1dB
Response limits ref computer mean, 1kHz-20kHz	+2.5, -1dB
Test tracking weight, loading	1.6g, n.a.pF
LF resonance frequency, (13.5g arm) (vert, lat)	8, 6Hz
Estimated compliance (vert, lat)	20, 35cu
Recommended arm effective mass	6-12g
LF resonance rise, (13.5g arm) (vert, lat)	11, 12dB
Typical selling price	£500

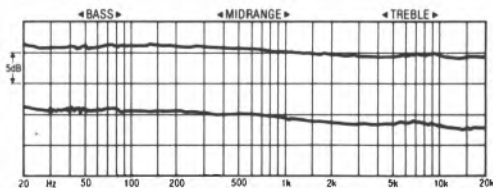

Frequency response, left and right channels

RECOMMENDED

NEW MUSIC FROM YOUR RECORDS THE WELL-TEMPERED ARM

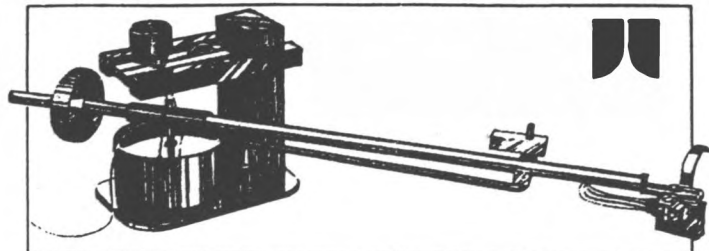

"...brings a new euphony to a black disc collection." HFHRR

"This has become my favourite *and* my reference standard tonearm." *Stereophile*

Acoustic Arts, 101 St Albans Road, Watford (0923-45250); **Doug Brady Hi-Fi**, Kingsway Studios, Kingsway North, Warrington (0925-828009); **KJ Leisuresound**, 48 Wigmore St, London W1 (01-486 8262); **The Music Room**, 50 Bridge Street, Manchester (061-835 1366); **The Music Room**, St. Vincent Street, Glasgow (041-248 7221); **Pinewood Music**, 64 Eastgate Street, Winchester (0962-61703); **Subjective Audio**, 2 Camden High Street, London NW1 (01-387 8281); **Zeus Audio**, 18 Castlecaulfield Road, Donaghmore, Dungannon, N. Ireland (08687-67935).

Distributed by **Automation Sciences Co.**, 20 Little Gaddesden, Berkhamsted (044284-2786)

AT 36ML
AT 33ML
AT 152ML^P
AT 160ML
AT 140ML

An expanding group of 'mc' and 'mm' cartridges with linear crystal technology (LC-OFC) plus the advanced Micro Linear stylus that's the closest profile yet to the original record cutter head.

Only at selected AT dealers.
For locations call 0532 771441.



audio-technica

ENJOY ADVANCED TECHNOLOGY

Grace

SUPEX

RATA

RP SERIES

TORLYTE[®]

RATA

RUSS ANDREWS
TURNTABLE ACCESSORIES
EDGE BANK HOUSE, SKELSMERGH,
KENDAL, CUMBRIA LN8 9NS
TELEPHONE: SELSIDE (053 983) 247

SUMMARY REVIEWS: CARTRIDGES

This book includes as many complete test reports as possible. Many other cartridges were tested for the last edition but space no longer allows us to print these in full: they are summarised here.

Every model here has been subjected to lab measurement and listening tests; these brief reviews cover the main test findings and give system matching guidance as well as comparative ratings on sound quality. All cartridges are moving — or induced — magnet types of normal output unless otherwise described; moving-coil types described as 'high output' will usually be suitable for use with standard (mm) phono amplifier inputs. Figures in brackets at the end of each review are: Cartridge mass in grams; vertical compliance in 'compliance units'; and test tracking weight in grams.

ADC Phase II (£20)

Fitted with a 'large footprint' elliptical tip, the *Phase II* offers good tracking, while sound quality was acceptable at the price, slightly 'soft' but with a clear and well focussed midrange. Arms in effective mass range 6-18g should be usable with this competent and well balanced model. (5.8g, 16cu, 2.1g)

ADC Phase III (£30)

With a 'sharper' elliptical stylus, tracking ability was still maintained, while treble response dipped less drastically than that of the cheaper Phase models. Sound quality showed mild softening and a trace of 'tizz', reducing extreme bass and treble detail; still suitable for arms 6-16g it was thought competitive with, though less spectacular-sounding than, the low-priced moving coil models. (5.8g, 18cu, 1.5g)

ADC TRX I (£79)

Differing in construction from the Phase range, the *TRX I* has a nude Vital II superelliptical tip and tapered titanium cantilever. A screw locks the stylus assembly to the alloy body. Response showed some uptilt above 7kHz; the sound was bright and 'tinkly', with a slightly softened 'rich' bass and hence a tendency to the classic hi-fi 'boom n' tizz' role. Exciting, if a little fierce at times, the relentlessness of the upper treble may in fact endear it to certain tastes and systems. (6.5g, 18cu, 1.2g)

ADC TRX II (£130)

With a tapered beryllium cantilever, the *TRX II* has a Vital III tip, and higher compliance than the 'I'. The treble rise was less pronounced but still noticeable, with such comments as 'fiercely exciting'. Midrange focus and dynamics were liked, but bass was a trifle 'plummy'. Though competent, this seemed insufficient to justify the cost. (6.5g, 30cu, 1.2g)

A&R E77 (£35)

The *E77*'s average compliance makes it suitable for most tonearms; response showed a mild lower-treble dip, followed by a peak at the HF extreme. The sound was well liked, described as balanced, clear and detailed, though with a little bass heaviness and treble 'spatter'. But the well-balanced *E77* sits neatly in the middle of the impressive '77 trio. (6g, 16cu, 1.8g)

B&O MMC5 (£20)

Cheapest of the B&O series, the '5 is specified as being less compliant than the other B&O models, though we consistently found the same resonant frequency (therefore the same compliance) throughout; compliance is necessarily high, to suit the ultra-low mass B&O arms. The elliptical stylus, on a straight aluminium cantilever, has slightly greater tip mass than the more expensive models, and tracking weight range is higher. Frequency response showed a smooth treble region, slightly depressed by 1-2dB. Well controlled, the sound had good focus and energy, though somewhat lacking in bass. (3.3g, 24cu, 1.5g)

B&O MMC3 (£35)

The '3 has a nude elliptical stylus on a tapered aluminium cantilever; measured results were virtually the same as other models in the range. Sound quality was a little 'laid back', the treble unobtrusively dropping away, midrange pleasantly enhanced and bass controlled if a little 'soft'. A respectable performer for the price, it remains better suited to B&O rather than universal application. (3.5g, 24cu, 1.2g)

B&O MMC2 (£47)

Sharing the sapphire-tube cantilever of the *MMC1*, this differs mainly in having a larger (0.12mm/0.1mm) stylus shank. Response and sound quality continued the family resemblance, with soft but controlled bass, low coloration, sweet treble and subjectively good dynamics. Well-engineered, the '2 offers only a modest improvement over the cheaper models, performance again apparently limited by the mechanical compromise of the plug-in adaptor. (3.3g, 24cu, 1.2g)

Denon 103S

Originally fitted with a Shibata stylus, the 'S version of the *103* has a tip now described as a special elliptical; it is no longer distributed in the UK. Sound quality was well liked though a trifle 'edgy' at the extreme top, and perhaps a little less convincing in terms of overall integration than the other 103 models.

AT 637 AT 6012
 AT 6024
 AT 607 AT 620 AT 609 AT 631
 AT 608_{mkl} AT 6002 AT 625
 AT 6017
 AT 610a **AT 628**

We're keen to help you maximise the potential of your hi-fi system. So much so that we've dedicated a group of special numbers to do the job. Along with our innovative AT 637 Electronic Stylus Cleaner and advanced AT 628 Linear Crystal cables you'll find a whole range of items designed to both cleanse and tighten up your sound. Check out the grand selection at your AT Dealer soon.

 **audio-technica**
 ENJOY ADVANCED TECHNOLOGY

WEST MIDLANDS AUDIO
 HI-FI CONSULTANTS

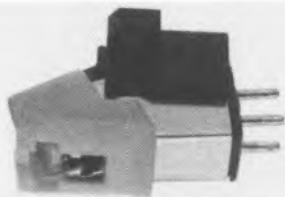

**KOETSU, REGA,
 NAIM, ROTEL**

To make sure you get the **MOST** from the music you enjoy best, we offer:-
 ★ Demonstrations by appointment
 ★ Delivery and expert installation
 ★ Keen part exchange deals
 ★ Credit facilities - details on request



AGENCIES INCLUDE: Linn Products • Naim Audio • Rega • Mantra • A & R • Nylech • Clark • Supex • Rala • Haybrook • Spencar • Kef • Celebration • Monitor Audio • Mordaunt Short • Tannoy • Nakamichi • Awa • Yamaha

229 Ombersley Rd. Worcester, WR3 7BY
 OPPOSITE CHECKETT'S LANE • OPEN 9.30 am to 8.30 pm
Tel: WORCESTER (0905) 58046

*South London
 Hi-Fi*
 FOR
*Better Equipment
 Better Prices*

FOR THE BEST
 ESOTERIC
 SOUNDS IN TOWN

NAGAOKA MP

BORN

A&R P77

A&R E77

A&R C77

AUDIO TECHNICA

100E

115G

3200XE11

140ML

ORTOFON

BMS20

BMS30

MC9

**210 Brixton Hill, Streatham,
 London SW2
 Tel: 01-674 4433**

**69 High Street, Reigate,
 Surrey
 Tel: (0737) 241358**

SUMMARY REVIEWS: CARTRIDGES

Denon 103D (£140)

Again a low-output (0.33mV) moving-coil, the 'D' has a tapered cantilever and special elliptical stylus. More compliant than the spherical-tipped 103, it offers improved tracking ability with lower tracking weight. A smooth but rising treble response was confirmed by subjective descriptions of brightness and 'splash'. This marred the sound quality a little, as it lacked the detail and transparency of some more exotic 'bright' designs. Clearly demanding a good quality tone-arm, the 1030 was quite competitive but not significantly preferred to the cheaper 108 on balance. (7.5g, 17cu, 1.5g)

Dynavector DV23RS (£150)

With Dynavector's famous ruby cantilever, this low-output (0.21mV) moving-coil has quite low compliance with different but both quite highly-damped LF resonances laterally and vertically. Rigid arms in the range 8-18g should be best, though virtually any arm would be usable. Response was very flat. Sound quality was not particularly favoured, described as somehow 'shut in', lacking energy and sparkle but with some HF edginess. (5.3g, 16cu, 1.5g)

Golding Electro 11LZ Boron (£120)

With boron cantilever and van den Hul stylus, the 11LZ is a low-output (0.19mV) moving-coil design. Our sample showed very low vertical compliance, with lateral compliance much higher; medium to heavy arms are to be preferred though it is difficult to avoid one or other of the (quite well damped) resonances occurring too high or low for comfort. The sound was well balanced but again lacked low-frequency authority, midrange focus and 'punch'. In all, a decent enough cartridge, but any improvement over the cheaper 11 was not thought sufficient to justify the higher price. (9g, 5cu, 1.8g)

Linn Asak (£219)

First of the Supex-sourced Linn models, the Asak is similar in many respects to the Trak and Karma models, having an unusually low compliance with little internal damping, so low mass arms should be avoided, and best results are likely towards the bottom end of the range 10-20g. Asaks deliver a lot of energy into the arm, so the inherent quality of this component can also prove a limiting factor. Sound quality was slightly more refined and even than that of the Trak but with similar solidity and fine full-range dynamics. (6g, 11cu, 1.8g)

Mission 773HC (£150)

Built to Mission specification by Dynavector in Japan, this successful moving-coil design has undergone several changes during its long lifetime; originally a 'high output type', its present output of around 0.22mV definitely needs an 'mc'

amplifier input. Medium mass arms are best suited, but the cartridge is flexible in this respect. With a substantially flat frequency response, the 773 showed good dynamics, lowish coloration, good focus, delicacy and 'air'. Perhaps not rivalling the very top designs in 'life' and transparency, it was thought sufficiently well balanced and competitively priced to merit recommendation. (8.2g, 14cu, 0.22mV)

NAD 9100 (£12)

Built by ADC, the 9100 offers a modest specification and spherical stylus. Frequency response was fairly well extended and a touch brighter than usual; subjectively, it was bright and 'bouncy', if a little relentless at the top end. It had much in common with the Phase I, though a touch more 'fizzy' and aggressive, more dynamic if rather coarse in the treble; it scored a 'Best Buy' rating. (5.8g, 12cu, 2g)

NAD 9200 (£22)

Another NAD variation by ADC, the 9200 has a low-cost diasa-type elliptical stylus. Compliance sensibly matches arms in the 6-19g range. Frequency response showed an even but determinedly dim treble; listening tests gave rather negative results, the sound described as unexciting, lacking body and a little coarse, listeners tending to prefer the 9100. An undistinguished contender. (5.8g, 18cu, 1.2g)

Nagaoka MP15 (£30)

Compliance proved rather high on this model, which has a nude elliptical stylus mounted on a tapered cantilever, and it is suited only to the lowest mass arms. Response showed a slight (1dB) treble rise. The sound was generally liked, described as solid with some treble detail, but the high compliance limits the potential of this interesting model. (6.8g, 36cu, 1.8g)

Nagaoka MP20 (£40)

With boron cantilever and elliptical 'triangle' tip, the MP20 has moderate compliance to suit arms up to 15g effective mass. Measured performance was generally good, and listening tests confirmed the usual Nagaoka qualities, but criticism was made of a rather 'scrapy' top and a somewhat 'sluggish' sound. (7.8g, 15cu, 1.8g)

Nagaoka MP50 (£95)

Rigidity has priority in this beautifully-made top-of-the-range Nagaoka; a locking screw secures the stylus in the strong metal body. Only light arms are suitable, due to the high compliance, though the high degree of damping helps here and gave good stability in the groove. With a boron cantilever and 'Triangle' superelliptical tip, the MP50 gave a rather impressive sound overall in terms of clarity, good detail and control, plus reasonable

SUMMARY REVIEWS: CARTRIDGES

dynamics, but with some 'construction' in the upper-mid, and slightly 'rich' bass. A good performer in many ways, it was nonetheless thought insufficiently distinguished or universal for recommendation. (9g, 31cu, 1.3g)

Ortofon VMS5E II (£14)

Despite its low price, the *VMS5* still has an elliptical stylus. The moderate compliance suits arms 8-18g, while tracking is good. Sound quality showed some 'swing' and 'pace', but was also thought rather untidy, though this is fair for the price. It clearly merited recommendation as good value for money. (5g, 16cu, 2g)

Ortofon VMS10E II (£21)

With a simple elliptical stylus (designated 'E'), the *VMS10* suits arms from 6-16g, though the measured tracking performance was not particularly good. Frequency response showed a 200Hz-7kHz droop which was not completely eliminated by the recommended 400pF capacitance loading (this can be achieved in most cases by adding Ortofon's neat little *CAP210* device, which clips between the cartridge pins). Described as rather ordinary, the sound was slightly 'bright' and 'obvious' in the treble, due rather to coarsening of detail than to any response imbalance. There seemed to be a general untidiness and congestion in the sound; some recent similarly-priced models, including Ortofon's, fared rather better. (5g, 18cu, 2g)

Ortofon VMS20E II (£35)

One of the most popular cartridges ever, the *VMS20* has an unspecified elliptical tip, tracking at a low 1g with a high compliance. Arms of effective mass 5-10g are suitable. Frequency response was smooth, while sound quality was described as generally 'laid-back', rather more 'tinkly' and less stable than the '10'. (5g, 35cu, 1g)

Ortofon VMS30E II (£52)

Top model in the *VMS* series, the '30' has a 'fine line' stylus and fairly high compliance, suiting arms of 5-13g effective mass. Frequency response loaded with 400pF, showed a gentle downtilt; with low capacitance, the 18kHz peak reached 3.5dB above the 8kHz level. Subjectively, the *VMS30* proved a capably relaxed performer, with fine stable stereo; yet it lacked the ability to generate excitement. Bass tended to be rather 'plummy' and dynamic discrimination weak. The over-damped, rather lifeless *VMS* sound now shows its age in modern high-performance players; nevertheless, there are still turntables which benefit from such good control of potential bass problems. (5g, 20cu, 1.3g)

Ortofon MC2000 (£450), transformer £400 extra). This prestige model has a body of solid alu-

minium and can be very firmly mounted. The expensive silver-wired transformer is needed to step up its exceptionally low output (-40dB) to match normal 'mc' inputs. Response was remarkably flat, and separation well maintained at HF. On listening, low coloration tended to highlight the suppressed 10kHz resonance; treble detail was described as 'etched', 'up-front', inclined to be 'fierce' and 'aggressive'. It did seem slightly 'cold' and 'clinical' overall, with some lack of 'bounce' in the lower mid. Clearly one of the best, there are few grounds on which to fault this model, except the extra expense of the transformer; the remarkable damping means almost universal arm compatibility, while the problem of system matching is primarily one of accommodating the *MC2000*'s slight 'glare'. (11g, 24cu, 1.5g)

Pickering XV15/625E

The US Pickering company is also responsible for Stanton cartridges, of similar design; disco models apart, the Pickerings appear relatively unavailable in the UK at present. The *XV15/625E* was first reviewed and recommended by HFC in 1977, when it was priced at £19! The 1984 price of £20 is much lower in real terms of course, and still allowed a recommendation. With good tracking despite the low downforce, the *625E* will work in most arms. Our test sample showed a gently down tilted response; on listening tests it emerged as one of the better models in its category. It was thought quite exciting, tending towards 'fierceness', with some forwardness and loss of depth. (6.4g, 12cu, 1.25g)

Pickering XV15/1800S (£40)

With a nude 'Stereohedron' line-contact tip, this *XV15* variant sailed through the listening tests last year with little but praise for the overall balance; detail, clarity and focus were all in evidence. Though the treble was slightly 'shut-in', bass was attractively 'bouncy'. Best used in arms up to 20g, and with about 275pF load capacitance, this is a fine cartridge with a civilised sound. (6.4g, 10cu, 1.25g)

Shure ME75ED (£22)

Shure's *M75ED II* was almost 'the' hi-fi cartridge for cost-conscious enthusiasts in the mid 1970s, though by 1977 the competition was catching up and the *HFC* review was not very favourable. Revived as an 'Encore' model, and tested in the 1984 edition, the '75ED' showed a 'splashy' sound quality due to its HF resonance, which gives a bright-sounding extreme top end above a 'laid-back' presence band. Bass was reasonably coherent if somewhat softened. A competent design, it showed its age sonically and went unrecommended. (6.4g, 11cu, 1.25g)

SUMMARY REVIEWS: CARTRIDGES

Shure M99E (£24)

Resembling the cheaper '92E, the M99E has higher compliance and will best suit arms of 5-10g effective mass, though the strong damping will minimise any mismatch. Response was consistent, with a 2dB mid/treble suckout. Sound quality was clean and controlled with 'crisp' low frequencies, but not particularly exciting. (7.4g, 15cu, 1.25g)

Shure M104E (£29)

This is a T4P or 'P-mount' plug-in design; conventional two-bolt mounting is via a structurally poor adaptor, which caused a glitch in the frequency response at around 200Hz. It sounded quite lively and 'punchy', though lacking real weight. Bass was quite articulate, mid a trifle recessed, stereo depth flattened; overall, not a substantial improvement on the M92E. (7.4g, 15cu, 1.25g)

Shure M105E (£45)

Moving up the range, this P-mount-adaptable model features Shure's damper/brush, is fitted with an elliptical stylus and tracks at 1.25g. Quite high compliance figures indicate low mass arms (6-12g) but the damper effectively negates the vertical resonance while damping the horizontal one, so arm matching becomes less essential. Frequency response showed a gentle treble downtilt reaching -3dB at 15-18kHz, and higher load capacitance helped lift output here. Sound quality was not all that well received, with a slightly 'spitty' sound lacking deep bass a dynamic contrast, but with stability and good control. This cartridge can be used in virtually any system, where it will perform unobtrusively and innocuously, with a balance that will suit many component combinations admirably. (7.4g, 22cu, 1.25g)

Shure M110HE (£55)

With 'Hyperelliptical' stylus tip, less damping and higher compliance than the cheaper Shures, this P-mount/adaptable model suits 5-15g arms. Frequency response showed a depressed treble above 12kHz; sound quality was thought eminently presentable but unexciting, with smooth, clear high frequencies but some boom and loss of definition in the bass. (7.4g, 20cu, 1.25g)

Shure M111HE (£67)

Similar to the M110HE, the M111HE is again compliant but effects on arm-cartridge stability are minimised by the 'Dynamic Stabiliser' damper/brush. Sound quality was not, in our view, sufficiently good to justify the price.

Shure ML120HE (£95)

Resembling the '140HE (see full review), this model has slightly lower compliance but still has a nude 'HE' tip. The sound was quite well liked,

clear, detailed and dynamic, if a little uncertain at low frequencies and with slightly 'exposed' treble; well balanced, but bettered by the '140. (4.5g, 12cu, 1g)

Shure V15 VMR (£185)

Latest in the long V15 series this Shure model pioneered the 'ridged' line contact stylus. Lab results were close to those of the M140HE; on listening tests, depth seemed a trifle compressed, the powerful bass was a little 'plummy' and the treble had a slight 'ispy' quality. Despite a fine midrange quality, the overall effect was a lack of 'energy', and slightly 'shut in' sound. In most respects the newer ML140HE was preferred. (6.6g, 24cu, 1g)

Supex SM100E (£69)

A conventional-looking moving magnet design, the SM100 shares the same stylus guard as the A&R cartridges. Arms 6-15g are suitable. Stylus is a simple elliptical, of indifferent polish on our 1984 sample. The sound is lively and well integrated, but marred by the HF resonance peak 'tinkle', quite audible on a full range system. This aside, it delivers as much musical information as many moving coils, the bass in particular having an attractive 'bounce', if limited extension. Rather idiosyncratic, it remains worth considering. (7g, 17cu, 1.5g)

Tallman Alchemist IIS (£413)

This model uses 'focussed field' techniques to produce high output from a moving-coil generator system otherwise similar to that of the S, as are the sapphire cantilever and line-contact tip. A dramatically rising treble (+2dB) at 10kHz, +4dB at 15kHz, +8dB at 20kHz on our 1984 sample) gave a brightness which dominated the subjective results and served to emphasise the cartridge's ability to portray treble detail and clarity. The bass lacked 'muscle' and weight, though the midrange was clear and detailed. This cartridge has some notable strengths, but in our view too anomalous a balance to justify recommendation here. (6.7g, 23cu, 2g)

Yamaha MC1S (£99)

Yamaha's m-c models seem to be only intermittently available; in fact the excellent MC11, supplied for review last year as a new introduction to the UK, was to our consternation never distributed here at all! But the long-established MC1S low-output moving-coil still did quite well; frequency response was impressively flat, the sound described as smooth, clean and uncoloured. Scoring more on neutrality than on soul, the '1S may not present the 'state of the art' but still is a thoroughly competent, decent-sounding design. (7.5g, 16cu, 1.8g)

DEALER GUIDE

ANDREW THOMSON

Specialist in HiFi

6-8 Bonnar Street, Dunfermline, Fife
Tel: 0383 724541

3 Whyte Causeway, Kirkcaldy, Fife
Tel: 0592 205997

All Hi-Fi Bought!

We buy or exchange ALL 2nd hand Audio & Video equipment.

Everything accepted in ANY condition — absolutely NOTHING refused!

MUSIC & VIDEO EXCHANGE
56 Notting Hill Gate, London W11
Open 7 days 10am-8pm
Tel: 01-727 3538

CHICHESTER HIGH FIDELITY

Appointed stockists of
A&R Cambridge, Castle, Celestion,
Creek Audio, Goldring, Kel, Linn,
Mordaunt-Short, Naim, Quad, Rega, Rogers,
SME, Nakamichi, Ackroyd, Tannoy
40 Little London, Chichester, W. Sussex
Telephone 0243 776402
(Closed all day Monday)



MON-FRI 9.30-7.30 SAT 9.30-6.00

- ★ We guarantee the best deal in the UK on any compact disc player!
- ★ We stock a huge range of HiFi from over 60 different makes

PAUL ROBERTS HI-FI

31 33 GLOUCESTER ROAD BRISTOL (0272) 429310
203 MILTON ROAD, WESTON SUPER MARE (0934) 414423
C.D. MAIL ORDER—PHONE RICKI WENN ON (0272) 429642

DUAL, REVOX, ADAMSON, CAMMIDGE, DENON, LEXICON, MURKIN, SILEX,
CROFTON, MERIDIAN, NAIM, ROTEL, ROYAL, SME, NAKAM



About Sound Hi-Fi Specialists

116 BOLD STREET LIVERPOOL
TEL: 051 709 4865
ARISTON, WALKER, REVOX,
THORENS, ALPHASON, SME



CREDIT FACILITIES
(Same day possible)
Tricity Finance APR 30.6%
Written details on request



DONBY, NORWICH, NORDIC, SOUNDCRAFT, SONY, JBL, QUAD, NAIM, LEXICON,
MEL, CYRUS, JAYTEC, DUBBER, SIBLING, BIRDA, SONY, SONY, SONY

G.E. MANDERS

For Nakamichi, Quad, Dual, Hafler,
Luxman, Denon, Revox, Sansui, Harman-
Kardon, A + R, Thorens, Sondek, QED,
Spendor, Technics etc.

2 Edward Street, Grimsby,
S. Humberside
0472-51391

Norman Audio

5 Fishergate Row, The Fishergate Centre,
Preston, Lancs. Tel: (0772) 53057

HI-FI SPECIALISTS

Most leading British manufacturers including:
A&R; Linn Products; Mission Cyrus; Revolver, etc.
Plus the best of imported brands like Aiwa; Dual;
Marantz, NAD; Rotel; Yamaha, etc.

Private demo rooms; Home demos; Service Dept; Full
credit facilities; free delivery and installation

BADA MEMBER

Image Hi-Fi

8 St. Anne's Road, Huddersley, Leeds LS6 3NX
Telephone (0532) 789374

Stockists of most of
the world's leading hi-fi
products.

Demonstrations by
appointment please

DEALER GUIDE

SELECTIVE AUDIO

Speak no evil, Fear no evil, Hear no evil...

The Forge Cottage
19 Crossgate
Otley LS21 1AA
W. Yorks.
Tel: (0943) 467689
Mon-Fri 9am-6pm



ROTEL



DENON



Norman H. Field

Hi-Fi

Technics

ALBANY HOUSE,
HURST STREET,
BIRMINGHAM B5 4BJ
Telephone: 021-622 2323



HI-FI MARKETS



Hear these turntables at



THE ROCK, QED, AREBIOI, AR, LEGEND,
THE SOURCE, REVOLVER, LOGIC,
SYSTEMDEK, DUAL, THORENS & ROTEL
Also a large range of cartridges stocked

2 WESTGATE, ROTHERHAM

Tel: 0709 370666

FINANCE AVAILABLE



Hi-Fi Components Ltd.

84 BATTERSEA RISE
LONDON SW11
01-223 1110



*For all your Hi-Fi needs at
discount prices.
Access & Barclaycard welcome.*

BEST BUY

the hi-fi centre OF WILMSLOW

For Real Quality Listen to:

QUAD ESL63-34-405 PLUS COMPACT DISC FROM PHILIPS,
SONY, TECHNICS, MARANTZ, J.V.C.
ALSO CHOOSE FROM BANG & OLUFSEN, REVOX, J.B.L.,
A.R., HARMAN KARDON, TEAC, TRIO, BOSE,
CELESTION, MORDAUNT SHORT, TANNOY, etc.

● PART EXCHANGE ● HOME DEMONSTRATIONS ●
FULL REPAIR FACILITIES IN OUR OWN WORKSHOPS ●
EVENING DEMONSTRATIONS BY APPOINTMENT.

GREEN LANE, WILMSLOW, CHESHIRE
(0625) Wilmslow 524766

ACCESS, BARCLAYCARD, DINERS CLUB, AMERICAN EXPRESS

● CLOSED WEDNESDAY EXCEPT BY APPOINTMENT



AR, ADC, AIWA, AKAI, ARISTON, B&W, BOSE, BOSTON
ACOUSTICS, CASTLE DENON, DIESIS, DUAL, HAFLER,
HEYBROOK, JBL, JVC, KEF, LUXMAN, MARANTZ,
MITSUBISHI, MONITOR AUDIO, MORDAUNT, SHORT,
MYST, NAD, NAKAMICHI, PIONEER, PROTON, QED,
QUAD, ROTEL, SME, TANNOY, TEAC, THORENS, TRIO,
VIDEOTONE, WHARFEDALE, YAMAHA

● DELIVERY SERVICE ● INSTALLATION ● CAR
PARKING ● TOP TAPE ● MAIL/TELEPHONE ORDERS
● INSTANT CREDIT UP TO £1,000
● ACCESS, BARCLAYCARD, AMEX

45 HIGH STREET, HOUNSLOW, MIDDLESEX
TEL: 01-570 7512

PETER ELLIS AUDIO

*Always a wide range of superior audio products in
stock, including:*

Loudspeakers: Castle, Rogers, Kef, Mordaunt Short,
Wharfedale, Mission

Amplifiers: A&R, Quad, QED, Creek

Cartridges: Drtofon, Goldring, ADC, Nagaoka, Rata

Turntables: Dual, Thorens, Walker, Ariston, Michell

Compact Disc Players: Akai, Trio, Philips

SINGLE SPEAKER DEMONSTRATION ROOM
BY APPOINTMENT ONLY

29 KIRKGATE, NEWARK, NOTTINGHAM
(0636) 704571

FOR A WIDE RANGE OF TURNTABLES, TONEARMS & CARTRIDGES

Recommended by this magazine

PHASE 3 HI-FI

**53 BRIGHTON ROAD
WORTHING, SUSSEX
TEL: 0903-206820**

BEST BUYS AND RECOMMENDATIONS: CARTRIDGES

Here we draw some general conclusions from our experience with some 180 cartridges tested in this and the last edition, before summing up on this year's Best Buy and Recommended models.

Over the past year, taken as a whole, cartridges have continued to become steadily but undramatically better. The super-compliant absurdities of the 'seventies have virtually disappeared, and the problem of fundamental arm/cartridge incompatibilities are much less common. This is doubtless due to market forces, but also in no small measure to Martin Colloms' sterling efforts in the previous volumes of this series.

Faulty examples and substantial variations between samples also seem to be rarer. Even under the microscope, good quality styli are fitted to fairly humble cartridges, though excessive globs of glue were still found in too many cases, including some embarrassingly expensive models.

The basic frequency response remains the most important initial indicator of sound quality, substantially defining the balance of the system. 'Perfect flatness' might seem to be a desirable end in itself, but should not be unduly emphasised.

The fact is that the average response for a large group of cartridges tends to show a gently falling response. And this seems to suit many systems quite well. Furthermore, after a short period of acclimatisation, the ear seems remarkably adept at adjusting to changes of frequency balance, hearing through this characteristic to more fundamental yet less easily identified qualities such as overall integrity, spatial coherence and dynamic range, and most important of all the sheer capability of musical communication.

It seems only very recently that it was quite difficult to find cartridges which showed good mechanical integrity in their body structure, yet now this has almost become the norm, particularly amongst models which are marketed by the specialist UK companies. (No doubt the rest of the world will get around to it once they too have decent turntables and arms to appreciate the advantages.)

In the last edition we were plagued by P-mount models with flimsy brackets which showed appalling midband resonances as a result of their mechanical inadequacy. We have done our best to avoid such horrors this time, and note with approval and admiration that Technics have come up with a P-mount (albeit an expensive one) which avoids much of this criticism.

The most interesting conundrum remains the tenuous, elusive, yet strongly suggested relationship between subjective sound quality and the

amount of cantilever low frequency damping.

Time and again we were confronted by subjective preferences for the lightly, and symmetrically, damped cartridges. For example, the completely undamped (albeit infuriatingly asymmetrical) Deccas seem to sound better and better every year, as turntables and arms steadily improve.

This observation is admittedly in the context of the high quality system which we used for the tests, and such cartridges may well be less practical in the more common or garden players which confuse differences. So as long as the majority of turntables fall far short of our high standards, there will remain a case for retaining some better damped more tolerant models.

Best Buys and Recommended models

At the end of the review programme, we have the task of weighing up the results to arrive at specific recommendations. As a general principle, a recommendation means that in our view the model did well enough to offer good value in its price category; a 'Best Buy' denotes exceptional value for money at a modest price. But it must be stressed that final choices should be made after considering all aspects.

Those who have picked this volume from the shelves of a well known newsagent chain during their lunch hour, hoping to glean all the information they want from a quick flip through the pages and a glance at these conclusions, may find the experience a frustrating one. A substantial number of the cartridges given full reviews are also recommended models.

However, this does not mean that we have lost our powers of discrimination — rather it more closely reflects the cost of paper! We have assessed something like 180 models during the work for this and the previous volume — far too large a number to provide full data on each. Models which are still available, and have not been given a page to themselves are to be found in the summary review section.

Although plenty of models merit recommendation, this does not necessarily mean that any such cartridge, slotted into any particular system, will automatically provide good results. Any attempt to assess cartridges *per se* is hampered by the knowledge that results will vary from turntable to turntable, from arm to arm, from amplifier to amplifier, and even according to the speakers and room.

This is where the specialist dealer comes into

BEST BUYS AND RECOMMENDATIONS: CARTRIDGES

his own. He can advise on the mixing and matching of components from a fund of experience in getting all sorts of systems to sound nicely balanced. And hopefully, if you find you haven't made the best choice by the time you get home and try it out, he will again come to the rescue with a likely alternative.

Following tradition, the cartridges are banded into different price groupings. By and large the more expensive models can sound better than the cheaper ones providing the turntable and arm are of sufficient quality not to mask the differences.

But in order to achieve reliable review results, even the cheapies were assessed in a top quality system (turntable and arm approaching £700, system as a whole nearly £7,000). A trifle inappropriate in some cases, this is still an unavoidable consequence of attempting to assess cartridges in isolation.

Low cost — under £20

The technically and sonically well-balanced latest *Audio Technica AT110 LC-OFc* (£16.50), and the lively lightly-damped *Grado MT* (£19) are two new Best Buys which join the existing six extant: the budget player oriented *ADC Phase I* (£12), its somewhat more aggressive *NAD 9100* (£12) relative, the clean and sparkling £20 *A&R C77*, the excitingly bright £16 *Linn Basik*, the laid back £14 *Nagaoka MP10*, and competently compatible £16 *Ortofon OM10*.

Recommended models include the powerfully restrained *Goldring Epic* (£16), the bright and detailed £20 *Pickering XV-15 625E*, the refined *RA1A RP20* (£20) and the P-mount compatible £15 *Shure 92E*.

Medium price — under £50

There are a couple of new Best Buys in this group — the high output and carefully balanced *Nagaoka MP11 Boron* (£29), and the fine-sounding low output £50 *Denon DL110* — join the lively low output *Ortofon MC10* with its impressive midrange and the finely engineered *B&O MMC4*, which sells at £25.

There are plenty of Recommended models besides. The new additions are the detailed, spacious *RA1A RP40* (£40), the well developed £42 *Audio Technica AT3200 XEII*, the competitive £30 *Glanz MFG-110EX*, the controlled and usefully compatible re-tested £40 *Shure M97HE*, and the paradoxical yet potent £37 *Rega RB100*. Established favourites include the delicately detailed £35. *A&R E77* and £45 *P77*, the controlled-yet-lively *Grado M3* (£43), the subtle and compatible £37 *Ortofon OM20*, well-balanced *ADC*

Phase IV (£41), and the clear and bouncy £40 *Pickering XV-15 1800S*.

Not too extravagant — under £150

Amongst high output models a new Best Buy is the spacious and lively £59 *Linn K9*.

New Recommended models include for the first time the dramatic, gutsy £69 *Empire MC-5M*, and the wonderfully idiosyncratic *Decca Londons* (from £80). Recommendations continue for the smooth and silky £93 *B&O MMC1*, the stable and well-focused £60 *Dynavector 10X4*, and the neutral and refined £120 *Shure ML140HE*. Two lively and dynamic low output Recommendations are the £80 *Denon 103* and £126 *Linn Trak* moving-coil models, and the more controlled £150 *Mission 773HC m-c*.

Expensive — over £150

New high output Recommendations include the powerful £260 *Supex SD901 IV*, the tantalising £248 *Decca Super Gold*, the fast and exciting £475 *Supex SD2000 High Output*, and the perennial £160 *Grace F9E II*. The 'alternative' Garrott-tipped *Decca* (£325) retains its status, with some reservations regarding the use of the special GB mounting clamp.

New low output Recommendations include the dramatic £500 *van den Hul MC 10* and the romantic £477 *Koetsu Black K*, while Recommendations for the solid- and fast-sounding £200 *Linn Asak* and *Linn Karma* (£340) continue.

Many of those who cannot contemplate the extravagance of the exotic models are nevertheless interested in their performance, and such models set the context of capability within which the more mundane are evaluated. Moreover each seems to possess its own quite distinctive character, and particular strengths.

Furthermore, each interacts in its own particular way with different ancillary equipment, so that firm statements and generalisations can be suspect.

The *van den Hul MC10* has joined the top group with a vengeance, creating a uniquely fine clarity and sweetness with impressive bandwidth and dynamic range. *Koetsu's Black K* substantially refines the Black to take the romantic lead. *Linn's Karma* has unparalleled bass solidity and great subjective 'speed', but the temperamental high output *Decca Super Gold* is the fastest of them all — in the midband.

And if these stick in the mind most memorably, there are a dozen other interesting and doughty performers too numerous to list.



EXPRESS ACCESSORIES



13 DEVOILS LANE, BISHOP'S STORTFORD, HERTS. CM23 3XD.
TEL: 0279 56282

Suppliers of high quality audio and video accessories

AGFA

Open reel tape and accessories

ALLSOP

Audio and video headcleaners

AUDIO LEADS

Full range of inter-connect cables for audio, video and computer

AUDIO TECHNICA

Cartridges, styli, headphones, microphones and care products

AVF

Speaker wall brackets and floor stands, TV wall brackets

BIB

Care products

CORAL

Cartridges

DISCWASHER

Care products

DUAL

Turntable mats

FIDELITY FASTENINGS

Speaker wall mountings

GLANZ

Cartridges and styli

GOLDRING

Cartridges, styli and care products

GRADO

Cartridges and, styli

HUNT EDA

Care products

MARBO

Mains distribution units

MASTERPLUG

Mains distribution units

MILTY

Care Products

NAGAOKA

Cartridges and Styli

ORTOFON

Cartridges and Styli

QED

Cable, Speaker Stands and Switching Units

RATA

Cartridges and Styli

REFERENCE

Speaker Stands

ROSS

Headphones, Microphones

SENNHEISER

Headphones

TARGET

Speaker Stands and Turntable Supports

TEK

Care Products and Electronic Timers

WATTS

Care Products

FREE ADVISORY SERVICE

Please write or telephone for any information or advice you may require

FREE DELIVERY

Free delivery on all orders over £5.00 in value. All items ex-stock and despatched within 24 hours.

TERMS

Payment by cheque, VISA or Access Order by post or by telephone.

FULL RANGE

The most comprehensive range of accessories available anywhere. We stock every accessory available

PLEASE WRITE OR PHONE FOR OUR FULL PRICE LIST

TECHNICAL INTRODUCTION: TURNTABLES

In this edition, the main turntable reviews cover some important new models and a necessarily small selection of established ones. These are supplemented by an extensive section of Summary Reviews.

With a limited number of full reviews, the turntable and tonearms section of this edition is intended as an 'update', placing new models in the context of the full-scale turntable review programme completed some six months ago for *Hi-Fi Choice* No 40, *CD Players & Turntables*. Readers seeking the complete laboratory test results on particular models which have been 'summarised' this time round should consult that edition.

Continuing improvements in laboratory technique have helped provide greater discrimination between products, and bring us a trifle closer to understanding and perhaps predicting the sonic performance from the technical data. It must be stressed, however, that the total performance and operating interaction that occurs in a turntable is very complex and not amenable to simple analysis, and listening tests will continue to play a vital part in product assessment. It is easy to hear turntable faults despite the poor quality of some discs, because the player faults are distinctly different. The failings of a weak turntable will pervade all the pressings it reproduces; a characteristic which will soon fatigue the listener.

While the audio industry generally concentrates on Compact Disc technology, many UK specialist firms have concentrated much of their efforts on continued analogue player improvement, to a point where even modestly-priced players show a distinct advantage when compared with imported price-equivalents. Both the empirical and theoretical understanding of the total balance of acoustic and subjective performance of a good LP player are growing apace, resulting in sonic refinement at quite modest prices. Such products are helping the UK industry to hold its own.

LABORATORY TESTS:

In our examination of turntable systems, tests have been devised to bring out, as much as possible, aspects relevant to sound quality. Only in the most simple and obvious cases do conventional measurements such as those for wow and flutter and rumble etc have much relevance to subjective quality. For example, peruse the figures for any modern turntable with pretensions to quality: rumble and wow figures are quoted which surpass even our test methods, and which are below audibility thresh-

olds; yet in practice these tell nothing about sound quality of the deck in question if experienced and perceptive listeners are involved.

Assuming that a turntable's sound quality *does* matter, we can then consider a number of subtle parameters which are notably difficult to qualify. For example, stereo imaging can be flawed in terms of both clarity and the ability to reproduce depth, due to instability in sub-chassis systems, excessive stored energy or coloration in the subchassis system and unwanted vibrational excitation arriving at the cartridge stylus. The bass may be weakened in both power and definition due to incipient acoustic feedback, also to counterweight resonances in arms, or to weak platter main bearings, which can encourage platter rocking at low frequencies. Sound quality in the midrange may be coloured and masked by structural resonances, plus coupled feedback in turntable lids or plinths, and if poorly isolated, also the shelf on which the deck is placed. Such middle range resonances may also be attributed to structural weaknesses in tonearms, and their mounting board or platform. The platter and subchassis themselves can also 'ring' or resonate in the mid register. The proportionality of plinth and platter mass can also be significant. A light platter on a strong heavy plinth will resonate more than when fitted to a lighter plinth where some mutual damping may be encouraged. Thin platters tend to ring like gongs, their damping partially controlled by choice of mat.

For the best sound quality the platter mass should be sufficient to provide a useful rotational inertia, providing a flywheel energy store, helping the platter resist small speed changes induced by variation in drive power, and the stylus drag which alters with music modulation. If the power is low and the platter light, then dynamic wow can occur as an audible pitch instability following loud programme transients.

Weak main bearings (including the support) can allow rocking modes in the platter to the detriment of coloration levels. Conversely, controlled stiffness and mechanical losses in the subchassis/arm mounting can help to trap and absorb unwanted energy which could otherwise be transmitted or reflected back into the platter or tonearm.

TECHNICAL INTRODUCTION: TURNTABLES

The execution of the springing associated with a suspended subchassis design is almost an art in itself, and is crucial in determining the operational stability as well as the isolation performance of the whole. The Linn *Sondek* exemplifies a model which may outwardly appear a trifle primitive in design, but which nonetheless incorporates many 'hidden' aspects which enhance its performance: there is hardly any detail of its construction which does not contribute to the whole. For example, the belt is critical in dimensional tolerance, surface finish, elasticity and internal loss factor. Any deterioration can affect speed accuracy, load tolerance, torque, wow and flutter, drive motor breakthrough rumble, as well as subchassis instability and behaviour. The audible repercussions are legion; for example excessive belt tension will mean the motor coupling will be too tight, resulting in worsened rumble and energy coupling to the platter, the subchassis will also be under excess lateral drag, impairing isolation and worsening vibration rejection; finally the belt-subchassis mass resonance may become involved — a factor usually kept at bay due to a minimal belt tension consistent with good drive.

In an earlier issue the 'flexibility' of the *Sondek* arm mounting facility was mentioned, but we now recognise that in practice this flexibility is an advantage rather than a weakness in the case of the *Ittok* arm series (the latest *Ittok* has undergone further revisions, see review). It is now apparent that an important terminating and absorbing function is provided by the 'composition' arm board and its apparently superficial fixing to the subchassis. Energy propagating from the cartridge down to the arm pillar is absorbed here, rather than being reflected back to the cartridge by a misterminted board/arm pillar interface (see Lux *PD300* review).

However we have found it dangerous to use the *Sondek* as a reference turntable for comparative auditioning, due to its unique character and sonic balance; but it does remain useful as a long term reference in view of its musically-balanced and satisfying performance. So far no other turntable has provided the same balance and combination of qualities and weaknesses which would allow an easier A/B comparison test. Good disc players increasingly represent a 'system', where motor unit, arm, cartridge and mat offer

an optimised combination. Alter any single part and one's view of the whole can be altered too.

Acoustic and vibration isolation

Returning to the more general discussion of factors affecting subjective performance, we classify energy arriving at the working cartridge from the outside under the heading of 'acoustic and vibration isolation', this including energy emanating from the music reproduced by the loudspeakers. The latter is a feedback-promoting effect which rapidly worsens sound quality with increasing gain, well before the point at which 'howl-round' is reached. The energy enters the turntable via two routes, both acting together. Vibration in the room structure is transmitted by the floor and excited in the support cabinet or shelf, entering via the turntable feet and base; airborne acoustic energy is intercepted by the entire turntable structure — the lid, the arm-board, the plinth, platter, disc and the subchassis.

The isolation performance of a turntable affects other subjective factors as well, these classically described as signal to noise ratio, and more recently noted as dynamic range or more simply still, 'dynamics'. The important distinction here is that traditionally the noise part of the signal to noise measurement was judged in the absence of the signal, this being the easiest way to do it. Take rumble as an example. Conversely, subjective dynamics concern how much unwanted noise is present in the reproduction while the music is also playing through a complete hi-fi system; that is, a judgement of the noise in the presence of a signal. This is much harder and requires some practice. Subjectively, one can learn to recognise the spurious noise which hangs like a coloured (acoustically that is) veil over the sound stage, masking fine musical detail and blurring the definition of sharp sounds or transients, resulting in a flat, two-dimensional image that lack true space, depth and ambience. In addition the dynamic relationship between soft and loud passages appears compressed, detracting from their liveliness and 'attack'. A system with a poor dynamic signal-to-noise ratio sounds as if the subjective volume is more constant, and is usually on the loud side at that.

In the lab it has proved possible to investigate some of those factors which affect

TECHNICAL INTRODUCTION: TURNTABLES

this dynamic quality, mainly via wide-band isolation tests. The vibration and acoustic isolation performances are assessed separately, and presented on one display where their joint effect may be judged.

For vibration purposes, the turntable was mounted on a reinforced wooden panel, flexibly mounted and driven in the horizontal plane by a small vibration exciter. The flexible mounting was provided by polyurethane foam, which gave an overall lateral resonance at around 3.5Hz. The acceleration at the centre of the table was monitored by a B&K accelerometer, and adjusted by an equaliser to show a fairly uniform value measured in constant bandwidth analysis over the important isolation range of 10Hz to 500Hz. Above this frequency range, even the worst rubber feet on primitive players are very effective. Below 10Hz questions of subchassis and cartridge resonance excitation arise, and these were dealt with separately.

The printed vibration graph represents the RIAA equalised output from a pickup cartridge on a record and demonstrates the isolation achieved between the vibrating test board and the stylus.

The second factor, acoustic isolation, was analysed in a similar manner, but here the excitation was a uniform pink-noise soundfield generated by a powerful loudspeaker, 1m distant. A B&K microphone system was used to help define a uniform frequency response at the record position over the useful range, 30Hz to 500Hz. A parametric equaliser aided this calibration. The sound pressure was set at 90dB while the measured result was scaled against standard rumble reference level of 10cm/sec lateral at 1kHz. The baseline is equivalent to -80dB.

Inevitably, both the turntable and the baseboard on which the turntable was mounted were jointly excited by this soundfield, and some contribution from the baseboard thus appears in the measurement depending on the vibration isolation characteristic of the turntable under test.

A turntable with excellent vibration and acoustic isolation performance has the potential for good subjective dynamics, though the resonant behaviour of the subchassis/platter arm combination will also play a part here.

For the printed graphs, as already noted, a split display is used. The upper half is a 60dB

(six division) section showing acoustic breakthrough with the mid screen representing a baseline of -80dB. The lower 60dB or six divisions are allocated to the vibration isolation, again with a -80dB baseline. The frequency axis is linear 10Hz to 500Hz; note that most other graphs use the usual logarithmic audio frequency scaling.

Suspension modes

Using the spectrum analyser and via selective frequency sweeps into the vibrator exciter, the various subchassis and suspension modes may be explored and noted. In particular, modes which overlap the critical area of arm cartridge resonance 9-12Hz are judged severely, in view of their potential interaction with the cartridge. Rotational modes are important in that scrub flutter may be easily induced, while the effect of general chassis movement on audible wow was also noted.

Disc impulse response

Following Moncrieff's lead on disc impulse response, a 4g plastic rod was allowed to fall at an angle of 45° onto the edge of a record, in position on the platter. The cartridge sensed the transmitted mechanical impulse as it arrived at the other side of the disc and its output was captured for analysis both as an impulse response (reproduced in the reviews) and also for Fourier processing.

This deceptively simple impulse test can produce much information about the whole suspended disc playing unit. The shock is applied to the disc, and how it is attenuated in its path across to the cartridge stylus tells us about the absorption and damping characteristics of the disc support. In addition, part of this excitation is transmitted to the platter, exposing any self resonances here. Via the platter, test energy also arrives at the subchassis via the main bearing. Flexure between platter and chassis can be revealed in addition to intrinsic chassis resonances, including harmonic ringing in the suspension springs.

Tonearm resonances

Tonearms possess an ability to flex and resonate in the audio bandwidth, and are therefore a potential source of coloration, due to their close coupling with the cartridge. Less severe with high compliance models, these resonant effects are most marked using a

TECHNICAL INTRODUCTION: TURNTABLES

close-coupled, less compliant moving-coil cartridge, the Osawa 60L, used to illustrate resonant interactions with the tonearms we tested, being an example. Its compliance measured 18×10^{-6} cm/dyne (18cu), and the acceleration in the side of its body resulting from a lateral sweep 20Hz-20kHz (TRS1007) was sensed by an ultra low mass wide-band accelerometer (B&K 8307) which records both bending and rotational modes in fair proportion.

Depending on the tonearm involved, it became apparent that severe resonances at the cartridge could be induced from as low as 30Hz right up to 20kHz, and that major differences in broad-band energy were also observable up to 20kHz. These resonances are akin to be delayed 'decay' energy responsible for the majority of loudspeaker colorations, and may be perceived in much the same way.

Ideally the arm should be infinitely rigid, to perform the task of supporting the cartridge accurately with respect to the record groove throughout the frequency range. At the same time the bearings, while free of slackness, must be of sufficiently low friction not to impede the progress of the stylus across the record, or affect its ability to ride warps and other related imperfections. Play and lack of rigidity in a tonearm not only colours the sound through audible resonance, but this very imprecision also upsets the cartridge/groove relationship, adding spurious intermodulation interference over the whole frequency range, and detracting from clarity and the quality of the stereo image.

We therefore examined arms for quality of headshell fixing, bearing play and friction, as well as for geometrical accuracy, effective mass and resonant properties. The resonance graph is not a linear function of acceleration, due to imperfection in the test cartridge (non-uniform mechanical impedance variation with frequency), and to the pre-emphasis used on the test disc. A theoretical approximation is however given for the ideal tonearm — a uniform acceleration from 20Hz to around 1.5kHz, the trend then rising at 6dB/octave in the 2kHz to 20kHz range.

To gain an idea of a single tonearm's relative performance, a study of several resonance graphs is essential; this allows recognition of common patterns, as well as some of unavoidable test cartridge/arm interactions.

In the case of 'super rigid' designs, the

coupling factor from cartridge body to the arm board is sufficiently firm to allow the cartridge to read the terminating absorption properties of the arm mounting itself, which has a noticeable effect on the resonance graph: this effect may be associated with the sound quality differences that occur when an *Ittok* is fitted to different turntables, for example.

Breaks or resonances occurring below 100Hz are usually generated by seismic modes in the counterweight assembly — the rubber decoupling bushes often employed frequently being the cause. From 100Hz to 2KHz, some of the lower level disturbances may result from arm pillar mounting effects, the subchassis structure etc, while from 150Hz to 250Hz flexure at the socket in detachable headshell arms is generally apparent, often as a severe mode with a strong step or 'platform' in relative energy level. Fixed head arms show a smoother energy trend, though bending or torsional resonances in the main tube are still apparent, with the more flexible types breaking up at 250Hz, and the 'ultra rigid' examples deferring this to a high 800Hz or so. Arm designers continue to attach odd appendages which are clearly detrimental to sound quality; these include springy finger lifts and the like. In one example the cue platform was also found to resonate in the mid range.

It is also possible to hear resonances in the internal springs used for bias compensation and downforce with certain arms. Tapping the arm gently with a small screwdriver blade while the cartridge is in place on a stationary record can also help expose such phenomena. Monitoring here is best done on headphones.

Arm effective mass and arm/cartridge subsonic resonance

Earlier issues of this series were rightly concerned over the poor compatibility of many tone/arm cartridge combinations then in use. More specifically, heavy 14-20g detachable head arms were being used with high compliance 30-60cu cartridges from such manufacturers as ADC, Empire, Ortofon and Shure (to name but a few). An unstable performance in many areas was the outcome of the resulting poorly-damped 5-7Hz resonances, lying in the worst range of record warp energy.

Matters are however improving now, with the general trend towards moderate stylus compliance plus reduced tonearm and cartridge mass combining to offer much better mechanical

TECHNICAL INTRODUCTION: TURNTABLES

matching than before.

Conversely the design requirements of the modern moving-coil cartridge seem to result in low compliance values suited to higher mass tonearms; indeed these demand the strength and good resonant characteristics of such designs. The medium mass *Ito* is well suited to such cartridges, and provides an ideal resonance combination in conjunction with the low compliance *Asak*.

With 'difficult' combinations of arm and cartridge, some method of damping the resulting subsonic resonance was considered necessary. Traditionally, this has involved a dashpot of some sort or another, filled with viscous silicone fluid and mounted in or near the arm pivots. However few arms nowadays still incorporate this feature and it is generally recognised that the correct place for a viscous damper is at the headshell, coupling the cartridge body to the disc surface via a sliding part. Rangabe first produced such a device, (sold as the *Z-Track*) but at the highest quality level, this type of device can cause some minor noises as some of the music energy is inevitably transmitted from the damper to the cartridge adding spurious sounds.

Recently, a new version of the arm damper has emerged on the Elite turntable where the fluid bath is placed over the record and engaged with a paddle mounted on the headshell adjacent to the cartridge. By its location it offers normal arm damping at the subsonic resonance and also a transmission path for structural resonances at the headshell end of the arm. In theory arm coloration is thus reduced, and in contrast to other schemes, the Elite is intended to complement an existing well-matched arm cartridge combination, not to rescue an ill-advised arrangement.

Low frequency sound quality

Really clean bass from a turntable is impossible due to the compromises involved in the complete recording/reproducing chain. For example, as mentioned in a previous issue, twelve low frequency filters are typically present between the original sound and the listener. Those we can pinpoint easily are those due to the loudspeaker itself, the amplifier and the cartridge/turntable combination, and to these we can add the disc cutter, the low frequency filter in the cutter amplifier and the magnetic head on the studio recorder. If a multitrack recording is involved,

then several tape stages may also be present, while the microphone capsule plus its pre-amplifier are also 'in line'. So far we have ten or so filters in cascade (or additive condition); now we can include the small audio transformers used for balanced line coupling of the vast majority of studio equipment namely microphones, noise reduction systems such as Dolby *A* and *dbx*, equalisers, echo, mixers etc. At best we can add five roll-offs due to the LF limiting frequencies of these transformers; at worst some recordings have up to 30; after passing through such stages it is a wonder that the bass sounds are worth listening to at all! As these coupling transformers usually have an HF limit at around 30kHz, their effects are present at the high frequency end of the spectrum as well. Further HF problems would include disc cutter resonance, microphone cut off (typically 16kHz), pickup cartridge tip mass resonance and tracing, plus many, many more.

Fortunately with modern transformerless balanced output amplifiers and digital recording systems, the potential now exists for a reduction in the number of sound degrading interfaces. Assuming a direct-coupled amplifier, and a DC coupled recorder, in principle a digital recording chain could be constructed with only two significant LF roll-offs, namely the microphone system and the loudspeaker. This is why the classic Direct Cut records such as the Sheffield series, using a minimum of ancillary equipment, have such a good bass.

Compact Disc is clearly at an advantage here since the player has a flat frequency response to below 5Hz and does not suffer problems of RIAA equalisation, subsonic resonance and the like. CD is also virtually immune to low frequency feedback, which is a major factor with many analogue turntables. On good recordings the CD bass compares with the original master and comfortably exceeds the present standard obtainable from analogue players.

Rumble

All these factors do not include the contribution of other mechanical defects in the turntable system which might not be directly audible but which might nonetheless disturb listening satisfaction. It has been suggested that the high transverse forces developed by some direct drive motors on the main bearing can generate a form of rumble which can be

TECHNICAL INTRODUCTION: TURNTABLES

detected as flutter sidebands in the lateral plane.

We have continued where possible to use the precision rumble coupler system which allows a DIN B threshold of measurement of close on -80dB , rather than the -65dB attainable from the best records or the -73dB available on master cut studio lacquers.

It is in precisely this range that one can begin to discriminate between direct drive motors in terms of rumble, and it can be easily illustrated by spectral analysis that many direct drive motors do generate more rumble than comparable belt drive counterparts.

On theoretical grounds it can be argued that a sufficiently low rumble level for direct inaudibility may still not guarantee complete freedom from other rumble induced effects. Whether directly audible or not, any unwanted or spurious displacement due to platter main bearing inadequacy or out of balance motor torque effects will interfere with the accuracy of groove/stylus tracing. After all DIN B rumble is only an arbitrary weighted curve approximating to the directly audible sound or rumble noise. With the help of the 'coupler' we have discovered that while a -72dB DIN B figure was in some instances insufficient to guarantee inaudibility, with others measurements as poor as -66dB gave an inaudible background at typical listening levels. This points to a failure of the weighting curve to cope with all types of rumble spectra.

In fact, we found it possible to trace sources of rumble noise for some of the turntables in the report. For example, several direct drive models in past tests had bearings with an intrinsic rumble in the -78dB DIN B region (power off, motor free-wheeled). Reconnection of the supply resulted in degraded figures, not due to hum, but generated by the torque pulses in the motor. This interference was also observed with at least one belt drive design, the source being readily traced to poor isolation of motor vibration from the arm base.

Unweighted DIN A readings were also taken, but inevitably, these results were dominated by the unwanted 'weighting' introduced by the particular subsonic resonance curve of the test cartridge, while the quality of vibration isolation could also contribute.

Wow and flutter

The Matsushita master acetate was used in conjunction with a new generation wow and

flutter instrument (model *WM7*) with an automatic reading facility (B&O instrumentation division). DIN specify peak readings which are difficult to estimate from the usually wildly fluctuating meter pointer, while the picture is further complicated by occasional random noise excursions; consequently with a conventional meter one tends to under-read. However, this new instrument has the ability to reject random effects and accurately records the peak periodic wow and flutter over either three selected intervals, or sigma functions. We used 'sigma 2' (5% of the test period).

By comparison with previous results this method yielded 20-30% higher readings with commensurately greater accuracy and consistency. Linear peak readings were also taken for wow below 6Hz, as well as for flutter above this frequency (with a poorly damped arm/cartridge subsonic resonance these measurements can be in error and, for example, a Shure *V15V* with damper was often employed for the flutter tests, rather than an *Osawa 60L*). The finest example recorded 0.04% DIN peak-weighted (sigma 2), and this level is probably close to the residual flutter on the test disc itself. Therefore models reading 0.05% or below are simply quoted as measuring less than 0.05%. Denon claim very low wow and flutter measurements using a magnetic shaft encoder, a derivative of their magnetic pulse speed control method encoded on the platter rim.

While still on this subject it is particularly interesting to note that some 0.1% unweighted peak wow can be produced by an off-centre displacement of the record of as little as 0.1mm which can be the result of poor record manufacture, an oversized or inaccurately placed centre hole (the standard specifies 7.24-7.33mm diameter) or even an under-sized turntable spindle. For an off-centre record rotating at $33\frac{1}{3}$ rpm, the wow frequency is 0.5Hz approximately, a rather slow rate.

The ear is most sensitive to wow in the 4-7Hz range; frequencies above this are not perceived in the form of wavering pitch, and even when excessive are only really audible as 'roughening' type of distortion increase. In part this explains why it is desirable to shift any turntable system subsonic resonances away from this region, be it suspension of arm/cartridge in origin. Since the two latter resonances should not coincide, we are left with the suggestion that the subchassis

TECHNICAL INTRODUCTION: TURNTABLES

resonance should be below 6Hz and that of the arm/cartridge above 8Hz. The maximum incidence of record warp amplitudes also falls within this critical 3-8Hz region, and further reinforces the suggestion.

Arm Geometry and Cartridge Alignment

Another important area concerns arm geometry and cartridge alignment. There are two extremes, one a system of mediocre quality where comparatively large errors in cartridge alignment may pass unnoticed, and the other an up-to-date high performance system, where poor adjustment will significantly degrade the potential end result. The automobile analogy is an elegant one; a family runabout with a low compression engine is fairly tolerant of poor engine tune, but a higher performance model is utterly dependent on accurately set timing, valve openings and mixtures etc.

A few degrees of cartridge misalignment will degrade the channel separation of a high class cartridge by a factor of some 15dB, but on the other hand it will produce relatively little impairment of the already moderate separation characteristic of a less expensive pick-up. At present the importance of accurate arm alignment is highly under-rated. Virtually all Japanese arms and turntables are currently supplied with an alignment procedure called 'overhang adjustment', which is accomplished by altering the amount the stylus tip overhangs the record spindle when the cartridge body is aligned immediately above it. But this is next to useless when quality cartridges are involved. While a 1° error can be easily seen and corrected with protractor, a small 1mm overhang error (less than 4/100 of an inch) can produce a similar degree of misalignment. One solution would be to use one of the protractor cards that are supplied with a number of universal pick-up arms, as these have an array of parallel lines against which the cartridge side face can be aligned when the stylus point is in a specified position. However the majority of protractor cards (SME and its counterparts) have a stylus point at a 6cm radius from the spindle, working on the basis that the optimum tracing distortion trade-off will thus be obtained, if using a traditional spherical stylus and a mix of 45rpm singles and 33 1/3 LPs. In practice, this is not the best solution for the mean music radii of today's 33 1/3 LPs (45s discounted), particularly if used with the now

almost universal elliptical and line/hyperbolic styli supplied with hi-fi cartridges.

With a correct offset angle (for which it is often necessary to rotate the cartridge laterally in the headshell, since most headshell offsets are not optimal), and with an accurate overhang for the actual arm length (the pivot to stylus dimension), a condition of minimum tracing error may be achieved. Two points of zero error are used, sensibly positioned between the maximum and minimum playing radii, with the inner zero at a radius of 6.6cm and the outer at 12.1cm. Such precision also suggests that the bias be equally carefully set, so that the stylus is kept as far as possible at its geometrically aligned position (large bias errors permit the out of balance forces to laterally deflect the cantilever, thus adding to tracking error).

Aside from matters of mass/compliance compatibility, damping, tracking weight and bias adjustments, two other alignments are also crucial. One is that the effective axis of the generator system within the cartridge is accurately aligned perpendicular to the record surface; hopefully this is ensured when the cartridge body itself is truly vertical when viewed from the front. Small degrees of tilt of the order of 1° may again degrade separation, and vertical alignment is particularly important with line contact and van den Hul tips where a small tilt will cause the long contact walls to miss the intended groove sections, resulting in an unwanted rake angle between the stylus axis and groove axis, with serious

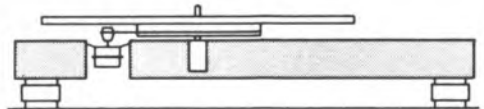

A solid plinth/belt drive type is often used in cheaper systems.

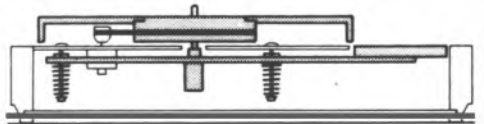

A decoupled sub-chassis/belt drive system offers good environmental and motor isolation. The entire suspended section is shaded.

THE ONLY CORNERS WE CUT ARE ON OUR TAGS

You have probably seen them. In dealers windows, attached to display models at exhibitions or featured in advertisements in the hi-fi press. Manufacturers are inordinately proud of them. As well they might be. We dish them out pretty sparingly.

So just why does a *HI-FI CHOICE* recommendation carry so much weight?

Because we commit thousands of pounds and many hundreds of man hours testing equipment for every issue of *HI-FI CHOICE*. And when we say 'testing', we really mean it.

Each issue is authored by one of Britain's finest audio technicians. We pit machine against machine under controlled laboratory conditions manufacturers claims against reality.

We conducted 'blind' listening tests using a panel of listeners. We print the reviews, warts and all. These are preceded by a 'Consumer Introduction' and a 'Technical Introduction', usually many pages in length. Each issue has a quick reference 'Overall Comparison Chart' and, of course, a 'Best Buys and Recommended Section'. Photographs of all models are included. Lastly, we award those little tags to

a selection of the models tested.

We usually publish five *HI-FI CHOICE* editions a year. They cost £2.50 per copy. Each one dedicated to a particular theme. We laminate the covers to make them last for years and supply quality binders to keep them in for permanent reference. We also maintain stocks of back issues for people to buy through the mail (using the coupon below) or you can visit our new Back Issues Centre in the West End of London. This is located at 14 Rathbone Place, London W1P 1DE, five minutes walk from Tottenham Court Road tube station.

Any new issue of *HI-FI CHOICE* is usually to be found at W. H. Smiths or other good newsagents. Some hi-fi dealers carry a stock of back issues, too, but in case of difficulty, contact us at the above address.

Ours is not a very economic way of producing a hi-fi publication. We could probably cut a few corners on obtaining the information we publish and make a lot more money. But our Series Editor,

Steve Harris, just wouldn't stand for it. And he stands for what is printed on the front cover of every *HI-FI CHOICE* — 'The most comprehensive Guide to Buying Hi-Fi Ever Published.'



If you prefer not to cut up your magazine use a photocopy of this form.

RUSH ME THE ISSUES OF HI-FI CHOICE TICKED BELOW:

- | | |
|---|--|
| <input type="checkbox"/> Amplifiers & Tuners (39) | <input type="checkbox"/> Loudspeakers (41) |
| <input type="checkbox"/> Best Buy Guide 1985 | <input type="checkbox"/> Cassette Decks & Tapes (42) |
| <input type="checkbox"/> CD Players & Turntables (40) | <input type="checkbox"/> Hi-Fi Choice Binders |

PRICES (inc. P&P): UK £3.50, Rest of World £4.25 (Air Service), Binders: UK £3.50, Air Service £4.50.

- Please debit my Access/Visa/Diners/American Express/Mastercharge* card
 I enclose cheque/postal order/international money order* for £ _____

Card _____ Signed _____

Name _____

Address _____

Make cheques payable to:
 SportsScene Publishers Ltd.
 Send coupon with remittance to:
 Hi-Fi Choice Offer, PO Box 320, London N21 2NB.1

*Delete where not applicable

HI-FI CHOICE

TECHNICAL INTRODUCTION: TURNTABLES

consequences for groove wear and tracing.

Finally the horizontal axis of the cartridge, that is the angle as seen by the cantilever back to the arm pivot from the stylus record contact point, must agree with the disc cutting standard. Nominally this measures 20° but in practice it is closer to 23° , and if this is not maintained, the stylus side contact line will rake across the cut groove axis at an angle, distorting the playback. Unfortunately it is not enough to simply ensure that the top surface of the cartridge is parallel to the record, as some cartridge manufacturers are not wholly consistent and many pickups when set visually parallel have cantilever/generator axis 'rake angles' as great as 40° .

Correction of this sort of error will require one of two solutions: either a lowering of the arm pivot by as much as 2.5cm (but with many cartridges this will cause fouling of the body on the record surface or complicate arm operation); or alternatively the preferred solution would involve rigid angled spacers at the headshell position, but these are not readily available. The only relevant angle when setting the 'rake' is that made by the cantilever with respect to the disc plane, and allowance needs to be made for higher compliance cartridge styli with their significant change in rake angle with applied tracking downforce.

Where a cartridge manufacturer has chosen to adopt say an incorrect 35° vertical tracking angle and has set the longer tracing edge of the stylus accordingly, no proper correction can be made via arm tilt, because if rake is correct the stylus/groove wall geometry will be wrong, and *vice-versa*.

SUBJECTIVE TESTS

Each turntable was placed on a substantial wooden coffee table, located some 3m from the loudspeakers, on a normal suspended timber floor. The relative performance on acoustic and vibration susceptibility was reliably assessed from physical observation, checking of feedback margins, and auditioning of selected music discs.

Comparative and sequential auditioning was undertaken, in an effort to explore the differences and similarities between the various models with 'blind' sessions employed on the most critical 'playoffs'. We found that turntable and tonearm auditioning was particularly difficult at the high quality end of the product spectrum due to the interaction

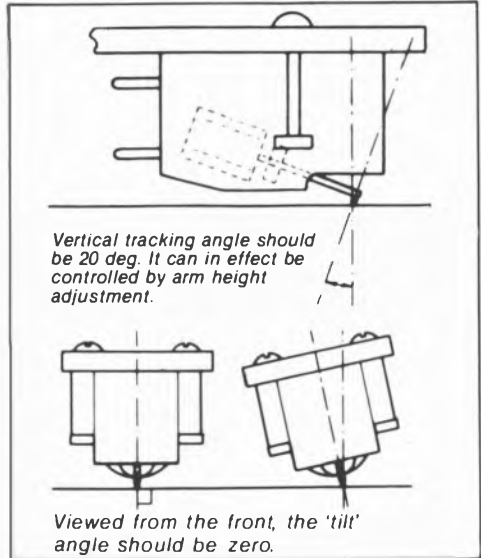

between different components. For example, two tonearms of nominally equivalent merit could affect the sound balance of the turntables to which they were fitted to such a degree that sensible assessment was impossible.

My own conclusion is that there is no such thing as a universal high performance motor unit, since the consequences of leaving other matters of disc support, arm and cartridge in someone else's hands usually prejudices the end result. I believe that a very limited number of options exist for each model to provide a top class performance, and we have tried to identify these, albeit in a limited fashion, for as many models as possible.

ACKNOWLEDGEMENTS

Many thanks are due to Paul Crook, my assistant on this issue; to Marianne Colloms for her help in checking and typing copy, and to the listeners involved in auditioning the product in this and the last issue; Paul Messenger, Alan, McGechan, Steve Harris, David Praker, John Atkinson and Paul Crook. Thanks are also due to the manufacturers who loaned product to aid evaluation and thanks also to Audio T, our local dealer, for the loan of equipment.

Martin Colloms

Acoustic Research EB101

Acoustic Research Ltd, High Street, Houghton Regis, Bedfordshire LU5 5QJ
Tel (0582) 603151



Following the successful relaunch of the classic AR deck (now the *Legend*), Acoustic Research UK have developed this further model. The *EB-101* has a vinyl 'black ash' finish and, inside, a steel girder subchassis substituting for the aluminium original. A new arm has also been commissioned from Japan, and this is factory fitted to provide a complete integrated player. For the review, a modest cartridge was also included, the whole expected to sell for around £190. This offers a considerable saving over the original model, equivalent to throwing in the arm and cartridge free.

This deck has rather a dark appearance, and comes with a low resonance tinted pvc cover on sprung hinges. The two piece alloy platter has been retained while on the bearing, as well as in other areas, tolerances have been improved. The arm is a robust example, with a firmly clamped headshell using a locking sleeve. Its bearings proved free from play, an important aspect.

Fully suspended, the chassis moved very freely and promised good acoustic and vibration isolation.

Lab report

The total platter mass was close to 2kg, healthy for the price category, with the two part construction offering good damping. Tested for disc impulse, the initial transient was quick with a fast decay and no low frequency hangover.

Speed change is manual, on lifting the outer platter. At 33 $\frac{1}{3}$ the deck ran nearly 0.5% fast, which was satisfactory, and slowing under load held to a fine 0.25%. Long term drift was

negligible with the synchronous motor employed. DIN peak weighted, the overall wow and flutter was fine at 0.09% with similarly low individual contributions from the wow and flutter components. Start up was fairly rapid at 3.5 seconds, and the player clearly had a healthy torque.

DIN B rumble measured very well, at -77dB. Little breakthrough was evident since the electrical and mechanical spectra matched well; just a hint of motor vibration was evident at 200Hz.

The high quality suspension was demonstrated by the excellent breakthrough responses for both acoustic and vibration excitation; here the unit was clearly up with the best modern examples.

Turning to the arm, here the robust headshell was nominally detachable but did not come with a plug and socket. Rotational adjustment is allowed, as well as overhang and lateral tracking angle. Effective mass was in the medium to high range at 13.5g including hardware, this suited to fairly low compliance cartridges.

Charted for arm resonances with the supplied Shure moving magnet cartridge the first break appeared around 700Hz, with the overall behaviour looking quite tidy, particularly at higher frequencies. Bearing friction was quite low, at 40mg lateral and 20mg vertical, while sensible bias levels were also established. Downforce calibration was accurate while the arm cue device operated well.

Sound quality

There was no doubt concerning the high subjective merit of this player. The sound was notably well focused, with good stereo stage width and depth. Transients were reproduced with good speed and attack, while the overall effect was lively, with well differentiated dynamics. The bass was quite good, articulate as well as extended, with considerable detail apparent. Overall the tonal balance seemed well proportioned while the supplied cartridge was quite tidy itself and did not let the deck down; a sort of 'AR *Basik*', I suppose!

Conclusion

This belt-drive turntable offers a remarkable package. A genuine high fidelity product, it had no significant subjective or lab tested weaknesses. Its rigid arm, good platter and drive, with a fine, effective subchassis, are comple-

mented by a workable cartridge, which will happily benefit from upgrading at some future date, if so desired. Pricing is also very competitive, and a Best Buy rating is the logical outcome.

GENERAL DATA

Integrated player

Motor section

Type.....belt-drive, subchassis
 Platter mass/damping.....2.0kg/good
 Finish and engineering.....very good, very good
 Type of mains lead/connecting lead...3 core, phonos plus earth
 Speed options.....manual change, 33, 45 rpm
 Wow and flutter (DIN peak wtc, sigma 2).....0.4%
 Wow and flutter (lin peak wtd 0.2-6Hz/6-300Hz).....0.1%/0.07%
 Absolute speed error.....+ 0.45%
 Speed drift, 1 hour/load variation.....negligible/- 0.25%
 Start-up time to audible stabilisation.....3.5 secs
 Rumble, DIN B wtd, L/R average (see spectrum).....- 77dB

Arm section

Approximate effective mass, inc screws, excl cartridge...13.5g
 Type/mass of headshell.....special/9.8g
 Geometric accuracy.....very good
 Adjustments provided.....tilt/overhang/offset
 Finish and engineering.....very good, very good
 Ease of assembly/setting-up/use.....very good/very good
 Friction, typical lateral/vertical.....40mg/20mg
 Bias compensation method.....internal spring
 Bias force, rim/centre (set to 1.5g elliptical).....225mg/275mg
 Downforce calibration error, 1g/2g.....- 0.05g/- 0.1g
 Cue drift, 8mm ascent/descent.....negligible, 1.0secs/2.5secs
 Arm resonances.....fairly good
 Subjective sound quality.....see system result
 Arm damping.....decoupled counterweight

System as a whole

Size (w x d x h)/clearance for lid rear.....44 x 38.5 x 16cm/7cm
 Ease of use.....good
 Typical acoustic breakthrough and resonances.....very good
 Subjective sound quality of complete system.....very good
 Hum level/acoustic feedback.....low/very good
 Vibration sensitivity/shock resistance.....excellent/fairly good
 Estimated typical purchase price.....£190 inc cartridge

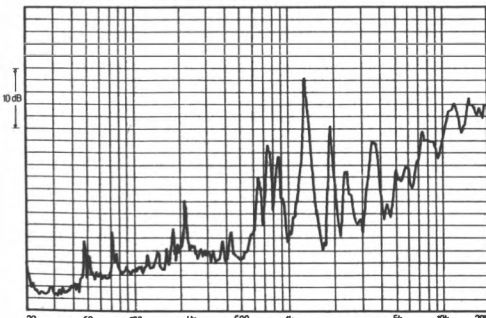

Structural arm resonances, audio band

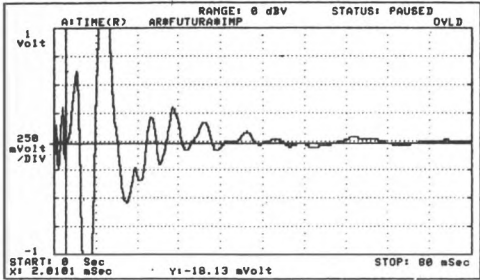

Disc impulse response, showing damping. Trace shows spurious output from cartridge when disc is subjected to a standard mechanical impulse.

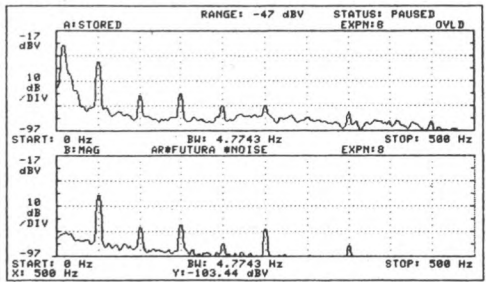

Rumble and noise. Upper display shows total rumble, lower section electrical rumble only. Scaling is as earlier charts, but with 40dB range.

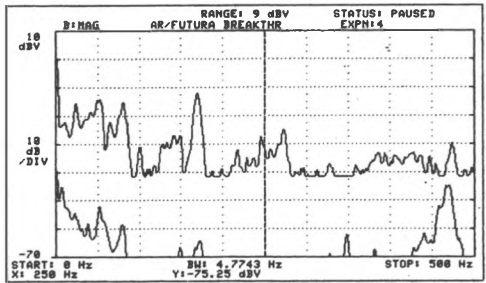

Breakthrough, acoustic (upper trace) and vibration (lower trace). Note that the baseline for the acoustic breakthrough trace is -80dB.

Charts above characterise general turntable behaviour. See text for commentary on the relevance of these results, but see Technical Introduction for explanation of test techniques

Alphason Opal and Xenon

Alphason, 190-192 Wigan Road, Euxton, near Chorley, Lancs PR7 6JW
Tel (02572) 76826



This review covers two new Alphason models, which, along with the *Delta*, extend the company's range of arms to cover a wide price spectrum.

ALPHASON XENON

Selling at around £196 this is the most expensive of Alphason's new tonearms and fills a gap in the market between the budget examples and the higher class £300 group such as the Alphason *HR100S* and the Linn *Ittok*.

The *Xenon* owes much to the well established *HR100S* and indeed uses the same good-sounding one-piece arm/shell unit, which comprises a large diameter 'S' shaped tube in titanium. This is now filled with a damping material to control higher mode vibrators.

Some savings have been made as regards details of the cue mechanism and bias compensator, as well as the exterior finish of the bearing assembly, but these have not significantly prejudiced the performance. The concentric bearing gimbal design is retained and is well aligned, offering negligible play plus very low levels of friction and stiction.

Lab report

Slightly on the high side of the medium mass range the effective mass with fixing hardware approached 13g. Cartridges in the range 8-20cu are most appropriate.

Rated highly as regards geometric accuracy, the arm proved easy to set up and use coming as it does with *Ittok*-compatible baseplate mounting hardware.

Bias correction erred on the high side for the disc rim or perimeter, but not unduly so. Resonances were few, as the structural resonance graph shows, and in any case, were of moderate degree — rather better than the *Opal* and closely resembling the *HR100S*.

Sound quality

At first it proved hard to separate this model from the well-rated *HR100*. The *Xenon* showed a solid overall control, with a firm sense of image focus over a wide frequency range. The treble was clear and finely detailed, the mid of undoubtedly low coloration, with minimal 'clang' or hardness. Bass was free from boom or emphasis. Open and clean sounding stereo depth was also respectably portrayed.

Conclusion

With Alphason's high standard of engineering, a basically good finish and a fine lab and sonic performance, the *Xenon* comes strongly recommended. The price was very fair for this arm, an essentially well balanced model in all respects.

ALPHASON OPAL

Comfortably under £100, the *Opal* nonetheless manages to maintain Alphason's high standards for solid engineering and low friction, with bearings free from play or looseness. It may be fitted via a single hole in an arm board, but compatibility with the popular *Ittok* mounting is provided via a special base, again clamped by a single large nut.

This is a fixed head arm, whose strong main beam is fitted with a properly clamped counterweight and supported on a concentric gimbal bearing. Thread and weight bias correction is provided. Appropriate calibrations are given for bias and downforce, and the arm falls into the medium-mass category; when typically balanced with hardware an effective mass figure of 10g was recorded.

Lab report

Performing well on lab test, this proved to be a well aligned and set up arm. The various facilities

worked well, while the bearing friction was held to excellently low levels. Bias compensation was very satisfactory and although the downforce calibration erred on the high side, if there is to be an error, this is where it should be.

Placed above average for arm resonances, in the audible range, several modes were distinguishable; for example one at 250Hz (counterweight) and others at 675 and 950 Hz, both first beam modes.

Sound quality

The *Opal* gave a good account of itself on audition, happily meeting the rated £90 tonearms in their own territory. In tonal balance it appeared lightweight and 'airy' with some 'zinginess' in the high treble — less well suited to moving coils in this respect. The bass was dry and firm, while mid focus and stereo depth were both pretty good. A particular attribute was the smooth uncoloured mid range, this an Alphason hallmark.

Conclusion

With its individual interpretation of good sound, the *Opal* proved to be a well designed and constructed British tonearm. There are no problems in recommending this one — let's give it a Best Buy!

GENERAL DATA

Opal tonearm

Arm section	
Approximate effective mass, inc screws, excl cartridge.....	10.0g
Type/mass of headshell.....	fixed
Geometric accuracy.....	very good
Adjustments provided.....	height/overhang/lateral
Finish and engineering.....	very good/very good
Ease of assembly/setting-up/use.....	very good/good/good
Friction, typical lateral/vertical.....	<20mg/<20mg
Bias compensation method.....	thread and weight
Bias force, rim/centre (set to 1.5g elliptical).....	240mg/220mg
Downforce calibration error, 1g/2g.....	+0.15g/+0.30g
Cue drift, 8mm ascent/descent.....	negligible, 2.0secs/4.5secs
Arm resonances.....	good+
Subjective sound quality.....	good
Arm damping.....	none
Estimated typical purchase price.....	£95

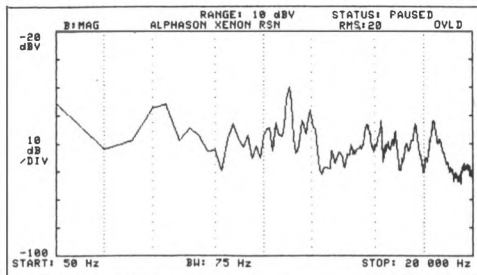

Structural arm resonances, audio band (*Xenon*)

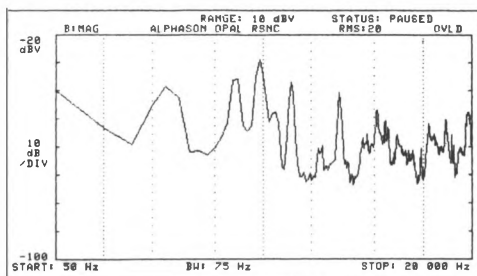

Structural arm resonances, audio band (*Opal*)

GENERAL DATA

Xenon tonearm

Arm section	
Approximate effective mass, inc screws, excl cartridge.....	12.75g
Type/mass of headshell.....	fixed
Geometric accuracy.....	very good
Adjustments provided.....	height/overhang lateral
Finish and engineering.....	excellent/excellent
Ease of assembly/setting-up/use.....	very good/good
Friction, typical lateral/vertical.....	<20mg/<20mg
Bias compensation method.....	thread and weight
Bias force, rim/centre (set to 1.5g elliptical).....	275mg/200mg
Downforce calibration error, 1g/2g.....	+0.25g/+0.25g
Cue drift, 8mm ascent/descent.....	negligible, 2.0secs/5.0secs
Arm resonances.....	very good
Subjective sound quality.....	very good
Arm damping.....	none
Estimated typical purchase price.....	£198

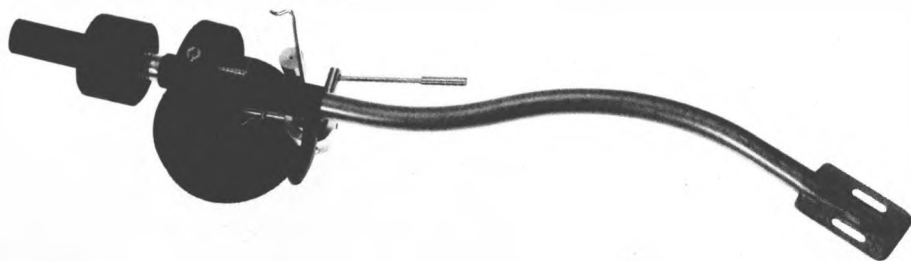

BEST BUY

Dual CS505-2 and CS505-2 Deluxe

Hayden Laboratories Ltd, Hayden House, Chiltern Hill, Chalfont St Peter, Bucks
Tel (0753) 888447



In production now for a number of years, the 505 design has undergone a continuing series of cumulative minor improvements which have helped maintain its competitive position. Price has also been kept in check.

The player is based on an old-style steel deck plate, supported on four foam-damped coil springs. This deck plate is heavily flanged to increase rigidity, and the modest platter is equipped with a fairly heavy rubber mat.

Belt driven by a 16-pole synchronous motor, the 505 is fitted with a unique variable pitch control, achieved by the use of a multi-lobed expansible motor pulley. Correct speed setting is achieved via stroboscope markings on the platter rim, though these were found none too easy to use.

For the latest 505-2 version the tonearm has been revised and is now fitted with a special detachable headshell with quite a firm fixing. The *Deluxe* has better looks and a lower resonance construction, this imparted by a substantial wooden plinth finished in 'black ash' vinyl. Both versions come complete with a compatible good-value Ortofon cartridge.

Lab report

A notable feature of the latest 505 is the significant reduction in rumble, which has improved from a satisfactory figure of 67dB to a new average of 73dB. Spectrum analysis

showed the usual contribution of motor vibration components, but these were not considered to be very serious. Speed characteristics were much as before with good wow and flutter, while good torque was also demonstrated, the mild 0.2% slowing under load being up with some of the best examples, and helping to offset the low inertia of the platter. Vibration and acoustic isolation factors remain unchanged, at a good level, and well above average for the price.

The arm now possesses a moderate effective mass, measured at 10g, this including mounting hardware. The headshell itself weighed a modest 4g. The arm was well aligned and the pivots were reasonable, proving moderate in friction but subject to a rather small pre-load; more than a gentle twist to the arm resulted in audible bearing 'clicking'. Biasing was accurate and downforce calibration acceptable. Arm structural resonances were chartered with the cartridge supplied; as can be seen on the graph, the first weakness appeared at 90Hz, while the main problems occurred at 220 and 400Hz, this result apparently not a great improvement on the previous design. Above 600Hz, however, the resonances were pretty well behaved.

Sound quality

The 505's sound was tuneful, lively, punchy and somewhat 'forward' in presentation. Pitch and

timing were also good, while the bass was fairly good and the stereo image had quite a respectable depth as well as above-average focus. It could sound a little muddled in the mid and treble but not seriously so, and the cartridge suited it well — we would not change it. The 'S' version showed a small improvement in clarity and definition, attributable to the improved plinth.

Conclusion

The 505 has managed to maintain its competitive position and provides a competent hi fi sound. In our view it is the clear £100 group leader, so much so that the less expensive players, including Dual's own 514, do not really

stand much of a chance. Strongly recommended as a complete package with the *OM10* cartridge, the 505-2 wins Best Buy status; the *Deluxe* is Recommended.

GENERAL DATA

Integrated turntable (inc cartridge)

Motor Section

Type.....semi-auto, belt drive, subchassis
 Platter mass/damping.....0.85kg/good
 Finish and engineering.....very good/good
 Type of mains lead/connecting lead.....2-core/phonos and earth
 Speed options.....variable, 33/45 rpm
 Wow and flutter (DIN peak wtd, sigma 2).....0.075%
 Wow and flutter (lin peak wtd 0.2-6Hz/6-300Hz).....0.95%/0.08%
 Absolute speed error.....- 0.1%
 Speed drift, 1 hour/load variation.....+ 0.065% / - 0.2%
 Start-up time to audible stabilisation.....2.4 secs
 Rumble, DIN B wtd, L/R average (see spectrum).....- 72/ - 74dB

Arm section

Approximate effective mass, inc screws, excl cartridge.....10g
 Type/mass of headshell.....special detachable/40g
 Geometric accuracy.....good
 Adjustments provided.....overhang/offset
 Finish and engineering.....very good/good
 Ease of assembly/set-up/use.....very good/very good/very good
 Friction, typical lateral/vertical.....40mg/20mg
 Bias compensation method.....spring
 Bias force, rim/centre (set to 1.5g elliptical).....225mg/225mg
 Downforce calibration error, 1g/2g.....- 0.12g/ - 0.2g
 Cue drift, 8mm ascent/descent.....very slight, 3.5 secs/3.0 secs
 Arm resonances.....average +
 Subjective sound quality.....average +
 Arm damping.....decoupled counterweight

System as a whole

Size (w x d x h)/clearance for lid rear.....43.5 x 37 x 14cm/7cm
 Ease of use.....good
 Typical acoustic breakthrough and resonances.....average +
 Subjective sound quality of complete system.....good
 Hum level/acoustic feedback.....good/good
 Vibration sensitivity/shock resistance.....good/good
 Estimated typical purchase price.....£110 (Deluxe, £130)

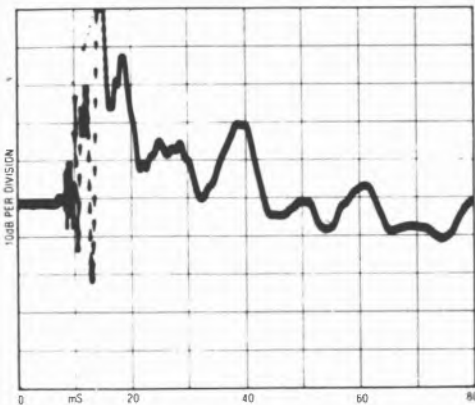

Disc impulse transmission showing damping

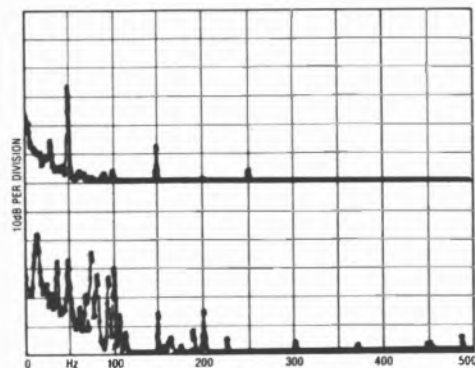

Rumble, electrical (above) and total (below)

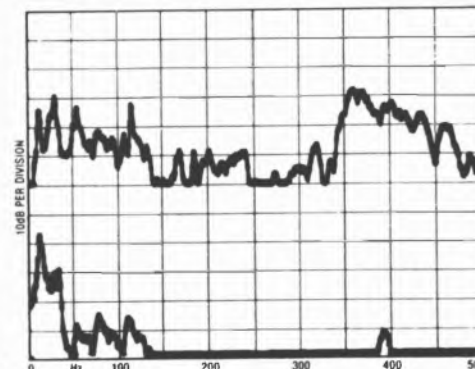

Breakthrough, acoustic (above) and vibration (below)

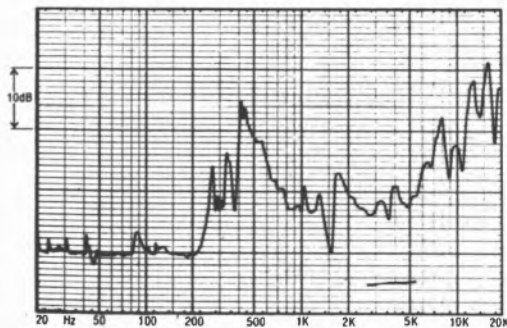

Structural arm resonances, audio band

Heybrook TT2

Mecom Acoustics, Knighton Hill, Wembury, Plymouth, Devon
Tel (0752) 863188

RECOMMENDED



First reviewed in its original form, the Heybrook *TT2* turntable design did undergo some revision after its first couple of years in production. A new cast aluminium subchassis with reinforcing flanges around the whole of its cruciform shape replaced the original box-section welded steel subchassis, which had a rather high mass. Such a major change indicated that a completely new review of the *TT2/III* was in order for 1984-5.

While this model is superficially reminiscent of a *Sondek*, a closer examination will reveal that Heybrook have used a rather different set of solutions to the problems of turntable design, solutions which do not appear to derive from any attempt to compromise engineering quality or finish. At the same time, the *TT2* is quite competitively priced if compared with certain of the more expensive brand leaders in the specialist field.

A very strongly constructed plinth is used, essentially of 45mm thick composite, only cut away where space is required for the arm leads, motor and associated wiring. Suspended on three multi-turn coil springs, the subchassis can be aligned from above, via three socket-head bolts fixed by an ingenious locking system.

A closely-toleranced main bearing is fitted, consisting of a steel shaft supported on a hardened thrust ball, and running in plain bronze

sleeves. The alloy platter weighs 2.8kg, and is in two pieces, the inner section also forming the drum on which the belt runs. A felt mat is standard.

Currently, the *TT2* suspension is set on the firm side, to provide better control, while a fairly stiff short belt has been chosen as likely to minimise wow effects. The main subchassis modes are in the 4.5 to 5Hz range, and correct arm lead dressing offers better control of the higher frequency rotational modes than before.

Arms tried with the *TT2* included the Linn *LVX* and the Alphason, but perhaps the most obvious choice was the Rega *RB300*, the two products complementing each other on grounds of their fine engineering and value.

Lab report

The well-constructed main bearing exhibited negligible play, while the subchassis proved to be well adjusted. A fine weighted wow and flutter figure of 0.065% was recorded, with equally good results for the flutter and wow when separately weighted, at 0.08% and 0.07% respectively. The deck ran fast by an acceptable 0.5%, while high torque was shown by the excellent 0.18% slowing under test loading. Dynamic wow will not be a problem here.

DIN B weighted rumble was very low: at almost -80dB, but spectrum analysis did show some moderate motor related mechanical

frequency components, specifically at 100Hz and 200Hz. The latter however measured at -78dB and in consequence was quite harmless.

The felt mat provided much the usual pattern of results for the disc impulse response; following a large initial transient, damping was fairly good although some mild 100Hz ringing can be seen in the decay response, this possibly platter rock.

Sound quality

On audition the latest TT2 was felt to offer an improvement over the earlier version, notably in terms of better transparency and depth, tied in with a clearer exposition of the dynamic contrasts in the music.

Pitch stability, rhythm and timing were all to a very good standard, while the bass was a strong point, with a welcome firmness coupled with good extension to the lower bass frequencies.

Solo singing focused well in the stereo sound stage, the latter exhibiting good space and depth. It compared well with far more expensive designs, making only slight concessions in areas of detail and dynamics on the most complex material.

Conclusion

One cannot help but be impressed by the fine finish and construction of this durable sub-chassis design, as well as by its competitive pricing and good performance both in the lab and the listening room.

Strong points included very low wow (approaching the Linn in this area) as well as its fine bass. It was easy to set up, remaining stably aligned, and attains a firm recommendation.

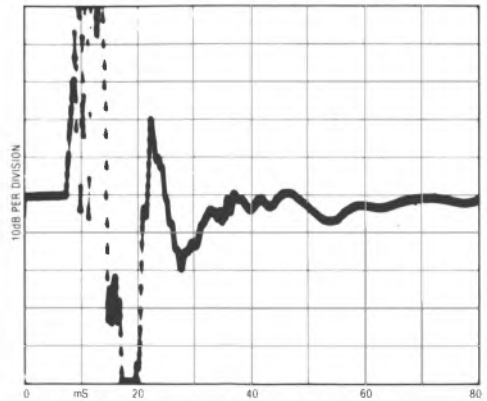

Disc impulse transmission showing damping

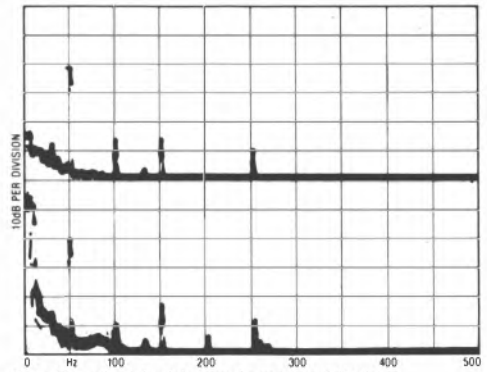

Rumble, electrical (above) and total (below)

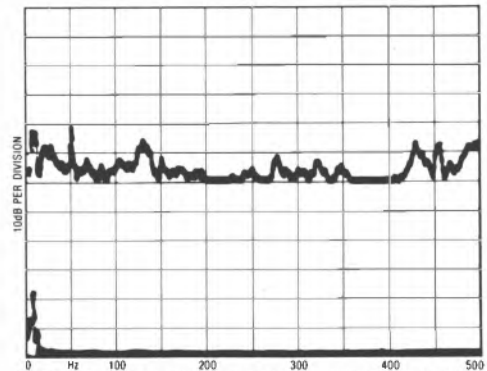

Breakthrough, acoustic (above) and vibration (below)

GENERAL DATA

Motor unit

Motor Section

Type.....	belt-drive, subchassis
Platter mass/damping.....	2.6kg/average +
Finish and engineering.....	very good/excellent
Type of mains lead/connecting lead.....	3-core/ -
Speed options.....	manual change, 33/45 rpm
Wow and flutter (DIN peak wtd, sigma 2).....	0.065%
Wow and flutter (Iln peak wtd 0.2-6Hz/6-300Hz)....	0.007%/0.08%
Absolute speed error.....	+ 0.5%
Speed drift, 1 hour/load variation.....	<0.1% / - 0.18%
Start-up time to audible stabilisation.....	3.8 secs
Rumble, DIN B wtd, L/R average (see spectrum).....	- 80 / - 78dB
Size (w x d x h)/clearance for lid rear.....	44 x 37 x 15.5cm/6cm
Ease of use.....	good
Typical acoustic breakthrough and resonances.....	very good
Subjective sound quality of complete system.....	very good
Hum level/acoustic feedback.....	very good/very good
Vibration sensitivity/shock resistance.....	very good/fairly good
Estimated typical purchase price.....	£235

Charts above characterise general turntable behaviour. See text for commentary on these results, see Technical Introduction for explanation of test techniques

RECOMMENDED

Linn Sondek LP12

Linn Products Ltd, 257 Drakemire Drive, Glasgow G45 9SZ
Tel 041-634 0371



With a decade or so of production behind the *Sondek*, the 'Nirvana' modification covered by the review in the 1984 *HFC* 'Turntables' edition has now been augmented by a further development called 'Valhalla' (as with the 'Nirvana', this is an easy retrofit). For years now, the popular slow-speed synchronous motors generally fitted to the sub-chassis belt drive turntables have been at the mercy of the mains supply. The latter's frequency, distortion, noise level, transient fluctuations and voltage all affect the motor's output and also the level of vibration emitted from the motor frame. Since the last issue, further refinements have included a bonded rather than a welded subchassis, plinth reinforcements, better springs, loaded main bearing oil and suspension lock nuts.

Ideally such motors should be run from a two phase supply, but the second phase-shifted line has generally been optimised in a less-than-ideal fashion by using a phase shifting capacitor. When a turntable is intended for UK and for US markets, a pulley change is also required.

'Valhalla' solves these problems by effectively isolating the motor electronically from the mains supply. Mains power is rectified and

smoothed to feed a bi-phase 100V low distortion power amplifier acting as the motor source. The exact 50Hz frequency is synthesised from a quartz oscillator. When fed clear, stable 50Hz, the motor generates less vibration and mains harmonic components, attaining a near perfect pulley speed stability over both the long and the short term. Power into the belt is more stable, with (in theory at least) a lower rumble and reduced subchassis vibration resulting from the power feed.

General alignment has also been improved with the recent introduction of larger and more accurate suspension springs and deckplate bolts. Our last *HFC* sample was still subject to suspension settling with use, and thus required occasional realignment; though low-fatigue springs now fitted should solve this problem.

To return to basic features, the *LP12* comprises a straightforward full sub-chassis belt driven turntable unit capable of accepting a variety of high quality tonearms. Deceptively simple in design, long experience with the product has shown that it has been subjected to such a high level of detailed development and refinement that almost every component down to the humblest screw fixings can be shown to have a significant effect on the

performance of the whole.

A substantial main bearing is used, with a hardened spindle ground to a slightly radiused point bearing on a thrust plate. High density PTFE sleeves in the bearing provide sufficient rigidity and very low rotational noise levels. The two piece platter is of considerable mass, cast in Mazak and turned to close tolerances, with a special grade of black felt used for the platter mat. Even now, considerable care is needed in setting up an *LP12* in a final installation, and the help of an experienced dealer is virtually mandatory.

Other minor improvements concern the light touch on-off switch with LED indicator, as well as extra screws front and back to help keep the baseboard in position.

The well damped platter weighs some 4.1kg. Our assessment of disc damping was revised for this year, and while the initial transient was certainly poorly damped by the felt mat, the impulse died away quickly thereafter, this a good result. A measurement taken last year showing the frequency transform of the felt mat versus an absorbent one has assumed greater significance this time round, inasmuch as it can be seen that while the 'composition' mat produced greater attenuation, its frequency response was uneven, while that of the felt was more uniform, suggesting lower overall coloration.

'Vallahalla' made its mark on the motor results with excellent wow and flutter, plus significantly lower linear wow. Absolute speed and accuracy was satisfactory, while loss under load was very good at 0.13%, another important result. DIN weighted rumble improved to a superb -80dB. In fact the spectrograms for residual measuring system noise and for the *Sondek* were very similar and to check this result the two were submitted to subtraction providing the second rumble photo - no mains related rumble components remain!

The *LP12* was not the very best in the issue as regards vibration isolation or acoustic breakthrough but the curves did confirm a high standard for these parameters nonetheless. Shock resistance was also quite good, with both acoustic feedback and hum very good.

Sound quality

A few years ago it was considered heresy to suggest that turntables could make a 'sound' at all, but meanwhile the *Sondek* has been a leading exponent in demonstrating just how different the subjective performances can actually be. It scored an excellent rating on audition, notwithstanding some mild spectral

continued

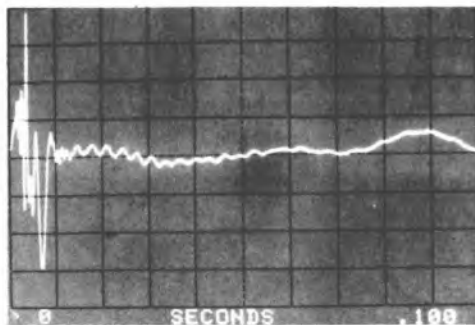

Disc impulse transmission showing damping

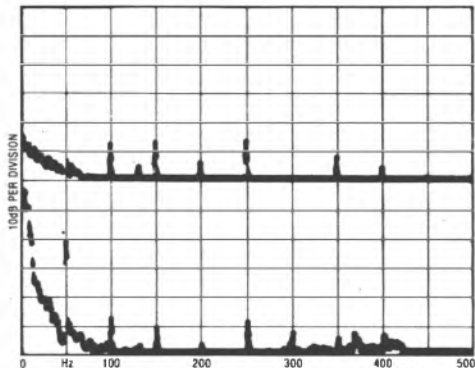

Rumble, electrical (above) and total (below)

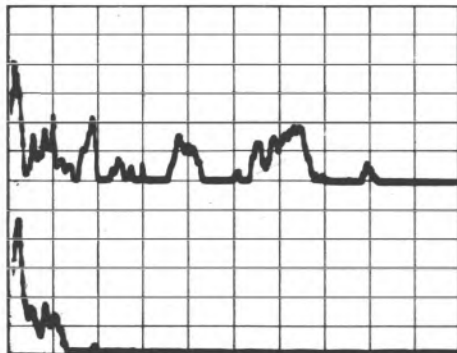

Breakthrough, acoustic (above) and vibration (below)

:harts above characterise general turntable behaviour. See text for commentary on these results, see Technical Introduction for explanation of test techniques

THE ULTIMATE CHOICE



LINN ITOK LVII

FULL RANGE ON DEMONSTRATION

RECOMMENDED



HFYBROOK TT2

FULL RANGE ON DEMONSTRATION

RECOMMENDED



ACOUSTIC RESEARCH EB101

FULL RANGE ON DEMONSTRATION

BEST BUY



DUAL C5505-2

FULL RANGE ON DEMONSTRATION

BEST BUY



REVOLVER

FULL RANGE ON DEMONSTRATION

RECOMMENDED

352-4 LOWER ADDISCOMBE RD
CROYDON

SURREY

Tel: 01-654 1231

01-654 2040



Full range of most cartridges recommended by this magazine on demonstration

SPALDINGS

LINN SONDEK *continued*

imbalance and coloration; a consumer who feels that absolute tonal neutrality is paramount is entitled to reject the LP12 but should be made aware of the importance of certain other factors. For example the LP12 has long generated a feeling of 'involvement' with the music for reasons that are only partly becoming understood.

After careful and prolonged listening the LP12 was found to excel in its ability to retain the timing, tempo, rhythm and pitch of complex percussive sections, failure here producing some loss of interest on the part of the listener. Additional qualities included rapid post-transient decay producing 'transparent silences' between successive notes and these were all too often obscured by hangover in other models. The felt mat also provided a level of tonal integration of bass and treble now considered optimum for the deck. The recent improvements have noticeably controlled the previously mild upper bass excess, this particularly true when the deck is used with a current *Ittok*. The *Ittok* arm still produces a spectacularly good sound with the *Sondek*; the Alphason arm also matched it well.

Conclusion

While many other analogue turntable companies appear to be treading water, Linn have continued to advance the standard of their LP12. This year it offered better focus, intertransient silences, stability and solidity. Pitch and rhythm remain excellent though this does depend on precise dressing of the arm cable. Alternatively, very stiff or very compliant arm cables may affect the sub-chassis dynamics but a good dealer can sort this out. A strong recommendation is maintained for this fine turntable.

GENERAL DATA

Motor unit

Motor Section

Type manual, belt-drive, synchronous motor, sub-chassis
Platter mass/damping 4.1kg/good
Finish and engineering excellent/excellent
Type of mains/connecting leads 2-core
Speed options 33rpm
Wow and flutter (DIN peak wtd, sigma 2) 0.06%
Wow and flutter (LIN peak wtd 0.2-6Hz/6-300Hz) 0.09%/0.05%
Absolute speed error - 0.2%
Speed drift, 1 hour/load variation quartz-locked/ - 0.13%
Start-up time to audible stabilisation6 secs
Rumble, DIN B wtd L/R average (see spectrum) - 80 dB
Size/clearance for lid rear 44.5(w) x 36(d) x 15(h)/5.5cm
Ease of use good
Typical acoustic breakthrough and resonances very good
Subjective sound quality of complete system excellent
Hum level/acoustic feedback very good/very good
Vibration sensitivity/shock resistance very good/good
Estimated typical purchase price afromosia, £425
(other finishes: walnut, £437; black, £449; rosewood, £466)	

discit
by LIFT



Please call for full details
Lift (UK) Ltd.
Finlandia Centre, Oxford Road,
Carrards Cross, Bucks. SL9 7RH.
Telephone (0753) 888120
Telex 849041 sharetg

Lift Verkaufsgeräte
Franzengasse 25
A-1050 Wien
Tel.: (0 22 2) 56 72 55
Telex: 136684

LIFT
systems with future

LIFT/ROW WITEN

The Oak/Zeta Junior arm

Moth Marketing, 47 Armstrong Close, Wilstead, Bedford
Tel (0234) 741152

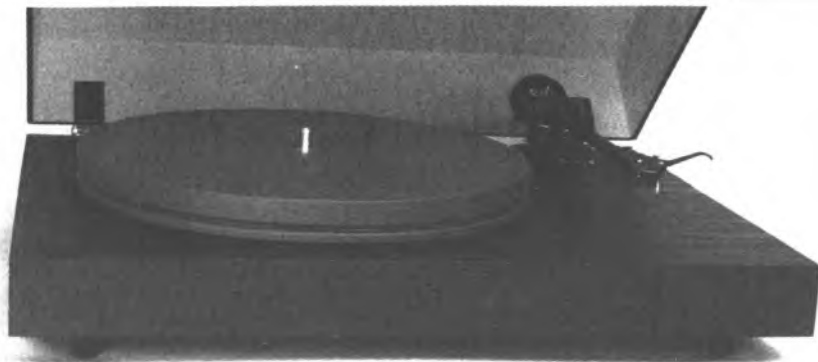

A budget turntable unit, the Oak is now supplied with the Zeta *Junior*, a newly-commissioned Japanese-built arm, fitted as standard. This effectively replaces the now discontinued ADC arm which was supplied with the earlier Oak model some years ago.

Considerable improvements have been made over the original Oak, the current turntable having a well-toleranced, inverted main bearing and a well-centred wood composition (MDF) platter driven by a distinctive synthetic rubber cord in bright red. Manual speed change is accomplished by flicking the cord from one pulley step to the other, and a powerful synchronous motor is fitted.

The *Junior* arm is reminiscent of the old ADC *LM-F1*, with a detachable, lightweight reinforced plastic headshell (this is interchangeable with that of the Linn, the *LVX*). A rotating counterweight is used, but this arm is too inexpensive to offer the luxury of bearings free of play, though its overall finish is excellent.

Lab report

Virtually in the low-mass category, the arm has an effective mass of 8.3g inclusive of hardware; substitution of the *LVX* headshell would increase this to 12g or so, to better suit low-compliance cartridges. Geometry was fine and the arm was easy to set up and use. Friction was low, while bias correction tended to the low side at the rim — solved by dialling a slightly higher value than normally required. Downforce was well calibrated, and the cue operated satisfactorily. Structural resonances were quite numerous and the arm scored a straight 'average' here.

Moving on to the turntable, the disc rested directly on the plain finished platter and this

resulted in fairly good disc damping; a platter rocking mode was evident at around 35Hz. Wow and flutter was just satisfactory at 0.25%, with similar unweighted contributions of flutter and wow. Speed error was all right at 1%, while start-up was rapid; the player had good torque characteristics. DIN B weighted, the rumble levels were unexceptional with figures in the mid sixties and so not quite to hi-fi standards. Analysis showed motor vibration breakthrough at 100 and 200Hz, thus audible as a slight low level 'drone' on very quiet sections of a record. Acoustic breakthrough was fairly well controlled by its structural solidity but the stiff plastic feet afforded little vibration rejection from the mounting surface. Variations in performance with different tables, platforms etc were expected and indeed found. Conversely, the rigid construction did afford good shock immunity.

Sound quality

The arm was considered to give a satisfactory performance, reasonably clean and well balanced, but not really in the class of its UK rival, the Rega *RB250*, which does have play-free bearings. Some 'clutter' at high frequencies was associated with certain mid colorations and a lack of stereo depth was noted.

The Oak motor unit gave an above-average performance for the type, with good clarity in the mid and treble ranges. The sound depended strongly on location and sounded rather lightweight on the test coffee table, lacking spaciousness, the bass also distinctly curtailed.

Conclusion

The Zeta *Junior* is, despite the above comments,

the only well-finished and competent tonearm available at the price; it should be welcomed for its contribution to the costing of budget turntable systems. The Oak deck is now presented in a refined form with a superior finish in real wood (black oak!), and it would be hard to deny that it represents fair value for money. Presentable results are possible from the package if appropriately sited.

GENERAL DATA

Motor unit (plus Zeta arm)

Motor section

Type.....belt drive, synchronous (manual)
 Platter mass/damping.....1.5kg/fairly good
 Finish and engineering.....very good/good
 Type of mains lead/connecting lead....2-core/phonos plus earth
 Speed options.....33, 45 rpm
 Wow and flutter (DIN peak wtd, sigma 2).....0.26%
 Wow and flutter (IIN peak wtd 0.2-6Hz/6-300Hz).....0.27%/0.20%
 Absolute speed error.....1.0%
 Speed drift, 1 hour/load variation.....negligible/-0.15%
 Start-up time to audible stabilisation.....1.5 secs
 Rumble, DIN B wtd, L/R average (see spectrum).....-64/-68dB

Arm section

Approximate effective mass, inc screws, excl cartridge.....8.3g
 Type/mass of headshell.....ADC detachable/3.0g
 Geometric accuracy.....very good
 Adjustments provided.....height/overhang/lateral
 Finish and engineering.....very good/good
 Ease of assembly/setting-up/use.....very good/very good
 Friction, typical lateral/vertical.....30mg/<20mg
 Bias compensation method.....internal spring
 Bias force, rim/centre (set to 1.5g elliptical).....120mg/200mg
 Downforce calibration error, 1g/2g.....-0.05g/-0.05g
 Cue drift, 8mm ascent/descent.....slight, 1.5secs/3.5secs
 Arm resonances.....average
 Subjective sound quality.....average+
 Arm damping.....counterweight decoupling

System as a whole

Size (w x d x h)/clearance for lid rear.....46 x 35 x 14.5cm/7cm
 Ease of use.....very good
 Typical acoustic breakthrough and resonances.....average+
 Subjective sound quality of complete system.....average+
 Hum level/acoustic feedback.....average/average-
 Vibration sensitivity/shock resistance.....average-/good
 Estimated typical purchase price.....£140 (without arm, £100)

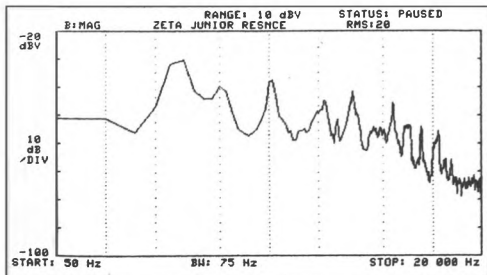

Structural arm resonances, audio band

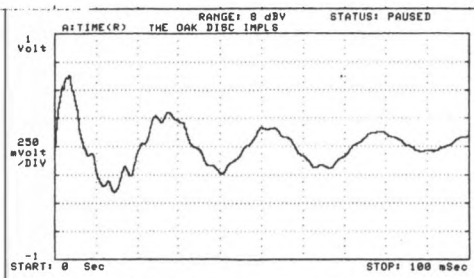

Disc impulse response, showing damping. Trace shows spurious output from cartridge when disc is subjected to a standard mechanical impulse.

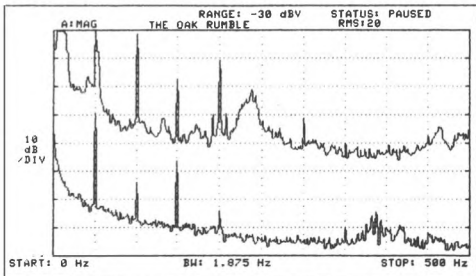

Rumble and noise. Upper display shows total rumble, lower section electrical rumble only. Scaling is as earlier charts, but with 40dB range.

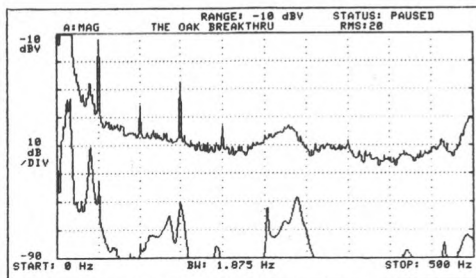

Breakthrough, acoustic (upper trace) and vibration (lower trace). Note that the baseline for the acoustic breakthrough trace is -90dB.

Charts above characterise general turntable behaviour. See text for commentary on the relevance of these results, but see Technical Introduction for explanation of test techniques.

Oracle Alexandria

Absolute Sounds Ltd, 42 Parkside, London SW19
Tel 01-947 5047

RECOMMENDED



Generally supplied as an integrated turntable, the *Alexandria* is the latest model from Oracle. It is an attractive design, built into a conventional plinth, and is finished in satin aluminium with a rosewood surround, and a hinged tinted cover.

Three detachable polished cylinders conceal the suspension springs, which are easily adjusted from above. The deck is powered by a Papst dc Hall effect motor, fitted with a large flywheel, the motor coupled to the platter by a precision flat belt. An outboard power supply is used, its external location affording low hum levels. The subchassis incorporates a spirit level to aid alignment and the two-piece platter helps belt loading. The outer platter section is fitted with a dense rubber damping ring on its periphery, and has been carefully balanced — there is an identifying keyway to maintain accurate alignment with the inner platter.

While it still has the established Oracle 'tacky' surface, to improve coupling to the disc, the mat is now carbon-fibre loaded to increase its rigidity. This is made use of in conjunction with a dome washer and the precision screw-down record clamp, which engages with the upper threaded portion of the platter spindle.

An average-sized conventional main bearing is fitted, incorporating oil lubrication.

Engineering fit and tolerances are good throughout.

The turntable came ready fitted with the *Prelude* tonearm, which has a separate connection panel for a flexible signal link from the subchassis, to help allow free movement of the suspension. A conventional phono-connected cable runs from the plinth output sockets to the amplifier.

The *Alexandria* is now also available without the fitted *Prelude* arm, in which form the asking price is around £950.

The arm has a fixed skeletal headshell, although this does possess an adequate cartridge mounting area. Many adjustments are provided, including lateral angle, overhang, tilt and height. The height adjustment allows correction for the cartridge vertical tracking angle (vta) during play, which may be rated as highly important by some users. Biasing is via the reliable thread and weight system and the arm also incorporates a sensitive end-of-side lift, a useful extra. Effective mass when set for a typical cartridge is around 9g, suiting it to cartridge compliances in the 10-25cu range, depending on cartridge mass. The arm's vertical geometry is also designed to improve tracking stability over high modulation passages and this behaviour was confirmed on test.

Lab report

The platter's mass was 3.1kg and in conjunction with the mat and clamp system, provided very good disc damping. However the platter itself was not free from resonance, as the disc impulse shows; here the finer long duration ripples are due to platter modes at 240 and 160Hz, identified via the frequency transform, but these aside disc damping was very good.

Wow and flutter, DIN peak weighted, was very good at 0.055%, with moderate linear wow and low flutter. Speed stability was fine, while good torque was also demonstrated, the

continued

GENERAL DATA

Integrated turntable

Motor Section

Type.....belt-drive, subchassis
 Platter mass/damping.....3.1kg/average
 Finish and engineering.....excellent
 Type of mains/connecting lead.....2-core remote/phonos, earth
 Speed options.....variable, 33/45 rpm
 Wow and flutter (DIN peak wtd, sigma 2).....0.055%
 Wow and flutter (lin peak wtd 0.2-6Hz/6-300Hz).....0.15%/0.07%
 Absolute speed error.....adjustable pitch
 Speed drift, 1 hour/load variation.....approx 0.15%/ - 0.25%
 Start-up time to audible stabilisation.....3.5 secs
 Rumble, DIN B wtd, L/R average (see spectrum)..... - 80/ - 82dB

Arm section

Approximate effective mass, inc screws, excl cartridge.....9g
 Type/mass of headshell.....non-detachable
 Geometric accuracy.....very good
 Adjustments provided.....tilt/height/overhang/offset
 Finish and engineering.....very good
 Ease of assembly/set-up/raise.....good
 Friction, typical lateral/vertical.....<20mg/<20mg
 Bias compensation method.....thread and lever
 Bias force, rim/centre (set to 1.5g elliptical).....300mg/250mg
 Downforce calibration error, 1g/2g.....uncalibrated
 Cue drift, 8mm ascent/descent.....very good, 2.5 secs/1.5 secs
 Arm resonances.....average +
 Subjective sound quality.....good
 Arm damping.....none

System as a whole

Size (w x d x h)/clearance for lid rear.....49 x 38.5 x 15.5cm/6cm
 Ease of use.....very good
 Typical acoustic breakthrough and resonances.....very good
 Subjective sound quality of complete system.....very good
 Hum level/acoustic feedback.....very good/very good
 Vibration sensitivity/shock resistance.....good/fairly good
 Estimated typical purchase price.....£1400 (£949 no arm)

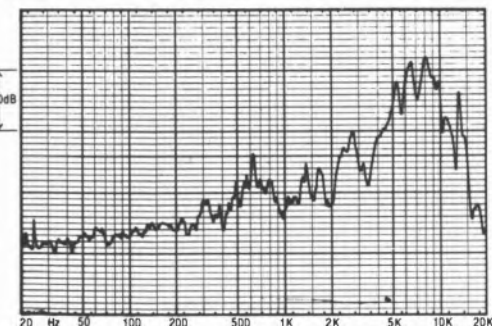

Structural arm resonances, audio band

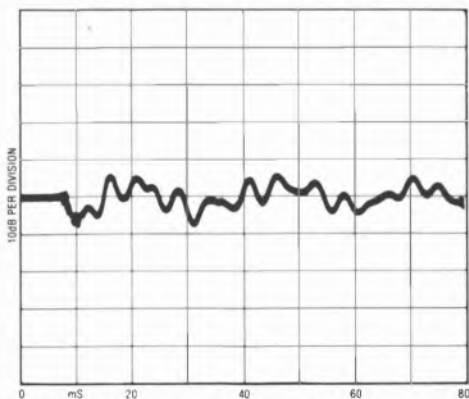

Disc impulse transmission showing damping

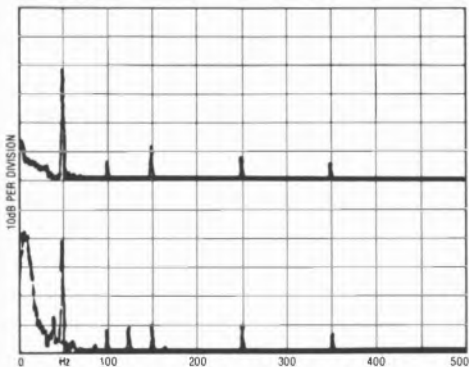

Rumble, electrical (above) and total (below)

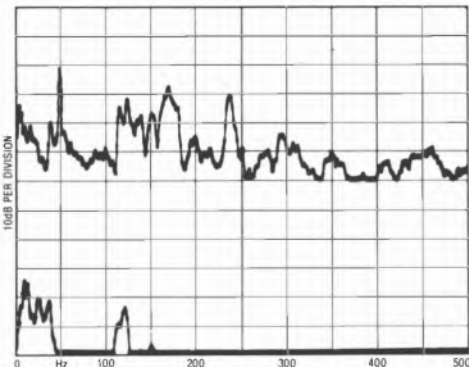

Breakthrough, acoustic (above) and vibration (below)

Charts above characterise general turntable behaviour. See text for commentary on these results, see Technical Introduction for explanation of test techniques

ORACLE ALEXANDRIA *continued*

0.25% slowing under load confirming this. Rumble was also excellent at better than -80dB DIN B weighted, while its spectrum analysis indicated that spurious vibrations were very low. Acoustic breakthrough was also very low, only slightly marred by a hint of sympathetic platter resonance. External vibration was well handled though this was not an exceptional result, and while the chassis dynamics were fine in the vertical plane, the design was rather stiff in rotation despite its 'hanging' suspension design. It was nonetheless superior to the *Delphi* in this respect.

Effective mass of the *Prelude* tonearm was noted at 9g including hardware, which is usefully below the current average of 13g for good designs. Friction was low in both planes, with minimal bearing play, but some rocking could be induced in the vertical plane due to pillar compliance. The geometry was fully up to standard, while the bias compensation covered a useful range and did not add additional friction. Tested for structural resonances, the main mode appeared at 500Hz with good control, this probably due to the torsional weakness mentioned previously. At higher frequencies however the behaviour was

tidy, pointing to a neutral sound. The auto stop/lift device applied negligible extra forces to the cartridge over the final music bands.

Sound quality

On test the *Alexandria* gave a good account of itself. Favourable comments were made concerning its good pitch stability and subjective sense of rhythm. The bass had an even character with pleasing extension, while the mid showed good clarity plus substantial stereo depth but with a hint of clouding in the upper bass lower mid region.

The treble was open and clear, free of false emphasis, and overall the tonal balance was neutral with a low-coloration character. The arm proved pleasantly unobtrusive, and proved to be a good match for a number of good quality moving coil cartridges.

Conclusion

The *Alexandria* can hardly be classed as particularly good value for money but it does offer a tidy, well designed and highly reliable package. This reliability includes its suspension alignment, which should remain stable for long periods. Taken as a whole its overall 'very good' performance qualifies it for recommendation despite its fairly high price.

M.R.M. Audio Products would like to thank their dealers for all their support and backing

MUSIC ROOM
221 St Vincent Street
Glasgow
Jack Lawson 041-221 2527

IMAGE Hi-Fi
8 St Anne's Road
Headingley, Leeds
Guy 0532 789374

MUSIC ROOM
50 Bridge Street
Manchester
Geoff Coleman 061-835 1366

SOUNDS EXPENSIVE
12A Regent Street
Rugby
Nick Pugh 0788 79736

ACOUSTIC ARTS LTD
101 St Albans Road
Watford
Jim Dovey 0923 33011

THE ULTIMATE ROOM
250 Station Road
Addlestone, Surrey
Terry Lees

WILMSLOW AUDIO LTD
35-39 Church Street
Wilmslow, Cheshire SK9 1AS
0625-529599

MOORGATE ACOUSTICS
2 West Gate
Rotherham
Keith Hobson 0709 370666

ZEUS AUDIO
Tullynure Lodge
18 Castlecaulfield Road
Donaghmore
Dungannon
David Campbell 08687 67935

ALT. MIDLAND HiFi
Studio 3
Royal London Building
Wulfruna Street
Wolverhampton
Mike Norton 0902 21877

THE PINWOOD MUSIC
COMPANY
64 Eastgate Street
Winchester
Peter West 0962 61703

M.R.M. AUDIO PRODUCTS

Auchentiber Farm, Fereneze Road, By Neilston, Glasgow G78 3AF

Tel: 041-881 1664

DEFINITIVE PERFORMANCE...

The SME Series V precision pick-up arm is described by experts as the 'best pick-up arm in the world'.

If you wish to obtain the highest possible sound quality from analogue records please write to us for details.



SME
SME Limited
Steyning, Sussex, BN4 3GY
Telephone: (0903) 814321

QED R232EN

QED Audio Products Ltd, 12 Ashford Industrial Estate, Shield Road, Ashford, Middlesex TW15 1AU
Tel Ashford 48236



Some time ago, QED successfully completed their all-British budget audio system with the introduction of the 232 turntable. That model has since been joined by the 232EN, a more advanced design incorporating an upgraded cartridge with an elliptical stylus, plus an electronic quartz-controlled motor power supply of unusually high quality for the price sector.

Like the 232, the 'EN is founded on a substantial solid plinth supported on resilient vibration absorbing feet. A glass platter is used, in conjunction with a belt-driven inner hub. The main bearing is well tolerated while disc support is via the popular black felt mat. Overall, the finish — satin black with gold lettering — is very good, while operating speeds are conveniently set by front panel push buttons.

The tonearm is a modern design and now has slotted headshell fixings for more accurate alignment. It comes fitted with a moving magnet cartridge custom-built by Goldring. The strongly-constructed and rigid headshell is permanently fixed to the main arm beam, the latter supported on strong gimbal bearings adjusted to be free from play.

The design objective was to offer a complete and foolproof integrated player with all components properly fitted, aligned and sonically balanced.

Lab report

While the cartridge was not subjected to full test it was found to give a more than satisfactory frequency response with worthwhile separation, plus good trackability at the chosen downforce, and it also matched the arm well. The latter proved to be more than competent with regard to arm

resonances, and provided a graph that showed good control with mild resonances at 500, 950 and 1600Hz. Effective mass lay in the medium category at approximately 12g, including hardware. Well aligned, the arm showed moderate friction levels and sensible degrees of downforce and bias correction, and the cue also operated well.

For the motor unit, the resilient feet provided good isolation at low mid frequencies, while the impaired isolation in the bass was nearer the norm for the type. Acoustic breakthrough was well handled though not to subchassis standards (note that the graph was taken with lid detached).

Speed measurements showed marginally better results than for the non-electronic version. Wow and flutter, DIN weighted, was fine at 0.12%, with the linear wow result predominant at a moderate 0.2%. Given the quartz motor reference, the absolute speed was somewhat low at -1.6% but this could be easily corrected in production by a minor change in pulley size. Slowing under load was a moderate 0.3%, and the DIN weighted rumble levels were rather better than for the non-electronic version, with an improvement to a good -70dB level. The main rumble components were at 100Hz and 200Hz and were not, for example, due to the main platter bearing. Start-up to audible speed stabilisation was also quite rapid.

Sound quality

The standard had improved compared with the already pleasing level set by the '232. In context, the 'EN provided a feeling of greater stability and quieter backgrounds, allowing finer musical detail to be resolved. Rhythm and timing were better, while piano reproduction was also rather above average. Clarity was most presentable throughout

the range, allied to the moderate stereo depth, but the full weight and attack of known programme was somewhat diluted in the bass.

Conclusion

QED have now provided the market with a trim, well styled integrated player, in attractive satin black. The electronic speed switching is a worthy addition while the entire ensemble of player, arm and cartridge reaches a worthy standard. Not in the Best Buy category, its general competence nonetheless assures the R232EN a firm recommendation.

GENERAL DATA

Integrated turntable

Motor section

Type.....belt drive, electronic
 Platter mass/damping.....1.0kg/fair
 Finish and engineering.....fairly good/fairly good
 Type of mains lead/connecting lead.....3-core/phonos
 Speed options.....33, 45 rpm
 Wow and flutter (DIN peak wtd, sigma 2).....0.12%
 Wow and flutter (lin peak wtd 0.2-6Hz/6-300Hz).....0.20%/0.10%
 Absolute speed error.....-1.6%
 Speed drift, 1 hour/load variation.....-1.0%/-0.3%
 Start-up time to audible stabilisation.....3.0 secs
 Rumble, DIN B wtd,
 L/R average (see spectrum).....-70.5/-69.5dB

Arm section

Approximate effective mass, inc screws, excl cartridge.....12g
 Type/mass of headshell.....fixed
 Geometric accuracy.....very good
 Adjustments provided.....none
 Finish and engineering.....good/good
 Ease of assembly/setting-up/use.....excellent/excellent/ver good
 Friction, typical lateral/vertical.....30mg/<20mg
 Bias compensation method.....thread and lever
 Bias force, rim/centre (set to 1.5g elliptical).....100mg/180mg
 Downforce calibration error, 1g/2g.....uncalibrated
 Cue drift, 8mm ascent/descent.....negligible, 1.5secs/4.0secs
 Arm resonances.....average+
 Subjective sound quality.....good
 Arm damping.....decoupled counterweight

System as a whole

Size (w x d x h)clearance for lid rear.....40 x 30 x 11cm/6cm
 Ease of use.....very good
 Typical acoustic breakthrough and resonances.....fairly good
 Subjective sound quality of complete system.....above average
 Hum level/acoustic feedback.....good/average+
 Vibration sensitivity/shock resistance.....average+/average
 Estimated typical purchase price.....inc cartridge, £199

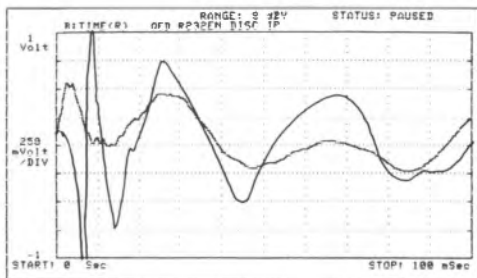

Disc impulse response, showing damping. Note second trace is on an expanded scale and should be ignored when making comparisons.

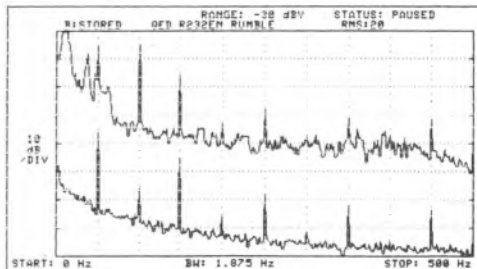

Rumble and noise. Upper display shows total rumble, lower section electrical rumble only. Scaling is as earlier charts, but with 40dB range.

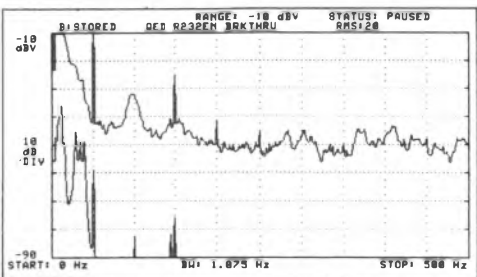

Breakthrough, acoustic (upper trace) and vibration (lower trace). Note that the baseline for the acoustic breakthrough trace is -90dB.

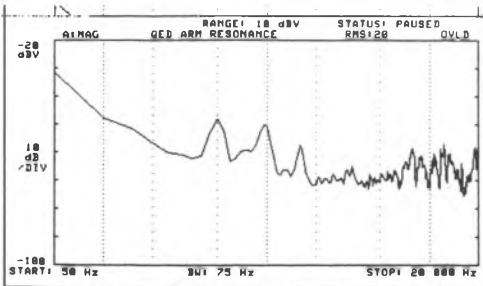

Structural arm resonances, audio band

Charts above characterise general turntable behaviour. See text for commentary on the relevance of these results, but see Technical Introduction for explanation of test techniques.

Rega Planar 2 and 3

Rega Research Ltd, 119 Park Street, Westcliffe-on-Sea SS0 7PD
Tel (0702) 333071

RECOMMENDED

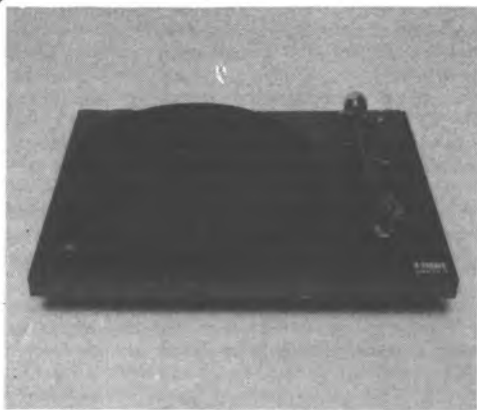

Since the 1984 edition, Rega have introduced the *RB300* arm which is now standard fitting on the *Planar 3* deck. The performance of this new combination is discussed fully in the *RB300* review. The *Planar 2* now comes with a simplified version of the new *RB300* arm, called the *RB250*.

A simple design, it comprises a solid chip-board plinth covered in tough matt black laminate. Three fairly stiff stepped rubber feet provide a stable tripod foundation while the high quality lid is directly hinged to the chassis plinth with neither springs nor isolation. A plain main bearing with a thrust ball is used, and tolerances were close here, with no detectable play. Belt-driven via a rubber cord, the inner platter hub is a reinforced plastic moulding, the uppermost projection forming the tapered centre spindle and the outer platter boss. The platter is made of thick plate glass (reduced in thickness for the *Planar 2*), and surmounted by a thick felt mat. In a simple and ingenious gravity suspension, a second drive belt is looped to support the slow speed synchronous drive motor and suppress vibration coupling to the platter.

The old Rega arm was the *Lustre* unit made to Rega specification in Japan and some demonstrators still favour this unit. The new *Planar 2* arm is a derivative of the Rega built *RB300* and is called the *RB250*. It has the same excellent bearings and one-piece cast arm tube, but has been simplified by the inclusion of a conventional rotating type of counterweight with sliding scale, which is partly decoupled. The leadout cable is fixed and the chassis earth is combined with one of the signal grounds. Phono

terminations are fitted.

Effective mass is around 11.5g including Rega's stainless steel mounting hardware, suiting it to moderate compliance cartridges or even modest moving coils.

Rega recommend that the deck should be placed on a light shelf, wall mounted, rather than a 'coffee table' or floor cabinet; this we found to be good advice.

Lab report

The platter was clearly well founded as the minimal low frequency ringing on the disc impulse response shows. The initial transient was poorly damped, however, a characteristic of thick felt mats.

Almost no metal work was present in the unit and this meant very little humfield screening was provided. In fact, hum levels were poorer than average and the choice of cartridge will need some care. Weighted wow and flutter was satisfactory but linear wow was on the high side at 0.21%, this measured without the mat as the felt is of slightly variable thickness. Speed was fairly accurate, but slowed a significant 0.4% under load with some overshoot after recovery due to motor suspension tension rocking. Start-up was average for a belt drive at 4.5 seconds.

Rumble levels were just satisfactory for the price averaging -71dB DIN. Spectrum analysis showed a considerable content of mains-related vibrations such as 100 and 200Hz, with 'pole harmonic' components around 200-300Hz. The bearing alone measured better than -78dB with the motor off, however. Acoustic breakthrough was about average and the lid was found to be influential here, and results were better when it was entirely removed. The plot is shown expanded by 10dB for lid up and down, the latter being preferred. Vibration isolation was also poorer than average.

The arm was well finished with very good geometry. It was easy to set up and use and demonstrated low bearing friction. Bias compensation was set to sensible levels and the cue worked well. Downforce calibration proved satisfactory.

Sound quality

Belying traditional assumed relationships between a number of technical parameters and sound quality, the Rega proves that a well-developed, subjectively-assessed balance of performance counts for more than technical

excellence with regards to any one parameter. On the debit side the Rega did suffer from a modicum of programme wow, particularly on rock programme, but this was not considered serious at this price level; a mild loss of stereo depth was also noted, together with an accompanying impairment of low bass definition and evenness. Conversely it sounded 'musical' in a balanced and coherent manner. With the latest arm the *Planar 2* sounded more confident. In the upper bass it was surprisingly articulate while mid and treble were notably smooth and sweet with better detail than before. Presentation of detail was considered well above average, little inferior to super-fi models in this respect.

Conclusion

The *Planar 2* offers a fine subjective performance and is both very well made and finished. All in all, this places it in the Best Buy category.

The *Planar 3* is also good, but does not offer quite the same value, and here standard recommendation is appropriate, especially with the excellent *RB300* arm.

GENERAL DATA

Integrated turntable

Motor Section

Type..... manual, belt-drive
 Platter mass/damping..... 2.2kg/good
 Finish and engineering..... very good/very good
 Type of mains/connecting leads..... 2-core phones
 Speed options..... 33/45 rpm
 Wow and flutter (DIN peak wtd, sigma 2)..... 0.09%
 Wow and flutter (LIN peak wtd 0.2-6Hz/6-300Hz) * 0.21%/0.45%
 Absolute speed error..... + 0.4%
 Speed drift, 1 hour/load variation..... synchronous/ - 0.4%
 Start-up time to audible stabilisation..... 4.5 secs
 Rumble, DIN B wtd L/R average (see spectrum)..... - 72/ - 70dB

Arm Section

Approximate effective mass, inc screws, excl cartridge.11.5g
 Type/mass of headshell..... universal detachable/8.0g
 Geometric accuracy..... very good
 Adjustments provided..... overhang/lateral angle
 Finish and engineering..... excellent/very good
 Ease of assembly/setting-up/use..... very good/very good/very good

Friction, typical lateral/vertical..... less than 25mg/15mg
 Bias compensation method..... internal magnet
 Bias force, rim/centre (set to 1.5g elliptical)..... 300,310mg
 Downforce calibration error, 1g/2g..... - 0.1g/ - 0.07g
 Cue drift, 8mm ascent/descent..... negligible 0.5 secs/1.5 secs
 Arm resonances..... very good
 Subjective sound quality..... very good
 Lead capacitance/damping method..... 70pF/counterweight decoupling

System as a whole

Size/clearance for lid rear..... 45(w) x 36(d) x 12.3(h)/7cm
 Ease of use..... fairly good
 Typical acoustic breakthrough and resonances..... average
 Subjective sound quality of complete system..... good
 Hum level/acoustic feedback..... average - /fairly good
 Vibration sensitivity/shock resistance..... average - /good
 Estimated typical purchase price Rega 2 £125; Rega 3 £188
 *worsened by unevenness in thick felt mat

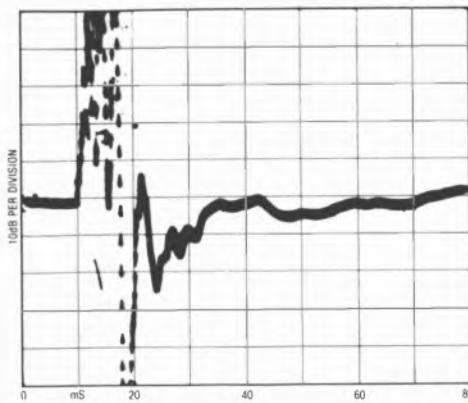

Disc impulse transmission showing damping

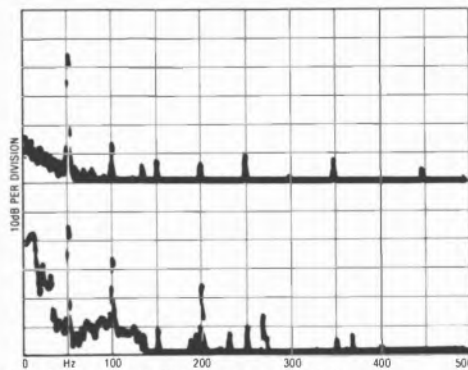

Rumble, electrical (above) and total (below)

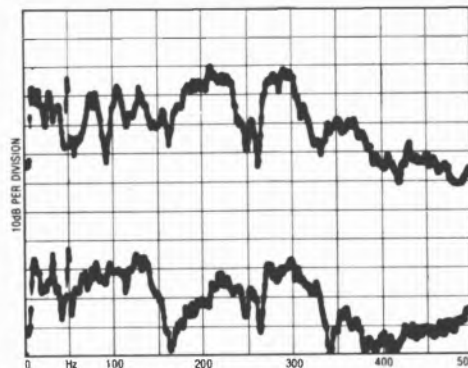

Breakthrough, lid up (above) and down (below)

Charts above characterise general turntable behaviour. See text for commentary on these results.

BEST BUY

Rega RB300

Rega Research Ltd, 119 Park Street, Westcliffe-on-Sea SS0 7PD
Tel (0702) 33071



For most of the tests here, the Rega *RB300* tonearm was fitted to a current-production *Planar 3* turntable, which is in fact the most usual combination and selling for just under £190. The arm can also be bought as a separate component (£90) and proved to be one of the most exciting introductions in the 1984 issue. The *RB250* arm is a simplified version of the *300* and is currently fitted to the *Planar 2*, the combination selling for around £125. We also subjected the *Planar 3* to a full retest, and comments on its sonic performance are included with this arm review. Very little change was recorded in the *3* performance, though the drive components did demonstrate some engineering improvement in terms of both quality and tolerances.

Getting back to the *RB300*, this Rega-made product uses a very rigid one-piece arm beam/headshell, which unusually is constructed from a hollow aluminium casting. No joints are present between cartridge platform and pivot. The bearings themselves are highly pre-loaded and yet mounted to such a high tolerance that friction is negligible while play is physically undetectable.

Rega's traditional magnetic frictionless bias compensator is employed, with a novel touch present in the design of the downforce mechanism. When set to zero, the carefully designed coil spring mechanism exerts a minus force of 3g so reducing the counterbalance requirements. Roy Gandy has aimed for the smallest possible counterweight in order to reduce its moment of inertia and consequently its effect on the dynamics of the rear section of the arm. To this end the

counterweight is machined from a very dense tungsten alloy, permitting a still smaller counterweight diameter.

The bearing gimbal is itself a substantial casting and Roy has abandoned the usual adjustable vertical pillar design, regarding this a structural weakness. His alternative is a threaded stem and large locknut; vertical height adjustment only possible using various washers, this assuming that the arm/cartridge combination will in any case fit the chosen turntable. For example the arm was a mite too high for an EMT cartridge, though fine for an *Asak*, when mounted on a Linn deck; on the *Lux 300*, the height was right for the EMT.

Lab report

Tests showed the *RB300* to have some of the finest bearings in the business; furthermore it was very competent in the important area of beam/headshell rigidity. Friction was very low in both planes, without a trace of play, and while biasing worked well, the calibrated figures were a little on the high side (by about 25%). Downforce calibration was accurate and cue operation fine. Geometric accuracy was to a high standard, while the effective mass was moderate at 10.5g, including the good-quality steel mounting hardware. A wide range of moving magnet and moving coil cartridges are judged suitable in the 8-22cu range.

Looking at the structural resonance response, the picture suggested good control and excellent rigidity. The 400Hz mode was probably the counterweight and was mild, while the first bending or torsional mode was deferred till to a remarkably high 1.5kHz — an

outstanding result. The treble was also remarkable for its absence of resonances after 4kHz.

Sound quality

It was clear after only a few minutes audition, that the *RB300* was a top flight performer. Depending on the chosen player, it proved quite comfortable in the company of other reference tonearms in the £250-£400 range.

The sound was notably dry and neutral with excellent control throughout the range. It proved capable of making one 'reference' arm sound dull and another hard and brash; and while the latter comparison could be interpreted by some as a lack of 'life' in the *RB300*, personally, I do not believe this. Its transients were judged excellent, while it offered a very well-focused sound stage with first rate depth. Cartridges up to £800 were tried without any embarrassment. Its only significant failing was a slight muddling of detail on complex musical passages.

Conclusion

The *RB300* is an excellent product which Roy Gandy can be justly proud of. Despite its modest price it sets new standards in performance, and a Best Buy rating is obviously appropriate. In conjunction with the turntable it forms the new *Planar 3* combination, and its benefits were clearly apparent in the *Planar*.

GENERAL DATA

	Tonearm
Approximate effective mass, inc screws, excl cartridge, 10-11g	
Type/mass of headshell.....non-detachable/-	
Geometric accuracy.....	very good
Adjustments provided.....	overhang/c/offset
Finish and engineering.....	very good/excellent
Ease of assembly/set-up/use.....	very good/excellent/ver good
Friction, typical lateral/vertical.....	15mg/15mg
Bias compensation method.....	magnetic
Bias force, rim/centre (set to 1.5g elliptical).....	340mg/330mg
Downforce calibration error, 1g/2g.....	+ 0.05g/ + 0.03g
Cue drift, 8mm ascent/descent.....	negligible, 0.5 secs/3 secs
Arm resonances.....	see graph
Subjective sound quality.....	very good
Arm damping.....	none
Estimated typical purchase price.....	£90

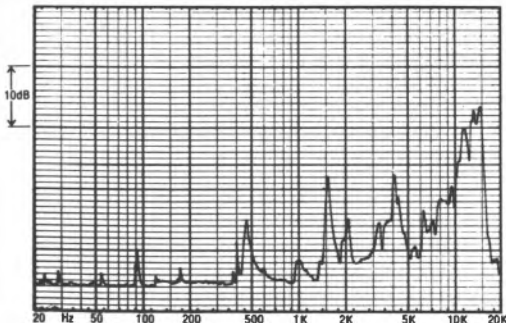

Structural arm resonances, audio band

WHICH IS YOUR BEST BUY?

Well, now you have had the chance to digest the data, descriptions and conclusions, which Best Buy or Recommended do you plump for?

I think you now need the opportunity to carry out your own review; to distil from your shortlist your own Best Buy — after all, you are the one doing the buying.

We can help. Each of our shops have two private single-speaker demonstration studios which can be reserved by appointment.

For over 12 years we have been closely associated with the Linn Sondek, but we also have all the other top brands, including:

ORACLE, PINK TRIANGLE, DUNLOP, SYSTEM DEK, THORENS, HEYBROOK, AR, REVOLVER, REGA, DUAL AND ROTEL

Our range of arms and cartridges is too wide to list but the most popular include:

ITTOK, L.V.X. BASIC PLUS, ALPHERSON, WELL TEMPERED ARM, REGA, MISSION, ZETA, KOETSU, ASAK, KARMA, SUPEX, NAGAOKA, A&R, AUDIO TECHNICA, ORTOFON, E.M.T.

Don't be confused. A rational approach to conducting your demonstration will soon identify the most suitable equipment. We are here to help — and look forward to seeing you.

W.A. BRADY & SON

401 Smithdown Road, Liverpool L15
3JJ. Tel: (051) 733 6859
Closed all day Wednesday.

DOUG BRADY HiFi

Kingsway Studios, Kingsway North,
Warrington. Tel: (0925) 828009
Closed all day Thursday

SEE Revolver

SEE Ltd, 49 Folly Lane, Warrington WA5 5ND
Tel: (0925) 571173



Now a well-established and popular model, the *Revolver* is a British designed and built motor unit, which can be supplied factory-fitted with the Mission 774LC arm or, at slightly higher cost, the Linn LVX arm, complete with *Basik* cartridge.

Essentially, the *Revolver* is a solid-plinth design, founded on a substantial Medite (MDF) board. This in turn, is mounted on three rubber feet, one at the rear and two at the front, these being rather similar to those used on the Rega models.

A secondary plinth element, namely the top plate on which the arm and platter are mounted, provides some decoupling from the plinth-mounted motor and lid. This plate is marginally isolated via stiff foam rubber strips, these joining it to the plinth proper. A hidden feature of the top plate is the rumble vibration canceller, which comprises a pair of lead weights mounted under the rear corners to avoid a coincident resonance and hence improve the signal to noise ratio.

The platter is rather light in weight and is cut from MDF. It is driven at its periphery by a long endless belt, power being provided by the usual double-pulley synchronous motor.

The main bearing is a simple design with a steel shaft and brass sleeve, run 'wet' with a

charge of oil supplied. The main bearing tolerance on our samples was very good, with no significant slack.

From its introduction, the *Revolver* featured a striking finish in first-class red or grey hammer paintwork — it is now additionally available in black ash. SEE also supply the 'PIG' rubber record clamp, along with their Starmat impregnated felt platter mat.

Lab report

The *Revolver* ran slightly fast, on last year's sample by a measured 0.4%, which is acceptable. Wow and flutter was a little below par at 0.18%, with both wow and flutter components in evidence. Slowing under load was however negligible — a good point. Platter mass was quite low and the disc damping result fairly typical for the type. On an early sample, rumble was also below par at -62/65dB, with 200Hz motor rumble apparent. Acoustic and isolation breakthrough were also not particularly good, though shock resistance was quite good. Unfortunately it was not possible to carry out full measurements on the current sample; while the graphs relate to the latest production, the tabulated results are from an

earlier sample.

Sound quality

On listening tests the *Revolver* scored 'average plus', and clearly benefitted from the competent performance of the chosen tonearm. The overall sound was nicely balanced however. Mild wow was occasionally heard, while neither pitch nor timing in music seemed too secure. The bass was free of boom or emphasis, but also lacked attack and weight and consequently sounded a bit 'soft'. Stereo depth was good however, and had pleasant perspectives.

Conclusion

The latest series *Revolver* features a thicker top deck, and build quality is much improved compared with the earliest examples. The main bearing still needs a period of running in. Priced at a little over £200 with Linn *LVX* arm and *Basik* cartridge, this model provides a decent sound quality and our recommendation continues.

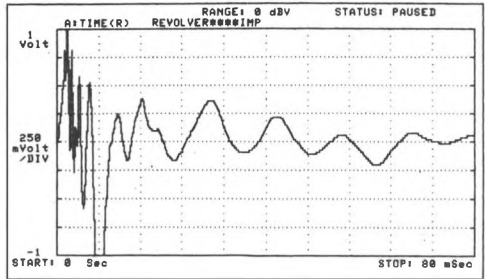

Disc impulse response, showing damping. Trace shows spurious output from cartridge when disc is subjected to a standard mechanical impulse.

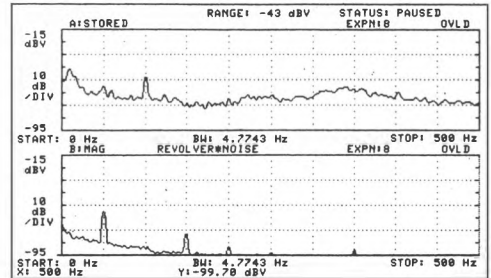

Rumble and noise. Upper display shows total rumble, lower section electrical rumble only. Scaling is as earlier charts, but with 40dB range.

GENERAL DATA

Motor Section

- Type.....plinth, belt-drive, synchronous
- Platter mass/damping.....1.0kg/fair
- Finish and engineering.....good
- Type of mains lead/connecting lead.....3-core
- Speed options.....manual change, 33 1/3/45rpm
- Wow and flutter (DIN peak wtd, sigma 2).....0.18%
- Wow and flutter (lin peak wtd 0.2-6Hz/6-300Hz).....0.15%/0.14%
- Absolute speed error.....+0.4%
- Speed drift, 1 hour/load variation.....negligible/ -0.12%
- Start-up time to audible stabilisation.....2.0 secs
- Rumble, DIN B wtd, L/R average (see spectrum).....62/65dB
- Size (w x d x h)/clearance for lid rear.....42 x 36 x 13/8.5cm
- Ease of use.....average
- Typical acoustic breakthrough and resonances.....average -
- Subjective sound quality of complete system.....average +
- Hum level/acoustic feedback.....fairly good/average -
- Vibration sensitivity/shock resistance.....fair/good
- Estimated typical purchase price.....£117, £185 (774), £215 (LVX)

(Note: measurements relate to an earlier sample.)

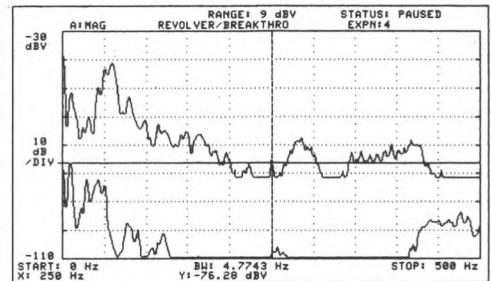

Breakthrough, acoustic (upper trace) and vibration (lower trace). Note that the baseline for the acoustic breakthrough trace is -80dB.

Charts above characterise general turntable behaviour. See text for commentary on the relevance of these results, but see Technical Introduction for explanation of test techniques

RECOMMENDED

SME Series V

SME Ltd, Steyning, Sussex BN4 3GY
Tel (0903) 814321

After several fallow years, SME have come up with a radically new state of the art tonearm. In fact we considered this product to be so important that we took a calculated risk that the results for the only model in existence, a pre-production prototype, would be representative of actual production samples available from about the end of 1985. It should be noted that this prototype had already travelled to exhibitions all over the world, but despite this it arrived in fine condition bar the lateral bearing friction which was on the high side; in production, figures of less than 40mg are anticipated for this parameter. Fortunately the friction level was not so high as to disturb the tracking of the test cartridge at 1.7-2g downforce.

At the phenomenal cost of £1138, this arm's design technology, engineering finish and sound quality are all directed towards justifying that cost. Previous SME designs employed a gravity loaded knife edge for the vertical plane bearing, but the 'V' uses firmly preloaded, high force stainless steel ball race bearings of the highest quality, offering zero detectable play or slack when properly assembled.

The main beam or tube, in thinwall cast magnesium, is a complex one-piece structure including the shell/cartridge platform, the massive beam, the yoke bearing assembly and

the rear section slide for the counterweight. The beam is heavily tapered both externally and in terms of its wall thickness. No joins are present from end to end though it must be said that the low-effective mass, high density tungsten counterweight block is joined via a cam lock system. Fine control of zero balance is via a thumbscrew, while downforce and bias correction is set by calibrated dials *a la* Linn Ittok.

While the mounting hardware is compatible with existing SME arms — the familiar oval hole with the four point fixing — the 'V' has a highly rigid vice-like clamp system which nevertheless includes the familiar rack for easy adjustment of overhang and offset geometry. Height adjustment is facilitated by a detachable control, which may be temporarily operated during play for fine tuning. Vertical tilt cannot be adjusted except perhaps by special wedge shims at the headshell.

The cable is a special van den Hul type, connected via a Japanese style 5 pin plug while the arm socket is a right angle type, with a viscous-damped free rotation, allowing the cable to take up a natural 'set' for alignment in subchassis turntables; in the current Linn player, the plinth reinforcement comes dangerously close to fouling this socketry, and will probably need cautious shaving away.

SME's internal arm wiring is specially selected for optimum sound quality.

Construction and finish of the test sample was quite excellent — anything less like a prototype I have rarely seen. It felt and operated like a Leica.

Concerning cartridge compatibility, the arm has a moderate effective mass and is suited to medium compliance cartridges in the 8-30cu range; the top limit is higher than expected and results from the arm's damping feature. A calibrated damper engages in a horizontally acting silicone fluid trough. A wide range of damping is possible, with the suggestion that it be used with extreme moderation. As such it can pacify the arm cartridge resonance, particularly with the higher compliance examples, and so stabilise tracking.

In the interests of low resonance, no finger lift is provided on the headshell, which has a milled undersurface for a good cartridge fit.

Lab report

On test this arm was found to be well calibrated with satisfactorily accurate downforce, as well as sensible levels of bias correction, the latter achieved without friction.

Effective mass depends to some degree on the mass of cartridge counter-balanced as well as the selected hardware, typically measuring 12g including fixings. With various fluid choices available from SME, any required damping can be achieved.

Analysis of the arm resonance behaviour was complicated by the necessary use of a new test cartridge. Impulse analysis showed a well damped main arm mode to lie at a high 1.6kHz, but the combination of rigidity and damping made it hard to identify on the swept graph shown. In comparative terms, this suggests a notably clean behaviour with this cartridge.

Sound quality

Perhaps in confirmation of its aspiration to set a new reference standard, this arm has the ability, once heard, to show just how colored and tonally unbalanced many other arms are.

The arm appears to have very little of its own false emphasis and, subjectively, it unleashes the black disc in a surprising manner. Several aspects caught our attention — for example, stage width is notably increased, yet central focusing is more precise over a wide frequency range. Tonally even, it allows previously 'difficult' musical passages such as certain female vocal tracks, to soar through the

frequency range without any hindrance or any suspicion of a 'forced' quality. Stage depth is remarkably good, with harmonic perspectives convincingly maintained in free space. Fine detail was excellently resolved, indeed certain detail was heard for the first time on many records. The bass was agreeably firm and extended, lacking any particular emphasis, while the treble was sweet and airy, slightly rich tonally compared with other arms.

Conclusion

Relying on SME's excellent track record for consistency and manufacturing quality, as well as their obvious dedication to the sonic excellence of this product, the future production model *Series V* can be regarded as an excellent tonearm in terms of design, engineering, build, and sound quality. While the high price constrains considerations of value, it can be argued that this arm does just what it set out to do, namely establish a new reference standard regardless of price. In our view the 'V' has a good chance of re-establishing the old SME slogan, 'The Best Pickup Arm in the World' and must be recommended.

GENERAL DATA

	Tonearm
Approximate effective mass, inc screws, excl cartridge.....	10.5g
Type/mass of headshell.....	fixed
Geometric accuracy.....	excellent
Adjustments provided.....	height/overhang/offset/damping
Finish and engineering.....	excellent/excellent
Ease of assembly/setting-up/use.....	very good/good/very good
Friction, typical lateral/vertical.....	100mg*/30mg
Bias compensation method.....	internal spring
Bias force, rim/centre (set to 1.5g elliptical).....	150mg/210mg
Downforce calibration error, 1g/2g.....	+0.02g/-0.07g
Cue drift, 8mm ascent/descent.....	negligible 1.5secs/3secs
Arm resonances.....	very good
Subjective sound quality.....	excellent
Arm damping.....	special structure; adjustable viscous damping
Estimated typical purchase price.....	£1138

* Over-torqued assembly on prototype; correct setting gives typically 30mg

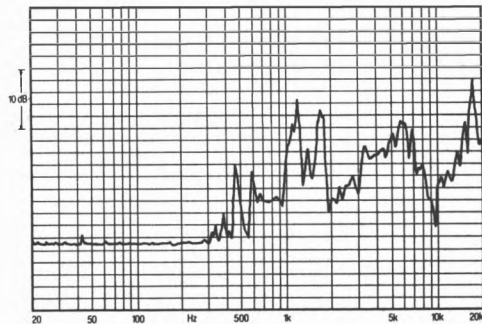

Structural arm resonances, audio band

RECOMMENDED

The Source

MRM Audio Products, Auchentiber Farm, Fereneze Road, By Neilston, Glasgow G78 3AF
Tel 041 881 1664



Selling at around £800, the *Source* is a superbly finished, substantially built belt-drive design, with a sprung subchassis. Its massive platter and chassis weight means that it is relatively impervious to alignment 'tweaking' and is happy with a range of tonearms, proving easy to set up. An electronic power supply feeds the substantial motor and provides for two speed operations at a flick of the front mounted switch. The transformer section is well isolated in a remote power lead box.

The subchassis is a thick steel plate, asymmetrically shaped and supported in a surprisingly complex manner by five carefully located coil springs. Vertical subchassis motion is excellent at 3-4Hz, but the system is rather stiff in the rotational mode. The main bearing is superb, and supports an amazing two part bronze platter weighing 7.5kg. A soft felt mat provides record support.

Lab results

Absolute speed was a touch slow at -1.1% (belt properly crowned). Wow and flutter at 0.13% was satisfactory, but could have been better, while the unweighted wow result of 0.23% suggested a possible belt imprecision. Drift was negligible, while slowing under load was a satisfactory -0.3%. Start-up was slow at 7.5 seconds, and the rumble results were fine, with dB figures in the mid seventies for an average of the two channels.

The disc impulse response was typical for a felt mat type, but note the clean decay with negligible delayed resonances. Acoustic and vibration breakthrough were both very low, though some mild

spring resonance effects may be seen in both graphs around the 300Hz region.

Analysed for rumble, the main bearing was clearly excellent, but interestingly a motor vibration component was evident at 25Hz, though this was not at a serious level.

Sound quality

This turntable gave a sound reminiscent of the US-built SOTA *Sapphire* model in respect of its ability to give a solid, weighty foundation to the reproduction. Bass was open and extended while the whole effect was one of an easy relaxed neutrality. In this respect it is probably unrivalled, though it was not felt to be so strong in areas of 'foot-tapping' timing and rhythm; the pitch stability also suffered slightly if the player was

GENERAL DATA

Motor unit

Motor section

Type.....	belt drive, subchassis
Platter mass/damping.....	7.5kg/average
Finish and engineering.....	excellent/excellent
Type of mains lead/connecting lead.....	remote transformer
Speed options.....	33, 45 rpm
Wow and flutter (DIN peak wtd, sigma %)	0.13%
Wow and flutter (lin peak wtd 0.2-6Hz/6-300Hz).....	0.23%/0.12%
Absolute speed error.....	-1.1%
Speed drift, 1 hour/load variation.....	0.01%/0.3%
Start-up time to audible stabilisation.....	7.5 secs
Rumble, DIN B wtd, L/R average (see spectrum).....	-77/-74dB

System as a whole

Size (w x d x h)/clearance for lid rear.....	50 x 40 x 15cm/4cm
Ease of use.....	very good
Typical acoustic breakthrough and resonances.....	excellent
Subjective sound quality of complete system.....	very good +
Hum level/acoustic feedback.....	negligible/low
Vibration sensitivity/shock resistance.....	very good/fair
Estimated typical purchase price.....	£800

subjected to the effects of footfalls or other similar subsonic disturbances.

Conclusion

Finely engineered, this heavyweight turntable did well on test, offering an alternative foundation for many tonearms and providing a distinctive standard with respect to bass extension and power. It did however, prefer a firm support to maximise its speed stability. A further strength was its ability to accept several tonearms which do not fit well on the smaller subchassis models such the Linn.

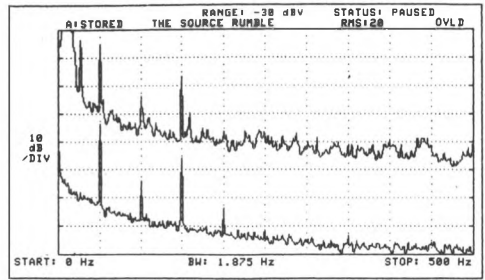

Rumble and noise. Upper display shows total rumble, lower section electrical rumble only.

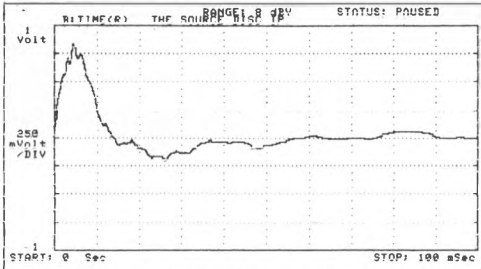

Disc impulse response, showing damping. Trace shows spurious output from cartridge when disc is subjected to a standard mechanical impulse.

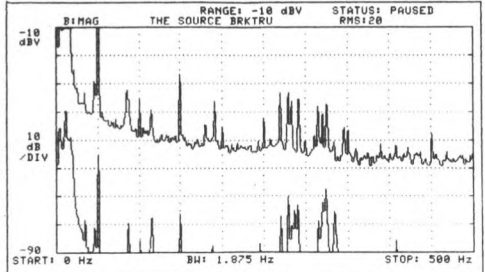

Breakthrough, acoustic (upper trace) and vibration (lower trace). Baseline for the acoustic breakthrough trace is -90dB.

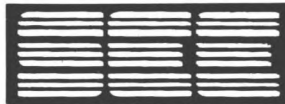

PRODUCTS FROM SEE LTD

THE REVOLVER:

F.B.A. Turntable of the year

THE PIG:

Probably the world's most successful record grip

THE DECK CHAIR:

the stylish turntable support

SEE LTD

49 FOLLY LANE, WARRINGTON WA5 5ND

Tel: 0925 571173

Systemdek IV

Systemdek Ltd, Unit 34, Kyle Road, Irvine Industrial Estate, Irvine, Scotland KA12 8LD
Tel (0294) 71251



This new design bears little resemblance to the earlier classic Systemdek III. It comprises a well-suspended belt-drive subchassis, using a set of hanging coil springs, like those of the budget IIX but uprated to cope with the higher platter mass. The concave platter surface of the III has been retained, together with an improved metal clamp, though the platter itself is now a composite type with the upper surface finished in a hard grade of vinyl to match the disc in contact with it. Two speeds are available, with electronic switching between them. The original spiral-groove oil-feed main bearing has been retained.

Platter mass is high at 4kg, and the construction affords very good disc damping, which promises a low-coloration sound. Arm fixing and lead dressing is straightforward and suspension is designed so that the deck can be easily levelled from above.

Lab report

The product of an experienced manufacturer, this deck returned a highly respectable lab performance. Wow and flutter was very low, and well below audibility, this performance being complemented by fine torque with negligible slowing under load. Absolute speed was commendably accurate with imperceptible drift. Rumble was excellently low, dB figures ranging in the upper seventies DIN B weighted.

The disc impulse was also excellently damped, though with a hint of a low-frequency sub-chassis/platter oscillation mode. The new record clamp and platter system was most effective, and both acoustic and mechanical vibration breakthrough were very well controlled.

Sound quality

This model sounded lively and dynamic with an excellent transient quality in the mid and treble registers. In tonal balance, the midrange was 'lean' and open while both mid and treble were crisp and clear, with fine detail and stereo focus. The bass exhibited good extension, but with a slight softening of impact and rhythm. On a firm support it proved nicely stable, but was less happy on floor tables where some low frequency shock or vibration might be present in the building.

Conclusion

This is a well-engineered upmarket turntable, with good facilities and performance for the money. The clarity and definition in the midrange and treble were outstanding, and it showed little weakness in other directions. True, the rotational chassis mode could have been set to a lower fre-

GENERAL DATA

Motor unit

Motor section

Type.....	belt drive, electronic
Platter mass/damping.....	4.0kg/good
Finish and engineering.....	very good/very good
Type of mains lead/connecting lead.....	3-core
Speed options.....	33, 45 rpm
Wow and flutter (DIN peak wtd, sigma 2).....	0.08%
Wow and flutter (lin peak wtd 0.2-6Hz/6-300Hz).....	0.10%/0.10%
Absolute speed error.....	0.03%
Speed drift, 1 hour/load variation.....	negligible/-0.1%
Start-up time to audible stabilisation.....	4.5 secs
Rumble, DIN B wtd, L/R average (see spectrum).....	-78/-75dB

System as a whole

Size (w x d x h)/clearance for lid rear.....	48 x 39 x 15.5cm/4cm
Ease of use.....	very good
Typical acoustic breakthrough and resonances.....	excellent
Subjective sound quality of complete system.....	very good
Hum level/acoustic feedback.....	low/very good
Vibration sensitivity/shock resistance.....	very good/fair
Estimated typical purchase price.....	£449

quency to improve the shock performance, but under most conditions, this will prove fairly unimportant. The Systemdek IV Electronic can be recommended.

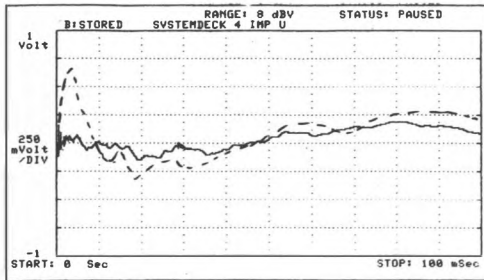

Disc impulse, showing damping. Dotted trace shows result without record clamp, solid trace shows damping with clamp in operation.

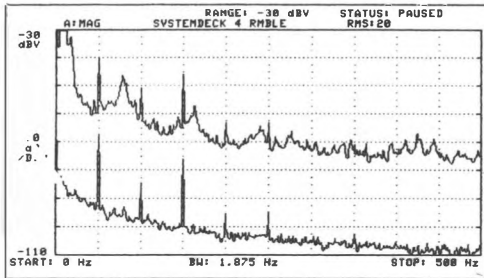

Rumble and noise. Upper display shows total rumble, lower section electrical rumble only. Scaling is as earlier charts, but with 40dB range.

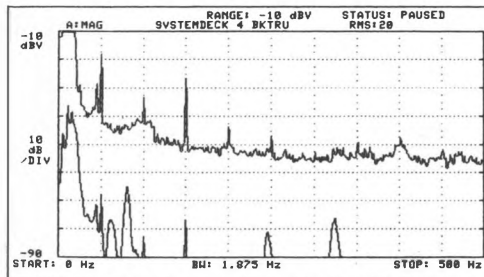

Breakthrough, acoustic (upper trace) and vibration (lower trace). Note that the baseline for the acoustic breakthrough trace is -90dB.

Charts above characterise general turntable behaviour. See text for commentary on the relevance of these results, but see Technical Introduction for explanation of test techniques.

Tandberg have been looking very closely at their specs?.. Is it time you did?..

3008A Pre-amplifier with a S/N ratio of -95dB (IHF) and 0.003% distortion. The digital disc input has a sensitivity of 70 MV and an overload rating of 20v.

3009A Power amplifier with a frequency response of 0.07HZ-1.5MHZ and pulse power capability of 1,500W into 0.5ohms.

3001A Programmable FM Stereo tuner with a S/N ratio of -95dB in mono and -92dB in stereo.

3006A Stereo power amplifier with an output of 150W per channel into 8 ohms and a frequency response of 1HZ-150KHZ.

3011A Programmable FM stereo tuner. Budget version of the 3001A with similar specifications e.g. useable sensitivity in mono is 0.85 micro volts.

3012A Integrated pre-amp/power amp with output of 100W per channel into 8 ohms. The digital disc input can handle in excess of 20 volts without overload. Frequency response on linear inputs is 5HZ-100KHZ.

3014A Cassette recorder with 32K microprocessor control system. Three heads and four motor tape transport mechanism. Built in tape calibration for any type of tape, programme search, Dolby B&C. Fixed and variable outputs, remote control option.

TD20ASE Reel tape deck with extremely quiet 4 motor tape transport system. Versatile input mixing facilities and a S/N ratio of -80dB without noise reduction circuits.

In all 3000A series the signal paths feature exclusively metal film resistors and polyester type capacitors to eliminate blurring of sound.

For detailed colour brochure on the Tandberg 300A Series send to:

TANBERG® LTD

Revie Road, Elland Road, Leeds LS11 8JG
Tel. 0532-774844

The Well Tempered Arm

Automation Sciences Co, 20 Little Gaddesdon, Berkhamsted, Herts HF4 1PA
Tel (044284) 2786

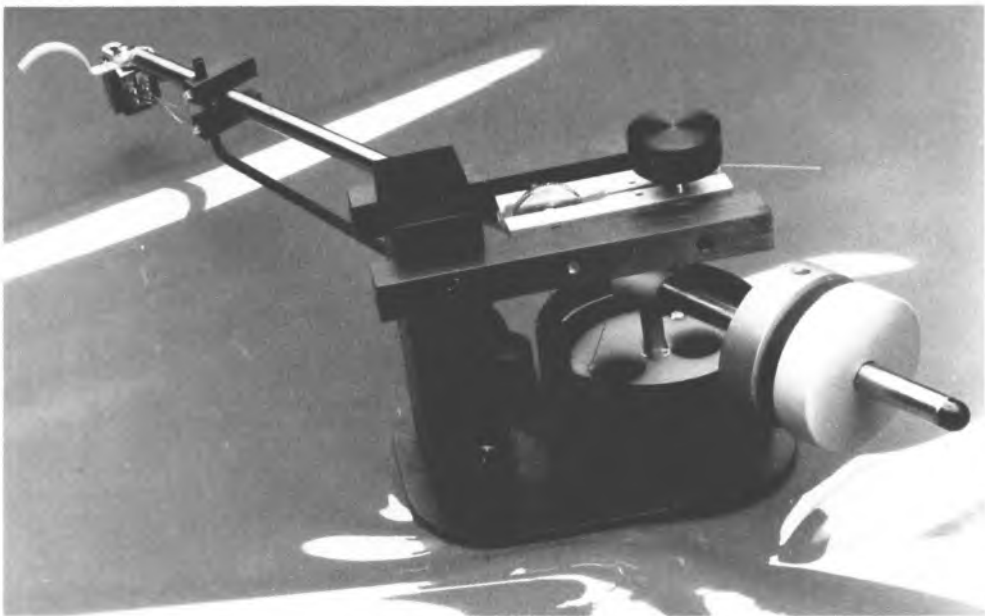

This arm is the fruit of many years of research conducted by US engineer, Bill Firebaugh. An unusual design, its closest relative would appear to be a fluid damped unipivot, but in fact, this model has managed to dispense altogether with bearings in the conventional sense. Diligent development has turned into reality the concept, mooted by several engineers, of an arm hanging on a thread. In this case, the use of two threads, or more properly, nylon monofilaments, improves stability and provides an elegant method of applying frictionless bias correction.

The arm has an undamped effective mass in the 10g range, and in use is heavily damped by a low-mass stabiliser working in a well of viscous silicone fluid, which, in a real sense, is the foundation for the arm. The subsonic arm/cartridge resonance is heavily damped, as are structural resonances in the arm taken as a whole, with the end result that the arm is singularly non-resonant.

It should be noted that the assembly is rather high and will not fit with most turntables with their lids in position; but for some models, modified lids may be available from the importer.

Lab report

The arm resonance graph demonstrated a well
138

controlled character, free from sharp breakups. In energy terms, some mid dominance was apparent but this was broad and thus of little consequence. The subsonic resonance was overdamped however, and so the cartridge/arm system was essentially resonance free.

Bias correction is applied by moving the relative positions of the two suspension threads to impart a slight twisting force to the arm. Adjustment is by a small thumbwheel, and when set at minimum, the measured bias correction value was appropriate for a typical cartridge of 1.5g tracking force. Rotated by one turn, 'anti-skating' of some 500mg or so was provided, appropriate to downforce in the 2.5 to 3.0g range. Checks confirmed the negligible stiction in the suspension and the damper assembly, so in practice friction values can be regarded as very low for small, slow arm movements.

A good range of geometric adjustments are possible, including vertical alignment while playing, and once set up the alignment was rated highly.

Sound quality

Properly set up, this arm gave a highly neutral, low-coloration sound — one which was balanced throughout the audio range. Compared with most

arms, it sounded 'quieter' in a subtle way — restrained yet finely detailed and extremely well focused through bass mid and treble registers. Images were unusually stable without the off-heard stylus 'fluttering' and uncertainty.

Conclusion

The high standard of sound quality shown here demands recommendation. Stable and relaxed, its

overall performance 'grows' on the listener with prolonged use. Its average effective mass and high damping suits it to a wide variety of cartridges, ranging from the robust low compliance versions, to the more delicate moving coils, and while its looks may be off putting and there are admittedly some mounting complications, the end results certainly justify the extra effort required.

GENERAL DATA

Tonearm

Arm section

Approximate effective mass, inc screws, excl cartridge.....	6.8g
Type/mass of headshell.....	fixed
Geometric accuracy.....	excellent
Adjustments provided.....	tilt, overhang, lateral
Finish and engineering.....	very good/very good
Ease of assembly/setting-up/use.....	difficult/average/average
Friction, typical lateral/vertical.....	none
Bias compensation method.....	twisted thread
Bias force, rim/centre (set to 1.5g elliptical).....	225mg/500mg
Downforce calibration error, 1g/2g.....	uncalibrated
Cue drift, 8mm ascent/ descent.....	no cueing device, poor drift/0.5secs
Arm resonances.....	excellent
Subjective sound quality.....	very good
Arm damping.....	very heavy damping
Estimated typical purchase price.....	£515

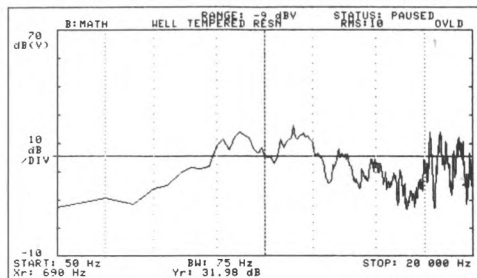

Structural arm resonances, audio band

HEYBROOK



The 'recommended' range

For full details of all products and your local stockist please contact the manufacturers

For further information and full review reprints please complete and return this coupon

Name _____ Address _____

Product HB1 HB2
HB3 TT2

Please tick ✓

Thorens TD316

Cambridge Ltd, Britannia Road, Waltham Cross, Herts EN8 7EF
Tel (0992) 716666



This new series Thorens turntable is a higher-quality replacement for the old *TD166*, a deck which offered excellent value. The *316* carries forward the established *166* arm, now fitted to the latest subchassis and drive system of the *320* series. One cost concession is seen in the change to black ash vinyl for the plinth exterior, a substitute for the real veneer of the *320* — but while the inner platter hub is now made from reinforced plastic, the outer ring is still the traditional Thorens Mazak metal casting.

Features include an electronic motor control with convenient two speed switching on the plinth plus the comparative luxury of a plinth-mounted cue control which allows jiggle-free operation despite the suspended subchassis.

The arm has been improved by replacing the old headshell with a new cast metal design, offering a sensible cartridge fitting and a firm locking collar. Bias compensation is by the established thread and weight system with down-force set by a calibrated dial and rotating counterweight.

Lab report

Thorens' current dense felt rubber mat gave a good result for disc damping, though with a mild 40Hz chassis/platter oscillation mode. Speed accuracy was good while slowing under load was satisfactory at 0.35%. Start-up was rather slow at 7.0 seconds owing to the slipping clutch mechanism on the motor pulley, but once up to speed this 'locked up', ensuring good torque.

No problems were evident in the drive stability

with weighted wow and flutter at an excellent 0.06%, while rumble was also commendably low. The suspension system rejected acoustic and vibration signals well, and also rated above average on shock resistance. The rotational subchassis vibrational mode was however at a higher than ideal frequency.

The arm also performed well, if not quite up to the standard of the best separate models at around £100. Friction was low, with negligible bearing slack exhibited on current production. Geometric accuracy was fine and the adjustments proved to be satisfactorily calibrated. Tested for structural resonances, two significant modes were resolved at 500Hz and 700Hz, which might result in some coloration, but the arm was quite well behaved in the upper frequency range, tolerably so for a typical moving coil cartridge of average quality.

Sound quality

Good points included a strong stable sound with good pitch and speed stability. The bass was weighty and extended with the mid moderate in coloration and good on detail. The treble was a touch exuberant but quite well focused. Stereo images were well presented in the width dimension but lacked some measure of depth transparency; overall it sounded a little less dynamic than top rated alternatives.

Conclusion

This is undoubtedly a competitive integrated player offering a fine finish as well as traditionally

good Thorens engineering. The arm mass is on the low side, suited to some of the more delicate moving magnet cartridges, and is also well calibrated and convenient. In contrast to the competition, this player also offers a good performance, two-speed electronic motor drive, and given all these considerations, comfortably qualifies for recommendation.

GENERAL DATA

Integrated turntable

Motor section

Type.....belt drive, subchassis, manual
 Platter mass/damping.....3.0kg/good
 Finish and engineering.....excellent/very good
 Type of mains lead/connecting lead.....remote transformer/phonos plus earth
 Speed options.....33, 45 rpm
 Wow and flutter (DIN peak wtd, sigma 2).....0.06%
 Wow and flutter (lin peak wtd 0.2-6Hz/6-300Hz).....0.14%/0.14%
 Absolute speed error.....-0.5%
 Speed drift, 1 hour/load variation.....<0.1%/-0.34%
 Start-up time to audible stabilisation.....7.0 secs
 Rumble, DIN B wtd, L/R average (see spectrum).....-74-76dB

Arm section

Approximate effective mass, inc screws, excl cartridge.....4.5g
 Type/mass of headshell.....fixed
 Geometric accuracy.....very good
 Adjustments provided.....height/overhang/lateral
 Finish and engineering.....good/good
 Ease of assembly/setting-up/use.....very good/very good
 Friction, typical lateral/vertical.....45mg/<15mg
 Bias compensation method.....thread and weight
 Bias force, rim/centre (set to 1.5g elliptical).....200mg/160mg
 Downforce calibration error, 1g/2g.....-0.075g/-0.15g
 Cue drift, 8mm ascent/descent.....good, 1.5secs/3.5secs
 Arm resonances.....good
 Subjective sound quality.....good
 Arm damping.....some counterweight decoupling

System as a whole

Size (w x d x h)/clearance for lid rear.....44 x 37 x 16cm/6.5cm
 Ease of use.....good+
 Typical acoustic breakthrough and resonances.....very good
 Subjective sound quality of complete system.....good+
 Hum level/acoustic feedback.....very good/very good
 Vibration sensitivity/shock resistance.....very good/average+
 Estimated typical purchase price.....£179

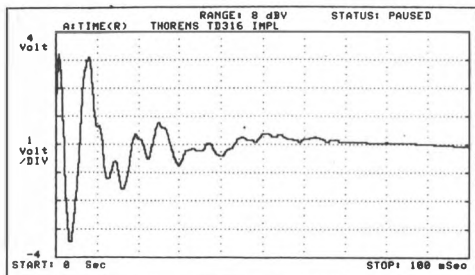

Disc impulse response, showing damping. Trace shows spurious output from cartridge when disc is subjected to a standard mechanical impulse.

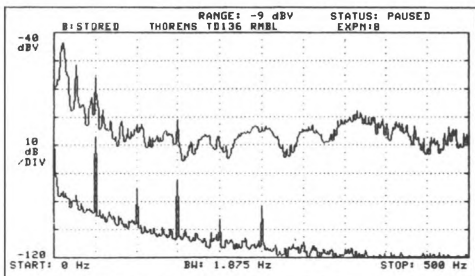

Rumble and noise. Upper display shows total rumble, lower section electrical rumble only. Scaling is as earlier charts, but with 40dB range.

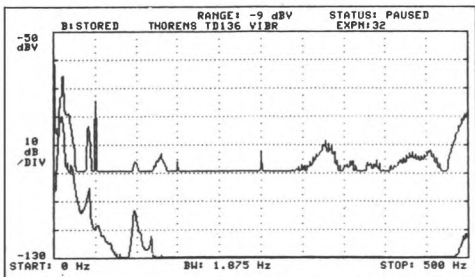

Breakthrough, acoustic (upper trace) and vibration (lower trace). Note that the baseline for the acoustic breakthrough trace is -90dB.

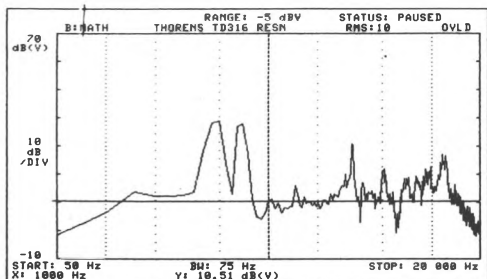

Structural arm resonances, audio band

Charts above characterise general turntable behaviour. See text for commentary on the relevance of these results, but see Technical Introduction for explanation of test techniques.

RECOMMENDED

Walker CJ58/AR arm

CW & J Walker Ltd, Brentwood, Red Lane, Frodsham, Cheshire WA6 6RA
Tel (0928) 33326



This recent turntable is now in full production form, with a fine wood veneer finished plinth plus improved support feet. Available as an integrated player with the AR tonearm and factory-aligned suspension, it was supplied for an updated report this time round.

Distinguished by its heavy, inert two-piece Tufnol platter, fitted with a high density bonded felt mat, the deck has a fabricated wood-composition subchassis, which is easily levelled from above by means of three socket head screws.

Lab report

In most respects the *CJ58* performed well — better than the earlier pre-production model tested in *Choice: CD Players and Turntables* (No. 40). Wow and flutter met a satisfactory 0.22% standard, while slowing under load was very good. Start-up time was typical at 4.0 seconds, and good rumble results were also obtained. The low metal content resulted in higher than usual levels of electrically-induced hum, though in the event, this also proved to be satisfactory. Shock resistance was considered average with some whipliness evident in the rotational mode of chassis freedom. Vibration and acoustic breakthroughs were well controlled while the disc impulse response gave the usual generally tidy result.

Sound quality

Auditioned with the AR tonearm, this player gave

a well balanced sound with a surprising level of detail and depth for the price category. This good rating includes the inexpensive Glanz cartridge supplied with the arm. The mid/treble region was tidy, pleasantly focused and in musical harmony. At low frequencies some loss of 'attack' and speed was noted, though this was not considered very serious or upsetting to the overall standard of performance, not a very fair criticism at the price.

Conclusion

This new integrated player combination presents a notably musical result in a competitive price area. Supplied complete with cartridge few could

GENERAL DATA

Motor unit plus AR arm

Motor section

Type.....	belt drive (manual)
Platter mass/damping.....	1.9kg/good
Finish and engineering.....	good/good
Type of mains lead/connecting lead.....	2-core/phonos
Speed options.....	33, 45 rpm
Wow and flutter (DIN peak wtd, sigma 2).....	0.22%
Wow and flutter (lin peak wtd 0.2-6Hz/6-300Hz).....	0.28%/0.08%
Absolute speed error.....	-1.23%
Speed drift, 1 hour/load variation.....	0.1%/-0.15%
Start-up time to audible stabilisation.....	4.0 secs
Rumble, DIN B wtd, L/R average (see spectrum).....	-75/-76dB

System as a whole

Size (w x d x h)/clearance for lid rear.....	48 x 38.5 x 14cm/5cm
Ease of use.....	fairly good
Typical acoustic breakthrough and resonances.....	very good
Subjective sound quality of complete system.....	good+
Hum level/acoustic feedback.....	good/very good
Vibration sensitivity/shock resistance.....	very good/average
Estimated typical purchase price.....	£200 (£130 without arm)

argue with the price given the overall standard of finish and performance. The *CJ58* is therefore recommended once again.

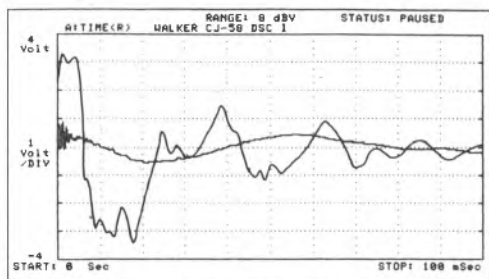

Disc impulse response, showing damping. Trace shows spurious output from cartridge when disc is subjected to a standard mechanical impulse.

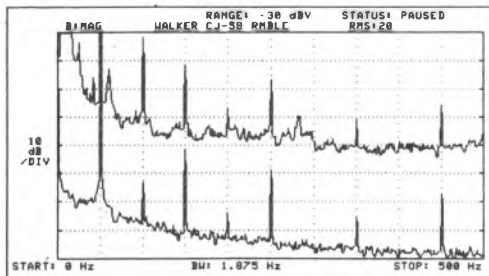

Rumble and noise. Upper display shows total rumble, lower section electrical rumble only. Scaling is as earlier charts, but with 40dB range.

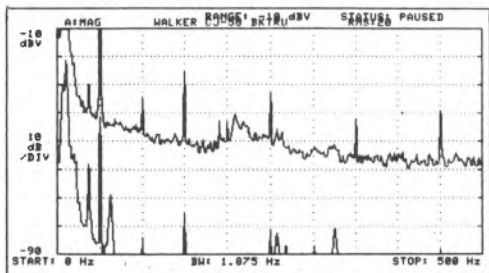

Breakthrough, acoustic (upper trace) and vibration (lower trace). Note that the baseline for the acoustic breakthrough trace is -90dB.

Charts above characterise general turntable behaviour. See text for commentary on the relevance of these results, but see Technical Introduction for explanation of test techniques.

ANDOVERAUDIO

Come in and listen for yourself. We'll offer you unbiased friendly advice and good demonstration facilities.



B&O MMC4

ADC ● AUDIO TECHNICA ● B&O
GOLDRING ● ORTOFON ● SHURE
AND SELECTED PRODUCTS FROM
OTHER MANUFACTURERS



105 HIGH STREET, ANDOVER
HANTS. TEL: 0264 58251



ERIC WILEY CASTLEFORD

AUDIO CENTRE

Agents for all leading
manufacturers of quality
turntables and cartridges

THE SMALL SHOP
with the
BIG STOCK
at the
BEST PRICES

85 BEANCROFT ROAD
CASTLEFORD
Tel: 553066/556774

Proven Accessories from QED!



Connecting your HiFi to the Mains

QED Mains Distribution Units overcome the problems associated with connecting HiFi equipment to the mains. They incorporate miniature 6 Amp sockets and are only 210 x 34 x 35 (mm). Fitted with mains lead and 13 Amp plug.

In line 4 skt (DU4) **Price £9.95**

In line 6 skt (DU6) **Price £11.95**

In line 4 skt interference suppressed
Price £18.50

In line 6 skt interference suppressed
Price £24.00

Special 6 Amp plugs to fit above units
Price £1.25 each.



Dealing with Interference Problems

This is a difficult and sometimes complex subject to deal with and for this reason we have published a separate QED booklet entitled "Interference causes and cures", available free on request. Interference products available include plug-in Mains Interference Suppressors, Ferrite Rings and Light Switch Suppressors.



C.D. Switching Unit



A.C.D. player needs a special input to work properly, but many (otherwise very good amplifiers) do not have such a dedicated C.D. input.

This need not be a problem with the QED COMPACT DISC SWITCHING UNIT, because not only does it switch between tuner and C.D. it also adjusts the level for optimum performance.

**Price
£18.50**

Switching Units & Volume Controls

A full range of Amplifier, Speaker, Tape, C.D. and Phono switching units together with Volume Controls and Headphone Adaptors.

The range now includes a new 2 way Speaker Switching Unit (SSU2) which will accept QED 79 strand speaker cable and a new 4 way unit (UHSS4) that will accept Monster and C38 type cables.



prices from
£9.50

The BEST BUY of Speaker Cables

Over 2 million metres of genuine QED 79 strand speaker cable has so far been sold, making it the most popular speaker cable ever produced.

HIFI Answers (Nov 82) concluded that, "Charging from bell wire c/r mains lead to QED 79 STRAND SPEAKER CABLE is the cheapest upgrade you will ever make."

WARNING: Beware of cheap imitations. Genuine QED 79 strand is embossed "QED AUDIO PRODUCTS"



PRICE
**79p
per metre**

Sound definition Speaker Stands

Speaker stands do not generally receive the attention they deserve - they are a very important part of a good HiFi System.

QED produce a range of five stands from £22.50 to £59.00 per pair.

The SD19S, SD15 and SD24 are "spiked" both top and bottom. To find out why and for a full explanation of why speaker stands sound different, send for the new Catalogue No. 9.

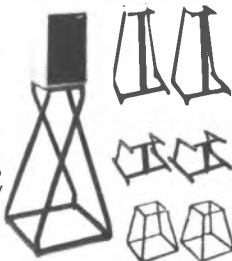

QED Products are recommended by all leading manufacturers and importers of HiFi Equipment. They are available from around 1000 HiFi retailers throughout the U.K.

Alternatively, order direct and we will despatch your order within 24 hours (subject to availability) Post and packing free. * All prices include V.A.T. @ 15% * Add 50p to orders under £5.00

For technical and nearest dealer information ring ASHFORD (Middx) 46236 - area code inside LONDON 69 or STD 07842.

QED Audio Products Ltd., Unit 12, Ashford Industrial Estate, Shield Road, Ashford, Middlesex. TW15 1AU.

North American Distributor: May Audio Marketing Ltd., 646 Guimond Blvd, Longueuil, QUE. J4G 1P8 Tel (514) 651-5707

Please send me your latest Catalogue No. 9 and the name of my nearest dealer
I enclose a First Class stamp

FOR MORE INFORMATION

NAME _____

ADDRESS _____

QED

SUMMARY REVIEWS: TURNTABLES AND TONEARMS

Many current turntables and tonearms were fully tested for the last edition and are still current, but space no longer allows us to print these reports in full; they are summarised in this section.

These reviews give a brief summary of our test findings on overall performance, sound quality, and compatibility with other components. For arm/cartridge matching, the arm effective mass figures quoted here can be compared with the range quoted in each cartridge review.

Acoustic Research Legend (£239)

A completely modernised revival of the classic AR subchassis design, this model offered fine all round performance, with an airy, articulate sound. The AR arm is roughly equivalent to a Mission 774LC; the player is also available fitted with a Linn LVX arm at £98. The *Legend* remains good value though somewhat eclipsed in this aspect by the cheaper *EB101*.

Alphason HR100S (£335, MCS version £385)

The current *HR100S* impressed strongly with its neutral and tonally balanced performance. Treble was detailed, yet free of edge or 'grain'; the midrange gave excellent rendition of vocal lines while bass was firm, extended and detailed. Stereo was exceptional. The 'MCS' version, wired throughout with van den Hul crystal 'mono' cable offers worthwhile gains in clarity and definition throughout the range; both versions can be recommended.

Ariston RD20 (£100)

Based on a plastic moulded plinth, the *RD20* has a simple arm of 9g effective mass. In Dual 505 style, the chassis is suspended by four coil springs, while the 1.37kg platter features Ariston's concave-centre clamp system. Sound quality was not rated very well, with a 'loud' muddled character apparent at times; no recommendation was appropriate.

Ariston RD40AC (£130, £200 with arm)

Conceived as a complete range, the *RD40* series starts with the basic synchronous motor powered 'AC'. Base plate and subchassis follow the circular form of the platter, with suspension springs in peripheral towers; the unit has a well finished 'engineered' look. It performed well with firm bass, good stereo and pleasing depth — hallmarks of a suspended subchassis. Attractively priced, the *RD40AC* can be recommended.

Ariston RD40E (£170, £240 with arm)

Here the *RD40AC*'s synchronous motor is replaced by a dc type, which allows a front panel speed change and independent variable controls. Subjectively, it was considered good, but some doubts were expressed over pitch stability; in the lab the 'E' gave slightly better rumble and better

wow and flutter than the 'AC' but did show some slowing under load, and this weakness precluded recommendation.

Ariston RD80SL (£160, £230 with arm)

Detail improvements to the *RD80* have resulted in the 'SL' version of this very well established player. Maintaining the standard in sound quality terms, it provided a well-focused stereo soundfield, stable and precise, while the overall balance was generally neutral and the sound fairly transparent. Bass showed good depth and evenness, and pitch stability was also pretty good. Recommendation continues.

Bang & Olufsen Beogram RX-2 (£110)

With excellent finish and unfussy styling, the *RX-2* offers fully automatic operation. Despite the lightweight platter and subchassis (suspended by leaf springs), the *RX-2* gave good isolation; the arm performed fairly well. The sound was fairly neutral, with a sweet, restrained treble register; overall it lacked some bite and attack, and bass could have been firmer. At around £135 including cartridge (only B&O types will fit) it is worth considering.

Bang & Olufsen TX4 (£200)

This 'linear-tracking' deck can also form part of a B&O 5000 system. Lab results were respectable, but the arm's resonant behaviour was rated poorer than average. Despite the fine subchassis, the sound did have weaknesses; musical dynamics showed some compression, the midband was muddled, detail and transient attack were suppressed. Bass was reasonable, but lacking in weight and impact. Worth considering as a superbly finished automatic.

Decca International (£100)

This unipivot arm was tested some issues back, when it gave a rather 'rich' tonal balance, with some bass muddling and mid-forwardness. With 12g effective mass, it might still be a good match for Decca's individual-sounding cartridges, but constructional quality is not good by modern standards.

Dual CS514 (£70)

Superficially resembling the '505', the '514's light plastic plinth gives only rudimentary isolation, via rubber grommets, of the 'subchassis'. Despite a nicely-made arm, the sound was not very satisfactory; it lacked dynamics and showed programme wow due to poor motor torque. Possibly worth considering for the cheapest systems, but the '505 is clearly well worth the extra money.

Add listening magic to your sound system



All Beyerdynamic Stereo Headphones are internationally renowned for their high frequency and powerful bass response. Making them ideal for digitally recorded tapes and compact discs.

The listening pleasure is total comfort. Ear pads so light, so soft, you'd hardly know you're wearing them.

Originally, the DT880 Monitor was designed for professional use.

But it was soon discovered by the Hi-Fi enthusiast as a stereo headphone of unique quality.

Being technical, it's the super sensitive samarium-cobalt systems that add the listening magic. Capable of producing a whole new dimension of sound from your audio equipment.

Relax with the perfect performance from a Beyerdynamic Headphone.

Please send me the free Beyerdynamic Headphone brochure and the name of my local stockist.

Name

Address

Postcode

Tel.



beyerdynamic



EXCELLENCE IN SOUND

BeyerDynamic, Unit 14, Cliffe Industrial Estate,
Lewes, Sussex BN8 6JL. Tel: 0273 479411

WCD 1985

SUMMARY REVIEWS: TURNTABLES AND TONEARMS

Elite Townshend Rock (£300)

This unique solid-plinth design incorporates a large silicone fluid damper, which operates at the headshell end of the arm. This is designed to control both the audio band structural resonances in the tonearm as well as the cartridge subsonic resonances. Shock resistance and record 'rumble' are also improved. The *Rock* did well on audition, demonstrating good stability of pitch, with a neutral tonal balance, firm clean bass, good perspectives in the midrange, and an unexaggerated treble. Stereo focus was good, and cartridges tracked well with reduced low-frequency noise. The *Rock* will accept most arms, but Elite Townshend offer the *Excalibur* (£299), designed to fully complement the turntable concept, and a wood plinth is now available at an extra £89. Further improvements have been made since our tests were carried out, but on the basis of these the *Rock* was recommended.

Grace G707 (£198)

This long-established and elegant arm is a rigid yet low-mass (7g) design with a fixed plastic headshell. In terms of tonal neutrality it seems to offer a slightly bright or coarse balance, and while it offers tight, extended and powerful bass, with good stereo depth and precision, recent introductions make it less competitive than in previous years.

Harman Kardon T35C (£159)

In this rigid plinth design the springy feet provide some isolation but do not deal with acoustic breakthrough. The 1.33kg platter is driven by a small dc motor, allowing electronic speed change. The arm showed quite serious resonant breakup. On listening tests, stereo focus did not sound very clear, while the bass had a lumpy, softened character; the sound lacked attack or life. Tonally it was pleasant enough, neither seriously coloured nor unbalanced. But with the standards set by the *Dual 505* or *Rega 2*, this 'old-fashioned' performance is no longer adequate.

Harman Kardon T55C (£239)

The *T55C* has a suspended subchassis, and comes with a heavy record clamp. Isolation and feedback resistance were much better than the '35. Subjectively, stereo images had greater width, and the sound showed more 'punch' and life, with bass definition improved. Some muddling also remained in the mid and treble. Still barely above average in sound quality, though, at a well above average price, the *T55C* could not be recommended.

Helius Orion (£435)

Built to uncompromising standards, the *Orion* uses a 'tri-ball' pivot system in a massive bearing

assembly, giving great rigidity and zero bearing play when correctly adjusted. Of medium effective mass (11g), this excellently engineered arm continues to justify its high price and is again recommended.

Linn Basik LVX (£98)

While offering the upgraded *LV Plus* version to the public, Linn still supply the *LVX* to other turntable manufacturers. Sourced in Japan, but built to Linn specification, the versatile (12.5g) *LVX* offers very satisfactory tonal balance and well defined stereo. It gives a sweet and musical treble, though the bass lacks some tautness.

Linn LV Plus (£98)

Essentially a fixed headshell (13.5g effective mass) version of the *LVX*, the *LV Plus* is also assembled with the bearings free from play, for good results with moving-coil cartridges. However, we have found that on some samples this gives high friction, a point to be watched. With this slight reservation the *Plus* can be warmly recommended, as against the *LVX* it shows reduced mid coloration, better integrated treble and more articulate upper-bass transients, attaining a fine standard for the price.

Linn Ittok LVII (£316)

Minor improvements over the years have helped maintain this arm's enviable reputation for excellent engineering, technical performance and sound quality. A rigid fixed head design of 14g effective mass, it best suits cartridges in the 8-16cu compliance range. The heavily engineered pillar and clamping arrangement allows an unrivalled strength of lock to be obtained between arm and mounting board; this means that the armboard becomes influential on final sound quality. On listening tests, the overall rating was a secure 'very good', but as with all components the result represents a balanced compromise. In our view the *Ittok's* strengths lie in its subjective speed of response to transients, fine transparency and ability to reveal atmosphere, depth and fine detail. Bass was to a fine standard with good extension and drive, while the treble was also revealing of detail, if very slightly brash and forward at times. A trace of upper mid hardness was also noted, where stereo focus suffered a mild dilution. The importance of this depends on the final combination of equipment chosen; the *Ittok* performs best on the current *LP12*, where the performance of the whole exceeds the sum of its parts. A top-quality universal tonearm, the *Ittok* remains strongly recommended.

Lux PD300 (when current, £375)

A massively constructed and beautifully finished subchassis turntable, the '300 also features the

SUMMARY REVIEWS: TURNTABLES AND TONEARMS

Lux vacuum platter system. The suspension system was found to give better sonic results when the foam sleeves and damping washers were removed from the springs, though this caused some 'nervousness' of chassis stability. Notably neutral and transparent, the 300 sounded almost clinically clear, slightly 'cold' or 'glassy'. Recommended in previous issues, the PD300 is now discontinued but was recently still available from stock.

Michell Synchro (£235)

With a cast ring-shaped subchassis, the *Synchro* has a striking, 'engineered' appearance enhanced by the pale green tinted glass platter, acrylic base and lid. It gave a very good standard of sound quality, with firm bass and an articulate detailed stereo presentation. Coloration was low while pitch and 'timing' were of a high order; feedback effects were negligible. The *Synchro* comfortably achieved recommendation.

Michell GyroDec (£595)

Built into a costly hand-fabricated glass-clear acrylic case and lid, the *GyroDec* can be fitted with two arms if required. The massive spoked 'wheel' subchassis is suspended from three coil springs, easily accessible for adjustment. The 4.5kg one piece platter has a strong record clamp and is belt-driven at its periphery by a large Papst synchronous motor. On audition, it sounded very neutral and transparent, producing stable and specious stereo images with impressive depth. It can be recommended despite its high price tag; for some, the appearance will go a long way towards justifying the cost.

Mission 775LCT (£180)

Supplied complete with a Mission 774LC arm, this player is founded on a solid plinth of rigid composition board, which relies for isolation on three Sorbothane feet; but though vibration rejection was measurably worse (by perhaps 10dB) than subchassis designs, the 775LCT did well in listening tests. It gave a tidy, coherent and well integrated sound and dynamics were good with an almost tactile percussive impact. Pitch and rhythm were good, as was the lightweight but tuneful bass. Stereo was good but with some loss of depth; the sound distinctly improved with the lid removed. The 775LCT is recommended.

Mission 774LC (£70)

Built in Japan to Mission's design this tonearm is a conventional gimbal type, but with a number of interesting features; the step-tapered main beam design has been chosen to distribute and moderate self-resonance; the headshell is fixed and there is no counterweight decoupling. Mounting requirements are the same as those of

the Linn models, and like these, it is likely to be found on a number of players. Taken overall, a clear explicit sound was produced, with good stereo focus as well as pleasing stereo depth. Depending on the cartridge, the upper range could sound a little untidy, with some coloration in the midrange. Bass was comparatively secure, detailed and articulate. Clearly meeting a real market need, the 774LC merits recommendation here.

Oracle Delphi (£1550)

Still current, with detail improvements, the original Oracle motor unit has an 'open' appearance and incorporates many special features. The skeletal magnesium subchassis is suspended on springs concealed in three piers attached to the acrylic base; correct subchassis behaviour with various arms is obtained by choosing the right combination from the total of nine colour coded springs provided. The platter incorporates Oracle's unique clamp system. Subjective impressions were of a rather 'dry' and well damped character, with a somewhat 'distant' mid and treble. Transients were reproduced very clearly, with good instrumental differentiation, and good depth and stereo focus. Criticisms in earlier issues centred on a failure to keep perfect subjective pitch on the most sensitive material, and the effects of the stiff chassis vibrational mode and residual vibration breakthrough.

Pink Triangle (£400)

Designed along classic lines, this UK motor unit has many unique features; the solid matt-finished acrylic platter, providing record support and termination; the very light but exceedingly rigid and well-damped subchassis, of honeycomb-core aircraft flooring material; the inverted ruby main bearing; and fine speed adjustment. The Triangle has long demonstrated qualities of low coloration and tonal neutrality as well as a pleasing musical balance. Bass was thought well above average, open and articulate, tuneful and with good weight and solidity. The sound appeared alive and yet unforced. Our most recent sample banished the dynamic wow (slowing under load) noted in earlier years, so removing our only significant reservation concerning this fine-sounding player, which can be recommended.

Revox B791 (£450)

In this 'childproof' design, the arm is a servo-controlled assembly concealed beneath a cover, the whole forming a parallel-tracking gantry which is swung across the playing surface once a disc has been placed on the platter. The servo responds to any forcible movement by instantly lifting the stylus, to make record or stylus damage

SUMMARY REVIEWS: TURNTABLES AND TONEARMS

virtually impossible. The cartridge is an Ortofon type. Sound quality was described as 'rich', with some midrange 'thickening', and felt a little 'compressed' in terms of perceived dynamic range, though pitching stability was extremely good. Hardly an audiophile product but the Revox *B791* is worth considering.

Rotel RP850 (£200)

The *RP850* reveals much evidence of careful design; it is actually very different from the visually-similar but much less competent *RP830*. The substantial plinth gives fairly good isolation; the platter, with a thick rubber mat, gives good disc damping; arm performance is above average. Sound quality, which improved notably with the lid removed, was tonally well balanced, with clean detailed midrange plus good treble, and only slight imprecision, heard as a touch of fizz. Bass was of reasonable definition, and stereo imaging was good. The *RP850* is recommended.

SME 3009 Series III and IIIS (£205, £147)

Designed to combine low mass with versatile cartridge matching, the *III* arm has extremely comprehensive adjustments; the simplified *IIIS* lacks some of these features but we found that it sounded indistinguishable. The sound was characterised by a 'soft' balance, with a subjectively subdued balance. Coloration was comparatively low and the overall sound pleasantly relaxed. Mass can be added to the headshell to raise effective mass to around 12g, to suit cartridges down to 8cu, but even so the arm is not primarily suited to low-compliance moving-coils. Nonetheless, respectable sound quality is combined with excellent construction and finish.

SME 3009R (£226)

This 'R' version is in effect a revamping of the earlier, heavier *3009* arm which preceded the *3009II Improved*, and offers higher mass to suit low-compliance cartridges. While construction and finish are to the usual superb SME standard, the subjective performance was in the 'average' group and did not in our view justify the price.

SOTA Sapphire

A massive subchassis design, with a plinth of solid oak, the US-built SOTA has a massive inverted main bearing with a sapphire thrust disc (hence the name). The Papst dc motor is fed by an external power supply, and has electronic speed switching and fine adjustment. The SOTA scored top marks for isolation; on listening tests it provided a stable and spacious stereo soundfield with good tonal neutrality, and an air of restraint prevailed the reproduction. Stereo images were well presented with good depth

ambience and fine width of stereo stage. It felt 'relaxed', in fact almost too much so at times. Though it was hard to fault the sound, one area of criticism was finally identified, namely the bass, which though undoubtedly even, tuneful and extended, seemed 'slow'. We found use of the *Ittok* helped liven up the balance. Undoubtedly a fine product, the SOTA is at present not available in UK, but its particular balance of performance would suit some systems.

Sumiko MDC800 (£1650)

Based loosely on the legendary Swiss-made Breuer, this medium mass (13g) arm is produced in Japan for an American company and imported to the UK by Absolute Sounds. In earlier tests the sound was found to be smooth and relaxed with good bass definition, fine depth, neutrality and tunefulness. Very minor criticisms were made of a slight stereo defocusing and mild coloration in the upper midrange, but the sound quality rated as very good by any standards. While the *MDC800* once stood alone at its exalted quality level, it has now been joined by competitors, often at more realistic prices.

Thorens TD320, TD321BC (£278, £215)

The *320's* massive plinth is of 40mm thick MDF, and the section cut out for arm mounting is transferred to the subchassis, the result being a wood-based high-mass subchassis of low resonance properties. Leaf springs replace the traditional coil springs for suspension, but the Thorens two-part Mazak platter is retained, belt-driven from a low voltage synchronous motor. This is fed by an electronically synthesised two phase power supply. The *320* comes with Thorens *TP16* arm, while the *321BC* comes without arm, or factory-fitted with a Linn arm as the *TD321LVX* (£338). Many other arms can be fitted. Performing very well in the listening tests, the *320* provided a stable, focused sound, with a feeling of substantial weight. Stereo images revealed fine depth and space, while pitch and rhythm were well maintained. Firmly recommended.

Zeta (£499)

Firmly in the 'super-fi' class, the Zeta is a fixed-headshell arm of exceptional rigidity. Estimated at 16g, its effective mass would ideally partner cartridges of 7-14cu. On listening tests, the bass was exceptionally good — deep, powerful, tight and articulate. Tonal balance was slightly 'heavy', in a relaxed and restrained fashion, full of depth detail and sharp stereo focusing, while the treble was sweet and transparent with negligible blurring. Constructional quality, finish and sound are all first rate, and while a high price must be paid, for many the results will justify the outlay.

W. DARBY & CO.

All the CHOICE turntables are
available from us

DUAL ARISTON **REVOX** THORENS

YAMAHA Bang&Olufsen

Cartridges available:

ORTOFON SHURE A & R GOLDRING
NAGAOKA ADC GRADO

LOCKEY HOUSE, ST. PETERS STREET
ST. ALBANS, HERTS.

0727-50961



Syrinx



SYRINX PU 3
'ipsissima'

The real key to better sound quality

Further information available from Syrinx Audio Limited, Royston House, Caroline Park, Granton, Edinburgh.
EH5 1QJ. Telephone: (031) 551-2404.

BEST BUYS AND RECOMMENDATIONS: TURNTABLES AND TONEARMS

Here we have listed those models we have selected as 'Best Buy', 'Recommended' and also those 'Worth Considering'. For the full picture, readers should refer back to the reviews themselves.

The 'Best Buy' classification is a specific one, and is only applied to products of exceptional performance and value, which in the case of integrated players refers to models that fall below a £200 price limit.

For this new *Cartridges* issue *Hi-Fi Choice* has aimed to provide an update of the black disc players section of the previous *CD Players and Turntables* edition. It presents an up-to-date view of the analogue turntable market with new reviews of recent introductions added to earlier material. The following product ratings have also been revised.

In the 'Recommended' category are products which we consider to offer a combination of generally good value plus fine performance — as price increases, so does the importance of absolute performance, while 'value' becomes a less relevant consideration.

Other products may still be above average in performance but are considered less strong on value for money — these we have listed as 'Worth Considering', and in some cases they may offer special features not found elsewhere.

These listings are of course *only* a guide — in any given individual situation, the choice of overall system and the mix of specific components may prove of greater significance than the rating of any individual component. Price is a major consideration when making the judgements summarised here, so the comments and indeed the ratings may need re-interpretation in the light of price fluctuations, be they up or down, or in view of the prevailing conditions in markets other than the UK.

BEST BUYS: INTEGRATED PLAYERS

Acoustic Research EB101 (inc cartridge)	£190
Dual CS505-2 (inc cartridge)	£110
NAD 5120 (inc cartridge)	£110
Rega Planar 2	£125
Systemdek 2X/LVX/Basik cartridge	£210

RECOMMENDED: INTEGRATED PLAYERS

Acoustic Research Legend	£240
Ariston RD40AC/Opus arm	£200
Ariston RD80SL/Opus arm	£230
Dual CS505-2 Deluxe (inc cartridge)	£130
Linn LP12/LV Plus/Basik	£525-£565
Linn LP12/Ittok	£740-£780
Mission 775LCT	£180
Oak/Zeta Junior	£140
Oracle Alexandria with arm	£1400

QED R232EN (inc cartridge)	£199
Rega Planar 3	£188
Rotel RP850	£200
SEE Revolver/Mission arm	£185
SEE Revolver/Linn LVX	£215
Thorens TD316	£200
Thorens TD320	£278
Walker CJ58/AR arm/cartridge	£200

BEST BUYS: MOTOR UNITS

Systemdek IIX	£120
Walker CJ61	£85

RECOMMENDED MOTOR UNITS

Ariston RD40AC	£130
Ariston RD80SL	£160
Elite Townshend Rock	£299
Heybrook TT2	£235
Linn Sondek LP12	£425-£465
Michell Synchro	£235
Michell GyroDec	£595
Pink Triangle	£400
SEE Revolver	£117
Systemdek IV	£449
The Source	£800
Thorens TD321BC	£215
Walker CJ58	£130

BEST BUYS: TONEARMS

Alphason Opal	£96
Rega RB300	£90

RECOMMENDED TONEARMS

Alphason Xenon	£196
Alphason HR100S	£335
Alphason HR100S MCS	£385
Helius Orion	£435
Linn Ittok	£316
Linn LVX (Basik)	£98
Linn LV Plus (Basik)	£98
Mission 774LC	£70
SME Series IIS	£147
SME Series V	£1138
Syrinx PU3	£320
Zeta	£499

WORTH CONSIDERING

Readers should consult both full and summary reviews to find the many models which we have rated 'worth considering'. Recent additions to the list include the Ariston *RD40E*, B&O *FX-2* and *TX-4*, Dual *514*, Nakamichi *Dragon*, Rotel *RP830* and Thorens *TD-320* with *TP16* arm.

is this a
WIND-UP?



WELL – we could hardly suggest that Edison would have approved, however The Sound Organisation Turntable Stand will improve the sound of ANY turntable ...GUARANTEED... or your money back! For details of your local dealer, see the facing page.

THE SOUND ORGANISATION

THE AUDIO CENTRE 284 Glossop Road, Sheffield S10 2HS. 0742-737893
AUDIO COUNSEL 12 Shaw Road, Oldham, Lancs OL1 3LQ. 061-633 2602
AUDIO EXCELLENCE 134 Crwys Road, Cardiff CF2 4NR. 0222-28565
AUDIO INSIGHT 53 Wolveston Rd, Stony Stratford, Milton Keynes MK11 1ED. 0908 561551
AUDIO PROJECTS 45 Headingley Lane, Leeds LS6 1DP. 0532 789115
AYLESBURY HI-FI 98 Cambridge Street, Aylesbury, Bucks. 0296-28790
BASICALLY SOUND The Old School, School Road, Bracken Ash, Norwich. 0508-70829
BILLY VEE 248 Lee High Road, Lewisham, London SE13 5PT. 01-318 5755
BRADY'S HI-FI 401 Smithdown Road, Liverpool L15 3JJ. 051-733 6859
BRADY'S HI-FI Kingsway Studios, Kingsway North, Warrington. 0925 828009
CHICHESTER HI-FI 40 Little London, Chichester, Sussex. 0243-776402
CLEARTONE AUDIO 235 Blackburn Road, Bolton, Lancs BL1 8DR. 0204-31423/399617
CLEARTONE AUDIO 62 King Street, Manchester M2 4WA. 061-835 1156
CLEARTONE AUDIO 52 Drake Street, Rochdale, Lancs OL16 1NZ. 0706-524652
EASTERN AUDIO 41 Bramford Road, Ipswich, Suffolk. 0473-217217
ELECTROTRADER 19 Colwyn Crescent, Colwyn Bay, Wales. 0492-48932
ERRICKS Fotosonic House, Rawson Square, Bradford, West Yorks. 0274-309266.
GRAHAMS HI-FI 86-88 Pentonville Road, London N1. 01-837 4412
GRIFFIN RADIO 94 Bristol Street, Birmingham B5 7AH. 021-692 1359
GULLIFORD HI-FI 28 Cowick Street, St Thomas, Exeter, Devon. 0392 218895
HARROW AUDIO 27 Springfield Road, Harrow, Middx. 01-863 0938
HAYWARD + HAYWARD HI-FI 38c High St, Corby, Northants NN17 1VX. 05363-61166
HI-FI EXPERIENCE Lion House, 227 Tottenham Court Road LW1P OHS. 01-580 7383
HOLBURN HI-FI 441/5 Holburn Street, Aberdeen, Scotland. 0224 585713
JEFFRIES HI-FI 4 Albert Parade, Green Street, Eastbourne. 0323-31336
JEFFRIES HI-FI 69 London Road, Brighton, Sussex. 0273-609431
KJ LEISURESOUND 48 Wigmore Street, London W1. 01-484 0552
LYRIC HI-FI 163 Stranmillis Road, Belfast. 0232-681296
MAETO MUSIK 14 The Toll, Buzby Road, Clarkston, Glasgow. 041-638-8252
NORMAN AUDIO 5 Fishergate Row, Butler Street, Preston, Lancs. 0772 53057
PHIL MARCH AUDIO 103a Beverley Road, Hull HU3 1XR. 0482-227867
PHONOGRAPH 60a Erpingham Road, Putney SW15 1BG. 01-789 2349
PHOTOCRAFT 40 High Street, Ashford, Kent. 0233-24441
PURKISS HI-FI 51-53 Picadilly, Hanley, Stoke-on-Trent, Staffs. 0782-265010
RADFORD HI-FI 52-54 Gloucester Road, Bristol, Avon. 0272-428 247/8
RADFORD HI-FI 43 King Edwards Court, Windsor, Berks. 95-56431
RADLETT AUDIO 141 Watling Street, Radlett, Herts. 09276-6497
RAYLEIGH HI-FI 44a High Street, Rayleigh, Essex. 0268-779 762
ROBERT RITCHIE HI-FI 102-106 Murray Street, Montrose, Scotland. 0674-73765
RUSS ANDREWS HI-FI 34 Northumberland Street, Edinburgh. 031-557 1672
THE SOUND ORGANISATION 1 Cathedral Street, London SE1. 01-403 2255 and 3088
THE SOUND ORGANISATION 36 Gillygate, York. 0904-27108
STRATHVISION 51/53 Overgate, Dundee DD1 1QQ, Scotland. 0382-28900
STUDIO 99 88 Fairfax Road, London NW6. 01-624 8855
SUBJECTIVE AUDIO 2/4 Camden High Street, London N1. 01-387 8281
TECHNOSOUND 55 Silbury Arcade, Milton Keynes MK9 3AG. 0908-604949
TECHNOSOUND 3 The Gallery, Arndale Centre, Luton, Beds LU1 2TW. 0582 30919
TONBRIDGE HI-FI 19-21 Quarry Hill Road, Tonbridge, Kent. 0732-366767
UNILET 35 High Street, New Malden, Surrey. 01-942 9567
UNILET Bute Street, South Kensington, London SW7. 01-589 2586
UXBRIDGE AUDIO 278 High Street, Uxbridge, Middx. 0895-33474
WEST MIDLANDS AUDIO 229 Ombersley Road, Northwick, Worcester. 0905-58046
WESTWOOD & MASON 46 George Street, Oxford OX1 2AN. 0865-47783
WOODS AUDIO-VISUAL 39 Victoria Street, Wolverhampton. 0902-772901

Dealer List

THE SOUND ORGANISATION

THE MICHELL CONNECTION

"The ultimate connectors for all quality speaker cables"



BANANA PLUG

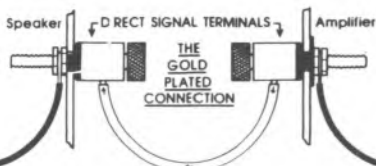

SPEAKER CLIP
ADAPTOR

You ain't heard nothin' yet, folks! GET THE CONNECTION!

For details please write:

J A Michell Engineering Ltd
Dept NHS, 2 Theobald Street, Borehamwood, Hertfordshire, England
Telephone 01-9530771

APPOLO GET YOUR SOUND OFF THE GROUND WITH APPOLO SPEAKER STANDS

A
MADE
IN THE U.K.

★ Send for your free product brochure containing our full range of stands to suit all your requirements.

★ T.V. wall brackets.

★ Speaker wall brackets.

★ Floor stands with spiked feet or castors.

★ T.V. video trolleys.

★ Video consoles.

Also a new range of Hi Fi Tables.

★ or contact your local dealer

APPOLO SPEAKER STANDS
UNIT 2, PRINCES END INDUSTRIAL ESTATE, NICHOLLS RD,
BATMAN'S HILL, TIPTON, W. MIDLANDS. TEL: TIPTON 021 520 5070

PLEASE SEND MY FREE BROCHURE

Name

Address

TRADE ENQUIRIES WELCOME.

HFC/L/85

Hunt E.D.A.

The Record Aristocrats



DEDICATED TO THE SCIENCE OF RECORD CARE

MK.6 BRUSH

Cleaning the helical grooves properly with our unique MK.6 Carbon Fibre and Velvet Brush, kills static dead, removes all such particles and dramatically reduces surface noise.

MK.12 BRUSH & THE TWIN

Fast, convenient and efficient.

ACOUSTIC & ANTIC RESONANT ANTI-STATIC MAT

Conductive fibres. Specially formulated and patented packing. Excellent reviews in Germany.

Clicks and Pops on records are usually caused by minute particles of grit, impacted into the vinyl by the stylus itself. These grit particles invariably have a minimum dimension of between 5 and 15 microns, and are invisible to the naked eye.

Cleaners that fail to reach below the stylus tip profile in the groove do more harm than good by brushing these harmful particles back into the grooves.

Carbon fibre was the only material we found that was fine enough to reach below the tip profile.



For further information send SAE to:

Omnicare Design and Marketing, Fanmont Engineering Ltd, 442, Staines Road, Hounslow, Middlesex, TW4 5AB. Tel: 01-570-9451. Telex: 246671MPEMGP.

ACCESSORIES GUIDE

While some accessories help get a system working at its best, others are less worthwhile. This survey looks at the huge variety of products available and picks some of the best.

Accessories play a vital if unglamorous role in the world of hi-fi and music reproduction. Many would include cartridges and headphones themselves as accessories, but having dealt with these at some length elsewhere, the following parsimonious allocation of editorial pages will be devoted to trying to come to terms with all the other 'bits and pieces'.

It seems only a few years ago that accessories began and ended with record care, with just a gesture towards keeping tape heads clean, and the necessary 'bubble pack' leads and adaptors to get the whole thing up and running. But the steady improvement in hi-fi equipment has increased our awareness of the need to take into account a number of new types of accessory — accessories which actually improve sound quality, albeit often in a capricious, arbitrary and unpredictable fashion.

These are playing an ever increasing role in determining how the whole package comes together in terms of sound quality, and to ignore them is to risk the ship for the ha'ap'orth of tar. Music centre quality is what it is because the product meets designations of price and convenience. Hi-fi product, of however illustrious a reputation, risks making a sound like a high priced music centre if assembled without attention to the details.

However, there is a major problem in accessing the worth of many of these new accessories, simply because their effectiveness depends on the components of the system and the environment in which it is being used. Though it is possible to fill the house with turntable tables, speaker stands and all manner of connecting leads to carry out listening tests, such an approach is, to a degree, only specific to the test situation. It provides a useful set of absolute values, but does not take account of the actual problems in the field.

We have adopted a rather different tack by picking the brains of a number of the country's more conscientious dealers, with their co-operation of course, gratefully acknowledged. These were selected less for the wide range of accessories that they stock than for the small range they specialise in. And for their commitment to the long-term success of their businesses, which is expressed as a desire to satisfy any customer even over a trifle, in the

expectation that he or she will then later return to purchase more valuable components and systems.

Lace these recommendations with a few years' experience coping with the vicissitudes of living with a 'high end' hi-fi system, and of trying to get the best out of it. Switch on the bullshit detector to cope with the snake-oil merchants, and we'll start a blow-by-blow rundown on getting the best out of the system, and the role of the hi-fi accessory in particular.

Record care

Looking after discs themselves is a good place to start. It is a highly controversial subject, with a variety of different opinions, accompanied by at least as many different solutions, and very subject to the vagaries of fashion and the flavour of the month syndrome.

To begin with one must distinguish between the regular day-to-day care of discs which are kept reasonably conscientiously, and the renovation or rescue of discs which have suffered major abuse.

Really dirty discs, particularly any polluted with sticky liquids, may be dealt with in several ways, all of which involve the application of some sort of solvent. The most frequently endorsed and least criticised method is to use the **Keith Monks** cleaning machine, which some dealers have installed as a customer service for a modest charge per disc. Sometimes a clean new inner sleeve is part of the price, and if a disc is dirty enough to need this sort of treatment it will probably need one anyway; **Nagaoka**, amongst others, supply good examples.

The Keith Monks machine is really too expensive for the individual to install for himself, and the Americans in particular have worked hard to produce a more domestic alternative; though products like the **Nitty Gritty** Record Cleaner have not been successful in the UK. But the **Disco-Antistat** from the Dutch-based company Knowin makes a fair attempt at a modest price, but not without a bit of palaver. Discs are rotated vertically with their playing surfaces being brushed while in an anti-static/solvent fluid bath: Unfortunately there is not the convenience of the vacuum assisted drying used in more elaborate machinery.

The oldest LP record cleaning treatment of them all is almost certainly the **Watts Manual**

ACCESSORIES GUIDE

Parastat. This involves a fairly elaborate cleaning procedure using specially shaped bristles. It has stood the test of time well, and is quite effective with dirty discs, though less well known than the **Preener** and **Dust Bug** which are really only effective against day-to-day dust.

A fairly recent technique uses a sort of 'face pack, a typical example being the **Metrocare Record Cleaning Film**. This is poured over the record surface and penetrates the grooves before setting to a soft plastic film. It is then peeled off, taking much of the debris with it (and leaving a bit of a static charge behind!). Still something of a rigmarole, it is certainly one of the most convenient and effective of the domestic treatments. (*This product really can make old records sound almost like new — Ed.*)

The morning after the party night before may need a fairly powerful solvent, for which **Last Power Clean** (£8) is reckoned to provide a pretty effective, though maybe a trifle drastic, cure.

Simple day-to-day dust removal is anything but simple. A fair body of opinion holds that the only really effective cleaner is the stylus tip itself, as it is the only thing which gets precisely to the part of the groove which needs cleaning, by definition. The attention should then be directed towards keeping the stylus clean, to which we will return shortly.

The 'stylus only' argument has plenty of weight, the only danger being the risk of impacting and embedding particles into the groove walls under the highish pressure which operates at the point of contact of the stylus.

But a practical problem, particularly with light downforce cartridges, and depending somewhat upon the shape of the stylus tip, is that of getting to the end of a side before the fluff takes over.

To combat this, an enormous range of products exist, some as accessories, some dangling on the front of the cartridges themselves. The audiophile automatically eschews any form of brush that tracks the groove as an unacceptable sonic compromise, a claim roundly refuted by most manufacturers of tracking cleaners.

Whatever the truth of the matter, there seems no reason not to clean the record first if necessary, then close the lid while it is playing to keep any extra dust off. And undoubtedly the most successful cleaning brushes are those made of carbon-fibre bristles. Versions which received some praise from the trade were those

by **Goldring** and **Stanton**.

The advantage of carbon-fibre over other materials is that the fibres are small enough to get down into the bottom of the groove, though persuading them to pick up and take away the particles takes some practice! The £8 **Hunt EDA Mk VI**, if still available, combines two c-f brushes with a plush pad, and is certainly the most effective low-aggravation cleaner around.

Conventional preeners in general, and rolling cleaners like the glue-strip **Pixall** and washable 'tacky' **Nagaoka** roller seem quite ineffective at getting down to the groove bottom, and the fear is that the 'land' between the grooves gets dusted, but that much of the dust finds its path of least resistance is to migrate to the groove bottom, assisted by the static charge which accompanies any friction cleaning device.

Static is generally regarded as a major enemy of clean discs, and great efforts are made to prevent the build up of charge, which acts as a magnet to all the dust particles in the locality. In fact, the major cause of static is the cleaning process itself, which is a further string to the 'stylus only' bow — even the stylus generates some static build-up, but much less severely than the various cleaners. (*Dry-air conditions produced by central heating are often to blame as well — Ed.*) The theoretical conductivity of carbon-fibre bristles seems to have little bearing upon their ability to create a static charge.

Having caused the static in the first place, the industry offers various panacea in the form of fluids such as **Permostat**. But the product that really seems to have caught the public imagination is the **Zerostat**, now entering its umpteenth year of production and celebrating with a new model and increased sales. This is a 'gun' which directs a 'spray' of ionisation to counter static. It is certainly harmless, as it goes nowhere near the record surface, though its effectiveness is a little unpredictable.

On a different tack, and much more controversial, **Last's** £16 **Record Preservative** fluid actually goes down into the groove as a form of lubricant, and is claimed to reduce wear and surface noise. Many users swear by it, others remain to be convinced.

As for the author, he is a lazy sonofabitch, only too happy to follow the 'stylus only' doctrine, with occasional recourse to a **Hunt Mk VI**. Personal observation suggests that too often record care is regarded as an end in itself, whereas the primary aim should be the reduction of surface noise. And rather more than half

ACCESSORIES GUIDE

the secret of 'reducing' surface noise lies in getting a decently matched and properly set up system that doesn't behave as a surface noise exaggerator, as is the case with far too many so-called hi-fi systems.

Stylus cleaning

In dealing with record care, mention was made of the stylus as a record cleaner, which it most certainly is whether one likes it or not. As a result it gets filthy pretty quickly, and needs more frequent attention than any other part of the system.

For many years this meant a soft camel hair artist's paintbrush (bent up at the tip) and a bottle of isopropanol from the local Chemist, taking care always to use the brush from back to front along the line of the cantilever. There are lots of proprietary versions of this basic formula, such as the **Audio Technica AT607** (£1.95), usually providing a better, stiffer, safer brush and combining the fluid dispenser.

In recent years the brush-and-solvent combination has been challenged by abrasive 'dry' cleaning methods. Doubts have been raised about possible long-term side effects of the use of even the gentle stylus cleaning fluids on the delicately controlled internal damping of the cartridge, sufficient to suggest that only the minimum fluid should be applied, and not over-frequently.

Furthermore it has been observed that some of the deposits that build up on the diamond tip are practically insoluble, including, it is believed, such things as stearates and mould-release agents present on brand new discs. And on the basis that diamond is just about the hardest thing around, abrasive cleaning is an obvious course to follow.

Linn Products set the ball rolling by giving away book matches labelled 'Stylus Cleaner & Review Disposal Kit', intimating that once one had incinerated the outpourings of the specialist press, one could use the striking strip as a stylus cleaner. To everyone's amazement it worked rather well (in the latter role at least), though there was some risk of damage if used clumsily.

Now Linn have discovered The Green Stuff, a plastics-based abrasive sheet which is flexible enough to remove the risk, and which seems to do a decent job of the cleaning. Linn dealers, who have to pay for the sheets themselves, have been known to slip in the odd 5 x 1cm strip, making deprecating gestures as one fumbles for the cheque book.

Although this simple abrasive strip seems to work well with most cartridges, those with the sharpest profiles, particularly the new 'ridged' models, seem to prefer something a little gentler (*Many cartridge manufacturers would decry abrasive cleaning — Ed.*)

Those who get really hooked on stylus cleaning blow £16 on the **Audio Technica AT637**, which is a motor-driven, battery powered vibrating abrasive pad. It was the most universally acclaimed item in our dealer poll, yet with a sincerity born of altruism rather than greed. One described it as the best thing since sliced bread — and in the next sentence referred me to the Chemist to buy isopropanol and cotton buds for tape head cleaning, instead of some similarly exotic head cleaner!

Vibrator cleaners are available from other firms such as **Goldring**, though all the various brands seem to appear and disappear sporadically, due, presumably, to vagaries of supply. For stubborn cases or occasional spring cleaning they may be used with a drop of fluid, but a suggestion for everyday use is to pop them on for ten minutes or so before settling down to listen to music, say while fixing a drink or beverage.

A similar pad designed for manual use without a vibrator is the £7 **Discwasher SC2**, from an American brand which is just starting to become available again after a brief absence, and which offers a wide range of other disc care products besides.

The author is mildly appalled to realise that he has no less than three stylus cleaning items affixed to his turntable by means of Blu-tack: a

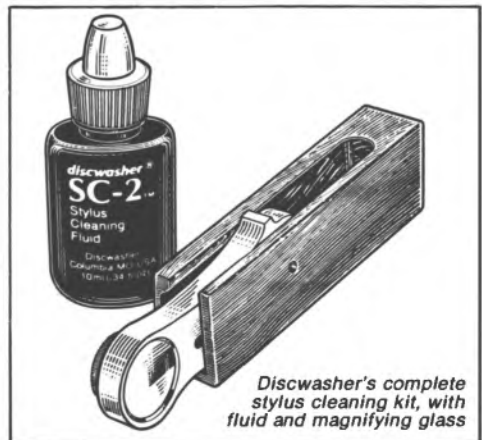

Discwasher's complete stylus cleaning kit, with fluid and magnifying glass

ACCESSORIES GUIDE

soft (ADC) brush for fluff, The Green Stuff for between sides, and **Cleanol** solvent/brush for a bi-weekly spruce or the occasional sticky bit!

Turntable supports

The latest accessory craze to hit record players is a much more substantial item which has nothing to do with styli. Turntable support structures of various kinds, frequently costing nearly £50, have mushroomed onto the market, led by the **Sound Organisation** table, which we used throughout our cartridge tests, but now including a number of rivals.

The simple fact is that record players are seismographs, purposely designed for the detection of vibration, some of which is wanted, some not. To some extent all are affected by their immediate acoustic and vibration environment, but the very popular Linn *LP12* certainly demonstrates significant changes in sound quality on different kinds of support, and some others do likewise.

On this occasion Linn have failed to take the lead by supplying an 'authorised' table, so several dealers stepped smartly into the gap, followed swiftly by accessory suppliers. There is still some debate about what the support is designed to do, but the basic criteria seem to consist of a low mass turntable-sized platform supported by spikes on a rigid frame.

The £50 Sound Organisation table is certainly best known, and inspired turntable manufacturer **Pink Triangle** to offer the £30

Aerolam Prop as a better-sounding platform. The £45 **Audio File** and £50 **Target** tables have an extra shelf and better levelling arrangements.

Alternatives to these rather inconveniently low tables are wall-mounted supports, such as the **Partington**, the £37 **Target TT1** and the £45 **Heybrook**.

The expensive Prop is not the only separately available platform, and a number of low cost alternatives have been designed to sit on an existing cabinet or shelf, supplied with or without feet. These include such models as the **QED Torlyte**, the **DS Soundbase** (available as platform with optional frame), the **Mission Isoplat**, and the **Quadropod**, the latter also supplying a set of spiked feet for the do-it-yourselfer or to use with proprietary platforms. The Isoplat is not spiked but is mounted on energy absorbing sorbothane feet, so is reckoned to be more effective with plinth type players than subchassis designs.

It is fair to describe the turntable support market as rather fluid and fickle at present. Certainly some dealers are a little reluctant to promote products produced by rival shops! A device which has claimed much attention is the **RATA Torlyte Stand**, a very neat design which dispenses with the support plate altogether.

Although we have tried to include all current turntable supports in the listing, new products in this area continue to appear.



'Torlyte' supports by QED, for turntables or other units — sound quality may benefit, but the reasons are little understood!

ACCESSORIES GUIDE

An additional point to note is that these support structures can actually improve the sound of other components such as amplifiers, though the mechanisms involved are even less well understood!

Other turntable accessories

Lumped together under this rather woolly heading we find turntable mats, disc clamps, and alignment gauges.

Mats were popular a while back, until turntable manufacturers cottoned on to the flaws in their existing mats and started putting them right.

Any mat is a compromise between damping the vibration in the disc and providing a firm support for it. The one essential is to start with an evenly supporting surface, and if this is not provided a mat change is worthwhile. Beyond that there are differences between mats, and scope for 'fine tuning' the balance of a system, but if the turntable manufacturer knows what he is about, the compromise will have been carefully chosen at the start.

Disc clamps also have their proponents and critics, and they are an integral part of several well-regarded turntable designs, enabling the disc to be stressed firmly into contact with the mat. Whether they have a useful role as a separate accessory is more of a moot point. Like mats they affect the balance of a system, for better or ill, and really should be taken into account at the turntable design stage. They are also a fiddly nuisance to use, as are the very 'tacky' turntable mats which offer high disc damping.

Assuming you are unlucky enough to have a dealer who doesn't line up your cartridge for you, then an alignment gauge is fairly indispensable. In fact the one *Choice* has published is reasonably useful, but our particular favourite is the *Elite*, which was used throughout the cartridge tests, and which gives a direct measure of the actual error at any point. Its efficacy can be confirmed by the gratifying closeness of the average results for Left and Right separation and tracking ability obtained in the tests.

Loudspeaker stands

For many the loudspeaker stand is merely a useful way to get the speakers out of the way when they are not being used, and enable the Hoovering to be done. This was once the case, because it was assumed that the reasons for stand mounting a loudspeaker was largely to

do with convenience and the acoustic benefits of getting the sound source up to ear level.

But more recently there has been a growing awareness that the loudspeaker needs a rigid support giving firm mechanical coupling to the floor. Castors are being replaced across the country by mildly vicious spikes which penetrate through the carpet and underlay to savage the floorboards beneath, with audible improvements that any good dealer can demonstrate. (An alternative school of thought stresses deliberately decoupling in a controlled manner, which may be worth pursuing if spiking doesn't work, but is clearly a minority opinion.)

For some reason which remains obscure, the most obviously effective mechanical coupling — of bolting the whole thing down — doesn't seem to work very well in practice. Best results seem to be had by firmly locating the stand on the floor, then resting the speaker on the top plate on spacing nuts or further spikes.

Our survey indicated many of the brands were the same as those producing turntable supports. Perhaps the most popular all-rounder was the **Heybrook HBS1** (£55), but the Linn stands (available for all Linn models) and the £50 **Sound Factory SF2** were also strongly endorsed in this middle-market sector.

Target seem to be the dominant brand at a slightly lower price, three different sized models costing from £35. They also market a £10 conversion kit so that existing stand owners can swap their castors for spikes.



Fighting off the spikes — speaker castors from Halver Rollen

ACCESSORIES GUIDE

Other low cost brands which were rated included **QED** and **Partington**.

At the top end of the marketplace **Stand & Deliver** are particularly noted for users of the Quad **ELS63** loudspeaker, and the £100-odd **Cliff Stone** Foundation models were held in very high regard.

The importance of the speaker stand can hardly be overlooked when the bulk of the £50 models are finding happy homes underneath loudspeakers that cost between £100 and £200.

Cables and connectors

The influence of cables and connectors upon sound quality was intimated a number of years ago, and has slowly been accepted, despite the lack of any coherent theoretical explanation for many of the subjective effects which are detectable.

To start to discuss the whys and wherefores would quickly clog the page allocation. More than any other component, connecting wires are system-dependent, so a more pragmatic approach is to find out which types are being supplied, and which give the most reliable results 'in the field'.

Everybody needs speaker cable, and nobody uses thin bell wire anymore. **QED** 42-strand and 79-strand are popular at the cheaper end of the market, the former frequently supplied free of charge with systems. **Naim**, **Supra** and **Mission**

speaker cables were also strongly endorsed for their cost-effectiveness and good sound quality, with **Monster** likewise at a slightly higher price.

More expensive still, but again getting a vote of confidence are **Force 4/Absolute Wire**, the **Hitachi** and **Audio Technica** Long Crystal cables, and the **van den Hul** designs.

Interconnect cables are relevant to those with separate pre- and power amplifiers, and are even more competitive and confusing, with **QED** Incon, and **RS** Blue leading the way at the low price end.

High-price interconnects will hold great fascination for the fanatic, who will probably need to try several different kinds in his system before deciding. Hopefully the dealer will ease his path by making samples available on loan. Top rated interconnects include **Randall**, **The Absolute Link**, **Hitachi LC** and **van den Hul**, the latter two arousing particular interest at present.

Connectors are currently getting as much attention as cables. The standard phono plug has finally been scorned by Naim Audio, which is making life a bit complicated as it brings the (rather nice) BNC video connector onto the scene. But there are some good phono plugs around, including the **RS** gold-plated types, and others from **EAR**, **van den Hul**, **Linn** and **Moth Marketing**.



Rigidity and good coupling to the floor are provided by modern speaker stand designs, like these from QED

ACCESSORIES GUIDE

Michell have carved out their own little niche with some fine high quality speaker terminals and connectors, while for adaptor leads between different connector standards the **VEDA** brand received several mentions along with **QED** interconnects..

And as if that is not enough, there is quite a lot of fuss going on at the mains connection end of things. Again from a 'good house-keeping' angle it makes sense to use the 'cleanest' mains connection possible. The £10 **MK 13amp** distribution board cropped up several times, along with the similarly priced **Marbo** for hard-wiring.

Operating rather differently by seeking to prevent 'dirty' mains from adversely affecting sound, the **RATA** Clamp and Superclamp have their adherents. This seems to be rather 'situation dependent', presumably because the quality of mains varies from place to place and at different times of the day (getting worse in the evenings when everyone switches on their TV sets).

Tape heads

With commendable frankness and honesty, many dealers indicated their preference here for cotton buds, isopropanol and Servisol spray, though kits with applicators are available from many sources. As a postscript to the preceding section, they also pointed out the need to keep electrical contacts at plugs and sockets clean as well.

Proprietary kits for this sort of general maintenance include **Audio Technica's** AT6021, with the AT624 specific to tape. **QED** TapeClean, **Revox**, **TEAC** and **Metrosound** were others mentioned by name.

The **Alleop Three** (£5) was the one 'gizmo' cleaner that was highly rated, for the lazy or for those with inaccessible heads to clean (which includes most car players).

The other occasional maintenance job which is worthwhile with tape heads is demagnetisation, courtesy **Maxwell** (£7.95), or the battery operated £8 **TDK**, which is nearly foolproof, and can be used for cassette decks or reel-to-reel recorders.

Pot pourri

All sorts of strange and wonderful, fascinating and even useful devices appear from time to time. I don't think I shall ever forget my amazement at the **Audio Technica** earwarming pads for Winter Walkmen. Then there is the toy Volkswagen Microbus which plays records

while running round them, developed in his spare time by a Sony engineer/VW enthusiast.

On a more serious note, **QED** do a useful line of switch boxes for those faced with a bewildering array of bits of equipment to fit into a modern 'minimalist' pre-amp. Cartridge mounting kits, from **Heybrook**, **Goldring** or **A&R**, for example, provide rigid fixing using socket head bolts, and can actually transform the sound of a system if such a precaution has not already been taken. Contact preservatives such as **Tweek** and **Cramolin** are another area of mild controversy, not least because of their high prices, but some users swear by them. Then there are special headshell leads, about which I am currently very perplexed. And a faintly bizarre German method of measuring cartridge/groove friction to assess stylus wear (or pollution), called **Protech**.

Finally, there are certain accessories which improve the service a dealer can offer his customers. Keith Monks record cleaners have already been mentioned, and are clearly useful, if expensive. Similarly good but expensive, I can personally vouch for the **Ortofon** Cartridge Test Computer which gave impressively reliable results in the great majority of cases, even though it did give me cause to swear occasionally. Rather less of an investment is a nice **Olympus** stereo microscope for stylus inspection, which Linn are encouraging their dealers to install, and which does a pretty decent job of assessing cleanliness and wear.

Trade Talk

We would like to thank the many dealers who were kind enough to help us in the preparation of this feature. They included:

Aston Audio, Alderley Edge, Cheshire
Audio Excellence, Cardiff
The Audio File, Bishop Stortford, Herts
Audio T, West Hampstead, London NW6
Audition Hi-Fi, Leicester
Bartletts, Holloway Road, London N7
W A Brady & Son, Liverpool 15
Chichester Hi-Fi, Chichester, West Sussex
Grahams Hi-Fi, Pentonville Road, London N1
Hampshire Audio, Chandlers Ford, Hants
Hi-Fi Care, Tottenham Court Road, London W1
Jeffries Hi-Fi, Brighton
The Music Room, Glasgow
Sound Advice, Loughborough
Spaldings Hi-Fi, Croydon, Surrey
Unilet, New Malden, Surrey

ACCESSORIES: LISTING

This listing covers manufacturers and distributors who specialise in accessories, or offer some items alongside a hi-fi equipment range. Where a large number of items is offered, we have summarised the range; readers are advised to contact the manufacturers for further information.

A&R CAMBRIDGE LTD

Denny End Industrial Centre, Waterbeach, Cambridge CB5 9PB. Tel (0223) 861550

Speaker stands (Medite) for Arcam One £49.90. Two £39.90, Three £45.00; various loading modules for A60; 2-way Active Crossover Board for SA60 (specify speaker) £40.25, for C200/Arcam One £74.75; range of Hi-Def interconnects.

ABSOLUTE SOUNDS

42 Farkside, London SW19. Tel 01-947 5047

Hitachi LC-OFC cable; speaker cables, SSX 101 £11.00/metre; SSX 102 2-core £5.00/metre; SSX 104 4-core £8.50/metre; PSAX 1.5m stereoset terminated £9.95; 1m stereo set, £35.00; 0.5m stereo set £30.00; Siltech LC-OFC speaker cables from £33.50/metre, interconnects from £50.00/metre; Randall Research interconnects, TX Flex phono to phono set £77.00/metre, other items available; Absolute Link interconnect £29.00/metre (mono); Absolute Wire — Force 4 speaker cable £3.25/metre; Audio Connectors; 5 pin tonearm connector £12.50; phono connectors for various interconnects; Planax Record Clamp £15.00; Tweek Contact Enhancer £17 (syringe); Goldmund Spirit Level £3.50; other accessories for specific A-S products.

ALLSOP

Path plc, 1 Berens Road, London NW10 5DY. Tel 01-969 2514

Orbitrac II Record Cleaner £14.95; Carbonoptic Fibre brush £6.95, Allsop 3 Cassette Cleaner £4.95, replacement cleaning parts set £2.95; Allsop 3 microcassette cleaner £4.95; Allsop 3 video cleaner VHS or Beta £14.95, U-Matic £44.95.

APPOLO STANDS

Zenith Crown Ltd, Unit 2, Princes End Industrial Estate, Nicholls Road, Batmans Hill, Tipton, West Midlands DY4 9LG. Tel 021-520 5070

Castor speaker stands (adjustable width) Appolo 4 (10in high) £18.95, Appolo 5 (10in, variable tilt) £26.95, Appolo 7 (10-15in adjustable height) £19.95; speaker stands with spikes (removable) Appolo 6 (12-16in or 20in high), Appolo 8 (16in or 20in) £25.95, Appolo 9 (24in high), Appolo 10 (16in high) £39.95; turntable/equipment table AT1 £39.95; AT3 £54.95; turntable wall shelf AT2 £35.95; two-tier wall shelf unit AT4 £39.95; speaker wall brackets AST £13.95, WBI £12.45; TV wall bracket £18.95.

ARJAY INTERIORS

54 Lower Marsh Lane, Kingston, Surrey KT1 3BJ. Tel 01-390 2101

Record storage system ST2 (holds 480 LPs) £109.00, ST3 (360 LPs) £89.00, ST4 (240 LPs) £55.00, ST5 (120 LPs) £34.00.

AUDIO FILE

40 Hockerill Street, Bishops Stortford, Herts. Tel (0279) 506576

Turntable table £45; mini turntable £25.

AUDIO-TECHNICA (UK) LTD

Hunslet Trading Estate, Low Road, Leeds. Tel (0532) 771441

Headshell AL-8, £5.50; AT-CF3 for straight arm £6.50; magnesium IEC headshells MG-10 (10g) £7.95, MG-6 (6g) £8.50, MG-8 (8g) £11.50, silver wired AT-MS £11.95, LT-12 £14.50; Silver Lite cartridge leads £3.50; LC-OFC cartridge leads £5.50, LC-OFC phono cables 1.3mm and 0.7mm £39.95 and £29.95; LC-OFC speaker cables available; Wet cassette cleaner £5.95; stylus cleaner £1.95; Electric stylus cleaner £15.95; Sonic Broom £6.95; other record care items; m-c step up transformers AT1000T £799.95, AT650 £158.95, AT630 £55.95; full range of headphones, microphones and microphone accessories.

ASTON AUDIO LTD

4 West Street, Alderley Edge, Cheshire. Tel (0625) 582704.

Distributors of Stand and Deliver speaker stands (for Quad ESL63 etc.) and other hi-fi products.

AUTOMATION SCIENCES CO

20 Little Gaddesden, Berkhamsted, Herts HP4 1FA. Tel (044 284) 2786

Van den Hul monocrystal interconnect D-102 and D202 both £8.65/metre (mono), tonearm cable £19/metre (stereo), speaker cable (single conductor) CS-12 £2.50/metre, D300 II £4.15/metre, D-300S II £9.75/metre; Empire stylus force gauge £19.50; Tiffany connectors (full range available); packaged with Tiffany connectors D-102 Mk II 1.5m stereo set £70.00; D-502 1.5m 5-pin to phonos (specify arm) £70.00; HS-300 silver headshell leads set £18.00; CYX Compact Disc damping foil £6.99/pack of 10.

BEARD

See Presence Audio Ltd.

BEYER DYNAMIC (GB) LTD

Unit 14, Cliffe Industrial Estate, Lewes, Sussex BN8 6JL. Tel (0273) 479411

Extensive range of high quality headphones.

BIB AUDIO/VIDEO PRODUCTS

Kelsey House, Wood Lane End, Hemel Hempstead, Herts HP2 4RQ. Tel (0442) 61291

ACCESSORIES: LISTING

Stylus cleaning kit £2.99; A602 record cleaning kit with fluid £3.98; Audio Care kit (including tape head cleaner, carbon fibre record brush, stylus cleaner) £7.98; Groovkleen sweep arm £3.49; CD cleaner £9.98; CD storage units (10 CDs) £2.99.

CECIL E WATTS LTD

Darby House, Sunbury-on-Thames, Middlesex. Tel (09327) 83252

Dust Bug sweep arm £3.59; Manual Parastat Mk IIA £13.25, with humid mop £13.25; Parastat Mk IV with stylus cleaner £10.95; Disc Preener £2.35; Stylus Cleaner 85p; Xstatic antistatic gun £10.95; complete range of refill fluids, wicks, brushes and pads for above.

CLARION SHOJI (UK) LTD

4-6 Faraday Road, Dorcan Industrial Estate, Dorcan, Swindon, Wilts SN3 5HQ. Tel (0793) 24081
Cassette head cleaner (Allsop mechanism).

CLIFF STONE AUDIO PRODUCTS

50 Poynders Hill, Leverstock Green, Hemel Hempstead, Herts. Tel (0442) 50657

Foundation Speaker stands 10S (10.5in) and 15S (15in) £112, 18/2 (18in) and 18U (18in, larger top plate) £89.00, 21A (21.5in) and 21B (21.5in, larger top plate) £89.00, Atlas 15 (15in) £59.95, Atlas 19 (19in, 2-position top plate) and Atlas 22 (22in) £49.95. Custom-built stands, POA.

DECCA

See Presence Audio Ltd

DELTEC PRECISION AUDIO

16 Claude Road, Roath, Cardiff, South Wales CF2 3FZ. Tel (0222) 482818

The Power mains RF noise filter with IEC-type plug/0.5 metre cable £74.00, 2 metre cable £92.00, 3.5 metre cable £110.00, with 13A-type socket/0.5 metre cable £74.00; full range of Solid Link gold phono to phono interconnects from £24.00 (0.75mm) to £78 (10mm); range of Solid Link speaker cables (with 4mm plugs) from 2 metre pairs, £32.00. Custom cable service (any other connectors on above cables) add £5.00 per custom stereo pair.

DISCWASHER

See John A Walker Ltd

EDWARDS' CONSTRUCTIONS

The Old Chapel, 282 Skipton Road, Harrogate, North Yorkshire HG1 3HB. Tel (0423) 500442

Complete range of furniture units for records, cassettes, hi-fi, TV and video etc. Varispace system 74in or 84in high units, Brunswick range record cabinets (all in teak, oak, sapele, walnut) and 7-drawer CD cabinet. Special orders undertaken.

GOLDRING PRODUCTS LTD

8 Greyfriars Road, Moreton Hall Industrial Estate, Bury St Edmunds, Suffolk IP32 7DX. Tel (0284)

701101

Electronic Stylus Cleaner £12.00; EXstatic conductive mat £5.50; EXstatic carbon fibre brush £6.00; HiFi Light for record deck £14.00; Stylus Care Kit £3.75; Stylus Tracking Force Gauge £5.50; Super EXstatic Cleaning Pad £6.50; EXstatic Sweep arm £11; standard headshells £3.50; headshell leads £1.50.

HALVER ROLLEN (UK) LTD

PO Box 15, Abingdon, Oxon OX14 4TG. Tel (0235) 819296

Roll-Around speaker trolleys, adaptable to a wide range of speaker sizes about £12.00.

HAYDEN LABORATORIES LTD

Hayden House, Chiltem Hill, Chalfont St Peter, Bucks. Tel (0753) 888447

Extensive range of Sennheiser headphones and microphones.

HEYBROOK

Mecom Acoustics Ltd, Knighton Hill, Wembury, Plymouth, Devon. Tel (0752) 863188

Speaker stands HBS1 for HB1, HB2 £55; HBS3 for HB3 £42.50; TS1 turntable shelf £44.95; AK1 cartridge mounting kit £4.95.

HUNT EDA

See Omnicare Ltd

HW INTERNATIONAL LTD

3-5 Eden Grove, London N7 8EQ. Tel 01-607 2717

Shure Stylus Force Gauge SFG-2 £12.75; Shure test record TTR-103 £19.50, TTR-109 £13.75, TTR-117 £19.50; Luxman m-c cartridge demagnetiser £25.00; felt-finish turntable mat £9.00.

INCATEC

23 Lincoln Way, Canvey Island, Essex. Tel (0268) 690895

Gold plated mains plugs 13A £9.06, 13A 2-pin £9.20, 15A £10.87; sockets 13A single £13.80, 13A single switched £16.79, 13A double £16.81, 13A double switched, 15A single £20.47, 13A 4-way £39.10.

KEITH MONKS AUDIO LTD

Progress House, Albert Road, Aldershot, Hants GU11 1SZ. Tel Aldershot 334123/4

A number of hi-fi dealers offer a record cleaning service using Keith Monks Record Cleaning Machines.

LINN PRODUCTS LTD

257 Drakemie Drive, Castlemilk, Glasgow G45 9SZ. Tel 041-634 0371

Speaker stands: Index £34.50; Isobarik £92; Kan £69; Sara £73.60; other accessories specific to Linn LP12 etc.

J A MICHELL ENGINEERING LTD

2 Theobald Street, Borehamwood, Hertfordshire. Tel 01-953 0771

Gold plated 4mm speaker plugs £9.75, terminals

ACCESSORIES: LISTING

£6.90; amplifier terminals £6.90; speaker clip adaptors £6.72 (all above prices are per set of 4, including post and packing).

MISSION ELECTRONICS LTD

Stonehill Industrial Estate, Huntingdon PE18 6ED. Tel (0480) 57477

Isoplat vibration isolation platform £19.95; Sorbomat platter mat £12.95; speaker stands, £29.95/pair, three types for 70,77; 700,707; 737,770,780; spikes £6.95, for 737,770,780, £9.95; speaker cable, 651 strand OFC £1.20/metre, 2 x 5m with plugs, £16.95; Cyrus equipment rack £69.95.

METROCARE

Cambrasound Ltd, Britannia Road, Waltham Cross, Herts EN7 8EF. Tel (0992) 716666

Record Cleaning Film kit including 'peel-off' fluid in bottle/appligator and drying stand £6.98; fluid only £3.99.

MILTY PRODUCTS LTD

5/6 Derwent Street Trading Estate, off Ordsall Lane, Salford, Lancs M5 4RE. Tel 061-834 4445

Record cleaner Pixall Roller MkII £7.49, refill Mk I or Mk II £1.24; Permostat fluid kit incorporating double-sided Duo-Pad £6.90, standard refill £4.73, jumbo refill £9.44; Permaclean kit £4.97, Permaclean jumbo size £4.19; Duo-Pad complete £1.59, refills £1.22; Work Mat £6.21; CD Cleaner £4.49; Gold Connect 4mm plugs £17.50/set of 4 inc screwdriver.

MONSTER CABLE

Custom Cable Service, Unilet, 35 High Street, New Malden, Surrey. Tel 01-942 9567

Speaker cables available in various standard lengths and customised to individual requirements include Monster Cable, Superflex, Powerline; Interlink interconnects; Xterminator terminations.

MOTH MARKETING

PO Box 200, Bedford MK40 1YH. Tel (0234) 741152
Moth distribute a wide range of accessories as well as an unrivalled catalogue of 'audiophile' and special-edition LPs and Compact Discs.

NAGAOKA

Path plc, 1 Berens Road, London NW10 5DY. Tel 01-969 2514

Full range of Nagaoka hi-fi accessories and miniature headphones.

OMNICARE LTD

442 Staines Road, Hounslow, Middlesex TW4 5AB. Tel 01-570 9451

Hunt EDA record care products: Low Profile Sweep arm, £7.95, Mk VI Carbon Fibre Brush £7.95; Mk 12 Carbon Fibre Brush £6.60; Omnicare Twin Brush £4.99; Omnicare SA1 Sweep Arm £8.50; Anti-Resonance Mat £7.95 (thick); £4.50 (thin); range of Cassette Cabinets.

ORTOFON (UK) LTD

Denmark House, Tavistock Industrial Estate, Ruscombe, Twyford, Berks RG10 9NJ. Tel (0734) 343621

Test Record £10.00; CAP210 cartridge capacitance loading device (210pF) £5.00.

PARTINGTON

1 Beechcroft Road, Orpington, Kent (0685) 59360

Range of professional and domestic speaker stands and wall mounting brackets with prices starting at around £20 for the adjustable PPIs and up to over £100 for the Dreadnought Class stands. Also new 16in and 19in rack mountings.

PIVOTELLI

Broadaker Co Ltd, Guernsey. Tel (0481) 46818

Complete range of pivoting wall brackets for speakers, television sets etc. Universal Stereo brackets start at £22.36 (screw-in baseplate) and range up to £64.90 ('limpet' large adjustable baseplate). Many other types available, including desk-mounting computer support and universal joints for use with all wall brackets.

PIXALL

See Milty Products Ltd.

PRESENCE AUDIO LTD

Eastland House, Plummers Plain, Horsham, West Sussex RH13 6NY. Tel (044 485) 333

Beard m-c head amplifier HA1 £103.50; Decca Diplomat carbon fibre brush £8.97, Zero Ohm Mk II brush £7.99, Deram Brush £3.99, Record Cleaner £7.99; Odyssey Perfect Lock gold-plated locking 4mm plugs £39.00/set of 4; Vecteur 'stackable' gold plated 4mm plugs £5.96/set of 4, record clamp £29, Vecteur linear crystal interconnects 'm stereo set £49.00; MDM colour coded interconnects £9.95; Jecklin Float headphones range.

QED AUDIO PRODUCTS LTD

Unit 12 Ashford Industrial Estate, Ashford, Middlesex. Tel Ashford 46236

Sound Definition speaker stands SD24 (24in, spikes) £59.00, SD15 (15in, spikes) £55, SD19S (19in, spikes) £37.50, SD19 (19in) £29.95, SD8 (8in) £22.95. Torlyte turntable platform (3 sizes) £35.00, CD platform £33.00; Cartridge Equaliser m-m £19.50, m-c £29.50; MCA-1 Moving-coil pre-amp £38.50; full range Incon interconnects from £1.10/metre; speaker cables 42 strand 38p/metre, 79 strand 79p/metre, C38 £1.75/metre; Speaker Switching units up to 6-way, 2-way from £9.50; Speaker Volume Control, 20W £18.50, 40W £29.00; Tape Switching units DIN 2-way £25.00, 3-way £28.00; phono 2-way £28.00, 3-way £38.00; other switching units phono £17.50, amplifier £19.95, CD £18.50; headphone adaptor £12.50; headphone control £18.50; attenuators DIN to DIN, DIN to phono, phono to phono, £9.50; full range care/

ACCESSORIES: LISTING

maintenance products, mains suppressors, mains distribution units and plugs.

QUADROPOD

J C Elison, Wells Cottage, Thrapston Road, Finedon, Northants. Tel (0933) 680744

Loudspeaker stands: Quadropod 1, £49.84; Quadropod 2 £44.00.

REVOX

F W O Bauch Ltd, 49 Theobald Street, Borehamwood, Herts WD6 4RZ. Tel 01-953 0091

Cartridge mounting kit for B791/795 decks; complete range of accessories for open-reeltape decks including tapes, reels, NAB reel adaptors, interconnects, cleaning kit, microphones and headphones.

ROSS ELECTRONICS

49-53 Pancras Way, London NW1 2QB. Tel 01-278 6371

Complete range of audio accessories and connecting leads; complete range of stereo headphones.

ROTEL HI-FI LTD

2-4 Erica Road, Stacey Bushes, Milton Keynes. Tel (0908) 317707

Supra loudspeaker cables twin 2.5mm 651 strand £1.50/metre, 4mm 1039 strands £2.30/metre; hi-fi cabinet RK-800 (mahogany) £69.00.

RTJ SERVICES

15 Mount Pleasant, Cockfosters, Hertfordshire. Tel 01-441 3978

In-line devices for cartridge loading adjustment. Various capacitance/impedances available.

RUSS ANDREWS TURNTABLE ACCESSORIES

Edge Bank House, Skelmersgh, Kendal, Cumbria LA8 9AS. Tel (053 983) 247

Torlyte turntable stand £99.00; Mains filters, Clamp 1 £5.50, Clamp 2 £8.50, Superclamp £19.95; Clean-Oil record cleaner (goat hair) £5.99; Cramolin contact cleaner £19.95 (brush kit or spray kit); SiderealKaps Premium Audio Grade Capacitors (minimum quantities 25).

SHURE

See HW International Ltd

THE SOUND FACTORY

Duke Street, Loughborough LE11 1ED. Tel (0506) 218254

Tripod equipment stands, complete range of modular units from £36.50. Speaker stands SF2 47cm high £48.50, SF3 (27, 37 or 47cm) £57.50; wall brackets SF4 £31.50; turntable wall bracket SF5 £55.50; turntable table £47.50.

THE SOUND ORGANISATION

1 Cathedral Street, London SE1. Tel 01-403 2255

Speaker stands from £69; floor stand £49-50; wall stand £32.50; sub stand £25; record track £59.50; wall bracket £29.50 a pair.

SHEFFIELD LAB (EUROPE) LTD

Suite 1, 30 Upper High Street, Thame, Oxon OZX7 3EZ. Tel (084 421) 7606

Direct-cut recordings and Compact Discs; list of current LPs and CDs sent on request.

SONY (UK) LTD

Sony House, South Street, Staines, Middlesex TW18 4PF. Tel Staines 61688

Extensive range of miniature and hi-fi headphones for all applications, range of connectors, adaptors and other accessories.

SUPRA

See Rotel

TARGET AUDIO PRODUCTS LTD

Unit 10A, Britannia Estate, Leagrave Road, Luton, Bedfordshire. Tel (0582) 424755

Speaker stands S1 (17in), £36; S2 (24in), £37; S3 (12in, larger base), £36; turntable wall shelf TT1, turntable table TT1, £45; speaker stand spike kit (8 spikes), £10; HJ15 stand, £79; HJ17/20 £69.

TEAC

Harman (Audio) UK Ltd, Mill Street, Slough, Berks SL2 5DD. Tel (0753) 76911

Range of accessories including miniature in-line m-c step up devices.

TEK MARKETING LTD

Burrell Road, St Ives, Cambridgeshire. Tel (0480) 62225

Zerostat Antistatic Pistol £9.95; 3000 Record Cleaner £16.95, replacement fluid £6.95; Quick Cleaner £4.75; Tek T31 Time Switch £20

VAN DEN HUL

See Automation Sciences Co

JOHN A WALKER LTD

1st Floor Suite, 55 North Street, Thame, Oxfordshire OX9 3BH. Tel (0844 21) 6929

Discwasher D4 record cleaner with fluid £11.95; D4 refill 1.2oz £1.95, 6oz £6.95, 16oz £14.95; SC2 stylus cleaner system with fluid £6.95, fluid £1.45; complete care set D4 and SC2 in walnut plinth £24.95; Perfect path head cleaner £4.95, CPR capstan/pinchroller cleaner £5.95; tape care set CPR, Perfect Path £14.95; D'Mag demagnetiser £17.95.

ZEROSTAT

See Tek Marketing Ltd

(Note: in compiling this Accessory Guide we have endeavoured to contact every manufacturer; however, the listing cannot claim to be totally comprehensive. Prices and product specifications will inevitably be subject to change. Readers should also note the availability of virtual copies of many successful 'name' accessory products, which may not necessarily match the specification of the original.)

SELECTED DEALER DIRECTORY

Choosing a good hi-fi dealer is the most vital step in acquiring the system that is right for you. This unique directory gives full information on dealers in your area whose demonstration facilities and dedication to customer satisfaction meet the very highest standards.

Conventional technical specifications, admirable though they may be, do not tell you how hi-fi will sound. Plenty of equipment can be made to jump through the technical hoops, and sounds 'very hi-fi'; but will still reproduce music in a way that is inaccurate, coloured, tiring, and subtly unsatisfying.

Such equipment offers an insidious long-term disincentive to music listening. Ask people who have recently bought a new hi-fi system whether they are pleased with it, and they will almost always say yes — after all, they felt it was the right decision at the time, and it may have sounded 'impressive' in a very brief, loud demonstration. Ask the same people whether they now spend more time listening to music than before, and you will find out if the system is really any good.

The split between 'mass market' audio and 'specialist' hi-fi has now become almost total. All-in-one 'rack' and 'midi' systems now tend to compete on looks, features and price rather than on sound quality, though claiming adequate technical performance; on the other hand, the specialist manufacturers have tried to make products that sound better, leaving out superfluous facilities and paying attention to aspects of the design which they find have audible effects on the sound, not just those which produce better paper specifications.

Of course, anything which can be heard must ultimately be technically explicable, even if the explanation is not currently to hand, and the *Hi-Fi Choice* reviewers have always led the way in developing new measurements which really do relate to the audible performance of the equipment. But the quality of any hi-fi component is determined by the balance of many more or less measurable factors, in what the designer judges to be the best possible compromise. When components are put together, the interactions and subtle blendings of their characteristics contribute to the overall system sound in extremely complex ways. And in any case, the final quality of the music played through the system will depend fundamentally on the room it is being used in! There really can be no substitute for listening to the system for yourself.

This is why *Hi-Fi Choice* has always insisted that the hi-fi buyer should never rely uncritically on equipment reviews — even its own! — but should seek the fair unpressurised demonstration which is available only at a good dealer. It is not

merely coincidence that the dealers who offer this kind of service are usually those who stock a good range of equipment from the 'specialist' manufacturers, and they will be ready to demonstrate the audible superiority of a carefully-chosen 'separates' system to the run-of-the-mill rack or midi system.

Of the dealers who are genuinely dedicated to hi-fi excellence, a growing number are members of BADA, the British Audio Dealers Association. BADA was established in 1982 on the premise that the retailing of quality hi-fi products is a specialist service which requires more expertise than the selling of less sophisticated goods. BADA recruits dealers who are 'serious about hi-fi' and who have been in business for at least three years. Member retailers are committed to offering the best possible demonstration facilities and advice; to offering (with certain conditions) exchange or refund on goods that prove unsatisfactory in use at home; and to providing a two-year labour and parts guarantee, transferable to any other BADA dealer if the customer moves home more than 30 miles after purchase. Virtually all BADA members are included in the Directory.

Make an appointment

Before visiting any shop, check whether an appointment is necessary — so that the dealer will be able to give you his full attention when you arrive for a demonstration. Take some of your own records along — they will save you wasting time getting used to strange material and wondering how it would have sounded on your old equipment. Don't worry if you feel you are ignorant of technicalities — just take your ears along with you, and don't be afraid to believe them. Don't go in with fixed ideas about equipment, which may make you pre-judge what you hear. Realise that any system will sound different in your home listening room — do use home trial facilities, remembering that this service costs the dealer time and trouble but also be aware that it may put just a little more pressure on you to buy. Don't worry if you have only a limited budget — 'real' hi-fi certainly need not always be more expensive than a package system.

A good system will make all your records sound better and give years of pleasure. The first step is to seek out the genuine hi-fi specialists in your area. With the Selected Dealer Directory, you will find them.

SELECTED DEALER DIRECTORY

AVON

ABSOLUTE SOUND AND VIDEO, 65 Park St, Clifton, Bristol. (0272) 24975. A&R, Denon, Dual, Meridian, Mission, NAD, Quad, Rotel, Technics, Yamaha, etc. (cl. Weds)

BADA MEMBER 

AUDIO BRISTOL LTD, 8 Park Row, Bristol 1. (0272) 291931.

AKG, Beyer, Dual, Mordaunt-Short, Revox, Sansul, Tannoy, Toshiba, Trio, Quad. Open Mon-Fri, 9-5.30, Sat 9-4.30. Home trial facilities, free installation, credit facilities, service dept.

PAUL GREEN HI-FI LTD, Kensington Showrooms, London Rd, Bath. (0225) 316197. A&R, Creek, Dual, Heybrook, Linn, Musical Fidelity, Rotel, Systemdek, Wharfedale. Dem facilities available, ring for appointment. Open Tues-Sat, 9-5.30. Home trial facilities, free installation, instant credit up to £1,000. Credit cards: Access, Barclaycard.

PAUL ROBERTS HI-FI, 31-33 Gloucester Rd, Bristol. (0272) 429370. Stock a full range of hi-fi from over 60 brands. Specialise in C.D. Dem facilities available. Open Mon-Fri 9.30-7.30, Sat 9.30-6.00. Home trial facilities. Free installation. Instant credit. Credit cards: Access, Visa, Amex. Service dept available.

PAUL ROBERTS HI-FI, 203 Milton Rd, Weston-Super-Mare. (0934) 414423. Stock a full range of hi-fi from over 60 brands. Specialise in C.D. Dem facilities available. Open Mon-Fri 9.30-7.30, Sat 9.30-6.00. Home trial facilities. Free installation. Instant credit. Credit cards: Access, Visa, Amex. Service dept available.

BERKSHIRE

FRASERS HI-FI & VIDEO, 67 Dedworth Rd, Windsor, (07535) 59662. Aiwa, Dual, Mitsubishi, Mordaunt Short, Pioneer, Sansui, Trio, Wharfedale, Sharp. Dem facilities available. Open 9.30-6p.m. Home trial facilities, free installation, credit facilities. Credit cards: Access, Barclaycard, Visa. Service dept.

READING HI-FI CENTRE, 4-6 Harris Arcade, Friar St, Reading. (0734) 585463. The best equipment, advice and service from Berkshire's premier Hi-Fi emporium!

BADA MEMBER 

BUCKINGHAMSHIRE

AUDIO INSIGHT LTD, 53 Wolverton Rd, Stony Stratford, Milton Keynes. (0908) 561551. A&R Audiolab, Heybrook, KEF, Linn, Mission Cyrus, Musical Fidelity, Nakamichi, Nytech, Rotel. Dem facilities available. Open Tues-Sat. Home trial facilities, free installation, instant credit up to £1,000. Credit cards: Access, Visa. Service dept.

AYLESBURY HI FIDELITY, 98 Cambridge St, Aylesbury. (0296) 28790. Dual, Heybrook, Linn arms, Musical Fidelity, Mission, NAD, Nakamichi, Quad, Rotel. Dem facilities available, ring for appointment. Open 10-6 Mon-Fri, 9.30-5.30 Sat. Home trial facilities, free installation, instant credit up to £1,000. Credit cards: Access, Amex, Diner, Visa. Service dept.

CHILTERN HI-FI, 146 High St, Aylesbury, Bucks. (0296) 31020. A&R, Aiwa, Akai, A&R, B&W, Bang & Olufsen, Dual Nakamichi, Technics, Yamaha. Dem facilities available. Open 9.30-5.30 Mon-Sat, Fri 9.30-7.00 closed Thurs. Home trial facilities, free installation, instant credit up to £2,000. Credit cards: Access, Barclaycard. Service dept.

JCV HI-FI SUPER STORE, 1 Viscount Way, Dukes Drive, Bl. (0908) 36734. Everything from specialist hi-fi to midi-systems all at the best prices.

BADA MEMBER 

CAMBRIDGESHIRE

CAM AUDIO, 110 Mill Rd, Cambridge. (0223) 60442. A&R, Creek, Linn, Mantra, Mission, Naim, Nakamichi, Rega,

Revoler, Teac. Dem facilities: 3 single speaker rooms. Appointment required for one not for 2. Open 9.30-6.30 Mon-Sat 9.30-3.00 Thurs. Free installation, interest free credit. Credit cards: Access, Amex, Barclaycard, Diners.

HI-FI PEOPLE, 42 Cowgate, Peterborough. (0733) 41755. 'Shop and home demonstrations from friendly people'.

BADA MEMBER 

STEVE BOXSHALL AUDIO, 41 Victoria Rd, Cambridge. (0223) 68305. Audiolab, Gale, JBL, Marantz, Mission, Nakamichi, Quad, Rogers, Rotel, Tannoy. Dem facilities 2 rooms, ring for appointment. Open 10-6. Mon-Sat. Free installation, credit facilities. Credit cards: Access, Barclaycard. Service dept.

CHESHIRE

ASTON AUDIO, 4 West St, Alderley Edge. (0625) 582704. Celestion, KEF, Musical Fidelity, Opus, Pink Triangle, Quad, Roberston, Spondor, Sondex, Tannoy. Dem facilities: 4 dem rooms, appointment required. Open 10-6 Tues-Sat. Home trial facilities, free installation. Instant credit up to £1,000. Credit cards: Access, Amex, Diners, Visa. Service dept.

BADA MEMBER 

DOUG BRADY HI-FI, Kingsway Studios, Kingsway North, Warrington. (Hadgate 0925) 828009. 'Largest choice of specialist Hi-Fi in N.W. £100-£20K'. All ccards. dem.rooms.

BADA MEMBER 

CHRIS BROOKS AUDIO, 29 Gaskell St, Stockton Heath, Warrington. (0925) 61212. Single speaker pair dems. Specialising in Linn, Rega, etc. Systems from £350.00.

BADA MEMBER 

NEW DAWN HI-FI, 1-3 Castle St, Lower Bridge St, Chester. (0244) 24179. Linn, Quad, Technics, National Panasonic, Denon, Rotel, Dual, Meridian, Aiwa, Philips. Dem facilities: 2 dem rooms. Open 9.00-5.30 Mon-Sat, closed Wed. Free installation, instant credit. Credit cards: Access, Barclaycard, Trustcard. **BADA MEMBER** 

SWIFT OF WILMSLOW, 4-8 St Annes parade, Wilmslow. (0625) 526213. A&R, Aiwa, Denon, Dual, Marantz, Mission, Monitor-Audio, Pioneer, Yamaha, NAD. Dem facilities available. Open Mon-Sat 9.15-5.45. Closed 1-2 Lunch. Home trial facilities, free installation, instant credit up to £1,000. Credit cards: Access, Barclaycard. Service dept.

CORNWALL

TRURO HI-FI, ETS Ltd, 25 King St, Truro. (0872) 79809. A&R, Denon, Dual, Heybrook, Mission Cyrus, Quad, Rotel, Teac/Tascam, Thorens. Dem facilities: Single speaker studio. Open Mon-Sat 8.45-5.30. Home trial facilities, credit up to £1,000. Credit cards: Access, Barclaycard, ETS. Service dept.

DERBYSHIRE

ACTIVE AUDIO, 12 Osmostat Rd, The Spot, Derby. (0332) 380385. 2 studios. Open Mon-Sat 9.30-6.00. All major credit cards. Finance available.

BADA MEMBER 

DORSET

BLACKMORE VALE, The Square, Gillingham, Dorset. (07476) 2474. A&R, Ariston, Boston, Dual, Kef, Marantz, NAD, Nagaoka, Sennheiser, Yamaha. Dem facilities available. Open Mon-Sat 9-5.30 Closed for lunch 1-2. Home trial facilities, free installation, instant credit up to £1,000. Credit cards: Access, Barclaycard. Service dept.

ESSEX

A.T. LABS, 442/4 Cranbrook Rd, Gants Hill, Ilford. (01) 518 0915. Open Mon-Sat, 10-6. Two single speaker dem. rooms. Access, Amex, Barclaycard.

BADA MEMBER 

SELECTED DEALER DIRECTORY

BEECHWOOD AUDIO, 6 Market St, Braintree. (0376) 29060. A&R, B&W, KEF, Meridian, Musical Fidelity, NAD, Nakamichi, Pink Triangle, Quad, Sondex. Dem facilities 2 single speaker rooms. Open Mon-Sat, 9.30-6.00. Home trial facilities. Free installation, instant credit up to £1,000. Credit facilities: Access, Amex, Diners, Visa.

BRENTWOOD MUSIC CENTRE, 2 Ingrave Rd, Brentwood. (0277) 221210. Acoustic Research, B&W, Dual, JBL, Marantz, Nakamichi, Quad, Sansul, Tannoy, Yamaha. Dem facilities available. Open Mon-Sat 9.30-5.30. Home trial facilities, free installation. Credit cards: Access, Visa. Service dept.

RUSH HI-FI & VIDEO, 5/6 Comhill, Chelmsford. (0245) 57593. Akai, Alwa, JVC, Marantz, NAD, Quad, Rotel, Sansul, Sony, Technics. Dem facilities available, ring for appointment. Open Mon-Fri 9.30-6.00 Sat 9.00-5.00. Home trial facilities, free credit. Credit cards: Access, American Express, Barclaycard, Diners. Service dept.

GLOUCESTERSHIRE

ABSOLUTE SOUND AND VIDEO, 40/42, Albion St, Cheltenham. (0242) 583960. A&R, Denon, Dual, Linn, Meridian, Mission, NAD, Rotel, Technics, Yamaha, etc. (Cl. Wed) BADA MEMBER 

ETTLES AND BUMFORD, Brewery Court, Cirencester. (0285) 3946. ADC, Alwa, Ortofon, Celestion, Grundig, Harman-Kardon, Hitachi, JBL, Teac, Trio. Dem facilities: One single speaker dem room. Open Mon-Sat 9.00-5.30. Home trial facilities, free installation, instant credit up to £1,000. Credit cards: Access, Visa. Service dept.

HAMPSHIRE

ANDOVER AUDIO, 105 High St, Andover. (0264) 58251. Bang & Olufsen, Fisher, Alwa, Marantz, NAD, Philips (CD), Proton, Rotel, Trio, Yamaha. Open Mon-Sat 9.5-3.30. Weds 9-1.00. Fri 9-8.00. Home trial facilities, free installation, credit facilities available. Credit cards: Access, Amex, Diners, Visa. Service dept.

HAMPSHIRE AUDIO Ltd, 2-12 Hursley Rd, Chandlers Ford. (04215) 2827/65232. Quality CD and analogue agencies. 5 Dem studios. Large free car park.

BADA MEMBER 

TRU-FI SOUND AND VISION, 10/12 Grosvenor Rd, Aldershot. (0252) 26390. Akai, Aiwa, B&W, Nakamichi, Hitachi, JMW, Mission, Mordaunt-Short, Nagaoka, Sony Technics. Dem facilities available. Open 9.30-6.00 Mon-Sat. Free installation, instant credit up to £1,200. Credit cards: Access, Barclaycard. Service dept.

HERTFORDSHIRE

ACOUSTIC ARTS Ltd, 101 St. Albans Rd, Watford, Herts. (0923) 45250. A&R, Audioplanar, Beard, Conrad-Johnson, Denon, Heybrook, Magneplanar, Mission, Quad, Rogers. Dem facilities: 2 dem studios, ring for appointment. Open Mon-Sat 9.30-5.30. Home trial facilities, free installation, instant credit up to £1,000. Credit cards: Access, Visa. Service dept.

RADLETT AUDIO, 141 Watling St, Radlett WD7 9NQ. (09276) 6497. Audio Innovations, Audio Research, Creek, Krell, Linn, Magneplanar, Musical Fidelity, Monitor Audio, ProAc, Rega. Dem facilities: single speaker dem room. Open Mon-Sat 9.30-5.30. Home trial facilities. Free inst. Credit up to £1,000. Credit cards: Barclaycard, Visa.

KENT

JOHN MARLEY HI-FI CENTRES, 2 Station Rd West, Canterbury. (Canterbury) 69329. B&W, Heybrook, Magnum, M.Y.S.T., Nakamichi, Pink Triangle, Rotel, Sansul, Technics, Quad. Dem facilities available. Open Mon-Sat 9.00-5.30 cl. Wed. Home trial facilities, free installation, instant credit

up to £1,000. Credit cards: Access, Barclaycard, Creditcharge. Service dept.

PHOTOCRAFT HI-FI, High St, Ashford, Kent. (0233) 24441/2. Open Mon-Sat 9.00-5.30. Wed-1 p.m. Free delivery. Int free credit. Access, Visa.

BADA MEMBER 

LANCASHIRE

MONITOR SOUND, 54 Chapel St, Chorley. (02572) 71935. A&R, Dual, Mission, Quad, Rogers, Rotel, Spendor, Thorens, Nakamichi, Yamaha. Dem facilities. 2 dem rooms. Open Mon-Sat, closed Weds. Home trial facilities, free installation, instant credit up to £1,000. Credit cards Access, Visa. Service dept.

PRACTICAL HI-FI, 198 Church St, Blackpool. (0253) 27703. 'Free five year guarantee on all systems. Buy with confidence'. BADA MEMBER 

PRACTICAL HI-FI, 84 Penny St, Lancaster. (0524)39657. '14 days option of exchange available. Buy with confidence'. BADA MEMBER 

LEICESTERSHIRE

MARKWELL ELECTRONICS Ltd, 76 Leicester Rd, Wigstone. (0533) 882758. Akai, Celestion, JVC, Hitachi, Marantz, Ortofon, Sansul, Sennheiser, Sony, Toshiba. Open Mon-Sat 9.00-8.00. Free installation, instant credit up to £1,000. Credit cards: Access, Visa. Service dept.

SOUND ADVICE, The Sound Factory, Duke St, Loughborough LE11 1ED. (0509) 218254. A&R, Creek, Linn Products, Mantcore, Naim Audio, Nakamichi, Nytech, Rega, Revox, Yamaha. Dem facilities: 2 studios-domestic size and furnishings. Appointment required. Open Mon-Sat 9.30-6pm. Free installation, credit facilities available. Credit cards: Access, Barclaycard. Service dept.

LINCOLNSHIRE

YATES & GREENHOUGH, 11-14 Emery Lane, Boston, Lincs PE21 8QA. (0205) 55755. B&W, Castle, Dual, Monitor Audio, Mordaunt-Short, Nakamichi, QED, Quad, Technics, Yamaha. Dem facilities available. Open 9.00-5.30, closed Thurs. Home trial facilities, free installation, instant credit up to £1,000. Credit cards: Access, Creditcharge, Visa. Service dept.

LONDON

A.T. LABS, 159 Chase Side, Enfield, Middlesex. (01) 367 3132. Open Mon-Sat 10am-6pm. Two single speaker dem rooms. Amex, Barclaycard, Access. BADA MEMBER 

ANALOG AUDIO, 849 High Rd, London N.12. (01) 445 3267. NAD, Denon, Pioneer, Yamaha, Rotel, Sansul, Dual, Thorens, Tannoy, Marantz. Dem facilities available. Open Mon-Sat 9.45-6.00. Free installation, instant credit up to £1,000. Credit cards: Access, Visa. Service dept.

AUDIO T, 190 West End Lane, London NW6. (01) 794 7848. Open Mon-Sat, 10-6.00. Two single speaker dem rooms. Access, Amex, Barclaycard. BADA MEMBER 

BARTLETTS HI-FI, 175-177 Holloway Rd, London N.7. (01) 607 2296/607 2148. 'Large range of British & Japanese products available: 2 bookable single spk.dem. rooms. Service dept. Mall order dept. Export worldwide. Access, Amex, Diners, Visa. BADA MEMBER 

BARTLETTS HI-FI, 19 High St North, London E.6. (01) 552 2716. BADA MEMBER 

BILLY VEE, 248 Lee High Rd, Lewisham, London SE13 5PT. (01) 318 5755/852 1321. Alwa, A&R, Creek, Dual, KEF, Linn, Heybrook, Quad, Naim, Rega. Dem facilities: £ single system studios ring for appointment. Open Mon-Sat 10am-7pm closed Thurs. Home trial facilities, free

SELECTED DEALER DIRECTORY

Installation, interest free credit up to £750.00. Credit cards: Access, Visa. Service dept.

BADA MEMBER 

GRAHAM'S HI-FI, 86-88 Pantenville Rd, London N1. (01) 837 4412. FBA Dealer of the year 1985. Linn, Naim, Rega etc. £300-£3,000-£13,000.

BADA MEMBER 

H.L. SMITH & CO Ltd, 287-289 Edgware Rd, London W2 1BE. (01) 723 5891. Aiwa, B&W, Denon, Dual, KEF, Ortofon, Panasonic, Sony, Technics, Yamaha. Dem facilities available. Open Mon-Sat 9.5-30, Thurs 9-1pm, instant credit up to £1,500. Credit cards: Access, Visa. Service dept.

K.J. LEISURESOUND, 48 Wigmore Street, London W1. (01) 486 8262. Linn, Magneplanar, DNM, Nakamichi, Michell, Celestion, SD Acoustics, Koetsu, Magnum, Goldbug. Dem facilities. Appointment required. Home trial facilities. Open 10-6 Mon-Sat. Free installation. Instant credit. Credit cards: Visa, Access. Service dept available.

MUSICAL IMAGES, 45 High St, Hounslow, Middlesex. (01) 570 7512. A&R, Denon, Dual, Heybrook, Nakamichi, Proton, QED, Quad, Tannoy, Yamaha. Dem facilities, ring for appointment. Open Mon-Sat 9.30am-6.00pm. Free installation, credit facilities. Credit cards: Access, Amex, Barclaycard, Diners. Service dept.

MYERS AUDIO, 6 Central Parade, Hoe St, London E17. (01) 520 7277/8. Bang & Olufsen, NAD, Nakamichi, Sansui, Technics, Hitachi, Panasonic, A&R, B&W, Mission. Dem facilities one dem room. Open Mon-Sat 10am-6pm. Free installation, instant credit up to £1,000. Credit cards: Access, Visa, Amex, Diners. Service dept.

WRBI HOME DEMONSTRATIONS, 13 St Johns Hill, London SW11 1TN. (01) 228 7126. Alphason, Audiostatic, Beard, Castle, Celestion, Decca, Ear, Elite, Jordan, Pink Triangle. Home demonstrations only. Appointment required. Open Tues-Thurs 10-6pm, Fri 10-7pm, Sat 10-5.30. Home trial facilities, free installation, instant credit up to £1,000. Credit cards: Access, Amex, Diners, Visa.

SUBJECTIVE AUDIO, 2-4 Camden High St, London NW1 0JA. (01) 387 8281. A&R, Burmester, Krell, Magnaplanar, Meridian, Linn, Nakamichi, John Bowers. Dem facilities: 3 single speaker dem rooms, appointment required. 10.00-6.00 Tues-Fri, 9.00-5.00 Sat. Home trial facilities, instant credit up to £10,000. Credit cards: All. Service dept.

TELESONIC Ltd, 92 Tottenham Court Rd, London. (01) 636 8177. A&R, B&O, B&W, Hafler, Luxman, KEF, QED, Quad, Nakamichi, Rogers, Dem facilities available. Open Mon-Fri 9.00-6.00pm, Sat 9.30-4.00pm. Home trial facilities, free installation, credit facilities available. Credit cards: Access, American Express, Diners, Visa. Service dept.

THE SOUND ORGANISATION Ltd, No 1, Cathedral St, London Bridge, London SE1 9DE. (01) 403 2255/3088. Akroyd, Creek, Dual, Exposure, Linn, Manticore, Mordaunt-Short, Naim, Nytech, Rega. Dem facilities available, ring for appointment. Open Tues-Sat, 10am-7pm. Home trial facilities. Free installation, instant credit up to £1,000. Credit cards: Access, Barclaycard. Service dept.

BADA MEMBER 

UNILET PRODUCTS Ltd, 14 Bute St, London SW7. (01) 589 2586. Mon-Sat 9-6. Dem facilities. Large stock. Credit cards: Access, Amex, Diners, Visa.

BADA MEMBER 

MANCHESTER

CLEARTONE HI-FI, 62 King St, nr. Kendals. (061) 835 1156. Best makes Linn, Creek, NAD, etc. Dem studio.

Compact disc centre, video and TV.

BADA MEMBER 

CLEARTONE HI-FI, 235 Blackburn Rd, Bolton. (0204) 31423. Best makes, Linn, Creek, NAD, etc. Dem studios. Laser vision and compact disc centre.

BADA MEMBER 

LLOYD PATON (LPM Ltd), 34 Moorfield Walk, Urmston, Manchester. (061) 747 9722. B&W, Dual, Hitachi, Marantz, Pioneer, Quad, Rogers, Tannoy, Technics, Trio. Dem facilities, 1 dem room. Open Mon-Sat 9am-5.30pm, Tues-Thurs 9am-7.30pm. Home trial facilities. Free installation, credit facilities available. Credit cards: Access, Visa. Service dept.

THE MUSIC ROOM, 50 Bridge St, Manchester. (061) 835 1366. 'Friendly advice and service. Choose from the widest range in Manchester.'

BADA MEMBER 

MERSEYSIDE

ABOUT SOUND, 116 Bold St, Liverpool L1 4JA. (051) 709 4865. Meridian, Mordaunt-Short, Musical Fidelity, Quad, Revox, Sansui, Sugden, Thorens, Walker, Yamaha. Dem facilities single speaker room. Ring for appointment. Open Tues-Sat 9.00am-5.30pm. Free installation, instant credit up to £1,000. Credit cards: Access, Diners, Visa. Service dept.

W.A. BRADY & SON, 401 Smithdown Rd, Liverpool. (051) 733 6859. 'Largest choice of specialist Hi-Fi in N.W. £100-£20K'. All c.cards. 3 dem rooms.

BADA MEMBER 

WEST MIDLANDS

ALTERNATIVE AUDIO Ltd, 95 Hobs Moat Rd, Solihull. (021) 742 0254. A&R, Audiolab, Denon, KEF, Marantz, Meridian, Mission, M.A., Pink Triangle, Philips. Dem facilities available, appointment required. 10.00-6.00 Tues-Sat, closed Mon. Home trial facilities, free installation, instant credit. Credit cards: Access, Visa, Amex.

FIVEWAYS HI-FIDELITY Ltd, 12 Islington Row, Edgbaston, Birmingham. (021) 455 0667. A&R, Creek, Dual, KEF, Meridian, Philips, CD, Quad, Revox, Rogers, Spondor, etc. Dem facilities. Single speaker dem room. Open 9.30-6.00 Tues-Sat. Home trial facilities, free installation, credit facilities. Credit cards: Access, Visa. Service dept.

GRIFFIN RADIO Ltd, 94 Bristol St, Birmingham. (021) 692 1359. Creek, Dean, Denon, KEF, Linn, Mordaunt-Short, Nakamichi, Rega. Dem facilities 2 single speaker rooms. Open Mon-Sat 9.30-6.00. Home trial facilities, free installation, instant credit up to £1,000. Credit cards: Access, Barclaycard.

SOUND ADVICE, 162 Alcester Rd, Mosley, Birmingham. (021) 449 3328. A&R, Creek, Linn, Manticore, Naim, Nakamichi, Nytech, Onix, Rega, Revox. Dem facilities 2 studios, ring for appointment. Open Mon-Sat 9.30am-6.00pm closed Wed. Free installation, credit facilities available. Credit cards: Access, Barclaycard. Service dept.

WARSTONES HI-FI STUDIO, 54a Warstones Rd, Penn, Wolverhampton. (0902) 345114. Dem facilities 3 rooms. Open Mon-Wed 10am-6pm. Thurs-Fri 10am-9pm. Sat 10am-6pm. Home trial facilities, free installation. Credit cards: Access, Visa, Eurocheque. Service dept.

NORFOLK

BASICALLY SOUND, Old School, School Rd, Beacon Ash, Norwich, Mulbarton. (0508) 70829. A&R, Audiolab, Heybrook, Linn, Mantra, Naim, Nakamichi, Rega, Spondor, Wharfedale. Dem facilities 2 single speaker rooms. Open Tues-Fri, 9.30-5.30 closed for lunch 1pm-2pm. Sat

SELECTED DEALER DIRECTORY

9.30-5.30pm. Home trial facilities, free installation, credit facilities. Credit cards: Access. Service dept.

NORTHANTS

HEYWOOD AND HEYWOOD HI-FI, 38c High St, Corby. (0536) 61166. A&R, Rotel, QED, KEF, Wharfedale, Dual, Aiwa, Marantz, JVC, Monitor Audio. Dem facilities 1 single speaker dem room. Open Mon-Sat 9.30-5.30 closed Weds. Home trial facilities, free installation, instant credit up to £1,000. Credit cards: Access, Visa, Eurocheque. Service dept.

LISTEN INN, 32a Gold St, Northampton. (0604) 37871.

'Shop and home demonstrations from friendly people.'

BADA MEMBER 

NOTTINGHAMSHIRE

PETER ELLIS AUDIO, 29 Kirkgate, Newark. (0636) 704571. A&R, Ariston, Castle, Hitachi, Panasonic, Thorens, Trio, Technics, Wharfedale, Quad. Open Mon-Sat 9.00-5.30, Thurs 9.00-12.30. Dem facilities: single speaker dem room. Ring for appointment. Free installation, instant credit up to £1,000. Credit cards: Access, Visa. Service dept.

OXFORDSHIRE

ABSOLUTE SOUND AND VIDEO, 19 Old High St, Headington, Oxford. (0865) 65961. A&R, Denon, Linn, Mission, NAD, Rotel, Yamaha. Also 256, Banbury Rd, Summertown. BADA MEMBER 

WESTWOOD AND MASON, 46 George St, Oxford. (0865) 247783. Linn, Naim, Rega, A&R, Heybrook, Dual, Mordaunt-Short, Spondor, Tannoy, Quad, etc.

BADA MEMBER 

WITNEY AUDIO, 28 High St, Witney, Oxford. (0993) 2414. A&R, Aiwa, Akai, Dual, KEF, Mordaunt-Short, Pioneer, Philips, Sony, Yamaha. Dem facilities. Open Mon-Sat 9.00-5.30. Free installation, instant credit up to £1,000. Credit cards: Access, Barclaycard. Service dept.

SHROPSHIRE

AVON HI-FI, 12 Barker St, Shrewsbury. (0743) 55166. A&R, B&W, JBL, Dual, NAD, Nakamichi, Revolver, Trio, Quad, Yamaha. Dem facilities available. Open Mon-Sat 9.00-5.30, cl. Thur. Home trial facilities, free installation, instant credit up to £1,000. Credit cards: Access, Barclaycard. Service dept.

SOMERSET

AVALON HI-FI STUDIO, The Old Nursery, Butleigh, Glastonbury. (0458) 50370. A&R, Audiolab, Goldbug, Helius, Nene Valley, Philips CD, Pink Triangle, Revolver, Spondor. Dem facilities: Studio & Home, ring for appt. Open Mon-Sat 9.30-5.30. Closed Weds. Late night Thurs. Home trial facilities, free installation. Credit cards: Access, Visa. Service dept.

WATTS RADIO — THE ENGINEERS, 1 West Street, Somerton. (0458) 72440. Castle, Dual, Denon, KEF, Mordaunt-Short, Ortofon, Quad, Rogers, Thorens, Yamaha. Dem facilities available. Open Mon-Sat 9-1, 2-5.30, Wed 9-1. Home trial facilities, free installation. Credit up to £1,000. Credit cards: Access. Service dept.

SUFFOLK

EASTERN AUDIO, 41 Bramford Rd, Ipswich. (0473) 21721. A&R, Aiwa, Celestion, Denon, Dual, Linn, NAD, Philips, Quad, Technics, Thorens.

BADA MEMBER 

SURREY

TRU FI SOUND AND VISION, 2 Cromwell Rd, Redhill, Surrey (0737) 66128. Akai, Aiwa, R&W, Nakamichi, Hitachi, JPW, Mission, Mordaunt-Short, Nagaoka, Sony, Technics. Dem facilities available. Open Mon-Sat 9.30-6.00. Free installation, instant credit up to £1,200. Credit cards:

Access, Visa. Service dept.

AERCO Ltd, 11 The Broadway, Woking. (04862) 4667. A&R, Ariston, Exposure, HK, A.R, Heybrook, JBL, KEF, Magnum, NAD, PT, Quad, Revox.

BADA MEMBER 

SPALDINGS HI-FI, 352-354 Lower Addiscombe Rd, Croydon, Surrey. (01) 654 1231/2040. Full range of Hi-Fi equipment. Full dem facilities. Access, Visa, H.P. etc.

BADA MEMBER 

UNILET PRODUCTS Ltd, 35 High St, New Malden Surrey KT3 4BY. (01) 942 9567. Mon-Sat 9-6. Thurs 9-7. Credit cards: Amex, Access, Diners, Visa. Dem facilities. Large stock. BADA MEMBER 

SUSSEX (EAST)

JEFFERIES HI-FI, 69 London Rd, Brighton, East Sussex. (0273) 609 431. 2 dem rooms, closed Mon, late night Wed. Parking, bus route. Credit facilities.

BADA MEMBER 

JEFFERIES HI-FI, 4 Albert Parade, Green St, Eastbourne, East Sussex. (0323) 31336. 2 dem rooms, closed Mon. Late night Wed. Parking, bus route. Credit facilities.

BADA MEMBER 

HASTINGS HI-FI, 31-32 Western Rd, St. Leonards On Sea. (0424) 442975. A&R, B&W, Mission/Cyrus, NAD, Nakamichi, Quad, Rotel, Systemdek, Tannoy, Yamaha. Dem facilities. 2 single speaker dem studios. Open Mon-Sat 9.00-7.00. Home trial facilities. Free installation, Credit facilities. Credit cards: Access, American Express, Barclaycard, Visa. Service dept.

SUSSEX (WEST)

BOWERS AND WILKINS Ltd, 1 Becket Buildings, Littlehampton Rd, Worthing. (0903) 64141. B&W, Dual, JVC, KEF, Nakamichi, Philips, Shure, Quad, Sony, Technics. Dem facilities 2 dem rooms. Open Mon-Sat 9.00-5.30, Weds 9.00-1.00. Home trial facilities free installation, instant credit up to £1,000. Credit cards: Barclaycard. Service dept.

TYNE AND WEAR

RED RADIO SHOP AND HI-FI CENTRE, 11 Olive St, (Off Park Lane) Sunderland. (Sunderland) 672087. Aiwa, Bose, Denon, JVC, Luxman, Michell, Pickering, Spondor, Thorens, Trio. Dem facilities available. Open Mon-Sat 9.00-5.30. Free installation, interest free credit. Credit cards: Advance, Barclaycard. Service dept.

WARWICKSHIRE

JCV HI-FI SUPERSTORE, Units 7/8 Wharf St, Warwick. (0926) 493796. 'Everything from specialist hi-fi to mid-systems all at the best prices!'

BADA MEMBER 

WILTSHIRE

ABSOLUTE SOUND AND VIDEO, 60, Fleet Street, Swindon. (0793)38222. A&R, Denon, Dual, Linn, Meridian, NAD, Rotel, Technics, Yamaha. (Cl. Wed).

BADA MEMBER 

YORKSHIRE (NORTH)

THE SOUND ORGANISATION, 36 Gillygate, York. (0904) 27108. Akroyd, Dual, Creek, Linn, Mordaunt-Short, Naim, Nytech, Sony, Wharfedale. Dem facilities available. Open Mon-Sat 10am-6pm. Home trial facilities, free installation, instant credit up to £1,000. Credit cards: Access, Amex, Barclaycard, Diners. Service dept.

BADA MEMBER 

YORKSHIRE (WEST)

ADJO PROJECTS, 45 Headingley Lane, Leeds. (0532) 789115. A&R, Audiolab, Creek, Heybrook, Linn, Musical Fidelity, Naim, Quad, Rega, Rogers. Dem facilities

SELECTED DEALER DIRECTORY

available, ring for appointment. Open Tues-Fri, 9.30-6.00, Sat 2.30-5.30. Home trial facilities, free installation, instant credit up to £1,000. Credit cards: Access, Creditcharge, Visa. Service dept.

BADA MEMBER 

ERRICKS, Fotosonic House, Rawson Square, Bradford. (0274) 309266. Dem facilities. Sales/service agents for A&R, Linn, Quad, Naim, Nakamichi, Mission etc.

BADA MEMBER 

HUDDERSFIELD HI-FI, 4 Cross Church St, Huddersfield, West Yorkshire. (0484) 44668. A&R, AR, Thorens, Meridian, Rogers, Mission, Mordaunt-Short, Harman-Kardon, Technics, Trio. Dem facilities: 3 dem rooms, ring for appointment. Open Mon-Sat 9.00-5.30, Thurs 9.00-8pm. Cl. Weds. Home trial facilities, free installation, instant credit facilities. Credit cards: Access, Visa. Service Dept.

IMAGE HI-FI Ltd, 8 St. Annes Rd, Headingly, Leeds. (0532) 789374. 'We stock most of the worlds leading Hi-Fi products'. Demos by appointment please.

BADA MEMBER 

NORTHERN IRELAND

THE AUDIO CENTRE, 84 Bridge St Portadown, Northern Ireland. (0762) 338059. Aiwa, Akai, Dual, Denon, Fisher, KEF, Marantz, Revox, Rotel, Sony. Open 9am-6pm Mon-Sat, closed Thurs. Home trial facilities, free installation, credit terms arranged. Credit cards: Access. Service dept.

SCOTLAND

Aberdeen

HOLBURN HI-FI, 441/445 Holburn St. (0224) 585713/57272. 'For the best buy in Hi-Fi consult Holburn Hi-Fi'.

BADA MEMBER 

Angus

ROBERT RICHIE HI-FI, 102 Murray, Montrose, Scotland. (0604) 73765. A&R, Creek, KEF, Linn, Naim, Quad, Rega, Sony, Technics, Wharfedale. Dem facilities available, ring for appointment. Open 9-1, 2-5 Mon-Sat, Wed 9-1. Home trial facilities, free installation, instant credit. Credit cards: Access, Barclaycard. Service dept.

EDINBURGH

RUSS ANDREWS HI-FI, 34 Northumberland St. (031) 557 1672. A.R., A&R, Creek, Dual, Heybrook, KEF, Linn, Naim, Nytech, Rotel.

BADA MEMBER 

GLASGOW

BILL HUTCHINSON Ltd, 43 Hope Street, Glasgow. (041) 248 2857. A.R., Aiwa, Denon, Dual, JVC, Mission, Mordaunt-Short, Omar, Technics, Yamaha. Dem facilities available. Open Mon-Sat 10-8.00pm. Free installation, instant credit. Credit cards: Access, Amex, Visa. Services dept.

MAETO MUSIC, 14 The Toll, Busby Rd, Clarkston. (041)638 8252. A.R., A&R, Creek, Dual, Heybrook, KEF, Linn, Naim, Nytech, Rotel. (cl. Mon). Open late Thurs.

BADA MEMBER 

PRISM AUDIO, 14 West Princes St, Glasgow G4 9BP. (041) 332 1779. C J Walker, Concordant, Elite Rock, Helius, JPW, Rotel, Sudden, Systemdek, Syrinx, Teac. Dem facilities: One large room, ring for appointment. Open Mon-Sat 9.30-5.30. Home trial facilities, free installation, instant credit up to £1,000. Credit cards: Access. Service dept.

THE MUSIC ROOM, 221 St. Vincent St, Glasgow. (041) 248 7221. 'Friendly advice and service. Choose from the widest range in Scotland'.

BADA MEMBER 

INVERNESS

NESS AUDIO, 1 Greig St, Inverness. (Inverness) 220440. A&R, Denon, J A Michell, KEF, Linn, Monitor, Audio, Naim, Quad, Revolver. Dem facilities: single speaker dem room. Open Mon-Sat 9-5.30. Home trial facilities. Free installation, instant credit. Credit cards: Access, Amex, Barclaycard. Service dept.

KIRKCALDY

ANDREW THOMPSON, 3 Whytescauseway, Kirkcaldy. (0592) 205997. Denon, Dunlop Systemdek, KEF, J A Michell, Nakamichi, Quad, Revolver, Tannoy, Yamaha. Dem facilities: 4 rooms. Appointment required. Open Mon-Sat 9-5.30. Home trial facilities, free installation, credit facilities up to £3,000. Credit cards: Access, Creditcharge, Visa. Service dept.

WALES

GLAMORGAN (WEST)

AUDIO EXCELLENCE, Number 9 High St, Swansea. (0792) 474608. 'South Wales only independant Hi-Fi specialist, dedicated to excellence'.

BADA MEMBER 

SOUTH GLAMORGAN

AUDIO EXCELLENCE, 134 Crwys Rd, Cardiff. (0222)28565. 'South Wales only independant Hi-Fi specialist, dedicated to excellence'.

BADA MEMBER 

WALES (NORTH)

ELECTRO TRADER HI-FI, 19 Colwyn Crescent, Rhos-On-Sea, Colwyn Bay. (0492) 48932. B&W, Dual, Musical Fidelity, NAD, Revolver, Rotel, Sansui, Tannoy, Thorens, Yamaha. Dem facilities, ring for appointment. Open Mon-Sat 9.30-5.30 closed for lunch 1-2. Home trial facilities, free installation. Credit cards: Access, Amex, Visa, Diners. Service dept.

**WE WOULD
LIKE TO HEAR FROM
YOU**

*if you have complaints or
praise for any of the shops
listed here.*

*If you feel your shop
should be included in this
directory please ring*

**Hi-Fi Choice on:
01-580 7857 or
01-631 1433**

GLOSSARY

This is not intended to give dictionary definitions of terms, but to explain their meanings in the context of this book.

Alignment: Refers to the geometrical relationship between cartridge stylus and groove in various planes (see *Consumer Introduction*.)

Alignment protractor: A device used to minimise the lateral tracking error of a cartridge/arm combination.

Amplitude: The actual size of a signal modulation, or distance travelled by a headphone transducing element, which corresponds to the level or relative loudness of the signal.

Armature: The moving parts of the generator in a pick up cartridge (see *Stator*).

Balance: 1) The overall relative loudness perceived at different frequencies (eg bass, treble) 2) the accuracy of the match between the two channels of a stereo transducer (eg cartridge or headphone).

Bass: LF part of the frequency spectrum, typically below 150Hz.

Binaural: Closed system recording/replay technique using headphones and 'dummy head' microphones.

Bottoming: The stylus scraping on the distorted rounded bottom of the groove due to incorrect stylus geometry.

Cantilever: The thin rod or tube that connects the stylus to the armature and hence the cartridge body.

Capacitance: A reactive electrical property present in pickup arm leads and amplifier inputs; correct matching is often important to ensure optimum inputs; correct matching is often important to ensure optimum performance (see *Loading*).

Channel separation: The degree to which the cartridge prevents breakthrough from one stereo channel to the other (see *Crosstalk*).

Circum-aural: Headphone type which encloses the ear and rests on the side of the head.

Coloration: Change in sound quality due to resonances or imbalances in frequency response.

Compatibility: The selection of interdependent components to achieve optimum system performance; notably arm/cartridge mass/compliance matching, cartridge electrical loading, or headphone compatibility with amplifiers.

Compliance: A measure of the springiness of the cantilever/armature seen from the stylus, expressed in compliance units (cu), where $1 \text{ cu} = 10^{-9} \text{ cm/dyne}$.

Crosstalk: The breakthrough signal measured in the alternate channel of a cartridge when a signal is recorded on one channel only, expressed in dB as the ratio of the unwanted to the wanted signal at appropriate frequencies.

Cutter: (*disc cutter*) Mechanism used to cut recorded signal onto lacquer master; consists of turntable, lathe, cutting head, cutting and servo amps.

Damping: A means of controlling resonances by means of a resistive medium (electrical, mechanical, or acoustic depending on situation).

Decibel (dB): A logarithmic unit that is convenient for expressing ratios that span a wide range on a linear scale. For simplicity it can be regarded as a measure of relative loudness; for example in frequency response and crosstalk measurements.

Direct-cut (disc): A recording technique that transfers the music via microphones and mixers direct to the disc-cutter without intermediate tape storage.

Disc-cutter: see *Cutter*

Distortion: Literally this can mean any deviation from the original, but usually refers to harmonic rather than intermodulation distortions when not specified.

Downforce: The weight, measured at the stylus, which holds it down in the groove.

Effective mass: The inertia, or mass-controlled resistance to movement, of a device, particularly important with regard to tonearms.

Electret: Effectively a permanently charged capacitor, it is used as the transducing element in certain cartridges and headphones.

Electrostatic: A principle employed in some headphone transducers using static electricity effects to set up a polarising field within which the modulated transducer medium moves.

Elliptical stylus: A specially shaped stylus profile that makes the 'plan view' radius along the length of the groove smaller than the 'elevation view' contact radius viewed from the front.

Farad: Measure of capacitance; for cartridge loading requirements the *microfarad* (μF , a millionth of a Farad), *nanofarad* (nF, a thousandth of a millionth of a Farad), or most commonly the *picofarad* (pF, a millionth of a millionth of a Farad) are commonly encountered.

Frequency: A rate of vibration, which responds to musical pitch in the audio band.

Frequency range or spectrum: Can refer to any particular group of frequencies, but commonly applied to the audible band from 20 to 20,000 cycles per second (Hz), extending from the deepest bass to the highest audible harmonics.

Frequency response: The variation in output over a frequency range, particularly of a transducer; can be expressed as a range with decibel limits, or depicted graphically.

Henry (H): Measure of inductance; more usually millihenry (mH), as in cartridge internal inductance.

Harmonic: The whole-number multiples of a base frequency or fundamental, so that twice that frequency is the second harmonic, and represents a pitch one octave higher, three times that frequency is the third harmonic, two octaves above the fundamental.

Harmonic distortion: (see *distortion*). The unwanted addition of harmonics to a single frequency signal.

Hertz (Hz): (see *frequency*). The normal measure of frequency, equal numerically to the outdated 'cycles per second'. Also kilohertz (kHz) which equals one thousand Hz, so the audible frequency range can be described as either 20-20,000 cycles per second (Hz), or 20Hz-20kHz.

HF: High frequency, typically above about 3kHz.

Impedance: Measure of resistance (and reactance) in alternating (ie audio) signals; this is of some importance in the compatibility of both cartridges and headphones with amplifiers.

Interaural: Concerning the differences between the sound perceived at the two ears.

Intermodulation (IM): A form of distortion arising from two or more signals producing non-harmonic signals that correspond to the sum or difference of the two frequencies.

kHz: see *Hertz*

kohm: see *Ohm*

Level: Refers to the relative level of a signal to another signal or to a datum, usually expressed in dB.

LF: Low frequency.

Linear: A transducer that produces an output that exactly portrays its input over the required operating range is described as linear, and is hence distortion free. Hence also nonlinearities (distortions).

Line-contact: A special stylus profile that extends the ellipse, increasing contact length up and down the sides of the groove.

Load or loading: The impedance (including resistive and reactive components, ie ohms, mH, pF) seen by one component looking back to its interconnected component; of importance in compatibility of cartridge/amp, and amp/headphone.

Master: Either the original tape from which cutting is done or the negative imprint taken from the original cut lacquer; used to create 'Mothers' and they in turn 'stampers' or 'Matrixes'.

Matrix: see *Master*.

Midrange, Midband: The central part of the audible frequency range.

Modulation: The audio signal is 'stored' by means of modulations within a medium, eg the 'wiggles' in the groove of a plastic disc, or the magnetic coding on a tape.

Monitoring: Listening to a programme to check the quality; headphones are particularly useful for monitoring stereo signals.

Mother: see *Master*.

Moving-coil: A transducer (eg cartridge or headphone) where the signal is generated by the movement of a coil within a magnetic field.

Moving magnet: The most common form of cartridge transduction, where the magnet moves while the coils are held relatively stationary.

Octave: Two-to-one ratio of pitch or frequency.

Offset angle: The angle measured between the centre line of the pickup cartridge and the line which joins stylus and arm pivot point.

Ohm: Unit of electrical impedance (including reactance) or resistance; also kohm, where 1 kohm = 1,000 ohms.

Orthodynamic (Isodynamic): Headphone transduction system where flat film conductor operates between permanent magnet plates.

Overhang: The amount by which the stylus overhangs the centre spindle of a turntable; see alignment in *Consumer Introduction*.

Presence: A quality of forwardness or immediacy in a sound balance, generally related to an upper-middle frequency response boost.

Q: A measure of the magnitude and shape of a resonance; the higher the Q, the sharper and more severe in amplitude the resonance.

Ringling: Oscillation due to the excitation of a poorly damped resonance.

Separation: As between the two channels of a stereo pickup; see *crossstalk*.

Shibata: A special stylus shape extending the elliptical to a 'line-contact' type of profile.

Side-thrust: A force acting on cartridges in pivoted (ie not parallel tracking) arms, due to the stylus/vinyl 'friction' acting along the line of the offset angle; hence bias or side-thrust compensation.

Signal: A term which embraces all encodings of sound.

Square wave: A signal which consists of a fundamental plus a (theoretically infinite) series of odd (3rd, 5th etc) harmonics in a precise phase and amplitude relationship. It is useful for examining transient performance, symmetry, resonance control and 'ringing'.

Stator: Refers to the non-moving parts in a cartridge's generator mechanism.

Step-up: A transformer or head amp used to boost or match the output of a moving-coil cartridge to use with a normal amplifier disc input.

Stylus: The specially shaped piece of diamond in contact with the groove and connected to the cantilever.

Subsonic: Below the audible range, ie below 20Hz.

Supra-aural: Headphone type that rests on the pinna or outer ear.

Tracing: The following of the groove modulations by the stylus; hence for example tracing distortion, caused by the inability of a spherical stylus to trace the high frequency inner grooves on a disc.

Trackability: The ability of the cartridge to cope with large amplitude modulations (or of the arm and cartridge to follow the groove itself properly).

Tracking force: see *downforce, playing weight*.

Ultrasonic: Frequencies above audibility, ie greater than 20kHz; also *supersonic*.

Vertical tracking angle (VTA): The angle at which the plane of motion of the stylus is set with respect to the vertical when viewed from a side elevation of the cartridge. Should match the 20° cutter standard.

Weighting: A factor or function that is applied to a measurement to increase its relevance and usefulness; eg the weighting curves applied to headphone frequency response measurements to take account of head, ear, and other related effects.

**14 DAYS
FREE TRIAL**
MAIL ORDER ONLY



50X

New low cost high output moving coil cartridge. Output voltage 2.0mV. Frequency response 20-20000Hz. 0.3 x 0.7 mil elliptical stylus 5mm straight aluminium pipe cantilever Weight 4.5gms

New Price £42.55
Exchange Price £36.80



20A2

Very high output voltage of 3.6mV. Frequency response 20-40000Hz Elliptical stylus. Tapered aluminium pipe cantilever Weight 5.3gms

New Price £110.40
Exchange Price £78.20



10X4

Latest improved type with nude and smaller diamond stylus. Output voltage 2.5mV. Frequency response 20-25000Hz. Straight tube aluminium cantilever Weight 4.5gms

New Price £59.80
Exchange Price £48.30

Dynavector CARTRIDGES

- Starting September 1st, Dynavector products will be available direct from Dynavector Systems (UK) Ltd (a wholly owned subsidiary of Dynavector Systems of Japan.) By omitting our distributor we are able to save costs which will enable dramatic price reductions to be passed to our customers.
- Dynavector cartridges will still be available from our dealers but if there is not one in your area, we will be pleased to supply you by fast mail order.
- Audition any of the famous Dynavector moving coil cartridges in your home. So confident are we on this offer that if you are not entirely happy with your purchase, you may return it to us within 14 days in good condition, and receive a full refund of the purchase price, less postal and insurance charges.
- **DYNAVECTOR OWNERS** — take advantage of our Exchange Scheme. Send your old Dynavector cartridge, irrespective of condition and choose any new model at the special exchange price.



23RS

Improved type of the famous 23R Karat. Super fine contact micro reach stylus. Frequency response 20-30000Hz. 2.3mm length tapered ruby cantilever. Weight 5.3gms

New Price £149.50
Exchange Price £93.15



17D2

Superb accuracy and faithful reproduction of the original record work. 70 micron meter square elliptical stylus. 1.7mm length round section straight diamond cantilever Weight 5.3gms

New Price £189.75
Exchange Price £159.25

*All prices inclusive of VAT
Offer open to UK residents only*



**TO ORDER: FILL IN THE CC UPON AND SEND TO:
DYNAVECTOR SYSTEMS (UK) LTD., 117 KING'S ROAD,
LONG DITTON, SURBITON KT6 5JE**

NAME _____ ADDRESS _____

POSTCODE _____

Please send me Model No _____ Cost £ _____

Postage and Packing & Insurance £1.80 _____ Total Cost £ _____

I enclose Cheque/P.O. No _____ Value £ _____

Signature _____
IF YOU OWN A DYNAVECTOR CARTRIDGE AND WISH TO REPLACE IT UNDER THE EXCHANGE SCHEME, RETURN IT TO US WITH YOUR ORDER.

PRODUCT INDEX

CARTRIDGES

ADC Phase I	19	Mission 773HC	89	Ariston RD40AC	145
ADC Phase II	87	Monster Alpha 2	62	Ariston RD40E	145
ADC Phase III	87	NAD 9100	89	Ariston RD80SL	145
ADC Phase IV	20	NAD 9200	89	Dual CS514	145
ADC TRX I	87	Nagaoka MP10	63	Dual CS505-2	110
ADC TRX II	87	Nagaoka MP11 Boron	64	Dual DX505-2 Deluxe	110
A&R C77	21	Nagaoka MP15	89	Elite Townshend Rock	145
A&R E77	87	Nagaoka MP20	89	Harman Kardon T35C	147
A&R P77	22	Nagaoka MP50	89	Harman Kardon T55C	147
Audio-Technica AT105E	23	Ortofon OM5E	65	Heybrook TT2	112
Audio-Technica AT110E	24	Ortofon OM10	66	Linn Sondek LP12	114
Audio-Technica AT115E	25	Ortofon VMS5E II	90	Lux PD800	147
Audio-Technica AT3200XE II	26	Ortofon VMS10E II	90	Michell Synchro	147
Audio-Technica AT140L	27	Ortofon OM20	67	Michell GyroDec	148
Audio-Technica AT33ML	28	Ortofon VMS20E II	90	Mission Cambridge 775LCT	148
Audionote 102	29	Ortofon VMS30E II	90	Oak	118
Bang & Olufsen MMC5	87	Ortofon MC10 Super	68	Oracle Alexandria	120
Bang & Olufsen MMC4	30	Ortofon MC2000	90	Oracle Delphi	148
Bang & Olufsen MMC3	87	Pickering XV15/625E	90	Pink Triangle	148
Bang & Olufsen MMC2	87	Pickering XV15/1800S	90	QED RP232	124
Bang & Olufsen MMC1	31	RATA RP20	69	QED RP232E	124
Decca London Blue	33	RATA RP40	70	Rega Planar 2	126
Decca London Gold	33	RATA RP70	71	Rega Planar 3	126
Decca Super Gold	34	Rega RB100	72	Revox B791	149
Decca/Garrott	35	Shure M92E	73	Rotel RP850	149
Denon 103	36	Shure ME75ED	90	SEE Revolver	130
Denon 103S	87	Shure M99E	91	SOTA Sapphire	149
Denon 103D	88	Shure M104E	91	The Source	134
Denon DL110	37	Shure M105E	91	Systemdek IV	136
Denon DL160	38	Shure ME97HE	74	Thorens 316	140
Empire DL160	39	Shure M110HE	91	Thorens 318	140
Dynavector DV10X IV	40	Shure M111HE	91	Thorens 320	149
Dynavector DV23RS	88	Shure ML120HE	91	Thorens 321	149
Glanz MFG 110EX	41	Shure ML140HE	75	Walker CJ58	142
Goldring Epic	42	Shure V15 VMR	91		
Goldring 1010	43	Stanton 500E II	76		
Goldring 1020	44	Stanton HZ9S	77		
Goldring 1040	45	Supex SM100E	91	TONEARMS	
Goldring Electro 2	46	Supex SD900 IV	78	Alphason Delta	108
Goldring Electro 2LZ Boron	88	Supex SD901 IV	79	Alphason Xenon	108
Grace F9E II	47	Supex SDX2000 High Output	80	Grace G707	145
Grado MT	49	Supex SDX2000 Low Output	81	Helius Orion	147
Grado M1	50	Talisman A	82	Linn Basik LVX	147
Grado M3	51	Talisman S	83	Linn Basik LV Plus	147
Highphonic	53	Talisman Alchemist IIIS	91	Linn Basik Ittok LVII	147
Koetsu Black	54	Technics P205C 4	84	Mission 774LC	148
Koetsu Red	55	van den Hul MC-10	85	Rega RB300	128
Linn Basik	56	Yamaha MC1S	91	SME 3009 Series III	149
Linn K9	57			SME 3009 Series IIIS	149
Linn Trak	58			SME 3009R	149
Linn Asak	89	TURNTABLES		SME Series V	132
Linn Karma	89	Acoustic Research EB101	106	Sumiko MDC800 The Arm	149
Mission Solitaire	61	Acoustic Research Legend	145	The Well Tempered Arm	138
		Ariston RD20	145	Zeta Junior	118
				Zeta	142

When you're looking for the book come to the library

We have the complete selection of all current *Hi-Fi Choice* editions available at our Back Issues Centre in the West End of London of London, just half a minute's walk from Oxford Street (close to Tottenham Court Road tube). Of course, you could order them from our excellent mail order service, using the coupon on page 70, but by visiting in person you save on postage costs. The Back Issues Centre also often has back numbers of *Hi-Fi Choice* on sale which we cannot offer through the mail order service because of shortage of stock. Our receptionists will also be happy to sell you a set of binders or take your subscription. Drop by next time you're in the West End. We're open Monday to Friday, 10am to 5.30pm.

HI-FI CHOICE BACK ISSUE CENTRE

Bunch Books
14 Rathbone Place,
London W1P 1DE

Monday to Friday
10am to 5.30pm

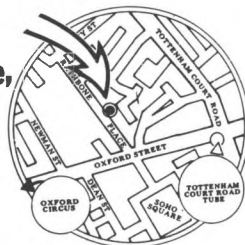

ADVERTISERS INDEX

Abbott Audio.....	60	Reading HiFi.....	60
Alternative Audio.....	48	Rotel HiFi.....	4
Andover Audio.....	143	Russ Andrews.....	86
Appollo Speaker Stands.....	154	Sansui.....	2-3
Ariston Acoustics.....	12	See Corporation.....	135
Audio Insight.....	60	Sevenoaks.....	32
Audio T.....	18	SME.....	123
Audio Technica.....	86 & 88	Sound Organisation.....	152-3
Automation Sciences.....	16 & 26	South London HiFi.....	88
Bang & Olufsen.....	15	Spaldings.....	116
Basically Sound.....	48	Syrinx.....	150
Beyer Dynamic.....	146	Tandberg.....	137
Brentwood Music Centre.....	48	West Midland Audio.....	88
Castle Green Distribution.....	IBC		
Cosmic.....	52	DEALER GUIDE 92-93	
Darbys HiFi.....	150	About Sound	
Doug Brady.....	129	Andrew Thomson	
Dynavector.....	174	Chichester HiFi	
Eric Wiley.....	143	G. E. Manders	
Express Accessories.....	96	HiFi Centre of Wilmslow	
Fanmont Omnicare.....	154	HiFi Components	
HiFi Care.....	16	Moorgate Acoustics	
J.A. Michell Engineering.....	54	Musical Images Ltd.	
Lift.....	117	Music & Video Exchange	
Linn Products.....	OBC	Norman Audio	
Mecom Acoustics.....	139	Norman H. Field	
MRN Products.....	122	Paul Roberts HiFi	
Nagaoka.....	8	Phase 3 HiFi	
Ortofon.....	10-11	Selective Audio	
QED.....	144		

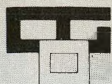

Castle Green DISTRIBUTION

DISTRIBUTORS
FOR



Hi-Fi — Compact Disc

Midi Systems — Professional Sound

Telephone 01-575-7070 NOW!

TRADE ENQUIRIES WELCOME

MARKETING

EDUCATION

PROMOTIONS

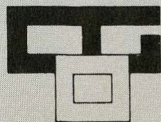

Castle Green DISTRIBUTION

Head Office:-
I.C.G. House
Station Approach
Oldfield Lane North
Greenford, Middlesex
UB6 0AL

Tel: 01-575 7070
Telex: 947838 GEEWS G
Facsimile: 01-578 2352



JUST FOR THE RECORD

It's been some years since we turned high fidelity thinking round by introducing the Sondek LP-12 turntable.

Till then – just in case you're too young to remember – most folk thought the loudspeaker was the most important component. With the LP-12, we demonstrated that the turntable was the first, all-important link in the chain of sound reproduction.

Pretty controversial stuff in its day – but as people stopped talking and started listening, the LP-12 became known as the finest turntable in the world. And all these years later, if you love music more than gadgetry, it's still the best source available.

Of course, we've not spent those years going round in circles. We've applied the same exacting standards of design and manufacture to a full range of high fidelity equipment – cartridges, tone arms, speakers, and most recently, the new Linn pre-amp and power-amp, completing the chain that began with the LP-12. And the result? Well, now as always, all we ask is that you listen and compare.

**Contact your specialist dealer
for an A-B demonstration.**



simply better!