

HI-FI CHOICE

CARTRIDGES & ACCESSORIES

The most comprehensive guide to buying cartridges,
headphones and accessories ever published.

£2.50

Best Buys Recommended
Over 150 Tests & Reviews

MISSION ELECTRONICS



because people like music

Editorial	5
Background to the review project	
Consumer Introduction	7
Cartridges: Design principles, choosing, fitting and alignment	
Technical Introduction	29
Cartridge testing: How and why the tests were carried out	
Full Reviews	36
Complete cartridge tests including full lab measurements	
Summary Reviews	105
Condensed reviews on a further 50-plus cartridge models	
Conclusions	124
General findings from the review programme	
Best Buys and Recommendations	129
Overall summing up on the models which did best in our tests	
Headphones	133
Introduction and reviews on more than 20 headphone models	
Accessories	143
Wide-ranging survey sorts useful items from gimmicky!	
Glossary	150
Guide to technical terms and jargon	

Editor: Steve Harris
Author: Paul Messenger
Advertisement Manager: Bernie McKelvie
Advertisement Executive: Judith Kelly
Group Art Director: Perry Neville
Group Production Manager: Sonia Hunt
Photography: Ian McKinnell
Illustrations: Mark Watkinson

Published by Sportscene Publishers Ltd,
14 Rathbone Place, London W1P 1DE
Tel: 01-631 1433
Distributed by Seymour Press Ltd,
334 Brixton Road, London SW9 7AG
Typesetting by In-Step Ltd,
33-41 Dallington Street, London EC1V 0BB
Printed by H E Warne & Co Ltd, St Austell

Any queries regarding the content of this book should be made in writing to: Hi-Fi Choice Editorial, 14 Rathbone Place, London W1. Enquiries cannot be dealt with by telephone. Note: many of the value judgements made within this publication are based on the estimated typical prices printed. While every effort is made to ensure that these are correct at the time of going to press, they are subject to fluctuation and are applicable only to the UK Market. Readers should therefore bear current prices in mind when interpreting comments on value for money. This edition © 1984 Felden Productions.

OUR NEW CARTRIDGE HAS SOMETHING A VARIABLE

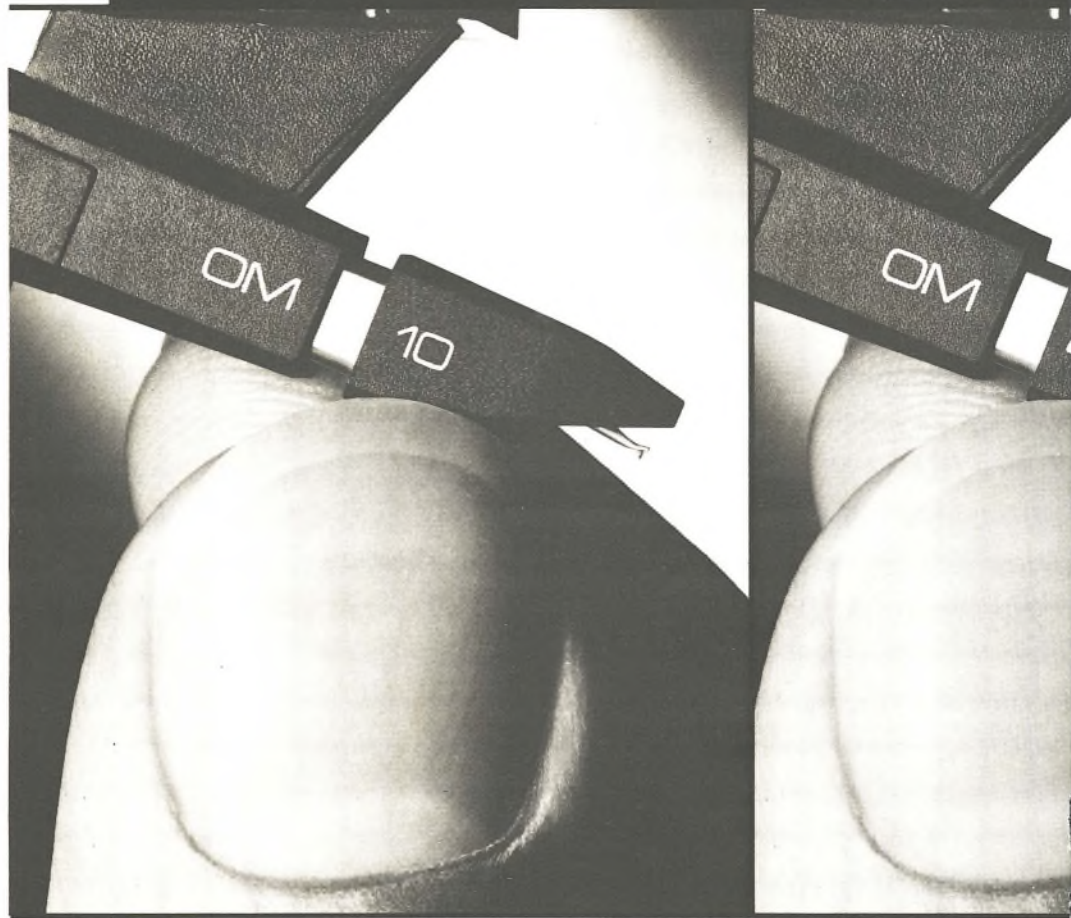

Hi-Fi cartridges (even the more expensive ones) have sometimes had one thing wrong with them.

If you want to upgrade them, you have to throw away the old cartridge. Along with the money it cost you.

Ortofon have found a way round this frustrating dilemma. And we've made it the principle behind our new

series of Optimum Match cartridges.

The OM Range (as it's more catchily known) features two basic cartridges.

Which, between them, will match almost any contemporary tonearm.

The OM, for all standard fittings, complete with removable weight-plate to differentiate between low and medium-mass models.



YOU WOULD NEVER EXPECT FROM ORTOFON. PERFORMANCE.



And the OMP for P mount (Plug-in), fittings.

Both these cartridges can then be fitted from a choice of three different stylus units, of increasing quality. The 10, an Elliptical diamond. The 20, a nude, highly-polished Elliptical diamond. And the 30, a highly-polished Fine Line diamond.

So, you can improve the performance of your cartridge without actually

changing the whole cartridge unit.

Have a look and listen at the new OM range at your Ortofon stockist. With the OM10 or OMP10 only setting you back around £14, the prices will be something else you never expected from Ortofon.

ortofon
accuracy in sound



FOR MORE INFORMATION CONTACT: ORTOFON LTD., DENMARK HOUSE, TAVISTOCK INDUSTRIAL ESTATE, W. TWYFORD, BERKS. RG10 9NJ. TELEPHONE: (0734) 343623.

What Hi-fi? Awards
winner
1985

tells you the best hi-fi to buy

tells you the best hi-fi to buy



**NAGAOKA WISHES TO THANK DAVID PRAKEL,
JIMMY HUGHES, NOEL KEYWOOD, ALVIN GOLD AND
KEVIN WHITCHURCH FOR SELECTING THE MP11,
BEST CARTRIDGE UNDER £50
"WITH SUPERB ALL-ROUND PERFORMANCE"**

THE NAGAOKA MP11. ONLY £19.

For further details contact Path Limited, 1 Berens Road, London NW10 5DY Tel: 01-969 2514.

Each edition in the Hi-Fi Choice series tests and compares as many models as possible in a given product category. This book offers the most comprehensive review of pickup cartridges ever undertaken, as well as coverage of headphones and accessories.

It's a hi-fi cliché to say that the importance of the pickup cartridge is out of all proportion to its tiny size. It's also true that while today a cartridge costing under £20 can do a fairly adequate job, the most refined performance is only available at a cost of some hundreds of pounds.

With the cartridge test programme in this edition, we've set out to cover the whole range as fully as possible. At one end of the spectrum, we have set out to discover the best low-cost models, and at the other we have assessed the 'exotic' models which, in terms of retail price anyway, are worth their weight in gold. And of course, we have unearthed some real gems in between!

In general, standards of sound quality at any given price level have been maintained or improved, which is quite remarkable considering that most models in the UK have to be imported and therefore paid for with ever-larger amounts of ever-weaker sterling. Most of the cartridges bearing British companies' brand names are actually built in Japan, the honourable exception to this rule being our sole home cartridge manufacturer, Goldring. Recently, Goldring have themselves started acting as OEM ('original equipment manufacturer') suppliers to some other British firms, so that 'made to order' versions of some of their cartridges are now available under the names of A&R, RATA and others.

The test programme for this *Cartridges* edition covers a pretty high proportion of the cartridges currently available (and readers should be warned that some are much more easily and widely available than others!), but it would have been impracticable to give a full page to every one. So after an initial series of screening tests, including both listening and measurement of course, about half the cartridges were selected for 'Full Review' treatment while the remainder are covered in the *Summary Reviews* section. While most of the recommendations come from the 'Full Reviews', we must make it clear that there are a great many very worthwhile products covered in the *Summary* section.

Previous *Cartridge* editions have included a section of headphone reviews, which seemed to fit more comfortably here than in any other part of the *Choice* series. This time we have

tested a selection of some 20 headphone models. In response to many requests, we have also broadened the scope of this edition by adding a section on accessories as well. While it is the 'record care' category which links most directly with the main subject of the book, we have attempted to survey the whole gamut of audio 'bits and pieces'.

Although his associations with *Hi-Fi Choice*, both as its former Editor and as a contributor, go back a good many years, this is Paul Messenger's first *Cartridges* edition. Regular readers will note the change of style as compared with the previous editions by Martin Colloms (who, at the time of writing, is working on the next *Amplifiers and Tuners* issue), but I am sure that Paul's painstaking test work, unflagging enthusiasm for the subject and careful judgements will not go unappreciated.

From the 140 or so cartridges that were examined, we have chosen a fairly small selection as 'Best Buys' and 'Recommended' models. It must be stressed that these ratings are intended only as a guide, and while they differentiate those cartridges that appear in our view to offer particularly good performance and value, these are by no means the only models which we feel should be considered by potential buyers.

Ultimately, a choice of cartridge should be influenced by personal taste as well as system matching considerations, which are dealt with in some depth in this book. The author has explained and allowed for his own preferences in reaching balanced conclusions to the reviews; on the other hand, our tests cannot possibly predict the sonic results of every possible permutation of system, room, musical and personal taste, so readers will need to relate our comments to their own specific requirements.

With this in mind, I should also add that the enlisting the aid of a friendly dealer with good demonstration facilities is a vital step in choosing any hi-fi component. The function of *Choice* after all is not to dictate, but to inform and guide; and with a wealth of information on what are in many ways the most fascinating of all hi-fi components, this edition should prove valuable both as a buying guide and as a complete work of reference.

Steve Harris

In the world of Game arms you could pay in excess of £25,000, for which you would get a beautifully hand built, hand engraved gun, but it would not improve your shooting performance in any way, just your image.

In the world of Hi-Fi arms you only need pay £399.00, for which you would get a beautifully hand built, hand engraved tone arm that would give you the best possible sonic performance irrespective of price and it will also improve your images.

ZETA

Designed, marketed and distributed by:

Esoteric Marketing

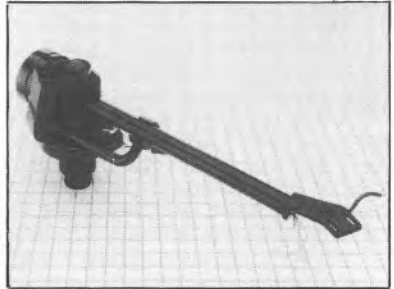

If you are considering replacing your old or buying your first moving coil cartridge then you could save a lot of money by using the Zeta M.C.D. moving coil cartridge demagnetizer.

In a matter of seconds you will give your cartridge a new lease of life and when used regularly will keep your cartridge at its best.

Contact your dealer for further information. Worldwide distributors:

Esoteric Marketing
23 Berrydale Rd, Northampton NN3 5EQ
Tel: 0604 411721

CONSUMER INTRODUCTION

For easy access, this introductory section is divided into three main parts. The first covers the role of the cartridge and general design problems; next comes a section giving guidelines on choosing a cartridge; finally the third part describes in detail the considerations of fitting and alignment which are necessary to get the best performance from any cartridge.

If the reviews in this book seem rather terse in their presentation, this is because the *Choice* format allows us to put all the essential background and general information into the introductory and concluding sections. To avoid the introductions becoming too unwieldy, they are broken up into sub-sections as far as possible — so that readers will find the heading they want without too much difficulty.

CARTRIDGE FUNCTION AND DESIGN

Though the smallest separate part of a hi-fi system, the cartridge is in some ways the most important — and it is certainly one of the hardest to manufacture, since inside that small 'block of plastic' attached to the end of the record player arm is some remarkable micro-engineering. The job of the cartridge is to 'read' the undulations of the record groove which represent the original sound, and to convert this mechanical representation of music into an electrical signal which can be fed to an amplifier, and in turn made to drive a pair of loudspeakers.

All cartridges work on the fundamental principle of following or tracing (or 'tracking') the groove with a flexibly-mounted stylus. The movements of the stylus in relation to the cartridge body can then be used to generate an electrical signal.

Many people still think of the stylus as the 'needle', this term being a hangover from the days of the 78. The stylus used in hi-fi cartridges today is of course much smaller in order to match the dimensions of the 'micro-groove' on LP records. It is actually a very tiny, carefully-shaped diamond, mounted on the end of a thin rod or tube called the cantilever, and may itself be only as thick as a pin or needle.

At the other end of the cantilever, inside the cartridge body, is a flexible hinge or pivot arrangement, which allows the cantilever-and-stylus assembly enough freedom of movement to follow the wiggles of the groove, but ideally should not allow any other movement which would cause distortion.

The electrical generating elements are usually on the other side of this pivot, with a magnet (or piece of magnetically permeable

material) being attached to the 'back end' of the cantilever. Movements of the magnet in relation to fixed coil windings produce tiny electrical signals in the latter, and these can be fed to the hi-fi amplifier input.

In the case of moving-coil cartridges, it is the coils which are attached to the cantilever (more often in front of the pivot) and their movement in relation to a very powerful fixed magnet produces the musical signal.

Though there are countless variations on the moving-magnet theme — ADC's 'Induced Magnet', Ortofon's 'Variable Magnetic Shunt', Audio-Technica's dual magnet, the Glanz 'Moving Flux' and the Grado 'Flux Bridger' are all quite impressive-sounding trade names — very nearly all current hi-fi cartridges can be put firmly into one of the two categories, moving-magnet or moving-coil. The few that cannot are those working on completely different principles such as the Micro-Acoustics Electret models or the Aurex capacitance-sensing cartridge, and one or two other extremely 'rare birds.'

Though the cartridge has to trace the undulations of the record groove, it has to do this while at the same time following the inward spiral of the groove across the record. It is here that the turntable and arm become important, as their function is to keep the record and cartridge in the correct relationship for groove tracing. The role of the turntable/arm system is covered in detail in *Hi-Fi Choice Turntables and Tonearms*. Suffice it to say here that turntables and arms can dramatically affect the sound quality of a cartridge, and as we are concerned with the cartridge's compatibility with other components, some overlap of material between the two editions is necessary.

To help appreciate the role of the cartridge, one can regard it as consisting of two basic components, the generator and the stator. The generator is the part that moves, and includes the stylus, cantilever, and moving armature (be it coil or magnetic); its job is to accurately reflect the modulations in the groove in the movements of its armature, which is a far from easy task. The stator is the main body of the cartridge which has to remain as independent

CONSUMER INTRODUCTION

of the movements of the generator as possible, as the signal is only generated as a result of the movement of one with respect to the other; it also has the vital function of locating the generator via the 'hinge' or 'pivot', which is one of the most critical points in the design.

Two different cartridge types

As already mentioned, there are two fundamentally distinct cartridge types. Moving-magnet and moving-coil types need to be considered separately because different circuitry generally is needed for their amplification.

Up to six or seven years ago, the moving magnet cartridge was the automatic choice for all hi-fi users apart from a very small minority who stuck by the moving-coil principles of operation. The moving-coil types were historically the antecedents, and there were several designs on the market up to about 18 years ago; then for about ten years a single Ortofon model only was available on the UK domestic market. It was usually considered a somewhat cranky choice, because its acknowledged subjective sweetness was marred by a poorer tracking performance than most of the moving magnet competitors, and there was the additional disadvantage of the need for a special step-up transformer between the cartridge and the normal amp input, which significantly increased the total cost.

But during this period, the moving-coil

cartridge was becoming regarded with increasing respect by the more extreme hi-fi buffs in Japan, and a number of new models began appearing on their domestic market. Over the last eight years or so these have started appearing on the UK market to join with the Ortofons, which have themselves swelled to five models. In the last book we included models by Fidelity Research, Supex, Dynavector, Coral, Entré, Satin, Denon, Elite, Mission, JVC, Audio-Technica and Sony, and this edition sees a whole new crop of makes and models. So the cult has grown despite the fact that users of most of the models may have a penalty of about £50 in step-up device costs before considering the cartridge.

This in turn has spawned another trend amongst amplifier manufacturers to incorporate circuitry which allows a moving-coil cartridge to be used without any apparent cost penalty (either including an extra built-in booster circuit or offering dealer-replaceable boards or modules is a lot cheaper than producing special separate 'black boxes with connectors, power supplies and the like.) Straight factory/dealer options of this type that carry no extra cost are available from specialist amplifier firms like Naim and Meridian and a very large proportion of the more upmarket imported amps now carry options for connecting both types of cartridge. However, in some cases the performance of the 'MC' input stages leaves a lot to be desired.

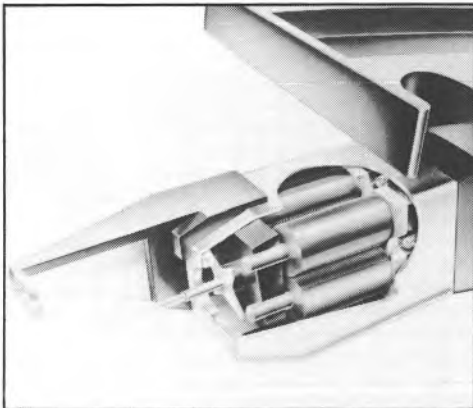

Cutaway 'moving magnet' cartridge (B&O) showing the four sensing coils for stereo operation.

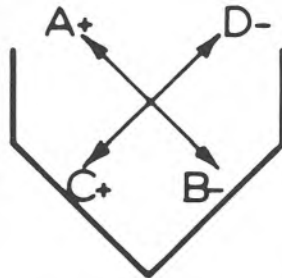

The stereo disc: this diagram represents either cutter or stylus. The lines A+ to B- and C+ to D- show the direction of vibration corresponding to the signals of each channel. A side-to-side vibration of cutter or stylus will cut or read (respectively) two signals of the same size and phase (both channels moving to '+' at the same time). This gives a central mono signal. A vertical cut gives equal size signals but out of phase, so that the two channels when mixed together will cancel.

CONSUMER INTRODUCTION

The disc itself

If one is going to discuss cartridges, then it is helpful to know something about the discs they are intended to reproduce. To go into the subject in any detail would require a book or two, so this description must deliberately try to leave out as much as possible and concentrate on the essentials. Starting with the programme which is to be recorded, this may come from a tape or 'direct' from musicians (a number of 'direct cut discs' exist that are aimed primarily at the hi-fi market and claim improved sound quality through omitting tape recorders from the chain — however, this may be outweighed by other technical limitations, and the performances themselves contain inevitable blemishes because a whole LP side must be cut with no editing). This programme either already exists as an 'electrical model' of the sound on the tape, or is converted to such by microphones, and is then suitably amplified and sent to a disc cutting machine. This is like a heavily engineered vertical lathe, with the cutter head mounted above a giant turntable platter.

A very carefully-made 14in blank lacquer master disc of relatively soft plastic on a precision aluminium blank is securely held down on the platter by vacuum suction. The cutting head consists of an accurately shaped diamond chisel which is held precisely in position by a number of feedback-controlled motors and then 'waggled' by the audio signal to trace a physical model of the signal into the plastic surface of the blank. A lot of sophisticated engineering is used to ensure a good result is obtained, with a jointless groove spiral cut into the plastic. A series of moulding and electro-plating processes ends up with a metal 'negative' stamper which is used to press the finished discs from lumps of hot malleable vinyl, and this should correspond pretty closely to the original 'cut'.

To give the required two signals for stereophony, the cutter head is 'waggled' by two different (though often similar) signals, so the head is driven by two motors diagonally disposed, as shown in the diagram. Thus if only one channel is cut, only one motor will be used and the cut will all be made along the same line: when both channels are used and fed with a complex stereo music signal, the cutter head is jiggled around in all directions by the action of the two motors.

The angle, as viewed from the side, of the cutting stylus edge to record surface is

supposed to be held to an international standard, so that the playback stylus can be set up to read it accurately, although there is a certain amount of variation and some controversy concerning exact angles, due to claimed springback effects in the plastics used for both cutting and playback for example.

Practical disc replay

The disc was cut using a heavily over-engineered machine costing many thousands of pounds, with the actual position of the cutter with respect to the disc always known and tightly controlled; unfortunately the same situation does not exist for playback. The cutting process involves varying the width of the groove according to the type of program at any particular time, so the 'pitch' of the groove spiral, or the distance between the grooves in successive revolutions, varies from place to place; this system enables greater dynamic range and playing time to be cut than would be possible with a fixed pitch. The mass production of the discs inevitably leads to errors in the exact centring of the spiral and a certain amount of warping.

So when it comes to placing a cartridge in exactly the same position as the cutter head, for the stylus to replicate the motion of the cutter and thus extract a similar signal to the one that went in, there is always a measure of uncertainty. The cartridge cannot be simply driven across the disc surface in a lathe like structure, but must be enabled to follow the pitch changes, eccentricities and warps. Although an enormous number of variations on the pivoted pickup arm theme have been used with varying degrees of success, all the systems involve fixing the cartridge arm in a carrier that allows the cartridge to move itself up and down from side to side. The stylus not only has to trace the groove modulations, it also has to support the cartridge and pickup arm head and make sure that they are in the right place to enable the stylus to get on with the business of reading the information in the groove.

To take extreme examples, if the stylus was fixed to the cartridge with a completely rigid cantilever, this task of following warps and suchlike might be fairly easy, but then there would be no relative movement possible to produce the signal corresponding to the record modulations! If on the other hand the cantilever was totally flexible, it would cope

THE GARROTT BROTHERS

work on the Decca cartridge is known well enough — especially since the development of the Garrott Micro-Scanner stylus. What is not sufficiently well known is that the sort of improvement wrought upon the Decca by Messrs.

Garrotts can also be enjoyed with almost any cartridge. A recent letter from an Austrian client said:

"I am delighted with the Micro-Scanner. Although some might say conversion of a Supex 901 might be trying to make a silk purse of a sow's ear, I find that the Micro-Scanner has produced a major improvement in a system that was pretty good before. Specifically, I have been able to move the speakers closer together, because, somehow, the sound stage seems wider, and while my favourite records still sound different, from record to record, they all sound better. But perhaps most unexpected is a significantly lower noise level, both on click from scratches and the virtual elimination of the hiss and other low level noise on many records. On a DMM disc the lack of noise is clearly on a par with that of Compact disc."

(copy available on request)

Cost of the above work? £120.00

Delivery period is about 4 weeks from receipt of cartridge and payment.

Details from:

The Parabolic Stylus Co.
P.O. Box 38
Torquay TQ1 1BW
Tel: 0803-26791

COSMIC

OPEN 7 DAYS A WEEK

9.00-6.00



YAMAHA K320



DENON DRM22

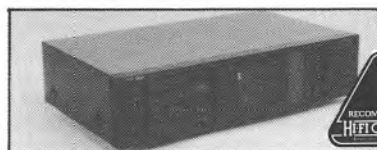

NAKAMICHI BX150

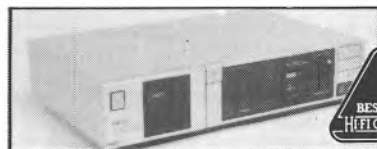

AKAI HXR44



AIWA ADR550



- Part exchange + credit facilities
 - Mail order. Acces + Barclaycard welcome.
- Aiwa, Denon, Dual, Fisher, Harman/Kardon, Hitachi, JVC, Luxman, Marantz, Nakamichi, Pioneer, Revox, Sansui, Sony, Teac, Technics, Yamaha.

244-256 STATION ROAD,
ADDLESTONE, SURREY,
WEYBRIDGE (0932) 54522/51753/43769

CONSUMER INTRODUCTION

with the recorded modulations, but be unable to drive the cartridge along the spiral of the groove and would flap all over the place, producing enormous outputs from warps and the like.

Low-frequency resonance

What is needed is a happy medium, so that the arm and cartridge follow the record imperfections and they are not reproduced by the cartridge, while the actual recorded modulations are traced by the stylus and give the appropriate signal output. This is achieved by selecting the appropriate 'springiness' in the cantilever hinge or pivot the 'spring' actually being a compliant rubber bung. Any combination of springiness and mass acts in a reasonably predictable way in response to different frequencies.

At low frequencies (where the record eccentricities and warps tend to occur) the spring remains stiff, and this is known as the 'stiffness region'. At a frequency that depends on the 'springiness' (known as compliance) and the mass of the arm and cartridge combination, there is a condition known as 'resonance' — the 'natural frequency' of the system, a very slight excitation will cause poorly-controlled large oscillations. At frequencies above resonance, the spring moves and the cartridge and arm stay stationary, so this 'compliance region' is where the cartridge actually works. In practise the audio signals we require from the disc are above 20Hz, while the imperfections that we don't want are mainly below 6Hz, so the system is best designed to have its resonance somewhere between these two, where there will be least danger of it being heavily excited.

However all is not yet straightforward; there are resonances and resonances. In order to prevent the resonance from being too violent and actually throwing the cartridge out of the groove, some damping is usually applied. In technical parlance, this changes the 'Q' of the resonance from a high to a lower value, so that it is less violent, but in the process spreads the effect over a somewhat wider range of frequencies. In practise the resonance usually raises the output from the cartridge by several times over a range of about a (subsonic) octave, and this uses up most of the 'free space' between the audio signals and the unwanted subsonic signals, so the correct placement of the cartridge resonance is a matter of great importance. If it is too high, the system will

tend to sound a little heavy in the bass (which may not matter too much with the majority of speakers in use, or on the majority of systems), but it also introduces phase shifting which some may feel gives a muddling effect in the extreme bass. If it is placed too low all the evidence suggests that it will cause unwanted large stylus excursions that will produce unpleasant distortions up in the audio region.

Arm design

So it is obvious that some care must be taken to match the arm and cartridge correctly, by ensuring that the combination of cartridge mass and the effective mass of the arm, when taken with the cartridge compliance, gives a resonance at the optimum frequency (10Hz for *Choice*). Happily the days of heavy S-shaped detachable head arms seem to be fading fast, and a variety of recent developments like the P-mount system, stiffer lighter cartridges, and lower mass straight arms means that the grosser mismatches of the past are easily avoided.

While the compliance/mass system described has been chosen to allow the cartridge as a whole to track the groove successfully, the best situation for tracing the modulations from the stylus' point of view would be an arm head of infinite mass! The only way it is possible to achieve this is to make the arm almost infinitely rigid instead, so that the stylus sees the entire mass of the turntable system reflected through the rigid arm, headshell, and cartridge. In short we require a fairly light arm to allow vertical or horizontal movement for tracking, but one that is infinitely rigid for accurate tracing with respect to other forces (such as torsional modes) generated by the cartridge.

This rigidity is necessary because movement of the stylus with respect to the cartridge body works against the compliance and damping, so energy is transmitted into the cartridge body by the stylus movement. If the cartridge itself is designed as a reasonably strong mechanical structure, and moreover one that can be fixed firmly into the headshell, and if rigidity is maintained throughout the construction of the cartridge and arm, then there is a reasonable chance that the wagging of the cantilever will be translated into a satisfactory accurate electrical reconstruction of the original signal. If however the rigidity is not maintained — and at any rate all practical examples of arms show significant loss of

The logical step forward



AN Audio, St Neots, Cambs CB8 7JZ 01
Audio Arts (Edinburgh) Ltd, Edinburgh
 031 7263979
Alternative Audio, Solihull, West Midlands
 021 7427254
Acoustic Arts Ltd, Watford, Herts SG13 3JN 01
Audition Hi-Fi Studios, Leicester Forest East
 LE3 3HG 0533 353807
Audio Services (Cambridge) Ltd, Cambridge
 02 2368305
Aurek, St Annen un Sea, Lances F8 1GG
 0153 719111
Avion d'Or (Aldershot), Gosport, Hampshire
 0458 53370
Aylesbury Hi-Fi, Bucks, 02962 8790
Bridge Hi-Fi, Walsall, West Midlands 0922
 64046
Bartlett, London N7 8JB 01 6072296
C.A.T. Electronics, Hare, Stoke on Trent
 08275 194
Cosmic Radio, Addlesea, Surey 0925254522
Cricks Chace, London 022 238718
D.F. Clarke Audio Services, Rushden
 Northants 093351349
Electric Trader (Hoddeston) Ltd, Rus on Sea
 Cymru Bay, Cymru Wales 049248932
Peter Ellis Audio, Newport, Neath 0636 304571
Graham Hi-Fi, London N1 01 8374412
Graham Mally, Bournemouth, Dorset 0332674929
Gleam Audio Ltd, Middleborough, Cleveland
 064 2248793
Harrow Audio, Harrow, Middlesex 081 0601
Halburn Hi-Fi, Aberdeen 0224585713
Houlton Hi-Fi Ltd, Gloucester 0452 25352
Houlton-Restling Ltd, Cardiff, South Wales
 0222 48011
Huddersfield Hi-Fi Centre, Huddersfield
 0484 4668
Image Hi-Fi Ltd, Huddersley, Leeds 0532
 789376
J.C.V. Organisation Ltd, Warwick 0926493796
Jaffrey, Brighton Sussex 0273609411
J.D. Stereo, Chippingham, Wiltshire 049664367
K.J. Leisure Sound, London 01 4868763
Martina Hi-Fi Centre, London N16 01 2545053
Meland Hi-Fi Studios, Wolverhampton Staffs
 0902 717174
Moorgate Acoustics, Rotherham S60 1AP
 0709 0666
Nick Dakin Ltd, Nottingham NG15 0R
 0602 783862
Nottingham Hi-Fi, Nottingham 0602 786919
Perfect Electronics, Alton, Beds 0453
 021 82333
Phonograph, Pulney, London SW15
 01 7892349
Prism Audio, Glasgow, Scotland 081 333 1779
Salford Hi-Fi Centre, Salford 02222 169
Shannon Radio (Manchester) Ltd, Urmston
 Manchester 061 7482339
Sounds Expensive, Rugby, Warwickshire
 0188 79736
Standards (Tonbridge) Ltd, Tonbridge Kent
 073353540
Suttons Music Centre, Bournemouth Dorset
 020275512
Suttons Music Centre, Southampton Hants
 01332481
Subjective Audio Ltd, London NW10 JH
 01 3818281
The Audio Council, Odham, Lancs
 061 6332602
Techno Sound Ltd, Central Milton Keynes 0908
 04949
University Audio, Cambridge 0223364237
Unial, New Malden 01 9429567
Urbidge Audio, Liphridge, Middlesex 0895
 33676
Westwood & Mason (Dorset) Ltd, Dorset
 012048 08524783
Zeus Audio, Dungannon, Co Tyrone N Ireland
 0868 740254

Please send me more information on Tempo front end combinations

Name _____

NHS 1/85

Address _____

Clip the coupon and send it to Logic Limited, 19 Hurlbutt Road, Heathcote Industrial Estate, Warwick CV34 6TD



LISTEN TO LOGIC
AND YOU WON'T THINK
ANY OTHER WAY

CONSUMER INTRODUCTION

rigidity at some frequency or another — then the cantilever generator and the stator will both move together at such frequencies. Hence lack of rigidity and/or structural resonances lead to coloration and loss of information.

The lower the cartridge's compliance, the greater the amount of energy it feeds into the arm, and hence the more crucial the rigidity of both cartridge and arm.

High-frequency resonance

We have already discussed cartridge damping as an aid in partially controlling the LF resonance of the arm cartridge, but cartridge designers also have to deal with another a second resonance this time at the high frequency end of the spectrum. This high-frequency resonance also arises from a mass/compliance situation, but here the interaction is between the springiness of the disc vinyl and the mass (or more accurately effective tip mass) of the stylus itself.

The compliance of the vinyl material is fairly well fixed, but there is some variation with tracking pressure in the actual compliance seen by the stylus contact area. In order to ensure that this resonance is beyond the range of audibility, the mass of the stylus and mass and length of cantilever and generator must be kept as low as possible, although once again this must not be done at the expense of rigidity. It is in the nature of resonances that they do not sound very nice, so any cartridge that does not attempt to remove the resonance to the supersonic region is likely to sound less good than one which does — this generalisation is certainly borne out of the results of *Choice* listening tests. Unfortunately, the micro-engineering involved in lowering the tip mass (and hence raising the resonant frequency) tends to be expensive! Mechanical damping in the cartridge's moving system may be used to tame the resonance, but a compromise must be reached with the amount of damping requires to cope with the rest of the frequency range satisfactorily; in an attempt to avoid compromising the damping requirements at different frequencies, some cartridges (for example Shure *V15IV*, Ortofon *MC30*) use a complex mechanical filtering system to apply controlled optimum amounts of damping at different frequencies, the extent to which this has been successful can be gleaned from the relevant reviews.

Detachable stylus

Many cartridges — indeed nearly all the moving magnet types — are fitted with removable stylus assemblies. This has the advantage that the owner can purchase a new stylus assembly without taking the unit out of service (if the stylus is only starting to wear, rather than the cantilever being damaged through mishandling.) However, manufacturers whose products do not have this facility normally arrange for dealers to provide an instant cartridge replacement service at a stylus replacement price. So unless one wishes to change styli frequently (for example the collector who wishes to substitute an assembly suitable for 78s, or the family man who would rather let his kids loose with something less expensive or exotic for their 45s) there is probably little to be gained. In fact the incorporation of a plug-in device necessarily involves *some* engineering compromise, because where a push-fit plug and socket exists there must be a degree of flexibility (and consequently some risk of freedom of movement between generator and stator with consequent danger of spurious signals and information loss). Having said that, some stylus assembly fitments are undoubtedly better engineered than others. When we asked one of the only moving magnet manufacturers who does *not* use a detachable stylus assembly (B&O) why they sacrificed this possible sales advantage, they stated that in their view the engineering compromises were too great, and that they would also rather check that the complete cartridge met specification on leaving the factory than chance a stylus/body mismatch of any sort.

Design of moving parts

Finally we come to the requirements for the generator system itself: the stylus, cantilever, and moving-coil or magnet (or whatever else.) Mechanically speaking the hinge or pivot that connects this moving assembly to the 'stator' body is the most crucial part, as this has also to provide the compliance. The hinge must allow horizontal and vertical cantilever motion, but minimise twisting or longitudinal (along the line of the cantilever) motion, and should remain stationary itself. It is important that the geometry of the entire assembly has been properly set, so that at the chosen tracking weight the generator lines up precisely in the groove with the agreed 20° vertical tracking angle and accurate horizontal alignment.

WARNING

A WORN STYLUS
WILL DAMAGE
YOUR RECORDS

REPLACE
YOUR STYLUS
TODAY WITH
A GENUINE
CONDOR
DIAMOND STYLUS

We have one of the largest stocks of Swiss and Japanese made diamond styli.

For your nearest **Condor** stockist please write to our Public Information Department,



Condor Electronics Limited,
Woodman Works,
204 Durnsford Road,
London, SW19 8DR

TRADE ENQUIRIES

If you are not already a Condor stockist please get in touch with our Sales department and ask for details of our 'Styli Starter Kits'.

LINN SONDEK, NAIM, ARC, NYTECH, KRELL

We Are
Surrounded
By
The
Best Names



Simply Hi-Fi

48, Spring Bank, Hull
Tel: (0482) 29240

Now solely under
The personal
supervision of
Walter H. Smith

MERIDIAN, OAK, SYRINX, AUDIO TECHNICA, ORTOFON, CELESTION, THRESHOLD, KOETSU, ORACLE, AUDIO RESEARCH, ETUDE, SUMIKO, TALISMAN

ARISTON, MISSION, NAD, BEARD, CREEK

A&R CAMBRIDGE, ACOUSTIC RESEARCH, HEYBROOK, YAMAHA, NAKAMICHI, DUAL, MONITOR AUDIO, MARANTZ, QUAD, KEF, MORDAUNT SHORT

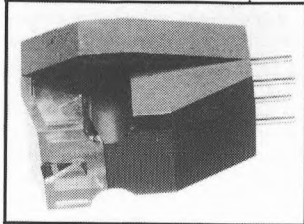

RATA RP20

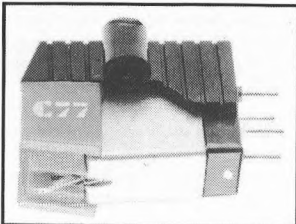

A&R C77

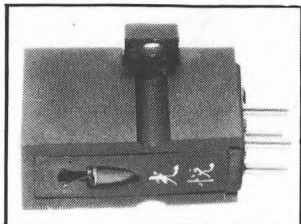

KOETSU BLACK

RECOMMENDED BY THIS MAGAZINE

Other agencies include:

A&R • AUDIOLAB • BURMESTER • BRIER • BREUER • CELESTION • CREEK • DUAL • ELITE • TOWNSHEND • GOLDRING • GRADO • GALE • HELIUS • JPW • KOETSU • K.E.F. • KRELL • LINN PRODUCTS • MAGNAPLANAR • MERIDIAN • MISSION • MICHELL • MORDAUNT SHORT • MUSICAL FIDELITY • MYST • NYTECH • NIGHTINGALE • ORACLE • ONYX • PERREAUX • PINK TRIANGLE • PROTOU PS AUDIO • QUAD • REGA • ROGERS • ROTEL • SYSTEMDEK • YAMAHA • SUPEX • ZETA

KEITH MONKS RECORD CLEANING SERVICE AVAILABLE

Reading Hi-Fi Centre

READING HI-FI CENTRE, 6, HARRIS ARCADE,
FRIAR ST., READING, BERKS. RG1 1DN. TELE (0734) 585463
Tues-Sat: 9.30am to 5.30pm. (LUNCH: 2 to 3pm. EXCEPT SAT.)
DEMONSTRATION APPOINTMENTS ADVISED!

Closed all day Monday



TARGET AUDIO PRODUCTS

HAVE THE ANSWER TO YOUR PRAYERS — WELL SOME OF THEM ANYWAY!

TT1 Do you have charging children, dashing dogs or just wonky floors? Then the TT1 could be the answer to one of your prayers. The TT1 is a very rigid turntable wall unit, with the shelf isolated on upturned spikes, ensuring that you get the ultimate results from your turntable.

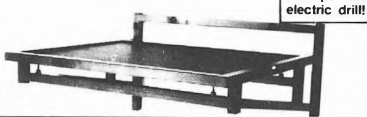

SPIKE KIT Have you recently bought speaker stands that do not have spiked feet and you are now saving up for another set — then Target Audio have the answer to another of your prayers. A complete spiked feet adaptor kit—everything you need to convert your stands to spikes — except an electric drill!



TT2 If you have none of the problems that make the TT1 so attractive, then the TT2 is the answer for you. This is a turntable table with a few extras. It has adjustable lockable spiked feet to make it perfectly level. These same feet are used to support the top shelf, which has metal discs fixed to the underside to ride on the tips of the spikes to ensure isolation with great rigidity. The TT2 is 20" tall, so you don't have to be a contortionist to change a record. It also has a lower shelf to take the electronics or what have you.



S1 The S1 is a very rigid three-legged speaker stand, standing 17" tall, with a 7" x 7" platform for the speaker and stands on adjustable lockable spiked feet. Suitable for all medium sized cabinets.



S2 The S2 is made to the same design as the S1, but stands 24" high. Suitable for the smaller ranges of speakers.



*The S1s are excellent stands and provide firm support...
- G. WATSON NFR, May 84

S3 The S3 is also a three legged stand, but has a 11" x 11" speaker base and stand 12" high and is suitable for the larger speakers.



WHY NOT CALL IN TO YOUR LOCAL DEALER TO HEAR THE DEMONSTRABLE DIFFERENCE THAT
"THE MOST POPULAR SPEAKER STANDS IN THE U.K. CAN MAKE TO YOUR SYSTEM;
OR CONTACT US FOR FURTHER DETAILS"

TARGET AUDIO PRODUCTS, UNIT 10A, BRITANNIA ESTATE, LEAGRAVE ROAD, LUTON, BEDS. TEL. (0582) 424755

CONSUMER INTRODUCTION

One of the frequently quoted performance criteria for a cartridge is 'trackability', which refers to the ability of the stylus to remain in contact with the groove modulation; at all times, and thus cope effectively with whatever has been cut onto the record. If this stops happening the result is mistracking which sounds unpleasant and also causes groove damage. Mistracking is usually heard as a crackling or crunching distortion on loud or complex passages. Moving-coil cartridges tend to mistrack in a more insidious way — instead of producing a sudden burst of treble distortion as the stylus momentarily 'lets go' of the groove, a low-compliance moving-coil will typically start to sound grainy or coarse at the onset of mistracking. Grooves damaged by mistracking (commonly found at the end of record sides when these have been played many times on an old autochanger!) will subsequently always produce a sound like that of mistracking, unless the stylus profile used is one which rides on a previously untouched part of the groove wall.

Trackability is certainly a vital parameter, but it should be considered in the context of other perhaps less easily-defined areas of cartridge performance. As the tests in this book show,

the cartridges which did best on listening tests were not all particularly good trackers — although the test bands used for tracking tests in any case offer more severe challenges to the cartridge's ability than most music discs. In practice, trackability is more crucial on some types of music than others, and large scale choral works for example will be very unforgiving of poor tracking abilities.

Stylus tip types

The groove width on a record has been standardised within limits for many years, so there is little chance that the stylus will not fit the groove at all. This does not mean that there are not a lot of problems for the engineer in getting the best performance. The fundamental trouble is that the cutter uses a 'V'-chisel type of profile with a straight cutting edge, yet if the stylus gets too close to mimicing this, it will damage the groove by doing a little cutting of its own! The original stylus shaped used was the spherical tip, chosen because it is by far the easiest to make and doesn't require careful lateral alignment. The spherical stylus leaves a circular 'footprint' on the groove wall which has a distinct 'length' that will naturally limit its ability to get in and out of the shortest

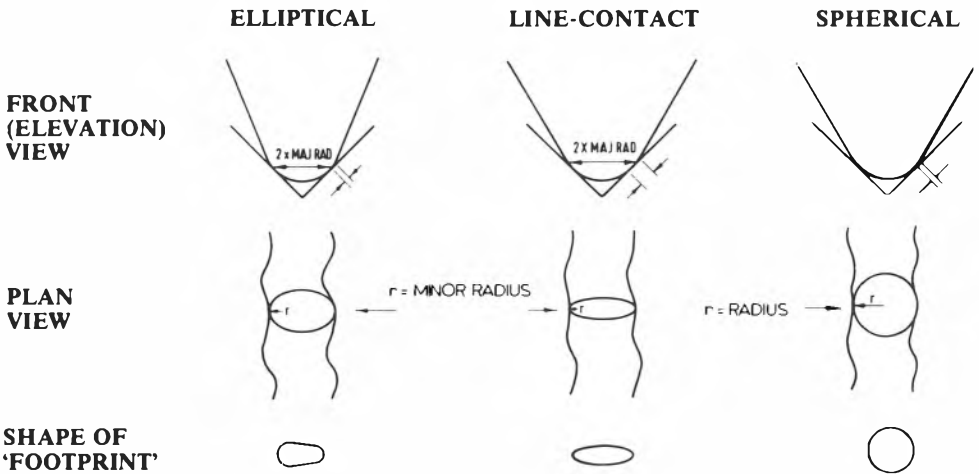

Different stylus types: The three sets of diagrams above attempt to show the difference between the main types of stylus profile, although these two-dimensional views cannot show the 3-D forms accurately. The 'footprint' shows the shape of the tip's contact area on the angled groove wall, and is not drawn to scale.

CONSUMER INTRODUCTION

modulations. This is fairly unimportant at the outside grooves on the edge of the disc, because here the vinyl is travelling comparatively quickly past the stylus, and the modulations are well spread out; towards the centre of the disc, where each successive revolution uses a comparatively shorter length of vinyl, the length required for the shortest wavelength (high frequency) modulations becomes smaller than the length of the footprint, so the stylus is unable to follow the groove modulations accurately.

This form of tracing distortion was first tackled by the introduction of elliptical styli, which made a shorter footprint on the groove wall and largely overcame these difficulties. To avoid groove damage, which for a constant tracking weight will increase as the area of the footprint decreases, these elliptical styli had to use a lower tracking weight, and their introduction certainly contributed towards the race to lower and lower tracking weights and higher compliances which has by now been fairly discredited as an end in itself, because of practicality and compatibility problems.

Having reduced the contact area by shortening the length of the footprint, it was quite a while before it was increased again by increasing the height up the sides of the groove. The original stimulus was to improve supersonic tracking for quadraphonic (CD 4) use, and the early examples got something of a bad reputation for increasing surface noise effects due, it was claimed, to them scraping too close

to the groove bottom. However nowadays nearly all the top designs use some form of 'line contact' elliptical profile, under a variety of trade names such as Aliptic (ADC), Fine Line (Ortofon), Hyper Elliptical (Shure), but there is some doubt whether they do offer any improvement over the conventional elliptical unless the alignment is absolutely correct. Actual stylus profiles are discussed, in the light of the test results, in the *Conclusions* section.

Amplifier matching

All normal amplifier disc inputs have particular characteristics in the load they present to the cartridge. Basically this consists of a certain value of resistance around 50kohm, plus a small amount of capacitance. Further parallel capacitance is added by the pickup leads themselves. Typical moving magnet cartridges may have a fairly high source resistance, but more significant is the inductance of the long coils of wire used. This combination of inductance capacitance and resistance produces an electrical resonance, which is very similar to the mechanical resonances described earlier. In fact the values involved are such that the electrical resonance is found in the same area as the tipmass/vinyl resonance — at the HF end of the audible frequency spectrum.

By careful control of all the variables involved, designers can make use of the electrical resonance — for example either to roll the cartridge off electrically before the

Arm and cartridge resonance matching: the low-frequency resonance of an arm/cartridge combination can be calculated from the arm effective mass, cartridge mass and cartridge compliance. Add together the arm and cartridge masses, and draw in the corresponding vertical line. Then draw in a horizontal line corresponding to cartridge compliance. Where the two lines intersect, the resonant frequency can be read from the diagonal scale. The shaded area is the optimum area within which the lines should intersect.

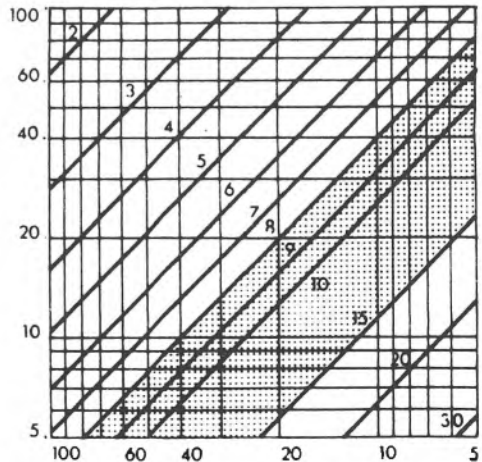

MAYWARE *World's Best Value High Fidelity Combination*

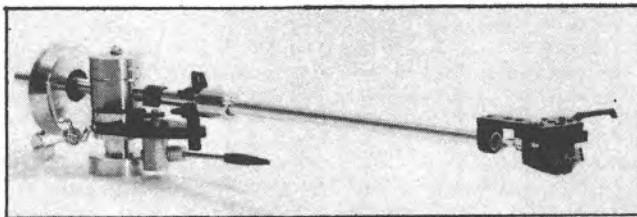

FORMULA MK.IV + MC-2V

"Indeed the combination of MK.IV + MC.2V cartridge (with T-24 transformer) reproduced my sequence of Test Records with unusual accuracy and tonal naturalness"

John Borwick GRAMOPHONE

For further information and full review reprints please complete and return this coupon.

NAME

ADDRESS

HFC12/84

MAYWARE LTD.

P.O. Box 58, Edgware, Middx. Tel: 01-958 9421

AURAK

The Hi Fi Specialists who care

We have stressed in the past, and still do, the importance of a correctly balanced and set up turntable, arm and cartridge. The amplifier and speakers are also important in playing their part in a system. Technical specifications, are only a guide to the products competence on a lab bench and do not tell us what they sound like.

We at Aurak not only pay attention to cartridge loading at the pre-amp input but to amplifier and speaker load matching, cables, amplifier support and other small, but important details that can give an inexpensive system rhythm and coherence to the music, allowing one to enjoy playing records without listening to the equipment.

**2nd Floor Suite,
46 Wood Street, St Annes on Sea,
Lancashire SY8 10G
0253 729111**



Open Tues Sat 11am-5pm.
Evening demos by appointment.



**"YOU DON'T HAVE TO BE A HI-FI
BUFF TO COME AND TALK TO US"
(BUT THEN YOU COULD BE!)**



WE STOCK THE PRODUCTS THAT
IMPRESSED THE EXPERTS AT
HI-FI CHOICE
STOCKISTS OF QUALITY PRODUCTS
Audio Technica, ADC, Bang & Olufsen, Glanz,
Goldring, Grado, NAD, Nagaoka, Ortofon, Osawa,
Shure
YOU'VE READ THE REVIEWS NOW
LISTEN FOR YOURSELF
**105 HIGH STREET, ANDOVER
HANTS. TEL: 0264 58251**

CONSUMER INTRODUCTION

mechanical resonance and so minimise its effect, or to use the electrical resonance to counteract the effect of damping and so extend the flat response region somewhat. While these techniques were undoubtedly useful in the past by enabling at least a reasonably flat output across the audible band to be obtained when materials and standards of cartridge engineering were less refined than they are today, this balancing of resonances is rather a crude technique.

Not only are resonances undesirable *per se*, because they are indicative of a loss or lack of control, but the cartridge designer is not in any real position to influence the amplifier designer who controls some of the variables. So increasingly moving magnet cartridges have their electrical as well as their mechanical resonances removed to the supersonic regions, while amplifier designers are tending to provide a range of options to help the user obtain the best match. But some amplifiers currently on sale have a very high input capacitance, which will give most cartridges a treble peak followed by severe rolloff. On the other hand, a few cartridges need a higher capacitance than that provided by most amplifiers!

Some cartridges are relatively impervious to changes in electrical loading, and providing they do not suffer from other design problems this is a good thing. The great majority of moving-magnets show small variations that can have a subtle but still significant subjective effect, yet provided their optimum loading is around the same as the typical loading presented by the majority of commercial systems, the customer is unlikely to end up with a totally 'wrong' result. As a rough guideline, most preamplifiers offer 47kohms plus around 50pF; most arm wiring negligible resistance plus about 150pF. The system is thus likely to present a total load to the cartridge of 47kohms plus 150-250pF. Others require loading that is rather different to the current norm, and may benefit from the use of special pickup leads (SME) or adaptors (RTJ) to achieve decent results. Throughout the reviews we have examined loading very closely, recommending the figure which we feel is optimum, and commenting if the cartridge behaviour is particularly critical to its loading.

By and large moving-coil cartridges do not suffer from these electrical matching problems at high frequencies, because their inductance is very small. However there is no real

standard for the requirements of the matching circuitry beyond those defined by actually making a cartridge which works, so there is considerable variation between different models, and these can occasionally cause problems. The *Technical Introduction* examines this rather more carefully, and each cartridge really needs to be examined on an *ad hoc* basis to ensure that there is no danger of matching problems in other areas, such as low frequency saturation in transformer devices or high frequency bandwidth problems. The upper frequency limit of a typical moving-coil cartridge may be electrically as high as 500kHz (0.5MHz) because of its low inductance, and while it may not be mechanically capable of transducing real signals at these frequencies, it is quite possible that spurious distortions could be produced and upset a head-amp or even some disc inputs.

Where there are potential matching problems with moving-coil cartridges we have tried to draw attention to them in the appropriate reviews.

CHOOSING A CARTRIDGE

Whether you have reached this section after ploughing through the preceding preambulations that have attempted to explain some of the complex interactions involved in cartridge design and system matching, or have merely jumped here in the hope of some simple advice, the fact remains: getting the best out of a system involves considering and juggling a large number of variables, many of which are either obscure or just plain cussed. To even start to make a choice, it is necessary to try and settle some of these, and the most obvious starting point is price. How much is it worth paying for a cartridge? Well as with most things the very best is going to be fairly expensive, yet at the same time there are some very good cheaper designs, and the law of diminishing returns does tend to apply.

Balancing the system

Crucial to the whole question of cartridge choice are the accompanying turntable and arm. All three components add their various distortions to the sound, and while it is still possible for the experienced ear to hear the excellence of one component through the limitations of another, this is not really relevant to a domestic system, where some degree of balance between the different components should be achieved.

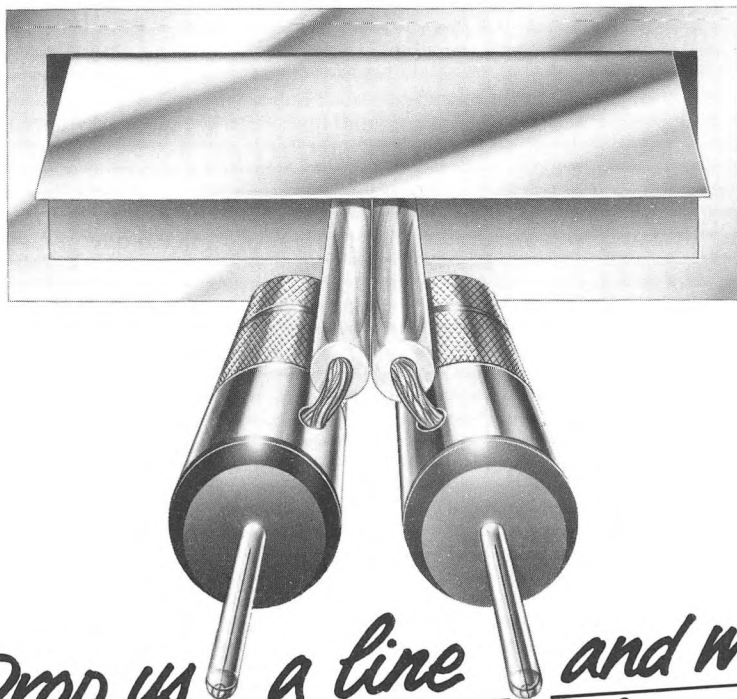

*Drop us a line and we'll
send you a cable*

Connecting your amplifier and speakers with one of the many special cables can dramatically improve the sound quality of your system. More and more reviewers are emphasising the benefits of fitting special cables and terminations.

But getting hold of exactly the right cable, in the right length is always a problem. And then you have to find the right terminations and accurately mount them.

Well now you can have cables tailormade to your requirements with the connections of your choice already fixed and individually tested.

And what do you have to pay for this service? No more than you'd pay for the separate items from your local hi-fi store (if only he has the stock). And for an extra £1.50 we'll pack them and post them to your door.

Send today for our free booklet and fully detailed order form.

**MILES OF CABLE IN STOCK. ABSOLUTE: AUDIO TECHNICA: CORAL: HITACHI: MISSION: MONITOR AUDIO:
MONSTER: MIT: NAIM: Q.E.D.: RANDALL: R.S.: SUPRA: ULTRA: VAN DEN HUL.
ALL THE RIGHT CONNECTIONS INCLUDING BANANA PLUGS FROM MICHELL ENGINEERING**

Name _____

Address _____

**CUSTOM CABLE
SERVICE**

Custom Cable Service, UNILET HI FI, 35 High Street, New Malden, Surrey. 01-942 9567.

CONSUMER INTRODUCTION

If one is assembling an entire record playing system, then the choices of different permutations and combinations become legion. Fundamentally the turntable itself is the most important, because this supports and powers the entire system while providing the environmental isolation, all of which are vital functions in preventing unwanted vibrations from interfering with the arm, cartridge and disc; certainly a modest arm on a good turntable outperforms a good arm on a modest turntable.

Matching arm and cartridge

Assuming that a turntable is already fixed or has been chosen, the chances are that it will be fitted with an arm anyway — and it is the behaviour of the arm that should further help narrow down the choice of cartridge. If an arm has not yet been chosen, then the field remains wide open, but with the proviso that the match of arm and cartridge is vital, and a decision on one will certainly narrow the suitable choices for the other. The problems of matching arm and cartridge to get the very best from each are extremely subtle, and are not yet entirely susceptible to scientific analysis and mathematical solution. However, while some of the important interactions remain beyond our ability to formulate, though not beyond our ability to hear, other arm/cartridge effects are well known (even though they are frequently ignored), and it is possible to satisfy some of the requirements for a good match by inserting measurable results into a simple formula.

If for no other reason than that we understand it and can therefore do something about it, this mechanism which optimises the mass of the cartridge, the effective mass of the arm, and the measured compliance of the cartridge can be considered the 'primary matching function' of the two components. We have dwelt at length on the need to try to match these elements to achieve a fairly 'safe' resonant frequency and minimise distortions arising from large cartridge cantilever movements at disc warp frequencies both in this book and in *Turntables and Tonearms*, perhaps to the point of labouring it. But there is no doubt that satisfying this one requirement can immeasurably improve a hi-fi system, and surprisingly this is still not widely appreciated.

Checking that this primary match is accomplished may appear to be rather 'technical', but with the aid of the graph we have provided it is

simplicity itself. The values for cartridge mass and cartridge compliance can be taken from the test results at the end of each review in this volume. The values for effective arm masses are similarly prominent in *Turntables and Tonearms*, though they should also be available from the manufacturer concerned. You simply add the two masses together and draw in the corresponding vertical line, then uses the compliance value to draw in a horizontal line; the point where they intersect corresponds to the resonant frequency of the combination read off the diagonal frequency scale. The shaded area marks out the area where this intersection should lie to avoid problems. The absolute ideal does not exist as such, but we believe that 10-12Hz is the target to aim for.

Arm damping

But what of the secondary effects of arm/cartridge matching? There is not a great deal of advice one can give apart from recommending careful listening tests, because these are by no means properly understood. The first area concerns arm pivot damping, which is available on a number of separate specialist arms but not many integrated players — though recently JVC and Sony have introduced decks whose servomotor controlled arms give electronically-applied damping, and these are reviewed in *Turntables and Tonearms*.

Probably the best advice on arm damping is still, 'if it's available, try it, vary it, and don't feel you have to use it if you prefer the sound without it.' For some cartridges damping is always essential, but these are rare, however if a cartridge/arm combination has too low a resonant frequency, a little damping is nearly always helpful. The real problem with assessing the worth of arm pivot damping lies in the fact that it helps in one direction while hindering a little in others, so each case really needs to be examined in its merits — that is, by ear! All cartridges are underdamped to some degree at their LF resonance, and a little moderate damping (often an extremely small amount) at the arm pivots is often more help than hindrance, so we have tended to recommend this for many cartridges. But it is by no means essential, particularly if the resonant frequency is fairly close to optimum, and the provision or lack of damping is by no means a vital determinant when choosing an arm.

Armpivot damping devices are, in the con-

CONSUMER INTRODUCTION

text of cartridge behaviour, rather crude in their action and obtaining the precise amount of damping to achieve the best results is not easy. Other ingenious ways of helping control the resonance have been tried, including the damping brush attached to the Shure V15/V and V, and similar devices for attachment to headshells.

Arm resonances

The most important secondary effect, and yet the one which is hardest to quantify, lies in the area of cartridge (and turntable) induced arm vibrations. The need for both cantilever compliance (springiness) and damping and the net result whereby the disc makes the stylus work against this spring and damping material and pushes energy into the cartridge body was discussed earlier. This tends to make the cartridge body try to move against its supporting structure the arm, and even amongst designers there is disagreement about the best way to cope with the vibrations that are transmitted into the arm; some argue that they should be dissipated gradually or damped in the headshell or arm tube, others that they should be led down the arm and into the turntable itself via very rigid arm bearings. But the problem is basically intractable, and no solution is entirely right for all circumstances and tastes.

The cartridge will transmit vibrations to the arm depending upon its compliance and internal damping, plus its mechanical integrity. So while a low-compliance, low-internal-damping cartridge offers some benefits here, by transmitting less vibrational energy, its corresponding matching arm will tend to be flimsier (lower effective mass) and less able to cope with them. The amount of vibration transmitted will also be reduced if there is internal flexibility in the cartridge or in its fixing to the arm, but if this is the case, the battle to avoid spurious relative movement is already lost.

The sad fact of life is that no arms are particularly good at coping with transmitted energy, and all show quite gross defects by resonating at certain frequencies when excited. Every arm shows a distinct and repeatable, if highly complex, 'fingerprint' of its areas of weakness when vibrated, as we showed in *Turntables and Tonearms*; likewise cartridges could be shown to have similar patterns. What is needed is for some bright spark to work out how to interpret and derive compatibility from this type of measurement; sadly the complex-

ity of the task suggests this is a long way off.

When one considers the fact that the well-damped low compliance cartridge with high 'mechanical impedance' transmits more energy into the pickup arm than a higher compliance model that exhibits greater trackability at lower tracking weights, it remains a strong possibility that some of the inherent virtues of the former may be offset by a relative failure of the arm to cope as adequately. A generalisation from our recent work on tonearms was that the arm itself played a major role in determining the overall sound when comparing high quality cartridges of a similar type, so when considering the highest quality models we are deliberately cautious, and would emphasise that these 'secondary' effects, which are so difficult to pin down, do assume considerable significance.

This was aptly illustrated by the experiences of a friend who had the option of using two cartridges in an arm not noted for its rigidity, one a high compliance magnetic and the other a low compliance moving-coil; while he preferred the sound of the moving-coil in absolute terms, he found that the extra energy transmitted to the arm by this model seemed to upset the stereo image focusing, so with some reluctance he decided to use the moving magnet type because it seemed to combine with the arm to produce the better of the two systems.

As far as these secondary effects are concerned, there is little that our reviews can do to help, as it is quite impossible to listen to every combination, Provided that the primary considerations are satisfied, the rest must come down to personal listening and the advice of a dealer. There have always been particular combinations of specialist arms and cartridges that are habitually considered well-matched (for example SME/Shure, Hadcock/Decca and Grace/Supex), but these have usually become known through their promotion by the manufacturers; undoubtedly other 'symbiotic' combinations exist, but are less widely known or publicised, and it is really just a matter of checking out two or three alternatives to get a well-balanced result.

GETTING THE BEST FROM A CARTRIDGE

Simply choosing a well-matched combination of turntable, arm, and cartridge is unfortunately only part of the story. It is equally important to ensure that the combination is properly set up in order to realise its maximum

1/2" Mounting Bracket makes the new MMC generation a universal fit. The MMC cartridge weighs only 33g with the mounting bracket. Extra weight can be added depending on mounting screws, angles, weight etc.

Symmetrical Permalloy Body Shell closes the magnetic circuit of the cartridge, acting as a shield against the effect of external hum fields and makes it possible to design such a small cartridge.

Powerful Samarium Cobalt Ring Magnet forms one of the poles in the air gap allowing for total symmetry in the magnetic system and no loss of magnetic current giving high output.

Multi-radial, Contact Line Diamond (MMC 1&2) is ensuring you precise high frequency sound reproduction, low EIM and thereby low record wear and perfect tracking.

Hollow Tube, Crystal Sapphire Cantilever (MMC 1&2). The Sapphire is 5 times stiffer than aluminium and 40% stiffer than beryllium. The sapphire tube cantilever ensures linear transfer of signals since longitudinal vibrations are eliminated.

Patented Computer designed Moving Micro Cross Armature (MMC), which is x-shaped, ensures excellent channel separation over the entire frequency range. It is minimalised to ensure low EIM and thereby minimal record wear and internal resonance control.

High Output, Low Impedance Coils make for easy matching and less critical choice of tonearm cables and preamplifier input characteristics.

Specifically Formulated Elastomer Suspension, together with the precise, symmetrically mounted cantilever, ensures that the stylus has a single, accurate pivot point to obtain better stereo imaging.

The new MMC series. Cartridges for the digital age.

Every music lover knows the excitement which comes from discovering a new hi-fi component that has suddenly made his music sound decisively better.

You will make that discovery, and experience that excitement, with the new Bang & Olufsen MMC Series Cartridges.

No longer will you have awareness that a cartridge has interposed itself between the music as it was recorded, and the music you are hearing. On the contrary, you will delight in finding new depth, detail and spatial perspective in even your most familiar recordings.

The cartridge as an electronic component.

The phono cartridge, of course, is by nature an electro-mechanical component. However, Bang & Olufsen has succeeded in virtually removing the performance

limitations placed on the cartridge by its mechanical design. The result is a change in cartridge performance so astounding, you might conclude that the new cartridges have become electronic components for the new age of improved software.

You already have the right turntable for an MMC cartridge.

The new MMC Series contains a cartridge that will match or exceed the abilities of the turntable you own. In fact, you may well find that your turntable has more potential than you imagined. A correctly matched MMC cartridge simply makes high performance possible where it wasn't before. And at prices starting from around £21, the improvement will be far from expensive!

The use of Samarium Cobalt for the MMC's ring magnet has allowed a significant reduction in the pickup's overall size. Its extreme smallness and lightness (only 33g including 1/2" mounting) means that the advantages of the MMC technique can now be enjoyed by users of heavier arms too!

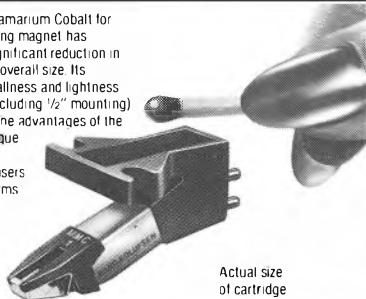

Actual size of cartridge

	MMC 1	MMC 2	MMC 3	MMC 4	MMC 5
Stylus diamond	Unframed contact line	Unframed contact line	Unframed elliptical	Titanium bonded elliptical	Titanium bonded elliptical
Cantilever	Sapphire tube	Sapphire tube	Tapered aluminium tube	Tapered aluminium tube	Straight aluminium tube
Effective tip mass	0.25 mg	0.3 mg	0.35 mg	0.4 mg	0.5 mg
Compliance	30 $\mu\text{m/mN}$	30 $\mu\text{m/mN}$	25 $\mu\text{m/mN}$	25 $\mu\text{m/mN}$	20 $\mu\text{m/mN}$
Frequency response	20-20,000 Hz ± 1 dB	20-20,000 Hz ± 1.5 dB	± 2 dB	20-20,000 Hz ± 2.5 dB	20-20,000 Hz ± 3 dB
Channel separation	>30 dB/1KHz	>25 dB/1KHz	>25 dB/1KHz	>22 dB/1KHz	>20 dB/1KHz

See and hear these amazing new cartridges at your local Bang & Olufsen dealer (he's listed in Yellow Pages under Television and Radio Shops) or send for the free Design Story to us, Bang & Olufsen UK Limited, Dept HC2, Eastbrook Road, Gloucester GL4 7DE. Telephone (0452) 21591

Bang & Olufsen

CONSUMER INTRODUCTION

potential performance. For the vast majority of players this is really just a matter of mounting the cartridge very tightly and with the correct alignment. Some of the very best turntables which use spring decoupled subchassis also respond well to small adjustments of the springs and careful dressing of the arm lead-out wires, and this tricky job is best tackled by someone with experience. But correct cartridge alignment assuming the cartridge itself had been engineered correctly, is largely a matter of exercising care and doing the right things.

It must be said that a turntable system carefully set up by an experienced dealer is capable of sounding a lot better than one that has been tinkered with by the enthusiastic amateur. However service of this quality is unhappily quite rare, so we have decided to describe a few techniques for the benefit of those who may not have access to this 'ideal' dealer.

The reason alignment is so important is that the cutting head moved in a fixed plane while inscribing the signal of the master blank. If we are going to get somewhere near getting this signal back, we need to make sure that the stylus replicates the movement of the cutter as far as possible, and the cartridge should therefore be lined up as accurately as possible to follow the cutter's route while the stylus moves in the same place as the head. This requires three different modes of alignment: the minimising of lateral tracking error; correct alignment of the cartridge's 'tilt'; correct setting of vertical tracking angle.

Unfortunately many arms, typically those fitted to the cheaper integrated players, only make provision for adjusting the lateral tracking angle and vertical adjustment is confined to 'bodging' with clumsy packing shims. Full details of the provision for adjustment and the geometric accuracy of many available arms are contained in *Turntables and Tonearms*, together with an alternative explanation of cartridge alignment, taking more account of the arm's role.

Lateral tracking angle alignment

When cutting a disc, the cutter head travels along a straight line which is a radius of the disc, starting at the circumference and travelling toward the centre. To exactly mimic this requires the use of a complex parallel-tracking arm like those fitted to the expensive Revox and B&O turntables. But most arms, for the

sake of simplicity and/or cheapness use a simple 'single' position pivot, and so the cartridge describes an arc as it traverses the record and will not exactly line up with the cutting line for much of the time. Ingenious application of geometry has however enabled the important angular error to be kept very small, so provided the alignment is carried out correctly the error should be undetectable; in fact it was once fashionable to use extra long arms (using a smaller part of their arc) to reduce this error, but it is now generally agreed that attendant problems of high mass are more significant, and that 8-9ins is sufficient.

The ingenious geometric 'trick' used to reduce lateral tracking error involves angling the headshell and hence cartridge 'set' with respect to the arm pivots, and then arranging for the stylus to overhang the centre spindle by a small amount. For the very best results, there are ideal values of angle and overhang for a particular arm length, a fact of which a number of manufacturers appear to be unaware; but even if the ideal relationship is not quite attained, the use of an alignment protractor will enable good results to be obtained. During its traverse across the record, the cartridge should show zero tracking error (that is, be absolutely tangential to the groove) on two occasions, one at about 3cm from the start, and again near the end of the playing area. It seems logical to consider seriously only the 12in disc, and a further factor that enters the calculations is the fact that the distortions are magnified towards the end of a record side, where the speed at which the vinyl passes beneath the stylus is at its lowest and the radius of curvature of the groove is tightest. The perceptive might enquire why the LP disc standard does not include such a simple innovation as a cutting lathe that moves along a standard arc therefore removing the need for careful lateral alignment, offset angles, and hence bias compensation. Well, the only answer is thank heaven we do at least have a standard! Those who recall the quadraphony snarl-up of a few years ago will realise the importance of this.

To get back to the point, the overhang angle of offset must be varied so that the front-to-back axis of the cartridge is tangential with the record groove taken at the point of stylus contact in at least one position close to the inner grooves of a typical LP; better still it should go through two zero points at 6.6 and 12.1cm radii. This may sound a little tricky to

CONSUMER INTRODUCTION

achieve, but with the assistance of a simple device known as an alignment protractor it becomes remarkably easy. Unfortunately a considerable number of the integrated players in *Turntables and Cartridges* specified a clumsy and far less accurate technique involving trying to measure the overhang in their manuals, and this is best ignored.

For convenience we have printed an accurate protractor which can be removed or traced (and will last longer on card). The small circle should be carefully cut out and placed over the turntable spindle, and adjustments made to the cartridge until it lines up between the parallel lines when the stylus is resting on both marked points. The method of adjustment will depend on the design of the arm. Most arms use a headshell with two slots for fixing the cartridge; start by assuming that the headshell itself is accurately aligned, and try to 'zero' both points by finding the correct position along the slots. If you can't get both to line up from any one cartridge position, then the geometry of the arm doesn't match the requirements we have derived, but a slight twist one way or the other (viewed from above)

changing the offset angle slightly should enable the 'two point position to be found. Some arms do not have adjustable headshells, and the whole arm pivot system is moved to and fro to change overhang (eg SME, Hadcock). In such cases the offset angle is fixed, and if two point alignment cannot be achieved, then it is necessary to settle for a single point at the inner grooves.

'Tilt' alignment

This is done to ensure that the cartridge is truly vertical when viewed from the front, in the hope (usually justified!) that the stylus will then sit evenly on the two groove walls. It is not necessary to be able to adjust this if the manufacturer has done his job correctly, because there is only one correct attitude; unhappily our experiences in *Turntables and Tonearms* showed that this is not always the case, and it is important to check that either an adjustment is provided or the alignment is correct before purchasing an arm or player.

The checking is easily done by lowering the cartridge onto a mirror, and examining whether the reflection lines up square with the cart-

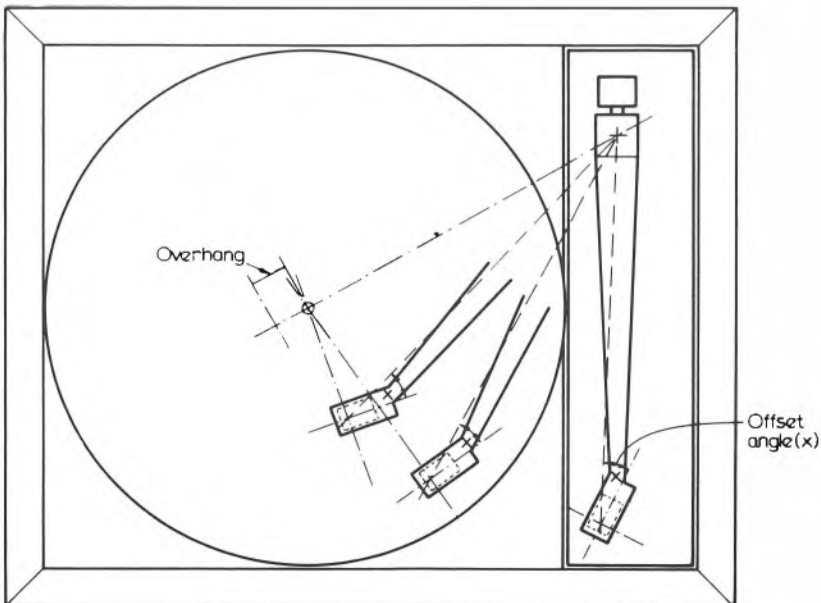

Lateral tracking angle alignment, showing offset angle and overhang.

CONSUMER INTRODUCTION

ridge when viewed from the front. If adjustment is not possible, and the alignment is incorrect, the only solution is to resort to packing on one side of the headshell, and this has its own unpleasant repercussions by weakening the mechanical bond between cartridge and arm. The cancellation test described in the next section will also show up errors in 'tilt' alignment, and can be used as a check if desired.

Vertical tracking angle (VTA) alignment

Last but by no means least is the vertical tracking angle, which is the angle between the true vertical and the vertical plane of movement of the stylus when viewed from the side. Cutting heads have now become standardised internationally at 20°, so this is the sort of figure to which one should aim to get the stylus aligned, particularly if it is a line-contact type with large contact length up the groove wall.

Unfortunately it is not possible to see the stylus angle with the naked eye, so one cannot do this directly. Without recourse to measuring gear there is little one can do but assume that the stylus is set at right angles to the line of the cantilever, and make some sort of guess as to whether the cantilever makes an angle of about 20° with the record surface. The only other approach is to do listening tests, either with a test record or a favourite music record.

One or two warnings however: first not all current discs conform exactly to the cutting standard, and some older records differ quite significantly. Certain parties have recommended in print that the VTA should be changed with each disc if necessary, but this strikes us as obsessional to a degree that will be guaranteed to spoil the music if not lead to a nervous breakdown. If one gets fairly close to the average, this should be more than sufficient.

The best way to adjust the VTA is to change the height of the arm pillar, and once again some arms do not provide for this. Alternative approaches include changing the thickness of the turntable mat or angling the cartridge with shims, but both these methods are likely to produce other detectable effects due to the mechanical changes introduced, and cannot really be considered reliable.

It was very encouraging to discover this time around that most cartridges correspond pretty closely to the 'correct' VTA when their upper surfaces are parallel to the disc. Where signifi-

cant variations were encountered we have mentioned the fact in the reviews; however it is not easy to measure VTA accurately, and it also depends on the downforce employed and perhaps sample variations were encountered we have mentioned procedure.

Many test records available to the consumer contain tracks that are recorded out of phase on the two channels (for example vertical modulation tracking test bands), and these should theoretically completely cancel when the pre-amp is switched to mono or the cartridge connections bridged to join both channels in phase. In fact, because of the imperfections of the system, some output will still be audible or measurable on a small meter connected across the speaker terminals. These distortion signals will be primarily crosstalk, and it should be possible to adjust the VTA or the 'tilt' alignment (or both) to get the minimum output level on listening or measuring. When this is achieved, the vertical alignment of the cartridge should be correct, always assuming that the cutting angle on the test record was right in the first place! Ortofon offer a disc which incorporates this test signal, and as they are responsible for the manufacturer of a sizeable proportion of the world's disc-cutting equipment, this one should be fairly safe.

Having completed the alignment procedures, check that everything has been tightened up, particularly cartridge and adjustment screws. Then tighten it all up again to make sure!

Downforce and bias compensation

All manufacturers recommend a downforce range for their cartridges, and this is determined by considering such things as the compliance, the force required to line up generator and stator elements internally, and the stylus footprint. By and large it is best to work in the upper half of this range to help avoid mistracking, which is a far more pernicious punisher of grooves than the downforce itself. Recent research has shown that the influence of warps, particularly in a poorly matched system, can cause large changes in the instantaneous tracking weight, so a little extra 'cushion' is well worthwhile.

The best practical way to set the downforce is to use the trackability bands of a test record (such as HFS 81). It is nice but not vital to cope with the +18dB 'Supertrack', but the +15dB should not cause any problems. Mistracking

CONSUMER INTRODUCTION

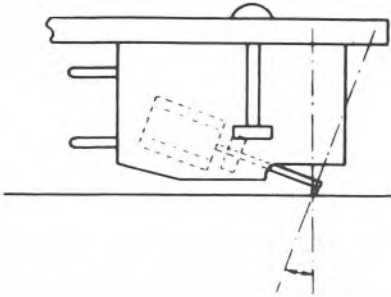

Vertical tracking angle should be 20 deg. It can in effect be controlled by arm height adjustment.

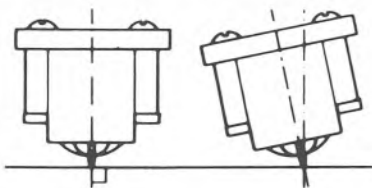

Viewed from the front, the 'till' angle should be zero.

can be heard as a doubling in frequency on these discs (the single tone is joined by another an octave higher). Probably the best approach is to set the manufacturers maximum recommended downforce and then reduce this slowly until tracking becomes edgy, and then go back a little for luck.

The trackability will also be affected by the bias compensation fitted to the arm, and we recommend this too is set by ear, because many of the arms tested in *Turntables and Tonearms* showed misleading bias calibration, and the required bias also depends on stylus shape. While reducing the tracking weight, one should note as mistracking starts to occur whether it happens equally on both channels; if it appears on one before the other, a small bias adjustment should be made until the first signs of mistracking are heard equally on both channels. A slight increase in tracking weight should restore a clean signal with the bias now correctly set.

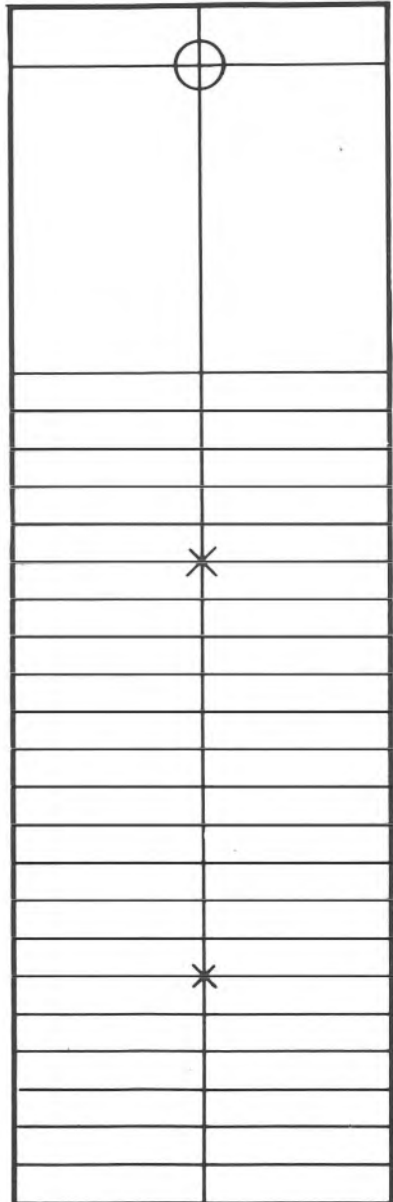

Alignment protractor (see 'Lateral tracking angle alignment').

PICKERING

for NASA

Pickering & Co. acknowledged for the quality and reliability of their products, have a design motto "Application Engineering" — to design and manufacture the best possible products for the purpose intended, this standard led to their micro-engineering talents being used on the space shuttle programme. The motto is true also for the Stanton subsidiary formed in 1967 to supply the broadcast and professional industry. Pickering laboratories use aerospace technology to the full and are the only cartridge company to have their own scanning electron beam microscope for research and development unequalled in the industry.

Perfection®



for YOU

Pickering and Co. the worlds' most experienced makers of pick-ups have over the past 38 years introduced more innovations and improvements in cartridge design and performance than any other manufacturer in this highly specialised field. Pickering offer you the latest technology at all price levels with the most comprehensive range of quality cartridges in the business.

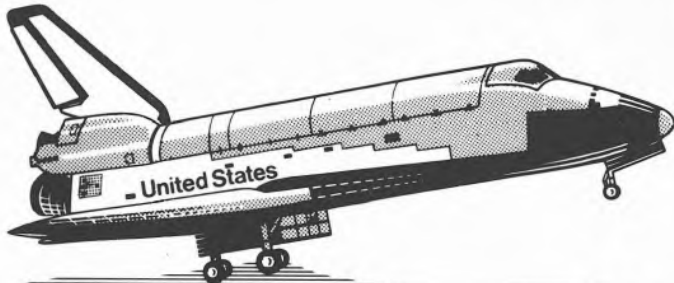

Available through

PICKERING CLUB DEALERS

About Sound
39 Albert Rd
WIDNES Cheshire
051 420-1887

Aerco Ltd
11 The Broadway
WOKING Surrey
04862-4667

Alternative Audio
27 Main St
The Village
East Kilbride SCOT
03552-27019

Armstrong Smith
65 King St
WALLASEY
Merseyside
051-639-9257

Audio Aids
52 George St
EDINBURGH
031-226-3979

Barnsley Hi Fi
40 42 Sheffield Rd
BARNLSLEY
0226 5549

Barrow Hi Fi Centre
122 Dalton Rd
BARRROW IN FURNESS
0229-36494

Best Hi Fi
24 Kingsgate St
Coleraine
Co Londonderry
N Ireland
0265 52843

Bryants Hi Fi
81 High St
ALDERSHOT
0252-20728

Cosmic Radio
252 Station Rd
ADDLESTONE
Surrey
0932 54522

Critics Choice
64a High St
LINCOLN
0522-38718

Darwen Hi Fi
219 Church St
DARWEN Lancs
0254 75201

Duck Son & Pinker
59-61 Bridge St
SWINDON
079322018

Electra-Centre
58 Lancaster Rd
PRESTON
0772 58488

Electro-Trader
19 Colwyn Cries
Rhys on Sea
Colwyn Bay
0492 48932

Peter Ellis
29 Kirkgate
NEWARK
0636 704571

H L Elliott Ltd
29 Lowther St
WHITEHAVEN
Cumbria
09463671

Erricks
Fotosonic House
Rawson Square
BRADFORD
0274-309226

Fairbotham & Co
58 62 Lower Hillgate
STOCKPORT
Cheshire
061-480-4872

Fairs Cameras
Dacie Hill
Rocklerry
BIRKENHEAD
051-645 5000

Norman H Field
35 37 Hurst St
BIRMINGHAM
021-622-3619

Forum Hi Fi
78 Lower Precinct
COVENTRY
0203-21218

Headington Audio
126 London Rd
HEADINGTON
Oxford
0865 68472

High Town Audio
106 Victoria St
CREWE Cheshire
0270 211091

Holburn Hi Fi
441-445 Holburn St
ABERDEEN
0224-25713

Huddersfield Hi Fi
4 Crosschurch St
HUDDERSFIELD
0484-44668

H W Audio Ltd
176 St Georges Rd
BOLTON
0204-38519

Tom Jaques Ltd
16 Wood St
LUNCASTER
0302 65565

Kennedys Electronics
3 Suddell Cross
BLACKBURN
0254-56917

Leicester Hi Fi
215 Melton Rd
LEICESTER
0533-667801

Lloyd Paton McGlynn
34 Moorfield Walk
Urmston
MANCHESTER
061-747-9722

Midland Hi Fi Studio
Royal London Buildings
Wulfruna St
WOLVERHAMPTON
0902-771774

Moorgate Acoustics
2 West Gate
ROTHERHAM
0709 70666

Norman Audio
51 Fishergate
PRESTON
0772 53057

Ormskirk Hi Fi
40 Church St
ORMSKIRK
0695 78055

P & A Audio
98 Liverpool Rd
CROSBY
051-924-7287

Practical Hi Fi
84 Penny St
LANCASTER
0524-39657
& 198 Church St
BLACKPOOL
0253-27703

Red Radio Shop
11 Olive St
off Park Lane
SUNDERLAND
0783 672087

Paul Roberts Hi Fi
203 Milton Rd
WESTON SUPER MARE
0934-414423

Severn Sound
Claremont Hill
SHEWSBURY
0743 57684

Southport Hi Fi
6 Princes St
SOUTHPORT
0704 36901

Stafford Hi Fi Studio
8 Lichfield Rd
STAFFORD Staffs
0785-51234

Studio 2
21-23 Scott Rd
SELBY
94 704812

KG & JM Sullivan
59 High St
Gorseon
SWANSEA
0792-894316

Technical & General
35 Marlrow Rd
LONDON SE20
01-778-3737

Peter Tyson
6 Abbey St
CARLISLE
0228 46757

Ward & Williams
34 Stockport Rd
ROMLEY
061-430-2934

Wigan Hi Fi
13 The Centre Arcade
WIGAN
0942-37977

Eric Wiley
64 Beacroft Rd
CASTLEFORD
0977-553066

Worthington Bros.
6 Liverpool Rd
NEWCASTLE
0782-617636



PICKERING *Perfection*

"for those who can hear the difference"

UK DISTRIBUTION; 24 Gillygate York Tel: (0904) 642463 24hrs

TECHNICAL INTRODUCTION

All the cartridges covered in this book have been subjected to stringent lab tests as well as careful listening tests. This section explains how and why the tests were carried out.

This is the fifth *Choice* to cover cartridges, and this time the somewhat different approach to the review programme reflects the evolution of the cartridge market in the interval since the last edition. As it is also the first cartridges issue by this author, a change of reviewing style will also be apparent; but of course the aims of the project are unchanged, and in fact we have managed to include more new cartridge reviews than ever before.

I should first note my personal preference for subjective rather than measurement-based reviewing. Not that I deny the value of technical tests — I for one find them fascinating reading, and lab measurements do frequently offer invaluable insights.

But they are fundamentally less useful than auditioning and hands-on experience of even the briefest kind. Furthermore, a major consequence of the resources needed to conduct a highly detailed laboratory test programme is to reduce the number of products which can be covered.

In its original inception, *Choice* attempted to test everything that was available, but in those days that might only have amounted to some 50 or so components in any product category. Now there are maybe 300 or so cartridges available (to a greater or lesser extent) on the UK market, under nearly 50 different brands.

It does seem a shame to discard a substantial percentage of the product before even commencing the test programme, so a radical re-appraisal on the *modus operandum* of the project has been undertaken. In an attempt to get back to the original ideas, and with the assistance of a recent development in test equipment, we decided to open the doors to as many review samples as manufacturers and distributors were prepared to send.

They responded in good part, and with a bit of chasing we managed to amass about 140 models, covering the great majority of available brands. We missed out on Glanz and Stanton — so it goes — but 25 or so Pickerings make an impressive substitute! Even amongst the exotics we managed to accumulate an interesting haul, though bad luck and prototypes prevented us from covering the interesting Van den Hul/Empire *MC1000*.

Each cartridge was given a relatively superficial first review, which enabled us to accumulate an enormous amount of useful

data, and then make a selection, based on various considerations' of models which would be given full, extended reviews.

This selection procedure must somehow manage to embrace a number of requirements. It must cover the most popular and available models, but it must also search for excellent value for money at any level. Furthermore it is desirable to start to establish the capabilities of the very best irrespective of price, both because excellence must be valued for itself whatever the cost, and because this provides the yardsticks by which more popularly priced products may be judged.

A (quite long) shortlist was compiled, from the computer test and subjective results, but also taking into account more pragmatic considerations. It would be patently stupid to ignore the *status quo* of the marketplace, so the established reputation, popularity, and widespread availability of leading designs must ensure their automatic inclusion.

Review criteria

There are many possible ways to analyse cartridges. For the purposes of this review exercise, sound quality takes precedence, though a reasonable technical performance is expected to back this up. We also take note of the practicality of the design, in terms of its suitability to commercially available turntables and arms, and pay some attention to the mechanical integrity of the 'stationary' cartridge parts, which so often seem to be overlooked in the quest for good performance in the moving elements.

We are frankly suspicious of the over-compliant cartridge. The low frequency resonance interaction between arm and cartridge mass and cartridge low frequency compliance is a vital determinant of overall performance. The 'target range' has traditionally been set at 8-12Hz, though our experience suggests that frequencies below 10Hz are better avoided, provided this is not achieved at the expense of flimsiness in arm construction.

There are a few low mass tonearms which offer decent rigidity, notably the long-established 5.5g Mission 774 and the new 9g Rega models. But the majority of the good high performance arms lie in the 10-20g effective mass range, current models apparently concentrating about 12-16g.

KOETSU



三三三



ABSOLUTE SOUNDS
42 PARKSIDE, LONDON, SW19
TEL: 01 947 5047
TELEX: 894800 Absol G.

"I have the simplest of tastes . . .
I am always satisfied with the best."
Oscar Wilde
Audio Research, Counterpoint, Koetsu, Krell,
Magneplanar, Oracle, Randall Research,
Sumiko, Talisman, United Sounds of America.

Write or phone for perceptive
advice and details of nearest
dealer.

TECHNICAL INTRODUCTION

Mechanical rigidity in the cartridge structure must be an important ingredient of sound quality, or why would mechanical rigidity play such an important part in the sound of different tonearms? A good tonearm is designed to accommodate the vibrational energy fed to it from the cartridge, so there is no earthly point in its owner fitting a cartridge which absorbs its own energy by sympathetic stator and body vibrations, and consequent loss of signal information.

Mechanical behaviour of the moving parts is no less important in determining the final sound, either in terms of the overall low frequency compliance discussed above, or the behaviour in the audio band itself. By and large this is covered by 'traditional' technical tests, and a few variations of our own, and is examined in more detail later in this introduction.

Price and value for money are a crucial element in *Choice* reviewing, and hopefully the prices quoted will not have varied too significantly by the time the reader studies the reviews. All value judgements are related to the prices as printed.

And lest we should be accused of taking an over-purist stance to the question of sound quality, ignoring real world considerations of the many horrible turntable systems which are actually out in the field, and whose owners are looking for a likely cartridge replacement, we have attempted to take into account the likely performance of the lower cost models under such conditions of severe mechanical compromise. However, we see little point in purchasing an extravagant cartridge for use in such a player — the money would be better spent on improving the player, so expensive cartridges are expected first and foremost to perform well under favourable conditions.

Screening procedure

It was felt that the listening procedures connected with the initial screening tests should use ancillary equipment of an adequately high, but not extravagant quality. The cartridges were carefully aligned using the Elite protractor, and were tightly mounted in Linn *Basik* LVX detachable headshells using substantial stainless steel nuts and bolts. Each cartridge was briefly run in, and mounted in the Linn LVX tonearm on an *LP12* player.

The LVX was considered ideal in many respects, with its medium mass and the convenience of a detachable headshell. The

inherent quality was found to be sufficiently good to provide broad discrimination between the cartridges during auditioning, using Mission *Cyrus Two* amplification and KEF 105.4 loudspeakers. Realistically, the *Basik* arm cannot be considered adequate to distinguish reliably between exotic models at the top end of the market.

Initial measurements

One of the more useful hi-fi by-products of the microcomputer revolution has been the introduction by cartridge manufacturer Ortofon of the *TC3000* cartridge test system. A strength of the *TC3000* over traditional techniques is the simplicity with which one can check the total performance of the system when varying parameters such as tracking weight, vertical tracking angle, bias compensation and input capacitance. The response measurements were clearly able to distinguish the effects of different amplifier loading conditions.

By no means a replacement for the careful examination using a variety of test discs in a well-equipped laboratory, it does provide a simple, quick, and impressively repeatable means of gleaning many of the most important parameters of cartridge performance. It therefore provided the foundation for the first series of 'screening' tests which were applied to all cartridges.

These computer test results, along with brief individual 'hands-on' listening, give a surprising amount of useful information about the different models. More than one sample of each can be compared for consistency.

Low-frequency resonance

The data on low frequency resonance is invaluable for ensuring good arm mass/compliance compatibility.

Figures for vertical and horizontal resonant frequencies and the resonance rise quoted in the data tables are for the individual cartridges mounted in an arm of 12.5g effective mass (itself close to the mean of conventional single-pivot arms, measured recently by Martin Colloms in *Hi-Fi Choice: Turntables & Compact Disc Units*).

Mean values, with standard deviation in brackets, for low frequency resonance of some 120 odd cartridge models were as follows: Vertical resonant frequency 9.7Hz (2Hz); Lateral resonant frequency 9Hz (1.7Hz); Vertical resonance rise 12.3dB (3dB); Lateral resonance rise 12.5dB (2.3dB).

TECHNICAL INTRODUCTION

Channel balance

The spot measurements relating to channel balance, separation and tracking abilities also provide useful information on the cartridges, though their 'spotty' nature means that they should not be over-interpreted!

It is better to rely upon response graphs for channel balance, as a variation of this factor across the frequency band is more troublesome than a specific constant shift which may be corrected simply enough by a balance adjustment on the amplifier. The mean value of the sample was a pretty impressive 0.45dB, with standard deviation 0.4dB. (*In the published graphs, we have separated left and right channel traces for clarity, but this makes any overall imbalance less obvious — Ed.*)

Tracking ability

Most cartridges sailed happily through the tracking ability test provided on the computer system, which provided a maximum test level of 80 μ m. In fact so many passed this level cleanly that the mean was 78 μ m for each channel, the standard deviation 4.5 μ m*.

One might infer that the tracking test was insufficiently severe, but in the author's opinion a sensible maximum has been chosen which indicates those cartridges which may cause problems if used unwisely, while avoiding the unnecessary 'glamorisation' of 'supertrackers'. It is in fact a reflection of the relative lack of importance that need be attached to this parameter nowadays, despite the fact that historically it was for many years accepted as a prime arbiter of cartridge quality.

Over many years the author has extensively used some of the 'worst' tracking cartridges in the book, where 80 μ m looks like pure self-indulgence, yet scarcely ever encountered mis-tracking during regular everyday use. Those with a particular penchant for operatic and choral music (or with a peculiar obsession with special audiophile discs) would do well to be a little cautious of the poorest trackers, but many users will no doubt find themselves confirming the author's experiences.

It must be remembered that standards of micro-engineering have advanced quite dramatically over the years, with reductions in moving mass and improved quality of styli leading the way. Today's best cartridge engineering can give perfectly adequate tracking abilities without compromising performance and sound quality through too high a compliance for sensible arm matching.

Moreover, the cartridges are not the only thing to have improved. The same can be said of turntables and tonearms. And again, in the author's opinion and experience, there's no better way to get good tracking from a cartridge than to start with a decent turntable/arm foundation, though unfortunately there was insufficient time further to explore this possibility objectively.

Stereo separation

The tracking test sets sensible limits, and so in fact does the separation test, though as with channel balance a single 'figure of goodness' is often a substantial oversimplification. One only has to start running through the narrow band analysis conducted for the main tests to realise how easily a poor single-figure result can give a misleading impression.

Nevertheless, it is a further guideline which helps to build up the picture, and again shows that even the more modest modern cartridge, properly mounted and driven, can give good results.

The mean for this parameter (bearing in mind that the 'double top' maximum of 30dB was comfortably achieved by many models) turned out to be a decent 27.6/28dB (L/R), with standard deviation 2.6dB*. The closeness of these means suggests that the separation imbalances recorded for some models are real, on the basis that they appear to have been randomly distributed on left and right channels, and hence unlikely to be due to the test setup, though we also suspect they are frequently due to overcompliance leading to groove instability.

The frequency response measurements needed to be carefully interpreted in the light of experience with the machine and discs. We conducted exhaustive statistical analysis of results, and relied upon comparison with various mean values obtained from different samples of the test cartridges.

In fact, we examined response trends on all cartridges over a certain minimum price, eliminated any that strayed more than one standard deviation from the mean, and then took the mean values of those that remained. Cross-checking with a different sample — a substantial subjectively-chosen group whose reputations and/or pretensions indicated the likeli-

(*Note for statisticians: this is not a normal distribution)

TECHNICAL INTRODUCTION

hood of decent frequency response — gave very similar results.

While this approach does not attempt to define an absolute 'flatness' of response, it has the practical benefit of establishing the norm, and a cartridge's performance in relation to the norm, which will be of value when 'fine-tuning' the balance of the system.

The final useful computer-derived measurement is that of output level. Not so much because of the actual value, or one's inability to equate it to the manufacturer's spec without unravelling the jargon which translates the different ways in which the two sets of measurements have been taken, but again because of the ease with which a specific cartridge's output can be related to the mean for the type (low or high output). If a cartridge varies significantly from the mean, it is only common sense to be a bit more careful in checking to make sure its output is appropriate to the gain and volume control settings on the particular amplifier.

As a rough guide, figures twice or half the mean are most unlikely to cause problems, and three times or one-third can generally be accommodated. Mean values recorded (one channel, 1kHz, 5cm/s) were 3.6mV for high output cartridges and 0.29mV for low output models, the distinction between the two showing distinct signs of blurring at the edges.

Extended Technical Tests

As stated at the beginning, a personal preference for auditioning rather than measuring hi-fi equipment does represent something of a bias in this edition of *Choice*. Nevertheless some additional stages of technical evaluation were carried out on the cartridges which received the 'full reviews'. In practice, these extra tests revealed much useful information.

Frequency response was plotted over the range 20Hz-20kHz, using the inner bands of the JVC *TRS-1007 II* test disc. This ultra-thick and ultra-flat disc is widely regarded as an industry standard, and was of good enough quality to enable traces to be made at low and high writing speeds, the former to establish the general trend while the latter provided useful additional information on the mechanical integrity of the cartridge and its general stability in the groove. Temperature was again held as closely as practical to 17-20°C, which is considered by the author to be most appropriate to the British climate, though below the range often specified by manufacturers.

The reference trace is taken with low-capacitance loading at the B&K measurement pre-amplifier (capacitance being 100pF including tonearm wiring and leads), which gets as close as possible to defining the inherent response of the cartridge.

Some moving magnet cartridges are specifically designed to make use of some additional capacitance loading to enhance their response. Usually this is done by providing a tuned electrical resonance to interact constructively with the inherent mechanical losses of the particular design, and so optimise response. Critics of this technique can sagely point out that two wrongs rarely make a right.

It will be noted that there is a discrepancy between the response charts and data therefrom, and the response data gathered by the Ortofon computer, which is also quoted. This is simply because the computer-derived data relates to a carefully chosen mean frequency response, whereas the pen chart assumes that the inherent response of the disc is ruler flat.

One naturally assumes that a flat frequency response is a desirable end in itself, but this is obviously an oversimplification. Good sound quality can come with a flat response, as the Garrott Decca and Ortofon *2000* in particular show. But the *Karma* and the Koetsus, the Supex and the Audionote also come in the top group subjectively, yet show a determinedly gently falling response.

More important perhaps than flatness per se is the general response evenness, so that if a straight line is drawn through the graph, any departures from the line are small, and more particularly, gradual. Any sharp change in response is more distracting sonically, and indicative of problems, than a gradual one.

A valuable by-product of the response trace is the opportunity to examine channel balance closely and in detail, as this provides further clues to the mechanical integrity of generator and stator. Some discrepancy at high frequencies (above 10kHz) may be deemed acceptable, but variations between channels (as distinct from constant channel differences) are definitely to be avoided. Constant channel differences may be evidence of some quality control shortfall, but can of course be rectified at the balance control.

The other key measurement of cartridge performance is stereo separation. We used the same test disc (different bands), but this time recorded the result using third-octave band averaging on a computing spectrum analyser.

DON'T BE PUT OFF BY SPECIALISTS

Over the last few years an aura of mystique has been built around a section of the Hi-Fi industry, so much so that many potential customers end up buying run of the mill rack systems as the easy way out instead of going to a specialist where they feel they may be pushed into buying something because of the "King's new suit of clothes" syndrome.

We are specialists but we also carry some of the regular imported Hi-Fi in order that you may compare and decide for yourself if you can hear the difference. Many of our customers prefer to start off with say a NAD 3020, DUAI 505, KEF Coda III system, or the new superb MISSION CYRUS I, with a view to upgrading at a later date. Others start off with a LINN or MICHELL GYRO, feed it through an EXPOSURE or SONDEX into GALES or ISOBARIKS.

Whatever your needs you can be sure of personal attention, expert advice and the opportunity to compare in the comfort of our listening lounge above the main shop.

Come and make your choice from:

ALPHASON, ARISTON, AR, A&R, AUDIO TECHNICA, BOSE, CRIMSON, DBX, DUAL, EXPOSURE, GALE, HEYBROOK, JVC, LINN PRODUCTS, MARANTZ, MICHELL, MISSION, MONITOR AUDIO, MORDAUNT-SHORT, NAD, NAKAMICHI, QUANTUM, SONDEX VALVE, SPENDOR, SUGDEN, TANNOY, TECHNICS, THORENS, WALKER, YAMAHA, YORKSHIRE HI-FI, ZETA.

NORMAN AUDIO LTD
51 FISHERGATE, PRESTON,
LANCS PR1 8BH
Tel 0772 53057

Grace

SUPEX

RATA

RP SERIES

TORLYTE®

RATA

RUSS ANDREWS
TURNTABLE ACCESSORIES
EDGE BANK HOUSE, SKELSMERGH,
KENDAL, CUMBRIA LA8 9AS
TELEPHONE: SELSIDE (053 983) 247

REVUE
-ASTLI
WHARFHAIT
MERIDIAN
YAMAHA
MARANTZ
TANNOY
HUNTLEIA
MORDAUNT SHORT
ROYCE AUDIO
NAKAM
-CHIEF



About Sound

Hi-Fi Specialists

c/o CALVERTS (WIDNES) LTD. tel: 051-420 1887
39 ALBERT ROAD. after hours:
WIDNES, CHESHIRE. 051-424 7912

OUR LISTENING ROOM IS AT YOUR DISPOSAL (by appointment please) TO AUDITION THE EQUIPMENT OF YOUR CHOICE

We will be pleased to install and set up the equipment of your choice in your home free of charge. We also stock an extensive range of styl and audio connecting leads.

Friendly Advice — after sales, service and repairs to all makes. Your satisfaction is our guarantee.



CREDIT FACILITIES
(Same day possible)
Tricity Finance APR 30.6%
Written details on request



IF YOU BUY A NAIM
You'll probably never ^{need} see us again!

Basically Sound

For people who can think for themselves

OLD SCHOOL, SCHOOL RD, BRACON ASH
NORWICH, NORFOLK, 0508 70829

TECHNICAL INTRODUCTION

Here we used a 50kHz bandwidth, which gave an opportunity to examine the amount of out-of-band spuria produced by the test cartridge.

This averaging technique can be rather flattering to the cartridge, but is still capable of providing useful results on the general trend, and spotlighting any notable anomaly. It is probable that the actual value of separation (recorded at three selected frequency bands in the data table) is less important than the trends and anomalies, which are very sensitive indicators to the mechanical behaviour and internal alignment of the cartridge sample, tending to highlight and confirm any potential problems indicated on the frequency response measurements.

Stylus examination

For full reviews, all styli were carefully examined under a high quality stereo microscope. This was certainly capable of weeding out any duff samples, checking alignment, polish, quality of mounting and orientation, and confirming (or denying) the manufacturer's general claim for the tip type and quality. This proved an adequate replacement for the examination and measurement carried out by Expert Pickups for earlier editions.

Extended listening

All the submitted cartridges were run in and auditioned briefly as part of the 'screening' procedures, using a decent but far from extravagant hi-fi system consisting of Linn LP12/LVX player, Mission *Cyrus Two* amplification, and KEF 104.2 loudspeakers (total retail around £1300).

Further listening involved formal 'blind' panel sessions, deliberately using inexperienced listeners with a greater interest in music than hi-fi, including mastertape comparison, and feeding Naim-tri-amplified Linn *Isobarik* loudspeakers from several players including Linn LP12/Ittok LVII, LP12/Basik LVX, Elite *Rock/Basik LVX*, and Michell *Gyrodec/Zeta* (silver wired).

Further extended listening was undertaken daily on specific models across a wide range of programme material, using the various players and, alternating with the tri-amp system, the redoubtable Beard (valve) pre/power combination driving the giant Audiostatic *Monolith II* electrostatic panel loudspeakers.

To further ensure that value judgements would not be excessively system- or room-dependent, two further listening visits were

organised, again concentrating on the more exotic models, to a couple of the more interestingly equipped homes of well-known UK hi-fi people. The first system used an Oracle *Premier* turntable with the exotic *Tri-Tracer* tonearm from California's Mod Squad, feeding Audio Research (tube) amplification (SP10/D70) and Magneplanar *MG1* (panel) loudspeakers. The second system was again Oracle-based, and provided access to the new SME *Series V* tonearm (which many confidently expect to become the new reference when in production). Amplification was in this instance provided by Sony *Esprit* units, feeding Quad *ELS63* loudspeakers.

Acknowledgements

The author would like to express his thanks first and foremost to all the distributors and manufacturers who had sufficient faith (or foolhardiness) to participate!

Special thanks for their support in the domestic listening are due to: Max Townshend of Elite, for loan of an Elite Rock, a studio standard tape recorder and mastertapes; to Brian Smith of Presence Audio and Bill Beard for Beard amplifiers and Audiostatic loudspeakers; to Alan Coleman of DW Labs for Michell *Gyrodec* and silver-wired Zeta arm; to Mission for *Cyrus Two*, KEF for 104.2 and The See Corporation for *Revolver* turntable; and to Naim Audio for assistance on pre-amplification matters; and also to Wilmex Ltd for extended loan of the excellent Stax *Lambda Pro* headphones; and to Jeffries Hi-Fi for much generous assistance throughout.

On the technical side, my thanks to Ortofon, without whose impressive *TC3000* computer data gathering would have been very hard work; Alvin Gold, for extended loan of his Neutrik pen-recorder; to Martin Colloms for his Nicolet computing spectrum analyser and a lot of invaluable advice; JVC for assistance with test discs; and Studio 99 for access to their Canon stereo microscope.

To Ricardo Franzavoci of Absolute Sounds and Alastair Robertson-Aikman of SME for their assistance in operating the 'away fixture' listening sessions. And finally, by no means least to long-suffering assistant Xavier Wilcox, who is certainly the only man alive who now can mount *and line up* cartridges in *Basik* headshells blindfold, who sadly fell victim to the hi-fi bug during the course of the project, and whose friends and relatives made up the bulk of the listening panel.

BEST BUY

ADC Phase I

Harman (Audio) UK Ltd, Mill Street, Slough, Berks SL2 5DD
Tel (0753) 76911

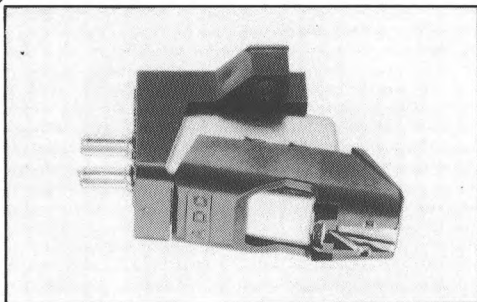

This long established American cartridge manufacturer is best known for using an 'induced magnet' variation on the moving magnet theme. ADC have applied this basic principle at different levels of refinement over many years.

Currently, the *Phase 1* is the cheapest ADC model. The detachable stylus assembly is a bit fiddly to fit properly, but the body is solidly made and can be secured tightly in the headshell.

The stylus has a spherical tip which was quite small and neatly mounted. Tracking weight is a sensible 2g, the compliance quite low (lower than the other ADCs), and the LF resonance well-damped, so the cartridge is suitable for a wide range of arms, with only the lowest mass examples best avoided.

Lab report

The output level and electrical amplifier loading requirements are average, so will suit all amplifiers. Although capacitance change made a minor difference to the response, the value seemed subjectively irrelevant.

Frequency response shows a generally smooth trend with pronounced but gentle treble rolloff. Channel imbalances are slight and confined to the frequency extremes, but there is clear evidence of some mechanical resonances in the midband.

Separation results were reasonable enough for the price, the spectrum analyser confirming the computer readings. Tracking abilities are clearly more than adequate, assisted by the highish tracking weight but impressive enough considering the compliance.

Sound quality

The balance of this cartridge was particularly liked. Considering its low price level, it showed a general midrange integrity which could be

the envy of more expensive designs, and surprisingly good 'focus' for a modest model, though inevitably there was little real impression of stereo depth.

Very much an 'up-front midrange' cartridge, the *Phase 1* offered treble that was inevitably lacking in output and detail. The bass lacked impact while still sounding quite firm and detailed. Though it could be said to lack subtlety, the sound was quite tuneful and involving, and well suited to rock material. The cartridge seemed unusually stable in the groove, which often seems to be associated with a solid coherent sound.

Conclusions

This is an unpretentious cartridge that manages to deliver a rather fine balance of qualities, particularly well-suited to budget turntables. Clearly a Best Buy, it offers almost universal compatibility and a decent sound quality. Even the treble rolloff could well be a positive benefit in the context of a budget system.

TEST RESULTS

Type, mass.....	moving magnet 9.5g
Stylus type.....	spherical
Stylus inspection result.....	well mounted, little polish
Output Level (1kHz, 5cm/s).....	3.5mV
Relative output (0dB = 1mV/cm/s).....	-1dB
Channel balance.....	0.25dB
Channel separation (L,R).....	21.6, 30dB
Tracking ability (L,R).....	80, 80µm
Frequency response limits 100Hz-5Hz.....	+1, -2dB
Frequency response limits 30Hz-20kHz.....	+1, -7dB
Stereo Separation L on R 100Hz, 3kHz, 10kHz.....	24, 23, 20dB
Stereo Separation R on L 100Hz, 3kHz, 10kHz.....	29, 29, 23dB
Channel diff. from graph, 100Hz, 1kHz, 10kHz.....	0, 0.5, 0dB
Response limits ref computer mean, 1kHz-15kHz.....	+0, -3dB
Response limits ref computer mean, 1kHz-20kHz.....	+0, -6dB
Test tracking weight, loading.....	2g, 275pF
LF resonance frequency, 12.5g arm (vert, lat).....	11, 11Hz
Estimated compliance (vert, lat).....	15, 15cu
Recommended arm effective mass.....	8-18g
LF resonance rise, 12.5g arm (vert, lat).....	11.3, 10dB
Typical selling price.....	£15

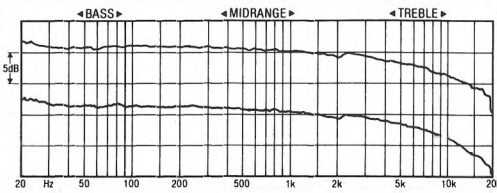

Frequency response, left and right channels

ADC Phase IV

Harman (Audio) UK Ltd, Mill Street, Slough, Berks SL2 5DD
Tel (0753) 769111

RECOMMENDED

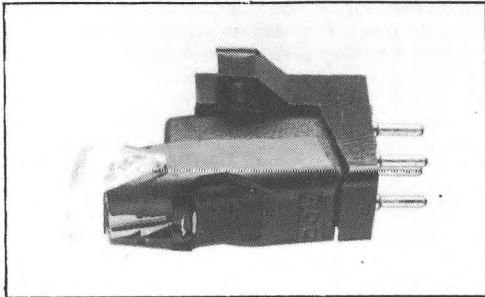

This £40 model is the top of the range for the traditional Phase series ADC induced magnet cartridges. The body construction seems sound, with sensible mounting lugs for firm headshell fixing, though removing or fitting the stylus assembly — in this instance carbon fibre instead of ordinary plastic — was a bit fiddly.

A nude elliptical stylus is specified, and this was confirmed on inspection. Tracking weight is a lowish 1.2g, and the compliance and damping are moderate enough to suit a wide range of low-medium mass arms.

Lab report

Output level and capacitance loading requirements are entirely average, which could ensure good amplifier compatibility. Capacitance adjustment does change response slightly, though not to the extent of being subjectively too distracting.

Frequency response showed a very smooth gently falling treble range with low loading which was rather better maintained but then rolled more sharply with increased capacitance. Channel balance was only fair, with some variation particularly at low frequencies (like *Phase I*). Interestingly, due either to the carbon fibre or the higher compliance, the midrange resonances noted with the *I* were virtually absent.

Channel separation was a touch disappointing considering the price level, being poorest at low frequencies, with some asymmetry. Tracking ability, on the other hand, was fine.

Sound quality

The improvement of high frequency output over the *I* was immediately obvious, though perhaps a trifle too much so. There is a family resemblance about the sound of the *Phases* which preserves fine integrity though the upper

bass and lower mid, but in the case of the *IV* the treble seemed a trifle 'detached'. The bass was rather lacking in 'weight' and 'power', though it was quite tuneful and uncoloured.

Stereo imaging was quite nicely focussed with reasonable depth, if a trifle 'narrow'. Though not the most dynamic of cartridges, it sounded pretty consistent throughout the range and seemed well-suited to all types of music. The cartridge sat reasonably securely in the groove despite the lowish tracking weight, though surface noise seemed a touch emphasised.

Conclusions

This is a pretty well-balanced design, as the *Phase* series generally seem to be. It suits the lower mass arms best, and can sound a touch 'bright', but detail and integrity are pretty good, and the sound betters many at its price.

TEST RESULTS

Type, mass.....	moving magnet 5.8g
Stylus type.....	nude elliptical
Stylus inspection result.....	adequate
Output Level (1kHz, 5cm/s).....	3.48mV
Relative output (0dB = 1mV/cm/s).....	-1.5dB
Channel balance.....	-1.03dB
Channel separation (L, R).....	24, 6, 30dB
Tracking ability (L, R).....	80, 80µm
Frequency response limits 100Hz-5Hz.....	+0.5, -2dB
Frequency response limits 30Hz-20kHz.....	+0.5, -4.5dB
Stereo Separation L on R 100Hz, 3kHz, 10kHz.....	28, 31, 26dB
Stereo Separation R on L 100Hz, 3kHz, 10kHz.....	30, 30, 25dB
Channel diff. from graph, 100Hz, 1kHz, 10kHz.....	0, 0.5, 0.5dB
Response limits ref computer mean, 1kHz-15kHz.....	+0, -2dB
Response limits ref computer mean, 1kHz-20kHz.....	+0, -3dB
Test tracking weight, loading.....	1.5g, 275pF
LF resonance frequency, 12.5g arm (vert, lat).....	9.5, 8Hz
Estimated compliance (vert, lat).....	16, 22cu
Recommended arm effective mass.....	5-14g
LF resonance rise, 12.5g arm (vert, lat).....	13.5, 13.5dB
Typical selling price.....	£45

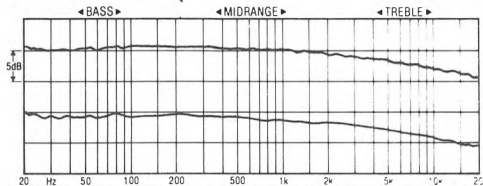

Frequency response, left and right channels

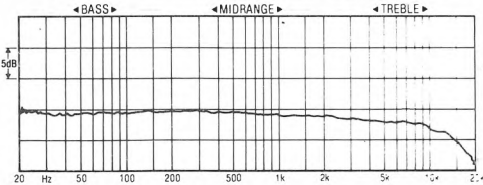

Frequency response with higher load capacitance

ADC TRX I

Harman (Audio) UK Ltd, Mill Street, Slough, Berks SL2 5DD
Tel (0753) 76911

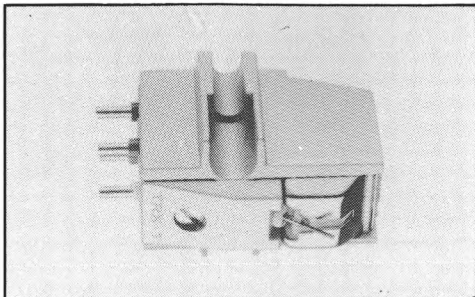

This is one of two Japanese-made prestige moving-magnet ADC's, featuring 'high-tech' cantilever and stylus material and a quite different construction from the established *Phase* series. It uses a large but light aluminium body, though the mounting lugs are not full-circle and need long screws. The stylus assembly is screw-fitted for improved location and vibration resistance.

Stylus is specified as nude Vital II, and examination revealed a fine tip on a small rectangular cross-section stone, mounted lengthwise rather than across the cantilever and with a fairly long shank. The tapered cantilever is fabricated from titanium, and tracking weight is a low 1.2g. Compliance is medium with greater than average damping, so the best matched arms will be low-medium mass models.

Lab report

Output level is average, with medium capacitance recommended. Though in fact no capacitance value would appear able to tame the extreme high frequencies of this brighter-than-average model, high capacitance was subjectively preferred.

Frequency response (low cap) measured very flat, but with a distinct uptilt and some unevenness and channel imbalance starting at 7.5kHz, while increasing loading started the rise earlier and gave a 2dB peak at 12kHz, but also rolled off any undesirable ultrasonics. Though no obvious resonances could be seen, the trace was less smooth and controlled than many others.

Separation was a trifle disappointing considering the price level, with poor values for one channel recorded by both methods. Tracking ability figures were a trifle marginal, and ADC include in an addendum to the manual that tracking force may be increased to 1.9g.

Sound quality

Determinedly bright and 'tinkly', with a slightly softened 'rich' bass, the *TRX-1* did tend to portray the classic hi-fi 'boom 'n' tizz' role. But qualitatively it was quite clean, detailed and dynamic, with decent stereo focus and perspectives. The sound was exciting, if a touch 'fierce' at times, and on music discs the cart-ridge tracked the groove quite securely.

Conclusions

The *TRX-1* went a long way towards delivering the sonic goods, and is competitive on sound and price with many moving-coil models. It is certainly flawed by the relentlessness of the upper treble, but even this characteristic might well endear it to certain tastes and systems.

TEST RESULTS

Type, mass.....	moving magnet 6.5g
Stylus type.....	Vital II
Stylus inspection result.....	confirmed, fine nude rectangular tip
Output Level (1 kHz, 5cm/s).....	3.3mV
Relative output (0dB = 1mV/cm/s).....	-2dB
Channel balance.....	0.4dB
Channel separation (L,R).....	23.5, 30dB
Tracking ability (L,R).....	65, 69µm
Frequency response limits 100Hz-5Hz.....	+1, -1.5dB
Frequency response limits 30Hz-20kHz.....	+1, -2dB
Stereo Separation L on R 100Hz, 3kHz, 10kHz.....	24, 20, 18dB
Stereo Separation R on L 100Hz, 3kHz, 10kHz.....	27, 32, 27dB
Channel diff. from graph, 100Hz, 1kHz, 10kHz.....	0, 0, 1dB
Response limits ref computer mean, 1kHz-15kHz.....	+2.5, -0dB
Response limits ref computer mean, 1kHz-20kHz.....	+2.5, -0dB
Test tracking weight, loading.....	1.2g, 275pF
LF resonance frequency, 12.5g arm (vert, lat).....	9, 9Hz
Estimated compliance (vert, lat).....	18, 18cu
Recommended arm effective mass.....	6-15g
LF resonance rise, 12.5g arm (vert, lat).....	11, 11dB
Typical selling price.....	£90

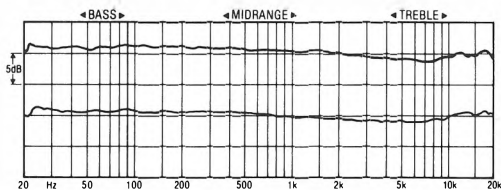

Frequency response, left and right channels

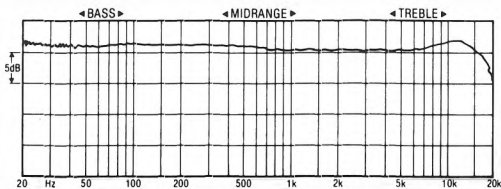

Frequency response with higher load capacitance

A&R C77

A&R Cambridge Ltd, Denny End Industrial Centre, Waterbeach, Cambridge CB6 9PB
Tel (0223) 861550

BEST BUY

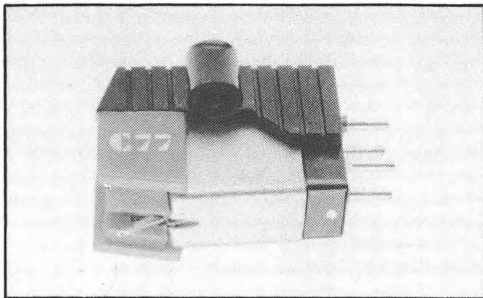

A&R are best known for their *A60* amplifier, but in recent years they have expanded their activities into the loudspeaker and cartridge markets. Their original cartridge policy was to take a fairly conventional moving magnet design and specify a very high quality stylus (Weinz Paroc on the original *P77*), while keeping the price quite modest.

They have added other models since, and made a number of developmental changes, so there are now three moving magnet cartridges, sharing a common body but differing in styli and cantilevers. The latest project is a moving-coil model which applies the original concept to a moving-coil design of Goldring manufacture.

The unassuming *C77* moving magnet model shows good mechanical integrity in body and stylus assembly. The latter has a spherical tip which was small, neat and well-mounted. Compliance is moderate with little damping, suited to the many arms in the effective mass range 7-15g. Tracking weight for this model is a sensible 1.8g, a figure which confers reasonable groove security.

Lab report

Output is conveniently average, and amplifier input capacitance is quite uncritical (250pF increase adding 1dB to treble level).

Frequency response showed a fairly obvious broad 3dB suckout in the mid treble, followed by a mild rise to the 16/17kHz resonance. Channel balance improved steadily towards high frequencies, and the overall trace did in fact manage to look quite 'clean' even at high writing speeds.

The separation analysis showed decent enough figures which were generally pretty consistent down to low frequencies, though reducing somewhat at HF. Tracking abilities were fine.

Sound quality

The measured frequency balance was quite obvious in the sound quality, but this is something of a compliment to an inherently very clear and clean sounding cartridge, which in many respects sounds most impressive considering its modest price.

The treble peak was a trifle obvious and sounded a little 'detached', perhaps because the extreme HF was not particularly detailed. Elsewhere the balance and dynamics were thoroughly impressive, with plenty of 'bounce' and a genuine attempt to convey stereo depth. Surface noise was not exaggerated, midrange focus was pretty good, and the general integrity was good.

Conclusions

Belying its rather nondescript appearance, the *C77* is the sort of model that gives moving magnets a good name. It offers good compatibility and sound quality at a very sensible price. Clearly a Best Buy, the only question mark lies over the treble peak and how it might interact with a given system and pair of ears.

TEST RESULTS

Type, mass.....	moving magnet 6g
Stylus type.....	spherical
Stylus inspection result.....	confirmed, well mounted
Output Level (1kHz, 5cm/s).....	3.75mV
Relative output (0dB = 1mV/cm/s).....	- 1dB
Channel balance.....	- 0.85dB
Channel separation (L,R).....	28.5, 28.8dB
Tracking ability (L,R).....	80, 80µm
Frequency response limits 100Hz-5Hz.....	+ 1, - 2.5dB
Frequency response limits 30Hz-20kHz.....	+ 1, - 9dB
Stereo Separation L on R 100Hz, 3kHz, 10kHz.....	22, 31, 22dB
Stereo Separation R on L 100Hz, 3kHz, 10kHz.....	28, 24, 22dB
Channel diff. from graph, 100Hz, 1kHz, 10kHz.....	0.5, 0.5, 1dB
Response limits ref computer mean, 1kHz-15kHz.....	+ 2.5, - 1.5dB
Response limits ref computer mean, 1kHz-20kHz + 2.5, - 2dB	
Test tracking weight, loading.....	1.8g, 300pF
LF resonance frequency, 12.5g arm (vert, lat).....	10, 10, 3Hz
Estimated compliance (vert, lat).....	16, 15cu
Recommended arm effective mass.....	6-16g
LF resonance rise, 12.5g arm (vert, lat).....	14.5, 12dB
Typical selling price.....	£16

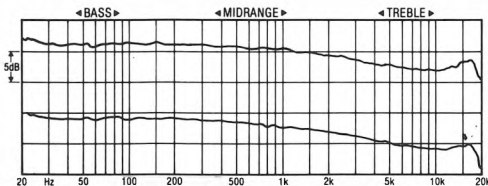

Frequency response, left and right channels

TO ALL HI-FI ENTHUSIASTS



We specialise in
PICKERING, ORTOFON, SHURE, A.D.C., AUDIO-TECHNICA, NAGOAKA, TONAR, EMPIRE, GLANZ.

We also have a complete range of replacement styli for every cartridge.

**SEVERN SOUND STUDIOS LTD
CLAREMONT HILL, SHREWSBURY
0743 57684**

THE ULTIMATE IN HI-FI SOUND
COMPACT
disc
DIGITAL AUDIO
THE U.K.'S LEADING SPECIALIST

- We stock the largest selection of Compact Disc players and discs in the U.K.
- We give a voucher for £1-00 off each of your first 200 discs + free disc exchange with every player we sell.
- We offer personal service and best price promise.
- We arrange free home demonstrations nationwide.

Mon-Fri 9.30-7.30 Sat 9.30-6.00

PAUL ROBERTS

Hi-Fi & Video, 203 Milton Road,
Weston-Super-Mare
(0934) 414423.

UPGRADING?

AN ADDITIONAL HI-FI UNIT?

Why not talk to US and hear a DEMONSTRATION from our range of critically acclaimed, award winning "BEST BUYS" in CARTRIDGES (including moving coils), TURNTABLES, AMPLIFIERS, TUNERS, CASSETTE DECKS, LOUDSPEAKERS and ACCESSORIES from ADC, ALLSOP, AR, ARISTON, AUDIO TECHNICA, DENON, DIESIS, DUAL, GOLDRING, GRADO, HARMON/KARDON, HUNTEDA, JBL, KOSS, MORDAUNT-SHORT, NAGAOKA, ORTOFON, QED, ROSS, SANSUI, SENNHEISER, TANNOY, TARGET AUDIO, TEAC, YAMAHA and other leading brand names.

COMPACT
disc
DIGITAL AUDIO

NOW is also a good time to improve your front end with a PHILIPS, YAMAHA or other make of COMPACT DISC PLAYER and receive TWO COMPACT DISCS of YOUR CHOICE (under £12) ABSOLUTELY FREE from:

BRENTWOOD MUSIC CENTRE

2 Ingrave Road,
Brentwood, Essex

Tel: (0277) 221210

(Just by the traffic lights at the east end of the High Street - 5 minutes by car from the A12/M25 intersection). Parking for collection of goods - please enquire before arrival

A&R P77

A&R Cambridge Ltd, Denny End Industrial Centre, Waterbeach, Cambridge CB6 9PB
Tel (0223) 861550

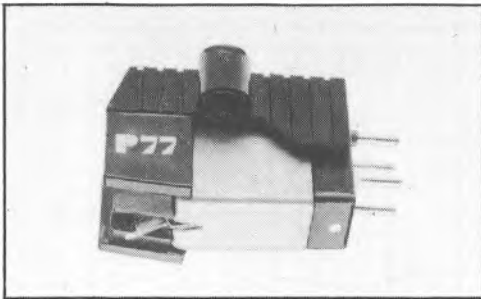

The original '77 started with a Weinz Paroc stylus profile on a conventional Japanese-sourced body/cantilever, chosen for good rigidity and sensible compliance. This stylus is now replaced by a special elliptical/line 'profiled' tip, which is fitted in the UK.

The quality of this tiny nude tip was confirmed by inspection, and is fair justification for the moderate £40 asking price. This A&R stylus assembly may be purchased separately, to upgrade any of the other A&R cartridges when the time comes for stylus replacement. Compliance was a touch lower than the other 77s, with rather greater damping, so low-medium effective mass arms are to be preferred.

Lab report

Medium output and uncritical capacitance loading should avoid any compatibility problems with amplifiers. Adding capacitance in fact served merely to fill the upper-mid/treble suckout by less than 1dB.

Frequency response showed a remarkable similarity to the C77, though the extreme HF peak was a trifle more pronounced. Channel balance was much closer — width-of-the-pen-trace stuff in fact — which confirms A&R's claim that they select the closest tolerance bodies for the P model. The trace itself was impressively smooth, with no obvious identifiable mechanical resonances midband.

Separation gave rather variable results, and it was difficult to determine a trend, but the figures were pretty reasonable nonetheless. Tracking abilities seemed fine.

Sound quality

Though the response indicated a less promising result than the C77, in fact the reverse was true. Though still a slightly 'tizzy' cartridge, the definition and 'sweetness' at

high frequencies was improved sufficiently to render the peak somehow less sonically 'isolated'.

In fact clarity, detail and control were impressive throughout, and quite good stereo images were produced, with reasonable depth albeit the occasional anomaly. The bass did sound a touch congested, perhaps the effect of increased damping which certainly made the cartridge very stable in the groove.

Conclusions

Another well balanced A&R cartridge, clearly meriting recommendation, the P77 does a pretty good job of justifying its extra cost over the C. Despite the measured response, it is one of the more listenable moving magnet cartridges around, while offering sensible wide-spread compatibility.

TEST RESULTS

Type, mass.....	moving magnet 6g
Stylus type.....	'profiled' line contact
Stylus inspection result.....	fine nude line contact tip
Output Level (1kHz, 5cm/s).....	3.4mV
Relative output (0dB = 1mV/cm/s).....	- 1.5dB
Channel balance.....	0.36dB
Channel separation (L,R).....	25.8, 24dB
Tracking ability (L,R).....	80, 80µm
Frequency response limits 100Hz-5Hz.....	+ 1, - 2.5dB
Frequency response limits 30Hz-20kHz.....	+ 1, - 4dB
Stereo Separation L on R 100Hz, 3kHz, 10kHz.....	21, 30, 22dB
Stereo Separation R on L 100Hz, 3kHz, 10kHz.....	33, 26, 35dB
Channel diff. from graph, 100Hz, 1kHz, 10kHz.....	0, 0, 0.5dB
Response limits ref computer mean, 1kHz-15kHz.....	+ 2, - 1.5dB
Response limits ref computer mean, 1kHz-20kHz + 3.5, - 1.5dB	
Test tracking weight, loading.....	1.8g, 300µF
LF resonance frequency, 12.5g arm (vert, lat).....	9, 8.6Hz
Estimated compliance (vert, lat).....	18, 19cu
Recommended arm effective mass.....	6-15g
LF resonance rise, 12.5g arm (vert, lat).....	10.6, 10.6dB
Typical selling price.....	£40

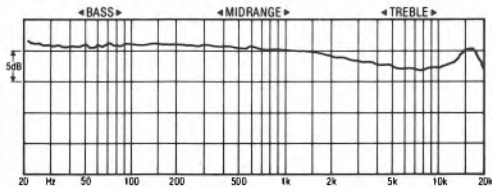

Frequency response (channels identical)

A&R PMX10

A&R Cambridge Ltd, Denny End Industrial Centre, Waterbeach, Cambridge CB6 9PB
Tel (0223) 861550

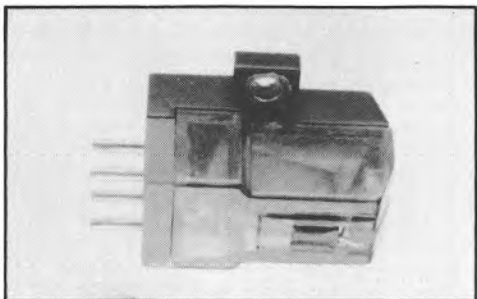

This all-British low-output moving-coil cartridge is manufactured by Goldring to A&R's specific requirements, then tipped by the latter's regular stylus specialist. At present it is cheaper than either Goldring model, and has a see-through red plastic body (definitely a Dynavector feature!).

Stylus is the same 'profiled' tip fitted to the P77, and its quality and set were confirmed under examination. This is a heavy cartridge at 9g, owing to the substantial metal baseplate which provides firm, rigid headshell contact. Yet is still recorded a high (15Hz) vertical LF resonance, albeit well damped. The lateral resonance was much lower at 10Hz, indicating some asymmetry in the generator, and implying at 15g is the desirable figure for arm effective mass, to avoid one of other resonance getting outside the ideal target zone. Tracking weight is a sensible 1.8g, and groove stability pretty good.

Lab report

While definitely requiring some sort of moving-coil input facility, the *PMX-10* has a pretty healthy output designed to feed most such inputs (100-470ohms).

Frequency response showed an even downtilted trend — almost flat but falling some 5dB from bass to treble. So far so reasonable, but the channel balance started to diverge at 400Hz, the gap becoming 1.5dB through the mid treble. Furthermore the range is riddled with a harmonic series of resonances, due to some internal mechanical problem presumably.

Separation was somewhat variable, with bands of excellence interspersed with indifferent figures; an almost total lack of out-of-band spurious was very encouraging. Though there were no obvious tracking problems, there wasn't much in reserve.

Sound quality

The overall sound was certainly well above average, but also in our view fell significantly short of the first division.

Treble showed good detail but was a trifle obtrusive, the mid sounded quite exciting and dynamic, but lacked depth and finesse, while the upper bass was particularly clear, the lower a touch 'soft' and 'warm'. Stereo showed some focus, but lacked convincing depth perspectives. High level passages caused a little strain.

Conclusions

Despite giving a very decent sound for the price, there are certain technical shortcomings which prevent this design from meriting full formal recommendation. It is pretty competitive and worth considering nonetheless, and could well settle down in production (our sample was one of the earliest).

TEST RESULTS

Type, mass.....	low output moving-coil 9g
Stylus type.....	'profiled' line contact
Stylus inspection result.....	fine nude line contact
Output Level (1kHz, 5cm/s).....	0.2mV
Relative output (0dB = 1mV/cm/s).....	-20dB
Channel balance.....	0.2dB
Channel separation (L,R).....	25.5, 25.9dB
Tracking ability (L,R).....	76, 80µm
Frequency response limits 100Hz-5Hz.....	+2, -2.5dB
Frequency response limits 30Hz-20kHz.....	+3, -3dB
Stereo Separation L on R 100Hz, 3kHz, 10kHz.....	29, 22, 21dB
Stereo Separation R on L 100Hz, 3kHz, 10kHz.....	28, 20, 21dB
Channel diff. from graph, 100Hz, 1kHz, 10kHz.....	0, 1, 1dB
Response limits ref computer mean, 1kHz-15kHz.....	+0, -2dB
Response limits ref computer mean, 1kHz-20kHz.....	+1, -2dB
Test tracking weight, loading.....	1.8g, n.a.
LF resonance frequency, 12.5g arm (vert, lat).....	15, 10Hz
Estimated compliance (vert, lat).....	6, 13cu
Recommended arm effective mass.....	12-20g
LF resonance rise, 12.5g arm (vert, lat).....	11, 11dB
Typical selling price.....	£110

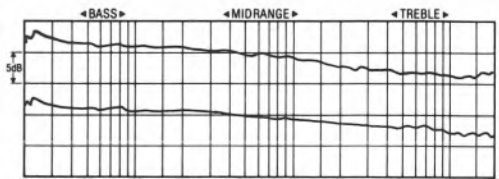

Frequency response, left and right channels

Apature

Esoteric Audio Research Ltd, The Old Chapel, Little Stukeley, Huntingdon, Cambs
Tel (0480) 53791

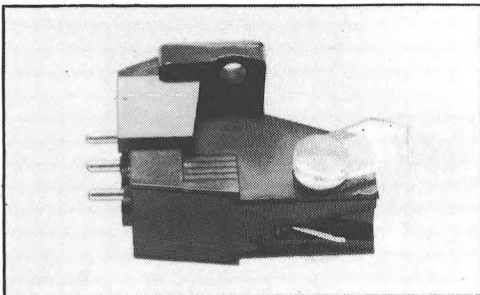

Nothing much is known of this cartridge, dubbed the Apature MC-150, save that it moves coils rather than magnets, yet has a high enough output to feed normal magnetic inputs, and is a surprisingly low cost (c£36) example of that type.

Sourced in Japan, it is distributed by a new operation connected with Tim de Paravacini, who is well known for his exotic E.A.R. valve amplification and is also involved in the distribution of Highphonic cartridges.

Physical inspection was unpromising, when the flimsy plastic cartridge body was found to be a push-fit into the flimsy plastic mounting bracket. Lacking any specification, however, our spirits were raised by the sight of a fine tiny nude rectangular-section stylus.

Although it is a low mass cartridge, compliance is also low, so medium-to-high effective mass arms should be used. We used a sensible 2g tracking weight to ensure decent tracking.

Lab report

Output is only a little below normal moving magnet levels, and like all moving-coils the Apature is tolerant of different amplifier loadings.

Frequency response shows the effect of the lack of mounting rigidity in midband discontinuities between 500 and 800Hz (much more dramatic with a fast plotter writing speed), similar to that shown by P-mount designs. The otherwise flat midband is then crowned by a broad 3dB rise over 10-18kHz. Channel balance showed a good match with a small discrepancy in level.

Separation was generally decent enough, if not particularly consistent, but confirmed the HF resonance by rapid deterioration here. Tracking was just about adequate, with little in hand for particularly 'difficult' material.

Sound quality

In the tradition of low cost moving-coils, the Apature managed to convey much of the excitement and dynamics of the breed, while sounding pretty untidy and unsubtle at the same time.

Bass was considered detailed if a touch 'boomy', the midrange was very dynamic and quite open, but the treble was bright and slightly 'smeared'. Stereo was unexceptional, as was tracking.

Conclusions

Not without its fair share of credits at the price, this lively, 'bouncy' cartridge was let down by the 'sting' at the top end, which was unfortunately rather obvious. Nevertheless it scored pretty well on many aspects of the sound, and who knows what effects the application of a little Superglue to the mounting bracket might achieve?

TEST RESULTS

Type, mass	high output moving-coil 3.8g
Stylus type	not specified
Stylus inspection result	fine small nude line contact
Output Level (1kHz, 5cm/s)	2.85mV
Relative output (0dB = 1mV/cm/s)	-3dB
Channel balance	0.4dB
Channel separation (L,R)	25.4, 30dB
Tracking ability (L,R)	.69, 70µm
Frequency response limits 100Hz-5Hz	+1, -1dB
Frequency response limits 30Hz-20kHz	+2, -1dB
Stereo Separation L on R 100Hz, 3kHz, 10kHz	20, 26, 22dB
Stereo Separation R on L 100Hz, 3kHz, 10kHz	28, 38, 18dB
Channel diff. from graph, 100Hz, 1kHz, 10kHz	1, 0.5, 1dB
Response limits ref computer mean, 1kHz-15kHz	+5, -0dB
Response limits ref computer mean, 1kHz-20kHz	+5, -0dB
Test tracking weight, loading	.2g, n.a.
LF resonance frequency, 12.5g arm (vert, lat)	12, 12Hz
Estimated compliance (vert, lat)	13, 13cu
Recommended arm effective mass	10-20g
LF resonance rise, 12.5g arm (vert, lat)	13, 11dB
Typical selling price	£36

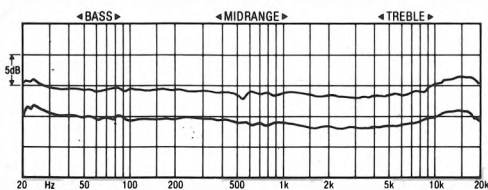

Frequency response, left and right channels

Audionote I02

DW Labs Ltd, PO Box 43, Dunstable, Beds LU6 2NZ
Tel (0582) 872138

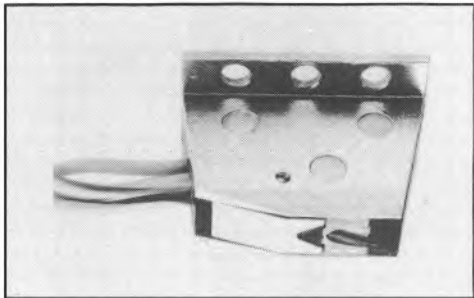

Possibly the most fascinating, certainly the most expensive cartridge in the book, the Audionote I02 on its own costs £800, and a package including a silver-wired step-up transformer totals some £1200. With an exemplary van den Hul tip, it shares the distinction of internal silver wiring with the top Ortofon model, and comes with flying leads for attachment to a silver-wired arm. (We were loaned a special Zeta for the purposes of the review.)

It is also twice the weight of any of the opposition, 18g no less, and built to give new meaning to the term rigidity, with four head-shell screws to boot. However, compliance is very low, so it suits a wide range of medium and high mass arms. Some asymmetry was apparent in the compliance, with notably heavy damping in the vertical plane.

Lab report

Output is very low (-28dB), so the matching (low impedance) transformer will often be needed, though we found Naim moving-coil boards just about usable directly. Experimenting with different loadings showed that reducing the impedance or adding the transformer seemed to cut down the detail, but also reduced the slightly obtrusive treble,

Frequency response was pretty impressive, albeit with a 3dB downtilt across the band through the midrange, and mild recovery above 6kHz. Channel balance was very good, though with minor departures at the frequency extremes. The trace was smooth through the midband, but uneven below 50Hz on one channel.

Separation was disappointingly asymmetric, but at the same time highly impressive in some respects, especially at low and mid frequencies. Tracking abilities seemed reasonable, particularly in view of the compliance, though there is not much in reserve for difficult discs.

Sound quality

Going some way towards justifying its extravagant price, the I02 vdH was obviously one of the very best, and was particularly liked for an extraordinarily relaxing midrange clarity, giving plenty of 'space' around instruments.

Notably clean in the upper bass, it reacted extremely well to panel speakers, and sounded thoroughly romantic via its transformer. Used directly into dynamic speakers the low bass was a bit 'rich' and the extreme top a trifle obvious — detailed, but exaggerating surface noise a little. It was a trifle prone to dust clogging, so records need to be kept clean. Not quite the 'fastest' cartridge, it was always one of the most listenable, though it certainly requires careful system and arm matching.

Conclusions

Very much the sort of product with which one enters into an emotional relationship, it is not for the fainthearted who prefer to fit and forget. Nevertheless it has some unique strengths which may well charm the dedicated enthusiast, and definitely represents one variation on the current state of the art.

TEST RESULTS

Type, mass.....	low output moving coil 18g
Stylus type.....	van den Hul
Stylus inspection result.....	confirmed, superb mounting
Output Level (1kHz, 5cm/s).....	0.03mV*
Relative output (0dB = 1mV/cm/s).....	-29dB
Channel balance.....	
Channel separation (L,R).....	
Tracking ability (L,R).....	
Frequency response limits 100Hz-5kHz.....	+1.5, -1.5dB
Frequency response limits 30Hz-20kHz.....	+2, -1.5dB
Stereo Separation L on R 100Hz, 3kHz, 10kHz.....	50, +, 26, 20dB
Stereo Separation R on L 100Hz, 3kHz, 10kHz.....	30, 20, 15dB
Channel diff. from graph, 100Hz, 1kHz, 10kHz.....	0, 0, 0dB
Response limits ref computer mean, 1kHz-15kHz.....	-
Response limits ref computer mean, 1kHz-20kHz.....	-
Test tracking weight, loading.....	2g, n.a.
LF resonance frequency, 12.5g arm (vert, lat).....	12, 10Hz
Estimated compliance (vert, lat).....	6, 14cu
Recommended arm effective mass.....	8-18g
LF resonance rise, 12.5g arm (vert, lat).....	8, 13dB
Typical selling price.....	£800

*requires special transformer, supplied as an extra

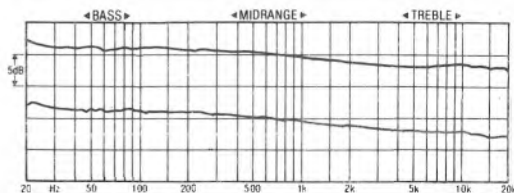

Frequency response, left and right channels

RECOMMENDED

Audio Technica AT110E

Audio Technica UK Ltd, Hunslet Trading Estate, Low Road, Leeds
Tel (0532) 771441

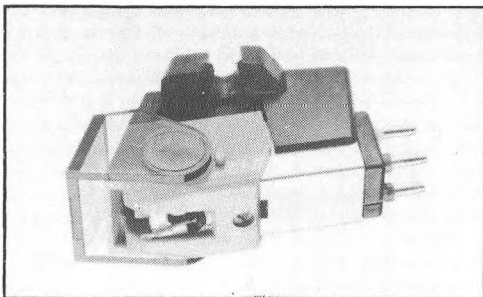

sound was pretty good within a limited bandwidth, quite uncoloured with decent bass resolution and fair dynamics. The treble was almost notable by its absence, though such a response can well suit the cheaper, brasher loudspeakers and amplifiers.

Conclusions

This is a decently engineered cartridge, well suited to its likely role in life, if a touch underdamped for use with the cheapest turntables. Though not a particular favourite, it clearly merits recommendation.

TEST RESULTS

Type, mass.....	moving magnet 7.5g
Stylus type.....	bonded elliptical
Stylus inspection result.....	confirmed, mild profile elliptical
Output Level (1kHz, 5cm/s).....	4.00mV
Relative output (0dB = 1mV/cm/s).....	0dB
Channel balance.....	0.75dB
Channel separation (L,R).....	30, 30dB
Tracking ability (L,R).....	80, 80µm
Frequency response limits 100Hz-5Hz.....	+ 1.5, - 1.5dB
Frequency response limits 30Hz-20kHz.....	+ 1.5, - 10dB
Stereo Separation L on R 100Hz, 3kHz, 10kHz.....	22, 26, 19dB
Stereo Separation R on L 100Hz, 3kHz, 10kHz.....	29, 28, 21dB
Channel diff. from graph, 100Hz, 1kHz, 10kHz.....	1, 1, 0dB
Response limits ref computer mean, 1kHz-15kHz.....	+ 0, - 1.5dB
Response limits ref computer mean, 1kHz-20kHz.....	+ 0, - 4dB
Test tracking weight, loading.....	1.8g, 150pF
LF resonance frequency, 12.5g arm (vert, lat).....	9, 9.5Hz
Estimated compliance (vert, lat).....	18, 13cu
Recommended arm effective mass.....	6-14g
LF resonance rise, 12.5g arm (vert, lat).....	16.5, 15dB
Typical selling price.....	£13

Japan's leading cartridge manufacturer, Audio Technica supplies many of the world's turntable manufacturers, so benefitting from enormous economies of scale — and ensuring competitive prices on cartridges sold to the consumer.

The AT110E is a conventional low-cost magnetic cartridge has a pretty rigid body shape (albeit with half-circle mounting lugs), and a very firmly located stylus assembly. It is solidly built, tracks at a sensible 1.5-2g, and has a mild elliptical profile stylus, which was adequately set.

Compliance is pretty sensible, permitting a reasonable range of low-medium mass arms, though to go above 14g would be to invite trouble, as there is little damping of the resonance.

Lab report

Output level is about average, and low (100-200pF) capacitance is specified. In fact capacitance increase did flatten the response, but curtailed the bandwidth and sharpened the peak a shade; basically pre-amp matching is quite uncritical.

Frequency response was determinedly downtilted, gently falling some 4dB from 100Hz-10kHz, though quite smoothly. Above 10kHz the treble rolled off quite quickly. Channel balance was impressive enough for such a low cost model, allowing almost complete matching by a minor balance control adjustment. The response traces were pretty smooth, with only a couple of minor midrange 'glitches'.

Separation was not particularly good, but rarely dropped below 20dB and was generally nearer 30dB. Tracking abilities seemed fine.

Sound quality

Reasonable enough considering the price, the

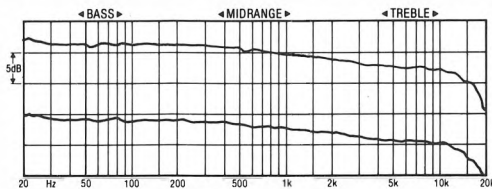

Frequency response, left and right channels

Audio Technica AT160ML

Audio Technica UK Ltd, Hunslet Trading Estate, Low Road, Leeds
Tel (0532) 771441

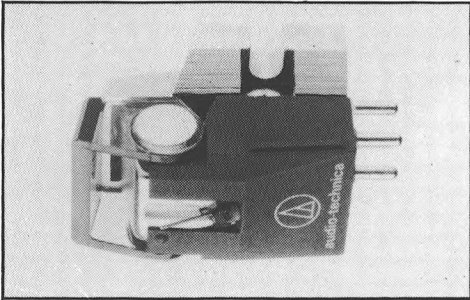

This is the moving-magnet model amongst the threesome which comprises A-T's latest high tech assault upon the audiophile cartridge market. A beautiful rectangular 'MicroLine' ridged beryllium cantilever, and the internal coils (much longer than those in a moving-coil model of course) are wound using special Long Crystal (LC) copper.

Compliance was very high, though with fair damping and good symmetry, so really this model is only suited to the lower effective mass arms.

Lab report

Output level is substantial, so no noise or sensitivity problems are conceivable, while the effect of capacitance upon the frequency response can be seen to be quite dramatic. The recommended low capacitance certainly provided the flattest frequency characteristic, though perversely, our subjective preference was for high capacitance.

To the manufacturers recommendation, response was very good, showing a 2dB midband downtilt from 300Hz to 4kHz, rallying slightly to 12kHz, and then rolling gently thereafter. With loading the low point was only 1dB at 2.5kHz; and the response then rose to a 2.5dB peak at 9kHz, rolling rapidly thereafter. Channel balance was held very close up to 9kHz, with slight (1dB) divergence thereafter.

Sound quality

Described as very sweet and dynamic, and notably 'uncongested' through the upper bass and midrange, the '160ML was rather less impressive at the frequency extremes.

Although the '160ML is sonically sensitive to minor adjustments of tracking weight, we never quite managed to bring the whole band into focus at the same time. With high capaci-

tance loading the treble was rather obvious (as was the relatively depressed presence), but there was better integration and less 'spit'. Bass seemed a little unpredictable, somewhat rich particularly if downforce was increased, but sounding odd on isolated occasions (perhaps down to arm matching).

Conclusions

The '160ML is not a particularly well balanced cartridge in some ways, but manages to vindicate its price in terms of sound quality through the midband, not to mention good tracking abilities and low coloration. This suits it best to a limited bandwidth system of high quality, and Quad Electrostatics or something similar might be a good place to start.

TEST RESULTS

Type, mass.....	moving magnet 8.3g
Stylus type.....	'ML'
Stylus inspection result.....	beautiful small ridged line contact
Output Level (1kHz, 5cm/s).....	4.8mV
Relative output (0dB = 1mV/cm/s).....	+ 1.2dB
Channel balance.....	0.3dB
Channel separation (L,R).....	23.9, 30dB
Tracking ability (L,R).....	80, 80µm
Frequency response limits 100Hz-5Hz.....	+ 1, - 1dB
Frequency response limits 30Hz-20kHz.....	+ 1, - 2.5/4dB
Stereo Separation L on R 100Hz, 3kHz, 10kHz.....	27, 32, 20dB
Stereo Separation R on L 100Hz, 3kHz, 10kHz.....	27, 26, 22dB
Channel diff. from graph, 100Hz, 1kHz, 10kHz.....	0, 0, 0.5dB
Response limits ref computer mean, 1kHz-15kHz.....	+ 1, - 2dB
Response limits ref computer mean, 1kHz-20kHz.....	+ 1, - 4dB
Test tracking weight, loading.....	1.5g, 150pF
LF resonance frequency, 12.5g arm (vert, lat).....	6, 6Hz
Estimated compliance (vert, lat).....	33, 33ccu
Recommended arm effective mass.....	5-10g
LF resonance rise, 12.5g arm (vert, lat).....	12, 10dB
Typical selling price.....	£135

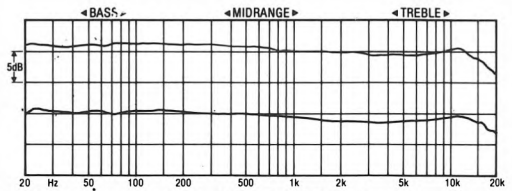

Frequency response, left and right channels

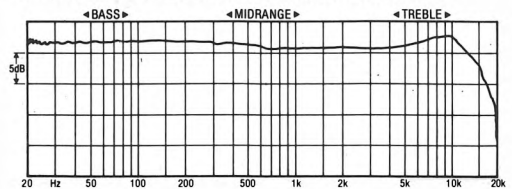

Frequency response with higher load capacitance

Audio Technica AT32E

Audio Technica UK Ltd, Hunslet Trading Estate, Low Road, Leeds
Tel (0532) 771441

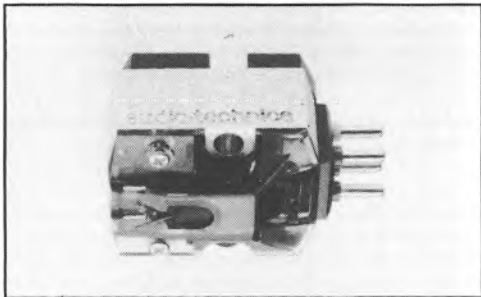

This bulky high output moving-coil model has appeared as the middle range amongst AT's m-c models in a number of guises over the years. Indeed it shares bodywork with the 'high tech' low output '33ML.

Impressive-looking, in a flashy sort of way, it is quite light in weight, due to plastic moulded parts of remarkable finish. The stylus guard was a perpetual pain in the proverbial. Compliance was moderate enough for low-medium effective mass arms, and tracking weight was 1.5g. The small nude elliptical tip was set on a fairly long shank.

Lab report

With a generous enough output level even by moving magnet standards, the cartridge is unaffected by small changes of amplifier input capacitance, so there are no potential pre-amp compatibility problems.

Frequency response was one of the flattest in the book, though somewhat brighter than the mean as a result, with some evidence of a nearly suppressed 8kHz resonance. Channel balance was pretty decent, but the trace was less 'tidy' than many, with some indication of internal resonance.

Separation was pretty good, particularly in the midband, though it deteriorated progressively towards the highest frequencies, and a fair amount of out-of-band ultrasonic spurious were generated. Tracking posed no problems whatever.

Sound quality

Undoubtedly an exciting sounding cartridge, it is also rather 'overblown' and untidy, lacking the subtlety and delicacy of the more expensive models like the '33 and '36.

Needletalk was quite noticeable, the bass was described as rather 'fat' and 'rich'. The dynamic midrange did tend to 'shout' some-

what, and there was little convincing impression of depth.

Conclusions

Though superficially an interesting model with an impressive technical performance, the subjective results showed a disappointing lack of subtlety for the price level, though it sounded exciting enough to appeal to the rock music fan.

TEST RESULTS

Type, mass.....high output moving-coil	6.8g
Stylus type.....small nude elliptical	
Stylus inspection result.....confirmed, long diagonal set shank	
Output Level (1kHz, 5cm/s).....		3.7mV
Relative output (0dB = 1mV/cm/s).....		- 1dB
Channel balance.....		0.1dB
Channel separation (L,R).....		30, 30dB
Tracking ability (L,R).....		80, 80µm
Frequency response limits 100Hz-5Hz.....		+ 1, - 0.5dB
Frequency response limits 30Hz-20kHz.....		+ 1, - 1dB
Stereo Separation L on R 100Hz, 3kHz, 10kHz.....		30, 40, 26dB
Stereo Separation R on L 100Hz, 3kHz, 10kHz.....		27, 30, 24dB
Channel diff. from graph, 100Hz, 1kHz, 10kHz.....		0.5, 0.5, 0dB
Response limits ref computer mean, 1kHz-15kHz.....		+ 2, - 0dB
Response limits ref computer mean, 1kHz-20kHz.....		+ 4.5, - 0dB
Test tracking weight, loading.....		1.5g, n.a.
LF resonance frequency, 12.5g arm (vert, lat).....		9, 9Hz
Estimated compliance (vert, lat).....		18, 18cu
Recommended arm effective mass.....		6-15g
LF resonance rise, 12.5g arm (vert, lat).....		13, 12dB
Typical selling price.....		£100

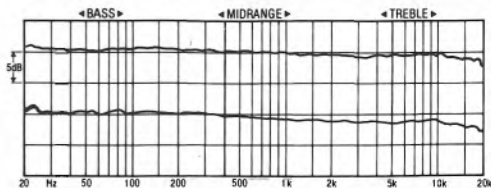

Frequency response, left and right channels

RECOMMENDED

Audio Technica AT33ML

Audio Technica UK Ltd, Hunslet Trading Estate, Low Road, Leeds
Tel (0532) 771441

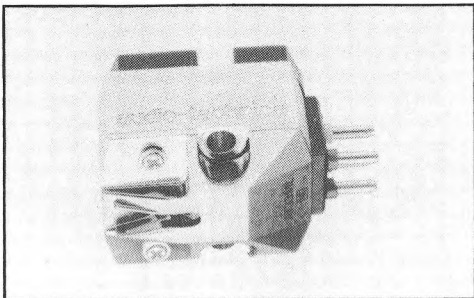

This new top model amongst A-T's middle range of moving-coil cartridges is a low output design costing around £160. This is quite an advance on the £100 of its sister AT32E II, but the '33 features some very up-to-the-minute technology, including Long Crystal (LC) internal wiring and a beautifully executed MicroLine 'ridged' stylus profile. The longish cantilever is gold plated beryllium tubing.

The body is rather bulky but beautifully (or maybe garishly) finished, using plastic and alloy, and can be firmly and closely mounted in the headshell. Compliance was moderate and lightly damped, suggesting a preference for lowish arm masses.

Lab report

Output level was substantial compared to most low output models, and is probably sufficient to drive some moving magnet input stages, though a proper high gain input is to be preferred.

Fitting a 3dB window across the bandwidth, the frequency response was fairly smooth but dominated by a 2dB peak at 12kHz, which is certainly low enough to be clearly audible. Though absolute channel balance was poor on our sample, the much more important channel matching was very close. The traces were quite smooth, but not without a slight ripple at fast writing speed particularly at high frequencies.

Separation figures were generally reasonable, though slightly asymmetric and far from spectacular considering the price. Some ultrasonic spurious were produced, but tracking was excellent.

Sound quality

The '33ML was an odd mixture, because in part it reflects characteristics of the range from which it comes, yet the additional high-tech design input was also clearly audible. The

result is quite a nice blend, strong on excitement and energy, if a little lacking in control, with fine mid focus, reasonable stereo depth, a marginally 'fat' bass, and slightly 'overblown' top. Though somewhat distracting and inclined to emphasise sibilants and surface noise, the treble was very clear and the dynamic range was most impressive.

Conclusions

Deserving recommendation for the sheer gusto of its performance, the '33ML provides good ammunition to support the claims that LC wiring provides improved sound quality. At the same time the 'untidiness' suggests that certain aspects of the design could be better balanced.

TEST RESULTS

Type, mass.....	low output moving-coil 6.8g
Stylus type.....	ML
Stylus inspection result.....	small square long shank with ridged line contact
Output Level (1kHz, 5cm/s).....	0.47mV
Relative output (0dB = 1mV/cm/s).....	- 17dB
Channel balance.....	0.0dB
Channel separation (L,R).....	25.2, 27.7dB
Tracking ability (L,R).....	80, 80µm
Frequency response limits 100Hz-5Hz.....	+ 1, - 0.5dB
Frequency response limits 30Hz-20kHz.....	+ 1, - 2dB
Stereo Separation L on R 100Hz, 3kHz, 10kHz.....	22, 29, 32dB
Stereo Separation R on L 100Hz, 3kHz, 10kHz.....	31, 27, 23dB
Channel diff. from graph, 100Hz, 1kHz, 10kHz.....	1, 1, 1.5dB
Response limits ref computer mean, 1kHz-15kHz.....	+ 1, - 0dB
Response limits ref computer mean, 1kHz-20kHz.....	+ 1.5, - 0dB
Test tracking weight, loading.....	1.5g, n.a.
LF resonance frequency, 12.5g arm (vert, lat).....	9, 9Hz
Estimated compliance (vert, lat).....	16, 16cu
Recommended arm effective mass.....	6-15g
LF resonance rise, 12.5g arm (vert, lat).....	14, 13dB
Typical selling price.....	£190

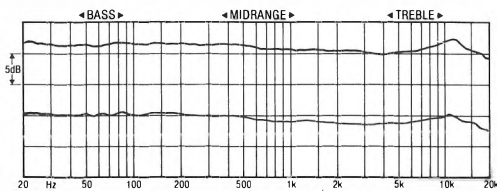

Frequency response, left and right channels

Audio Technica AT36ML

Audio Technica UK Ltd, Hunslet Trading Estate, Low Road, Leeds
Tel (0532) 771441

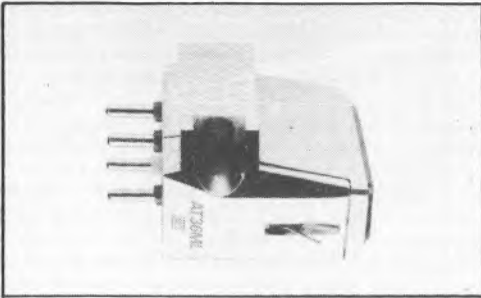

This new upmarket, low-output moving-coil model costs around £250, and features the same combination of advanced technology as the other MLs, including the Long Crystal (LC) copper wiring, a long gold-plated beryllium tube cantilever, and a MicroLine 'ridged' stylus, the latter's profile being properly aligned but cut on a slightly asymmetric shank.

Compliance was on the low side, with fair damping and slight asymmetry, so a wide range of arms is suitable, particularly the medium mass models. Despite the low compliance, downforce of 1.5g gave no tracking problems.

Lab report

This model has one of the lowest outputs in the book, and will probably require some special care to get proper matching. It will work adequately with most decent m-c pre-amps, perhaps at the expense of slight background noise and insufficient volume control range, but was also subjectively sensitive to different impedances.

Frequency response was very good, the downtilt held to 2dB between 200Hz and 7.5kHz, with the following section showing good control and impressive extension. There was some minor channel imbalance at high frequencies, and also intermittently elsewhere in the range. The low output made assessment of resonances at high writing speed a little uncertain, due to hum and noise, but there did appear to be a harmonic series of tiny 'glitches' at low frequencies, and some 'wrinkling' at the extreme top.

Sound quality

The AT36 sounded interestingly 'different' from most cartridges, and was a bit of a chameleon, reacting unexpectedly to different amplifier loadings or transformers. It could be exciting,

very clean and with fine midrange focus and dynamics. Bass extension was clear, though somewhat 'softened', and the sound could be a little 'thin' and lacking in power and weight. High frequencies were generally clear and detailed, but rather 'sparkly bright'.

Though the '36 found its way into several of the most exotic tonearms and systems in the world, we never fully came to grips with the sound of this model, while being aware of great potential in certain respects, notably the midrange.

Conclusions

Otherwise fine technical performance was a little marred by the asymmetric separation and ultrasonic output, and the low output clearly needs very careful treatment. Furthermore we got such an odd bag of results from various listening sessions that firm recommendation is inadvisable.

However, the '36 did have some unique strengths, particularly in terms of midrange focus and delicacy. It is not too extravagantly priced, and is certainly worth auditioning, the secret of success presumably lying amongst the subtleties of component matching.

TEST RESULTS

Type, mass.....	low output moving-coil 7.5g
Stylus type.....	microline
Stylus inspection result.....	slightly asymmetric stone, ridge line profile
Output Level (1kHz, 5cm/s).....	0.09mV
Relative output (0dB = 1mV/cm/s).....	-33dB
Channel balance.....	0.0dB
Channel separation (L,R).....	30, 30dB
Tracking ability (L,R).....	80, 80µm
Frequency response limits 100Hz-5Hz.....	+1, -2dB
Frequency response limits 30Hz-20kHz.....	+1.5, -2dB
Stereo Separation L on R 100Hz, 3kHz, 10kHz.....	31, 41, 40dB
Stereo Separation R on L 100Hz, 3kHz, 10kHz.....	38, 30, 27dB
Channel diff. from graph, 100Hz, 1kHz, 10kHz.....	0, 0, 0dB
Response limits ref computer mean, 1kHz-15kHz.....	+1, -0.5dB
Response limits ref computer mean, 1kHz-20kHz + 2.5, -0.5dB	
Test tracking weight, loading.....	1.5g, n.a.
LF resonance frequency, 12.5g arm (vert, lat).....	11, 10Hz
Estimated compliance (vert, lat).....	11, 12cu
Recommended arm effective mass.....	6-18g
LF resonance rise, 12.5g arm (vert, lat).....	10, 13dB
Typical selling price.....	£257

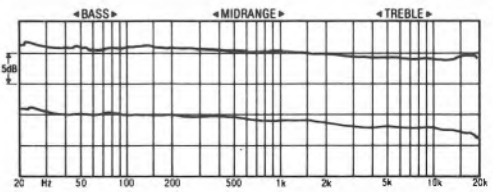

Frequency response, left and right channels

BEST BUY

Bang & Olufsen MMC4

Bang & Olufsen (UK) Ltd, Eastbrook Road, Gloucester GL4 7DE
Tel (0452) 21591

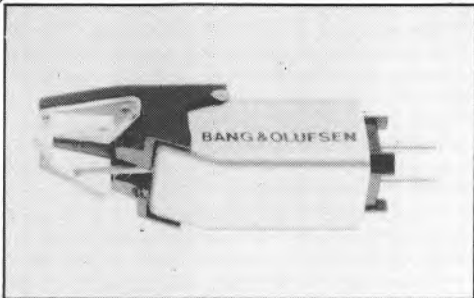

Sound quality

There is a close family resemblance throughout the B&O range. All are handicapped by slight softening and blurring at low frequencies, which gives a relaxed rather than 'punchy' presentation, with fine control.

The '4 was picked out for its particular solidity and overall balance, which seemed remarkably 'seamless' for the price. Midrange clarity, dynamics and focus are excellent, giving fine stereo imaging. The treble is well balanced and controlled for the price, though a touch unrefined. Stability was impressive and surface noise was well under control.

Conclusions

The general standard attained by the B&Os transcends their modest price level, and does much to reinforce their claim that moving magnets sound as good as moving-coils. The mounting bracket problem keeps them from the top class, but its sonic significance will depend on the relative importance the listener attaches to powerful integrated bass.

The level of engineering expertise demonstrated in other respects is mildly awe-inspiring, and an added bonus is the relatively easy time given to the tonearm by such light-tracking cartridges.

TEST RESULTS

Type, mass.....	moving magnet 3.3g
Stylus type.....	elliptical
Stylus inspection result.....	short squat brazed elliptical, little polish
Output Level (1kHz, 5cm/s).....	2.55mV
Relative output (0dB = 1mV/cm/s).....	-4dB
Channel balance.....	+1, -3dB
Channel separation (L,R).....	30, 30dB
Tracking ability (L,R).....	80, 80µm
Frequency response limits 100Hz-5Hz.....	+1, -1.5dB
Frequency response limits 30Hz-20kHz.....	+1, -3dB
Stereo Separation L on R 100Hz, 3kHz, 10kHz.....	30, 38, 27dB
Stereo Separation R on L 100Hz, 3kHz, 10kHz.....	26, 39, 26dB
Channel diff. from graph, 100Hz, 1kHz, 10kHz.....	0.5, 1, 0.5dB
Response limits ref computer mean, 1kHz-15kHz.....	+0, -1dB
Response limits ref computer mean, 1kHz-20kHz.....	+2, -1dB
Test tracking weight, loading.....	1.2g, 200pF
LF resonance frequency, 12.5g arm (vert. lat).....	9, 9Hz
Estimated compliance (vert. lat).....	24, 24cu
Recommended arm effective mass.....	-5.15g
LF resonance rise, 12.5g arm (vert. lat).....	15, 12dB
Typical selling price.....	£24

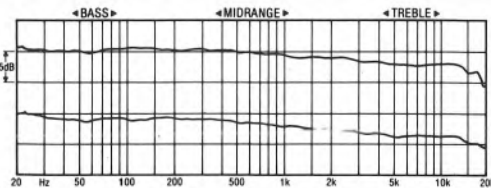

Frequency response, left and right channels

Selected to represent the lower end of the B&O range, this cartridge slots neatly into the hierarchy of five models, which share a common adaptor to provide compatibility with B&O's turntables and their super-light arms.

The cartridge itself is a little miracle of engineering miniaturisation, though the adaptor is slightly flexible and the connection only push-fit. The whole weighs a mere 3.3g, tracks at a low 1.2g, using a tapered aluminium cantilever fitted with a small titanium-bonded elliptical tip, which examination suggested was a little short on polish.

Compliance needs to be high enough to match B&O's own arms, yet is still low enough (with the low cartridge mass) to allow a reasonable range of low-medium mass arms to be used.

Lab report

Output level is rather below average, but this almost certainly only means that users will have the luxury of a wider volume control range! The change in measured response with increased capacitance was very marginal, but the sound was slightly preferred.

Response is most impressive, showing the usual gently falling trace, with a mild recovery to a well-damped resonance at around 10kHz. Channel balance was fine. Much of the class of this cartridge can be gleaned from the remarkably smooth trace even at high writing speed, but the Achilles heel of the adaptor resonance is shown clearly at 900Hz, similar to though less severe (and at a higher frequency) than those encountered with P-mount cartridges, but subjectively significant nonetheless.

Despite the low cost of this model, fine results were obtained for separation, particularly in the midband, bettering 30dB over most of the range. Tracking was (inevitably) impressively secure throughout.

Bang & Olufsen MMC1

Bang & Olufsen (UK) Ltd, Eastbrook Road, Gloucester GL4 7DE
Tel (0452) 21591

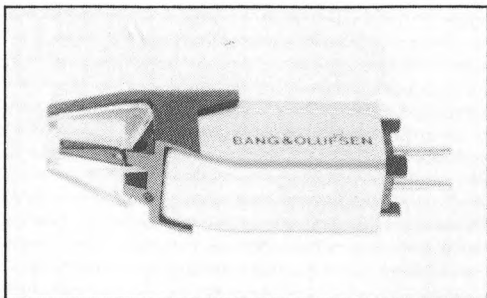

With the top-of-the range *MMC1*, B&O throw all their advanced technology into a miniature cartridge with jewelled cantilever and tiny diamond tip with exquisite line-contact profile (but with a sensible shank long enough to avoid too much dust collection). Regrettably again we have the plug-in adaptor, though the overall mass is still low, and downforce a superlight 1g.

Compliance is pretty sensible, considering it has to accommodate B&O's own ultra-low-mass arms, though 13g arm effective mass represents the top limit for safety.

Lab report

Output is a little on the low side, but should be sufficient for the great majority of amplifier moving magnet inputs. Though specified and measured as insensitive to capacitance loading changes, in fact we found low capacitance inputs substantially superior subjectively.

Response and channel balance were exemplary, save for the 900Hz 'glitch' we attribute to the mounting adaptor. That apart the trace was pretty smooth, gently falling 4-5dB across the band with exemplary high frequency control.

Stereo separation was likewise reference-standard stuff, with outstanding figures throughout the band, and no compromise at high frequencies. Groove stability was decent and tracking ability fine, despite the low downforce, though the cartridge as a whole was rather microphonic.

Sound quality

The extraordinary clarity and detail at high frequencies are almost sufficient to rate this amongst the very top cartridges, and will be sufficient and convincing reason for many purchasers. But one does notice the treble,

inasmuch as it somehow draws attention to itself, while the bass plods along a bit, almost as an afterthought. Focus, midrange dynamics, and stereo imaging were of the highest order.

Conclusions

Probably deserving recommendation for its strengths, the *MMC1* also deserves a better adaptor. (Perhaps GB Engineering can be persuaded to make a clamp, or Mission a special 774 wand!) Even as it stands it is a very satisfying cartridge, possibly with greater appeal to the classical than rock listener. Meanwhile the enthusiast prepared to chance his delicate stylus assembly and start messing around with Superglue and Araldite could well find himself with a true audiophile cartridge on the cheap.

TEST RESULTS

Type, mass.....	moving magnet 3.3g
Stylus type.....	small nude 'line'
Stylus inspection result.....	fine, tiny, long 'pegged' line contact
Output Level (1kHz, 5cm/s).....	2.75mV
Relative output (0dB = 1mV/cm/s).....	-2dB
Channel balance.....	0.4dB
Channel separation (L,R).....	30, 30dB
Tracking ability (L,R).....	80, 80µm
Frequency response limits 100Hz-5kHz.....	+1, -1.5dB
Frequency response limits 30Hz-20kHz.....	+1, -4dB
Stereo Separation L on R 100Hz, 3kHz, 10kHz.....	29, 38, 32dB
Stereo Separation R on L 100Hz, 3kHz, 10kHz.....	33, 48, 34dB
Channel diff. from graph, 100Hz, 1kHz, 10kHz.....	0.5, 0.5, 0dB
Response limits ref computer mean, 1kHz-15kHz.....	+0, -3dB
Response limits ref computer mean, 1kHz-20kHz.....	+2, -3dB
Test tracking weight, loading.....	1g, 200pF
LF resonance frequency, 12.5g arm (vert, lat).....	9, 8Hz
Estimated compliance (vert, lat).....	24, 21cu
Recommended arm effective mass.....	5-13g
LF resonance rise, 12.5g arm (vert, lat).....	13, 12dB
Typical selling price.....	£93

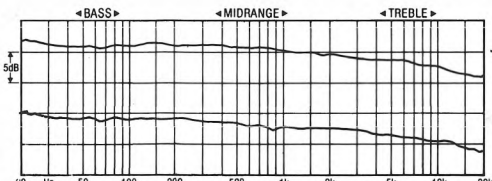

Frequency response, left and right channels



PROBABLY THE GREATEST CHOICE

of storage units for Hi-Fi, Records, Compact Discs, Cassettes and books for the established collector and the beginner whose storage can be increased as the collection grows.



Above is just one of our VARISPACE units 33½" wide x 46" high to hold approx 200 LPs plus 360 cassettes and 290 compact discs. Tell us what you want to store and we will offer you a system to suit your exact requirements in melamine or wood.

Contact: ECC, "Dept HFC", 4 Brunswick Drive, Harrogate HG1 2PZ.

Phone: 0423-500442 day or 60921 evenings.

Send two 13p stamps for complete catalogue.

AUDIO EXCELLENCE

IT'S YOUR CHOICE . . .

Freedom of choice is a much abused phrase these days. However, it's something we are passionate about at Audio Excellence.

We won't subject you to a diatribe about why you should buy a Linn LP12 or a Pink Triangle or a Krell or a Naim, a Magneplanar or a Quad 63.

We will let *you* listen and *you* decide.

Of course we will offer advice and guidance if asked, but we won't cajole you with dogma or hidden persuasion.

Now isn't that what you've always wanted?

Call us or better still come and see us soon.

Audio Lab, Audio Research, AR, Ariston, A&R, ARC, Burmester, Celestion, Counterpoint, Creek, Dual, Gate, Heybrook, KEF, Koetus, Krell, Linn, Magna Planar, Marantz, Meridian, Mission, Monitor Audio, Musical Fidelity, NAD, Nakamichi, Niytech, Naim, Pink Triangle, Quad, Revox, Spondor, Syrinx, Systemdek, Tannoy, Thorens, Walker, Yamaha, Zeta.

134 CRWYS ROAD, CARDIFF. TEL: 0222-28555

9 HIGH STREET, SWANSEA. TEL: (0792) 474608

**BOTH SHOPS:
TUES-SAT: 9.30-5.30
CLOSED MONDAY**



audio-technica

For your ears only...

Here's just a third of our exciting headphone range. A line-up that includes three ultra light 'point-series' mini-phones, four open back 'bi-polar' dynamic designs and two uncompromisingly accurate electroret-condenser models.

A range too that's styled to be both easy on the eye and on the ears with all the sound advantages you'd expect from a world leader in transducer technology. Hear them at your Audio-Technica dealer or write to us for full information.

ATH-6D
top dynamic
phone with case
RSP £49.95

ATH-01
mini-phone with
standard + mini jack
RSP £9.95

ATH-B
ultimate
electret
performance
RSP £139.90



audio-technica

Audio Technica Ltd, Hunslet Trading Estate, Low Road, Leeds, LS11 1BL. Tel: (0532) 771411

Denon 103

Hayden Laboratories, Hayden House, Chiltern Hill, Chalfont St Peter, Bucks
Tel (0753) 888447

RECOMMENDED

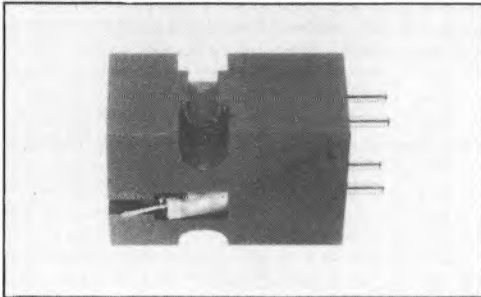

One of the oldest models still in current production, the 103 is the low output moving-coil model which Denon made originally for NHK, the Japanese equivalent of the BBC, and which definitely made a major contribution towards the revival of the genre. Price has been held through the years, and now £60 looks fairly modest. Other models in the 103 series, with more sophisticated styli and cantilevers, have been covered in the summaries.

It is a large but quite solid and heavy cartridge, with large headshell contact area but half-circle retaining lugs. Spherical styli may lack status, but that fitted here was very neat. Compliance is quite low, allowing matching with a usefully comprehensive range of arms from 6-16g effective mass.

Lab report

Some high-gain pre-amps (notably certain valve models) should be able to take the 103 directly into moving magnet inputs, but most users will find it provides plenty of urge for m-c inputs.

Frequency response shows a fairly modest 2dB downtilt through the midrange, and a slight flattening out at 7-8kHz. In fact a straight line could be drawn through the response trace from 20-20kHz with deviations of less than 0.5dB, which is very impressive at this (or any) price level. However, the response was 2dB 'brighter' if taken at the outer grooves, a function of the limited scanning radius of the spherical tip. Channel balance was pretty good, and the response was smooth, with just a tiny 900Hz 'glitch' and some bass unevenness.

Separation generally exceeded 30dB across the bulk of the band, reducing somewhat at the extremes, and 2.5g tracking weight (no problem with the large footprint area of a spherical tip) provides adequate tracking abilities and extraordinary groove stability — it is easy to understand its popularity in broadcast studios.

Sound quality

Very well received, the strength of the sound is its fine integration and great liveliness, coupled with a firm and powerful bass. Treble can be inconsistent, and generally sounded a little rolled off, while the midrange extended the good clarity established through the bass.

Conclusions

Spherical styli may be unfashionable, but they have always worked exceedingly well in the 103. Once again this stalwart shines out from the pack, and furthermore offers fine value for money and general (moving-coil) compatibility.

TEST RESULTS

Type, mass.....	low output moving-coil 8.5g
Stylus type.....	spherical
Stylus inspection result.....	small v. short shank, diagonal set
Output Level (1kHz, 5cm/s).....	0.44mV
Relative output (0dB = 1mV/cm/s).....	-19dB
Channel balance.....	-1.0dB
Channel separation (L,R).....	29.7, 28.4dB
Tracking ability (L,R).....	75, 80µm
Frequency response limits 100Hz-5Hz.....	+1, -1dB
Frequency response limits 30Hz-20kHz.....	+1.5, -3dB
Stereo Separation L on R 100Hz, 3kHz, 10kHz.....	32, 31, 26dB
Stereo Separation R on L 100Hz, 3kHz, 10kHz.....	25, 32, 26dB
Channel diff. from graph, 100Hz, 1kHz, 10kHz.....	0, 0, 0.5dB
Response limits ref computer mean, 1kHz-15kHz.....	+1, -0dB
Response limits ref computer mean, 1kHz-20kHz.....	+1.5, -0dB
Test tracking weight, loading.....	2.5g, n.a.
LF resonance frequency, 12.5g arm (vert, lat).....	10, 10Hz
Estimated compliance (vert, lat).....	13, 13cu
Recommended arm effective mass.....	6-16g
LF resonance rise, 12.5g arm (vert, lat).....	15, 13dB
Typical selling price.....	£60

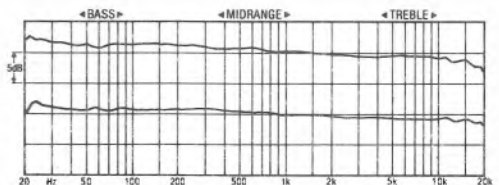

Frequency response, left and right channels

Denon 207

Hayden Laboratories, Hayden House, Chiltern Hill, Chalfont St Peter, Bucks
Tel (0753) 888447

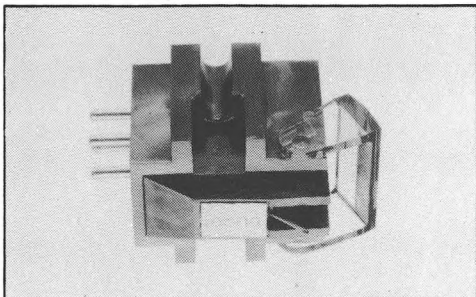

This low output moving-coil cartridge costs £130, and comes from a separate series of more recently-designed Denon models which are much lighter than the 103s. The brown plastic body is visually enhanced by a tortoise-shell Art Deco finish, redolent of Waterman fountain pens from the '30s!

The special elliptical stylus specified turned out to be a delightful and very tiny rectangular section nude stone. Compliance was very high, indicating that even the modest enough 12.5g of our test arm was on the high side, and 10g should be regarded as maximum effective mass. Tracking weight was a fairly low 1.4g.

Lab report

Definitely needing a moving-coil input, the 207 will manage with 20dB of m-c gain, though a little more wouldn't come amiss.

Frequency response was extremely flat to 5kHz, but rose thereafter to a +1.5dB plateau from 10-20kHz. Channel balance was pretty close through the midrange in any case, while there was no indication of structural resonances on the trace.

Separation gave pretty good values quite consistently, bettering 30dB over much of the midrange, though there was also some evidence of spurious ultrasonics. Tracking was fine, which is no surprise in view of the compliance.

Sound quality

The sound was commendably lively, though also rather 'fierce'. The presence region was strong, and the midrange as a whole was clear and detailed, with decent integration. However, the bass was a trifle 'soft', and the cartridge was a little unstable in the groove.

Conclusions

By no means a poor cartridge, neither is it a 54

cheap one, and the 207 remains a mild disappointment, not least because of the success of its better established stablemates.

TEST RESULTS

Type, mass.....	low output moving-coil 4.7g
Stylus type.....	special elliptical
Stylus inspection result.....	superb rectangular section small nude ell
Output Level (1kHz, 5cm/s).....	0.34mV
Relative output (0dB = 1mV/cm/s).....	- 23dB
Channel balance.....	0.1dB
Channel separation (L,R).....	24.3, 30dB
Tracking ability (L,R).....	80, 80µm
Frequency response limits 100Hz-5Hz.....	+ 0.5, - 0dB
Frequency response limits 30Hz-20kHz.....	+ 2, - 0dB
Stereo Separation L on R 100Hz, 3kHz, 10kHz.....	31, 25, 20dB
Stereo Separation R on L 100Hz, 3kHz, 10kHz.....	32, 30, 19dB
Channel diff. from graph, 100Hz, 1kHz, 10kHz.....	0, 0, 0.5dB
Response limits ref computer mean, 1kHz-15kHz.....	+ 2.5, - 0dB
Response limits ref computer mean, 1kHz-20kHz.....	+ 5, - 0dB
Test tracking weight, loading.....	1.5g, n.a.
LF resonance frequency, 12.5g arm (vert, lat).....	8, 6Hz
Estimated compliance (vert, lat).....	.24, 41cu
Recommended arm effective mass.....	5-12g
LF resonance rise, 12.5g arm (vert, lat).....	11, 13dB
Typical selling price.....	£130

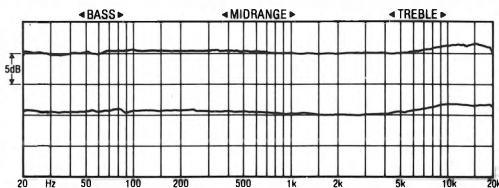

Frequency response, left and right channels

Dynavector DV10X 4

Logic Ltd, 19 Hurlbutt Road, Heathcote Industrial Estate, Warwick CV34 6TD
Tel (0926) 20302

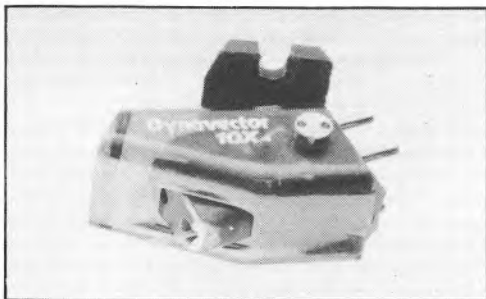

This lightweight high output moving coil from Japanese specialist Dynavector is the latest in a long series of 10X models, which are accustomed to high ratings in *Choice*. Though the transparent bodywork is cantilevered from a plastic mounting plate, rigidity is reasonable. The longish cantilever looks a little vulnerable to accidental damage, and the stylus is a fine quality nude elliptical on a rectangular shank.

Compliance is fairly low and pretty well damped, so medium-to-high mass arms are to be preferred. Tracking abilities fell slightly short of the target despite the reasonable 1.7g downforce.

Lab report

Output level is lower than most models intended for moving magnet inputs, but was still high enough to be most unlikely to cause any difficulties. Capacitance matching is of course irrelevant in a low impedance moving-coil design.

Frequency response followed the familiar downtilted pattern but only dropping some 3dB across the whole band. The high frequency resonance is quite well controlled, but at a lowish 7-8kHz, while there were also a couple of midrange 'glitches' to cope with at 600 and 800Hz. Channel balance showed some 0.5dB variation at different parts of the main frequency spectrum, but was held quite closely at high frequencies.

Separation figures were good for a cartridge at this price level (or any price level, for that matter), albeit with mild channel asymmetry.

Sound quality

In some respects this was the most balanced sounding of the Dynavectors, and certainly delivered a very decent level of quality. Bass was felt to be slightly overdamped, with mild upper bass richness combining to give an

impression of slightly limited extension. The mild treble peak was audible as a slight 'bright-ness', and emphasised by 'smearing'. Midrange focusing was very good, and this tended to draw attention away from the limitations at the extremes. Stereo seemed a trifle lacking in depth, but was impressively solid and stable, as was the general behaviour of the cartridge in the groove.

Conclusions

This is a fine sounding cartridge at a realistic price, with the added convenience of driving moving magnet stages directly. Tracking ability is less its forte than groove stability, yet damping should be sufficient to ensure successful widespread compatibility, so firm recommendation is clearly indicated.

TEST RESULTS

Type, mass.....	high output moving-coil 4.5g
Stylus type.....	nude elliptical
Stylus inspection result.....	good small rectangular section
Output Level (1kHz, 5cm/s).....	2.35mV
Relative output (0dB = 1mV/cm/s).....	- 4dB
Channel balance.....	0.4dB
Channel separation (L,R).....	26.1, 30dB
Tracking ability (L,R).....	80, 77µm
Frequency response limits 100Hz-5Hz.....	+ 1.5, - 1dB
Frequency response limits 30Hz-20kHz.....	+ 2, - 2dB
Stereo Separation L on R 100Hz, 3kHz, 10kHz.....	23, 32, 23dB
Stereo Separation R on L 100Hz, 3kHz, 10kHz.....	35, 35, 30dB
Channel diff. from graph, 100Hz, 1kHz, 10kHz.....	0.5, 0.5, 0.5dB
Response limits ref computer mean, 1kHz-15kHz.....	+ 1, - 1dB
Response limits ref computer mean, 1kHz-20kHz.....	+ 2, - 1dB
Test tracking weight, loading.....	1.7g, n.a.
LF resonance frequency, 12.5g arm (vert, lat).....	11, 12Hz
Estimated compliance (vert, lat).....	12, 10cu
Recommended arm effective mass.....	8-18g
LF resonance rise, 12.5g arm (vert, lat).....	well damped
Typical selling price.....	£75

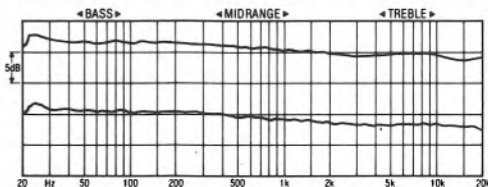

Frequency response, left and right channels

Dynavector DV17D 2

Logic Ltd, 19 Hurlbutt Road, Heathcote Industrial Estate, Warwick CV34 6TD
Tel (0926) 20302

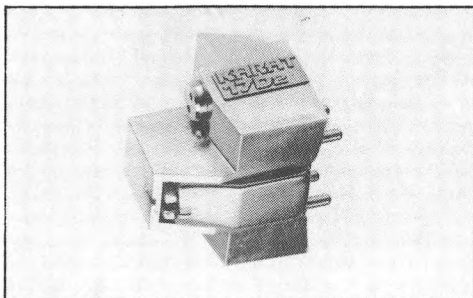

One of the famous Karat series, this low-output moving-coil model is unusual in being equipped with a very short pure diamond cantilever. The body is gold finished, and has a metal top plate of limited area with screw inserts, enabling reasonable headshell tightening. The stylus was firmly pegged through the tip fixing problems that afflicted Karats in their very early days, and the tip had a fine swept-elliptical profile — almost a ridge in fact.

Compliance is quite low and nicely symmetrical. The damping is very unusual; quite moderate laterally, the vertical resonance is totally damped. A wide range of medium-high mass arms are suitable, including Dynavector's own idiosyncratic designs.

Lab report

Though definitely a low output model requiring some sort of m-c facility, the 17D2 has enough level to be unproblematic in this respect.

Frequency response is startlingly flat through the midband, from 100Hz to 5kHz, tailing off very gently to -3dB at 20kHz, and showing slight (1.5dB) channel imbalance here. The solitary 'glitch' occurred at 1.2kHz (cf. Linn *Karma*, Koetsu *Black!*), and the trace as a whole showed only very mild unevenness right across the band, even at high speed writing.

An Achilles heel the Karat shares with the Decca is poor separation, due presumably to the (respectively) short and non-existent cantilevers. For the price of the cartridges, the figures were mediocre.

Sound quality

Somewhat inconsistent auditioning results indicate that this *Diamond Karat* is very sensitive to set-up, which is one of the hallmarks of a really good cartridge. With care it could produce stunningly good mid/presence

integration, focus and projection, described in one comment as 'the electrostatic cartridge'. On the negative side, the balance was distinctly 'bright' and could sound a little 'fierce', while the bass was clean enough but sounded like something of an afterthought — a typical over-damped characteristic.

Conclusions

A difficult cartridge to sum up, because its strengths are very real, yet its weaknesses, at the bass end in particular, are rather important to this particular reviewer. Only a handful of more expensive designs handle the mid/presence with anything like the same verve, so in the right (probably electrostatic-based) system the 17D2 will offer fine value.

TEST RESULTS

Type, mass.....	low output moving-coil 5.3g
Stylus type.....	line contact
Stylus inspection result.....	firmly set, pronounced line
Output Level (1kHz, 5cm/s).....	0.25mV
Relative output (0dB = 1mV/cm/s).....	-23dB
Channel balance.....	0.6dB
Channel separation (L,R).....	23.9, 21dB
Tracking ability (L,R).....	80, 80µm
Frequency response limits 100Hz-5Hz.....	+0.5, -0.5dB
Frequency response limits 30Hz-20kHz.....	+1, -3dB
Stereo Separation L on R 100Hz, 3kHz, 10kHz.....	21, 24, 23dB
Stereo Separation R on L 100Hz, 3kHz, 10kHz.....	20, 20, 19dB
Channel diff. from graph, 100Hz, 1kHz, 10kHz.....	0.5, 0.5, 0.5dB
Response limits ref computer mean, 1kHz-15kHz.....	+0, -1.5dB
Response limits ref computer mean, 1kHz-20kHz +0, -2.5dB	
Test tracking weight, loading.....	1.9g, n.a.
LF resonance frequency, 12.5g arm (vert, lat).....	n.a.*, 12Hz
Estimated compliance (vert, lat).....	10cu
Recommended arm effective mass.....	10-25g
LF resonance rise, 12.5g arm (vert, lat).....	0*, 11dB
Typical selling price.....	£210

*see text

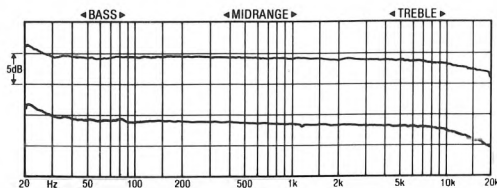

Frequency response, left and right channels

Elac EMC1

Presence Audio, Eastland House, Plummers Plain, Horsham, West Sussex RH13 6NY
Tel (0444) 85333

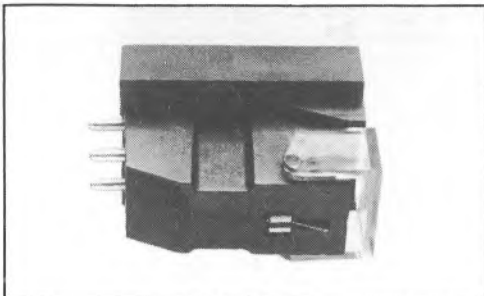

This German company (not to be confused with the North London speaker manufacturer) are amongst the oldest cartridge manufacturers, but their availability in the UK has been rather sporadic. Now a selection of models are being reintroduced here by Presence Audio, and this £230 low output moving-coil model looks the most interesting.

A van den Hul II stylus is fitted, the quality of which was confirmed on examination (not to mention the inordinate quantity of adhesive which had been used to keep it in place). Moderate enough compliance values indicate low-medium mass arms are to be preferred.

Lab report

The output was very low indeed, so care will be needed to use a quiet enough pre-amp, with a transformer the obvious (compromise) alternative. Clearly some care needs to be taken to get a good match.

Frequency response was quite remarkably flat from 30Hz-5kHz, but rose steadily to +3dB at 20kHz. Channel balance was pretty close, and the bulk of the response trace was pretty smooth, though there were a couple of midrange 'glitches' and some treble unevenness on one channel.

Separation figures were consistently fine on both channels, and there were no worries over tracking ability.

Sound quality

The sound was well liked, with good stability and firm bass. Notably uncoloured, clean and controlled, apart, that is, from the high frequency 'sizzle' which proved quite difficult to ignore, though its obtrusiveness did depend upon the material being played.

Certain systems will tend to capitalise upon the strengths and avoid this weakness, so panel speakers and valve amplifiers are likely

to work best. Another technique is to 'slug' the cartridge by loading it with a low impedance, and the very low output would indicate that only a transformer is really suitable.

Conclusions

The *EMC-1* has plenty of promising attributes, and treble apart was one of the lowest coloration cartridges we encountered. But it is expensive and a little tricky to use, requiring careful component matching, so general recommendation is not really appropriate.

TEST RESULTS

Type, mass.....	low output moving-coil 6.8g
Stylus type.....	van den Hul
Stylus inspection result.....	confirmed, heavily glue v. small tip
Output Level (1kHz, 5cm/s).....	0.11mV
Relative output (0dB = 1mV/cm/s).....	-32dB
Channel balance.....	1.6dB
Channel separation (L,R).....	30, 30dB
Tracking ability (L,R).....	77, 80µm
Frequency response limits 100Hz-5Hz.....	+0.5, -0dB
Frequency response limits 30Hz-20kHz.....	+2/3, -0dB
Stereo Separation L on R 100Hz, 3kHz, 10kHz.....	27, 34, 28dB
Stereo Separation R on L 100Hz, 3kHz, 10kHz.....	31, 35, 27dB
Channel diff from graph, 100Hz, 1kHz, 10kHz.....	0.5, 0.5, 0.5dB
Response limits ref computer mean, 1kHz-15kHz.....	+2.5, -0dB*
Response limits ref computer mean, 1kHz-20kHz.....	+4.5, -0dB*
Test tracking weight, loading.....	1.5g, n.a.
LF resonance frequency, 12.5g arm (vert, lat).....	10, 8Hz
Estimated compliance (vert, lat).....	15, 22cu
Recommended arm effective mass.....	5-15g
LF resonance rise, 12.5g arm (vert, lat).....	11, 11dB
Typical selling price.....	£230

*tested at low temperature.

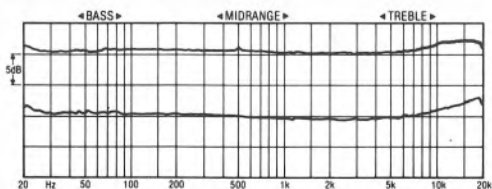

Frequency response, left and right channels

Elite EEI 747

Elite Townshend Ltd, Enterprise House, 44-46 Terrace Road, Walton on Thames, Surrey
Tel (0932) 46844

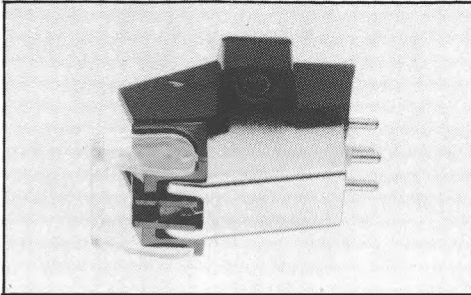

some unease about the extreme bass and treble.

Conclusions

Sonically quite well liked, reservations remain about the very low output and the need for careful pre-amp matching, plus the mildly inexcusable treble peak (a total contrast to Elite's 800!), not to mention a rather optimistic specification. Still, it is a pretty good sounding model for all that, and is not unreasonably priced.

TEST RESULTS

Type, mass.....	low output moving magnet 6g
Stylus type.....	parabolic
Stylus inspection result.....	small nude rectangular longitudinal
Output Level (1kHz, 5cm/s).....	0.11mV
Relative output (0dB = 1mV/cm/s).....	-32dB
Channel balance.....	0.6dB
Channel separation (L,R).....	30.30dB
Tracking ability (L,R).....	80.80µm
Frequency response limits 100Hz-5kHz.....	+1, -1.5dB
Frequency response limits 30Hz-20kHz.....	+3/2, -1.5dB
Stereo Separation L on R 100Hz, 3kHz, 10kHz.....	29, 31, 30dB
Stereo Separation R on L 100Hz, 3kHz, 10kHz.....	34, 34, 28dB
Channel diff. from graph, 100Hz, 1kHz, 10kHz.....	0.5, 0.5, 1dB
Response limits ref computer mean, 1kHz-15kHz.....	+0, -1.5dB
Response limits ref computer mean, 1kHz-20kHz + 6.....	-1.5dB
Test tracking weight, loading.....	1.8g, n.a.
LF resonance frequency, 12.5g arm (vert. lat).....	9.6Hz
Estimated compliance (vert. lat).....	18.40cu
Recommended arm effective mass.....	5-12g
LF resonance rise, 12.5g arm (vert. lat).....	13.11dB
Typical selling price.....	£80

This Elite model is an example of that curious phenomenon, the low output moving magnet cartridge. It is manufactured in Japan to the specification of Australian stylus specialists EEI, and uses a boron rod cantilever fitted with a nude parabolic tip, which had a tiny rectangular shank mounted longitudinally.

Compliances are on the high side (our sample was well outside spec), particularly in the lateral plane, indicating that low mass arms are to be preferred. Tracking weight is a sensible 1.8g.

Lab report

The recorded output was somewhat below specification, so this may be a sample problem or anomalous measurement, and we suspect the latter. If it is for real, substantial m-c pre-amp gain will be required, and noise could start to be a problem. Capacitance loading does not affect this low impedance/output device.

Frequency response showed a smooth and clean trace which was pretty flat, albeit downtilted 2dB to 7kHz. There was a minor controlled resonance at 10kHz, then a sharp rise starting at 15kHz and rising 3dB by 19kHz, all of which fails to accord with the 0.5dB limits 20Hz-20kHz specified. Channel balance was pretty close, and no midband resonances could be detected.

Separation figures were consistently good across the band, holding a fine 20dB at the extreme top with out-of-band spurs quite well suppressed. Tracking abilities were also good.

Sound quality

The sound was generally quite liked, being quite authoritative if a bit bright. Needletalk and surface noise were low, and good 'punch' and power with fine detail and dynamics were delivered in the midband, though there was

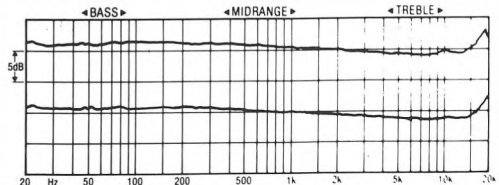

Frequency response, left and right channels

Garrott Decca

Parabolic Stylus Co, PO Box 38, Torquay TQ1 1DW
Tel (0803) 26791

RECOMMENDED

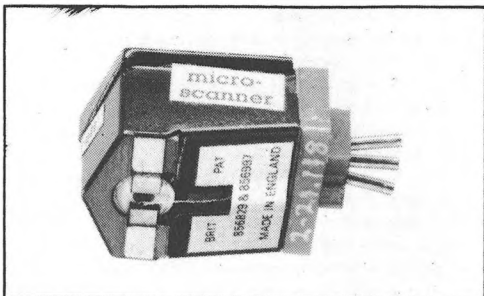

Though Deccas are hardly available in the UK, the 'Microscanner' version, modified in Australia by the Garrott Brothers, has built a strong reputation among UK audiophiles, and a special clamp made by GB Engineering is included in this very non-standard £290 package.

There is no conventional cantilever, merely a tie-wire holding the vertical moving-iron element with its attached tiny line-contact stylus. The body is thin and of quite flexible metal, so the clamp cannot be tightened hard, nor should it be fixed too firmly in the headshell. Compliance is totally undamped and quite dissimilar in the two planes, so arm and turntable matching is a little unpredictable, with the traditional recommendation for a damped rigid unipivot arm of quite high mass still relevant, while tracking weight is a low 1.3g.

Lab report

Output is more or less sufficient, and the cartridge is insensitive to capacitance; some enthusiasts prefer to load it with lower than standard impedance.

Frequency response is remarkably flat from 100Hz to 5kHz, above which there is some mild untidiness but little of which to complain. Channel balance is very close. Generally very clean, the series of short 'glitches' around 2kHz relate to the suspension tie.

Separation figures are very mediocre, which says as much about the meaningfulness of this measurement than anything else! Tracking tended to be a bit 'edgy', but serious mistracking was in fact rarely encountered.

Sound quality

The midrange clarity and dynamics of this cartridge are so startling that one easily ignores its less impressive characteristics.

Across the broad central band of the response it provides such extraordinary speed of reaction, lack of 'hangover' and signal integrity that one is reminded of electrostatic and horn loudspeakers. There is some coloration here to be sure, and an occasional intimation that things are slightly exaggerated, but the stereo focus and aliveness can be breathtaking.

That said, the treble is a trifle uncomfortable and 'fierce', bass lacks power and energy, and low bass seems almost absent. Surfaces themselves seem extraordinarily quiet, but imperfections are ruthlessly revealed by the rapid rise time. Groove stability and handling sensitivity are the pits!

Conclusions

This is not a cartridge for the casual; it demands as much as it delivers, and can be as tiresome as it can be rewarding. But the enthusiast who encounters the Garrott Decca will have to face two questions. The first is whether or not he can live with its various vicissitudes; the second is whether he can possibly live without it! I'll use mine Mondays to Fridays when there's an R in the month.

TEST RESULTS

Type, mass.....moving iron (high output) 9 including clamp Stylus type.....Garrott Microscanner	
Stylus inspection result.....fine-line profile on tiny rod	
Output Level (1kHz, 5cm/s).....—	
Relative output (0dB = 1mV/cm/s).....—	
Channel balance.....—	
Channel separation (L,R).....—	
Tracking ability (L,R).....—	
Frequency response limits 100Hz-5kHz.....+ 0.5, - 0dB	
Frequency response limits 30Hz-20kHz.....+ 1, - 0.5dB	
Stereo Separation L on R 100Hz, 3kHz, 10kHz.....18, 19, 11dB	
Stereo Separation R on L 100Hz, 3kHz, 10kHz.....21, 22, 12dB	
Channel diff. from graph, 100Hz, 1kHz, 10kHz.....0, 0, 0dB	
Response limits ref computer mean, 1kHz-15kHz.....—	
Response limits ref computer mean, 1kHz-20kHz.....—	
Test tracking weight, loading.....1.3g, n.a.	
LF resonance frequency, 12.5g arm (vert, lat).....12, 6Hz	
Estimated compliance (vert, lat).....8, 30cu	
Recommended arm effective mass.....8-16g*	
LF resonance rise, 12.5g arm (vert, lat).....both very severe	
Typical selling price.....£290	

*some arm damping may be tried if available

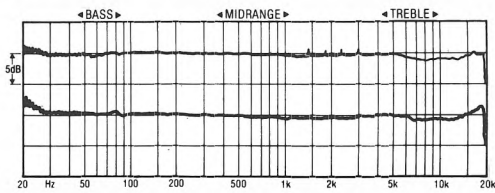

Frequency response, left and right channels

RECOMMENDED

Goldring Epic

Goldring Products Ltd, Anglian Lane, Bury St Edmunds IP32 6SS
Tel (0284) 64011

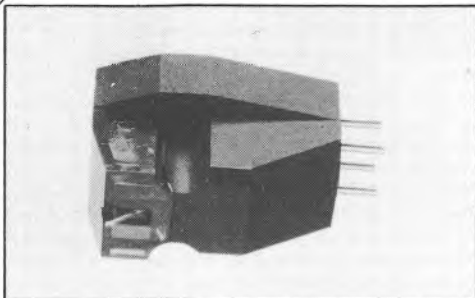

This new budget cartridge from Goldring has attracted plenty of interest and favourable comment since its launch, and has already spawned spin-off models (see RATA *RP20*). The body is rather large, though it can be mounted tightly with good contact area; however, after we had re-mounted it for the third time, there was some crumbling at the lugs, so a little care is necessary here.

Stylus assembly made a fine tight fit, and the specified elliptical tip was confirmed and neatly mounted. Compliance is moderate and well-damped, so arms of up to 16g effective mass look a safe enough bet. The downforce of 2g helps to give reasonable tracking performance.

Lab report

Plenty of output for the least sensitive amplifiers, plus a response which shows little change in shape with added capacitance will ensure no compatibility problems here. In fact the rather 'dim' response was improved a couple of dB by an extra 250pF without any untoward side effects, so adding a little extra capacitance may be beneficial.

The response trend is determinedly downtilted at high frequencies, falling some 6dB between 1kHz and 20kHz, which is not too promising. But it does follow a smooth and even trend, the final HF region is under fine control, and the curve itself is pretty smooth, with only one minor (750Hz) 'glitch'.

Channel balance was acceptable enough for the price, and separation likewise, at least showing good balance and evenness if not at a particularly exalted level. Tracking abilities are adequate, and groove stability pretty good.

Sound quality

Dominated by the dulled response, the Epic tended to sound bass heavy but was quite

impressive in terms of integration and focus, and was quite liked as a result on the listening tests. One hesitates to call it lively, but 'punchy' is not a bad adjective. Dynamics and coloration were pretty decent throughout, and stereo imaging showed some depth, albeit with some congestion.

Conclusions

This unpretentious cartridge is rather too dull in balance for the standard of ancillary equipment we used during listening, but the tight high frequency control is not ill-suited to the budget equipment it is likely to partner. Providing the body plastic is reinforced, the generally decent performance in other respects indicates cautious recommendation in the right system context.

TEST RESULTS

Type, mass.....	moving magnet 6.5g
Stylus type.....	elliptical
Stylus inspection result.....	neat simple elliptical
Output Level (1kHz, 5cm/s).....	3.8mV
Relative output (0dB = 1mV/cm/s).....	0dB
Channel balance.....	0.3dB
Channel separation (L,R).....	28.6, 25.7dB
Tracking ability (L,R).....	70, 69µm
Frequency response limits 100Hz-5Hz.....	+1, -3dB
Frequency response limits 30Hz-20kHz.....	+1.5, -6/7dB
Stereo Separation L on R 100Hz, 3kHz, 10kHz.....	21, 27, 29dB
Stereo Separation R on L 100Hz, 3kHz, 10kHz.....	18, 23, 25dB
Channel diff. from graph, 100Hz, 1kHz, 10kHz.....	0.5, 0.5, 1dB
Response limits ref computer mean, 1kHz-15kHz.....	+0, -3dB
Response limits ref computer mean, 1kHz-20kHz.....	+2, -3dB
Test tracking weight, loading.....	1.8g, 200pF
LF resonance frequency, 12.5g arm (vert, lat).....	10, 10Hz
Estimated compliance (vert, lat).....	13, 13cu
Recommended arm effective mass.....	6-14g
LF resonance rise, 12.5g arm (vert, lat).....	11, 11dB
Typical selling price.....	£16

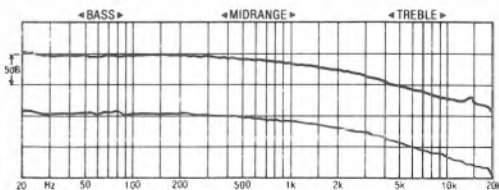

Frequency response, left and right channels

Goldring Electro II

Goldring Products Ltd, Anglian Lane, Bury St Edmunds IP32 6SS
Tel (0284) 64011

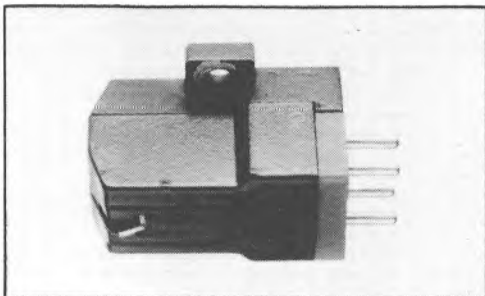

This high-output moving-coil has been around a couple of years now, and is the original model in the *Electro* series. It is a heavy cartridge with a substantial metal mounting plate to ensure close mechanical contact with the arm.

A fine van den Hul tip was fitted, which is unusual in a £125 cartridge. Downforce was a sensible 1.8g, and compliance quite low, though asymmetrical in frequency and damping. The recommended range of arm masses is 8-16g, with the middle of the range preferred.

Lab report

Though nominally a high output type, the *Electro*'s output is somewhat below average for moving magnet inputs, so the individual purchaser would be wise to check there is enough level to get the amplifier up to clipping without background noise problems. An mc input, if available, should work with no problem.

Frequency response showed a gentle 2.5dB downtilt from 100Hz to 4kHz, a mild (1dB) peak at 8kHz, and then a rather ragged though tolerably balanced rolloff. Channel balance was fair and the trace quite smooth, with just a couple of 'glitches' between 500Hz and 1kHz.

Separation figures were rather disappointing considering the price level, showing a marked deterioration towards high frequencies, though the generation of ultrasonic spurious was at an encouragingly low level. Tracking abilities were reasonable enough, but without a great deal in reserve.

Sound quality

The overall balance was pretty good, if a touch 'bright', giving a pleasant 'airiness', albeit with a touch of surface noise. However, low frequencies were a little lacking in authority and the presence lacked 'punch' and focus to a degree.

Conclusions

Decent enough in most aspects of its performance, quality of the *Electro II* generator doesn't really justify the highish price, despite the fine stylus. It is a pretty decent all-rounder to be sure, but does not excel sufficiently in any respect to warrant recommendation.

TEST RESULTS

Type, mass.....	high output moving-coil 9g
Stylus type.....	van den Hul
Stylus inspection result.....	fine tiny vdH tip
Output Level (1kHz, 5cm/s).....	1.93mV
Relative output (0dB = 1mV/cm/s).....	-7dB
Channel balance.....	0.4dB
Channel separation (L,R).....	28.1, 27.8dB
Tracking ability (L,R).....	80, 75µm
Frequency response limits 100Hz-5Hz.....	+1.5, -1dB
Frequency response limits 30Hz-20kHz.....	+2, -4/5dB
Stereo Separation L on R 100Hz, 3kHz, 10kHz.....	23, 23, 14dB
Stereo Separation R on L 100Hz, 3kHz, 10kHz.....	31, 25, 16dB
Channel diff. from graph, 100Hz, 1kHz, 10kHz.....	1, 0.5, 0.5dB
Response limits ref computer mean, 1kHz-15kHz.....	+0, -1.5dB
Response limits ref computer mean, 1kHz-20kHz.....	+1, -3dB
Test tracking weight, loading.....	1.8g, n.a.
LF resonance frequency, 12.5g arm (vert, lat).....	13, 10Hz
Estimated compliance (vert, lat).....	7, 13cu
Recommended arm effective mass.....	8-16g
LF resonance rise, 12.5g arm (vert, lat).....	9, 13dB
Typical selling price.....	£125

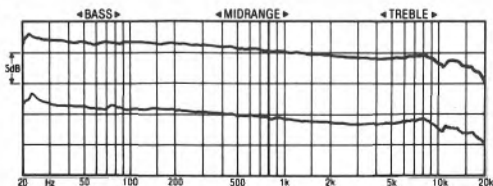

Frequency response, left and right channels

RECOMMENDED

Grace F9E

Russ Andrews Turntable Accessories, Edgebank House, Skelsmergh, Kendal, Cumbria LA8 9AS
Tel (05398) 3247

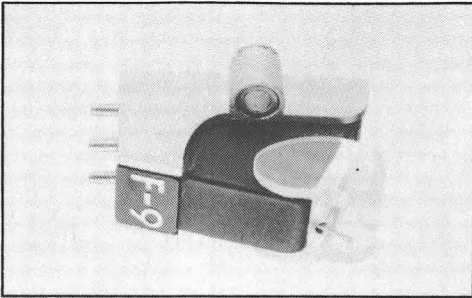

One of the oldest moving magnet designs still current, the *F9E* has weathered the passage of time remarkably well, and remains something of cult model both in the UK and US. Made in Japan by a manufacturer better known for tone-arms, the body construction is very solid and somewhat reminiscent of the Supex moving-coils (not surprisingly, as the families are related). The stylus assembly makes a very tight fit, and is enlivened by the rather practical use of fluorescent clear plastic. The Stylus is a high quality Vital elliptical.

Compliance is quite high with some damping, so low-medium effective mass arms are likely to work best. Even at the low recommended downforce of 1.2g, tracking abilities were good; higher downforce is preferred by some users.

Lab report

Output level is fine for moving magnet inputs, and no particular recommendation is made for capacitance. As the graphs show, there is a significant difference at high frequencies, and perhaps paradoxically the high-cap option was subjectively preferred.

Frequency response showed a 2dB downtilt between 300Hz and 5kHz, followed by a 1dB peak at 12kHz. With loading the downtilt was reduced to 1.5dB, the peak increased to 2dB, with faster rolloff thereafter.

Channel balance showed unfortunate minor discrepancies at high frequencies and in the lower midband, and separation was disappointingly asymmetric, with reasonable figures nonetheless.

Sound quality

Comments such as 'Nicely solid and dynamic' gave the Grace a good start, and praise was also given to the fine midrange projection and focus, and decent degree of bass extension

and discrimination. However, it was not a particularly 'tidy' cartridge; the treble 'edge' was audible, could sound a little 'fierce' and draw attention to surface noise. The cartridge might be described as a little over-dramatic, with control starting to go at the frequency extremes, and consequently drawing one's attention to and emphasising these zones.

Conclusions

Still a redoubtable contender as a sound quality rival for many moving-coils, the *F9E* has its own character reflected in the response, yet achieves an unusually well-integrated sound, with the additional benefit of the traditionally good moving magnet tracking abilities. Technical performance is solid enough, if less than spectacular, so recommendation is merited despite the (recent) price rise.

TEST RESULTS

Type, mass.....	moving magnet 6.1g
Stylus type.....	vital elliptical
Stylus inspection result	longitudinal rectangular super ellipse
Output Level (1kHz, 5cm/s).....	3.7mV
Relative output (0dB = 1mV/cm/s).....	-1dB
Channel balance.....	0.1dB
Channel separation (L,R).....	30, 30dB
Tracking ability (L,R).....	80, 80µm
Frequency response limits 100Hz-5Hz.....	+1, -1dB
Frequency response limits 30Hz-20kHz.....	+2, -3.5dB
Stereo Separation L on R 100Hz, 3kHz, 10kHz.....	28, 26, 23dB
Stereo Separation R on L 100Hz, 3kHz, 10kHz.....	36, 35, 22dB
Channel diff. from graph, 100Hz, 1kHz, 10kHz.....	0, 0, 0dB
Response limits ref computer mean, 1kHz-15kHz.....	+1.5, -0dB
Response limits ref computer mean, 1kHz-20kHz.....	+1.5, -1.5dB
Test tracking weight, loading.....	1.2g, 200pF
LF resonance frequency, 12.5g arm (vert, lat).....	8, 7Hz
Estimated compliance (vert, lat).....	24, 28cu
Recommended arm effective mass.....	5-12g
LF resonance rise, 12.5g arm (vert, lat).....	11, 9dB
Typical selling price.....	£160

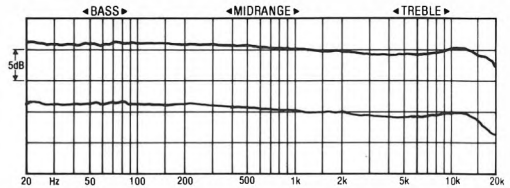

Frequency response, left and right channels

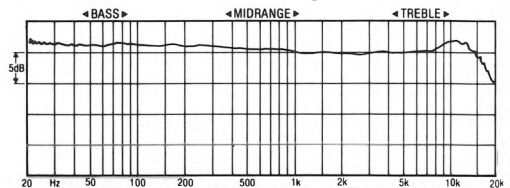

Frequency response with higher load capacitance

Grado M3

Grado Products UK Ltd, Lynch House, Alwalton, Peterborough PE7 3UY
Tel (0733) 236562

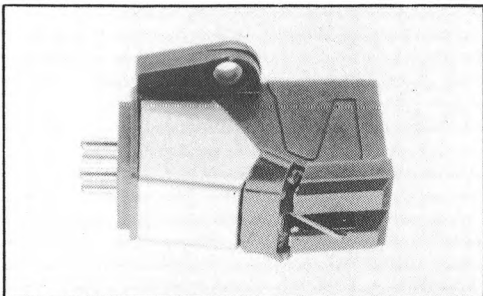

Grado cartridges are unusual in several ways, the most obvious being the almost total lack of low frequency damping, which is not so much of a bad thing *per se*, but which does mean that the accompanying turntable needs to be pretty decent. The body is a rather soft blue plastic, and we frankly didn't dare try the recommended three-point mounting spacer for fear of tearing off the lugs, which showed signs of straining when tightened. Stylus was a nicely shaped and mounted special elliptical.

The compliance is beautifully chosen for the test arm, and perfectly symmetrical, so a fair range of arm effective masses should be useable despite the high resonance rise.

Lab report

Output level is round about average and Grados are unaffected by capacitance changes, so there are no amplifier matching problems. Hum susceptibility is a known Grado trait, and will depend upon the turntable, so should be checked out if proposing purchase.

Frequency response sorted out the cheaper *T* and the *M3* quite comfortably, while at the same time showing some significant strengths in both. They were identical from 100Hz to 6kHz, showing impressive channel balance but a gently curving downtilt of 4dB. Whereas the *T* then recovered substantially, showing some channel divergence above 12kHz, the *M3* flattened and then turned down again at 9kHz, smoothly following the original trend under exceptional control. The trace as a whole was devoid of other identifiable resonances.

Separation measurements were fairly unspectacular, if reasonably consistent, and showed quite good control of ultrasonic spurs. Tracking posed no problems, stability was quite impressive despite the 1.5g tracking weight, and surface noise stayed under good control.

Sound quality

Liked in particular for its lively openness, the *M3* was a bit of a lightweight when it came to bass 'slam', but managed to sound remarkably uncongested throughout most of the band.

The midrange showed reasonable focus and stereo was quite promising, while the balance as a whole sounded a touch 'bright' and 'cold', somewhat lacking in richness and mid bass power. Some treble brightness was audible, but the combination of control and detail was good for the price.

Conclusions

A very decent sounding cartridge for the price, not to mention some impressive results in the technical testing, ensures recommendation for this Grado, and the suggestion that other models in the Master series deserve checking out, according to the depth of your pocket. However, it is not a cartridge to use with an inadequate turntable; Grados have a habit of sounding only as good as their players.

TEST RESULTS

Type, mass.....	moving magnet 5.5g
Stylus type.....	elliptical
Stylus inspection result.....	confirmed, small & neat
Output Level (1kHz, 5cm/s).....	3.4mV
Relative output (0dB = 1mV/cm/s).....	-1.5dB
Channel balance.....	0dB
Channel separation (L,R).....	23.6, 21.8dB
Tracking ability (L,R).....	80, 80µm
Frequency response limits 100Hz-5Hz.....	+2, -2dB
Frequency response limits 30Hz-20kHz.....	+2, -2/3dB
Stereo Separation L on R 100Hz, 3kHz, 10kHz.....	25, 23, 22dB
Stereo Separation R on L 100Hz, 3kHz, 10kHz.....	33, 32, 25dB
Channel diff. from graph, 100Hz, 1kHz, 10kHz.....	0, 0, 0dB
Response limits ref computer mean, 1kHz-15kHz.....	+1, -2dB
Response limits ref computer mean, 1kHz-20kHz.....	+3, -2dB
Test tracking weight, loading.....	1.5g, n.a.
LF resonance frequency, 12.5g arm (vert, lat).....	10, 10Hz
Estimated compliance (vert, lat).....	16, 16cu
Recommended arm effective mass.....	6-14g*
LF resonance rise, 12.5g arm (vert, lat).....	18, 17dB
Typical selling price.....	£43

*with slight damping if available

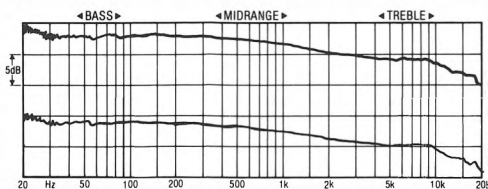

Frequency response, left and right channels

Highphonic MCA3

Esoteric Audio Research Ltd, The Old Chapel, Little Stukeley, Huntingdon, Cambs
Tel (0480) 53791

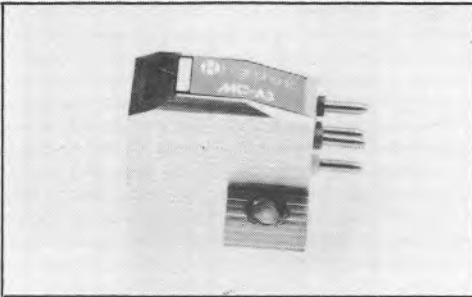

This exquisitely crafted low output moving-coil cartridge costs a fairly substantial £250, and comes from a group of ex-Denon engineers. The hereditary influence from Denon's 300 series is apparent, with the emphasis on low moving mass and also on a low specified tracking weight (1.1g).

The body is a beautifully finished metal casting, and the stylus a tiny line-contact rod. Compliance is very high, though fairly well damped, but this model is really only suitable for low mass arms.

Lab report

Output level is very low. Though not beyond the capabilities of a decent, low-noise, moving-coil pre-amp; this isn't the sort of cartridge to use into the add-on m-c stage of the typical integrated amplifier.

Frequency response is very impressive, while following the familiar trend of a gently falling midrange from 100Hz-5kHz (2dB in this instance), a short shelf to 10kHz, followed by a fairly gentle rolloff thereafter, which was the only evidence of any channel imbalance. A solitary, tiny 800Hz 'glitch' remains unexplained.

Separation figures were mostly outstanding, particularly through the mid/bass, but with the odd inconsistency elsewhere. Out-of-band spurious were exceptionally low at 25kHz, but more normal at 40kHz. Tracking was exemplary, though stability the precise opposite.

Sound quality

One strength of this particular exotic is just about the sweetest treble of them all, a feature which is undeniably seductive after listening to 130 other variations on that particular theme! However, it did sound rather 'bright', as if unable to avoid attracting attention to itself, and one could describe the sound as a little

'cold' or 'clinical'.

The bass as a whole and the upper bass in particular sounded 'lean', and very uncoloured, with good differentiation but lacking a little 'power' subjectively. Dynamics and focus were pretty good, while depth was a little curtailed.

Conclusions

This beautifully engineered cartridge is not too expensive considering its superb tracking abilities at high frequencies, its wide dynamic range and lack of colouration. Ultimately, however, I find myself in close agreement with another reviewer who suggested that it has a sound which is closer to Japanese than UK tastes, but which has its own validity nonetheless.

TEST RESULTS

Type, mass.....	low output moving-coil 6.6g
Stylus type.....not specified
Stylus inspection result.....	minuscule line profile rod, some glue
Output Level (1kHz, 5cm/s).....	0.12mV
Relative output (0dB = 1mV/cm/s).....	-30dB
Channel balance.....	0.5dB
Channel separation (L,R).....	30, 30dB
Tracking ability (L,R).....	80, 80µm
Frequency response limits 100Hz-5Hz.....	+1, -1dB
Frequency response limits 30Hz-20kHz.....	+1, -3/5dB
Stereo Separation L on R 100Hz, 3kHz, 10kHz.....	31, 34, 38dB
Stereo Separation R on L 100Hz, 3kHz, 10kHz.....	37, 28, 24dB
Channel diff. from graph, 100Hz, 1kHz, 10kHz.....	0, 0, 0.5dB
Response limits ref computer mean, 1kHz-15kHz.....	+1, -0dB
Response limits ref computer mean, 1kHz-20kHz.....	+1.5, -0dB
Test tracking weight, loading.....	1.1g, n.a.
LF resonance frequency, 12.5g arm (vert, lat).....	8, 6Hz
Estimated compliance (vert, lat).....	20, 38cu
Recommended arm effective mass.....	5-12g
LF resonance rise, 12.5g arm (vert, lat).....	12, 12dB
Typical selling price.....	£250

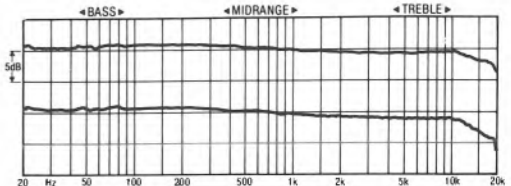

Frequency response, left and right channels

RECOMMENDED

Koetsu Black

Absolute Sounds Ltd, 42 Parkside, London SW19
Tel 01-947 5047

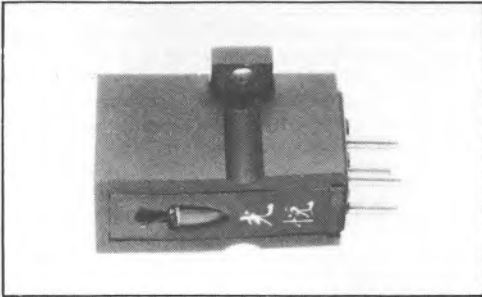

The £430 *Black* is the cheaper of the two extravagant but popular Koetsus reviewed here. Made in Japan in limited numbers under the supervision of legendary craftsman Sugano, who was once with Supex, the *Black* has recently been improved by the addition of some of the technology of the *Red*.

It is a heavy low output moving-coil model, built into a black metal body with little embellishment, and is undoubtedly capable of rigid headshell mounting. Lack of radiusing on the connecting pins is a minor irritation. Stylus was unspecified, but was a very fine swept elliptical tip on a long rectangular shank.

Compliance is fairly low, but greater vertically than laterally, with some damping, so medium mass arms are to be preferred. A fairly substantial 1.9g downforce was used, though tracking abilities were still a trifle marginal, and this is not the cartridge for those who place a premium on this parameter.

Lab report

Though nominally low output, the *Black* generates a pretty substantial signal, so although a step-up stage of some sort is theoretically necessary, a sensitive, quiet moving-magnet pre-amp input may be able to take it directly.

The extremely straight response shows a marked midband downtilt of 2.5dB from 400Hz to 5kHz, whereupon there was mild channel divergence, one continuing down a further 2dB by 20kHz, the other dropping only 0.5dB. The trace looked very clean, albeit with some minor unevennesses and a 1.2kHz 'glitch' (ironically identical to the Linn *Karma's* sole indiscretion). Though the high frequency imbalance was mildly disappointing, the response control here was quite exceptional.

Separation figures were pretty good, albeit with mild asymmetry, and control of ultrasonic

spuria was equally impressive, at 20dB below crosstalk on the alternate channel.

Sound quality

Immediately impressive, the *Black* is a true heavyweight, with a 'rich' and powerful 'big' sound. The integration from upper bass through to lower treble is delightful, providing stable well-focussed stereo of great depth.

Consistently liked for the high level of detail, it could occasionally sound a touch 'bright', and the bass a trifle 'sluggish', and certainly made a better match with panel speakers and valve amplifiers than the Linn/Naim dynamic system.

Conclusions

Undoubtedly amongst the top few on sound quality, the *Black* conveyed plenty of 'power' with splendid midrange clarity, and was reasonably tolerant of tonearm mechanical performance due to its high inherent mass. Clearly meriting recommendation despite the rather high price, it is important that selection is carefully made as part of an appropriate system which enhances its particular strengths.

TEST RESULTS

Type, mass.....	low output moving-coil 9.5g
Stylus type.....	not specified
Stylus inspection result.....	longitudinal rectangular shank with swept ellipse
Output Level (1kHz, 5cm/s).....	0.4mV
Relative output (0dB = 1mV/cm/s).....	- 20dB
Channel balance.....	0.1dB
Channel separation (L,R).....	30, 30dB
Tracking ability (L,R).....	69, 65µm
Frequency response limits 100Hz-5Hz.....	+ 1.5, - 1.5dB
Frequency response limits 30Hz-20kHz.....	+ 1.5, - 2dB
Stereo Separation L on R 100Hz, 3kHz, 10kHz.....	35, 35, 28dB
Stereo Separation R on L 100Hz, 3kHz, 10kHz.....	30, 30, 24dB
Channel diff. from graph, 100Hz, 1kHz, 10kHz.....	0, 0, 1dB
Response limits ref computer mean, 1kHz-15kHz.....	+ 1, - 0.5dB
Response limits ref computer mean, 1kHz-20kHz + 3,	- 0.5dB
Test tracking weight, loading.....	1.8g, n.a.
LF resonance frequency, 12.5g arm (vert, lat).....	.9, 11Hz
Estimated compliance (vert, lat).....	16, 11cu
Recommended arm effective mass.....	6-16g
LF resonance rise, 12.5g arm (vert, lat).....	12, 13dB
Typical selling price.....	£430

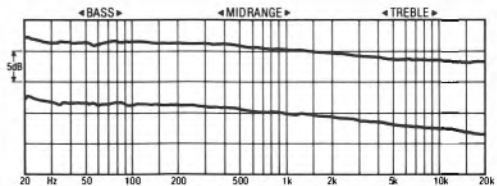

Frequency response, left and right channels

**WE STOCK
THE FOLLOWING
BEST BUY AND
RECOMMENDED
CARTRIDGES REVIEWED IN
THIS BOOK...**

**NAGOKA, SHURE, ADC, AUDIO-
TECHNICA...**

**ALL AT VERY
COMPETITIVE PRICES**

PHASE 3 HI-FI

**53 BRIGHTON ROAD
WORTHING, WEST SUSSEX
Tel: Worthing (0903) 206820**

Grace
SUPEX
RATA RP SERIES
TORLYTE[®]

RATA

**RUSS ANDREWS
TURNTABLE ACCESSORIES
EDGE BANK HOUSE, SKELSMERGH,
KENDAL, CUMBRIA LA8 9AS
TELEPHONE: SELSIDE (053 983) 247**

**THE PICK of
the BUNCH**

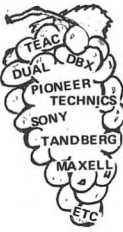

In every crop of HI-Fi Products (whether it be top quality separates or a budget rack system), there is always a small proportion that is better than the next. Come and sample the pick of the crop at



Some of the sweetest sounds come from our smaller friends

**Jeffries
Hifi**

4 Albert Parade, Green St, Eastbourne.
 Tel: 0323 31336
 69 London Rd, Brighton
 (closed Mon) Tel: 0273 609431

**Highest Quality Adjustable
SPEAKER STANDS**
 Direct from The Manufacturer

*Enhance your listening pleasure with these sturdy
and practical pair of speaker stands*

only **£19.95** Includes post packaging & VAT. Limited period only

- Mounted on spikes or easy running castors (Please state which required when ordering)
- Adjustable width up to 13"
- Top section on upward incline with non slip neoprene pads
- Approximate Dimensions Height 12", Width 11", Depth 10"

INDUSTRIAL SERVICES
P&J Regd No. 253307



ORDER YOUR SPEAKER STANDS NOW!

To: P & J Industrial Services, Musker St, Crosby, Merseyside L23 0UB Tel 051-931 4249

Please send me _____ pair of speaker stands at £19.95 (Price includes post & Packing U.K. Mainland only) * with spikes * with castors

I enclose cheque for _____ or debit my Access Card No. _____

Signature _____
 Name _____ Address _____

PostCode _____ Tel _____
 Or Transcash Ref: 6930654
 Please allow 28 days for delivery * delete which not required



Koetsu Red

Absolute Sounds Ltd, 42 Parkside, London SW19
Tel 01-947 5047

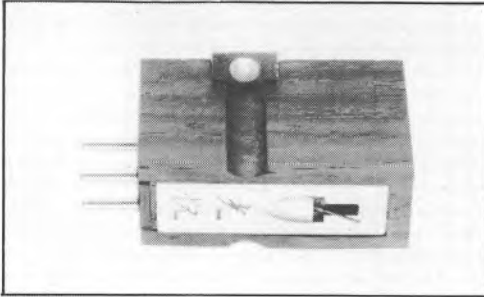

Considerably more expensive than the *Black*, the *Red* Koetsu is by far the prettier model, looking like an expensive Mah Jong tile in its beautifully finished rosewood sleeve. The stator and generator assemblies are built on a solid metal foundation, which can be bolted closely to the headshell.

Stylus type is unspecified, but consisted of an inherently fine small long-shank tip with mildly anomalous super-ellipse/line profile, slightly spoilt by an unsightly 'carbunkle' of adhesive on one side of the shank near the tip. Compliance is low, quite lightly damped, and mildly asymmetric, suited to a wide range of medium-high effective mass arms. Like the *Black*, despite near 2g downforce, margins of tracking ability are not generous, and may be further compromised if not used with the best tonearms.

Lab report

This low output moving-coil packs sufficient 'wallop' for some sensitive low noise moving magnet inputs, though some sort of step up stage will probably be necessary.

Frequency response was a further refinement on the *Black* in straightness: a line drawn between 30Hz and 20kHz would drop 2dB, but show no deviation greater than 0.5dB. Such trends as exist corroborate subjective observation of slight richness and brightness, but the high frequency region is remarkably flat and well controlled.

Channel balance was pretty good, though bettered by others, and there were several minor 'glitches' below 1kHz on the otherwise smooth trace.

Separation was exceptional in the upper mid and lower treble, but rather poorer at low frequencies and in the 16kHz band, and also showed rather higher output of ultrasonic spurious than the *Black*.

Sound quality

The magnificently 'laid back' balance seemed particularly well suited to classical music, and the sound showed a significant improvement in smoothness, control and refinement over the *Black*, further enhancing the stereo soundstage. Suiting panel speakers and valve amplification even better than the *Black*, it was a little less 'fiery' and exciting on dynamics, and sounded a touch 'slower' at low frequencies.

Conclusions

This beautiful cartridge could perhaps have done a little more to justify its very high price in terms of quality control, but is clearly a worthwhile graduation for those already seduced by the charms of the *Black*, with improved detail and control throughout the mid and treble. It is a little less forgiving of arm quality than the *Black*, and, inevitably, requires even more careful selection of ancillaries to make the most of its strengths.

TEST RESULTS

Type, mass.....	low output moving-coil 7.5g
Stylus type.....	specified high quality
Stylus inspection result.....	good superellipse but overglued
Output Level (1kHz, 5cm/s).....	0.34mV
Relative output (0dB = 1mV/cm/s).....	-22dB
Channel balance.....	0dB
Channel separation (L,R).....	30, 30dB
Tracking ability (L,R).....	74, 66µm
Frequency response limits 100Hz-5Hz.....	+1, -1dB
Frequency response limits 30Hz-20kHz.....	+1, -1.5dB
Stereo Separation L on R 100Hz, 3kHz, 10kHz.....	21, 36, 31dB
Stereo Separation R on L 100Hz, 3kHz, 10kHz.....	27, 39, 24dB
Channel diff. from graph, 100Hz, 1kHz, 10kHz.....	0.5, 0.5, 0.5dB
Response limits ref computer mean, 1kHz-15kHz.....	+2, -1dB
Response limits ref computer mean, 1kHz-20kHz.....	+4, -1dB
Test tracking weight, loading.....	1.9g, n.a.
LF resonance frequency, 12.5g arm (vert, lat).....	12, 11Hz
Estimated compliance (vert, lat).....	9, 11cu
Recommended arm effective mass.....	9.18g
LF resonance rise, 12.5g arm (vert, lat).....	15, 15dB
Typical selling price.....	£650

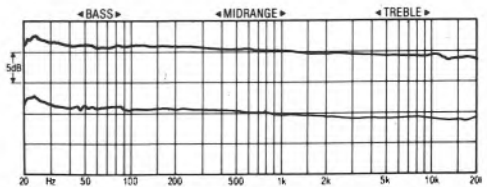

Frequency response, left and right channels

BEST BUY

Linn Basik

Linn Products Ltd, 235 Drakemire Drive, Castlemilk, Glasgow G45 9SZ
Tel 041-634 0371

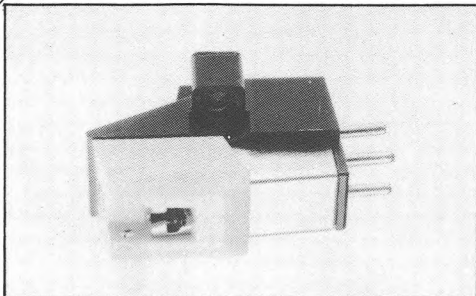

Conceived originally by Linn as a giveaway with the arm of the same name, to drive home the company's view that the arm is infinitely more important than the cartridge, the current model *Basik* is now available as a separate £12 item. It is made in Japan by Audio Technica and based on the *AT105*, but seems to have acquired something of a cult reputation for itself as a 'giant killer'.

This simple moving magnet design has good mechanical properties in terms of body rigidity and stylus fit, though the stylus itself was rather heavily glued. Compliance is on the high side of medium, which means that arms should be on the low side of medium mass, a category which just about accommodates Linn's own designs!

Lab report

Output is quite sufficient in level, and although it is fairly tolerant of capacitance, there was little doubt that it sounded best well-loaded.

Frequency response actually measured best with low capacitance, where it was very good indeed, holding ± 1 dB from 20Hz-16kHz; increased capacitance emphasised the 10kHz peak a touch and curtailed the bandwidth slightly. Channel balance was poor in terms of absolute error. The high writing speed trace was a little untidy, confirming the slight unevenness on the original chart.

Separation was distinctly uninspiring, lurking around the 20dB mark, due we suspect to the lively highish vertical compliance. Tracking, on the other hand, was pretty good.

Sound quality

Reflecting its low cost in terms of general brashness and unsubtlety, the *Basik* nevertheless did a decent job in conveying detail and dynamics through most of the range, though surface noise tended to be exaggerated and

the sound could occasionally be described as 'fierce'. Definitely preferred on rock rather than classical music, this cartridge tried hard to give a good impression of overall integrity. Groove stability was reasonable.

Conclusions

No cartridge better deserves the epithet 'cheap and cheerful', yet the *Basik* goes much further in delivering the goods than its price level might indicate. It is one of the brightest-sounding amongst the better low cost cartridges, which will either be a blessing or a curse to the prospective purchaser, according to system and taste.

TEST RESULTS

Type, mass.....	moving magnet 5g
Stylus type.....	spherical?
Stylus inspection result.....	rather heavy glueing, small
Output Level (1kHz, 5cm/s).....	3.38mV
Relative output (0dB = 1mV/cm/s).....	- 1.5dB
Channel balance.....	0.98dB
Channel separation (L,R).....	28.1, 28.5dB
Tracking ability (L,R).....	80, 80 μ m
Frequency response limits 100Hz-5Hz.....	+ 1, - 1dB
Frequency response limits 30Hz-20kHz.....	+ 1.5, - 3.5dB
Stereo Separation L on R 100Hz, 3kHz, 10kHz.....	20, 23, 19dB
Stereo Separation R on L 100Hz, 3kHz, 10kHz.....	20, 19, 16dB
Channel diff. from graph, 100Hz, 1kHz, 10kHz.....	1.5, 1.5, 1.5dB
Response limits ref computer mean, 1kHz-15kHz.....	+ 3, - 2dB
Response limits ref computer mean, 1kHz-20kHz.....	+ 3, - 2dB
Test tracking weight, loading.....	2g, 300pF
LF resonance frequency, 12.5g arm (vert, lat).....	8.8, 8.6Hz
Estimated compliance (vert, lat).....	25, 26cu
Recommended arm effective mass.....	6-14g
LF resonance rise, 12.5g arm (vert, lat).....	15.6, 11.2dB
Typical selling price.....	£12

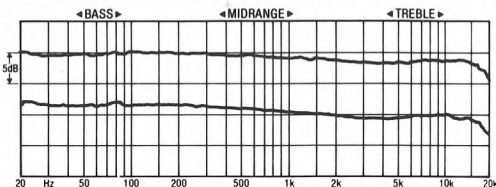

Frequency response, left and right channels

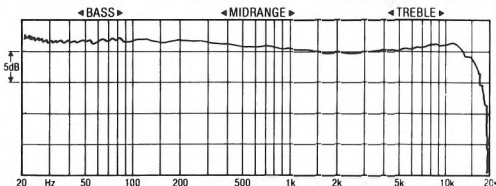

Frequency response with higher load capacitance

Linn Trak

Linn Products Ltd, 235 Drakemire Drive, Castlemilk, Glasgow G45 9SZ
Tel 041-634 0371

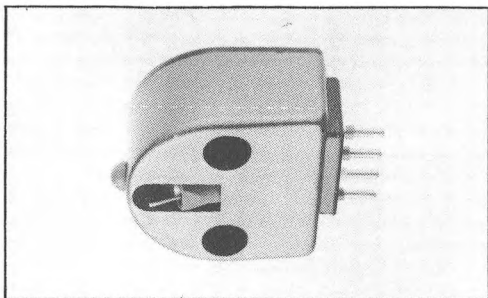

The *Trak* is a low cost version of the well respected and established *Asak*. It is understood to have slightly less stringent production tolerances and to undergo final quality control in Japan, without the automatic Glaswegian inspection applied to the most costly models.

It is a low output moving-coil model of solid construction, with a distinctive metallic blue can. A fine small nude stylus of rectangular section was well fitted. Tracking weight is 2g which helps cope with the low compliance. This is best suited to arms towards the middle of a 10-18g effective mass range, in view of the virtual absence of LF damping.

Lab report

Output is sufficient for any decent moving-coil stage, and the 470ohm recommended loading is pretty widespread, so there are unlikely to be any compatibility problems here.

Frequency response is very similar to all Linn's m-c models, fitting a fairly tight 3dB window across the bandwidth 40Hz-20kHz. The midrange downtilt was some 2.5dB between 200Hz and 5kHz, followed by a well controlled 11kHz peak and gentle rolloff thereafter. Channel balance was very close throughout, though the trace was a little livelier than the other Linn m-cs, with a few small 'glitches' at the low frequency end.

Separation was pretty good, if not quite to *Karma* standards, rarely falling below 30dB except for gentle worsening at high frequencies. Despite the name, tracking abilities were a bit marginal, though the lack of damping will place much of the responsibility on the turntable and arm.

Sound quality

The sound was considered a trifle 'heavy', a little recessed in the lower treble, and then with a slight emphasis at the extreme top. However,

'difficult' distorted treble was handled pretty well, and the sound was reassuringly solid, with fine full-range dynamics, good focus, and plenty of detail. All-in-all a thoroughly impressive result for the price, albeit leaning slightly in the direction of 'boom 'n' tizz'.

Conclusions

Clearly fine value for money in itself, the *Trak's* limitations lie more in the difficulties it can present tonearms than anywhere else, though tracking abilities are also a trifle suspect. The chances are that anyone with a tonearm capable of doing the *Trak* justice may well have set his cartridge sights a little higher than £110, yet at the same time this model definitely delivers the goods, and deserves warm recommendation.

TEST RESULTS

Type, mass.....	low output moving-coil 6g
Stylus type.....	vital
Stylus inspection result.....	confirmed, small nude rectangular special ell
Output Level (1kHz, 5cm/s).....	0.18mV
Relative output (0dB = 1mV/cm/s).....	- 26dB
Channel balance.....	0.25dB
Channel separation (L,R).....	27.2, 28.9dB
Tracking ability (L,R).....	74, 71µm
Frequency response limits 100Hz-5Hz.....	+ 1.5, - 1.5dB
Frequency response limits 30Hz-20kHz.....	+ 2.5, - 1.5dB
Stereo Separation L on L 100Hz, 3kHz, 10kHz.....	32, 24, 25dB
Stereo Separation R on L 100Hz, 3kHz, 10kHz.....	35, 30, 25dB
Channel diff. from graph, 100Hz, 1kHz, 10kHz.....	0, 0.5, 0dB
Response limits ref computer mean, 1kHz-15kHz.....	+ 2.5, - 0dB
Response limits ref computer mean, 1kHz-20kHz + 3.5, - 0dB	
Test tracking weight, loading.....	2g, n.a.
LF resonance frequency, 12.5g arm (vert, lat).....	11.5, 12Hz
Estimated compliance (vert, lat).....	11, 10cu
Recommended arm effective mass.....	10-18g
LF resonance rise, 12.5g arm (vert, lat).....	17.5, 17.5dB
Typical selling price.....	£110

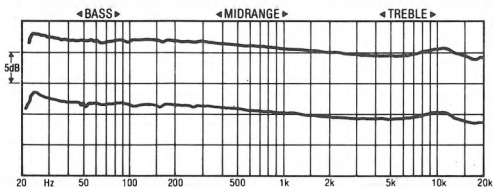

Frequency response, left and right channels

ONE THING
LEADS TO
ANOTHER...

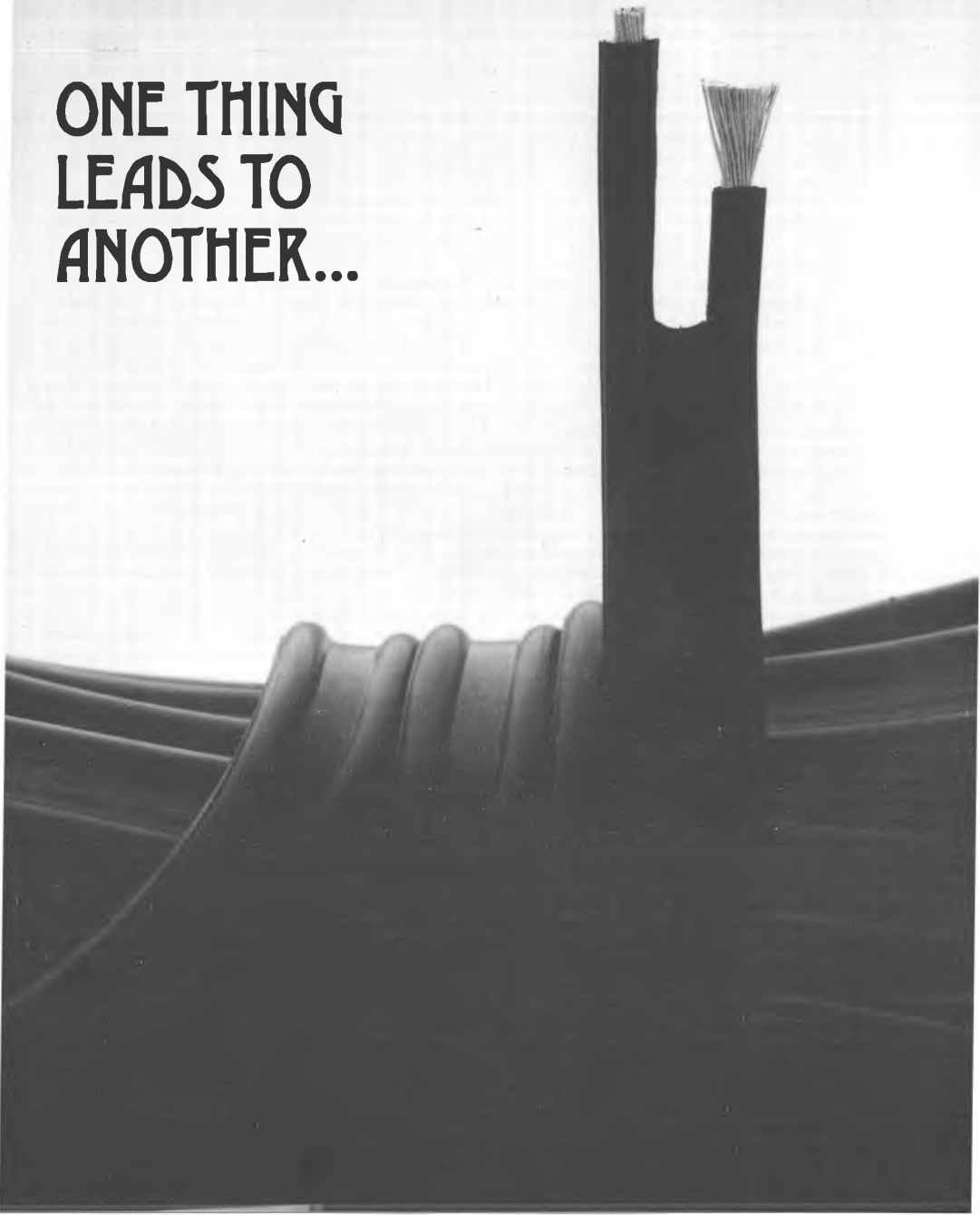

naim audio
MANUFACTURERS OF AUDIO EQUIPMENT

naim audio cable type **NAC A4**

NAIM AUDIO LIMITED, SOUTHAMPTON ROAD, SALISBURY, ENGLAND SP1 2LN. TELEPHONE (0722) 332266

Linn Karma

Linn Products Ltd, 235 Drakemire Drive, Castlemeik, Glasgow G45 9SZ
Tel 041-634 0371

RECOMMENDED

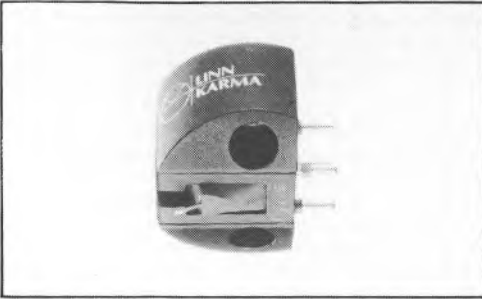

Since the decision to design their own cartridges for Supex to manufacture, rather than merely acting as the latter's distributors, Linn's models have increasingly taken their own path. *Karma* is clearly much more of a Linn cartridge than its predecessors.

The body is a small strong alloy casting. The (short) aluminium alloy cantilever carries a swept elliptical (Vital) tip, which was a tiny well-angled rectangular section nude stone.

Compliance is low, symmetrical, and with very little damping, so medium-to-high mass arms are the rational choice, with the *Ittok* making an admirable match. Downforce is 1.7g, which gave adequate tracking abilities but left little in hand.

Lab report

Undoubtedly a low output model, the *Karma* still has sufficient output for any decent m-c input, with an easily met impedance recommendation of 470ohms.

Frequency response is smooth but with a fairly large 3dB downtilt, running from 100Hz to 5kHz, then a small, controlled 1dB peak at 10kHz, and a small 'glitch' at 14kHz. Channel balance was very close with fine control at high frequencies. At high writing speed, there was a solitary 'glitch' at 1.2kHz, ironically identical to the Koetsu *Black's* sole blemish!

Separation figures were amongst the best in the book.

Sound quality

With the best will in the world, the author is going to find it impossible to remain entirely dispassionate about the model he has purchased and been using over an eighteen month period. It is interesting to note that the original (first batch) sample appears to have retained its character, though the latest samples are notably sweeter and smoother at

high frequencies.

The *Karma* sound is essentially very weighty, powerful and extended in the bass, and slightly bright and brittle in the mid treble. Integration and control are major strengths, yet there is none of the congestion that often accompanies more heavily damped models — *Karma* is very 'fast' in the manner of the Decca (though not to the same degree), yet extends this subjective speed over a much wider bandwidth. Focus, dynamics and projection in the midband are exceptional, but the sound is a little 'clinical', lacking the warmth, romance and depth of smoother sounding high-end models. Yet because of the fine integration, what seems to be less apparent detail translates into more coherent information.

Conclusions

Capable of superb results in the right system context, *Karma* sets new standards for bandwidth integration, and is uncoloured and fast to boot. But by coupling such a bandwidth of high mechanical energy to the tonearm, it also sets new standards for interface problems. While it may be strongly recommended for use in Linn-based systems, there must be similarly strong note of caution against more general applications, where results will be less predictable.

TEST RESULTS

Type, mass.....	low output moving-coil 6.2g
Stylus type.....	Vital superelliptical
Stylus inspection result.....	confirmed, fine small stone, accurately set
Output Level (1kHz, 5cm/s).....	0.2mV
Relative output (0dB = 1mV/cm/s).....	-26dB
Channel balance.....	0.25dB
Channel separation (L,R).....	30, 30dB
Tracking ability (L,R).....	80, 76µm
Frequency response limits 100Hz-5Hz.....	+2, -1dB
Frequency response limits 30Hz-20kHz.....	+2, -2dB
Stereo Separation L on R 100Hz, 3kHz, 10kHz.....	30, 33, 35dB
Stereo Separation R on L 100Hz, 3kHz, 10kHz.....	32, 37, 33dB
Channel diff. from graph, 100Hz, 1kHz, 10kHz.....	0, 0, 0.5dB
Response limits ref computer mean, 1kHz-15kHz.....	+1, -0dB
Response limits ref computer mean, 1kHz-20kHz + 2.5.....	-0dB
Test tracking weight, loading.....	1.7g, n.a.
LF resonance frequency, 12.5g arm (vert, lat).....	11.5, 11.5Hz
Estimated compliance (vert, lat).....	12, 12cu
Recommended arm effective mass.....	9-18g
LF resonance rise, 12.5g arm (vert, lat).....	15.5, 14.5dB
Typical selling price.....	£340

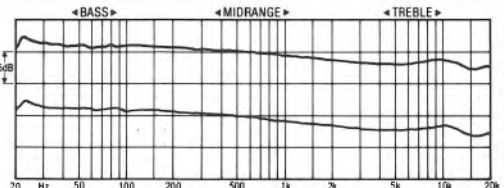

Frequency response, left and right channels

RECOMMENDED

Logic Gold

Logic Ltd, 19 Hurlbutt Road, Heathcote Industrial Estate, Warwick CV34 6TD
Tel (0926) 20302

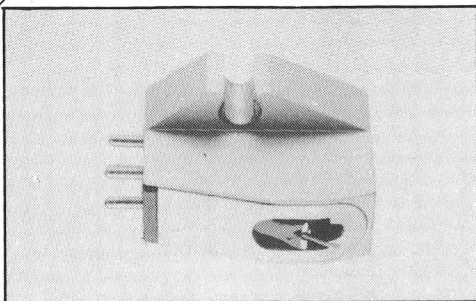

This quite heavy low output moving-coil model is sourced in Japan by turntable manufacturer Logic. It is built into a solid, rigid metal body, and uses rather more conventional technology than the same company's upmarket *Black* model, in the form of an aluminium cantilever and elliptical stylus.

Price is a quite reasonable £95, and the small nude elliptical stylus looked well set. Compliance is a trifle high considering the mass of the cartridge, so despite the fairly high damping, high effective mass arms are in this instance better avoided.

Lab report

Output is quite adequate for the typical moving-coil input, and is naturally substantially independent of loading.

Frequency response shows the usual mild midband downtilt, dropping 2dB from 200Hz-5kHz; level is then maintained to about 13kHz before rolling gently, though on this sample there is some uncertainty on one channel in particular above 5kHz. The trace shows mild unevenness with a few very minor 'glitches', and channel balance was very close apart from the extreme treble.

Separation figures were fairly consistent and pretty good, bettering 30dB across most of the band, and with evidence that little in the way of ultrasonic spuriae were being produced. Tracking abilities were fine.

Sound quality

The quality of this modest enough sonic cartridge was impressively powerful and dynamic, though rather 'toppy' and 'bright'. The sound was very solid, firm and lively with plenty of detail and quite good stereo 'space', but was a little 'untidy' at high frequencies, with a tendency to sound 'brittle' and 'fierce'. Groove stability was not very high.

Conclusions

Definitely a leading contender amongst the lower-priced moving-coils, the *Gold* has a lot going for it but suffers somewhat for its high lateral compliance, which affects stability and restricts arm choice to the lower mass models. Providing it is carefully matched to ancillaries it clearly presents a well-judged set of compromises, and merits recommendation in its class.

TEST RESULTS

Type, mass.....	low output moving-coil 8.5g
Stylus type.....	elliptical
Stylus inspection result.....	small nude special elliptical
Output Level (1kHz, 5cm/s).....	0.29mV
Relative output (0dB = 1mV/cm/s).....	-23dB
Channel balance.....	0.4dB
Channel separation (L,R).....	23.7, 30dB
Tracking ability (L,R).....	80, 80µm
Frequency response limits 100Hz-5kHz.....	+1, -1dB
Frequency response limits 30Hz-20kHz.....	+1.5, -2.5dB
Stereo Separation L on R 100Hz, 3kHz, 10kHz.....	22, 30, 30dB
Stereo Separation R on L 100Hz, 3kHz, 10kHz.....	27, 32, 30dB
Channel diff. from graph, 100Hz, 1kHz, 10kHz.....	0, 0, 1dB
Response limits ref computer mean, 1kHz-15kHz.....	+2, -0dB
Test tracking weight, loading.....	2g, n.a.
LF resonance frequency, 12.5g arm (vert, lat).....	9, 6Hz
Estimated compliance (vert, lat).....	16, 34cu
Recommended arm effective mass.....	0.5-12g
LF resonance rise, 12.5g arm (vert, lat).....	11, 13dB
Typical selling price.....	£95

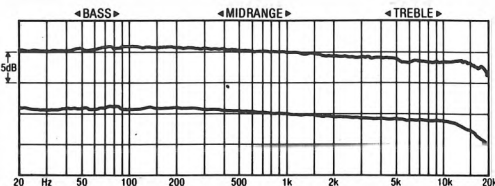

Frequency response, left and right channels

Mission Solitaire

Mission Electronics Ltd, Stonehill, Huntingdon, Cambridge PE18 6ED
Tel (0480) 57477

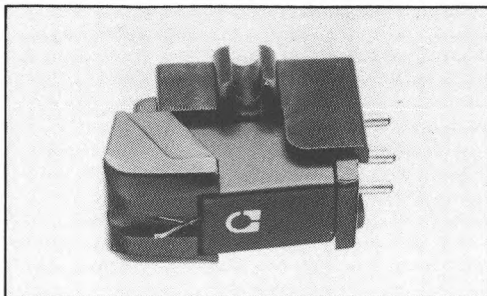

This conventional moving-magnet cartridge is sourced from the Far East and marketed by Mission Electronics as their middle model.

It uses a solid-looking plastic body with a decently fitting stylus assembly, the elliptical stylus itself being fairly substantial and firmly 'pegged' through the cantilever. Compliance and damping are both moderate, so a wide range of arm masses can be accommodated.

Lab report

This model has a substantial output, and is also quite sensitive to changes in capacitance, the graph clearly showing that the addition of 250pF increases the 10kHz level some 2.5dB. Though amplifier sensitivity is clearly no problem, some experimentation with capacitance loading could well pay off.

Frequency response looks impressively smooth and extended, though the midrange downturn with low capacitance is a full 5dB from 200Hz-8kHz. Increased capacitance reduces this to only 2dB, with the corner now turning at 5.5kHz, followed by a gentle 10kHz peak and fairly rapid rolloff thereafter. Channel balance was very impressive, with only very minor blemishes, and the high writing speed confirmed a pretty smooth trace with 'glitches' few and small.

Stereo separation was not too impressive, recording values in the mid twenties fairly consistently. Tracking abilities, on the other hand, were fine.

Sound quality

Described as 'firm' and 'punchy', the *Solitaire* had a touch of moving-coil character about its sound. Definition was limited at high frequencies, yet output was quite generous, so there was a touch of 'smear' which was mildly irritating. The midrange and upper bass were nice and clear with good dynamics, though the bass

proper sounded a touch congested and constrained.

Conclusions

One could be forgiven for overlooking the *Solitaire* because its lack of specific character is its major strength.

In fact it offers a very nice blend of compromises if examined closely, and should match well with turntables in the mid price sector, say from £150-£300, providing in many senses a slightly smoother and sweeter version of the inherently decent sound of leading budget models like the ADC *Phase 1*, Linn *Basik* and Ortofon *OM10*. Furthermore, the sensitivity to capacitance loading can be exploited for system matching.

TEST RESULTS

Type, mass.....	moving magnet 5.7g
Stylus type.....	elliptical
Stylus inspection result.....	substantial 'pegged' elliptical
Output Level (1kHz, 5cm/s).....	2.46mV
Relative output (0dB = 1mV/cm/s).....	- 4dB
Channel balance.....	0.4dB
Channel separation (L,R).....	20.4, 30dB
Tracking ability (L,R).....	80, 80µm
Frequency response limits 100Hz-5Hz.....	+ 1.5, - 1.5dB
Frequency response limits 30Hz-20kHz.....	+ 1.5, - 4dB
Stereo Separation L on R 100Hz, 3kHz, 10kHz.....	19, 25, 22dB
Stereo Separation R on L 100Hz, 3kHz, 10kHz.....	22, 29, 25dB
Channel diff. from graph, 100Hz, 1kHz, 10kHz.....	0, 0, 0dB
Response limits ref computer mean, 1kHz-15kHz.....	+ 0, - 1.5dB
Response limits ref computer mean, 1kHz-20kHz + 0, - 1.5dB	
Test tracking weight, loading.....	1.8g, 200pF
LF resonance frequency, 12.5g arm (vert, lat).....	10, 10Hz
Estimated compliance (vert, lat).....	15, 15cu
Recommended arm effective mass.....	6-16g
LF resonance rise, 12.5g arm (vert, lat).....	13.5, 12.5dB
Typical selling price.....	£38

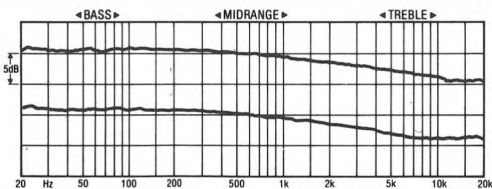

Frequency response, left and right channels

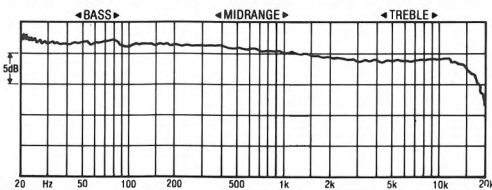

Frequency response with higher load capacitance

RECOMMENDED

Mission 773HC

Mission Electronics Ltd, Stonehill, Huntingdon, Cambridge PE18 6ED
Tel (0480) 57477

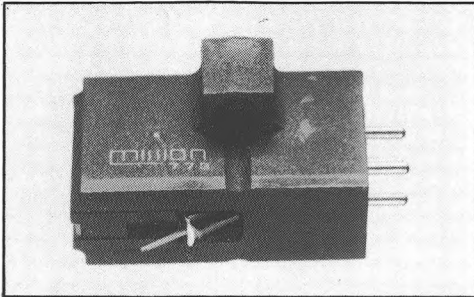

This Mission model is sourced from Dynavector in Japan, yet is very much to Mission's specification, and has undergone several internal changes over the years, while retaining the familiar red-embellished black body which has featured before in these pages. With the appearance of the *Rose* (a prototype of which was examined for the short reviews), it is no longer Mission's 'flag carrier', and has held its £150 price well over the years.

The body is well shaped for rigid mounting, though the currently fashionable hex bolt heads are rather a tight fit in the lug channels. Stylus polish was a little disappointing, and showed a slightly extended elliptical profile. Clearly having a very similar generator to the *Rose*, compliance is on the low side, mildly asymmetric, and quite heavily damped, which indicates that medium mass arms are to be preferred, but that the design is quite flexible in this respect. Downforce of 2g gives acceptable tracking abilities, but with little headroom.

Lab report

Now a low output cartridge (whereas before it was an in-betweeny), the 773 definitely needs a moving-coil input of some description, and is well matched to the typical sensitivities of such inputs.

Frequency response could be accommodated within a 2dB window, showing a gentle downtilt of 2dB from 200Hz to 4kHz, and mild unevenness thereafter, with well damped peaks at 9 and 18kHz. Channel balance was pretty close throughout, while some very tiny 'glitches' were visible intermittently, most evident between 500Hz and 1kHz, with slight HF 'wrinkling' seen at high writing speed.

Separation values were pretty unexceptional, though they were well maintained through the HF resonances, while some ultrasonic spurious were also detected.

Sound quality

Soundwise this is a very well balanced all-rounder, showing an even subjective response with quite good dynamics, (lowish) coloration, (good)ish focus, fine delicacy and 'air', and reasonable treble detail, albeit with occasional 'spits' and 'hardness'. The bass sounded a little congested and restrained, and lacked the 'heavyweight' nature of some of the livelier m-c models, while remaining firmly and impressively controlled.

Conclusions

While not perhaps rivalling the very top designs in terms of 'life' and transparency, the Mission is sufficiently well balanced and competitively priced to merit recommendation. It does not seem to be particularly arm- or turntable-sensitive, but the tracking abilities may be a little marginal for some users.

TEST RESULTS

Type, mass.....	low output moving-coil 6.2g
Stylus type.....	superelliptical
Stylus inspection result.....	poorly polished, slightly extended elliptical
Output Level (1kHz, 5cm/s).....	0.22mV
Relative output (0dB = 1mV/cm/s).....	-24dB
Channel balance.....	0.1dB
Channel separation (L,R).....	29.2, 30dB
Tracking ability (L,R).....	80, 73µm
Frequency response limits 100Hz-5Hz.....	+ 1.5, - 1dB
Frequency response limits 30Hz-20kHz.....	+ 1.5, - 2.5dB
Stereo Separation L on R 100Hz, 3kHz, 10kHz.....	26, 29, 22dB
Stereo Separation R on L 100Hz, 3kHz, 10kHz.....	22, 26, 19dB
Channel diff. from graph, 100Hz, 1kHz, 10kHz.....	0, 0, 0dB
Response limits ref computer mean, 1kHz-15kHz.....	+ 1.5, - 0dB
Response limits ref computer mean, 1kHz-20kHz.....	+ 4, - 0dB
Test tracking weight, loading.....	2g, n.a.
LF resonance frequency, 12.5g arm (vert, lat).....	11, 9Hz
Estimated compliance (vert, lat).....	14, 16cu
Recommended arm effective mass.....	6-16g
LF resonance rise, 12.5g arm (vert, lat).....	9, 10dB
Typical selling price.....	£149

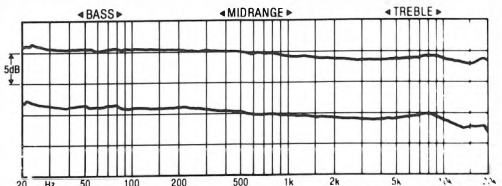

Frequency response, left and right channels

NAD 9100

NAD, Coustau House, Greycaine Road, Watford, Herts WD2 4SB
Tel (0923) 27737

BEST BUY

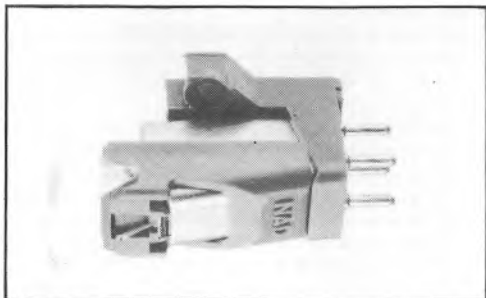

(no disrespect intended) was quite well liked, and considered one of the best of the budget contenders.

It has much in common with the *Phase I* naturally, but is a touch more 'fizzy' and aggressive. The healthier treble output gives a 'faster' more dynamic sound, though the treble was qualitatively rather coarse. Stereo was rather 'up-front', with some mid coloration masking depth. Splendid groove stability as usual provided the overall sound with reassuring solidity.

Conclusions

Clearly a Best Buy model for the rock music fan, but lovers of opera and choral music might nevertheless do better to avoid this model's tracking (in)abilities. Sonically, it is a vindication of the virtues of low compliance, but care should be taken to avoid using it in an already brightly balanced system.

TEST RESULTS

Type, mass.....	moving magnet 5.8g
Stylus type.....	spherical
Stylus inspection result.....	neatly mounted
Output Level (1kHz, 5cm/s).....	3.85mV
Relative output (0dB = 1mV/cm/s).....	-0.5dB
Channel balance.....	0.5dB
Channel separation (L,R).....	28.1, 30dB
Tracking ability (L,R).....	70, 63µm
Frequency response limits 100Hz-5Hz.....	+0.5, -1dB
Frequency response limits 30Hz-20kHz.....	+1.5, -2dB
Stereo Separation L on R 100Hz, 3kHz, 10kHz.....	29, 21, 24dB
Stereo Separation R on L 100Hz, 3kHz, 10kHz.....	31, 31, 24dB
Channel diff. from graph, 100Hz, 1kHz, 10kHz.....	0.5, 0.5, 0dB
Response limits ref computer mean, 1kHz-15kHz.....	+1.5, -1.5dB
Response limits ref computer mean, 1kHz-20kHz.....	+3, -1.5dB
Test tracking weight, loading.....	1.5g, 300pF
LF resonance frequency, 12.5g arm (vert, lat).....	14, 12Hz
Estimated compliance (vert, lat).....	12, 14cu
Recommended arm effective mass.....	10-20g
LF resonance rise, 12.5g arm (vert, lat).....	10, 12dB
Typical selling price.....	£10

In the UK, the NAD brand is available through a chain of independent dealers, who are loosely affiliated in the Hi-Fi Markets operation. Like the other moving magnet models in the NAD range, the 9100 is of obviously ADC manufacture, costing a mere £10 with modest specification and spherical stylus. Body and stylus holder are an unattractively vivid blue plastic, which is a bit soft; we clearly strained the plastic when headshell mounting.

The stylus was set neatly enough, and the cantilever compliance was quite low and well damped, so medium-high mass arms are likely to make the best match — a worthwhile feature in a low price cartridge. Tracking weight is given as a broad 1-2g, but the tracking abilities are not all that great so 2g was adopted.

Lab report

Output level is average, as is the recommended amplifier capacitance loading, though the subjective effect of adjusting this was quite minor.

Frequency response was both well extended and a touch brighter than average, though still with the characteristic gentle ADC downtill. There was something of a 'sting' at both ends of the response graph, though the bass rise merely reflects the low compliance. Channel balance was pretty indifferent, and a series of midrange structure resonances was measured that were even more extreme than those shown by the (slightly more compliant) Phase I.

Separation was reasonable enough, though there was a distinct asymmetry in favour of one channel. Tracking abilities were just about adequate, but with little in hand for the most difficult material.

Sound quality

Bright and bouncy, if a trifle relentless at high frequencies, this cheap 'n' cheerful cartridge

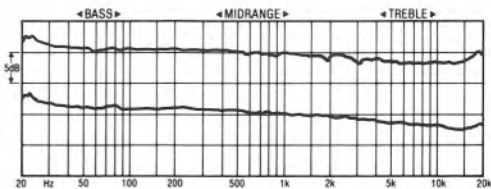

Frequency response, left and right channels

THE ONLY CORNERS WE CUT ARE ON OUR TAGS

You have probably seen them. In dealers windows, attached to display models at exhibitions or featured in advertisements in the hi-fi press. Manufacturers are inordinately proud of them. As well they might be. We dish them out pretty sparingly.

So just why does a *HI-FI CHOICE* recommendation carry so much weight?

Because we commit thousands of pounds and many hundreds of man hours testing equipment for every issue of *HI-FI CHOICE*. And when we say 'testing', we really mean it.

Each issue is authored by one of Britain's finest audio technicians. We pit machine against machine under controlled laboratory conditions manufacturers claims against reality.

We conducted 'blind' listening tests using a panel of listeners. We print the reviews, warts and all. These are preceded by a 'Consumer Introduction and a 'Technical Introduction', usually many pages in length. Each issue has a quick reference 'Overall Comparison Chart' and, of course, a 'Best Buys and Recon Section'. Photographs of all models are included. Lastly, we award those little tags to

a selection of the models tested.

We usually publish five *HI-FI CHOICE* editions a year. They cost £2.50 per copy. Each one dedicated to a particular theme. We laminate the covers to make them last for years and supply quality binders to keep them in for permanent reference. We also maintain stocks of back issues for people to buy through the mail (using the coupon below) or you can visit our new Back Issues Centre in the West End of London. This is located at 14 Rathbone Place, London W1P 1DE, five minutes walk from Tottenham Court Road tube station.

Any new issue of *HI-FI CHOICE* is usually to be found at W. H. Smiths or other good newsagents. Some hi-fi dealers carry a stock of back issues, too, but in case of difficulty, contact us at the above address.

Ours is not a very economic way of producing a hi-fi publication. We could probably cut a few corners on obtaining the information we publish and make a lot more money. But our Series Editor,

Steve Harris, just wouldn't stand for it. And he stands for what is printed on the front cover of every *HI-FI CHOICE* — 'The most comprehensive Guide to

Buying Hi-Fi Ever Published.'

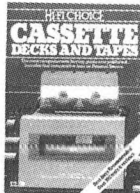
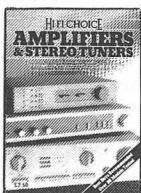
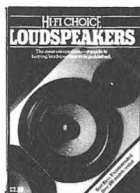

Rush me the issue of *Hi-Fi Choice* ticked below:

- TURNTABLES & COMPACT DISC UNITS @ £3.00
 LOUDSPEAKERS @ £3.00 COMPLETE SYSTEMS @ £3.00
 AMPLIFIERS & STEREO TUNERS @ £3.00
 BESTBUY GUIDE @ £3.00 CASSETTE DECKS AND TAPES @ £3.00

All prices include post and packing in the U.K

Overseas orders please add £1.20 (sea) or £1.75 (airmail) for each issue*

- Please debit my American Express/Access/Barclaycard (Visa)*
 Please send me ___ binder(s) at £3.50 each Card No. _____

I enclose a cheque or money order for £_____ Expiry Date _____

Signed _____ Name _____

Address _____

Make cheques payable to SportsScene Publishers
 Ltd. Send coupon with your remittance to:
 Hi-Fi Choice Offer,
 14 Rathbone Place, London W1P 4DE.

HI-FI CHOICE

*Delete where not applicable **Best Buy Guide, £2.30(sea) £4.00 (airmail)

C/S

Nagaoka MP10

Three Marketing Ltd, 1 Berens Road, London NW10 5DY
Tel 01-969 2514

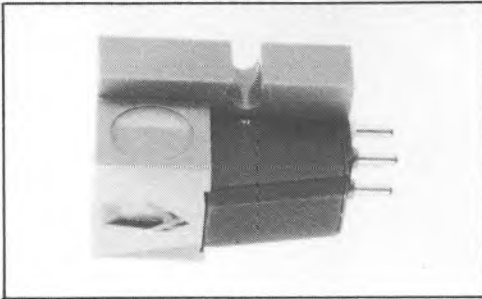

Very much the 'baby' of the Nagaoka moving magnet range, the *MP10* shares the same impressively rigid body structure, albeit as a plastic moulding in an unattractive dull red colour, with lower mass than the metal models higher up the range. Humbly sporting a spherical tip, which was actually quite small and neatly mounted, a substantial 2.3g down-force ensures good tracking ability and groove stability.

Compliance is lower, nicely symmetrical, and less damped than the other Nagaokas, so although the *MP10* is probably best served by low mass arms, medium mass models are almost as suitable.

Lab report

Substantial enough in output for any moving magnet input, Nagaoka specify low capacitance loading, which should be particularly respected in this instance, as the treble rolloff is already quite severe, and is only made worse by increasing capacitance.

Frequency response shows a pronounced downtilt commencing at 300Hz, increasing in slope a little around 2kHz until levelling out some 5dB down at 13kHz, then finally rolling off at 17kHz. Despite the inaccuracy of this response in absolute terms, the lack of sudden change throughout the band is praiseworthy. Furthermore, channel balance stayed closely within 0.5dB, and 'glitches' were merely minor unevennesses, predominantly below 1kHz.

Separation figures rivalled many cartridges costing many times the price, even showing respectable control at high frequencies.

Sound quality

Despite the treble rolloff, which in the manner of spherical styli becomes more severe towards the end of a side (our response was taken at roughly the middle of a side), the *MP10*

was very well liked for the 'seamlessness' and control of its sound, which showed remarkably good integration for such a low cost design. High frequencies did sound 'shut in', and depth was curtailed, but the bass and mid were satisfyingly energetic, 'bouncy' and 'punchy'.

Conclusions

An obvious Best Buy; spherical tip apart, the *MP10* is clearly substantially better balanced than the other Nagaokas, with much better stability and control than the over-compliant '11 which seems to have been consistently overrated by other magazines. Moreover, the slightly 'dim' balance could well prove to be an ideal partner to the less-than-tidy tonearms, amplifiers and loudspeaker which its price suggests will be frequent partners.

TEST RESULTS

Type, mass.....	moving magnet 6.8g
Stylus type.....	spherical
Stylus inspection result.....	small and neat
Output Level (1kHz, 5cm/s).....	3.75mV
Relative output (0dB = 1mV/cm/s).....	0.9dB
Channel balance.....	0.54dB
Channel separation (L,R).....	28.9, 30dB
Tracking ability (L,R).....	80, 80µm
Frequency response limits 100Hz-5Hz.....	+1, -3dB
Frequency response limits 30Hz-20kHz.....	+1.5, -7dB
Stereo Separation L on R 100Hz, 3kHz, 10kHz.....	27, 29, 24dB
Stereo Separation R on L 100Hz, 3kHz, 10kHz.....	32, 30, 25dB
Channel diff. from graph, 1kHz, 10kHz.....	0.5, 0.0dB
Response limits ref computer mean, 1kHz-15kHz.....	+0, -3.5dB
Response limits ref computer mean, 1kHz-20kHz.....	+0, -4dB
Test tracking weight, loading.....	2.3g, 100µF
LF resonance frequency, 12.5g arm (vert, lat).....	9, 8.7Hz
Estimated compliance (vert, lat).....	17, 18cu
Recommended arm effective mass.....	5-13g
LF resonance rise, 12.5g arm (vert, lat).....	11.3, 12.3dB
Typical selling price.....	£15

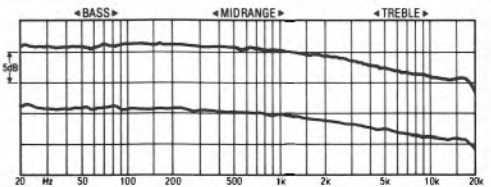

Frequency response, left and right channels

Nagaoka MP30

Three Marking Ltd, 1 Berens Road, London NW10 5DY
Tel 01-969 2514

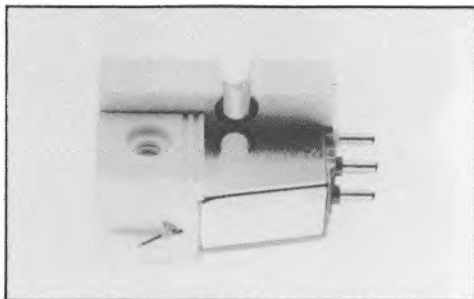

This fairly upmarket moving magnet model weighs a quite heavy 9g, with clear evidence of careful attention being paid to body and stylus assembly design to ensure good rigidity and close headshell coupling, using an aluminium body and screw-fit stylus assembly.

Stylus is a small 'Triangle' elliptical, much of which was set in the glue which attached it to the boron cantilever. Compliance is quite high, so only low mass arms need apply, though heavy damping indicates some flexibility in this respect. Tracking weight is 1.5g.

Lab report

Output is somewhat below normal, though not sufficiently so to cause any compatibility qualms. Capacitance loading is specified at 100pF, which we also found gave best measured results, but which unfortunately restricts the range of ideal options for tone-arms and amplifiers rather, as few contribute as little as 50pF each.

Frequency response was a little unusual, holding the bass level pretty flat up to 700Hz before starting to droop at an increasing pace until levelling some 4dB down at 15kHz. Channel balance was pretty good, with a mild departure from 500Hz to 3kHz. The trace was pretty smooth and free from glitches except at the low end of the frequency range where there was some discontinuity.

Separation figures were rather unspectacular and mildly asymmetric, though tracking was good, as one would expect from the compliance.

Sound quality

The MP30 showed good general clarity and control, but the treble sounded rather 'detached', lacked 'sparkle' yet was described as a little 'feathery'. At the same time dynamics were rather muted and perspectives very 'laid

back', and the bass a trifle ill-defined. Groove stability was not particularly good.

Conclusions

The MP30 has a few technical points in its favour, and the value of the solid Nagaoka construction is at least partly vindicated in the very controlled sound quality, though the mechanical and electrical compatibility constraints, plus some sample variability are rather unfortunate. Technical performance is certainly adequate, though the balance of variables does seem to have been oriented excessively towards tracking ability at the expense of other worthwhile considerations.

TEST RESULTS

Type, mass.....	moving magnet 9g
Stylus type.....	nude elliptical
Stylus inspection result.....	heavily glued, good quality nude elliptical
Output Level (1kHz, 5cm/s).....	2.7mV
Relative output (0dB = 1mV/cm/s).....	-4dB
Channel balance.....	0.7dB
Channel separation (L,R).....	29.7, 27.9dB
Tracking ability (L,R).....	80, 80µm
Frequency response limits 100Hz-5Hz.....	+0.5, -3dB
Frequency response limits 30Hz-20kHz.....	+0.5, -4dB
Stereo Separation L on R 100Hz, 3kHz, 10kHz.....	25, 31, 22dB
Stereo Separation R on L 100Hz, 3kHz, 10kHz.....	22, 24, 22dB
Channel diff. from graph, 100Hz, 1kHz, 10kHz.....	0.5, 0.5, 0dB
Response limits ref computer mean, 1kHz-15kHz.....	+0, -2.5dB
Response limits ref computer mean, 1kHz-20kHz.....	+0, -3dB
Test tracking weight, loading.....	1.5g, 100pF
LF resonance frequency, 12.5g arm (vert, lat).....	7.5, 6.5Hz
Estimated compliance (vert, lat).....	21, 26cu
Recommended arm effective mass.....	5-10g
LF resonance rise, 12.5g arm (vert, lat).....	9, 10dB
Typical selling price.....	£55

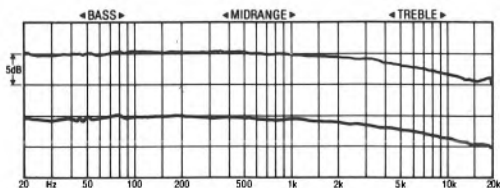

Frequency response, left and right channels

Nagaoka MP50

Three Marketing Ltd, 1 Berens Road, London NW10 5DY
Tel 01-969 2514

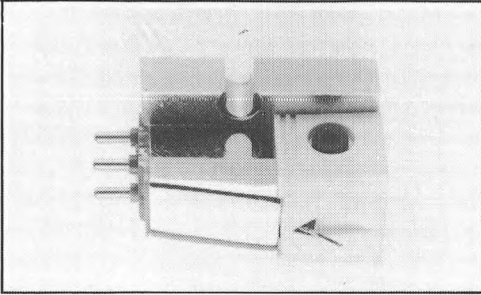

Beautifully-crafted, this cartridge is a fairly expensive example of the moving-magnet genre at £90, and sits at the top of Nagaoka's range of six similarly shaped models. It is heavy, at 9g, and rigidity is clearly given some priority with the aluminium body with large headshell contact area, and screw-in stylus assembly.

The boron rod cantilever is fitted with a small and neat but rather heavily glued 'Triangle' stylus, which had swept 'superellipse' shape but seemed slightly skew in alignment. Tracking weight is a light 1.3g, and compliance very high (c30cu), which means that theoretically only the lightest arms should be used, though heavy damping may help ameliorate any mismatch.

Lab report

Output level was a trifle below average, though not sufficiently so to cause any difficulties. The recommendation for loading capacitance is a low 100pF, any increase further 'dulling' the response, and many tonearms and amplifiers will exceed this by themselves, let alone when added together, so some care should be taken in matching.

The frequency response was pretty decent looking, falling steadily, very gently and without any suckout, some 2.5dB from 500Hz to 15kHz. However, absolute channel balance was rather poor and somewhat inconsistent. Though smooth enough, the response trace showed 'glitches' at low frequencies.

Separation figures were rather disappointing considering the price level, and showed some asymmetry between channels, though results might have been improved in a lower mass arm. Tracking abilities were impeccable.

Sound quality

The *MP50* had a rather impressive sound

overall in terms of clarity, good detail and control, plus reasonable dynamics and balance. The bass sounded slightly 'rich' and there did seem to be some constriction in the upper mid, but the high level of damping ensured pretty good groove stability.

Conclusions

Far too compliant for any but the lowest mass arms, the *MP50* consequently has a limited range of application. Though the sound quality was pretty good, the technical examination revealed a few weak spots. A decent enough model, it is insufficiently distinguished or universal enough to merit recommendation.

TEST RESULTS

Type, mass.....	moving magnet 9g
Stylus type.....	superelliptical
Stylus inspection result.....	heavily glued, extended elliptical, slight skew
Output Level (1kHz, 5cm/s).....	2.36mV
Relative output (0dB = 1mV/cm/s).....	- 4dB
Channel balance.....	1.2dB
Channel separation (L,R).....	25.8, 21.8dB
Tracking ability (L,R).....	80, 80µm
Frequency response limits 100Hz-5Hz.....	+ 0.5, - 0.5dB
Frequency response limits 30Hz-20kHz.....	+ 0.5, - 2dB*
Stereo Separation L on R 100Hz, 3kHz, 10kHz.....	24, 29, 24dB
Stereo Separation R on L 100Hz, 3kHz, 10kHz.....	19, 20, 19dB
Channel diff. from graph, 100Hz, 1kHz, 10kHz.....	1, 1, 1dB
Response limits ref computer mean, 1kHz-15kHz.....	+ 0.5, - 1dB
Response limits ref computer mean, 1kHz-20kHz.....	+ 2, - 1dB
Test tracking weight, loading.....	1.3g, 100pF
LF resonance frequency, 12.5g arm (vert, lat).....	6, 6Hz
Estimated compliance (vert, lat).....	.31, .31cu
Recommended arm effective mass.....	5-10g
LF resonance rise, 12.5g arm (vert, lat).....	8, 8.5dB
Typical selling price.....	£90

*LF problems, see text



Frequency response, left and right channels

Hi-Fi in Somerset and the West



AVALON HI-FI

STUDIO

PHONE GLASTONBURY
(0458) 50370

The Old Nursery,
Butleigh, Glastonbury

We can offer a studio or home demonstration, by appointment, of equipment we feel confident to recommend for its high quality performance and reliability.

Access and Visa facilities.

*Large selection of special pressings.
SAE or Phone for details.*

Mon to Sat 9.30 a.m. to 5.30 p.m.
Closed Wednesday.
Late Night Thurs
(by prior appointment).

Pink Triangle
Logic

Heybrook

Ariston

Revolver

NVA

Myst

Creek

Analohab

A&R Cambridge

Hellins

Syrinx

Goldring

Spendor

Zeta

QED

Monitor Audio

SD Accountants

KeF

Kiseki

Diesis

Rayleigh Hi-Fi

THE Specialists

Reading About Hi-Fi and Music might well be interesting. . .

But Hearing For Yourself is Better

We now have 2 superb demonstration rooms, to insure that listening is a pleasure — and choosing HiFi that meets your needs is not a Chore.

Book your appointment Today. . .

. . .and audition the right Hi Fi for YOU.

AGENCIES INCLUDE: A&R ★ ASAK ★ AKROYD ★ BLQ ★ CREEK ★ DUAL ★ KEF ★ GALE ★ GRACE ★ HEYBROOK ★ LINN PRODUCTS ★ MERIDIAN ★ MISSION ★ MONITOR AUDIO ★ MUSICAL FIDELITY ★ NAIM AUDIO ★ NAKAMICHI ★ NYTECH ★ QED ★ QUAD ★ REGA ★ REVOLVER ★ REVOX ★ ROGERS ★ SPENDOR ★ SUGDEN ★ SUPEX ★ SYRINX ★ SYSTEMDEK ★ TECHNICS ★ YAMAHA ★

44A High Street, Rayleigh, Essex. Tele. (0268) 779762

3 YEARS PARTS AND LABOUR GUARANTEE ON HI-FI SYSTEMS

FULL FINANCE FACILITIES AVAILABLE — DETAILS ON REQUEST — A. P. R. 26.5%



MAINTENANCE
1984

Ortofon OM10

Ortofon UK Ltd, Denmark House, Tavistock Industrial Estate, Ruscombe, Twyford, Berks RG10 9NJ
Tel (0734) 343621

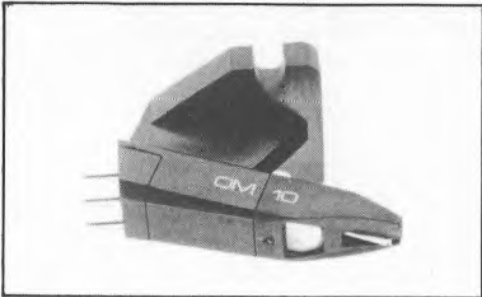

This cartridge is often supplied with the popular Dual 505 budget turntable, and is also available as a separate item. The OM designation refers to an optional mass facility, because the 5g cartridge mass contains 2.5g of ballast, which may be removed if the tonearm is capable of balancing such a low mass.

Experiencing this difficulty ourselves, we elected to retain the ballast, but this option, theoretically at least, should allow a wider range of arm masses to be accommodated.

However, it can be argued that the provision of mass as mere ballast must compromise structural rigidity, and certainly the body mounting was rather skeletal, though the stylus assembly made a good fit. Compliance was moderate enough to suit a wide range of arms, the heavier ones benefitting from ballast removal.

Lab report

With enough output to drive any amplifier, this model is designed to work into a highish capacitance to achieve the manufacturer's intended results at the high frequency resonance. Where pre-amp input loading is low, adaptors may be used in the signal line.

Frequency response looks most impressive despite the low cost of the cartridge, dropping quite smoothly 3dB between 100Hz and 7kHz, then rallying to 19kHz. Adding capacitance to the manufacturer's recommendation reduces the treble droop to 1dB at 3kHz, and the response starts rolling gently at 10kHz. Channel balance was found to be quite close, but with a broad 0.5dB error 100-600Hz which cannot be corrected and may be audible. There is also evidence of quite pronounced 'glitches' in response at 500Hz and 1.2kHz, with some general unevenness at high frequencies.

Separation figures were pretty good, albeit asymmetric to a marked degree between

channels and with significant sample variation, while tracking abilities were fine.

Sound quality

Nice but noisy (referring to record surfaces) is a snapshot comment on the OM10 sound. High frequencies were audibly down compared with the more expensive OMs, but were nevertheless clean and well controlled.

The midrange was nicely integrated and open-sounding, while the bass did show a degree of overhang.

Conclusions

Clearly one of the leading 'cheapies', the OM10 gives a decent overall performance, albeit with some sample variation, not to mention a fine level of sound quality for the price.

TEST RESULTS

Type, mass.....	moving magnet 5g*
Stylus type.....	'E'
Stylus inspection result.....	neatly mounted simple elliptical
Output Level (1kHz, 5cm/s).....	3.6mV
Relative output (0dB = 1mV/cm/s).....	- 1dB
Channel balance.....	0.23dB
Channel separation (L,R).....	23.6, 21.6dB
Tracking ability (L,R).....	80, 80µm
Frequency response limits 100Hz-5Hz.....	+ 1, - 1dB
Frequency response limits 30Hz-20kHz.....	+ 1, - 5dB
Stereo Separation L on R 100Hz, 3kHz, 10kHz.....	30, 45, 39dB
Stereo Separation R on L 100Hz, 3kHz, 10kHz.....	22, 24, 25dB
Channel diff. from graph, 100Hz, 1kHz, 10kHz.....	0.5, 0.5, 0.5dB
Response limits ref computer mean, 1kHz-15kHz.....	+ 1.5, - 0dB
Response limits ref computer mean, 1kHz-20kHz.....	+ 1.5, - 0dB
Test tracking weight, loading.....	1.5g, 400pF
LF resonance frequency, 12.5g arm (vert, lat).....	9, 7.6Hz
Estimated compliance (vert, lat).....	19, 24cu
Recommended arm effective mass.....	5-15g**
LF resonance rise, 12.5g arm (vert, lat).....	7, 11.7dB
Typical selling price.....	£12

*includes 2.5g ballast

**if arm can be re-balanced with ballast removed

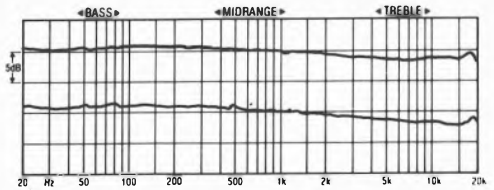

Frequency response, left and right channels

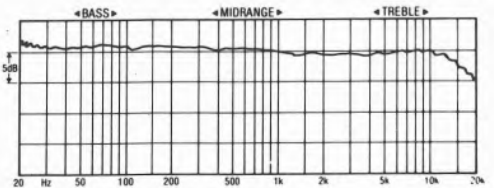

Frequency response with higher load capacitance

RECOMMENDED

Ortofon OM20

Ortofon UK Ltd, Denmark House, Tavistock Industrial Estate, Ruscombe, Twyford, Berks RG10 9NJ
Tel (0734) 343621



This is the £30 middle model in Ortofon's stylish 'optional mass' range of moving magnet cartridges. It is a 2.5g cartridge with 2.5g of removable ballast, the latter necessary more to enable conventional arm counterbalances to work than for any other reason, as it contributes nothing to the structural rigidity. In fact body rigidity is not too bad and stylus fit is quite good.

Even fully laden, the *OM20* can match a fair range of arm effective masses, though high mass examples will benefit from ballast removal. Tracking weight is a low 1.25g, but tracking ability was still good.

Lab report

Substantial output avoids any likelihood of amplifier sensitivity mismatch. Ortofon usually specify high capacitance loading, but there was no mention in the instruction leaflet on this occasion. In fact the subjective difference was quite slight, and the measured change not that great either.

Frequency response was very flat with capacitance loading, falling within a 1dB 'window' from 30Hz to 15kHz, while without capacitance the high frequency extension was marginally increased, at the expense of an overall 2dB 'window'. Channel balance was a little disappointing, and 'glitches', relating to the mounting we suspect, are visible either side of 1kHz. The trace as a whole was a little uneven at high frequencies, but not severely so.

Separation figures were reasonable enough, and were well maintained at high frequencies, though they were somewhat asymmetric and uneven throughout the band.

Sound quality

Generally very well balanced tonally, if a touch 'thin' and 'bright', the *OM20* succeeds 82

handsomely as an all-rounder despite a certain lack of excitement. Focus, depth and dynamics were well below the best, but the general level of competence and control were very convincing, with good lateral stereo.

Conclusions

Definitely deserving recommendation, this turned out to be our favourite amongst Ortofon's moving magnet cartridges. While it may not produce one of the most dynamic sounds around, it offers impressive compatibility mechanically and sonically with the fairly modest equipment which one would expect it to partner, and generally delivers the goods in a well-balanced manner.

TEST RESULTS

Type, mass.....	moving magnet 5g*
Stylus type.....	E
Stylus inspection result.....	mild elliptical, decent quality
Output Level (1kHz, 5cm/s).....	3.6mV
Relative output (0dB = 1mV/cm/s).....	-1dB
Channel balance.....	-0.23dB
Channel separation (L,R).....	23.6, 21.6dB
Tracking ability (L,R).....	.80, .80m
Frequency response limits 100Hz-5Hz.....	+1, -0dB
Frequency response limits 30Hz-20kHz.....	+1.5, -0dB
Stereo Separation L on R 100Hz, 3kHz, 10kHz.....	30, 26, 25dB
Stereo Separation R on L 100Hz, 3kHz, 10kHz.....	35, 36, 28dB
Channel diff. from graph, 100Hz, 1kHz, 10kHz.....	+1, 1, 1.5dB
Response limits ref computer mean, 1kHz-15kHz.....	+1.5, -0dB
Response limits ref computer mean, 1kHz-20kHz.....	+1.5, -0dB
Test tracking weight, loading.....	1.25g, 400pF
LF resonance frequency, 12.5g arm (vert, lat).....	9, 7.6Hz
Estimated compliance (vert, lat).....	.21, .25cu
Recommended arm effective mass.....	5-16g**
LF resonance rise, 12.5g arm (vert, lat).....	7, 11.7dB
Typical selling price.....	£30

*includes 2.5g ballast

**if arm balances with ballast removed

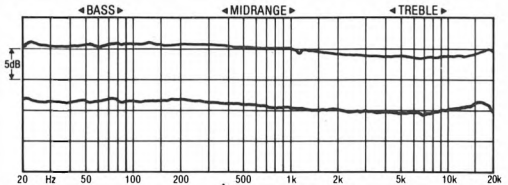

Frequency response, left and right channels

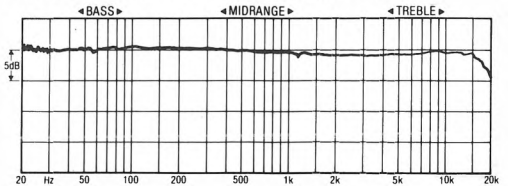

Frequency response with higher load capacitance

Ortofon VMS10E2

Ortofon UK Ltd, Denmark House, Tavistock Industrial Estate, Ruscombe, Twyford, Berks RG10 9NJ
Tel (0734) 343621

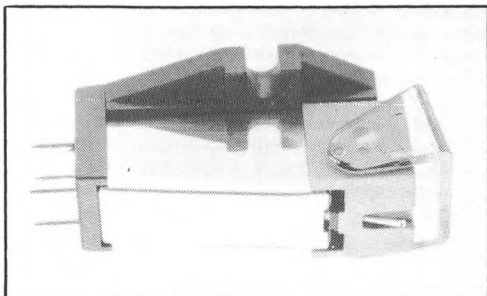

This is the £19 budget contender amongst Ortofon's conventionally-bodied moving magnet cartridges. It has a low mass in a sensible, fairly rigid (longish) body with close fitting stylus assembly.

The stylus is simply designated 'E', and consists of a neatly mounted simple elliptical. Tracking weight is a sensible 2g and compliance modest, so a wide range of low and medium mass arms are suitable, aided by fairly high damping.

Lab report

Substantial output will feed all amplifiers happily, though the manufacturer specifies high capacitance loading, so it will be up to the user or dealer to ensure that this requirement is met. (Ortofon supply a handy little device called *CAP 210*, which clips in place amongst the cartridge pins and provides the extra capacitance needed by some amplifiers.)

Frequency response was quite respectable, showing good treble control and quite good channel balance. In point of fact the 200Hz-7kHz droop was merely reduced from 3.5dB to 2.5dB by the addition of capacitance, which is unlikely to be particularly audible in the context. The trace did show some general uneasiness and several minor discontinuities.

Separation figures were reasonable enough, though nothing special, with a mild channel imbalance here, while the measured tracking abilities were distinctly marginal.

Sound quality

Described as rather 'ordinary', the sound was slightly 'bright' and 'obvious' in the treble due to coarsening of detail rather than any actual imbalance. Indeed the balance as such was good, but there did seem to be a general untidiness and congestion in the sound, which showed limited focus and depth.

Conclusions

This cartridge gave the impression of being rather over-damped in the sort of systems we were using for audition, though it might well come into its own in comparison to livelier designs when used under more typical and trying turntable and tonearm combinations. Moreover, some of its own similarly priced stablemates fared rather better, and showed less evidence of tracking problems to boot.

TEST RESULTS

Type, mass.....	moving magnet 5g
Stylus type.....	'E'
Stylus inspection result.....	neatly mounted simple elliptical
Output Level (1kHz, 5cm/s).....	5.8mV
Relative output (0dB = 1mV/cm/s).....	+ 3dB
Channel balance.....	-0.9dB
Channel separation (L,R).....	24.9, 25.8dB
Tracking ability (L,R).....	65, 50µm
Frequency response limits 100Hz-5Hz.....	+ 1.5, - 1.5dB
Frequency response limits 30Hz-20kHz.....	+ 1.5, - 2dB
Stereo Separation L on R 100Hz, 3kHz, 10kHz.....	28, 35, 28dB
Stereo Separation R on L 100Hz, 3kHz, 10kHz.....	22, 30, 25dB
Channel diff. from graph, 100Hz, 1kHz, 10kHz.....	1, 0.5, 0.5dB
Response limits ref computer mean, 1kHz-15kHz.....	+ 1, - 0.5dB
Response limits ref computer mean, 1kHz-20kHz.....	+ 1, - 3.5dB
Test tracking weight, loading.....	2g, 400pF
LF resonance frequency, 12.5g arm (vert, lat).....	9.3, 10Hz
Estimated compliance (vert, lat).....	18, 16cu
Recommended arm effective mass.....	6-16g
LF resonance rise, 12.5g arm (vert, lat).....	11.7, 11.3dB
Typical selling price.....	£19

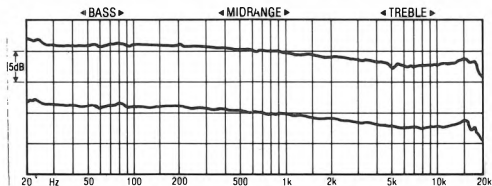

Frequency response, left and right channels



Frequency response with higher load capacitance

Ortofon VMS30E2

Ortofon UK Ltd, Denmark House, Tavistock Industrial Estate, Ruscombe, Twyford, Berks RG10 9NJ
Tel (0734) 343621

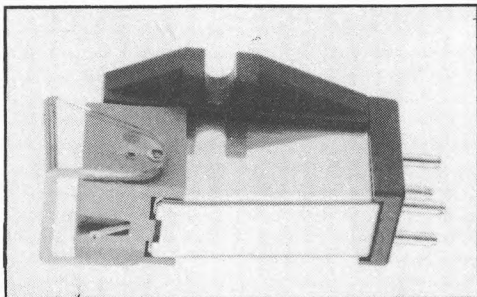

This is the top model in the range of magnetic cartridges which use a conventional body, still similar to that with which Ortofon introduced their first moving magnet models some fifteen years or so ago. It is a sound enough structure, if a little long for easy fitting in some headshells, and has a well located rather than tightly fitting stylus assembly, interchangeable with the other three models.

Stylus is a decent enough 'fine line' profile, with tracking weight a fairly low 1.3g. Compliance is fairly high, indicating that lower mass arms should really be used, particularly in view of the fact that there is little damping in the vertical plane.

Lab report

No matching problems should be encountered in terms of amplifier sensitivities, though high capacitance loading is the manufacturers recommendation and does a fine job of curbing the peak on the frequency response. Ortofon's little CAP 210 device adds that many pFs to make life easy for dealer and customer using amplification with low input capacitance.

Frequency response when loaded shows a gentle downtilt, falling 2.5dB between 200Hz and 5kHz, levelling to 15kHz and rolling thereafter. In contrast, with low capacitance the 18kHz peak was 3.5dB up compared with the level at 8kHz.

Separation readings were very consistent and impressive, particularly midband, albeit with the usual worsening towards the high frequency resonance. Tracking abilities were fine, though groove stability was a trifle suspect.

Sound quality

The VMS30 II proved to be a capably relaxed and slightly laid-back performer, albeit hardly the stuff of which audiophile legends are

made. To be sure, it did little that was untoward, and presented a reasonably balanced perspective with fine stable stereo, yet lacked any real ability to generate excitement and 'fire'. The bass tended to be rather rich and 'plummy', with weak dynamic discrimination.

Conclusions

Safe and reliable the VMS sound may be — the design was conceived when turntables were much poorer than they are today, and their rather overdamped and lifeless sound is beginning to show its age in the context of modern high performance players. Nevertheless there are many turntables around which will relish such good control, and the VMS 30 is well placed to perform undemandingly in demanding circumstances.

TEST RESULTS

Type, mass.....	moving magnet 5g
Stylus type.....	fine line
Stylus inspection result.....	swept elliptical (line) confirmed
Output Level (1kHz, 5cm/s).....	5.06mV
Relative output (0dB = 1mV/cm/s).....	+ 2.5dB
Channel balance.....	0.13dB
Channel separation (L,R).....	30, 30dB
Tracking ability (L,R).....	80, 80µm
Frequency response limits 100Hz-5Hz.....	+ 1, - 1dB
Frequency response limits 30Hz-20kHz.....	+ 1, - 1dB
Stereo Separation L on R 100Hz, 3kHz, 10kHz.....	30, 44, 22dB
Stereo Separation R on L 100Hz, 3kHz, 10kHz.....	24, 48, 20dB
Channel diff. from graph, 100Hz, 1kHz, 10kHz.....	0.5, 0.5, 0dB
Response limits ref computer mean, 1kHz-15kHz... + 1.5, - 1dB	
Response limits ref computer mean, 1kHz-20kHz... + 3, - 1.5dB	
Test tracking weight, loading.....	1.3g, 400pF
LF resonance frequency, 12.5g arm (vert, lat).....	8.5, 7.5Hz
Estimated compliance (vert, lat).....	20, 35cu
Recommended arm effective mass.....	5-13g
LF resonance rise, 12.5g arm (vert, lat).....	14, 10dB
Typical selling price.....	£40

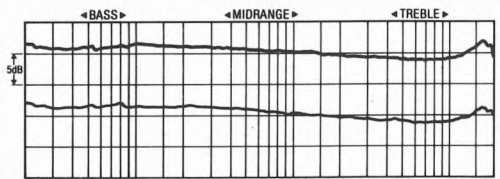

Frequency response, left and right channels

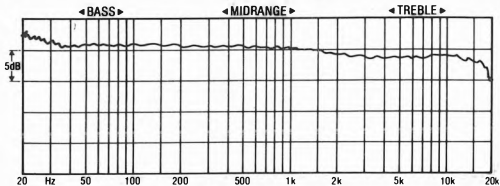

Frequency response with higher load capacitance

BEST BUY

Ortofon MC10 Super

Ortofon UK Ltd, Denmark House, Tavistock Industrial Estate, Ruscombe, Twyford, Berks RG10 9NJ
Tel (0734) 343621

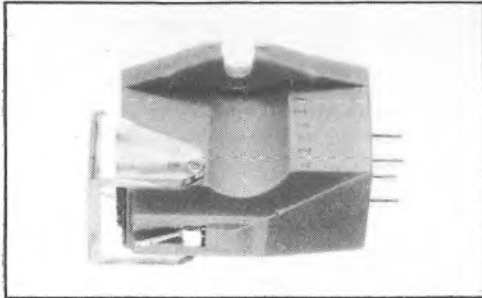

Ortofon deserve considerable respect for their singlehanded bearing of the moving-coil torch through the dark years of moving-coil magnet domination. But when the 'coils become fashionable again, and lots of amplifiers started including provision for low output cartridges (so removing all the hassle of step-up devices), they were left a little out on a limb, with such low outputs that transformers were still almost mandatory.

The new *MC10 Super* sets out to change all that, providing a fully competitive and comparable £40 model in the middle of the popular price bracket. There are still a few of the old oddities around its true to say, including the unusually 'deep' body, requiring different arm height adjustment from most other models, not to mention the silly hinged stylus guard, and semicircular mounting lugs which are prone to distortion. Stylus was an accurately shaped and aligned small nude elliptical.

Compliance is impressively symmetrical, lightly damped, and very sensibly chosen for low- to-medium mass arms. Although the tracking reserve is not great, it will still be sufficient for all but the most extreme cases.

Lab report

Output level is close to ideal for normal amplifier moving-coil inputs, and the really clever trick is that Ortofon have done this while retaining the sonically superior low impedance coils.

Frequency response shows a fairly pronounced midrange downtilt amounting to some 3dB between 200Hz and 7kHz, whereupon there was a mild and slightly uneven recovery. Channel balance was pretty good throughout. The overall trace showed areas of vague unevenness, but no distinct resonances.

Separation figures were rather average, though quite well balanced and notably well

maintained at high frequencies.

Sound quality

What a delightfully sweet-sounding cartridge this is. There is a touch of the 'boom'n'tizz' which indicates a little loss of control at the frequency extremes, but even these balance each other nicely, while the midrange sound delightfully clear, open and uncongested, with decent stereo, depth, dynamics and focus, and a pleasantly 'airy' sound. It has much of the delicacy of far more expensive designs, if lacking quite the same degree of control, sophistication and smoothness.

Conclusions

Ortofon's extensive experience has somehow managed to come up with a beautifully judged package which combines the full open, dynamic qualities of moving-coils without resort to overdamping or undue lack of control. The balance errs a trifle on the latter side (indicated by the separation figures perhaps), which may place a premium on the quality of the turntable. But it is hard to envisage a better overall combination of the various parameters within the cost constraints.

TEST RESULTS

Type, mass.....	low output moving-coil 7.2g
Stylus type.....	E
Stylus inspection result.....	fine small nude elliptical
Output Level (1kHz, 5cm/s).....	0.32mV
Relative output (0dB = 1mV/cm/s).....	- 22dB
Channel balance.....	-0.1dB
Channel separation (L,R).....	30, 30dB
Tracking ability (L,R).....	.75, 74µm
Frequency response limits 100Hz-5kHz.....	+ 1.5, - 1dB
Frequency response limits 30Hz-20kHz.....	+ 1.5, - 2dB
Stereo Separation L on R 100Hz, 3kHz, 10kHz.....	22, 26, 20dB
Stereo Separation R on L 100Hz, 3kHz, 10kHz.....	24, 28, 21dB
Channel diff. from graph. 100Hz, 1kHz, 10kHz.....	.05, 0.5, 0.5dB
Response limits ref computer mean, 1kHz-15kHz.....	+ 3, - 0dB
Response limits ref computer mean, 1kHz-20kHz + 3.....	- 0dB
Test tracking weight, loading.....	1.5g, n.a.
LF resonance frequency, 12.5g arm (vert, lat).....	9, 9Hz
Estimated compliance (vert, lat).....	15, 15cu
Recommended arm effective mass.....	5-15g
LF resonance rise, 12.5g arm (vert, lat).....	14, 12dB
Typical selling price.....	£40

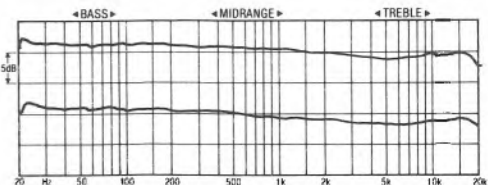

Frequency response, left and right channels

Ortofon MC2000

Ortofon UK Ltd, Denmark House, Tavistock Industrial Estate, Ruscombe, Twyford, Berks RG10 9NJ
Tel (0734) 343621

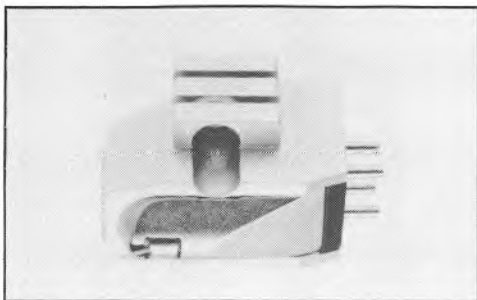

This beautifully-crafted prestige low-output model from Ortofon is elaborately packaged, with a full colour brochure. It is frequently supplied with an expensive, heavy silver-wired step-up transformer, and itself uses silver wire internally. The cartridge body is fabricated from a piece of solid aluminium, and can be very firmly mounted.

The stylus is a delightful super-elliptical profile on a tiny, square section long shank, set at a rake angle on the tapered aluminium cantilever. Compliance is quite high, yet remarkably well damped so that LF resonance is almost non-existent.

Lab report

Output is astonishingly low, by our assessment around -40dB, so the 20-25dB gain offered by most moving-coil amplifiers is unlikely to be adequate. Hence the transformer is necessary to get low background noise performance and adequate gain, though we have some doubts about the sonic characteristics of such devices.

Frequency response did not show the expected HF rise we expected from the Ortofon literature, but was remarkably flat (with or without transformer).

Separation figures were taken directly and are again good and quite consistent, were pretty well maintained at high frequencies, but did show rather more ultrasonic spurious than produced by some other top designs.

Sound quality

The inherent low coloration and wide bandwidth of this model tended to spotlight the 10kHz suppressed resonance, to the extent that it became the dominant feature in the sound. Treble detail was described as 'etched' and 'up front', tending to focus on a close-miked singer, for example, and inclined to

sound a touch 'fierce' and 'aggressive' with some programme. The bass was very clean and powerful, though rather 'dry' for some tastes, while the mid showed fine dynamic range.

While it was easy to respect the sonic achievements of this model, it was also subjectively rather less easy to like the slightly 'cold' and 'clinical' presentation, and the bass and lower mid did sound rather 'damped' and lacking in 'bounce'. We actually preferred to put up with the hiss and leave out the transformer, though its inclusion did help ameliorate the 'clinical' character somewhat, while masking some detail elsewhere.

Conclusions

Clearly one of the very best, there are few grounds on which to fault the 2000, save perhaps the inconvenience of its very low output, which means that the transformer will be an almost mandatory additional expense.

The remarkable damping should ensure universal arm compatibility, but has perhaps served to lessen the subjective appeal somewhat, and the problem of system matching is primarily one of accommodating the slight 'glare' to achieve potentially fine integration.

TEST RESULTS

Type, mass.....	low output moving-coil 11g
Stylus type.....	Symmetrical Contact Line (SCL)
Stylus inspection result.....	very small section line contact with long shank
Output Level (1kHz, 5cm/s).....	-
Relative output (0dB = 1mV/cm/s).....	-
Channel balance.....	-
Channel separation (L,R).....	-
Tracking ability (L,R).....	-
Frequency response limits 100Hz-5Hz.....	+1, -0.5dB
Frequency response limits 30Hz-20kHz.....	+1, -1dB
Stereo Separation L on R 100Hz, 3kHz, 10kHz.....	30, 29, 35dB
Stereo Separation R on L 100Hz, 3kHz, 10kHz.....	30, 38, 32dB
Channel diff. from graph, 100Hz, 1kHz, 10kHz.....	0, 0, 0dB
Response limits ref computer mean, 1kHz-15kHz.....	-
Response limits ref computer mean, 1kHz-20kHz.....	-
Test tracking weight, loading.....	1.5g, n.a.
LF resonance frequency, 13.5g arm.....	6.7Hz*
Estimated compliance (vert, lat).....	24cu
Recommended arm effective mass.....	less than 10g*
LF resonance rise, 13.5g arm.....	very well damped*
Typical selling price.....	£400 (transformer £400 extra)

*see text

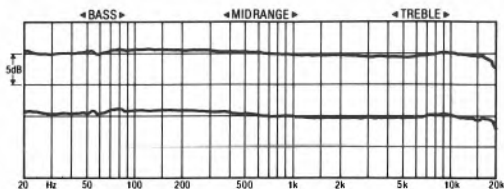

Frequency response, left and right channels

Pickering Super Red

Pickering, 24 Gillygate, York
Tel (0904) 642463

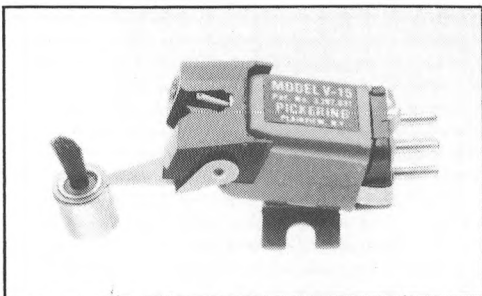

Chosen to represent the little red-bodied cartridges which comprise one of Pickering's cheaper ranges, and which are clearly aimed at the rock enthusiast, the *Super Red* costs £18 complete with Dustamatic brush, is fairly light in weight and (1.25g) tracking.

Like many Pickerings it uses the metal bracket for fixing, which offers reasonable rigidity in itself, but which is easily distorted when attempting to fix it firmly in the headshell. Stylus assembly fits reasonably well, but without any real rigidity. The specified simple elliptical stylus profile was confirmed by our stylus examination.

Compliance was low enough to match a fair range of arm masses, though the lack of damping indicates that the range 12-15g would be optimum.

Lab report

Output level was a little below average, though not enough to cause any alarm, while recommended capacitance is a nice, average 275pF; changes here have only minor effects.

Frequency response was quite dramatic. Impressively smooth and falling less than 2dB from 200Hz to 5kHz, output then rose to an undamped resonance at 16kHz. In spite of this (or, perhaps, because of it) channel balance was very good. The response looked much cleaner and smoother than most, albeit with a few low frequency 'glitches'.

Separation figures were pretty fair through most of the band, but collapsed utterly at the HF resonance, while tracking abilities behaved not dissimilarly.

Sound quality

The sound quality was not at all bad considering the price. The midrange was clear, airy and uncongested, and although the treble did sound somewhat isolated, there was reason-

able detail nonetheless. The bass was described as punchy, but a bit 'bonky'.

Conclusions

Marred somewhat by the treble 'sizzle', which at least has the grace to stay right at the edge of the audio band, this is not a bad cartridge at all in other respects, offering useful arm compatibility and a pleasantly lively midrange. At the same time the lack of damping suggests that results could be a little unpredictable in the sort of low cost turntable it is likely to partner, so some caution is advisable.

TEST RESULTS

Type, mass.....	moving magnet 5.7g
Stylus type.....	elliptical
Stylus inspection result.....	simple neat elliptical confirmed
Output Level (1kHz, 5cm/s).....	2.65mV
Relative output (0dB = 1mV/cm/s).....	- 5.5dB
Channel balance.....	0.2dB
Channel separation (L,R).....	27.5, 26.5dB
Tracking ability (L,R).....	80, 80µm
Frequency response limits 100Hz-5Hz.....	+1, - 0.5dB
Frequency response limits 30Hz-20kHz.....	+3, - 5dB
Stereo Separation L on R 100Hz, 3kHz, 10kHz.....	23, 32, 5°dB
Stereo Separation R on L 100Hz, 3kHz, 10kHz.....	27, 32, 5°dB
Channel diff. from graph, 100Hz, 1kHz, 10kHz.....	1, 1dB
Response limits ref computer mean, 1kHz-15kHz.....	+6, - 1dB
Response limits ref computer mean, 1kHz-20kHz.....	+6, - 2.5dB
Test tracking weight, loading.....	1.25g, 275pF
LF resonance frequency, 12.5g arm (vert, lat).....	10, 9Hz
Estimated compliance (vert, lat).....	15, 17cu
Recommended arm effective mass.....	7-16g
LF resonance rise, 12.5g arm (vert, lat).....	16, 15.5dB
Typical selling price.....	£18

*see text

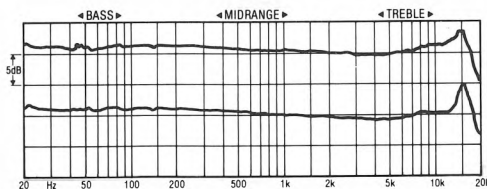

Frequency response, left and right channels

HI-FI

A WEEK IN POLITICS IS A VERY LONG TIME
A MONTH SELLING HI-FI MAKES YOU A CONSULTANT
A YEAR TALKING ABOUT HI-FI MAKES YOU A GURU

In an industry where the 'flavour of the month' mentality increasingly dominates, we have been consistently selling the finest High Fidelity Equipment since 1966, a time when a large slice of the Hi-Fi fraternity were still in short trousers. High Fidelity — not TV's, not crystal sets, not Dansettes.

Since our inception we have been devoted to making the best equipment available for our customers musical enjoyment. We realise this doesn't make us GURUS, but its a damn good start.

MUSIC

Music? Yes we have never allowed gimmicks, promises of high profits, or rave reviews to sway us.

Our belief is that Hi-Fi equipment, whether budget or state of the art, is only worthwhile if it reproduces music enjoyably. We are all music lovers at Audio T, first and foremost. We believe that specifications alone have become almost meaningless and that your selection of Hi-Fi equipment should be made with your ears. You must listen to the music of your choice, in a constructive manner in a suitable demonstration room. That is why we were the first shop to operate a 'dems by appointment' system. That is why we believe you should have as long as you need to make your choice of Hi-Fi to live with.

& AUDIO T

Audio T may have been around a lot longer than most of the so called Hi-Fi Consultants, but we are not yet long in the tooth. Our attitude is one of enthusiasm as it was when we started. We still spend a great deal of our time evaluating new products. And rather than jumping on a bandwagon we will have our own opinion of products as and when they become available. We have strong traditional ties with great British companies like SPENDOR, LINN, QUAD and KEF as well as more recent additions such as A&R, PROAC and HEYBROOK.

We have been here getting things right for a long time. After all if you don't agree with us, you can always go to a 'new boy' or one of our born-again competitors.

AUDIO T
The Audio Consultants
190 West End Lane
London NW6 1SQ
01-794 7848

RECOMMENDED

Pickering XV15/625E

Pickering, 24 Gillygate, York
Tel (0904) 642463

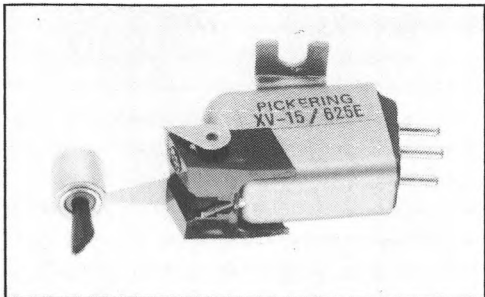

Long regarded as a stand-out model in Pickering's popularly priced *XV-15* range, the 625E has come down significantly in price to a modest enough £20. The body mechanics include a reasonable stylus assembly fit and Pickering's metal mounting bracket, whose semicircular lugs make little headshell contact and are prone to distortion if tightened with too much enthusiasm. The Dustomatic brush is part of the package. The stylus fitted was unexceptional, with a slightly skewed profile.

Compliance is a sensible value for low-medium mass arms, showing good symmetry and light damping. Downforce is a low 1.25g, yet tracking abilities were fine.

Lab report

Output level is normal, and the recommendation is for medium capacitance loading; it can be seen from the graphs that the loading change only really affects the range above 8kHz. The opportunity for a little subjective system fine-tuning here is worthwhile, and our preference was for high capacitance.

Frequency response shows a very gentle 1.5dB midband downtilt between 200Hz and 4kHz, above which the channels diverge somewhat. (Given appropriate equipment it would be possible to load the two channels differently, and so achieve a near flat response to 18kHz!) There were further sections of channel imbalance below 600Hz. The trace was pretty smooth, but with some treble unevenness and a few tiny midband 'glitches'. Separation figures were generally rather mediocre.

Sound quality

Lacking the treble smoothness of the 1800S, the 625E clearly emerged as one of the better cartridges in its class. The sound was quite exciting, if tending to 'fierceness', conveying plenty of detail with some 'forwardness' and

loss of depth. The bass was a bit 'thumpy' without any great extension, yet the decently integrated midband of this model sets it apart a little from the herd.

Conclusions

The price reduction is sufficient to retain the competitiveness of this model despite the new improved budget cartridges from elsewhere. It is a very well balanced all-rounder suitable for most applications, yet provides liveliness and midband detail uncommon in the more versatile models.

TEST RESULTS

Type, mass.....	moving magnet 6.4g
Stylus type.....	elliptical
Stylus inspection result.....	only average quality
Output Level (1kHz, 5cm/s).....	3.75mV
Relative output (0dB = 1mV/cm/s).....	- 1dB
Channel balance.....	- 1.3dB
Channel separation (L,R).....	30, 25, 1dB
Tracking ability (L,R).....	80, 80µm
Frequency response limits 100Hz-5Hz.....	+ 1, - 0.5dB
Frequency response limits 30Hz-20kHz.....	+ 1.5, - 8dB
Stereo Separation L on R 100Hz, 3kHz, 10kHz.....	28, 28, 21dB
Stereo Separation R on L 100Hz, 3kHz, 10kHz.....	21, 20, 17dB
Channel diff. from graph, 100Hz, 1kHz, 10kHz.....	0.5, 0, 1dB
Response limits ref computer mean, 1kHz-15kHz.....	+ 1.5, - 0.5dB
Response limits ref computer mean, 1kHz-20kHz.....	+ 1.5, - 2dB
Test tracking weight, loading.....	1.25g, 275pF
LF resonance frequency, 12.5g arm (vert, lat).....	9.7, 9Hz
Estimated compliance (vert, lat).....	12, 14cu
Recommended arm effective mass.....	6-16g
LF resonance rise, 12.5g arm (vert, lat).....	12, 12.3dB
Typical selling price.....	£20

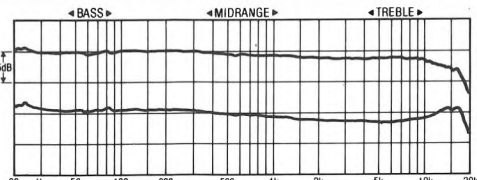

Frequency response, left and right channels

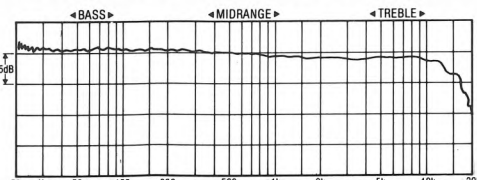

Frequency response with higher load capacitance

RECOMMENDED

Pickering XV15/1800S

Pickering, 24 Gillygate, York
Tel (0904) 642463

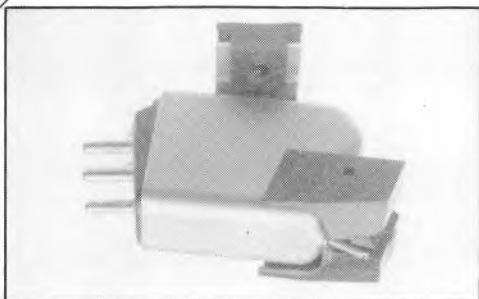

Towards the top of Pickering's popular XV-15 range of cartridges, the 1800S is supplied with the (optional) Dustomatic brush and the mounting bracket is Pickering's usual metal bracket with semicircular lugs. Though not necessarily any less rigid than other arrangements, this system reduces the contact area with the headshell significantly, with or without the plastic inserts, and the lugs are rather prone to distortion when tightened.

Stylus was confirmed as a nude line-contact Stereohedron tip, decently mounted. Compliance is very low, particularly in view of the low 1.25g tracking weight, though tracking abilities did not seem to be impaired, and the cartridge is therefore well-suited to medium-high mass arms; damping is very light, so good quality turntables and tonearms are probably necessary.

Lab report

Output is somewhat below average, though unlikely to cause any problems, while the recommended loading is a sensible moderate value, and large changes had a small subjective effect in any case.

Frequency response did show variation with capacitance loading, sufficient to indicate that a total value of around 200pF might give the smoothest response, which is close to the recommendation. Both traces were drooping slightly to around 8kHz, low capacitance causing the response to rally slightly, high capacitance to continue the rolloff.

Channel balance was only fair, and the chart showed a general mild unevenness rather than any specific resonances. Separation was pretty good even at high frequencies, and showed fine channel balance.

Sound quality

The 1800S sailed through the listening tests

90

with little but praise for the general overall balance. Decent detail, clarity and focus were all in evidence, though the treble was perhaps a touch 'shut in' and the bass was attractively 'bouncy' without carrying any particular weight. In some senses it was a more civilised version of the cheaper 625E's sound, with a rather better judged treble.

Conclusion

This is a fine cartridge, which has been sensibly engineered to give good compatibility with higher mass pickup arms, yet shows little compromise as a result. The sound singles it out as one of the better moving magnets, causing little offence by omission or addition.

TEST RESULTS

Type, mass.....	moving magnet 6.4g
Stylus type.....	stereohedron
Stylus inspection result.....	confirmed nude stereohedron
Output Level (1kHz, 5cm/s).....	2.4mV
Relative output (0dB = 1mV/cm/s).....	-4dB
Channel balance.....	0.55dB
Channel separation (L,R).....	30, 30dB
Tracking ability (L,R).....	80, 80µm
Frequency response limits 100Hz-5Hz.....	+1, -1.5dB
Frequency response limits 30Hz-20kHz.....	+1, -3dB
Stereo Separation L on R 100Hz, 3kHz, 10kHz.....	26, 30, 30dB
Stereo Separation R on L 100Hz, 3kHz, 10kHz.....	26, 30, 30dB
Channel diff. from graph, 100Hz, 1kHz, 10kHz.....	0.5, 0.5, 0.5dB
Response limits ref computer mean, 1kHz-15kHz.....	+1, -1dB
Response limits ref computer mean, 1kHz-20kHz.....	+1, -2dB
Test tracking weight, loading.....	1.25g, 275pF
LF resonance frequency, 12.5g arm (vert. lat).....	16, 12Hz
Estimated compliance (vert. lat).....	4.7, 10cu
Recommended arm effective mass.....	10-20g
LF resonance rise, 12.5g arm (vert. lat).....	17, 13.5dB
Typical selling price.....	£40

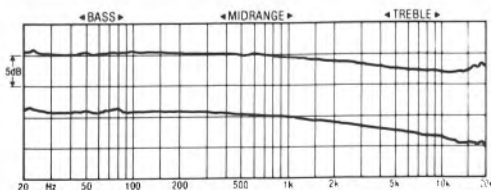

Frequency response, left and right channels

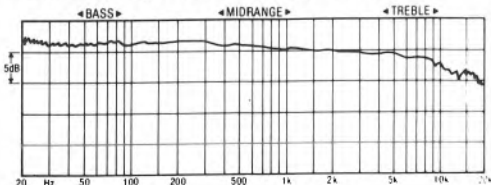

Frequency response with higher load capacitance

Pickering TL2S

Pickering, 24 Gillygate, York
Tel (0904) 642463



The P-adaptable cartridge is in fact a familiar Pickering/Stanton type modified for T4P use. A conventional moving magnet design, it weighs a modest 6g, tracks at a light 1.25g, and shows the usual lack of rigidity in the P-adaptor; the stylus assembly makes a decent fit, but is by no means tight.

The stylus is a swept elliptical form known as a Stereohedron, and a neatly mounted nude stone was fitted. Compliance is quite low, though not at the expense of tracking performance, and quite symmetrical, so a useful range of arm masses can be used.

Lab report

Output is generous, and the recommendation for medium capacitance loading can easily be met. In fact this model is only mildly sensitive to changes in loading, and was subjectively preferred when fairly well-loaded.

Apart from the appalling midband P-mount 'wobble', the frequency response is pretty decent, recording a broad 2dB suckout centred on 7kHz and then peaking to +1dB at 17kHz. Channel balance is impressively close throughout, and the trace is smooth enough, though it is difficult to assess the effect that the 300Hz discontinuity might have elsewhere in the band.

Separation figures were rather average, though nicely consistent between channels nonetheless, the midband 'glitch', attributed to the P-mount adaptor, confirmed again along with the high frequency resonance.

Sound quality

The sound was described as pleasant enough if rather ordinary. Overall tonal integration and balance was quite good though bass was distant, subdued and rather 'soft' in character. Treble was nice and 'airy' with some sparkle and life through the presence band.

Conclusions

This is an obvious example of a quite decent generator system being compromised by the mounting arrangements, which further confirm the inherent incompatibility of T4P and traditional half-inch mounting standards within the same cartridge.

Despite this inherent limitation it was capable of quite decent sound quality, particularly in the treble region, which showed good detail.

TEST RESULTS

Type, mass.....	moving magnet 5.9g
Stylus type.....	stereohedron
Stylus inspection result.....	neat nude stereohedron
Output Level (1kHz, 5cm/s).....	3.95mV
Relative output (0dB = 1mV/cm/s).....	0dB
Channel balance.....	0.9dB
Channel separation (L,R).....	27, 29.9dB
Tracking ability (L,R).....	80, 80µm
Frequency response limits 100Hz-5Hz.....	+0.5, -1.5dB
Frequency response limits 30Hz-20kHz.....	+1, -2dB
Stereo Separation L on R 100Hz, 3kHz, 10kHz.....	23, 26, 19dB
Stereo Separation R on L 100Hz, 3kHz, 10kHz.....	24, 25, 21dB
Channel diff. from graph, 100Hz, 1kHz, 10kHz.....	0, 0, 0dB
Response limits ref computer mean, 1kHz-15kHz.....	+0, -1.5dB
Response limits ref computer mean, 1kHz-20kHz.....	+0, -5dB
Test tracking weight, loading.....	1.25g, 275pF
LF resonance frequency, 12.5g arm (vert, lat).....	12, 10Hz
Estimated compliance (vert, lat).....	12, 13cu
Recommended arm effective mass.....	8-15g
LF resonance rise, 12.5g arm (vert, lat).....	12.5, 16dB
Typical selling price.....	£35

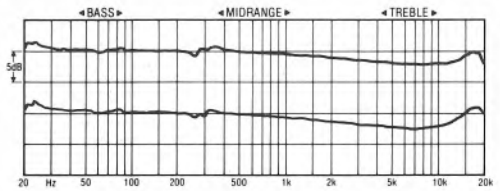

Frequency response, left and right channels

Pickering XSP3003

Pickering, 24 Gillygate, York
Tel (0904) 642463

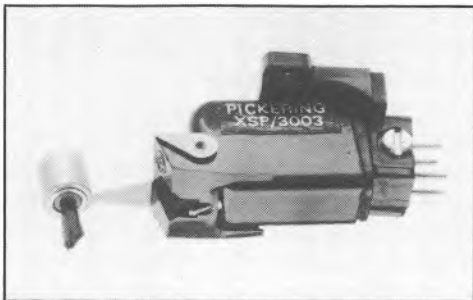

This is a fairly upmarket £75 moving magnet cartridge which is designed to be used either in P-mount arms or with conventional half-inch headshells using an adaptor, our tests concentrating entirely on the latter. While the stylus assembly made a pretty good fit, the P-bracket was a flimsy and sonically unpromising affair.

The stylus is Pickering's house version of a line contact tip, known as Stereohedron, and was of generally decent quality, tracking at a modest 1.25g. Compliance is well chosen for arm compatibility across a broad range of low-medium mass tonearms, though the lack of damping suggests the quality of turntable will play a part too.

Lab report

Amplifier matching is unlikely to pose any problems, as output is close to average and capacitance changes showing little measured effect.

Frequency response looks decidedly old-fashioned, with the rather obvious and dominant treble peak centred on 14kHz, rising 3.5dB from the broad 5kHz trough. Channel balance was pretty good (expected from a lightly damped model), but the other key feature of the response is a horrendous double resonance centred on 200Hz, due to the inadequacy of the adaptor. There was also some low bass unease (revealed in a trace made at high writing speed), but apart from that the trace was quite clean (assisted, no doubt, by the decoupling effect of the adaptor).

Separation reflected the 200Hz and 14kHz resonances, and also showed some asymmetry between channels, with generally undistinguished figures, while tracking abilities were just about adequate.

Sound quality

Despite the unpromising technical perform-
92

ance, the '3003 was quite liked subjectively for its generally decent balance and uncongested sound, albeit in a rather unspectacular P-mount context. High frequency 'untidiness' was noted, but detail was pretty good and dynamics good for a moving magnet model. While it was nothing special, it nevertheless turned in a workmanlike performance.

Conclusions

This is obviously a pretty good sounding model for the P-mount user, but the compromise involved in the adaptor is in our view unacceptable for conventional use. One might also have hoped for slightly better control or extension of the HF resonance, which is too much within the audio band to be really acceptable.

TEST RESULTS

Type, mass.....	moving magnet 6g
Stylus type.....	stereohedron
Stylus inspection result.....	nude stereohedron confirmed
Output Level (1kHz, 5cm/s).....	3.08mV
Relative output (0dB = 1mV/cm/s).....	-2dB
Channel balance.....	0.77dB
Channel separation (L,R).....	30, 26.9dB
Tracking ability (L,R).....	77, 73µm
Frequency response limits 100Hz-5kHz.....	+1, -1dB
Frequency response limits 30Hz-20kHz.....	+3, -1dB*
Stereo Separation L on R 100Hz, 3kHz, 10kHz.....	29, 33, 33dB
Stereo Separation R on L 100Hz, 3kHz, 10kHz.....	19, 23, 18dB
Channel diff. from graph, 100Hz, 1kHz, 10kHz.....	0.5, 0.5, 0dB
Response limits ref computer mean, 1kHz-15kHz.....	+2.5, -0dB
Response limits ref computer mean, 1kHz-20kHz.....	+2.5, -0dB
Test tracking weight, loading.....	1.25g, 275pF
LF resonance frequency, 12.5g arm (vert, lat).....	9, 9.3Hz
Estimated compliance (vert, lat).....	18, 15cu
Recommended arm effective mass.....	6-15g
LF resonance rise, 12.5g arm (vert, lat).....	18, 17.3dB
Typical selling price.....	£75

*with capacitance added.



Frequency response with higher load capacitance

RATA RP20

Russ Andrews Turntable Accessories, Edgebank House, Skelsmergh, Cumbria LA8 9AS
Tel (05398) 3247

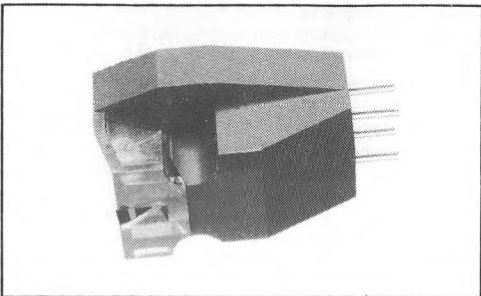

Although a recent introduction, the Goldring *Epic* has already spawned a spin-off in the form of the Russ Andrews Turntable Accessories (RATA) *RP20*. RATA have been importing and distributing fairly expensive Grace and Supex cartridges for a number of years. Faced by the continual downward drift of pound versus yen, they are looking to introduce home-grown budget models to their own requirements.

Sharing a common body with the *Epic*, albeit with different internal wiring, the same problem of crumbling lugs reared its head. However, the inherent shape is good, if bulky. Stylus fit is pretty secure, with a simple well fitted elliptical tip, which has a rather sharper profile than that of the *Epic*.

Compliance is close enough to the *Epic* for a similar range of suitable arm masses, but damping is lighter, so the heavier arms are better avoided, particularly as tracking weight is reduced to 1.5g.

Lab report

The healthy output will drive amplifiers most efficiently. Claimed to be independent of loading capacitance, our sample still showed both measured and audible improvement when using high capacitance.

The response trace illustrates the reduced damping at high frequencies, where the treble flattens out at around 5kHz and then regrettably builds up to a substantial peak on one channel, though the other channel is very impressively controlled. Once again the slight 800Hz 'glitch' is visible, though the trace is nice and steady otherwise. Tracking abilities and groove stability seemed much the same, in spite of the lower tracking weight.

Sound quality

Marred by the distinctly audible treble peak on one channel (5dB difference between

channels!), the sound was otherwise very promising for the price, with good integration and low frequency solidity, and a clear dynamic midrange with the beginnings of fine stereo imaging. The 'sparkle' was a bit strong at the top of course, and tended to upset the imaging rather, but hopefully this is merely a sample problem.

Conclusions

Despite the treble problems of our sample, and in the expectation that body strength is improved, this model clearly merits recommendation. It offers an inherently rather better balanced sound than the *Epic* which justifies the slightly higher cost. It will be interesting to see what RATA come up with for the *Epic*-based *RP40* and '70 models they are planning.

TEST RESULTS

Type, mass.....	moving magnet 7.6g
Stylus type.....	simple elliptical
Stylus inspection result.....	confirmed neat mounting
Output Level (1kHz, 5cm/s).....	3.55mV
Relative output (0dB = 1mV/cm/s).....	- 1dB
Channel balance.....	-0.9dB
Channel separation (L,R).....	28, 26.6dB
Tracking ability (L,R).....	80, 80µm
Frequency response limits 100Hz-5Hz.....	+ 1, - 2.5dB
Frequency response limits 30Hz-20kHz.....	+ 1, - 3dB
Stereo Separation L on R 100Hz, 3kHz, 10kHz.....	26, 41, 27dB
Stereo Separation R on L 100Hz, 3kHz, 10kHz.....	19, 24, 27dB
Channel diff. from graph, 100Hz, 1kHz, 10kHz.....	1, 1, 0dB
Response limits ref computer mean, 1kHz-15kHz... + 3, - 1dB	
Response limits ref computer mean, 1kHz-20kHz... + 6, - 1dB	
Test tracking weight, loading.....	1.8g, 250pF
LF resonance frequency, 12.5g arm (vert, lat).....	9, 9Hz
Estimated compliance (vert, lat).....	15, 15cu
Recommended arm effective mass.....	6-14g
LF resonance rise, 12.5g arm (vert, lat).....	15, 14dB
Typical selling price.....	£21

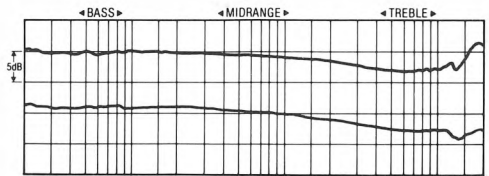

Frequency response, left and right channels

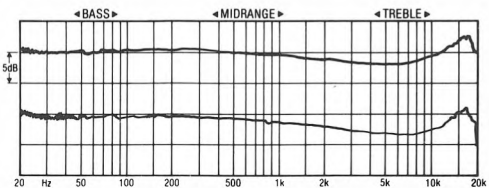

Frequency response with higher load capacitance

RECOMMENDED

Shure M92E

HW International Ltd, 3-5 Eden Grove, London N7 8EQ
Tel 01-609 0293

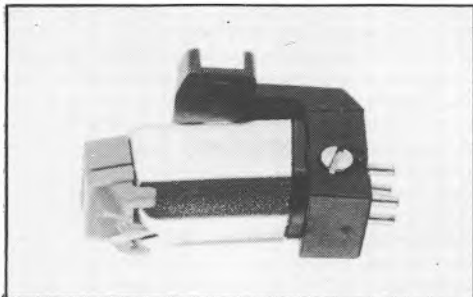

This is the bubble-packed baby amongst Shure's P-adaptable moving magnet cartridges, costing a modest £12.

Stylus is a simple neatly mounted elliptical, and tracking weight is a light 1.25g. Compliance is modest enough, though unusually the vertical figure is higher than the horizontal. The range of arm masses which can ideally be accommodated is therefore quite narrow, but well chosen nonetheless, while heavy damping will assist general compatibility with cheaper equipment.

Lab report

Output level is pretty substantial, so no problems here, but this model is fairly sensitive to capacitance loading, and a high rather than low figure improves the trace 2dB at 9kHz while also suppressing the 20kHz peak.

Frequency response shows yet again the problem of the P-adaptor, yet in other respects is most impressive, particularly with loading where the ruler straight range from 300Hz to 9kHz falls a gentle 2dB, with decent rolloff control beyond. Channel balance is pretty close, and the trace is relatively free from 'glitches' outside the P-mount influence.

Separation figures were unimpressive, with significant channel assymetry, and tracking abilities were not too impressive either, though they are nevertheless adequate.

Sound quality

As is so often the case with low cost cartridges, the 92E was quite a pleasant surprise, though it showed its limitations nonetheless, particularly in terms of a 'flattened' sound stage with little apparent depth. The balance was very well judged, with no part of the range particularly obtrusive. Though the treble range was under quite good control, there was little real detail here, and some of its

attempts to simulate this were rather obvious. The mid was somewhat recessed, but the bass kept trucking along quite nicely, with little boom or overhang. In all, the 92E gave a rather impressive display of control for the price, though was inclined to make heavy weather of high frequency distortion.

Conclusions

Capable of a respectably decent sound for a respectably low price, the 92E deserves cautious recommendation. And one cannot help feeling that it might have made a Best Buy were it not hampered by the P-mount adaptor, which reduces its competitiveness in its price class. P-mount users would do well to investigate this model if seeking a low cost replacement, as it is a pretty decent performer.

TEST RESULTS

Type, mass.....	moving magnet 6.4g
Stylus type.....	simple elliptical
Stylus inspection result.....	confirmed, neatly mounted
Output Level (1kHz, 5cm/s).....	4.85mV
Relative output (0dB = 1mV/cm/s).....	+ 2dB
Channel balance.....	0.6dB
Channel separation (L,R).....	27.6, 25.1dB
Tracking ability (L,R).....	59, 69µm
Frequency response limits 100Hz-5Hz.....	+ 3, - 3dB*
Frequency response limits 30Hz-20kHz.....	+ 0, - 4dB*
Stereo Separation L on R 100Hz, 3kHz, 10kHz.....	18, 22, 22dB
Stereo Separation R on L 100Hz, 3kHz, 10kHz.....	26, 35, 30dB
Channel diff. from graph, 100Hz, 1kHz, 10kHz.....	0.5, 0.5, 0.5dB
Response limits ref computer mean, 1kHz-15kHz.....	+ 0, - 4dB
Response limits ref computer mean, 1kHz-20kHz.....	+ 0, - 4dB
Test tracking weight, loading.....	1.25g, 250pF
LF resonance frequency, 12.5g arm (vert, lat).....	9, 12Hz
Estimated compliance (vert, lat).....	18, 12cu
Recommended arm effective mass.....	10-15g
LF resonance rise, 12.5g arm (vert, lat).....	10, 7dB
Typical selling price.....	£12
*at low capacitance (c. 100pF)	

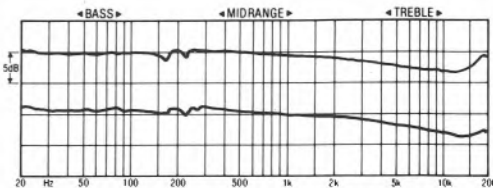

Frequency response, left and right channels

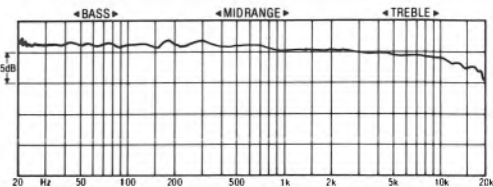

Frequency response with higher load capacitance

Shure ME75ED

HW International Ltd, 3-5 Eden Grove, London N7 8EQ
Tel 01-609 0293

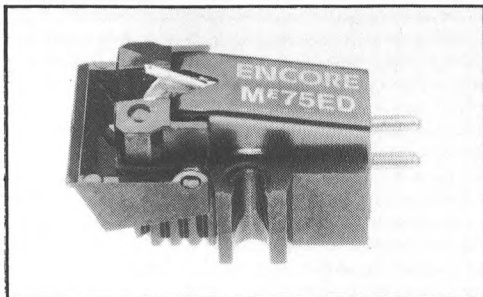

Shure have recently re-introduced a series of their 'old favourites' from the 1970s. The 75ED was probably the most famous of these and has been selected for full review in its *Encore* reincarnation.

A conventional enough moving magnet cartridge costing £22, it has a nice rigid body moulding and well-fitting rather than tight stylus assembly. The tip has a fairly sharp elliptical shape, and was neatly enough mounted, though the cantilever did not appear to have been very accurately formed. Compliance was pretty sensible from the point of view of matching a wide range of low-medium mass arms.

Lab report

Output was quite high, so no amplifier sensitivity problems, while the cartridge is designed for medium-high capacitive loading, and this helped to produce the flattest response.

Frequency response is quite good, with a shallow (-2dB) depression in the mid treble followed by a rise to an 18kHz resonance: with lower capacitance the depression was deeper, the resonance higher and at a higher frequency. Channel balance was pretty close, but there were a couple of odd 'glitches' and uneven response areas.

Separation figures were nothing exceptional, showing a marked discrepancy between channels and virtually disappearing towards the high frequency resonance. Tracking seemed little problem, though the measurement was marginally below standard.

Sound quality

Reflecting its measured response, this model sounded rather 'bright' at high frequencies after a slightly 'laid back' presence. Unfortunately, unlike some models, this HF resonance was qualitatively rather 'splashy', with poor

detail resolution at the same time as drawing attention to itself.

In other respects there was the impression of quite a wide integrated bandwidth with reasonable bass coherence, albeit somewhat softened and lacking in drama.

Conclusions

Clearly still quite a competent design, the 75ED does tend to show its age in terms of sonic limitations at high frequencies. It has usefully wide electrical and mechanical compatibility, and is well balanced enough to be a viable alternative, though its ruggedness of construction sits a little uneasily with the light tracking weight, and one wonders whether a cross between the *ED* and *EJ* models wouldn't make the best compromise.

TEST RESULTS

Type, mass.....	moving magnet 6.4g
Stylus type.....	sharp elliptical
Stylus inspection result.....	confirmed, neat mounting
Output Level (1kHz, 5cm/s).....	5.4mV
Relative output (0dB = 1mV/cm/s).....	+ 2dB
Channel balance.....	0dB
Channel separation (L, R).....	21.7, 30dB
Tracking ability (L, R).....	.80, .75µm
Frequency response limits 100Hz-5Hz.....	+ 0.5, - 1.5dB
Frequency response limits 30Hz-20kHz.....	+ 2, - 3.5dB
Stereo Separation L on R 100Hz, 3kHz, 10kHz.....	20, 23, 21dB
Stereo Separation R on L 100Hz, 3kHz, 10kHz.....	30, 31, 26dB
Channel diff. from graph, 100Hz, 1kHz, 10kHz.....	.05, 0.5, 0.0dB
Response limits ref computer mean, 1kHz-15kHz.....	+ 1, - 1dB
Response limits ref computer mean, 1kHz-20kHz.....	+ 2, - 1dB
Test tracking weight, loading.....	1.25g, 300pF
LF resonance frequency, 12.5g arm (vert, lat).....	12, 10Hz
Estimated compliance (vert, lat).....	.11, .15cu
Recommended arm effective mass.....	5-15g
LF resonance rise, 12.5g arm (vert, lat).....	.11, .14dB
Typical selling price.....	£22

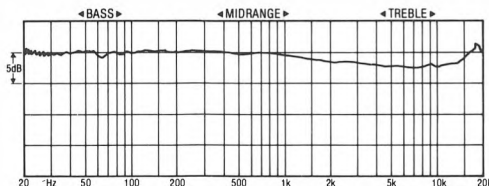

Frequency response, left and right channels

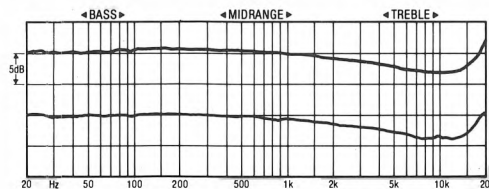

Frequency response with higher load capacitance

Shure M104E

HW International Ltd, 3-5 Eden Grove, London N7 8EQ
Tel 01-609 0293

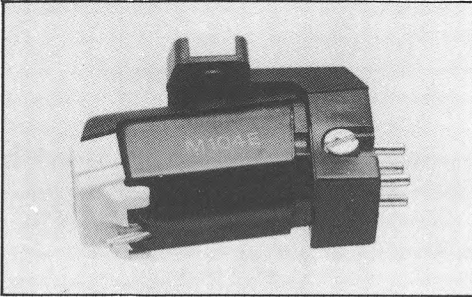

Designed for use either as a T4P plug-in cartridge, or conventionally mounted in half-inch slots, the 104E is on the heavy side at 7.4g, though this extra mass takes the form of a fairly flexible rear pivoting adaptor rather than making any contribution towards improving rigidity at the headshell mounting.

Compliance is moderate and fairly heavily damped, so while the optimum arm effective mass is under 10g, higher mass arms can be accommodated without problems. Stylus is a decent quality nude elliptical, in a holder that seemed better located than that of the 92E.

Lab report

This cartridge has quite a high output, so amplifier matching should be no problem, but loading capacitance needs a little watching as it causes mild balance shifts above a quite low 3kHz. The manufacturer's 200-300pF recommendation is about right.

Frequency response is dominated by the effects of the P-mount adaptor, which are, as usual, pretty horrific in our view. Leaving that aside, the response is very even, with the choice between flat-to-8kHz and gentle rolloff, or a 2dB 8kHz suckout and 19kHz resonance (and points in between, of course). Channel balance was good up to 8kHz, whereupon some divergence began.

Separation was pretty mediocre considering the cost of the cartridge, with a mild imbalance between channels and the usual 200Hz 'P-mount effect'. Tracking abilities were adequate.

Sound quality

The 104E had a fairly respectable sound quality, though not perhaps up to one's expectations for the price. It sounded quite lively and 'punchy', albeit lacking real 'weight'. Bass was quite articulate, with only slight 'blurring'. The

mid was a trifle recessed, and the presence and mid treble slightly 'forward' and demonstrative. While highlighting detail, the treble was perhaps a little too obtrusive for the amount of information presented. Stereo depth was distinctly 'flattened'.

Conclusions

This is a very capable cartridge in many ways, but suffers from the compromises inevitable with P-compatibility. Furthermore it failed to deliver the goods on sound quality, giving no substantial improvement over the 92E in our view.

TEST RESULTS

Type, mass.....	moving magnet 7.4g
Stylus type.....	nude elliptical
Stylus inspection result.....	nude elliptical confirmed
Output Level (1kHz, 5cm/s).....	5.25mV
Relative output (0dB = 1mV/cm/s).....	+ 2dB
Channel balance.....	-0.1dB
Channel separation (L,R).....	30, 21dB
Tracking ability (L,R).....	73, 80µm
Frequency response limits 100Hz-5kHz.....	+ 1, - 1dB
Frequency response limits 30Hz-20kHz.....	+ 1, - 2dB
Stereo Separation L on R 100Hz, 3kHz, 10kHz.....	24, 28, 25dB
Stereo Separation R on L 100Hz, 3kHz, 10kHz.....	19, 21, 19dB
Channel diff. from graph, 100Hz, 1kHz, 10kHz.....	0.5, 0.5, 0.5dB
Response limits ref computer mean, 1kHz-15kHz.....	+ 0, - 4dB
Response limits ref computer mean, 1kHz-20kHz.....	+ 0, - 4dB
Test tracking weight, loading.....	1.25g, 250pF
LF resonance frequency, 12.5g arm (vert, lat).....	9, 8Hz
Estimated compliance (vert, lat).....	15, 20cu
Recommended arm effective mass.....	5-15g
LF resonance rise, 12.5g arm (vert, lat).....	.8, 9dB
Typical selling price.....	£37

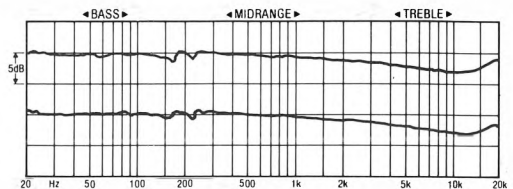

Frequency response, left and right channels

RECOMMENDED

Shure ML140HE

HW International Ltd, 3-5 Eden Grove, London N7 8EQ
Tel 01-609 0293

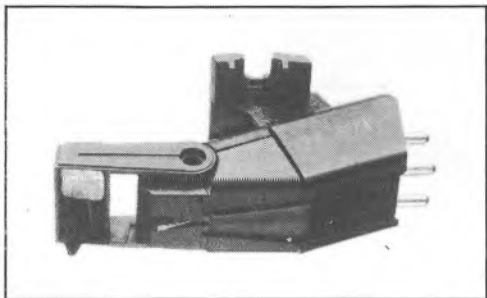

Along with its sister 120 model, this design constitutes a new lightweight body style for Shure's sub-V15 models, including a very neat re-design on the built-in stabiliser/damper brush mechanism.

'HE' is the part of the nomenclature that refers to a Hyperelliptic profile stylus, which proved to be a nicely set nude stone with swept elliptical extended contact. The LF resonance indicates moderate compliance and damping, suitable to a usefully wide range of arms.

Lab report

Output was average, as is the recommendation for capacitance loading, so there are unlikely to be any compatibility problems with this cartridge. In fact the response does show a fair amount of variation with loading, so some experimentation in situ may be worthwhile; our subjective preference was for low rather than high capacitance.

Frequency response was almost identical to the V-15 V MR — pretty smooth and flat in either condition, one producing an effectively flat response to 10kHz rolloff, the other a gentle 2dB downtilt between 200Hz and 10kHz, then down a further 2dB at 20kHz. Channel balance was out a surprising amount for such an expensive model, and although correction can be made with the balance control, this leaves a minor discrepancy above 10kHz.

Separation figures were pretty decent in themselves, and were quite well maintained at high frequencies, but also showed some channel asymmetry. Despite the low 1g downforce, tracking was good, and groove stability more than adequate with the stabiliser's assistance.

Sound quality

This cartridge gave a well balanced slightly 'bright' sound which was much better inte-

grated at high frequencies than the '120. There was some bass softening, but extension was good and the overall focus and dynamics were promising.

Upper bass seemed slightly suppressed, so the sound was a little lacking in 'body', but was crisp, clear and informative nonetheless, particularly through the central midband. Qualitatively the treble was a match for many moving coils.

Conclusions

This is a well balanced cartridge, preferred in a number of ways to the more expensive V-15 V MR. Though expensive, it sounds good and has very sensible parameters for matching other equipment, while providing good tracking at low downforce with the help of the stabiliser.

TEST RESULTS

Type, mass.....	moving magnet 4.5g
Stylus type.....	hyperelliptic
Stylus inspection result.....	confirmed, nude stone
Output Level (1kHz, 5cm/s).....	3.75mV
Relative output (0dB = 1mV/cm/s).....	- 1dB
Channel balance.....	0.15dB
Channel separation (L,R).....	30, 30dB
Tracking ability (L,R).....	80, 80µm
Frequency response limits 100Hz-5kHz.....	+ 0.5, - 1dB
Frequency response limits 30Hz-20kHz.....	+ 0.5, - 1.5/3.5dB
Stereo Separation L on R 100Hz, 3kHz, 10kHz.....	33, 35, 31dB
Stereo Separation R on L 100Hz, 3kHz, 10kHz.....	27, 28, 24dB
Channel diff. from graph, 100Hz, 1kHz, 10kHz.....	0.5, 0.5, 1dB
Response limits ref computer mean, 1kHz-15kHz.....	+ 1, - 1dB
Response limits ref computer mean, 1kHz-20kHz.....	+ 1, - 1dB
Test tracking weight, loading.....	1g, 250pF
LF resonance frequency, 12.5g arm (vert, lat).....	10, 9.5Hz
Estimated compliance (vert, lat).....	15, 16cu
Recommended arm effective mass.....	6-16g
LF resonance rise, 12.5g arm (vert, lat).....	14, 11dB
Typical selling price.....	£150

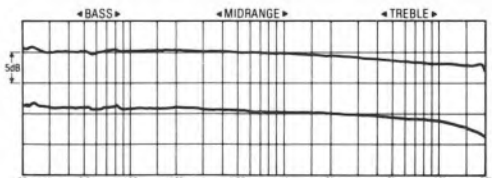

Frequency response, left and right channels

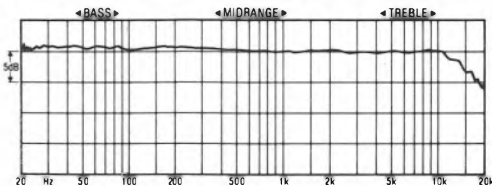

Frequency response with higher load capacitance

Shure V15 VMR

HW International Ltd, 3-5 Eden Grove, London N7 8EQ
Tel 01-609 0293

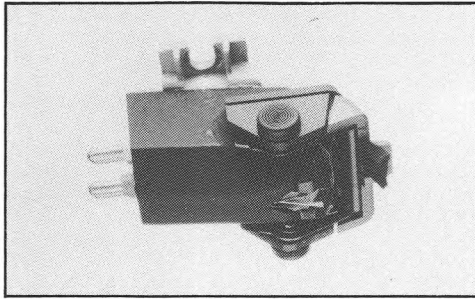

This latest version of Shure's longstanding 'prestige' V-15 series was one of the first in the world to use the now increasingly fashionable 'ridged' line-profile stylus. This was accurately set, with a longish shank which should help reduce dust clogging, though this purpose is already served by the incorporation of the damper/brush mechanism.

Lab report

Output level is lower than most of the type, but not low enough to cause any likely problems, while capacitance loading is specified as average, but in fact showed a significant sensitivity to change, worth investigating.

Frequency response paralleled the '140HE' very closely, the only real difference being the slightly poorer absolute channel balance, more than compensated by the significantly closer matching at high frequencies. The option, simply, is to run with a flat response to 10kHz and then rolloff (high capacitance), or start downtilting very gently above 200Hz to -3dB at 20kHz (not to mention points in between).

Separation figures were pretty good, though mildly asymmetric and far from spectacular considering the high price. Some evidence of spurious ultrasonic output was detected. Tracking abilities were naturally excellent, with groove stability enhanced by the stabiliser.

Sound quality

The initial listening gave promising results, notably in terms of the fine stability of the soundfield, but extended familiarity led to the identification of some limitations. Balance was quite good, though it seemed to favour the mid-range, which was very clear and detailed, rather than the extremes which were less well focused. There was certainly 'space', and 'air', though the depth seemed a trifle compressed.

The bass was powerful but a little 'plummy'

while the treble had a slightly 'lippy' quality, and the rolloff or controlled resonance area did seem noticeable. To some extent the limitations at the bandwidth extremes were emphasised because of the fine midrange section, but the overall effect was a lack of 'energy' and a slightly 'shut in' sound.

Conclusions

Perhaps our expectations of this model were a little too high, but we must admit to a slight disappointment, particularly in regard to the treble, and would hope to find a subjectively more extended bandwidth at this price level. In most respects it seemed equalled or surpassed by the newer and more reasonably priced *ML140HE*, which is arguably the better balanced design.

TEST RESULTS

Type, mass.....	moving magnet 6.6g
Stylus type.....	'MR'
Stylus inspection result accurate long shank microridge line	
Output Level (1kHz, 5cm/s).....	2.88mV
Relative output (0dB = 1mV/cm/s).....	-3dB
Channel balance.....	0.95dB
Channel separation (L,R).....	28.8, 28.8dB
Tracking ability (L,R).....	80, 80µm
Frequency response limits 100Hz-5Hz.....	+0.5 -1dB
Frequency response limits 30Hz-20kHz.....	+0.5 -2/3dB
Stereo Separation L on R 100Hz, 3kHz, 10kHz.....	30, 31, 26dB
Stereo Separation R on L 100Hz, 3kHz, 10kHz.....	24, 27, 32dB
Channel diff. from graph, 100Hz, 1kHz, 10kHz.....	1.5, 1.5, 1dB
Response limits ref computer mean, 1kHz-15kHz.....	+0.5, -1dB
Response limits ref computer mean, 1kHz-20kHz + 0.5 -1dB	
Test tracking weight, loading.....	1g, 250pF
LF resonance frequency, 12.5g arm (vert, lat).....	0(8.5°), 7.5Hz
Estimated compliance (vert, lat).....	24, 31cu
Recommended arm effective mass.....	5-12g
LF resonance rise, 12.5g arm (vert, lat).....	0 (10.5°), 9.5dB
Typical selling price.....	£260
	*without stabiliser

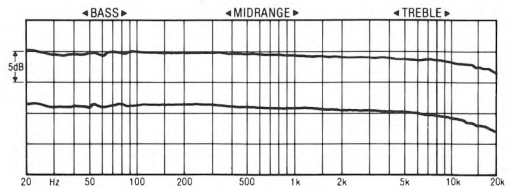

Frequency response, left and right channels

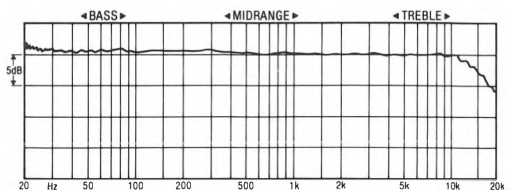

Frequency response with higher load capacitance

Supex SM100E

Russ Andrews Turntable Accessories, Edgebank House, Skelsmergh, Cumbria LA8 9AS
Tel (05398) 3247

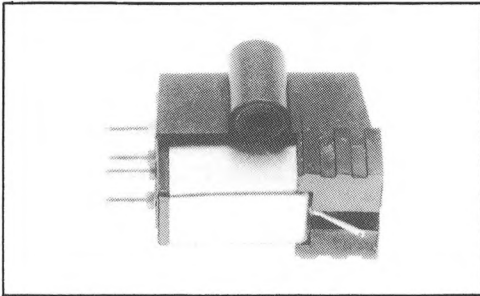

Much cheaper than the moving-coils for which Supex are justly famous, the *SM100* is a conventional moving magnet design, and is still a fairly expensive example of that breed, selling at £70. It is so conventional looking as to appear nondescript, and interestingly has the same stylus guard as the A&R models! The stylus assembly makes a good fit, and the body is well-designed for rigid headshell mounting.

Compliance is moderate and symmetrical, so a good range of low and medium mass arms can be accommodated. Tracking weight is pretty average at 1.5g, and the stylus is a simple elliptical, of rather indifferent polish.

Lab report

Substantial output will match any amplifier, and the distributor indicates that a wide range of capacitance can be used, though in fact our measurement indicates that higher values are to be preferred.

Frequency response looks a trifle old-fashioned, with the downtilted midrange running from 300Hz to 5kHz, then a 3dB rise to 14kHz resonance. Channel balance was rather poor, and one or two midband resonances can be seen between 500Hz and 1.5kHz, though the trace as a whole looks quite smooth even at high writing speed.

Separation figures are reasonable and reasonably balanced between channels, though collapsing at the high frequency resonance. Tracking abilities were pretty good.

Sound quality

This lively and well-integrated little performer is marred by the HF resonance 'tinkle', which is quite audible on a full range system. Setting aside this limitation, the amount of information is fully the measure of many moving-coils, and the bass in particular stays attractively 'bouncy', if rather limited in extension.

Dynamic range is very good through the majority of the range, though stereo and focus was a touch lacking and depth somewhat curtailed.

Conclusions

A somewhat idiosyncratic cartridge with its little treble peak, the *SM100* somehow 'knows its place' and doesn't seem to overreach itself, yet gives fine and quite well balanced results within its capabilities. Compatibility is good, so the only question that remains is for the prospective purchaser to establish to what extent the peak might prove a source of annoyance. Certainly this is a model worth considering, despite its now fairly high price.

TEST RESULTS

Type, mass.....	moving magnet 7g
Stylus type.....	elliptical
Stylus inspection result.....	mild ellipse, indifferent polish
Output Level (1kHz, 5cm/s).....	4.05mV
Relative output (0dB = 1mV/cm/s).....	0dB
Channel balance.....	0.3dB
Channel separation (L,R).....	26.1, 30dB
Tracking ability (L,R).....	80, 80µm
Frequency response limits 100Hz-5Hz.....	+1, -1.5dB
Frequency response limits 30Hz-20kHz.....	+2, -5dB
Stereo Separation L on R 100Hz, 3kHz, 10kHz.....	26, 25, 20dB
Stereo Separation R on L 100Hz, 3kHz, 10kHz.....	29, 30, 19dB
Channel diff. from graph, 100Hz, 1kHz, 10kHz.....	0.5, 0.5, 1dB
Response limits ref computer mean, 1kHz-15kHz.....	+5.5, -1dB
Response limits ref computer mean, 1kHz-20kHz + 5.5, -1dB	
Test tracking weight, loading.....	1.5g, 300pF
LF resonance frequency, 12.5g arm (vert, lat).....	9, 9Hz
Estimated compliance (vert, lat).....	17, 17cu
Recommended arm effective mass.....	6-15g
LF resonance rise, 12.5g arm (vert, lat).....	12, 11dB
Typical selling price.....	£70

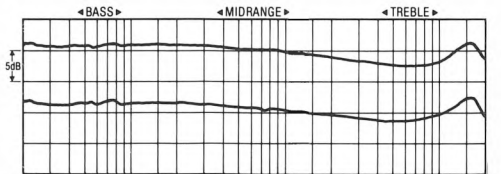

Frequency response, left and right channels

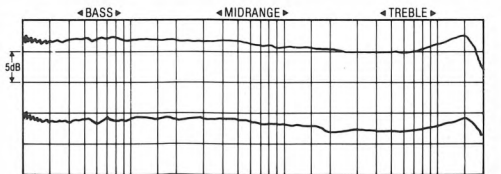

Frequency response with higher load capacitance

RECOMMENDED

Supex SD900

Russ Andrews Turntable Accessories, Edgebank House, Skelsmergh, Cumbria LA8 9AS
Tel (05398) 3247

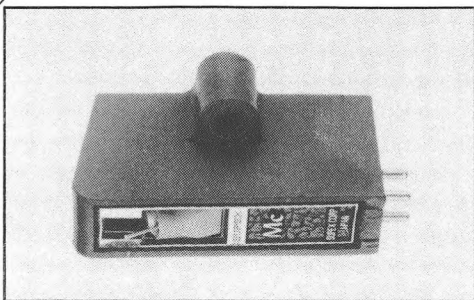

This long established model was one of the earliest of the new generation Japanese low output moving-coil models, and Supex has since been a major influence behind other brands as well. The 900 carries on, at £200 very much the archetype tried and tested model, with gradual refinement but no major change.

It is a heavy low output cartridge, tracking at up to 2g, and is fitted with a Vital stylus, which is a small nude rectangular-section swept elliptical. Mechanical construction is solid, allowing firm headshell fixing. Compliance is low, with little damping, indicating that medium-high mass arms will make the best match.

Lab report

Output is fairly low, so some form of moving-coil input or transformer will be necessary.

Frequency response showed a midrange downtilt of some 3dB between 200Hz and 5kHz. Bass was firmly maintained due to the high LF resonance, while the treble also rallied above 5kHz, showing mild unevenness within a narrow 1.5dB window. Channel balance was near perfect, while the traditional Supex 'glitch' appeared as usual at around 7kHz.

We recorded some quite amazingly good figures for separation, through the midband in particular but maintained quite well at the extremes and showing low ultrasonic spurious output. Tracking, in contrast, can be a touch marginal, though we encountered no particular problems in this regard.

Sound quality

Still capable of some of the best sounds around, the 900 has few vices and many virtues, not the least of which is superb integration, providing a 'seamlessness' and avoiding the all-too-common protrusion of sore thumbs in the manner of many cartridges.

Bass is firm and extended, if not particularly 'fast', the mid has fine focus, 'air' and 'space', with a slightly 'laid back' balance, while the treble just sparkles unobtrusively. Stereo imaging is particularly fine.

Conclusions

Still quite capable of cutting it amongst the best, the 900E Super has been around so long it's easily overlooked, but delivers plenty of goods for the £200 asking price. In some senses it bridges the gap between the Linn and the Koetsu types of sound, and is easily accommodated by today's better tonearms.

TEST RESULTS

Type, mass.....	low output moving-coil 9g
Stylus type.....	vital, super ellipse
Stylus inspection result.....	small rectangular snak swept ellipse
Output Level (1kHz, 5cm/s).....	0.19mV
Relative output (0dB = 1mV/cm/s).....	-27dB
Channel balance.....	0.1dB
Channel separation (L,R).....	30, 30dB
Tracking ability (L,R).....	80, 69µm
Frequency response limits 100Hz-5Hz.....	+1, -2dB
Frequency response limits 30Hz-20kHz.....	+1.5, -2.5dB
Stereo Separation L on R 100Hz, 3kHz, 10kHz.....	.28, >5.0, 36dB
Stereo Separation R on L 100Hz, 3kHz, 10kHz.....	.34, >5.0, 27dB
Channel diff. from graph, 100Hz, 1kHz, 10kHz.....	0, 0, 0dB
Response limits ref computer mean, 1kHz-15kHz.....	+2.5, -0.5dB
Response limits ref computer mean, 1kHz-20kHz.....	+5.5, -0.5dB
Test tracking weight, loading.....	2g, n.a.
LF resonance frequency, 12.5g arm (vert, lat).....	12, 11Hz
Estimated compliance (vert, lat).....	8.5, 9.5cu
Recommended arm effective mass.....	10-20g
LF resonance rise, 12.5g arm (vert, lat).....	16, 16dB
Typical selling price.....	£200

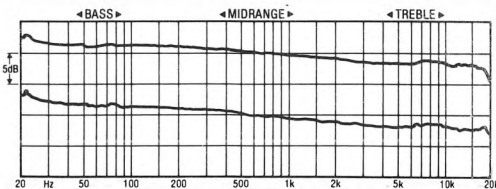

Frequency response, left and right channels

Talisman S

Absolute Sounds, 42 Parkside, London SW19
Tel 01-947 4047

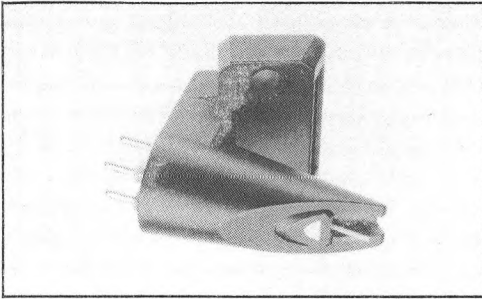

This US-designed low output moving-coil cartridge is one of a series of models based upon a common body but with different cantilevers, styli and generating systems. The body is an attractive alloy moulding of quite low mass and 'cantilevered' shape, not dissimilar to the Ortofon *OM* series in appearance, which gives good rigidity with limited headshell contact. The sapphire cantilever was fitted with a beautiful, small line-contact tip.

Compliance is moderate and lightly damped, so a useful range of arm masses will give a good match, centred on the medium mass models. Downforce is a fairly substantial 2g, ensuring decent tracking ability.

Lab report

While definitely needing a moving-coil facility on the amplifier, output is close to the average for low output models, so no level incompatibility is likely.

Frequency response is a little unusual, and is dominated by a significant high frequency rise, starting around 5kHz, and reaching an average +4dB by 20kHz. (The more recent *Alchemist III*S high output model showed an even stronger rise.) The rest of the range is relatively flat, fitting within a 1dB window. Channel balance was very close through most of the range, but started to diverge again at around 5kHz, winding up 2dB apart by 20kHz. The trace as a whole was clean below 500Hz but then showed a slight unevenness with several tiny but identifiable 'glitches'.

Separation figures were unexceptional, showing some unevenness and asymmetry, and tailing off towards the HF resonance, with some evidence of ultrasonic spuriae.

Sound quality

Though the treble rise dominated in an absolute sense, the Talisman was nevertheless

a pretty good sounding cartridge, satisfyingly 'sweet', relaxing, and easy to listen to. Furthermore, if the treble was rather obvious, it was also quite clean, clear and integrated.

Though it does not deliver the bass 'slam' or 'impact' of some other moving-coils, the bass was nicely controlled and well extended. The midrange was very clear with good detail and stereo presentation, if slightly muted dynamically.

Conclusions

Though somewhat idiosyncratic in a number of ways, the sheer sweetness of the sound remains an important strength. While it is unlikely to appeal to fundamentalists of any particular school of cartridge design, it is a well-judged alternative, unlikely to displease.

TEST RESULTS

Type, mass.....	low output moving-coil 6.3g
Stylus type.....	line contact
Stylus inspection result.....	beautiful small line contact
Output Level (1kHz, 5cm/s).....	0.28mV
Relative output (0dB = 1mV/cm/s).....	-23dB
Channel balance.....	0.1dB
Channel separation (L,R).....	27.6, 30dB
Tracking ability (L,R).....	80, 80µm
Frequency response limits 100Hz-5Hz.....	+1, -0dB
Frequency response limits 30Hz-20kHz.....	+2.5/6, -0dB
Stereo Separation L on R 100Hz, 3kHz, 10kHz.....	26, 22, 21dB
Stereo Separation R on L 100Hz, 3kHz, 10kHz.....	38, 30, 22dB
Channel diff. from graph, 100Hz, 1kHz, 10kHz.....	0, 0, 1dB
Response limits ref computer mean, 1kHz-15kHz.....	+4, -0dB
Response limits ref computer mean, 1kHz-20kHz.....	+7, -0dB
Test tracking weight, loading.....	2g, n.a.
LF resonance frequency, 12.5g arm (vert, lat).....	9, 10Hz
Estimated compliance (vert, lat).....	18, 15cu
Recommended arm effective mass.....	6-16g
LF resonance rise, 12.5g arm (vert, lat).....	16, 12dB
Typical selling price.....	£230

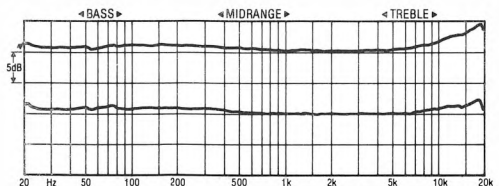

Frequency response, left and right channels

BEST BUY

Yamaha MC11

Natural Sound Systems Ltd, Unit 7, Greycaine Road, Watford WD2 4SB
Tel (0923) 36470

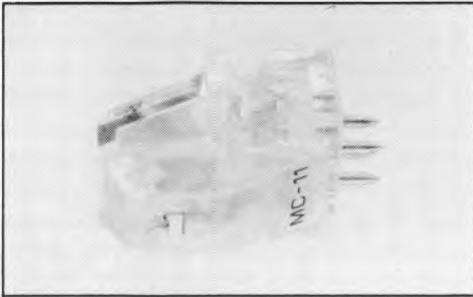

This is the low output one of two new Yamaha moving-coils, selling at the unusually low price of £35. Visually quite striking with its clear plastic body making optical illusions with the innards, the structure is sensibly shaped for rigidity. The special elliptical stylus profile quality was confirmed, while noting that the stone is quite large, and is pegged through the cantilever.

Compliance is low, slightly asymmetric and quite heavily damped, so medium-high mass arms provide the best match, though the damping should ensure almost universal application. Interestingly, the tracking abilities do not appear to have been impaired.

Lab report

This is definitely a low output cartridge, but not so as to cause any problems to the typical moving-coil input.

Frequency response is very flat for such a modestly priced model, remaining within a 2dB window from 30Hz to 20kHz, though with the 9-12kHz region mildly exposed. Channel balance was excellent, and only one tiny 'glitch' could be identified, at 1.2kHz, plus mild unevenness following the 10kHz resonance.

Separation figures were equally impressive, particularly through the lower midband, and were reasonably well maintained at high frequencies.

Sound quality

This is a highly impressive sounding cartridge for the price, offering genuine moving-coil quality with little compromise. The main criticism can be directed towards a degree of 'thickening' at extreme bass and in particular in the treble, where dynamic contrast and detail seem to fade, somewhat in the way a compressor/limiter operates in a recording studio.

It is possible to get minor changes in treble

balance by 'tuning' the tracking weight, though we couldn't quite ever manage to bring it completely into focus. Yet this is nitpicking when an 'almost budget' cartridge can deliver midrange focus, dynamics and liveliness the way this model does. Stereo was also impressive laterally, though a bit restricted on depth.

Conclusions

Although it does not rival the upmarket low-impedance models for delicacy and subtlety, the MC11 doesn't lose out by all that much, either sonically or technically. The sound may be a little too heavily damped for some tastes, but with many turntables this could prove a positive advantage. It is an important representative of a new breed of 'civilised' budget m-c cartridges, and an obvious Best Buy.

TEST RESULTS

Type, mass.....	low output moving-coil 5.3g
Stylus type.....	special elliptical
Stylus inspection result.....	long pegged swept elliptical, tip anomalous
Output Level (1kHz, 5cm/s).....	0.34mV
Relative output (0dB = 1mV/cm/s).....	- 22dB
Channel balance.....	0.6dB
Channel separation (L,R).....	30, 30dB
Tracking ability (L,R).....	80, 80µm
Frequency response limits 100Hz-5Hz.....	+ 1, - 0.5dB
Frequency response limits 30Hz-20kHz.....	+ 1, - 0/1dB
Stereo Separation L on R 100Hz, 3kHz, 10kHz.....	27, 27, 18dB
Stereo Separation R on L 100Hz, 3kHz, 10kHz.....	37, 30, 22dB
Channel diff. from graph, 100Hz, 1kHz, 10kHz.....	0, 0, 0.5dB
Response limits ref computer mean, 1kHz-15kHz.....	+ 1, - 1dB
Response limits ref computer mean, 1kHz-20kHz.....	+ 2.5, - 1dB
Test tracking weight, loading.....	1.8g, n.a.
LF resonance frequency, 12.5g arm (vert, lat).....	11, 9Hz
Estimated compliance (vert, lat).....	12, 18cu
Recommended arm effective mass.....	10-20g
LF resonance rise, 12.5g arm (vert, lat).....	8, 10dB
Typical selling price.....	£35

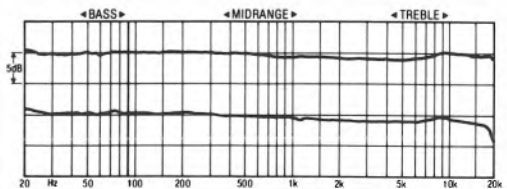

Frequency response, left and right channels

Yamaha MC21

Natural Sound Systems Ltd, Unit 7, Greycaine Road, Watford WD2 4SB
Tel (0923) 36470

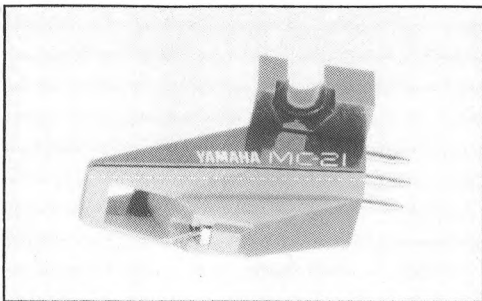

For the same price as the delicious transparent little *MC11*, you can do away with the step-up devices and go for the even more fascinating-looking high output *MC21*, which turns out to share much of the same moving parts.

This is a real lightweight at 2.7g, with 'droop snoot' styling that looks and feels a bit flexible. Stylus matches the *11*, with the same fine swept-elliptical with long shank pegged through the cantilever.

Compliance is stiff enough to suit medium-high mass arms, and shows some asymmetry between lateral and vertical components, both of which are heavily damped. Tracking has not been compromised, at the sensibly high 1.8g recommended downforce.

Lab report

The term high output might be regarded as a touch optimistic in this instance. Nevertheless most amplifiers will have the sensitivity and noise performance to accommodate the *'21* without difficulty.

Having more turns on the generator to produce high output inevitably increases the moving mass and reduces the control of the system. This can be seen in the frequency response, which shows many of the same characteristics as the *MC11*, but is distinctly less confident at the HF rolloff, with rather poorer channel balance to boot. The high speed trace also showed a succession of small sharp resonances extending from low frequencies up 1kHz, and a generally less smooth trace than the low output model.

Separation figures further drive home the inferiority of this high output version, which are frankly mediocre, comparison or not.

Sound quality

The results of auditioning are enough to reinforce one's faith in the validity of cartridge

measurement! While retaining some of the fine midband tonal characteristics, the overall sound quality seemed to have lost most of its dynamic range, somehow skimming the top surface only of the sound, resulting in poor stereo and focus, bass softening and some treble untidiness — no worse in balance terms, it now sounded detached and 'tinkly'.

Conclusions

There can be few better examples of the interchangeability of components between silk purses and sows ears than shown by the two Yamaha moving-coil 'cheapies'. Whether the failure of the *'21* is due to the added coil turns or to the lack of structural rigidity will remain a moot point — probably both made their contribution. But there can be no clearer illustration of the fine balance of components involved in cartridge design.

TEST RESULTS

Type, mass.....	high output moving-coil 2.7g
Stylus type.....	superelliptical
Stylus inspection result.....	long pegged swept elliptical
Output Level (1kHz, 5cm/s).....	1.78mV
Relative output (0dB = 1mV/cm/s).....	- 7dB
Channel balance.....	0.7dB
Channel separation (L,R).....	28.7, 27.5dB
Tracking ability (L,R).....	80, 80µm
Frequency response limits 100Hz-5kHz.....	+ 1/1.5, - 0.5dB
Frequency response limits 30Hz-20kHz.....	+ 1/1.5, - 2.5/3.5dB
Stereo Separation L on R 100Hz, 3kHz, 10kHz.....	27, 25, 17dB
Stereo Separation R on L 100Hz, 3kHz, 10kHz.....	34, 22, 15dB
Channel diff. from graph, 100Hz, 1kHz, 10kHz.....	0.5, 0.5, 1dB
Response limits ref computer mean, 1kHz-15kHz.....	+ 1, - 0dB
Response limits ref computer mean, 1kHz-20kHz.....	+ 1.5, - 0dB
Test tracking weight, loading.....	1.8g, n.a.
LF resonance frequency, 12.5g arm (vert, lat).....	12, 9Hz
Estimated compliance (vert, lat).....	21, 21cu
Recommended arm effective mass.....	10-20g
LF resonance rise, 12.5g arm (vert, lat).....	9, 9dB
Typical selling price.....	£30

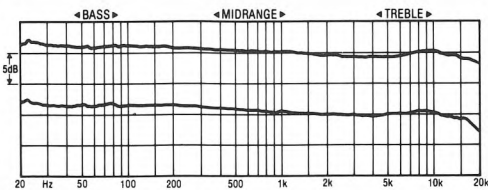

Frequency response, left and right channels

"With the INCON speaker cable, the sound was sweet, open, transparent, tuneful and very easy to follow. Both sonically and musically the QED cable transformed the sound"

JIMMY HUGHES: HI FI ANSWERS MAY '84

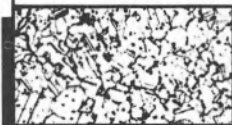

NORMAL HIGH PURITY COPPER



XP GRADE OFHC INCON COPPER

Take a look at the above micro photographs and you will see for yourself why it's no surprise that QED INCON sounds better than other speaker cables – the secret's in the copper!

QED AUDIO PRODUCTS LTD

UNIT 12, ASHFORD INDUSTRIAL ESTATE, SHIELD ROAD, ASHFORD, MIDDX, TWIS 1AU

QED

"the TORLYTE platform is the clear first choice offering the most relaxed and encouraging listening".

HiFi NEWS, August 1984



It is now an undisputed fact that turntables (and amplifiers) work best when mounted on light rigid surfaces isolated from the adverse effects of heavy tables or cabinets.

TORLYTE is QED's solution to the problem as it is both incredibly light and extremely rigid. It also has a very low Q so it will not alter the frequency response of the turntable.

TORLYTE isolating platforms are available in three sizes, all fitted with four adjustable point supports which act as an effective low frequency filter and easy levelling method.

Price £35 00

There are three sizes available:

- TP1 400 x 340 x 20mm finished in graphite grey
- TP2 445 x 350 x 20mm finished in black (LJUN/REGA size)
- TP3 480 x 370 x 20mm finished in black (P.T. size)

Made in England

QED AUDIO PRODUCTS LTD

UNIT 12, ASHFORD INDUSTRIAL ESTATE, SHIELD ROAD, ASHFORD, MIDDX TWIS 1AU

QED

HI-FI CHOICE BEST BUYS IN CARTRIDGES

Available at **Alternative Audio Ltd**



**A&R, *Audio Technica, *Grado, *Linn Basik, *Nagaoka, *Ortofon, *Shure.*

- We cater for a wide range of tastes and budgets by offering carefully selected Hi-fi products from the finest manufacturers.
- Demonstrations are arranged by appointment in our single Speaker demonstration room, simulating a domestic environment, to ensure the correct choice of equipment.
- Most products are covered by a full 2 year warranty; repairs and manufacturers are carried out in our own service departments.
- Systems can be installed at homes in the West Midlands area at no extra charge.
- Aiwa, Akai, A&R, Ariston, Audiolab, Beyer, Bose, Celestion, Clearwater, Denon, Dual, Gale, Glanz, Goldring, Helius, Heybrook, Kef, Logic, Marantz, Maxwell Meridian, Mission, Monitor Audio, Mordaunt-Short, Musical Fidelity, NVA, Pink Triangle, QED, QUAD, Revolver, Rogers, Rotel, Sansui, Systemdek, Sanyo, TDK, Technics, Thorens, Wharfedale, Yamaha.



BY APPOINTMENT HI-FI SPECIALIST

ALTERNATIVE AUDIO LTD

95 HOBS MOAT ROAD, SOLIHULL, WEST MIDLANDS B92 8JL

TEL: 021-742 0254

OPEN HOURS: TUESDAY TO SATURDAY 10am to 6pm

CREDIT TERMS AVAILABLE

ADC Phase II

On the second rung of the 'Phase' ladder, the grey-bodied *II* shares most of the features of the other models. The black stylus assembly is fitted with a 'large-footprint' elliptical tip, allowing tracking weights of 2g and above so assisting good tracking performance without excessive compliance. Samples showed quite good consistency on all parameters, with the gently falling frequency response the dominant characteristic.

Sound quality was considered quite acceptable considering the price, with the slightly 'soft' sound characteristic of this range surrounding a clear and well-focused midrange. Arm matching should be no problem, as a broad effective mass range of 6-18g should be usable. Overall the *Phase II* is a highly competent, well balanced model which fits comfortably in the range and the marketplace.

TEST RESULTS

Type, mass.....	moving magnet 5.8g
Output Level (1kHz, 5cm/s).....	3.6mV
Channel balance.....	0dB
Channel separation (L,R).....	29.8, 29.9dB
Tracking ability (L,R).....	80, 80µm
Frequency response limits 1kHz-15kHz.....	+0, -3dB
Frequency response limits 1kHz-20kHz.....	+0, -4dB
Test tracking weight, loading.....	2.1g, 275pF
LF resonance frequency, 12.5g arm (vert. lat).....	9.6, 9.3Hz
Estimated compliance (vert. lat).....	18, 16µc
Recommended arm effective mass.....	6-18g
LF resonance rise, 12.5g arm (vert. lat).....	11.6, 12dB
Typical selling price.....	£25

ADC Phase III

Sharing much in common with the *II* and *IV* in particular, *Phase III* is fitted with a 'sharper' elliptical stylus, for a £10 price increase over the *II*. Tracking weight range is necessarily lowered, but tracking ability is well maintained. The treble frequency response falloff shown by both cheaper models has been significantly reduced; it was non-existent on one sample, and on average is clearly now very gentle.

Compliance showed reasonable consistency and correspondence with similarly sensible values for the other Phase models, and should suit a wide 6-16g arm effective mass range. Sound quality showed just a mild 'softening' and a touch of 'tizz' which reduced extreme bass and treble detail. All in all this is another very competent ADC design, full competitive with, though less spectacular sounding than, the low-priced moving-coil models.

TEST RESULTS

Type, mass.....	moving magnet 5.8g
Output Level (1kHz, 5cm/s).....	2.45mV
Channel balance.....	0.13dB
Channel separation (L,R).....	27.7, 29.3dB
Tracking ability (L,R).....	80, 79.3µm
Frequency response limits 1kHz-15kHz.....	+1, -1dB
Frequency response limits 1kHz-20kHz.....	+1, -1.5dB
Test tracking weight, loading.....	1.5g, 275pF
LF resonance frequency, 12.5g arm (vert. lat).....	9.9, 9.6Hz
Estimated compliance (vert. lat).....	18, 16µc
Recommended arm effective mass.....	6-16g
LF resonance rise, 12.5g arm (vert. lat).....	10.6, 10.6dB
Typical selling price.....	£35

ADC TRX-2

This second TRX model is twice the price of the *1*, and features an exotic tapered beryllium tube cantilever with 'Vital III' line-contact stylus. Compliance was higher than the *1*, giving some evidence of groove instability in a medium mass arm — so arms with low effective mass are indicated, but providing greater tracking safety margins in return. Stereo separation figures were a touch disappointing at this price level, though one might blame the mild arm mismatch for this.

Frequency response showed a similar rising trend to the *TRX-1*, but markedly less pronounced, resulting in a less exaggerated balance, but a 1-2dB plateau through the mid treble nonetheless. This was quite noticeable subjectively, giving rise to descriptions such as 'fiercely exciting', and observations of forward, flattened stereo perspectives.

Midrange focus and dynamics were liked, but the bass was a trifle 'plummy'. Though very competent in many ways, the subjective performance was considered insufficient to justify the high price.

TEST RESULTS

Type, mass.....	moving magnet 6.5g
Output Level (1kHz, 5cm/s).....	3.5mV
Channel balance.....	0.6dB
Channel separation (L,R).....	23.1, 30dB
Tracking ability (L,R).....	80, 80µm
Frequency response limits 1kHz-15kHz.....	+2, -0dB
Frequency response limits 1kHz-20kHz.....	+2, -0dB
Test tracking weight, loading.....	1.2g, 275pF
LF resonance frequency, 12.5g arm (vert. lat).....	7, 8Hz
Estimated compliance (vert. lat).....	30, 23µc
Recommended arm effective mass.....	5-12g
LF resonance rise, 12.5g arm (vert. lat).....	13, 13dB
Typical selling price.....	£180

A&R E77

This middle model amongst A&R's moving magnet designs is really only restricted to summary review coverage for reasons of space. Performance was very consistent between

SUMMARY REVIEWS

samples and with the other A&R '77s, though channel balance error was 1.1dB in the poorer case. Compliance was average, well suited to most tonearm masses, though the resonance itself had a fairly high peak, and one sample looked a trifle unstable on warps.

Tracking and stereo separation were both fine, while the frequency response showed a mild 1dB dip through the lower treble followed by a slightly larger peak at extreme HF. Sound quality was well liked, described as well-balanced, clear and detailed, but with a little bass heaviness and treble 'spatter' to mask some fine detail. For around £33, the well-balanced E77 sits neatly in the middle of this impressive-sounding trio of models.

TEST RESULTS

Type, mass.....	moving magnet 6g
Output Level (1kHz, 5cm/s).....	3.5mV
Channel balance.....	0.8dB
Channel separation (L,R).....	30, 30dB
Tracking ability (L,R).....	80, 80µm
Frequency response limits 1kHz-15kHz.....	+2, -1.5dB
Frequency response limits 1kHz-20kHz.....	+2, -1.5dB
Test tracking weight, loading.....	1.8g, 300pF
LF resonance frequency, 12.5g arm (vert, lat).....	10, 9Hz
Estimated compliance (vert, lat).....	16, 18cu
Recommended arm effective mass.....	8-16g
LF resonance rise, 12.5g arm (vert, lat).....	14.5, 15.5dB
Typical selling price.....	£33

Audio Technica AT115E

This £20 model is third up AT's range. A simple magnetic with specified nude elliptical stylus, compliance is a touch on the high side with little LF damping, suggesting low mass arms are to be preferred. Separation, channel balance and tracking abilities were all fine, while the frequency response showed some sample variation and a general treble downtilt at high frequencies, amounting to some 2dB. Sound quality was quite liked, with praise for lively dynamics. The treble was a significant improvement over the 110E, though a touch 'scratchy' and obtrusive. This is a workmanlike design offering sound value for money.

TEST RESULTS

Type, mass.....	moving magnet 7.2g
Output Level (1kHz, 5cm/s).....	3.5mV
Channel balance.....	0.4dB
Channel separation (L,R).....	30, 30dB
Tracking ability (L,R).....	80, 80µm
Frequency response limits 1kHz-15kHz.....	+0, -2.5dB
Frequency response limits 1kHz-20kHz.....	+0, -5dB
Test tracking weight, loading.....	1.5g, 150pF
LF resonance frequency, 12.5g arm (vert, lat).....	9, 9Hz
Estimated compliance (vert, lat).....	18, 18cu
Recommended arm effective mass.....	6-16g
LF resonance rise, 12.5g arm (vert, lat).....	14.5, 14dB
Typical selling price.....	£20

B&O MMC5

Cheapest of the B&O series, the £20 MMC5 is specified as being marginally less compliant than the others, though are findings give the same resonant frequency consistently and throughout.

The elliptical stylus has slightly greater mass than the more expensive models, the cantilever is straight aluminium tubing, and the tracking weight range is slightly higher. Compliance of these models is higher than average, necessarily so in order to match with B&O's own ultra-lightweight arms. Frequency response showed a smooth treble region slightly depressed by 1-2dB. The sound was well controlled with good focus and energy, though somewhat lacking in bass. This potentially fine cartridge was marred by constructional compromises though it was a good performer nonetheless.

TEST RESULTS

Type, mass.....	moving magnet 3.3g
Output Level (1kHz, 5cm/s).....	2.45mV
Channel balance.....	1.23dB
Channel separation (L,R).....	27.7, 25.6dB
Tracking ability (L,R).....	80, 80µm
Frequency response limits 1kHz-15kHz.....	+0, -2.5dB
Frequency response limits 1kHz-20kHz.....	+0, -2.5dB
Test tracking weight, loading.....	1.5g, 200pF
LF resonance frequency, 12.5g arm (vert, lat).....	9, 9Hz
Estimated compliance (vert, lat).....	24, 24cu
Recommended arm effective mass.....	5-15g
LF resonance rise, 12.5g arm (vert, lat).....	16, 13.5dB
Typical selling price.....	£20

B&O MMC3

Middle of the five-model B&O range, the £35 '3 has an elliptical nude stylus on tapered aluminium cantilever. It shares many characteristics of the other models in the range, including the plug-in adaptor mounting and 24cu compliance. Despite the low mass of the cartridge, relatively low LF damping indicates that low mass (under 12g) arms are to be preferred. Tracking was very secure, channel balance

TEST RESULTS

Type, mass.....	moving magnet 3.3g
Output Level (1kHz, 5cm/s).....	2.5mV
Channel balance.....	0.3dB
Channel separation (L,R).....	30, 27dB
Tracking ability (L,R).....	80, 80µm
Frequency response limits 1kHz-15kHz.....	+0, -2.5dB
Frequency response limits 1kHz-20kHz.....	+0, -2.5dB
Test tracking weight, loading.....	1.2g, 200pF
LF resonance frequency, 12.5g arm (vert, lat).....	9, 9Hz
Estimated compliance (vert, lat).....	24, 24cu
Recommended arm effective mass.....	5-15g
LF resonance rise, 12.5g arm (vert, lat).....	17, 15dB
Typical selling price.....	£35

SUMMARY REVIEWS

close, and separation pretty good. Frequency response was very smooth and flat, with HF level about 1dB below the mean, drooping to -2dB 12-15kHz. Sound quality was considered a little 'laid back', with the treble unobtrusively dropping away, the midrange pleasantly enhanced, and the bass controlled but a little 'soft'. A very respectable and neutral performer for the price, it remains better suited to B&O rather than universal application.

B&O MMC2

Sharing the sapphire tube cantilever which B&O pioneered with the *MMC1*, specifications reveal little difference except a slightly larger (0.12mm/0.1mm) stylus shank and tighter quality control, though £47 is a very worthwhile price reduction compared with the flagship model. Similarly highish compliance and limited LF damping, not to mention the low tracking weight range, suggest that low mass (under 12g) arms should give best results. Tracking was fine, but our sample (or its adaptor fit) gave slightly poorer separation than the other models in the range.

Frequency response was also very similar to the '1 and '3, slightly flatter than the latter on one channel. Sound quality continued the family resemblance of soft but controlled bass, good tracking and low coloration, with the mid and treble described as very sweet but with good dynamics, slightly laid back and lacking focus. Though clearly another well-engineered model, the improvement over cheaper models in the range is only modest, and the overall performance as a universal cartridge would appear to be again limited by the plug-in adaptor.

Denon 103S

Middle model of the triad based on the long established *103C*, the *S* had lighter moving parts and was originally fitted with a Shibata stylus. The tip is now merely described as a special elliptical. Compliance measured a moderate 16cu at LF resonance, allowing a wide range of arms to be used, though the lack of internal damping indicates these should preferably be below 14g in effective mass. Output is healthy for a low-output design, though some form of step-up will probably be required with most amplifiers. Stereo separation and channel balance were good, whereas the tracking abilities were a little

below average.

Frequency response was both flat and well maintained at the highest frequencies, confirming Denon's successful achievement of design objectives. Sound quality was well liked, with a stable, solid and punchy sound and better HF balance than the 'C' or 'D', though a touch 'edgy' at extreme HF.

A thoroughly worthwhile model in its own right, the *103S* is still a trifle overshadowed by the cheaper 'C', though it offers some areas of distinct improvement, it is slightly less convincing in terms of total integration.

Denon 103D

Similar to the other *103* models, this top £120 model uses a tapered cantilever and special elliptical stylus. Greater compliance allows a lower tracking weight, though in fact our measurements indicated a similar LF resonance to the 'S', albeit with rather greater damping.

Despite the lower tracking weight, tracking abilities were improved, and separation was fine. A slightly lower output makes some sort of moving-coil boost mandatory.

Frequency response showed a smooth but rising treble response from below 10kHz, which was confirmed by subjective descriptions of brightness and 'splash'. This marred the sound quality a little, as this treble rise lacked the detail and transparency of some of the more exotic 'bright' designs. The overall sound was well liked, described as solid, lively and bright, while clearly demanding a good quality rigid tonearm. Though quite competitive, the *103D* was not significantly preferred to the cheaper *103* on overall balance.

TEST RESULTS

Type, mass.....	low output moving-coil 7.5g
Output Level (1kHz, 5cm/s).....	0.33mV
Channel balance.....	0.7dB
Channel separation (L,R).....	30, 30dB
Tracking ability (L,R).....	78, 80µm
Frequency response limits 1kHz-15kHz.....	+1.5, -0dB
Frequency response limits 1kHz-20kHz.....	+3, -0dB
Test tracking weight, loading.....	1.5g, n.a.
LF resonance frequency, 12.5g arm (vert, lat).....	9, 9Hz
Estimated compliance (vert, lat).....	17, 17cu
Recommended arm effective mass.....	5-15g
LF resonance rise, 12.5g arm (vert, lat).....	12, 13dB
Typical selling price.....	£120

Dynavector DV23RS

Fitted with Dynavector's famous ruby cantilever, the *23RS* is a quite expensive £165 low

HELLO

I've a brain the size of a planet and all they wanted me to do was write this silly little advertisement to tell you that this is the best company in the world. If I've told them once I've told them a million times not to exaggerate — it's only the No.1 retailer in Scotland.

Drop in for a blether to:

HI-FI CORNER

1, HADDINGTON PLACE,
EDINBURGH
Tel (031) 556 7901

44, COW WYND, FALKIRK
Tel (0324) 29011

75, MURRAY PLACE,
STIRLING
Tel (0786) 5053

THE GRAMOPHONE CO

ROSE ST PRECINCT,
EDINBURGH
Tel (031) 225 9535

INCATECH

*Gold plated mains
plugs & sockets
See dealers
for details*

Wonfor Electronics
(0268) 690895

Dealers include:

Rayleigh Hi-Fi
(Rayleigh) 0268-779762

Avalon Hi-Fi
(Glastonbury) 0458-50370

Audiofile II
(Colchester) 0206-577519

Subjective Audio
(London) 01-387 8281

W.R.B.I.
(London) 01-943 1436

Billy Vee
(London) 01-318 5755

Audio T
(Middlesex) 01-794 7848

A.T. Labs
(Middlesex) 01-363 7981

Steve Boxshall Audio
(Cambridge) 0223-68305

SUMMARY REVIEWS

output moving-coil model, bracketed by two companion Karats in this famous range. Compliance is quite low, with quite highly damped different LF resonances laterally and vertically. Virtually any arm should be useable, though high rigidity medium/high mass examples (8-18g) might be expected to give the best results. Tracking abilities were fine and channel balance good, though separation figures might have been better at this price.

Frequency response was very flat indeed, though with a slight rise at very high frequencies on the right hand channel. Sound quality was not particularly favoured, the sound being described as somehow 'shut in' in the mid-range, lacking energy and sparkle and with some HF 'edginess'.

TEST RESULTS

Type, mass.....	low output moving-coil 5.3g
Output Level (1kHz, 5cm/s).....	0.21mV
Channel balance.....	0.3dB
Channel separation (L,R).....	28.9, 26dB
Tracking ability (L,R).....	80, 80 μ m
Frequency response limits 1kHz-15kHz.....	+ 1, - 0.6dB*
Frequency response limits 1kHz-20kHz.....	+ 2, - 0.6dB*
Test tracking weight, loading.....	1.5g, n.a.
LF resonance frequency, 12.5g arm (vert, lat).....	12, 10Hz
Estimated compliance (vert, lat).....	16, 15cu
Recommended arm effective mass.....	10-22g
LF resonance rise, 12.5g arm (vert, lat).....	8, 9dB
Typical selling price.....	£165

*low temperature (15°C)

Elac ESG 796 H30

Near the top of a long series of twelve Elac models, the '30 designation refers to the specification compliance. The van den Hul type II stylus, goes some way towards justifying the high price. Our measurements indicated that compliance at resonance was even higher than spec, giving LF resonant frequencies as low as 6/7Hz in the 12.5g test arm, and suggesting that only the lowest mass arms are really suitable.

Despite the degree of groove insecurity caused by the compliance, tracking abilities were still more than adequate, while separation and channel balance spot measurements were

TEST RESULTS

Type, mass.....	moving magnet 6.5g
Output Level (1kHz, 5cm/s).....	3.2mV
Channel balance.....	0.4dB
Channel separation (L,R).....	30, 30dB
Tracking ability (L,R).....	79, 80 μ m
Frequency response limits 1kHz-15kHz.....	+ 0, - 1.8dB
Frequency response limits 1kHz-20kHz.....	+ 0, - 2.7dB
Test tracking weight, loading.....	1.25g, 300pF
LF resonance frequency, 12.5g arm (vert, lat).....	6, 7Hz
Estimated compliance (vert, lat).....	38, 30cu
Recommended arm effective mass.....	3-10g
LF resonance rise, 12.5g arm (vert, lat).....	16, 14dB
Typical selling price.....	£150

fine. The response at high frequencies (15kHz plus) was very sensitive to capacitance, and could certainly be 'tuned' to achieve a flat response for either channel, though a 2-3dB channel imbalance also appeared here. The sound was well liked, described as open and clear, slightly 'cold', but quite 'fast' and with some 'bite', and a touch 'tinkly' at the extreme top end. Overall this is a competent enough design marred by excessive compliance.

Elac EMM 190 HB33

Though from a different series, it is difficult to distinguish this model physically from the 796 H30, and the same observations apply regarding body and stylus assembly design. In fact the spec. compliance has been increased an (insignificant) 3cu, the price reduced to £100, and the vdH tip is now mounted on a boron cantilever. Almost identical low frequency characteristics, with high compliance and little damping, again indicates that only the lowest mass arms are suitable. Though the tracking ability measurement was fine, separation and channel balance were a little disappointing.

Elite EEI 800

This neat £40 moving magnet model is of Japanese manufacture to Australian specifications. It uses a nude 'parabolic' diamond tip on conventional aluminium cantilever, and shows sensible body construction and stylus assembly fit. Quoted compliance is a sensible enough 18cu, though our measurement indicated a rather higher figure at resonance, suggesting that only low mass arms should be used. Channel balance was a rather disappointing 1.3dB out, and separation also gave only reasonable results, though tracking was fine.

Frequency response was very consistent between both channels of two samples, but the

TEST RESULTS

Type, mass.....	moving magnet 6g
Output Level (1kHz, 5cm/s).....	3.8mV
Channel balance.....	1.3dB
Channel separation (L,R).....	27.5, 24dB
Tracking ability (L,R).....	80, 80 μ m
Frequency response limits 1kHz-15kHz.....	+ 0, - 5.5dB
Frequency response limits 1kHz-20kHz.....	+ 0, - 6dB
Test tracking weight, loading.....	1.8g, 300pF
LF resonance frequency, 12.5g arm (vert, lat).....	8, 6Hz
Estimated compliance (vert, lat).....	23, 40cu
Recommended arm effective mass.....	5-12g
LF resonance rise, 12.5g arm (vert, lat).....	11.5, 11.5dB
Typical selling price.....	£40

SUMMARY REVIEWS

balance was significantly down in treble nonetheless. This was confirmed by audition, the sound having a rich, rather 'heavy' sound, though qualitatively good in terms of midrange, treble and stereo imaging. Though the distinctive balance prevents recommendation, this cartridge has some undeniably good qualities.

Goldring G920 IGC

Quite modestly priced, considering a van den Hul II stylus is fitted, the 920 is a lightweight design. Though by no means flimsy, the mounting plate has a restricted contact area and some movement can be induced in both bracket and stylus assembly. Though different in lateral and vertical planes and not quite in accordance with specification, compliance was sensibly low for matching a wide range of rigid arms, and the similarly sensible playing weight ensures decent tracking abilities. Channel balance was excellent, and stereo separation pretty good as well.

Apart from one channel of one sample, frequency response was quite consistent, more or less flat to 15kHz and then a gentle rolloff beyond. The clear treble was liked subjectively, though the bass quality was rather 'soft', and dynamics lacked some contrast. Overall this is a pleasantly balanced and competitively priced model which is perhaps beginning to show its age now, though wearing it rather well nonetheless.

TEST RESULTS

Type, massmoving magnet	4.3g
Output Level (1kHz, 5cm/s)	4.4mV
Channel balance	0.3dB
Channel separation (L,R)	30, 28dB
Tracking ability (L,R)	73, 77 μ m
Frequency response limits 1kHz-15kHz	+2, -0dB
Frequency response limits 1kHz-20kHz	+2, -4dB
Test tracking weight, loading	1.75g, 200pF
LF resonance frequency, 12.5g arm (vert, lat)	11, 9Hz
Estimated compliance (vert, lat)	14, 22cu
Recommended arm effective mass	6-16g
LF resonance rise, 12.5g arm (vert, lat)	9.5, 11.5dB
Typical selling price	£34

Goldring 910 IGC

Very similar in specification to the 920, this more expensive model features the more 'purist' van den Hul stylus profile, accounting for the higher price. Measurement confirmed a sensibly low compliance suited to a wide range of popular arms in the 8-18g range, one sample perhaps being a little too stiff and well damped laterally. Spot measurements showed channel

110

balance was superbly close, tracking ability quite competent and very close to the 920, and separation a trifle poorer.

Frequency response was quite consistent and a little bright through the mid treble, rolling off a little at very high frequencies. Sound quality was considered fair, with a nice mid-range but a slightly 'feathery' high frequency 'sparkle' and somewhat softened bass. A pleasant enough design, it is not really as competitive as the cheaper 920 model.

TEST RESULTS

Type, massmoving magnet	4.3g
Output Level (1kHz, 5cm/s)	4.5mV
Channel balance	0.05dB
Channel separation (L,R)	26.6, 28dB
Tracking ability (L,R)	74, 76 μ m
Frequency response limits 1kHz-15kHz	+2, -0dB
Frequency response limits 1kHz-20kHz	+2, -2dB
Test tracking weight, loading	1.75g, 200pF
LF resonance frequency, 12.5g arm (vert, lat)	11, 10.5Hz
Estimated compliance (vert, lat)	14, 15cu
Recommended arm effective mass	8-18g
LF resonance rise, 12.5g arm (vert, lat)	10, 9dB
Typical selling price	£65

Goldring Electro IILZ

This latest introduction in Goldring's *Electro* moving-coil series is a quite expensive £180 low-output model with boron cantilever and van den Hul stylus. Quite a heavy cartridge, it showed very low compliance indeed in the vertical plane on our sample, and a marked difference in resonant frequency between vertical and lateral planes. Arms in the medium to heavy effective mass range are clearly to be preferred, but it is difficult to avoid one or other of the (quite well-damped) resonances from occurring at either too high or too low a frequency for comfort. Spot measurements for channel balance, separation and tracking abilities were reasonable enough, but a little disappointing for the price.

Frequency response showed one channel 2-3dB down above 10kHz, whereas the other channel was about 1dB up, results which were

TEST RESULTS

Type, masslow output moving-coil	9g
Output Level (1kHz, 5cm/s)	0.19mV
Channel balance	0.3dB
Channel separation (L,R)	23.8, 27.1dB
Tracking ability (L,R)	77, 78 μ m
Frequency response limits 1kHz-15kHz	+1.5, -2.5dB
Frequency response limits 1kHz-20kHz	+2, -3dB
Test tracking weight, loading	1.8g, n.a.
LF resonance frequency, 12.5g arm (vert, lat)	15, 10Hz
Estimated compliance (vert, lat)	15, 13cu
Recommended arm effective mass	12-20g
LF resonance rise, 12.5g arm (vert, lat)	11, 11dB
Typical selling price	£185

slightly more extreme than, but similar to the other *Electro* models, including the A&R version. The sound was well balanced but lacked low frequency authority, midrange focus and 'punch'. In all the *ILLZ* is a decent enough cartridge, but any improvement over other *Electro* models was not considered really sufficient to warrant the higher price.

Grado T

Grados are a curious mixture of good and bad qualities. The fixing lugs showed distinct signs of stress when firmly flat mounted, so we were reluctant to stress them further by using the three-point adaptor supplied. The notable characteristic is an almost completely undamped LF resonance, which is fortunately nicely symmetrical and with compliance ideally chosen to match most arms, though it naturally makes the cartridge rather 'lively' in the groove, and probably places a premium on turntable and arm quality. Channel balance was very good, tracking ability fine, but separation unexceptional.

Frequency response showed a remarkable similarity between our two samples; a little down in the lower treble, it began rising at 15kHz and peaked 4-5dB on the right channel at 18-20kHz. The sound was well liked (in a good turntable), with praise for solid and powerful bass, which was perhaps a touch firm, with mild overhang, a clear, spacious slightly 'laid-back' midrange, and competent enough treble. Assuming a good enough turntable (and arm) are available, the *T* is something of a snip.

TEST RESULTS

Type, mass.....	moving magnet 5.5g
Output Level (1kHz, 5cm/s).....	3.6mV
Channel balance.....	0.3dB
Channel separation (L,R).....	20.9, 26.2dB
Tracking ability (L,R).....	.80, .80 μ m
Frequency response limits 1kHz-15kHz.....	+2, -1dB
Frequency response limits 1kHz-20kHz.....	+5, -1dB
Test tracking weight, loading.....	1.5g, n.a.
LF resonance frequency, 12.5g arm (vert, lat).....	10, 10Hz
Estimated compliance (vert, lat).....	16, 16cu
Recommended arm effective mass.....	8-16g
LF resonance rise, 12.5g arm (vert, lat).....	20, 18dB
Typical selling price.....	£22

**light arm damping might be beneficial*

Kiadea MC10

This £350 low output moving-coil Japanese cartridge is being brought to the UK by Aston Audio. Little is known apart from the fact that it is made for the Canadian operation Perspective

Audio, though the packaging at least owes a great deal to Koetsu for inspiration! The cantilever looks like conventional aluminium (which has no implied criticism), and the body looks respectably solid. Compliance is nicely symmetrical and a trifle higher than similar models, which improves the tracking margin while maintaining good separation, though low-to-medium effective mass arms are to be preferred. Channel balance was impressively close.

Frequency response proves to be the main weakness, as it shows a steady rise from 12kHz, recording some 5dB above the mean at 20kHz. Sonically it was well liked. The bass was well-damped, praised for solidity, stability and power, but a treble 'sizzle' was noticeable nonetheless. Though it is possible that there are systems which would benefit from the treble boost of this otherwise fine quality cartridge (electrostatic speakers would be an obvious place to start), the subjective imbalance is slightly too distracting for general recommendation. But the sonic virtues do go a long way towards justifying the price.

TEST RESULTS

Type, mass.....	low output moving-coil 9g
Output Level (1kHz, 5cm/s).....	0.28mV
Channel balance.....	0.3dB
Channel separation (L,R).....	30, 30dB
Tracking ability (L,R).....	.80, .80 μ m
Frequency response limits 1kHz-15kHz.....	+3.5, -0dB
Frequency response limits 1kHz-20kHz.....	+5.5, -0dB
Test tracking weight, loading.....	1.8g, n.a.
LF resonance frequency, 12.5g arm (vert, lat).....	9, 9Hz
Estimated compliance (vert, lat).....	18, 18cu
Recommended arm effective mass.....	6-15g
LF resonance rise, 12.5g arm (vert, lat).....	11, 12dB
Typical selling price.....	£300

Linn Asak

This famous model is given only a summary merely because the newly introduced *Trak* is identical in many respects, while the *Karma* has now taken over at the top of Linn's range. First of the Supex-sourced Linn models, the *Asak* is similar in many respects to those with full reviews, having an unusually low compliance with little internal damping, so low mass arms should be avoided, and best results are likely towards the bottom end of the range 10-20g; *Asaks* deliver a lot of energy to the arm, so the inherent quality of this component can also prove a limiting factor. Spot measurements showed good separation but rather below average channel balance and tracking ability.

SUMMARY REVIEWS

Frequency response showed one sample a little 'brighter' than the other, but both were respectably flat through low and mid treble, with a 2-3dB rise in the 18-20kHz region. Sound quality was slightly more refined and even than the *Trak*, but with a similar solidity and fine full-range dynamics.

TEST RESULTS

Type, mass.....	low output moving-coil 6g
Output Level (1kHz, 5cm/s).....	0.17mV
Channel balance.....	0.5dB
Channel separation (L,R).....	30, 27.9dB
Tracking ability (L,R).....	66, 67 μ m
Frequency response limits 1kHz-15kHz.....	+3, -0dB
Frequency response limits 1kHz-20kHz.....	+4.5, -0dB
Test tracking weight, loading.....	1.8g, n.a.
LF resonance frequency, 12.5g arm (vert, lat).....	11.5, 12Hz
Estimated compliance (vert, lat).....	11, 10cc
Recommended arm effective mass.....	9-18g
LF resonance rise, 12.5g arm (vert, lat).....	17, 17dB
Typical selling price.....	£200

Logic Claro Black

This £215 low output moving-coil model is sourced from Japan by UK turntable and arm manufacturer Logic, along with the cheaper *Gold* model which is given a full review. Distinguishing features of the *Black* include a solid beryllium cantilever and 'micro-ridge' stylus. Quite a heavy cartridge, compliance was about average, somewhat higher than the spec. suggested, though fine for matching most arms nonetheless (6-16g effective mass recommended), and contributing to good tracking abilities. Separation was also good, though the channels were a disappointing 1dB apart.

Frequency response indicated a smooth, slightly recessed, treble, but for some unexplained reason the sound was found to be fierce almost to the point of 'shriekiness', though powerful and with good dynamics. Too late for the main reviews, we received a second sample which was subjectively distinctly superior — very nice indeed, in fact, with none of the aggressiveness of the original. Apparently the *Black* needs a good 10 hours running in!

TEST RESULTS

Type, mass.....	low output moving-coil 8.5g
Output Level (1kHz, 5cm/s).....	0.16mV
Channel balance.....	1.0dB
Channel separation (L,R).....	30, 30dB
Tracking ability (L,R).....	80, 80 μ m
Frequency response limits 1kHz-15kHz.....	+0, -1.5dB
Frequency response limits 1kHz-20kHz.....	+0, -1.5dB
Test tracking weight, loading.....	.9g n.a.
LF resonance frequency, 12.5g arm (vert, lat).....	8.5, 9Hz
Estimated compliance (vert, lat).....	17, 16cc
Recommended arm effective mass.....	5-16g
LF resonance rise, 12.5g arm (vert, lat).....	12.5, 11dB
Typical selling price.....	£215

Mission Rose

This unusual wooden-bodied cartridge is a development of the 773, featuring a micro-ridge stylus, and is likewise sourced from Dyna-vector to Mission specification. Our intention to accord it a full review was thwarted by the unavailability of production versions, and the following comments relate to a pre-production sample. Showing a similar well-damped LF resonance to the 773, it is suited to the unusually wide range of tonearm masses offered by Mission themselves, from 5-18g. Spot measurements for channel balance, separation and tracking ability were somewhat poorer than the 773, and the latter could be considered a trifle marginal for some users.

Frequency response was very flat, even and well balanced, slightly down in the lower treble and then rising beyond audibility. Sound quality was considered likely to be prejudiced by the inability to get proper mechanical contact between body and headshell, due to the prototype lugs used, and this is expected to change in production. The bass was distinctly softened and 'light', though quite articulate nonetheless. The midrange had a slight 'edge' but conveyed good detail and depth, while the treble was tonally prominent but sweet, with fairly good detail and integration. Clearly a design with the sort of sonic potential to match its high price, the final production *Rose* would benefit from a little more bass authority and less presence emphasis.

TEST RESULTS

Type, mass.....	low output moving-coil 7g*
Output Level (1kHz, 5cm/s).....	0.25mV
Channel balance.....	0.3dB
Channel separation (L,R).....	24.1, 30dB
Tracking ability (L,R).....	64, 66 μ m
Frequency response limits 1kHz-15kHz.....	+0, -1dB
Frequency response limits 1kHz-20kHz.....	+1, -1.5dB
Test tracking weight, loading.....	.2g, n.a.
LF resonance frequency, 12.5g arm (vert, lat).....	10, 9Hz
Estimated compliance (vert, lat).....	13, 16cc
Recommended arm effective mass.....	7-16g
LF resonance rise, 12.5g arm (vert, lat).....	9, 9dB
Typical selling price.....	£300

*estimated (production sample not available)

NAD 9200

This variation upon an ADC theme is specified to NAD's requirements, using a low-cost diasatype elliptical stylus of unambitious dimensions. Compliance is sensibly matched to average arm masses in the 6-19g range, spot measurements showing separation and tracking in good light, though channel balance

was below average on our sample.

Frequency response showed an even though determinedly dim treble characteristic, some 3dB down by 15kHz and continuing to fall thereafter. Listening tests gave rather negative results, the sound described as unexciting, lacking body, and a little coarse, and in fact we favoured the cheaper *9100* by a significant margin. Though competent in many respects, overall the *9200* must be considered an undistinguished contender.

TEST RESULTS

Type, mass.....	moving magnet 5.8g
Output Level (1kHz, 5cm/s).....	4.75mV
Channel balance.....	0.75dB
Channel separation (L,R).....	30, 30dB
Tracking ability (L,R).....	74, 80µm
Frequency response limits 1kHz-15kHz.....	+0, -3dB
Frequency response limits 1kHz-20kHz.....	+0, -4.5dB
Test tracking weight, loading.....	1.2g, 275pF
LF resonance frequency, 12.5g arm (vert, lat).....	9, 10Hz
Estimated compliance (vert, lat).....	18, 15cu
Recommended arm effective mass.....	6.16g
LF resonance rise, 12.5g arm (vert, lat).....	13, 11dB
Typical selling price.....	£22

Nagaoka MP11

This is the elliptical tipped version of the *MP10*, which so stormed through the listening tests as to eclipse the performance of this popular but slightly more expensive version. Compliance is higher than the *10*, so lightweight arms (under 10g) are to be preferred. Spot measurements of channel balance, separation and tracking ability were consistently good across three samples.

Frequency response measurement confirmed that low (100pF) capacitance gave the best result, with a smooth gentle rolloff throughout the treble of 1-2dB. These highly promising measurements were let down a little during audition. Enhanced treble compared to the *'10* was more than offset by a generally less tidy sound, with some tendency to warp instability and 'tremble', due probably to the highish compliance combined with little damping,

TEST RESULTS

Type, mass.....	moving magnet 6.8g
Output Level (1kHz, 5cm/s).....	4.25mV
Channel balance.....	0.16dB
Channel separation (L,R).....	28.5, 29.9dB
Tracking ability (L,R).....	80, 80µm
Frequency response limits 1kHz-15kHz.....	+0, -2dB
Frequency response limits 1kHz-20kHz.....	+0, -3dB
Test tracking weight, loading.....	2.0g, 100pF
LF resonance frequency, 12.5g arm (vert, lat).....	7, 7Hz
Estimated compliance (vert, lat).....	35, 35cu
Recommended arm effective mass.....	5.10g
LF resonance rise, 12.5g arm (vert, lat).....	14, 13dB
Typical selling price.....	£19

despite the modest enough mass of the test arm. Though undoubtedly a well engineered model in many ways, the *'11* is less universally applicable than the *'10*, and should be reserved for the lower mass arms.

Nagaoka MP15

Sharing excellent body structure characteristics with the other Nagaoka models, the £30 *'15* has a tapered cantilever and nude elliptical stylus. Compliance proved to be very high, though with slightly more damping than the *'11*, so the *'15* should only be used with the lowest mass arms. While this ensures good tracking, it may have played a part in a separation figure that was somewhat below average. Channel balance was very good.

Frequency response was even and quite flat, with merely a 1dB upper treble rise at 100pF loading so a slight increase is in load capacitance could not only be tolerated but might prove slightly beneficial. Sound was generally liked, and was described as fairly solid with some treble detail, though the excessive compliance did not breed confidence. Overall this is potentially a most interesting model marred by high compliance.

TEST RESULTS

Type, mass.....	moving magnet 6.8g
Output Level (1kHz, 5cm/s).....	3.73mV
Channel balance.....	0.16dB
Channel separation (L,R).....	30, 24.3dB
Tracking ability (L,R).....	80, 80µm
Frequency response limits 1kHz-15kHz.....	+1, -0.5dB
Frequency response limits 1kHz-20kHz.....	+2, -0.5dB
Test tracking weight, loading.....	1.8g, 100pF
LF resonance frequency, 12.5g arm (vert, lat).....	6, 6.5Hz
Estimated compliance (vert, lat).....	36, 26cu
Recommended arm effective mass.....	5.10g
LF resonance rise, 12.5g arm (vert, lat).....	11, 12dB
Typical selling price.....	£19

Nagaoka MP20

This is the £40 variation upon a theme by Nagaoka, threatening even higher compliance and offering a boron cantilever and elliptical 'Triangle' tip. In fact compliance turned out to be rather more sensible than any since the *'10*, and arm masses up to 15g should be usable. Spot measurements showed exemplary channel balance, ample tracking abilities and good separation, with fine consistency.

Frequency response showed a little less consistency, though the responses were commendably even, ranging from flat to a gentle 1-2dB treble rolloff at the recommended

OUR ATTITUDE?

It's sad that so many of today's music lovers appear to view the selection and purchase of hi-fi equipment as something akin to taking unpleasant medicine, i.e. "close your eyes, swallow hard and you'll feel better"

It really doesn't have to be like that! Subjective Audio's customers have proved to their own friends, time and time again that certainly at *this* dealer, the process of auditioning and purchase is both highly enjoyable and interesting, and not something to be apprehensive about

"Word of mouth" recommendation is the best sort of compliment a dealer can receive and we get a good deal of satisfaction from it. We find that total honesty (some call it bluntness) coupled to a co-operative attitude is the best assistance we can give to potential customers. Interestingly, 80% of visitors to our premises during the last 7 years have become customers — sooner or later.

Naturally, space precludes us from giving you the whole story, but if you are really interested or just curious, all you have to do is to contact us by phone or letter, requesting our information pack. It will be sent by first class post within 24 hours.



Our Facilities

- 1 Three purpose built single speaker demonstration rooms — fully stocked with the world's finest equipment.
- 2 Close to Euston, Kings Cross and St Pancras BR stations as well as Mornington Crescent Tube.
- 3 Delivery and full installation service within 50 miles of central London.
- 4 All major credit cards accepted at no additional charge.
- 5 Instant credit up to £1000.00 for suitable applicants — please write for full details.
- 6 Interest-free credit facilities on a small number of different items each month — please write for full details.
- 7 Sensible and attractive part exchange quotations.
- 8 Full EXPORT facilities to all parts of the world.

Our Suppliers

A&R (Cambridge)
Audio Research
Audio Vois
Beard
B.S. Meridian
Burmester
Celestion
Dreadnought
Dynavector
EMT/Van Den Hul
Etude
Gale

Goldring
Grace
Harbeth
Helius
Heybrook
Kesiki
Koetsu
Krell
Linn Products
Logic
Magneplanar
Magnum

Michell Engineering
Nakamichi
Oracle
Pink Triangle
QED Cables
Revox
Sony
Spendor
Sumiko
Supex
Talisman
Yamaha

SUBJECTIVE AUDIO LTD

Audio Consultants

2-4 Camden High Street
London NW1 0JH, England
Tel: (01) 387 8281

100pF. Higher capacitances increase the rolloff markedly, and few combinations of arm and pre-amp give as low a figure as this, so in practice some treble rolloff is almost inevitable. Listening tests confirmed the general high quality Nagaoka sound, but criticism was made of a rather 'scrappy' top and a somewhat 'sluggish' sound.

TEST RESULTS

Type, mass.....	moving magnet 7.8g
Output Level (1kHz, 5cm/s).....	3.16mV
Channel balance.....	0.03dB
Channel separation (L/R).....	29.2, 29.8dB
Tracking ability (L/R).....	.80, 80µm
Frequency response limits 1kHz-15kHz.....	+0, -3dB
Frequency response limits 1kHz-20kHz.....	+0, -3dB
Test tracking weight, loading.....	1.8g, 100pF
LF resonance frequency, 12.5g arm (vert, lat).....	.9, 7Hz
Estimated compliance (vert, lat).....	.15, 24cu
Recommended arm effective mass.....	.6-1.2g
LF resonance rise, 12.5g arm (vert, lat).....	.11, 10dB
Typical selling price.....	£40

Ortofon OM30

Top of Ortofon's OM series, covered in more detail elsewhere, the £50 '30 has a 'fine line' stylus with very low tip mass, and continues the neat trick of offering optional mass alternatives of 2.5g or 5g by means of a ballast weight. Though many tonearms will find counterbalancing 2.5g quite awkward in practice, the compliance of this cartridge is so high that perseverance in operating the arm with its effective mass minimised (*ie* the counterweight as close to the bearings as practical) should be worthwhile. Even so, the theoretically ideal maximum arm effective mass for this model is down around 5g! In other respects performance on spot measurements was exemplary.

Frequency response was reasonably even and quite consistent between samples, showing a treble region mildly elevated by 1-2dB. Subjective reaction was rather less positive, and the sound was described a reasonable

TEST RESULTS

Type, mass.....	moving magnet 5*g
Output Level (1kHz, 5cm/s).....	3.97mV
Channel balance.....	0.1dB
Channel separation (L/R).....	29.5, 30dB
Tracking ability (L/R).....	.80, 80µm
Frequency response limits 1kHz-15kHz.....	+1.5, -0dB
Frequency response limits 1kHz-20kHz.....	+2.5, -0dB
Test tracking weight, loading.....	1.25g, 400pF
LF resonance frequency, 12.5g arm (vert, lat).....	.75, 5Hz
Estimated compliance (vert, lat).....	.24, 60cu
Recommended arm effective mass.....	.3-1.0g
LF resonance rise, 12.5g arm (vert, lat).....	13.5, 12.5dB
Typical selling price.....	£50

*includes optional (fitted) 2.5g ballast

but undramatic, lacking convincing integration and having a 'shimmery' top end. Though impressive in a number of ways, one must question the real-world practicality of such a high compliance design.

Ortofon VMS5E II

This is the low price model in the famous VMS series of magnetic cartridges, costing a modest £12 yet still specified with an elliptical tip. Sensible compliance values and tracking weight ensure good matching to a wide range of arm masses, 8-18g, while maintaining good tracking performance, while exemplary and consistent results were also obtained for spot measurements on separation and channel balance.

Frequency response showed good consistency between stylus assembly samples, and was generally pretty flat, though one channel was rolled off by 1-2dB in the treble. Sound quality has some 'swing' and 'pace', but was also regarded as rather 'untidy', though this is a fair enough result for the price. Clearly a competent enough model, it is perhaps insufficiently distinguished for Best Buy rating, but clearly merits recommendation as good value for money.

TEST RESULTS

Type, mass.....	moving magnet 5g
Output Level (1kHz, 5cm/s).....	.5mV
Channel balance.....	0.16dB
Channel separation (L/R).....	.30, 29.9dB
Tracking ability (L/R).....	.79, 79µm
Frequency response limits 1kHz-15kHz.....	+1, -2.5dB
Frequency response limits 1kHz-20kHz.....	+1, -3.5dB
Test tracking weight, loading.....	.2g, 400pF
LF resonance frequency, 12.5g arm (vert, lat).....	10, 11.5Hz
Estimated compliance (vert, lat).....	.16, 13cu
Recommended arm effective mass.....	.6-18g
LF resonance rise, 12.5g arm (vert, lat).....	11.5, 10.5dB
Typical selling price.....	£12

Ortofon VMS20E II

One of the most popular cartridges ever, the £30 VMS20 sits firmly in the middle of Ortofon's conventional moving magnet range. Stylus tip is an unspecified elliptical, tracking at a low 1g with a high compliance. The latter was confirmed by recording the lowest LF resonant frequencies amongst the VMS series, indicating that arm effective masses should lie in the range 5-10g. Good tracking is an inevitable by-product of this compliance, but so probably are the rather average separation figures.

SUMMARY REVIEWS

Frequency response was generally smooth, quite even and consistent, with a mild tendency to treble brightness (+1/2dB) on one channel, and dimness at very high frequencies on the other channel, a possibly unfortunate conjugation. Sound quality was a touch disappointing, described as quite delicate but unexciting and 'laid back', rather more 'tinkly' and less stable than the '10. Though competent in many respects, the '20 is rather too compliant for the majority of conventional tonearms currently available.

TEST RESULTS

Type, mass.....	moving magnet 5g
Output Level (1kHz, 5cm/s).....	4.3mV
Channel balance.....	0.1dB
Channel separation (L,R).....	28.2, 29.2dB
Tracking ability (L,R).....	80, 80µm
Frequency response limits 1kHz-15kHz.....	+2, -0dB
Frequency response limits 1kHz-20kHz.....	+2.5, -0dB
Test tracking weight, loading.....	1g, 400pF
LF resonance frequency, 12.5g arm (vert, lat).....	7.5, 6Hz
Estimated compliance (vert, lat).....	35, 40cu
Recommended arm effective mass.....	3.10g
LF resonance rise, 12.5g arm (vert, lat).....	13, 11dB
Typical selling price.....	£30

Pickering Red Hot Needle

Part of the same V-15 series as the *Super Red* and *NP/AC*, the *Red Hot Needle* has an elliptical stylus which should have ample contact area for its highish tracking weight range (2g, ±1g). The (optional) 'dustamatic' brush forms a part of the £13 package. Compliance measurement gave two similar and one substantially different result for our three samples, so taking the majority opinion, arm masses in the range 6-16g would appear suitable. Output level was healthy though again showed some variation, but channel balance was comfortingly close, tracking ability fine on spot measurements, and separation consistent, symmetrical, and fair enough considering the price.

Frequency response is subdued in the lower treble, peaking 2-3dB at 15kHz and then drop-

TEST RESULTS

Type, mass.....	moving magnet 5.7g
Output Level (1kHz, 5cm/s).....	4.11mV
Channel balance.....	0.27dB
Channel separation (L,R).....	27, 25.8dB
Tracking ability (L,R).....	80, 80µm
Frequency response limits 1kHz-15kHz.....	+3, -1dB
Frequency response limits 1kHz-20kHz.....	+3, -1dB
Test tracking weight, loading.....	2g, 275pF
LF resonance frequency, 12.5g arm (vert, lat).....	10.7, 0.71Hz
Estimated compliance (vert, lat).....	12, 16cu
Recommended arm effective mass.....	6-18g
LF resonance rise, 12.5g arm (vert, lat).....	12, 14dB
Typical selling price.....	£13

ping gently, which shows competent engineering but a rather high tip (moving) mass. The sound was considered 'punchy', but a bit 'one-note' in the bass, lacking in mid-bass warmth, and with quite reasonable treble control though little real detail. Frankly in hi-fi terms the *RHN* is hampered by its rugged cantilever.

Pickering XV-15 150DJ

This particular £13 variation on Pickering's *XV-15* series uses a low cost spherical stylus and rugged cantilever for Disco applications (back-cueing etc.), and is designed for 3g tracking. Compliance is quoted at a sensible 10cu, and this proved to be about the average for lateral and vertical figures, which showed a disturbingly large 1:2 ratio, the stiff vertical compliance was also strongly damped, which should benefit DJ applications. Spot measurements of channel balance, separation and tracking were all fine.

Frequency response showed the treble slightly bright in the lower regions (+1dB through to 12kHz), followed by severe rolloff beyond. This was confirmed subjectively by the description 'a real thumper', the observation of some 'shriek' but no real treble, and a general lack of subtlety and depth.

Pickering XV-15 350C

This £17 *XV-15* model is intended for the more robust manual turntables and good quality automatics, and uses a spherical stylus with a fairly stiff compliance specification, confirmed on measurement but revealing some mechanical asymmetry between vertical and lateral planes. Nevertheless the values are well chosen, with average internal damping, for a broad range of arm effective masses (8-18g). Spot measurements gave good results for tracking, channel balance and separation.

Frequency response of one sample was very

TEST RESULTS

Type, mass.....	moving magnet 6.4g
Output Level (1kHz, 5cm/s).....	4.13mV
Channel balance.....	0.2dB
Channel separation (L,R).....	30, 29.8dB
Tracking ability (L,R).....	80, 80µm
Frequency response limits 1kHz-15kHz.....	+0.5, -1dB
Frequency response limits 1kHz-20kHz.....	+0.5, -2.5dB
Test tracking weight, loading.....	2g, 275pF
LF resonance frequency, 12.5g arm (vert, lat).....	12.5, 10Hz
Estimated compliance (vert, lat).....	10, 14cu
Recommended arm effective mass.....	8-16g
LF resonance rise, 12.5g arm (vert, lat).....	11, 12dB
Typical selling price.....	£17

good, whereas the other showed a slightly depressed treble, though neither could be considered poor. Sound quality was quite liked, with reasonable detail and a solid sound, possessing some bass differentiation (and some murkiness), a slightly recessed mid and exposed lower treble, with rolled-off extreme treble. In all, this is a workmanlike cartridge, properly engineered for its intended application, and worth considering for general purpose use where the finer nuances are not required.

Pickering XV-15 625DJ

This 'DJ' version of that stalwart of the XV-15 series, the '625, costs a similar £20 but omits the 'dustomatic' brush. Stylus is similar, though the tracking weight is higher.

Frequency response was smooth, even and balanced, slightly down in treble compared with the mean (-1dB). Sound quality was not at all bad, having a 'thumpy' bass, 'punchy', rather 'flat' and 'forward' mid projection, but was a touch aggressive, lacking treble refinement. Not quite up to the standard of the domestic equivalent, this is still a pretty decent cartridge.

Pickering XV-15 757S

Near the top of the XV-15 series, this £30 model features a Stereohedron stylus and greater than average compliance at a lowish 1.25g tracking weight. Spot measurements for separation and tracking ability were both fine, one sample showing a mild channel imbalance.

Treble frequency response was also impressive, being well matched between samples and just a touch (1dB) brighter than the mean up to 15kHz, rolling off gently thereafter. Sound quality was less highly rated, due mainly to criticism of lower treble forwardness, with 'glare' and 'fierceness', though there was praise for good control and reasonable detail.

TEST RESULTS

Type, mass.....	moving magnet	6.4g
Output Level (1kHz, 5cm/s).....		3.4mV
Channel balance.....		0.4dB
Channel separation (L,R).....		30, 30dB
Tracking ability (L,R).....		80, 80µm
Frequency response limits 1kHz-15kHz.....	+ 1.5, - 0dB	
Frequency response limits 1kHz-20kHz.....	+ 1.5, - 0dB	
Test tracking weight, loading.....	1.25g, 275pF	
LF resonance frequency, 12.5g arm (vert, lat).....	9, 9Hz	
Estimated compliance (vert, lat).....	17, 17cu	
Recommended arm effective mass.....	5-15g	
LF resonance rise, 12.5g arm (vert, lat).....	14.5, 13.5dB	
Typical selling price.....		£30

Pickering TLE

The cheapest of the Pickerings to offer P-mounting as an alternative to conventional 1/2in. centre fixing, the unit with adaptor costs £15, and is fitted with an elliptical stylus. With the adaptor fitted for normal arm fixing, there was a noticeable lack of rigidity about the assembly. Compliance proved to be sensibly chosen for normal arm working and consistent between samples, suitable for matching arm masses from 6-16g, though perhaps a little too stiff for the shortest low mass P-mount arms when the bracket is not required. Spot measurements were fine for tracking ability, but one sample misbehaved a little on separation and two on channel balance.

Frequency response fairly consistently showed a slightly recessed lower treble, then a gentle rise to +2/3dB at a 15-18kHz resonance. Sound quality was not particularly distinguished, with criticism of a 'soggy bottom', slight 'splash' — a touch bright and coarse — though the midrange was praised as well balanced. The subjective results were not really encouraging enough to single this model out, though to be fair the bass complaint seems to have been pretty universal towards all P-mount-adaptable models.

TEST RESULTS

Type, mass.....	moving magnet	5.9g
Output Level (1kHz, 5cm/s).....		2.54mV
Channel balance.....		0.7dB
Channel separation (L,R).....		28.6, 26.8dB
Tracking ability (L,R).....		80, 80µm
Frequency response limits 1kHz-15kHz.....	+ 3, - 1dB	
Frequency response limits 1kHz-20kHz.....	+ 3, - 1dB	
Test tracking weight, loading.....	1.25g, 275pF	
LF resonance frequency, 12.5g arm (vert, lat).....	10.6, 9Hz	
Estimated compliance (vert, lat).....	13, 18cu	
Recommended arm effective mass.....	6-16g	
LF resonance rise, 12.5g arm (vert, lat).....	13.6, 15.6dB	
Typical selling price.....		£15

Pickering TLE-2

This £25 model is very similar in appearance to the TLE, and shows similar lack of body rigidity. Compliance and LF damping measured identically. Spot measurements showed similarly good tracking abilities but rather poorer than average stereo separation. Even the frequency response characteristics were more or less identical, with mild lower treble suckout and 15-18kHz peak, so it was little surprise to find similar subjective comments of a touch of treble 'edge' and brightness. If there is an improvement over the TLE, we find ourselves hard pushed to unearth it!

SUMMARY REVIEWS

Pickering TL-3S

The S-series of P-mount Pickerings are clearly more rigid than the Es, this £45 model being designed for light tracking weight with a Stereohedron stylus. Compliance gave much the same sensible value as all the Pickerings, so again a wide 6-16g arm effective mass range is suitable. Spot measurements gave quite adequate tracking, but rather below average separation and channel balance results.

Frequency response was very impressive, with good matching and flat response to 15kHz, with steady rolloff thereafter. The sound quality did not raise much enthusiasm, and was described as rather 'lifeless', with softened bass, and a little 'spitty' compared to the 2S. Probably compromised more by the P-mount facility than any other consideration.

TEST RESULTS

Type, mass.....	moving magnet 5.9g
Output Level (1kHz, 5cm/s).....	3.85mV
Channel balance.....	1.0dB
Channel separation (L,R).....	29, 23 dB
Tracking ability (L,R).....	80, 80µm
Frequency response limits 1kHz-15kHz.....	+1, -0dB
Frequency response limits 1kHz-20kHz.....	+1, -6dB
Test tracking weight, loading.....	1.25g, 275µF
LF resonance frequency, 12.5g arm (vert, lat).....	11, 10Hz
Estimated compliance (vert, lat).....	12.5, 13cu
Recommended arm effective mass.....	8-18g
LF resonance rise, 12.5g arm (vert, lat).....	12, 15.5dB
Typical selling price.....	£45

Pickering TL-4S

Top of the TL-S series of P-mount adaptable cartridges, the £60 4S shows much the same sensible compliance as the other Pickerings, suitable for 6-16g effective mass arms. Spot measurements again confirmed good tracking abilities, with average channel balance and reasonable stereo separation.

Frequency response was almost identical to the 3S, with marginally better control of the 15kHz 'corner'. Sound quality again suffered the P-mount criticism of being soft and sub-

TEST RESULTS

Type, mass.....	moving magnet 5.9g
Output Level (1kHz, 5cm/s).....	3.77mV
Channel balance.....	0.45dB
Channel separation (L,R).....	26.4, 26.4dB
Tracking ability (L,R).....	77, 80µm
Frequency response limits 1kHz-15kHz.....	+1, -0.5dB
Frequency response limits 1kHz-20kHz.....	+1, -4dB
Test tracking weight, loading.....	1.25g, 275µF
LF resonance frequency, 12.5g arm (vert, lat).....	11, 9.5Hz
Estimated compliance (vert, lat).....	12.5, 17cu
Recommended arm effective mass.....	6-15g
LF resonance rise, 12.5g arm (vert, lat).....	12.5, 14.5dB
Typical selling price.....	£60

dued, though in other respects the cartridge was very competent, and certainly free of obvious flaws. For the serious P-mounter (if any such exist!), the 4S represents an interesting proposition, but the lack of low frequency authority diminishes its appeal in a 'universal' context.

Pickering XSP-4004P

Similarly to the fully-reviewed 3003P, this £90 P-mounted-adaptable model with 'dustomatic' brush shows interesting minor specification changes, including improved tracking ability and wider bandwidth, yet higher inductance and resistance with lower output. Slightly more compliant than most Pickerings, 13g would appear to be the maximum ideal arm mass, though correspondingly the match with low mass P-arms will be enhanced. Channel balance and tracking spot measurements were fine, though separation was only average.

Frequency response showed great consistency and a gentle, smoothly rising treble characteristic, +1.5dB at 15kHz, +3dB at 18kHz, and +4dB at 20kHz. Sound quality was not preferred to the 3003P, as the bass sounded more ponderous, and the HF rise gave a slight 'edge' to the sound. The midrange was considered nicely open and dynamic.

Pickering XLZ-3500S

This is the cheapest of the three conventional-mounting low-output moving magnet models in the extensive Pickering range. It features the 'dustomatic' brush and an elliptical stylus, tracks at a light 1.25g, and needs a moving-coil input or headamp. Compliance was a little higher than most Pickerings, and showed some variation in lateral and vertical planes, uncharacteristic of Pickerings as a whole; best results are probably to be had in tonearms of around 10g effective mass. Channel balance and tracking ability were fine, separation being

TEST RESULTS

Type, mass.....	low output moving magnet 5.1g
Output Level (1kHz, 5cm/s).....	0.2mV
Channel balance.....	0.2dB
Channel separation (L,R).....	28.6, 28.1dB
Tracking ability (L,R).....	80, 80µm
Frequency response limits 1kHz-15kHz.....	+1.5, -0dB
Frequency response limits 1kHz-20kHz.....	+1.5, -0dB
Test tracking weight, loading.....	1.25g, n.a.
LF resonance frequency, 12.5g arm (vert, lat).....	7.5, 10.5Hz
Estimated compliance (vert, lat).....	26, 13cu
Recommended arm effective mass.....	5-12g
LF resonance rise, 12.5g arm (vert, lat).....	14.5, 11dB
Typical selling price.....	£55

slightly poorer in one sample than the other.

Frequency response was smooth, even and quite consistent, just a touch on the bright side of neutral through the mid treble region. High frequencies were considered balanced and well integrated with reasonable detail, but some criticism was made of mid compression and bass 'sluggishness'.

Pickering XLZ-7500S

Top of the low-output models, having low internal inductance and requiring moving-coil type input facilities, the '7500S has a Stereo-hedron stylus. Compliance was towards the higher end of Pickering's sensible range, suggesting suitable arm effective masses in the range 5-15g. Tracking was fine, but channel balance and separation measurements were a little below average.

Frequency response showed close treble balance and a mild +2dB shelf from 12-20kHz, which is a little surprising considering the flatter response of the P-mount equivalent. Additioning confirmed many good qualities in this design, but the sound was 'softened'.

TEST RESULTS

Type, mass.....	low output moving magnet 5g
Output Level (1kHz, 5cm/s).....	0.25mV
Channel balance.....	0.5dB
Channel separation (L,R).....	30, 22.3dB
Tracking ability (L,R).....	80, 80µm
Frequency response limits 1kHz-15kHz.....	+2.5, -0dB
Frequency response limits 1kHz-20kHz.....	+2.5, -0dB
Test tracking weight, loading.....	1.25g, n.a. pF
LF resonance frequency, 12.5g arm (vert, lat).....	9, 8Hz
Estimated compliance (vert, lat).....	19, 19cu
Recommended arm effective mass.....	5-14g
LF resonance rise, 12.5g arm (vert, lat).....	12, 13dB
Typical selling price.....	£100

Pickering TLZ-7500S

Very much the pick of Pickering's P-mounts.

Frequency response showed an even trend, a fraction up to 10kHz followed by a gentle downtilt at 15-18kHz. Sound quality was relaxed, 'sparkly' and spacious.

TEST RESULTS

Type, mass.....	low output moving magnet 6.6g
Output Level (1kHz, 5cm/s).....	0.19mV
Channel balance.....	0.2dB
Channel separation (L,R).....	26, 30dB
Tracking ability (L,R).....	80, 80µm
Frequency response limits 1kHz-15kHz.....	+1, -1dB
Frequency response limits 1kHz-20kHz.....	+1, -2.5dB
Test tracking weight, loading.....	1.25g, n.a.
LF resonance frequency, 12.5g arm (vert, lat).....	9, 9Hz
Estimated compliance (vert, lat).....	17, 17cu
Recommended arm effective mass.....	5-15g
LF resonance rise, 12.5g arm (vert, lat).....	15.5, 13.5dB
Typical selling price.....	£115

Shure M99E

Sister cartridge to the 'bubble pack' 92E model which is fully reviewed, the £23 99E is another of those which are adaptable for P-mount operation, with some consequent increase in mass and loss of mechanical rigidity. Compliance is on the high side, particularly laterally, so care should be taken to use low effective mass arms (5-10g preferred), though the comparatively strong low frequency damping will help to minimise any mismatch. Channel balance and separation spot measurements were both rather disappointing.

Frequency response was quite consistent in showing a gentle 2dB suckout in the mid treble, with resonance indicated around 20kHz. The sound was considered quite clean and controlled, slightly muted at HF but with some sibilant emphasis, nice midrange projection, and quite 'crisp' low frequencies. In all this is a competent but not particularly exciting model.

TEST RESULTS

Type, mass.....	moving magnet 7.4g
Output Level (1kHz, 5cm/s).....	5.2mV
Channel balance.....	0.7dB
Channel separation (L,R).....	24.2, 18.8dB
Tracking ability (L,R).....	80, 80µm
Frequency response limits 1kHz-15kHz.....	+0, -3dB
Frequency response limits 1kHz-20kHz.....	+0, -3dB
Test tracking weight, loading.....	1.25g, 250pF
LF resonance frequency, 12.5g arm (vert, lat).....	9, 6Hz
Estimated compliance (vert, lat).....	15, 35cu
Recommended arm effective mass.....	5-10g
LF resonance rise, 12.5g arm (vert, lat).....	9, 9dB
Typical selling price.....	£23

Shure M105E

This £55 P-mount-adaptable model features Shure's brush/damper/stylus guard assembly, has an elliptical stylus and tracks at 1.25g. Quite high compliance figures indicate low mass arms (6-12g), but the damper effectively negates the vertical resonance while damping the horizontal one, so arm matching becomes less essential, though an extended LF bandwidth is perhaps better avoided. Tracking ability, separation and channel balance were all good.

Frequency response showed quite good consistency with a gently downtilted treble starting around 10kHz, reaching -3dB at 15-18kHz. Higher input capacitance seemed to assist in maintaining treble output. Sound quality was not all that well received, with a soft and slightly 'spitty' sound lacking deep bass and dynamic contrast, but with stability and generally good control. The 105E can be

SPEAKERS OF AUTHORITY.

LD 20.

"This fine value system must clearly be strongly recommended."

HI FI NEWS & RECORD REVIEW. November 1983.

"This speaker ebbs & flows with the music, conveying dynamics as musicians use the term, the structure of a piece of music preserved."

HI FI ANSWERS. November 1983.



LD 30 II.

"Strongly characterised range of tonal colours and free expansive sounding bass performance."

HI FI ANSWERS. May 1984.

"Bass was exceptionally tight & well controlled without coloration."

"...better, more spacious acoustic than the other speakers in the group."

WHAT HI FI. February 1984.



LD 50.

"This model is obviously another strong contender and carries my firm recommendation."

HI FI NEWS & RECORD REVIEW. November 1983.

"This performance package is unusual in £200 speakers and almost unheard of at the asking price of the LD 50."

HI FI ANSWERS. April 1983.



To Marantz Audio (UK) Ltd, 15/16 Saxon Way Industrial Estate, Moor Lane, Harmondsworth, Middlesex, UB7 0IW. Tel: 01-897 6633. Please send me details of Marantz Speakers LD20, LD30 II, LD50 and other hi-fi equipment and my nearest Marantz Dealer's address.

Name _____

Address _____

HFC 1

marantz®

bolted into virtually any system, where it will perform unobtrusively and innocuously, with a balance that will suit many component combinations admirably.

TEST RESULTS

Type, mass.....	moving magnet 7.4g
Output Level (1kHz, 5cm/s).....	4.35mV
Channel balance.....	2.25dB
Channel separation (L,R).....	29.5, 28.5dB
Tracking ability (L,R).....	80, 80µm
Frequency response limits 1kHz-15kHz.....	+ 0, - 5dB
Frequency response limits 1kHz-20kHz.....	+ 0, - 5dB
Test tracking weight, loading.....	1.25g, 250pF
LF resonance frequency, 12.5g arm (vert, lat).....	0 (8.5°), 7Hz
Estimated compliance (vert, lat).....	22, 33cc
Recommended arm effective mass.....	5-12g
LF resonance rise, 12.5g arm (vert, lat).....	0 (10°), 9.7dB
Typical selling price.....	£55

**no resonance with damper*

Shure M110HE

This £67 P-adaptable model partners the 111HE, omitting the damper mechanism but incorporating Shure's Hyperelliptic stylus shape. Less damping than cheaper Shure models indicates that the highish compliance is best matched by a low mass arm, 5-12g effective mass being a sensible target. Spot measurements showed separation, tracking ability and channel balance were all good.

Frequency response showed a smooth well matched trend but at a generally depressed treble level, down some 2-4dB from 12-20kHz. Sound quality was considered eminently presentable but somewhat unexciting, with smooth, clear high frequencies but some 'boom' and loss of definition in the bass. This is another Shure design which 'plays it safe', giving decent performance in most areas, but hampered, we suspect, by the constraints introduced by P-mount adaptability.

TEST RESULTS

Type, mass.....	moving magnet 7.4g
Output Level (1kHz, 5cm/s).....	4.5mV
Channel balance.....	0.1dB
Channel separation (L,R).....	30, 30dB
Tracking ability (L,R).....	80, 76µm
Frequency response limits 1kHz-15kHz.....	+ 0, - 4dB
Frequency response limits 1kHz-20kHz.....	+ 0, - 4dB
Test tracking weight, loading.....	1.25g, 250pF
LF resonance frequency, 12.5g arm (vert, lat).....	8, 6Hz
Estimated compliance (vert, lat).....	20, 35cc
Recommended arm effective mass.....	5-10g
LF resonance rise, 12.5g arm (vert, lat).....	11, 13dB
Typical selling price.....	£67

Shure M111HE

Similar in most respects to the 110HE, this £85 P-adaptable cartridge incorporates the 'dynamic stabiliser' as well as the Hyperellip-

tical tip. Compliance is clearly high, though its effect upon arm/cartridge stability is minimised by the stabiliser. The M111HE, in our view, does not really deliver good enough sound quality to justify the highish price.

Shure ML120HE

This expensive model is the first of the modern Shures to abandon the notion of P-mount compatibility, and makes a worthwhile weight saving as a result. Despite comments regarding internal structural rigidity, neither mounting bracket nor stylus assembly give any particular confidence in this respect. The stabiliser is more neatly designed than those fitted to cheaper models, and the HE suffix naturally refers to a (nude) Hyperelliptic tip. Compliance is sensibly modest, so even without the stabiliser a wide range of arms (6-16g) can be accommodated, and the stabiliser should ensure no arm-matching problems whatever. Spot measurements showed reasonable channel balance, separation and tracking ability, though perhaps not quite up to the expectations of the price level.

Frequency response was commendably even though a touch bright on one channel in the treble, with some evidence of a mild (1dB) peak at around 10kHz. The sound of this model was quite well liked, being described as quite clear, detailed and dynamic, but a little uncertain at low frequencies and with slightly exposed treble detail. Quite decent sound and generally fine, balanced performance.

TEST RESULTS

Type, mass.....	moving magnet 4.5g
Output Level (1kHz, 5cm/s).....	3.15mV
Channel balance.....	0.25dB
Channel separation (L,R).....	26.3, 30dB
Tracking ability (L,R).....	74, 73µm
Frequency response limits 1kHz-15kHz.....	+ 1.5, - 0dB
Frequency response limits 1kHz-20kHz.....	+ 1.5, - 0dB
Test tracking weight, loading.....	1g, 250pF
LF resonance frequency, 12.5g arm (vert, lat).....	11*, 9.5Hz
Estimated compliance (vert, lat).....	12, 16cc
Recommended arm effective mass.....	6-18g
LF resonance rise, 12.5g arm (vert, lat).....	0, 10 (10, 11.5)±dB
Typical selling price.....	£120

**resonance removed by stabiliser
†resonance rises without stabiliser*

Shure ME75EJ

The 75EJ was one of the most famous cartridges of its day, its 1.5-3g tracking weight making it the natural partner to many budget turntable systems. Compliance was very sensible for this role, and still is, matching

8-18g arms with little difficulty. Spot measurements were reasonable enough considering the price, with excellent channel balance, but a little poorer than the cheaper '70B.

In response terms, treble was notable in its absence, -2dB at 5kHz, and continuing down to -5dB at 15kHz. Surprisingly, and probably inexplicably, the treble loss was not on this occasion reflected in the subjective results, though high frequencies were qualitatively described as 'flattened', uninteresting, and without 'sparkle'. Bass was well extended with some 'thump', and midrange sounded slightly constrained with little depth. Considering its usefully wide compatibility and sensible tracking weight, and despite the unpromising response, this is quite an interesting model at a realistic price, though not a first choice for sound quality.

TEST RESULTS

Type, mass.....	moving magnet	6.4g
Output Level (1kHz, 5cm/s).....		6.35mV
Channel balance.....		0.3dB
Channel separation (L,R).....		21, 30dB
Tracking ability (L,R).....		80, 80µm
Frequency response limits 1kHz-15kHz.....	+ 0, -	5.5dB
Frequency response limits 1kHz-20kHz.....	+ 0, -	6.5dB
Test tracking weight, loading.....	2g, 250pF	
LF resonance frequency, 12.5g arm (vert, lat).....		8, 5Hz
Estimated compliance (vert, lat).....		22, 55cu
Recommended arm effective mass.....		5-10g
LF resonance rise, 12.5g arm (vert, lat).....		12, 13dB
Typical selling price.....		£17

Shure ME95ED

The 95ED is a light-tracking elliptical-tipped model with quite high compliance, showing some asymmetry in lateral and vertical LF resonance behaviour. Matching tonearms are best restricted to the rather narrow 5-10g effective mass range. Spot measurements showed good tracking abilities and reasonable separation and channel balance figures.

Frequency response was evenly and consistently well maintained to 15kHz, falling

TEST RESULTS

Type, mass.....	moving magnet	6g
Output Level (1kHz, 5cm/s).....		3.85mV
Channel balance.....		0.7dB
Channel separation (L,R).....		25.7, 30dB
Tracking ability (L,R).....		80, 80µm
Frequency response limits 1kHz-15kHz.....	+ 0.5, -	1dB
Frequency response limits 1kHz-20kHz.....	+ 0.5, -	3.5dB
Test tracking weight, loading.....	1.25g, 250pF	
LF resonance frequency, 12.5g arm (vert, lat).....		9, 6Hz
Estimated compliance (vert, lat).....		18, 40cu
Recommended arm effective mass.....		5-10g
LF resonance rise, 12.5g arm (vert, lat).....		11, 14dB
Typical selling price.....		£25

fairly rapidly thereafter. The subjective assessment confirmed the improved treble energy and detail, while commenting on mild obtrusiveness nonetheless. Bass was described as soft but with reasonable detail, and the mid showed some flattening of depth and dynamics.

Shure ME97HE

Though substantially more expensive than the other Encore cartridges, the £40 '97 is quite good value with its nude Hyperelliptic tip and dynamic stabiliser, and was once, not so long ago, accorded Best Buy rating in these pages. Compliance is sensibly stiff, and the stabiliser negates much of the effects of LF resonance, so virtually any arm may be used with impunity, with particular suitability to those in the 10-20g range. Spot measurements were fine for tracking ability and channel balance, but separation was rather disappointing.

Frequency response showed a smooth and quite well-balanced gently falling treble, some 2dB down at 15kHz, with increased rolloff thereafter. Sound quality was considered pretty decent, nicely balanced with a slight dissociated 'tizz' and some bass 'softening', but retaining reasonable discrimination and with pleasant, slightly compressed, midrange. On the basis of good subjective balance and overall performance, plus almost universal applicability, the 97HE remains a recommended model.

TEST RESULTS

Type, mass.....	moving magnet	6.6g
Output Level (1kHz, 5cm/s).....		2.5mV
Channel balance.....		0.3dB
Channel separation (L,R).....		21.2, 27.3dB
Tracking ability (L,R).....		79, 80µm
Frequency response limits 1kHz-15kHz.....	+ 0, -	3dB
Frequency response limits 1kHz-20kHz.....	+ 0, -	4.5dB
Test tracking weight, loading.....	1.25g, 250pF	
LF resonance frequency, 12.5g arm (vert, lat).....		12, 12Hz
Estimated compliance (vert, lat).....		11, 11cu
Recommended arm effective mass.....		8-20g
LF resonance rise, 12.5g arm (vert, lat).....		0*, 8dB
Typical selling price.....		£40

*effect of optional included damper

Supex SD901

This silver-bodied version of the 900 has been established for very many years and was one of the earliest high output moving-coils. A recent price rise has unfortunately taken it to £175. It is a heavy model, but the stiff compliance,

which has little damping and is impressively symmetrical, suits it to rigid tonearms in the wide effective mass range 9-25g. At a fairly high tracking weight, tracking abilities look fine (though practical past experience suggests a decent arm is needed here), with channel balance and separation likewise.

Frequency response was impressively smooth and even, rising slightly at high frequencies rather more on the right than left channel. Sound quality was a little too 'heavy' and 'thumpy' in the bass, but with fine stereo, detail and integration through the slightly 'laid back' midrange. Dynamics were reasonable and treble detail and control quite good. The term high output is only relative, so the 901 needs pretty good amplifier gain (or an m-c input) as well as decent arm quality. Given such requirements, and assuming the ultimate in tracking ability is not a priority, it is capable of a fine sound for the price and deserves recommendation.

TEST RESULTS

Type, mass.....	high output moving-coil 9.5g
Output Level (1kHz, 5cm/s).....	0.65mV
Channel balance.....	0.5dB
Channel separation (L,R).....	28.3, 30dB
Tracking ability (L,R).....	80, 74µm
Frequency response limits 1kHz-15kHz.....	+2, -0dB
Frequency response limits 1kHz-20kHz.....	+4.5, -0dB
Test tracking weight, loading.....	2.2g, n.a.
LF resonance frequency, 12.5g arm (vert, lat).....	11, 11Hz
Estimated compliance (vert, lat).....	9, 9cu
Recommended arm effective mass.....	9-18g
LF resonance rise, 12.5g arm (vert, lat).....	14, 15dB
Typical selling price.....	£140

Talisman Alchemist IIIS

This latest Talisman model carries a pretty hefty £350 price-tag, and uses 'focused field' magnetic techniques to provide a high output from a similar generator mechanism to the original S. Tracking at a sensible 2g, it uses a sapphire cantilever and line contact stylus. Compliance proved to be on the high side, indicating preference for low mass arms and suitability to a 5-15g range of effective masses. Spot measurements indicated good tracking abilities and channel balance, but separation was a little down on one channel from our expectations at this price level.

Frequency response showed dramatically rising high frequencies, +2dB at 10kHz, +4dB at 15kHz, and +8dB at 20kHz. The 'brightness' and 'toppiness' resulting from this imbalance clearly dominated the subjective results, and served to emphasise the cartridge's effective-

ness in portraying treble detail and clarity. Bass lacked 'muscle' and 'weight', sounding a little soft, but midrange was very clear and detailed with quite good dynamics. Overall this very sweet sounding cartridge has some notable strengths, but too anomalous a balance to justify recommendation.

TEST RESULTS

Type, mass.....	high output moving-coil 6.7g
Output Level (1kHz, 5cm/s).....	2.0mV
Channel balance.....	0.1dB
Channel separation (L,R).....	26.9, 30dB
Tracking ability (L,R).....	80, 80µm
Frequency response limits 1kHz-15kHz.....	+4, -0dB
Frequency response limits 1kHz-20kHz.....	+8, -0dB
Test tracking weight, loading.....	2g, n.a.
LF resonance frequency, 12.5g arm (vert, lat).....	7.5, 9Hz
Estimated compliance (vert, lat).....	23, 18cu
Recommended arm effective mass.....	5-12g
LF resonance rise, 12.5g arm (vert, lat).....	12, 14dB
Typical selling price.....	£330

Yamaha MC1S

This £99 low output moving-coil model was recommended (at £70) in the last edition, and has almost done well enough to retain that status here, though its days are apparently now numbered by the advancing tide of technological change (not to mention lower prices on the latest models). Reasonable well-damped symmetrical compliance ratings indicate good compatibility with a wide range of arms, preferably in the 5-15g effective mass range. Spot measurements gave good results for tracking ability and separation, while channel balance was reasonable.

Frequency response was impressively flat, consistent and smooth through the lower treble, starting to rise at 15-18kHz to an out-of-band peak. The sound was described as smooth, commendably clean and uncoloured though a trifle compressed in space and dynamics. Scoring more on neutrality than character or 'soul', the '1S is a thoroughly competently engineered, decent-sounding moving-coil design.

TEST RESULTS

Type, mass.....	low output moving-coil 7.5g
Output Level (1kHz, 5cm/s).....	0.17mV
Channel balance.....	0.6dB
Channel separation (L,R).....	30, 29.8dB
Tracking ability (L,R).....	80, 80µm
Frequency response limits 1kHz-15kHz.....	+1.5, -0dB
Frequency response limits 1kHz-20kHz.....	+3, -0dB
Test tracking weight, loading.....	1.8g, n.a.
LF resonance frequency, 12.5g arm (vert, lat).....	9, 9Hz
Estimated compliance (vert, lat).....	16, 16cu
Recommended arm effective mass.....	5-15g
LF resonance rise, 12.5g arm (vert, lat).....	10, 10dB
Typical selling price.....	£99

CONCLUSIONS: CARTRIDGES

With the test programme complete, it is time to look back on the testing and the listening, to see what patterns emerged and whether any useful generalisations can be made; to try and get some perspectives on the whole project and on cartridges in general.

Two points in particular deserve ramming home forcefully, and decorating with a few choice anecdotes. The first is simply that the cartridge is the servant of the arm, and the arm the servant of the turntable.

And the second is that simple mechanical rigidity, subjectively determined by inspection, is as good an indicator to cartridge sound quality as anything else, and rather better than many of the more elaborate tests. It is of course simplistic to assume that inspection can do any more than establish whether the cartridge can be firmly fixed to the arm and that the stylus assembly, if detachable, is unlikely to rattle.

There is no way of examining the internal mechanical integrity directly without dismantling the cartridge, so one can only look for clues like 'glitches' in the measures response or inconsistencies in the separation. Our findings indicate that there is as much room for internal improvement as there is in the area of headshell fixing.

In their quest for widespread compatibility, many models have compromised rigidity severely. The obvious example of this is the T4P compatible cartridges, where the brackets are clearly inadequate for conventional headshell fixing. One can only deduce that the desire to offer retailers a single inventory of products adaptable for either format has taken precedence over engineering considerations in this respect.

One can similarly deduce that the (quite good) Ortofon OM models would work better if the ballast mass was no longer regarded as an optional end in itself, but rather was at least partly incorporated to improve the structural integrity of the body.

The LF resonance and component matching

The simplistic matching of arm effective masses to cartridge mass and compliance so that the LF resonance is around 10-12Hz is very worthwhile, but only scratches the surface of the problem.

Such a recommendation is only really valid if one assumes adequate arm rigidity and bearing quality. During the project we conducted a listening test with a high quality arm but with a maladjusted (rattly) bearing. Immediately the tracking ability, focus, and image stability

became severely compromised, more or less directly in proportion to the stiffness of the cartridge compliance.

Used in a good enough arm, low compliance models generally seem to offer better sound quality than high compliance types, but such capabilities can be squandered all too easily by unwisely chosen ancillaries.

High mass advantages

One sideline observation is that high mass cartridges of good mechanical integrity can help to 'smooth out' the inadequacies of the tonearm. The Audionote was the prime example of course, but the Koetsu *Black* and Supex models added corroborating evidence. Incidentally, this provides at least half an explanation for the fascination Japanese audiophiles have for heavy headshells. Their proclivity for swapping cartridges keeps them loyal to the old SME/JEI detachable headshell format, which still shows rigidity problems even in the best form of execution, so the heavy headshell tries to compensate. (Flatter, better-pressed discs probably make the attendant warp-riding problems somewhat less acute.)

Turntable questions

Turntable compatibility is really less straightforward still. It is very difficult to obtain any data on the subsonic misbehaviour and inadequacies of turntables, though there is some indication that this plays an important role. (The very fact that the sound of a system can be substantially affected by the state of set-up of the turntable indicates that the turntable must influence the output of the cartridge by some mechanism.) There is also some evidence, admittedly rather tenuous, that the less heavily damped cartridges have the potential to sound better than heavily damped models. But it is also probably true to say that the more heavily damped models are likely to perform more consistently under a wide range of operating conditions, and with indifferent turntables in particular.

Styli

Styli play an important role in the perception and pricing of cartridges. Whether they play such a significant role in the sound produced

CONCLUSIONS: CARTRIDGES

must remain something of a moot point. Certainly the characteristics of a stylus can be reflected in the end results of the sound — one cannot disguise the mild treble rolloff which a spherical tip experiences towards the end of side due to the geometry of the groove — but there is little evidence from our work that extending and narrowing the contact area beyond a properly swept ellipse significantly improves the sound.

In fact those with the greatest ratio between the two dimensions of groove contact did have a tendency to sound a little 'toppy', though perhaps this is merely evidence that their alignment is ultra-critical. Indeed one or two of the most refined tips showed an irritating tendency to clog with dust and groove debris rather easily, which is certainly a point to bear in mind for those who are less than scrupulous about record cleaning.

Extended contact

One could question whether extended line contact styli might not be an opportunity for an increase in tracking weight, to the general benefit of stability. Tracking weights were reduced with the introduction of elliptical styli in order that the smaller contact area would not increase the pressure on the groove walls. Now that the area has effectively been increased by extending the contact length up the side of the groove wall, it would appear that the vinyl loading has been reduced, which is not necessarily a good thing if effective contact is to be maintained.

Frequency response

It is fairly clear that the test disc was reliable from 100Hz to at least 10kHz and probably to 20kHz, though there was clearly some regularly repeated unevenness below 100Hz. The great majority of cartridges showed a downtilted midrange region, though as far as we can gather from extensive listening tests this does not seem to have been a particular disadvantage subjectively.

It is probably true that departures from the best straight line which can be drawn through the trace are at least as audible, if not more audible than the overall trend. And it is also true that a mild high frequency peak need not sound worse than a 'flattened' peak which may involve significantly worse phase characteristics. Ortofon do actually make this point in their copious literature on the *MC2000*, so we were a little surprised not to find a mild high

frequency rise with this cartridge under our test conditions.

Separation

A usefully sensitive indicator of mechanical integrity, good separation figures across the audio band frequently correlate with good sound quality. But the corollary is not necessarily true, witness the figures for the good sounding Garrott Decca and Dynavector *Karat 17D2*.

We also examined the output on the alternate channel at frequencies above the 20kHz bandwidth of the test disc for some of the cartridges, notably wide-bandwidth moving-coil models. The better sounding models often showed low levels of these ultrasonic spurious, 20dB or better below an already good level or separation.

Amplifier matching

Correctly matching the amplifier input by means of the capacitance loading of moving magnet cartridges to give the flattest response does sometimes produce a worthwhile subjective improvement, but this is not always the case. One is after all only tuning the amplitude response by manipulation of the phase response, and it is not necessary to reiterate the previous comments upon the unpredictable annoyance factors of different treble peaks.

Low-output cartridges have no agreed standard, and are little affected by loading changes in any case. Some of the lowest output models will almost certainly need a transformer, whose introduction subjectively seemed to enhance the midrange at the expense of the bass in particular, and the treble detail and bandwidth to a degree (the latter not necessarily an unpleasant by-product, and in some instances quite the reverse).

Provided there was sufficient output (down to -30dB ref 1mV/cm/s is about the practical limit for most pre-amps), a properly designed moving-coil input stage seemed to give best results, with 50-500ohm loading. We attempted to examine theories that very low input impedances were desirable to damp the cartridge, but, speaking subjectively again, these seemed more inclined to slug the poor thing into submission, more severely even than a transformer. However, there may still be much to learn about the interaction of cartridge and pre-amplifier, and it would be rash to pretend to have all the answers.

DEALER GUIDE

HI-FI CONSULTANTS

Demonstrations any time, by appointment
Telephone 0625 582704



4 West Street, Alderley Edge, Cheshire

HI FI
CHOICE
RECOMMENDED

**ANDREW
THOMSON**

**THE SPECIALISTS
IN HI FI
HI FI? SO SORRY
SIMPLY BETTER.**

6-8 BONNAR ST, DUNFERMLINE, FIFE.
TEL 0383 724541 EST 1930

Hi-Fi Components Ltd.

84 BATTERSEA RISE
LONDON SW11
01-223 1110



*For all your Hi-Fi needs at
discount prices.
Access & Barclaycard welcome.*

TURNTABLES, ARMS, CARTRIDGES, STYLI

We specialise in the Great Classics

ADC; AKG; CONNOISSUER; GARRARD; GOLDRING;
LENCO; PICKERING; ORTOFON; SHURE; SME;
THORNES.

All available, Genuine, Equipment, Spares, & Manuals
even for some very early models.

Servicing, Repairs, and Refurbishing in our own
workshops.

Specialist Styli for early recordings — 78s & LP

TECHNICAL & GENERAL
35 Marlow Road, London SE20 7XX
Tel: 01-778 3737



- AR ■ A & R Cambridge
- Ariston ■ Aiwa ■ B & O
- B & W ■ Castle ■ Celestion
- Dual ■ Hitachi ■ JVC
- Monitor Audio ■ Mordaunt-Short
- Phillips CD ■ Pioneer
- Quad ■ Revox ■ Rotel
- Sony ■ Spondor ■ Technics
- Thorens

54 Chapel Street, Chorley,
Lancashire. Tel: (02572) 71935

Image Hi-Fi

**Stockists of most of
the World's leading
Hi-Fi Products**

Single Speaker Demos
By Appointment

Service with a 

8 St Annes Road

(off A660 Otley Road)

Headingley, Leeds LS6 3NX
Telephone: (0532) 789374

SELECTIVE AUDIO



**OTLEY
W. YORKS**
Tel: 0943-467689

(BY APPOINTMENT)
ACCESS/AMERICAN EXPRESS WELCOME



HiFi in Leicester and the Midlands

By appointment, please

Audition HiFi (0533) 393607

147 HINCKLEY ROAD, LEICESTER FOREST EAST, LEICESTER LE3 3PG.

DEALER GUIDE

the hi-fi centre
of WILMSLOW. . .

For Real Quality Listen to:
QUAD ESL63-14405 PLUS COMPACT DISC FROM PHILIPS, SONY, TECHNICS, MARANTZ, I.V.C.

ALSO CHOOSE FROM BANG & OLUFSEN, REVOX, J.B.L., A.R. HARMAN, KARDON, TEAC, TRIO, BOSE, CELESTION, MORDAUNT SHORT, NORDMENDE, TANNOY, etc.

● PART EXCHANGE ● HOME DEMONSTRATIONS ● FULL REPAIR FACILITIES IN OUR OWN WORKSHOPS ● EVENING DEMONSTRATIONS BY APPOINTMENT.

GREEN LANE, WILMSLOW, CHESHIRE
(0625) Wilmslow 524766

ACCESS. BARCLAYCARD. DINERS CLUB. AMERICAN EXPRESS

● CLOSED WEDNESDAY EXCEPT BY APPOINTMENT

D.F. CLARKE AUDIO
Hi-Fi Specialists

Nytech, Thorens, ARC, Goldring, RATA, Logic, Quad, Mordaunt-Short, QED, Dual, Kingsbrook, Glanz, Ortofon, Hadcock, Grace, Supex, Audio Technica, Nagaoka, Grado, Walker, Castle, Target

Plus Accessories & Audiophile Discs
Home or Studio Demonstrations by appointment

36 Lodge Road, Rushden, Northants
Tel: (09334) 57349

CHICHESTER HIGH FIDELITY



APPOINTED STOCKISTS OF
A&R CAMBRIDGE, CASTLE, CELESTION, CREEK AUDIO, GOLDRING, K.F.F., LINN, MORDAUNT SHORT, NAIM, NAKAMICHI, QUAD, REGA, ROGERS, S.M.E., TANDBERG

40 LITTLE LONDON, CHICHESTER, W. SUSSEX
TELEPHONE 0243 776402
(Closed all day Monday)

John Chapman
Hi-Fi Ltd

Linn Products, Meridian, Naim Audio, Nytech Audio, Nantua, Mantra, Amadeus, Rega Research, Akroyd, Grace and Supex.

Contact John Chapman
By appointment please.
0202 570307

3 Plassey Crescent, Bournemouth, Dorset.

GLASGOW
PRISM AUDIO
Hi-Fi Consultants & Dealers
for
Concordant, J.P.W., Logic, Monro, I.A.S., Questar, Sota, Syrinx, Rock and many more.

14 West Princes St, Glasgow G4
Tel: 041 332 1779

BEST-BUY **RECOMMENDED**

We have the best in cartridges:
LINN BASIK ● LINNTRAK ● LINN KARMA ● ORTOFON MC10 SUPER ● A.T. 110E ● A.T. 115E

Also stockists of:
LINN ● NAIM ● A & R ● MISSION ● NYTECH ● QUAD ● MORDAUNT-SHORT ● HEYBROOK

ERRICK'S OF BRADFORD
RAWSON SQUARE, BRADFORD BD1
Tel: (0274) 309266

GERRY & GILL THORPE TELEVISION HI-FI VIDEO

For the largest choice of hi-fi in Cornwall.
Systems — Midis — Minis — Separates — compact disc players — accessories etc.
Full repair facilities in our own workshop

4/6 Fore Street, St. Austell
TEL: 75400

Also at GT Sound & Vision,
25 Trinity Street, St. Austell.

MIDLAND HI-FI STUDIO

ROYAL LONDON BUILDING, WULFRUNA STREET
WOLVERHAMPTON. (0902) 771774
STAFFORD STUDIO

8 LICHFIELD RD, STAFFORDSHIRE. (0785) 51234
Stockists of:
ORTOFON ● GRADO ● PICKERING ● NAGAOKA
We stock the cartridges recommended by Hi-Fi Choice

CONCLUSIONS: CARTRIDGES

Moving magnets or coils

It may well be true that there is no real inherent difference between these two *modus operandi*, though the facts of the matter remain that as a breed the moving-coils generally do tend to sound better.

On the other hand they also tend to be more expensive, better engineered, and oriented towards sound quality rather than universal compatibility, any or all of which are equally cogent reasons for superior end results.

One inescapable difference is that moving magnet models use more wire than high output m-cs, which in turn use more wire than low output m-cs. Empirical subjective evidence indicates the shorter the wire the better the sound, and there is some evidence that length of wire (or to be more precise the number of inter-crystal boundaries in high purity copper wire) can affect sound quality through any conductor. The recent development of LC (long crystal) wire seems to improve the 'transparency' of wire by a factor of 100. This should assist all cartridge types, but will particularly

reduce the handicap that moving magnet models face in this respect. The only such model in the book was the *AT160ML*, which had a distinct and pleasant sonic character compared to other moving magnet types, though hampered by one or two other considerations.

Last word

Though one can be sternly critical of certain aspects of modern cartridges, many do a very adequate job at quite realistic prices, and there has been a notable trend towards improved sound quality at constant or reducing prices for a number of years, as has also been the case with turntables and tonearms.

It is also obvious that there is still plenty of room for future improvement along the same road, which is heartening for those with large collections of LP discs, not to mention a predilection for the wonderful diversity of its catalogue. None of which is any comfort for those who seek to replace the medium with the Compact Disc.

How can a Linn Sondek outperform a Linn Sondek?



Some would argue that a Linn Sondek is the best turntable in the world. Some, on the other hand, would not even bother to argue. But there is one thing that they would all have to agree on. There is only one Linn Sondek. So how can it out-perform itself?

The answer can be found by the side of this copy.

The Sound Organisation turntable table at just £49.50 is one of the best ways to upgrade the sound of any system.

Don't take our word for it, after all we're the manufacturers.

Just read the independent reviews that appear month after month after month. Come and listen for yourself or send £49.50 to the address below and we'll send you one, post free, with a money back guarantee that it will do what we say it will. Delivery within 7 days. Or 'phone us for your nearest dealer.

THE SOUND ORGANISATION

You can't go wrong. We wouldn't let you.

1 Cathedral Street, London SE1 (near London Bridge) Tel: 01-403 3088 or 01-403 2255

BEST BUYS AND RECOMMENDATIONS

Here the author sums up the strong points of those cartridge models which have been selected as Recommended or Best Buys, and those which in our view deserve a particularly honourable mention and could be well worth considering.

This inviolable tradition of *Hi-Fi Choice* puts the author firmly on the spot, so he is entitled to take a paragraph or two to wriggle off it.

Invariably, there is an element of personal choice in this selection. With the best will in the world, one tries to appreciate the alternative preferences and points of view, but when it comes to formal recommendation one is inclined to be cautious, particularly about the expensive models that may work excellently in some circumstances but be hard to justify in others.

The bias is inevitably towards the low cost models, because they work, and often work as well as the player to which they are fitted allows them. (Indeed a minor worry for this reviewer is that so few models gave problems with tracking ability, which may have been because of the high quality turntables and arms used in the tests.)

More expensive models have to demonstrate their superiority to these cheapies, and frequently only do so in select aspects of performance. The recommended models are at least partly chosen with eye to their compatibility with likely partnering equipment, and for the good overall balance which they achieve for their position in the marketplace.

Low cost magnetics

Below £30, magnets are still wiggled within coils of wire, and output is sufficient for any amplifier's conventional phono inputs.

Working alphabetically through the Best Buys, the **ADC Phase I** (£12) is nicely balanced and unpretentious, capable of working well in budget players and providing a slightly 'dim' sound balance which will often be a positive advantage.

The £18 **A&R C77** shows fine mechanical integrity and generally good compatibility. It has a very clean and well integrated bass and midrange, with a touch of 'sparkle'.

The £25 **B&O MMC4** may have suffered a little in the cause of universality, but made up for this with outstanding engineering and an exceptionally well balanced sound, lacking a little in bass 'power'.

The £12 **Linn Basik** is the other side of the coin, sounding notably 'energetic', integrated and informative. On the other hand, there is no denying that it does perhaps tend to allow its

enthusiasm to run away with itself at high frequencies.

At only £10, the **NAD 9100** goes even further in some respects, compromising tracking ability somewhat and suiting heavyish arms, and providing a fairly aggressive sound.

The £15 **Nagaoka MP10** was highly rated for its integrated clean sound, with a 'dim' balance that could be usefully exploited in a cheap system. Mechanical performance and compatibility is good, though low capacitance loading from arm and pre-amp is to be preferred.

At £12, the **Ortofon OM10** is a very safe choice from the point of view of arm and system compatibility, and performs very competently in every respect. It is perhaps a little less exciting sounding than some of the competition.

Recommended models in this class include the **Audio Technica AT110E** (£13), which is a well balanced model favouring lower mass arms, with a fairly restrained treble output compared to the not dissimilar Linn Basik.

The **Goldring Epic** (£16) showed splendid bass power and bass/mid integration, but treble was perhaps a little too restrained and the body plastic could do with some reinforcement. (*Now improved, we're told — Ed.*)

The £20 **Pickering XV-15 625E** is a long term recommendation that remains competitive at its new low price. It offers good compatibility and mechanical performance with an attractively detailed 'bright' balance.

The **RATA RP20** (£21) is a refinement of the Goldring *Epic* with improved treble output that was subjectively appreciated. Definitely one of the best-sounding budget models, there are similar mild reservations regarding the body plastic.

The £12 **Shure 92E** sounded fairly well despite the P-mount bracket, and T4P compatibility could be a plus for some users. Measurements were reasonable, though tracking abilities are not great.

Medium price, high output models

Increasing the price level to £50 starts to bring some high output moving-coil models into the picture, though the majority of recommended models are still moving magnet types. There are no Best Buys as such here, though a number of models rate Recommendation (and

BEST BUYS AND RECOMMENDATIONS

others unmentioned are worth considering).

The £33 **A&R E77** and £44 **P77** both offer improvements over the fine **C77** in terms of treble resolution and delicacy. All three models share the same body, so one's purchase can be upgraded at a later stage.

The **Grado M3** (£43) showed a significant improvement over the **T**, and goes on sounding better as its ancillaries are improved. The sound is a trifle 'lightweight', and construction could be improved.

The £30 **Ortofon OM20** showed a significant improvement in balance and subtlety over the **OM10**, almost sufficient to rate as a Best Buy. It offers similarly wide compatibility while responding to the more refined turntable.

The £40 **Pickering XV-15 1800S** gave a very pleasing subjective balance, with fine mid and treble delicacy in a usefully compatible package.

The well-balanced **Shure M97HE**, now at £40, remains a recommended model.

Low cost, low output models

Not exactly low cost in the moving magnet sense of the word, 'under £50' is cheap by moving-coil standards, and two models have distinguished themselves as obvious Best Buys, offering unusual refinement for such modest prices, though naturally requiring a suitable moving-coil amplification stage.

The £40 **Ortofon MC10 Super** avoids the very low output of its predecessor and gave a very well balanced performance with fine dynamic midrange, if a trifle untidy at the frequency extremes and with one or two other quirks.

The £35 **Yamaha MC11** is similarly well balanced, and is perhaps a slightly 'safer' choice than the Ortofon, though it was inclined to sound a little over-damped in the bass and treble and less transparent in the midrange.

High priced high output models

Restricting ourselves to recommendations only above £50, there are quite a number of high output models, both moving magnet and moving-coil, which managed to deliver the goods technically and sonically without compatibility compromises.

The £93 **B&O MMC1** suffers slightly but inevitably from its universal mounting bracket, but was an engineering *tour de force* in other respects, giving outstanding separation and response for a relatively modest price. Not perhaps the first choice for a rock fan, it is very refined and gives low mass arms a fairly easy

time.

The £75 **Dynavector 10X4** is a high output moving-coil which gave perhaps the best overall balance for this marque, with fine midrange focus, good general stability, and versatile compatibility, if a trifle limited in tracking abilities.

The **Garrott Decca**, £290 complete with GB clamp, is utterly, uniquely idiosyncratic, and for those who can capitalise on its strengths, quite wonderful in its own way. Not for the fainthearted, it requires some emotional commitment on the part of the user.

The **Grace F9E** has recently gone up to £160, which is a pity, but still merits recommendation for a fine combination of wide bandwidth dynamics and good tracking abilities, while also being fairly easy on its partnering tonearm.

The £150 **Shure ML140HE** also offers the advantages of a refined moving magnet design in a good sounding and almost universally compatible package, notably neutral and with good tracking abilities.

The long-established **Supex 901** (£170) still sounds superb, if a bit 'bright', with fine stereo and dynamics, wide compatibility, but slightly restricted tracking abilities. Nominally high output, it needs a fairly sensitive/noise-free pre-amp.

High priced low output models

Covering a range of prices from £50 up to nearly £1000 and a much great diversity than the previous categories, recommendation is the order of the day, with the advice that system optimisation plays an increasingly important role, and that only high quality tonearms should be used.

The £160 **Audio Technica AT33ML** is the most exciting-sounding model from their new MicroLine series, with fine dynamics and focus, if a trifle 'untidy'. Output is very healthy and mechanical compatibility pretty straightforward.

The £60 **Denon 103** would have merited Best Buy status but for its spherical stylus, and still sounds better integrated than its derivatives with more advanced styli. Tracking is not a forte, but groove stability is exceptional at the high tracking weight, and the sound is lively and dynamic, with plenty of output and versatile compatibility.

The £450 **Koetsu Black** is our most expensive recommendation, giving a satisfying combination of dynamics and sophistication,

BEST BUYS AND RECOMMENDATIONS

with excellent stable stereo. Certainly requiring first class ancillaries, it nevertheless managed to sound consistently good in a variety of circumstances.

The £110 **Linn Trak** looks something of a steal, until you add the cost of an arm capable of handling its mechanical exuberance! Though demanding in this respect, and a little limited in tracking abilities, its performance can approach the best on most material.

At £200, the **Linn Asak** is slightly more *svelte* and better controlled than the *Trak*, though very similar in many other respects.

The **Linn Karma** (£340) is capable of quite remarkable wideband integration and dynamics. Though notably consistent, performance may again be constrained by the quality of the arm.

The £90 **Logic Gold** gave fine moving-coil dynamics and a powerful sound for its reasonable price, though it is a trifle 'bright' and 'brash'; better suited to lower mass arms.

At £150, the **Mission 773HC** is a smooth performer technically and soundwise. Generally 'tamer' than most moving-coils, it should offer fairly predictable performance with a wide range of ancillaries, though tracking abilities were unexceptional.

The £200 **Supex 900** continues to offer great refinement in a package which becomes increasingly attractive as arm quality improves. Soundfield integration and stereo performance are more impressive than tracking ability.

Honourable mentions: £230 moving-coils

For some reason, presumably coincidental, we encountered a gaggle of fascinating m-c designs at this price, all of which rate honourable mention, but all of which were a trifle idiosyncratic in one way or another (see reviews).

Alphabetically then, the **Audio Technica AT36ML** was smooth and tantalising, with very low output. The **Dynavector Karat 17D2** had a wonderful midrange but seemed less predictable elsewhere. The **Elac EMC-1** was notably clear and uncoloured, but 'bright' in balance. The **Highphonic MCA-3** had fine tracking abilities in particular, just about everything else in abundance, but ultimately lacked 'weight'. The **Logic Black** largely redeemed its aggressive tendencies with a second 'well run in', sample, and now looks impressively well-balanced. The **Talisman S** is delightfully uncoloured and easy on the ear despite its over-bright balance.

Any of the above represent valid alternatives

to the recommended models in the right system context.

Honourable mentions: The 'high end'

It may be difficult to justify the really expensive cartridges in conventional value for money terms. Moreover, such cartridges tended to be more extravagantly idiosyncratic than cheaper models, often sounding superlative in some particular respect, but perhaps less balanced overall (see reviews).

The £800 **Audionote IO2** sounded rich and incredibly clean through the bass and lower mid, but was somewhat idiosyncratic in other respects. The **Koetsu Red** enhanced the midrange and treble control and spaciousness of the *Black*. The **Ortofon MC2000** definitely requires a transformer but is almost universally compatible mechanically, sonically neutral but tending to 'spotlight' the upper mid.

Worth considering by the enthusiast for whom price is a secondary consideration, with these sort of cartridge swings and roundabouts abound; total system enhancement is the only real criterion for final choice.

Previous winners

One or two cartridges which did very well in the last edition (*Hi-Fi Choice* No 28) have somehow slipped through the net and were not retested for this new edition. This year, no Glanz cartridges were received in time for our deadline, but it should be noted that the **Glanz MFG31E** was a recommended model last time round, and was praised for its neutral tonal balance.

A high-output moving-coil of Dutch manufacture, the **Tenorel TMC10** was achieved a Best Buy rating last time for its combination of neutral balance and good detail at a price of only £40, though some treble hardness was noted. In some ways this low-cost m-c design can be seen as a precursor of the current crop.

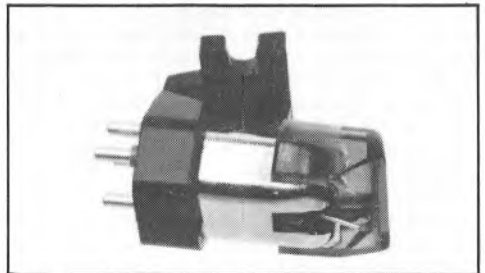

Goldring G920IGC — one of the many models worth looking up in the 'Summary Reviews' section

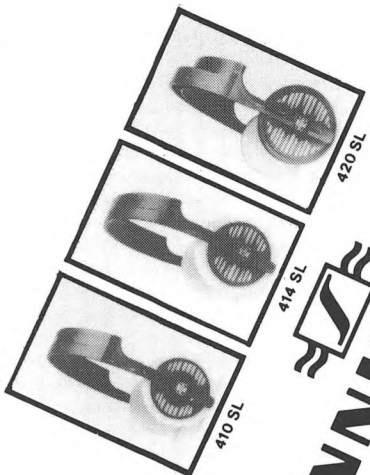
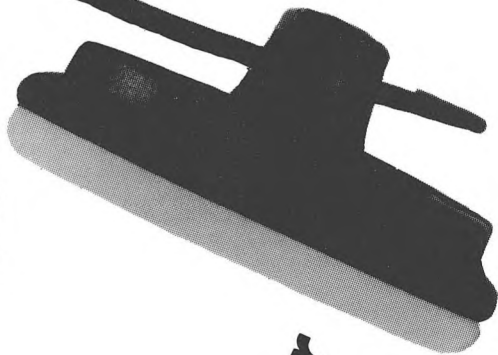
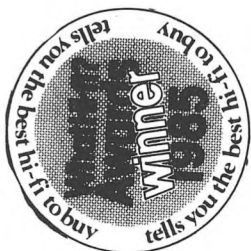

SENNHEISER **The best gets better**

The SL series. Three new headphones from Sennheiser, updating their classic designs with the latest technology. Ask your local dealer for a demonstration or write to us for your free Sennheiser colour catalogue.

Hayden Laboratories Limited,
FREEPOST. (NO stamp required),
Hayden House, Chiltern Hill,
Chalfont St Peter, Bucks. SL9 9BS.

HEADPHONES: INTRODUCTION

This review section covers a selection of headphones from leading manufacturers, and does not attempt to be exhaustive. It assesses suitability for use with both hi-fi and portable players.

Headphones occupy a strange position in the hi-fi market. Not quite a component in their own right, they are rather more than a simple accessory, and many users, for a variety of reasons, prefer them to loudspeakers. However, it's true to say that they do not attract the same fanatical interest as other specialist hi-fi components, and for this reason we have confined ourselves to fairly superficial subjective reviews, concentrating upon the more popularly-priced models from a handful of the better regarded specialist ranges. (Most of the big consumer electronics manufacturers include headphones to complete their ranges, but these products are rarely taken all that seriously, often having merely been bought in from an OEM manufacturer and 'badge engineered'.)

Koss claim to have developed the 'Stereophone' concept during the immediate post-war years, but headsets themselves of course go back to the early days of radio. Early 'phones, particularly those emanating from the US and later Japan, tended to be closed-back types designed to exclude sounds from outside, and incidentally prevent sounds from escaping.

But in Europe open-back designs were appearing, which had certain inherent advantages, in terms of sound quality, compactness and light weight. These have thrived to an extent that closed-back models are the exception rather than the rule, the old 'heavyweights' now only used where their isolation properties are valued (*eg* recording studios).

When Sony introduced the *Walkman* portable cassette players, where portability is paramount, open-back was the obvious route. Selling in their millions, each accompanied by a pair of compact 'phones, this fresh product concept has given the headphone a new lease of life, and has resulted in some most ingenious engineering.

Some of the models included here are specifically for portables, and are assessed with this in mind. Adaptors for converting between 3.5mm and ¼ inch jacks are freely available, though these models do need attenuation if used with an amplifier (usually provided at the headphone socket).

Besides the open/closed back option, another fundamental difference between

models lies in whether they sit on, in, or around the outer parts of the ear. Jargon distinguishes *supra-aural* (pressing against the side of the ear) from *circum-aural* (enclosing the ear and pressing against the side of the head). *Intra-aural* is an obvious name for the tiny little ones that actually sneak into the ear.

Headphone listening

Headphone listening remains a somewhat solitary occupation, despite the option of powering two or more sets simultaneously. It is also mildly claustrophobic (particularly with the old closed-back models), and disorienting (because in reality soundfields stay still, and do not move with one's head).

But effectively eliminating the acoustic of the listening environment provides much more intimate contact with the recording environment; not to mention offering as much dynamic range as the listener wants, without causing more than mild annoyance to others.

The headphone substitutes for the real audio world one of its own devising, which is both a strength and weakness. Anyone who doubts the uncanny nature of this illusion should try listening to binaurally recorded material (this has been recorded using a 'dummy head', with just two microphones placed at ear positions). More real than any stereo, the listener can shut his eyes and find himself in a completely alien environment, remarkably coherent in all directions, so that a voice from behind can cause an involuntary glance over the shoulder (where-upon the voice stays determinedly behind the head rather than the body, of course, which is where the disorientation bit comes it).

Conventional recordings are normally balanced for loudspeaker replay (though *Walkman*-balanced recordings are known to be available in Japan). When headphones are substituted, the sound is driven directly into the ear from the side and without any room reverberation, resulting in a 'thinner', 'toppier' balance, with stereo images created inside rather than in front of the head. This in turn tends to emphasise surface noise, tape hiss and high frequency distortions.

Headphones can help to narrow the gap between the music and the brain, but they have one other limitation which keeps them firmly at the level of illusion. They are low acoustic power devices that only operate at the ears,

HEADPHONE REVIEWS

whereas a concert, be it rock or classical, has the added visceral impact of whole body energy, which loudspeakers (generally rather unsatisfactorily) at least try to recreate.

The headphone experience can never replicate the chest-cavity upper-bass resonances which one may encounter at a rock concert. Consequently there is a slight risk that the listener will seek to compensate by raising volume levels above the level at which hearing damage can occur, and manufacturers are careful to warn against this abuse.

The reviews

The reviews combine a few simple facts on the different models with various subjective observations regarding comfort, sound quality, and loudness capability, from which an attempt to assess value for money (related to the published price) is made. Though these value judgements are based on combining the assessments of several persons, comfort in particular, and sound quality to a lesser extent, are down to individual taste. Hopefully our comments will act as a guide, but you wouldn't expect someone to choose you a hat or pair of shoes for comfort, so you ought not to rely entirely on someone else's judgement for a pair of headphones.

Bang & Olufsen Form 1

This beautiful new model upholds B&O's remarkable record for inspired yet consistent design. Ultra-modern in their familiar house style, ingenious swivelling earpieces and sprung headband make them effectively self-adjusting, while still exerting ample side pressure. Unlike the earlier *U70*, which was an isodynamic design, *FORM 1* uses two moving-coil drivers.

The head-fitting arrangements seemed pretty effective, with the load distributed between outer ear and temple. However, the pressure on the ear was quite noticeable, and the optimum location not too easy to determine, while both lateral adjustment and extra pressure could change the sound significantly. The extending cord had a fairly strong tug which could be a trifle uncomfortable.

TEST RESULTS

Type.....	open, supra-aural, moving-coil
Mass.....	150g
Size rating.....	medium
Length of cord.....	extendable, 2.75m max
Comfort rating.....	fair
Sound quality rating.....	fair
Loudness rating.....	good
Price.....	£40

Sound quality showed very good control throughout, but with a somewhat limited bandwidth and 'shut-in' sound. The bass seemed significantly curtailed, resulting in a rather 'light' balance, emphasising somewhat the same inherent characteristic of headphone listening. Coloration was low and stereo imaging good.

While one cannot fail to be impressed by the physical aspects of this design, they were not the most comfortable 'phones. Sound quality was also reasonably good but unexceptional, as is value for money.

Beyer DT320

This lightweight circum-aural design costs a modest £24, and proved quite comfortable in a slightly 'plastic' way. They were easy to locate correctly on the head, and gave a consistent sound, showing little change with increased soundpad pressure.

Sound quality was dominated by 'cuppy' mid colorations, and the limited bandwidth contributed to a slightly 'shut in' feel. Though lacking extension, treble was under pretty good control, but bass seemed a little ill-defined and coloured. Though good loudness was possible, this was at the expense of increased bass distortion.

Not a bad headphone, and comfortable to wear, the sound was unexceptional in its class.

TEST RESULTS

Type.....	semi-open, circum-aural, dynamic
Mass.....	105g
Size rating.....	medium
Length of cord.....	3m
Comfort rating.....	good
Sound quality rating.....	fair
Loudness rating.....	fair
Price.....	£24

Beyer DT220

This £40-odd circum-aural model is an example of a true closed-back type, offering slightly better isolation in both directions than the other models in this report. However, that would seem to be the only real virtue, because in other respects it falls significantly short of its competition. Though rugged-looking, it is heavy, very 'plastic', with ill-fitting pads and a tight uncomfortable headband.

The sound suffered the closed-back syndrome of distinct midrange coloration, and was very 'shut-in' and mildly claustrophobic compared to open-back models. Though sensitive, the loudness capability was limited by the

increasingly unpleasant coloration as levels were increased.

While the closed-back '220 is not a bad example of the type, unless there is any overriding reason for choosing this kind of headphone, comparably priced open-back models sound distinctly better.

TEST RESULTS

Type.....	closed back, circum(?) aural, dynamic
Mass.....	250g
Size rating.....	large
Length of cord.....	min 1m, max 3m
Comfort rating.....	poor
Sound quality rating.....	poor
Loudness rating.....	fairly good
Price.....	£43

Beyer DT660 II

This £65 model is unusual in being a new closed-back model, though it offered little in terms of acoustic isolation either from inside or outside. The closed system incorporates a form of bass reflex loading for the driver.

Although constructed predominantly from light plastics, it still turned the scales at a heavyish 250g, while in fact scoring quite well on the comfort ratings. The 1.5m coil could be extended to 3m and did not 'tug' severely, the earpiece padding and headband were quite comfortable, and they stayed stably in a well-defined position. Additional side pressure had no effect upon the sound balance.

Rated highly on sound quality, the 660's dominant characteristic was a powerful but rather rich bass. But this was accompanied by fine mid and treble focus, detail and 'air', low in coloration and pleasantly free of fierceness. In all honesty the bass was something of a weak-spot qualitatively, with significant 'boomy' coloration, yet the power was fair recompense, sufficient to generate significant earpiece vibration when exploring the (good) loudness capabilities.

In some respects this headphone could be enjoyed simply because the tonal balance subjectively approximated loudspeaker listening more closely than most. While it lacked a little against our high-priced electrostatic reference, the gap was not enormous; the '660 deserves firm recommendation.

TEST RESULTS

Type.....	closed, circum-aural, dynamic reflex
Mass.....	250g
Size rating.....	large
Length of cord.....	min 1.5m, max 3m
Comfort rating.....	good
Sound quality rating.....	good
Loudness rating.....	very good
Price.....	£65

Beyer DT 880 Monitor

This brand new model is a refinement of the existing 880s, and uses a very light moving-coil driver with high power magnets in a slotted-back semi-open circum-aural plastics body. Using foam more in the manner of a cloth, the earpads were extremely comfortable, as was the headset as a whole despite its highish weight, with good stability and acoustic positioning, but some sonic variation with pad pressure.

The sound was extremely 'open' and 'spacious', with very low coloration and good bandwidth. The bass level as a whole was on the dry side, though reasonably uncoloured and fairly extended. Treble was very delicate and controlled, if perhaps just a touch on the bright side. Maximum sound level was limited by bass distortion.

Mildly 'laid back' in sound terms, the *Monitors* do a fair job of supporting Beyer's assertion that they provide almost electrostatic level of sound quality. They are extremely comfortable besides, so well merit recommendation despite the price, though head-bangers will prefer the '660.

TEST RESULTS

Type.....	semi-open, circum-aural, dynamic
Mass.....	195g
Size rating.....	large
Length of cord.....	min 1m, max 3m
Comfort rating.....	very good
Sound quality rating.....	very good
Loudness rating.....	fairly good
Price.....	£110

Beyer DT880 Studio

Predecessor to the *Monitor*, the *Studio* is still available at a slightly lower cost (as is the straight 880). Specification is very close, using the same basic components throughout apart from slightly less comfortable vinyl-type pads.

Sound quality was very similar, though somewhat less well-controlled and rather more 'forward' in the presence band (which some users may prefer).

A fair alternative to the *Monitor*, the *Studio* is nevertheless eclipsed by the new model.

TEST RESULTS

Type.....	semi-open, circum-aural, dynamic
Mass.....	195g
Size rating.....	large
Length of cord.....	min 1m, max 3m
Comfort rating.....	good
Sound quality rating.....	good
Loudness rating.....	good
Price.....	£89

HEADPHONE REVIEWS

Koss P/19

This £15 'mini' portable does not have the folding capability of the *KSP* but is no less compact. It is a supra-aural design which sits fairly firmly against the outer ear, so that one is certainly aware of its presence. It does not hold position all that securely, though the sound does not vary a great deal with movement.

Firm, bright and open are all appropriate adjectives to describe a decently portrayed but strictly limited sound balance. Real bass and treble are hardly to be expected at this price level, but qualitatively the midrange is pretty good. The upper mid/presence is 'untidy' with a 'jangly' sort of coloration, and this can become uncomfortable is played too loud.

Overall this is a reasonably balanced portable, typical of the breed, which sounds decent enough at its price.

TEST RESULTS

Type.....	open, supra-aural, dynamic, portable
Mass.....	45g
Size rating.....	small
Length of cord.....	2.15m
Comfort rating.....	average
Sound quality rating.....	fair
Loudness rating.....	below average
Price.....	£15

Koss K/20 Lightweight

Making a rather dramatic contrast to the similarly priced 'mini' *P/19*, the '20 is described as 'lightweight', and presses quite firmly on the whole of the outer ear. Limited padding makes them noticeable rather than uncomfortable, and they weigh very little.

The sound is even more of a contrast, with a 'fat' rather 'rich' and not particularly clean upper bass emphasis. The midrange is clear and quite open, sounding slightly 'laid back'. The treble is clear and detailed; but a little uneven and not particularly extended. It is thankfully free from the 'fierceness' that afflicted the cheaper Koss portables, and was capable of pretty high levels, the limiting factor being the gradual exaggeration of the bass distortion.

Slightly unbalanced with its bass-heavy

TEST RESULTS

Type.....	open, supra-aural, dynamic
Mass.....	75g
Size rating.....	small
Length of cord.....	2.50m
Comfort rating.....	fair
Sound quality rating.....	very fair
Loudness rating.....	good
Price.....	£16

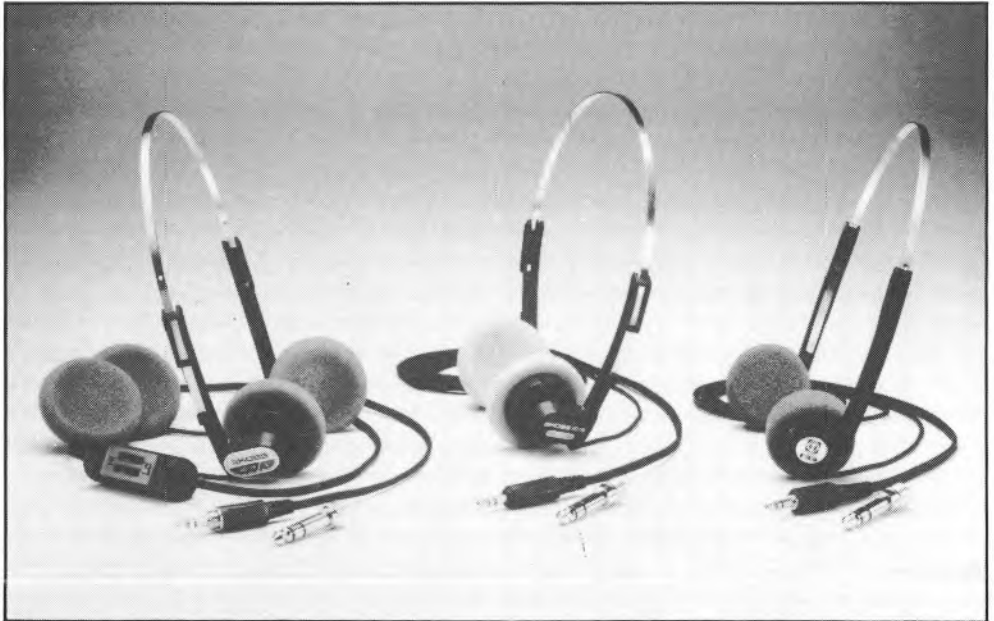

Three new 'mini' Koss models, *KC-24*, *KC-19* and *KC-10*, will supplement those reviewed here.

HEADPHONE REVIEWS

characteristic, the *K/20* is nevertheless pleasant to listen to, with good detail and openness, particularly at modest levels. It is also comfortable, stable, and doesn't cost much, so must obviously be recommended.

Koss Sound Partner (KSP)

This very light £20 portable headset folds and clips together to be small enough to fit in the palm of the hand, and comes supplied with a bijou carrying pouch. Light and comfortable to wear, the metal headband applied light pressure which is distributed between the temple and the outer ear. The sound varied somewhat with positioning and pressure.

Sound quality is attractively open and quite 'powerful', but dominated by a distinctly 'fierce' presence/lower treble, which is initially impressive, but ultimately fatiguing. Though undoubtedly providing good 'forward' clarity, better control and extension would have been preferred. The bass was quite clean, reasonably extended and sounded quite powerful, though power handling was a little limited.

Worth considering as a modestly priced well-equipped portable, the sound is quite impressive and exciting, but could ultimately prove somewhat fatiguing.

TEST RESULTS

Type.....	open-back, supra-aural, dynamic
Mass.....	50g
Size rating.....	small, folding
Length of cord.....	2.75m
Comfort rating.....	fairly good
Sound quality rating.....	fair
Loudness rating.....	fairly good
Price.....	£20

Koss Porta-Pro

This model is designed primarily as a de luxe headphone for portables, folding up for pouch or pocket yet cleverly providing pressure adjustment between the earpiece and temple pads. In terms of producing comfortable secure-fitting 'phones this was pretty successful, but the awkwardness of re-setting the headband when putting them on downrated the comfort somewhat. There was a fair change in bass coupling with pressure, so the sound balance could be tuned by the 'comfort setting' to some extent. A mute switch is provided on the (shortish) cord.

Sound quality was reasonably good, though somewhat heavy in the bass, tonally as well as in terms of balance. Elsewhere the sound was a little 'untidy', with some mid coloration and

treble unevenness, and ultimately somewhat limited treble extension, but quite good detail and focus. Loudness capabilities were very good, enlivened by the pulsing vibration of the little universally-jointed earpieces!

For those who have the patience for the headband, the *Porta-Pro* provides a pretty reasonable upgrade from the sort of headsets normally supplied with portables. Not for the faint-hearted, it can sound a trifle 'fierce' and will not hide the limitations inherent in many portables and pre-recorded cassettes.

Pickering OA7

At least offering an alternative presentation to the norm, the *OA7* has an attractive gilt finish with brown pads and band. Fairly firm in construction, it was similarly firm on the ears, but not unduly uncomfortable despite a fairly high weight. Positioning and side pressure were both fairly uncritical.

Sound quality was pretty decent, with a slightly 'shut in' sound, due to a mild loss of upper treble emphasising moderate mid coloration and lower treble 'brightness'. Bass was firm and detailed, without exaggeration, though somewhat lacking extension. Loudness capabilities were quite impressive, though not without some low frequency distortion.

Perhaps a trifle on the expensive side for the sound quality delivered, the *OA7* is still a decently balanced product with a distinctive appearance in its favour.

TEST RESULTS

Type.....	open, supra-aural, dynamic
Mass.....	150g
Size rating.....	medium
Length of cord.....	3.10m
Comfort rating.....	fair
Sound quality rating.....	fairly good
Loudness rating.....	good
Price.....	£55

Sennheiser HD40

Smallest, lightest and cheapest of the Sennheisers, the '40 should not be overlooked. It is effectively a portable design, as the pads rotate and the band can be distorted without fear of damage; though it has not been optimised for low voltage portable use, it will work pretty well nonetheless. The more skeletal construction makes it marginally less comfortable than the more expensive Sennheisers.

Sound quality is a most pleasant surprise, being limited in bandwidth but remarkably well-

HEADPHONE REVIEWS



Sennheiser's HD40, a long-standing 'Best Buy'

controlled therein, which is surely the ideal characteristic of low cost 'phones. As a result they sounded more 'open' than the 410 and better controlled than the 414, and both of these are good sounding models in their respective price categories. Clearly a Best Buy, the '40 delivers more than one has any right to expect for the price.

TEST RESULTS

Type.....	open-back, supra-aural, dynamic
Mass.....	60g
Size rating.....	small
Length of cord.....	3m
Comfort rating.....	fairly good
Sound quality rating.....	fairly good
Loudness rating.....	fair
Price.....	£13

Sennheiser HD410SL

This open-back, supra-aural headphone sits lightly, stably and comfortably on the ears, but shows significant change in sound with position, as well as bass enhancement with extra pressure.

Carefully placed, the sound is mid-range centred, with some 'shut in' coloration. Treble detail and extension are limited, but show good control of unwanted resonances. Bass is firm and fairly even, showing good power handling and loudness capability.

This is another well-balanced design from Sennheiser, which works well enough considering the low price, though the level of coloration might be unacceptable to some.

Sennheiser HD414SL

This latest, substantially revised version of one of the most popular headphones ever made costs a reasonable £25. It has Sennheiser's now traditional bright yellow foam ear pads, weighs a modest enough 100g, and sits lightly, precisely and predictably on the head and ears, despite the supra-aural mode of operation.

Sound quality has a very pleasant 'openness', with good apparent bandwidth despite a slight 'cupped hands' midrange coloration. Increasing earpad pressure did change the sound slightly, filling up the bass a little, but the sound was pretty consistent either way, and stayed together pretty well if asked to go loud. Though the bandwidth did sound a little limited, there were few tonal aberrations as the sound gently dropped away either side of the slightly prominent mid.

A fine sounding headphone at its price, the 414 in its latest guise continues to merit recommendation, both for comfort and for sound quality at the price.

TEST RESULTS

Type.....	open-back, supra-aural, dynamic
Mass.....	100g
Size rating.....	medium
Length of cord.....	3m
Comfort rating.....	very good
Sound quality rating.....	fairly good
Loudness rating.....	good
Price.....	£25

Sennheiser HD420SL

This £30 model comes from a different series to the 414, and offers a somewhat superior general standard of performance, with mildly different emphases. Comfort was considered slightly inferior, due to the harder earpads and mild weight increase, though the appearance was pleasantly less obtrusive. The sound changed little with extra ear pressure, but the 'phones needed to be carefully positioned on the ear for the best sound.

Sound quality was quite 'bassy', or more accurately 'upper-bassy', giving the impression of a 'big' sound, but also mildly distracting. Although the midrange coloration is significantly improved, and the presence and treble

TEST RESULTS

Type.....	open-back, supra-aural, dynamic
Mass.....	129g
Size rating.....	medium
Length of cord.....	3m
Comfort rating.....	good
Sound quality rating.....	good
Loudness rating.....	good
Price.....	£31

HEADPHONE REVIEWS

were reasonably well-controlled, overall integration seemed marginally less good than that of the 414.

The slightly 'rich' balance coupled with the traditional Sennheiser 'openess' makes the 420 a better headphone than the 414, and it comes at only a marginally higher price, so it is an obvious Best Buy.

Sennheiser HD230

This model, in distinct contrast to the other Sennheisers, is a closed-back circum-aural type, and uses two drive units to cover the frequency range. It is quite heavy, felt 'bulky' when on, and was not regarded as particularly comfortable, certainly compared with Sennheiser's open-back models. Location was precise, and placement or pressure made little difference to the sound.

Sound quality was decent enough for the price, and had the bass power that is often associated with closed models. But the bass also sounded 'detached' and 'overblown', making the sound rather 'thick', coloured and 'shut in'. Presence and treble were impressively well-controlled, detailed and unexaggerated, but the midrange still sounded 'dulled'.

Though this is a decent attempt to produce a high quality closed-back headphone, the inherent problems, particularly at the bass end, have not yet been successfully overcome in this elaborate model.

TEST RESULTS

Type.....closed back, circum-aural, 2-way dynamic
Mass.....260g
Size rating.....large
Length of cord.....3m
Comfort rating.....fair
Sound quality rating.....fair
Loudness rating.....good
Price.....£68

Sony MDR10T

These are tiny lightweight portables which rest very lightly on the ears, weighing very little in themselves. They cost a mere £10, and are certainly very comfortable, if a little uncertain in positioning and quite responsive to pressure changes.

Sound quality is really quite good in the midrange and treble, though given to fierceness if driven at any level. There is no bass, or even reasonable facsimile thereof.

Accepting the lack of bass, this headset produces quite a reasonably clear and open

sound, with good stereo, and is comfortable and compact to boot. But can one accept the non-existent bottom end?

TEST RESULTS

Type.....open-back, supra-aural, dynamic
Mass.....27g
Size rating.....small
Length of cord.....2m
Comfort rating.....fairly good
Sound quality rating.....fair
Loudness rating.....poor
Price.....£10

Sony MDR-S30

This pretty little model is in fact a closed-back supra-aural type, with swivelling earpieces for easy stowage. It is fairly light, stable and comfortable, without being a particular favourite in this respect, and seemed a little short on cord length. It is fitted with the ingenious Sony adaptor for both jack sizes.

Sound quality was fairly reasonable considering the limited bandwidth, but was also quite 'shut in' in the presence region, lacking 'air' and 'space'. Integration was pretty good through the upper bass and lower mid, while bass and treble extremes were free from exaggeration. Decent loudness levels were possible, and indeed the sound seemed to 'open up' somewhat at higher levels.

This is quite a punchy-sounding headphone, but lacks bandwidth and sounds excessively 'middy'.

TEST RESULTS

Type.....closed back, supra-aural, dynamic
Mass.....120g
Size rating.....medium
Length of cord.....2m
Comfort rating.....fairly good
Sound quality rating.....poor
Loudness rating.....fair
Price.....£15

Sony MDR-S50

Big brother to the '30, the difference in sound is sufficiently dramatic to more than justify the higher price. Physically, they are practically identical in all but colour, though the '50 is enlivened by the addition of volume controls at the earpieces.

Sound quality was a substantial improvement over the '30 and the '50 managed to sound much more like a closed back 'phone. This inevitably means rather limited bass extension, but also good subjective power. The balance turned out to be pretty well judged, albeit a touch on the heavy side. The midrange and treble showed reasonable balance, detail

HEADPHONE REVIEWS

and extension, albeit some residual coloration.

This is an unusually competently designed closed-back model. It doesn't offer anything much in the way of isolation, being designed to sit on rather than enclose the ears, but it does offer decent sound quality of its type at a very realistic price, with the added convenience of earpiece volume controls.

TEST RESULTS

Type.....	closed-back, supra-aural, dynamic
Mass.....	125g
Size rating.....	medium
Length of cord.....	2m
Comfort rating.....	fairly good
Sound quality rating.....	fairly good
Loudness rating.....	good
Price.....	£25

Sony MDR-A50LV

The designation may be unmemorable, but these extraordinary tiny 'phones are quite the opposite. Significantly the lightest, there is no padding, and the units actually sit inside the outer ear; some found this comfortable, others the reverse, and one might also question the hygiene aspects, not to mention the silliest short cord we encountered, complete with a volume control.

Sensitive enough for portable use, the sound quality was quite remarkable, with a sense of integration that is rarely achieved with conventional outer-ear 'phones. Moreover, the bass was qualitatively a significant improvement in power and extension over that achieved by conventional *MDR-10* types, if not quite in the *CD7* league. Care needs to be taken to site the earpieces correctly, but once in place they are quite secure, and provide very adequate if not extravagant levels. The mid and treble is a little 'forward', but was unusually free of significant aberrations or resonances.

If you don't mind coping with the earwax, this is just the thing to buy to see the expression on friends' faces. It is also a real and significant success for the creative Sony engineers; combining fine sound quality and originality at a very modest price. The *A50-LV* is an obvious Best Buy, and an important step in the evolution of the headphone.

TEST RESULTS

Type.....	open-back, intra-aural, dynamic
Mass.....	14g
Size rating.....	tiny
Length of cord.....	1m
Comfort rating.....	controversial
Sound quality rating.....	fairly good
Loudness rating.....	fair
Price.....	£20

Sony MDR CD7

£70 seems quite a lot of money to pay for fairly ordinary looking Walkman-type 'phones, despite the 'Digital' flash on the side holding promise of advanced technology. In fact, the *CD7* clearly represents the state-of-the-*Walkman-art*, and is presumably intended to partner Sony's new portable CD player. Certainly they are too sensitive for direct unattenuated connection to amplifiers, and are obviously designed primarily for low voltage portable use, though they are sufficiently revealing to make one uncomfortably aware of the limited inherent quality of even good portables. They are very comfortable and light, but unfortunately difficult to site precisely for consistent bass reproduction, and are also quite sensitive to pressure changes.

Sound quality is very good, substantially justifying the high price, with low levels of coloration, good treble control and detail, albeit a touch 'forward' in balance, and reasonable (if unpredictable) bass extension and clarity. The sound is a touch 'in the head', reflecting the semi-open design, but loudness capability is very impressive indeed — one feels obliged to sound a note of caution about exploring the prodigiously clear high levels!

Definitely a recommended model for anyone wishing monitor-type quality from portable-type sources, as a general purpose performer this Sony is less cost-effective and capable; the uncertainty of earpiece location could do with improvement too.

TEST RESULTS

Type.....	semi-open, supra-aural, dynamic
Mass.....	80g
Size rating.....	small
Length of cord.....	3m
Comfort rating.....	good
Sound quality rating.....	good
Loudness rating.....	excellent
Price.....	£70

Stax Lambda Pro

Borrowed from importer Wilmex primarily to assist in cartridge testing work, the *Lambda Pro* also made a fine yardstick for comparing the headsets. There is no way of reviewing it in any real context, because fitting into the 9-page allocation meant giving the true exotics a wide berth. But it certainly stood its ground unflappably against the under-£100 models assembled here, even though one might be a little pressed to justify the £500 pricetag, which includes the essential and elaborate power unit.

HEADPHONE REVIEWS

Stax use the expression 'ear speakers', and this is an apt enough description, as they sound remarkably good even when removed from the head, despite the bass cancellation. They are bulky and quite heavy, yet supremely comfortable, partly because there is no sense of pressure build up — they work between the listener and his acoustic environment, instead of removing the latter and substituting their own output. This is clearly little use where some noise exclusion is required, but is handy for those who still want to hear the telephone or door bell ring. Conversely, they actually make quite a lot of noise, and may be a source of irritation to others in the same room.

The sound is very superior, particularly through the bass region, which has good power and extension with unusually low coloration. The midrange is particularly transparent, with fine focus, and the treble has exceptional

detail and good extension, while sounding a little 'bright' (to some extent related to the difference between side mounted headphones and loudspeakers, countered perhaps in the sister Sigma models).

One can hardly fail to recommend such a good headphone, but one can hardly be expected to rate value for money either. The *Lambda Pro* provided a remarkable analysis of the source, and so is justified only for a high quality system. In that context, it would certainly make a nice new addition to the family.

TEST RESULTS

Type.....	open-back, circum-aural, electrostatic
Mass.....	325g
Size rating.....	large
Length of cord.....	2.5m
Comfort rating.....	good
Sound quality rating.....	excellent
Loudness rating.....	fairly good
Price.....	£550, inc SRM II power unit

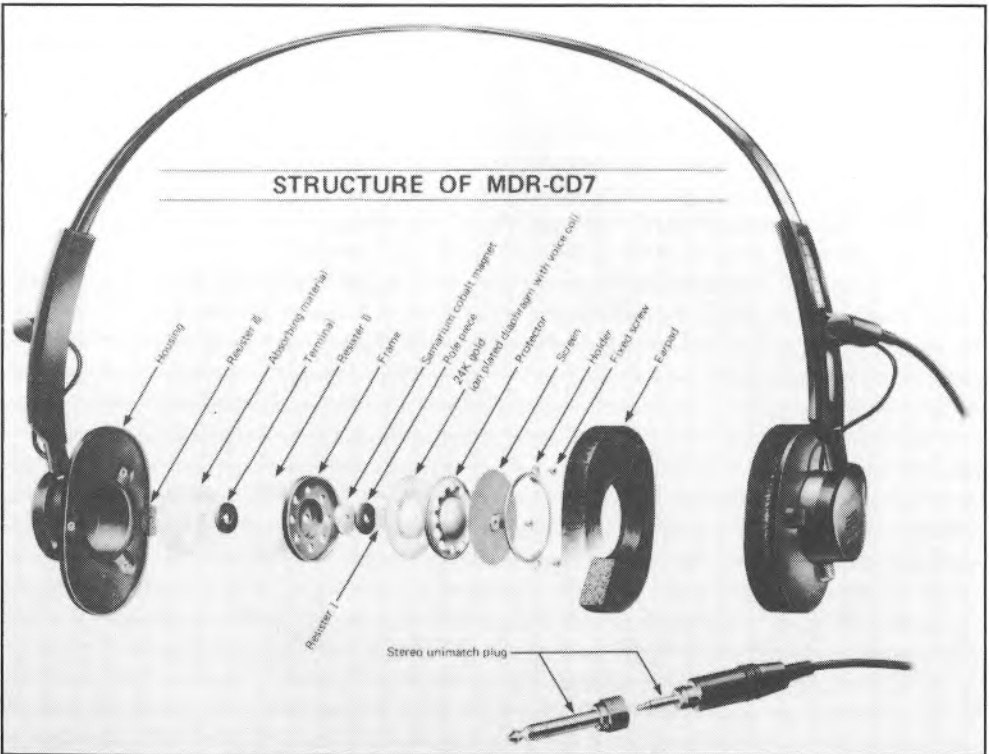

Elaborate construction of Sony's 'high-tech' CD7, designed for digital sources

THE MICHELL CONNECTION

"The ultimate connectors for all quality speaker cables"

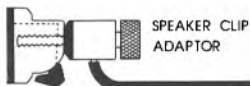
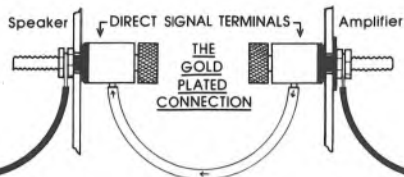

You ain't heard nothin' yet, folks! GET THE CONNECTION!

J A Michell Engineering Ltd

2 Theobald Street, Borehamwood, Hertfordshire, England
Telephone 01 953 0721

IF YOU'RE SERIOUS ABOUT SOUND LISTEN TO

TEAC **AKAI**

Technics

JVC **SONY**

and

Quad, KEF, Dual, JBL,
Thorens, B&W, M-S, etc.

FRENCH

52 DORDON ROAD, DORDON,
TAMWORTH. Tel: (0827) 892252

For Quality
T.V. ★ Video ★ Hi-fi

THE PEOPLE TO KEEP YOU IN THE
PICTURE WITH SOUND ADVICE
Instant Credit
Facilities Available

HEYBROOK



The 'recommended' range

For full details of all products and your local stockist please contact the manufacturers

MECOM (ACOUSTICS) LTD.
Knighton Hill, Wembury, Plymouth, Devon. Phone (0752) 863188

For further information and full review reprints please complete and return this coupon

Name _____
Address _____

Product HB1 HB2
HB3 TT2

Please tick ✓

While some accessories help get a system working at its best, others are less worthwhile. This survey looks at the huge variety of products available and picks some of the best.

Accessories play a vital if unglamorous role in the world of hi-fi and music reproduction. Many would include cartridges and headphones themselves as accessories, but having dealt with these at some length elsewhere, the following parsimonious allocation of editorial pages will be devoted to trying to come to terms with all the other 'bits and pieces'.

It seems only a few years ago that accessories began and ended with record care, with just a gesture towards keeping tape heads clean, and the necessary 'bubble pack' leads and adaptors to get the whole thing up and running. But the steady improvement in hi-fi equipment has increased our awareness of the need to take into account a number of new types of accessory — accessories which actually improve sound quality, albeit often in a capricious, arbitrary and unpredictable fashion.

These are playing an ever increasing role in determining how the whole package comes together in terms of sound quality, and to ignore them is to risk the ship for the ha'ap'orth of tar. Music centre quality is what it is because the product meets designations of price and convenience. Hi-fi product, of however illustrious a reputation, risks making a sound like a high priced music centre if assembled without attention to the details.

However, there is a major problem in accessing the worth of many of these new accessories, simply because their effectiveness depends on the components of the system and the environment in which it is being used. Though it is possible to fill the house with turntable tables, speaker stands and all manner of connecting leads to carry out listening tests, such an approach is, to a degree, only specific to the test situation. It provides a useful set of absolute values, but does not take account of the actual problems in the field.

We have adopted a rather different tack by picking the brains of a number of the country's more conscientious dealers, with their co-operation of course, gratefully acknowledged. These were selected less for the wide range of accessories that they stock than for the small range they specialise in. And for their commitment to the long-term success of their businesses, which is expressed as a desire to satisfy any customer even over a trifle, in the

expectation that he or she will then later return to purchase more valuable components and systems.

Lace these recommendations with a few years' experience coping with the vicissitudes of living with a 'high end' hi-fi system, and of trying to get the best out of it. Switch on the bullshit detector to cope with the snake-oil merchants, and we'll start a blow-by-blow rundown on getting the best out of the system, and the role of the hi-fi accessory in particular.

Record care

Looking after discs themselves is a good place to start. It is a highly controversial subject, with a variety of different opinions, accompanied by at least as many different solutions, and very subject to the vagaries of fashion and the flavour of the month syndrome.

To begin with one must distinguish between the regular day-to-day care of discs which are kept reasonably conscientiously, and the renovation or rescue of discs which have suffered major abuse.

Really dirty discs, particularly any polluted with sticky liquids, may be dealt with in several ways, all of which involve the application of some sort of solvent. The most frequently endorsed and least criticised method is to use the **Keith Monks** cleaning machine, which some dealers have installed as a customer service for a modest charge per disc. Sometimes a clean new inner sleeve is part of the price, and if a disc is dirty enough to need this sort of treatment it will probably need one anyway; **Nagaoka**, amongst others, supply good examples.

The Keith Monks machine is really too expensive for the individual to install for himself, and the Americans in particular have worked hard to produce a more domestic alternative; though products like the **Nitty Gritty** Record Cleaner have not been successful in the UK. But the **Disco-Antistat** from the Dutch-based company Knowin makes a fair attempt at a modest price, but not without a bit of palaver. Discs are rotated vertically with their playing surfaces being brushed while in an anti-static/solvent fluid bath. Unfortunately there is not the convenience of the vacuum assisted drying used in more elaborate machinery.

The oldest LP record cleaning treatment of them all is almost certainly the **Watts** Manual

ACCESSORIES

Parastat. This involves a fairly elaborate cleaning procedure using specially shaped bristles. It has stood the test of time well, and is quite effective with dirty discs, though less well known than the **Preener** and **Dust Bug** which are really only effective against day-to-day dust.

A fairly recent technique uses a sort of 'face pack', a typical example being the **Metrosound** Record Rejuvenation Fluid. This is poured over the record surface and penetrates the grooves before setting to a soft plastic film. It is then peeled off, taking much of the debris with it (and leaving a bit of a static charge behind!). Still something of a rigmarole, it is certainly one of the most convenient and effective of the domestic treatments. (*This product really can make old records sound almost like new — Ed.*)

The morning after the party night before may need a fairly powerful solvent, for which **Last Power Clean** (£8) is reckoned to provide a pretty effective, though maybe a trifle drastic, cure.

Simple day-to-day dust removal is anything but simple. A fair body of opinion holds that the only really effective cleaner is the stylus tip itself, as it is the only thing which gets precisely to the part of the groove which needs cleaning, by definition. The attention should then be directed towards keeping the stylus clean, to which we will return shortly.

The 'stylus only' argument has plenty of weight, the only danger being the risk of impacting and embedding particles into the groove walls under the highish pressure which operates at the point of contact of the stylus.

But a practical problem, particularly with light downforce cartridges, and depending somewhat upon the shape of the stylus tip, is that of getting to the end of a side before the fluff takes over.

To combat this, an enormous range of products exist, some as accessories, some dangling on the front of the cartridges themselves. The audiophile automatically eschews any form of brush that tracks the groove as an unacceptable sonic compromise, a claim roundly refuted by most manufacturers of tracking cleaners.

Whatever the truth of the matter, there seems no reason not to clean the record first if necessary, then close the lid while it is playing to keep any extra dust off. And undoubtedly the most successful cleaning brushes are those made of carbon-fibre bristles. Versions which received some praise from the trade were those

by **Goldring** and **Stanton**.

The advantage of carbon-fibre over other materials is that the fibres are small enough to get down into the bottom of the groove, though persuading them to pick up and take away the particles takes some practice! The £7 **Hunt EDA Mk VI**, if still available, combines two c-f brushes with a plush pad, and is certainly the most effective low-aggravation cleaner around.

Conventional preeners in general, and rolling cleaners like the glue-strip **Pixall** and washable 'tacky' **Nagaoka** roller seem quite ineffective at getting down to the groove bottom, and the fear is that the 'land' between the grooves gets dusted, but that much of the dust finds its path of least resistance is to migrate to the groove bottom, assisted by the static charge which accompanies any friction cleaning device.

Static is generally regarded as a major enemy of clean discs, and great efforts are made to prevent the build up of charge, which acts as a magnet to all the dust particles in the locality. In fact, the major cause of static is the cleaning process itself, which is a further string to the 'stylus only' bow — even the stylus generates some static build-up, but much less severely than the various cleaners. (*Dry-air conditions produced by central heating are often to blame as well — Ed.*) The theoretical conductivity of carbon-fibre bristles seems to have little bearing upon their ability to create a static charge.

Having caused the static in the first place, the industry offers various panacea in the form of fluids such as **Permostat**. But the product that really seems to have caught the public imagination is the **Zerostat**, now entering its umpteenth year of production and celebrating with a new model and increased sales. This is a 'gun' which directs a 'spray' of ionisation to counter static. It is certainly harmless, as it goes nowhere near the record surface, though its effectiveness is a little unpredictable.

On a different tack, and much more controversial. Last's £16 **Record Preservative** fluid actually goes down into the groove as a form of lubricant, and is claimed to reduce wear and surface noise. Many users swear by it, others remain to be convinced.

As for the author, he is a lazy sonofabitch, only too happy to follow the 'stylus only' doctrine, with occasional recourse to a Hunt Mk VI. Personal observation suggests that too often record care is regarded as an end in itself, whereas the primary aim should be the reduction of surface noise. And rather more than half

the secret of 'reducing' surface noise lies in getting a decently matched and properly set up system that doesn't behave as a surface noise exaggerator, as is the case with far too many so-called hi-fi systems.

Stylus cleaning

In dealing with record care, mention was made of the stylus as a record cleaner, which it most certainly is whether one likes it or not. As a result it gets filthy pretty quickly, and needs more frequent attention than any other part of the system.

For many years this meant a soft camel hair artist's paintbrush (bent up at the tip) and a bottle of isopropanol from the local Chemist, taking care always to use the brush from back to front along the line of the cantilever. There are lots of proprietary versions of this basic formula, such as the **Audio Technica AT607** (£1.65), usually providing a better, stiffer, safer brush and combining the fluid dispenser.

In recent years the brush-and-solvent combination has been challenged by abrasive 'dry' cleaning methods. Doubts have been raised about possible long-term side effects of the use of even the gentle stylus cleaning fluids on the delicately controlled internal damping of the cartridge, sufficient to suggest that only the minimum fluid should be applied, and not over-frequently.

Furthermore it has been observed that some of the deposits that build up on the diamond tip are practically insoluble, including, it is believed, such things as stearates and mould-release agents present on brand new discs. And on the basis that diamond is just about the hardest thing around, abrasive cleaning is an obvious course to follow.

Linn Products set the ball rolling by giving away book matches labelled 'Stylus Cleaner & Review Disposal Kit', intimating that once one had incinerated the outpourings of the specialist press, one could use the striking strip as a stylus cleaner. To everyone's amazement it worked rather well (in the latter role at least), though there was some risk of damage if used clumsily.

Now Linn have discovered The Green Stuff, a plastics-based abrasive sheet which is flexible enough to remove the risk, and which seems to do a decent job of the cleaning. Linn dealers, who have to pay for the sheets themselves, have been known to slip one the odd 5 x 1cm strip, making deprecating gestures as one fumbles for the cheque book.

Although this simple abrasive strip seems to work well with most cartridges, those with the sharpest profiles, particularly the new 'ridged' models, seem to prefer something a little gentler (*Many cartridge manufacturers would decry abrasive cleaning — Ed.*)

Those who get really hooked on stylus cleaning blow £14 on the **Audio Technica AT637**, which is a motor-driven, battery powered vibrating abrasive pad. It was the most universally acclaimed item in our dealer poll, yet with a sincerity born of altruism rather than greed. One described it as the best thing since sliced bread — and in the next sentence referred me to the Chemist to buy isopropanol and cotton buds for tape head cleaning, instead of some similarly exotic head cleaner!

Vibrator cleaners are available from other firms such as **Goldring**, though all the various brands seem to appear and disappear sporadically, due, presumably, to vagaries of supply. For stubborn cases or occasional spring cleaning they may be used with a drop of fluid, but a suggestion for everyday use is to pop them on for ten minutes or so before settling down to listen to music, say while fixing a drink or beverage.

A similar pad designed for manual use without a vibrator is the £7 **Discwasher SC2**, from an American brand which is just starting to become available again after a brief absence, and which offers a wide range of other disc care products besides.

The author is mildly appalled to realise that he has no less than three stylus cleaning items affixed to his turntable by means of Blu-tack: a

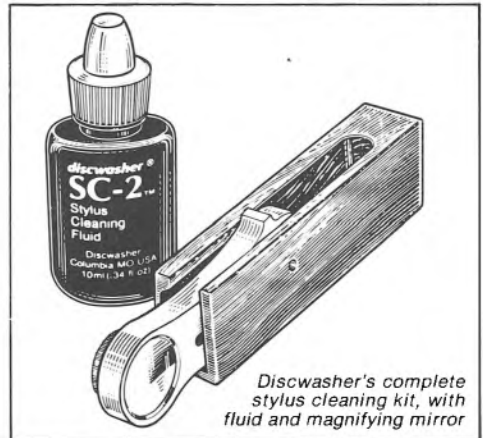

Discwasher's complete stylus cleaning kit, with fluid and magnifying mirror

ACCESSORIES

soft (ADC) brush for fluff, The Green Stuff for between sides, and **Cleanol** solvent/brush for a bi-weekly spruce or the occasional sticky bit!

Turntable supports

The latest accessory craze to hit record players is a much more substantial item which has nothing to do with styli. Turntable support structures of various kinds, frequently costing nearly £50, have mushroomed onto the market, led by the **Sound Organisation** table, which we used throughout our cartridge tests, but now including a number of rivals.

The simple fact is that record players are seismographs, purposely designed for the detection of vibration, some of which is wanted, some not. To some extent all are affected by their immediate acoustic and vibration environment, but the very popular Linn *LP12* certainly demonstrates significant changes in sound quality on different kinds of support, and some others do likewise.

On this occasion Linn have failed to take the lead by supplying an 'authorised' table, so several dealers stepped smartly into the gap, followed swiftly by accessory suppliers. There is still some debate about what the support is designed to do, but the basic criteria seem to consist of a low mass turntable-sized platform supported by spikes on a rigid frame.

The £50 Sound Organisation table is certainly best known, and inspired turntable manufacturer **Pink Triangle** to offer the £30

Aerolam Prop as a better-sounding platform. The £45 **Audio File** and £50 **Target** tables have an extra shelf and better levelling arrangements.

Alternatives to these rather inconveniently low tables are wall-mounted supports, such as the **Partington**, the £35 Target TT1 and the £46 **Heybrook**.

The expensive Prop is not the only separately available platform, and a number of low cost alternatives have been designed to sit on an existing cabinet or shelf, supplied with or without feet. These include such models as the **QED Torlyte**, the **DS Soundbase** (available as platform with optional frame), the **Mission Isoplat**, and the **Quadropod**, the latter also supplying a £9 set of spiked feet for the do-it-yourselfer or to use with proprietary platforms. The Isoplat is not spiked but is mounted on energy absorbing sorbothane feet, so is reckoned to be more effective with plinth type players than subchassis designs.

It is fair to describe the turntable support market as rather fluid and fickle at present. Certainly some dealers are a little reluctant to promote products produced by rival shops! A great many are keenly anticipating the arrival of the **RATA Torlyte Stand** (as are we ourselves), which dispenses with the support plate altogether. Prototypes circulating during the summer left a great impression, and the price is keen too, but as this goes to press production samples have yet to appear.

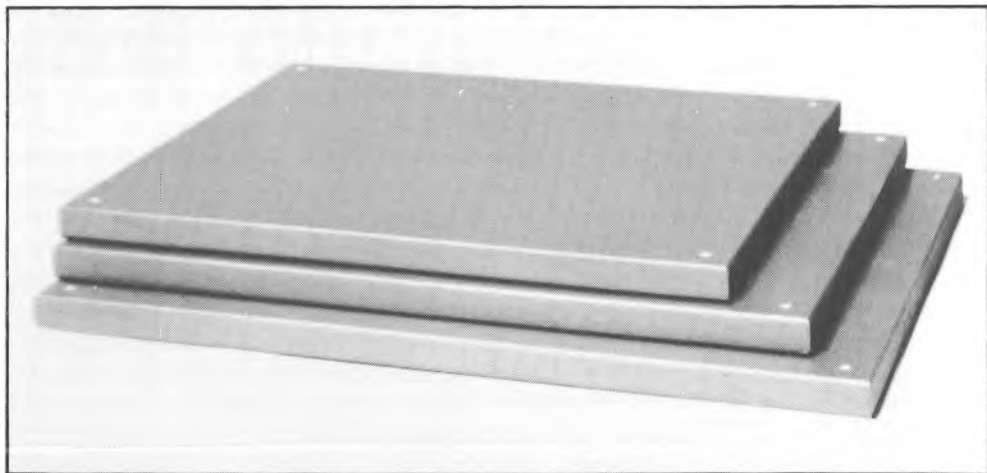

'Torlyte' supports by QED, for turntables or other units — sound quality may benefit, but the reasons are little understood!

An additional point to note is that these support structures can actually improve the sound of other components such as amplifiers, though the mechanisms involved are even less well understood!

Other turntable accessories

Lumped together under this rather woolly heading we find turntable mats, disc clamps, and alignment gauges.

Mats were popular a while back, until turntable manufacturers cottoned on to the flaws in their existing mats and started putting them right.

Any mat is a compromise between damping the vibration in the disc and providing a firm support for it. The one essential is to start with an evenly supporting surface, and if this is not provided a mat change is worthwhile. Beyond that there are differences between mats, and scope for 'fine tuning' the balance of a system, but if the turntable manufacturer knows what he is about, the compromise will have been carefully chosen at the start.

Disc clamps also have their proponents and critics, and they are an integral part of several well-regarded turntable designs, enabling the disc to be stressed firmly into contact with the mat. Whether they have a useful role as a separate accessory is more of a moot point. Like mats they affect the balance of a system, for better or ill, and really should be taken into account at the turntable design stage. They are also a fiddly nuisance to use, as are the very 'tacky' turntable mats which offer high disc damping.

Assuming you are unlucky enough to have a dealer who doesn't line up your cartridge for you, then an alignment gauge is fairly indispensable. In fact the one published on page 27 is reasonably useful, but our particular favourite is the **Elite**, which was used throughout the cartridge tests, and which gives a direct measure of the actual error at any point. Its efficacy can be confirmed by the gratifying closeness of the average results for Left and Right separation and tracking ability obtained in the tests.

Loudspeaker stands

For many the loudspeaker stand is merely a useful way to get the speakers out of the way when they are not being used, and enable the Hoovering to be done. This was once the case, because it was assumed that the reasons for stand mounting a loudspeaker was largely to

do with convenience and the acoustic benefits of getting the sound source up to ear level.

But more recently there has been a growing awareness that the loudspeaker needs a rigid support giving firm mechanical coupling to the floor. Castors are being replaced across the country by mildly vicious spikes which penetrate through the carpet and underlay to savage the floorboards beneath, with audible improvements that any good dealer can demonstrate. (An alternative school of thought stresses deliberately decoupling in a controlled manner, which may be worth pursuing if spiking doesn't work, but is clearly a minority opinion.)

For some reason which remains obscure, the most obviously effective mechanical coupling — of bolting the whole thing down — doesn't seem to work very well in practice. Best results seem to be had by firmly locating the stand on the floor, then resting the speaker on the top plate on spacing nuts or further spikes.

Our survey indicated many of the brands were the same as those producing turntable supports. Perhaps the most popular all-rounder was the **Heybrook HBS1** (£50), but the **Linn** stands (*Kan 1* and *2* and *Sara*, £40-60) and the £50 **Sound Factory SF2** were also strongly endorsed in this middle-market sector.

Target seem to be the dominant brand at a slightly lower price, three different sized models costing around £35. They also market an £8 conversion kit so that existing stand owners can swap their castors for spikes.



Fighting off the spikes — speaker castors from Haromark

ACCESSORIES

Other low cost brands which were rated included **QED** and **Partington**.

At the top end of the marketplace **Stand & Deliver** are particularly noted for users of the Quad **EL563** loudspeaker, and the £100-odd **Cliff Stone** Foundation models were held in very high regard.

The importance of the speaker stand can hardly be overlooked when the bulk of the £50 models are finding happy homes underneath loudspeakers that cost between £100 and £200.

Cables and connectors

The influence of cables and connectors upon sound quality was intimated a number of years ago, and has slowly been accepted, despite the lack of any coherent theoretical explanation for many of the subjective effects which are detectable.

To start to discuss the whys and wherefores would quickly clog the page allocation. More than any other component, connecting wires are system-dependent, so a more pragmatic approach is to find out which types are being supplied, and which give the most reliable results 'in the field'.

Everybody needs speaker cable, and nobody uses thin bell wire anymore. **QED** 42-strand and 79-strand are popular at the cheaper end of the market, the former frequently supplied free of charge with systems. **Naim**, **Supra** and **Mission**

speaker cables were also strongly endorsed for their cost-effectiveness and good sound quality, with **Monster** likewise at a slightly higher price.

More expensive still, but again getting a vote of confidence are **Force 4/Absolute Wire**, the **Hitachi** and **Audio Technica** Long Crystal cables, and the **van den Hul** designs.

Interconnect cables are relevant to those with separate pre- and power amplifiers, and are even more competitive and confusing, with **QED** Incon, and **RS** Blue leading the way at the low price end.

High-price interconnects will hold great fascination for the fanatic, who will probably need to try several different kinds in his system before deciding. Hopefully the dealer will ease his path by making samples available on loan. Top rated interconnects include **Randall**, **The Absolute Link**, **Hitachi LC** and **van den Hul**, the latter two arousing particular interest at present.

Connectors are currently getting as much attention as cables. The standard phono plug has finally been scorned by Naim Audio, which is making life a bit complicated as it brings the (rather nice) BNC video connector onto the scene. But there are some good phono plugs around, including the **RS** gold-plated types, and others from **EAR**, **van den Hul**, **Linn** and **Moth Marketing**.

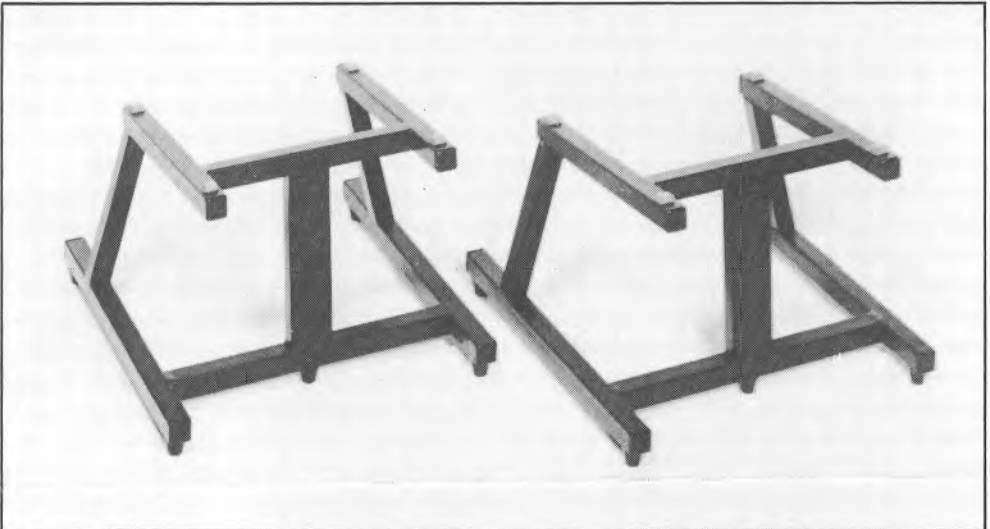

Rigidity and good coupling to the floor are provided by modern speaker stand designs, like these from QED

Michell have carved out their own little niche with some fine high quality speaker terminals and connectors, while for adaptor leads between different connector standards the **VEDA** brand received several mentions along with **QED** interconnects..

And as if that is not enough, there is quite a lot of fuss going on at the mains connection end of things. Again from a 'good house-keeping' angle it makes sense to use the 'cleanest' mains connection possible. The £10 **MK** 13amp distribution board cropped up several times, along with the similarly priced **Marbo** for hard-wiring.

Operating rather differently by seeking to prevent 'dirty' mains from adversely affecting sound, the **RATA** Clamp and Superclamp have their adherents. This seems to be rather 'situation dependent', presumably because the quality of mains varies from place to place and at different times of the day (getting worse in the evenings when everyone switches on their TV sets).

Tape heads

With commendable frankness and honesty, many dealers indicated their preference here for cotton buds, isopropanol and Servisol spray, though kits with applicators are available from many sources. As a postscript to the preceding section, they also pointed out the need to keep electrical contacts at plugs and sockets clean as well.

Proprietary kits for this sort of general maintenance include **Audio Technica's** AT6021, with the AT624 specific to tape. **QED** Tapeclean, **Revox**, **TEAC** and **Metrosound** were others mentioned by name.

The **Allsop Three** (£4) was the one 'gizmo' cleaner that was highly rated, for the lazy or for those with inaccessible heads to clean (which includes most car players).

The other occasional maintenance job which is worthwhile with tape heads is demagnetisation, courtesy **Maxell** (£7.75), or the battery operated £15 **TDK**, which is nearly foolproof, and can be used for cassette decks or reel-to-reel recorders.

Pot pourri

All sorts of strange and wonderful, fascinating and even useful devices appear from time to time. I don't think I shall ever forget my amazement at the **Audio Technica** earwarming pads for Winter Walkmen. Then there is the toy Volkswagen Microbus which plays records

while running round them, developed in his spare time by a Sony engineer/VW enthusiast.

On a more serious note, **QED** do a useful line of switch boxes for those faced with a bewildering array of bits of equipment to fit into a modern 'minimalist' pre-amp. Cartridge mounting kits, from **Heybrook**, **Goldring** or **A&R**, for example, provide rigid fixing using socket head bolts, and can actually transform the sound of a system if such a precaution has not already been taken. Contact preservatives such as **Tweek** and **Cramolin** are another area of mild controversy, not least because of their high prices, but some users swear by them. Then there are special headshell leads, about which I am currently very perplexed. And a faintly bizarre German method of measuring cartridge/groove friction to assess stylus wear (or pollution), called **Protech**.

Finally, there are certain accessories which improve the service a dealer can offer his customers. Keith Monks record cleaners have already been mentioned, and are clearly useful, if expensive. Similarly good but expensive, I can personally vouch for the **Ortofon** Cartridge Test Computer which gave impressively reliable results in the great majority of cases, even though it did give me cause to swear occasionally. Rather less of an investment is a nice **Olympus** stereo microscope for stylus inspection, which Linn are encouraging their dealers to install, and which does a pretty decent job of assessing cleanliness and wear.

Trade Talk

We would like to thank the many dealers who were kind enough to help us in the preparation of this feature. They included:

Aston Audio, Alderley Edge, Cheshire
 Audio Excellence, Cardiff
 The Audio File, Bishop Stortford, Herts
 Audio T, West Hampstead, London NW6
 Audition Hi-Fi, Leicester
 Bartletts, Holloway Road, London N7
 W A Brady & Son, Liverpool 15
 Chichester Hi-Fi, Chichester, West Sussex
 Grahams Hi-Fi, Pentonville Road, London N1
 Hampshire Audio, Chandlers Ford, Hants
 Hi-Fi Care, Tottenham Court Road, London W1
 Jeffries Hi-Fi, Brighton
 The Music Room, Glasgow
 Sound Advice, Loughborough
 Spaldings Hi-Fi, Croydon, Surrey
 Unilet, New Malden, Surrey

GLOSSARY

This is not intended to give dictionary definitions of terms, but to explain their meanings in the context of this book.

Alignment: Refers to the geometrical relationship between cartridge stylus and groove in various planes (see *Consumer Introduction*.)

Alignment protractor: A device used to minimise the lateral tracking error of a cartridge/arm combination.

Amplitude: The actual size of a signal modulation, or distance travelled by a headphone transducing element, which corresponds to the level or relative loudness of the signal.

Armature: The moving parts of the generator in a pick up cartridge (see *Stator*).

Balance: 1) The overall relative loudness perceived at different frequencies (eg bass, treble) 2) the accuracy of the match between the two channels of a stereo transducer (eg cartridge or headphone).

Bass: LF part of the frequency spectrum, typically below 150Hz.

Binaural: Closed system recording/replay technique using headphones and 'dummy head' microphones.

Bottoming: The stylus scraping on the distorted rounded bottom of the groove due to incorrect stylus geometry.

Cantilever: The thin rod or tube that connects the stylus to the armature and hence the cartridge body.

Capacitance: A reactive electrical property present in pickup arm leads and amplifier inputs; correct matching is often important to ensure optimum inputs; correct matching is often important to ensure optimum performance (see *Loading*).

Channel separation: The degree to which the cartridge prevents breakthrough from one stereo channel to the other (see *Crosstalk*).

Circum-aural: Headphone type which encloses the ear and rests on the side of the head.

Coloration: Change in sound quality due to resonances or imbalances in frequency response.

Compatibility: The selection of interdependent components to achieve optimum system performance; notably arm/cartridge mass/compliance matching, cartridge electrical loading, or headphone compatibility with amplifiers.

Compliance: A measure of the springiness of the cantilever/armature seen from the stylus, expressed in compliance units (cu), where $1 \text{ cu} = 10^{-6} \text{ cm/dyne}$.

Crosstalk: The breakthrough signal measured in the alternate channel of a cartridge when a signal is recorded on one channel only, expressed in dB as the ratio of the unwanted to the wanted signal at appropriate frequencies.

Cutter: (*disc cutter*) Mechanism used to cut recorded signal onto lacquer master; consists of turntable, lathe, cutting head, cutting and servo amps.

Damping: A means of controlling resonances by means of a resistive medium (electrical, mechanical, or acoustic depending on situation).

Decibel (dB): A logarithmic unit that is convenient for expressing ratios that span a wide range on a linear scale. For simplicity it can be regarded as a measure of relative loudness; for example in frequency response and crosstalk measurements.

Direct-cut (disc): A recording technique that transfers the music via microphones and mixers direct to the disc-cutter without intermediate tape storage.

Disc-cutter: see *Cutter*

Distortion: Literally this can mean any deviation from the original, but usually refers to harmonic rather than intermodulation distortions when not specified.

Downforce: The weight, measured at the stylus, which holds it down in the groove.

Effective mass: The inertia, or mass-controlled resistance to movement, of a device, particularly important with regard to tonearms.

Electret: Effectively a permanently charged capacitor, it is used as the transducing element in certain cartridges and headphones.

Electrostatic: A principle employed in some headphone transducers using static electricity effects to set up a polarising field within which the modulated transducer medium moves.

Elliptical stylus: A specially shaped stylus profile that makes the 'plan view' radius along the length of the groove smaller than the 'elevation view' contact radius viewed from the front.

Farad: Measure of capacitance; for cartridge loading requirements the *microfarad* (μF , a millionth of a Farad), *nanofarad* (nF, a thousandth of a millionth of a Farad), or most commonly the *picofarad* (pF, a millionth of a millionth of a Farad) are commonly encountered.

Frequency: A rate of vibration, which responds to musical pitch in the audio band.

Frequency range or spectrum: Can refer to any particular group of frequencies, but commonly applied to the audible band from 20 to 20,000 cycles per second (Hz), extending from the deepest bass to the highest audible harmonics.

Frequency response: The variation in output over a frequency range, particularly of a transducer; can be expressed as a range with decibel limits, or depicted graphically.

Henry (H): Measure of inductance; more usually millihenry (mH), as in cartridge internal inductance.

Harmonic: The whole-number multiples of a base frequency or fundamental, so that twice that frequency is the second harmonic, and represents a pitch one octave higher, three times that frequency is the third harmonic, two octaves above the fundamental.

Harmonic distortion: (see *distortion*). The unwanted addition of harmonics to a single frequency signal.

Hertz (Hz): (see *frequency*). The normal measure of frequency, equal numerically to the outdated 'cycles per second'. Also kilohertz (kHz) which equals one thousand Hz, so the audible frequency range can be

described as either 20-20,000 cycles per second (Hz), or 20Hz-20kHz.

HF: High frequency, typically above about 3kHz.

Impedance: Measure of resistance (and reactance) in alternating (ie audio) signals; this is of some importance in the compatibility of both cartridges and headphones with amplifiers.

Interaural: Concerning the differences between the sound perceived at the two ears.

Intermodulation (IM): A form of distortion arising from two or more signals producing non-harmonic signals that correspond to the sum or difference of the two frequencies.

kHz: see *Hertz*

kohm: see *Ohm*

Level: Refers to the relative level of a signal to another signal or to a datum, usually expressed in dB.

LF: Low frequency.

Linear: A transducer that produces an output that exactly portrays its input over the required operating range is described as linear, and is hence distortion free. Hence also nonlinearities (distortions).

Line-contact: A special stylus profile that extends the ellipse, increasing contact length up and down the sides of the groove.

Load or loading: The impedance (including resistive and reactive components, ie ohms, mH, pF) seen by one component looking back to its interconnected component; of importance in compatibility of cartridge/lamp, and amp/headphone.

Master: Either the original tape from which cutting is done or the negative imprint taken from the original cut lacquer; used to create 'Mothers' and they in turn 'stampers' or 'Matrixes'.

Matrix: see *Master*.

Midrange, Midband: The central part of the audible frequency range.

Modulation: The audio signal is 'stored' by means of modulations within a medium, eg the 'wiggles' in the groove of a plastic disc, or the magnetic coding on a tape.

Monitoring: Listening to a programme to check the quality; headphones are particularly useful for monitoring stereo signals.

Mother: see *Master*.

Moving-coil: A transducer (eg cartridge or headphone) where the signal is generated by the movement of a coil within a magnetic field.

Moving magnet: The most common form of cartridge transduction, where the magnet moves while the coils are held relatively stationary.

Octave: Two-to-one ratio of pitch or frequency.

Offset angle: The angle measured between the centre line of the pickup cartridge and the line which joins stylus and arm pivot point.

Ohm: Unit of electrical impedance (including reactance) or resistance; also kohm, where 1 kohm = 1,000 ohms.

Orthodynamic (Isodynamic): Headphone transduction

system where flat film conductor operates between permanent magnet plates.

Overhang: The amount by which the stylus overhangs the centre spindle of a turntable; see alignment in *Consumer Introduction*.

Presence: A quality of forwardness or immediacy in a sound balance, generally related to an upper-middle frequency response boost.

Q: A measure of the magnitude and shape of a resonance; the higher the Q, the sharper and more severe in amplitude the resonance.

Ringing: Oscillation due to the excitation of a poorly damped resonance.

Separation: As between the two channels of a stereo pickup; see *crosstalk*.

Shibata: A special stylus shape extending the elliptical to a 'line-contact' type of profile.

Side-thrust: A force acting on cartridges in pivoted (ie not parallel tracking) arms, due to the stylus/vinyl 'friction' acting along the line of the offset angle; hence bias or side-thrust compensation.

Signal: A term which embraces all encodings of sound.

Square wave: A signal which consists of a fundamental plus a (theoretically infinite) series of odd (3rd, 5th etc) harmonics in a precise phase and amplitude relationship. It is useful for examining transient performance, symmetry, resonance control and 'ringing'.

Stator: Refers to the non-moving parts in a cartridge's generator mechanism.

Step-up: A transformer or head amp used to boost or match the output of a moving-coil cartridge to use with a normal amplifier disc input.

Stylus: The specially shaped piece of diamond in contact with the groove and connected to the cantilever.

Subsonic: Below the audible range, ie below 20Hz.

Supra-aural: Headphone type that rests on the pinna or outer ear.

Tracing: The following of the groove modulations by the stylus; hence for example tracing distortion, caused by the inability of a spherical stylus to trace the high frequency inner grooves on a disc.

Trackability: The ability of the cartridge to cope with large amplitude modulations (or of the arm and cartridge to follow the groove itself properly).

Tracking force: see *downforce, playing weight*.

Ultrasonic: Frequencies above audibility, ie greater than 20kHz; also *supersonic*.

Vertical tracking angle (VTA): The angle at which the plane of motion of the stylus is set with respect to the vertical when viewed from a side elevation of the cartridge. Should match the 20° cutter standard.

Weighting: A factor or function that is applied to a measurement to increase its relevance and usefulness; eg the weighting curves applied to headphone frequency response measurements to take account of head, ear, and other related effects.

When you're looking for the book come to the library

Here, in the heart of London's West End, just two minutes walk from Tottenham Court Road underground station, can be found copies of almost every *Hi-Fi Choice* ever published.

For example, there are issues of *Hi-Fi Choice: Loudspeakers* dating back to 1978, containing reviews of several speakers still current, but never subsequently tested in any later issue. Or *Hi-Fi Choice: Tuners*. Or even the first *Video Choice*.

These and all current volumes in the series are on sale at 14 Rathbone Place, as well as both current and back copies of *Which Bike?* and *Personal Computer World*.

Nowhere is there a more complete collection of the many different volumes of *Hi-Fi Choice* published to date — anywhere in the world.

You will find the *Choice* that you are looking for, here on the shelves.

HI-FI CHOICE

BACK ISSUE CENTRE

**Bunch Books
14 Rathbone Place,
London W1P 1DE**

**Monday to Friday
10am to 6pm
Saturday 11am to 5pm**

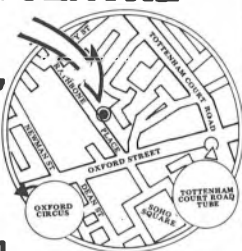

ADVERTISERS' INDEX

Audio Excellence.....	Audio	Incatech	108	The Sound Organisation	128
Excellence	52	Logic	12	Severn Sound Audio	40
Aurak	18	Linn Products	OBC	Target Audio	15
About Sound	66	Mayware	18	Local Dealer Guide	
Audio Technica	52	Mission Electronics	IFC	Aston Audio	126
Andover Audio	66	Mecom Acoustics	142	Andrew Thomson	126
Alternative Audio	104	Michell Engineering	142	Audition Hi Fi	126
Absolute Sounds	30	Naim Audio	70	D.F. Clarke	127
Bang & Olufsen	23	Nagoaka	4	Chichester Hi Fi	127
Brentwood Music Centre	40	Norman Audio	34	John Chapman	127
Basically Sound	34	Ortofon	2/3	Erricks of Bradford	127
Condor Electronics	14	P & J Industrial Services	66	Gerry & Gill Thorpe	127
Cosmic	10	Phase 3 Hi Fi	34	Hi Fi Components	126
Custom Cables	20	Paul Roberts Hi Fi	40	Hi Fi Centre of Wilmslow	127
Edwards E.C.C.	52	The Parabolic Stylus Co.	10	Image Hi Fi	126
Esoteric Marketing	6	Pickering Cartridges	28	Midland Hi Fi/Stafford Hi Fi	127
Hi Fi Care	IBC	QED	104	Prism Audio	127
Hayden Laboratories-Sennheiser	132	Russ Andrews/RATA	18/34	Selective Audio	126
		Reading Hi Fi	15	Technical & General	126

HI-FI CARE LTD

We don't stock or sell any hi-fi or video equipment!

But we do stock and specialise in hi-fi audio and video accessories for most leading brands of equipment.

Example: our stylus range begins from steel needles for wind-up gramophones to the very latest moving-coil cartridge for the most advanced turntable.

Why not visit Hi-Fi Care's walk round stores

To see the latest in microphones, headphones, record/tape care, audio/video tapes, switchboxes, plugs and leads, speaker/TV stands and brackets, cartridges and styli, TV/FM aerials and boosters, plus a comprehensive range of video accessories and many difficult to find accessory items too numerous to mention.

Our knowledgeable and helpful staff would be pleased to advise you on your requirements at:

HI-FI CARE LTD

**245 Tottenham Court Road, London W1 Tel 01 637 8911/2
7 Tottenham Court Road, London W1 Tel 01 637 0371**

SHOP HOURS MON-SAT 9AM-6PM
PHONE ORDER CAN BE ACCEPTED ON ACCESS & VISA

TAX FREE SERVICE FOR OVERSEAS CUSTOMERS

Deliver us from evil



For information on legitimate Hi-Fi contact:
LINC PRODUCTS LTD, 235 Drakemire Drive, Glasgow, G45 9SZ. Tel: 041 634 0371 (10 lines)