

Founded 1925

Incorporated  
by Royal Charter 1961*To promote the advancement  
of radio, electronics and kindred  
subjects by the exchange of  
information in these branches  
of engineering*

# The Radio and Electronic Engineer

**The Journal of the Institution of Electronic and Radio Engineers**

## Two Complementary Publications

**W**ITH this issue of their Journal, IERE members receive the fourth number of the fortnightly newspaper, *The Electronics Engineer*. The first number of this new publishing venture on the part of the Institution, announced in November, was sent separately to members of IERE and of SERT at the end of January and already there have been many appreciative comments by members of all grades, whose professional activities are spread right across the electronic and radio engineering 'spectrum'.

It cannot be emphasized too often that *The Electronics Engineer* is intended to be a members' publication in that its purpose is to serve 'the engineer' rather than 'engineering'. This apparent play on words is important: it highlights the respective future roles of *The Radio and Electronic Engineer* and the newspaper, whereby the older, established, learned Journal will primarily concentrate on the presentation of original papers and reviews from the whole field of electronic and radio engineering as well as general interest papers, while *The Electronics Engineer* will stress the more individual aspects of an engineer's professional life and activities. There will of course be no rigid rule-following, for instance in regard to such areas where a permanent record of a member's achievements is felt desirable and is therefore printed in the Journal; similarly the newspaper will present short articles on technical matters, usually those of a more ephemeral nature.

It is hoped that the popular feature of so many periodicals, the 'Letters' page, will flourish in both publications and *The Radio and Electronic Engineer* will particularly welcome comments on papers and on technical matters generally, while *The Electronics Engineer* will provide a forum for opinion and comment on current topics of interest to all engineers.

The role of Local Sections, whether in Great Britain or overseas, is important in supporting the Institution's work for engineers as well as for engineering through the opportunities which regular meetings provide for informal exchanges. As well as publishing a continual up-dating service on meetings, *The Electronics Engineer* will contain reports on Local Section meetings and other functions which in the past have only occasionally found room in the Journal. The co-operation of all members concerned with Local Section affairs will give this part of the new publication even more of the 'personal' flavour that is the intention.

Finally, we may repeat that an important aspect of *The Electronics Engineer* is its section devoted to appointments advertising for chartered electronic engineers, technician engineers and technicians. Just as this fortnightly paper presents an unequalled medium for the employer seeking expertise in electronics to reach precisely that group, so too does it put forward positions relevant solely to electronics professionals: they are therefore urged to make it their prime source of information on employment opportunities in the industry, government service and education.

F.W.S.

# Applicants for Election and Transfer

THE MEMBERSHIP COMMITTEE at its meeting on 14th January 1980 recommended to the Council the election and transfer of the following candidates. In accordance with Bye-law 23, the Council has directed that the names of the following candidates shall be published under the grade of membership to which election or transfer is proposed by the Council. Any communication from Corporate Members concerning the proposed elections must be addressed by letter to the Secretary within twenty-eight days after publication of these details.

January Meeting (*Membership Approval List No. 268*)

## GREAT BRITAIN AND IRELAND

### CORPORATE MEMBERS

#### Transfer from Member to Fellow

EGLEY, Austin. *Sheffield*

#### Transfer from Graduate to Fellow

GAGE, Andrew Charles. *Camberley, Surrey.*

#### Transfer from Associate Member to Member

PATTERSON, Adrian Gifford. *Yate, Avon.*

#### Direct Election to Member

ADAM, Abdelraouf Mohamed. *Portsmouth.*  
SUMMERBELL, Frederick. *Houghton-Le-Spring,  
Tyne and Wear.*

### NON-CORPORATE MEMBERS

#### Direct Election to Graduate

CHUI, Chi Pang. *London.*  
FISHER, Noel James. *Hayes, Middlesex.*

TAYLOR-BROWN, Jeremy David. *Wakefield,  
W. Yorks.*

#### Direct Election to Associate Member

FIELDING, Brian. *St. Albans, Herts.*  
GREATBATCH, Dennis. *Sheffield.*  
OKONKWO, Alexander U. *London.*

#### Direct Election to Student

FERMOR, Nicholas Charles. *London.*  
KHAN, Nai Seng. *Plymouth.*  
KOLODZIEJ, Ronald John. *Cranfield, Bedfordshire.*  
PARR, David Frederick. *Bolton, Lancashire.*  
RAGUNATHAN, Rajaratnam. *Southall, Middlesex.*  
SPRIGGS, James William. *Canterbury, Kent.*  
SRISKANTHA, Selvadurai. *Southall, Middlesex.*  
WONG, Yew Thy. *Swansea.*

## OVERSEAS

### CORPORATE MEMBERS

#### Transfer from Graduate to Member

BUCKINGHAM, David. *Geneva, Switzerland.*

#### Direct Election to Member

CHEUNG, Shu Wing. *Kowloon, Hong Kong.*  
KANDASAMY, Kanapathipillai. *Jeddah, Saudi  
Arabia.*  
LEE, Pui Kwong. *Hong Kong.*  
LEE, Wing On. *Kowloon, Hong Kong.*

### NON-CORPORATE MEMBERS

#### Transfer from Student to Graduate

LIU, Chi Kin. *Shauiwan, Hong Kong.*  
VONTAS, Dimitrios. *Pireas, Greece.*

#### Direct Election to Graduate

CHEUNG, Pui Wai Alfred. *Causeway Bay, Hong  
Kong.*  
HALAWI, Tawfic Sulciman. *Beirut, Lebanon.*

#### Direct Election to Student

CHAN, Cheung Fat. *Shatin, Hong Kong.*  
LAI, Kwai Chung. *Kowloon, Hong Kong.*  
LAM, Kam Wo. *Kowloon, Hong Kong.*  
NG, Shek Kwong. *Kennedy Town, Hong Kong.*

## Letter to the Editor

From: F. J. Stone, M.Sc., C.Eng., M.I.E.R.E.

### The Engineer-Author

Mr Powell has raised a number of very valid points on the responsibilities of a Technical Author.\* He does however seem to have missed another important facet, his obligations under the Health & Safety at Work Act.

Section 6 of that Act requires the provision of adequate and accurate operating, installation and repair information essential to support the safe use of any piece of equipment. Such documentation must have been tried and tested. If this is to be successful the engineer and author must co-operate very closely, for their own sakes under Section 36, and that of their employer who will also be liable under Section 37. Of course the whole thing is complicated when documents are being written for subcontractors of the main contract, they also have responsibilities under the Act.

Where information is being prepared for a customer who is an equipment user, the author will need to work very closely with that customer to enable him to meet his obligations under Section 2.

So, not only must the information provided with any equipment clearly show the use for which it was designed, it must also describe any hazards likely to arise out of its use and also how these may be overcome.

May I suggest a new title, Engineer-Author-Lawyer?

109 St Anne's Road,  
London Colney, St Albans,  
Herts AL2 1NU.  
6th December 1979

F. J. STONE

\* *The Radio and Electronic Engineer*, 49, p. 543, November 1979.

## SENIOR STAFF VACANCY AT IERE HEADQUARTERS

Further restructuring of the IERE headquarters' organization to concentrate more effort on to our learned society activities has created a senior staff vacancy. The incumbent of this restructured post will be required to promote and manage the full range of the work of the Professional Activities Department which, acting in support of our Specialized Group Committees, plans and implements the Institution's programme of conferences, colloquia and lecture meetings.

Applicants for this important post should be qualified electronic or radio engineers or physicists who are keenly interested in work aimed at the further advancement of the science and technology of electronic and radio engineering in all its facets. And since the post involves Secretaryship of the Institution's Professional Activities Standing Committee and its subcommittees, applicants should ideally have some previous experience of technical administration in support of such bodies.

The position, which is permanent and pensionable, offers good prospects of advancement to the successful candidate. The preferred age is 40-55 and the salary is negotiable up to equivalent public service executive level.

Any members interested in, or able to recommend potential candidates for, this senior staff vacancy, is invited to communicate direct with the Secretary at 99 Gower Street, WC1E 6AZ (Telephone 01-388 3076).

## Members' Appointments

### CORPORATE MEMBERS

**P. J. Carrington** (Member 1973, Graduate 1971) has joined the European Marketing Centre of Tektronix International in Amstelveen, Netherlands, as Product Manager for frequency domain instruments. Mr Carrington was previously employed by Marconi Instruments, Sanders Division, and latterly by Tektronix (UK) as a specialist on signal processing systems.

**A. A. R. Edet** (Member 1973, Graduate 1969) who has been Principal Engineer/Manager with the Department of Posts & Telecommunications, Government of Nigeria at Port Harcourt for the past year, has been promoted to the rank of Assistant Chief Engineer and now holds the post of Territorial Controller of the Cross River State.

**J. A. Ferla, M.Sc.** (Member 1973, Graduate 1961) has successfully completed his master's degree course in educational studies at the University of Aston in Birmingham under a Ministry of Overseas Development Education Development Award Studentship, and has joined the Hastings College of Further Education as Professional Tutor in Education.

**G. E. G. Graves** (Member 1973) has been appointed Technical Manager, Heavyweight Torpedo, with the Directorate of Underwater Weapon Projects (Naval) Portland. Mr Graves previously served within the Directorate of Military Guided Weapons on Project Headquarter Staff and as a Resident Project Officer at British Aerospace, Stevenage.

**C. A. Hillier, B.Sc.** (Member 1978) is now Chief Engineer of CTVC, the television presentation training studios in Hertfordshire, following an internal re-organization. Formerly Mr Hillier was with the BBC in the Video Tape Section and a Liaison Engineer in their Programme Planning Group.

**L. Horton** (Member 1975, Graduate 1965, Student 1962) who is a Professional Officer with the University of Sydney, has been appointed to take charge of a new cosmic ray experiment investigating the density spectrum of high energy cosmic rays in Wyong, N.S.W. He was previously officer in charge of the high energy cosmic ray extensive air shower experiment at the University's Cosmic Ray Station at Narrabri, N.S.W.

**Sqn Ldr P. F. W. Hutchins, RAF** (Member 1972, Graduate 1967) has been appointed Electronic Warfare Engineering Officer at Central Tactics and Trials Organization at RAF High Wycombe. He was previously Officer Commanding Electrical Engineering Squadron at RAF Coningsby.

**A. C. J. Kirkham, M.Sc.** (Member 1971) has been appointed Deputy Chief Electricity Meter Examiner at the Department of Energy Headquarters in London. Mr Kirkham was previously Area Electricity Meter Examiner based at Southampton.

**Sqn Ldr T. S. Page, RAF** (Member 1973, Graduate 1967) has been appointed CSDE Project Officer—Nimrod Mk2 and Tactical Sensors, at RAF Swanton Morley. He was previously a Project Officer on Nimrod Mk2 at RAF Farnborough.

**D. W. Reay** (Member 1971, Graduate 1965) who joined Harlech Television in 1972 as Engineering Manager and Chief Engineer of the Television Centres in Cardiff and Bristol, has been appointed Director of Engineering.

**R. G. Skelton, B.Sc.** (Member 1961), formerly General Manager with SKF (UK), has joined Neve Electronics International, Melbourn near Cambridge, as Group Manufacturing Director.

**G. H. Sturge** (Member 1963) has retired from the BBC after 17 years service, for the last 7 years as Assistant Head of the Engineering Information Department. Mr Sturge will be working on certain projects for the Engineering Information and Engineering Recruitment Department on a part-time basis.

**G. Taylor** (Member 1971, Graduate 1968) who was with Norman Blezard & Partners as an Electrical Design Engineer from 1978 to 1979, has now joined the North Western Regional Health Authority as a Main Grade Engineer.

**Sqn Ldr N. V. Zotov, RAF** (Member 1974, Graduate 1971) has been appointed Senior Engineering Officer, IX Squadron, RAF Waddington. He was previously on the staff at HQ Strike Command, RAF High Wycombe.

### NON-CORPORATE MEMBERS

**S. Kannan** (Associate 1955) has joined Codan Pty of Adelaide, South Australia, as Quality Assurance Engineer. Mr Kannan's previous appointment was with Pye Industries, N.S.W., as Quality Control Manager.

**A. T. Sampanthar** (Associate 1977) who is with the Sri Lanka Cement Corporation has had his appointment as Superintendent in the Electrical Section confirmed.

## Obituary

The Institution has learned with regret of the deaths of the following members.

**Richard Filipowsky, Dipl. Ing., Dr. Techn.** (Fellow 1951) died in Tampa, Florida on 22nd December 1978, aged 63. Born in Vienna and educated at the Technische Hochschule from where he graduated with a Diploma in applied physics in 1939, Dr Filipowsky worked throughout the war years with Telefunken on the development of pulse techniques. From 1946-48 he was Director of the Institute RATEM for scientific documentation at Röhth in Austria and then for two years was Chief Engineer in the laboratory of Radio Marconi, Lisbon. In 1950 Dr Filipowsky went to India to become Professor and Head of the Department of Electronics at Madras Institute of Technology. Here he remained until 1955 and during this period he took an

active part in the establishment of the Institution's Madras Section, serving as its Secretary, and he also contributed an outstanding paper on 'Electrical pulse communication systems' published in three parts in the Journal in 1955/56 which gained him the Heinrich Hertz Premium. He was a holder of more than 20 patents, mainly for television and pulse techniques.

In 1956 Dr Filipowsky went to the United States where he worked first for Westinghouse and later for IBM at its Communications Systems Centre in Rockfield, Maryland.

**Wing Commander Albert Edward Jaquemet, O.B.E., RAF (Retd)** (Fellow 1959, Member 1955) died on 5th December 1979, aged 72 years. Wing Commander Jaquemet had a

distinguished career in the Signals Branch of the RAF which he first joined in 1923 as an apprentice at the Electrical and Wireless School at Flowerdown. Between 1936 and 1940 he was Communications Superintendent of Misr Airlines, Egypt, and in 1940 he was commissioned in the RAF as Technical Signals Officer; from 1944 to 1946 he was Technical Signals Advisor to the British Military Mission to Egypt. In 1946 he joined British Overseas Aircraft Corporation as Signals Officer, and a year later he was appointed Manager for International Air Radio. After holding appointments in Greece, Burma and the UK, Wing Cdr. Jaquemet was appointed Manager of the company's engineering division in 1952, a post he held until his retirement at the end of 1966. He continued as a Consultant to the company for a further four years.



## Colloquium Report

# The Philosophy of Maintenance in an Age of Miniaturization

*Held at the Royal Institution, London, on 20th November, 1979. Organized by the Electronic Production Technology Group Committee*

Approximately fifty participants joined in lively discussions, which followed stimulating presentations by authors from design, procurement and user organizations. The morning session was chaired by Mr L. Hale of British Aerospace, Stevenage, and the afternoon session by Professor D. R. Towill of UWIST, Cardiff.

The following are summaries of the contributions. (The speakers are willing to provide further information on direct application by members of the Institution.)

### Maintenance of Ground Electronics in the Royal Air Force

Sqn Ldr S. W. Sarll (*HQSTC*)

Historically, the Royal Air Force has framed its maintenance policy on the need to service and repair all its equipment on a world-wide basis. Centralized storage and maintenance depots have supported front line units and stations with the backing of industrial resources for major repairs and overhauls. Vast sums of money are committed for initial purchase and annual consumption of spares to support a wide range of equipment. Each and every item must be given a Service Catalogue number and be fully documented in spares publications with computer-aided supply management.

All low-voltage electronic equipment is now manufactured using printed circuit boards having very high m.t.b.f. figures. It may not be cost-effective to provide all the necessary means for every repair down to individual components, even for a military organization. Consideration is therefore being given now to an alternative approach of 'discard on defect' in a modified form for defective p.c.b.s. So, by investing in a moderately larger initial order of p.c.b.s than required by the prime equipment, considerable economies can be made in reduced documentation, procurement, and repair costs.

Defective items are to be stored, not thrown away, so that in the unlikely event of stores stock being exhausted before the working life of the prime equipment has expired, the p.c.b.s can be returned to the manufacturer and repaired on a batch basis. An added attraction in times of galloping inflation is the advantage of buying all spare p.c.b.s at relatively low cost. The user must, however, be persuaded to consider minimizing life cycle costs, not simply production costs, if full advantage is to be gained from this new approach.

### User Aspects and their Influence on Design

A. S. Leyland (*British Aerospace, Warton*)

In the aircraft industry the success of a product can be decided on the ability to service and maintain the aircraft and so a great deal of attention is given to maintainability. This means costs in terms of extra weight to provide access panels, lower packaging density and extra circuitry in electronics which, in turn, reduce pay load or degrade performance or both. There is therefore always a search for the best possible maintainability within the allowable volume and weight constraints.

Considering only the avionic and electrical aspects of the problem, by providing hinged panels in many parts of the aircraft, good accessibility and easy removal and replacement of the Line Replaceable Units has been achieved. On aircraft such as the Tornado there still remains the biggest problem: which unit is faulty and must be replaced?

At present there are several methods available including diagnosis by replacement, and discard on failure. The problem for the future is that there will be a comprehensive set of electronic equipment using common data highways. Testing must therefore be catered for from initial design as part of the basic design, as it will be impossible to add test points and circuitry later. Some of the requirements to meet this philosophy will involve major changes in present practices to obtain a much better maintainability on electronic equipment on the next generation of aircraft. These include the aircraft manufacturer taking early responsibility for specification of test philosophy, and enforced consideration of test techniques at the performance specification stage, as distinct from waiting until the sub-system manufacturer has built his prototypes.

### The Standard Electronic Module Programme—One Solution to the Problem of Rising Support Costs

G. S. G. Spencer (*ASWE, Portsdown*)

The question of containing the increasing costs of supporting complex electronic equipment in service has been of major concern to the armed forces of recent years. Inflation and complexity are not the only contributory factors. Repair by replacement policies have added considerably to the overall cost.

The Royal Navy in looking at the problem is studying the US Navy's Standard Electronic Modules (SEM) Programme which is a highly successful design standardization programme that is commanding considerable attention as a result of its achieving significant cost and reliability results. It establishes a rational discipline for the development process for military electronic systems by providing families of functional electronic modules which are already developed, documented, and qualified, and for which a wide industrial base exists. Although this programme has been heavily orientated at resolving system maintenance and logistical support problem areas, it nevertheless constitutes a readily available and highly effective 'building block' approach for accomplishing research and development functions which brings about significant reduction in development time.

The cycle costings have been spectacularly reduced, (maintenance costs typically have been halved). Some 20 US firms are committed to using SEM techniques, including one for commercial application as distinct from military usage. Within 12 months, certain parts of UK industry are expected to follow suit.

### A Simulation Technique for Evaluating Competing Maintenance Philosophies

A. Davies (*UWIST, Cardiff*)

The discrete event simulation model described is designed to optimize repair/discard decisions for electronic modules which make up an equipment supported by a multi-echelon supply system. For an arbitrary four-module electronic assembly, pre-chosen stocking levels are set at each of the three echelons comprising the supply system, so as to achieve a 97% availability requirement.

The supply system model is at present restricted to include only two alternative philosophies. These are:

Repair using 'in-house' facilities at 1st and 2nd echelons only.

Discard all modules at failure.

Both options are executed successively, thereby generating data from which system performance may be evaluated for the stocking levels chosen.

Repair/discard decisions are then made by comparing cost data produced during execution of the programme, the model simulating supply system performance over projected equipment service life, for both options. A single purchase of spares to run the system for this period is assumed. The results obtained from one run of the simulation model show a good correlation to the predicted stocking levels for the discard option, with the availability constraint of 97% being met for the majority of equipments. However, in the repair case some over- and under-provision of spares is noted against the four modules considered.

The model is capable of considerable extension, so as to provide the user with the information on which to compare a wide range of alternative maintenance policies. It should be noted that the model is designed to simulate the actions necessary at each test stage, so that typical time history of spares levels, etc., are available from the print out.

#### Status Words in System Exercise and Diagnosis

A. Bavister and R. Shabolt (*British Aerospace, Stevenage*)

Traditional techniques for system tests and for fault diagnosis have been based on methods of parametric measurement and branching diagnosis. The advent of microprocessors incorporated into systems provides new approaches to the diagnosis of failures in systems which are largely analogue in nature.

Parallel access to status indication is described showing its use as a diagnostic tool by codified results in new and unity sequences. Thus techniques of organizing and recognizing fault patterns are borrowed from digital technology and applied to analogue system diagnosis. Failure modes are discussed and a method developed for utilizing the information derived from the success or failure of each of a group of tests. The areas of present investigation and future development are indicated, and the need for reliable and rapid feedback indicated. There has also emerged a need to agree on simple definitions of terms

such as 'fault', 'multiple fault', 'incident', 'failure' and 'defect', which at present have inconsistent usage between various Branches, Establishments and Industry.

#### Testability

R. M. Sawtell (*Marconi Avionics, Rochester, Kent*)

The conflict between the designer of prime equipment, and the designer of the test equipment which requires testability to be provided within the design of the prime equipment, to enable this system to be tested and diagnosed to the minimum number of components, within the minimum elapsed time is examined. Designers of the prime equipment are primarily concerned with the performance of the equipment, and hence the operational capability, whereas the designers of the test equipment are concerned with the design of the test equipment and its performance in testing the units and sub-modules of the electronics system of the prime equipment, within the shortest possible time, with a minimum amount of test equipment.

#### ATE Maintenance Philosophy

P. J. Hand (*Marconi Space and Defence Systems, Hillend, Fife*)

This paper concentrated not in the areas of how maintenance of present-day automatic test equipment is carried out, but how new maintenance techniques must be developed to test the ATE's that are now becoming available. New technologies being incorporated in the design of new systems can be used, not to increase the complexity of self testing, but to benefit from the current difficulties and ensure simplification of techniques being used, wherever practical, without detriment to the depth of testing required.

These philosophies of ATE testing have been established by manufacturers of ATE who not only have many years of ATE design experience but are also major users of such equipment in the UK. The basis of a new approach to maintenance is required to use ATE that is purely modular using virtual instrument techniques. This paper demonstrated how this approach increases the reliability and availability of the system and reduces the cost of ownership. It also enables the user to have more direct control over the maintenance and calibration of the test system.

L. HALE; D. R. TOWILL

---

## Microprocessor Application Courses

Since 1976, the Department of Electronics at the University of Southampton has been providing intensive short courses on microprocessors, specially designed and developed for industrial personnel. The highly successful 3-day course 'Theory and Practice of Microprocessors' has now been presented on 23 separate occasions to over 800 delegates. The Department has now prepared a series of courses looking beyond to practical skills in the hardware and software development of microprocessor systems. The course almost entirely comprises 'hands on' involvement with a Motorola M6800 development equipment and following a familiarization period, two days will be devoted to the solution of individual projects from real-world applications.

Numbers will be restricted to ensure adequate availability of equipment and expert supervision will be provided at all times.

The five-day courses are suitable for those who have completed

introductory courses and who wish now to become directly involved with microprocessor systems. These courses will be given on the following dates:

21st-25th April; 14th-18th July; 22nd-26th September 1980.

Fee for the course £250 including course notes, luncheons and refreshments.

A special combination course of a two-day introductory syllabus followed by a three-day 'hands on' session will be held from 24th-28th March 1980. Fee for the course, £250.

The courses are supported under the Department of Industry's Microprocessor Applications Project. Details and application forms from: Microprocessor Unit, Department of Electronics, The University, Southampton SO9 5NH (Tel: (0703) 559122, ext. 2882).

# ANNOUNCEMENTS

## Centenary of British Audiometry

Three years ago we all celebrated the centenary of Alexander Graham Bell's patent of the telephone. Many innovations, social as well as technical, have followed but it is interesting to note a celebration, in 1979, of the centenary of the consequential invention by Professor D. E. Hughes of the audiometer. Professor Hughes is of course well known for his early work in 'radio' communication, also in 1879, using a technique which has been the cause of controversy as to whether it did or did not anticipate, by over ten years, Marconi's early experiments.

However, his invention of the first fully electrical audiometer may be regarded as a pioneering example of 'medical electronics' and as such fully deserving the recognition given to it by the symposium organized jointly by the British Society of Audiology and the Science Museum and held at the Science Museum, London, on 19th October last. Seven papers were presented and have been collected together as Supplement No. 2 to the *British Journal of Audiology* dated November 1979.

Titles of the papers are:

Electrical engineering 100 years ago—B. Bowers (Department of Electrical Engineering, The Science Museum).

David Edward Hughes, F.R.S.—J. E. J. John (Department of Audiology, University of Manchester).

Hughes' audiometer—S. D. G. Stephens (Department of Auditory Rehabilitation, Royal National Throat, Nose and Ear Hospital).

Hughes' place in the history of radio—W. K. E. Geddes (Department of Electrical Engineering, The Science Museum).

Audiometers from Hughes to modern times—S. D. G. Stephens.

The scope of present day audiometry—R. R. A. Coles (Institute of Sound and Vibration Research, The University of Southampton).

Measuring hearing loss in the future—R. S. Tyler (MRC Institute of Hearing Research, University of Nottingham).

Copies of the supplement containing the centenary symposium papers may be obtained from the *British Journal of Audiology*, 105 Gower Street, London WC1E 6AH, price £1.25 post free.

An exhibition of equipment showing the development of audiometry during the past 100 years was arranged at the Science Museum and this will remain open until April 1980.

## VDUs and the Operator

Considerable interest was aroused by a short article from the Association of Optical Practitioners entitled 'The VDU and The Operator', which was reprinted in the *Journal* in April 1979. The authors S. G. Rosenthal and J. W. Grundy have now written two broader-based booklets on the subject of v.d.u.s and their effect on eyes, also published by the AOP.

'Vision and VDUs' which contains the original paper, and additional information, is aimed at employers, medical, safety and personnel officers, plant buyers and management in general. It costs £1.50 per copy.

'VDUs and You' is of a less technical nature and is aimed at the operator and should serve to allay operators' fears about possible adverse effects on the eyes. It also shows how to avoid

eyestrain and ensure optimum use of the equipment. This booklet is available in packs of 10, 50, 100 at £1.75, £8.00 and £12.50 per pack respectively.

Orders with remittance should be sent to The Association of Optical Practitioners, (VDU Department), Bridge House, 233 Blackfriars Road, London SE1 8NW.

## Index to Volume 49

The Index for the 1979 Volume of *The Radio and Electronic Engineer* (comprising title page and principal contents list, subject index and index of persons) is being sent automatically to all subscribers to the *Journal* with this issue.

Members who wish to obtain a copy of the Index for binding with their *Journals* or to keep separately for reference purposes may obtain a copy free of charge on application to the Publications Sales Department, IERE, 99 Gower Street, London WC1E 6AZ, by letter, or by telephoning 01-388 3071.

Indexes are included in all bound volumes of the *Journal* and members who propose to send their 1979 issues for binding need not apply for a copy of the Index beforehand.

## Standard Frequency Transmissions

(Communication from the National Physical Laboratory)

Relative Phase Readings in Microseconds  
NPL—Station  
(Readings at 1500 UTC)

December 1979	MSF 60 kHz	GBR 16 kHz	Droitwich 200 kHz
1	-2.7	7.5	42.7
2	-3.0	8.0	42.4
3	-3.0	8.7	42.2
4	-2.9	8.4	41.9
5	-3.1	8.2	41.6
6	-2.9	8.7	41.3
7	-3.1	8.0	41.1
8	-3.3	8.5	40.8
9	-3.3	4.7	40.6
10	-3.1	6.2	40.4
11	-3.3	7.4	40.3
12	-3.3	8.4	40.1
13	-3.5	8.0	40.0
14	-3.2	9.1	39.8
15	-3.6	5.7	39.6
16	-3.7	8.0	39.5
17	-3.7	8.1	.
18	-3.5	8.5	.
19	-3.7	8.9	.
20	-3.4	9.1	.
21	-3.7	9.4	38.5
22	-3.7	8.3	38.2
23	-3.9	8.4	38.0
24	-3.9	8.9	37.8
25	-3.9	8.2	37.5
26	-3.9	9.3	37.2
27	-4.1	8.6	37.0
28	-3.9	8.4	36.9
29	-3.7	9.2	36.8
30	-4.0	7.7	36.6
31	-3.8	8.1	36.4

Notes: (a) Relative to UTC scale (UTC<sub>NPL-Station</sub>) = +10 at 1500 UTC, 1st January 1977.

(b) The convention followed is that a decrease in phase reading represents an increase in frequency.

(c) Phase differences may be converted to frequency differences by using the fact that 1 μs represents a frequency change of 1 part in 10<sup>11</sup> per day.



## First Destinations of Polytechnic Students Qualifying in 1978

A statistical report on those obtaining First Degrees and Higher Diplomas by full-time and sandwich course study has been published by the Committee of Directors of Polytechnics. It is the third of the annual surveys developed by a Working Party of Polytechnic Careers Advisers which covers all full-time and sandwich first-degree and Higher Diploma courses in the 30 polytechnics in England and Wales.

The Booklet elaborates on the summary report of the survey given in the digest published by the Central Services Unit for University and Polytechnic Careers Services, and gives the picture for specific disciplines for both degrees and higher diplomas (which include those under the auspices of BEC and TEC, as well as HNDs). It also includes separated breakdowns by subject areas for full-time and sandwich courses.

Amongst other facts the survey shows:

There was an 18.7% increase in the output of first-degree graduates over 1977 and a corresponding 17.3% rise in higher diplomates. The percentages of those believed unemployed have fallen to new low levels.

Over 70% of graduates and over 90% of higher diplomates qualified in subject areas of an applied nature.

Amongst those graduates whose destinations were known and who went into permanent employment were nearly 70% from Education courses, 98% from Pharmacy and 79% from Computer Studies. Business Studies furnished the largest number of qualifiers moving into employment, with 701 graduates and 576 higher diplomates: Education provided 1091.

There was a slight movement in categories of employment towards the Public Service from Industry and Commerce, and a slight move from Industry to Commerce. Nevertheless, 88% of Engineering and Technology graduates entered these latter two areas.

Omitting B.Eds., 30% of polytechnic graduates and practically a half of the higher diplomates qualified from sandwich courses, emphasizing the importance attached to practical training. 72% of sandwich course engineers and technologists went into industry and commerce: taking into account students returning to their previous employment through sponsorship, nearly 80% of all sandwich course graduates went into industry and commerce.

Apart from the proportion of B.Ed. graduates from university-controlled courses, practically all graduates are from courses validated by CNAAB.

The Report, 'First Destinations of Polytechnic Students Qualifying in 1978', is available price £4.00 (including postage in the UK) from: Committee of Directors of Polytechnics, 309 Regent Street, London W1R 7PE.

## 'Challenge of Choice'—A Film on New Technology in Telecommunications

A new film that explores the implications of the revolution taking place in telecommunications has been produced by Standard Telephones and Cables (STC). Entitled 'Challenge of Choice', the 25-minute 16 mm colour film looks at the impact current and future developments in telecommunications will have on people's lives at home and at work. It is not a conventional promotional film, but one deliberately designed to provoke discussion.

The 'Challenge of Choice' derives its title from its exploration of three important decisions. Firstly, the choice telecommunications administrations must make when selecting their suppliers; secondly, the choices offered to people as a

result of developments in communications technology in education, leisure and work; and, finally, the choice society must make about the application of technological developments still in their infancy.

The final sequence of the film examines the marriage of biology and electronics where it is thought that the developing science of 'bio-electronics' may give us new ways to communicate with computers, perhaps by thought alone, thereby extending and amplifying human intelligence.

The film, made by World Wide Pictures, is one of the first documentaries to be made with a stereophonic soundtrack and includes original electronic music by John Saunders.

Free loan of the film can be arranged through Guild Sound and Vision, Woodston House, Oundle Road, Peterborough PE2 9PZ.

## D. of I. Research and Development Annual Report Published

Last year the Department of Industry spent £134M on research and development, a reduction in real terms of 3% on the previous year, according to its 'Research and Development Requirements and Programmes Report 1978-79'.

There was a 40% increase, however, in the computers, systems and electronics field and a 9% increase in mechanical engineering and machine tools. £55M was spent in industry, £45M in the Department's industrial research establishments and £34M with other contractors including research associations.

The Report covers all the Department's research and development but this year concentrates on the work of the Requirements Boards, whose task is to co-ordinate Government policy with industrial needs, particularly in the light of possible advances abroad. They also define R & D priorities requiring co-operation between private and public sector.

Many of the Requirements Boards are encouraging energy conservation which receives a separate section in the Report this year. Projects include increasing the efficiency of different types of kilns, recovery of waste heat in aluminium melting furnaces and sulphuric acid plant, new methods of textile manufacture to save both energy and water.

Computer technology is being applied to many areas: in simulators for aircraft and ship handling and for mathematical modelling to replace component testing. A computer-based detailed drawing system has been developed with support from the Mechanical Engineering and Machine Tools Requirements Board which has also continued to encourage wider use of computer-aided engineering in firms.

An automatic control system for bulk melting furnaces has been developed with support from the Engineering Materials Requirements Board which relies on a microprocessor and ensures optimal combustion conditions during the cycle.

New materials have been developed, tested and successfully exploited. Liquid crystals developed with support of the Computers, Systems and Electronics Requirements Board are now being sold to Japan. Carbon fibre reinforced plastics antennae will be used on the *Intelsat V* communications satellites and basic R & D for this was supported by the Engineering Materials Requirements Board.

Safety at work and in the environment has been considered by many of the Requirements Boards. The Ship and Marine Technology Requirements Board has looked at the problems experienced by pilots at their work, and by all personnel boarding ships. It has also continued to support R & D on oil pollution.

Work on reclamation and re-use of materials continues to be supported by the Chemicals and Minerals Requirements Board: aluminium drink cans, for example, are being used in the production of permanent magnet alloys.

The Metrology and Standards Requirements Board gives financial support to the British Calibration Service and in this area new methods of measurement have been developed. Laser interferometry has been used in calibrating the pitch of tapered screw thread gauges of particular relevance to the oil industry,

a new machine at the National Physical Laboratory has assisted in the calibration of load cells used to test motorway bridge bearings, for example, and a calibration service for ultrasonics has been built up for use in medical diagnostic equipment. Long distance time comparisons have been made by satellite and this method will probably replace time transfer by ground links. The data from *Meteosat* is becoming widely used in daily weather forecasts and a second model of this satellite is in preparation.

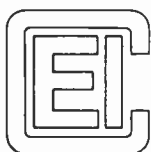

## How Many Chartered Engineers?

Until July 1979, when computerization of the Chartered Engineers register was completed, the CEI had been unable to reply with any precision to enquiries about the total number of Chartered Engineers. It is now known that the figure at the end of September 1979 was 195 500, subject to a statistically nominal adjustment for additions and deletions in the pipeline.

The number revealed by the computer has been surprising and encouraging, since it is some 20% more than previous estimates which had been based upon sampling. One problem had always been that many individuals have multiple membership of institutions and, consequently, there was considerable duplication in the earlier records. In fact, the total number of names on the books was in excess of 220 000 and it has only been possible to cut out the duplications—and even 'quintuplications'—with the aid of the computer.

CEI and the Engineers Registration Board consider that this figure justifies the confident claim of CEI that those registered as Chartered Engineers—by its voluntary system—represent the major proportion of all those in the profession.

It has admittedly taken rather a long time to set up the register in its new form. The basic information was that held by the CEI's sixteen Corporation Members, ten of whom held their records in various forms in computer systems and the remainder relied upon manual systems. To establish the new register a variety of inputs had to be dealt with.

In view of the scale of the information provided by institutions it is not surprising that there were a number of real discrepancies in the spelling of names and many other cases in which mis-spelling appeared likely. Only manual checking can meet the need in these circumstances since the computer will make two entries if there is a single letter difference between two inputs of a name. The checkers needed to determine whether the 'Mohammed Sayed' recorded by one institution was the same person as the 'Mahomet Said' of another institution. Again, problems were posed by the 2060 Smiths, the 1088 Browns and the 537 Robinsons, a great proportion of whom bear the sole forename of John!

A few members of institutions have complained about having to declare their date of birth for the register and it will be of interest to them to know that it was that factor which enabled distinction to be made between those registrants otherwise indistinguishable. The register only records full names, date of birth, sex, the institutions of which the individual is a corporate member and his grades of membership in those institutions: neither the private address nor the employer of the Chartered Engineer are listed. In the

interests of economy it is important that only those details which are stable and essential for the purposes of the register are recorded. Frequent updating is a highly time-consuming task and hence expensive.

The Register is strictly confidential and its maintenance is covered by regulations which include:

- 5.4 'An authorised official of each member of the Engineers Registration Board shall have the right to inspect during normal office hours, or be supplied with details of the record of any person admitted to the Register who is a corporate member of his organization.'
- 5.5 'Any person whose name is entered on the Register, or has good reason to suppose it is, may inspect during normal office hours, or be supplied with details of, his entry by prior arrangement with the office.'
- 5.6 'No other person or organization shall be permitted to inspect, or be supplied with, the record of any person admitted to the Register without the agreement of that person or the prior approval of the Secretary of the Engineers Registration Board.'

Until the Chartered Engineers Section Board was established in January 1978, the registration of all Chartered Engineers had been the responsibility of CEI's Standing Committee on Education and Training (Committee A). Practically, the register was held by the individual institutions in the forms of their own membership records which were copied for CEI when the original register was set up in 1965 and periodically updated with the names and details of new corporate members. The system did not provide for CEI to delete a registrant's name on decease or for any other reason.

In view of the size of the Chartered Engineer's register it was decided to adopt a computerized system rather than the 'Kardevoyor' method which has proved efficient and effective for the lesser numbers on the registers of Technician Engineers (51 400) and Engineering Technicians (18 800). The output of the computer is recorded upon 29 pieces of microfiche, each containing the basic facts of about 7000 chartered engineers in alphabetical order. By inserting the appropriate microfiche into a reader, the operator can check on an individual entry in a matter of seconds.

The actual cost of installing the computerized system proved to be only £6608 although there had been an original estimate of £25 000 when it had been thought that it might be necessary to send reply cards to all engineers. CEI considers that in all respects the register meets the needs: not only does it provide all the essential information but also it does so economically, efficiently and rapidly.



# Derivation of User Communication Requirements



R. V. LATIN, B.Sc., M.Sc., C.Eng., M.I.E.E.

Electronic communication needs of user organizations call for a 'purpose orientated' examination if they are to be properly understood and solutions derived. Identification of the hardware and implementation are generally well covered in the literature and the paper therefore concentrates on obtaining a better understanding of an organization and its communication environment so that a fully effective and efficient service can be given.

## Introduction

We would all probably agree that good and timely communications may be crucial for the attainment of organizational effectiveness, growth and survival. The forthcoming era of increasingly more costly energy and natural resources will see an emphasis on using electronic communications to optimize the use of resources, to obtain a consistent supply of resources for production, and to market goods and services in an intensely competitive world.

The impact of electronic communications on society and, in particular, on the behaviour and effectiveness of organizations, is just not known. We cannot apply effectiveness considerations to electronic communications serving organizations until we place a measureable value on the information handled and the people who generate and use such information. The information economy badly needs accepted valuing methods if we must rely on numerical analysis as a basis for our decisions. For example, it has been postulated that the value of information decays according to different ageing laws which depend on the type of information being sent: administration, finance, supply, marketing and planning.

The electronic communication-organizational interface has moved away from the telex room, or similar specialized communication centre. It is now beginning to affect every facet of business life. Unfortunately, communications ultimately concerns people, with their many value judgments and needs; these are often intangible and cannot be accommodated by general laws.

Today, users are faced by a bewildering collection of electronic equipment and potential communication service offerings, encouraged by the rapid advances in technology.

---

**Bob Latin** graduated in electronic engineering at Birmingham University in 1961 when in the RAF. After six years in engineering management on aircraft and in charge of an h.f. radio station, he obtained his Master's degree in astronautics (space systems and inter-planetary orbits) at the US Air University, Ohio. On his return to the UK in 1969, he became involved in research on future defence integrated communication systems at SRDE, Christchurch. After a period at Staff College, he assumed responsibilities in 1973 for the UK Defence Satellite Communications System *Skynet* in the Ministry of Defence; in 1976 he became responsible for specifying strategic communication requirements, and he completed his Service career as Assistant Director, Signals (Air) in 1977.

For four years he was Open University tutor on system management courses at which time he developed his ideas on the application of systems thinking to the derivation of user requirements. Mr Latin is now employed as a Senior Principal Research Engineer at Standard Telecommunications Laboratories, Harlow, and is involved in the development of new switching concepts for integrated services digital networks and the identification of future user requirements.

How on earth do we find our way through this complicated maze of offered technological solutions to find a system to meet our needs? Worse still, how do we determine what our real needs are? Both the user and supplier have a vital interest in finding a clear definition of need.

The purpose of this paper is to outline a comprehensive approach to the determination of a user's communication needs. This aims at providing a clear understanding of a user's organization and its internal and external environment, before deciding what type of communication system changes should be considered: namely, define the problem before looking for solutions.

## A Purpose-orientated Approach

A derivation of a set of communication needs is highly complicated, often unquantifiable, and protracted. There are no short cuts: you either pay out now or much more later.

It is fundamental to the analysis of need that the investigations are not biased from the beginning by what is technically available or possible. Such factors should be introduced later when the user fully appreciates his own and inter-related organizational environments: what needs to be achieved and why? What are the freedoms and constraints in terms of organizational structural changes permitted, psychological and sociological adaptation and economic and environmental interactions.

An eclectic approach is required which is purpose-orientated and not solution-orientated.

## Underlying Premise

The underlying premise to our analysis should be based on a recognition that the most basic requirement in ensuring the successful operation of an organization is the continual, undistorted and uninhibited flow of the RIGHT information (i.e. not unprocessed data) to the RIGHT person at the RIGHT time and at acceptable cost. Any communication system which fails to provide for this requirement is immediately suspect.

## Levels of Abstraction

The derivation and satisfaction of our communication needs can be approached through four levels of abstraction:

**1. Organization.** A thorough understanding is required of the organization, its national, international, social, economic and resource environment, its goals, objectives and tasks, its decision-making processes, its current and required performance, and its main freedoms and constraints, which determine what we are able to do. From this understanding, coupled with an analysis of the information flows embedded in the structure and crossing the organizational boundary to

other organizations, we should be in a good position to derive an accepted set of communication needs. These will be derived in qualitative and quantitative terms, and must be described in a language which is comprehensible to all concerned.

**2. Communication Media.** A thorough understanding of the characteristics of the different types of communication media, or services which might be used to satisfy the derived needs, is required. Here we are concerned with man-media interactions. From a comparison with the current communication media or services in use, the extent of the development programme and organizational adjustments required may be deduced.

**3. Communications Equipment.** A thorough understanding of the communication equipment and systems available to satisfy the derived needs and an appreciation of the equipment trends. In particular, any equipment shortcomings and limitations should be highlighted, so that the necessary compromises can be examined in the light of the information gained from the two previous levels of abstraction. Always be prepared to revise your deductions, since a change to the organization's goals, objectives or tasks may become necessary if you proceed with your intention at this stage. Many iterations may be required. The overlap between need, human factors and technology provides the output required to derive a specification which provides the interface between user and designer.

**4. Implementation.** A thorough understanding of the ingredients necessary for a well specified and managed design, development, implementation and follow-up monitoring programme is required. It is vital that shortcomings are recognized as early as possible in the project so that modifications or organizational adjustments can be introduced. Changes late in the life of a project can be very costly. If it is necessary to introduce a large complicated system without investing in a prototype first, then be prepared to accept the delivered system as the prototype, because that is what it will turn out to be.

On the whole, we are well aware of many of the tasks associated with Levels 3 and 4, and there is a supply of good engineers able to deal with the problems that arise, or there used to be.

Levels 1 and 2 fall into the 'no man's land' of organizational management and system engineering. The manager concentrates on the social and economic aspects of the organization served by the system, and the engineer on the technological aspects of the communication system. The root cause of any unsuccessful system often occurs at the interface between these two areas of interest.

An incorrect identification of the more important organizational needs, and a lack of awareness of how people may respond to a new communications environment, could result in the procurement of a system which, technically sound, is counter-productive as far as improving the communications between people is concerned. For example, it is little use speeding up the information output flow if the way people choose, or have to work, results in massive information overload at the input. Man's reading speed of 1 or 2 lines a second should not be overlooked, and his rate of assimilation of the written word is most certainly a great deal less. Furthermore, the ability to communicate with clarity and brevity is a skill which is in short supply; we should be wary of adding to the problems in this area.

On the other hand, a new system can be so good that it becomes choked by the unexpected demands placed on it. Adequate attention to Levels 1 and 2 can help to spot important side effects.

The main emphasis in the literature has been on Levels 3 and

4. Those of us who have been blooded in communication system procurement programmes have a good grasp of the many problems and frustrations here. Yet, when we survey with incredulity the burnt offerings from the supplier, we quickly become involved in legal arguments over words in the contract and, in the worst cases, mutual abuse. This reaction, which is quite normal, fails to recognize that the root cause of the problem lies in a failure to define and to comprehend the requirements in the first place; both parties share some responsibility for this, and it is never black and white.

It is the lack of guidance to help us tackle Levels 1 and 2 which frustrates our good intentions. As we enter the information age, this weakness will come to haunt us again and again.

### Level 1: Analysis and Synthesis

The approach to Level 1 should be based on an analysis of the organization, which aims to determine the more important constituent parts and interactions, followed by a synthesis to obtain the best understanding of the organization as a whole.

The approach recognizes that a change to any constituent part affects the whole. This is very important in communication planning, because we are likely to affect the main links that hold an organization together, or its links with the outside world, and these are primarily based on information flows.

A list of questions, based on the approach to understanding complex human activity systems adopted by the Open University Systems Course Team, and my own experience in this field of trying to define my organizational communication needs, is given in the Appendix to this paper. Let me immediately qualify the list by admitting that it is not yet considered to be a complete and sufficient list. It will, however, provide much needed guidance to deriving requirements for potential users of modern electronic communication systems.

A common reaction to this stage of the analysis is: 'We will never get started on our project, and they want it yesterday!' It is not that bad, for as you gain experience in using this approach, and come to understand your organization, you will quickly be able to decide what is important and what is lost in the noise.

The whole approach should be adaptive: be prepared to change the objectives. It is possible that the problem has nothing to do with communication systems or computers, but is caused by a deeper organizational defect. Time and effort spent at this stage can often save a reputation, and prevent the introduction of an expensive white elephant.

When the communication needs have been identified, we have to decide the type of organization-communication system arrangements which would best serve these needs. This is approached by designing a hypothetical model which comes close to meeting the communication needs. Then, by comparing it with the appreciation gained from Level 1 of the current organization-communication system, areas requiring compromise and changes can be identified. However, we are not just comparing different sets of equipment, but two different human-based systems which are served by two sets of communication equipment.

In order to arrive at a realistic comparison, some ideas of the way people are likely to react to, and interact with, the different communication systems, is required. This brings us to Level 2 of our investigations.

### Level 2: Communication Media (Man-System Matching)

At this level, we are interested in the human and organizational behavioural factors which might have a bearing

on the changes we would like to make to the human communications environment. The latter will be affected by whatever we implement. Education of management and employees is also likely to be an important consideration.

Whilst we would like to know in advance how people will react to a particular system device or service, there exists no adequate or acceptable model of human behaviour which we can use. Furthermore, there does not exist a forum in which users can come together to compare experiences and learn from each other's mistakes. Only when major failures occur do we learn anything, and even then the facts that emerge are very sketchy.

The terminal device, in the way it accommodates the man-machine interface, can have a major influence on whether a particular system is used or not. If the mismatch is severe then,

in general, people will not make the effort to use it. Researchers have found that geographical separation from a terminal will inhibit its use—people will walk or travel to engage in face-to-face communication, but not to use a terminal. However, with the increasing cost of energy, cost avoidance may change people's attitudes.

Despite the many and severe problems in this area, we should, at least, identify the unknowns. These should be graded in their importance and used to identify those parts of the communication system which should be introduced into the organization with great care and with limited expectations. This might prevent people making over-optimistic plans dependent on an early exploitation of the communications environment. Some useful information on the possible impact of new (and old) communication systems is summarized in

Table 1. Some characteristics of different communications media

1 Face to Face	Good for encouraging communications, building up trust, developing inter-personal relationships, encouraging obedience of subordinates, settling conflicts and misunderstandings, and tackling other emotive issues such as bargaining. A highly interactive media.
2 Paper	Typography can be adapted to suit message content and the impact desired. A good media for colour. Part of everyday life and habits—people are used to handling written/printed matter, and obtain some pleasure in storing, browsing and expressing thoughts in this media. Helpful as an aid to ordering one's thoughts. Accepted for generations as the most powerful media for communicating over time, and many have a built-in trust in the written word and handwritten signature. Written evidence is a powerful weapon in law. Low interaction media. Cost of paper is likely to increase with the scarcity of production and wood resources. The rising costs of transportation could have an important impact. It is a manpower intensive media. Delays in handling and transportation are becoming increasing incompatible with the needs of modern society. The huge quantity of paper-based information and the high costs of the associated overheads will encourage the use of the alternative electronic media. Differences in interpretation and ability in expressing thoughts in writing coupled with the slow response times can lead to serious misunderstandings.
3 Telex	Overcomes some of the more serious delays and transportation costs in the paper media: however, for short messages only. It is not suitable for bulk multi-address information transportation. Paper is at present the output but with the adoption of v.d.u.s in Teletex this need not be true in the future. With the appropriate use of computer technology can provide a basic storage and retrieval facility. Can be used in a conversational mode and is more interactive than 2. The need for typing skills and the noise of some older machines isolates the system from the true user. The code used in upper case makes the information difficult to comprehend quickly, and seriously restricts the typography that can be used. People have an ingrained belief that messages must be kept short and tend to sacrifice clarity for brevity. Input mode slow and tedious.
4 Facsimile	Can provide a fast way of communicating between the minds of two or more people. Highly accommodating in the use of typography—hence the widespread adoption by the Japanese. Can be used for communicating, with accuracy, highly complex information such as drawings. Interaction is similar to 3. Lack of equipment standardization has inhibited the wide-spread use of this media. Like paper, it suffers from similar disadvantages in storage and retrieval. Bandwidth vs. speed problems need to be considered. Developments in digital processing and transmission could see some major advances and more use of facsimile.
5 Audio (e.g. telephony)	Useful for embarrassing situations, since it helps to depersonalize the environment. Therefore, it is less stressful for unpleasant tasks. Problem solving and information exchange can take less time than face-to-face. Relatively highly efficient in the use of time for information exchange between the minds of two or more people. The system today covers most areas of human activity, and is relatively easy to use. A highly interactive media. Can cause annoyance in interrupting busy people who may also have to respond when not in a receptive mood. Lack of non-verbal cues can cause difficulties in identification and in handling emotive tasks. Information retention can be transitory without information recording. A good media for imparting incorrect information and therefore, it can reduce the feeling of trust. The user has little control over unwanted calls. Can be too impersonal. Real-time response can be counter-productive in complex situations.
6 Video Phone	Has similar advantages to the audio-only system with the addition of more non-verbal cues and the exchange of non-verbal information such as simple pictures. Has similar disadvantages, and the relatively wide bandwidth required incurs a significant cost penalty. The small size of the picture detracts from the feeling of participation, and the viewer needs to lean into the viewer to enhance participation. Resolution at present not sufficient for a full page of normal typescript. Raises psychological questions about personal privacy, but is, however, less depersonalizing than audio alone.
7 Computer-based Message System	Encourages communications and candid exchanges. Frees people from having to interact in real-time. Can reduce delays in decision making. A choice exists on when to receive a message. Messages could be sent and received whenever and wherever required. Could avoid travel costs, as do 2 to 6. Electronic media reduces handling overheads. Medium to highly interactive media. People can too easily swamp others with unprocessed data causing information overload. Messages are too easily destroyed and altered in current systems, reducing trust. Loss of verbal and non-verbal cues can lead to major misunderstandings. Some typing skills required and a special etiquette has to be evolved to make the best use of the media.



Table 1, but there is still much work to be done in this area. We would be well advised to be cautious in the way we make use of the available information: different results can be expected under different operating conditions, and in different organizations.

### Conclusions

There are few suitable methodologies available which could assist users to derive their real electronic communication needs. The derivation of such needs is exceedingly complex and open-ended. Nevertheless, by obtaining a better understanding of the organization concerned, it is possible to extract the more important needs and, more importantly, limit the scope for errors.

The approach adopted should be 'purpose-orientated'. To assist this process, four levels of abstraction have been defined as a progressive way to derive and satisfy an organization's communication needs.

The lower levels of identifying the appropriate hardware and implementation, have been well covered in the literature. An approach to obtaining a better understanding of an

organization and its communications environment has been proposed. The final outcome should be the continual, undistorted and uninhibited flow of the right information to the right person at the right time, and at acceptable cost.

### Bibliography

- Checkland, P. B., 'Towards a system-based methodology for real-world problem solving', *J. Systems Engng*, 3, no. 2, pp. 87-116, 1972.
- 'Human Activity Systems: A System Approach'. The Open University—Systems Management Technology Course 1974.
- Porter, L. W., *et al.*, 'Communications in Organisations', (Penguin Modern Management Reading, Harmondsworth, Middlesex, 1977).
- Short, J. *et al.*, 'The Social Psychology of Telecommunications' (Wiley, New York, 1976).
- 'Long Range Research Report 14, 1970-1977'. Post Office Corporation (UK).
- Special Issue on Social Implications of Telecommunications, *IEEE Transactions on Communications*, COM-23, no. 10, October 1975.
- Waddington, C. H., 'Tools for Thought' (Jonathan Cape, London, 1977).
- 'Computer message systems', *EDP Analyzer (USA)*, 15, no. 4, pp. 1-14, April 1977.

## Appendix: Communication Needs

### Level 1—Organization's communication environment: analysis and synthesis

*OBJECTIVE: To obtain the fullest understanding of an organization's communications environment, and thereby to derive areas which need to be improved.*

#### 1. The Organization and its Immediate Communications Environment

What does the Organization, as a dynamic interacting human system really do and/or provide?

*Comment: It may provide a service—what type of service and with what aim?*

What are the organization's constituent parts?

##### (a) People?

High level decision makers—strategy and plans?

Tactical, day-to-day decision makers?

Routine decision makers?

Doers—people who carry out the actions required by the decision makers, and may include the decision makers themselves?

Feeders—people who convey information on behalf of decision makers and doers?

Gatesmen—people to whom information gravitates in the formal and mostly informal communications network?

##### (b) Activities involved?

Information request, retrieval, storage and generation?

Information transmission, reception, filtering (that is, removal of the relevant from the irrelevant)?

Command and control?

Administration, accounting, purchasing, maintenance, marketing, etc?

Distribution?

Service and customer support?

##### (c) Resources used in addition to people?

Materials, equipment, tools, plant, vehicles, etc?

Information:

— paper

mail, courier, secretarial, reproduction, records and filing, clerical, drawing, production, printing, library, etc?

— telecommunications

audio and video telephones, telegraphy and Telex, facsimile, closed circuit television, v.d.u.s, audio and video conferencing, paging, mobile radio and telephone, electrowriters, Teletex, etc.?

— computer-based

data processing systems, data entry and collection systems, telemetry, word processing, text editing, graphics, messages and facsimile, Prestel, information storage and retrieval, process and production control, optical character readers, etc?

*Comment: All the time we are looking out for weak spots in the associated communications, formal and informal network, and the vital flows.*

What external systems influence the organization under study?

(a) Customers, competitors, financial markets, suppliers, etc?

(b) Government departments, Post Office, EEC, etc?

What interactions does our organization have with the above external organizations (flows of money, goods, people, equipment, information, constraints, etc.)?

*Comment: We are looking for the weaknesses in, and vital characteristics of, the communications associated with those external organizations which have, or could have in the future, a significant impact on the behaviour of the organization.*

## 2. The Organization and its Internal Activities

What are the main inputs and outputs?

Break down the organization into its functional parts (not as described by the organization tree, but as they occur in practice) and describe these on an activity or processing basis.

What are the flows between these internal functional or operational parts?

What resources are employed in each activity or processing stage?

How are conditions controlled at each stage?

What measures the efficiency of each of the activities or processes?

*Comment: The lack of a measure for efficiency could be a major obstacle to obtaining an accurate assessment of communication need. The question of efficiency measurement should be settled first.*

## 3. Organizational Social Structure

Here we examine the people in the organization, and the way they interact to satisfy their own and the organizational needs. The aim should be to filter out, for in-depth study, those people whose communication needs are not being served by the present system, or could do with improvement.

What people and groups belong to the organization?

What purposes do these people and groups have for the organization?

What powers and responsibilities does each group really have, and who does what?

How do they interact in terms of information flows?

Where do the real centres of power lie?

What outside groups does each interact with, in terms of information flows, and can these flows be quantified over time?

What creates group adhesion and identity—face-to-face contact perhaps?

*Comment: Not all the above questions may affect the derivation of communication needs, but we should consciously rule them out.*

## 4. Impact of Change

Here we examine the way our Organization reacted in the past, and is likely to react to change. We also investigate the type of changes to be expected in the future. For example, it might be no use proposing a new system which failed before, or asking for expenditure in the face of heavy losses in the previous year: test the ground before you step on it.

What special or chance events have recently occurred, and how did they affect the Organization?

What relevant external changes or innovations are likely, and how might they affect the Organization?

Are there any particular personalities, or special factors, to consider?

## 5. Corporate Behaviour

Here we look at the Organization as a whole, and try to identify the basis for its existence. All the time, we are trying to identify those aspects which have a major bearing on the communication needs.

What, basically, does the Organization really do? We may have to revise our answer given to the question in (1).

What gives the Organization its identity (this could be very important if a new communication system masks this identity)?

What are the main immediate and future objectives?

Can the achievement of these objectives be measured, and, if so, are they—and how?

## 6. Corporate Policies

Wherever we want to go we have no choice but to start from where we are.

How is the organization likely to behave in the future?

How is it possible to implement changes?

What effects might such changes have, and might some be counter-intuitive?

On what criteria can we decide what changes are desirable?

Whose values determine what is desirable?

## 7. The Investigator

We all have personal biases, motives and hobby horses, so some self-critical examination might help us to discover blind spots. At the very least, it will help those examining the results of the analysis to perform a proper assessment.

*Manuscript received by the Institution on 30th July 1979.  
(Paper No. 1917/Comm 191)*

# Direct detection of a Barker code carried on a p.s.k. signal

**Professor G. S. HOBSON,**  
B.A., Ph.D., C.Eng., M.I.E.E.\*

**M. PALOYANNIDIS,** B.Eng., M.Eng.†  
and

**R. C. TOZER,** B.Eng., M.Eng., Ph.D.‡

## SUMMARY

The signal acquisition time at the input to a charge transfer device is often much shorter than the minimum clock period for useful operation of the device. A feasibility study has been carried out to use this property to down-convert and detect directly, in one operation, a signal pattern carried by phase-shift keying a signal whose frequency is much greater than the maximum clock frequency of the charge transfer device.

\* *University of Sheffield, Department of Electronic and Electrical Engineering, Mappin Street, Sheffield S1 3JD.*

† *Formerly at the University of Sheffield.*

‡ *Formerly at the University of Sheffield; now in the Department of Electrical Engineering Science, University of Essex, Wivenhoe Park, Colchester CO4 3SQ.*

## 1 Introduction

Sampled-data, analogue delay lines with many tapping points along their length may be realized with charge transfer devices (c.t.d.). With appropriate weighting and summing of the signals from the tapping points it is possible to build matched filters for signals whose shape in the time domain corresponds to the tap weights.<sup>1,2</sup> The sampled data rate of these serial delay lines is controlled by a system clock and there is an upper frequency limit dictated by the cumulative effects of incomplete charge transfer caused by the finite time of transfer between each of the many stages. Typically, an incomplete charge transfer fraction of  $10^{-3}$  per stage is the upper limit allowable in a device with, say, one hundred stages.

The input stage of the devices naturally self-samples the continuous analogue signal present at this point and the time of signal acquisition is set by the appropriate clock signal edge at the first stage. The time required for signal acquisition up to this timing point to an accuracy of, say, 1% is much shorter (at least one order of magnitude under usual operating conditions) than the time between successive signal transfers inside the c.t.d. This relative rapid acquisition originates from both:

- (i) the reduced accuracy required in one signal transfer at the input when compared with that required for each of the many cumulative transfer errors inside the device; and
- (ii) the relatively slow charge transfer rate that occurs for signal samples with a magnitude less than approximately 1% of saturation level of charge that can be stored in each stage.<sup>1,2</sup>

The objective of the work described here was to establish the feasibility of using this high speed acquisition to 'recognize' directly a particular signal shape carried on a 180° phase shift keyed (p.s.k.) signal in the intermediate frequency range around 10 MHz or 20 MHz. The conventional step of down-conversion to baseband before signal recognition was omitted. The clock rate of the c.t.d. was appropriate to our desired signal and was typically in the range of tens to hundreds of kilohertz. It is anticipated that such a simple system may be useful for instrumentation when a test signal in the range 1 MHz to several tens of megahertz is transmitted through some device region whose properties are under inspection. The correlation peak associated with this type of matched filter detection has attractive signal/noise enhancement properties even though these may be counteracted by the wider noise frequency bandwidth implied by short acquisition time. Unfortunately it was not possible to carry out a meaningful study of these noise considerations and this account is confined to illustration of the feasibility of signal acquisition.



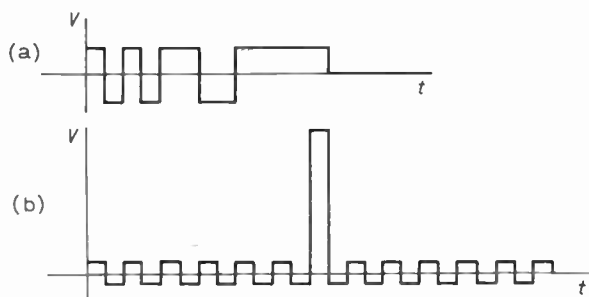

Fig. 1. (a) A 13-bit Barker code, and (b) its autocorrelation function.

**2 The Detection System**

The c.t.d. used was a 32-tap developmental charge-coupled device (c.c.d.) but the results could equally well have been taken with a commercially available device such as the Reticon 32-tap bucket-brigade. We have measured acquisition times of better than 10 ns with settling to better than 1% for both types of device by measuring the device response to a step function. However these simple measurements were limited by the rise-times of pulses available to us.

The signal chosen for recognition was a 13-bit Barker code which has the form in successive clock intervals of +V, -V, +V, -V, +V, +V, -V, -V, +V, +V, +V, +V, +V as shown in Fig. 1(a). The tap weights of the c.t.d. detector had the same form and the correlation peak should be of the form shown in Fig. 1(b). The p.s.k. transmitter had the form shown in Fig. 2. The voltage controlled oscillator was a 74124 TTL oscillator working in the region of 10 MHz to 20 MHz. Its frequency was counted down with TTL counters to control a synchronous Barker code generated from TTL shift registers. The phase inversion was carried out with a 7476 exclusive-or gate for simplicity instead of the correct modulator. The modulated signal had a square-waveform but we wished to simulate the sinusoidal conditions that would be used if the frequency response of a system under test was required. Accordingly, the p.s.k. signal passed through a 6th-order low-pass inductance/capacitance filter before entering the transmission path.

A correlation pattern defect occurred because the binary operation that is implied caused the zero level outside the range of the Barker code to be non-existent and this 'resting' level is either the +V or -V level according to choice. This defect is largely irrelevant for a feasibility study as long as the actual correlation pattern is known. When the resting level is chosen to correspond to -V the correlation pattern has the form shown in Fig. 3. It can be seen that a spurious negative level is generated outside the range of the code correlation response and the detail of the 'sidelobes' around the correlation peak has been modified. However, the correlation peak is still 13 times greater than the

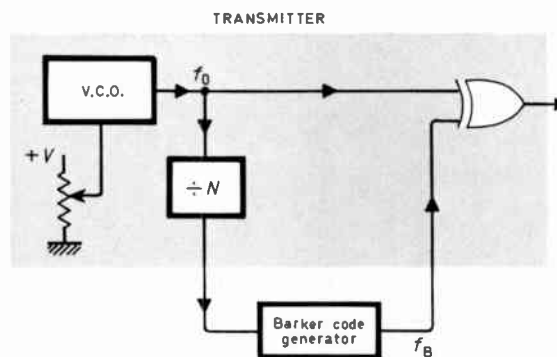

Fig. 2. The block diagram of the p.s.k. transmitter.

individual bit response and the 'extra' negative signal when compared with the correct Barker code response simply makes the correlation peak sit on a 'pedestal'. In our receiver circuit a diode and capacitor d.c. restoring circuit was included in the analogue tap output summing circuitry so that the negative resting level shown in Fig. 3 became the zero level.

The c.t.d. was driven from a clock whose origin frequency was four times the transmitter frequency which was then permanently in phase-lock with the receiver. This procedure was adopted so that standard TTL D-type flip-flops and counters could be used to generate clock driving (or signal shift) waveforms for two c.t.d.s which had a frequency of about 100 kHz but had a timing difference of one-quarter of a period of the transmitted frequency. In this way the signal acquisition in the two c.t.d. channels corresponded to in-phase, I, and quadrature, Q, components of the received signal as shown in Fig. 4 so that we could obtain both amplitude and phase information.

**3 System Performance**

Figure 5 shows the Q and I components of the correlation response when the overall phase shift of the

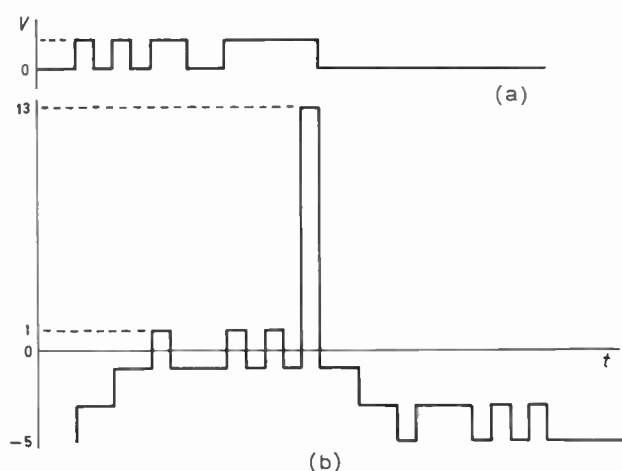

Fig. 3. The autocorrelation function of a 13-bit Barker code with a negative 'resting' level.

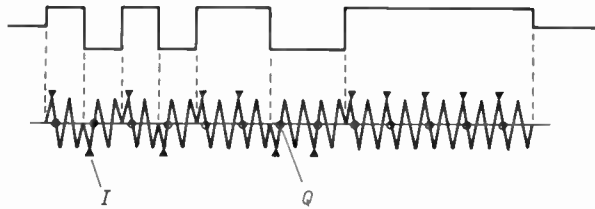

Fig. 4. Illustration of the in-phase and quadrature sampling points on a p.s.k. signal.

received signal has been set to give a near minimum output in the *Q*-channel. Similar outputs were observed in each channel as the phase shift of the transmitted signal was varied by changing the length of the connecting coaxial cable. Their relative amplitudes and signs corresponded semi-quantitatively to that expected from the phase shift but errors arise owing to finite acquisition time effects discussed later.

It can be seen that the correlation pattern in Fig. 5 was not quite identical with that expected in Fig. 3. This is caused by signal smearing arising from incomplete charge transfer which accumulated to approximately 10% over the length of the c.t.d. The correlation peak was also degraded and we obtained a peak no greater than 10 times that of the bit pattern. This optimum result was obtained for transmitted frequencies of both 10 MHz and 20 MHz but we could not work at higher frequencies owing to the limitations of our digital circuitry. However these frequencies are two orders of magnitude greater than the actual c.t.d. clock frequency. Even though we were not clocking the c.t.d. at its maximum frequency it could not have been clocked faster than approximately 1 MHz.

The correlation peak was degraded under conditions where the signal was shared between *I* and *Q* channels. This is to be expected because the signal changes significantly during the acquisition time-constant of the c.t.d. when the acquisition is not at the signal turning points. The effect is to integrate the signal non-linearly over the finite acquisition period and the effect is different for rising and falling signals when using the fill-and-spill input that we adopted.<sup>3</sup>

#### 4 Conclusions

We have shown that it is feasible to down-convert and detect directly signal patterns in one operation using charge transfer devices under conditions where the signal

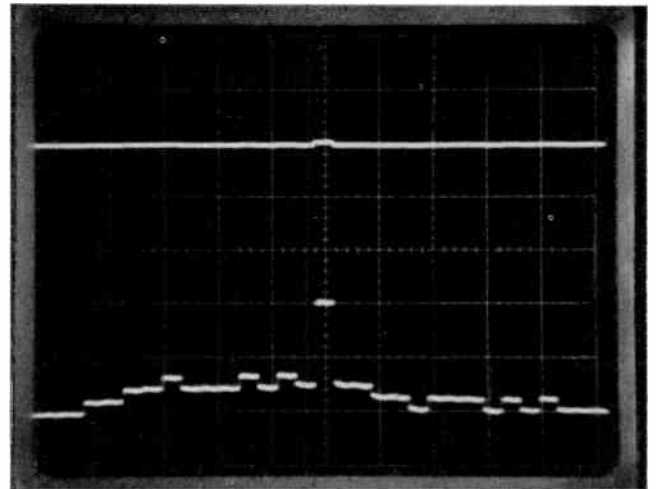

Fig. 5. The experimentally observed autocorrelation pattern in the in-phase channel (lower trace) when the quadrature channel (upper trace) is sampling near to the zero point of the carrier.

frequency is significantly greater than the maximum clock frequency of the c.t.d.

This is an advantageous use of the alias property of sampled data systems in contrast to its more usual troublesome properties. It is made possible because the acquisition time of signal samples at the input to a charge transfer device is usually much shorter than the minimum time between charge transfers when a signal propagates through the device without the occurrence of unacceptable signal smearing.

#### 5 Acknowledgment

This work was supported by a Science Research Council research grant. The authors would like to thank J. Birchenoff of the Plessey Company, Havant, Hants., for the discussions which led to this feasibility study.

#### 6 References

- Hobson, G. S., 'Charge-coupled devices', *Proc. Instn Elect. Engrs*, **124**, no. 11R, pp. 925-45, November 1977.
- Hobson, G. S., 'Charge-transfer Devices' (Edward Arnold, London, 1978).
- Sequin, C. A. and Mohsen, A. M., 'Linearity of electrical charge injection into charge-coupled devices', *IEEE J. Solid State Circuits*, **SC-10**, pp. 81-92, April 1975.

*Manuscript first received by the Institution on 6th August 1979 and in final form on 5th October 1979.*  
(Paper No. 1919/CC 316)

# Frequency-independent analogue phase-shift network technique using field effect transistors

S. R. AL-ARAJI, Ph.D., C.Eng.,  
M.I.E.E., M.I.E.R.E.\*

J. E. ALLOS, Ph.D., C.Eng., F.I.E.R.E.\*

and

K. N. KHALIS, B.Sc., Dip.(Eng.)\*

## SUMMARY

A frequency-independent phase-shift network has been designed and constructed using field effect transistors as variable resistors. The operation of the system is shown to be similar to that of a phase lock loop with a self-generating v.c.o. Analysis of the system is given assuming linear operation. Phase difference outputs have been obtained in the frequency range 20–80 kHz. The phase error introduced in any set phase difference is  $\pm 2^\circ$  in this frequency range. Theoretical predictions indicate this error could be reduced by an order of magnitude.

\* Department of Electrical Engineering, College of Engineering, Baghdad University, Baghdad, Iraq

## 1 Introduction

In recent years several major developments in communication technology have resulted in a need for phase-shift networks independent of frequency to give quadrature and other phase shifts. Phase-shift circuits may be designed using passive elements but because of the inherent frequency dependence of these components, narrow band use is mandatory.<sup>1</sup> The phase shift obtained by this method also depends on the accuracy of the component values used in this design. Digital techniques can be used to provide phase difference signals over a wide range of frequencies.<sup>2</sup> The clock frequency used in this technique is usually much higher than the required output signal frequency which is a disadvantage in many applications.

In this paper, however, an analogue circuit is suggested to provide the required phase shifts using a field effect transistor (f.e.t.) as a variable resistance. The circuit consists of two RC lag networks in which the resistance (R) is an f.e.t. The input and output signals from the network are compared by a phase-sensitive rectifier the output of which is used to control the f.e.t. channel resistance automatically.

The phase shift is then kept constant at 90 degrees or at a chosen angle close to 90 degrees over a wide range of frequencies.

## 2 The Proposed System

The field effect transistor is operated in the constant-current portion of its output characteristic in many linear applications. However, the device has a further property that is almost unparalleled when compared with other devices. When operating in the triode region the f.e.t. exhibits the properties of an ohmic channel resistance whose value is a function of the gate to source voltage ( $V_{GS}$ ). The channel resistance,  $r_{DS}$ , is exponentially proportional to  $V_{GS}$  and may be represented by the following empirical relationship:

$$r_{DS} = r_0 \exp(-\lambda V_{GS})$$

where  $r_0 = r_{DS}$  at  $V_{GS} = 0$ , and  $\lambda$  is a constant which depends largely on the pinch-off voltage ( $V_P$ ) of the device.

The exploitation of this variable resistance property in circuit applications has already been the subject of numerous publications.<sup>3</sup> One of the applications is the use of the f.e.t. in phase-shifting networks. A simple lag

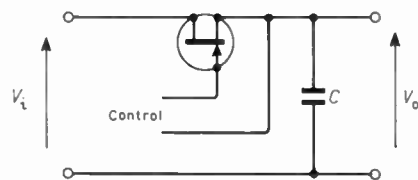

Fig. 1. Simple lag network using a field effect transistor.



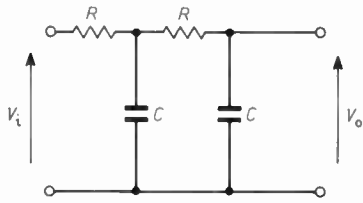

Fig. 2. Second-order lag network.

circuit is shown in Fig. 1. The phase shift given by the network is

$$\theta = -\tan^{-1} \omega Cr_{DS}$$

$$= -\tan^{-1} [\omega Cr_0 \exp(-\lambda V_{GS})]$$

By suitable choice of  $C$  the phase lag may be set at any specified value greater than zero and less than  $90^\circ$ . When a reverse bias is applied to the gate the phase increases and approaches  $90^\circ$  as the bias approaches the pinch-off value. Two lag networks, constituting the phase shifting network (p.s.n.), Fig. 2, have been used to achieve the required phase shift between  $0-180^\circ$ .  $R$  represents  $r_{DS}$  of each f.e.t. The p.s.n., however, also gives signal attenuation. A resistive signal channel can be designed to give the same attenuation as that of the p.s.n. as shown in Fig. 3.

The phase difference between  $V_{01}$  and  $V_{02}$  is monitored by a phase-sensitive detector (P.D.) which produces a direct voltage proportional to the divergence of the angle from the set phase shift. After amplification and integration, this output is fed back to the f.e.t. gates to control the channel resistance  $r_{DS}$ . The insertion of the resistive signal channel enables two approximately equal amplitudes of  $V_{01}$  and  $V_{02}$  to be obtained. This improves the phase detector linearity; also in many applications, two phase-shifted outputs of the same amplitude are required.

The amount of attenuation at any selected phase shift can be calculated as follows:

The transfer function of the p.s.n. is that of second-order lag and is easily shown to be

$$\frac{V_0}{V_i} = \frac{1}{1 + j3\omega CR - \omega^2 C^2 R^2}$$

$$= \frac{1}{(1 - \omega^2 C^2 R^2) + j3\omega CR}$$

$$\left| \frac{V_0}{V_i} \right| = \frac{1}{\sqrt{(1 - \omega^2 C^2 R^2)^2 + (3\omega CR)^2}}$$

In order to find the attenuation factor  $K$  let

$$\sqrt{(1 - \omega^2 C^2 R^2)^2 + (3\omega CR)^2} = K.$$

Solving for  $\omega CR$  to give

$$(\omega CR)^2 = \frac{-7 \pm \sqrt{49 - 4(1 - K^2)}}{2}.$$

The angle  $\theta$  is given by

$$\theta = -\tan^{-1} \frac{3\omega CR}{1 - \omega^2 C^2 R^2}.$$

If  $\theta = \pi/2$ , for example then  $(\omega CR)^2 = 1$ . Substituting this in the equation above and solving we find  $K = 3$ . Therefore

$$\left| \frac{V_0}{V_i} \right| = \frac{1}{3}.$$

$K$  can be set to a value appropriate to the phase shift required.

### 3 Theoretical Analysis

The system proposed is in fact similar to that of a phase-lock loop (p.l.l.) operating with the free-running

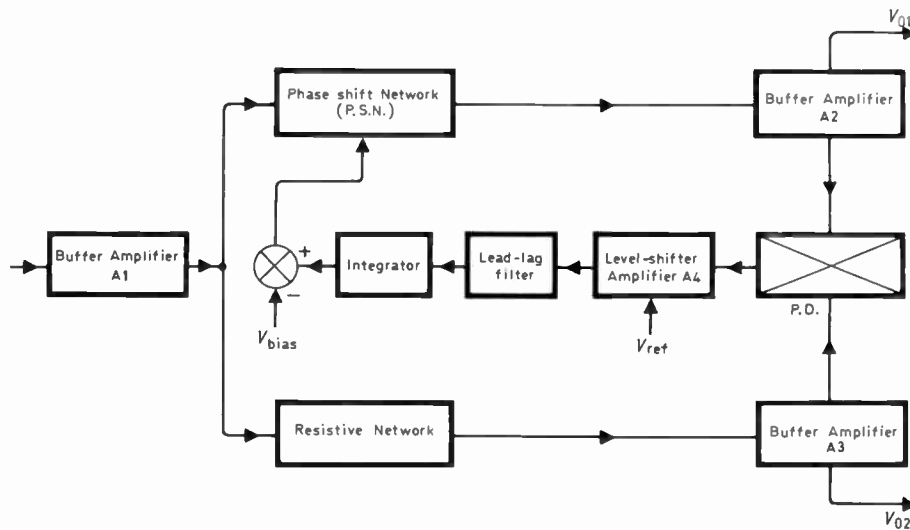

Fig. 3. General diagram of the system.

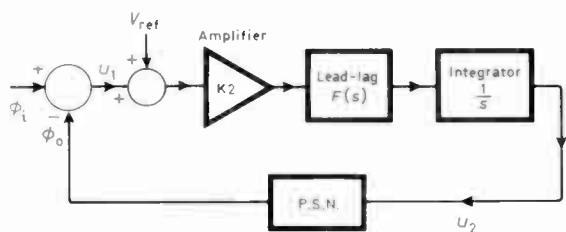

Fig. 4. System block diagram.

frequency of the v.c.o. at the same as the input frequency, and thus giving 90° phase shift between the two inputs to the phase detector and zero d.c. level to the v.c.o. This is achieved because both inputs to the phase detector are derived from the same source and hence are identical in frequency. The phase shift produced by the p.s.n. is a function of the integrator output; in other words, the p.s.n. together with the integrator behave as a v.c.o. ( $V_{bias}$ , in Fig. 3, is adjusted so that in open loop, the p.s.n. gives the required phase shift at the centre frequency). The offset of the level shifter (A4) can be used to vary the phase shift on either side of 90°, as will be shown later.

3.1 System Block Diagram

The block diagram of the system is shown in Fig. 4. If a sinusoidal detector is assumed,

$$u_1 = K_1 \sin(\phi_i - \phi_o) \tag{1}$$

where  $\phi_i$  is the phase of  $V_{o2}$  in Fig. 3 and  $\phi_o$  is the quadrature phase of  $V_{o1}$

$$u_2 = (u_1 + V_{ref}) \frac{K_2 F(s)}{s} \tag{2}$$

$$\phi_o = f(u_2). \tag{3}$$

For a linear approximation, equation (1) becomes

$$u_1 = K_1(\phi_i - \phi_o) \tag{4}$$

and equation (3) becomes

$$\phi_o = K_3 u_2.$$

Substituting in equation (2)

$$\phi_o = K_3 [K_1(\phi_i - \phi_o) + V_{ref}] K_2 \frac{F(s)}{s}$$

$$\phi_o = K_0 \frac{F(s)}{s} \phi \tag{5}$$

where

$$\phi = \phi_i - \phi_o + \phi_r$$

$$\phi_r = \frac{V_{ref}}{K_1}$$

$$K_0 = K_1 K_2 K_3. \tag{7}$$

$K_1$  is the phase detector constant,<sup>1</sup>  $K_3$  will be evaluated in the next Section and  $F(s)$  is given by<sup>4</sup>

$$F(s) = \frac{1 + s\tau_2}{1 + s\tau_1} \tag{8}$$

where

$$\tau_1 = (R_1 + R_2)C, \quad \tau_2 = CR_2.$$

3.2 Phase Shift Network

In the phase shift network (p.s.n.) of Fig. 2

$$R = r_o \exp(\lambda u_2).$$

The transfer function of a second-order lag network has been given earlier and can be written as

$$\frac{V_2}{V_1} = \frac{1}{(1 - \omega^2\tau^2) + j3\omega\tau}$$

$$\angle \frac{V_2}{V_1} = -\tan^{-1} \frac{3\omega\tau}{1 - \omega^2\tau^2}.$$

Since

$$\phi_o = 90^\circ - \angle \frac{V_2}{V_1},$$

then,

$$\cot \phi_o = \frac{3\omega\tau}{1 - \omega^2\tau^2} \tag{9}$$

$$= \frac{3x}{1 - x^2},$$

where  $x = \omega\tau = 1 - \delta$

$$\cot \phi_o = \frac{3(1 - \delta)}{2\delta}$$

$$= \frac{3}{2\delta} \text{ approximately since } \delta \text{ small}$$

$$\frac{d\phi_o}{d\delta} = \frac{2}{3} \cos^2 \phi_o$$

and

$$\frac{d\phi_o}{du_2} = \frac{2}{3} \lambda \omega r_o C \exp(\lambda u_2) \cos^2 \phi_o.$$

In other words for  $\phi_o$  close to 0°, and  $\lambda u_2 \ll 1$  where the linear approximation is valid.

$$\phi_o = \frac{2}{3} \lambda \omega r_o C u_2.$$

Therefore

$$K_3 = \frac{2}{3} \lambda \omega r_o C. \tag{10}$$

3.3 Linear Solution

From equation (5), the open loop transfer function of the system,  $G(s)$ , is given by,

$$G(s) = K_0 \frac{F(s)}{s}$$

and substituting equation (8)

$$G(s) = \frac{K_0(1 + s\tau_2)}{s(1 + s\tau_1)} = \frac{K(s + a_2)}{s(s + a_1)} \tag{11}$$



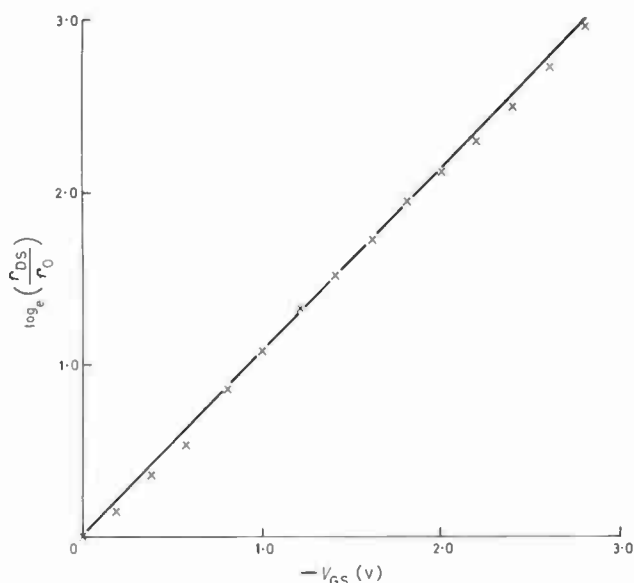

Fig. 7. Measured channel resistance characteristic of the f.e.t.

between  $V_{01}$  and  $V_{02}$ ,  $V_{bias} = -6$  V and the voltage at the f.e.t.s gates will be reduced to  $-3$  V through the potential divider formed by the two  $56$  k $\Omega$  resistors. The integrator output is assumed to be zero at this point.

For the circuit shown, data were taken for different values of desired phase shifts in the range of  $70^\circ$ – $110^\circ$ . The results are shown for both open loop and closed loop to illustrate the improvement obtained. With the loop open at point P in Fig. 6 and the phase difference between  $V_{01}$  and  $V_{02}$  set at  $90^\circ$  at the centre frequency of  $50$  kHz and as the frequency changes in the range  $20$ – $80$  kHz, the phase difference becomes  $90^\circ \pm 35^\circ$ , i.e. an error of  $\pm 35^\circ$  is introduced in the frequency range mentioned. This is also true if the phase difference is set above or below  $90^\circ$  as shown in Fig. 9. However, on closed loop the phase error is reduced to  $\pm 2^\circ$  in the frequency range  $20$ – $80$  kHz as shown by the crosses in Fig. 10.

error due to temperature variation. This error, however, can be reduced by selecting temperature compensated amplifiers. The output of A4 is applied to a lead-lag filter network to improve the transient behaviour of the system. This network together with the  $12$  k $\Omega$  connected to the virtual earth of the integrator will result in an attenuation factor of  $12/232$  and  $\tau_1 = 116$  ms,  $\tau_2 = 2.2$  ms.  $V_{bias}$  is adjusted on open loop so that the p.s.n. gives the required phase shift at the centre of the operating frequency range. For  $90^\circ$  phase difference

### 5 Closed-loop Phase Error

Equation (12) shows that, theoretically, the steady state error of the system will be zero. This is based on the assumption of a perfect integrator. The actual integrator used (Fig. 6) will in fact have a transfer function as follows:

$$G_1(s) = \frac{R}{r(1+sCR)}$$

where  $r = 12$  k $\Omega$ ,  $R = 1$  M $\Omega$  and  $C = 0.01$   $\mu$ F

i.e., 
$$G_1(s) = \frac{1}{0.012(1+0.01s)} \quad (13)$$

By replacing  $1/s$  in equation (5) by the above expression, the overall transfer function becomes

$$G(s) = \frac{K_0(1+s\tau_2)}{0.012(1+0.01s)(1+s\tau_1)} \quad (14)$$

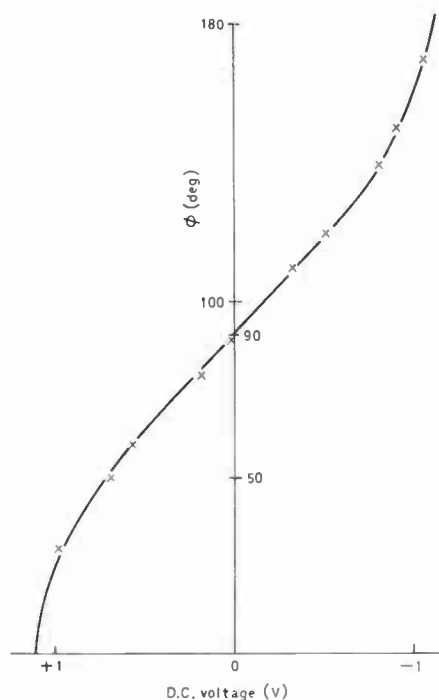

Fig. 8. Measured phase detector characteristic.

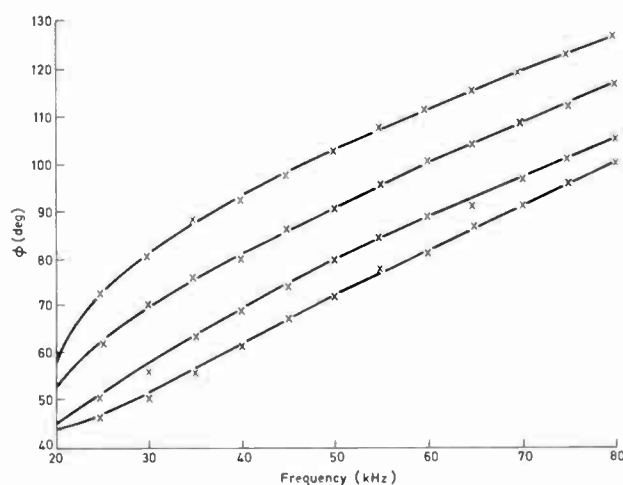

Fig. 9. Open-loop characteristic of the system.



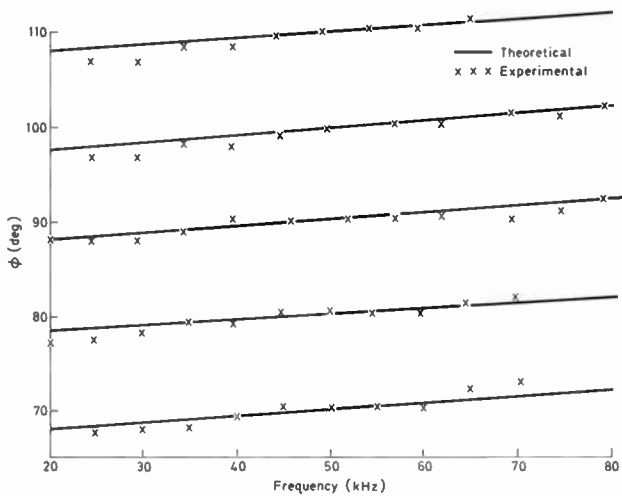

Fig. 10. Closed-loop characteristic of the system.

The system is no longer a type-1 system and a steady-state error will result. For an input of phase step magnitude  $\Delta\phi$  this will be given by:<sup>5</sup>

$$\phi_{ss} = \lim_{s \rightarrow 0} \frac{\Delta\phi}{1 + G(s)} = \frac{1}{1 + \frac{K_0}{0.012}} \Delta\phi \quad (15)$$

where, from equation (7),  $K_0 = K_1 K_2 K_3$ , and from Fig. 8,  $K_1 = 0.0178$  volt per degree.  $K_3$  is given by equation (10), where from Fig. 7,  $\lambda = 1$  per volt, and  $r_0 = 90 \Omega$ . Taking  $\omega = 2\pi \times 50$  kHz, and  $C = 0.01 \mu F$ , then  $K_3 = 0.1885$  radian per volt, or 10.8 degrees per volt. The gain  $K_2$  is made up of the gain of the level shifter, and the attenuations of the loop filter and the  $2 \times 56$  k $\Omega$  potential divider, i.e.

$$K_2 = \frac{100}{3.8} \times \frac{12}{232} \times \frac{1}{2} = 0.68$$

This gives  $K_0 = 0.13$  and

$$\phi_{ss} = 84.5 \times 10^{-3} \Delta\phi \quad (16)$$

If it is assumed that the circuit will give the correct phase shift at a certain frequency (taken here as 50 kHz), then if the frequency is different from this value by say,  $\Delta\omega$ , the p.s.n. will give an offset phase shift of, say,  $\Delta\phi$ , which will result in an input to the integrator whose output will then correct the p.s.n. but with a steady-state error as shown above. This  $\Delta\phi$  is exactly as if a step input of phase is applied to the system of magnitude  $\Delta\phi$ . Thus, to obtain the steady-state phase error as a function of frequency, from equation (9),

$$\frac{d\phi_0}{d\omega} = \frac{3\tau(1 + \omega^2\tau^2)}{1 + 7\omega^2\tau^2 + \omega^4\tau^4}$$

which at  $\omega\tau = 1$ ,

$$\frac{d\phi_0}{d\omega} = \frac{2}{3} \tau = \frac{\Delta\phi}{\Delta\omega}$$

Therefore, from equation (16),

$$\begin{aligned} \phi_{ss} &= 56.3 \times 10^{-3} \Delta\omega\tau \text{ radians, or} \\ \phi_{ss} &= 3.23 \Delta\omega\tau \text{ degrees.} \end{aligned} \quad (17)$$

This shows that the expected error in the frequency range of 20–80 kHz (i.e.  $\Delta\omega\tau = \pm 0.6$ ) is  $\pm 2^\circ$  which agrees with the experimental results obtained. This also indicates that this error can be reduced by increasing the open loop gain of the system.

### 6 Conclusion

A phase-shift network independent of frequency has been designed and constructed using field effect transistors. By varying the offset of the level shifter A4, the desired phase difference between  $V_{01}$  and  $V_{02}$  in Fig. 6 can be varied in excess of  $\pm 20^\circ$  on either side of  $90^\circ$ . The analysis of the system assumed operation in the linear region. When the loop is closed, at any desired phase difference, the phase shift stays constant at the set value over the frequency range 20–80 kHz with a phase error of  $\pm 2^\circ$ . This can be reduced further by increasing the open-loop gain ( $K_0$ ) of the system as shown in Section 5, e.g. if the level shifter feedback resistor is increased from 100 k $\Omega$  to 1 M $\Omega$  giving an increase in gain of the order of 10, the phase error will be reduced to  $\pm 0.2^\circ$ . However, it was not possible to check this practically, since the resolution of the available phasemeter was  $1^\circ$ . The phase shifted outputs are maintained at the same amplitude level by introducing an attenuating resistive signal channel to compensate for the insertion loss introduced by the p.s.n. The addition of a lead-lag filter in the feedback loop improved the transient behaviour of the system.

The network can operate at frequencies much higher than 80 kHz provided that the channel capacitance  $C_{DS}$  of the f.e.t.s is low, in which case the shunting effect of  $X_{DS}$  is negligible.

The non-linear behaviour of the system has not been discussed and it is a subject of further study. The system described in this paper is very useful in many communication applications such as mobile direct conversion receivers, diversity circuits, television etc.

### 7 References

- 1 Saraga, W., 'The design of wide band phase splitting networks', *Proc. IRE*, 38, pp. 754–70, July 1950.
- 2 Chow, W. F., 'Tunnel diode digital circuits', *IRE Trans. on Electronic Computers*, EC-9, pp. 295–300, September 1960.
- 3 Gosling, W., Townsend, W. G. and Watson, J., 'Field Effect Electronics', chap. 11, pp. 215–49 (Butterworths, London, 1971).
- 4 Blanchard, A., 'Phase-locked Loops', chap. 3 (Wiley, New York, 1975).
- 5 D'Azzo, J. J. and Houpis, C. H., 'Feedback Control System Analysis and Synthesis', Section 6–4, pp. 173–9 (McGraw-Hill, New York 1966).

Manuscript first received by the Institution on 1st February 1979 and in revised form on 12th July 1979  
(Paper No. 1921/CC 318)

# Resonant modes in re-entrant cavities

SUSANTA SEN, B.Sc., M.Tech.,\*

P. K. SAHA, B.Sc., M.Tech., Ph.D.\*

and

Professor B. R. NAG,

D.Sc., Ph.D., M.S., M.Sc.(Tech.)

## SUMMARY

Experimentally-determined tuning characteristics are presented for a long cylindrical re-entrant cavity having dimensions similar to those used for Gunn oscillators and for studies on semiconductors. The results indicate the simultaneous existence of the dominant TEM and the fundamental TE modes of resonance. A perturbation technique is given for the identification of the modes. Theoretical calculations of the resonant frequencies using simple models are presented. Experimental values of the  $Q$ -factors of the resonator for both the modes of resonance are also given.

\* Institute of Radio Physics and Electronics, 92 Acharya Prafulla Chandra Road, Calcutta 700 009.

## 1 Introduction

Narrow-gap re-entrant cylindrical cavities are often used for the microwave measurement of semiconductor parameters and also for the construction of Gunn oscillators. The dimensions of the cavity are governed by the frequencies of oscillation and the impedance of diodes in the case of Gunn oscillators,<sup>1</sup> and by the dimensions of the samples for semiconductor measurements.<sup>2</sup> The dimensions are often such that the cavities have multimode resonant characteristics which lead to difficulties in the interpretation of experiments. As no experimental results on the characteristics of such cavities are reported in the literature, the authors made a detailed study of the tuning characteristics and  $Q$  of a narrow-gap re-entrant cylindrical cavity, having dimensions similar to those used in early experiments.<sup>1, 2</sup> The study was motivated by the authors' intention to use the cavity for the measurement of microwave magneto-conductivity of semiconductors. Results of these studies are reported in this paper.

## 2 The Cavity

The dimensional details of the re-entrant cavity under investigation, together with its coupling arrangement with a waveguide are shown in Fig. 1(a) and (b). The length and the conductor diameters of the cavity were chosen mainly from the experimental data of previous workers.<sup>1, 2</sup>

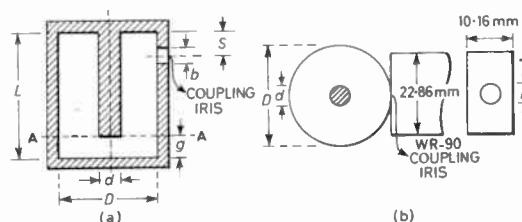

Fig. 1. (a) Coaxial re-entrant cavity.  $L = 24.0$  mm,  $D = 18.0$  mm,  $b = 6.5$  mm,  $S = 9.25$  mm,  $d = 6.0, 8.0$  and  $10.0$  mm,  $g = 0.5$  mm to  $6.0$  mm.

(b) Schematic diagram of the cavity to WR-90 waveguide coupling.

The outer conductor of the cavity was constructed by making a cylindrical hole of diameter  $D$  and length  $L$  in a rectangular brass block. The coupling iris was made on the cylindrical wall of the outer conductor thus prepared. The waveguide flange was fixed to the brass block such that the iris appeared in the transverse plane of the waveguide. The cavity was completed by covering the cylindrical bore with a lid, which also held the inner conductor axially. Provision was made for fixing inner conductors of various diameters with the lid, using a screw arrangement.

### 3 Experimental Results

We have determined experimentally the tuning characteristics, type of the resonant modes and  $Q$ -values of the cavity described in Section 2. These results are presented in this section.

#### 3.1 Tuning Characteristics

The resonant frequency of the cavity was determined with a time domain reflectometer arrangement shown in Fig. 2. The output of the microwave oscillator is swept in the frequency range of interest by the sweep generator.

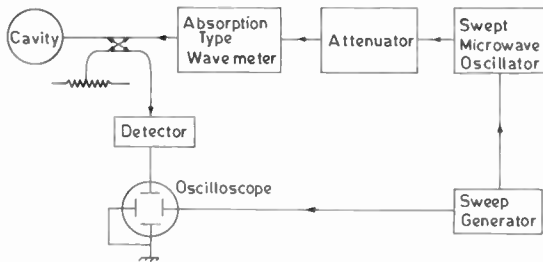

Fig. 2. Experimental arrangement for measuring resonant frequencies of the cavity.

The signal reflected from the cavity is detected and fed to an oscilloscope, whose trace is also swept by the same sweep signal. Since the cavity absorbs power only at its resonant frequencies, the oscilloscope display indicates dips at these frequencies. It is finally measured by tuning the absorption type wavemeter to resonate at the same frequency as the cavity. The resonant frequencies in X-band were measured for different gap heights  $g$ , adjusted by changing the length of the inner conductors. The experiment was repeated for three different inner conductor diameters. The results of this experiment, plotted in Fig. 3, show the variation of the resonant frequency as a function of gap height  $g$  with the ratio of the conductor diameters ( $D/d$ ) as parameter. Figure 3 indicates that the cavity resonates at two different frequencies for every choice of dimensions. One of the resonant frequencies is found to be almost independent of ( $D/d$ ) but to vary strongly with  $g$ . The other one exhibits just the opposite kind of dependence on ( $D/d$ ) and  $g$ . The two resonant frequencies exhibiting different types of variation indicate the presence of two different modes of resonance in the cavity. These two modes will henceforth be called Mode I and Mode II respectively. In the following Section, a method is described for clear identification of the two modes.

#### 3.2 Determination of Resonant Modes

The cavity was perturbed with a 1 mm thick annular Teflon ring, placed perpendicular to the axis of the cavity

at different positions along its length (Fig. 4) and the perturbed resonant frequency measured. For the cavity dimensions chosen, the unperturbed resonant frequencies of Mode I and II are 9.09 and 8.26 GHz respectively. The shift in the resonant frequency due to perturbation was then determined as a function of the position of the ring along the cavity length. A simple calculation reveals that the shift in resonant frequency is

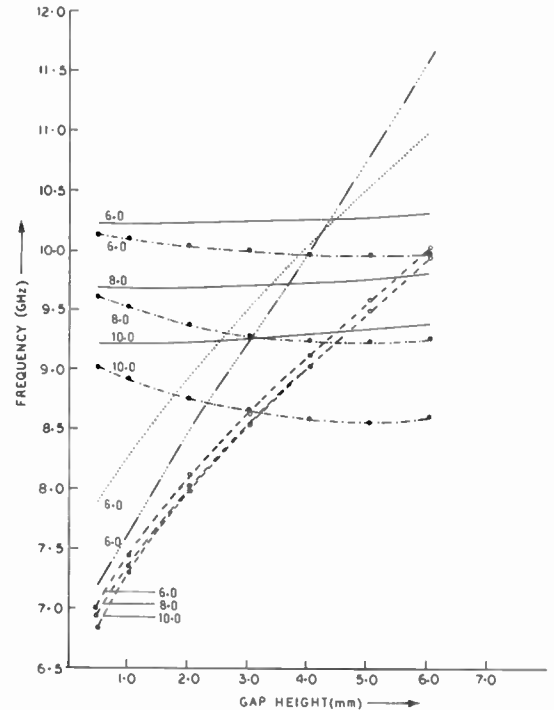

Fig. 3. Resonant frequency as function of gap height  $g$  with inner conductor diameter  $d$  in mm, as parameter.  $D = 18.0$  mm. Experimental curves (See Sect. 3): - - - - Mode I; ····· Mode II. Theoretical curves (see Sect. 4):

- coaxial TEM and cylindrical  $E_{01}$  modes;
- ····· coaxial TEM line terminated by capacitance (Marcuvitz);
- coaxial  $H_{11}$  and cylindrical  $H_{11}$  modes.

proportional to the square of the electric field at the point of perturbation. Thus a plot of the frequency shift against position of the ring indicates the nature of variation of the electric field along the cavity length. Such a plot for the two modes of resonance in the above mentioned cavity is shown in Fig. 4. For any particular mode, the distance of the electric field maximum in the coaxial section must be a quarter of the corresponding guide wavelength. From Fig. 4, this distance is 8.5 mm and 16 mm respectively for 9.09 GHz and 8.26 GHz resonances. From the chosen value of ( $D/d$ ) we find from calculation that all the modes, other than TEM and  $H_{11}$  modes, are cut-off for the observed resonant frequencies of 9.09 and 8.26 GHz. Also, we find that the guide wavelength for TEM mode at 9.09 GHz is 33 mm and that for  $H_{11}$  mode at 8.26 GHz is 61 mm. We may



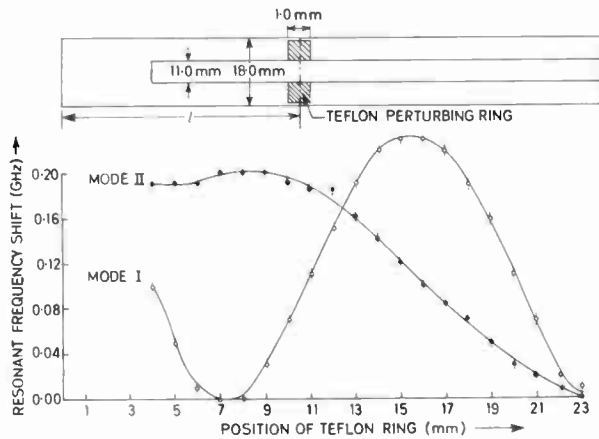

Fig. 4. Shift in resonant frequency due to perturbation as a function of position of the perturbing Teflon ring of thickness 1 mm.  $L = 24.0$  mm;  $D = 18.0$  mm;  $d = 11.0$  mm.

therefore identify the resonance at 9.09 GHz (corresponding to Mode I) to be due to excitation of TEM mode and that at 8.26 GHz (corresponding to Mode II) due to the excitation of  $H_{11}$  mode. We thus conclude that the resonance characteristics for Mode I correspond to TEM mode and those for Mode II correspond to  $H_{11}$  mode.

3.3 Q-factor

The Q-factors of the re-entrant cavity for both the resonant modes were also measured as a further evaluation of its usefulness with different dimensions. A reflection bridge technique<sup>3</sup> was used to measure  $Q_u$  as well as the coupling factor  $\beta$ . The experimental results are presented in Table 1. It can be seen that  $Q_u$  for the  $H_{11}$  mode is consistently higher than that for the TEM mode. The  $Q_u$  (TEM) however increases as the gap height is increased and gradually approaches the  $Q_u$  ( $H_{11}$ ).

4 Theoretical Resonant Frequency

Theoretical analysis of long cylindrical re-entrant cavity discussed in this paper was carried out by Moreno.<sup>4</sup> In

this model, Moreno treated the re-entrant gap as a parallel plate capacitor, terminating the coaxial line of length  $(L-g)$ , above the plane AA', which supports TEM wave. Such a simple model fails to give good correspondence with experiments mainly because the capacitance due to the fringing fields in the gap region is of the same order of magnitude as the gap capacitance. As no analytical expression for the fringing capacitance is available in literature, the authors used Marcuvitz's empirical formula<sup>5</sup> for the effective capacitance  $C_{eff}$  of the gap region to determine the resonant frequency of the cavity, as an extension of Moreno's work. Marcuvitz's formula is given by

$$C_{eff} = (\pi d^2/4g) + 2d \cdot \ln [(D-d)/2g]. \tag{1}$$

Accordingly, the resonant frequency is determined from the condition of zero reactance given by

$$Z_0 \tan \left\{ \frac{2\pi f_0}{c} (L-g) \right\} = \frac{1}{2\pi f_0 C_{eff}} \tag{2}$$

where  $f_0$  is the resonant frequency of the cavity and  $c$  the velocity of light;  $Z_0$ , the characteristic impedance of the coaxial line supporting TEM wave, is given by

$$Z_0 = \frac{1}{2\pi} \sqrt{\frac{k_0}{\epsilon_0}} \ln (D/d). \tag{3}$$

It should be noted that equation (1) is stated for  $2\pi g/\lambda \ll 1$  and  $2g/(D-d) \ll 1$ . Clearly, these restrictions are not satisfied for large gaps, but (1) is still a good approximation as has been shown by Green.<sup>6</sup> In the analysis, the fringing term is considered negligibly small as  $(D-d) \approx 2g$ , which is also evident from the formula. The theoretical results obtained from this model is also plotted in Fig. 3. It is observed that the fit between the theoretical and experimental curves is poor; even the shape of the two curves are different.

The resonant frequency of the cavity may be determined from another simple model. The cavity is treated as a junction between a coaxial line above the plane AA' and a cylindrical guide below the plane AA' and resonance is determined by equating the net reactance to zero. Considering the coaxial line to support

Table 1.  $Q_u$  and  $\beta$  for various cavity dimensions and modes.

Inner conductor diameter (d)	8.00 mm		10.0 mm	
	Coaxial $H_{11}$ mode	Coaxial TEM mode	Coaxial $H_{11}$ mode	Coaxial TEM mode
Gap height (g)	$Q_u$	$\beta$	$Q_u$	$\beta$
1.0 mm	2049	2.92	1491	1.57
3.0 mm	2508	1.10	1752	0.82
6.0 mm	2606	0.54	2470	0.29

TEM wave, its input reactance at the plane AA' is given by

$$X_1 = jZ_0 \tan \left\{ \frac{2\pi f_0}{c} (L-g) \right\} \quad (4)$$

The cylindrical section is assumed to support  $E_{01}$  mode which seems to be logical from a comparison of the field configurations in the two sections. Accordingly, the input impedance of the cylindrical section is given by

$$X_2 = Z_{E_{01}} \tanh \{ \gamma_{E_{01}} \cdot g \} \quad (5)$$

where  $Z_{E_{01}}$  = characteristic impedance of the cylindrical guide in the  $E_{01}$  mode

$$= (\gamma_{E_{01}} / jk_0) \cdot \eta_0$$

and  $\gamma_{E_{01}}$  = propagation constant of  $E_{01}$  wave in the cylindrical guide

$$= \left[ \left( \frac{4.810}{D} \right)^2 - k_0^2 \right]^{1/2}$$

The resonant frequency is finally determined, neglecting the effect of higher-order modes, from the condition

$$x_1 + x_2 = 0. \quad (6)$$

The shape of the resonant curves obtained from this model is similar to that of the experimental curves. But there remain differences in the exact values of the resonant frequencies.

The resonant frequency in the  $H_{11}$  mode may similarly be calculated by considering the coaxial line to support the  $H_{11}$  mode. We may also assume, considering the field configurations, that the cylindrical guide also supports an  $H_{11}$  mode wave. The reactances of the coaxial and cylindrical guides at the plane AA' are thus respectively given by

$$x_1 = \frac{jk_0 \eta_0}{\gamma_{11}} \cdot \tanh [\gamma_{11} \cdot (L-g)] \quad (7)$$

and

$$x_2 = \frac{jk_0 \eta_0}{\Gamma_{11}} \cdot \tanh [\Gamma_{11} \cdot g] \quad (8)$$

where  $k_0$  and  $\eta_0$  are the free-space wavenumber and impedance respectively.

$\gamma_{11}$  and  $\Gamma_{11}$  are the propagation constants of  $H_{11}$  wave in coaxial and cylindrical guide respectively, and are given by

$$\gamma_{11} = \left[ \left( \frac{2\chi_{11}}{d} \right)^2 - k_0^2 \right]^{1/2} \quad (9)$$

$$\Gamma_{11} = \left[ \left( \frac{3.682}{D} \right)^2 - k_0^2 \right]^{1/2} \quad (10)$$

where  $\chi_{11}$  is the first root of the equation:

$$J_1' \left( \frac{D}{d} \chi \right) N_1'(\chi) - N_1' \left( \frac{D}{d} \chi \right) J_1'(\chi) = 0.$$

The resonant frequency is calculated from eqn. (6) and plotted in Fig. 3. As for Mode I, the theoretical and the experimental curves have the same shape. Though there are differences in the values, the quantitative agreement for Mode II is better than that for Mode I.

## 5 Discussions

The tuning characteristics of a narrow-gap long cylindrical re-entrant cavity having dimensions similar to those used in Gunn oscillators have been investigated experimentally as well as theoretically. The cavity is found to have two modes of resonance for the experimental frequencies in the X-band. The modes have been identified as the TEM and  $H_{11}$  modes by a perturbation technique. The  $Q$ -factors for different dimensions and the two modes of resonance are also given.

The shape of the tuning characteristics are found to agree with those obtained from a suggested theoretical model, but there remain discrepancies in the quantitative values. We note that in our analysis the reactance of the coupling iris was not included and also we have neglected the effect of higher-order modes. We may attribute the observed discrepancies to these simplifying assumptions. However, this conclusion may be confirmed by a more detailed analysis of the reactance of the re-entrant gap.<sup>7</sup>

## 6 Acknowledgment

One of the authors (S.S) is grateful to C.S.I.R. India for financial support.

## 7 References

- 1 Foulds, K. W. H., 'LSA oscillation in coaxial-line circuit', *Electronics Letters*, **6**, pp. 189-90, 19th March 1970.
- 2 Eldumati, I. I. and Haddad, G. I., 'Cavity perturbation techniques for measurements of the microwave conductivity and dielectric constant of a bulk semiconductor material', *IEEE Trans. on Microwave Theory and Techniques*, MTT-20, pp. 126-32, February 1972.
- 3 Ghosh, G., Sen, Susanta, Dasgupta, D. and Saha, P. K., 'Method of measuring loaded  $Q$ -factor of single-ended cavity resonators using reflection bridge', *Rev. Sci. Instrum.*, **49**, pp. 378-9, March 1978.
- 4 Moreno, T., 'Microwave Transmission Design Data' (Dover, New York; 1958).
- 5 Marcuvitz, N., 'Waveguide Handbook' (Dover, New York; 1965).
- 6 Green, H. E., 'The numerical solution of some important transmission-line problems', *IEEE Trans. on Microwave Theory and Techniques*, MTT-13, pp. 676-92, September 1965.
- 7 Collin, R. E., 'Field Theory of Guided Waves' (McGraw-Hill, New York; 1960).

Manuscript first received by the Institution on 7th August 1979 and in final form on 31st October 1979.  
(Paper No. 1920/CC 317)

# Effect of sharp-cut-off video-frequency filters on chrominance signal response in PAL colour television

B. R. PATEL, B.Sc.(Eng.)\*

## SUMMARY

In television System I, the nominal bandwidth is 5.5 MHz but in most practical transmission systems the actual bandwidth is greater. There is a likelihood that video low-pass filters will be used in the future, for example in association with digital codecs, and it has been found that even when such filters have a passband of 5.5 MHz, critical signals such as colour bars and electronically generated captions exhibit ringing. To investigate the effect, the responses of existing PAL coder/decoders have been measured with and without a low-pass filter to define the transmission channel bandwidth. The filter currently proposed by the CCIR to shape the chrominance signal in the coder has a substantial response well above 5.5 MHz. In this situation it will have to be accepted that critical signals may be distorted at intermediate points along future transmission channels containing low-pass filters.

\* Visual Telecommunications Division, Post Office Research Centre, Martlesham Heath, Ipswich IP5 7RE.

## 1 Introduction

The requirements<sup>1, 2</sup> for transmission of System I 625-line PAL colour-television signals over video links are based on nominal bandwidths extending up to 5 MHz for the luminance channel and from 3.5 to 5.5 MHz for the chrominance channel. These assumptions do not imply any necessary restriction of the bandwidth of the transmission channel to 5.5 MHz, and indeed the absence of sharp cut-off, channel-defining low-pass filters in British Post Office links has meant that useful performance exists above 5.5 MHz. Thus the situation is open to exploitation for the transmission of signals with spectra extending beyond 5.5 MHz. Due to the slow rate of cut-off of the shaping filters in the chrominance channel of PAL coder/decoder combinations (codecs), ringing at chrominance transitions has not usually been a problem. If, however, the transmission band is limited by a sharp cut-off filter, ringing of the chrominance signal may occur. The ringing frequency, being approximately the difference between the 3 dB-loss frequency of the filter and the colour sub-carrier frequency, is much lower than that associated with luminance transitions and is consequently more disturbing. It shows up as oscillatory changes in saturation following the chrominance transition.

With the advent of digital transmission, particularly in schemes requiring a sampling frequency as close as possible to the Nyquist sampling frequency, the use of sharp cut-off filters before digital coding and after decoding is a potential source of trouble. A decision will soon have to be taken as to whether or not the choice of filters should be influenced by their effect on the most critical signals such as electronically generated captions. The stopband requirements for filters associated with digital codecs for television have been investigated elsewhere,<sup>3, 4</sup> but ringing in the chrominance channel due to limiting the bandwidth of the PAL-coded signal was not covered.

To provide data on which to base discussions, a series of steady-state and waveform responses of two professional-quality PAL colour-television codecs was measured with and without sharp cut-off low-pass filters in the video path. Quite separate from these measurements, the effect of varying the characteristics of such filters on the ringing at a simulated chrominance transition was also investigated.

## 2 Measurement

A simplified block diagram of a colour-television codec is given in Fig. 1. For each combination of the one coder and two different decoders that were used, the attenuation/frequency and waveform responses were measured. For completeness, the attenuation/frequency response of each decoder alone was also measured, and used to derive the coder response. In all the



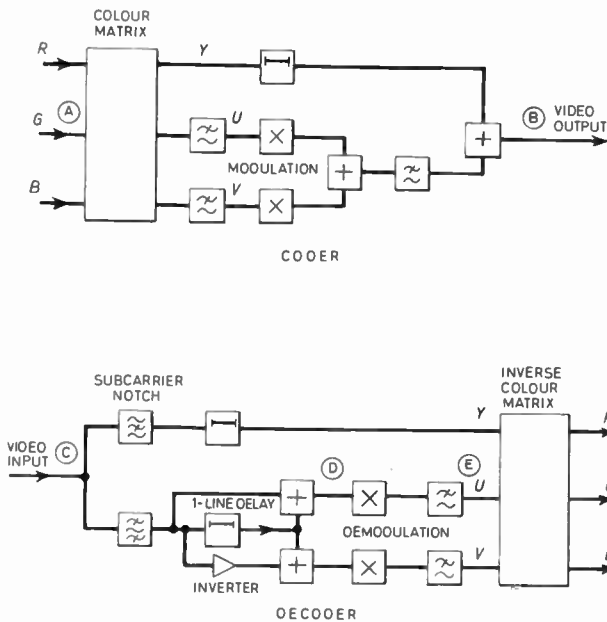

Fig. 1. Colour television codec. (The PAL switch has been omitted for simplicity.)

measurements described, test signals were combined with synchronizing and/or blanking signals where necessary for the correct operation of the coder and decoders. High input impedance amplifiers were used at signal tap-off points so that the circuit being measured was not affected. As the differences between the responses of the *U* and *V* channels were very small, the *U* channel response is presented throughout as typical.

2.1 Steady-state Responses

In each of the two decoders used, the chrominance-channel response is determined primarily by two filters, one a band-pass filter prior to demodulation and the other a low-pass filter after demodulation. As a first attempt to measure this response a double-sideband suppressed-carrier amplitude-modulated signal was injected at C and the baseband signal was measured at E. However, the difference in phase between the delayed and undelayed signals as related to the period of the sine-wave modulating signal, gave a fluctuating output at E as the modulating frequency was varied. To overcome this problem, measurements were made first with the delay-line path disabled and then with the undelayed path disabled and the two measurements averaged. The differences between the delayed and the undelayed plots are shown in Fig. 2 for both decoders 1 and 2. For ease of measurement, the bandpass response from C to D was first measured and then combined with the baseband response from D to E, measured by applying a baseband, sine-wave input at D and replacing the sub-carrier frequency input to the multiplier by a d.c. voltage.

The resulting responses of the decoders from C to E expressed as equivalent bandpass responses are given in

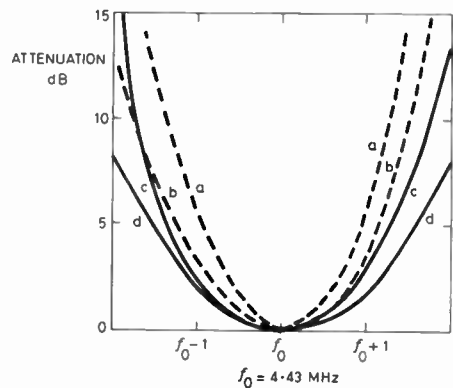

Fig. 2. Attenuation/frequency response of:

- a decoder no. 1, delay line path only;
- b decoder no. 1, delay line path by-passed (simple PAL mode);
- c decoder no. 2, delay line path only;
- d decoder no. 2, delay line path by-passed (simple PAL mode).

Fig. 2 both with the delay-line path by-passed (simple PAL mode) and with the delay line path only.

The codec responses were measured by applying a baseband sine-wave input signal at A and measuring the response at E both with the delay-line path and the undelayed path in the decoders disabled. The two responses were then averaged in terms of voltage to give the effective baseband response of each codec with the decoders operating in their delay-line mode; the responses of the two codecs appear as curves (b) and (d) in Fig. 3. The coder response, curve (e) in Fig. 3 is obtained simply by subtracting the response of the simple PAL decoder from the corresponding codec response, not shown.

The codec responses were then remeasured with a sharp cut-off low-pass filter (designated filter A and described in Table 1) in the video path between the coder and decoder. Curves (a) and (c) in Fig. 3 show how the codec responses have been modified by the sharp cut-off low-pass filter.

Table 1  
Details of 9th-order elliptic filters used

Filter	Passband MHz	Frequency when loss is		No. of 2nd-order all-pass sections in equalizer	Delay	
		3 dB MHz	40 dB MHz		Frequency range MHz	Ripple ns
A	0.5-5	5.7	6.0	4	4.9	< ±3
B	0.5-5	5.7	6.0	7	5.35	< ±3
C	0.5-0	5.2	5.5	4	4.5	< ±3

2.2 Waveform Responses

To measure the waveform responses, RGB input signals to the coder, appropriate to the generation of the 100.0.100.0 colour bar test signal,<sup>5</sup> were used. On the

displayed picture the green to magenta transition, corresponding to large chrominance steps in both the colour difference channels, simultaneously, was found to be the one most affected when the video signal was band-limited and was therefore chosen to illustrate the low-frequency ringing on the waveform. Due to imperfections in the decoders used, the ringing associated with a transition in the *U* channel was noticeably different on alternate lines which made it difficult to illustrate the distortion on an oscilloscope display of the waveform. The colour-difference signals were therefore further averaged by a separate, distortion-free line-averaging circuit similar to that in the PAL decoder but having a significantly wider bandwidth. This procedure is justified on the grounds that the eye would tend to average such line-to-line differences in any case. The waveforms are illustrated in Fig. 4.

**3 Results**

The attenuation/frequency response of the coder, Fig. 3 curve (e), meets the manufacturer's specification and is as proposed<sup>6</sup> by the CCIR. There is no such corresponding proposal for decoders. The two decoder characteristics which can be seen in Fig. 2, curves (a), (b) and (c), (d), differ significantly, having relative losses of 4.5 dB and 2.5 dB at 1 MHz from the sub-carrier. The corresponding overall codec responses, Fig. 3(b) and (d), have respective loss figures of 7 dB and 4 dB at 1 MHz, with the decoders operated in the PAL delay-line mode. The curves (a) and (c) show the effect of introducing filters in the video path. From theory a 6 dB step in the characteristics is expected and was found with the decoders operating in the simple PAL mode. However, with the decoders operating in the delay line mode a 4 dB step is observed. This is believed to be due to the group delay characteristic of the PAL delay lines but could not be verified by measurement because the accuracy of the available measuring equipment was insufficient. The corresponding waveform responses of the two codecs as typified by the green to magenta transition are shown in Fig. 4. The magnitudes of the 2nd overshoot are quoted in the figure because of the presence of 1st overshoot in the basic performance of decoder 2. The sharp cut-off filter, introduced between the coder and the decoder, causes ringing on the displayed picture, which is noticeable in particular with decoder 2. About half as much ringing is observed with the narrower bandwidth decoder 1. The ringing is greater following the transition because the delay equalization of the filter does not extend over the whole of the video band.

The effective baseband response of the chrominance channel of the PAL codecs tested can be approximated by the response of the 0.5 μs half-amplitude duration sine-squared shaping network (-6 dB at 1 MHz) commonly employed for measurements on television

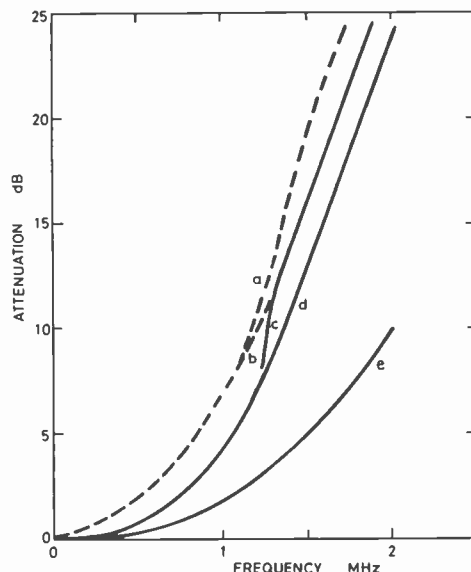

Fig. 3. Attenuation/frequency response of chrominance channel for:

- a coder-decoder no. 1 with filter A in the video path;
- b coder-decoder no. 1;
- c coder-decoder no. 2 with filter A in the video path;
- d coder-decoder no. 2;
- e coder only.

links. Because the various filtering processes being considered are linear, the order in which they occur is immaterial. A chrominance bar waveform having transitions shaped by this 0.5 μs sine-squared shaping network can therefore be used to simulate the behaviour of the codecs when studying the effects of video filtering. As expected, the character of the ringing observed on the

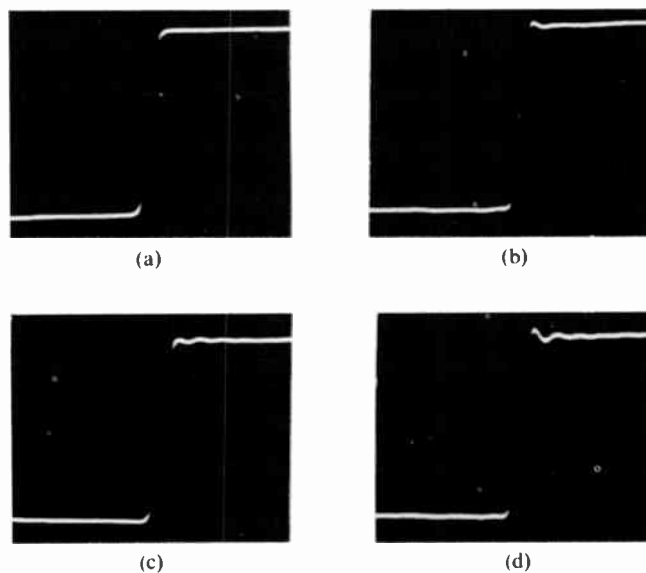

Fig. 4. Green to magenta transition of colour bar signal:

- (a) without filter } decoder no. 1
- (b) with filter A in the video path giving } (rise-time
- 2nd overshoot of -1% } 0.55 μs)
- (c) without filter } decoder no. 2
- (d) with filter A in the video path giving } (rise-time
- 2nd overshoot of -2% } 0.45 μs)

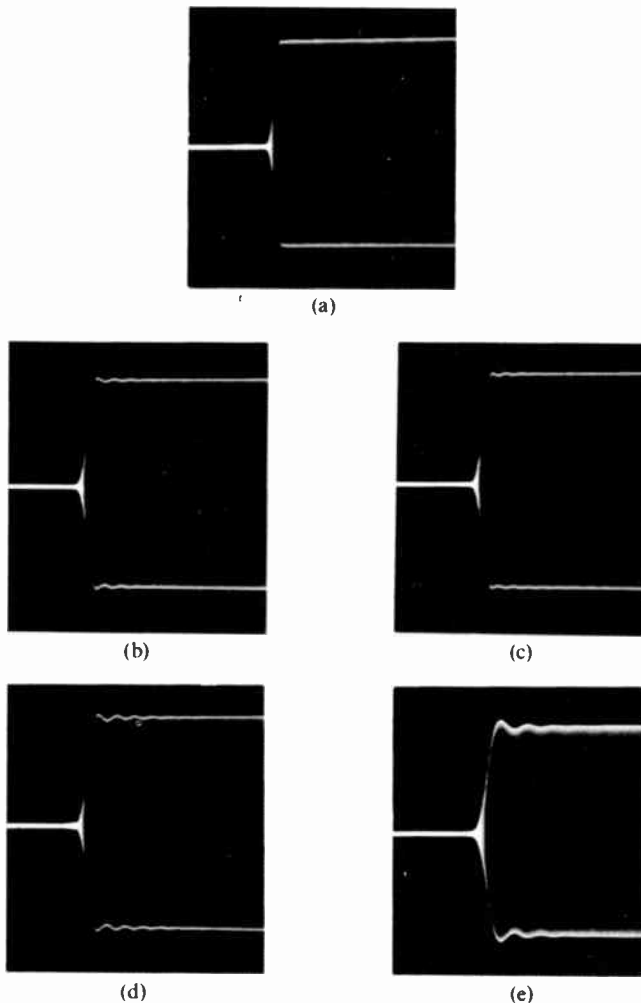

Fig. 5.  $0.5 \mu\text{s}$  chrominance bar (a):

- (b) through one filter A, giving 1st overshoot 2%:  
 (c) through one filter B, giving 1st overshoot 1%:  
 (d) through three filter A, giving 1st overshoot 3.5%:  
 (e) through one filter C, giving 1st overshoot 5%.

envelope of the ' $0.5 \mu\text{s}$  chrominance bar' when passed through the sharp cut-off filter, Fig. 5, is similar to that observed in the colour-difference signals from the codecs.

With the filter A, as described in Table 1, where the delay is flat up to 4.9 MHz (i.e. 0.5 MHz beyond 4.43 MHz sub-carrier frequency), the first overshoot of the ringing is 2%, see Fig. 5(b). Extending the delay equalization to 5.35 MHz with filter B, Fig. 5(c), almost halves the ringing, although seven instead of four sections are required in the delay equalizer. With three filters of type A in tandem, as might occur with three digital codecs connected in tandem during the changeover period from analogue to digital transmission the first overshoot of the ringing increases to 3.5%, Fig. 5(d). The above mentioned amplitudes of the overshoots agree closely with the respective figures of 2.3, 1.2 and 3.7%, computed from the transfer function of the filters. Further, as a matter of interest it may be noted that the computed values of the overshoots with ten filters of type A in tandem is 5%; with ideal delay

equalization, the values for one, three and ten type A filters in tandem are 0.8, 1.0 and 1.1%.

In television Systems B and G the PAL coder chrominance channel characteristic is similar to that for System I but the nominal video bandwidth is 5 MHz. To indicate the effect of bandwidth limitation in Systems B and G, the result of transmitting the  $0.5 \mu\text{s}$  chrominance bar waveform through filter C, a frequency scaled version of filter A (see Table 1), is shown in Fig. 5(e). The amplitude of the 1st overshoot is 5%.

#### 4 Discussion

The effect of sharp cut-off filters on chrominance step waveforms has been demonstrated. The amplitude of the resultant ringing has been shown to be dependent upon the combined responses of a sharp cut-off filter in the video path and shaping filters in the PAL codec. The observed ringing effect can also be demonstrated simply by the transmission of a  $0.5 \mu\text{s}$  chrominance bar test waveform through the sharp cut-off filter alone, as the steady-state response of the chrominance channel of PAL codecs is similar to that of a  $0.5 \mu\text{s}$  half-amplitude duration sine-squared shaping filter.

Filter A gives 2.3% first overshoot following the  $0.5 \mu\text{s}$  chrominance bar edge. For filter B, which extends the delay equalization to 5.35 MHz but having an otherwise identical specification, the corresponding overshoot is 1.2%. From theory, with ideal delay equalization, the corresponding computed figure is 0.8%.

The subjective impairment of a single filter with four delay equalizing sections has been estimated as 0.02 imp,<sup>7</sup> and with three such filters in tandem, the value increases to 0.08 imp. The figures are based on the estimated subjective impairment corresponding to luminance channel *K*-rating. With critical signals such as colour bars and captions the subjective impairments will be appreciably greater.

The two decoders considered in this investigation were of professional quality. However, the decoders in domestic receivers generally have narrower chrominance channel bandwidths, and therefore the impairment described is less of a problem. This will not necessarily be the case in future, particularly with the advent of teletext for which improved i.f./r.f. performance is anticipated.

By arranging that the step in, for example, curve (c), Fig. 3, is shifted to the 20 dB loss point, the ringing is found to become negligible. This can be achieved either by increasing the transmission link bandwidth to a value around 20% greater than that of filter A, or by arranging for the overall chrominance channel bandwidth of the codec to be scaled down by about 20% from that of the  $0.5 \mu\text{s}$  half-amplitude duration sine-squared shaping network. Both changes have disadvantages. In the latter case colour spreading at edges is increased, while in the former case the noise bandwidth is increased and for



digital systems the sampling frequency may have to be increased.

The picture seen by the domestic viewers is subject to the video bandwidth limitation imposed at the broadcast transmitter to allow the introduction of sound carrier. The effect of limitation in transmission links elsewhere therefore tends to be masked. However, it is important to realize that if reliance is to be placed on broadcast receivers or transmitters to shape the chrominance channel, rather than shaping the signal at source, it will have to be accepted that out-of-band energy will often result in a signal waveform of poor appearance at intermediate points along the transmission chain.

## 5 Conclusions

The results of this investigation may be summarized as follows:

1. The PAL signal, as specified for 625-line television, requires a bandwidth in excess of 5.5 MHz for distortionless transmission.
2. Current practical transmission systems generally permit some usage of wider bandwidths but future systems, particularly those employing digital coding, may introduce a sharp cut-off close to 5.5 MHz.
3. The effect of such a cut-off is to cause ringing of the chrominance signal component at a frequency of about 1 MHz which is subjectively more disturbing than the 5.5 MHz ringing caused by the same filter on the luminance signal component.
4. Pictures with abrupt chrominance transitions such as coloured captions cause the greatest ringing. The ringing on average scenes is small.
5. The amplitude of the ringing and hence its visibility is dependent on the properties of both the channel-defining filter and the PAL coder-decoder combination.
6. The ringing can be reduced by raising the cut-off frequency (approximately the 3 dB point) of the channel-defining filter, extending the range of the delay equalization nearer to the cut-off frequency and reducing the number of such filters in the transmission chain.
7. The ringing can also be reduced by reducing the

chrominance bandwidth of the PAL codec. The response of the coder is specified but that of the decoder is not, and is determined by the equipment manufacturer. In the case of receivers the overall response depends on both the r.f./i.f. and the chrominance decoder bandwidths.

8. Because different samples of professional decoder may have significantly different characteristics, the subjective assessment of a given channel-defining filter may vary from this cause.

9. For studying the performance of channel-defining filters the response of a PAL coder and typical professional decoder can be simulated by using a 0.5  $\mu$ s chrominance pulse-and-bar test signal.

## 6 Acknowledgments

The author would like to thank Mr I. F. Macdiarmid for helpful discussions during the course of the work and Mr R. Weeks for the design of the filters and providing the computed data in Section 3 to support the measured results.

Acknowledgment is made to the Director of Research of the British Post Office for permission to publish this paper.

## 7 References

- 1 Macdiarmid, I. F., 'Performance requirements of links for colour television' in 'International Broadcasting Convention'. IEE Conf. Pub. 46, 1968, pp. 6.8.1-6.8.4.
- 2 'Requirements for the transmission of television signals over long distances (System I only)'. CCIR Recommendation 451-2, Geneva 1974.
- 3 Brown, A. and King, R. W., 'Digital video: reduction of sampling frequency to 11.9 MHz'. BBC Research Dept. Report no. 1972/36.
- 4 Belcher, R. A. and Gaskell, P. S., 'Subjective effects of band limiting the colour-difference signals in PAL television System 1', BBC Research Dept. Report no. 1976/19.
- 5 Specification of television standards for 625-line System 1 transmissions. January 1971, Published by the Independent Broadcasting Authority and the British Broadcasting Corporation.
- 6 'Characteristics of television systems'. CCIR Report 624-1, Kyoto, 1978.
- 7 Allnatt, J. W., 'Subjective quality of television pictures impaired by linear waveform distortion', *Electronics Letters*, 13, no. 18, pp. 546-8, September 1977.

*Manuscript first received by the Institution on 6th August 1979 and in final form on 23rd October 1979  
(Paper No. 1918/Comm 192)*

## The Author

**Bhupendra Patel** commenced studies at Woolwich Polytechnic, London in 1957 and after receiving a B.Sc. degree in electrical engineering in 1961, joined the Research Department of the British Post Office at Dollis Hill. Following two years of general training in the Atomic Frequency Standards Laboratories, he joined the Visual Telecommunications Division, moving to the new Research Centre at Martlesham Heath in Suffolk with the Division in 1976. His work includes the implementation of video frequency networks with particular emphasis on time domain applications.



train of narrow pulses, which is unsuitable as input to an exclusive-OR phase comparator. To overcome this difficulty either a D-type flip-flop phase comparator may be used, or a ÷2 pulse squarer included at the output of the divider. The latter solution is appropriate if a pulse squarer is also included as in (a).

- (c) The simple exclusive-OR phase comparator may be employed provided that the duty cycle of both its inputs is close to 50%. If this condition is met, the level of low frequency components at the output will be kept to a minimum, minimizing any residual frequency modulation of the v.c.o. If the input duty cycle is not suitable, then an edge triggered type of digital phase comparator may be employed.<sup>2</sup>
- (d) From equations (1) and (8) (see Appendix), the output frequency is given in general by:

$$f_0 = f_1 \frac{N \pm 1}{N}$$

and the offset of  $f_0$  from  $f_1$  by:

$$f_1 - f_0 = \pm \frac{f_1}{N}$$

Care must be taken that the range of the v.c.o. is not sufficient to bring about false locking, so that its range about centre frequency should be rather less than  $\pm f_1/N$ . The range, therefore, becomes narrower as  $N$  increases. This is in accordance with the fact that the resolution increases with  $N$  and hence the required range in practice becomes narrower.

- (e) The loop filter and linear amplifier may be of any convenient type.

Figure 4 shows the system configuration using the above simple elements. Provided that a long enough divide chain is employed, this same hardware can perform the required frequency shifting function for a variety of applications.

Some examples of practical designs using this system are perhaps useful as illustrations. To synthesize a frequency offset by nominally 1 kHz from a given

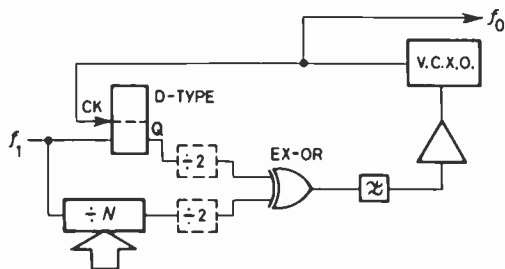

Fig. 4. Synthesizer incorporating digital D-type flip-flop mixer, ÷2 pulse squarer and exclusive-OR phase comparator.

10 MHz frequency source,

i.e.  $f_1 = 10^7$  Hz

and  $f_0 = 9999000$  Hz

then, substituting in equation (1)  $N = 10^4$ .

Substituting into (3), the output frequency resolution obtainable in this case will be

$$\frac{\partial f_0}{\partial N} = 0.1 \text{ Hz.}$$

Similarly, to synthesize an output frequency nominally of 10 MHz variable over a narrow range in steps of 1 Hz, the required parameters are

$$f_1 = 10003162 \text{ Hz}$$

and

$$N = 3163$$

and to generate a frequency with a resolution of 2.5 Hz from a 10 MHz source,

$$N = 2000$$

and

$$f_0 = 9995000 \text{ Hz.}$$

## 2.2 Factors Affecting the Programmable Dividers

The value of  $N$  determined in the basic design of any system defines the minimum number of divider stages required. Whether all of these stages are programmed, however, is a different consideration. As an illustration consider the case of the first example above. A nominal value for  $N$  of 10 000 has been arrived at, and this will require at least 14 bits of divider. The total range of a 14-bit divider if all the bits are programmable is:

$$N = 2$$

to

$$N = 16384$$

As discussed previously, the lower end of this range is inappropriate as the non-linearity of the system becomes excessive. The high end of the range presents no problems, provided that the phase comparator frequency does not become excessively low as a consequence. The total frequency range over which the synthesizer operates is, of course, defined by the allowable range of  $N$ .

One factor of importance in certain applications is the number of bits available for programming the synthesizer. Commonly an eight-bit address word only is available, and the effect which this has on the range may be evaluated as follows:

- (i) Consider the binary equivalent of the nominal value of  $N$ , in this case:

$$10000_{10} \equiv 10\ 0111\ 0001\ 0000_2$$

- (ii) If only the least significant eight bits may be

programmed, then the range of  $N$  obtainable is:

$$10\ 0111\ 0000\ 0000 \equiv 9984$$

to

$$10\ 0111\ 1111\ 1111 \equiv 10239$$

(iii) Substituting these values into equation (1) the maximum and minimum output frequencies may be determined:

$$|f_0|_{\min} = 9998999\ \text{Hz}$$

$$|f_0|_{\max} = 9999023\ \text{Hz}$$

(iv) The worst-case frequency resolution may now be determined from equation (3) by substitution of the minimum value of  $N$

$$\left| \frac{\partial f_0}{\partial N} \right|_{\max} = 0.10003\ \text{Hz.}$$

### 2.3 Comparator Frequency

In the second example quoted, it was shown that in order to synthesize a frequency of nominally 10 MHz with a resolution of 1 Hz,  $f_1 = 10003162\ \text{Hz}$ ,  $N = 3163$  and hence the phase comparator frequency is  $f_3 = 3163\ \text{Hz}$ . If this same requirement is applied to the conventional synthesizer of Fig. 3(b) the following values result:

$$L = 10^7$$

$$M = 10^7$$

$$f_1 = 10\ \text{MHz}$$

and

$$f_3 = 1\ \text{Hz}$$

Not only does the f.s.s. show considerable economy of hardware over the conventional approach, but the higher phase comparator frequency involved affords reduced residual f.m., improved acquisition time and less stringent filter requirements.

### 3 Applications

The combination of high frequency resolution and simplicity of construction have rendered the f.s.s. appropriate in applications such as the following.

#### 3.1 A Digitally-temperature-compensated Crystal Oscillator<sup>3, 4</sup>

Figure 5 is the block diagram of an all-digital technique for the temperature compensation of crystal oscillators, details of which may be found in reference 3.

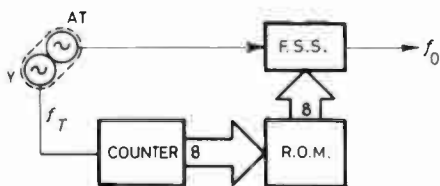

Fig. 5. All-digital technique for temperature compensation of crystal oscillator.

The technique affords considerable improvement in temperature stability and noise performance over conventional corrected oscillators, and could not have been made practical without the very high frequency resolution of a f.s.s.

The heart of the system is a frequency shifting synthesizer which generates a corrected frequency from that of a temperature varying AT-cut quartz crystal oscillator. The synthesizer is addressed according to temperature-law data contained in a read-only memory (r.o.m.), the appropriate data being selected according to temperature information. This is obtained by counting the linearly temperature dependent frequency of a second crystal oscillator controlled by a Y-cut crystal held in close thermal contact with the AT-cut crystal.

The synthesizer employed has as its output a voltage-controlled crystal oscillator which is driven at a high level in order to obtain optimum noise performance. It is capable of correcting the AT-cut crystal oscillator frequency to within 0.5 Hz over the temperature range to 0 to 50 C, representing a frequency stability of 5 parts in  $10^8$ . An l.s.i. version of the oscillator is currently being developed commercially.

#### 3.2 A Digitally Controlled Clarifier for S.S.B. Radio

When a digital channel synthesizer is employed in a single sideband radio system, the clarifier commonly consists of a fine-tune control on the master oscillator of the synthesizer. When the frequency of the master oscillator is used elsewhere, however, (for example when one high-stability oscillator is used to control several equipments), this fine-tune is not possible. Incorporation of the fine-tune facility into the channel synthesizer would require considerable increase in its complexity.

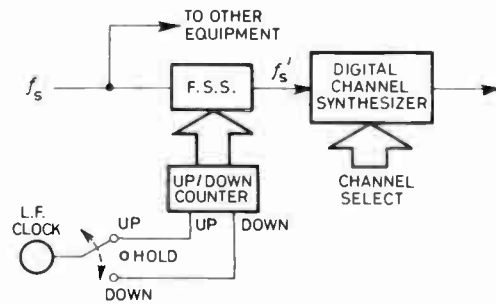

Fig. 6. Digital clarifier for s.s.b. reception using f.s.s.

Figure 6 shows the schematic of a digital clarifier based upon the frequency shifting synthesizer. The f.s.s. is used to vary the clock frequency of the channel synthesizer without disturbing the standard frequency source, leaving the latter available for other uses. The address to the f.s.s. may be obtained from a digital UP/DOWN counter clocked by a low-frequency (say 5 Hz) oscillator. A three-position switch may be employed to gate the clock pulses to either the 'count-up' or 'count-

down' port.

The digital nature of this clarifier makes it suitable for incorporation into an automatic version<sup>5</sup> in which pilot information is encoded onto the transmission. On reception the clarifier is allowed to scan through its range until the pilot information indicates correct tuning, when the output of the counter is latched. Such a system has the advantage over analogue sample/hold arrangements that its memory is indefinite.

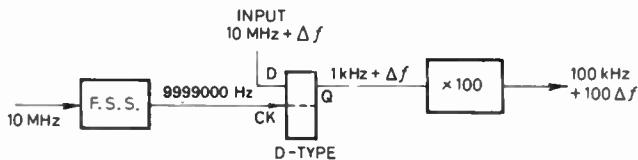
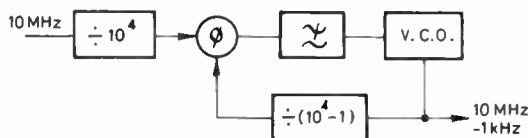
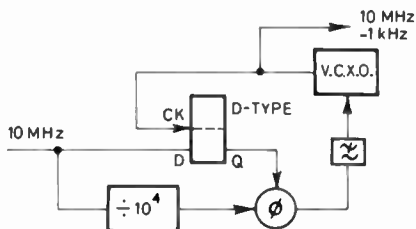

Fig. 7. Simple frequency error multiplier.



(a) Conventional approach.



(b) Using f.s.s. techniques.

Fig. 8. Offset frequency generation

### 3.3 Fixed Offset-frequency Source

The need arises for a synthesizer to generate a 9999000 Hz signal from a 10 MHz frequency standard (similar to the first example of Sect. 2.1), for use in the simple frequency error multiplier of Fig. 7. Figures 8(a) and 8(b) allow comparison of the conventional and f.s.s. approaches to this requirement and show a clear economy in the latter.

### 4 Discussion

The simplicity with which very high frequency resolution may be obtained using a frequency shifting synthesizer makes the technique attractive in many areas. Its relatively low cost allows its effective use in routine as well as exacting applications, for both fixed and programmable frequency generation. The combination of two such synthesizers would broaden the possibilities still further.

### 5 Acknowledgments

The authors acknowledge the receipt of a Science Research Council CASE award (to G. A. Warwick) in collaboration with Racal Instruments Ltd., Windsor, Berkshire. Particular thanks are due to Mr. K. Thrower for helpful discussions throughout the work.

### 6 References

- 1 Nemeč, J., 'A high frequency synthesizer with a digital mixer', *Electronic Design*, 4, pp. 120-2, 15th February 1977.
- 2 Morgan, D. K. and Stuedel, G., 'The COS/MOS Phase-locked Loop', RCA application note ICAN-6101.
- 3 Warwick, G. A., Gosling, W. and Prescott, A. J., 'A digital technique for temperature compensation of crystal oscillators', Conference on Radio Receivers and Associated Systems, Southampton, July 1978, IERE Conference Proceedings no. 40, pp. 207-16.
- 4 'Digital compensation technique in crystals yields ultrastability', *Electronics*, September 14th, 1978, pp. 67-8.
- 5 Gosling, W., McGeehan, J. P. and Holland, P. G., 'Receivers for the Wolfson SSB VHF land mobile radio system', Conference on Radio Receivers and Associated Systems, Southampton, July 1978, IERE Conference Proceedings no. 40, pp. 169-78.

### 7 Appendix

The equations corresponding to (1) to (4) for the case  $f_0 > f_1$  are easily derived as follows:

From Fig. 1, when the loop is phase locked:

$$f_2 = f_3$$

If  $f_0 > f_1$ , then  $f_0 - f_1 = f_1/N$   
from which

$$f_0 = f_1 \left[ \frac{N+1}{N} \right] \tag{8}$$

and

$$f_1 = f_0 \left[ \frac{N}{N+1} \right] \tag{9}$$

Differentiating these with respect to  $N$ , assuming other values constant:

$$\frac{\partial f_0}{\partial N} = -f_1 \left[ \frac{1}{N^2} \right] \tag{10}$$

and

$$\frac{\partial f_1}{\partial N} = f_0 \left[ \frac{1}{(N+1)^2} \right] \tag{11}$$

All other aspects of the performance and design of a f.s.s. are identical for  $f_0 < f_1$  and  $f_0 > f_1$ .

*Manuscript first received by the Institution on 19th October 1978 and in revised form on 13th March 1979  
(Paper No. 1922/CC 319)*



# Transmission of speech by adaptive sampling

J. DUNLOP, Ph.D., M.Sc.\*

and

N. C. CHANGKAKATI, Ph.D., B.Sc.†

## SUMMARY

This paper describes a technique for reconstructing a signal which has been sampled at a rate related to its short-term maximum frequency. The method described is based upon a theoretical simulation of active signal recovery filters containing periodically-operated switches. The cut-off frequency of such a filter is a function of the switching duty cycle. It is shown that the optimum filter is one with a sharp cut-off characteristic. The poor transient response usually associated with such filters is not a significant signal distortion factor.

\* Department of Electronic Science and Telecommunications, University of Strathclyde, Royal College, 204 George Street, Glasgow G1 1XW.

† Formerly at the University of Strathclyde; now at the Regional Engineering College, Siltchar, Assam, India.

## List of symbols

$f(t)$	input signal
$f_c$	carrier frequency of a frequency-modulated signal
$f_m$	modulating frequency
$\Delta f$	carrier deviation
$f_{inst}$	instantaneous frequency
$f_0$	instantaneous cut-off frequency of time-varying filter
$T$	state transition interval
$T_s$	switching period
$t_0$	interval that a switch is closed
$t_1$	memory length of pre-filter
$g$	switching duty cycle
$H(j\omega)$	frequency response of a network
$H(j\omega/g)$	frequency response of a network with a periodically operated switch
$[V_{in}(t)]$	input vector
$[v_c(t)]$	state vector
$[A]$	system matrix
$[f]$	distribution matrix, represents the coupling between the state variables and the input signal
$R$	percentage harmonic distortion
$v_n$	amplitude of $n$ th harmonic in the discrete Fourier transform of input signal
$v'_n$	amplitude of $n$ th harmonic in the discrete Fourier transform of output signal
$N$	number of spectral components in the discrete Fourier transform

## 1 Introduction

It is well known that some classes of signals, e.g. speech and television, occupy all of their respective bandwidths for only a relatively small portion of their respective durations. In theory such signals may be sampled at a rate equal to twice their short-term maximum frequencies (subsequently referred to as 'instantaneous frequency') without loss of information. It has been shown<sup>1</sup> that in the case of speech the average sampling rate can be reduced to 25% of the rate when sampling occurs at twice the maximum frequency. If asynchronous multiplexing techniques are used,<sup>2</sup> significant increases in channel capacities can be achieved by sampling a number of speech signals at an adaptive rate. Recent renewed interest has been shown<sup>3</sup> in the possibilities of asynchronously transmitting speech signals using packet switching techniques.

A major problem in any non-uniform sampling system is the regeneration of distortion-free speech signals from the non-uniform samples. A number of techniques for achieving this have been described in the literature<sup>4, 5</sup>

but they suffer from the disadvantage that they are either very difficult to realize in practice, or contribute significant distortion to the regenerated speech signal. The purpose of this present paper is to suggest a technique for recovering speech signals which have been adaptively sampled, which produces minimal signal distortion and at the same time is relatively easy to implement in a practical sense. The results presented are theoretical and based on simulation. It should be pointed out, however, that the demodulation technique described is based upon filters in which time-constant multiplication is achieved by component switching, which is straightforward to achieve in practice.

**2. Speech Model**

The initial study on recovering speech from non-uniform samples was based upon computer simulation. It was found necessary to produce a reasonably realistic speech model for simulation purposes which would examine the performance of the demodulation scheme under the expected worst conditions. Since sampling frequency will be related to the short-term maximum frequency of the speech it was felt, intuitively, that the most stringent demands on any speech reconstruction system would be imposed by a signal having the greatest rate of change of short-term maximum frequency.

A survey of published results has shown that on average the transition between sounds |b| and |U| e.g. (*boot*) produces the highest rate of change with a value of  $1.66 \times 10^5$  Hz/s. The appropriate short term maximum frequencies associated with sounds |b| and |U| are respectively 180 Hz and 3.5 kHz and the transition between these sounds has an average duration of 20 ms. It is convenient from the point of view of analysis to assume a sinusoidal variation of frequency over the 20 ms interval which means that the maximum rate of change of frequency can be incorporated in a frequency-modulated tone where the period of modulation may be taken as 40 ms. The model then becomes a single tone of frequency 1.84 kHz modulated by a second tone of frequency 25 Hz. The amplitude of the second tone is of course chosen to produce the desired maximum and minimum frequencies. The frequency-modulated model is given in equation (1):

$$f(t) = A \cos \left[ 2\pi f_c t - \frac{\Delta f}{f_m} \sin 2\pi f_m t \right] \quad (1)$$

where  $f_c = 1.84$  kHz,  $f_m = 25$  Hz and  $\Delta f = 1.66$  kHz.

**3 Time-varying Low-pass Filter for Signal Recovery**

If the modulating frequency of a frequency-modulated wave is much lower than the frequency deviation, the modulation index becomes very large and the f.m. signal may be represented in a quasi-stationary form, i.e. as a single tone, equal in frequency to the instantaneous

frequency of the modulated wave, which migrates along the frequency axis.

It has been shown<sup>6</sup> that if the transmission function of a low-pass filter is varied slowly in a periodic fashion the time-varying frequency response can also be represented as a migrating characteristic in the frequency domain. This is shown in Fig. 1.

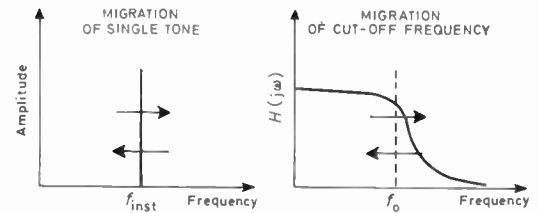

Fig. 1. Quasi-stationary representation of a frequency-modulated wave and a time-varying frequency response.

Clearly if the cut-off frequency of the filter tracks the instantaneous frequency of the f.m. wave, all frequencies above this instantaneous value will be attenuated by the filter. This forms the basis of the technique for demodulating adaptively sampled speech signals. A block diagram is shown in Fig. 2, where the cut-off frequency of the time-varying filter tracks the 'instantaneous frequency' of the speech waveform.

The quasi-stationary model of Fig. 1 is valid for f.m. waveforms only when the modulating frequency is much less than the frequency deviation. For time-varying filters the quasi-stationary model is valid only if the parameters of the system do not change appreciably over an interval equal to the network memory length which is defined in this context as the interval of time, after the occurrence of an impulse, beyond which the impulse response is negligibly small compared with its peak value. A fifth-order Chebyshev low-pass filter with a cut-off frequency of 190 Hz has a memory length of approximately 100 ms which is greater than the period of the 25 Hz modulating tone.<sup>7</sup> Hence the quasi-static approximation cannot be used for system evaluation.

Zadeh<sup>5</sup> has shown that under these circumstances the time-varying transfer function  $H(j\omega, t)$  can be expanded in a parallel/series combination of a fixed number of time-invariant filters with sinusoidally varying gains.

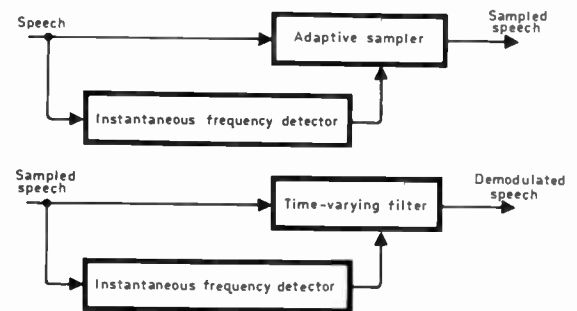

Fig. 2. Adaptive sampling and demodulation system.

The evaluation of the invariant transfer functions is extremely complex even for low-order systems and is strictly valid only for periodic variations, which are unlikely to occur in practice.

A time-varying frequency response on the other hand can be produced simply by incorporating electronic switches in conventional active filters and these filters can be conveniently analysed using the state variable approach.

**4 Realization of a Time-varying Transfer Function**

Filter tuning by component switching is a well-established technique.<sup>8-10</sup> The principle is explained by reference to the simple RC network of Fig. 3. When the switch is closed and a step of amplitude  $V_1$  is applied at the input, the capacitor voltage is given by  $v = V_1[1 - \exp(-t/RC)]$ . If the switch is operated in a

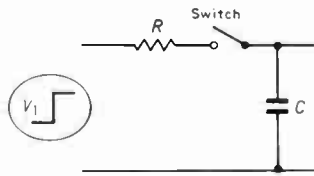

Fig. 3. RC network with a periodically operated switch.

periodic manner it is apparent that the capacitor will charge at a slower rate as the charging process can only occur during the intervals when the switch is closed. The presence of a periodically varying switch thus effectively increases the value of  $R$ . The capacitor voltage is now given by  $v = V_1[1 - \exp(-gt/RC)]$  where  $g$  is the duty cycle of the switch, i.e.  $g = t_0/T_s$  where  $T_s$  is the switching period and  $t_0$  is the ON time of the switch. The time-constant of the filter and hence its cut-off frequency are directly related to the switching duty cycle  $g$ . The step response of the circuit at a fixed value of  $g$  is shown for two different values of  $T_s$  in Fig. 4.

It should be noted that the apparent time-constant is not changed by altering the switching frequency but the higher the switching frequency the better is the approximation to a continuous curve. If  $H(j\omega)$  is the frequency response of the network when the switch is permanently closed, the presence of a periodically

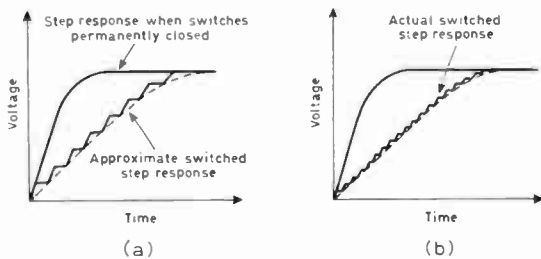

Fig. 4. Step response of a RC network with a periodically-operated switch (a) low switching frequency (b) high switching frequency.

operated switch transforms this response to  $H(j\omega/g)$ . The cut-off frequency of the RC network can be made a function of time by making the duty cycle  $g$  time varying. This technique may be extended to higher order RC filters as shown in Fig. 5.

The switches in this circuit may be realized by m.o.s. analogue switches which are all driven from a common variable-duty-cycle switching waveform. The lowest switching frequency which may be used without producing excessive granularity on the output signal is  $1/5T_{max}$  where  $T_{max}$  represents the maximum time-constant of the network. It should also be noted that in the circuit of Fig. 5 buffering is required at the output to prevent  $C_5$  from discharging during the periods when the switches are off. The presence of periodically operated

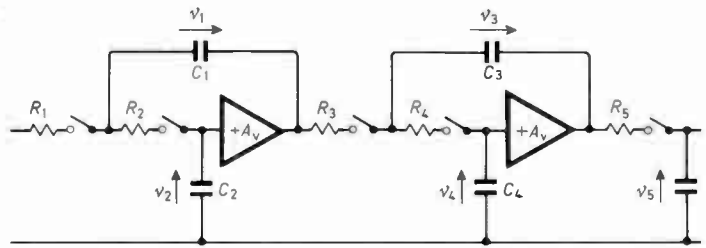

Fig. 5. Electronically-tunable fifth-order filter.

switches in the circuit makes the filter response effectively non-linear. The circuit therefore is most easily analysed using state space techniques. The circuit does of course behave in a linear manner when the switches are closed. Considering the circuit of Fig. 5 in which the capacitor voltages are taken as state variables the state equations of the network can be written

$$[\dot{v}_c(t)] = [A][v_c(t)] + [f][V_{in}(t)] \tag{2}$$

If  $[v_c(t)]$  represents the state variables at time  $t$  and  $[v_c(t+T)]$  represents the state variables at time  $T$  later, then from the usual definition of differential coefficient

$$[\dot{v}_c(t)] = \frac{[v_c(t+T)] - [v_c(t)]}{T} \tag{3}$$

eliminating  $[v_c(t)]$  from equation (2) and solving for  $[v_c(t+T)]$  gives the recursive formula

$$[v_c(t+T)] = (T \cdot [A] - [I]) \cdot [v_c(t)] + T \cdot [f] \cdot [V_{in}(t)] \tag{4}$$

where  $[I]$  is the identity matrix. The output at any time  $(t+T)$  is thus defined by a knowledge of the state variables and the input signal at the time  $T$  earlier. If  $T$ , the transition interval, is made very small, equation (4) approximates closely to a continuous output. When the switches are open the capacitor voltages  $[v_c(t)]$  remain fixed at the values at the instant the switches open. If  $V_1$  to  $V_5$  represent the voltages on the capacitors  $C_1$  to  $C_5$  of Fig. 5 the state equations become:

$$\begin{bmatrix} \dot{V}_1 \\ \dot{V}_2 \\ \dot{V}_3 \\ \dot{V}_4 \\ \dot{V}_5 \end{bmatrix} = \begin{bmatrix} -(1/R_1 C_1 + 1/R_2 C_1) & (1/R_2 C_1 - A_v/R_2 C_1 - A_v/R_1 C_1) & 0 & 0 & 0 \\ 1/R_2 C_2 & (A_v - 1)/R_2 C_2 & 0 & 0 & 0 \\ 0 & A_v/R_3 C_3 & -(1/R_3 C_3 + 1/R_4 C_3) & (1/R_4 C_3 - A_v/R_4 C_3 - A_v/R_3 C_3) & 0 \\ 0 & 0 & 1/R_4 C_4 & (A_v - 1)/R_4 C_4 & 0 \\ 0 & 0 & 0 & A_v/R_5 C_5 & -1/R_5 C_5 \end{bmatrix} \times \begin{bmatrix} V_1 \\ V_2 \\ V_3 \\ V_4 \\ V_5 \end{bmatrix} + \begin{bmatrix} 1/R_1 C_1 \\ 0 \\ 0 \\ 0 \\ 0 \end{bmatrix} \cdot [V_{in} \ 0 \ 0 \ 0 \ 0] \quad (5)$$

In order to choose a suitable switching frequency account must be taken of the bandwidth of the input signal.<sup>9</sup> The switching frequency must be significantly higher than the highest frequency component in the input. When the input is a sampled waveform the bandwidth is, in theory, infinite. To accommodate such a signal some initial limiting is required. In the work described here this was achieved by use of a fifth-order low-pass Chebyshev filter with a fixed cut-off frequency of 4 kHz. This pre-filter does not remove the distortion components produced by the adaptive sampling but does provide a continuous band limited signal for the electronically tuned filter.

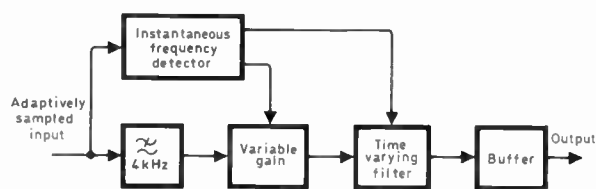

Fig. 6. Time-varying signal reconstruction.

It is apparent from uniform sampling theory that the energy in a reconstructed signal is related to the ratio of sample pulse width to sampling period. When this factor is extended to an adaptively sampled signal it is clear that for a constant sampling pulse width the energy in the reconstructed signal is inversely related to the sampling frequency and will change as this sampling frequency changes. To compensate for this effect a variable gain amplifier is required. With reference to Fig. 2 the control signal for this amplifier is also derived from the 'instantaneous frequency' detector. The complete reconstruction system is shown in Fig. 6.

**5 Time-varying Signal Reconstruction**

In order to assess the performance of a practical realization of the scheme shown in Fig. 6 it is desirable to use a test signal which is periodic. The frequency modulated wave of the form given in equation (1) provides the necessary frequency transition and is also periodic. When using the discrete Fourier transform in spectral analysis it is also advantageous to have a signal which is periodic and has the same period as the time window of the discrete Fourier transform. The advantage of such a signal<sup>13</sup> is that no spectral leakage occurs in the discrete Fourier transform.

The spectrum produced by the discrete Fourier transform consists of harmonics of the reciprocal of the

time window of the transform itself. In order to make these harmonics correspond to the frequency components of the frequency-modulated wave the minimum and maximum frequencies were changed to 900 Hz and 3510 Hz. If the centre frequency is chosen as 1850 Hz the sidebands for a 25 Hz modulating signal then correspond exactly with the components of the discrete Fourier transform with a time window of 40 ms. The original rate of change of frequency of  $1.66 \times 10^5$  Hz/s is also maintained.

The signal used for analysis is shown graphically in Fig. 7. This signal was adaptively sampled and applied to a time-varying demodulation scheme containing three different types of tuned fifth-order low-pass filter, namely Bessel, Butterworth and Chebyshev.

**6 Results and Conclusions**

When a signal is sampled uniformly the function of the reconstruction filter is to eliminate all frequency components, generated by the sampling process, above the original signal band. When the signal is sampled adaptively and time-varying demodulation is used a further source of distortion can result from transients generated in the filter outputs. The transient response of a linear network containing a periodically operated switch has been obtained by Desoer.<sup>11</sup> The relative importance of the two types of distortion must be assessed in order that the optimum demodulation characteristic may be specified.

Dunlop and Phillips<sup>7</sup> have shown that the memory length of a fifth-order Chebyshev filter, which has a sharp cut-off characteristic, has a normalized value of 96 seconds. The corresponding figure for a Bessel fifth-order filter, which has a gradual cut-off characteristic, is also given and has a value of 6 seconds. Hence it can be

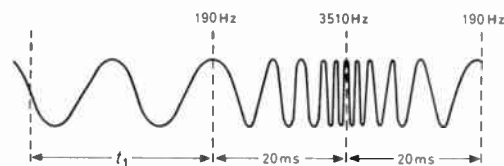

Fig. 7. Test signal for adaptive sampling and demodulation.



concluded that sharp cut-off characteristics are associated with poor transient response. It would be expected therefore that the transient distortion produced by a Bessel filter should be considerably less than the corresponding distortion produced by a fifth-order Chebyshev filter with the same cut-off frequency.

The sampling frequency chosen in the simulation was 2.35 times the 'instantaneous frequency', a figure which corresponds to the standard used in 64K bit/s p.c.m. In the computer simulations the sampling pulse train was generated by multiplying the test signal in frequency by 2.35 and determining the zero crossings, each alternate zero crossing corresponding to a sampling instant. In a practical system the sampling waveform would be derived by differentiating the speech waveform and detecting the zero crossings of the differentiated signal. It would of course be necessary in practice to multiply the output frequency of the zero crossing detector by the factor 2.35. A number of techniques for achieving this are suggested in the Appendix. Figure 7 indicates that a constant frequency of 190 Hz was applied to the demodulation system before the f.m. transition. This is necessary to allow any transients in the output of the pre-filter to die away before the transition begins;  $t_1$  corresponds to the memory length of the pre-filter.

The time-varying filter characteristic can be regarded as imposing a simultaneous amplitude and phase modulation on the spectrum of the input signal. As this work was primarily aimed at audio signals, and the human ear is relatively insensitive to phase distortion, the results have been presented in terms of frequency distortion. The spectrum of the output of one complete f.m. cycle was compared with the spectrum of one complete f.m. cycle at the input using discrete Fourier transform (D.F.T.) techniques. The harmonics produced by the D.F.T. are harmonics of the time window of the signal analysed, which in this case will be harmonics of 25 Hz. The percentage harmonic distortion  $R$  was computed by the expression of equation (6).

$$R = \sum_{n=1}^N \frac{(v'_n - v_n)^2}{\sum_{n=1}^N v_n^2} \times 100\% \quad (6)$$

where

$N$  = total number of spectral components (1024)  
 $v_n$  = amplitude of  $n$ th harmonic of input before sampling  
 $v'_n$  = amplitude of  $n$ th harmonic of the output after demodulation.

The distortion figures produced for Bessel, Butterworth and Chebyshev filters with cut-off frequencies of 1.03 times the 'instantaneous frequency' were

Bessel	26.3%
Butterworth	13.6%
Chebyshev	5.7%

The Chebyshev filter clearly produces significantly less

distortion than the other types of filter. In an attempt to quantify the distortion due to transient response alone, the test signal was applied to the demodulation circuit in continuous form (i.e. unsampled). The frequency distortion for Bessel and Chebyshev filters were computed as

Bessel	3.66%
Chebyshev	3.08%

This is a rather surprising result as it suggests that the transient response of a Chebyshev filter containing a periodically-operated switch is in fact better than the corresponding Bessel response. This result has been verified by practical measurement.<sup>12</sup>

It would seem reasonable to assume therefore that the major source of signal distortion is due to the components produced by the sampling process which appear in the pass-band of the time-varying filter. This type of distortion is clearly minimized by a filter which has an attenuation/frequency characteristic which increases rapidly beyond the cut-off frequency. The Chebyshev filter which falls into this category therefore performs significantly better as a time-varying reconstruction scheme.

## 7 Further Work

The computer simulations show clearly that reconstruction of adaptively sampled speech signals is feasible with a time-varying low-pass filter. Such a characteristic is easily realizable with periodically-operated switches the optimum characteristic being a sharp cut-off outside the filter pass-band. Work is continuing at Strathclyde on the physical realization of such a system and it is hoped to publish the results of subjective tests in due course.

## 8 References

- Birdsall, T. G., Ristenbatt, M. P. and Weinstein, S. B., 'Analysis of asynchronous time multiplexing of speech sources', *IRE Trans. on Communication Systems*, **CS-10**, pp. 390-7, December 1962.
- Ristenbatt, M. P. and Rothschild, D. R., 'Asynchronous time multiplexing', *IEEE Trans. on Communication Technology*, **COM-16**, no. 3, pp. 349-57, June 1968.
- Roberts, L. G., 'The evolution of packet switching', *Proc. IEEE*, **66**, no. 11, pp. 1307-13, November 1978.
- Mathews, M. V., 'External coding for speech transmission', *IRE Trans. on Information Theory*, **IT-5**, pp. 129-36, September 1959.
- Spogen, L. R., Shaver, H. N. and Baker, D. E., 'Speech processing by the selective amplitude sampling system', *J. Acoust. Soc. Am.*, **32**, no. 12, pp. 1621-5, December 1960.
- Zadeh, L. A., 'Frequency analysis of variable networks', *Proc. IRE*, **38**, pp. 291-9, March 1950.
- Dunlop, J. and Phillips, V. J., 'Signal recovery from repetitive non-uniform sampling patterns', *The Radio and Electronic Engineer*, **44**, pp. 491-503, September 1974.
- Hirano, K. and Nishimura, H., 'Active RC filters containing periodically operated switches', *IEEE Trans. on Circuit Theory*, **CT-19**, pp. 253-60, May 1972.
- Edwards, G. P., 'Variable bandwidth filters using switching', *Electronics Letters*, **5**, no. 1, pp. 12-13, January 1969.
- Mazumder, N. C., Hulley, L. N. and Bell, E. C., 'A synthetic approach to switching for filter tuning', *Int. J. Electronics*, **35**, no. 6, pp. 769-87, December 1973.

- 11 Desoer, C. A. 'Transmission through a linear network containing a periodically operated switch', IRE Wescon Conference Record, Pt. 2, pp. 34-41, 1958.
- 12 Phua, Y. T., 'Adaptive sampling and demodulation of speech signals', M.Sc. thesis, University of Strathclyde, Glasgow, January 1978.
- 13 Brigham, O., 'The Fast Fourier Transform' (Prentice-Hall, Englewood Cliffs, N.J., 1974).
- 14 Kincaid, R. and Shirely, F., 'Get something extra in filter design', *Electronic Design*, 13, pp. 114-21, June 1979.

**9 Appendix: Practical considerations**

The main problem in a practical system is to provide a sampling frequency which is 2.35 times the instantaneous frequency of the speech. If peak sampling is used this produces a sampling frequency which is approximately twice the instantaneous frequency. Even with uniform sampling significant signal distortion can arise when practical low-pass filters are used. Hence with non-uniform sampling it is highly desirable to sample above the instantaneous Nyquist frequency.

A straightforward practical method of realizing fractional frequency multiplication is to use a phase-locked loop with frequency divider circuits in the input circuitry and also between the voltage controlled

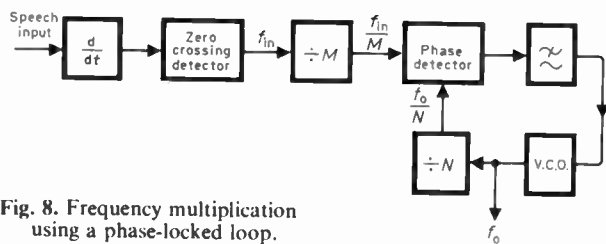

Fig. 8. Frequency multiplication using a phase-locked loop.

oscillator and phase detector in the feedback loop. A typical arrangement is shown in Fig. 8. If the input frequency is divided by  $M$  and the output of the v.c.o. is divided by  $N$  the loop will lock when

$$f_0/N = f_{in}/M$$

i.e.  $f_0 = f_{in} N/M$  (7)

$f_0$  is the output frequency of the v.c.o. and  $M$  and  $N$  are both integers which are produced by binary counting circuits. If  $N = 7$  and  $M = 3$  then  $f_0 = 2.333 f_{in}$  which is a reasonable approximation to the required figure of 2.35.

Experimental tests with a SE565 phase-locked loop i.c. have shown that the maximum rate of change of frequency which can be accommodated before the loop loses phase lock is approximately  $2.5 \times 10^4$  Hz/s. This is well below the maximum rate of change of frequency used in the simulation. Hence transient response of the loop does present some practical difficulties but these are not, however, unsurmountable. A less elegant solution, but one which has been shown to perform adequately in practice,<sup>12</sup> is shown in Fig. 9. In this case the output of the zero crossing detector is fed to a frequency to voltage converter. The output of this circuit can be amplified by the required amount and then fed to a voltage to frequency converter. These circuits can be designed to

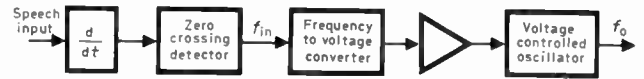

Fig. 9. Frequency multiplication with a frequency to voltage and voltage to frequency converter.

have transient responses which are insignificant and can be adjusted for any fractional frequency multiplying factor.

**Table 1**

Filter type	$R_1$	$R_2$	$R_3$	$R_4$	$R_5$
Chebyshev	75.2K	54.2K	196.6K	44.1K	121.6K
Butterworth	71.3K	27.3K	27.2K	71.3K	44K
Bessel	9.4K	11.7K	6.6K	20.7K	12.1K

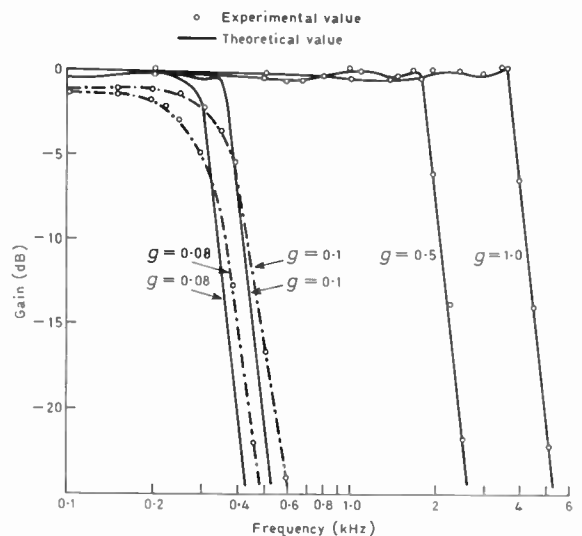

Fig. 10. Frequency response of a fifth-order Chebyshev switched filter.

The other major component in a practical demodulation scheme is the electronically-tuned filter. These filters are designed by standard techniques<sup>14</sup> for a cut-off frequency corresponding to when the switches are permanently closed. In all the simulations undertaken the highest cut-off frequency was fixed at 3.61 kHz. This figure was chosen because in the case of the Chebyshev filter it gives maximum relative attenuation between the signal frequency and the lower side frequency component which (when a sampling frequency of 2.35 times is used) is 1.35 times the signal frequency. The component values for the three types of filter assuming all capacitors have a value of 0.01  $\mu$ F and  $A_v = 2$  are given in Table 1. In the case of the Chebyshev filter these are the values required for a passband ripple of 0.5 dB.

The theoretical and measured frequency response of a fifth-order Chebyshev switched filter is shown in Fig. 10 the switching frequency being chosen as 50 kHz.

*Manuscript first received by the Institution on 21st May 1979 and in revised form on 29th June 1979. (Paper No. 1923/Comm 193)*

## Contributors to this issue\*

**Geoffrey Hobson** received a B.A. degree in physics from the University of Oxford in 1961 and a Ph.D. from the University of Sheffield in 1971. From 1961 to 1967 he worked on laboratory simulation of ionospheric plasma, transistor circuitry, the electronic transport properties of germanium and silicon, and device aspects of the Gunn effect at the Royal Radar Establishment. In 1968 he joined the Department of Electronic and Electrical Engineering of the University of Sheffield where he continued his work on Gunn effect and avalanche devices. Dr Hobson became a Senior Lecturer in 1971 and a Reader in 1974. He is a joint author of a book on 'The Gunn Effect' and his present research interests include applications of charge transfer devices, on which he has also written a book, and software and hardware aspects of digital signal processing with particular application to the solution of industrial problems. In 1979 Dr Hobson was appointed to a Personal Chair in the Department.



**Richard Tozer** received a B.Eng at the University of Sheffield in 1970 and was awarded the degrees of M.Eng. and Ph.D. in 1972 and 1975 respectively, for work on frequency stability of impatt diode oscillators. He spent the next three years as a Research Assistant at the University of Sheffield, working on applications of charge-coupled devices. Since September 1978, Dr Tozer has been a lecturer in the Department of Electrical Engineering Science at the University of Essex, where his interest is active sound cancellation.



**Miltiadis Paloyannidis** received an honours degree in electronic engineering from the University of Sheffield in 1977 and then went on to the Leeds/Sheffield master's degree course in microwave communications engineering, obtaining his M.Eng. degree in 1978. He has since returned to his native country, Greece, to take up an industrial position.



**P. K. Saha** received the B.Sc. (Hons) degree in physics and the M.Tech. degree in radio physics and electronics from the University of Calcutta in 1963 and 1966 respectively, and the Ph.D. degree from the University of Leeds in 1970. During 1970 he was a Post-Doctoral Fellow at Queen Mary College, University of London, and since 1971 has been on the teaching staff of the Institute of Radio Physics and Electronics, University of Calcutta. Dr Saha has worked in the area of microwave antennas and is currently engaged in the field of solid-state microwave sources and microwave integrated circuits.

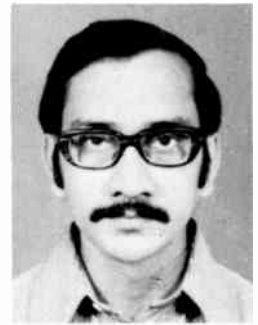

**Professor Biswaranjan Nag** is a member of the teaching staff of the Institute of Radio Physics and Electronics, Calcutta University. He received his B.Sc. degree in 1951 and M.Sc. (Tech.) in 1954 from Calcutta University, the M.S. degree from Wisconsin University in 1960, and Ph.D. and D.Sc. degrees in 1961 and 1970 respectively from Calcutta University. Dr Nag has worked on electronic computers, non-linear phenomena in electronic oscillators, wave propagation in ionized media and microwave measurement of semiconductor properties. His present research interests are concerned with electron transport in compound semiconductors and microwave semiconductor devices. He was awarded the Shanti Swarup Bhatnagar Prize for 1975 for his contributions in the field of electron transport in semiconductors. He was a Jawaharlal Nehru Fellow during the years 1975-77. In 1977 he was elected a fellow of the Indian National Science Academy. He is the author of 140 research papers and two books; seven of his papers have been published by the Institution and in 1962 Dr Nag received the Sir J. C. Bose Premium for a paper on a two-state circuit using an inductively coupled Colpitts oscillator.



**Susanta Sen** received the B.Sc. (Hons) degree in physics and the B.Tech. and M.Tech. degrees in radio physics and electronics from the University of Calcutta in the years 1970, 1973 and 1975 respectively. He joined the Institute of Radio Physics and Electronics, University of Calcutta, as a Research Fellow in 1976 and has been a Lecturer at the Institute since 1978. He is working in the field of microwave semiconductor measurements.

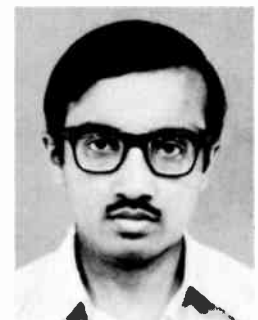



**Saleh Al-Araji** (Member 1977) was awarded an Iraqi Ministry of Oil Scholarship in 1966, and he gained the B.Sc., M.Sc. and Ph.D. degrees from the University of Wales in 1968, 1969 and 1972 respectively. After completing his doctorate he participated in the Home Office joint research programme on mobile radio communication at Swansea. He was awarded the Clerk Maxwell Premium jointly with Professor W. Gosling in 1976 for a paper entitled 'An automatic clarifier for s.s.b. speech communication'. In 1973 Dr Al-Araji was appointed lecturer at the University of Baghdad where he is now Assistant Professor and Communication and Electronics Research Group Leader.



**Janan Allos** (Fellow 1979) graduated from Battersea College of Technology in 1956 with a B.Sc. (Eng.) degree of the University of London and then spent four years in Daura Refinery, Baghdad. In 1960 he returned to England to study for his Ph.D. degree at Kings College, London and in 1963 went back to Baghdad where he is now Assistant Professor and Computation and Control Research Group Leader. From 1964 until 1978 Dr Allos held the positions of Chief Engineer and Technical Director of Forster and Sabbagh Co. (Electronic and Communication Division).



**Khalis N. Khalis** graduated from the University of Sulymania, Iraq, with a B.Sc. degree in physics in 1973. In 1975 he obtained a postgraduate Diploma in Electronics and Communication from the College of Engineering, University of Baghdad where he is at present a demonstrator.



**Rob Prescott** was amongst the first group of students to be awarded the Dip.Tech. (Eng.) at the College of Advanced Technology, Birmingham, now the University of Aston. After graduating he was employed as a design engineer with the GEC. In 1960 he left industry for a post at the Bristol College of Science and Technology and has remained in education ever since. He is now Director of Studies in the School of Electrical Engineering at the University of Bath and is also the Honorary Secretary of the Universities Mobile Radio Research Consortium.



**Professor William Gosling** (Fellow 1968), is head of the Electronics Group in the School of Electrical Engineering at the University of Bath. He is President of the Institution for this year. See Journal for September 1979, page 422 for a full career note.



**Tony Warwick** graduated from the University of Bath in 1976 with an honours degree in electrical and electronic engineering having completed a four-year thin sandwich course sponsored by EMI Electronics, Wells, Somerset. Since returning to the University he has undertaken a programme of postgraduate research into digital techniques for the temperature compensation of crystal oscillators as a Science Research Council CASE student in association with the Advanced Development Division of Racal Group Services.



**John Dunlop** graduated in electrical engineering in 1966 from University College of Swansea and was awarded the degree of Ph.D. by the University of Wales in 1970. He was appointed to his present lecturing post at the University of Strathclyde in 1969. His research interests have covered the fields of speech signal processing and digital processing of Doppler radar signals and he has worked in the latter field with financial support from the Ministry of Defence. His other current research interests are in the area of underwater data communications and this work is being funded by the Science Research Council Marine Technology Programme. He is also a consultant in the application of microprocessors in instrumentation systems.



**Nipendra Changkakati** graduated in electrical engineering in 1965 from the University of Gauhati, India. He was awarded the degree of B.Tech. by I.I.T. Madras in 1968 and was appointed to a lecturing post at the University of Gauhati in 1969. After a period of research at the University of Strathclyde he was awarded the degree of Ph.D. in 1976. He was appointed to his present post as Associate Professor of Electrical Engineering, at the Regional College of Engineering, Silchar, India in 1977. His current research interests include digital signal processing, opto-electronics and radio propagation.

