

Founded 1925

Incorporated  
by Royal Charter 1961

To promote the advancement  
of radio, electronics and kindred  
subjects by the exchange of  
information in these branches  
of engineering

# The Radio and Electronic Engineer

The Journal of the Institution of Electronic and Radio Engineers

## Forty Years' Retrospect

**T**HIS month's cover picture reminds us that it is just 35 years since the Institution acquired the leasehold of 9 Bedford Square. It soon outgrew this accommodation and expanded into No. 8: as readers of the last Annual Report know, the Institution now looks forward to acquiring a building of its own. Of course, the original acquisition of 9 Bedford Square was in itself very much an act of faith, for the decision to enter into a long lease with the then Ministry of Works was taken at a time of economic difficulty and, even more important, the outbreak of the last War.

A few members still with us, Past Presidents and senior members were concerned with the decision but it is generally recognized that the architect of the scheme was Graham Clifford, who at the end of this month—March 1977—retires from the office of Secretary of the Institution after forty years of service. Details about his successor are given on page 132, but Mr. Clifford will, however, continue working for the Institution for another year on special projects which include the launching of a Trust to finance the acquisition of the Institution's own freehold building.

The past forty years, so eventful on the world scene, have been marked by many significant milestones for the Institution. These start appropriately with the first issue of the Institution's Journal: then a slim octavo quarterly with a circulation of a few hundred copies; now recognized as one of the leading British journals on electronic engineering with a world-wide circulation of over 15,000 copies a month. The present issue provides a fitting occasion to reminisce on some of the events chronicled, since Mr. Clifford, who has been intimately concerned with the Journal during that time, now also retires as its Managing Editor.

The wartime volumes naturally relate the problems of meeting the demands of the Services, research and industry for trained radio engineers. But despite all pressures the Institution's Technical Committee found time to write 'Post War Development Reports' containing authoritative proposals on technical education, on broadcasting, both radio and television, and on the organization of research. It is fascinating today to re-read these and similar more recent reports and note how many of their ideas have eventually been implemented.

Prescient too have been some of the Addresses of our Past Presidents: in 1946 Lord Mountbatten spoke about applications of the recently invented electronic computer to information retrieval which have only come to fruition in the last ten years or so. In fact implementation of one of these new techniques (selective dissemination of information) was an early achievement of the National Electronics Council, a body advocated in this Journal for several years and eventually formed under the chairmanship of Lord Mountbatten in 1964. Initially Mr. Clifford was Secretary to the Council and since 1967 he has been its Treasurer.

Many far-reaching changes on which Mr. Clifford guided successive Institution Councils have been recorded in the Journal: the granting of the Royal Charter; membership of CEI and constructive criticism of its policies; continuous revision of membership and educational requirements to enable engineers to meet the challenge of new techniques; and the expansion of our learned society activities. Parallel to this work in London has been the fostering of the electronic engineering profession throughout the world by setting-up overseas divisions and sections and this outward looking attitude of the IERE has found its reflection in *The Radio and Electronic Engineer*.

The retirement of Graham Clifford from a lifetime's active involvement with this Institution and its Journal does indeed suggest a paraphrase of Sir Christopher Wren's own words: If you seek a monument, read within.

P. A. ALLAWAY

## Contributors to this issue\*



Edmund Jarvis (Member 1969) qualified in telecommunications at Willesden Polytechnic and in 1968 he received the City and Guilds Insignia Award for a thesis on 'Multi-access satellite repeaters'. He has been concerned with R & D on satellite and line-of-sight radio-delay systems at Dollis Hill and at Backwell, for some twenty-five years, notably with measurement of the variation in noise temperature of the atmosphere above 10 GHz. Mr. Jarvis is now Head of a Group at the Post Office Research Centre, Martlesham, Ipswich, which is concerned with 11 GHz digital radio-relay system development.



Mike Lea is a graduate of Imperial College, University of London, and he received his M.Sc. in semiconductor physics from Chelsea College. Following several years industrial experience he joined the Electronics Department at the University of Southampton in 1971 and started research into associative parallel processors; this work was transferred to Brunel University in 1972. Mr. Lea is now a Lecturer in digital systems and the leader of the associative processing research team at Brunel University. He has published several papers in the field of associative memories and processors. As a design consultant he is the founder-director of Computer Systems Engineering and has organized many specialist courses on computer architecture.



J. F. Vaneldik received his B.Sc. degree in 1962 and his Ph.D. degree in 1971, both in electrical engineering at the University of Alberta. In the intervening years he was employed by the Defense Research Board of Canada, the Instrumentation and Control Engineering Section of Sherritt Gordon Mines Limited and he engaged in independent consulting work in industrial control on several major projects. In 1971 he joined the Academic Staff of the Electrical Engineering Department at the University of Alberta where he currently holds the position of Associate Professor. His research interests are in the control and electronic instrumentation areas.



David Routledge graduated in engineering physics from the University of Alberta, Canada in 1964. After working on microwave devices with Bell Northern Research, Ottawa, he enrolled at Queen's University in Kingston, where he earned a M.Sc. and Ph.D. in radio astronomy. In 1969 he returned to the University of Alberta with a Killam post-doctoral fellowship and was appointed Assistant Professor in Electrical Engineering in 1971 and Associate Professor in 1975. His current research is in decametric radio astronomy techniques.



E. T. Powner first served an apprenticeship with the Ministry of Aviation and then obtained a B.Sc. degree at King's College, University of Durham (now Newcastle-upon-Tyne), graduating in 1962. He went to English Electric Computers Limited (now ICL) as an engineer to work on advanced computer techniques and industrial data processing. In 1963 he joined the staff of the Department of Electrical Engineering and Electronics, U.M.I.S.T., as an Assistant Lecturer and was promoted to Lecturer in 1965, and to Senior Lecturer in 1974. His current research interests are mainly in the fields of traffic simulation and control and the application of digital techniques to industrial and medical problems.



T. J. Terrell studied at the Harris College (now Preston Polytechnic), obtaining an H.N.D. in electrical engineering in 1965, at the completion of a five-year engineering apprenticeship. After three years with the Post Office Engineering Department he joined Mullard Magnetic Components in 1967, working on the design and development of electronic measuring instruments and digital systems. Two years later he attended a one-year M.Sc. course in digital electronics at U.M.I.S.T. and obtained his degree in 1970. For the following two years he worked at U.M.I.S.T. on the design and implementation of a digital simulator for computer-controlled traffic studies, and was awarded a Ph.D. degree in 1972. In September 1972 Dr. Terrell was appointed as a Lecturer in the Electrical Engineering Department of Preston Polytechnic and in September 1974 he was promoted to Senior Lecturer. Some of his research interests are in the areas of traffic simulation and digital techniques applied to signal analysis and processing.

Ralph Benjamin (Fellow 1976) is Chief Scientist at the Government Communications Headquarters. A fuller biography appeared in the January/February 1977 issue of the Journal.

\* See also page 111.

# Micro-APP: a building block for low-cost high-speed associative parallel processing

R. M. LEA, M.Sc., A.R.C.S., C.Eng., M.I.E.E.\*

## SUMMARY

A design technique, which allows the data-storage and the word-control functions of a byte-organized variable record-length Associative Parallel Processor (APP), to be integrated on a single l.s.i. chip is discussed, and a new l.s.i. device, called the Micro-APP, is proposed. Two implementations of the Micro-APP (16 words  $\times$  16 bits and 32 words  $\times$  12 bits) are described and their characteristics compared with a similar APP in which all functions are implemented separately. Improvements of 16% and 112% in bit-per-pin ratio and reductions of 96% and 94% in cost-per-word-row are reported. Minimum times for a search/write cycle (with tag resolution) of 190ns and 220ns are also recorded.

\*Department of Electrical Engineering and Electronics, Brunel University, Kingston Lane, Uxbridge, Middlesex UB8 3PH.

## 1 Introduction

Conventional computing hardware has been developed to support fast arithmetical and logical computations. More precisely the CPU (central processing unit) provides stored program control of a sequential ALU (arithmetic and logic unit) which performs binary operations on fixed length operands. It follows that the CPU is well suited to those data processing jobs which can be transformed into an ordered sequence of binary operations. Unfortunately there is an increasing number of data processing jobs for which the transformation can be difficult. Typical examples include:

- Information retrieval
- Data-base management
- Text (word) processing
- Computer language processing

A common characteristic of these applications is the need for simple processing of multiple data-elements which are inter-related within an information structure.

Consider a file of unemployed workmen which contains fields such as NAME, NATIONALITY, SEX, AGE, OCCUPATION, etc. A possible search request could be 'list the names of welders who are British, male and under the age of 45'. Of course the CPU can be programmed to perform this task, but the result will be slow in execution, expensive in storage and time-consuming in program development. The basic problem is that the CPU has not been designed for this type of task.

A more suitable type of processor would support associative operations on a large number of variable length text strings in parallel; that is all records would be interrogated, at the same instant of time, for the content of WELDERS, BRITISH, MALE and LESS-THAN-45. Thus the matching domain of records could be isolated rapidly with savings in storage (content-addressing removes the need for special address directories) and program development (powerful search instructions would allow simple algorithms). This integration of content-addressing and parallelism is provided in the Associative Parallel Processor (APP).<sup>1</sup>

The basic organization of an APP comprises an associative memory array (AMA) and two information channels (to provide independent access to the word-rows and bit-columns of the AMA) which are operated under stored-program control, as shown in Fig. 1. Word-rows of the AMA are allocated for the storage of information words which are processed in parallel within the array. There are three primitive processing operations which the associative memory can support:<sup>1</sup>

- SEARCH: Those word-rows, for which the content matches the data in selected fields of the search register (SR), are tagged in the tag register (TR).
- WRITE: The content of those word-rows which have been tagged by a search operation is modified to match that of selected fields of the search register (SR).
- READ: The content of a tagged word-row is transferred to the read register (RR).





Micro-APP (see Fig. 2) and many Micro-APP chips could be supported by a single SIA and DIA unit, this disadvantage has only minimal importance. Moreover, it is likely that the size of AMA which could be integrated on a bipolar Micro-APP would satisfy few applications. Hence, in common with most of the currently available micro-processors, the Micro-APP would be fabricated with m.o.s. l.s.i. technology.

## 2.2 Tag Register

A study of APP designs and their modes of operation reveals that the role of the tag register (TR) is by no means well defined. The TR may be volatile (a mismatch clears a previously set tag) or non-volatile (an explicit clear signal is required). Some APP designs comprise more than one TR to implement specific search routines. Moreover, confusion between tags, record 'markers' and 'activities' and record 'control-bits' is commonplace.<sup>1-4, 12-14</sup> Hence, for any new APP design, the role of its TR must be carefully considered. Indeed, this is particularly relevant to the Micro-APP, for which minimum complexity, high speed (namely avoidance of the inherent long time-constants of m.o.s. fabrication technology) and maximum application are important design criteria.

Further study of the role of the TR reveals that for most operations its sole purpose is to staticize the output signals from matching word-rows of the AMA between search and write or read operations.<sup>1</sup> Hence the primitive 'associative process' is either a 'search-and-write' or 'search-and-read' function. Consequently, except for a very few operations, search and TR have no unique associative processing significance. Moreover, these operations can be synthesized from the primitive functions by the use of 'tag images', which are copies of the content of the TR stored in selected bit-columns of the AMA.<sup>14-16</sup>

A single volatile TR has been selected for the Micro-APP which is restricted to 'search-and-write' (or read) functions. Requirements for non-volatility and other TR configurations are satisfied by programmer defined tag-images.

## 2.3 Communication

Various schemes have been proposed to provide feedback (binary, tertiary and threshold) from the match reply (MR) output of the APP to the host computer.<sup>1-4, 12-14</sup> Propagation logic to provide communication between adjacent word-rows of the AMA has also been suggested.<sup>12</sup> Hence to cover the widest range of applications, a single-line threshold feedback system (in which the output current is proportional to the number of matching word-rows) and simple gating to propagate tags between adjacent word-rows have been selected for the Micro-APP.

## 2.5 Multiple Response Resolution

Since the Micro-APP would perform 'search-and-read' as a primitive operation it is essential that multiple tags, set during the search, are automatically resolved before the read part of the operation. Several techniques have

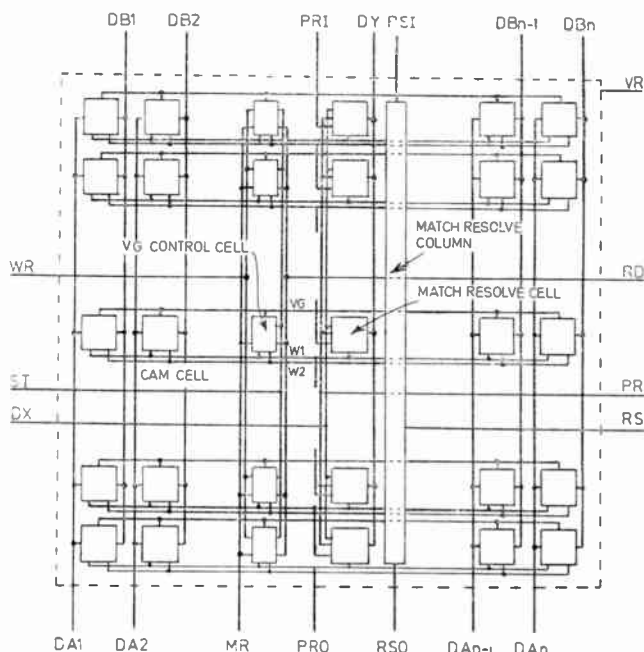

Fig. 3. Organizational layout of the Micro-APP chip.

been proposed<sup>1-4, 12</sup> and a simple signal propagation network has been incorporated into the word control logic (WCL) of the Micro-APP for this purpose.

## 3 Micro-APP Description

### 3.1 Micro-APP Array

The Micro-APP is organized as a two-dimensional array of  $m$  word-rows and  $(n+3)$  bit-columns, as shown in Fig. 3. Each word-row comprises  $n$  CAM cells and 3 service cells, known as the VG control cell, the match resolve cell and the corresponding cell of the match resolve column, which are interconnected by the word-control lines, VG, W1 and W2. The cells in each bit-column are interconnected by common lines which have external connections to data-lines DA, DB (CAM cells) and array-control-lines WR, ST, MR (VG control cells), PR, PRI, PRO, DX, DY (match resolve cells) and RS, RSI, RSO (match resolve column).

There is a single positive voltage reference, VR, external connexion to the Micro-APP, which is also connected to the i.c. chip substrate. Since the Micro-APP would be implemented with p-channel, enhancement-mode m.o.s. fabrication technology a 'negative logic' convention is observed. Hence the voltage level of a logical '0' corresponds to that of the voltage reference VR and voltage levels which are appreciably more negative than the m.o.s. threshold-voltage correspond to a logical '1'.

### 3.2 CAM and VG Control Cells

The associative memory array (AMA) of the Micro-APP is designed to operate in the following ordered sequence:

1. Standby
2. Search
3. Write or read

**Table 1** Truth table for the basic operational sequence of the Micro-APP

Step	Operation	DA	DB	WR	RD	MR	ST	W1°	W2°	D°	D+	W1+	W2+	VG+	Output
1	Standby	1	1	1	0	0	1	×	×	×	×	1	0	1	
2	Match 0	1	0	0	0	1	0	1	0	1	0	1	0	0	Current in MR if one or more word-rows match
	Match 1	0	1	0	0	1	0	1	0	1	1	0	0		
	Masked search	0	0	0	0	1	0	1	0	×	×	1	0	0	
3	Read	0	0	0	1	0	0	1	0	1	1	1	0	0	Current in DA Current in DB
	Masked read	0	0	0	1	0	0	0	0	×	×	0	0	0	
	Write 0	1	0	1	0	0	0	1	0	1	0	1	0	1	
	Write 1	0	1	1	0	0	0	1	0	1	1	0	1	1	
	Masked write	×	×	1	0	0	0	0	0	×	×	0	0	0	

D represents the logical state of the CAM cell.  
 ° before operation.  
 + during and after operation.  
 × logical 'don't care'.

Typical values:

Voltage reference = VR = +12 volts.

Logical '1' = 0 volts (except for ST where '1' = -8 volts).

Logical '0' = +12 volts.

The logical conditions necessary to control this sequence are defined in the truth table of Table 1.

The memory is based on an existing design for a self-refreshing dynamic m.o.s. CAM. Since this design is the subject of a previous publication,<sup>7</sup> its structure and operation will not be described in detail.

**3.2.1. Standby**

The CAM cell, shown in Fig. 4, is said to store a logical '1' when the parasitic capacitance associated with the gate of m.o.s. transistor T1 is charged to a negative potential (with respect to the voltage reference VR). Conversely, the cell is said to store a logical '0' when the gate of T4 is charged. During standby all the word-control lines VG are charged to a logical '1' (via T11) in the corresponding VG control cells. Hence the charge stored in the CAM cells is refreshed during standby by current flow in either T3 or T2, depending on the state of the cells. In addition, all the word-control lines W1 are charged to a logical '1' (via T13) and all the W2 lines are discharged to a logical '0' (via T14) during standby.

**3.2.2. Search**

The tag register of the Micro-APP is implemented as the set of the word-control lines W1. When charged to a logical '1' these lines represent set tags in the tag register. During a search operation the W1 lines corresponding to mismatching word-rows of the AMA are discharged to a logical '0' (via T5, T7 and DA, or T6, T8 and DB in mismatching CAM cells). Hence the charge remaining on the W1 lines corresponding to matching word-rows primes them for the subsequent write or read operation.

The interrogation signals on the data lines DA and DB must be delayed for 10 ns (as indicated in Fig. 5) while the word control lines VG are discharged to a logical '0' (via T11) to avoid modifying stored data during the search operation.

**3.2.3 Write**

The word-control lines VG corresponding to matching word-rows are charged to a logical '1' (via T11) for a write operation. Hence the contents of the CAM cells of these word-rows are changed (via T2 and T3) accord-

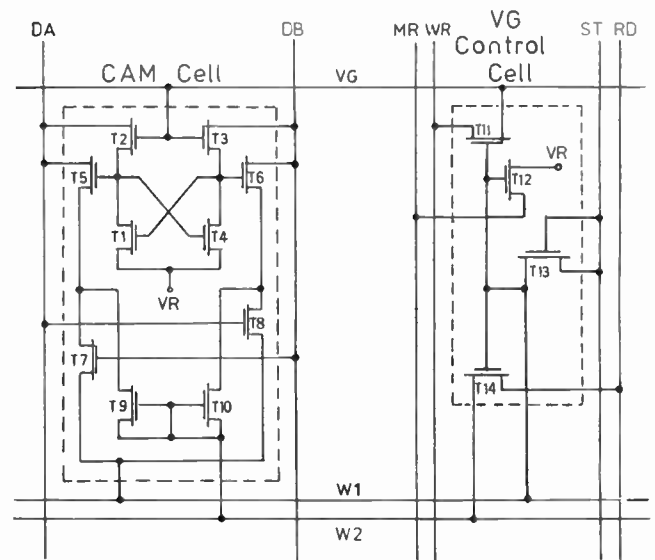

**Fig. 4.** Content addressable memory (CAM) cell and VG control cell of the Micro-APP.

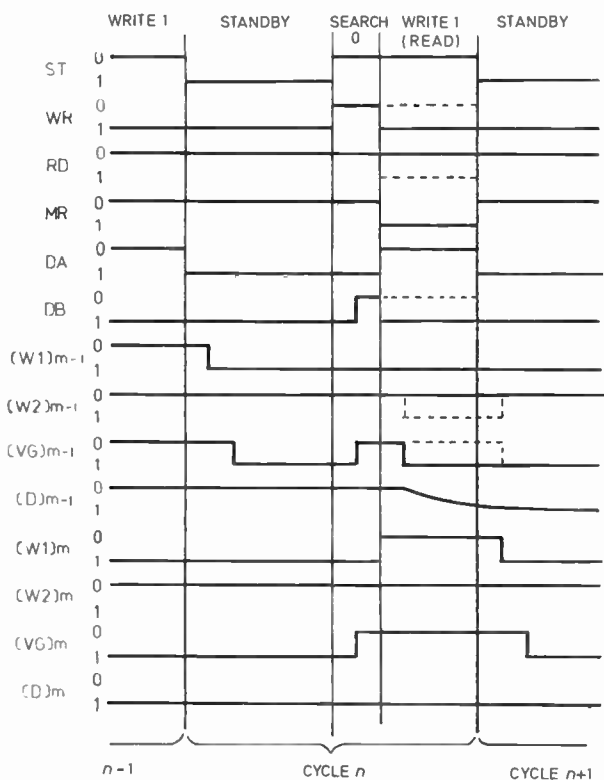

Fig. 5. Basic timing sequence of the Micro-APP.

ing to the voltage, impressed on the data lines DA and DB, as shown in Fig. 5.

The standby-search-write sequence of operations can be used to set up a 'tag image' (copy of the tag register in a selected bit-column of the array). Hence 'tag images' can be set up for those applications requiring non-volatile tag registers.

3.2.4 Read

The word-control line W2 corresponding to a matching word-row is charged to a logical '1' (via T14) for a read operation. Hence current will flow between the W2 line

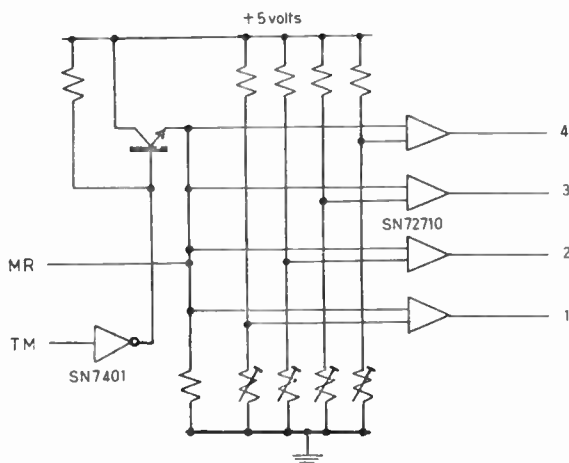

Fig. 6. External threshold matching circuit for the Micro-APP.

and the data lines DA and DB (via T5 and T9, or T6 and T10) according to the logical states of the CAM cells in the word-rows.

3.3 Match Reply

The match reply line MR is common to all word-rows in the Micro-APP. After the search operation the array-control line MR is taken to a logical '1' such that for each matching word-row current will flow via T12. Therefore, for a particular array, the current flowing in the MR line will be proportional to the number of matching word-rows in the array. Consequently an external 'threshold matching' circuit, such as the one shown in Fig. 6, can be employed. The circuit can be adjusted to distinguish between 0, 1, 2, 3 and 4 matching word-rows, when the threshold match-enable TM is taken to a logical '1' (positive logic).

3.4 Match Resolve Cell and Columns

The purpose of the match resolve cell, shown in Fig. 7, is to assist two functions:

1. propagation of tags within the tag register;
2. automatic resolution of multiple tags within the tag register.

The functions are performed after the search and before the read/write part of the basic operational sequence of the Micro-APP.

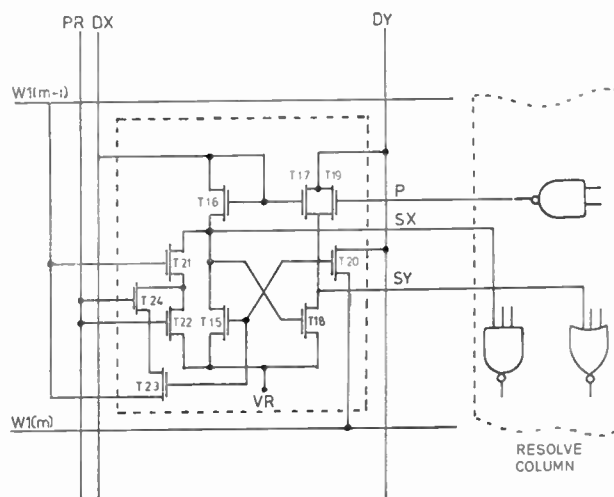

Fig. 7. Match resolve cell of the Micro-APP.

3.4.1 Tag propagation

The array-control line PR is common to all the match resolve cells in the Micro-APP and when it is set to a logical '1' a match in word-row  $m-1$  causes the match resolve cell in word-row  $m$  to be set, as shown in Fig. 8.

The propagation of tags is achieved by the following sequence of events, as shown in Table 2 and Fig. 8:

- (1) Node SX of the match resolve cell is discharged to a logical '0' by current flow in T21 and T22.
- (2) Node SY is charged to a logical '1' by current flow in T17.



Table 2 Truth table for the tag propagation and tag resolution options

Operation	RS	DX	DY	PR	P	W1 <sup>o</sup> (m-1)	W1 <sup>o</sup> (m)	SX <sup>o</sup>	SY <sup>o</sup>	SX <sup>+</sup>	SY <sup>+</sup>	W1 <sup>+</sup> (m-1)	W1 <sup>+</sup> (m)
Standby	0	1	0	0	0	×	×	×	×	1	0	1	1
Search/	0	1	0	0	0	1	1	1	0	1	0	1	0
Propagate	0	1	1	1	0	1	0	1	0	0	1	0	1
Search/	0	1	0	0	0	1	1	1	0	1	0	1	0
Propagate	1	1	1	1*	0	1	0	1	0	0	1	1	0
Run	1	1	1	0	1	1	0	0	1	0	1	1	1
Resolve	1	0	0	0	1	1	1	0	1	0	1	0	✓

° before operation.  
 + after operation.  
 × logical 'don't care'.  
 \* pulse.

Typical values:

Voltage reference = VR = +12 volts.  
 Logical '1' = 0 volts (except for RS, DX, DY where '1' = -8 volts).  
 Logical '0' = +12 volts.

(3) The word-control line W1(m-1) is discharged via T23 and T24, and W1(m) is charged via T20.

As indicated in Fig. 8 the data lines DA and DB must be set to logical '1' during the tag propagation.

The option of tag propagation will prime word-row m for the subsequent read or write operation. If the match resolve cell in word-row m+1 has also been set then the logical state of W1(m) will be indeterminate until the array control line PR is reset, whereupon W1(m) will be charged, in good time for the subsequent read/write operation.

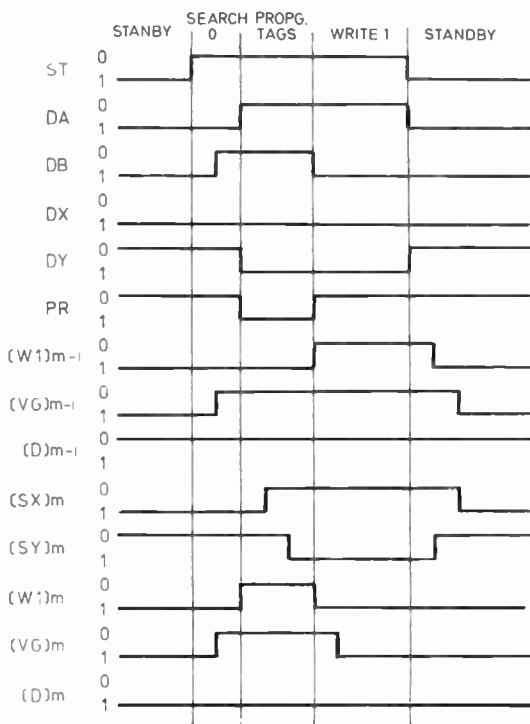

Fig. 8. Timing sequence with tag propagation.

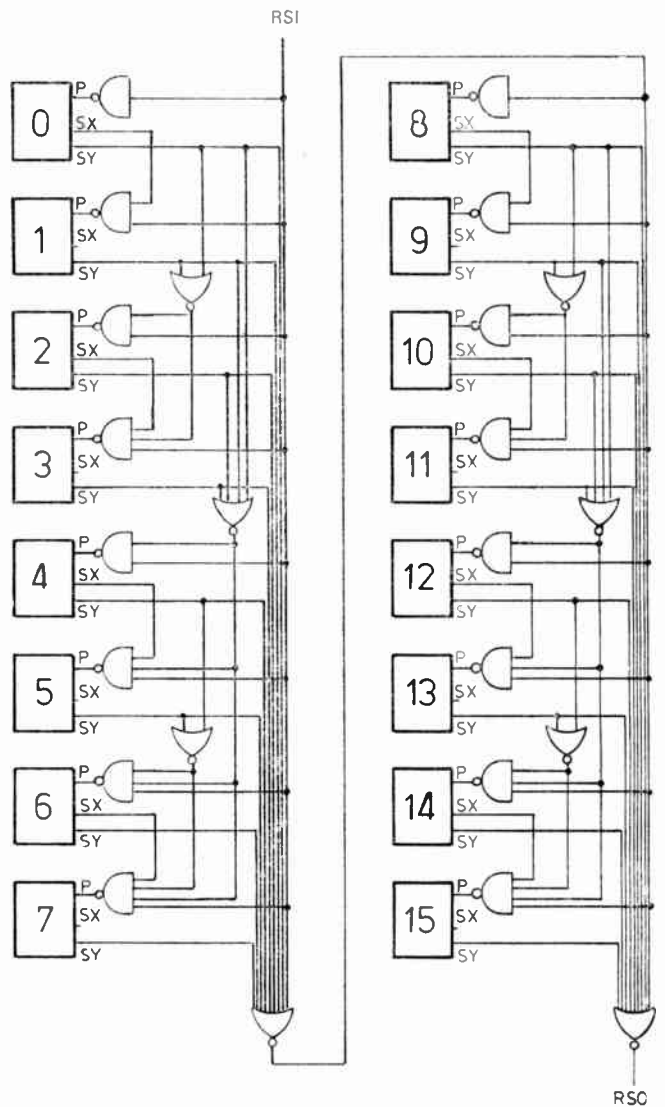

Fig. 9. Schematic organization of the match resolve column of the Micro-APP.



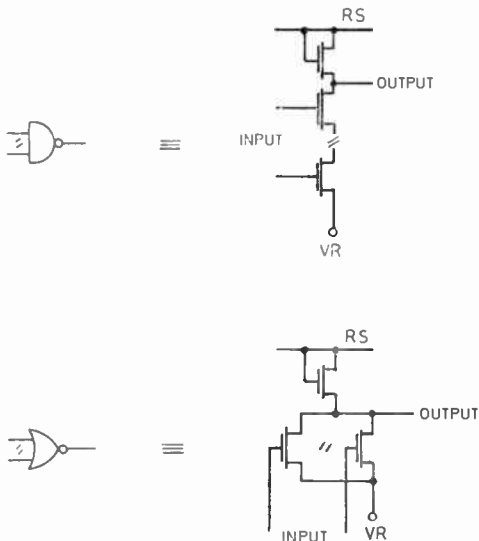

Fig. 10. Implementation detail for the match resolve column.

The array-control lines PRI and PRO provide propagation signals into the first word-row and out from the last word-row of the Micro-APP chip, as shown in Fig. 3.

3.4.2 Multiple tag resolution

The match resolve column, shown in Fig. 3, provides the Micro-APP with an automatic facility for the resolution of multiple tags in the tag register. When enabled by the array-control line RS, the match resolve column discharges the word-control line W1 in all matching word-rows except the matching word-row with the lowest index.

The match resolve column comprises a high-speed signal propagation network of NOR and NAND gates, as shown in Figs. 9 and 10. The SX and SY nodes of all the match resolve cells provide a parallel input to the network. A signal is injected into the propagation network for every occurrence of SY being set to a logical '1'. In addition, the network provides a parallel output to the P terminals of the match resolve cells. The match resolve column is enabled when the array-control line RS is set to a logical '1'.

The automatic resolution of multiple tags is achieved by the following sequence of events as shown in Table 2 and Fig. 11:

(1) Propagate: As tag propagation described in Section 3.4.1 except that the signal on the array-control line PR must be shortened to a pulse of 10 ns duration.

(2) Run: The match resolve column sets to a logical '1' all those P terminals of higher index than the injected signal. Hence in the case of multiple tagging all P terminals below the first injected signal will be set.

(3) Resolve: All match resolve cells with their P terminal set to a logical '1' will become set by current flow in T19. Hence the corresponding word-control lines W1 will be discharged (via T20).

After a search operation utilizing the option of multiple tag resolution the first matching word-row will remain primed for the subsequent read or write operation.

The array-control lines RSI and RSO provide resolving signals into and out from the Micro-APP chip, as indicated in Fig. 3 and 9.

4 Evaluation of the Design

To investigate the feasibility of the Micro-APP an integrated circuit layout was attempted and probable performance data, based on computer simulation studies, were estimated. The chip layout rules adopted were those of a standard silicon-gate p-channel m.o.s. process.

Initial studies indicated that the optimum dimensions of the basic CAM cell would be in the ratio of 2 : 1 which leads to certain constraints in the choice of array size for the Micro-APP.

Chip Length: The implementation complexity of the match resolve column effectively limits its length to a

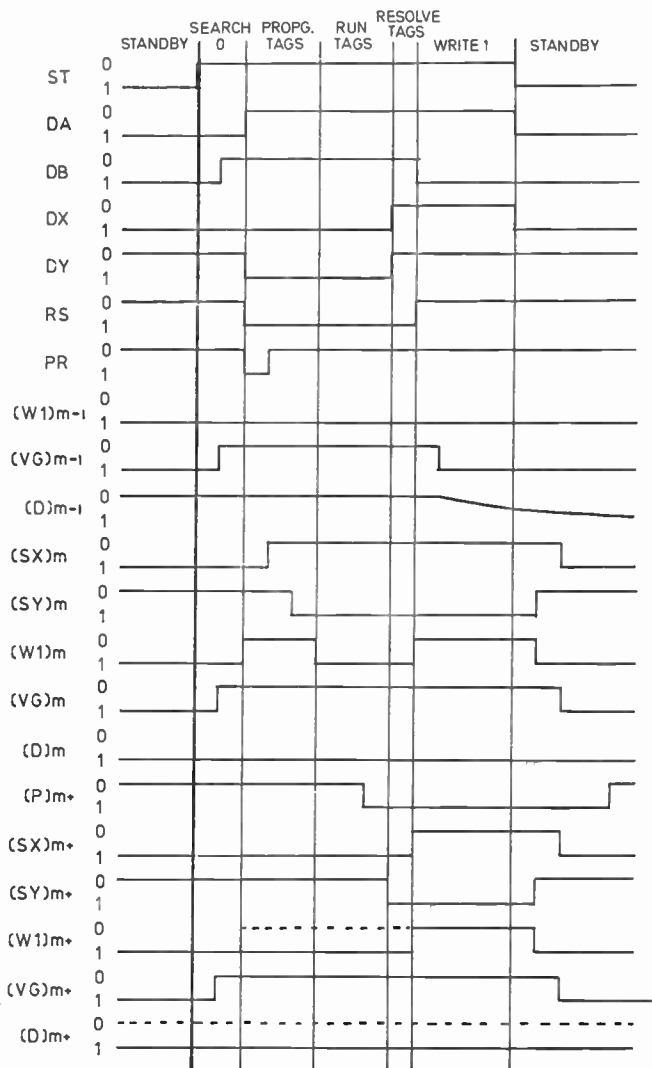

Fig. 11. Timing sequence with multiple tag resolution.

block of 16 word-rows. Hence, for convenient integration, the chip length is restricted to the size which will accommodate one 16-word block or 2 blocks in parallel. The experimental layout indicated the following chip-lengths.

4.29 mm (169 mil) for 16 word-rows  
4.67 mm (184 mil) for 32 word-rows

**Chip Width:** The range of probable applications for a variable record-length APP is likely to require 9–16-bit-columns (i.e. one 8-bit character field and up to 8 control-bits).<sup>1, 14–16</sup> However, packaging limitations and chip dimensions restrict the choice of the number ( $n$ ) of bit-columns. It can be observed from Fig. 3 that the number of chip terminals equals  $(2n+13)$ . Hence for optimum packaging of a standard dual-in-line pack the preferred values of  $n$  are 11 (36-pin d.i.l. pack) and 13 (40-pin d.i.l. pack). Of course if open-chip assembly methods, such as the flip-chip or beam-lead techniques, are employed this restriction does not exist. Consequently, the two values of  $n$  equal to 12 and 16 were chosen for the experimental layout, with the resulting chip widths:

4.34 mm (171 mil) for 2 12-bit-columns  
3.00 mm (118 mil) for 1 16-bit-column

Hence the 16-word  $\times$  16-bit and the 32-word  $\times$  12-bit array sizes would be preferred, for the reason of convenient chip dimensions.

The results of the feasibility investigation for the two Micro-APP organizations are listed in Table 3.

## 5 Conclusions

The design investigation described in this paper indicates the feasibility of the Micro-APP for byte-

Table 3

Array size	16 $\times$ 16	32 $\times$ 12
Chip size:	4.29 $\times$ 3.00 mm	4.67 $\times$ 4.34 mm
Chip terminals:	45	37
Data-line capacitance:	4 pF	7 pF
Minimum cycle time:		
Synchronous control	190 ns	220 ns
Asynchronous control		
Read cycle	40 ns	40 ns
Read cycle with tag propagation	70 ns	70 ns
Read cycle with tag resolution	110 ns	140 ns
Write cycle	120 ns	120 ns
Write cycle with tag propagation	150 ns	150 ns
Write cycle with tag resolution	190 ns	220 ns
Power dissipation:	307 mW	461 mW
Works-cost-price†	£0.51	£1.50

† Assuming open-chip assembly (namely flip-chip or beam-lead techniques) for the 16-word Micro-APP and a 40-pin dual-in-line package for the 32-word Micro-APP. The figures are derived from a costing method described in Ref. 9 and do not include amortization of development costs.

organized variable record-length associative processing applications.

Table 4

Comparison of the bit-per-pin ratios of the two Micro-APP designs with that of a basic CAM device<sup>7</sup>

Device	Dual-in-line package	Open-chip assembly
16 words $\times$ 8/16 bits CAM <sup>7</sup>	3.6	4.9
16 words $\times$ 16 bits Micro-APP	—	5.7
32 words $\times$ 12 bits Micro-APP	9.6	10.4

By incorporating the word control logic (WCL), and the tag register (TR) on the l.s.i. chip supporting the associative memory array (AMA), the Micro-APP provides the following benefits:

- (1) Reduced pin-count: a comparison of the bit-per-pin ratio's of the two versions of the Micro-APP with that of the content addressable memory (CAM) device<sup>7</sup> on which the AMA of the Micro-APP is based, is shown in Table 4.
- (2) Reduced number of sense and drive interface amplifiers (SIA and DIA): a comparison of the cost-per-word-row of the two Micro-APPs with that of the basic CAM organization is shown in Table 5. The figures are based on the estimated 100 + selling prices (after amortization of development costs) of the Micro-APPs and the implementation cost (100 + selling prices) of a discrete APP implementation utilizing the CAM design and the SIA/DIA design of Ref. 7.

The key feature of the Micro-APP design is the implementation of its tag register as transient charge of the word-control lines W1 during the active part of read and write cycles. The application of this technique to a particular published CAM design has been reported.<sup>7</sup> However, the technique is applicable to other CAM designs. For example, the CAM design, described in Ref. 8 (with the addition of suitable refreshing circuitry) could form the basis of a cheaper and faster Micro-APP. Moreover, for simple CAM cell designs, the technique could be applied to small fixed record-length associative processing applications.<sup>1, 15</sup>

At the present time insufficient associative processing experience exists for a standard Micro-APP product to be specified. Hence early implementations are likely

Table 5

Comparison of the costs-per-word row of the two Micro-APP designs with that of a discrete APP implementation†

Data organization	Micro-APP	CAM <sup>7</sup> device + discrete SIA/DIA WCL and TR
16 words $\times$ 16 bits	£0.08	£1.79
32 words $\times$ 12 bits	£0.12	£1.85

† Assuming 100 + selling prices.

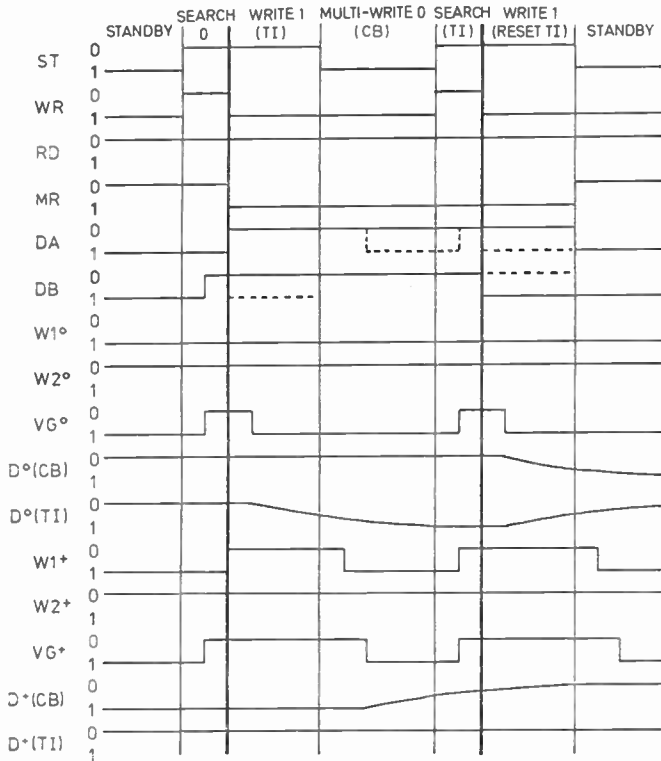

Fig. 12. Timing sequence with 'clear option'.

Legend: TI tag image            ° matching word-row  
 CB control bit                + mismatching word-row

to be orientated towards specific non-numerical information processing applications. A particular modification of the Micro-APP, which would be useful for certain string processing applications,<sup>1, 13-16</sup> would provide 'clear options' immediately after the search in each operational sequence. This operation is best considered as a 'multi-write 0', to be performed on selected bit-columns in all word-rows of the associative memory array of the Micro-APP. The effect of a 'clear option' is to kill control-bits (also called activities, tags and markers) in mismatching word-rows after a 'tag image' corresponding to matching word-rows has been set up. The timing diagram shown in Fig. 12 indicates how an unmodified version of the Micro-APP can support a 'clear option'. The operation adds an extra 110 ns to the minimum cycle time of the Micro-APP. However, for those applications requiring frequent use of 'clear options', simple modifications to the CAM cell and VG control cell design could reduce this time penalty to about 50 ns, without incurring a significant increase in cost. Another simple modification (to the match resolve cell) would allow dual-direction tag propagation. These and other modifications, the optimum number of bit-columns and the most useful mode of communication with the host computer are criteria which are yet to be established. However, research into the architecture, software and applications of associative parallel pro-

cessing is in progress at Brunel University and answers to these questions will soon be forthcoming, whereupon the formalization of a standard Micro-APP product might be possible.

6 Acknowledgments

Research into associative parallel processing at Brunel University is supported by the Science Research Council and the British Library. Patent protection for the Micro-APP design has been obtained by the National Research Development Corporation.

7 References

1. Lea, R. M., 'Information processing with an associative parallel processor', *IEEE Computer*, 8, pp. 25-32, November 1975.
2. Hanlon, A. G., 'Content addressable and associative memory system—a survey', *IEEE Trans. on Electronic Computers*, EC-15, pp. 509-21, August 1966.
3. Minker, J., 'An overview of associative or content-addressable memory systems and a KWIC index to the literature: 1956-1970', *Computing Rev.*, 12, pp. 453-504, October 1971.
4. Parhami, B., 'Associative memories and processors: an overview and selected bibliography', *Proc. IEEE*, 61, pp. 722-30, June 1973.
5. Lea, R. M., 'A design for a high-speed m.o.s. associative memory', *Electronics Letters*, 8, No. 15, pp. 391-3, 27th July 1972.
6. Lea, R. M., 'Toward a low-cost cell design for high-speed m.o.s. associative memories', *Datafair Research Papers*, 11, pp. 418-24, 1973.
7. Lea, R. M., 'A design for a low-cost high-speed m.o.s. associative memory', *The Radio and Electronic Engineer*, 45, pp. 177-82, April 1975.
8. Lea, R. M., 'Low-cost high-speed associative memory', *IEEE J. Solid State Circuits*, SC-10, pp. 179-87, June 1975.
9. Lea, R. M., 'The comparative cost of associative memory', *The Radio and Electronic Engineer*, 46, pp. 487-96, October 1976.
10. Shead, C. J., 'The associative memory: a versatile circuit element', *GEC J. Sci. Tech.*, 40, No. 3, pp. 119-25, 1973.
11. Lea, R. M., 'A design for an interface current for m.o.s. associative memory arrays', Brunel University Tech. Memo., CE/R/030, August 1975.
12. Lee, C. Y., 'Intercommunicating cells—a basis for a distributed logic computer', *Proc. AFIPS (FJCC)*, 22, pp. 130-6, 1962.
13. Beaven, P. A. and Lewin, D. W., 'An associative parallel processing system for non-numerical computation', *Computer J.*, 15, 4, pp. 343-9, 1973.
14. Lea, R. M. and Wright, J. S., 'A novel memory concept for information processing', *Datafair Research Papers*, 11, pp. 413-7, 1973.
15. Dyke, J. G. and Lea, R. M., 'An associative parallel processor for local editing applications', *Digital Processes*, 1, No. 2, pp. 89-101, 1975.
16. Lea, R. M., 'Text compression with an associative parallel processor', Brunel University Tech. Memo., No. C/R/038, March 1976.

Manuscript first received by the Institution on 7th May 1976 and in final form on 29th July 1976. (Paper No. 1753/Comp. 178.)

© The Institution of Electronic and Radio Engineers, 1977

# Letter

From: P. R. Armstrong, B.Eng. and  
A. P. Anderson, B.Sc.(Eng.), Ph.D.

## Spatial Filtering of Microwave Images Suggested by Human Visual Processes

In a recent paper<sup>1</sup> we described a microwave imaging system using a spherical scanning technique. The system was operated in the outdoor environment from which interfering spatial noise was present with the image of the target. Subsequently, it has been possible to indicate that noise suppression in microwave imagery, and therefore enhanced object recognition, might be obtained by a low-pass filtering process,<sup>2</sup> despite the limitations already imposed by the small recording aperture. This brief communication presents the further improvements in image quality obtainable from the data in reference 1 by use of the low-pass spatially filtered (Fourier) model of the human visual system.<sup>3</sup>

The sequence of Figs. 1 (a)-(d) shows the effect of different window functions. Figure 1 (a) shows the raw data of the Fourier hologram, and the reconstituted noisy image (excluding the conjugate image and autocorrelation outputs). If the phase of the image distribution is discarded, a symmetrical Fourier transform of the image can be generated, and suitable windows applied as shown in Figs. 1 (b)-(d). The window of Fig. 1 (b) is a crude approximation to the human modulation transfer function (h.m.t.f.)<sup>4</sup>, which, when suitably scaled, is seen to provide an improved representation of the letter 'E'. Figure 1 (c) shows a two-dimensional representation of the h.m.t.f. When this window function is applied to the microwave data, the appearance of the reconstituted 'E' is improved further. This result is similar to viewing the display from a distance of 4.5m, and is consistent with the findings of Ginsburg<sup>3</sup> for (optical) recognition of simple shapes.

Further improvements in the image can be obtained by inspection of the Fourier transform distribution, plus some *a priori* knowledge of the object, including its attitude with respect to the recording aperture. For simple shapes which are within the capability of this imaging system, the Fourier transforms have a simple structured pattern, parts of which can be distinguished from the spatial noise. In Fig. 1 (d) a simple window has been chosen to include what appear to be target signal areas and exclude noise. This window is consistent with the attitude of the target, and the reconstituted image is seen to be improved with respect to Fig. 1 (b). Possibly a similar rotation of the h.m.t.f. filter would produce further slight improvement; this would be analogous to tilting one's head to aid recognition.

P. R. ARMSTRONG  
A. P. ANDERSON

Department of Electronic & Electrical Engineering,  
The University of Sheffield, Mappin Street,  
Sheffield S1 3JD.

17th December 1976.

### References

1. Anderson, A. P., Jones, D. G., Bennett, J. C. and Mawani, S. J., 'Microwave holographic remote sensing using a Fourier transform/spherical scanning technique', *The Radio and Electronic Engineer*, 46, No. 11, pp. 555-9, November 1976.
2. Anderson, A. P., Armstrong, P. R., Bennett, J. C. and Mayhew, J. E. W., 'Noise suppression in microwave imagery by exploitation of the m.t.f. approach to human vision', Proc. 6th European Microwave Conference, September 1976, pp. 112-6.
3. Ginsburg, A. P., 'Pattern recognition techniques suggested from psychological correlates of a model of the human visual system', IEEE Proc. 1973 NAECON, Dayton, Ohio, pp. 309-16.
4. Campbell, F. W., Kulikowski, J. J., and Levinson, J., 'The effect of orientation on the visual resolution of gratings', *J. Physiol.*, 187, pp. 427-36, 1966.

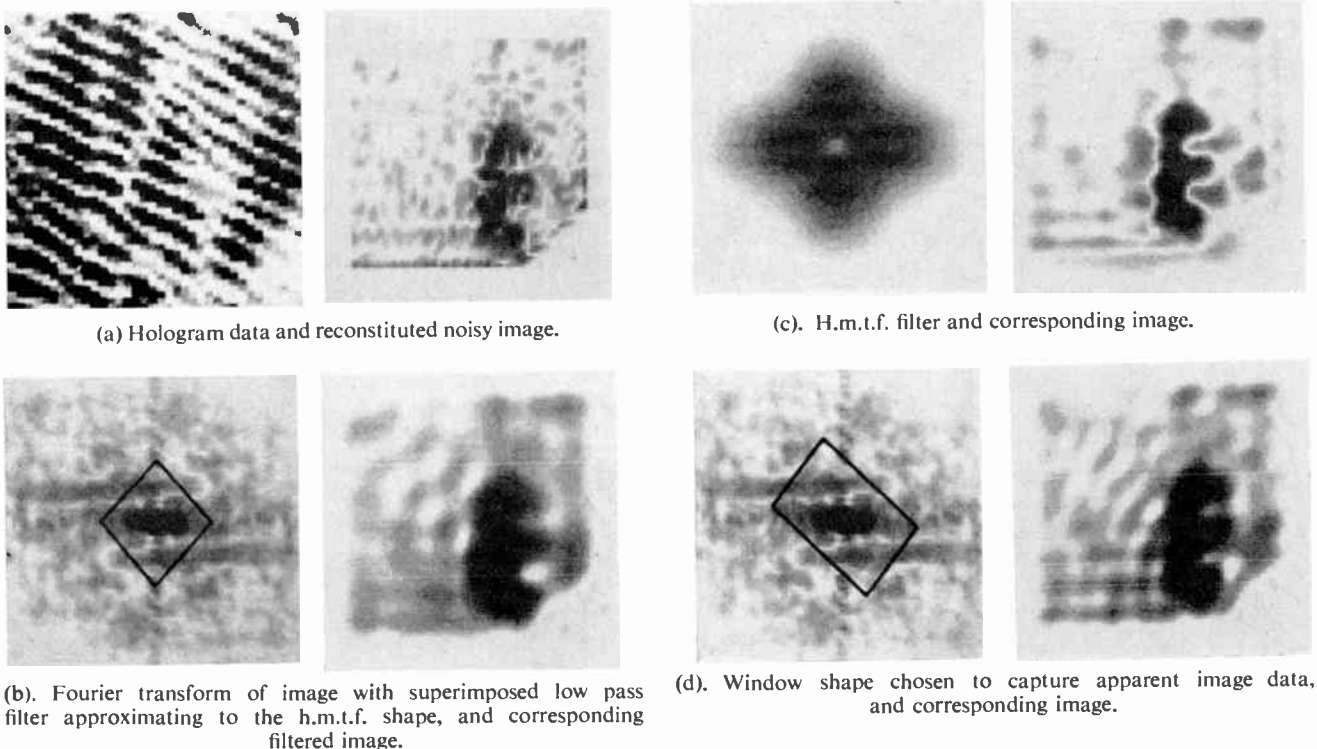

Fig. 1



# The use of phase-control height diversity for 11 GHz digital radio systems

E. G. JARVIS,  
C.G.I.A, F.I.T.E, C.Eng., M.I.E.R.E.\*

## SUMMARY

It has been proposed that the existing sites and structures of the Post Office line-of-sight radio networks should be utilized to facilitate the introduction of a t.d.m. overlay network in the frequency band 10.7-11.7 GHz. Those sections that suffer the greatest variations in propagation characteristics owing to their length may need a diversity system. This paper shows that at 11 GHz and at the bit-rates being considered and using phase-shift-keyed modulation, it is possible to use phase-control height diversity which is an economic and effective diversity system used in the frequency modulated radio network.

\*The Post Office Research Centre, Martlesham Heath, Ipswich IP5 7RE.

## 1 Introduction

The Post Office proposes to use the sites and structures existing for the 4 and 6 GHz line-of-sight radio network to establish an 11 GHz digital radio network to facilitate the introduction of a t.d.m. overlay network. Experimental work has been carried out on coherent and differential-coherent p.s.k. 2-level systems at a data rate of 60 Mbit/s and on 4-level systems at 120 Mbit/s. A diversity system will be necessary on those sections which are affected by excessive multipath propagation conditions.

Three types of diversity receiver system are in practical use.<sup>1</sup>

- (a) *Selection systems* use two receivers and select the channel with the best carrier-to-noise ratio; in digital systems this implies writing two bit streams into separate stores, means of reading the signals out of the stores, detecting and correcting timing differences, and rapid switching or combining of receiver outputs.
- (b) *Equal-gain receiving systems* add together the received signals and the noise. Combination may take place at baseband, i.f. or r.f. At baseband, the problems of bit storage exists but at i.f. or r.f. it is the modulated carriers which are being combined so means must be provided for maintaining phase alignment of the signals. If combination is effected at r.f. only one receiver is required.<sup>2</sup>
- (c) *Maximal-ratio receiving systems* add together the received signals but the gain in a fading channel is reduced after a certain level of fade to remove the noise of that channel. Two receivers are required.

The optimum system for combating multipath fading depends on the degree of correlation of the received signals causing the fading. If the two signals are near-correlated, there is little between maximal-ratio and equal-gain systems. Anti-correlated signals favour selection and maximal-ratio systems.

On overland paths there is generally near-correlation, and the most cost-effective system for use on f.m. systems is an equal-gain phase-control height diversity system using r.f. combining.<sup>2, 3</sup> After a theoretical study and laboratory tests, a diversity system of this type was installed for field testing over a 64 km radio section carrying data at a rate of 60 Mbit/s.

## 2 Propagation Aspects

An investigation carried out in 1965<sup>4</sup> into multipath radio propagation at 11.0 to 11.5 GHz included measurements of the variation of echo mean amplitude and amplitude range with delay on sections having path lengths of 57 km, 38.6 km and 31 km. Figure 14 in Reference 4 is important to the present investigation. The measurements on all three sections indicate that the echo mean amplitude decreases with increasing delay. In particular, the measurements indicate that echo delays of a half bit duration at 60 Mbit/s, 8.3 ns, only occur once in a year and will have an echo amplitude that is 30 dB less than the amplitude of the direct signal; and also, echo amplitude is between 10 dB and 30 dB below

the direct signal for echo delays greater than a quarter symbol duration on the 57 km section and one-sixteenth of a symbol on the 31 km section.

The echo signal arriving via the interfering path can affect the direct signal in two ways:

- (a) The time delay can be significant compared with the duration of a digital symbol and so produce significant signal distortion at the decision centres of the symbols when one symbol interferes with another.
- (b) The time delay can be insignificant compared with the duration of a digital symbol and therefore not produce significant signal distortion at the decision centres of the symbols, but the phase delay can affect the phase and amplitude of the resultant signal at the receiver and cause errors due to a reduced carrier-to-noise ratio.

The 1965 investigation leads to the supposition that since the time delay is limited to less than a half bit at a 60 Mbit/s symbol rate, and since this amount of delay is an extreme case, controlling and equating the phase of the carriers at the input to the receiver prior to the demodulator would be instrumental in improving the

error probability of the system during multipath conditions.

### 3 Computations and Laboratory Work

A computer program has been produced to calculate the effect of multipath fading on the performance of 2-level phase-shift-keyed digital radio systems.<sup>5</sup> This program was developed to include 4-level systems and used to make a preliminary assessment of the effect of using automatic phase-control diversity systems on phase-shift-keyed digital radio systems having sections with the propagation characteristics of the sections investigated in 1965.

Figure 1 shows that, in both 2-level c.p.s.k. and d.c.p.s.k. systems, when the relative delay between signal paths is less than 0.5 bits, the phase delay is less than 45° and the echo amplitude relative to the main path is -6 dB, the error probability approaches that for a main path C/N of 10.3 dB when the delayed signal is in phase with and adds to the direct signal. Where the phase delay is greater than 45° for time delays less than 0.5 bit and where time delays are greater than 0.5 bit, in general, a rapidly increasing error probability results. Practical systems would be designed with a fade margin so further computations (Figs. 2 and 3) were made for

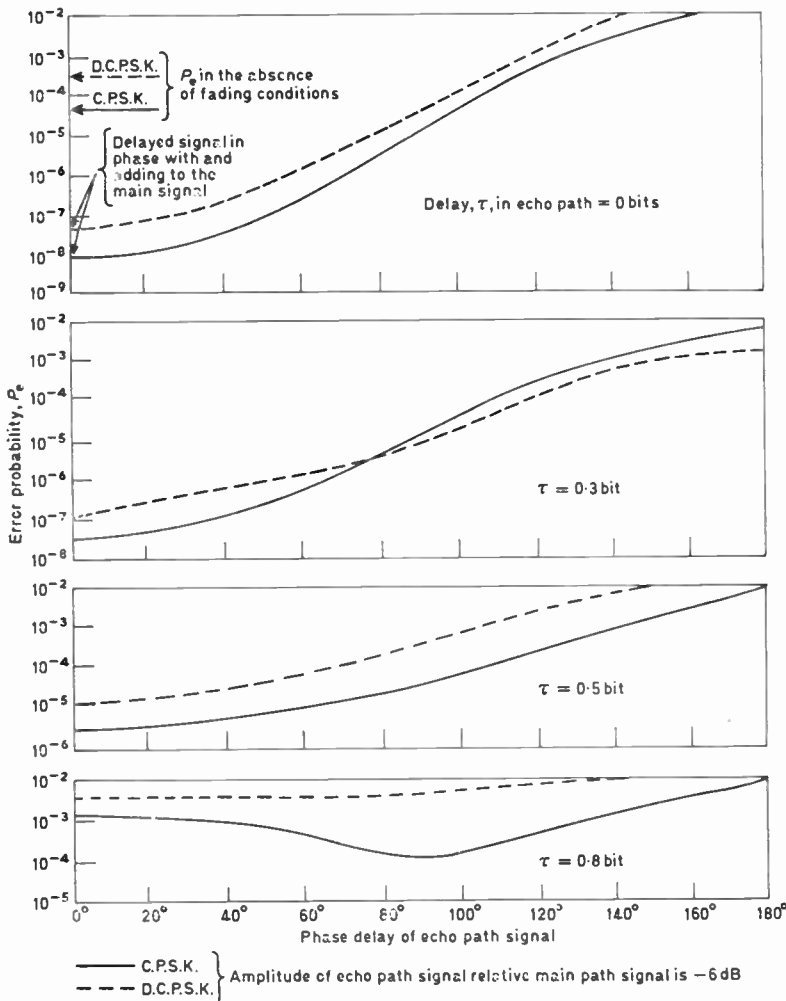

Fig. 1. 2-level system error performance for a main path C/N = 10.3 dB.

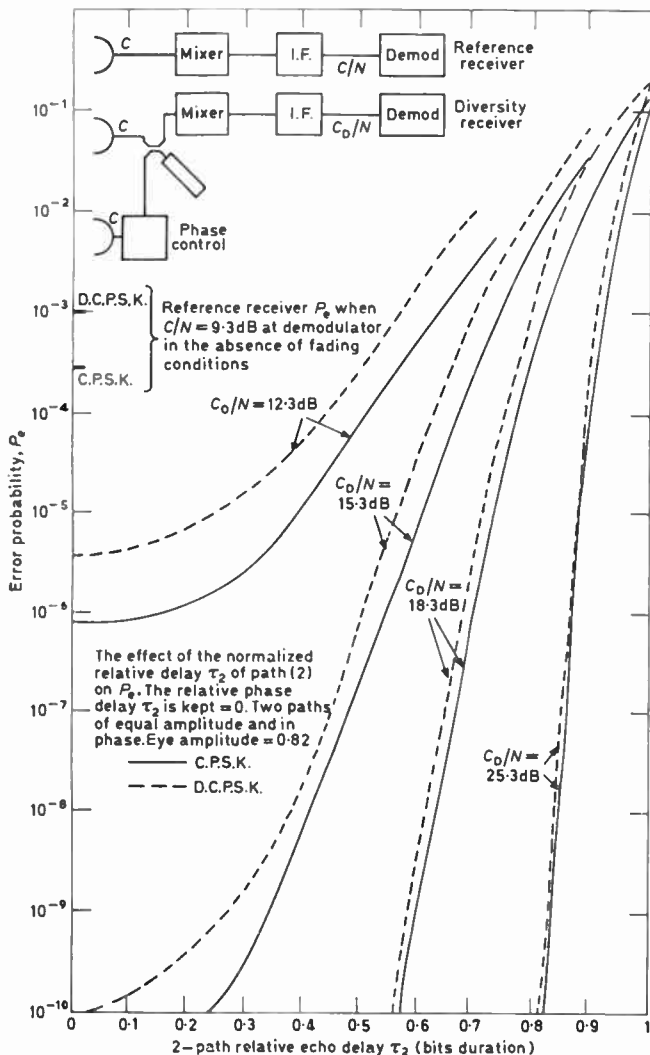

Fig. 2. 2-level system with fade margins.

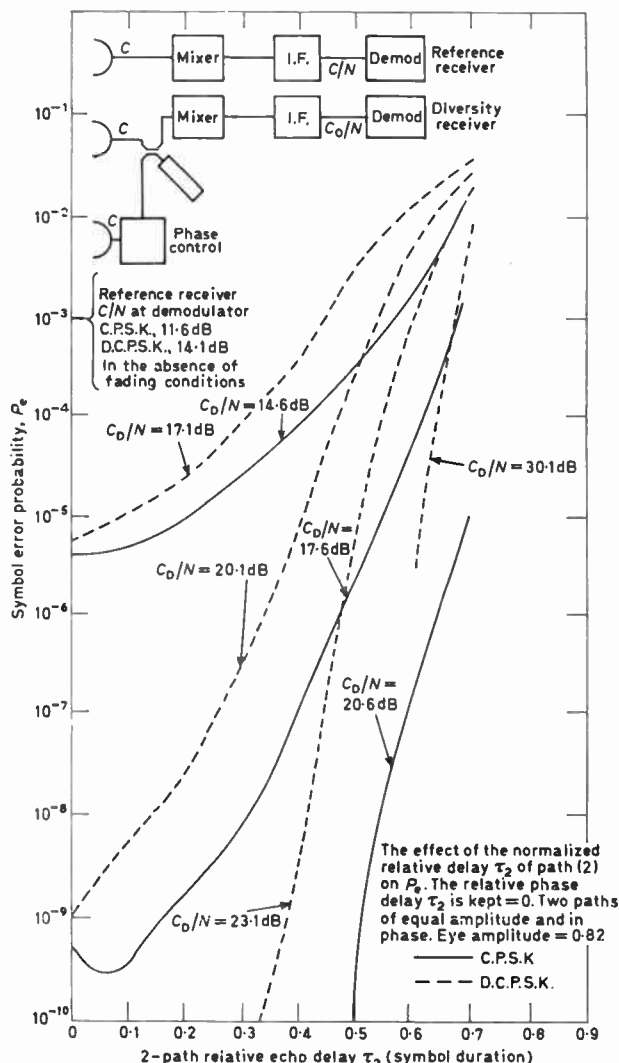

Fig. 3. 4-level system with fade margins.

2-level and 4-level systems to indicate the effect of increasing the  $C/N$  ratio at the demodulator. The case postulated was for two resultant signals of equal power at the aerial outputs, one resultant signal being phase controlled, so that in this special case, the signals then combine at the input to the demodulator to give a  $C/N$  ratio 3 dB greater than that obtained using no diversity system. The reference receiver error probability indicates the expected error probability in the absence of fading conditions without a diversity system.

The curves show, for a number of carrier-to-noise ratios, error probability against two-path relative echo delay while the relative phase delay is zero as in a phase-control diversity system. The two paths are of equal amplitude. The curves indicate that the system will combat the effects of the multipath fading measured in Reference 4. A system is considered out-of-service when the error probability is worse than  $10^{-3}$ .

Practical measurements made in the laboratory, using a 60 Mbit/s 2-level phase-shift-keyed system, confirmed and extended the information obtained from the computer program. Diversity equipment was then built and

its satisfactory laboratory operation confirmed by testing with the multipath simulator described in Reference 6.

#### 4 Early Practical Results

The Post Office radio link between Dunstable and Charwelton was equipped with a digital system using 2-level phase-shift-keying at 60 Mbit/s and using phase-control diversity on one receiver with two vertically-spaced aerials 10 metres apart. A second receiver used as a reference receiver had one aerial.

We were concerned with the improvement in the signal level and in the error rate that is effected by the diversity system during multipath fading. If a plot is made of fade depth against probability of outage time or against time elapsed at a given fade depth as in Fig. 4, fading with a Rayleigh distribution will have a slope of 10 dB per decade of probability or 10 dB per decade of time elapsed.<sup>7</sup> The slope for the control system is shown to be near to 10 dB per decade below a fade depth of 20 dB. The curve is a cumulative curve for all fades in September 1973. Long shallow fades appear to follow a different statistical law and Vigants<sup>7</sup> has been followed

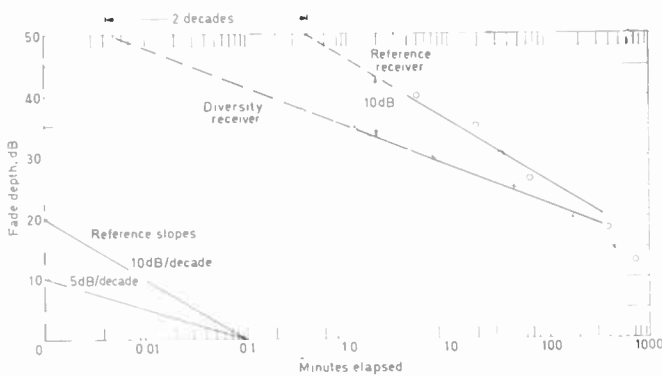

Fig. 4. Monthly total, September 1973; Dunstable-Charwelton; 11 GHz, 64 km.

in only showing fades deeper than 20 dB. The ideal slope for the diversity system would be due to a Rayleigh squared distribution and would be 5 dB per decade. The slope shown is near to 6.5 dB per decade.

Figure 4 indicates nearly two decades of improvement in the time that a fade depth 30 dB greater than the 20 dB fade depth is exceeded. This result is in agreement with Vigants.

In digital systems, the improvement in error rate with increased signal level can be expected to be about one order of probability of error per dB of signal level. Figure 4 indicates that diversity could provide about ten orders of probability of improvement at a 43 dB fade depth during ideal Rayleigh fading. Provided that phase correlation is maintained in the diversity system and that intermodulation distortion is not introduced by the propagation conditions, a very marked error rate improvement can be expected from the diversity receiver as compared with the reference receiver.

Figure 5 shows the error recordings at the reference and diversity receivers for a period of nine hours of multipath fading. Error rate is measured with an integra-

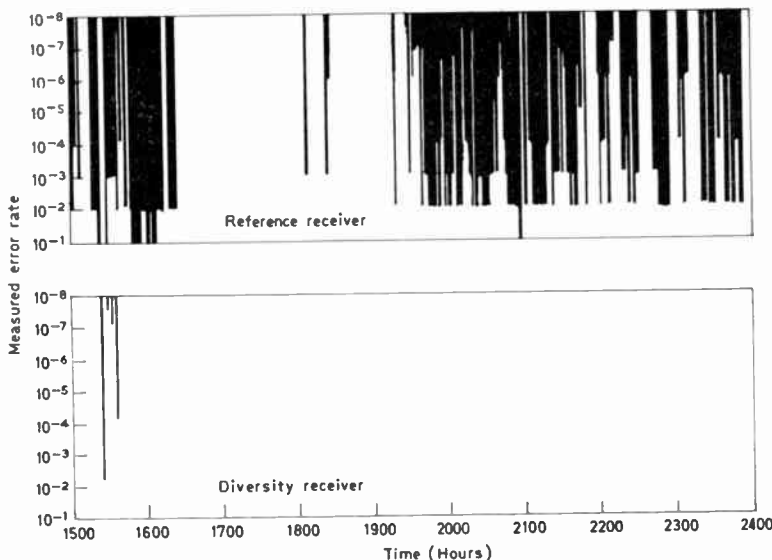

Fig. 5. Computer plot of reference and diversity receiver errors between 1500-2400 hours on 22nd November 1973.

tion time of one second. The fade margin was reduced by 10 dB from normal planning levels, simulating severe multipath conditions. There was only one error burst when an error rate of  $10^{-4}$  was exceeded on the diversity receiver. The ratio of the total number of errors recorded on the reference and diversity receivers in this example is 230 : 1, most of the diversity errors occurring in the one error burst; without this burst the ratio is 22 820 : 1. In a typical period of ten hours with less severe fading, no errors occurred on the diversity receiver while  $51 \times 10^6$  errors occurred on the reference receiver.

### 5 Conclusions

The problem of applying diversity to 11 GHz digital radio-relay systems has been assessed and solved by analysing the propagation characteristics relevant to digital systems and computing the effect of these propagation characteristics on the error rate characteristics of the system. A height diversity system has been designed and constructed to prove the findings in the laboratory. A radio section of the network has been commissioned and the improvement in both signal level and error rate probability demonstrated in the field.

Field tests will continue and provide additional data for a more detailed assessment of the system.

### 6 Acknowledgment

Acknowledgment is made to the Director of Research of the Post Office for permission to publish this paper.

### 7 References

- Brennan, D. G., 'Linear diversity combining techniques', *Proc. Inst. Radio Engrs*, 47, pp. 1075-1102, June 1959.
- Vigants, A., 'The number of fades in space-diversity reception', *Bell Syst. Tech. J.*, 49, pp. 1513-30, September 1970.
- Lewin, L., 'Diversity reception and automatic phase correction', *Proc. Instn Elect. Engrs*, 109, Part B, No. 46, pp. 295-304, July 1962.
- Turner, D., Easterbrook, B. J. and Golding J. E., 'Experimental investigation into radio propagation at 11.0 to 11.5 GHz', *Proc. Instn Elect. Engrs*, 113, pp. 1477-89, 1966.
- Davies, M. C., 'The Calculated Effect of Multipath Fading on the Performance of a 2-level Phase-shift-keyed Digital Radio-relay System', Post Office Research Department Report No. 333, October 1972.
- Davies, M. C. and Moore, P., 'Methods for investigating the effects of multipath fading on 2-phase digital radio systems', *Instn Elect. Engrs Conference Publication No. 98*, 'Propagation of Radio Waves at Frequencies above 10 GHz,' pp. 33-7, 1973.
- Vigants, A., 'Space diversity performance as a function of antenna separation', *IEEE Trans. on Communication Technology*, COM-16, No. 6, pp. 831-6, December 1968.

Manuscript first received by the Institution on 21st April 1976 and in revised form on 2nd August 1976. (Paper No. 1754/Cam. 141.)



# A new sub-bottom profiling sonar using a non-linear sound source

P. PETERSEN, M.E.E.,\*

J. M. HOVEM, Dr.Ing.,†

A. LØVIK, M.Sc.†

and

T. KNUDSEN, Dr.Ing†

*Based on a paper presented at the IERE Conference on Instrumentation in Oceanography held at Bangor on 23rd to 25th September 1975*

## SUMMARY

This paper describes a sub-bottom profiling sonar based on a non-linear sound source. The primary frequencies are centred around 38 kHz giving a difference frequency in the range of 1–7 kHz with beamwidth from  $10^\circ$ – $5^\circ$ .

Using the relative broad bandwidth of the system the transmitted signal can be phase-modulated and the received signal compressed by correlation technique.

The design considerations, specifications and performance of the system are outlined and the first results from field experiments are included.

\* SIMRAD AS P.O. Box III, 3191 Horten, Norway.

† Electronics Research Laboratory (ELAB), University of Trondheim, N-7034 Trondheim-Nth, Norway.

## 1 Introduction

Recent research in non-linear generation of sound offers a new solution to the problem of obtaining a low-frequency sound source with narrow beamwidth without excessive transducer dimensions. Among the possible applications of this source perhaps the most interesting is sub-bottom profiling, where the conflicting requirements of penetration and resolution are difficult to compromise with conventional sonars. The work to be reported in this paper is directed towards the design of an operational system for sub-bottom profiling and at the same time to provide a flexible tool for further investigations in practical use of non-linear sound sources.

## 2 Design Considerations

Deep penetration with sufficient horizontal and vertical resolution are important requirements of a sub-bottom profiling sonar. These requirements are affected by the acoustical properties of the sub-bottom materials as well as economical and operational constraints on transducer size, stability and self-noise. Considering only the acoustical properties the following remarks will illustrate the difficulties in combining deep penetration with good resolution.

### 2.1 Penetration

The echo level from a sub-bottom layer is determined by its acoustic reflectivity and the absorption in the sediments above. The absorption is likely to be the most important factor which ultimately will determine the maximum penetration.

The absorption is frequency dependent and will vary with the type of sediment. Although the measured values differ considerably it appears that the absorption often increases linearly with frequency and therefore is a constant when expressed in dB per unit of wavelength. From results collected by several investigators<sup>1–5</sup> the following values are assumed to be fairly typical:

sand 1–2 dB/wavelength  
clay/silt 0.1–0.3 dB/wavelength

As an indication to what this means in terms of penetration, the echo level from a perfect reflecting layer has been calculated.

For the situation depicted in Fig. 1 and assuming medium absorption values for clay/silt (0.15 dB/wavelength) the transmission loss is shown in Fig. 2. If, for

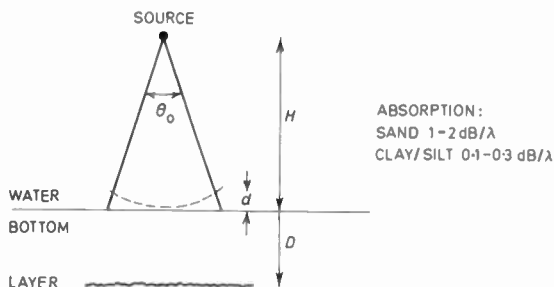

Fig. 1. Geometry of sonar sub-bottom profiling.

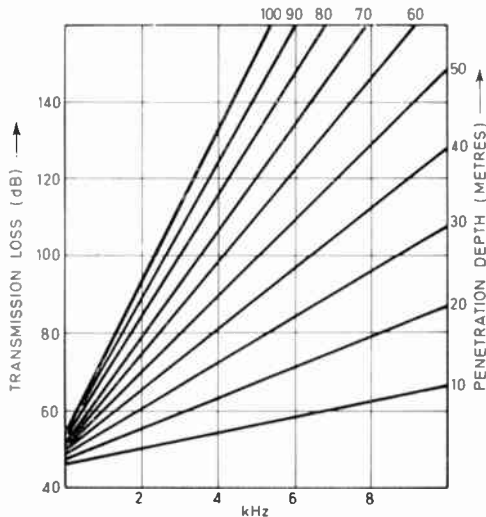

Fig. 2. Transmission loss as function of frequency and penetration depth.

instance, the system can tolerate a transmission loss of 100 dB the maximum penetration will be about 80 m at 3 kHz and 35 m at 7 kHz. In sand the penetration will be reduced to about 9 and 4 m respectively.

2.2 Resolution

The depth resolution is determined by the length of the transmitted pulse, or in case of a pulse compression system, the bandwidth. A bandwidth of 1 kHz limits the resolution to about 0.75 m.

The depth resolution is also determined by the beamwidth of the system. With reference to Fig. 1 and assuming an irregular bottom the depth resolution *d* is approximately given by

$$d \approx \frac{1}{8} \theta^2 H \tag{1}$$

*θ* being the total beamwidth and *H* the height above the seabed. This dependency is shown in Fig. 3 and for instance a beamwidth of 10° is required to give a resolution of about 0.5 m at a distance of 100 m. For a circular transducer this beamwidth corresponds to a diameter of 7 m at 3 kHz and 3 m at 7 kHz.

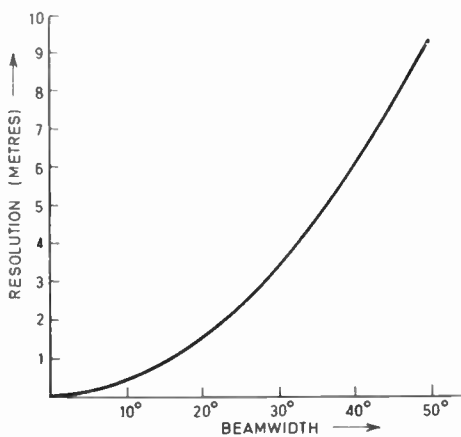

Fig. 3. Vertical resolution as function of beamwidth.

3 Non-linear Generation of Sound

Non-linear generation of sound represents a new possibility for obtaining a low-frequency sound source with narrow beamwidth without excessive transducer dimension. Among the possible applications perhaps the most interesting is a system for sub-bottom profiling. The following brief discussion will outline the basic principles and the most important properties of non-linear sound sources.

3.1 Basic Principles

The speed with which an acoustic signal will travel in water depends on the pressure and this varies with the location on the waveform causing a distortion of the waveshape as the signal travels.

If, for instance, a sinusoidal waveform is transmitted with sufficient high amplitude, the distortion will eventually lead to a sawtooth waveform containing higher harmonics of the transmitted frequency (Fig. 4). Since the attenuation increases with frequency the higher harmonics will disappear after some distance and the signal again resembles the originally transmitted signal.

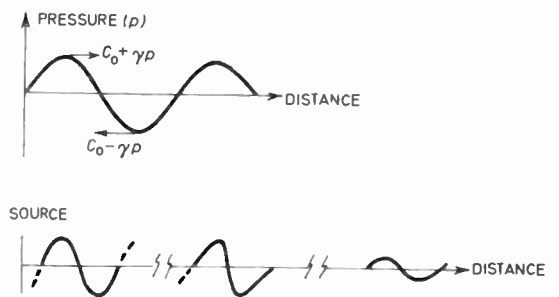

Fig. 4. Distortion of sine wave due to non-linearity.

The fact that water is not completely linear is used in the non-linear or parametric generation of acoustic signals. The non-linearity is, however, very weak and can in most applications be described by a quasi-linear method. According to this method the contribution to the parametric soundfield is given by a volumetric source strength:<sup>6-11</sup>

$$q = \frac{\beta}{c_0^4 \rho_0^2} \frac{\partial}{\partial t} P_i^2 \tag{2}$$

Here  $P_i$  is the instantaneous pressure at the point,  $c_0$  is the speed of sound,  $\rho_0$  the water density and  $\beta$  is a dimensionless parameter. The parametric radiation at a position given by *r* is then obtained by integration over the volume where interaction takes place.

$$P_s(\mathbf{r}) = -\frac{\rho_0}{4\pi} \int_v \frac{\partial q}{\partial t} \frac{\exp [jk(\mathbf{r}-\mathbf{r}')] }{|\mathbf{r}-\mathbf{r}'|} d\mathbf{v} \tag{3}$$

Generation of low frequency sound is accomplished by using a conventional transducer simultaneously excited by two primary frequencies  $f_1$  and  $f_2$  separated by  $\Delta f$  and centred around a mean primary frequency  $f_0$ :

$$\begin{aligned} f_1 &= f_0 - \frac{1}{2} \Delta f \\ f_2 &= f_0 + \frac{1}{2} \Delta f \end{aligned} \tag{4}$$

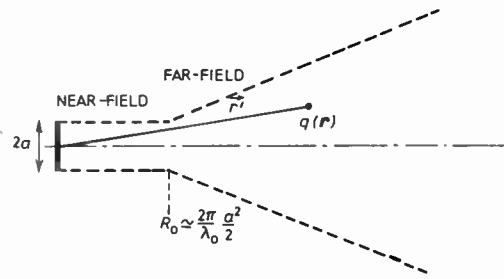

Fig. 5. Non-linear interaction.

The non-linearity will cause the two primary waves to interact thereby generating a sum and a difference frequency component of which only the difference frequency  $\Delta f$  is of interest for applications. The difference frequency component can be calculated by evaluating the primary sound pressure and integrating over the volume of interaction. This volume is approximately bounded as indicated in Fig. 5. In the nearfield of the transducer the primary waves are collimated and bounded by the transducer area. At larger distances the volume becomes wider and will in distance be limited either by absorption or by spherical divergence.

The calculation of the secondary sound level is in general quite complicated and approximations and numerical methods must be used. A particular simple and illustrative case is when the nearfield extends so far out that interaction is limited by absorption in the near field. The difference frequency source distribution then resembles a continuous end-fire array with an exponential taper. This case was originally treated by Westervelt<sup>6</sup> and gives the secondary source level as

$$P_s = \text{constant} \times (\Delta f)^2 P_i^2 \tag{5}$$

and with the directivity pattern

$$D_s(\theta) = \frac{1}{\left[ 1 + \left( 2\pi \frac{\Delta f}{c_0 \alpha} \right)^4 \sin^2 \left( \frac{\theta}{2} \right) \right]} \tag{6}$$

with a beamwidth of

$$\theta_0 \approx 2 \sqrt{\frac{2\alpha c_0}{\pi \Delta f}}$$

These results are only valid for a particular case but they illustrate some important properties of a well-designed parametric source. The secondary source level will increase with the square of the difference frequency and with the square of the primary sound pressure. The directivity pattern is without significant sidelobes and almost as narrow as the primary beamwidth. Since a typical ratio between the primary and difference frequency is about 10 this means that secondary beamwidth is considerably less than conventional operation of a transducer of the same size.

### 3.2 Excitation

In general the primary signal is given by

$$P_p(t) = A(t) \cos(2\pi f_0 t) \tag{7}$$

where  $A(t)$  is an envelope of the signal and  $f_0$  is the mean

primary frequency. Then from equations (2) and (3) the secondary signal generated by interaction is of the form:

$$P_s(t) = \text{constant} \times \frac{\partial^2}{\partial t^2} P_p^2(t). \tag{8}$$

Assuming that the squared envelope  $A^2(t)$  is periodic with period  $T = (\Delta f)^{-1}$  it can be expanded in a Fourier series of the fundamental frequency  $\Delta f$ . Using equation (8) this gives at the difference frequency a component with amplitude

$$a_s = \text{constant} \times \frac{\Delta f^2}{T} \int_{-T/2}^{T/2} A^2(t) \cos\left(2\pi \frac{t}{T}\right) dt. \tag{9}$$

Two types of modulation are of particular interest. In the linear mode the primary signal is the sum of two signals at frequencies  $f_0 \pm \frac{1}{2}\Delta f$

$$P_p(t) = \frac{1}{2}A_0 \cos[2\pi(f_0 + \frac{1}{2}\Delta f)t] + \frac{1}{2}A_0 \cos[2\pi(f_0 - \frac{1}{2}\Delta f)t] \\ = A_0 \cos(\pi\Delta f t) \cos(2\pi f_0 t). \tag{10}$$

This signal is produced by modulating  $f_0$  with  $\frac{1}{2}\Delta f$  and feeding both sidebands to the transducer.

In this case  $A(t) = A_0 \cos(\pi\Delta f t)$  and the secondary amplitude becomes

$$a_s = \text{constant} \times \Delta f^2 \frac{1}{2} A_0^2. \tag{11}$$

In the pulsed mode the envelope is a square wave with peak amplitude  $A_0$ . With 50% duty cycle (Fig. 6) the secondary amplitude becomes

$$a_s = \text{constant} \times \Delta f^2 \frac{2}{\pi} A_0^2. \tag{12}$$

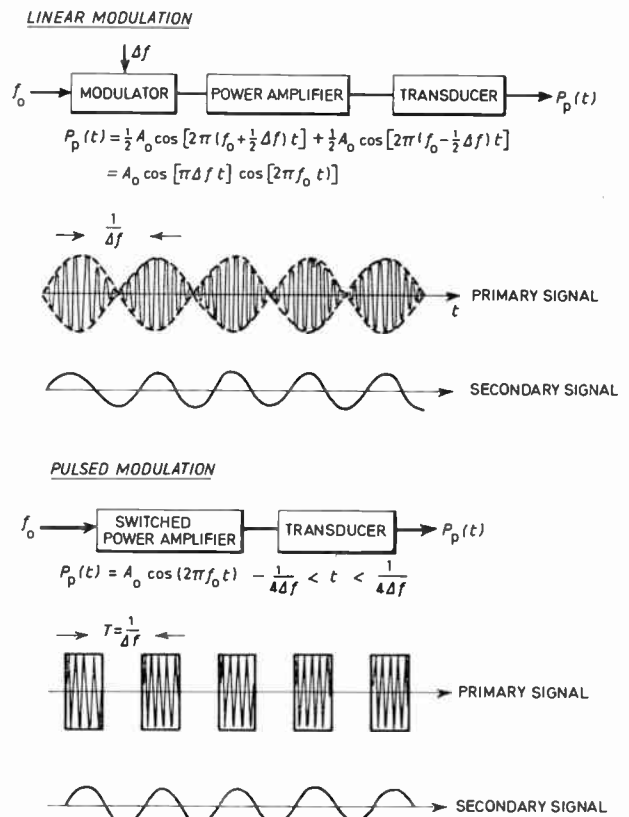

Fig. 6. Waveforms of a non-linear source.

With a constraint on the peak primary amplitude the pulsed mode is therefore more efficient than the linear mode by  $20 \log(4/\pi) = 2.1$  dB.

It is important that the difference frequency is only generated in the water by interaction and not in the electronics, in which case the narrow secondary beam pattern will be destroyed.<sup>12</sup> The linear mode of excitation therefore requires a very high degree of linearity in the electronics which is very expensive, especially for the power amplifier. In the pulsed mode no linear amplification is required and the power amplifier can be of the switched type.

#### 4 System Description

The parametric sonar to be described was designed for high resolution sub-bottom profiling, and at the same time to be a flexible experimental system for further work in practical utilization of non-linear acoustic. For this reason a number of possibilities have been implemented in the system which are now under investigation.

##### 4.1 General Description

Figure 7 shows the major components of the system. The transducer has an area of 0.25 m<sup>2</sup> and is composed of 218 piezoelectric elements. The mean primary frequency is 38 kHz and the directivity index at this frequency is 33 dB, corresponding to a beamwidth of 4°. With a 5 kW power amplifier the primary source level at present is 127 dB relative to 1 µbar. With improved matching and reduction of various losses it should be possible to increase the source level considerably.

The timing and function unit provides synchronization signals and generates the various signal codes which can be transmitted. The difference frequency can be selected as 0.8, 1.6, 3.3 or 6.7 kHz in short pulses or in longer phase-modulated sequences.

The returned signal at the difference frequency is received by a 10 m long hydrophone cable with 40 hydrophones giving a noise suppression of about 10–15 dB.

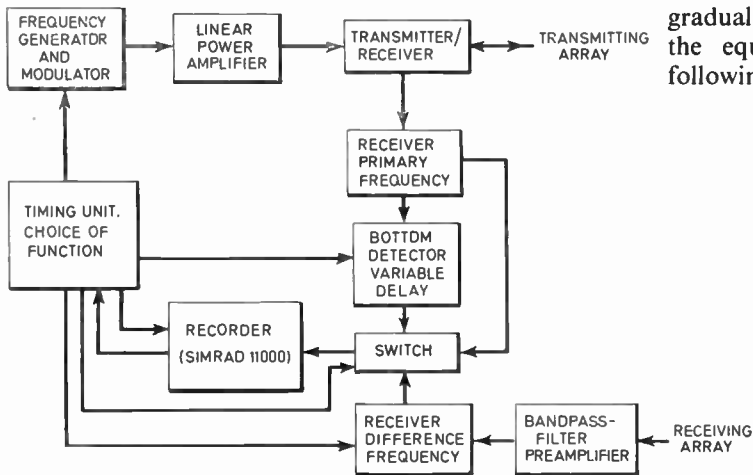

Fig. 7. Block diagram of the system.

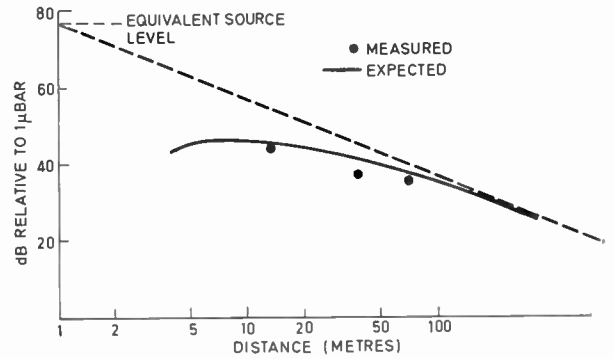

Fig. 8. Secondary sound level as function of distance. Frequency 3.3 kHz.

After bandpass filtering and amplification the received signal is correlated with a replica of the transmitted signal. The processed signal is thereafter fed to a Simrad 11000 recorder for presentation.

In addition to reception of the difference frequency there is also a receiving chain on the primary frequency connected to the transmitting transducer. The received signal on this chain can be used for precise detection of the first bottom echo or displayed as in a conventional echosounder at 38 kHz.

In normal operation the transmitting transducer is housed in a towed body with the receiving array trailing. The height above the bottom should be about 100 m and the distance from the towing vessel about 200 m.

##### 4.2 Secondary Source Level and Distribution

Most of the volume of interaction is in the far field of the primary source and extends out to about 100 m. Within this distance there is a gradual building-up of secondary sound pressure.

The secondary sound pressure has been measured in axial positions at 13, 37 and 69 m from the transducer. The measurements have been done at all the four difference frequencies and there is a good agreement with approximate numerical calculations.

Figure 8 shows as an example the results obtained at 3.3 kHz. At longer distance the sound pressure will gradually approach the  $R^{-1}$  asymptotic behaviour and the equivalent secondary source level is found by following the asymptote back to 1 m.

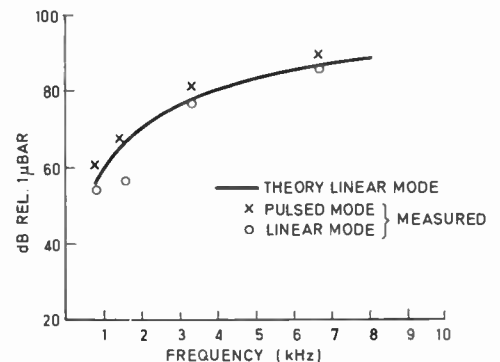

Fig. 9. Secondary source level as function of difference frequency.



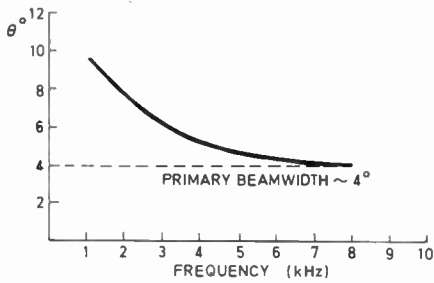

Fig. 10. Secondary beamwidth as function of frequency.

Figure 9 shows the equivalent secondary source level as function of frequency and the theoretical values computed by the methods given in Refs. 7-9. Measurements have been done with linear modulation as well as pulsed, and with the same peak primary pressure the results confirm the advantages with the pulsed operation as indicated in Section 3.2.

The beam width as function of frequency has been computed and is shown in Fig. 10. Due to difficulties with controlling the geometry it has not been possible so far to confirm these values by measurements. It is planned to do this at a later stage, but the preliminary investigations seem to confirm the predicted values.

4.3 Modulation and Signal Reception

The system can transmit short c.w. pulses with a length depending on the difference frequency which may be 1, 2 or 4 cycles long.

In order to obtain additional noise suppression without sacrificing time resolution the system can also transmit longer modulated signals and then the returned signal is correlated against a replica of the transmitted signal. The modulated signals are sequences of *N* phase shifts of 180° or 0° according to prescribed codes. The following codes are implemented:

- N* = 13 Barker code
- N* = 31 pseudo-random sequence
- N* = 63 " "

Ideally a code of length *N* yields an equivalent increase in the signal-to-noise ratio of  $10 \log N = 11, 15$  or 18 dB.

In order to generate a phase shift of 180° in the secondary signal the phase of the primary signal must be changed by 90°. Figure 11 shows as an example the primary signal and the secondary signal for the *N* = 13 Barker code. On reception the secondary signal is divided into a phase and a quadrature component, both separately correlated against the binary reference and thereafter combined (Fig. 12). The correlator is based on recirculating shift-registers.

5 Preliminary Results

The first test was conducted in July 1975 with emphasis on the measurements of the primary and secondary source levels. Only on one occasion so far has the system been tried for bottom penetration. This trial took place outside Horten in water depths of about 140-190 m, where the bottom is relative flat and silty. The ship was drifting with the transmitting and receiving array suspended at a height about 80 m above the bottom. At the time of the trial the correlator was not working properly and the measurements were done with short c.w. pulses only.

Recordings were made on all the four difference frequencies and on the primary frequency with various pulselengths. Figures 13 and 14 show examples of the recording at 3.3 and 6.7 kHz. The maximum penetrations observed were:

38 kHz	~ 15 m
0.8 kHz	~ 15 m
1.6 kHz	~ 35 m
3.3 kHz	~ 40 m
6.7 kHz	~ 35 m

It is evident that an 'optimum' frequency exists and this is also to be expected from Figs. 2 and 9. In this case the frequency is about 3 kHz.

6 Conclusions and Future Developments

Measurements on parametric sources are in good agreement with theoretical predictions. This is encouraging for further applications of parametric sources. The

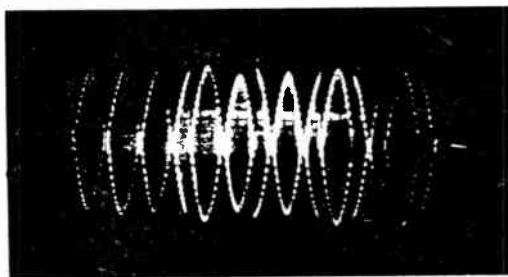

(a) Transmitted signal at the primary frequencies.

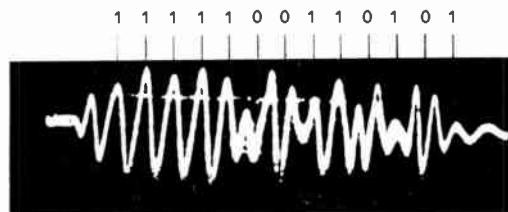

(b) Coded signal at the difference frequency, 1.6 kHz.

Fig. 11. Modulated waveforms.

Coded signal; 13-bit Barker code. 1 cycle per phase shift.

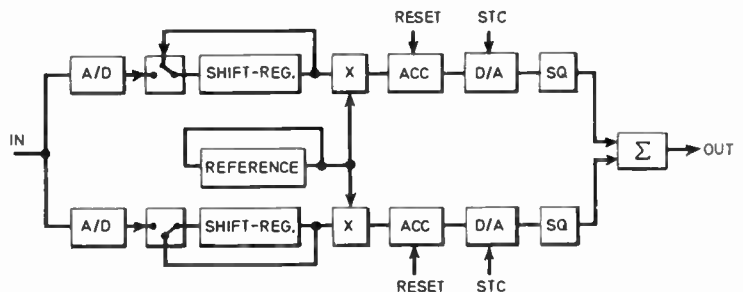

Fig. 12. Correlator.

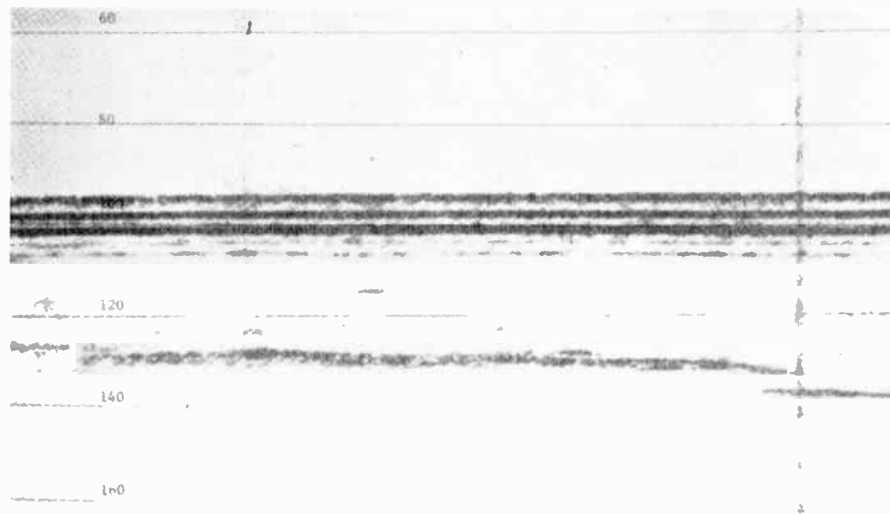

Fig. 13. Echogram: Difference frequency 3.3 kHz. Linear modulation  
Depth in metres below transmitting array.

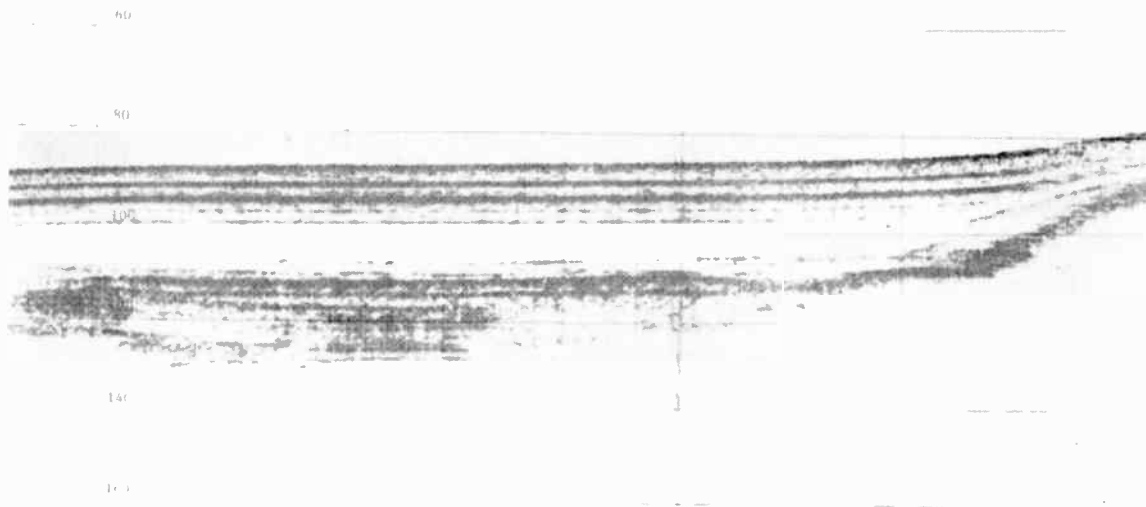

Fig. 14. Echogram: Difference frequency 6.7 kHz. Pulsed modulation  
Depth in metres below transmitting array.

general concept of using a parametric source in a sub-bottom profiling system has been verified with the detection of sub-bottom features down to about 40 m.

Within the existing system it is expected to increase this depth considerably. First, because the result was obtained without the correlator which has the potential of reducing the noise by 10–15 dB. Secondly, the primary source level can be increased by 5–10 dB, equivalent to 10–20 dB increase in the secondary source level. This increase in source level will be done using a switched power amplifier and the pulsed mode which now has been verified.

The present system is experimental, and further work and refinements are necessary to convert it into an operational system. Towing and controlling the arrays under various conditions are expected to be the most important tasks in this respect.

## 7 Acknowledgments

The work reported is a part of a research programme in which Simrad A/S, Electronics Research Laboratory and Department of Physics, The University of Bergen, are participating. The programme is financed by Simrad A/S and the Norwegian Council for Scientific and Industrial Research.

## 8 References

1. Hamilton, E. L., 'Prediction of in-situ acoustic and elastic properties of marine sediments', *Geophysics*, 36, No. 2, pp. 206–84, April 1971.
2. Mackenzie, K. V., 'Reflection of sound from coastal bottoms', *J. Acoust. Soc. Am.*, 32, No. 2, pp. 221–31, February 1960.
3. Hamilton, E. L. *et al.*, 'Acoustic and other physical properties of shallow-water sediments off San Diego', *J. Acoust. Soc. Am.*, 28, No. 2, pp. 1–15, January 1956.

4. Nafe, J. E. and Drake, C. L., 'Physical properties of marine sediments', in 'The Sea', Vol. 1/2/3, Hill, M. N. (Ed.), Chap. 29 (Interscience, New York, 1962/63).
5. Hastrup, O., 'The Reflectivity of the Top Layer in the Naples and Ajaccio Abyssal Plains', SACLANT ASW Research Centre, Tech. Report No. 118, July 1968.†
6. Westervelt, P. J., 'Scattering of sound by sound', *J. Acoust. Soc. Am.*, 29, p. 199, 1957.
7. Mellen, R. H. and Moffett, M. B., 'A Model for Parametric Sonar Radiator Design', Naval Underwater System Center (NUSC) Tech. Memo. PA 41-229-71, 1971.
8. Moffett, M. B., 'Parametric Radiator Theory I', Naval Underwater System Center (NUSC) Tech. Memo. PA 4-234-71, 27th September 1971.†
9. Mellen, R. H., 'Recent developments in parametric sonar', SACLANTCEN Memorandum SM-23, 15th September 1973.†
10. Muir, T. G. and Willette, J. G., 'Parametric acoustic transmitting arrays', *J. Acoust. Soc. Am.*, 52, No. 5, pp. 1481-6, 1972.
11. Berkta, H. O., 'Nonlinear Acoustics', Proceedings of the NATO Advanced Study Institute on Signal Processing, Loughborough, 1972.
12. Eller, A. I., 'Adaption of the NLR Acoustic Research Tank Facility for Experiments on Parametric Sonar, with Preliminary Results', Naval Research Lab., Washington D.C.

*Manuscript received by the Institution on 3rd March 1976. (Paper No. 1755/AMMS78.)*

† Obtainable from National Technical Information Service, Springfield Va., 22151, U.S.A.

© The Institution of Electronic and Radio Engineers, 1977

## The Authors



**Per Pettersen** received his education at the Technical University of Norway, being awarded an M.E.E. in Electrical Engineering in 1956. He worked for three years as a research engineer at the Norwegian Defence Research Establishment division for Underwater Warfare on an ASW system. He then joined the Simrad company in Horten, Norway, and is now Chief Engineer and Head of Hydro Acoustic Systems.

Scientist and Head of the Underwater Acoustics group at the Electronics Research Laboratory in Trondheim.



**Arne Løvik** gained his 'sivilingeniør' degree in electrical engineering from the University of Trondheim in 1971. From 1972 to 1974 he was with Simrad A/S, Horten, Norway, where he worked on underwater acoustic systems and transducers. Since 1974 Mr. Løvik has been with the Underwater Acoustics group at the Electronics Research Laboratory in Trondheim.



**Jens M. Hovem** obtained the 'sivilingeniør' degree (M.Sc.) in electrical engineering from the University of Trondheim in 1962. From 1962 to 1966 he taught and did research in the applications of communication theory at the University of Trondheim and obtained the Dr.Eng. degree in 1966. From 1966 to 1972 he was with the Saclant ASW Research Centre in La Spezia, Italy, where he carried out underwater acoustics research with emphasis on propagation studies and signal processing. Since 1972 Dr. Hovem has been Senior



**Tor Knudsen** was awarded the 'sivilingeniør' degree in electrical engineering by the University of Trondheim in 1969. From 1971 to 1973 he did research into the applications of communication theory at the University of Trondheim and obtained his Dr.Eng. degree in 1974. In 1973 he joined the Underwater Acoustics group at the Electronics Research Laboratory in Trondheim.

# A digital instrument with histogram output

T. J. TERRELL, M.Sc., Ph.D., C.Eng., M.I.E.E.\*

and

E. T. POWNER,

B.Sc., M.Sc.Tech., Ph.D., C.Eng., M.I.E.E.†

## SUMMARY

The paper discusses the basic design philosophy and principle of operation of a digital instrument which automatically measures a physical variable periodically, and produces a corresponding histogram output of the measured values.

An illustrative example is given of how the instrument may be employed in quality control techniques applied to the production of ferrite components. Other possible applications are briefly discussed.

\* Department of Electrical and Electronic Engineering, Preston Polytechnic, Preston PR1 2TQ.

† Department of Electrical Engineering and Electronics, U.M.I.S.T., Manchester M60 1QD.

## 1 Introduction

During the last thirty years a whole new branch of electronics has developed; a branch concerned with data in digital form. In the early nineteen-fifties some of the first commercial digital measuring instruments appeared, thereby allowing relatively precise unambiguous measurements to be taken. Peripheral devices were developed to print or punch the digital reading, thus producing a permanent record on paper.

Indeed, with the advent of the digital voltmeter it became possible to present, in digital form, any quantity which could be converted to a proportional voltage reading by using an appropriate transducer,<sup>1</sup> and since this includes most physical variables it is possible to record and process all telemetered or logically sensed data in digital form.

However, sometimes a digital record is an abused method of presenting certain data, such as periodic measurements of voltage drift or temperature variation, and it is not an uncommon occurrence to see a printed or punched list of readings which give no indication of how they are distributed relative to some quantifiable parameter, such as their mean or standard deviation. For this reason some of the early print-out devices were provided with what was then relatively expensive analogue outputs, which were used to obtain analogue chart-recordings of the measurements, thus providing a visual indication of their distribution.<sup>2</sup>

It is now well known that one of the most fundamental techniques used for putting order into a disarray of readings is to present their frequency distribution in the form of a histogram. But unfortunately the task of sorting large amounts of data and accurately drawing the corresponding histogram is often tedious and time-consuming. Hence it is not surprising to find that some considerable effort has been directed at automating the measurements together with the histogram compilation process, and an analogue instrument capable of carrying out this task has been described by Taylor.<sup>3</sup>

Today the electronic instrument designer has at his disposal a wide range of relatively cheap digital integrated-circuits, which offer an alternative digital solution to many problems associated with measuring analogue variables. Also digital integrated circuits offer the inherent advantage of fast reliable operation, which makes many digital instruments suitable for direct connection, on-line, to other digital peripheral devices, such as a mini-computer used for real-time analysis of the measurements.

With the foregoing in mind the authors decided that there is a need for a digital instrument which will periodically measure a physical variable and automatically compile a corresponding histogram output. Consequently such an instrument has been designed and developed, and the authors' objectives are to present to the reader the basic design philosophy and principle of operation of the instrument, together with some practical applications. It was felt that detailed circuit diagrams are outside the scope of a paper of this nature, and the reader interested in these is referred to Terrell.<sup>4</sup>



## 2 Basic Design Philosophy and Principle of Operation

### 2.1 General Description

A block diagram of the instrument is shown in Fig. 1. The instrument has been designed to automatically compile a histogram of deviations between data derived digitally by some form of digital instrument (d.v.m., frequency counter, etc.), plus in some cases a suitable transducer, and a reference input which may be set to any desired value between 000 and 999 on three decade thumbwheel switches.

The externally-derived digital data are presented to a decade counter/storage register, in some cases via interface circuits to ensure correct logic levels. Simultaneously reference data are transferred from the thumbwheel switches to another decade counter/storage register. The two sets of stored digits are presented to a digital comparator which decides whether the two inputs are equal or which is the greater of the two. The output of this comparison sets up control circuits which in turn feed fast clock pulses to the decade counter/storage register that contains the smallest stored number. After a finite number of clock pulses both decade counter/storage registers become equal in value, and this condition is sensed by the digital comparator which results in the fast clock being stopped. The number of fast clock pulses needed to achieve this result is counted using the frequency-divider and deviation-counter, the count being equal to the difference between the two inputs. The binary code corresponding to the difference count is then decoded and used to operate the appropriate counter of the histogram output.

In the prototype instrument the histogram consisted of 21 classes, each class being recorded on a three-digit electromechanical counter. The centre class records the number of times the measured input equals the reference input. The remainder are divided into ten classes on either side of the centre to record the deviation. Two other counters have been provided to record the number of times a measurement correspondingly falls outside the upper and lower limits of the histogram. Another counter has been provided to record the total number of measurements.

The instrument will allow either single-shot or free-running operation. In the free-running mode measurements are taken periodically under the control of an internal sampling-clock, which is variable in frequency from 0.25 Hz to 30 Hz, and hence the sampling rate may be varied from a maximum of four operations per second to a minimum of one operation every 30 seconds. In the single-shot mode measurements are obtained by manual operation, and therefore the rate at which measurements are taken is directly controlled by the operator. In the case where the duration between measurements is greater than 30 seconds an externally timed operating contact may be connected and used to control the measurement rate.

Facilities have also been provided to allow the width of the class interval to be selected. This is achieved by selecting, by means of a switch, which stage of the frequency-divider is connected to the deviation-counter.

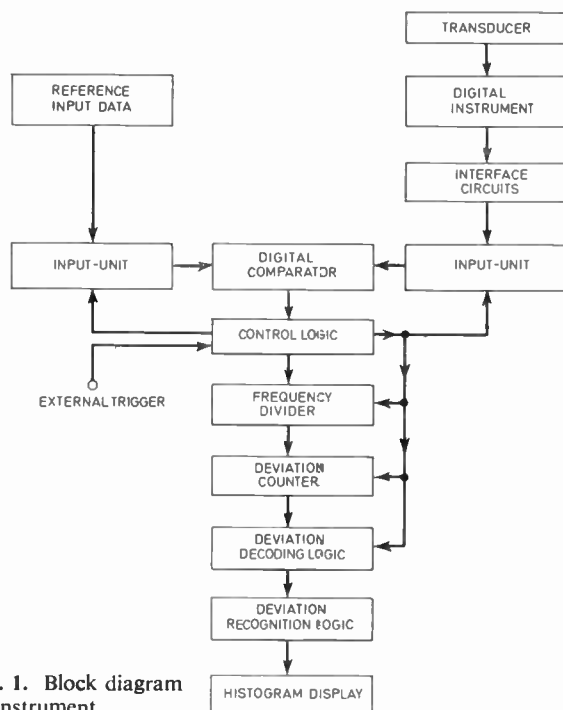

Fig. 1. Block diagram of instrument.

### 2.2 Input of Digital Data

The purpose of the input circuits is to accept two sets of digital data in parallel binary-coded-decimal form (1248). The first set is derived from three thumbwheel-switches which correspond to the reference input value. The second set is derived from the digital measuring instrument which correspond to the measured value. The input circuits are required to perform two functions, namely, on command of a control signal the input-unit must accept the parallel binary-coded-decimal (b.c.d.) inputs and store them so that they will be available when required by the digital comparator. Also the input-unit must be capable of being used as a decade counter on subsequent application of clock pulses. Because of the dual function of the input-unit it has been designated as a decade counter/storage register, which was implemented using three SN74192 t.t.l. integrated circuits. These counters allow parallel entry of input data, and on application of a control strobe signal the b.c.d. inputs are loaded, thus presetting the counter/register to the desired state. Applied clock pulses are counted up, the count starting from the preset number.

For many applications of the prototype instrument a Solartron digital voltmeter (LM1619) was used as the input source, thereby providing a corresponding digital representation of the measured variable. The logic levels of the digital voltmeter are: logical 0 = 0 V and logical 1 = -12 V. The required logic levels of the SN74192 input-units are: logical 0 = 0 V and logical 1 = +5 V. Clearly in order to make the digital voltmeter compatible with the instrument, interface-circuits had to be provided to convert the negative logic levels into positive logic levels. In contrast the input data derived from the thumbwheel switches did not require any conversion of logic levels, and were therefore connected directly to the second input-unit.

### 2.3 Logic for Deriving Statistical Data

The logic circuits for deriving the statistical data must be capable of performing three distinct functions, namely:

- (i) varying the width of the histogram class interval,
- (ii) counting the fast clock pulses which represent the difference between the reference and measured inputs, and
- (iii) produce an output signal to operate the appropriate histogram counter.

Function (i) was implemented using a frequency-divider, which is a digital logic system that accepts input pulses of frequency  $f$  Hz and produces suitable output pulses of frequency  $f/N$  Hz, where  $N$  is an integer. A simple, and yet convenient way of obtaining pulse frequency division, is by using a bistable element as the frequency dividing device, in which case  $N = 2^k$ , where  $k = 1, 2, 3, \dots$ , etc. In particular, a SN7493 t.t.l. integrated circuit operates as a four-stage binary counter, the outputs of which divide the input pulses by integer multiples of 2. Hence with a single SN7493 it is possible to obtain outputs of  $f/1, f/2, f/4, f/8$  and  $f/16$ , with corresponding histogram class intervals of 1, 2, 4, 8 and 16, which are the values used in the prototype instrument. Clearly it may in some cases be desirable to have class intervals of values which are different than those used in the prototype instrument. For example, a more flexible system will result if four separate frequency dividing units are provided. Typically these could be  $f/2, f/3, f/4$  and  $f/5$ , and if a 'patchboard-system' similar to that used in an analogue computer or the U.M.I.S.T. digital traffic simulator<sup>5</sup> is employed, it is possible to interconnect (patch up) these to give histogram class intervals of 1, 2, 3, 4, 5, 6, 8, 10, 12, 15, 20, 24, 30, 40, 60 and 120.

Function (ii) was simply achieved by using a four-stage ripple through binary counter (SN7493), the b.c.d. outputs being connected to the deviation-decoding-logic.

Function (iii) was achieved using the deviation decoding-logic and the deviation recognition-logic. The deviation-decoding-logic employs a variety of NAND gates (SN7400, SN7420, etc.) to decode uniquely states  $(1)_{10}$  to  $(10)_{10}$  inclusive of the deviation-counter; however, it should be noted that a more up-to-date alternative would be to use an SN74154 t.t.l. integrated circuit to uniquely decode the states of this counter. The occurrence of these decoded states then corresponds to the deviation from the reference value. For each deviation there are two sections of the histogram display which must be considered, namely the cases when the system input is greater than or less than the reference, and the purpose of the deviation-recognition-logic is to decide which of these two cases actually applies to the measured deviation, and hence select the appropriate display section. Therefore for each output of the deviation-decoding-logic two NAND gates ( $\frac{1}{2}$  of a SN7400) have been used to decide which section of the histogram display must be operated. Both gates having a particular output of the deviation-decoding-logic connected to one of their inputs, the remaining inputs of each gate being

connected to the Q and  $\bar{Q}$  terminals respectively of a controlling flip-flop (control logic). This control flip-flop may be assumed to be initially reset so that Q is low (0 V) and  $\bar{Q}$  is high (+5 V). If after a comparison has taken place, a signal is obtained from the digital comparator which corresponds to a condition of the reference being less than the measured input, then Q and  $\bar{Q}$  are allowed to remain in their initial states. Alternatively, if a signal is obtained from the comparator corresponding to the condition of the reference being greater than the measured input, then the controlling flip-flop will be set in the opposite state, namely Q high and  $\bar{Q}$  low. Obviously the controlling flip-flop is used to enable the appropriate side of the histogram display, and simultaneously inhibit the other side.

### 2.4 Histogram Display

In order to keep development costs within reasonable bounds, electromechanical counters were employed in the prototype instrument. It was found in practice that for the majority of applications this type of indicator was satisfactory, their only limitation being maximum speed of operation. Alternatively a faster, but relatively more expensive display, would be one employing electronic-displays such as 7-segment l.e.d. arrangements.

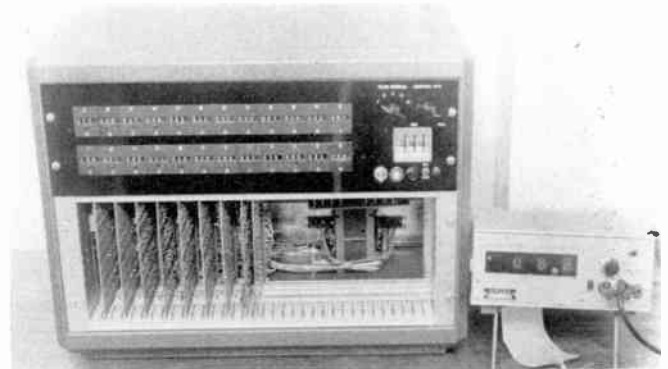

(a) Front view of instrument with digital voltmeter as input source.

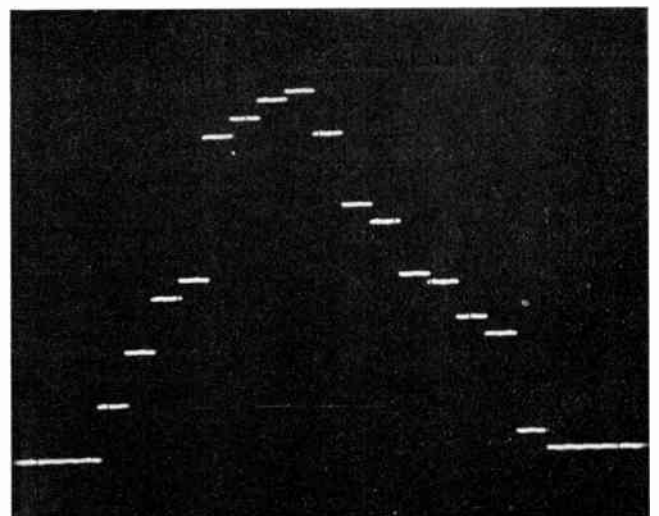

(b) C.r.t. display of histogram output.

Fig. 2.

It is worth pointing out that the physical arrangement of the histogram display in the prototype instrument is far from ideal (see Fig. 2(a)), and a better arrangement would be to have the displays with a one-to-one correspondence with the normal form of histogram found in the majority of related text books.<sup>6</sup> However, the authors interfaced their instrument to a digital mini-computer so that the histogram could be kept in its store, and subsequently be displayed in the normal form on a c.r.t. (see Fig. 2(b)).

2.5 Control Logic

Obviously the purpose of the control logic is to ensure that each part of the system carries out its task in the correct sequence. Basically the main component of the control logic is a three-stage binary-counter (3 × SN7474), each state (0-7)<sub>10</sub> being uniquely decoded (Function (iii), Section 2.3) to perform a given control operation. The function of each control state is summarized in the form of a flow-chart, shown in Fig. 3, which illustrates the control-logic sequence employed in the prototype instrument.

3 Practical Applications

3.1 Quality Control in Production of Ferrite Components

When applying quality control on a production line which is geared to the manufacture of consumer products

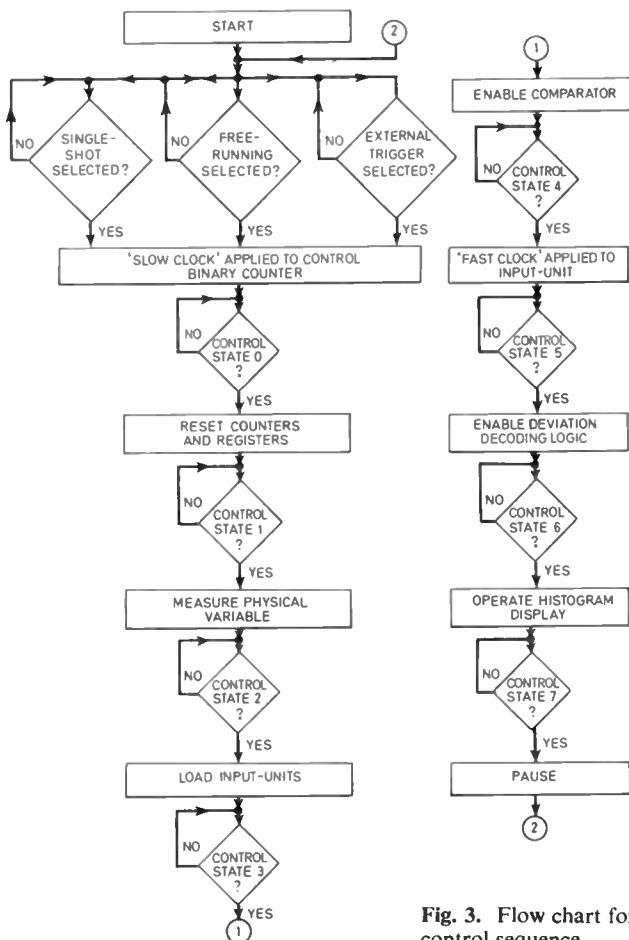

Fig. 3. Flow chart for control sequence.

the main aim is to ensure that the products conform to an acceptable standard.

In the manufacture of ferrite components an important magnetic property, which is monitored to give a measure of the component's quality, is the dimensionless constant commonly referred to as the relative permeability,  $\mu_r$ . The term 'permeability' is widely used, and often this parameter has a variety of qualifying subscripts.<sup>7</sup> For example, the initial permeability,  $\mu_i$ , and the amplitude permeability,  $\mu_a$ , are of interest when trying to assess the characteristics of ferrite components. Furthermore, it is worth noting that there are several other parameters, such as disaccommodation factor, residual loss factor and hysteresis coefficient, which are of interest to the quality control manager. However, the instrument described in this paper is only suitable for determining the distribution of permeability parameters, and consequently this section of the paper will only be concerned with this particular area of interest.

To demonstrate the underlying principle of using the authors' instrument, it will be useful to consider that the ferrite components under investigation consist of a winding of  $N$  turns on an ideal toroid having a mean magnetic path length  $l$  metres and cross-sectional area  $A$  m<sup>2</sup>. The inductance,

$$L = (\mu_0 \mu_r N^2 A) / l \text{ henrys}$$

where

$$\mu_0 = 4\pi 10^{-7} \text{ H/m}$$

Therefore

$$\mu_r = (Ll) / (\mu_0 N^2 A)$$

and clearly  $\mu_r$  is directly proportional to  $L$  for a magnetic circuit having a particular geometrical configuration and fixed number of turns. Now if the inductor,  $L$ , forms part of the simple frequency selective circuit of a Colpitts oscillator (see Fig. 4), then a variation in  $L$ , which corresponds to a variation in permeability, will produce a corresponding variation in the oscillator frequency,  $f_0$ , because

$$f_0 \approx 1 / \left[ 2\pi \sqrt{L \frac{C_1 C_2}{C_1 + C_2}} \right] \text{ Hz}$$

Using the information on design data listed in Table 1, the variation of  $f_0$  with  $\mu_r$  may be determined, resulting in the  $f_0/\mu_r$  characteristic shown graphically in Fig. 5. Referring to Fig. 5 it is seen that the relationship between  $f_0$  and  $\mu_r$  is non-linear. However, to good approximation, the characteristic curve may be linearized over three distinct and useful working permeability ranges, namely: A, 600-800; B, 800-1100; and C, 1100-1400.

Hence it is seen that by using the Colpitts oscillator as the transducer, followed by a digital frequency meter (see Fig. 1) it is possible to use the authors' instrument to monitor the distribution of permeabilities of manufactured ferrite components. For example, if the instrument is being operated to monitor ferrite components having permeabilities falling in the limited range 800-1100, then it would be convenient to select a class

Table 1. Design data

$C_1 = C_2 = 0.01 \mu\text{F}$	$l = 8 \times 10^{-2} \text{ m}$
$A = 4 \times 10^{-6} \text{ m}^2$	$N = 10$



interval of 15, with the mean permeability being equal to 950. In terms of oscillator frequency this would produce a mean value of  $f_0 = 293$  kHz, with a class interval of 2.4 kHz.

By taking samples of the ferrite components at regular intervals, perhaps 50 or 100 at a time, and by subjecting them to quality control using the instrument and transducer outlined herein, that is, by obtaining a histogram of the permeability distribution, together with suitable action and warning limits<sup>8</sup>, the number of defective components per sample may be observed, thereby allowing a statistical *significance test* to be applied, which clearly may then be used to test if a production line is working correctly.

### 3.2 Other Possible Applications

In addition to the application discussed above, the authors have also used the instrument for several other practical applications, namely:

- (a) to observe mains-voltage variation over a 24-hour period using a d.v.m. as the input;
- (b) to observe the frequency variation of a tuned-collector oscillator over considerable environmental temperature variation, using a frequency counter as the input, and
- (c) to control batch-sorting equipment on the ferrite-component production-line. In this system every component was tested, and the signal used to operate the appropriate histogram-counter was used to simultaneously operate a particular solenoid, which in turn operated a 'mechanical-gate' to divert the tested component off a moving conveyer-belt to a receiving point associated with a particular range of permeability values.

Obviously if any suitable transducer and associated digital instrument (Fig. 1) are available for use with the authors' instrument, then it is possible to compile a histogram of the variation of a variety of physical quantities.

Since the instrument is digital in form, then it is quite feasible to interface the deviation recognition logic, via a buffered digital input/output stage, to a digital-mini-computer, to render real-time analysis of the measured values.

### 4 Concluding Remarks

This paper has outlined a digital instrument which will periodically measure a physical variable and compile a histogram of its distribution. The practicality of the instrument has been demonstrated by considering its use as an aid to quality control in the production of ferrite components. Other possible applications have been briefly discussed.

The instrument uses t.t.l. integrated circuits, which means that the system can be implemented relatively cheaply. Also the fact that inherently fast and reliable measurements are possible makes the instrument suitable for use as a peripheral device to a modern digital mini-computer.

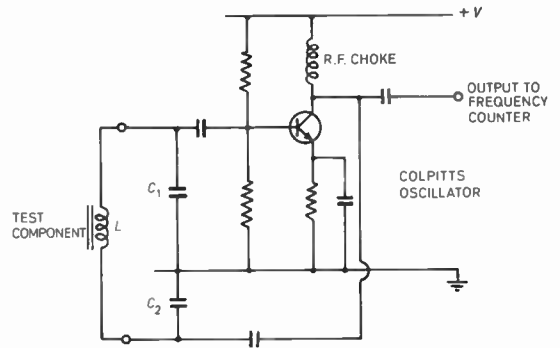

Fig. 4. Instrument transducer formed by Colpitts oscillator.

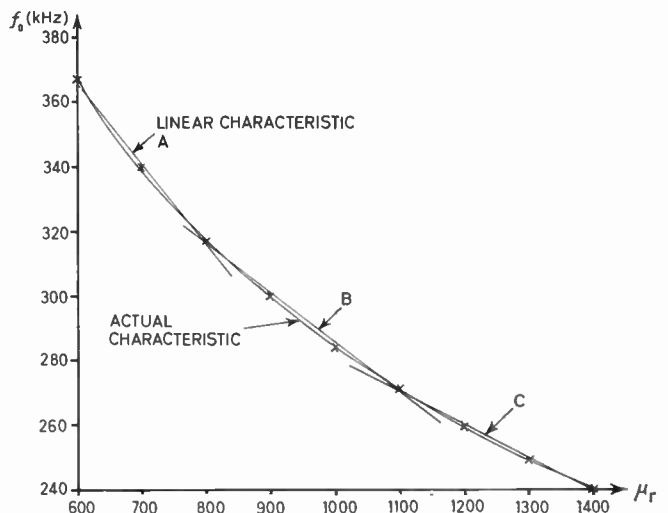

Fig. 5. The non-linear frequency/permeability characteristic of the Colpitts oscillator.

The authors envisage that in the near future the basic design philosophy and principle of operation of their instrument may be adapted to form the basis of this type of instrument implemented using a microprocessor. This possibility is now under investigation.

### 5 References

1. Oliver, F. J., 'Practical Instrumentation Transducers' (Pitman, London, 1971).
2. Bagley, A. S. and Hilton, E. A., 'A fast digital recorder with analog output for automatic data plotting', *Hewlett-Packard J.*, 8, No. 8, pp. 1-4, March 1957.
3. Taylor, R. W., 'Statistical analyser with up-dated histogram display', *J. Phys. E. (Scientific Instruments) Series 2*, 1, pp. 825-6, 1969.
4. Terrell, T. J., 'Digital signal analyser', M.Sc. Dissertation, U.M.I.S.T., October 1970.
5. Terrell, T. J., 'Logic design of a digital simulator for computer controlled traffic studies', Ph.D. Thesis, U.M.I.S.T., October 1972.
6. Moroney, M. J., 'Facts from Figures' (Pelican, Harmondsworth, 1967)
7. Snelling, E. C., 'Soft Ferrites' (Iliffe, London, 1969).
8. The Open University, 'Statistics and Reliability', Technology Foundation Course Unit 10, pp. 23-24, 1972.

Manuscript first received by the Institution on 14th April 1976 and in final form on 27th May 1976. (Paper No. 1756/M14.)

© The Institution of Electronic and Radio Engineers, 1977



# A phase-locked-loop phase-shifter for band-limited signals

D. ROUTLEDGE, M.Sc., Ph.D.\*

and

J. F. VANELDIK, B.Sc., Ph.D.\*

## SUMMARY

The need for a voltage-controllable phase-shifter frequently arises in radio astronomy interferometry work. This paper describes a particular implementation of such a phase shifter in which a phase-locked loop of special design is used as the principal phase-shifting element. Relative phase-shifting of a band-limited signal is accomplished by mixing the signal with a phase-shifted local oscillator output derived from the phase-locked loop.

Details of circuit operation, construction and performance are presented. Particular attention is devoted to obtaining a wide range of phase shifts. The paper concludes with a description of three specific applications of the circuit to a radio source flux density measurement program.

\* Department of Electrical Engineering, University of Alberta, Edmonton, Canada. T6G 2E1

## 1 Introduction

Phase shifters are often designed to handle only digital signals and are then incapable of preserving amplitude variations. Alternatively, phase shifters implemented as analogue circuits are frequently unable to deal adequately with signals of appreciable spectral width. The circuit described here was developed for radio astronomical interferometry and will shift the phase of a band-limited signal by nearly two cycles of the median frequency, while fully preserving all amplitude information contained in the signal.

The new principle involved is that of introducing a controlled offset voltage into a phase-locked loop (p.l.l.) to simulate an error signal within the loop. As the phase-locked loop tracks a reference oscillator input, the offset voltage causes the voltage-controlled oscillator (v.c.o.) inside the loop to generate a signal at the same frequency as, but with a controllable phase difference from, the reference input signal.

To shift the phase of a band-limited noise signal, the signal is simply multiplied in two symmetrical mixers by, respectively, the reference oscillator and v.c.o. output signals from the p.l.l. Multiplication by the reference oscillator output is carried out to preserve the phase reference of the original noise signal even after mixing. The mixing operations proceed according to the well-known relationship:

$$a_i(t) \cos(\omega_0 t) \cdot \cos(\omega_L t - \phi) \\ = \frac{1}{2} a_i(t) [\cos\{(\omega_0 + \omega_L)t - \phi\} + \cos\{(\omega_0 - \omega_L)t + \phi\}]$$

where  $a_i(t)$  is an envelope function,  $\omega_0$  and  $\omega_L$  are the signal and local oscillator frequencies respectively, and  $\phi$  is the relative phase angle of the v.c.o. output. Clearly, the phase difference generated in the p.l.l. between the reference oscillator and v.c.o. output signals is reproduced directly as an equivalent phase shift between the outputs from the two mixers. To be consistent, either the sum or difference frequency components must be selected from both mixer outputs.

The term 'phase shift' requires clarification when used in conjunction with signals of non-zero bandwidth, especially if no carrier is present, as is the case for band-limited noise. The phase shifter described here will shift the phase of each and every component in a frequency band of interest by the same amount. Strictly speaking, a pure relative time-delay is required. However, since the circuit described produces relative phase-shift only, approximations become necessary.

Let the signal have median angular frequency  $\omega_0$ , and let its spectrum extend  $\frac{1}{2}\Delta\omega$  on each side of  $\omega_0$ , with  $\Delta\omega \ll \omega_0$ . Also, let the signal be described in quadrature-carrier notation<sup>1</sup> as

$$s(t) = a_i(t) \cos \omega_0 t - a_q(t) \sin \omega_0 t$$

where  $a_i(t)$  and  $a_q(t)$  are in-phase and quadrature envelope functions respectively, with time variations restricted such that  $s(t)$  has spectral components within  $\omega_0 - \frac{1}{2}\Delta\omega \leq \omega \leq \omega_0 + \frac{1}{2}\Delta\omega$ . The same signal, delayed in time by an amount  $\tau$ , would then be expressed as

$$s(t - \tau) = a_i(t - \tau) \cos \omega_0(t - \tau) - a_q(t - \tau) \sin \omega_0(t - \tau)$$

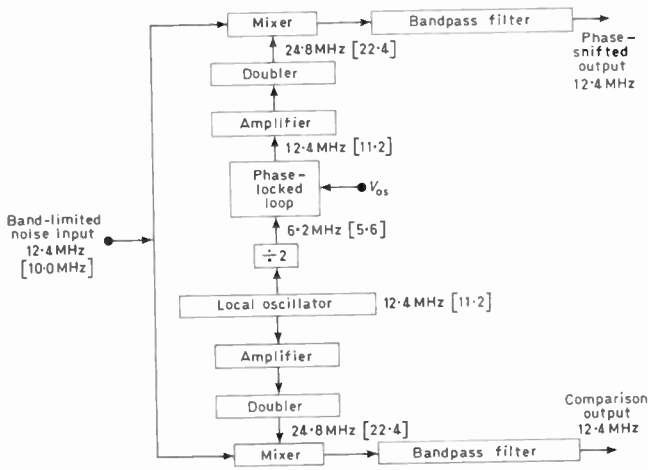

Fig. 1. Phase-shifter circuit. Offset voltage  $V_{0s}$  controls relative phase of band-limited noise output signals. Frequencies in brackets refer to heterodyne operation; other frequencies refer to homodyne operation.

But, by assumption,

$$a_i(t - \tau) \approx a_i(t)$$

and

$$a_q(t - \tau) \approx a_q(t)$$

provided that  $\tau \ll 2\pi/\Delta\omega$ . If the product  $\omega_0\tau$  is now identified as a phase shift  $\theta$ , it follows that

$$s(t - \tau) \approx a_i(t) \cos(\omega_0 t - \theta) - a_q(t) \sin(\omega_0 t - \theta)$$

Thus, it may be said that  $s(t)$  has been retarded in phase by  $\theta$  radians, this being approximately equivalent to a delay of  $\tau$  seconds. In actuality, the instantaneous frequency of  $s(t)$  varies within the interval  $\Delta\omega$ , and the error involved in ascribing phase shift  $\theta$  to every frequency in the interval, when strictly a delay  $\tau$  is being discussed, will be as large as  $(\Delta\omega/2\omega_0)\theta$  radians at the band edges. The authors assume this error to be small, as in the case discussed below where  $\Delta\omega/2\omega_0 = 6 \times 10^{-4}$ .

## 2 The Circuit

The circuit configuration is shown in block diagram form in Fig. 1. The phase shifter has two channels, each containing a mixer followed by a bandpass filter. The two mixer channels are identical, operate on a common noise input signal, and derive their respective local oscillator inputs through similar chains of amplifiers and

frequency doublers from a single crystal oscillator. Shifting of the relative phase of the noise outputs is performed in the mixers by shifting the phase of the local oscillator signal to one mixer with respect to the local oscillator input to the other mixer. To this end, a phase-shifting phase-locked loop, to be described later, is inserted in the local oscillator signal path for one mixer.

In Figs. 1 and 2, the frequencies indicated without brackets refer to the basic 'homodyne' operation in which no frequency translation of the signal occurs, i.e. the input and output frequencies are equal. The frequencies inside brackets refer to an alternate 'heterodyne' system in which the input and output frequencies are chosen to be different. Heterodyning may well be advantageous if in-band distortion products are troublesome, or if there is significant transmission of v.c.o. and reference oscillator signal through the frequency doublers and mixers to the output. For example, such feedthrough effects may cause unwanted spurious output in a correlating interferometer, although this may readily be eliminated by use of phase switching and subsequent synchronous detection as described by Baars *et al.*<sup>2</sup> In the authors' system, no unwanted in-band signals appeared when the frequencies were chosen as shown in brackets in Fig. 1 and when bandpass filters having 3 dB passbands of 0.5 MHz at a centre frequency of 12.4 MHz were used. It should be noted that the 12.4 MHz centre frequency was chosen simply because it is well suited to the radio astronomical interferometry programme in which the Electrical Engineering Department of the University of Alberta is presently engaged.<sup>3</sup>

Details of the phase-locked loop, the principal part of the phase shifter, are shown in Fig. 2. As is usually the case, this loop incorporates a phase detector, an amplifier and filter, and a voltage-controlled oscillator in a negative feedback arrangement. It is imperative that free integration be included to cause the loop to track phase, rather than frequency, with minimum error even for ramp inputs. Although the error signal in a p.l.l. is normally taken to be the d.c. component of the phase detector output, in this p.l.l. the error signal comprises the difference between the phase detector output and a d.c. input signal labelled  $V_{0s}$  in Figs. 1 and 2. Negative feedback systems operate to minimize their own error signals. If the above modified error signal is to approach zero, the phase detector output must

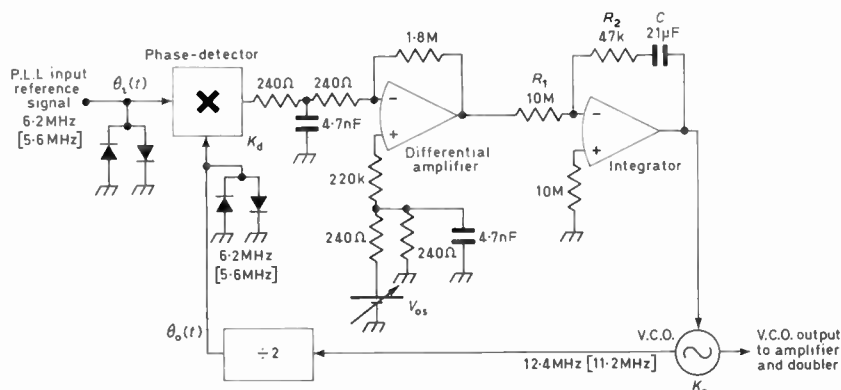

Fig. 2. Phase-locked-loop detail.

cancel  $V_{os}$ . This implies a phase difference proportional to  $V_{os}$ , between the reference input and the v.c.o. output, provided the phase detector operates linearly. Phase detector linearity is very difficult to obtain over a phase range of more than  $\pm\frac{1}{2}\pi$  radians.<sup>4</sup> Therefore, to extend linear phase shifter operation to a range of  $\pm\pi$  radians, while limiting the phase detector to its linear range of  $\pm\frac{1}{2}\pi$  radians, frequency division and multiplication by factors of two are inserted in the p.l.l. and local oscillator signal paths. Frequency doubling simultaneously doubles the v.c.o. output phase shift.

Commercial integrated circuit phase-locked loops do not usually allow for the addition of a control signal,  $V_{os}$ , or for insertion of a free integrator. Therefore, discrete components and circuits were used. The phase detector was an Analog Devices 429B transconductance multiplier with a 3 dB bandwidth of 10 MHz; the operational amplifiers were Burr-Brown 3500E low drift integrated circuits; and the v.c.o. was a crystal-controlled Colpitts circuit employing a 2N3904 transistor, with a Motorola MV1636 varactor diode across the crystal for voltage controlled tuning. All frequency division was performed by high-frequency emitter-coupled Motorola 1013 J-K flip-flops. To improve the linearity of the phase detector, its input signals were squared with Hewlett-Packard 2835-237 Schottky diodes used as wide-band limiters.

The local oscillator also consisted of a 2N3904 transistor in a crystal-controlled Colpitts circuit. Frequency doubling was carried out in tuned m.o.s.f.e.t. circuits built with RCA 40673 transistors and driven by Motorola MC1590 video amplifiers. Since the Hewlett-Packard 10534A mixer units have 50 ohm input impedances and require at least 0.25 V r.m.s. of drive signal, 2N3904 emitter follower output stages were incorporated in the doublers. The mixers fed stagger-tuned bandpass amplifiers built with RCA 40822 m.o.s.f.e.t.s and Miller 8853 transformers to provide 50 ohm matching to the mixers, 60 dB of gain, and a 3 dB bandwidth of 0.5 MHz. Finally, all circuits, except the emitter-coupled logic, were powered from regulated  $\pm 15$  V d.c. power supplies. The emitter-coupled flip-flops required  $-5$  V d.c.

### 3 Circuit Performance

The transfer function of the p.l.l. with respect to phase inputs and outputs is approximately given<sup>5</sup> by

$$H_1(s) = \frac{\theta_0(s)}{\theta_1(s)} = \frac{2\zeta\omega_n s + \omega_n^2}{s^2 + 2\zeta\omega_n s + \omega_n^2}$$

where  $s$  is the Laplace operator,  $\omega_n = (K_0 K_d / R_1 C)^{1/2}$ ,  $\zeta = R_2 C \omega_n / 2$ ,  $\theta_1(s)$  is the reference oscillator phase,  $\theta_0(s)$  is the v.c.o. output phase (after division by 2), and  $K_d$  and  $K_0$  are the gain constants of the phase detector and of the v.c.o.-divider combination respectively. The p.l.l. transfer function applicable to the phase shifter system is

$$H_2(s) = \frac{2\theta_0(s)}{V_{os}(s)} = \frac{2H_1(s)}{K_d}$$

where  $V_{os}(s)$  is the d.c. input control signal to the p.l.l.

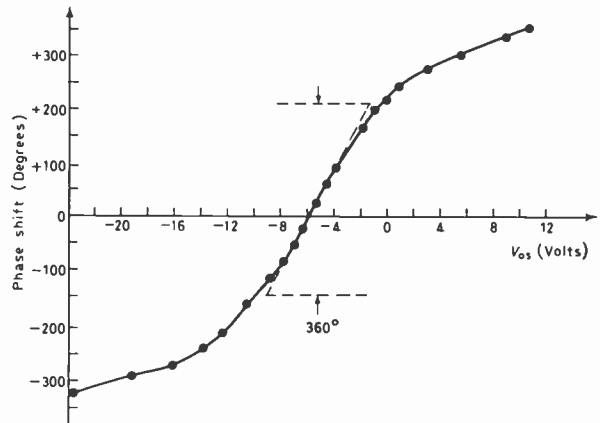

Fig. 3. Phase shift at 12.4 MHz versus control voltage. Location of origin is arbitrary and may be adjusted by means of operational-amplifier or phase-detector offset.

Measurement at 6.2 MHz (i.e. after the divide-by-two circuit) established that  $K_0 = 9.11 \times 10^6 \text{ rad s}^{-1} \text{ V}^{-1}$ , including the differential amplifier gain, and that  $K_d = 1.73 \times 10^{-3} \text{ V/rad}$ . From this it followed that  $\zeta$  had a value of 4.3 and that  $\omega_n$  was 8.65 rad/s. These parameters were set to ensure that the loop would exhibit no ringing and to guarantee good pull-in and lock-in behaviour. Experimental observation of the loop response to step changes in  $V_{os}$  confirmed the above-expected results.

The phase-shifting capabilities of the homodyne and heterodyne systems were first tested with monochromatic input signals of 12.4 MHz and 10.0 MHz respectively. Phase differences between the 12.4 MHz outputs were measured with a Hewlett-Packard 7805 vector voltmeter. A plot of the observed phase shift versus control voltage characteristic for the homodyne system is shown in Fig. 3. The system exhibited good linearity over the central range of operation, with maximum departure from linearity over 360° being 25°, or 7% of full scale. Non-linearities in the phase-detector characteristic cause changes in the parameter  $K_d$  of approximately a factor of two at the extremes of the 360° range. Should certain applications require it, the linearity may be further improved and the useful range extended by incorporating frequency division and multiplication by amounts greater than the factor of two used in this implementation. Alternatively, the phase-detector characteristic could be improved by applying true square waves to a digital phase detector. Moreover, the origin may be shifted arbitrarily by offset voltage adjustment.

The phase-shifting performance of the system was expected to be independent of the type of input signal used, and tests with white noise, band-limited to a 15 kHz interval around 10 MHz, or 12.4 MHz, confirmed this expectation. Measurement of output phase shift was complicated by the fact that the H-P 7805 vector voltmeter would not respond to noise inputs. A Signal Laboratories precision transconductance multiplier, built for 12.4 MHz, was used instead as an indirect phase indicator. This multiplier was first calibrated with monochromatic 12.4 MHz inputs, using the H-P 7805, and was then used exactly as it would be in a correlating

interferometer, producing 'interference fringes' as  $V_{os}$  was varied monotonically. The resulting curve of phase shift versus control voltage was indistinguishable from that given in Fig. 3.

#### 4 Circuit Applications

The most obvious use of the new circuit is in calibrating interferometers used in the present programme of flux-density measurements of cosmic radio sources. In order to obtain a meaningful interferometer output when a noise signal is injected simultaneously into both interferometer channels, the relative phase of the injected calibration signals must be adjusted for maximum correlator output. The new circuit will allow this to be done, and would likely be used in the heterodyne form for this operation.

A lobe-sweeping interferometer, for monitoring possible slow ionospheric scintillations, may be required in the authors' flux-measurement installation. The phase shifter could again be used, this time in the homodyne form, with a sawtooth waveform applied as the control voltage,  $V_{os}$ , to produce continuous cyclical phase variations. The step response of the p.l.l. becomes important in this application because a rapid fly-back without ringing is required between linear segments of the  $V_{os}$  waveform.

The most interesting application of the new circuit will undoubtedly be in 'complex correlation interferometers', first analysed by Clapp and Maxwell,<sup>6</sup> and used successfully in radio astronomy at 26.3 MHz by Hubbard and Erickson.<sup>7</sup> This form of correlating interferometer offers the specific advantages of gain stability and power linearity over standard 'open-loop' interferometers. To close the feedback loop, however, the band-limited noise signals which are injected at the inputs of the interferometer channels must not only be controlled in amplitude, but must possess the correct relative phase relationship

to produce a continuous null at the interferometer output. Furthermore, the in-phase and quadrature components of the interferometer output must both be nulled. Work is now under way in this Department to adapt the new p.l.l. phase shifter to this control problem. Considerable improvement in simplicity and reliability should ensue over previous circuitry which used four temperature-limited vacuum diodes, four hybrid rings, and four cross-coupled filament transformers with two secondary windings each.

#### 5 Acknowledgment

This work was supported by operating grants from the National Research Council of Canada.

#### 6 References

1. Carlson, A. B., 'Communication Systems, An Introduction to Signals and Noise in Electrical Communication', p. 174, 2nd ed. (McGraw-Hill, New York, 1975).
2. Baars, J. W. M., *et al.*, 'The synthesis radio telescope at Westerbork', *Proc. IEEE*, **61**, No. 9, pp. 1258-66, September 1973.
3. Shaw, R. A. and Routledge, D., 'A digital-analogue minimum detector for riometers', *The Radio and Electronic Engineer*, **44**, No. 7, pp. 355-6, July 1974.
4. Gardner, F. M., 'Phaselock Techniques', p. 65 (Wiley, New York, 1966).
5. *Ibid.*, p. 8.
6. Clapp, R. E. and Maxwell, J. C., 'Complex correlation interferometer', *IEEE Trans. on Antennas and Propagation*, **AP-15**, No. 2, pp. 286-90, March 1967.
7. Hubbard, J. R. and Erickson, W. C., 'A stabilized cross-correlation radiometer', *IEEE Trans. on Antennas and Propagation*, **AP-15**, No. 2, pp. 291-4, March 1967.

*Manuscript first received by the Institution on 14th June 1976 and in final form on 20th September 1976. (Paper No. 1757/CC268.)*

© The Institution of Electronic and Radio Engineers, 1977

## Letter to the Editor

*From:* J. R. Brinkley, C. Eng., F.I.E.R.E.

### A Pioneer of Airborne Radio

I was interested to read Mr. G. May's tribute to Dr. A. C. Bartlett's pioneer work on v.h.f. airborne radiotelephone equipment. I did not mention Dr. Bartlett in my paper 'Fifty Years of Mobile Radio' in the Golden Jubilee issue of the IERE Journal because while I was aware that some quite outstanding innovator had been at work in this field with crucially important wartime results, I was unaware that it was Dr. Bartlett, whom I was not fortunate enough to meet.

The direct effect of Dr. Bartlett's work was of course to airborne radio communication but the indirect effects were also considerable. I well remember, as a very young engineer at the Post Office Research Station at Dollis Hill, our astonishment in September 1939 in examining the first 100-watt

crystal controlled transmitter and the first crystal-controlled vehicle mobiles working on frequencies from 80 to 130 MHz. These fully 'productionized' designs were years ahead of their time and were clearly derived directly from the RAE work. The production engineering was carried out by the GEC at Coventry by a brilliant team, led by E. P. Fairbairn.

It was early access to this equipment which enabled us to equip Britain's police and fire services with efficient v.h.f. mobile radio systems long before other countries and this in turn led to the post-war domination of the mobile radio export market by UK industry. The story of Dr. Bartlett's work and its consequences thus provides an early and outstanding example of commercial spin-off resulting from a brilliant government development initiative.

J. R. BRINKLEY

Redifon Limited,  
Broomhill Road,  
London SW18 4JQ.  
26th January 1977



# Superselectivity in the azimuth and frequency dimensions

R. BENJAMIN,

D.Sc., Ph.D., B.Sc., A.C.G.I., C.Eng., F.I.E.E., F.I.E.R.E.\*

## SUMMARY

The possibility of extrapolation from a limited segment of a well-behaved waveform or wavefield is briefly discussed, in terms of elementary information theory, in order to establish its basic limitations and possible applications. Next, the paper briefly outlines the superdirective null forming technique for generating wideband superdirective antennas of moderate total directivity. It then develops the analogous concept of superselective frequency-notch generation. A number of possible embodiments of this technique are then described, and the frequency-domain and time-domain techniques are compared. Finally some suggestions are made for further work.

\*Government Communications Headquarters, Oakley, Cheltenham, Gloucestershire GL52 8AJ.

## 1 Introduction

Superdirectivity involves a given number of antenna elements 'compressed' into less than the normal optimum aperture.

It may be known that a signal wavefield can be validly described in terms of the amplitudes and phases of  $2n+1$  mutually independent uniform plane wavefronts across a given 'virtual' aperture  $D$ , at inclinations to the plane of the aperture of  $\sin^{-1}(-n\lambda/D)$ ,  $\sin^{-1}(-(n-1)\lambda/D)$ ,  $\sin^{-1}(-(n-2)\lambda/D)$ , through zero to  $\sin^{-1}(+n\lambda/D)$ , where  $D = n\lambda$ .

In accordance with the sampling theorem (or, more basically, from the theory of simultaneous equations), these  $2n+1$  wavefronts can, in turn, be fully represented by  $2n+1$  amplitude and phase samples across the given 'virtual' aperture.

If these measurements are now confined to a real aperture smaller than the full virtual aperture, then the total incident energy potentially accessible for measurement is reduced *pro rata*. Furthermore, the requirement to infer features of the full aperture distribution from the reduced aperture available causes the measurements to be made at undesirably close spacings, resulting in considerable correlation between adjacent measurements (so that only part of each measurement contributes additional information).

The theoretical possibility of such superdirectivity has long been known as an academic freak, but has generally been regarded as impractical for real use. However, superdirective endfire doublets have in the past been used on a small scale in underwater acoustics. More recently such doublets, using delays rather than phase changers for generating single or twin nulls, have been used more extensively as multi-octave directional receiving elements in h.f. radio. There they have proved very effective, used either singly or as components in multiple arrays. A recent paper by the author has discussed the principles of such superdirective arrays using delay null-formers and suggested extensions thereof.<sup>9</sup> The present paper outlines some of the physical principles behind superdirectivity in terms of simple signal theory. It goes on to show that these principles should find application for 'superselectivity' in the frequency plane, for waveforms of restricted duration, analogously with superdirectivity for antenna or transducer systems of restricted aperture.

It accordingly outlines the principles and limitations of superselective frequency-notch generation and suggests when and how it could be used in practice. Limited software implementation has proved the technique to be effective for some practical problems.

## 2 Information-Theoretical Considerations

Superselectivity—in frequency or direction, can only be achieved within the basic limitations of information theory. These will now be explored in this Section.

Shannon's classical theorem tells us that the information potentially available from bandwidth  $B$  and observation time  $T$  is

$$I = 2BT \log_2(1 + s/n)$$

where  $s/n$  is the signal/noise (voltage) ratio. This may be generalized to give

$$I = 2BT\theta D \log_2(1 + s/n) \quad (1)$$

where  $\theta$  is the solid angle surveilled and  $D$  the antenna aperture (in half-wavelengths squared), and power is assumed to be spread uniformly over all resolution cells in the receiving system.

This formula also implies that a given amount of energy will have the maximum potential to convey information when it is most widely and uniformly spread in the dimensions of time, frequency, aperture space and solid angle. Hence a designer is unlikely, of his own free will, to restrict his antenna aperture or time window to less than required to give him comfortably the resolution required. There are, however, some practical circumstances when physical constraints limit the available aperture to less than the desirable actual planar wavefield, or the time 'window' to less than the full duration of the actual waveform to be analysed. These are then the conditions when superdirectivity or superselectivity may come into their own.

A plane wavefront (or indeed any combination of a finite number of such wavefronts) cannot sustain a substantially uniform power density within an antenna aperture and then drop instantaneously to zero outside this aperture. Equally, a waveform of finite bandwidth cannot start and stop instantaneously at the edges of a time window. Hence there must be some scope for inferring from the waveform or wavefield actually accessible for observation how that function in fact continues over a wider 'virtual' time window or antenna aperture.

According to the sampling theorem, a signal of bandwidth  $B$  and duration  $T$  is fully specified by any number of samples exceeding  $2BT$ , preferably—but not necessarily—equally spaced over the time window  $T$ . Similarly, a wavefield over an aperture  $D$  is fully specified by any number of samples exceeding  $2D/\lambda$ , where  $\lambda$  is the relevant wavelength, and these samples should preferably—but not necessarily—be equally spaced over  $D$ . When these samples are crowded into the limited accessible aperture (or window) but are to represent a wider 'virtual' aperture, the observed measurements are highly coupled and so correlated. Only the small fractional differences, from the wavefield inferable from fewer 'normally'-spaced elements, will convey any information for extrapolation purposes. Hence much higher signal/noise ratios are required to make these field extrapolations viable. If the full virtual aperture  $D$  was to be specified with a signal to noise ratio in its elements of  $s/n$ , the restricted aperture  $D'$  can at best give the equivalent information only if its signal/noise ratio is  $s'/n$  where, from (1) above

$$1 + s'/n = (1 + s/n)^{D/D'} \quad (2)$$

For instance, if  $s/n = 3$  and  $D/D' = 2$ ,  $s'/n = 15$ . Since these  $s/n$  are voltage ratios, the extra power required would be 25 times, i.e. 14 dB ideally—and rather more in practice.

Since this was calculated on the basis of giving the same information as would be available from the virtual aperture  $D$  with signal/noise ratio  $s/n$ , it will also give the angular information appropriate to that aperture. The required 25-fold increase in power density over the halved aperture would, however, entail an increase in the incident energy by at least 12.5 times. Superdirectivity has to discard most of this, due to coherent cancellation when looking for differences in closely-correlated signal samples. Conventional additive coherent processing, on the other hand, would benefit from this incident power in full for detection against non-coherent internal or near-field noise. Despite 'throwing away' so much of the signal power, for the sake of higher directional discrimination, superdirectivity does offer a real and potentially important advantage. This is due to the fact that we are not dealing with a quasi-uniform distribution of signal power over the total solid angle, but with a modest number of discrete point-source emitters. We can exploit this prior knowledge and generate (superdirective) resolution cells which are better matched to this target pattern, thus giving better position determination and resolution of these emitters. Furthermore, under these specific conditions, we *do* improve the discrimination against non-coincident external far-field noise. The net effect on detectability will then depend on the relative importance of this far-field noise (which is reduced both absolutely and in comparison with the reduced signal) and of the near-field and internal noise (which is maintained, and hence of increased significance in relation to the reduced signal).

Thus superdirectivity does improve the *external* signal/noise ratio for each of its (narrowed) beams, as a result of looking at a reduced sector of the total solid angle. This reduction is achieved by coherent null-generation in some off-axis directions, and a substantial degree of coherent cancellation in other directions, with a smaller degree of such cancellation in the wanted direction. This cancellation in the wanted direction, arises from the need to extract information from the *difference* of nearly equal signal samples, and explains the need for the higher  $s/n$  shown above. As long as external noise remains dominant, superdirectivity is thus beneficial.

### 3 The Effect on Signal/Noise Ratios

There is a 'philosophical' difficulty in the foregoing argument: the assumption is made that external noise is dominant, and its effect is treated in accordance with classical information theory. However, with 'super-close' samples of the wavefront (or waveform), this noise will be correlated from one sample to the next, and so will appear not to conform to the assumptions of information theory. At any instant in time, this external far-field noise can be fully defined in terms of the linear superposition of a very large number of plane wavefronts, of such bandwidths that these wavefronts maintain their nature for a time not less than the transit time across the antenna array. Hence the relative far-field noise, at the output of the beam former, will indeed be reduced by the factor of superdirectivity, as postulated.

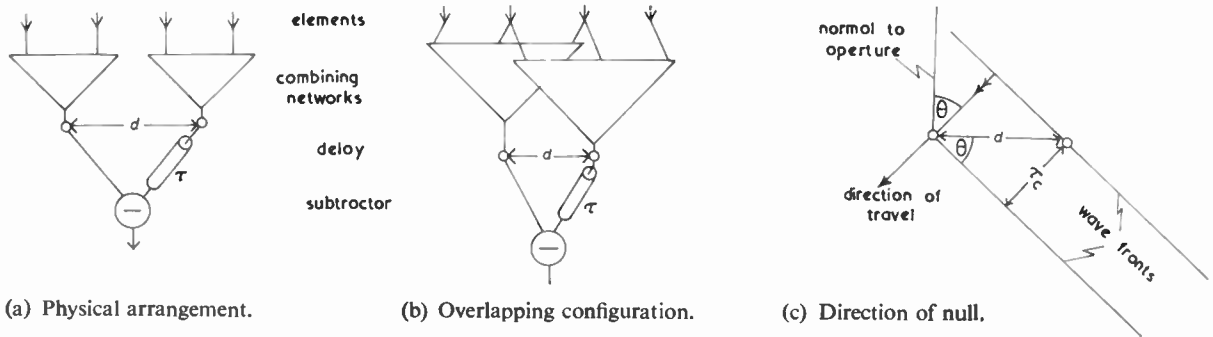

Fig. 1. Null generation in an antenna.

The total information available within the accessible aperture has been computed on the standard basis, as if for a smaller number of normally-spaced elements (samples), and hence retains its normal validity. The numerous more closely-spaced samples actually used experience a substantial degree of correlation for any incident plane wavefront—be this due to signal or to noise. The combining networks can then be regarded as cancelling out this correlated component of the signal and of the far-field noise by a common factor, prior to performing conventional coherent beam-forming on the resultant residue. This residue is equivalent to the weaker, normally-spaced samples from a wider aperture, and so coherent beam-forming will de-correlate off-axis 'noise'. Thus the signal/noise ratio of the equivalent elements of the virtual aperture will be the same as that of the true aperture with:

- its internal and near-field noise unchanged;
- its far-field noise power reduced by both  $(s/s')^2$  and  $D'/D$ ;
- its signal power reduced by  $(s/s')^2$ .

(As before, the 'dashes' refer to the real aperture and the plain symbols to the virtual aperture.)

Thus, if  $N$ ,  $n$  and  $R$  refer to external noise, internal noise and signal/noise voltage ratio, respectively,  $n = n'$  and

$$R = s' / [(N')^2 + (n')^2]^{1/2}$$

$$R' = s' / [(N')^2 D'/D + (ns'/s)^2]^{1/2}$$

Hence  $R = R'$ , i.e. the normally-processed and superdirective signal-to-noise ratios are equal if

$$(N'/n)^2 = [(s'/s)^2 - 1] / [1 - (D'/D)] \tag{3}$$

Using equation (2) to derive  $s/s'$ , and equation (3) for the final row, the figures for several values of  $D'/D$  are given in Table 1 for  $s/n = 3$ .

Much bigger losses still, relative to the internal noise, would arise with larger  $s/n$ , thus requiring even larger  $N'/n$  to make superdirectivity worthwhile. An approximate general formula is

$$N'/n = 3.75 \left[ 7.5 \left( \frac{s}{n} - 1 \right) \right]^{D/D'} \tag{4}$$

all quantities being arithmetic ratios (not dB). Thus any significant superdirectivity factor will entail a very substantial penalty in the ratio of signal to internal noise, even under theoretically ideal conditions, and it

will be rarely—if ever—worth attempting to attain superdirectivity factors of more than about 2.5. Superdirectivity—and superselectivity—factors of this order have however been obtained, under practical conditions, by off-line computation, using the very powerful but computationally expensive 'maximum entropy' method. A simpler, less ideal, but still quite effective technique is that of superdirective null-forming, discussed in the next Section.

#### 4 Superdirectivity using Delays for Null Forming

Any antenna can form directional nulls by taking two similar sets of samples of the incident wave-front from two similar sections of the array, displaced by  $d$  centre-to-centre. Subtracting the two via a delay  $\tau$  (equivalent to a propagation distance  $\tau c$ ) produces a null at the angle  $\theta = \sin^{-1} \tau c/d$  relative to the broadside-on axis. See Fig. 1(a) and (c). In practice  $d$  is normally made equal to the inter-element spacing, so that the two groups of similarly combined elements overlap by all but one element, as illustrated schematically in Fig. 1(b). Furthermore, each of the two identical partial arrays, thus combined to generate a null, may itself be the result of one or more previous similar null-forming operations on appropriately smaller constituent arrays. Thus the inclusion of each additional element will permit the generation of one additional null. Hence, the number of distinct measurements (i.e.  $M$  elements or space samples) determines the number of nulls that can be formed ( $M-1$ ). Thus we have sufficient degrees of freedom to generate  $M$  beams, so that the peak of each coincides with a null in all the other  $M-1$  patterns.

Table 1  
Examples of ideal superdirectivity gains and losses

Aperture ratio $D/D'$ i.e. superdirectivity factor	1.6	2	2.5	3	4
Possible gain against external noise $10 \log_{10} D/D'$	2 dB	3 dB	4 dB	5 dB	6 dB
Minimum loss against internal noise $20 \log_{10} S'/S$	8.5 dB	14 dB	20 dB	26 dB	39 dB
Required power ratio of external/internal noise for no net loss	12 dB	17 dB	22.5 dB	28 dB	40 dB



These conditions apply just as much with super-directivity (or *mutatis mutandis* with superselectivity). However, the array elements are then spaced by less than a half wavelength. They are thus so closely correlated that the generation of a null in one direction no longer permits coherent addition for peak generation in any other direction. Despite this loss of mainlobe gain, the process does, however, sharpen the response curve and so increase the directivity. The eventual radiation pattern is then the product of that of the individual elements, the array-factor of any sub-arrays into which they are grouped, and the array factors of the various null generations. When a null is generated superdirectively, the gain increases with increasing angular separation from the null, but never recovers fully. For instance, in an endfire system, a symmetrical pair of rear hemisphere nulls, although also attenuating the main lobe, will increase the relative sensitivity of the main lobe as against *all* other directions of look. Forward-hemisphere nulls would normally improve the *mean* directivity, whilst slightly enhancing the relative strength of some rear lobes. As the coefficients of the simultaneous equations get more nearly correlated, the unknowns (i.e. the desired outputs) become defined as small differences between relatively large nearly-equal quantities (the input measurements), thus making the process very vulnerable to small errors or disturbances.

The extent to which a limited actual aperture can thus represent a larger virtual aperture is restricted by the fact that, in practice, the ability to extrapolate the wavefield extends only by a few wavelengths, and/or by a small ratio, beyond the limits of the real (accessible) aperture. Any attempts to go beyond this would involve high-order differences of nearly equal measurements, and so would soon impose unacceptable tolerance problems and an equally unacceptable loss of gain. Hence superdirectivity is probably most promising for virtual apertures small in terms of wavelengths. Furthermore, for the postulated correlation to exist at all, it is essential that the wanted signal and unwanted noise sources have wavefields spatially coherent over the full virtual aperture, which can thus be inferred from a limited highly correlated sample within the accessible actual aperture.

It is implicit in these assumptions that a superdirective antenna is very susceptible to any phenomena which produce extraneous uncorrelated effects on the signals from closely-spaced antenna elements. Consequently such systems are very vulnerable to:

- near-field scatterers (acting on the signals received from both wanted and unwanted far-field sources);
- external near-field noise, internal thermal noise, quantization errors, or interference pick-up;
- engineering tolerances, component instabilities, etc.

Similarly, it is susceptible to any changes in a single propagation path—or to multi-path wave-interference effects—which occur in such a manner and at such a rate as to vitiate the assumed correlations within the actual and virtual apertures.

Subject to these reservations, modest degrees of super-

directivity can be of real practical value in external-noise limited situations.

Let us now see how we can translate these ideas from the directional to the frequency domain.

### 5 The Concept of Superselectivity

The conventional antennas or transducer array, with suitably 'weighted' elements at spacings of just under half a wavelength (at the maximum frequency) has its analogue in the transversal filter, i.e. a delay line with suitably weighted tapings spaced by just under half a period. Just as superdirective arrays can be derived from and related to normal arrays, so it must also be possible to derive superselective filters, similarly related to normal transversal filters. Furthermore, there are some quite significant practical problems where signals are only readily accessible during a time window too short to achieve all the desirable selectivity by established filtering techniques. Somewhat surprisingly, however, such superselectivity does not appear to have been considered heretofore.

The preceding Section showed how directional nulls are generated by balancing the difference in time of arrival of a wavefront, at two spatially separated sampling terminals, by the appropriate delay. Analogously, frequency nulls can be generated by balancing the difference in phase of a sinusoidal waveform, at two temporally separated sampling terminals, by the appropriate phase-shift. (If only a single null operation of this type is used, the result is subject to a phase ambiguity by integral multiples of  $2\pi$ . This ambiguity can, however, be eliminated, if necessary, by the parallel connection of two or more of these time/phase filters, generating the same null by different means.) The transfer characteristic of multiple sequential filters is the product of the individual filter characteristics. Hence, multiple coincident nulls in cascade will produce a composite null, with a broadened 'bottom' and steepened sides.

One variant of the basic frequency-null generator, using non-dispersive delay  $\tau$  and phase-shift  $\phi$ , is illustrated in Fig. 2. For 'superselectivity',  $\omega_0 \tau = \phi$ , so as to generate a zero at angular frequency  $\omega_0$ , where  $\phi$  is the fixed phase-shift defined in Fig. 2 and  $\phi < 2\pi$ .

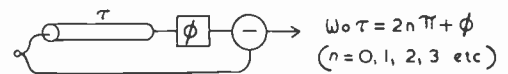

Fig. 2. A frequency-domain null generator.

Thus, analogously to superdirectivity, the null frequency is specified by signals spanning less than the full cyclic period. The correlation of these two signal samples will then reduce the gain achievable in the pass band of the network, and so the system will be rather vulnerable to circuit noise, quantization errors, component tolerances, etc. Furthermore, just as the superdirective antenna presupposes an adequately stable amplitude and phase pattern in its observation space, so the superselective filter postulates a similarly stable amplitude and phase pattern in the pertinent observation



time. Here too, signal/noise considerations and restricted long-term correlation in the waveform makes it difficult to extrapolate from a narrow actual time window, by more than a few wave periods and/or a proportion of its length, to a larger virtual time window. However, subject to these reservations, a cascade of such filters may be used to generate desired band-stop characteristics or, associated with a conventional filter, to sharpen the response of a band-pass system.

**6 Variants of Superselective Null-forming Circuits**

In this Section we shall outline a variety of schemes for achieving superselective null generation in practice, be it in hardware form or by computer algorithms. Both arbitrary phase-shifts and phase shifts of  $\pi$  (by sign inversion) and  $\pi/2$  (by 'differentiation') are considered, and it is shown that a null can readily be generated with a time window little greater than a quarter period of the relevant frequency. This is, of course, contingent on this time window being representative of the generality of the wave-form.

Basic time/phase-shift null generation entails delaying the signal by  $\tau$  where this is equal to one (or more) complete periods of the appropriate frequency, and then subtracting it from the (identical) undelayed signal (see Fig. 3(a)). Unimpaired gain is obtained at frequencies where this delay is an odd number of half periods.

Alternatively, the delay could be restricted to half a period (or an odd number of half periods) of the appropriate frequency. Since this produces an antiphase condition, a null could then be generated by adding the delayed and undelayed signals (see Fig. 3(b)). A delay by one half period would define the signal  $F(t)$  by half the normal time window and thus would be an example of superselectivity. The transfer function of this network (including the ambiguities) is  $2F(t - \tau/2) \cos \omega\tau/2$ , giving a maximum when

$$\omega\tau = 2n\pi$$

and a zero when

$$\omega\tau = (2n + 1)\pi$$

$n$  being zero or any integer.

The foregoing is a special case of matching a time delay (of  $\pi/\omega_0$ ) against a fixed phase shift of  $\pi$  (obtained by sign inversion). Using the superhet principle, any desired positive or negative differential phase-shift can be applied to the local oscillators of the delayed and un-delayed signal, so as to bring the two into phase (or anti-phase) at angular frequency  $\omega_0$ , for null generation (see Fig. 3(c)). Thus the time window can, if desired, be reduced indefinitely (in principle)—at the cost of an appropriately reduced transfer 'gain' at off-null frequencies. This circuit also permits continuous 'steering' of the frequency null by merely adjusting the relative local-oscillator phase.

If it were desired to perform this process in a computer, rather than in a real network, it would not normally be desirable to heterodyne the signal to a much higher carrier frequency, because of the high data-rate entailed. If this constraint is accepted, the only phase changes easily generated directly are those of  $\pi$ , by sign

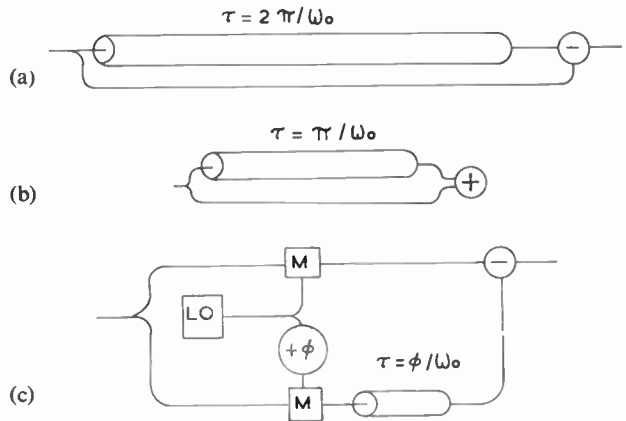

Fig. 3. Generation of frequency nulls by balancing delay against phase change.

reversal as in Fig. 3(b), or of  $\pm\pi/2$ , by 'differentiation'. 'Differentiation' can be accomplished by subtracting from the present signal  $F(t)$  the delayed signal  $F(t - 2\delta)$ . The resultant is then equal to  $2\delta F'(t - \delta)$ , where  $F'(t - \delta)$  is the differential of the signal at the centre-tap of the delay-line. If the signal is sinusoidal, i.e.  $F(t) = \sin \omega t$ , the exact result of the differencing process is

$$2 \frac{\sin \omega\delta}{\omega} \cdot F'(t - \delta) = 2 \sin \omega\delta \cdot \sin(\omega t - \delta + \pi/2)$$

Thus we obtain a signal proportional to that at the centre-tap, but phase-shifted through exactly  $\pi/2$ . The associated 'gain' is less than unity and, for small  $\delta$ , proportional to the frequency. Figure 4(a) shows such a  $\pi/2$  phase-shift circuit, using 'differentiation' (strictly differencing) by the subtraction of signals spaced symmetrically about the—imaginary—centre-tap of the delay-line. Thus  $\tau$  can be made very short in comparison with the period  $2\pi/\omega$ , provided the resulting reduction in 'gain' is accepted.

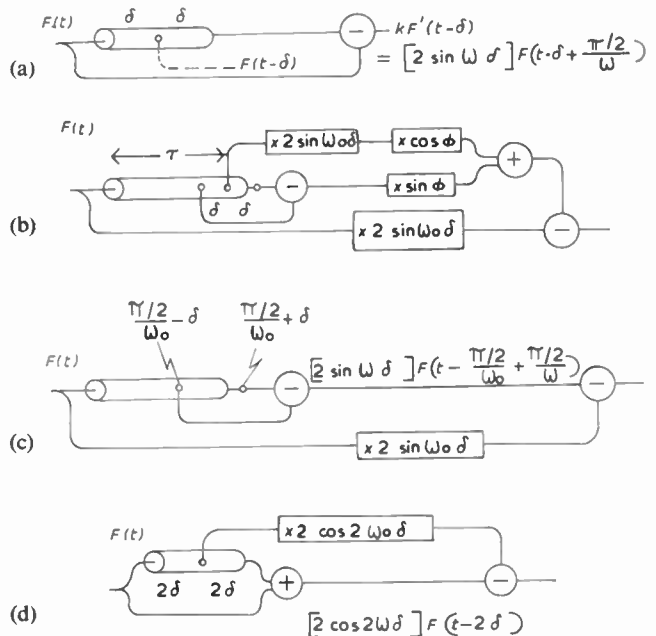

Fig. 4. The use of differentiation in frequency-null generation.

The exact equivalent of the continuously phase-changing circuit of Fig. 3(c) can then be produced, as shown in Fig. 4(b). Here the sine wave from the centre-tap is attenuated externally by the same factor  $2 \sin \omega_0 \delta$  as is the cosine wave (internally) in the process of its generation by the differencing process—and both are delayed by  $\tau$ . Multiplication by  $\cos \phi$  and  $\sin \phi$  respectively (in fixed attenuators), to shift the combined phase by  $\phi$ , produces a sum equal to

$$[2 \sin \omega_0 \delta]F(t - \tau + \phi)$$

This, in turn, is subtracted from  $F(t)$ , similarly scaled down (externally) by the fixed ratio  $2 \sin \omega_0 \delta$ , to generate the required null. (In practice it may be expedient to make  $\tau = \delta$ , so as to save one extra tap on the delay line—and make the fullest use of that line.)

Frequently it will be more expedient to accept the fixed phase change of  $\pi/2$  due to 'differentiation'. We can then generate a null at angular frequency  $\omega_0$  by the use of a delay line with an imaginary 'centre tap' at delay  $\pi/(2\omega_0)$  and real taps differing from this by  $\pm \delta$ . The direct function  $F(t)$ , scaled by the fixed ratio  $2 \sin \omega_0 \delta$  is then subtracted from the result. The operation would use samples spread over a  $1/4$  period plus  $\delta$  (see Fig. 4(c)).

As yet a further alternative, a total phase-shift of  $\pi$  can be generated by double 'differentiation', as shown in Fig. 4(d). Although derivable from two of the circuits in Fig. 4(a) in cascade, it is more readily appreciated as a simple 2nd-difference circuit. Essentially this defines the null frequency  $\omega_0$  by the differential equation  $D^2 = -\omega_0^2$ .† It gives a pass characteristic proportional to  $(\sin^2 \omega \delta - \sin^2 \omega_0 \delta)$ , subject to amplitude scaling by  $4 \sin^2 \omega \delta$ . Since this circuit puts two identical null-generators in cascade, it generates the product of their transfer characteristics and accordingly also changes the cusp into a blunt null, with appropriately steepened 'side-walls'.

A transversal filter specifies a polynomial function by 1st-order equations relating a set of measurements spread over an appropriate period in time. A superselective filter, on the other hand, includes higher-order derivatives, using more closely-spaced observations but no increase in the total number of measurements.

Clearly the 'differentiation' and superselectivity algorithms of Fig. 4 need not be restricted to computer software or hardware, but may equally well be implemented by analogue circuit techniques as has indeed been illustrated in the schematic diagrams.

### 7 Superselective Elements in Composite Filters

The transfer characteristic of the basic superselective circuit, derived in Section 6, comprises a series of deep and sharp nulls, equally spaced along the frequency axis, separated by smooth, semi-sinewave peaks of alternate sign. Thus a superselective 'notch' filter imposes attenuation outside the stop band, and this may be quite acceptable, in many applications. However, the continued variation of this attenuation, as a function

of frequency difference from the null, would often be an embarrassment. It would then be desirable to reduce the gain at any frequency  $f_0 + \delta$  to approximately that at  $f_0 - \delta$ , where  $f_0$  is the frequency of the null, and  $\delta$  is the frequency difference beyond which the gain (i.e. attenuation) is to be levelled off to—approximately—a constant value. This could clearly be achieved with any specified degree of accuracy, by the series-connection of the appropriate succession of further notch filters, designed to reduce the gain to the appropriate minimum at their respective minimum-gain frequencies. These further filters could be basically of the same type as those of Fig. 3 or of Fig. 4(b) and (c). However, in this case, the gain of the two 'branches' of the filter would be unbalanced, so that the subtraction of the two branch signals would reduce the output to the desired minimum, at the appropriate notch frequency, rather than to zero. This generates a gain characteristic as a function of  $\omega$  which is the resultant of a vector of amplitude  $\epsilon$  (where  $\epsilon < 1$ ) and relative phase  $\pi + \phi - \omega\tau$ , adding to a unit vector of absolute phase  $\omega t$ . This process produces a blunt minimum—rather than a sharp cusp-shaped null. Furthermore, as  $\omega\tau$  changes through  $2\pi$ , the rotation of the smaller vector produces a smooth progressive phase-shift through  $2 \sin^{-1} \epsilon$ , in place of the instantaneous phase reversal at the null, which arises in a normal superselective filter (where  $\epsilon = 1$ ) (see Fig. 5).

As already indicated, the amplitude/frequency characteristic of a superselective filter takes the form of a rectified sinusoid with sharp cusps, but it also undergoes a sign reversal at these cusps, and hence is in a more basic sense truly sinusoidal. The following argument demonstrates this fact and shows how it can be exploited to control the shape of the response curve of a composite filter.

The gain characteristic of a simple superselective element is periodic in the frequency plane and of the form

$$\begin{aligned} & \sin [\omega(t - \tau) + \phi] - \sin \omega t \\ &= 2 \cos [\omega(t - \tau/2) + \phi/2] \sin (\phi/2 - \omega\tau/2) \end{aligned}$$

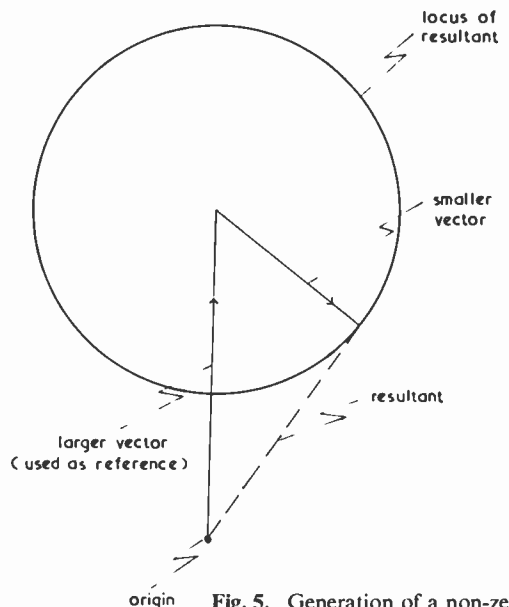

Fig. 5. Generation of a non-zero notch.

† Where  $D$  is the differential operator  $d/dr$ .

where the second factor defines the sinusoidal amplitude response (as a function of the angular frequency  $\omega$ ) and the first the linear phase response. This feature allows a 'square top' pass band to be built up from a 'fundamental' and its odd 'harmonics' (in the gain/frequency plane) by connecting the appropriate superselective filters in parallel. Since this involves scaling up both the phase-shift  $\phi$  and the delay  $\tau$  by the odd factor  $(2n+1)$  (defined by the order of the 'harmonic'), it will increase the observation time by the same factor. (Note the terms 'fundamental' and 'harmonic' here refer to periodicities of the spectral shape along the frequency axis: a higher periodicity implies a smaller frequency increment between nulls.)

For minor improvements to the shape of the pass band, the series insertion of controlled minima is probably most economical. For a more stringent specification, on the other hand, the best answer would probably be based upon the parallel combination of odd harmonic elements, to generate the desired shape of the pass-band by Fourier synthesis. However, it would probably pay to modify these elements by appropriate series minima, and in this case minor departures from the harmonic relationship might also become desirable.

Thus the combination of such filter elements can rather conveniently generate a 'periodic' pattern of sharp nulls, separated by flat pass-bands along the frequency axis. This could well be of value, either by itself or to enhance the characteristics of conventional filters of relatively low  $Q$ . Alternatively, however, we may place two or more identical superselective filter-systems in cascade, so as to produce flattened—but rounded—nulls. If we then further cascade several such arrays, with appropriately staggered nulls, we can generate a broad flat null by entirely superselective techniques. In fact the flattened null due to two identical superselective operations in cascade is sinusoidal, hence several such doublets can be combined, using Fourier synthesis, to form a stop-band of (more or less) any desired shape.

The finite spacing to the next, ambiguous null could evidently be a further undesirable feature of superselective filters in some applications. However, with the circuit of Figs. 3(c) or 4(b), the ratio of the frequency difference between the nulls,  $\Delta f$ , to the frequency of the first null,  $f_0$ , is

$$\Delta f/f_0 = 2\pi/\phi$$

Clearly this can be made as large as desired, provided  $\phi$ —and hence the 'gain' of the filter—are made sufficiently small. The relatively high pass-band attenuation encourages the use of superselectivity in conjunction with series amplifiers—or in negative feedback circuits so as to convert nulls into peaks (see below). If a pre-amplifier is used, which has enough gain both to make up for the filter losses at the wanted frequencies and to raise the signal above the thermal noise level, the sensitivity of a superselective system will be limited only by the sum of *in-band* external noise and *in-band* amplifier noise referred to the input terminal. The signal and external noise are of course equally affected by the transfer characteristics of the filter (including its *in-band* atten-

uation). The most far-reaching limitation of the basic superselectivity principle is its restriction to generating stop bands but not pass bands: 'all-zero' filters with no 'poles'. In a computer program or a suitable active circuit, this restriction can be circumvented by making the gain

$$G = 1/\{\varepsilon + |\sin(\omega\tau/2 - \phi/2)|\}$$

where  $\varepsilon$  can be made arbitrarily small. The modulus of the sine function may be required (as shown), since the sine changes sign at the origin, which could cause instability in an active feed-back circuit. Alternatively a blunt, double-coincident null could however be generated. Since that type of filter avoids the sign change, it could be inserted in the feedback path of an operational amplifier of gain  $A = 1/\varepsilon$ , thus giving

$$G = 1/\{\varepsilon + \sin^2(\omega\tau/2 - \phi/2)\}$$

### 8 The Relation between Conventional and Superselective Filters

In order to appreciate the distinctive features of superselectivity, so as to see its role *vis-à-vis* established filter techniques, this section examines some of the basic differences between various types of conventional filter, and between them and the superselective frequency-null generator.

Highly frequency-selective devices involve 'poles' or 'zeros' in their transfer characteristics. In conventional resonant circuits these zeros in the denominator or numerator of the characteristic arise from equal but opposite signals in components of equal but opposite reactance. Commonly this produces then an interchange of energy between these components, with only minimal dissipation or external input or output. This is different from the bridge-type frequency selector or the superselective circuit, both of which depend on the *comparison* of two signals of equal magnitude (but not necessarily equal power)—without any energy exchange between the two branches. (A number of bridge-type circuits in cascade produce a lattice filter, and this can then similarly generate zeros—but not poles—without the use of resonance effects.)

There are also basic differences between the time-weighting of the input signals in

- the conventional resonant circuit,
- the 'gated' resonator,
- the transversal (tapped delay-line) filter,
- and the superselective filter.

These differences, and their implications, are discussed more fully below.

Reference 10 shows that, for the best definition of frequency, a time window should have symmetrical V-shaped weighting, with maximum weight at the two extremities and zero in the middle. Superselective filters, balancing the signals from opposite ends of a delay line against each other, meet this requirement. A normally-selective transversal filter can also have its delay-line tappings weighted in accordance with this rule. On the other hand, non-superselective transversal filters are frequently operated recursively (adding a slightly



attenuated replica of their output to the input), to enlarge their effective time window. In this mode, their 'weighting' over the resultant enlarged time window will have an exponential envelope. A conventional resonant circuit, used for frequency-selective acceptance or rejection, has similarly a time-dependent weighting of

$$\exp(-f_0 t/Q)$$

where  $f_0$  is the resonant frequency,

$t$  is the time by which the given sample preceded the present

and  $Q$  is the 'quality' of the resonant circuit, i.e. its ratio of reactive to resistive 'power'.

Such a circuit has a bandwidth of  $f_0/Q$ . It will take rather over  $Q$  cycles of steady excitation to approach the steady-state condition where, in each cycle, it dissipates as much energy as it receives from the source, and stores  $Q$  times that energy. Its equivalent time window may be defined as  $Q/f_0$  seconds, but the non-optimum exponential weighting implies that it uses time in a relatively inefficient manner.

If a high- $Q$  resonator is fed with energy at a steady rate for a precise time-interval  $T$ , where  $T \ll Q/f_0$ , signal energy at the resonant frequency  $f_0$  builds up linearly and coherently during time  $T$ , thus giving uniform 'weighting'. If, however, the frequency is  $f_0 + \delta$ , the vector defining the signal flowing into the integrator will suffer a progressive phase change at the rate  $d\phi/dt = 2\pi\delta$ , producing a total phase change  $2\pi\delta T$  in time  $T$ . Thus, if  $\delta T$  is any (positive or negative) integer, each phase of signal flowing into the integrator within time  $T$  will be matched by an identical antiphase component within the same integration time-frame, and hence the signal at the end of time  $T$  will be zero. (More generally the relative response will be  $(\sin 2\pi\delta T)/2\pi\delta T$ ). Thus nulls are generated for all integral numbers of cycles of frequency difference within the selected time window, concurrently with generating the wanted frequency peak. (This principle is used, e.g. in the Collins 'Kineplex' system and in the 'Piccolo' system developed for the British Foreign Office.)

A common example of non-resonant null generation is the Wien Bridge shown in Fig. 6. In this case zero output is obtained at frequency  $f_0$ , where  $2\pi f_0 C = 1/R$ , the output being then the difference between two identical voltages, but some attenuation is also experienced at all other frequencies. Steady-state conditions are built up, in the Wien Bridge network, in about  $1/2f_0$  seconds and, as with any other filter, unless the initial build-up can be 'gated' out, it needs a minimum observation time substantially in excess of the response build-up time.

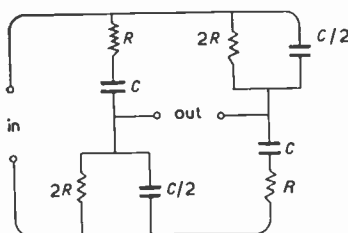

Fig. 6. The Wien bridge.

The delay/phase-shift superselective network is in many respects similar to a Wien Bridge, with two important exceptions:

- (a) the response time can be reduced (in theory indefinitely) at the expense of a consequent reduction in the transfer efficiency at non-null frequencies;
- (b) the nulls (as already pointed out) are subject to ambiguities of any additional integral number of cycles in the delay time.

This ambiguity might be put to good use, in appropriate applications, e.g. to use a single filter to combat interference from (or with) a whole spectrum of equally-spaced communications channels. The same applies to the high- $Q$  time-gated integrator above, or to appropriate transversal filters.

The time window required for a superselective filter must clearly be significantly greater than the maximum differential delay between inputs to the final combining unit. However, Figs. 3(b) and 4(c) show how this differential delay can be made half a period or a little over a quarter period respectively, and with the circuits of Figs. 3(c) and 4(b) and (d) it can be made even less. Hence superselectivity is likely to be of particular value on those—relatively infrequent—occasions when the scope for more orthodox frequency-selective processing is limited by the restricted duration of the relevant signals.

### 9 Multiplexed Use of Superdirectively Weighted Apertures or Superselectively Weighted Time Windows

A virtual time window of  $N$  independent samples—or a virtual aperture of  $N$  independent elements—can be matched to the phase slope in time—or space—so as to 'tune' it to  $N$  independent frequencies—or directions. In this section it will be shown that this process applies equally when the samples—or elements—are packed at 'super-close' spacing. A common prior superselective—or superdirective—combining process can then be arranged to feed all  $N$  filters—or beams.

In a linear antenna array, a set of delays or phase changers may be so arranged that a plane wavefront, arriving from any given direction  $\theta$ , will emerge co-phasally from the leads of all the antenna elements. This output will then be indistinguishable from that due to a plane-wave impinging normally on the array. Hence its directional response pattern will also benefit from any subsequent superdirective processing matched to a normally incident (broadside-on) signal.

Superdirective beam forming, as shown in Fig. 1, can be re-arranged so as to use an independent network for each antenna element, where each such network comprises a tapped delay-line, whose outputs are combined via appropriate weightings and sign changes. The outputs of these single-element 'superdirective' modifiers can then finally be combined in a beam-forming bus bar. If it is required to slew the beam to the right or left, the appropriate beam-tilting phase-shift or delay for each



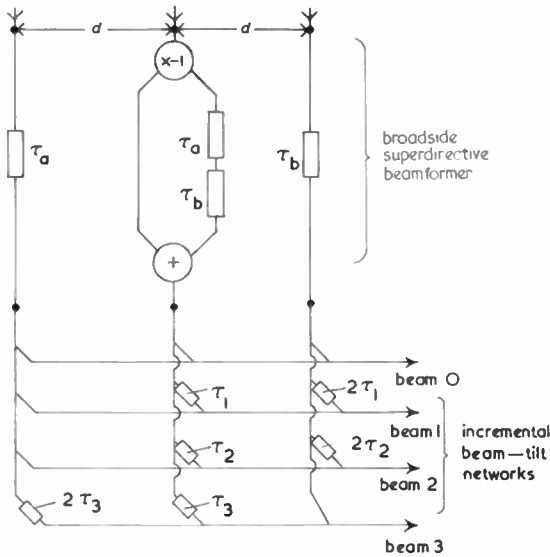

- beam 0 : broadside-on
  - beam 1 : at  $\theta = \sin^{-1} + \tau_1 c/d$
  - beam 2 : at  $\theta = \sin^{-1} + \tau_2 c/d$
  - beam 3 : at  $\theta = \sin^{-1} - \tau_3 c/d$
  - null b at  $\sin^{-1} - \tau_b/cd$
  - null a at  $\sin^{-1} - \tau_a/cd$
- } from beam axes

Fig. 7. Multiplexed use of superdirective antenna weighting network.

antenna element and the superselectivity modifier network for that element can then be connected in series, in either order. However, putting the superselective modifier first, would allow its output to be multiplexed onto several parallel beam-tilt elements (see Fig. 7). Thus a single superdirective system for the antenna array can supply a whole group of beam-tilt networks and combiners, and so it can give the benefit of its beam sharpening to a number of beams 'looking' in different directions. Clearly these multiple beams could equally well be formed by computation, e.g. by performing a Discrete Fourier Transform (D.F.T.) on the outputs from the set of antenna leads. Thus a software D.F.T. can have the benefit of a common prior (hardware or software) superdirective processing stage, applied to the elements of the array—and normally matched to the broadside-on direction.

Analogous arguments apply to a superselective system. Here a single tapped delay line will provide a set of signal samples spaced across the desired time window. These may then be modified in amplitude and phase (including sign) so that their addition would provide the desired superselective filter characteristics at the selected centre frequency. A prior frequency changer will make this filter available to any other selected frequency. The filter delays will then be experienced after transformation and hence will still be at the design frequency of the network. The equivalent result can be achieved for multiple parallel filters, e.g. by applying delays to the local oscillator feeds following a common superselective network, as shown in Fig. 8.

Once again, the formation of the multiple frequency outputs can be achieved by D.F.T. in a computer if

desired, and the prior superselective weighting of the time window can similarly be done by 'software'. The author's colleague, Dr. R. Hamer, has used this software approach: he evolved a time-window weighting function combining one pair of symmetrical superselective sign reversals with an amplitude taper to give a 30% reduction of lobe width without increase in side lobes, and used this to provide the inputs to a D.F.T. to generate a set of tone filters.

### 10 Relations between Superselectivity and Superdirectivity

The similarities between superdirectivity and superselectivity have been a pervasive feature throughout the preceding sections. It may therefore be instructive to collate some of the features pertaining to superselectivity and their equivalent in superdirectivity (where it exists), in order to illuminate their analogies and some important differences. This is done in Table 2.

### 11 Concluding Remarks—Further Work

The paper has discussed the theoretical basis for extrapolating a limited observed segment of a wavefield or waveform, and indicated the minimum conditions to be met. It has outlined possible ways of implementing the principle, concentrating on the new phenomenon of superselectivity. The feasibility and utility—in appropriate circumstances—of modest degrees of wideband superdirectivity is probably not sufficiently appreciated,

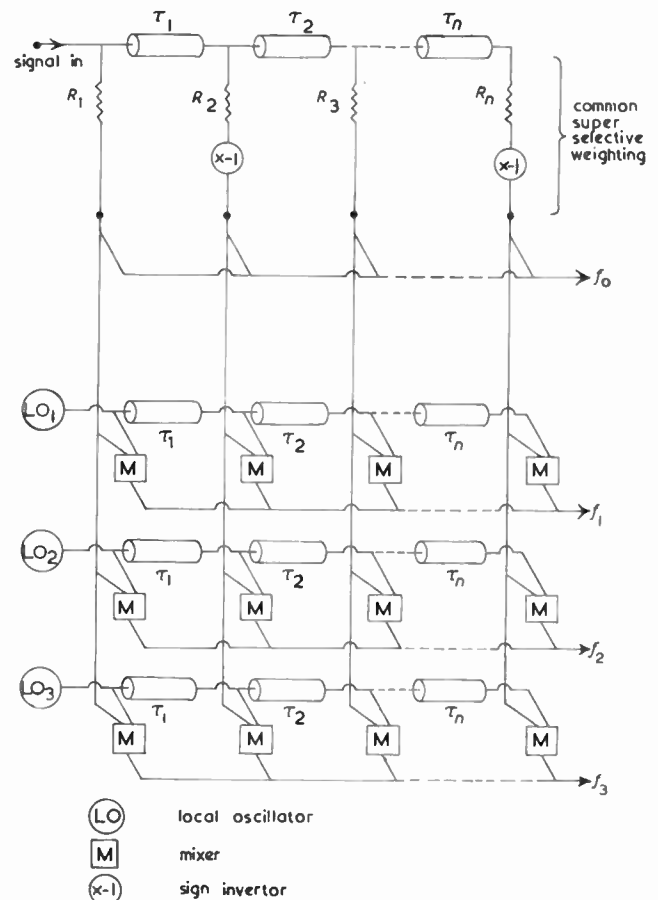

Fig. 8. Multiplexed use of superselective network.

**Table 2**  
Relationships between superselectivity and superdirectivity

Superselectivity	Superdirectivity
Time 'window' (in periods)	Space aperture (in wavelengths)
Time samples	Space elements
Frequency and fractional bandwidth	Direction (strictly sine of direction) and beamwidth
Spot frequency of null determined in terms of periodic time	Line bearing of null determined in terms of $\sin \theta$
Ambiguity by integral number of periods	No directional ambiguity within design frequency range
Mainly effective for time windows of few periods	Mainly effective for apertures of few wavelengths
Relevant when available time window is limited and signal/noise is good	Relevant when available aperture is limited and signal/noise is good
Requires continuity of waveform characteristics beyond time window	Requires continuity of wave field characteristics beyond antenna aperture
One preamplifier can cover full time-window and, if wideband, full frequency spectrum	No equivalent single-device pre-amplifying surface to reinforce wavefront prior to signal extraction and processing
Ideally improves discrimination against off-frequency noise almost unconditionally (when using pre-amplification)	Improves discrimination against directionally distinct external noise subject to limit set by internal and nearfield noise
Rather sensitive to tolerances	Very sensitive to tolerances
Requires a set of at least $M$ time samples for $M - 1$ independent frequency nulls (each subject to ambiguity, see above)	Requires at least $M$ space samples for $M - 1$ independent directional nulls
Each null circuit branches out from one input and converges onto one output	Null number $N$ combines $(N + 1)$ inputs into $N$ outputs
Hence $N$ nulls can be formed in a simple series cascade of $N$ circuits	Hence $N$ nulls require a "triangular" array of $(N + 1)N/2$ combiners with $N + 1$ parallel inputs
For a given sensitivity, the minimum length of the time window is proportional to the number of independent nulls specified	For a given sensitivity, the minimum space window is proportional to number of independent nulls specified

but has, in fact been fully established. (There is, however, room for further development and exploitation). For superselectivity, on the other hand, there is both need and scope for substantial further work on dove-tailing the principle with other forms of frequency analysis or filtering, before its utility can be properly assessed.

Analogously to superdirectivity—increasing the angular resolution of a given aperture—or superselectivity—increasing the frequency resolution of a given time 'window'—it should be possible to develop 'supertiming', i.e. sharpening of the time resolution for a given bandwidth. This possibility, and its potential applications—if any—has not yet been actively considered, as far as the author knows.

Subsequently to this work the author has become aware of the theoretical work on the 'maximum-entropy' method.<sup>11</sup> This computes the spectrum (or angular pattern) that best accounts for all the observable features of the received signal, with the minimum of needless assumptions on its nature, both inside and outside the space actually observed. Hence it may be regarded as the theoretical optimum. This technique has been applied very effectively by some of the authors' colleagues to both frequency and directional analysis. The 'maximum entropy' method is however computationally rather laborious, and not normally suitable for on-line use. Hence any simple but still effective approximations to that method might prove very useful. Adaptive superselective frequency or spectrum analysis might go some way towards meeting this need. For both techniques Section 3 will indicate what aperture (or window) expansion factor to use.

## 12 References

Relevant papers, not all specifically referred to in the text, include:

- Hansen, W. W. and Woodyard, J. R., 'A new principle in directional antenna design', *Proc. Inst. Radio Engrs*, **26**, pp. 333-45, 1938.
- Woodward, P. M. and Lawson, J. D., 'The theoretical precision with which an arbitrary radiation pattern may be obtained from a source of finite size', *J. Instn. Elect. Engrs*, **95**, Part 111, No. 37, pp. 363-70, 1948.
- Davies, D. E. N., 'Independent steering of each zero of the directional pattern for a linear array', *Trans. IEEE on Antennas and Propagation*, AP-15, No. 2, pp. 296-8, 1967.
- Davies, D. E. N. and Longstaff, I. D., 'Some new studies of angular resolution for linear arrays', *The Radio and Electronic Engineer*, **32**, No. 6, pp. 341-50, 1966.
- Moxon, L. A., 'Supergain aerials', *Radio Communication*, **48**, No. 9, pp. 589-90, 1972.
- Haseler, J. B. and Gething, P. J. D., 'Linear arrays with broadened nulls', *Proc. Instn. Elect. Engrs*, **121**, No. 3, pp. 165-8, 1974.
- Tucker, D. G., 'Superdirective arrays: the use of decoupling between elements to ease design and increase bandwidth', *The Radio and Electronic Engineer*, **34**, No. 4, pp. 251-5, 1967.
- Anderson, A. P., Davies, W. S., Dawood, M. M. and Galanakis, D. E., 'Note on transistor-fed active array antennas', *IEEE Trans. on Antennas and Propagation*, AP-19, pp. 537-9, 1971.
- Benjamin, R., 'On the use of delays for wide-band superdirective beam-forming in endfire and broadside arrays', *The Radio and Electronic Engineer*, **45**, No. 9, pp. 451-61, 1973.
- Benjamin, R., 'The physical basis of signal theory', *The Radio and Electronic Engineer*, **47**, No. 1/2, pp. 49-58, 1977.
- Burg, J. P., 'Maximum entropy spectral analysis', Paper presented at the 37th Annual International Meeting, Soc. of Explor. Geophys., Oklahoma City, Okla., 31st October 1967.
- Redgment, P. G., 'Superdirective arrays', *The Radio and Electronic Engineer*, **36**, No. 1, p. 33, July 1968 (Letter).
- Tucker, D. G., 'The signal/noise performance of electroacoustic strip arrays', *Acustica*, **8**, No. 1, pp. 54-62, 1958.
- Tucker, D. G., 'Signal/noise performance of superdirective arrays', *Acustica*, **8**, No. 2, pp. 112-6, 1958.

Manuscript first received by the Institution on 17th December 1975 and in final form on 7th June 1976. (Paper No. 1758/Com. 142.)

# IERE News and Commentary

## CEI Examination Entries for Next Year

Any Institution member who intends to attempt any part of the CEI Exemption or the Part 2 Academic Test in May 1978 should note that the entry procedure will be different from that used in previous years. Entry forms will continue to be obtainable from the Institutions, but when completed, they must be returned *directly to CEI*, together with a remittance for the fees or a receipt for their deposit at a local bank for onward transmission. Because of the new arrangement, it will no longer be possible for Colleges to issue entry forms to their students: each entry form will be issued to a named individual only and computer-coded by the issuing Institution with the information needed to enable CEI to verify that the entry complies with any special Institution requirements as well as its own.

The closing dates for receipt of entries will be 15th November 1977 for candidates sitting at centres outside the British Isles, and 15th January 1978 for those sitting at British Isles Centres. Because of the need to enter computer codes on entry forms before despatching them to candidates, it will be necessary to allow the Institution a little more time for handling than has previously been required. We therefore recommend that applications for entry forms should be sent not later than mid-September in cases where the closing date for receipt is 15th November 1977, and not later than the end of November 1977 in cases where the closing date is 15th January 1978. Any candidate who is in doubt about any matter connected with examination entries should write at once to the Institution's Education Department for advice.

## Nominations for 1977 John Smeaton Medal

The Council of Engineering Institutions is now inviting nominations for the 1977 John Smeaton Medal. The award was founded in 1974 by CEI in conjunction with the Smeatonian Society of Civil Engineers to mark the 250th anniversary of the birth (in 1724) of the eminent engineer John Smeaton.

Awarded for 'an outstanding achievement in engineering in the widest sense and not restricted as to discipline', the medal is intended to go to an engineer whose achievement as an individual can be recognized primarily by engineers and by the general public if possible.

The first award was made to Mr. Geoffrey Binnie, consultant to Binnie and Partners, the London consulting engineers, for his outstanding work on dams and irrigation. The 1975 medal was awarded to Sir Stanley Hooker, Technical Director of Rolls-Royce (1971) Limited in recognition of his distinguished work in aviation engineering, particularly in the design and development of aviation gas turbines. No award was made in 1976.

Nominations for the 1977 John Smeaton Medal, together with a citation, should be addressed to the Secretary, Council of Engineering Institutions, 2 Little Smith Street, London, SW1P 3DL, marked 'Confidential', and should reach CEI by *31st May, 1977*. Enquiries should be addressed to Mr. R. Mason at the same address, telephone number: 01-799 3912.

## CEI Secretaries Committee

At the January meeting of the Standing Committee of Secretaries of CEI Constituent Members a presentation was made to Mr. Graham Clifford to mark his retirement from the Secretaryship of the IERE and therefore from the Committee. Mr. Clifford was the first Chairman of the Secretaries Committee which was set up in 1968 and provides a forum for agreeing the details of broad decisions reached by the Council.

## New Zealand Division

At the recent Annual General Meeting of the New Zealand Division of the Institution, Mr. J. P. Conyers-Brown (Member) was appointed chairman in succession to Mr. G. C. Mowat (Fellow), who had served in that capacity for the past two years. Mr. Conyers-Brown is managing director of Cepak Automation, Wellington.

## Graduate Members and the CEI Part 2 Academic Test

This notice is of direct concern only to those persons who were admitted to GRADUATE membership of the Institution before 1st January 1974 and who have not since transferred to Corporate Membership. Members of all classes can, however, assist in making it effective by drawing it to the attention of any Graduate member to whom they believe it may apply.

Since 1st January 1974, applicants for Corporate Membership have been required to hold an engineering qualification of at least UK first degree standard. There are still a substantial number of Graduates admitted *before* that date whose qualifications were not of that standard and who cannot therefore be transferred to Corporate Membership without further examination. The CEI Part 2 Academic Test (2 papers from Part 2 of the CEI examination) was established as a qualifying means for persons in this position, but *it will be phased out after 1979*.

There are therefore only two more chances for those who need to do so to make the first of the two attempts allowed—namely in May 1978 and May 1979. Entry forms from candidates sitting outside the British Isles must be received by 15th November preceding the examination; those from candidates sitting in the British Isles must be received by 15th January of the examination year. Graduate members admitted before 1974 who know they are required to take the Test should therefore note these dates and apply for entry forms in good time: any who are uncertain whether they need to take it should consult the Institution without delay.



## CEI Opposes Government Inquiry on Engineering Profession

In a letter to Mr. Eric Varley, the Secretary of State for Industry, CEI's Chairman, Sir Charles Pringle, has reiterated the Council's view that a Government inquiry into the engineering profession 'is neither necessary nor desirable.' The letter, dated 8th February, follows reports that such an inquiry was being considered by the Government.

'Indeed', says Sir Charles's letter, 'the very subjects which any general inquiry are likely to study—education, training, qualification and registration of engineers—are matters on which my Council is already making considerable progress. Moreover, the revised organization of the Council has now been agreed without dissent amongst its members and will lead to greater cohesion of the profession as well as widening very significantly the opportunity for suitably qualified candidates to become chartered engineers.'

After pointing out that the Council's Supplementary Charter and By-laws giving effect to the reorganization were now being considered by the Privy Council, Sir Charles referred to the study currently in hand by the British Association—in which both CEI and the Department of Industry are involved—into the education, recruitment and deployment of engineers for manufacturing industry.

'Accordingly', continues Sir Charles, 'I thought it might be useful for me to confirm to you that the view of this Council on the need for an inquiry into the engineering profession has not changed. We still believe any such inquiry to be unnecessary and a wasteful use of resources in the light of the action already well in hand—action which will undoubtedly be delayed whilst awaiting the outcome of any Government inquiry.'

'Nevertheless', he concludes, 'this Council would give every help and assistance should any form of Government or public inquiry be held despite our opinion that such an inquiry can only lead to a further period of uncertainty just as the profession is achieving a new unity and a new stability.'

The views expressed by the Chairman were strongly endorsed by the Executive Committee of CEI at its meeting of 10th February. CEI has action already in hand to look into those areas which it has been suggested might be the subject of any public inquiry, and is considering whether any further action might be advisable to strengthen the profession. For example, there are many areas of public interest and concern where some form of registration of engineers or a form of licence to practice could be advisable. This subject is under active examination in consultation with the Council's member Institutions.

## APPOINTMENT OF NEW SECRETARY OF THE IERE

Mr. Graham D. Clifford, C.M.G., C.Eng., F.I.E.R.E., F.C.I.S., retires as Secretary of the Institution on 31st March 1977. As announced at the Annual General Meeting, the Council has appointed Air Vice-Marshal Sinclair M. Davidson, C.B.E., C.Eng., F.I.E.R.E., F.R.Ae.S., RAF, as Secretary. Mr. Clifford will continue as Director of the Institution with special responsibilities for a further year.

First appointed as Honorary Secretary of the then British Institution of Radio Engineers in March 1937, Mr. Clifford shortly afterwards was appointed its first full-time Secretary; he will thus have completed over 40 years of service when he retires, a record probably unmatched in any other similar body.

Air Vice-Marshal Sinclair Davidson, at present Assistant Chief of Defence Staff (Signals) at the Ministry of Defence, will retire prematurely from the Royal Air Force in order to take up his appointment as Secretary of the Institution on 1st April 1977.

Since he qualified for membership in 1951 (elected Fellow in 1971), Air Vice-Marshal Davidson has been active in Institution affairs and has served on several Standing and Specialized Group Committees, including the Aerospace, Maritime and Military Systems Group Committee, the Management Techniques Group Committee and the Education and Training Committee. He has also served on the Executive Committee and on the Council, and was elected a Vice-President in 1973/74 and in 1976. In addition, Air Vice-Marshal Davidson is the Institution member on a Council of Engineering Institutions Standing Committee and he has represented the Ministry of Defence on the National Electronics Council.

The Air Vice-Marshal's distinguished career in the Royal Air Force commenced in 1939, as a boy entrant. During the war years, he served as aircrew in Coastal Command and he was commissioned in 1942. From the end of hostilities until 1949 he served in Air Staff and aircrew instructor posts as a Signals/Radar Leader and then transferred to the Technical (Signals) branch of the RAF and after further engineer training graduated from the RAF Technical College in 1950.



Since 1950 he has held a wide range of signals and electrical engineer staff appointments in the UK and in the Middle East. After graduating from the Imperial Defence College he was promoted to Air Commodore in January 1969 and was appointed Director of Signals (Air) at the Ministry of Defence. He was the Air Officer Wales and Station Commander RAF St. Athan before being promoted to Air Vice-Marshal in November 1974, when he took up his position as Assistant Chief of Defence Staff (Signals). He was appointed C.B.E. in 1968.



## Queen's Silver Jubilee Award

The Council has instituted a new Award which will commemorate the Silver Jubilee of Her Majesty Queen Elizabeth II. It will be given for an outstanding innovation or development in electronic engineering which has resulted in profitable production.

The Award, which will take the form of a silver plaque and an illuminated citation, will be restricted to United Kingdom and Commonwealth individuals or organizations.

Members of the Institution are invited by the Council to apply on their own account or to make recommendations of individuals or organizations for the Award. Such nominations should be accompanied by a brief description of the work which is being put forward for consideration. Please send nominations by not later than 31st May 1977 to the Institution, marked for the attention of the Secretary of the Silver Jubilee Award Committee (Mr F. W. Sharp), from whom further details may be obtained. It is intended to make the announcement of the first Award at the Annual General Meeting on 5th October 1977.

## CEI Chairman and Vice-Chairman for 1977/78

The Board of the Council of Engineering Institutions elected Air Marshal Sir Charles Pringle as Chairman and Sir John Atwell as Vice-Chairman for 1977/78. They took office immediately after the meeting of 20th January.

Sir Charles Pringle, K.B.E., M.A., C.Eng., F.R.Ae.S., RAF (Ret.), who succeeds Mr. Tony Dummett as Chairman, retired from the Royal Air Force in 1976, taking up an executive appointment with Rolls-Royce (1971) Limited, he is also a non-executive director of Hunting Engineering Limited. His last Services appointment was Controller of Engineering and Supply (RAF). Sir Charles was President of the Royal Aeronautical Society in 1975/76.

Sir John Atwell, C.B.E., B.Sc., M.Sc., C.Eng., F.I.Mech.E., F.R.S.E., lately Chairman of the Engineering Division of the Weir Group, was President of the Institution of Mechanical Engineers in 1973/74. From 1972 to 1976 Sir John was Chairman of the Requirements Board for Mechanical Engineering and Machine Tools of the Department of Industry, and since 1975 has been Chairman of Court of the University of Strathclyde. He has recently been appointed to the Government's new Advisory Council for Applied Research and Development.

## 1979 World Administrative Radio Conference

A widening of the area of consultation in preparation for the 1979 World Administrative Radio Conference in Geneva—the results of which will govern the allocation of radio frequencies to particular services for the rest of this century—was announced in the House of Commons on 26th January by the Home Secretary, the Rt. Hon. Merlyn Rees, M.P.

In a written reply to Mr. Phillip Whitehead, M.P. (Derby North), Mr. Rees said that although a substantial measure of consultation with users and manufacturers of radio equipment had already taken place, a wider programme of consultation was desirable before the United Kingdom's proposals for the conference were formulated. 'Inevitably there will be conflicts between the claims of different services', said the Home Secretary. 'Significant decisions will have to be made about economic and social priorities; large scale investment plans will be affected.'

Mr. Rees added that comments from all interested bodies and members of the public should be sent to the Home Office Radio Regulatory Department, Waterloo Bridge House, Waterloo Road, London SE1 8UA, by 30th April 1977.

The 1979 International Telecommunication Union Conference in Geneva will be the first of its kind for 20 years; it will have the power to revise the International Radio Regulations, including those governing the allocation of frequency wavebands for all users of radio. With the rapidly growing demand for radio services the frequency spectrum is now a scarce resource, and major changes in the allocations of frequencies could either mean increased market opportunities for the industry or a considerable rise in costs for Britain's radio users.

## OCEANOLOGY INTERNATIONAL 78:

### Conference on Offshore Instrumentation and Communications

A one-day international conference highlighting the role of electrical and electronic engineers in the important exploitation of offshore oil, gas and mineral resources is being sponsored next year by the IEE with the association of the IERE and to be held on 9th March 1978. This will be one of 13 conferences organized by the major engineering and marine institutions in the UK and held during the week 6th to 10th March, to coincide with the large triennial exhibition of Ocean Technology at Brighton organized by BPS Exhibitions Ltd.

Papers are invited on the following areas of interest:

#### Radio Communications and Underwater Communications

Communications may include data, voice or control signals to and from shore, platforms, mobiles and sub-surface units.

#### Offshore Metering and Production Control

The requirements for high reliability metering and unattended control in the hostile marine environment presents new challenges as offshore production steps up.

#### Underwater Inspection and Intruder Detection

Routine inspection of underwater engineering complexes can be aided by optical or acoustic imaging systems, whilst security of structures may include provision for automatic monitoring of intrusion.

#### Navigation, Search and Positioning

Surface and underwater navigation is important in exploration and exploitation phases and positioning critical in site work.

#### The Measurement and Applications of Environmental Data

Winds, temperature, waves and currents may limit site operations whilst the long-term statistics of such environmental parameters are needed for structural design work. There are thus requirements of offshore data acquisition instrumentation and for real time as well as statistically reduced data.

Papers of up to 4000 words should be original, but as exploitation of resources is now underway, special consideration will be given to review papers which summarize positions reached in the above topics, particularly emphasizing operational experiences to date with installed systems. Papers which address the problems of extending techniques into deeper waters and to further offshore will be welcomed.

Preliminary titles of proposed papers should be submitted now to the Secretariat at the address given below. Final synopses of not more than 250 words are required by 1st July 1977. Authors of accepted papers will be informed in July and final texts will be required by 1st October 1977.

Address for all communications associated with this sub-conference is: 'Offshore Instrumentation and Communications', Divisional Activities Department, The Institution of Electrical Engineers, Savoy Place, London WC2R 0BL.

# NEC See Post Office Telecommunications Research

The National Electronics Council has, as its main purpose, to review and make recommendation upon the social impact (in the broadest sense) of electronics on the national life. The Council comprises representatives from the highest level of government, both sides of industry and universities as well as members with wider interests.

One of the Council's recent practices, and one for which it is to be commended, is to hold its meetings at locations where there are developments in electronics of interest to members and which are visited before and after the formal business. Thus meetings have been held at the Independent Broadcasting Authority's Engineering Headquarters near Winchester, at the National Physical Laboratory, Teddington and, more recently, at the Post Office Research Centre, Martlesham Heath.

The Post Office Research Centre, which was officially opened by H.M. The Queen, just a year ago replaces the Laboratories at Dollis Hill which were opened about 50 years ago. The move to the former Suffolk RAF airfield which started in 1968, is now approaching completion. The Research Centre's function is to carry out applied research into device materials and techniques, system research and advanced development related to projects selected to meet the needs of operational unit of the Post Office. It thus covers a wide range of activities which change in level and in their interaction with each other.

During their visit, NEC members saw four main areas of research: optical fibre transmission systems, millimetric waveguide field trials, the Pathfinder experimental stored program control exchange, and semiconductor component reliability.

## Optical Fibre Transmission Systems

Equipment is now being assembled at Martlesham for a feasibility trial system to operate at 8 Mbit/s over fibre cable to be laid in duct between the Research Centre and the Telephone Exchange at Kesgrave, about 5 km distance. This system will be extended a further 7 km to Ipswich Telephone Exchange by the end of 1977. The essential attraction of systems of this type is for junction applications between telephone exchanges. A future additional cable soon to be delivered will be suitable for 140 Mbit/s transmission over several kilometres.

The transmission of television by direct amplitude modulation of a light emitting diode coupled to an optical fibre was also demonstrated over short lengths of fibre. Analysis of the system performance indicates, in agreement with a recent analysis by the Siemens Company in Germany, that transmission up to a distance of about 4 km should be practicable with this system. The Siemens analysis showed, however, that up to about 8 km or more could be reached for single-hop systems if analogue pulse position modulation is used in conjunction with a laser sender and an avalanche photodiode receiver. The basic attraction for fibre systems against conventional systems in these applications arises from the combination of longer repeater spacings (or longer distances between send and receive terminals for single-hop systems) and much smaller usage of duct space.

## Millimetric Waveguide Field Trial

A comprehensive UK programme of research and development on guided millimetric waveguide systems is being co-ordinated and predominantly funded by the Post Office

Research Department, with the overall objective of paying the way for the early availability of operational systems. The primary task was to set up a full scale PO/industry field trial of a waveguide system over a 14 km route between Martlesham and Wickham Market in Suffolk and this was completed by the autumn of 1975.

The waveguide, a precision 50 mm diameter helix of fine copper wire set within a lossy resin impregnated glass fibre tube, produced in 3 m lengths, was jointed and laid in a welded steel duct. The waveguide and the duct are pressurized with dry nitrogen and dry air respectively.

The 50 mm helix waveguide now being produced has a typical basic attenuation of less than 2 dB/km within the frequency range 40 to almost 100 GHz, and less than 3 dB/km from 32 to about 110 GHz has been split into five bands, 32-40, 41-49, 52-68, 72-88 and 90-110 GHz. Each of these broadbands is subdivided into 16 channels of 500 MHz width.

Using relatively simple filters and 4-phase modulation each channel can provide a digital capacity of about 400 Mbit/s. This means that such a system has an inherent capability for the transmission of about 32 Gbit/s each way, which is equivalent of more than 400,000 telephone circuits.

There is now no doubt about the technical feasibility of satisfactory waveguide systems, but the extent to which they come into operational use is largely a matter of economics. However, the latest capital cost studies are sufficiently encouraging to suggest that high-capacity waveguides could have a significant role to play in the trunk network based on telephone growth alone; in addition they offer possibilities for the economic provision of a range of new visual telecommunication services, including Confravision.

## Pathfinder Experimental SPC Exchange

An experimental exchange using stored program control is serving about 100 staff at the Research Centre. Although very small, the exchange has been designed so that up to 2000 customers can be connected and will provide, as a minimum, most of the standard facilities offered by a conventional exchange; it has the high reliability which is required for public service. It is equipped with junction circuits to the production exchange which serves the Research Centre and a variety of incoming and outgoing junctions to Ipswich for access to the national network.

A major objective in the design of Pathfinder was to minimize the cost and to achieve this, extensive use is made of computer control with its ability to alter functions without the need to make wiring changes. The processors are arranged in a 2-level hierarchy, different degrees of processing power and security being required at each level.

The highest level is represented by a highly reliable multi-processor which is remotely situated. This enables the cost of tasks which require large electronic stores or which are infrequently used, to be shared between many exchanges. Such tasks are fault diagnosis and the control of special facilities. The second level consists of two microprocessors which are responsible for the control of basic telephone service while at the lowest level in the hierarchy a number of single-chip microprocessors perform the simple tasks; these tasks can be performed by any one of several units so that the failure of any one degrades, but does not interrupt, service.

The speech paths in Pathfinder are switched by reed relays similar to those used in modern production exchanges; the

constraints at present imposed by the standard telephone make this necessary. However, in Pathfinder, the reeds are confined to the speech path only and relay control is performed electronically rather than by additional reeds.

### Semiconductor Component Reliability

Semiconductor devices—and integrated circuits in particular—are being used to a rapidly increasing extent in telecommunications equipment. Amongst other advantages they offer the prospect of higher standards of equipment reliability and, in consequence, an opportunity to check the escalating cost of maintaining the Post Office network.

The component reliability standards required especially in respect of long life, are generally tighter than those for other applications: experience has shown that such high reliability cannot be taken for granted. It is therefore necessary for the Post Office to prepare procurement specifications designed to assure the required quality, for which the Research Department determines the necessary test requirements and test methods. The task is approached through a blend of basic studies of failure mechanisms and component testing, with the emphasis on tests to accelerate ageing and simulate a normal lifespan, often using elevated temperature as the stress factor.

The bipolar types of integrated circuit presently under investigation include both linear components—particularly operational amplifiers—and digital t.t.l. and e.c.l., as well as circuits such as relay drivers combining digital and linear functions; all of which respond to life testing at high ambient temperatures, the relay drivers and the low-power versions of t.t.l. being particularly sensitive.

For complex m.o.s. integrated circuits where functional testing (even once) becomes difficult, procedures are being developed to qualify the progress technology and then separately validate individual circuit designs. The studies of hybrid integrated circuits, which employ both active and passive component technologies, have to take account of the differences in response to the stress factors according to the types and tolerances of the different components within the circuits.

Other studies embrace transistors, opto-couplers and impatt diodes as well as topics common to all types of integrated circuit such as metallization (devising surge tests for defects and tests for corrosion susceptibility), hermetic encapsulation (where moisture traces are demonstrably hazardous) and plastic encapsulation which has shown itself still to be generally unacceptable for many telecommunications equipments.

### Time Synchronization using BBC Television Signals

The line and frame synchronization signals of the BBC Television Service are generally controlled by an atomic frequency standard. In consequence they may be utilized, subject to certain restrictions, to achieve time synchronization (and a corresponding frequency monitoring facility) over an appreciable area of the country to an accuracy of 1  $\mu$ s.

The technique used at NPL is to observe, on an oscilloscope display, one of the group of the first field synchronization pulses in relation to a local seconds pulse. An observer at a remote site monitors the same synchronization pulse from a common transmitter, in relation to his local time. Then by applying either the calculated or the measured propagation delay, the time at the remote site may be determined relative to the time at Teddington.

The reference point in the received signal is the start of the second field synchronization pulse even line, in the field immediately following the UTC reference pulse (see diagram). The magnitude of the time difference cannot therefore exceed 40 ms.

The NPL measurements are made on Mondays to Fridays between 1100 UT and 1300 UT and a correction is applied for propagation delay with an estimated uncertainty of 1  $\mu$ s. Tables giving these time differences may be obtained monthly from the National Physical Laboratory, Teddington, Middlesex TW11 0LW (Telephone 01-977 3222, ext. 3947).

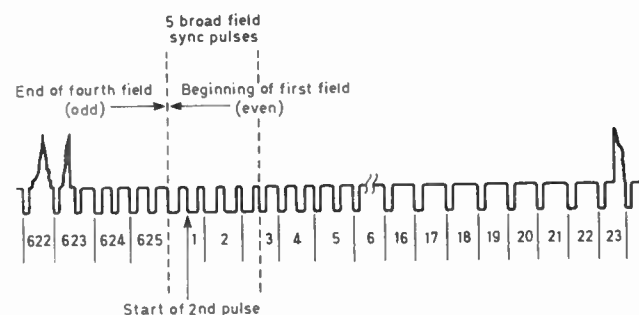

Vertical synchronizing and blanking waveforms for a video signal.

### Standard Frequency Transmissions—January 1977

(Communication from the National Physical Laboratory)

January 1977	Relative Phase Readings in Microseconds NPL—Station (Readings at 1500 UT)		
	MSF 60 kHz	GBR 16 kHz	Droitwich 200 kHz
1	10.0	10.0	10.0
2	10.0	10.0	9.9
3	9.6	10.6	9.7
4	9.6	11.6	9.6
5	9.4	10.5	9.5
6	9.6	10.8	9.3
7	9.5	12.2	9.3
8	9.5	12.1	9.1
9	9.6	11.9	8.9
10	9.7	12.0	8.9
11	9.7	12.1	8.9
12	9.5	11.9	8.7
13	9.5	11.9	8.6
14	9.5	11.0	8.6
15	9.5	10.4	8.5
16	9.8	11.3	8.5
17	9.7	11.2	8.3
18	9.8	10.5	8.3
19	9.3	10.8	8.1
20	9.1	9.8	7.9
21	9.3	11.2	7.8
22	9.3	10.8	7.7
23	9.5	8.0	7.5
24	9.3	9.0	7.3
25	9.3	9.0	7.3
26	9.1	10.2	7.1
27	9.3	10.3	7.0
28	9.3	10.3	7.0
29	9.1	10.8	6.7
30	8.9	10.5	6.5
31	8.9	8.4	6.3

Notes: (a) Relative to UTC scale ( $UTC_{NPL} - Station$ ) = +10 at 1500 UT, 1st January 1977.

(b) The convention followed is that a decrease in phase reading represents an increase in frequency.

(c) Phase differences may be converted to frequency differences by using fact that 1  $\mu$ s represents a frequency change of 1 part in  $10^{11}$  per day.



# IBC '76

*The International Broadcasting Convention was held in London in September 1976, and its sponsors were the Electronic Engineering Association, the Institution of Electrical Engineers, the IERE, the IEEE, the Royal Television Society and the Society of Motion Picture and Television Engineers. This report has been contributed by the IERE representatives on the Management Committee, Mr P. L. Mothersole and Mr R. S. Roberts, who also served on the Programme Committee, Mr. Mothersole as its Chairman.*

The Sixth International Broadcasting Convention, held at Grosvenor House on 20th–24th September 1976, proved to be the most successful held so far. Over 2500 visitors attended, of whom about 40% were from overseas, representing some 50 countries. For 1974 the figures were about 2000 visitors and 44 countries.

The associated exhibition was again very successful. By skilful use of the limited space at Grosvenor House, the number of exhibitors was increased to 60. Despite the identification of the IBC with this venue, the announcement that the 1978 Convention will be held at the new Wembley complex has been well received.

The Convention was formally opened by Earl Mountbatten, who said:

‘Airlines justly claim that they have shrunk the world. Television has shrunk the time element to literally zero.’

In a brief review of broadcasting developments since 1947, he traced the impressive advances from the days of the thermionic valve through transistors to the era of colour television and satellites.

Paying tribute to the Independent Broadcasting Authority on reaching its 21st anniversary, Lord Mountbatten highlighted some of the contributions made by its engineers. He also referred to the new vistas being opened up by Teletext, the system of television data transmission now being operated experimentally by the IBA and BBC.

‘How does all this affect the man in the street?’ asked Lord Mountbatten. ‘Every week a new transmitter comes into service, allowing more and more homes to receive colour television and bringing the magical figure of 100% coverage nearer.’ He warned, however, that while television has enormous potential, it placed a tremendous responsibility on those responsible for its operation. ‘We must avoid Orwell’s 1984 prophecy’, he said, ‘and the spectre of big brother. Teletext must never become telesnooper.’

The papers’ sessions were very well attended, the 600-seat lecture hall being full on several occasions.

Sessions chaired by J. A. Flaherty (USA), on Studio Systems, included six papers. N. Smuts gave a description of the SABC television centre at Johannesburg, and detailed the concepts and philosophies underlying the operation of centralized colour equipment. A paper by J. H. Deveson of

Radio Telefis Eireann gave an interesting description of a new presentation system in which high utilization with low capital and operating costs were the objectives. M. W. S. Barlow, of the Canadian Broadcasting Corporation, gave an up-date on CBC’s auto-switching modular systems. O. Skydstруп of Central Dynamics (Canada) described a new concept in vision mixers, with reduction in hardware and complete freedom in execution of effects sequences as objectives. P. Marchant of ITN (UK) described an economic locking system for outside broadcast use. A modified digital time-base corrector permitted synchronism with the main mix studio for several hours, during which no control is needed between the studio and the o.b. G. D. Iles and Mrs. G. Claydon of Marconi Communications Systems described a new digital synch. pulse generator of high accuracy and stability.

The session on Recording was chaired by Dr. P. Zaccarion (Italy) and two papers were presented. C. E. Anderson and W. A. Taylor of Ampex gave an interesting survey of twenty years of videotape. The paper by P. N. Kelly of LWT (UK) and C. E. Urban of BBC (UK) on v.t.r. standards surveyed the needs of broadcasters, and the financial implications of the introduction of a new standard.

Sessions on Picture Origination were chaired by D. Mills (RSA), and opened with a paper by M. Cosgrove and R. J. G. Ellis of Pye TVT (UK) on the design philosophy for a range of modern cameras. By the use of 85 modules, a comprehensive range of cameras becomes available with considerable economic advantages. A paper by K. Howe and J. R. Warner (BBC) outlined a BBC operational evaluation system for cameras, and next F. J. van Roessel of Philips AV Systems (USA) surveyed the design of a compact camera, using  $\frac{3}{8}$ -in plumbicons, and intended primarily for electronic news gathering. The University of Bradford (UK) presented a paper on measurement and simulation of signal/noise performance of picture sources, by R. Green, Dr. M. A. M. Ali-Zaid and Dr. J. G. Gardiner. The work is still proceeding and it is hoped that it will form the basis for a standard test procedure. A ‘state-of-the-art’ survey of solid-state image sensors was given by G. M. Le Couteur (BBC), who concluded that a likely time for the introduction of cameras with broadcast quality was between five and ten years hence.

Opening the second of the Picture Origination sessions, L. A. Spong of ATV Network (UK) outlined the requirements for a lens performance specification for cameras. J. H. Reed of Canon Amsterdam NV (Holland) on ‘Ergonomic optics’ considered the special problems involved in handling small, compact cameras. A lighting system, micro-computer based and using flexible-disc storage, was described by J. Barrett of Dynamic Technology (UK), and, finally, ‘Sub-titling of foreign feature films’ was the subject of a paper by W. R. Hawkins, W. Murray, W. Rhodes and R. H. Spencer of the BBC. A system was described using a ‘floppy disk’ for storage, with mini-computer control, and title retrieval as required. Work is continuing on overall assessment of reliability and maintenance.

The ‘Digital Techniques’ session was chaired by G. Hansen (Belgium) and opened with a paper on a digital system for store and display of still pictures by W. G. Conolly of CBS Television Network (USA), and C. E. Anderson and J. Dierman of Ampex (USA). A ‘disk-pack’ store is used for immediate access to 1500 stills, with a longer-term stock of 5000. P. R. McKee of ITN (UK) outlined experience of computer-produced graphics, particularly suitable for display of fast-changing news items such as election results. D. W. Osborne of BBC Research Department (UK) described an experimental digital system for multiplexed video and audio signals at 120 Mbit/s. Participation in field trials with the UK



Post Office were very successful, and provided useful information on interfacing, jitter and error observation. To conclude this session, A. A. Goldberg of CBS Technology Center (USA) read a paper on 'Extending P. C. M. video response above the Nyquist limit', in which he described a method of coding NTSC 525/60 signals with a bit rate no greater than required for conventional coding within a 4.2 MHz bandwidth

Sessions on 'New Information Systems' were chaired by P. L. Mothersole, VG Electronics (UK), who read the opening paper on 'Broadcast and wired Teletext systems'. N. W. Green of ITCA (UK) discussed the problems involved in implementing the system on the independent network in the UK. Details of an experimental 'Text transmission system' were given by K. Murasaki, Y. Numaguchi and A. Maebara of the NHK Technical Research Laboratories (Japan). Various impairments were studied, and the technical feasibility of the system was verified. J. E. D. Ball of the Public Broadcasting Service, Washington (USA) described work on 'Closed captioning of television programmes for the hearing impaired'. The system, similar to the Teletext concept, can supply captions to viewers with a hearing impairment. Captions would normally only be visible to viewers with a suitable 'add-on' unit. A paper on Viewdata, a system for providing similar 'pages' of information to broadcast Teletext but over PO lines, again using the domestic receivers, was read by S. Fedida of the Post Office Research Department (UK). The amount of information that can be accessed by dialling is virtually unlimited, and a page can be displayed in less than 2 seconds. It is considered to be a complementary system to broadcast Teletext.

The paper by E. Insam and L. J. Stagg of the GEC Research Centre (UK) described a television receiver for display of both broadcast and wired Teletext using remote control and automatic dialling. 'Measurement and specification of Teletext waveforms' was read by J. P. Chambers of BBC Research Department (UK), in which the 'eye' display was suggested for possible definition of waveform. P. R. Hutt of IBA (UK) described 'Field tests of IBA Teletext transmissions'. The tests are still proceeding, but they have shown that at least 90% of viewers receiving a Grade 4 or better signal will receive Teletext with a bit error rate of  $10^{-3}$  or better.

Sound Systems sessions, chaired by P. Hansen (Denmark), opened with a paper by P. W. Granet of Mellotronics (UK) on 'Automation in radio broadcasting', in which he traced the history of computer-controlled operations from 1956 to the present. C. Henocq and R. H. Belgrove of the BBC (UK) considered recording on 'Cartridge machines: standards and problems in use' detailing some BBC experience, and suggesting a need for future improvements in signal/noise ratio of the system. 'Requirements for a new generation audio recorder' were presented in a paper by A. M. Heaslett of Ampex Corporation (USA); after outlining the performance restrictions of current designs, an advanced system was proposed. 'An automatic audio test-tape maker' was the subject of a paper by C. Hencocq and R. J. Taylor of BBC Designs Department (UK). The BBC has about 4000 recorders in use, and rapid production of accurate test-tapes was outlined.

'The application of memory techniques to sound mixing consoles for programme production' by G. A. C. Watts and D. A. Tilsley of Rupert Neve & Co. (UK) opened the second group of papers, and the authors detailed the many advantages arising from the use of a computer-aided console. A paper was then read by M. M. Gleave and W. I. Manson of the BBC (UK) on 'Variable emphasis limiters for sound programme signals', pointing out that pre-emphasis on f.m. systems accentuates a risk of over-modulation, and existing systems of gain reduction drop the overall signal level. The paper outlined a system for varying only the emphasis. 'A proposal for

a traffic information service' was made in a paper by R. S. Sandell and M. W. Harman of BBC Research Department (UK). A system of about 70-80 low-powered transmitters on a single frequency, spaced at about 30 km, is proposed. Problems associated with reception were discussed, and field trials have verified the feasibility. J. D. MacEwan of BBC (UK) read a paper on 'BBC's radio taxis, and their operational use'. Radio cars of various types have been used for many years, but a reappraisal of requirements for replacement vehicles led to adoption of a type of vehicle similar to that used by the London taxi service. Operation of the car, which has full recording facilities and a radio link for direct programme participation, was described.

Sessions on Transmitters were chaired by H. Chemin (France). The opening paper, by D. R. Bowers of Marconi Communication Systems (UK), was on 'Automatic frequency changing for high-power h.f. transmitters'. It described a digital control system for changing to any of 32 stored channels in less than 15 seconds. 'Design of a completely solid-state 1 kW a.m. broadcast transmitter' was the subject of a paper by E. C. Westenhaver of Harris Corporation (USA). Some new approaches to amplitude modulation were considered, together with combining of power modules. G. Fallon and J. Hervier of Thomson-CSF (France) described 'A new generation of klystrons for u.h.f. television transmitters', in which five cavities are used to produce an output up to 47 kW at an efficiency of 52%.

The paper 'Television transmitter drive system design' by D. Drury and E. G. Plume of Pye TVT (UK) related the development of a comprehensive i.f. modulated drive system of modular design, suitable for any standard. 'Generation of vestigial sideband signals by digital processing' was read by J. S. Lothian of IBA (UK), and two methods of generating were considered. Advantages in the use of digital filtering were discussed. A paper by J. McGrath of RTE (Ireland) showed how it is proposed to operate a transmitter network with precision carrier offset. A burst of high-accuracy 5 MHz reference frequency is inserted in the vertical blanking period at the programme origination centre. At the transmitter, the burst is extracted, and used as a reference to control the carrier frequency. 'BBC monitoring and information centres' were the subject of a paper by D. A. Carter, C. G. Maxfield and G. C. Wands of the BBC (UK), which dealt with the proposed establishment of four centres for the BBC UK network. Automatic fault reporting units at unattended stations will monitor continuously the critical points of an installation, and any change in conditions is notified to the m.i.c. by a binary code. The Kirk o'Shotts m.i.c., the first to become operational in 1975, was described. J. B. Watson of IBA (UK) read a paper on 'Digital automatic measuring equipment' (DAME). Insertion test signals permit the measurement of about twelve parameters of the video signal, and are processed by a digital system, controlled with a micro-processor. A paper by P. A. Crozier-Cole of IBA (UK) on 'Regional operations centres for the IBA network' describes a project, nearing completion, for continuous monitoring of the IBA network, at four centres.

The final sessions were chaired by E. Gavilan (Spain), and concerned Aerials and Distribution. The opening paper, by P. K. Onnigian of Jampro Antenna Co. (USA), was on 'Test results comparing circular with horizontal polarization in u.h.f. television broadcasting'. Field tests showed some advantages for circular polarization, particularly where room aerials are used for reception. 'Microwave concepts for ENG' was the subject of a paper by D. W. Atchley, Jr. (USA) and D. Cronshaw (UK) of Microwave Associates, in which a 13 GHz link was described, together with operational experience. E. T. Ford of IBA (UK) described 'A dual-

frequency highly directional m.f. aerial' used by the Authority on 1151 and 1546 kHz. With ten co-channels to protect, nulls of up to 24 dB are required in specific directions.

'Television transmission in the European communication satellite system' was described by Dr R. A. Harris of the European Space Agency, ESTEC, Netherlands. Proposals were outlined for a system whereby EBU can be provided with two permanent channels, and others as may be required, using the 11 and 14 GHz bands. Problems concerned with 'Provision of colour television service in the Channel Islands' were discussed by B. F. Salkeld and M. D. Windram of IBA (UK). Reception for re-broadcast of 'off-air' transmissions from Rowridge, Stockland Hill and Caradon Hill, was described. Interference effects were discussed, and an adaptive aerial system described. A paper by W. Horak of Siemens (Federal Republic of Germany) on 'Television programme distribution over fibre CATV networks' discussed transmission, amplification, modulation, signal/noise and other aspects of a system using glass fibre cables.

The discussion session on Electronic Journalism (ENG) was chaired by E. R. Rout (BBC) with a panel consisting of J. A. Flaherty (USA), M. Morizono (Japan), F. van Roessel (USA), J. Fielek (USA) and A. Protheroe (UK). This technique is now established in the USA, and most other broadcasting organizations are heading towards similar systems. The topicality of the subject was apparent since the planned attendance of 300 was well oversubscribed, and a follow-up had to be held. The discussions covered technical aspects of portable equipment, and experience of operations with news editors contributing.

*The papers read at IBC 76 are published as IEE Conference Publication No. 145 which may be purchased from Publications Sales, IEE, P.O. Box 26, Hitchin, Herts. SG5 1SA; the UK price is £9.90 and the overseas price £11.60. Members of the IERE may obtain copies at the special reduced price for sponsoring organizations of £6.60; these orders should be sent through the IERE Publications Department at 9 Bedford Square, London WC1B 3RG.*

## Applicants for Election and Transfer

### Meeting: 15th February 1977 (Membership Approval List No. 230)

#### GREAT BRITAIN AND IRELAND CORPORATE MEMBERS

##### Transfer from Member to Fellow

BEYNON, John David Emrys. *Southampton.*  
HEWITT, Roy William Samuel. *Ashford, Middlesex.*

##### Direct Election to Member

PULLEN, Richard Martin. *Monmouth, Gwent.*  
SOUTHON, John Douglas. *Farnborough, Hampshire.*

#### NON-CORPORATE MEMBERS

##### Direct Election to Graduate

JOBLING, David Trevor. *Southampton.*  
JONES, Nigel Hudspeth. *Colyton, Devon.*

##### Direct Election to Associate Member

CHARNLEY, Malcolm. *Shevington, Wigan.*  
CORKE, Graham Frederick. *St. Leonards-on-Sea, Sussex.*  
GAME, Ian Donald. *Northampton.*  
MANEK, Suresh Jivan. *London.*  
MYERS, Graham. *Stockton, Cleveland.*  
WILLIS, Robin David. *London.*

##### Transfer from Associate to Graduate

TULIP, Lawrence Wilfred. *Newcastle-upon-Tyne.*

#### STUDENTS REGISTERED

CHU, Joseph Hung Ming. *Middlesbrough, Cleveland.*  
IRVING, David Ian. *Whitley Bay, Tyne and Wear.*  
KERNAN, Brendan Dermot. *Dublin, Ireland.*  
LI, Yiu Fai. *Middlesbrough, Cleveland.*  
RANCE, Grahame Edward. *Cardiff, South Glamorgan.*  
ROBERTS, David Killin. *New Quay, Dyfed.*  
ROGERS, Peter Stephen. *London.*

#### OVERSEAS

#### CORPORATE MEMBERS

##### Transfer from Graduate to Member

OYEMI, Thomas Gregory. *Kano, Nigeria.*

##### Direct Election to Member

CHU, Kwai-Luen. *Hong Kong.*  
KONG, Victor Chee-Foon. *Ottawa, Ontario.*

LEE, Cheng Siong. *Singapore.*  
LIM, Yan Kwong. *Singapore.*

#### NON-CORPORATE MEMBERS

##### Transfer from Student to Graduate

SOO, Ah Lek. *Kuala Lumpur, Malaysia.*  
YUEN, Chung Him. *Hong Kong.*

##### Transfer from Student to Associate Member

HINGSTON, William Frederick. *Needham, Massachusetts.*

##### Direct Election to Associate Member

KINGSTON, Richard David. *Ndola, Zambia.*  
PANG, Ka Poh. *Labuan, Sabah, East Malaysia.*

##### Direct Election to Associate

ELIATAMBY, Joseph Pararajasingam. *Ekala, Kotugoda, Sri Lanka.*

#### STUDENT REGISTERED

GAN, Beng Cheng. *Singapore.*  
HO, Sui Lam. *Hong Kong.*  
NGAI, Fatt Kee. *Singapore.*

### Meeting: 23rd February 1977 (Membership Approval List No. 231)

#### GREAT BRITAIN AND IRELAND

#### CORPORATE MEMBERS

##### Transfer from Member to Fellow

BORTHWICK, Roland Heneage. *Walton-on-Thames, Surrey.*  
WADDINGTON, Damer Evelyn O'Neill. *St. Albans, Hertfordshire.*

##### Transfer from Graduate to Member

BOWLER, John Francis. *Slough, Berkshire.*  
CHAMPION, Peter Robert. *New Malden, Surrey.*  
GIBSON, Peter Hedley. *Camberley, Surrey.*  
MORRIS, Stephen John. *Caepphill, Mid-Glamorgan.*  
SHIRT, David Godfrey. *Northolt, Middlesex.*

##### Transfer from Student to Member

WEBSTER, Peter Bruce. *London.*

##### Direct Election to Member

BISHOP, Graham Dudley. *Newbury, Berkshire.*  
BURGESS, John Richard. *Keighley, West Yorkshire.*  
COFFEY, John Albert. *Newbury, Berkshire.*  
NIVEN, Forrest Nelson. *Saffron Walden, Essex.*  
SHUTTLEWORTH, Timothy John. *Caldecote, Cambridgeshire.*  
\*THOMAS, Peter Hulton. *Eastbourne, Sussex.*

#### NON-CORPORATE MEMBERS

##### Direct Election to Associate Member

LAWRENCE, Stanley Douglas. *West Molesey, Surrey.*

\*Subject to Mature Candidate Procedure.

#### STUDENTS REGISTERED

HARRIS, Derek. *Neath, West Glamorgan.*  
JOHNSON, Gareth. *Pewsey, Wiltshire.*  
O'REILLY, Francis John. *Dublin.*  
WILLIAMS, Keith. *Cardiff.*

#### OVERSEAS

#### CORPORATE MEMBERS

##### Transfer from Graduate to Member

EGHAREVBA, Thomas John. *Borno State, Maiduguri, Nigeria.*

##### Direct Election to Member

BIN OTHMAN, Abu Bakar. *Kuala Lumpur, Malaysia.*

#### NON-CORPORATE MEMBERS

##### Direct Election to Graduate

PATEL, Kanubhai. *Lusaka, Zambia.*

# Members' Appointments

## CORPORATE MEMBERS

**Mr. B. R. Ackroyd** (Member 1969, Graduate 1960) who joined the Marconi Company, Chelmsford, in 1968 as a Senior Engineer, has been promoted from Section Leader, Modem Development, Space and Tropospheric Department, to Group Chief, Telephony System A, Digital Development Department.

**Mr. M. Z. Aziz** (Member 1973) who was formerly a Principal Design and Development Engineer with Standard Telecommunication Laboratories, Harlow, has been promoted to Senior Research Engineer.

**Mr. T. E. Chappell** (Member 1972, Graduate 1967) has been appointed Senior Control and Instrumentation Design Engineer with Kennedy and Donkin, consulting engineers, in Manchester. He was previously Control and Instrumentation Engineer with the Nuclear Power Corporation, Risley, Lancs.

**Mr. D. E. A. Coles** (Member 1973) has taken up a post with A&M Hearing Aids Ltd., Crawley. His previous appointment was with Cable & Wireless Ltd., London, where he was a Telex Systems Engineer.

**Mr. A. L. Cotcher, M.Sc.** (Member 1962) has been appointed a director of Satra Consultants (UK) Ltd., whom he joined as General Manager two years ago. From 1967 to 1974 he was Managing Director of the London advertising agency, Howard Panton Ltd.

**Lt.-Col. W. J. Crouch, B.Sc., REME** (Member 1971) who for the past year has been GSO2 (Weapons) at HQ DEMA(A), Ministry of Defence, London, has been appointed Officer Commanding Radar Branch, REME Support Group at the Royal Signals and Radar Establishment, Great Malvern, Worcestershire.

**Cdr. D. W. Jackson, RN** (Member 1966) has been appointed Technical Staff Officer with the Ministry of Defence Ordnance Board in London. From 1969 to 1977 Commander Jackson served as Technical Superintendent, Naval Shore Wireless Stations, Ministry of Defence.

**Sqdn. Ldr. L. C. McNally, RAF** (Member 1973) has taken up the appointment of Chief, Communications Operations Facilities Control, in the Regional Signal Support Group at HQ AFCENT. He previously held a Ministry of Defence staff appointment with Signals 50 (Air).

**Sqdn. Ldr. C. F. P. Merchant, RAF** (Member 1972, Graduate 1968) has been posted to the United States as RAF Exchange Officer in the 1842nd Electronic Engineering Group of the USAF's HQ Air Force Communications Service at Richards-Gebaur

Air Force Base, Missouri. For the past three years he has been at the Ministry of Defence with Signals 51 (Air).

**Sqdn. Ldr. P. B. Murphy, RAF** (Member 1973) has returned to the UK from West Germany, where he had been with Engineering Co-ordination 1, Headquarters RAF Germany, at Rheindahlen. He is now Officer Commanding Electrical Engineering Squadron, RAF St. Mawgan, Cornwall.

**Mr. W. C. Owen** (Member 1973, Graduate 1970) who from 1970 to 1976 was a Design Engineer with Y-ARD (Consultants) Ltd. in Glasgow, has taken up an appointment as Project Engineer with the Horstmann Gear Company at Bath.

**Mr. B. K. Price** (Member 1973, Graduate 1970) has been promoted to Senior Lecturer in the Department of Electronic and Radio Engineering at Riversdale College of Technology, Liverpool, which he joined as a Lecturer in 1971.

**Mr. G. A. Price** (Member 1968), formerly a Principal Professional and Technology Officer in Communications S23, has been appointed Assistant Director, Communications S3, Ministry of Defence Procurement Executive, in London.

**Mr. Y. A. A. Raji** (Member 1972) who has been with Nigerian External Telecommunications since 1966, has been promoted from Principal Engineer to Chief Engineer.

**Mr. R. R. Ritchie** (Member 1961) has been appointed Development and Engineering Director with Group 4 Securitas International (Products) Ltd., at Tewkesbury.

**Sqdn. Ldr. W. W. Robinson, RAF** (Member 1972) is currently Senior Engineering Officer attached to RAF Saxa Vord, Unst, Shetland. Last year he completed postgraduate studies at the RAF College, Cranwell, following service in Cyprus and with the Royal Radar Establishment, Great Malvern.

**Mr. J. W. Squires** (Member 1973, Graduate 1970) who is with the Ministry of Defence (Navy), has been promoted from Engineer to Senior Engineer. Mr. Squires was formerly a Development Engineer with Marconi Space & Defence Systems Ltd., Frimley, where he was working on weapons systems.

**Mr. J. A. Stanley** (Member 1970, Graduate 1964) has joined Membrain Ltd. as Principal Engineer. He was previously Engineering Director with Data Recall Ltd., London.

**Mr. L. J. Sutherland** (Member 1972, Graduate 1970) has taken up an appointment with EMI Sound and Vision Equipment Ltd., Hayes, working on broadcasting equipment development. From 1964 to

1976 he was a Senior Development Engineer in the Advanced Development Laboratory of Rank Radio International Ltd.

**Mr. C. J. Taylor** (Member 1975, Graduate 1969) who was a Project Engineer with the Department of Posts and Telegraphs, Papua, New Guinea, from 1972 to 1976, has taken up an appointment as an Engineer Grade B with Fairey Australasia Pty. Ltd. at the Tidbinbilla Tracking Station, Canberra. Mr. Taylor was awarded the Arthur Gay Premium for 1974 for a paper on the testing of magnetic disk packs for data recording.

**Wing Cdr. S. A. R. Taylor, D.S.C., D.F.M., RAF (Ret.)** (Member 1960, Graduate 1959) has taken up an appointment as Technical Officer with the British Standards Institution after completing 36 years' service with the RAF.

**Mr. B. C. Waterman** (Member 1973, Graduate 1972) has been promoted from Air Traffic Engineer 1 to Senior Air Traffic Engineer with the Civil Aviation Authority.

**Mr. P. Wesson** (Member 1965, Graduate 1962) who from 1971 to 1976 was Service Manager with Beckman-R.I.I.C. Ltd., has joined A. Gallenkamp & Co., London, as Group Service Organisation Manager.

**Mr. C. J. White** (Member 1955, Graduate 1952) has taken up an appointment with the Ministry of Overseas Development as a Radio Engineering Consultant to the Government of Ghana on secondment from the BBC; he will be concerned with the design and commissioning of a v.h.f. f.m. studio/transmitter system in Upper Region. Mr White joined the BBC as a Research Engineer in 1952, and from 1969 to 1976 he worked in Vientiane, Laos, under the auspices of the Ministry of Overseas Development as Transmitter Engineer with responsibility for the installation, operation and maintenance of the country's medium and short wave network donated by the British Government under the Colombo Plan.

## NON-CORPORATE MEMBERS

**Mr. S. K. Ashley** (Graduate 1971) has been promoted to Executive Engineer, Postal Mechanisation Planning, with the Midlands Postal Board in Birmingham.

**Mr. M. Asim** (Graduate 1971) who was previously a Development Engineer with Tektronix UK Ltd., is now a Senior Design Engineer with Gould Advance Ltd., Hainault, Essex.

**Mr. T. Davis** (Graduate 1967) is now Computer Systems Service Manager with Hewlett-Packard Ltd., Wokingham.

**Mr. C. L. Lawson** (Associate 1972) has taken up the appointment of Project Manager, Unico GmbH at Eiserfeld, West Germany. He was previously a Computer Development Engineer with Philips Electrologia GmbH, Eiserfeld.



# Forthcoming Institution Meetings

Wednesday, 20th April

JOINT IEE/IERE/BES MEDICAL AND BIOLOGICAL ELECTRONICS GROUP

## Physiology for Engineers—The Auditory System

By Dr. A. R. D. Thornton (*University of Southampton*) and H. A. Beagley (*Institute of Laryngology and Otolology*)

Botany Lecture Theatre, University College London, 2 p.m.

Thursday, 21st April

JOINT IEE/IERE COMPUTER GROUP AND IERE AUTOMATION AND CONTROL SYSTEMS GROUP

## Design philosophy of pocket calculators MEETING CANCELLED

Tuesday, 26th April

ELECTRONICS PRODUCTION TECHNOLOGY GROUP

## Colloquium on NEW TECHNIQUES AS AIDS TO PRODUCTION POSTPONED

Tuesday, 3rd May

AEROSPACE MARITIME AND MILITARY SYSTEMS GROUP

## Colloquium on FISH INDUSTRY ELECTRONICS

Royal Institution, Albemarle Street, London W1, 2 p.m.

Advance registration is necessary. For further details and registration forms, apply to Meetings Officer, IERE.

Thursday, 5th May

AUTOMATION AND CONTROL SYSTEMS GROUP

## Introduction to Microprocessors

By G. S. Evans (*Warren Point Ltd.*)

Goldsmiths Theatre, London School of Hygiene and Tropical Medicine, 6 p.m.

Tuesday, 10th May

JOINT IEE/IERE/BES MEDICAL AND BIOLOGICAL ELECTRONICS GROUP

## Physiology for Engineers—The Visual Cortex

By Dr. S. Szeki

Botany Lecture Theatre, University College London, 6 p.m.

Wednesday, 18th May

MEASUREMENTS AND INSTRUMENTS GROUP

## Colloquium on MEASUREMENT AND POLLUTION POSTPONED

## Thames Valley Section

Thursday, 28th April

Annual General Meeting followed by L.S.I. logic systems design

By Professor D. Lewin (*Brunel University*)  
Caversham Bridge Hotel, Reading, 7 p.m.

## South Western Section

Tuesday, 5th April

JOINT MEETING WITH IEE

## Automatic handwriting and speech recognition systems

R. Watson and B. Payne (*National Physical Laboratory*)

The College, Regent Circus, Swindon, 6.15 p.m. (Tea 5.45 p.m.)

Wednesday, 27th April

## Electrical and avionic systems in helicopters

By R. N. Lake and J. C. Firmin (*Westland Helicopters*)

Queens Building, University of Bristol, 7 p.m. (Tea 6.30 p.m.)

Monday, 2nd May

Annual General Meeting

Royal Hotel, Bristol, 7 p.m. (Tea 6.30 p.m.)

## Beds & Herts Section

Thursday, 28th April

Annual General Meeting followed by

## Instruments of the new music

By K. Winter (*University of Cardiff*)

Music Centre, Hatfield Polytechnic, College Lane, Hatfield, 7 p.m. (Tea 6.30 p.m.)

## Kent Section

Thursday, 14th April

Annual General Meeting followed by

## The ins (pick-ups) and outs (loudspeakers) of hi-fi systems

R. E. Cooke (*KEF Electro-Acoustics*) and a representative from Shure Electronics  
Boxley Country Club, Boxley, Nr. Maidstone, 7 p.m. (Tea 6.30 p.m.)

Thursday, 28th April

CEI KENT AND SUSSEX BRANCH LECTURE

## The engineer in society

By B. John Lyons (*Electrical Power Engineers' Association*)

Town Hall, Tunbridge Wells, 7 p.m. (Light refreshments from 6.30 p.m.)

## East Midlands Section

Tuesday, 19th April

Annual General Meeting

Hawthorn Building, Room 08, Leicester Polytechnic, 7.15 p.m.

## South Midlands Section

Wednesday, 20th April

## Electromagnetic compatibility in perspective

L. J. Fountain (*School of Signals*)

Followed by Annual General Meeting  
Foley Arms Hotel, Malvern, 7 p.m.

## West Midlands Section

Wednesday, 6th April

Annual General Meeting followed by

## Newspapers into the 80's

By D. Humphreys (*Express and Star*)

For synopsis see January/February Journal page 88.

Wolverhampton Polytechnic/Express and Star Offices, 7 p.m. (Tea 6.30 p.m.)

## Yorkshire Section

Thursday, 28th April

Visit to York sorting office followed by

Annual General Meeting and buffet supper  
G.P.O. Sorting Office, 4 Leeman Road, York, 7 p.m.

Ladies welcome: full details to follow by post

## Merseyside Section

Wednesday, 13th April

## The Post Office millimetric waveguide system

By G. Morrow (*Post Office Research Centre*)  
Synopsis: An account of the P.O. field trial between Martlesham Heath and Wickham Market Telephone Exchange will be followed by a description of the waveguide and its ancillary equipment, the planning and installation of an operational waveguide route and the future of waveguides will be discussed.

Department of Electrical Engineering and Electronics, University of Liverpool, 7 p.m. (Tea 6.30 p.m.)

## North Eastern Section

Tuesday, 12th April

## Multimicroprocessor system

By Dr. E. L. Dagless (*University College of Swansea*)

Y.M.C.A., Ellison Place, Newcastle, 6 p.m. (Tea 5.30 p.m.)

## North Western Section

Thursday, 21st April

## Flight simulation

By J. Morrison (*B.A.C. Warton*)

Renold Building, U.M.I.S.T., Manchester, 6.15 p.m.

## Northern Ireland Section

Tuesday, 19th April

Annual General Meeting followed by a lecture on

## Radio control of model aircraft

Cregagh Technical College, 6.30 p.m.