

Founded 1925

Incorporated  
by Royal Charter 1961

*"To promote the advancement  
of radio electronics and kindred  
subjects by the exchange of  
information in these branches  
of engineering."*

Volume 44 No. 6

June 1974

# The Radio and Electronic Engineer

The Journal of the Institution of Electronic and Radio Engineers



## The Eighth Clerk Maxwell Memorial Lecture

'OUR SPACE PROGRAMME AFTER APOLLO'

By Wernher von Braun, Dr.-Ing.\*

*Presented at a meeting of the Institution in London on 21st March 1974*

Before I delve into the subject of my Address, let me say how much I appreciate the honour which the Institution of Electronic and Radio Engineers has bestowed upon me by inviting me to deliver this year's Clerk Maxwell Memorial Lecture. The list of previous Maxwell Lecturers shines like a constellation of bright stars and I frankly enjoy basking in their light.

Forty years ago, when I was an engineering student, James Clerk Maxwell's electrodynamic equations were to me about what King David's psalms are to a budding priest. When I received your invitation, however, it occurred to me that there may still be another important message in the accomplishments of this great man that we should heed in our often so thoughtless modern world. The staggering cost of modern research, whether we are talking about linear accelerators for particle research, nuclear reactors for fission and fusion work, supersonic windtunnels, or experimentation and exploratory work in space, has generated a widespread belief that nowadays progress in the natural sciences can only be wrought with huge expenditure of money. And yet, when we look at Maxwell's work, we must conclude that no research grant, and no amount of public funding, could possibly have bought masterpieces of human creativity such as his theses on 'A dynamical theory of the electromagnetic field' or 'The dynamical theory of gases'. Clerk Maxwell himself, in his characteristic modesty, would probably explain that he owed much of his greatness to the fact that he stood on the shoulders of a giant, Michael Faraday. Such comment, of course, would merely confirm the deep reverence he held for his brilliant teacher. When I look at the proliferating number of subatomic particles, at puzzling phenomena such as quasars, pulsars and black holes which thus far simply refuse to fit into any

grand scheme of things, I must conclude that the world of contemporary physics is ready for another Maxwell—a man in whom mathematical proficiency is matched by intuitive genius to see what really makes things tick. And I believe that latter-day Maxwell, too, will bring about an intellectual breakthrough without a multi-billion dollar budget.

Tonight, I want to talk to you about a programme that was indeed bought by the American public for a staggering sum of money. But let me hurry to add that I am more convinced than ever that the space programme was and is one of the smartest investments America has ever made. For it has produced what is worth more than gold in today's cynical world: new technology and managerial capability, new opportunities to respond to some of the most pressing problems of our time, and new horizons for human activity. In addition, I should like to think that it has also done something for the human spirit and that it has added a little bit to that pool of fundamental knowledge about the Laws of Nature, to which Clerk Maxwell contributed so much.

Looking back at the *Apollo* lunar landing programme and its offshoot, the *Skylab* Space Station project, I submit that we have learned six decisive lessons:

- (1) Man can travel to and land on another heavenly body and return to earth safely. By carrying his life support systems with him, whether inside his spacecraft or strapped to the back of his spacesuit, he can do effective research and conduct surface expeditions even under environmental conditions as harsh and inhospitable as on our airless moon.
- (2) Man can comfortably live and proficiently perform exacting tasks over long periods of time under zero-gravity conditions.

\* Fairchild Industries Inc., Germantown, Maryland 20767, USA.

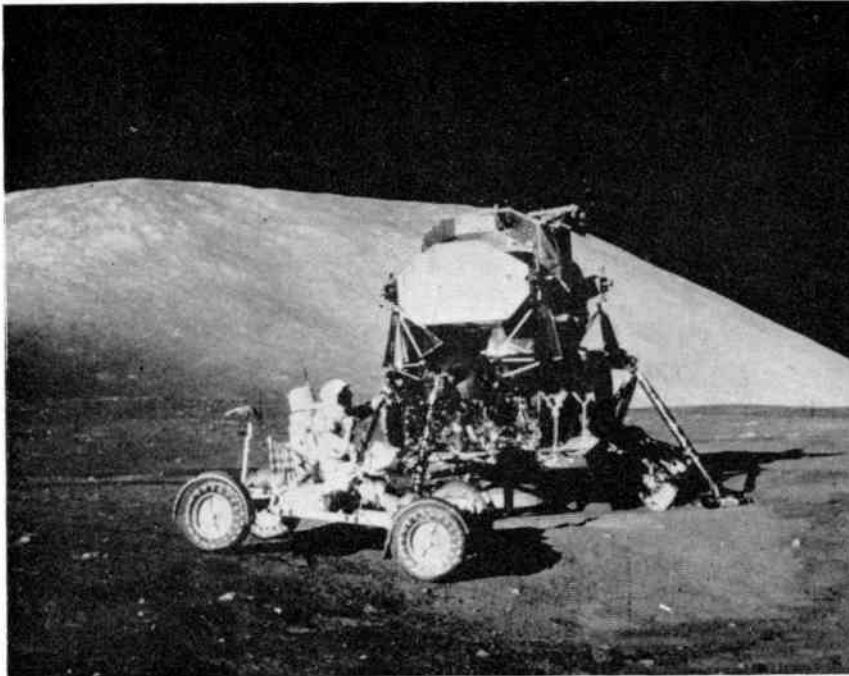

Fig. 1. The Lunar Module and a Rover and astronaut on the surface of the Moon. The mountain in the distance is 26 miles away and 3000 m high.

- (3) Voice, colour video and wide-band data communications can be maintained through all phases of a space expedition.
- (4) Stellar and solar observations from orbit, offering unrestricted use of the entire electromagnetic spectrum, have become a most powerful tool of astrophysical research.
- (5) Earth observations from orbit, using sophisticated photographic techniques and multi-spectral sensors, are already providing an extremely valuable service in a large number of fields, including global crop and forest surveys, prospecting for minerals and fossil fuels, land-use planning, census taking, cartography, oceanography and meteorology including related fields such as storage dam water management, hurricane warnings and general weather forecasting.
- (6) The zero-gravity environment in an orbital space station offers unique opportunities for research in botany, zoology and medicine and for experimentation in the fields of crystal growth, alloying of immiscible ingredients, electrostatic forming of precise glass and other surfaces, and of purification of vaccines and other pharmaceutical substances. Some of these experiments may soon lead to specialized industrial processing and manufacturing operations in orbit.

### Lunar Exploration

Figure 1 shows a Lunar Module, a Rover and an astronaut on the surface of the Moon. The Rover was actually an afterthought in the *Apollo* programme. Safety considerations required the touchdown site to be relatively smooth and free of boulders, whereas the most interesting geological features on the Moon are usually associated with craters, mountains and rift valleys. This

dilemma resulted in the familiar desire of all tourists to have a rental car at their disposal upon arrival at the airport. As an automobile, the Rover surely does not look like much, but it is loaded with exotic technological challenges.

For instance, normally lubricated bearings would not work on the Moon, as any grease or oil would rapidly evaporate in the hard vacuum. Bearings, therefore, had to be either pressure-sealed or lubricated with a non-evaporating solid powder. Titanium sulphide was found to be particularly well suited.

Since normal combustion engines could not be used on the airless moon, the Rover had to be powered by electric motors. The lack of air-cooling for the wheel-mounted motors necessitated the development of high-temperature armatures, and the wheel disks were used as radiation coolers.

All astronauts returning from the Moon were unanimous in their reports that it is extremely difficult to estimate distances. Our ability to estimate distances here on Earth results, of course, from a mental exercise whereby we correlate the known absolute size of a familiar object such as a tree or a two-storey building with the angle subtended by that object. On the Moon, there are no familiar objects and it is next to impossible to tell whether a boulder is small and nearby, or large and far away. The problem is further compounded by the nearness of the optical horizon caused by the Moon's relatively small diameter. On flat terrain an astronaut loses sight of the Lunar Module at a distance of less than a mile. In case of a sudden emergency during a land excursion, such as a small leak in a spacesuit or a problem with a life support back-pack, it was desirable for the astronauts to know at all times in which direction to head to return to the Lunar Module in the shortest possible time, and without having to retread their footprints. A simple dead reckoning device was therefore added to the Rover's

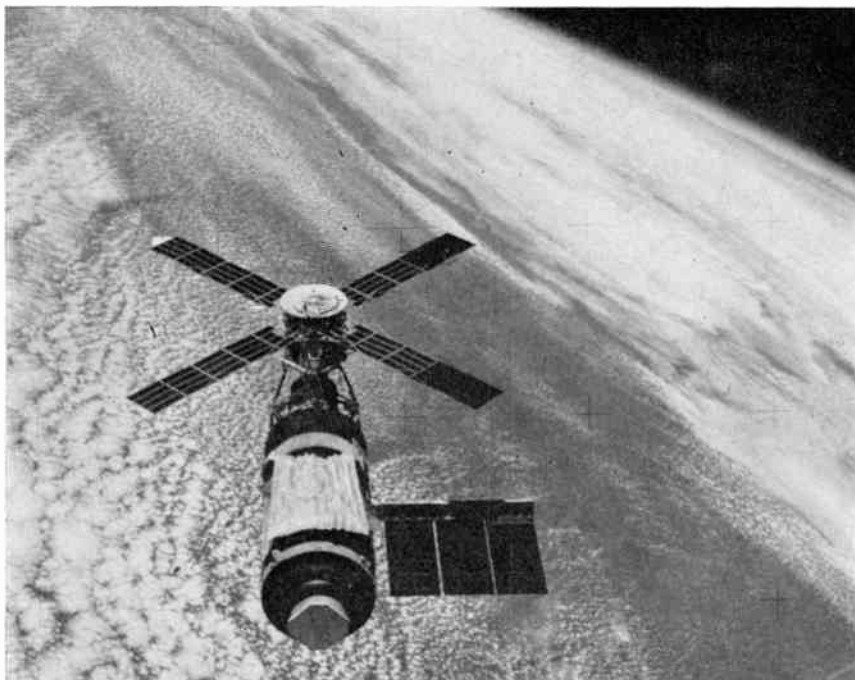

Fig. 2. *Skylab* in orbit. The photograph shows the sheet placed in position to replace the bumper shield ripped off during the ascent. Only one of the solar cell arrays for utility power is extended, the other having been lost.

instrumentation; its homing needle would at all times point in the direction of the Lunar Module.

### The Skylab Missions

*Skylab* itself is shown in Fig. 2 which is a photograph taken by one of the three teams of astronaut scientists who lived in this station for periods of 28, 59 and 84 days. *Skylab* weighs about 100 tons, is 118 feet long and was launched into orbit by the first two stages of the same *Saturn V* rocket that carried our *Apollo* astronauts to the Moon.

When the first crew (travelling in an *Apollo* Command Module launched up by a smaller *Saturn IB* rocket) arrived they found that during the ascent the supersonic slipstream had ripped off a bumper shield designed to evaporate impacting micrometeoroids before they reached the station's pressure shell. The shield also tore off one of the two large arrays of solar cells that were to provide utility power for the station. In addition, the loss of the sun-shading shield badly fouled *Skylab's* sensitive temperature control system. It took a truly heroic effort on the part of Pete Conrad and his teammates, to save the \$2000M *Skylab* programme from disaster.

Coming now to the purposes of the programme the summary conclusion of the medical experts was that the three 28, 59, and 84-day *Skylab* missions clearly failed to reveal any effects that would put an upper limit on the time that men can live in weightlessness. At the same time, *Skylab* taught many useful lessons as to how, with the aid of training devices such as a stationary bicycle or spring expanders, crew members can retain their muscle tone and overall physical fitness.

The so-called Apollo Telescope Mount (ATM) is shown in Fig. 3; this is actually an array of seven special telescopes designed to study the Sun, particularly in those

parts of the electromagnetic spectrum for which the Earth's atmosphere is opaque. The instruments are mounted on a gimbal-suspended cruciform spar that can be aimed and continuously held at any object on the Sun with a very high accuracy. The ATM has its own wind-mill-shaped array of solar cells to power its various experiments. Six of the instruments recorded their

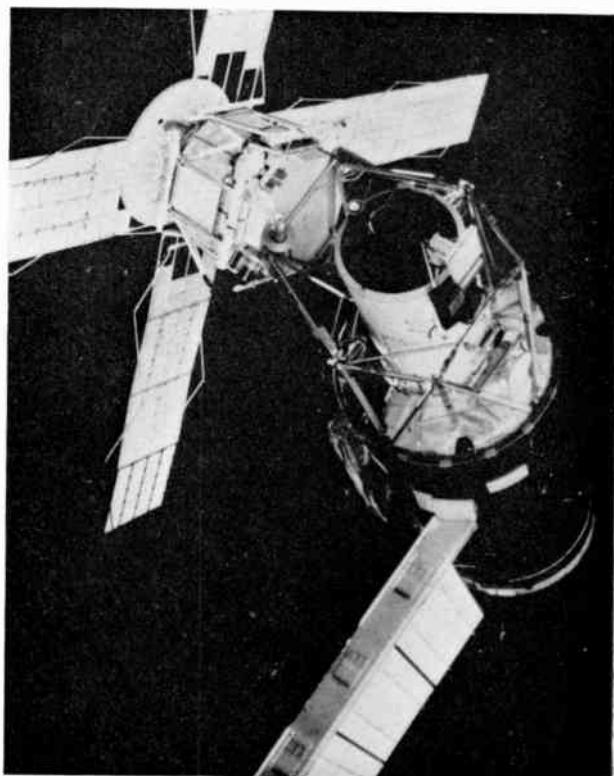

Fig. 3. The *Apollo* telescope mount used for optical and ultra-violet observations.

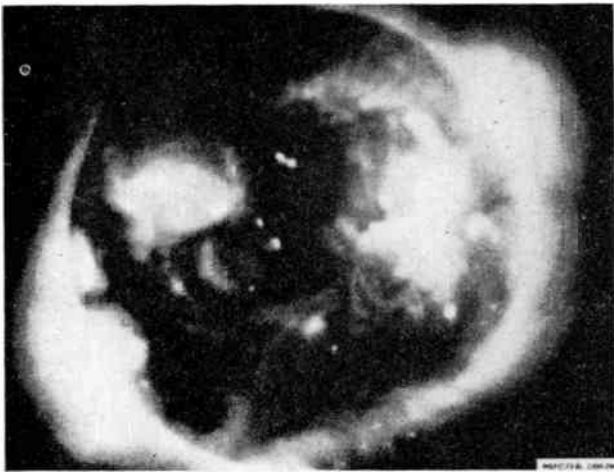

Fig. 4. X-ray photograph of solar corona taken by one of the ATM cameras.



Fig. 5. Spectroheliograph of a solar eruption.

observations on film while the seventh relied on telemetric transmission of photoelectric data. The six photographic instruments returned a total of 182,800 exposures of the Sun or the solar corona. The transmitted data are the equivalent of an additional 12,000 frames, mostly pictures taken in the extreme ultra-violet portion of the spectrum.

Figure 4 is a photograph taken with one of the ATM cameras of the Sun in the X-ray region. The black regions are 'coronal holes' which indicate the local absence of million-degree coronal gases radiating in the X-ray and extreme ultra-violet, and expose the much cooler solar surface beneath as black splotches. Coronal holes are now interpreted as regions in which the magnetic field lines leave the Sun radially rather than looping back to another spot on the Sun's surface. The resulting weak outbound radial fields are believed to serve as conduits for relatively low temperature gases puffed up by the sun's surface then streaming outward and ultimately forming the solar wind.

Nevertheless, some aspects of these gas eruptions are still shrouded in mystery. During the second *Skylab* mission, an eruption was photographed with the ATM spectroheliograph which showed a vast cloud of about 50,000 tons of helium gas stuck together to an altitude of about 500,000 miles (Fig. 5). At this distance, the cloud seemed to come to a rather abrupt standstill, as though blocked by an unseen wall, and some material appeared to return toward the Sun as a rain, distinguished by fine threads. Clearly, both magnetic and gravitational fields were at work here, but these curious forms defy explanations by the interaction between these fields alone and imply that there may have been additional factors involved.

Twenty-two *Skylab* experiments were conducted to study the effect of zero gravity on processes such as crystal growth or alloying a mix of normally uncooperative materials. In most of these experiments a solid cartridge of the test substance was inserted into the cavity of an electrically-heated furnace where it was radiation-heated to the melting point (Fig. 6). Due to the lack

of gravity, the melt would not form a puddle but rather hovered in the centre of the furnace, its wall contact limited to the opening through which the cartridge had been inserted. While melted, the sample's ingredients could intermingle in a much less inhibited fashion than under normal Earth conditions, as there were no gravity-driven forces such as sedimentation or convection tending to separate the heavier from the lighter elements. Thus the mixing would result purely from random diffusion. It was hoped that if the melt was then permitted to slowly resolidify under carefully controlled temperature conditions, some materials might form large and near-perfect crystals while others might form alloys that simply could not be produced on earth.

These expectations were more than borne out. For instance, an indium-antimonide crystal of unprecedented smoothness and perfection was created in the furnace (Fig. 7). By heating above vaporization temperature and subsequent cooling, germanium-selenium and germanium-tellurium crystals were made that were ten times as large and much more homogeneous than those grown in Earth laboratories.

All these exotic-sounding materials are semiconductors which, of course, form the heart of modern solid-state electronics. Size and performance of transistors, solid-state 'chips', switching devices and even rectifiers are limited by the industry's ability to produce larger and more perfect semiconductor crystals. *Skylab* results are considered so exciting that there is now much talk about continuing these semiconductor experiments during the joint U.S.-Soviet *Apollo-Soyuz* docking venture in 1975. In addition, a number of materials processing laboratory modules will be built for the new Space Shuttle.

No less successful were attempts to alloy material compositions called 'immiscible' because they refuse to mix on Earth due to gravity. Gold-germanium, lead-zinc-antimony and lead-tin-indium mixture were melted and resolidified under zero gravity and produced metallurgical regions of such fine dispersions that elated experimenters labelled them 'space mayonnaise'. Such alloys simply cannot be made in Earth laboratories.

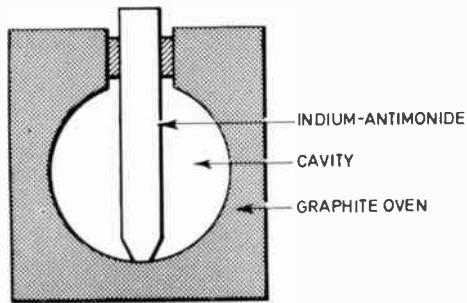

Fig. 6 (above). Furnace for melting metals by radiation heating in gravitationless conditions.

Fig. 7 (right). Indium antimonide crystal grown in a furnace of the type shown in Fig. 6.

Most of our technological prowess is based on a rather limited number of metal alloys which we use to build our bridges, aircraft, precision instruments or nuclear reactors. If the spectrum of available alloys could be widened, a new world may open up for us. But under gravity, liquid lead and liquid aluminium would not alloy any more than oil would mix with water.

Some alloys such as niobium/zinc become super-conductive when cooled down to the temperature of liquid helium. That means their electric resistance drops to absolute zero. The electrons whirling through a super-conductive coil wound around an electromagnet, for instance, keep whirling even after the power cord has been unplugged. Imagine if we could learn how to produce in future zero-gravity experimentation an alloy that was super-conductive at room temperature! (There is nothing in the book that says this is physically impossible.) We could then convey vast amounts of electrical energy from a utility safely located in a remote area to a densely populated urban-industrial district with zero loss. Maybe one day we would even have automobiles without gas tanks. A multi-million ampere current whirling around through a few superconductive coils in our car would replace the gasoline and serve as energy storage. The current would be slowly drained while driving and the coils would be reloaded with electrons by plugging the car into a wall outlet in the garage.

Dreamstuff? Maybe. But dreams are the bases of all real advances. Today, with the scarcity of natural resources and the energy crunch upon us, people expect scientists and technologists once again to pull the rabbit out of the hat and work miracles. It could well be that posterity will say that *Skylab* helped to put the rabbit into the hat.

Stunningly beautiful pictures, taken with hand-held cameras by the early *Gemini* and *Apollo* astronauts, rendered convincing proof that systematic earth observation from orbit should be of great value to many human activities. Figure 8 shows the Sinai Peninsula, the Red Sea and Eastern Egypt. Such results encouraged physicists to develop an imaging technique that would provide

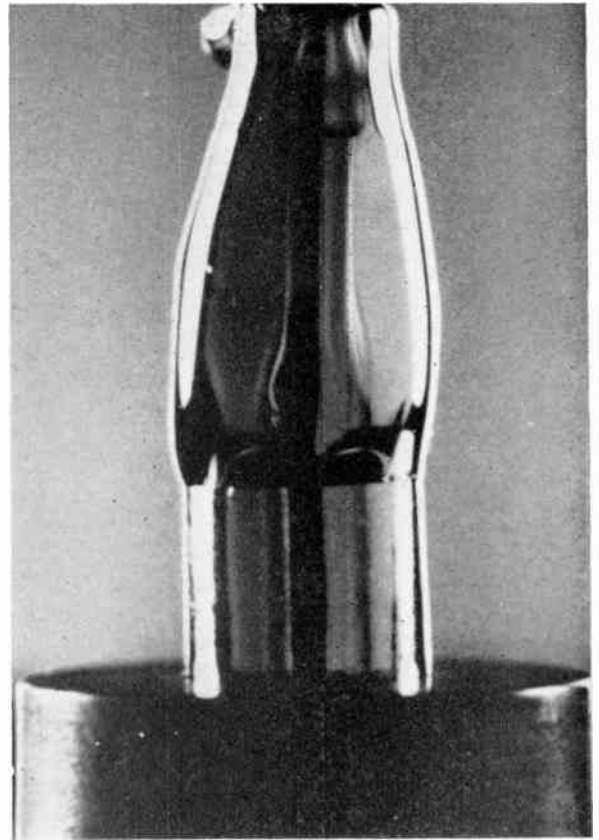

more information by utilizing the different reflectivities of the photographed terrain in various bands of the spectrum. Figure 9 shows the principle of such a multi-spectral scanner. As the satellite moves through its orbit at a speed of nearly five miles per second, an oscillating mirror scans a swath of land underneath about 20 miles wide. An ever-changing image corresponding to an area of 250 feet diameter is continuously focused onto the flat



Fig. 8. Photograph taken from orbit.

ends of a fibre-optics bundle which feeds the impinging light to a number of spectral filters. Behind each filter sits a photomultiplier which produces a continuous electrical current directly proportional to the light intensity received from the ground target in the spectral region passed by the respective filter.

Using classical television techniques, these currents can now be assembled into black-and-white lantern slides which portray the terrain's reflective properties in a particular spectral region. By projecting light beams of different colours through these different black-and-white diapositives, we can assemble a multicoloured rendition of the overflow terrain with a much greater information content than a simple visible-light or infra-red photograph (Fig. 10).

It has been demonstrated that this method is powerful enough to discern, from orbit, a rye from a wheat field, a cotton patch from a rice paddy, or a deciduous from a coniferous forest. And since a typical survey satellite, whether manned like *Skylab* or unmanned like our Earth Resources Technology Satellite *ERTS-1*, orbits the Earth about eighteen times a day, it can conduct such surveys on a global scale. With the help of calibration farms in different parts of the world, even the expected crop yield can be predicted with great accuracy.

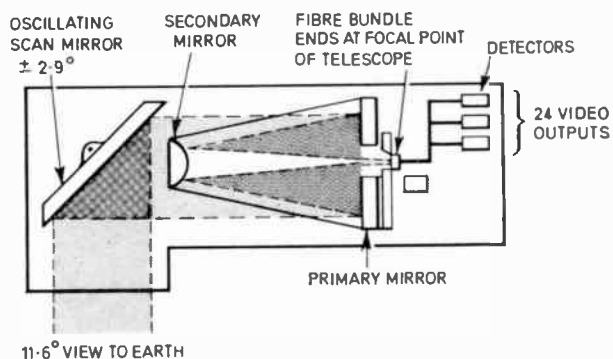

Fig. 9. Diagrammatic representation of a multispectral scanner.

It would appear that in a world plagued by regional population explosions, by inability of developing countries to buy an adequate amount of fertilizer and resulting widespread starvation, a global survey system that can continuously inform us on the available supplies will be of inestimable value. The continuous global surveys will, at the same time, provide up-to-date information on the movement of new people into urban areas and previous unsettled regions of the world. Thus, it will provide us with the two essential pieces of information for a future

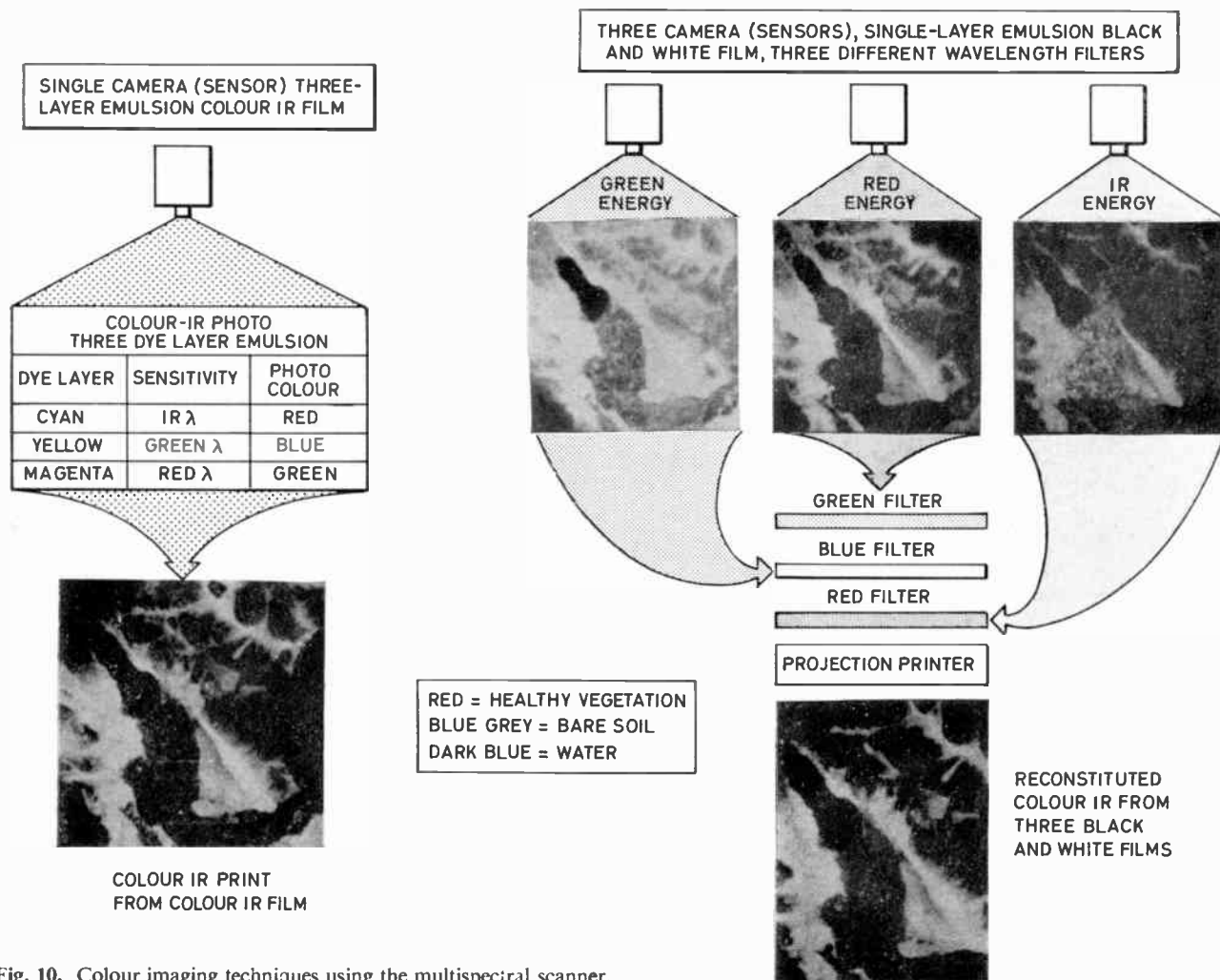

Fig. 10. Colour imaging techniques using the multispectral scanner.

world-wide resources management system, namely the supply and the demand: Where is the food to feed and the raw material to support jobs for the world's growing population? And where are the hungry mouths that must be fed and the hands that want to be employed?

### The Reusable Space Shuttle

NASA's largest post-*Apollo* space technology project is the Reusable Space Shuttle. Thus far, all space launches, whether manned or unmanned, have been conducted with one-shot rockets which irretrievably dropped their stages into the ocean as they thrust their payloads into orbit and beyond. From the cost standpoint, this method is about as effective as throwing your airliner away after a single flight. Space engineers have always dreamed of a vehicle that could fly into orbit, return to Earth, refuel and do it again—maybe hundreds of times. But the catch is that orbital speed is about 24 times as high as the speed of sound, and it takes an awful lot of fuel to build up such speeds.

After many years of study, NASA finally came up with the configuration shown in Fig. 11: a reusable aircraft-like 'orbiter', about the size of a small commercial jetliner, to which a large tank for liquid hydrogen and liquid oxygen is strapped. These propellants are used by three rocket engines mounted in the orbiter's tail. Attached to the large tank are two powerful, solid-fuel rockets which assist the orbiter's engines until a speed of approximately Mach number 5 has been attained.



Fig. 11. The Reusable Space Shuttle mounted on its booster rockets.

At this point, the booster rockets are exhausted, separated and ultimately parachuted into the ocean for reloading and repeated use. The orbiter with its external tank forges ahead until it reaches very nearly orbital speed. Its tail engines are now shut off and the big tank is detached and allowed to re-enter the atmosphere where it will burn up like a shooting star. A small orbital manoeuvring unit, burning storable propellants carried inside the orbiter, will then ease the orbiter into a stable orbit where it may remain for periods of up to two weeks.

Upon completion of its space mission, the orbiter deboosts itself back into the atmosphere, performs a long-stretched hypersonic and supersonic glide and slows

down to subsonic speed. It ultimately lands on a runway like an airliner.

On the ground, the payload can be exchanged for another one. The Shuttle's large cargo bay (Fig. 12) can accommodate a payload the size of a large cross-country bus; maximum payload weight is 65,000 pounds (30 tonnes). After the new payload has been loaded into the hatch, the orbiter is mated to a new external tank and to two reloaded boost rockets. Two weeks after return to Earth, it is ready for another flight.

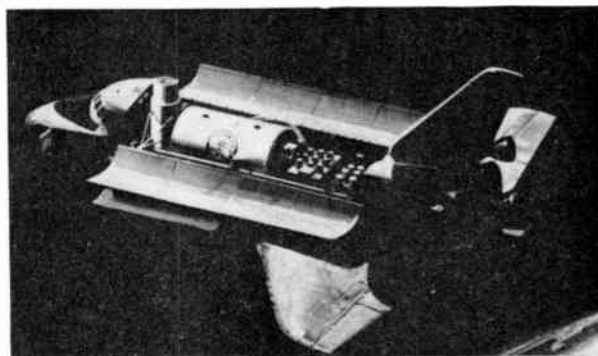

Fig. 12. Space Shuttle with *Spacelab* docking module and experiment pallets.

With conventional, non-reusable space launch vehicles, it costs approximately \$500.00 to orbit one pound of net payload, and about \$1,000.00 if we want that payload back. The Shuttle is designed to fly a pound of payload up and back for about \$160.00. This improvement in cost-effectiveness is hoped to open up space for many scientific, economical and industrial pursuits for which it is simply too expensive today.

Once operational, the Space Shuttle will fly many unmanned spacecraft to orbit. These spacecraft can be carefully monitored while being activated in orbit and they can be returned to earth if found faulty. But, the most important use of the Shuttle will be in support of manned scientific and exploratory work. Various types of palletized laboratory modules, for activities in fields such as astronomy, medicine, biology, resource prospecting, oceanography and meteorology, can be placed in the orbiter's cargo bay. Their operators need not be astronauts as the Shuttle is designed to support orbital activities for anyone qualified to ride an airliner as a passenger. You have undoubtedly heard that the basic laboratory module is being developed here in Europe under the auspices of ESRO, the European Space Research Organization.

One of the most promising cargo modules for the Shuttle will be the Large Space Telescope (LST), a 3-metre telescope that can be aimed at any point in the sky with an accuracy of one-tenth of a second of arc (Fig. 13). The LST will be built for a lifetime of over 30 years, and as no one knows what the most interesting objects of celestial research will be that far out in the future, it must be a highly flexible instrument. It will normally be used in the unmanned mode, but after

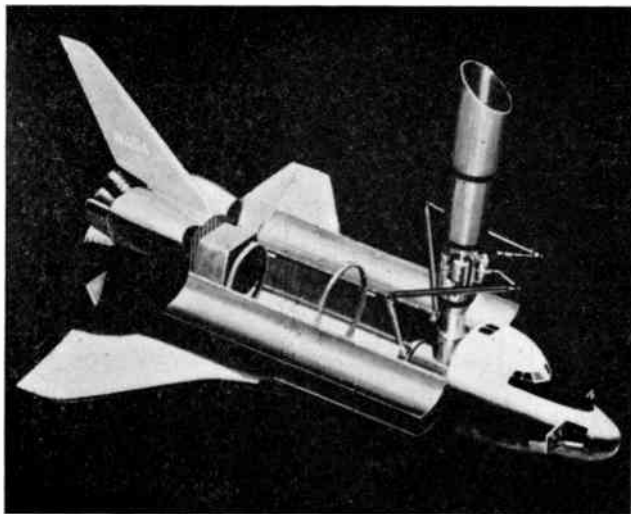

Fig. 13. The large space telescope as carried into orbit by a Space Shuttle vehicle. Its dimensions can be appreciated when related to the astronaut shown working on the exterior just above the Shuttle's crew section.

completion of each scientific mission assignment it will be revisited by Shuttle-borne scientists and technicians, who may replace a camera by a spectrograph or a photomultiplier, or who may fix a sticky attitude gyro. They will then set it up for its next assignment.

Beyond the Earth, there still beckons Mars, the red planet. Photographs taken by *Mariner 9* have shown that Mars clearly has a far more active recent geological history than most people had expected. Figure 14(a) shows a canyon on Mars twice as deep and twice as wide as the Grand Canyon in Arizona, and on Fig. 14(b) is Nix Olympica, the largest known volcano in our Solar System—300 miles in diameter and 6000 metres high.

In 1975 the United States plans to send the first two *Viking* soft-landing, unmanned spacecraft to Mars. One of their most intriguing tasks will be the search for life and by 1976, we should know whether a visit to Mars by man is warranted to follow up with a detailed exploration.

NASA has a complete blueprint for such a manned expedition to Mars, but at this time this is not an approved and budgeted project. All elements, propellants and crews will be carried into an earth orbit by a series of flights of the reusable shuttle vehicle plus two remaining *Saturn V* flights for extra large payload units. The interplanetary expedition will consist of 12 men travelling in two ships which fly in formation. Departing from Earth orbit, the two ships will be thrust into a circumsolar orbit by nuclear-rocket engines. Two-hundred and seventy days later the two ships will be deboosted by a second burst from their own nuclear rocket engines into an orbit around Mars.

They will stay there for a period of eighty days during which surface excursions will be made with a chemical-powered two-stage rocket, a Martian equivalent of the Lunar Module that carried the *Apollo* astronauts from lunar orbit to the Moon's surface and back. For the return flight to Earth, the interplanetary ships' nuclear engines will be turned on for a third time.

The homebound flight will pass close enough to the planet Venus to dispatch two unmanned radio-equipped probes into the Venusian atmosphere. At the same time, Venus's gravitational field will be strategically utilized to reduce the speed at which the ships re-enter the gravitational field of the Earth.

The ships will finally settle, with the help of another blast by the nuclear rocket engines, in an orbit around the Earth, and will be able, after refuelling, restocking with supplies and a thorough checkout, to be used again for

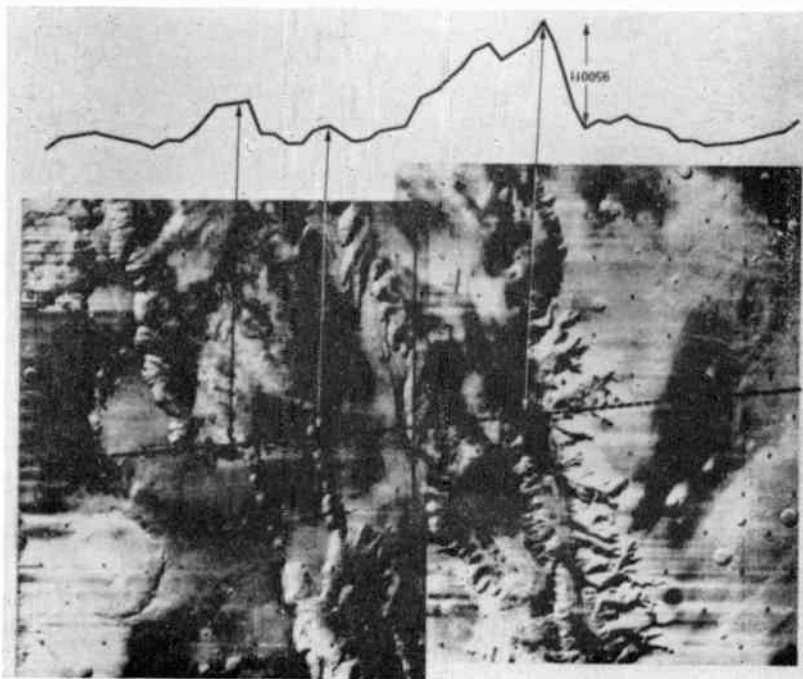

(a)



(b)

Fig. 14. Photographs of Mars taken by *Mariner 9*.



another voyage to Mars. Total round-trip will be 640 days or nearly two years.

A heavy prototype of the nuclear engine required for such a voyage has already performed a number of highly successful static tests. And the spacecraft, in which the astronauts will live for most of their absence from Earth is nothing but a single of those shuttle-compatible modules that will meanwhile have been developed as building blocks for an earth-orbital space station.

### Epilogue

Further out there are the other planets of our solar system. Unlike Alexander the Great, who wept when he reached the Indian Ocean because there were no new worlds for him to conquer, our astronauts can go on and on with their peaceful conquest.

During the Renaissance, Prince Henry the Navigator of Portugal established in his seaside castle of Sagres the closest precedent to what NASA is trying to accomplish in our time. He systematically collected maps, ship designs and navigational instruments from all over the world. He attracted Portugal's most experienced mariners. He laid out a step-by-step programme aimed at the exploration of Africa's Atlantic coast and the discovery of Africa's southernmost tip, which he knew had to be circumnavigated if India were to be reached by the sea. With equal determination he pushed for the possibly

shorter west-bound route to the Far East. Prince Henry trained the astronauts of his time, men like Ferdinand Magellan and Vasco de Gama, and he created the exploratory environment that launched Columbus from neighbouring Spain on his historical voyage.

Self-centred, medieval Europe was subsequently turned into an outgoing, exploring and expanding continent. England became a different place and spread the benefits of the scientific and industrial revolution around the globe after men like Sir Francis Drake or Sir Walter Raleigh followed in the footsteps of the Portuguese and Spanish navigators. As a direct result of this age of exploration which opened their eyes and revamped their standards, Europeans and their American off-spring have led the world ever since in intellectual dynamism.

Henry the Navigator would have been hard put had he been requested to justify his actions on a rational basis, or to predict the payoff or cost-effectiveness of his programme of exploration. He committed an act of faith and the world became richer and more beautiful as a result of his programme. Exploration of space is the challenge of our day. If we continue to put our faith in it and pursue it, it will reward us handsomely.

*Manuscript received by the Institution on 21st March 1974. (Address No. 48.)*

© The Institution of Electronic and Radio Engineers, 1974

## The Author

Dr. Wernher von Braun is now Vice-President of Engineering and Development with Fairchild Industries, Germantown, Maryland, USA. He was formerly Deputy Associate Administrator of the National Aeronautics and Space Administration, Washington D.C.

He was born in 1912 and studied at the University of Berlin where he obtained his doctorate. His interest in space exploration dates back to 1930 when he first started experimenting with liquid fuel rockets. During the 'thirties he was a member of the German Rocket Society and during the Second World War he worked at the Rocket Research Station at Peenemunde.

In 1945 Dr. von Braun went to the USA and for the next five years he was Project Director of Guided Missile Development at Fort Bliss, Texas, and also advisor for V-2 test firings at the White Sands Proving Ground, New Mexico. In 1950 he moved to the Redstone Arsenal where he remained for the

next ten years, initially as Technical Director in charge of the Guided Missile Development Division and from 1956 to 1960 as Director of the Ballistic Missile Agency. When the US space programme was initiated by NASA he was appointed Director of the George C. Marshall Space Flight Center at Huntsville, Alabama, and in this capacity he was responsible for the development of a series of powerful satellite launchers. After ten years at Huntsville, Dr. von Braun moved to NASA Headquarters in Washington, from where he retired two years ago.

Dr. von Braun is a Member of the International Academy of Astronautics and the National Academy of Engineering; he is a Fellow of the American Astronautical Society and an Honorary Fellow of the American Institute for Aeronautics and Astronautics. He was awarded the Langley Medal by the Smithsonian Institution in 1967, and is the holder of several honorary degrees.

# The Eighth Clerk Maxwell Memorial Lecture

## London: 21st March 1974

Before the lecture the IERE President, Dr. Ieuan Maddock (left) talks with Dr. von Braun and Mr. G. D. Clifford, Director of the Institution (centre).

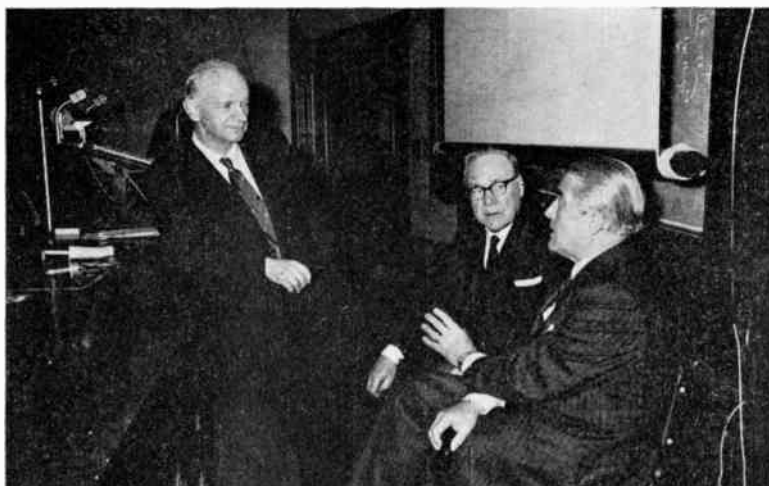

Of the seven previous Clerk Maxwell Memorial Lectures, five have been given at either Oxford or Cambridge during Institution Conventions and two in London. None of these venues however was quite so well attended as was the London School of Hygiene and Tropical Medicine when Dr. Wernher von Braun spoke on 'Our Space Programme after *Apollo*'. The normal seating capacity of the Theatre was quickly filled, and extra chairs and permitted standing room occupied well before the lecture was due to start, and several dozen latecomers had to be turned away.

Those who crammed the Theatre first heard the President, Dr. Ieuan Maddock, introduce Dr. von Braun. He reminded them of the great contributions to rocketry which the lecturer had made, first in Germany before and during the Second World War, and later in the USA, in making it possible for man first to venture into space and then to land on the Moon.

The lecture, delivered with a dry wit and occasional topical asides which delighted the audience, was embellished with numerous slides, mostly in natural colour which did justice to the spectacular beauty of the Earth and heavens that has been revealed by space exploration. To conclude his presentation, Dr. von Braun showed two films, the first describing the Reusable Space Shuttle project and the second consisting of an unedited sequence of pictures taken by the *Skylab* crew; the latter gave a far more convincing idea than has many a more polished production of what it is really like in space and particularly the effects of zero gravity.

The appreciation of those present for a memorable lecture was aptly voiced by Mr. L. H. Bedford, President of the Institution from 1948-50, and himself a guided missile engineer. It was at his suggestion that the Institution established the Clerk Maxwell Memorial Lectures in 1951.



Dr. von Braun and a few of his audience. Third from the left in the front row is Mr. L. H. Bedford, a Past President of the IERE, and to his left and right respectively are two Vice Presidents of the Institution, Dr. P. A. Allaway and Professor W. Gosling.

# Track straightness in helical scan video tape recorders

YUJI WADA, B.Sc.\*

*Based on a paper presented at the IERE Conference on Video and Data Recording held at Loughborough on 10th to 12th July 1973*

## SUMMARY

This paper describes a way of achieving interchangeability of tapes recorded on helical scan video tape recorders and lays stress on the shape of the trace of the video head actually recorded on the tape. It describes a method of measuring straightness of track that has been used in a factory producing cassette v.t.r.s.

\*Manager, Video Division, Sony Corporation, P.O. Box 10, Tokyo Airport Post Office, Tokyo 149.

## 1 Introduction: Governing Factors of V.T.R. Playback Picture Quality

When considering the design of a video tape recorder, several different factors have to be taken into account in order to ensure good picture quality when recorded tapes are played back by different machines. The two major considerations are:

- (a) the video signal recording system,
- and (b) the video track format.

The major parameters of a video recording system are:

- (i) frequency and deviation of f.m. carrier,
- (ii) recording chrominance subcarrier frequency,
- (iii) recording system of control signal.

The characteristics of the playback circuit are left free to be determined by each design engineer in whatever way he feels the best picture quality can be obtained. Therefore, playback circuit characteristics vary fairly widely whereas recording circuit characteristics are based on standard specifications. (Some of the difficulties encountered can be more easily resolved if the machine is designed for one particular tape type only.)

Video track format is very closely related to tracing interchangeability and although the requirements are determined in detail, realization is not as simple as in the case of the electrical characteristics because of the variations between different manufacturers' designs and between types of machines. Differences in the methods of construction of tape transport mechanism, tape guiding, drum guide surface treatment, drum assembly part machining and differences in the level of assembly technology all affect interchangeability requirements. Since there can even be differences between the machines of the same type made by the same manufacturers it can be seen that achievement of perfect interchangeability is very difficult in practice.

In this paper an investigation of design procedure for tape format, method of measuring straightness and results, is made based on the Sony 'U-matic' PAL system.

## 2 Tape Format and Video Track Straightness

In general, the following items are determined in the tape format specification for a video tape recorder. (Fig. 1). The values given are for the 'U-matic' PAL system.

drum diameter	$\phi$	110 mm
tape speed	$V_t$	95.3 mm/s
video track pitch	$P$	0.165 mm
video track angle (on the stationary tape)	$\theta_0$	4°54'49.1"
video track angle (on the moving tape)	$\theta$	4°58'06.2"
video width (one field)	$W$	14.8 mm
distance of video track centre (from reference edge of tape)		10.45 mm
control head distance ( $X$ is distance on tape between end of 180° scan point of video head and control head)	$X$	74 mm
number of fields per second	$f_v$	50.0

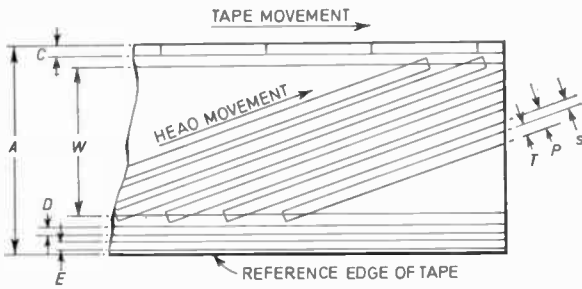

Fig. 1. Magnetic tape format.

A	tape width	19.00 mm
W	video width (one field)	14.8 mm
C	control track	0.6 mm
D	audio track (ch-2)	0.8 mm
E	audio track (ch-1)	0.8 mm
P	video track pitch	0.165 mm
T	video track width	0.085 mm
S	video guard bandwidth	0.080 mm

With the drum diameter, tape speed, video width, distance of video track centre and control head distance fixed, the video track angle on the stationary tape, the video track angle on tape in motion and also the video track pitch can be calculated.

2.1 Video Track Angle on Stationary Tape,  $\theta_0$

The video track angle can be calculated from the drum diameter and the video width (Fig. 2).

$$AB = \frac{110\pi}{2} = 172.78760 \text{ mm}$$

$$\sin \theta_0 = \frac{BC}{AB} = \frac{14.8}{172.78760} = 0.085654297$$

Therefore,  $\theta_0 = 4^\circ 54' 49.1''$

2.2 Video Track Angle on Moving Tape,  $\theta$

$$BC = 14.8$$

$$AA' = \frac{V_t}{v} = \frac{95.3}{50} = 1.90600000 \text{ mm}$$

$$AC = AB \times \cos \theta_0 = 172.15258723 \text{ mm}$$

$$A'C = AC - AA' = 170.24658723 \text{ mm}$$

$$\tan \theta = \frac{BC}{A'C} = 0.086932726$$

Therefore,  $\theta = 4^\circ 58' 06.2''$

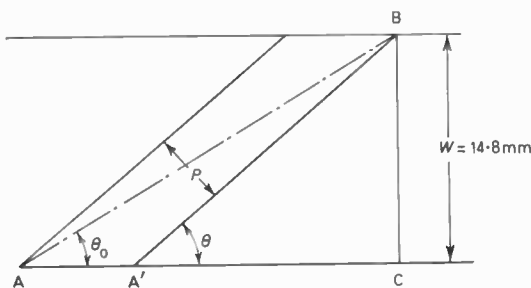

Fig. 2. Video track angles on stationary and moving tape.

2.3 Video Track Pitch P

$$P = AA' \times \sin \theta = 0.165071204$$

Angle of tapered guide on the drum is arranged to be the same as the video track angle,  $\theta_0$ , on stationary tape.

2.4 Video Track Straightness

In order to maintain tracking interchangeability, the shape of the recorded video track on the tape need not be straight providing that the same shape is maintained on all machines but special shapes require special mechanical construction of the tape transport and narrow the freedom of design, thus hindering technical improvements.

The video track is found to be almost straight if a tape guiding mechanism is used which will maintain smooth tape running. The 'U-matic' is based on this philosophy, and the actual straightness of the track is determined by a displacement measurement from an ideal straight line.

2.5 Control Head Distance

The positioning of the control head, which records and plays back the reference signal for controlling the tracking servo circuit is very important. This distance, 'X', which is measured on the recorded tape as the distance between the end of 180° scan point of video head and

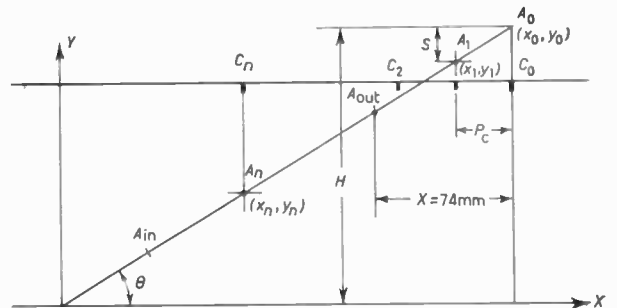

Fig. 3. Determination of track straightness.

control head pulse, is 74 mm. If this position differs from machine to machine, even though the track straightness is exact, mistracking will result, and the reproduced picture will be very noisy or unstable in colour reproduction.

3 Methods of Ensuring Video Track Straightness and Correction of Control Head Positioning

Studies of tape patterns on helical scan video tape recorders have already been made.† In general, during manufacture, tracking tape is used as the reference for tape transport alignment. The envelope of the reproduced r.f. signal from the tracking tape is made flat over the whole trace of the video head by adjusting the tape transport mechanism.

The method which is used in the Sony factory to measure the straightness of the track of this tracking tape will now be described. Figure 3 shows the theoretical

† Hirano, M., 'Study of tape patterns on helical scan VTR', *J. Inst. Telev. Engrs Japan*, August 1972.

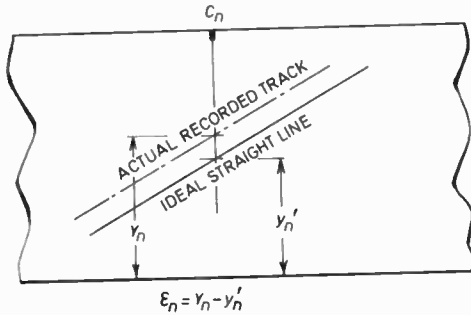

Fig. 4. Deviation of recorded track from ideal straight line.

video track pattern based on specification of tape format. Now one complete video track is taken up, with the end of the 180° scan point of the video head being designated  $A_{out}$  with the control track signal point being designed  $C_0$ .

A co-ordinate such as that shown in Fig. 3 is drawn and a perpendicular from the  $C_n$ th control signal toward the lower edge of the tape (the lower edge will be used as the reference of tape transport) and the crossing point of this perpendicular and video track is designated  $A_n(x_n, y_n)$ . When the tape speed is exactly 95.3 mm/s, the height of  $A_n$  point  $y_n$  is

$$y_n = H - ns \tag{1}$$

If tape speed has deviation of  $\Delta V_t$ , taking  $C$  as the correcting coefficient of tape speed, then

$$C = V_t / (V_t + \Delta V_t)$$

The height of  $A_n$  point with the tape speed deviation of  $\Delta V_t$  can be written

$$y'_n = H - n \frac{s}{C} \tag{2}$$

where  $y'_n$  is the ideal height of  $A_n$  from reference edge when speed variation is  $V_t$ . We now define  $\epsilon_n$  in Fig. 4 as:

$$\epsilon_n = Y_n - y'_n$$

(where  $Y_n$  is the actual height of  $A'_n$  from reference edge) and term it 'straightness at the point  $A_n$ , which shows the actual track deviation from the theoretical straight track.

It is too difficult to measure  $Y_1, Y_2 \dots Y_n$  on a particular track; therefore a perpendicular is dropped from a control pulse to the lower edge of the tape and a measurement made from this edge to each video track along the perpendicular. These lengths correspond to  $\dots Y_n, Y_{n-1}, Y_{n-2} \dots$  etc. on the tracks.

Then  $\epsilon_n$  can be obtained as follows:

$$\epsilon_n = Y_n - y'_n = Y_n - \left( H - n \frac{s}{C} \right) \tag{3}$$

where  $H = (\text{height of } A_{out}) + X \tan \theta$  ( $X = \text{distance of control track pulse from video track}$ ). Now height of  $A_{out} = \text{distance of centre of video track from reference edge together with half the video width} = 10.45 + 14.8/2 = 17.85 \text{ mm}$ . Therefore

$$H = 17.85 + 74 \times 0.086932726 = 24.2830 \text{ mm}$$

also

$$s = 2 (V_t / f_v) \tan \theta$$

$$= 2 (95.3/50) \times 0.086932726 = 0.331387 \text{ mm}$$

Measurement is made over the video width of 14.8 mm. The closest perpendicular to  $A_{out}$  is the 19th, whose height  $y_{19} = 17.9867$ , and that closest to  $A_{in}$  is the 64th whose height  $y_{64} = 3.0742$ . Measurement will be by optical microscope, and the height of the track will be measured from the reference lower tape edge.

If we now rename  $Y_{64}$  as  $Y_1$  and rename  $Y_{19}$  as  $Y_{46}$ , we may rewrite (3) as

$$\epsilon_i = Y_i - H + (65 - i)s/C \tag{4}$$

where  $i = 65 - n$

By the above measurement, tracking tape for alignment can be measured and the amount of deviation from the ideal straight line,  $\epsilon_i$ , can be calculated and plotted on a graph. Figure 6 shows the deviation from the theoretical value and also shows the practical position of control head.

#### 4 Effect of Mistracking on Picture Quality

When a recorded tape is played back on a machine with a different playback pattern, the reproduced r.f. waveform may be uneven. An example is shown in Fig. 5. Disturbance of picture quality caused by mistracking can be explained as follows:

Part A: The part where the r.f. output level is nil or almost nil gives random noise on luminance and chrominance, and the picture on the monitor receiver will not synchronize.

Part B: This is partly unstable but the monitor receiver will synchronize with difficulty. Picture very noisy. The permissible r.f. output level for acceptable picture quality depends on noise level of play-back amplifier, limiter gain, a.f.c. characteristic of monitor receiver, threshold of colour killer and setting level of a.c.c. circuit and many other factors which makes it difficult to determine precisely. But generally speaking - 6 dB for the luminance signal and - 3 dB for the chrominance signal will be the critical point. For the U-matic, which uses 85  $\mu\text{m}$  track width, maximum partial permissible mistracking will be about 45  $\mu\text{m}$ .

Part C: Good picture quality. In general, within 3 dB deviation to the normal output, there is no tape interchangeability problem, but a sudden drop of play-back signal, of say within 0.1 ms, will adversely effect picture quality even if there is a deviation of only 1 dB. The decrease of about 3 dB will not affect picture quality very much, but naturally, if it is compared with the best tracking picture, there is a certain difference in the quality; this is because of the poorer carrier/noise ratio. With the noise source remaining the same, if the signal

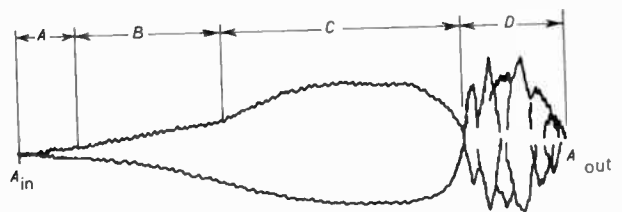

Fig. 5. Reproduced r.f. waveform.

component diminishes, the carrier-to-noise ratio becomes poorer and so does picture quality. Noise sources are:

- (i) Play-back amplifier noise.
- (ii) Tape modulation noise.
- (iii) Head pressure noise.
- (iv) Capacitively or inductively picked up noises.

Part D: When the mistracking increases to the stage of picking up adjoining track information, two carriers will beat with each other and cause disturbances in the play-back picture. With frequency modulation recording systems, this kind of beat disturbance is most annoying. Usually interchangeability is determined by whether this beat component exists or not.

### 5 Checking the Results of Straightness Measurements

Figure 6 shows video track straightness on three different parts of a recorded tape. The recorded tracks were rendered visible by wet processing of magnetic powder in order that this could be drawn. The three curves show three different parts of the tape within a cassette. Ideally those three curves should be coincident, but this may be prevented for the following reasons:

- (i) Weaving of tape edge.
- (ii) Weaving of tape itself caused by the tape transport and tape guides.
- (iii) Error caused by measurement.
- (iv) Deviation of tape width.

Item (iii) has nothing to do with tape interchangeability, but an allowance of about 2–3  $\mu\text{m}$  of measurement error has to be made at present.

The most important factor for interchangeability is item (ii), and if the correlation of the three straightness curves is poor, this will result in a level variation when the tape is interchanged. Theoretically, if the control head is placed in the exact position (as measured from the end of 180° scan of video track) it will meet with the specification, but if the video track is bent at the end of 180° scan, it is meaningless to adjust tracking at that point; therefore, the control head should be placed where the centre part of the video track gives the maximum output.

Accordingly, if the deviation at the centre part of the track from the reference line is taken as the 'deviation of video track centre', this value indicates the displacement of control head positioning. It is convenient to use the difference between the maximum value and the minimum value of the vertical axis of the track pattern of this figure as the definition of straightness.

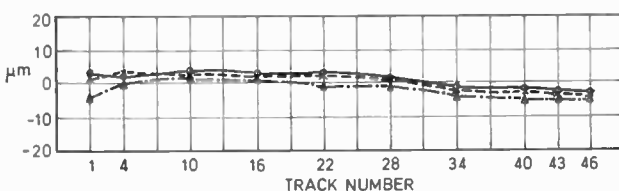

Fig. 6. Straightness of video track.

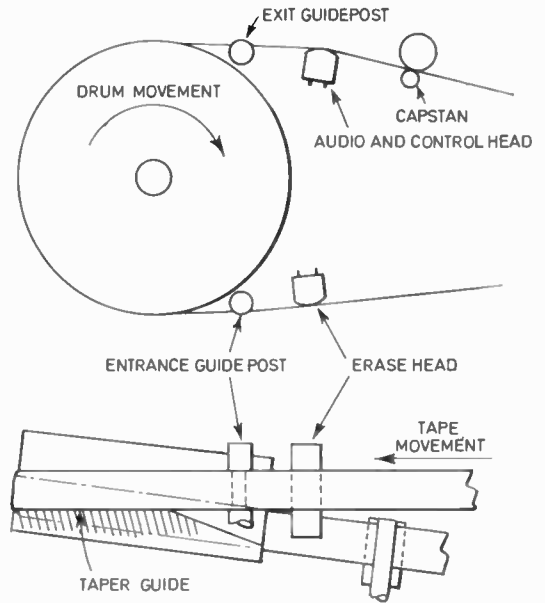

Fig. 7. Tape transport mechanism.

### 6 Straightness Needed to Ensure Tracking Interchangeability in Ordinary Video Tape Recorders

Each manufacturer tries to maintain track interchangeability using his own method of tape path adjustment. For the 'U-matic', tracking tape for tape path alignment is played back, and the reproduced r.f. envelope is corrected by adjustment of guides, which determine the tape path, to achieve the 'flat' characteristic. It could be considered that the track straightness of a machine is exactly the same as that of the tracking tape if the tracking tape gives a flat envelope. Therefore, if the straightness of the tracking tape is strictly controlled, machines which are adjusted using that tracking tape should be compatible as far as interchangeability is concerned.

Even if the track straightness of the tracking tapes is strictly controlled to within 10  $\mu\text{m}$  of straightness, the machines which are adjusted using these tracking tapes will still vary slightly. It is very important to decide how much deviation from the ideal can be allowed while still assuring tape interchangeability. For the 'U-matic', track straightness is kept within 25  $\mu\text{m}$ , and within this straightness limit there is complete interchangeability without noticeable deterioration of picture quality.

### 7 Recorded Video Track Curve Shapes

Video track straightness of the normally adjusted video tape recorder depends directly upon the straightness of the taper guide which is mounted on the lower side of the drum surface. This is because the tape path is adjusted so that the lower edge of the tape will run along the upper edge of the taper guide (Fig. 7). The tape itself is made of polyester with a thickness of 20–30  $\mu\text{m}$ , and it will bend easily when a force is applied across its width. The downward force needed for stable tape running along the taper guide could be obtained by providing an upper rotating drum of slightly larger diameter and also

using the drum input and output guideposts, or by suitable alignment of erase head and audio head. If, through application of these measures, too much guiding force results, the tape will bend slightly across its width. The recorded tape produced under these conditions can be shown to have video track curves which deviate from the ideal as described below.

7.1 Excessive Force at Input Side of Video Head

If the input side tape guidepost exerts too much force, the tape will curl outwards and the actual recorded track will be higher than the intended position. When the straightness is measured, an upward bend in the pattern at the input side of the video head will be noticed.

7.2 Incorrect Adjustment at Output Side of Video Head

At the output side of the video head, the tape will tend to float due to the rotating drum. The output guidepost is adjusted to prevent this floating, but if the adjustment is not correct the tape will float a little at the output side of video head and the actual recording on the tape will be made lower than it should be. As a result, the measured pattern will show a downward bend at the output side of the video head.

7.3 An Arc-shaped Pattern

If both input and output guide are adjusted to give too much force, the tape has a tendency to float at the centre part of the taper guide. In this case, the tape pattern will appear as a downward arc.

7.4 Bent Towards the Right Side

If, during assembly of the head drum, the drum shaft is inclined toward the head output direction compared with the reference surface of the lower drum, even though the tape transport is adjusted to run along the taper guide, the measured pattern will tilt downward to the right.

7.5 Instability of Tape Pattern

When several parts of the tape are measured and show different curves, this is caused by 'weaving' of tape during motion, as previously mentioned. This can be caused not only by weaving of the tape width itself but also by unstable tape back tension or by an inclined rotating drum and vibration of the axis. Machines with these faults give an unstable picture with a large amount of jitter.

8 Conclusions

The importance of video track straightness for the interchangeability of tape has been discussed in detail based on the 'U-matic' system; but this applies not only for the 'U-matic' system but also to all kinds of helical scan video tape recorders. Ensuring perfect tracking interchangeability between all types of video tape recorder will make the video tape recorder a real consumer product and will help greatly in increasing its popularity.

*Manuscript first received by the Institution on 15th March 1973 and in final form on 6th April 1973 (Paper No. 1588/Com 91).*

© The Institution of Electronic and Radio Engineers, 1974

STANDARD FREQUENCY TRANSMISSIONS—April 1974

(Communication from the National Physical Laboratory)

April 1974	Deviation from nominal frequency in parts in 10 <sup>10</sup> (24-hour mean centred on 0300 UT)			Relative phase readings in microseconds NPL—Station (Readings at 1500 UT)		April 1974	Deviation from nominal frequency in parts in 10 <sup>10</sup> (24-hour mean centred on 0300 UT)			Relative phase readings in microseconds NPL—Station (Readings at 1500 UT)	
	GBR 16 kHz	MSF 60 kHz	Droitwich 200 kHz	*GBR 16 kHz	†MSF 60 kHz		GBR 16 kHz	MSF 60 kHz	Droitwich 200 kHz	*GBR 16 kHz	†MSF 60 kHz
1	—	—	-0.1	—	—	17	0	0	-0.1	699	600.3
2	—	—	-0.1	—	—	18	0	0	-0.1	699	600.5
3	—	—	-0.2	—	—	19	-0.1	-0.1	-0.1	700	601.0
4	—	—	-0.1	—	—	20	0	0	-0.2	700	601.3
5	—	—	-0.1	—	—	21	0	0	-0.2	700	601.6
6	—	—	-0.1	—	—	22	-0.1	0	-0.1	701	601.8
7	+0.1	+0.1	-0.2	699	598.4	23	0	-0.1	0	701	602.4
8	0	0	-0.2	699	598.6	24	0	0	0	701	603.2
9	+0.1	+0.1	-0.2	698	598.7	25	0	0	-0.1	701	603.0
10	0	0	-0.2	698	599.2	26	0	0	-0.1	701	603.6
11	0	0	-0.2	698	599.5	27	0	0	-0.1	701	603.8
12	0	0	-0.2	698	599.4	28	0	0	0	701	603.6
13	-0.1	0	-0.1	699	599.6	29	0	0	-0.1	701	603.6
14	0	0	-0.2	699	599.6	30	0	0	-0.1	701	603.4
15	0	0	-0.3	699	600.2						
16	0	0	-0.2	699	600.3						

All measurements in terms of H-P Caesium Standard No. 334, which agrees with the NPL Caesium Standard to 1 part in 10<sup>11</sup>.

\* Relative to UTC Scale; (UTC<sub>NPL</sub> - Station) = + 500 at 1500 UT 31st December 1968.

† Relative to AT Scale; (AT<sub>NPL</sub> - Station) = + 468.6 at 1500 UT 31st December 1968.

## Contributors to this issue



Mr. J. A. L. Potgiesser joined the Philips Research Laboratories, Eindhoven, in 1954. For the next thirteen years he worked on television pick-up tubes and electron beam-plasma interactions and in 1967 he received the physical engineering degree from the Technical University of Eindhoven. Since then he has been working on magnetic recording.



Mr. J. Koorneef has been with the Philips Research Laboratories, Eindhoven, since 1949. He has taken several courses in electronics and physics, and since 1954 he has worked mainly on ceramic technology, especially ferrite magnetic recording heads.



and Defence Systems. Dr. J. K. Stevenson is a Lecturer in the Department of Electronics and Electrical Engineering at the Polytechnic of the South Bank, London. A graduate of the University of London, he obtained his doctorate following work at Queen Mary College and before going to his present appointment at the start of the last academic year, he was with the General Electric Company, initially at the Hirst Research Centre and subsequently with Marconi Space

His main research interests are in circuit theory and he contributed two papers to the Institution's *Journal* on this subject last year.



film insulators, semiconductors and transistors. Mr. De Mey is working on the theoretical aspects of Hall effect in semiconductors and the diffusion of mobile ions in evaporated dielectrics for his doctor's thesis.

Mr. Gilbert De Mey received his diploma of civil electrotechnical engineer at the State University of Ghent, Belgium, in 1970. In 1972, after his military service, he obtained the postgraduate degree of engineer in telecommunication techniques at the same university. He is now research assistant in the microelectronics division of the Laboratory of Electronics; the microelectronics research group specializes in the study of thin



Mr. Yuji Wada is a graduate of Kyushu University, Japan, from whom he obtained a B.Sc. degree in electric physics in 1958. Since then he has been with the Sony Corporation where he was concerned for three years with research work on semiconductors. Since 1962 his principal interests have been in video tape recorders, first on development and since 1970 on engineering and production aspects.



and was later appointed to a Readership. Professor Holt's main teaching and research interests are in circuit and systems studies; computer aided design; computer simulation of systems; and the theory and construction of thin film devices.

Professor A. G. J. Holt (Member 1959, Graduate 1953) holds a Personal Chair in Electrical Engineering in the University of Newcastle upon Tyne. He has worked with the Post Office Engineering Department and served with the RAF and following research in the Department of Electronics at the University of Southampton he was awarded the Ph.D. degree in 1959. He went to Newcastle as a Lecturer in 1957



at the Electrical and Electronic Engineering Department, University of Newcastle upon Tyne, where he is currently involved with research in control theory, and distributed and active network theory.

Dr. J. Attikiouzel received the B.Sc. degree in Electrical Engineering from Newcastle University in June 1969 with first class honours; he was also awarded the John Smith prize. For the next three years he carried out research into computer aided design for active networks; he was awarded a Ph.D. in May 1973. Since completing his doctoral research, in October 1972, he has been appointed as a Research Officer



University of Newcastle upon Tyne, receiving his B.Sc. degree in 1969. From 1969 until 1973 he was engaged in research on tantalum thin film microcircuits at Newcastle. Mr. Chapman is at present a Lecturer in the Department of Electrical Engineering, Paisley College of Technology, Renfrewshire.

Mr. R. Chapman (Graduate 1967) served five years as a Technician Apprentice with the AEI Electronic Apparatus Division and English Electric Valve Company at Lincoln. During this time he attended Lincoln College of Technology and gained an H.N.C. with endorsements to obtain Graduate Membership of the Institution. From 1966 to 1973 he studied in the Department of Electrical and Electronic Engineering at the



# Mechanical wear and degeneration of the magnetic properties of magnetic heads caused by the tape

J. A. L. POTGIESSER†

and

J. KOORNEEF†

Based on a paper presented at the IERE Conference on Video and Data Recording held in Birmingham on 10th to 12th July 1973.

## SUMMARY

One kind of abrasive wear of magnetic heads is characterized by the generation of a lot of small scratches (typical dimensions:  $0.1 \mu\text{m}$ ) due to hard particles embedded in the tape. After scratching, the outer head surface is left under a very high compressive stress (up to  $3000 \text{ N/mm}^2$  in ferrites) which greatly change the magnetic properties of the material. This gives rise to a decreasing short-wavelength sensitivity due to a more or less non-magnetic layer on the head surface.

† Philips Research Laboratories, Eindhoven, The Netherlands.

## 1 Introduction

In short-wavelength recording a decrease in sensitivity during the first operational hours is often observed, the so-called 'degradation'.

Typical figures are a decrease of 6 dB at a wavelength or  $2 \mu\text{m}$  in the first 2 hours, at 3 m/s (120 in/s) tape speed. After that, the sensitivity remains constant over a long period of time.

If a wrong method is used during polishing of the working part of the head, the decrease is already introduced in the head's 'virginal' state and a decrease during life-time is not observed. In some devices, using a high tape speed, the decrease occurs during the time needed to adjust a new head and again a decrease during life-time is not observed. Thus if poor measures are taken it is difficult to define the head's virginal state.

The right procedure for experiments is to adjust and measure at very low tape speed and perform life-tests at the desired tape speed.

Results for a head with 1 mm track-width,  $50 \mu\text{m}$  gap-height,  $0.7 \mu\text{m}$  gap-length are given in Fig. 1. Curve A gives the typical behaviour during life-time. The decrease

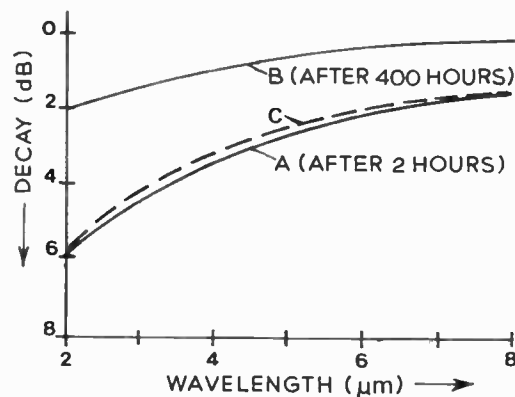

Fig. 1. Results for a head of 1 mm track width,  $50 \mu\text{m}$  gap-height and  $0.7 \mu\text{m}$  gap-length.

can easily be explained by introducing a certain head-to-tape distance. The loss due to  $0.2 \mu\text{m}$  distance reasonably fits with the measured curve (curve C).

The degradation is always accompanied by the appearance of small scratches on the working part of the head. When precautions are taken during the life-test, such as brushing the tape with a felt brush and afterwards blowing off the loosened particles with a blast of air (Fig. 2), the appearance of scratches and the degradation (Fig. 1, curve B) are enormously diminished. For this reason, scratching and the influence of scratches on the properties of transducer heads have been investigated.

## 2 Factors Affecting Wear

### 2.1 Abrasiveness of Tapes

With ferrite heads, the first sign of wear is the appearance of very small scratches on the head surface after a few operational hours. These scratches may be caused

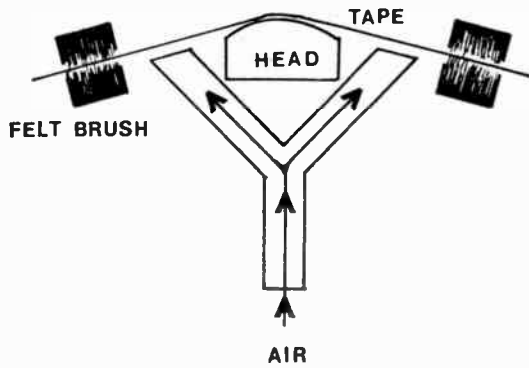

Fig. 2. Brushing the tape with a felt brush and using an air-blast for blowing off loosened particles.

by abrasive particles from the environment or in the tape itself. But whether the system is isolated from the environment or not, scratches appear with almost the same frequency. The conclusion is that in normal conditions head wear is due to the abrasiveness of the tape. This can be seen to be so from Fig. 3.

A new tape was passed for some time along track 1 of a dummy head. The procedure was repeated with the same tape in track 2. The scratches were measured as the amount of light scattered by an incident light beam. An incident beam, perpendicular to a well-polished surface, is reflected in its own direction except when scratches are present on the surface. In that case part of the beam is scattered in all directions. Thus the output of a light detector, with its axis at an angle to the incident beam, is a measure of the amount of scratches. The diagram shows that a new tape is obviously more abrasive than a used one while, in the circumstances met with in this experiment, a new tape is the main source of abrasive wear.

In another experiment a tape was passed over the same head several times. A micrograph was made with dark-field illumination (Fig. 4). It shows some scratch bands of a width corresponding to the uncertainty in position of the tape. The conclusion is that the same particle adhering to, or protruding from, the tape surface scratches the head every time the tape passes it.

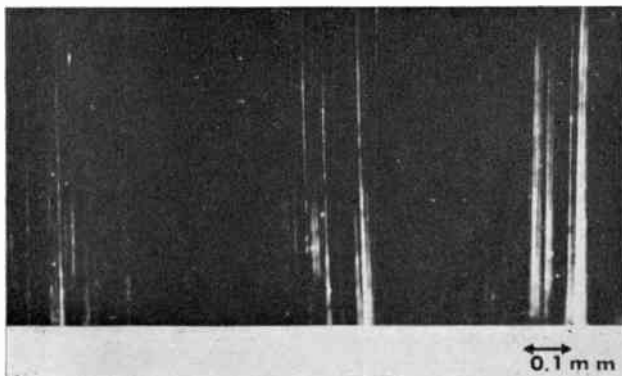

Fig. 4. Dark-field image of some groups of scratches.

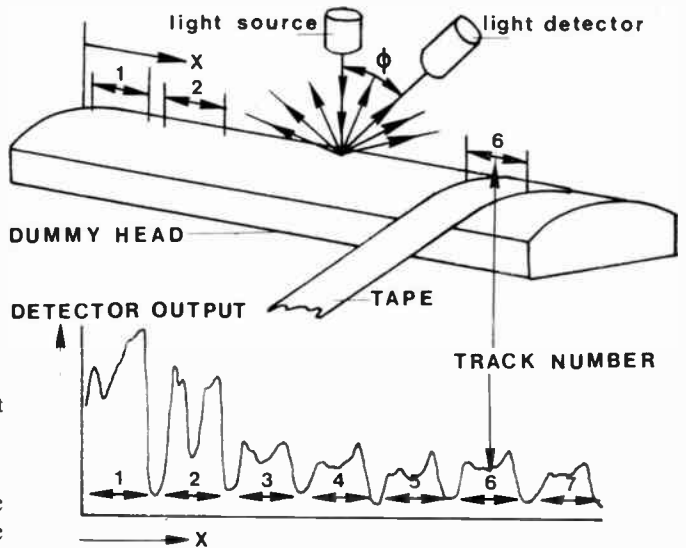

Fig. 3. Effect of tape abrasiveness on the head.

### 2.2 Nature of the Hard Particles

From the preceding it should be clear that the abrasive particles are to be found on the surface or throughout the tape coating.

In order to find out the nature of eventual foreign objects in tape coatings, a number of different commercial tapes have been investigated, by dissolving the oxide and the binder, and then making micrographs of the residue. In many cases glass-like particles are observed as shown in Fig. 5.

The residue was also analysed spectrochemically and with the electron microscan. Most of the fragments appeared to consist of elements commonly used in glasses.

As milling with glass pearls is a common practice in tape manufacturing, the presence of glass in the coating is not surprising. One manufacturer gave a figure of a loss of 80 g glass per 100 kg lacquer during milling. Although the lacquer is filtered afterwards, the fragments can not be removed completely due to the fact that

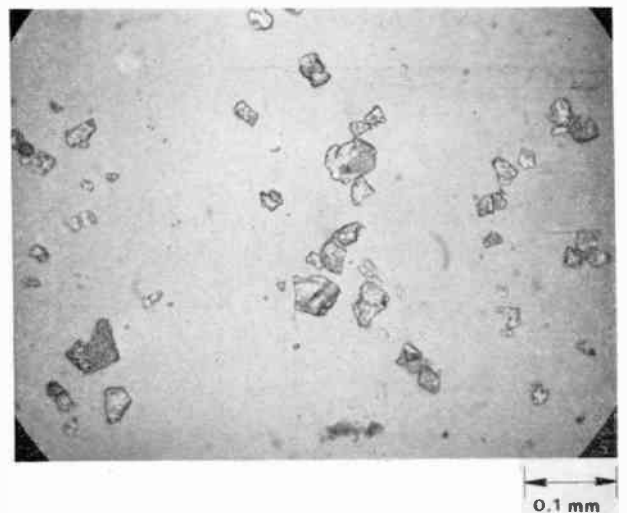

Fig. 5. Particles found in tape coatings.

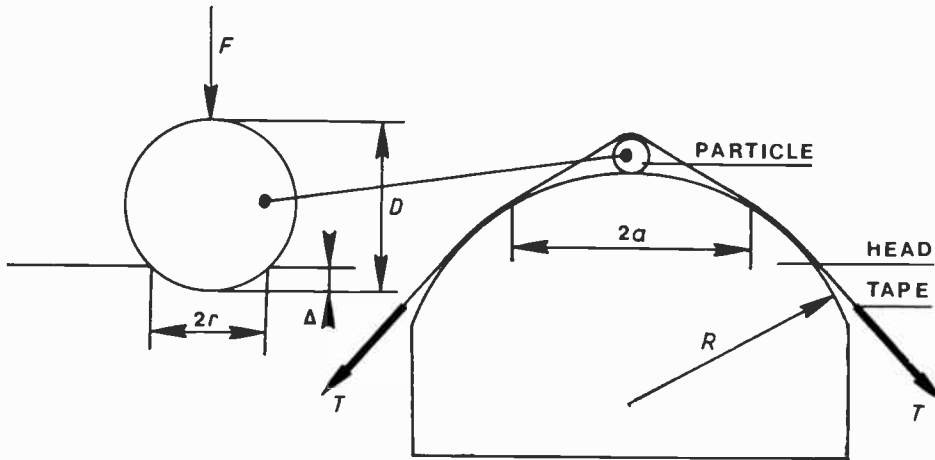

Fig. 6. Lifting of tape from the head by particle.

extremely fine filters cannot be used as they would also remove the magnetic particles or at least very high pressures would have to be applied in order to get the lacquer to pass the filter.

In some cases one can, with transmitted light, observe glass fragments in a tape as light dots in a microscope. With reflected light a glass fragment-like object becomes visible.

The fragments are harmful if they protrude from the tape surface. Obviously these asperities can be removed by the means mentioned in the introduction.

### 2.3 Model of the Scratching Mechanism

With the assumptions that

- (i) a scratch is caused by only one hard, spherical, particle jammed between the tape and the head surface,
- (ii) the tape is perfectly flexible,
- (iii) the head materials hardness is  $H$ ,

the scratch-depth can be calculated by a method similar to the Rabinowicz method for conical particles.<sup>1</sup>

As shown in Fig. 6 the tape is lifted by a particle over a region of diameter  $2a$  where  $a^2 \approx 2DR$  ( $D \ll R$ ). The normal pressure, exerted by the tape on the head surface is  $p = T/R$ .

So the force on the particle,  $F = \pi a^2 p = 2\pi DT$ , allows the particle to penetrate the head material over a depth  $\Delta$ , so that  $F = \pi r^2 H$  where  $r^2 \approx D\Delta$ , ( $\Delta \ll D$ ). It follows that  $\Delta = 2T/H$ , being independent of particle size or head radius. With practical values for  $T$  and  $H$  of  $10^{-1}$  N/mm and  $3000$  N/mm<sup>2</sup> respectively,  $\Delta$  becomes about  $0.1 \mu\text{m}$ , which is in reasonable agreement with the values actually found as shown in Fig. 7, which shows a picture of a scratched head surface, made by light interference on a Linnik-type microscope.<sup>2</sup> The difference in height between two light bands is  $0.3 \mu\text{m}$ , so most scratches indeed have a depth of approximately  $0.1 \mu\text{m}$ .

A similar technique, with a transparent tape or head, can be used to visualize the action of a particle jammed between tape and head as shown in Fig. 8. The incident light beam passes the transparent tape while part of the beam is reflected by the head side of the tape and another

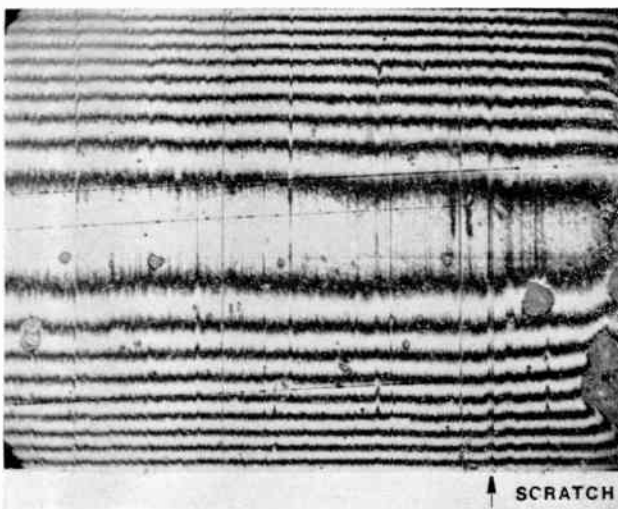

Fig. 7. Scratched head surface.

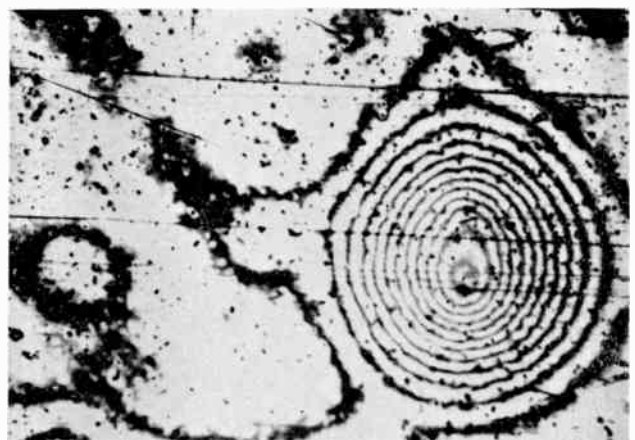

Fig. 8. Interference pattern showing the influence of a particle jammed between tape and head. (Particle height:  $3.8 \mu\text{m}$ ; diameter of lifted region:  $300 \mu\text{m}$ ).

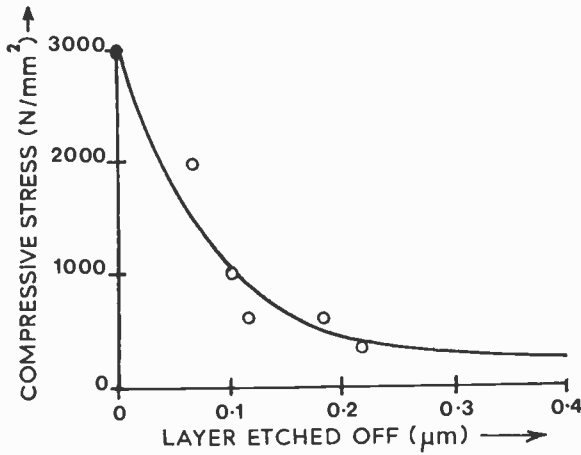

FIG. 9

Fig. 9. Compressive stress as a function of scratch depth.

part by the head surface. If there is a spacing between these two surfaces an interference pattern, as in the picture, arises in which the difference in height between two light rings is 0.3 µm. By counting rings and measuring their diameters the shape of a lifted region is obtained. Most particle diameters found in this way are less than 3 µm while the diameters of the lifted regions are about 100 times this value.

A scratch can only be made if the local normal pressure is sufficiently high. The average normal pressure exerted by the tape is typically 10<sup>-2</sup> to 10<sup>-1</sup> N/mm<sup>2</sup>, so scratching does not occur if the tape is perfectly smooth. Only asperities can raise the local pressure above the breaking strength of the head material according to the preceding calculation.

### 3. Effect of Wear on Mechanical Properties of Tape

#### 3.1 Stress Due to a Single Scratch

A powerful technique for assessing the way in which surface scratches influence the material is Lang's method of X-ray topography.<sup>3</sup> In transmission, a point-for-point diffraction image of a thin single crystal specimen is built up on a sensitive film. Strains, dislocations and other interruptions of the perfect crystal structure show a change in contrast. In this way it is shown that a small scratch on the surface carries a wide compressive strain-field around it.†

#### 3.2 Stresses Due to Polishing

In the preceding Section scratching by tapes of a surface was dealt with. In fact this treatment is not different in principle from other mechanical treatments like polishing or grinding. As polishing can be done faster and more accurately than scratching by tapes, this Section investigates stresses due to polishing.

When polishing one side of an initially flat, thin, stainless platelet, in many cases a curved surface is observed after the treatment. This is due to stresses

built up in a surface layer. If the thickness of this layer is much less than the thickness *d* of the platelet the curvature *K* is given by<sup>4</sup>

$$K = 6T/(Ed^2)$$

where *E* is the Young's modulus, and *T* is the total compressive stress integrated over the thickness of the surface layer. The sign of the curvature indicates either a compressive or a tensile stress. By etching off the surface layer in parts and simultaneously measuring *K*, *T* is obtained as a function of the thickness *Δ* of the layer etched off. Differentiation of this curve with respect to *Δ* gives the stress *σ* as a function of the depth from the original surface. This function is given in Fig. 9.

In the case of ceramics, *σ* appears to be a compressive stress (in ground metals *σ* is a tensile stress in the upper surface and compressive in the remaining part, due to temperature effects during grinding). What is remarkable is that on the surface, *σ* has a value almost equal to the breaking strength of the material (3000 N/mm<sup>2</sup>) independent of the treatment, in contradiction to the depth of the layer.

#### 3.3 Influence on the Bulk

The compressive stress must be compensated by a tensile stress in the inner part of the specimen. A platelet with a thickness *d* carrying on each of its flat sides a compressive stress layer, characterized by *T* (Sect. 3.2), has a tensile stress 2*T/d* in the bulk (if *d* ≫ thickness of the compressive stress layer). If *d* decreases, the tensile stress will become equal to the tensile strength if *d* = *d*<sub>min</sub>, and the platelet will break. Thus with a particular mechanical treatment it is impossible to achieve a thickness less than *d*<sub>min</sub>.

### 4 Effect of Wear on Magnetic Properties of Tape

#### 4.1 Effect on the Bulk Magnetic Properties

For a low stress *σ*, Rathenau and Fast<sup>5</sup> derived for the change in permeability

$$d\mu \simeq \sigma.$$

As to grinding the faces of a Ni-Zn ferrite ring, the compressed layer is independent of the thickness of the ring and the tensile stress in the bulk is proportional to the inverse of the thickness. Typical values for the permeability as a function of the thickness are given in the following table:

Thickness (µm)	250	500	1000	1200
μ	900	1200	1600	1900

Although less pronounced Mn-Zn ferrites show the same effect.<sup>6</sup>

With the Mössbauer effect, too, the ground, thin platelets are investigated. With this technique<sup>7</sup> the direction of the bulk magnetization in thin samples of magnetic materials can be determined from the intensity ratios of the hyperfine lines in a Mössbauer spectrum. A powder sample without any texture was used as a standard. Ground platelets show deviations from the

† Stacy, W. T. and Rankin, P. J. Private communication.

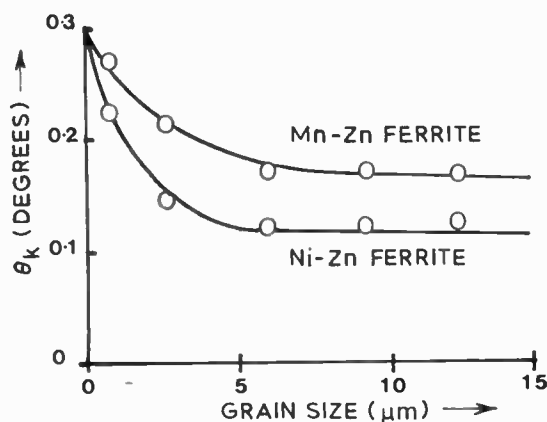

Fig. 10. Kerr angle as a function of surface damage due to different sizes of abrasive particles.

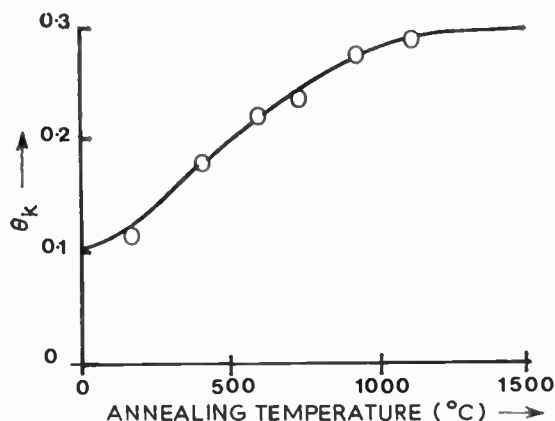

Fig. 11. Kerr angle as a function of annealing temperature.

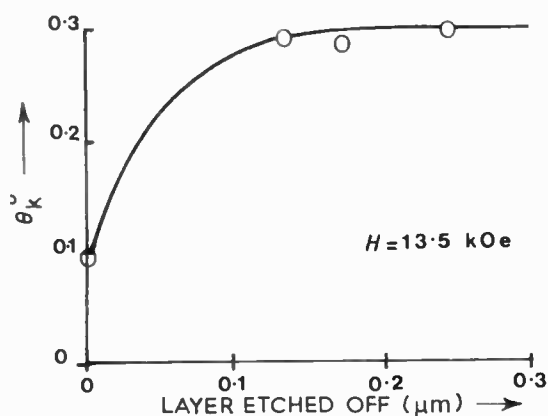

Fig. 12. Dependence of Kerr angle on etching of damaged polished surface.

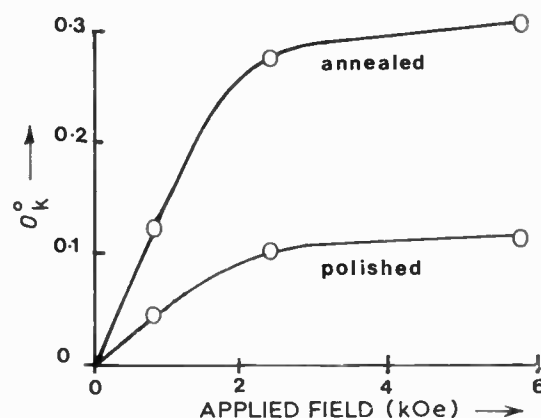

Fig. 13. Comparison of Kerr angle variation with applied field for annealed and polished surfaces.

directions of magnetization as found in the standard. The sign of the deviation depends on the sign of the magnetostriction coefficient of the investigated materials. By etching off a surface layer the deviation decreases. This proves that an induced anisotropy exists in the bulk of ground platelets.†

#### 4.2 Effect on the Surface Layer

A serious problem in measuring the magnetic properties of a surface layer is that it is attached to a magnetic substrate. So most methods measure the properties of this substrate, the bulk of the material. A way round this difficulty is the use of less penetrating radiation, like visible light with a penetration depth of about  $0.5 \mu\text{m}$ . A powerful method in this respect is the use of the magneto-optic Kerr effect, in which the rotation of the plane of polarization of a beam of polarized light reflected against a magnetic substance, is studied. The angle of rotation  $\theta_k$  is proportional to the magnetization and depends on the type of Kerr effect. There are three types of Kerr effects, the polar, the transversal and the longitudinal effect which differ in their mutual orientation of the plane of reflection, the magnetization and the light

propagation vector. In the experiment described, the polar effect is used in which the magnetization is parallel to the light beam and both are perpendicular to the reflecting surface. The polar effect is chosen for its rotation, this being larger than for the two other geometries. The Kerr angle  $\theta_k$  also depends on the wavelength of the incident light. Ferrites show a pronounced peak of  $\theta_k$  at a wavelength of  $0.3 \mu\text{m}$ . For this case the rotation for an undisturbed surface is about  $0.3^{\circ}$ . The angle decreases as soon as there is any surface damage, say, due to polishing.‡ In a first experiment the quality is studied of Mn-Zn and Ni-Zn ferrites surfaces obtained by polishing with diamond powder of varying grain size. The result shown in Fig. 10 clearly demonstrates the influence of diamond grain size. Pitch was used as a polishing base.

In a second experiment we tried to discover whether a damaged surface could be restored by annealing. One sample was annealed at subsequently increasing temperatures. The annealing time was always about 15 minutes. It appears to be necessary to apply a temperature as high as  $1100^{\circ}\text{C}$  to obtain complete recovery of the surface (Fig. 11).

† v. Wieringen, J. S. Private communication.

‡ Wittekoek, S. Private communication.

In a third experiment the damaged surface of a polished sample was etched off in parts, simultaneously measuring the Kerr angle (Fig. 12). Apparently the damaged layer is less than  $0.1 \mu\text{m}$  in this case.

Finally the Kerr angle of a polished and an annealed sample are compared as a function of the applied field (Fig. 13). It follows that the saturation fields are equal but the saturation magnetization differs. From the latter it may be concluded that the damage mainly results in a changing saturation magnetization but this can not explain the behaviour of the material in a replay head. This behaviour can be better explained by the relative permeability decreasing to almost 1 in a surface layer with a thickness of about  $0.2 \mu\text{m}$ . But the magnetization is measured in a somewhat wider layer and with fields rather high compared with those found in replay heads. Nevertheless, the Kerr effect is a good tool in evaluating the materials and surface treatments.

If sufficiently thin platelets are used and if the surface layer has a behaviour quite different from the bulk, this would become visible in the Mössbauer spectrum. For example, iron in non-magnetic lattice sites gives one absorption line, which in ferrites is split up into 6 symmetrical lines for Fe in tetrahedral or octahedral sites. In a Ni-ferrite sample of  $7 \mu\text{m}$  thickness, less than 1.5% Fe was found to be in non-magnetic sites. Thus if this is entirely due to the surface layer, this layer has a thickness of about  $0.05 \mu\text{m}$  which by itself would be insufficient to explain the phenomena as found in replay-heads (see introduction).

An illustrative example of surface damage, probably similar to that found in recording heads, can be found in bubble technology.<sup>8</sup> If a well-prepared bubble platelet, carrying an arbitrary domain pattern, is polished, for example with diamond powder, the polished surface is compressed. If the domain pattern is changed by an external field, while observed with the help of the Faraday effect, the new pattern and that present during polishing become visible simultaneously. In the surface layer the pattern could not be changed by the external field due to the fact that this layer is brought into a state of high coercivity by polishing.

## 5 Conclusion

The effect on wear rate due to scratching can easily be calculated. The cross-section of a typical scratch has an area about  $10^{-2} \mu\text{m}^2$ . So  $10^5$  scratches per mm width

are necessary to achieve a wear of  $1 \mu\text{m}$ . The relative speed in a video recorder is about 10 m/s. So 1 scratching particle per 20 m tape per mm width will cause this wear in about 50 hours.

Mechanical treatments of the surface of a specimen gives tensile stresses in the bulk, which, for example, gives difficulties in producing narrow track heads. In addition the permeability decreases which results in a lower recording head efficiency.

In the surface of a recording head high compressive stresses may be present, due to scratching by tapes. With the help of the Mössbauer effect it is found that the compressed surface is characterized by Fe in non-magnetic sites and by a high stress-induced anisotropy. With the help of the Kerr effect a decreased saturation magnetization is found. Thus a layer exists, with disturbed magnetic properties, which gives effectively a head-to-tape distance as found in magnetic recording.

## 6 References

1. Rabinowicz, E., 'Friction and Wear of Materials', p. 168 (John Wiley, New York, 1965).
2. Francon, M., 'Progress in Microscopy', p. 144 (Pergamon Press, Oxford, 1961).
3. Frank, F. C., Lawn, B. R., Lang, A. R. and Wilks, E. M., 'A study of strains in abraded diamond surfaces', *Proc. R. Soc. A*, **301**, pp. 239-52, 24th October 1967.
4. Knowles, J. E., 'The effect of surface grinding upon the permeability of manganese-zinc ferrites', *J. Phys. D.*, **3**, pp. 1346-51, September 1970.
5. Rathenau, G. W. and Fast, J. F., 'Initial permeabilities of sintered ferrites', *Physica*, **21**, pp. 964-70, December 1955.
6. Hirota, E., Mihara, T., Ikeda, A. and Chiba, H., 'Hot-pressed Mn-Zn ferrite for magnetic recording heads', *IEEE Trans on Magnetics*, **MAG-7**, pp. 337-41, September 1971.
7. Morel, J. P., 'Mössbauer effect study of the spontaneous magnetization of two sublattices of iron in  $\text{NiFe}_2\text{O}_4$  ferrite', *J. Phys. Chem. Solids*, **28**, pp. 629-34, April 1967. (In French).
8. Luff, P. P. and Lucas, J. M., 'Cylindrical magnetic domain propagation in  $\text{Sm}_{0.55}\text{Tb}_{0.45}\text{FeO}_3$  platelets possessing high surface coercivity', *J. Appl. Phys.*, **42**, pp. 5173-5, November, 1971.

Manuscript received by the Institution on 22nd March 1973. (Paper No. 1589/Comm. 92).

© The Institution of Electronic and Radio Engineers, 1974

# New design curves for exponentially tapered distributed RC networks

Professor A. G. J. HOLT,  
Ph.D., C.Eng., M.I.E.R.E.,\*

J. ATTIKIOUZEL, Ph.D.\*

and

R. CHAPMAN, B.Sc.\*

## SUMMARY

A modification to the basic method of curvilinear squares used to design the geometric shape of exponentially tapered distributed RC networks is described. It is shown that the new method simplifies the design process and also makes it easy to check if a projected taper can be fitted in a specified space on a substrate.

\* Department of Electrical and Electronic Engineering, The Merz Laboratories, University of Newcastle upon Tyne, Newcastle-upon-Tyne NE1 7RU.

The theory and applications of distributed parameter RC networks tapered to make the resistance and capacitance per unit length functions of distance, are well known.<sup>1-4</sup> It is not always simple to obtain the geometric shape required to give a distributed network a specified electrical taper; usually construction techniques are employed which are based upon the theory of curvilinear squares.<sup>5,6</sup>

This contribution outlines a modification to the well known method of curvilinear squares used for the design of distributed RC circuits; it has the advantages of being simpler to use and allowing the designer quickly to see if a projected tapered network will fit in a given size substrate.

The method of curvilinear squares is a graphical construction for the solution of field problems. It relies upon the fact that flows and equipotential lines in a field map must intersect at right angles, so that the areas embraced by such lines must tend to true squares on progressive subdivision. The construction as it applies to the present problem is shown in Fig. 1.

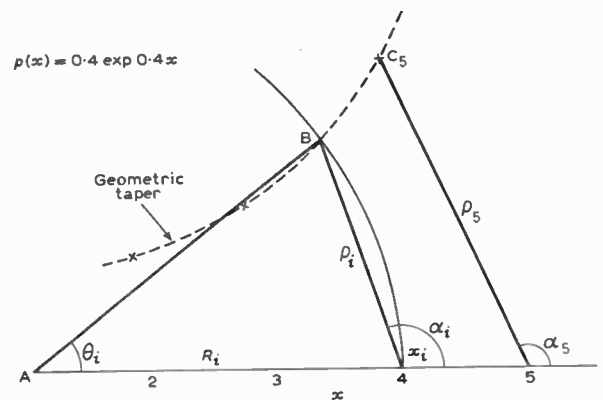

Fig. 1. Graphical construction for exponential taper.

For any value of  $x = x_i$ , a step is taken back along the  $x$  axis, a distance  $R_i$ . A line (AB) is drawn at an angle  $\theta_i$  from the point  $x = x_i - R_i$  and an arc of radius  $R_i$  constructed from the same point. The intersection of the arc with the line AB is the construction point for the geometric taper.

For a given electrical taper  $p(x)$  the constructional details for the distributed network are computed by calculating  $p(x)$  and  $dp(x)/dx$ , both for  $x = x_i$ . The values of  $R_i$  and  $\theta_i$ , shown in Fig. 1, are given by the following equations:

$$\theta_i = \tan^{-1} \left( \frac{dp(x)}{dx} \right) \Big|_{x = x_i}$$

$$R_i = \frac{p(x)}{\theta_i} \Big|_{x = x_i}$$

This procedure is repeated for as many values of  $x$  as the particular application demands.

This design method may with advantage be modified as follows. Simple geometry on the isosceles triangle

A, B,  $x = x_i$ , in Fig. 1 yields

$$\alpha_i = \frac{\theta_i + 180^\circ}{2}$$

$$\rho_i = 2R_i \sin\left(\frac{\theta_i}{2}\right)$$

Thus, it is possible to construct tapered distributed RC networks by drawing a line of length  $\rho_i$  at an angle  $\alpha_i$  degrees, centred upon  $x = x_i$ . This modification to the basic method considerably simplifies the construction of the geometric tapers. To illustrate this point, note the construction of the intersection point for  $x = 5$  in Fig. 1, compared with the intersection point for  $x = 4$  where the basic method requiring the calculation of  $R$  and  $\theta$  is employed.

Consider the exponential taper where

$$p(x) = h \exp(kx)$$

Figures 2(a) and (b) show the values of  $\rho$  and  $\alpha$  plotted against  $x$  for  $k = 0.4$  and  $h = 0.3$ . The point  $C_5$  on the taper can readily be found by reading  $\rho_5$  and  $\alpha_5$  from Fig. 2, and hence the geometric form can be simply designed.

In many situations the substrate area allocated to an exponentially tapered distributed network will be limited by such factors as the amount of photoreduction used, area on the substrate required for other components, etc. The curves in Fig. 2 allow the designer readily to check if a projected design is possible on a given substrate size.

Assume it is required to design a network having the exponential taper:

$$p(x) = h \exp 0.4x$$

$$0 \leq x \leq 10$$

Figure 2(a) shows that for this taper  $h$  cannot be much greater than 0.2, because  $\alpha$  and  $\rho$  become too large at the larger values of  $x$ . Under these conditions the width of the taper network might become too large for the available substrate area. Let the substrate area allocated for the distributed network be, for example, 5 cm x 10 cm and let one unit of  $x$  equal 1 cm, so using the entire allocated length for the taper. Figure 2(a) gives that for  $x = 10$ ,  $\rho = 10.11$  and  $\alpha = 128.6^\circ$ . Thus, with one unit of  $x$  equal to 1 cm, the taper will exceed the width allocated to it and a reduction in the magnification of the taper is necessary.

It is clear from this example that when design graphs of the form of Fig. 2 are plotted, information on the size of the taper can be obtained at an early stage in the design.

**Conclusions**

It has been shown that by a modification to the basic method of constructing exponential tapers, the constructional technique is simplified. Any point on the taper

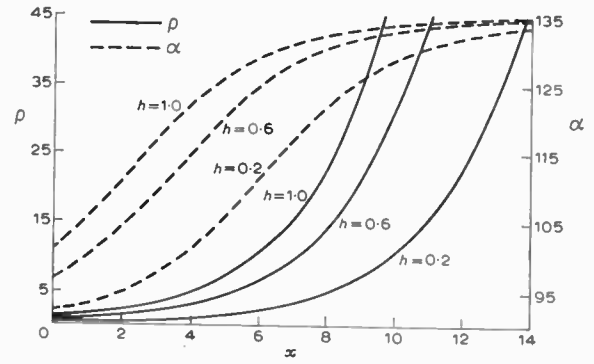

(a)  $k = 0.4$  and varying  $h$ .

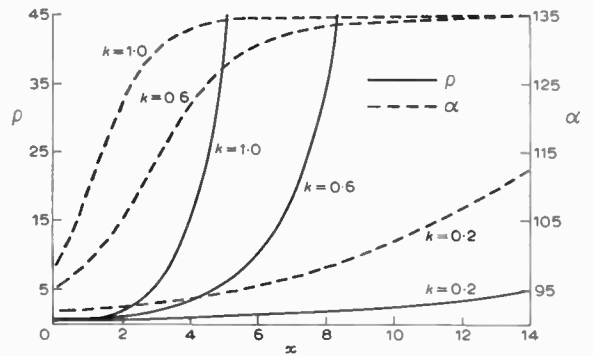

(b)  $h = 0.3$  and varying  $k$ .

Fig. 2. Design curves for exponentially tapered distributed networks

may be obtained by measuring one length and one angle. Also, by computing a family of curves as shown, it is possible to find if a network with a given taper will fit into a specified substrate size.

**References**

1. Ghauri, M. S. and Herskowitz, G. J., 'The effect of shaping and loading on distributed RC networks', *J. Franklin Inst.*, **278**, pp. 108-23, August 1964.
2. Edson, W. A., 'Tapered distributed RC lines for phase-shift oscillators', *Proc. IRE*, **49**, pp. 21-4, June 1961.
3. Wilson, B. L. H. and Wilson, R. B., 'Shaping of distributed RC networks', *Proc. IRE*, **49**, pp. 1330-1, August 1961. (Correspondence.)
4. Ghauri, M. S. and Kelly, J. J., 'Introduction to Distributed-Parameter Networks: With Application to Integrated Circuits' (Holt, Rinehart and Winston, New York 1968).
5. Moore, A. D., 'Mapping techniques applied to fluid mapper patterns', *Trans. Amer. Inst. Elect. Engrs*, **71**, pt. 1, pp. 1-6, 1952.
6. Oehler, K. L. and Duesterhoeft, W. C., 'A graphical design for exponentially tapered RC circuits', *IEEE Trans. on Circuit Theory*, **CT-12**, pp. 288-90, June 1965.

Manuscript first received by the Institution on 3rd October 1973 and in final form on 11th February 1974 (Short contribution No. 172/CC201)

© The Institution of Electronic and Radio Engineers, 1974



# An expansion method for calculation of low-frequency Hall effect and magneto-resistance

Ir. G. De Mey\*

## SUMMARY

The potential equation in three dimensions for a semiconductor, placed in an external magnetic field, is derived. This equation is solved by an expansion technique. The first-order expansion gives the Hall effect, whereas the second-order describes the magneto-resistance effect. The theory is applied to a rectangular and a cylindrical volume, which are treated analytically.

\* Laboratory of Electronics, Ghent State University, Sint Pietersnieuwstraat 41, 9000 Ghent, Belgium.

## 1 Introduction

Much attention has been devoted to the study of the field problem in Hall generators.<sup>1-5</sup> This problem is of great importance in the investigation of accurate Hall mobility measurements on semiconductors<sup>6-9</sup> or in constructing probes for magnetic field strength measurements.<sup>10</sup>

In the present paper an expansion method is put forward which enables us to calculate the Hall effect and magneto-resistance at low frequencies using a Hall plate medium whose conductivity remains constant and in which displacement current (at high frequencies) plays no significant part. In the theory, which will be outlined in the next two sections, the product  $\varepsilon$  of the Hall mobility  $\mu_H$  and magnetic field strength  $B$  is an important parameter. In many applications the following inequality holds:<sup>11</sup>

$$\varepsilon = \mu_H B \ll 1 \quad (1)$$

In order to use more convenient units we express  $\mu_H$  in  $\text{cm}^2/\text{Vs}$  and  $B$  in gauss. Condition (1) becomes then  $\mu_H B \ll 10^8$ . For a typical semiconductor such as silicon with an electron mobility  $\mu_H = 1000 \text{ cm}^2/\text{Vs}$  and a typical magnetic field strength  $B = 3000$  gauss, we see that condition (1) is fulfilled.

Starting from eqn. (1) we can establish an expansion method where  $\varepsilon$  is treated as a small perturbing parameter.<sup>12</sup> All quantities appearing in the theory are written as a power series in  $\varepsilon$ . These series are substituted in the original equations, which will be derived in the next Section, and by collecting all terms containing the same power of  $\varepsilon$ , we get a set of equations, each of which corresponds to a certain order in  $\varepsilon$ . It will be seen from eqn. (1) that retention of only the lowest-order equations is necessary to give adequate accuracy.

This method offers the advantage of being not restricted to two-dimensional problems. Each equation of the set is easier to solve than the equation originally given. On the other hand it is possible to give a physical interpretation to some of the equations obtained by the expansion method. The zeroth-order equation gives the electrostatic field which will be built up when there is no magnetic field, the first-order expansion gives the Hall effect, while the second-order gives the magneto-resistance effect.

The theory outlined in this paper can also be applied to other physical problems described by analogous equations, e.g. in magneto-hydrodynamics.

## 2 Basic Equations

The constitutive relation between the current density  $\mathbf{J}$  and the electric field  $\mathbf{E}$  in a n-type semiconductor can be stated as:<sup>5</sup>

$$\mathbf{E} = \rho \mathbf{J} + \mu_H \rho (\mathbf{J} \times \mathbf{B}) \quad (2)$$

where  $\rho$  represents the resistivity of the sample.  $\mathbf{B}$  is an externally applied uniform constant magnetic field. Equation (2) can be easily inverted, giving rise to:

$$\rho(1 + \mu_H^2 B^2) \mathbf{J} = \mathbf{E} - \mu_H (\mathbf{E} \times \mathbf{B}) + \mu_H^2 \mathbf{B} (\mathbf{E} \cdot \mathbf{B}) \quad (3)$$

At low frequencies, the time dependence of  $\mathbf{E}$  can be neglected. The fundamental equations for  $\mathbf{J}$  and  $\mathbf{E}$  are

then:

$$\nabla \cdot \mathbf{J} = 0 \tag{4}$$

$$\nabla \times \mathbf{E} = 0 \tag{5}$$

Taking the divergence of both members of eqn. (3) we obtain in accordance with eqn. (4):

$$\nabla \cdot \mathbf{E} - \mu_H \nabla \cdot (\mathbf{E} \times \mathbf{B}) + \mu_H^2 \nabla \cdot [\mathbf{B}(\mathbf{E} \cdot \mathbf{B})] = 0 \tag{6}$$

Remembering the fact that  $\mathbf{B}$  is a constant vector, and taking eqn. (5) into account, we have:

$$\nabla \cdot (\mathbf{E} \times \mathbf{B}) = \mathbf{B} \cdot (\nabla \times \mathbf{E}) - \mathbf{E} \cdot (\nabla \times \mathbf{B}) = 0 \tag{7}$$

$$\nabla \cdot [\mathbf{B}(\mathbf{E} \cdot \mathbf{B})] = \mathbf{B} \cdot \nabla (\mathbf{E} \cdot \mathbf{B}) \tag{8}$$

which yield:

$$\nabla \cdot \mathbf{E} = -\mu_H^2 \mathbf{B} \cdot \nabla (\mathbf{E} \cdot \mathbf{B}) \tag{9}$$

Without loss of generality we accept that  $\mathbf{B}$  is directed along the z-axis:

$$\mathbf{B} = B\mathbf{u}_z \tag{10}$$

Equation (9) then becomes:

$$\nabla \cdot \mathbf{E} = -\mu_H^2 B^2 \frac{\partial E_z}{\partial z} \tag{11}$$

By putting:

$$\mathbf{E} = -\nabla \phi \tag{12}$$

eqn. (5) is automatically fulfilled. Equations (11) and (12) then give rise to the following equation:

$$\frac{\partial^2 \phi}{\partial x^2} + \frac{\partial^2 \phi}{\partial y^2} + (1 + \mu_H^2 B^2) \frac{\partial^2 \phi}{\partial z^2} = 0 \tag{13}$$

This equation can be transformed to  $\nabla^2 \phi = 0$  by a homothetical transformation along the z-axis:

$$Z = \frac{z}{\sqrt{1 + \mu_H^2 B^2}} \tag{14}$$

In eqn. (2) we have neglected the intrinsic magneto-resistivity of the semiconductor. Magneto-resistance effects, which will be discussed further on, are only caused by the sample geometry.

### 3 Expansion Method

We consider a volume  $V$  of a semiconductor immersed in a magnetic field  $\mathbf{B}$  (Fig. 1). The equation for the potential  $\phi$  is, according to eqn. (1):

$$\nabla^2 \phi + \varepsilon^2 \frac{\partial^2 \phi}{\partial z^2} = 0 \tag{15}$$

The surface of  $V$  is provided with several metallic boundaries  $S_i$  ( $i = 1, 2 \dots$ ), which are held at constant potentials  $V_i$  ( $i = 1, 2 \dots$ ). This gives a boundary condition for  $\phi$ :

$$\phi = V_i \text{ on } S_i \text{ (} i = 1, 2 \dots \text{)} \tag{16}$$

At the free boundary  $S$ , which consists of the whole non-metallized part of the surface and separates the metallic boundaries, the current density vector  $\mathbf{J}$  should be tangent:

$$\mathbf{J} \cdot \mathbf{n} = 0 \text{ on } S \tag{17}$$

where  $\mathbf{n}$  denotes the unity vector directed normally to the surface. From eqns. (1) (3) (10) and (12) the boundary condition (17) can be rewritten as:

$$\nabla \phi \cdot \mathbf{n} - \varepsilon (\nabla \phi \times \mathbf{u}_z) \cdot \mathbf{n} + \varepsilon^2 (\nabla \phi \cdot \mathbf{u}_z) (\mathbf{u}_z \cdot \mathbf{n}) = 0 \text{ on } S \tag{18}$$

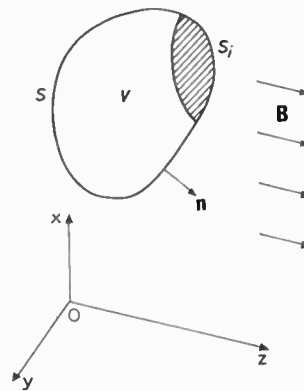

Fig. 1. Volume  $V$  of a semiconducting material immersed in an external magnetic field. For the sake of clarity only one metallized boundary surface  $S_i$  has been drawn.

In the expansion method the potential  $\phi$  is written as a power series in  $\varepsilon$ :

$$\phi = \phi_0 + \varepsilon \phi_1 + \varepsilon^2 \phi_2 + \varepsilon^3 \phi_3 + \dots \tag{19}$$

After substitution of the proposed solution (19) in the equation (15), we get:

$$\nabla^2 \phi_0 + \varepsilon \nabla^2 \phi_1 + \varepsilon^2 \nabla^2 \phi_2 + \dots + \varepsilon^2 \frac{\partial^2 \phi_0}{\partial z^2} + \varepsilon^3 \frac{\partial^2 \phi_1}{\partial z^2} + \dots = 0 \tag{20}$$

Expression (20) should be true for all values of  $\varepsilon$  satisfying condition (1). Therefore all the sums of coefficients belonging to the same power of  $\varepsilon$  should vanish:

$$\nabla^2 \phi_0 = 0 \tag{21}$$

$$\nabla^2 \phi_1 = 0 \tag{22}$$

$$\nabla^2 \phi_2 + \frac{\partial^2 \phi_0}{\partial z^2} = 0 \tag{23}$$

The same treatment can be applied for the two boundary conditions (16) and (18). When a coefficient of  $\varepsilon^i$  is set to zero, we call it a  $i$ th-order expansion equation or condition. Finally we get:

for the zeroth order:

$$\nabla^2 \phi_0 = 0 \text{ in } V \tag{24}$$

$$\nabla \phi_0 \cdot \mathbf{n} = 0 \text{ on } S \tag{25}$$

$$\phi_0 = V_i \text{ on } S_i \tag{26}$$

for the first order:

$$\nabla^2 \phi_1 = 0 \text{ in } V \tag{27}$$

$$\nabla \phi_1 \cdot \mathbf{n} = (\nabla \phi_0 \times \mathbf{u}_z) \cdot \mathbf{n} \text{ on } S \tag{28}$$

$$\phi_1 = 0 \text{ on } S_i \tag{29}$$

for the second order:

$$\nabla^2 \phi_2 + \frac{\partial^2 \phi_0}{\partial z^2} = 0 \text{ in } V \tag{30}$$

$$\nabla \phi_2 \cdot \mathbf{n} = (\nabla \phi_1 \times \mathbf{u}_z) \cdot \mathbf{n} - (\nabla \phi_0 \cdot \mathbf{u}_z) (\mathbf{u}_z \cdot \mathbf{n}) \text{ on } S \tag{31}$$

$$\phi_2 = 0 \text{ on } S_i \tag{32}$$

for the  $i$ th order:

$$\nabla^2 \phi_i + \frac{\partial^2 \phi_{i-2}}{\partial z^2} = 0 \text{ in } V \tag{33}$$

$$\nabla\phi_i \cdot \mathbf{n} = (\nabla\phi_{i-1} \times \mathbf{u}_z) \cdot \mathbf{n} - (\nabla\phi_{i-2} \cdot \mathbf{u}_z)(\mathbf{u}_z \cdot \mathbf{n}) \quad \text{on } S \quad (34)$$

$$\phi_i = 0 \quad \text{on } S_i \quad (35)$$

The solution of equations of a given order  $i$ , requires only the knowledge of the potentials of lower orders. Starting with the zeroth order, the series of problems mentioned above can be solved successively.

The other quantities such as  $\mathbf{J}$  are also expressed as a series like (19):

$$\mathbf{J} = \mathbf{J}_0 + \varepsilon\mathbf{J}_1 + \varepsilon^2\mathbf{J}_2 + \varepsilon^3\mathbf{J}_3 + \dots \quad (36)$$

which leads to:

$$-\rho\mathbf{J}_0 = \nabla\phi_0 \quad (37)$$

$$-\rho\mathbf{J}_1 = \nabla\phi_1 - \nabla\phi_0 \times \mathbf{u}_z \quad (38)$$

$$-\rho(\mathbf{J}_2 + \mathbf{J}_0) = \nabla\phi_2 - \nabla\phi_1 \times \mathbf{u}_z - (\nabla\phi_0 \cdot \mathbf{u}_z)\mathbf{u}_z \quad (39)$$

By integrating (36) over a metallic surface  $S_i$ , the current  $I_i$  supplied at this contact can also be written as a series similar to expression (36).

#### 4 Application to a Rectangular Volume

The theory outlined in the preceding Section will be applied now to a rectangular volume as shown in Fig. 2. This simple example has been chosen in order to demonstrate clearly the expansion method.

The zeroth-order equations (24), (25) and (26) are now:

$$\nabla^2\phi_0 = 0 \quad (40)$$

$$\nabla\phi \cdot \mathbf{n} = 0 \quad \text{on } S \quad (41)$$

$$\phi_0 = V \quad \text{on } S_1 \quad (42)$$

$$\phi_0 = 0 \quad \text{on } S_2 \quad (43)$$

Because  $S_1$  and  $S_2$  are parallel to the  $yOz$  plane, the solution is obviously:

$$\phi_0 = \frac{V}{a} x \quad (44)$$

By using eqn. (37) we find the zeroth-order current density  $\mathbf{J}_0$ :

$$\mathbf{J}_0 = -\frac{1}{\rho} \frac{V}{a} \mathbf{u}_x \quad (45)$$

By integrating (45) over a cross-section of the volume we obtain the zeroth-order current  $I_0$ :

$$I_0 = \frac{1}{\rho} bc \frac{V}{a} \quad (46)$$

The first-order eqns. (27) (28) and (29), which yield the change of the potential proportional to  $\varepsilon$ , are for the rectangular geometry:

$$\nabla^2\phi_1 = 0 \quad (47)$$

$$\nabla\phi_1 \cdot \mathbf{n} = -\frac{V}{a} \mathbf{u}_y \cdot \mathbf{n} \quad \text{on } S \quad (48)$$

$$\phi_1 = 0 \quad \text{on } S_1 \text{ and } S_2 \quad (49)$$

where eqn. (44) has been used to obtain (48).

This problem can be solved by eigenfunctions expansion for cylindrical volumes.<sup>13</sup> We put therefore:

$$\phi_1 = \sum_n \sum_p B_{np}(x)\psi_{np}(y, z) \quad (50)$$

Due to (28),  $\psi_{np}(y, z)$  are the Dirichlet eigenfunctions of a rectangle:<sup>14</sup>

$$\psi_{np}(y, z) = N_{np} \cos \frac{n\pi y}{b} \cos \frac{p\pi z}{c} \quad (51)$$

$N_{np}$  is the normalization constant. The eigenvalue  $-\mu_{np}^2$  of  $\psi_{np}$  is given by:

$$\mu_{np}^2 = \left(\frac{n\pi}{b}\right)^2 + \left(\frac{p\pi}{c}\right)^2 \quad (52)$$

For  $B_{np}(x)$  we find the differential equation:<sup>13</sup>

$$\frac{d^2 B_{np}(x)}{dx^2} - \mu_{np}^2 B_{np}(x) + \int_L \psi_{np} \nabla\phi_1 \cdot \mathbf{n} dL = 0 \quad (53)$$

From (28) and (44) we find:

$$B_{no}(x) = \frac{VcN_{no}}{\mu_{no}^2 a} \left[ 1 - \frac{\cosh n\pi/b[x-(a/2)]}{\cosh(n\pi a/2b)} \right] \quad (54)$$

$n = 1, 3, 5, \dots$

Because the given problem is in fact two-dimensional, which can be seen from Fig. 2, the index  $p$  can only attain the value  $p = 0$ .

From (50) and (54) we can deduce the Hall voltage between the points A and B (Fig. 2):

$$V_H = \varepsilon[\phi_1(A) - \phi_1(B)] = -\frac{8\varepsilon\rho I_0}{\pi^2 c} \sum_n \frac{1}{n^2} \left( 1 - \frac{1}{\cosh(n\pi a/2b)} \right) \quad (55)$$

The plot of  $V_H$  against  $a/b$  is given in Fig. 3. If  $a \gg b$  we find from eqn. (55) by summing the zeta function:<sup>15</sup>

$$V_H = -\frac{8\varepsilon\rho I_0}{\pi^2 c} \sum_n \frac{1}{n^2} = -\frac{\rho I_0}{c} \varepsilon \quad (56)$$

This is exactly the formula given by Van Der Pauw.<sup>6</sup>

For the second-order expansion the calculation can be performed in a similar way. We put then:

$$\phi_2 = \sum_k \sum_l C_{kl}(x)\psi_{kl}(y, z) \quad (57)$$

The coefficients  $C_{kl}(x)$  are found to be:

$$C_{00}(x) = -\sum_{n=1,3} \frac{1}{\mu_{n0}^3} N_{00} \tanh\left(\mu_{n0} \frac{a}{2}\right) \frac{8Vc}{ab} \times \left[ \frac{x-a/2}{a/2} - \frac{\sinh \mu_{n0}[x-(a/2)]}{\sinh \mu_{n0}(a/2)} \right] \quad (58)$$

$$C_{k0}(x) = -\sum_{n=1,3} \frac{1}{\mu_{n0}(\mu_{n0}^2 - \mu_{k0}^2)} \frac{8Vc}{ab} N_{k0} \tanh\left(\mu_{n0} \frac{a}{2}\right) \times \left[ \frac{\sinh \mu_{k0}[x-(a/2)]}{\sinh \mu_{k0}(a/2)} - \frac{\sinh \mu_{n0}[x-(a/2)]}{\sinh \mu_{n0}(a/2)} \right] \quad (59)$$

where  $k = 2, 4, 6, \dots$

By integrating (39) over a section, we find the second-order current  $I_2$ :

$$\frac{I_2}{I_0} = -\frac{16}{\pi^2} \frac{b}{a} \sum_{n=1,3} \frac{1}{n^3} \tanh\left(\frac{n\pi a}{b}\right) \quad (60)$$

which is also shown on Fig. 3. The negative sign in (60) indicates that the resistance will increase under the influence of a magnetic field. When  $a \ll b$ , the expression (60) becomes unity. This magneto-resistance effect can be compared with the Corbino disk.<sup>16</sup> When  $a \gg b$ , the

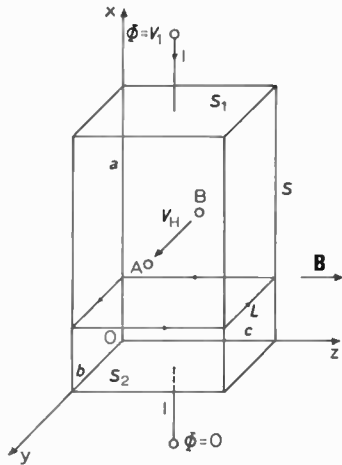

Fig. 2. Rectangular volume placed in a magnetic field B. The points A and B have the coordinates (a/2, b, c/2) and (a/2, 0, c/2).

magneto-resistance effect is zero.

It can be easily verified that the second-order potential  $\phi_2$  makes no contribution to the Hall voltage. Also the first-order potential  $\phi_1$  has no influence on the magneto-resistance effect ( $I_1 = 0$ ).

**5 Application to a Cylindrical Volume**

The treatment is similar as for the rectangular volume. We shall restrict ourselves to the principal results.

The zeroth-order expansion gives the results (Fig. 4):

$$\phi_0 = \frac{V}{a} x \tag{61}$$

$$I_0 = \frac{V \pi R^2}{\rho a} \tag{62}$$

The Dirichlet eigenfunctions for the circular section are:<sup>14</sup>

$$\psi_{np}(r, \theta) = N_{np} \begin{Bmatrix} \cos n\theta \\ \sin n\theta \end{Bmatrix} J_n \left( x_{np} \frac{r}{R} \right) \tag{63}$$

where  $N_{np}$  is a normalization constant and  $x_{np}$  the  $p$ th root of the transcendental equation:

$$J'_n(x_{np}) = 0 \tag{64}$$

The eigenvalues  $-\mu_{np}^2$  of (63) are given by:

$$-\mu_{np}^2 = -\frac{x_{np}^2}{R^2} \tag{65}$$

The first-order expansion gives:

$$\phi_1 = \sum_n \sum_p B_{np}(x) \psi_{np}(r, \theta) \tag{66}$$

where:

$$B_{1p}(x) = -\frac{RN_{1p}}{a\mu_{1p}^2} V \pi J_1(x_{1p}) \left[ 1 - \frac{\cosh \mu_{1p}[x - (a/2)]}{\cosh \mu_{1p}(a/2)} \right] \tag{67}$$

the other coefficients being zero. The constant  $N_{1p}$  is given by:

$$N_{1p}^2 = \frac{2}{\pi R^2} \frac{1}{J_1^2(x_{1p})} \frac{x_{1p}^2}{x_{1p}^2 - 1} \tag{68}$$

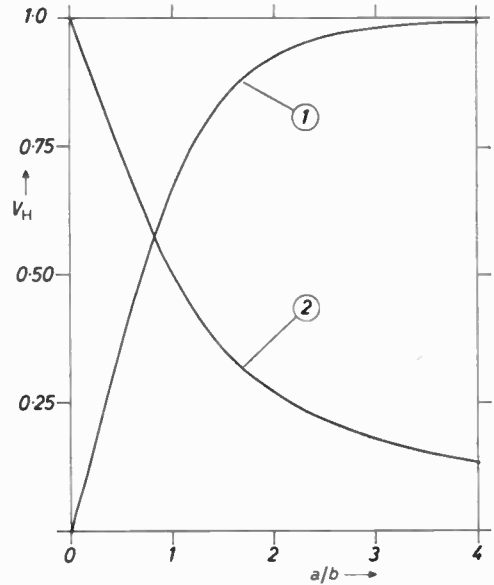

Fig. 3. Hall voltage (curve 1) and magneto-resistance effect (curve 2) of a rectangular volume.

The Hall voltage derived from (66) is:

$$V_H = -4\epsilon\rho I_0 \frac{1}{\pi R} \sum_p \frac{1}{x_{1p}^2 - 1} \left[ 1 - \frac{1}{\cosh \mu_{1p}(a/2)} \right] \tag{69}$$

The relationship of  $V_H$  against  $a/R$  is shown on Fig. 5. With the help of eqn. (64) it can be easily verified that:

$$I_1 = 0 \tag{70}$$

The second-order expansion yields:

$$\phi_2 = \sum_k \sum_l C_{kl}(x) \psi_{kl}(r, \theta) \tag{71}$$

$$C_{00} = -\sum_p \frac{\pi^2 R^2}{\mu_{1p}^2} N_{00} N_{1p}^2 J_1^2(x_{1p}) \frac{V}{a\mu_{1p}} \tanh \mu_{1p} \frac{a}{2} \times \left[ \frac{x - (a/2)}{a/2} - \frac{\sinh \mu_{1p}[x - (a/2)]}{\sinh \mu_{1p}(a/2)} \right] \tag{72}$$

$$C_{01} = -\sum_p \frac{\pi^2 R^2}{\mu_{1p}^2 - \mu_{01}^2} N_{01} J_0(x_{01}) N_{1p}^2 J_1^2(x_{1p}) \frac{V}{a\mu_{1p}} \times \tanh \left( \mu_{1p} \frac{a}{2} \right) \times \left[ \frac{\sinh \mu_{01}[x - (a/2)]}{\sinh \mu_{01}(a/2)} - \frac{\sinh \mu_{1p}[x - (a/2)]}{\sinh \mu_{1p}(a/2)} \right] \tag{73}$$

$$C_{21} = -\sum_p \frac{\pi^2 R^2}{2(\mu_{1p}^2 - \mu_{21}^2)} N_{21} J_2(x_{21}) N_{1p}^2 J_1^2(x_{1p}) \frac{V}{a\mu_{1p}} \times \tanh \left( \mu_{1p} \frac{a}{2} \right) \times \left[ \frac{\sinh \mu_{21}[x - (a/2)]}{\sinh \mu_{21}(a/2)} - \frac{\sinh \mu_{1p}[x - (a/2)]}{\sinh \mu_{1p}(a/2)} \right] \tag{74}$$

All other coefficients are zero. The current  $I_2$  is then:

$$\frac{I_2}{I_0} = -1 + \sum_p \frac{2}{\pi} \frac{1}{x_{1p}^2 - 1} \left[ 1 - \frac{2R}{ax_{1p}} \tanh \frac{ax_{1p}}{2R} \right] \tag{75}$$

This relationship is also plotted in Fig. 5. For  $a \ll R$  we

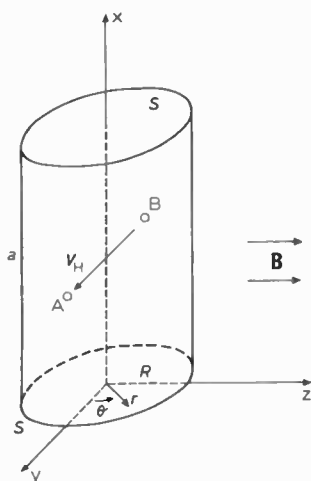

Fig. 4. Cylindrical volume placed in a magnetic field  $B$ . The points A and B have the cartesian coordinates  $(a/2, R, 0)$  and  $(a/2, -R, 0)$ .

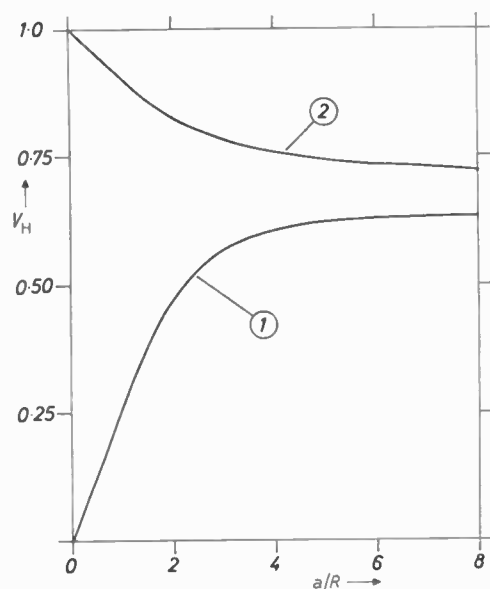

Fig. 5. Hall voltage (curve 1) and magneto-resistance effect (curve 2) of a cylindrical volume.

## 7 References

- Bonnefille, R., Chevalier, G., and Guichard, Q., 'Contribution à l'étude de la répartition du potentiel dans les éléments à effet Hall', *Solid State Electronics*, 11, pp. 141-5, 1968.
- Becquevort, J. L., 'Dispositif analogue pour la détermination du potentiel dans les éléments à effet Hall', *Solid State Electronics*, 11, pp. 147-53, 1968.
- De Sabata, I., 'Le champ électrique des générateurs à effet Hall placés dans des champs magnétiques variables', *Revue E*, 6, pp. 355-61, 1971.
- De Mey, G., 'Integral equation for the potential distribution in a Hall generator', *Electronics Letters*, 9, pp. 264-6, 14th June 1973.
- De Mey, G., 'Field calculations in Hall samples', *Solid State Electronics*, 16, pp. 955-7, 1973.
- Van Der Pauw, L. J., 'A method of measuring specific resistivity and Hall effect of discs of arbitrary shape', *Philips Research Reports*, 13, pp. 1-9, 1958.
- Newsome, J. P. and Silber, W. H., 'The resistance matrix and electrical characteristics of the symmetrical rectangular Hall plate with different electrode configurations', *Solid State Electronics*, 12, pp. 631-43, 1969.
- De Mey, G., 'Influence of sample geometry on Hall mobility measurements', *Archiv für Elektronik und Übertragungstechnik*, 27, pp. 309-13, 1973.
- Lange, J., 'Method for Hall mobility and resistivity measurements on thin layers', *J. Appl. Phys.*, 35, p. 2659, 1964.
- Haeusler, J. and Lippmann, H., 'Hallgeneratoren mit kleinem Linearisierungsfehler', *Solid State Electronics*, 11, pp. 173-82, 1968.
- Many, A., Goldstein, Y. and Grover, N. B., 'Semiconductor Surfaces', p. 73 (North-Holland Publishing Company, Amsterdam, 1965).
- Van Bladel, J., 'Electromagnetic Fields', p. 45 (McGraw-Hill, New York, 1964).
- Van Bladel, J., *loc. cit.*, p. 117.
- Courant, R. and Hilbert, D., 'Methoden der Mathematischen Physik', p. 255 and ff. (Springer, Berlin, 1968).
- Abramowitz, M. and Stegun, I., 'Handbook of Mathematical Functions', p. 808 (Dover, New York, 1965).
- Madelung, O., 'Grundlagen der Halbleiterphysik', p. 111 (Springer, Berlin, 1970).
- Wang, S., 'Solid State Electronics', p. 243 (McGraw-Hill, New York, 1966).

Manuscript first received by the Institution on 5th July 1973 and in revised form on 26th October 1973 (Paper No. 1590/CC202)

© The Institution of Electronic and Radio Engineers, 1974

# Synthesis of narrowband cascaded crystal-capacitor lattice filters

J. K. STEVENSON,

B.Sc., Ph.D., M.Inst.P., C.Eng., M.I.E.E.\*

## SUMMARY

A design procedure is given for crystal lattice filters with a maximum bandwidth for quartz of approximately 0.15% of the centre frequency; the method results in simple formulae in terms of the elements of a low-pass ladder of any order.

\* Formerly with The General Electric Company Limited, Telecommunications Research Laboratories, Hirst Research Centre, Wembley, Middlesex; now with the Department of Electrical and Electronic Engineering, Polytechnic of the South Bank, London SE1 0AA.

## List of Principal Symbols

$a$	inverse fractional bandwidth of a band-pass network ( $a = \omega_0/\Delta\omega$ )
$D$	ratio of input to output decrements
$d$	decrement, or inverse $Q$ -factor, for a low-pass reactance
$g$	element in normalized low-pass ladder network
$K_{v,v+1}$	coupling coefficient between branches $v$ and $v+1$ of a low-pass network; $K_{v,v+1} = 1/(g_v g_{v+1})^{\frac{1}{2}}$
$\kappa$	source resistance for normalized low-pass ladder network
$n$	order of network, which equals the number of crystal resonators (Jaumann lattice)
$jR$	frequency independent reactance
$\omega_c$	band-pass cut-off frequency
$\omega_0$	band-pass centre frequency
$\Delta\omega$	bandwidth

## 1 Introduction

Crystal filters were discussed in an earlier paper<sup>1</sup> in which a wideband synthesis procedure was presented. The transformation techniques are extended here for use in narrowband applications.

For filters with a centre frequency lying in the range 1–50 MHz, AT-cut quartz is usually employed operating in the thickness-shear mode of vibration. The crystals are normally specified to resonate at a single frequency. However, unless each crystal is carefully designed and plated, additional resonances may occur between the series resonant frequency for the plated crystal and the frequency without the electrode mass-loading. Design geometries for eliminating the additional modes of vibration, which exist as lateral standing waves in the plated region (trapped energy modes), are well known and readily applied.<sup>2,3</sup> However, crystals which easily satisfy the criterion<sup>†</sup> are liable to possess either low  $Q$ -factors due to insufficient electrode mass-loading, or low motional and static capacitances, as a result of using small electrode areas. Reducing the motional capacitances increases the impedance level which in turn increases the effect of capacitive strays; it also increases the inductive losses if the final lattices are realized in equivalent Jaumann form. In order to minimize the effect of unwanted crystal responses and to lessen the

<sup>†</sup> Assuming that the first antisymmetric inharmonic mode is not excited because of symmetry, the electrode length to thickness ratio  $2a/b$  should satisfy the following, which is a generalized form of Bechmann's criterion.<sup>3</sup>

$$2a/b \leq (2.17/p)[\omega_e/(\omega_s - \omega_e)]^{\frac{1}{2}}$$

where  $\omega_e$  and  $\omega_s$  are the resonant frequencies (cut-off frequencies) for the electroded and surrounding regions, and  $p$  the order of the harmonic mode. This expression is obtained by setting the first symmetric inharmonic-mode eigenfrequency equal to  $\omega_s$ . Satisfying the criterion ensures the elimination of both thickness shear and thickness twist inharmonic modes in the  $X$  and  $Z'$  directions, respectively. The analysis is based on an idealized two-dimensional model and therefore neglects coupling to flexure modes. Nevertheless, application of these formulae has been found to result in satisfactory crystals.

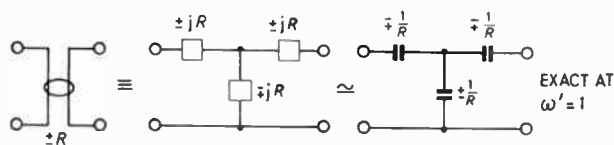

(a) Impedance inverter

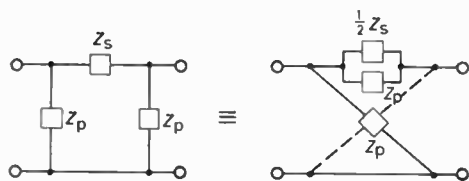

(b) π-network to lattice

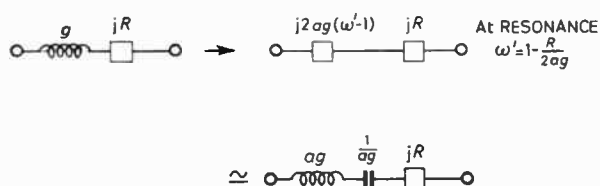

(c) Frequency transformation for a piezo-electric resonator (normalized notation)

Fig. 1. Network equivalences

stop-band deterioration due to unbalanced lattices, single-pole crystal-capacitor lattice sections are used here, with  $n$  lattice sections for an  $n$ th order filter.

Network and frequency transformations are applied to a low-pass ladder network and result in a band-pass circuit of suitable configuration for accepting quartz crystals. A method restricted to an antimetric ladder of even order is given by O'Meara.<sup>4</sup> Smythe<sup>5</sup> has overcome this limitation on symmetry for crystal-capacitor sections, but with his method the crystal motional reactances vary with the element values of the low-pass analogue.

The design procedure given here is based on O'Meara's approach and has overcome the restrictions on network order and element values; the solution is for crystals of equal motional capacitance.†

## 2 Design Method

We commence with a low-pass ladder network normalized with respect to load termination  $R_L$  and cut-off frequency  $\omega_L$ . An impedance inverter, shown symbolically in Fig. 1(a), is inserted between adjacent elements as given in Fig. 2. For equal inductors we require

† Note that there are many applications of narrowband crystal filters involving the selection of a single frequency, and in these instances the use of insertion loss methods (as described here) in place of the simpler image parameter techniques may not be justified. However, insertion loss designs are preferable for filters required for transmitting bands of frequencies, as in telephony and f.m. communication, and are especially valuable for pulsed systems, since the use of Bessel polynomials can result in linear phase filters with minimal overshoot.

$$g_1 = g_2 R_{12}^2 = g_3 \left( \frac{R_{23}}{R_{12}} \right)^2 = \dots$$

$$= g_n \left( \frac{R_{12} R_{34} \dots R_{n-1,n}}{R_{23} R_{45} \dots R_{n-2,n-1}} \right)^2 \dots n \text{ even}$$

$$= g_n \left( \frac{R_{23} R_{45} \dots R_{n-1,n}}{R_{12} R_{34} \dots R_{n-2,n-1}} \right)^2 \dots n \text{ odd}$$

The coupling reactance between elements  $m$  and  $m+1$  is therefore given by

$$R_{v,v+1} = \frac{g_1}{(g_v g_{v+1})^{\frac{1}{2}}} = \frac{K_{v,v+1}}{d_1}$$

$$\dots 1 \leq v \leq n-1$$

where the input and output decrements (inverse  $Q$ -factors),  $d_n$  and  $d_1$ , and coupling coefficients  $K_{v,v+1}$  are given as follows

$$d_n = \frac{1}{\kappa g_n}; \quad \frac{\kappa}{g_n} \dots n \text{ even}; n \text{ odd}$$

$$d_1 = \frac{1}{g_1} = \frac{1}{q_1} \quad (1)$$

$$K_{v,v+1} = \frac{1}{(g_v g_{v+1})^{\frac{1}{2}}} \dots 1 \leq v \leq n-1 \quad (2)$$

Using Fig. 2(b), the new source termination,  $\kappa_T$ , is given as follows

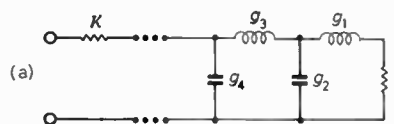

(a) Initial circuit

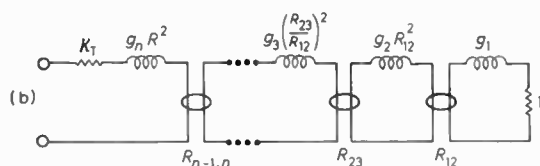

$$R = \frac{R_{12} R_{34} \dots R_{n-1,n}}{R_{23} R_{45} \dots R_{n-2,n-1}}, \quad \kappa_T = \frac{R^2}{\kappa} \dots n \text{ even}$$

$$R = \frac{R_{23} R_{45} \dots R_{n-1,n}}{R_{12} R_{34} \dots R_{n-2,n-1}}, \quad \kappa_T = \kappa R^2 \dots n \text{ odd}$$

(b) Addition of inverters

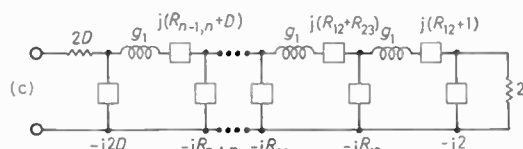

(c) Transformation of terminations

Fig. 2. Low-pass ladder

$$\begin{aligned} \kappa_T &= \frac{1}{\kappa} \left( \frac{R_{12}R_{34} \dots R_{n-1,n}}{R_{23}R_{45} \dots R_{n-2,n-1}} \right)^2 \\ &= \frac{g_1}{\kappa g_n} = \frac{d_n}{d_1} = D \quad \dots n \text{ even} \\ &= \kappa \left( \frac{R_{23}R_{45} \dots R_{n-1,n}}{R_{12}R_{34} \dots R_{n-2,n-1}} \right)^2 \\ &= \frac{\kappa g_1}{g_n} = \frac{d_n}{d_1} = D \quad \dots n \text{ odd} \end{aligned}$$

The source termination is therefore  $D$ , the ratio of input to output decrements. With the inverters in T form and the terminations transformed to provide a negative reactance of smallest magnitude (to be realized with a capacitor) we obtain Fig. 2(c). After converting into lattice form using the transformation in Fig. 1b we obtain Fig. 3(a);  $-jR_c$  is a dummy reactance corresponding to a capacitor which need not be determined here.

With a low-pass to arithmetically symmetrical band-pass transformation for piezoelectric resonators given by<sup>6</sup>

$$[\omega']_{LP} = \left[ \frac{\omega' - 1}{\omega_c' - 1} \right]_{BP} = [2a(\omega' - 1)]_{BP}$$

the inductors are transformed as shown in Fig. 1(c). Normalized frequencies are indicated by a prime and the normalization is now with respect to  $\omega_0$  instead of  $\omega_L$ .  $a$  is defined as follows,

$$a = \frac{\omega_0}{\Delta\omega} = \frac{\omega_0}{\omega_c - \omega_{-c}} = \frac{\omega_0}{2(\omega_c - \omega_0)}$$

where  $\omega_0$ ,  $\omega_{-c}$ ,  $\omega_c$  denote the centre frequency, lower cut-off and upper cut-off frequencies, respectively;  $\Delta\omega$  is the bandwidth. The motional capacitance and normalized frequency resulting from an inductor  $g$  and reactance  $jR$  are therefore as follows

$$\frac{1}{ag}, \quad 1 - \frac{R}{2ag}$$

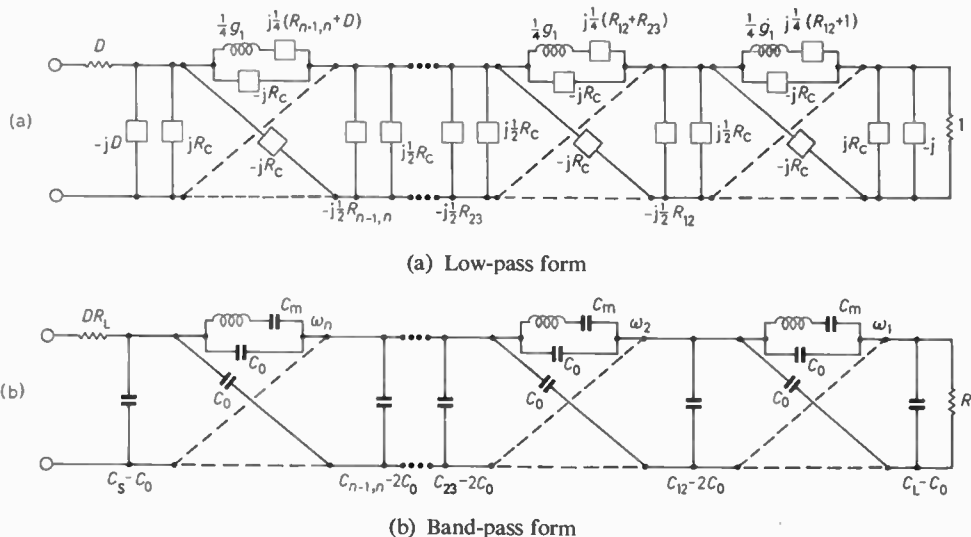

Fig. 3. Lattice representation

With normalized values denoted by a prime, denormalization is performed as follows

$$R = R_L \cdot R', \quad L = \frac{R_L}{\omega_0} \cdot L',$$

$$C = \frac{1}{\omega_0 R_L} \cdot C', \quad \omega = \omega_0 \cdot \omega'$$

### 3 Design Formulae

Element values and frequencies, corresponding to the circuit in Fig. 3(b), are given as follows,

$$\omega_v = \omega_0 - \frac{\Delta\omega}{2} (K_{v-1,v} + K_{v,v+1}) \quad \dots 1 \leq v \leq n$$

$$C_{v,v+1} = \frac{1}{\omega_0 R_L} \cdot \frac{2d_1}{K_{v,v+1}} \quad \dots 1 \leq v \leq n-1$$

where  $K_{01} = d_1$  and  $K_{n,n+1} = Dd_1$

Also,

$$C_m = \frac{1}{\omega_0 R_L} \cdot \frac{4d_1}{a}$$

$$C_L = \frac{1}{\omega_0 R_L}$$

$$C_s = \frac{1}{\omega_0 R_L} \cdot \frac{1}{D}$$

$$R_s = DR_L$$

### 4 Bandwidth Limitation

The maximum bandwidth is determined by the parallel capacitors whose minimum value is zero. From Fig. 3(b),

$$C_0 \leq \frac{1}{\omega_0 R_L} \cdot \frac{d_1}{z}$$

where

$$z = [d_1, K_{v,v+1}, Dd_1]_{\max} \quad \dots 1 \leq v \leq n-1$$



The fractional bandwidth is limited as follows

$$\frac{\Delta\omega}{\omega} = \frac{1}{a} \leq \frac{1}{4rz}$$

where  $r(= C_0/C_m)$  is the crystal capacitance ratio. For fundamental mode quartz crystals,  $r \approx 250$ . Hence,

$$\frac{\Delta\omega}{\omega} \leq \frac{0.1}{z} \% \approx 0.15\%$$

For Butterworth and low-ripple Chebyshev responses ( $\leq 0.2$  dB) with  $D = 1, z = d_1 = 1/g_1$ .

**5 Example**

To illustrate the procedure we will design an 8th-order Butterworth<sup>7</sup> band-pass filter with a centre frequency of 50 MHz and a 3 dB bandwidth of 50 kHz. The design will use crystals with a motional capacitance of 0.01 pF and a static to motional capacitance ratio of 150.

For the given Butterworth characteristic we have the following,<sup>†</sup>

$$d_1 = 2.5637 \quad K_{12} = K_{78} = 1.5192 \quad K_{34} = K_{56} = 0.5538$$

$$K_{23} = K_{67} = 0.7359 \quad K_{45} = 0.5099$$

From the specification data,

$$f_0 = 50 \text{ MHz} \quad \Delta f = 50 \text{ kHz} \quad a = 1000$$

$$\omega_0 = \pi 10^8 \text{ rad/s} \quad C_m = 0.01 \text{ pF} \quad C_0 = 1.50 \text{ pF}$$

Using the design formulae we then obtain,

$$R_L = R_S = 3264 \Omega \quad C_L = C_S = 0.975 \text{ pF}$$

$$f_1 = f_8 = 49.897927 \text{ MHz} \quad C_{12} = C_{78} = 3.291 \text{ pF}$$

$$f_2 = f_7 = 49.943622 \text{ MHz} \quad C_{23} = C_{67} = 6.794 \text{ pF}$$

$$f_3 = f_6 = 49.967757 \text{ MHz} \quad C_{34} = C_{56} = 9.029 \text{ pF}$$

$$f_4 = f_5 = 49.973407 \text{ MHz} \quad C_{45} = 9.806 \text{ pF}$$

An analysis is shown in Table 1 and Fig. 4. The maximally flat attenuation-frequency behaviour has been accurately maintained but the attenuation at the upper cut-off frequency has an error of 0.07 dB due primarily to using capacitors in place of constant reactance elements for the seven inverters and two terminating transformations. This distortion (and any further distortion resulting from practical realization) is probably of no consequence but may be avoided by analysing the pass-band edges to locate the 3 dB points from which a modified cut-off frequency and bandwidth are easily determined.

Allowing for crystal static capacitance, the parallel capacitors are given as follows,

$$C_L - C_0 = C_S - C_0 = -0.525 \text{ pF}$$

$$C_{12} - 2C_0 = C_{78} - 2C_0 = 0.291 \text{ pF}$$

<sup>†</sup> These values are given by the author's tables. Element values of 8th-order filters are readily available<sup>7,8</sup> and from these values of  $d_1$  and  $K$  may be evaluated using eqns. (1) and (2); values of  $q_1$  and  $K$  are given directly for filters up to 8th order.<sup>8,9</sup> Note that published values are usually for frequencies normalized with respect to the natural Butterworth cut-off frequency, at which the attenuation is as follows,

$$a_0 = 10 \log_{10} (1 + \omega^{2n})_{\omega=1} = 10 \log_{10} 2 = 3.010 \text{ dB}$$

leading to

$$d_1 = 2.5629 \quad K_{12} = K_{78} = 1.5187 \quad K_{34} = K_{56} = 0.5537$$

$$K_{23} = K_{67} = 0.7357 \quad K_{45} = 0.5098$$

**Table 1**

Computer output from analysis of filter pass-band (8th-order Butterworth characteristic)

FREQ (Hz)	ATTEN (dB)	PHASE (deg)
49975000.	3.008	360.413
49977500.	0.732	413.021
49980000.	0.117	459.696
49982500.	0.013	499.649
49985000.	0.001	535.500
49987500.	0.000	568.915
49990000.	0.000	600.762
49992500.	0.000	631.552
49995000.	0.000	661.636
49997500.	0.000	691.285
50000000.	0.000	720.726
50002500.	0.000	750.172
50005000.	0.000	779.833
50007500.	0.000	809.939
50010000.	0.000	840.763
50012500.	0.000	872.657
50015000.	0.001	906.140
50017500.	0.016	942.089
50020000.	0.127	982.177
50022500.	0.761	1028.999
50025000.	3.068	1081.698

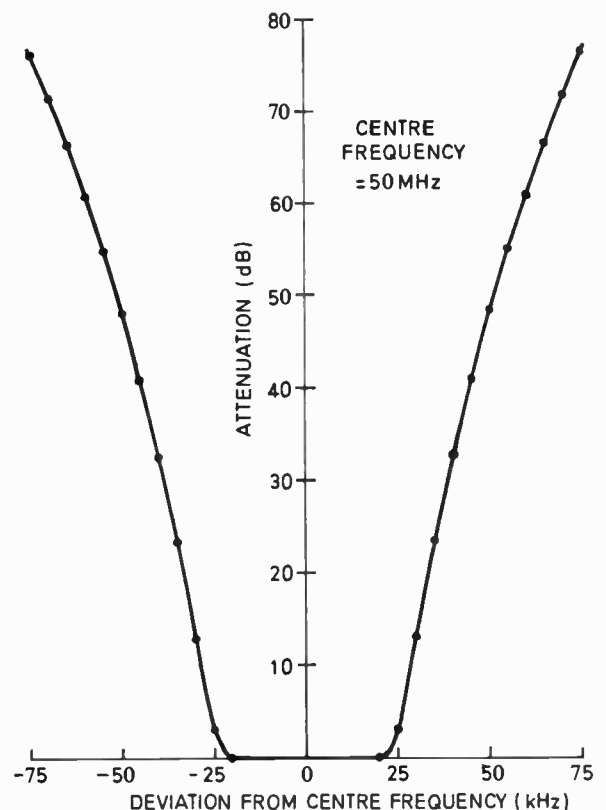

Fig. 4. Response of filter in example.

$$C_{23} - 2C_0 = C_{67} - 2C_0 = 3.794 \text{ pF}$$

$$C_{34} - 2C_0 = C_{56} - 2C_0 = 6.029 \text{ pF}$$

$$C_{45} - 2C_0 = 6.806 \text{ pF}$$

The negative end capacitors are not a serious problem as they may be realized with inductors having the same reactance at  $\omega = \omega_0$ , i.e.  $L_p = 1/[\omega_0^2(C_0 - C_L + C_p)]$  where  $C_p$  is the inductor self-capacitance (plus any stray capacitance). The equivalent parallel resistance of each inductor  $R_p$  causes no distortion if it is treated as part of the termination; the 'external' termination  $R_L$  is then replaced by  $R_p R_L / (R_p - R_L)$ . Resistive losses in crystals and centre-tapped Jaumann transformers (if the network is realized in unbalanced form) can usually be ignored as there is generally no appreciable distortion of the characteristics, simply an increase in insertion loss. Distortion due to crystal losses may be overcome by predistorting the original ladder.<sup>7</sup>

With a crystal capacitance ratio of 250, which is a more realistic value for quartz,  $C_{12} - 2C_0 = C_{78} - 2C_0 = -1.709 \text{ pF}$ . These negative capacitors result from using a Butterworth characteristic for which  $K_{12}$  increases with network order. Chebyshev<sup>7</sup> characteristics are usually preferable for high-order filters. With  $D = 1$  and 3 dB normalization both  $C_L - C_0 (= C_s - C_0)$  and  $C_{12} - 2C_0 (= C_{78} - 2C_0)$  are positive for a pass-band ripple  $\geq 0.03 \text{ dB}$ .

## 6 Conclusions

The simple formulae given here enable a useful class of narrow-band lattice filters to be designed without recourse to circuit theory.

## 7 Acknowledgment

The author acknowledges the support given by the Procurement Executive, Ministry of Defence, for this work.

## 8 References

1. Stevenson, J. K., 'Synthesis of wideband cascaded double-pole crystal lattice filters', *The Radio and Electronic Engineer*, **43**, No. 10, pp. 631-7, October 1973.
2. Curran, D. R., and Koneval, D. J., 'Energy trapping and the design of single and multi-electrode filter crystals', *Proceedings of the 18th Annual Symposium on Frequency Control*, Fort Monmouth, pp. 93-119, 1964.
3. Shockley, W., Curran, D. R., and Koneval, D. J., 'Trapped-energy modes in quartz filter crystals', *J. Acoust. Soc. Amer.*, **41**, pp. 981-993, 1967.
4. O'Meara, T. R., 'The cascade synthesis of crystal filters with transmission zeroes at infinity', *IEEE Trans. on Circuit Theory*, **CT-10**, No. 4, pp. 533-4, December 1963.
5. Smythe, R. C., 'On the realization of crystal-capacitor tandem lattice band-pass filters', *IEEE Trans.*, **CT-11**, No. 1, p. 170, March 1964.
6. Stevenson, J. K., and Redwood, M., 'The motional reactance of a piezoelectric resonator—a more accurate and simpler representation for use in filter design', *IEEE Trans.*, **CT-16**, No. 4, pp. 568-72, November 1969.
7. Weinberg, L., 'Network Analysis and Synthesis' (McGraw-Hill, New York 1962).
8. Zverev, A. I., 'Handbook of Filter Synthesis' (Wiley, New York 1967).
9. 'Reference Data for Radio Engineers', 4th Edition (ITT Corporation, 1956).

*Manuscript first received by the Institution on 13th November 1973 and in final form on 9th January 1974 (Paper No. 1591/CC203)*

© The Institution of Electronic and Radio Engineers, 1974

# IERE News and Commentary

## INSTITUTION PREMIUMS FOR 1975

The Council of the Institution announces that authors of the following papers are to receive Premiums for papers published in *The Radio and Electronic Engineer* during 1973.

### MAIN PREMIUMS

**HEINRICH HERTZ PREMIUM** *Value £50*  
(Physical or mathematical aspects of electronics or radio)  
'The Theory of Cylindrical Antennas with Lumped Impedance Loadings'  
by Professor B. D. Popović (University of Belgrade).  
(Published in the April 1973 issue of the *Journal*)

**MARCONI PREMIUM** *Value £50*  
(Engineering of an electronic system, circuit or device)  
'Multiple Channel U.H.F. Reception on Naval Ships'  
by H. P. Mason (Admiralty Surface Weapons Establishment).  
(May)

### SPECIALIZED TECHNICAL PREMIUMS

**LORD BRABAZON PREMIUM** *Value £25*  
(Aerospace, Maritime or Military Systems)  
'Data Compression Techniques as a Means of Reducing the Storage Requirements for Satellite Data: A Quantitative Comparison'  
by Dr. L. F. Turner (Imperial College).  
(October)

**A. F. BULGIN PREMIUM** *Value £25*  
(Theory or practice of electronic components or circuits)  
'The Design of a Precision Video Delay Line'  
by L. E. Weaver (B.B.C. Designs Department).  
(December)

**REDIFFUSION TELEVISION PREMIUM** *Value £50*  
(Advances in communications or broadcasting engineering)  
'An Experimental Differential P.C.M. Encoder-Decoder for Viewphone Signals'  
by G. A. Gerrard and Dr. J. E. Thompson (Post Office Research Department).  
(March)

**P. PERRING THOMS PREMIUM** *Value £50*  
(Radio or television receiver theory or practice)  
'A V.H.F. Surveillance Receiver Adapted for the Reception of Suppressed Carrier Double-Sideband Transmission'  
by Dr. R. C. V. Macario (University College, Swansea).  
(July)

**J. LANGHAM THOMPSON PREMIUM** *Value £50*  
(Theory or practice of control engineering)  
'The Application of a Commutated Filter to the Design of a Frequency Response Analyser'  
by Dr. C. J. Paull (University of Nottingham) and W. A. Evans (University College, Swansea).  
(June)

**SIR CHARLES WHEATSTONE PREMIUM** *Value £25*  
(Electronic instrumentation or measurement)  
'The Computation of Best Windward and Running Courses for Sailing Yachts'  
by J. Elliot (EMI Electronics).  
(December)

### GENERAL PREMIUMS

**ARTHUR GAY PREMIUM** *Value £25*  
(Production techniques in the electronics industry)  
'Electrolytic Capacitors: Their Fabrication and Interpretation of Their Operational Behaviour'  
by Dr. A. R. Morley (Plessey Company) and Professor D. S. Campbell (Loughborough University of Technology).  
(July)

**ADMIRAL SIR HENRY JACKSON PREMIUM** *Value £25*  
(History of radio or electronics)  
'The Struggle for Power, Frequency and Bandwidth'  
by C. S. den Brinker (Texas Instruments).  
(January/February)

**ERIC ZEPLER PREMIUM** *Value £25*  
(Education of electronic and radio engineers)  
'The Influence of Semiconductors on the Teaching of Electronics'  
by Dr. K. J. Dean (South East London Technical College).  
(January/February)

As there was no paper during the year which could be identified as being 'most outstanding' it has been decided that the **CLERK MAXWELL PREMIUM** should be withheld. There were not any sufficiently outstanding papers falling within the terms of the following Premiums and they also are withheld:

**CHARLES BABBAGE PREMIUM**  
(Electronic computers)

**LESLIE MCMICHAEL PREMIUM**  
(Management techniques in electronic engineering)

**DR. NORMAN PARTRIDGE PREMIUM**  
(Audio frequency engineering)

**LORD RUTHERFORD PREMIUM**  
(Nuclear physics or engineering)

**DR. V. K. ZWORYKIN PREMIUM**  
(Medical and biological electronics)

**SIR JAGADIS CHANDRA BOSE PREMIUM**  
(Indian paper)

**HUGH BRENNAN PREMIUM**  
(North Eastern Section paper)

**LOCAL SECTIONS PREMIUM**

The authors will receive their Premiums and Awards from the President of the Institution at the Annual General Meeting to be held in London on Thursday, 3rd October, 1974.

Notice to all Corporate Members of the Institution of Electronic and Radio Engineers

## Nominations for Election to the 1974-75 Council of the Institution

In accordance with Bye-Law 49, the Council has nominated the following members for election at the Annual General Meeting to be held in London on Thursday, 3rd October, 1974.

### The President

*For Re-election:* I. Maddock, C.B., O.B.E., D.SC., F.R.S.

### The Vice-Presidents

Under Bye-Law 46, all Vice-Presidents retire each year but may be re-elected provided they do not thereby serve for more than three years in succession.

*For Re-election:*

P. A. Allaway, C.B.E., D.TECH.; Professor W. Gosling, A.R.C.S., B.SC.; A. St. Johnston, B.SC.

*For Election:*

H.R.H. The Duke of Kent, G.C.M.G., G.C.V.O.; Professor W. A. Gambling, PH.D., D.SC.

### The Honorary Treasurer

S. R. Wilkins

### Ordinary Members of Council

Under Bye-Law 48, Ordinary Members of Council are elected for three years and may not hold that office for more than three years in succession.

#### FELLOWS

*For Election to fill the sole vacancy:*

Professor D. E. N. Davies, M.SC., PH.D.

#### MEMBERS

*For Election to fill the sole vacancy:*

M. S. Birkin

The remaining members of Council will continue to serve in accordance with the period of office laid down in Bye-Law 48.

Bye-Law 50 provides that:

Within twenty-eight days after the publication of the names of the persons nominated by the Council for the vacancies about to occur any ten or more Corporate Members may nominate any one other duly qualified person to fill any of these vacancies by causing to be delivered to the Secretary a nomination in writing signed by them together with the written consent of the person nominated undertaking to accept office if elected, but each nominator shall be debarred from nominating any other person for the same vacancy.

By Order of the Council

GRAHAM D. CLIFFORD,  
Secretary.

28th June 1974.

---

Brief biographical notes on members nominated for election to the Council will be published with the Notice and Agenda for the Annual General Meeting.



## First Engineers Registration Board Assembly

*The first General Assembly of the Engineers Registration Board, the nationally recognized registration authority for Engineers and Technicians, was held on 15th May 1974 at the Institution of Civil Engineers in London.*

This Assembly marked a milestone in the progress of the ERB which was established in 1971 under the Charter of the Council of Engineering Institutions, and with Governmental approval. It was the first occasion on which representatives of all 46 member bodies of the ERB in each of its three sections (Chartered Engineer, Technician Engineer and Technician) had met together to discuss matters of common interest.

In his address of welcome Major-General Sir Leonard Atkinson, Chairman of the CEI, said that since its formation the ERB had been largely preoccupied with laying the foundations and overcoming the many problems involved in providing, for the first time, the structure of a composite Register of all levels of professional and technical competence. This Assembly provided an opportunity to take stock of the achievements of the ERB, and to review the next stages of its development.

Having been proposed by Mr. A. J. Kenward (Chairman, Technician Engineer Section) and seconded by Mr. J. K. Bennett (Vice-Chairman, Technician Board), Dr. D. F. Galloway was unanimously elected as the first Chairman of the Engineer Registration Board. Dr. Galloway has been Chairman of the ERB Co-ordinating Committee since its formation in December 1971.

After Dr. Galloway had thanked the Assembly for their vote of confidence in him, he called upon the chairmen of the three Sections of the ERB to present their Progress Reports.

In his report of the Chartered Engineer Section, Professor J. F. Coales stressed the importance of maintaining the high standards for qualification as a Chartered Engineer if continued and progressive recognition was to be achieved. He reminded the delegates that the CEI examinations were now the academic qualification against which exemptions would be assessed. As regards training, it was hoped that CEI Statement No. 11 would be published before the end of this year. For the future the CEI would continue work to achieve comparable standards between all the Chartered Engineering Institutions, and he foresaw the eventual possibility of a single body acting as the authority for assessing the qualifications for registration as a Chartered Engineer.

Mr. A. J. Kenward, reporting on the work of the Technician Engineer Board, told the Assembly that in the 15 months that the Board had been in being common standards for registration had now been agreed, and that the Qualifications Committee were continuing to make progress on comparable academic qualifications. There were already approximately 34 000 registered Technician Engineers and he foresaw this increasing to double this figure in the coming year. He considered that it would not be over-optimistic to forecast over 100 000 registrations eventually.

The report for the Technician Board was given by Mr. J. K. Bennett in the unavoidable absence abroad of the Chairman, Mr. H. W. Payne. As with the Technician Engineer Board, Mr. Bennett was enthusiastic about the support that had so far been given and was extremely optimistic as to the future of this, the youngest of the three ERB Sections.

In his address Dr. Galloway set out what he considered to be the main functions of the ERB for the future. These were, consultation with the Government, liaison with the EEC, and liaison and contact with industry. He did not wish to elaborate on these aims but rather to pose a number of questions for member bodies of the ERB to consider, such as 'Is there a case for State Registration of Engineers?', 'Should the Government set up special schemes for education and training?', 'What should be the attitude of ERB towards the EEC?' and 'Should there be a Federation of Institutions?'.

During the general discussion that followed the following were among the points raised.

It was agreed that national propaganda particularly in the Technician Engineer and Technician fields would prove beneficial.

The introduction of a title such as 'Engineer' similar to that of 'Doctor' had been considered but it presented considerable problems since the word had such varied interpretations in different sections of society.

In reply to a question on relationship with the EEC, the Secretary of CEI, Mr. M. W. Leonard, spoke of the 'great deal

of misunderstanding on the right to practise'. Engineers and technicians could, in fact, work more freely not only in this country but throughout Europe. The problems were not the right to practise; they stem from the establishment of threshold of responsibility levels and qualifications that could be used as a basis for negotiation by the British Government with its opposite numbers. Mr. Leonard said that the British system of recognition of professional qualifications was essentially different from that of the Continent in that we gave a great deal of emphasis to practical training and experience with responsibility. The engineering bodies of Europe had reached agreement over mutual qualifications and it was surely possible for the governments to do the same.

The question of compulsory registration of Technician Engineers has been considered but the disadvantages would appear at present to outweigh any advantages that might accrue from such a course. Consideration must be given to means to enable the Technician Engineer to become a Chartered Engineer where he is not a member of one of the Chartered Institutions; ways and means of achieving this were already being considered.

### Chairman of the Engineers Registration Board



Dr. D. F. Galloway, C.B.E., C.Eng., first Chairman of the Engineers Registration Board and also Chairman of the Board's Co-ordinating Committee, is a Past President of the Institution of Mechanical Engineers.

Educated at Birmingham Central Technical College and Cambridge University, he gained a Ph.D. for his researches on the machining of light alloys. While with the Birmingham Small Arms

Company he was concerned with the design and development of single and multi-spindle automatic machines; later he joined the Dunlop Rubber Company, where he was engaged on the design and layout of mass production plant.

In 1939 Dr. Galloway was appointed Assistant Director of the Research Department of the Institution of Production Engineers at Loughborough College. He was later appointed Director, and in 1946 he was involved in the formation of the Production Engineering Research Association of Great Britain. As the Director of PERA since its formation, Dr. Galloway has been responsible for the development of the research, consulting and other services which now cover most aspects of manufacture.

### Present Membership of the Three Sections of ERB

#### Chartered Engineer Section

Royal Aeronautical Society  
 Institution of Chemical Engineers  
 Institution of Civil Engineers  
 Institution of Electrical Engineers  
 Institution of Electronic and Radio Engineers  
 Institute of Fuel  
 Institution of Gas Engineers  
 Institute of Marine Engineers  
 Institution of Mechanical Engineers  
 Institution of Mining Engineers  
 Institution of Mining and Metallurgy  
 Institution of Municipal Engineers  
 Royal Institution of Naval Architects  
 Institution of Production Engineers  
 Institution of Structural Engineers

#### CHAIRMAN OF THE CHARTERED ENGINEER SECTION



Professor J. F. Coales, C.B.E., M.A., C.Eng., F.R.S., is Vice-Chairman of CEI and a Past President of the Institution of Electrical Engineers (1971/72). He is Professor of Engineering (Control) at Cambridge University and a member of the Environmental Design and Engineering Research Committee, Building Research Establishment; the British Council Science Advisory Committee; the Engineering and Buildings Board

of the Agricultural Research Council, and of the Council for Environmental Science and Engineering. He is also President of the newly formed international body, World Environment and Resources Council.

Professor Coales has published a large number of original papers on radio direction-finding, magnetic amplifiers, computers, automation, control and systems engineering and on engineering education.

## Technician Engineer Section

Association of Mining Electrical and Mechanical Engineers  
Association of Public Lighting Engineers  
Association of Water Officers Ltd.  
Bureau of Engineer Surveyors  
Highway and Traffic Technicians Association Ltd.  
Illuminating Engineering Society  
Institute of Automobile Assessors  
Institute of Engineers and Technicians  
Institute of Fuel  
Institute of Hospital Engineering  
Institute of Marine Engineers  
Institute of Measurement and Control  
Institute of the Motor Industry  
Institute of Plumbing  
Institute of Quality Assurance  
Institute of Road Transport Engineers  
Institute of Sheet Metal Engineering  
Institute of Works and Highways Superintendents  
Institution of Agricultural Engineers  
Institution of Chemical Engineers  
Institution of Electrical and Electronic Technician Engineers  
Institution of Electronic and Radio Engineers  
Institution of Engineers and Shipbuilders in Scotland  
Institution of Gas Engineers  
Institution of General Technician Engineers  
Institution of Heating and Ventilating Engineers  
Institution of Mining Engineers  
Institution of Nuclear Engineers  
Institution of Plant Engineers  
Institution of Production Engineers

Institution of Public Health Engineers  
Institution of Railway Signal Engineers  
Non-Destructive Testing Society of Great Britain  
North East Coast Institution of Engineers and Shipbuilders  
Royal Aeronautical Society  
Royal Institution of Naval Architects  
Society of Civil Engineering Technicians  
Society of Electronic and Radio Technicians  
Society of Licensed Aircraft Engineers and Technologists  
Welding Institute

### CHAIRMAN OF THE TECHNICIAN ENGINEER SECTION



Mr. A. J. Kenward, B.Sc., C.Eng., is Secretary of the Society of Electronic and Radio Technicians and of the Radio, Television and Electronics Examination Board and he is a member of the Department of Education and Science Technician Education Council. From 1949 to 1965 Mr. Kenward was Education Officer of the IERE.

## Technician Section

Association of Mining Electrical and Mechanical Engineers  
Association of Public Lighting Engineers  
Association of Water Officers Ltd.  
Bureau of Engineer Surveyors  
Highway and Traffic Technicians Association Ltd.  
Illuminating Engineering Society  
Institute of Engineers and Technicians  
Institute of Hospital Engineering  
Institute of Marine Engineers  
Institute of Plumbing  
Institute of Quality Assurance  
Institute of Road Transport Engineers  
Institute of Sheet Metal Engineering  
Institute of Works and Highways Superintendents  
Institution of Agricultural Engineers  
Institution of Electrical and Electronic Technician Engineers  
Institution of General Technician Engineers  
Institution of Heating and Ventilating Engineers  
Institution of Plant Engineers

Institution of Public Health Engineers  
Non-Destructive Testing Society of Great Britain  
Royal Institution of Naval Architects  
Society of Civil Engineering Technicians  
Society of Electronic and Radio Technicians  
Society of Licensed Aircraft Engineers and Technologists  
Welding Institute

### CHAIRMAN OF THE TECHNICIAN SECTION



Mr. H. W. Payne is Secretary (External Affairs) of the Society of Licensed Aircraft Engineers and Technologists, and Secretary General of the International Federation of Airworthiness Technology and Engineering (IFATE). He joined the Society in 1963 as Secretary General following service in the R.A.F. as an air traffic control officer.

# CEI News

## CEI to Establish John Smeaton Award

To mark the 250th anniversary, on 8th June, of the birth of the eminent engineer John Smeaton, the Council of Engineering Institutions in association with the Smeatonian Society of Civil Engineers has established an award for outstanding achievements in engineering. To be awarded annually, this will take the form of a medal and an honorarium.

The award will be made for achievement relating to engineering in the widest sense and will not be restricted to a particular discipline, neither will the achievement necessarily have been documented in the form of a contribution to learned society proceedings, or have been the subject of an academic paper.

A Smeaton Award Committee, on which the Smeatonian Society will be represented, is to be set up by CEI to advise on the conditions and to adjudicate on the award. It has already been agreed, however, that this shall not be a project team award but one going to an individual for personal achievement.

Smeaton, a Yorkshireman, is probably best known for his Eddystone lighthouse completed in 1759. Originally an instrument maker, he worked on such projects as a vacuum pump, revolving speculum (artificial horizon), improvements to the magnetic compass and development of a ship's log for continuously recording the apparent distance travelled. A commission to design a watermill and the paper he later presented to the Royal Society on this subject in 1759 led Smeaton away from his profession of instrument making and into the field of engineering. His early works were all concerned with designing water and wind mills. His most famous work—the building of the Eddystone lighthouse, off Plymouth—was begun in 1756. In the 1760s he established himself as an engineer of outstanding ability and he was called in to advise on most of the problems within the engineering spectrum of the day, including canals, harbours, land drainage, bridges, steam engines and mills. His masonry bridge over the River Tweed at Coldstream still stands today much as he left it.

Together with Robert Mylne he was a founder member of the Society of Civil Engineers in 1771. The object of the Society was to provide a meeting place where surveyors and instrument makers, but primarily engineers, could meet to discuss informally matters of common interest. After Smeaton's death in 1792 it was renamed the Smeatonian Society of Civil Engineers; two centuries later it still enables eminent engineers to meet for the same purpose.

## Certificates of Registration as Technician Engineer CEI

Certificates of Registration as Technician Engineer CEI (or Technician CEI) are now available on application direct to the Engineers Registration Board. The cost will be £3 which includes VAT, postage and packing.

The certificates measure 32 × 23 cm on ivory board and are signed by the Chairman of the appropriate section and the Secretary of the ERB.

Application forms can be obtained from the IERE or direct from the ERB, 2 Little Smith Street, London SW1P 3DL, to whom the completed form and remittance must be sent.

## Government Urged to Set Up a British Oceanic Authority

The urgent establishment of clear national policies and objectives for the future progress of British marine and off-shore activities—to be developed jointly with industry and the community—has been called for by the British National Committee on Ocean Engineering (BNCOE). In its evidence to the House of Commons Select Committee on Science and Technology (Sub-Committee 'D') studying 'National Policy on Seabed Engineering', BNCOE urged in particular the establishment of a British Oceanic Authority as a statutory body to assist in formulating national policies and subsequently in implementing them.

BNCOE said in its evidence that a British Oceanic Authority should be headed by a prominent figure with at least as great a political and business stature as the Chairmen of the major nationalized industries and who would have ready access to the Prime Minister and other senior Ministers. The Secretary of State for Industry would be responsible for the new Authority and would provide its direct budget, the remainder coming from appropriate departments or bodies—both private and public—for whom work was undertaken by the Authority.

The Government, said BNCOE, should allocate an annual budget in the region of £125M for the support and development of Britain's participation in marine activities matched by a like amount in industry, this total figure being related to the current rates of investment in these activities and the need to develop 'Big Technology'. A substantial proportion of this

The Council of  
Engineering Institutions



Incorporated by  
Royal Charter 1965

## ENGINEERS REGISTRATION BOARD

*This is to certify that*

---

*at the nomination of*

---

*has been registered by the Engineers Registration Board as a*

**TECHNICIAN ENGINEER CEI**

*and is entitled to use the designatory letters "T. Eng. (CEI)"*

Dated this \_\_\_\_\_ day of \_\_\_\_\_ 19\_\_\_\_



  
**Chairman  
Technician Engineer Board**

  
**Secretary**

This certificate is the property of the Engineers Registration Board and must be returned on request. It is valid only for so long as the holder remains a member of a member Institution of the Engineers Registration Board.



sum should be allocated by the new Authority, especially for developing British off-shore and underwater capabilities jointly with industry.

In its evidence the Committee said that 'while the principal aim of the BNCOE must be to promote the interests of professional engineers and through them of the public at large, we find in the field of ocean activities a situation which can only be improved by other actions of the Government and others to provide a framework within which engineers can work for the benefit of the community as a whole'.

Seabed engineering, continued BNCOE, was an extension of several existing branches of engineering in new inter-disciplinary groupings, and often on scales far greater than had been encountered hitherto on land. There was thus the need to

establish broad new interfaces to bring together the resources required and give them the impetus needed to make satisfactory progress.

The BNCOE was formed in 1970 as an inter-disciplinary engineering body consisting of Chartered Engineers specializing in the various aspects of ocean engineering. It provides the British representation on the non-governmental international Engineering Committee on Oceanic Resources (ECOR). The aim of the BNCOE is: 'to stimulate the development of Britain's engineering capabilities in the oceans and to provide a focus for professional engineering opinion in this field in dealing with the public, H.M. Government, Parliament, international bodies and other organizations.' IERE representatives on BNCOE are Mr. P. W. Warden and Mr. M. J. Tucker (alternate).

## Recent Government and Industry Publications

### International Progress in Metrication

According to the latest report of the Metrication Board\* Britain now faces a situation in which more than 87% of exports goes to countries which are metric or are changing to metric. Another 12% goes to the USA where the metric change is already under way in industry and only the timetable and the governmental institutional arrangements for coordinating the changeover remain to be settled. Well under 1% of exports goes to the countries which have yet made no decision to change. The probability is that the World will be substantially metric before the end of this decade.

The most important overseas markets are in the process of changing. In some the change is virtually complete, in others the rate of change is accelerating. Not only Western Europe but India and Japan as well as the Soviet Union, China and Latin America are already metric. During the year The Bahamas, Barbados, The Gambia, Jamaica, Nauru, Sierra Leone, Tonga and Western Samoa decided to go metric. This leaves only Brunei, Burma, Liberia, Yemen Arab Republic and Yemen People's Democratic Republic which have not yet decided to make the change. There are now 140 countries, including all the members of the Commonwealth, which are already metric or are changing to metric.

At the end of 1972 the Metrication Board reported that in Britain the momentum of the metric change in engineering had to increase to reach the engineering industries' agreed target of 75% metric production by the end of 1975. The fourth annual survey of metrication progress in the engineering industries carried out during October and November 1973 showed that nine out of ten firms had some production in metric. The proportion of firms having more than half their production in metric increased from 26% to 45% between 1972 and 1973. The largest increase was by small firms with less than 100 employees where the proportion with over half metric production increased from 20% to over 50%. Between the 1972 survey and that for 1973 the proportion of total production by value in metric or with metric interfaces went up from 35% to 44%.

These surveys were not designed to provide a reliable measure of progress in individual engineering sectors. The Board commissioned an investigation to ascertain the extent of progress not only overall but also within some 20 important individual sectors, to identify problems and to provide indications of what further needs to be done to help the change to metric. The fieldwork for this survey, which was largely com-

pleted by the end of December 1973, included discussions with over 250 firms. The preliminary indications were that there may be some specific problems in certain sectors, including slowness in demand from users for metric products, but there are no general obstacles to progress in the engineering industries as a whole. However, there is insufficient appreciation within the industries of the benefits to be secured from speeding the change and this may mean they fail to achieve the agreed target. The Board expects to publish a detailed report on the survey in 1974.

### New Export Handbook

The British Overseas Trade Board has published a 1974 edition of its Export Handbook for British firms trading abroad. First published in 1967 the Export Handbook now has an annual circulation of over 70,000 copies. This edition has been brought up to date in its description of all the Government services available for exporters, together with mention of private agencies, many useful addresses and a long bibliography. It is available free of charge from The Department of Trade, Room D 05, Export House, 50 Ludgate Hill, London EC4M 7HU or from any regional office.

### EEA Career Leaflets

The Electronic Engineering Association have re-issued a revised series of seven leaflets on Careers in the Electronics Industry. They cover:

1. Careers in the Electronics Industry—a general leaflet.
2. Training of Craftsmen in the Electronics Industry.
3. Training of Technicians and Technician Engineers in the Electronics Industry.
4. Undergraduate Training in the Electronics Industry.
5. Graduate Training for Engineering Appointments in the Electronics Industry.
6. Graduate Training for non-Engineering Appointments in the Electronics Industry.
7. Pay during Training in the Electronics Industry.

The Career Leaflets have been sent to: University Appointments Boards Officers, all Polytechnics, all Department of Employment Officers covering the Professional and Executive Register, all Local Authority Careers Officers (Youth Employment), all boys and mixed schools offering 'A' level and 'O' level courses.

The leaflets are available on request from: Electronic Engineering Association, 8 Leicester Street, London WC2H 7BN. (Tel: 01-437 0678.)

\* 'Going Metric: the next phase' Report of the Metrication Board for the year ending 31st December 1973. H.M. Stationery Office, London, 1974. Price 95p.

# Members' Appointments

## CORPORATE MEMBERS

**Mr. J. G. Cottrell** (Fellow 1959, Member 1955, Graduate, 1950) has been appointed Executive Assistant to the Managing Director of Standard Telephones and Cables Limited. Mr Cottrell has for the past 25 years been with the Plessey Company; from November 1971 to September 1973 he was



Divisional Managing Director of Communications and Marine Systems, and subsequently Director of Projects on the Company's Corporate Staff. From 1959 to 1964 Mr Cottrell served on the Programme and Papers Committee and he took a leading part in the formation in 1964 of the East Anglian Section as its first Honorary Secretary, later serving as Chairman from 1968 to 1970.

**Mr. K. G. Beauchamp, Ph.D., C.G.I.A.** (Fellow 1969, Member 1952, Associate 1947) who has been Computer Manager at Cranfield Institute of Technology since 1967, has taken up the position of Director of Computer Services at the University of Lancaster. Before going to Cranfield Dr. Beauchamp was at the Atomic Weapons Research Establishment where he was concerned with data acquisition and computation work, latterly as Computer Manager in charge of the combined analogue/digital facility.

**Group Captain R. Morris, M.A., RAF** (Fellow 1966, Member 1945) has taken up the appointment of Assistant Director (Policy) on the Defence Signals Staff. He was previously Head of the RAF Maintenance Data Centre at Swanton Morley.

**Mr. R. W. Timms** (Fellow 1973, Member 1963) who is with Marconi Space and Defence Systems Limited, has been appointed Engineering Services Manager at Hillend, Dunfermline; he was previously Chief Engineer at this factory.

**Mr. A. D. Amott** (Member 1970) who came back to England two years ago and has been working as Systems Engineer with G.T.E.I.S., Feltham, has returned to Canada and is now Sales Engineer (Data Communications) with Texas Instruments, Richmond Hill, Ontario.

**Mr. J. Baguley** (Member 1967, Graduate 1962) has recently joined Erie Electronics Limited as General Manager of the Thick Film Division. He was previously Chief Project Engineer with Racal Communications Limited.

**Brigadier R. H. Borthwick, B.Sc. (Eng.)** (Member 1955) has been appointed Head of the Communications Division of the Civil Service Department, on retiring from the Army after 31 years' service with the Royal Signals

**Sqn. Ldr. A. S. D. Burke, RAF (Ret.)** (Member 1972) is now working for Sir Robert McAlpine & Sons Limited as Chief Mechanical and Electrical Engineer on the oil rig construction project at Ardyne Point, Argyll. Before retiring from the RAF Sqn. Ldr. Burke was Officer Commanding Electronic Systems Squadron, Central Servicing Development Establishment, RAF Swanton Morley.

**Mr. T. F. Carruthers** (Member 1972, Graduate 1970) is now Senior Quality Engineer with Burroughs Machines Limited, Glenrothes, Fife. He was previously a Design Engineer with Dorman Smith Control Gear Limited, Preston.

**Major S. C. Craxford, M.A., REME** (Member 1971, Graduate 1967) has been appointed S.O.1 Special Studies, H.Q. Technical Group REME. His previous appointment was GSO2 (W) at the Royal Radar Establishment, Malvern.

**Mr. Shi Wei Kong** (Member 1973, Graduate 1969) is now with the Education Department, Government of Hong Kong, and holds the appointment of Education Officer (Technical).

**Sqn. Ldr. R. J. A. McGuigan, RAF** (Member 1972, Graduate 1968) has returned to the UK to take up the appointment of Officer Commanding Engineering Wing at RAF West Drayton. For the past 3 years he was at HQ Near East Air Force.

**Sqn. Ldr. S. K. Morgan, RAF** (Member 1966) has completed a three years' posting as RAF Liaison Officer at the Rome Air Development Center, US Air Force, Rome, New York, and is taking a course at the RAF Staff College, Bracknell.

**Mr J. H. Puckette** (Member 1951), formerly Deputy for Plans, Programmes and Test at the joint US-UK Research and Development Site, Orford Ness, Suffolk, has been appointed Field Programme Manager and Chief Engineer of the USAF System Command Electronic Systems Division, West Germany.

**Mr. J. O. Ranson** (Member 1970, Graduate, 1966) who has been with Decca Navigator Company since 1969 as Senior Engineer, is now Senior Logic Designer.

**Sqn. Ldr. I. Shephard, RAF** (Member 1973) has been appointed to Air Engineering 10a, Ministry of Defence. He was previously CSD Project Officer, RAF Farnborough, Hants.

**Mr. A. Shinwell** (Member 1973, Graduate 1965) is now with the Digital Systems Division of Ferranti Limited, Bracknell, as Documentation Co-ordinator. He was previously a Lecturer at the Engineering Training Centre of ICT Limited, Letchworth.

**Mr. I. J. Shelley** (Member 1959, Associate 1946) and **Mr. N. W. White** (Member 1971) have received the Geoffrey Parr Award of the Royal Television Society, for their work on the design and development of automatic monitoring and control equipment for unattended transmitters.

Mr. Shelley, who is Head of Monitoring and Control in the BBC's Designs Department, led the team which designed the monitoring system; Mr. White, Manager of the Communications Division of Marconi Instruments Ltd., led the team which produced an insertion signal analyser and the companion instrument, the data monitor, based on the BBC design.

## NON-CORPORATE MEMBERS

**Dr. Walter Bruch** (Honorary Fellow 1970) who has been Chief of the Basic Television Research Department of AEG Telefunken since 1959, has been awarded The Royal Television Society's Gold Medal for outstanding contributions to television. Dr. Bruch invented the PAL system of colour television as well as systems for recording colour television on tape and disks. From 1964 to 1970 he was President of the German Television Society.

**Mr. J. P. Collis, M.A.** (Companion 1970) who joined The Rank Organisation in 1962 as Assistant to the Group Marketing Director and subsequently was appointed Managing Director of Rank Bush Murphy Limited in 1965 and to the Board of the Rank Organisation in 1967, has moved to Royal Worcester Limited as Chief Executive.

**Mr. C. J. Cumner** (Graduate 1970) who has been with Stein Atkinson Stordy Limited as Systems Engineer concerned with Furnace Control since 1968, has been appointed Executive Assistant to the Managing Director of the Company.

**Inst. Lt. J. G. Fairgrieve, B.Sc., RN** (Graduate 1970) is serving at the Department of Defence Computer Institute, Washington D.C., as Lecturer on Computer Software.

**Mr. W. Fong Yan, M.Sc., Ph.D.** (Graduate 1970) has completed his studies for a doctorate in the Department of Physics, Brunel University and has joined the Semiconductors Division of Westinghouse Brake & Signal Company as a Research Physicist in the Physical Research Laboratory.

# INSTITUTION OF ELECTRONIC AND RADIO ENGINEERS

## Applicants for Election and Transfer

THE MEMBERSHIP COMMITTEE at its meetings on 28th December 1973, 7th and 21st May 1974 recommended to the Council the election and transfer of 130 candidates to Corporate Membership of the Institution and the election and transfer of 28 candidates to Graduateship and Associateship. In accordance with Bye-law 21, the Council has directed that the names of the following candidates shall be published under the grade of membership to which election or transfer is proposed by the Council. Any communications from Corporate Members concerning these proposed elections must be addressed by letter to the Secretary within twenty-eight days after the publication of these details.

### Meeting: 28th December 1973 (Membership Approval List No. 183)

#### GREAT BRITAIN AND IRELAND

##### CORPORATE MEMBERS

###### Transfer from Graduate to Member

CARTER, Terence Arthur. *Lytham St. Annes, Lancashire.*  
CLARK, Martin William. *Hayling Island, Hampshire.*  
COLLINS, Terence Victor. *East Grinstead, Sussex.*  
COPS, Michael Herbert. *Solihull, Warwickshire.*  
CRAWLEY, Graham Dymond. *Bromley, Kent.*  
DANIELS, Basil John. *Bexley, Kent.*  
DEAN, George. *Stockport, Cheshire.*  
DENCH, Edward James. *Weymouth, Dorset.*  
FARMAN, Michael Edward. *Maidenhead, Berkshire.*  
FARNDON, David Hedley. *Woodford Green, Essex.*  
FLEGG, Robert Andrew. *Bisley, Surrey.*  
FOXWELL, Colin. *Camberley, Surrey.*  
FRENCH, John William. *Fleet, Hampshire.*  
GARRIOCH, James Traill Moodie. *Broadstone, Dorset.*  
GREATOREX, Barry John. *Great Totham, Maldon, Essex.*  
GREENHOUGH, Alan Sydney. *Maldon, Essex.*  
GREENSMITH, John Patrick. *Ratcliffe-upon-Soar, Nottingham.*  
GROSSART, Colin Douglas. *Falkirk, Scotland.*  
HANSFORD, Laurence Ives. *Maidenhead, Berkshire.*  
HARNDEN, Frank Edward. *Coleford, Gloucestershire.*  
HART, Ronald Ernest. *Winscombe, Somerset.*  
HAY, Alfred Elgar, M.Phil. *Farnham, Surrey.*  
HEATH, Brian William Frederick. *Pinner, Middlesex.*  
HERRING, Malcolm Brian. *Bishop Wilton, York.*  
HERRINGTON, Peter George. *Farnborough, Hampshire.*  
HORSWILL, Gordon. *Runcorn, Cheshire.*  
HUGHES, Owen Cecil. *Beckenham, Kent.*  
HUGHES, Stephen John. *Farnham, Surrey.*  
HUMPHRIS, Robert Stanley. *Little Sutton, Wirral, Cheshire.*  
HYDE, Thomas Edmund. *Luton, Bedfordshire.*  
HYETT, David Michael. *Cheltenham, Gloucestershire.*  
JAMES, Albert Henry. *Malvern, Worcestershire.*  
JEARY, Alan Peter. *Reigate, Surrey.*  
JEFFERIES, Barry. *Edinburgh.*  
LOVETT, Alan. *Sandiacre, Nottinghamshire.*  
NEWCOMB, Kenneth Philip Alfred. *Crawley, Sussex.*  
PEARCE, Barry Seward. *Lee-on-Solent, Hampshire.*  
REEVES, Anthony John. *Colchester, Essex.*  
RISEBOROUGH, Michael Keith. *Biggleswade, Bedfordshire.*  
ROBERTS, Malcolm James. *Luton, Bedfordshire.*  
ROBERTS, Paul Franklin. *Chipham, Sussex.*

ROMAINE, David Albert Frederick. *Camberley, Surrey.*  
SADLER, John Barrie, Lieutenant R.N. *Hayling Island, Hampshire.*  
SANFORD, Peter Robert. *Staines, Middlesex.*  
SANGHRAJKA, Bharat Kumar Revulal. *Leighton Buzzard, Bedfordshire.*  
SCALLY, Dick. *Reading, Berkshire.*  
SCHOLEFIELD, Richard Browne. *Twickenham, Middlesex.*  
SCOTT, Douglas. *Huncote, Leicester.*  
SHAW, William Thomas. *Swansea, Glamorgan.*  
SHEEHAN, Daniel. *Swansea, Glamorgan.*  
SILLS, William Henry Albert. *Sunbury-on-Thames, Middlesex.*  
SLATER, John Charles, Captain REME. *Barkham, Wokingham, Berkshire.*  
SMITH, Colin Staddon. *Bishops Stortford, Hertfordshire.*  
SMITH, Robinson. *Carlisle, Cumberland.*  
SMITH, Roger Charles. *Harrow, Middlesex.*  
SMITH, Trevor Charles. *Rushden, Northamptonshire.*  
SPICELEY, David Robert. *Chelmsford, Essex.*  
SQUELCH, Brian Michael. *Paddock Wood, Kent.*  
STERLING, Derek. *Great Totham, Essex.*  
STEVENS, Leonard Ronald James. *Gravesend, Kent.*  
STEVENS, Raymond. *Cardiff.*  
STEWART, William. *Dunfermline, Fife.*  
STOBART HOOK, Barry, M.A.(Cantab.). *Portsmouth, Hampshire.*  
STOKES, John Francis Arthur. *Harrow, Middlesex.*  
TANER, Ertan. *Barnet, Hertfordshire.*  
TAYLOR, Robert Elery. *St. Albans, Hertfordshire.*  
TERRILL, Kenneth Phillip Frank. *Pinner, Middlesex.*  
TILLOTT, Brian. *Aylesford, Maidstone, Kent.*  
TINKLER, Kenneth. *Cheltenham, Gloucestershire.*  
TIZZARD, Anthony Richard. *West Lothian, Scotland.*  
TRODDEN, John Joseph. *Langport, Somerset.*  
USHER, Alan. *Bexley, Kent.*  
VINCE, Robert. *Rochester, Kent.*  
VUDALI, Tahsin. *Slough, Buckinghamshire.*  
WALLIS, David Thomas. *Garston, Hertfordshire.*  
WALLMAN, Bryan Frank William. *Malvern, Worcestershire.*  
WARING, David Frederick. *Wotton-under-Edge, Gloucestershire.*  
WARREN, Hilary Allison. *Twickenham, Middlesex.*  
WARRICK, David. *Lisburn, County Antrim, N. Ireland.*  
WATERMAN, Bryan Charles. *Slough, Buckinghamshire.*  
WATSON, Stuart John. *Ashford, Middlesex.*  
WESTON, Robert Dale. *London, WCI.*  
WHEELER, Rodney Edward William. *Erith, Kent.*  
WHEELER, Roger. *Colchester, Essex.*  
WHITMORE, John Geoffrey. *Chatham, Kent.*  
WILKINSON, Peter Roy. *Chester.*  
WILLIAMS, Alan Thomas. *Churchdown, Gloucestershire.*

WILLIAMS, Bernard. *West Malling, Kent.*  
WILLIAMS, Francis John. *Sutton, Surrey.*  
WILLIAMS, Frederick Arthur Charles, Major REME. *Wokingham, Berkshire.*  
WILLIAMS, Ronald. *Warrington, Lancashire.*  
WILLS, Brian Reginald. *Fleet, Hampshire.*  
WILSON, Kenneth. *Gleadless, Sheffield.*  
WOOLNOUGH, John Michael Frederick. *Ilford, Essex.*  
WRIGHT, Ronald Stuart. *High Wycombe, Buckinghamshire.*  
YOUNG, Brian Eric. *Dartford, Kent.*  
ZAIDI, Syed Athar Husain. *Cosby, Leicester.*

###### Transfer from Associate to Member

GRANT, John Eric, B.A., Lieutenant-Colonel. *Wolverton, Buckinghamshire.*  
WATERS, Ian Morley. *Stow-cum-Quy, Cambridge.*

###### Direct Election to Member

CARVER, David John, Lieutenant-Commander R.N. *Southsea, Hampshire.*  
FOSTER, David Vernon. *Havant, Hampshire.*  
GRINDLEY, Allan Reginald. *Northampton.*  
HARPER, George Barrie. *Halstead, Essex.*  
HARRISON, David John. *Weston Colville, Cambridge.*  
JAMES, Brian Michael, B.Sc.(Eng.), M.Sc. *London, N.3.*  
MILES, Sydney Frank. *Worthing, Sussex.*  
POWELL, Michael John, Captain REME. *Reading, Berkshire.*  
PRICTOE, Ralph Bertram. *Bedford, Bedfordshire.*  
ROWE, Roy Edward. *Petersfield, Hampshire.*  
STANTON, Thomas Nicholas. *Bolton, Lancashire.*  
VILLA, Peter Giancarlo. *Newport, Monmouthshire.*  
WADE, Patrick Alphonsus. *Blanchardstown, County Dublin.*

#### OVERSEAS

##### CORPORATE MEMBERS

###### Transfer from Graduate to Member

ELLIOTT, Colm Anthony. *Victoria, Australia.*  
GARNER, John Terence. *Noordwijk, Holland.*  
HEGDE, Mohandas Kota. *Davengere, India.*  
IWUCHUKWU, John Chukukadibia. *Surulere, Lagos, Nigeria.*  
KANOR, Edward Ayiku. *Accra, Ghana.*  
KIRK, David Reginald, B.Sc.(Eng.). *Muscat, Sultanate of Oman.*  
JAYAWARDHANA, Stanley Cecil. *Ratmalana, Sri Lanka.*  
OSIME, Stephen Ehizele. *Surulere, Lagos, Nigeria.*  
RIGG, John Farrer. *Nova Scotia, Canada.*  
SERIKI, Sikiru Ayinla. *Mushin, Lagos State, Nigeria.*  
SIOW, Keng Cheng. *Singapore 14.*  
STEWART, Charles Lorimer. *Auckland, New Zealand.*  
THIRUNAVUKARASU, Sellathurai. *Batticaloa, Sri Lanka.*  
WELLALAGE, Gunapala Madduma. *Eningen, West Germany.*  
YOUNG, Martin John. *The Hague, Holland.*

###### Transfer from Associate to Member

TIN, David Wa-Cheong. *Kowloon, Hong Kong.*

###### Direct Election to Member

BRAGANZA, Joseph Vincent Paul. *Poona 1, Maharashtra State, India.*  
WITZ, Barry. *Transvaal, South Africa.*

###### Direct Election to Associate Member

DEAN, Alan. *Baughurst, Basingstoke, Hampshire.*  
EMERSON, Lionel Robert. *Cheltenham, Gloucestershire.*  
ESCRIPT, Gordon. *Garforth, Leeds.*  
MITCHELL, John David. *Maidenhead, Berkshire.*  
STUBBS, Barry Leslie. *Saffron Walden, Essex.*

###### STUDENT REGISTERED

AJINA, Sarmad Hassan. *London, N.W.1.*

### Meeting: 7th May 1974 (Membership Approval List No. 184)

#### GREAT BRITAIN AND IRELAND

##### CORPORATE MEMBERS

###### Transfer from Graduate to Member

HOGG, Martin, B.Sc. *Stoke D'Abernon, Surrey.*

##### NON-CORPORATE MEMBERS

###### Direct Election to Graduate

PRATT, John Walter, B.Sc. *Tewkesbury, Gloucestershire.*

WEAVER, Brian Edward. *Reading, Berkshire.*

###### Transfer from Student to Graduate

LONGSTAFF, Ian, B.Sc. *Spennymoor, County Durham.*

###### Transfer from Graduate to Associate Member

BENTLEY, John. *Chapel-en-le-Frith, Derbyshire.*

## OVERSEAS

### NON-CORPORATE MEMBERS

#### Direct Election to Associate Member

HOLLINGSWORTH-PALFREY, Alfred Walter.  
*Safat, Kuwait.*  
NZURIKE, Christopher Alajemba. *Nsukka, Nigeria.*  
OYEGUN, Samuel Odigie. *Benin City, Nigeria.*

#### Transfer from Graduate to Associate

SIMPSON, Douglas. *Eersel (N.Br.), The Netherlands.*

#### Direct Election to Associate

BRAHMBHATT, Jagannath Khodabhai. *Nairobi, Kenya.*  
CHEN, Gaik Yew. *Kuala Lumpur, Malaysia.*  
PAYNE, Dennis John. *Nairobi, Kenya.*

SAMSON, William Charles. *Lusaka, Zambia.*  
WELASHEY, John Shonga Patrice. *Yaounde, Republic of Cameroun.*

### STUDENTS REGISTERED

CHAN, Chun Wai. *Singapore 3.*  
OMUGBE, Peter. *Zaria, North Central State, Nigeria.*  
SUBRAMANIYA, Pilli. *Singapore 3.*

### Meeting: 21st May 1974 (Membership Approval List No. 185)

## GREAT BRITAIN AND IRELAND

### NON-CORPORATE MEMBERS

#### Transfer from Graduate to Associate Member

ATKINSON, Brian William. *London, S.E.27.*  
POTTER, David Malcom, Flight Lieutenant.  
*Weston-Super-Mare, Somerset.*

#### Direct Election to Associate Member

MATTHEWS, Ian David. *Holyhead, Anglesey.*  
MURO, Elisante Elikana. *Penylan, Cardiff.*

WILKINSON, Geoffrey, Squadron Leader.  
*Lyneham, Chippenham, Wiltshire.*

#### Direct Election to Associate

FOSTER, Martin George. *Hornchurch, Essex.*

## OVERSEAS

### NON-CORPORATE MEMBERS

#### Direct Election to Graduate

SAVVIDES, Savvas. *Larnaca, Cyprus.*

#### Transfer from Graduate to Associate Member

SINGH, Kalyan. *Kanpur 12, India.*

#### Direct Election to Associate Member

AFOLABI, Jacob Kehinde. *Lusaka, Zambia.*  
LOPES, Clifford Francis. *Ontario, Canada.*

### STUDENTS REGISTERED

ADEDIRE, Benedict Adeleke. *Ibadan, Nigeria.*  
BABU, Solomon. *Dar-es-Salaam, Tanzania.*  
HU, Kin Hoong. *Singapore 3.*  
LEE, Soon Kiat. *Singapore 2.*

Correction to List No. 180 (published in May 1974 Journal)

Transfer from Associate to Member

Ellis-Jones, Frank to read ELLSON-JONES, Frank.

## Forthcoming Conferences

### Conference on Charge Coupled Devices

CCD 74, the International Conference on the Technology and Applications of Charge Coupled Devices, has attracted worldwide interest, and over sixty authors from the major government and industrial research establishments and universities in the UK, Europe, USA and Canada will be contributing papers. These concern the impact of charge coupled devices in the application areas such as communications, radar, sonar, television, memories and imaging. Two sessions will deal with theory and technology respectively.

Seven speakers of international reputation will present review papers, including Dr. G. F. Amelio (Fairchild Camera and Instrument Corporation) and Dr. M. F. Tompsett (Bell Laboratories), who tested the original device.

Organized by the University of Edinburgh in association with the Institution of Electrical Engineers and the Royal Radar Establishment, the Conference will take place in Edinburgh from 25th to 27th September.

Further details are available from the University of Edinburgh, Centre for Industrial Consultancy and Liaison, 14 George Square, Edinburgh EH8 9JZ (Telephone 031-667 1011, Ext. 2369).

### Symposium on Digital Communication

An International Symposium on Digital Communication is being arranged by the Motilal Nehru Regional Engineering College, Allahabad, from 15th to 17th November, 1974. Supported by the Indian Division of the IERE and by Indian Telephone Industries, the Steering Committee, which is under the chairmanship of Professor M. K. Khanijo, Head of the Department of Electrical Engineering at the College, is preparing technical sessions on Digital Transmission, Digital

Radio Systems, Integrated Switching and Transmission and on Devices; there will also be open technical and discussion sessions.

Offers of papers and requests for further information should be addressed to Professor Khanijo at the above address.

### EEA Joint Venture in Australia

The Electronic Engineering Association, in conjunction with the British Overseas Trade Board, will sponsor and coordinate the participation of UK companies at the 15th National Radio and Electronic Engineering Exhibition to be held in the buildings of the University of New South Wales, Sydney, Australia, from 25th to 29th August, 1975.

Organized by the Institution of Radio and Electronics Engineers, Australia, the Exhibition is being held in conjunction with an associated conference, the theme of which is 'The Overall Impact of Electronics in Today's Society'. Technical sessions will include:

- Electronic Systems and Control
- Communications through Optical Fibres
- Microelectronics
- Health Electronics
- Telecommunications
- Industrial Electronics
- Educational Electronics
- Broadcasting
- Computers and Calculators

UK companies interested in the Joint Venture Exhibition should telephone the EEA Information Officer, Frank Sherry, 01-437 0678. Information on the Conference and Exhibition generally may be obtained from the IREE Australia, Science House, 157 Gloucester Street, Sydney, NSW 2000.