

# The Journal of THE BRITISH INSTITUTION OF RADIO ENGINEERS

FOUNDED 1925

INCORPORATED 1932

*"To promote the advancement of radio, electronics and kindred subjects  
by the exchange of information in these branches of engineering."*

---

VOLUME 18

OCTOBER 1958

NUMBER 10

---

## 32nd ANNUAL REPORT OF THE COUNCIL OF THE INSTITUTION

*The Council has pleasure in presenting the 32nd Annual Report of the Institution which reviews the proceedings for the twelve months ended 31st March, 1958. The Annual General Meeting will be held on 26th November, 1958, at the London School of Hygiene and Tropical Medicine, Gower Street, W.C.1.*

### INTRODUCTION

The annual report of a professional Institution, like all other annual reports, is expected to comment on material progress—or lack of it! It is, however, of particular importance that an Institution report should provide evidence of the ways in which it is fulfilling its objects.

It is hardly necessary to remind members that the main purpose of the Institution is to promote the advancement of radio science by the exchange of information. In this regard, the present annual report records that the 1957 Convention on *Electronics in Automation* was the most successful of all the Institution's Conventions. It more than justified the decision of the Council to plan such gatherings *only* when a new development warrants the holding of special meetings.

The title of the 1957 Convention also underlined the Institution's direct and active concern with Electronics. The versatile techniques which originally served only the needs of radio communication are now applied to countless other fields of human activity, many of which are at least as significant, industrially and socially, as radio communication itself. With all such applications, the Institution is as directly concerned as it is with Radio, the parent science. For reasons of tradition and convenience, the Institution retains the name of the parent.

The expansion of the *Journal*, both in content and in circulation is, of course, an essential contribution to the dissemination of information. Another and equally important factor is the holding of more regular meetings during the year; there has generally been an increasing attendance at Institution meetings and a further addition to the number of Sections.

The growing influence exerted by the Institution is shown by additional appointments of members to serve on outside bodies, particularly in the fields of education and standardization. Much good can be achieved by such co-operation.

In order to achieve the main object of the Institution it is, of course, essential that there should be a continual recruitment of properly trained personnel to the radio engineering profession. The growth of membership points to the Institution's success in this connection; it is also evidence of the widespread desire of the young engineer to qualify in radio and electronic engineering through those schemes which are approved by the Council as exempting from or leading to the Graduateship Examination.

Much remains to be done in promoting schemes of education and training which will suitably prepare the young engineer for entry to an increasingly important field of the engineering profession. For this reason, the work of the Education Committee is now to be separated from that of the Examinations Committee. The latter will, in future, be concerned only with conducting the Institution's Graduateship Examination and recommending exemptions.

The achievement of the principal objects of any Institution depends very largely upon the efforts of those who are able and willing to assist in its work. In this respect, the Institution is most fortunate in the quality of its membership. It is by the efforts of such members that the Institution continues to grow materially as well as in stature and influence. On behalf of every member who has taken part in such work, the Council takes pleasure in presenting this annual report.

**PROFESSIONAL PURPOSES COMMITTEE**

The Committee is primarily concerned with formulating and advancing Institution policy under three main headings: firstly, to review the constitution of the Institution; secondly, to review the various means whereby the Institution can aid the dissemination of technical knowledge in the radio and allied fields; thirdly, to advance the development and status of the Institution.

In the first particular, the Committee is satisfied that the present membership of the Council and its Committees is adequate and fairly representative of the activities of the entire membership.

Whilst the Chairmen of all local Sections are also ex-officio members of the General Council, much useful work is done by holding an annual meeting of representatives of all the local Sections. The last meeting held on October 11th, 1957, promoted valuable exchange of opinion on the best means for ensuring that papers selected for local Section meetings should be of maximum interest to the local membership.

**Groups.**—The Committees which are being appointed to look after the interests of specialized Groups will also do much to help the local Sections in the arrangement of their programmes of meetings. It has, however, been felt that it is now desirable to divide the present work of the Programme and Papers Committee. In consultation with the Chairman of that Committee, Council has now accepted a recommendation that a Programme Committee will work in conjunction with the Group Committees in compiling the programme of Institution meetings, thus giving further help to the local Sections. The separate Papers Committee will then be free to concentrate on the assessment of papers and otherwise to give more direct attention to the content of the Institution's Journal and any other publications of that character which may be planned in the future.

**Overseas.**—On occasions, the Chairmen of local Sections overseas have also been able to attend Council meetings. The Professional Purposes Committee has, however, recommended that a review be made of ways in which the Institution might be of further service to members overseas, particularly in providing facilities for more regular meetings. Where

there is a sufficient number of members in any district overseas, it is recommended that a local Section Committee be appointed; where two or more local Sections can be supported in any country, it is desirable to appoint an Advisory Committee to operate in much the same way as the Indian Advisory Committee functions.

**Future education policy.**—For some time it has been apparent that it is essential to relieve the Education and Examinations Committee of some of its present burden of work. That Committee is already operating an Examiners Panel; it is now intended that a separate Education Committee should be appointed to give advice and help in such matters as promoting further courses in radio and electronic engineering, and otherwise strengthening the Institution's relationship with technical colleges and universities.

The separate Examinations Committee will in future be able to devote more time to the assessment of courses which are being submitted to the Institution in increasing numbers by colleges who are anxious to meet the Institution's examination requirements.

**Institution representation on other bodies.**—The Institution continues to receive requests for its representatives to serve on the committees and advisory bodies of educational and other organizations. There is never any difficulty in finding willing and able members for this valuable work and the Council welcomes such opportunities for providing such useful service.

During the last few years there has also been a comparatively new field of activity in the establishment of national committees whose work is confined to a specialized branch of engineering. There is much to commend the setting up of such bodies which tend to bring together the development and production engineers who make the equipment, and the users of such products.

In the case of the British National Committee on Non-Destructive Testing, the Institution was invited to nominate a representative. An invitation was also extended to the Institution to assist in preparations for the holding of an International Conference on

Medical Electronics. The first Conference was subsequently held in Paris in June, 1958.\*

In other specialized fields there appears to have been an effort to restrict membership of the national body, but where the terms of reference are such as to indicate that the Institution might participate to mutual advantage, the Council has made the necessary application to join the appropriate body.

**Registration of Engineers.**—Further consideration has been given to the operation of the Technical and Scientific Register. As stated in the last Annual Report, it is appreciated that the Register set up in wartime is not now extensively used, but the method of compiling the Register still gives widespread dissatisfaction. The subject has been ventilated through the Parliamentary and Scientific Committee and during a meeting of that body it was made apparent that the present policy of maintaining the Register did not meet with the approval of a number of professional bodies. It is understood that the Parliamentary and Scientific Committee is still hoping to arrange for a discussion of this matter at ministerial level.

**Building Appeal.**—The report of the Finance Committee shows that good progress has been made in securing the capital required to purchase more suitable and permanent accommodation.

At the request of the Council, the Committee is continuing to investigate offers of available accommodation. It is very probable that the most satisfactory solution will be to purchase suitably sited premises for ultimate conversion into a building providing the accommodation which the Institution needs.

**Exhibitions.**—Editorials in the *Journal*† have at times dealt with the part that the Institution may play in any commercial exhibition or show. As a result of requests received from a local Section, a report was made to the Council on the question of whether local Conventions or Symposiums might be held together with exhibitions sponsored by a local Section. In the event, the Council resolved that "Local

Sections are not authorized to arrange exhibitions of manufacturers' products. The Council of the Institution does, however, permit of such products being exhibited concurrently with the holding of a symposium or similar type of meeting provided that the equipment exhibited is relevant to the papers presented during the symposium".

**Conventions and other Institution meetings.**—Successive Councils have agreed that it is not essential for the Institution to hold an annual dinner in London. There is merit in such functions being held on occasion by local Sections, and a main Institution function in London serves the purpose of bringing members together only on very special occasions.

Such a function has not been held in London since 1951 and in the absence of any other special meetings of the Institution during the year, plans were made for an Institution dinner to be held on 1st May, 1958.

The Committee has also been concerned with recommendations to Council on the theme of the next Convention which the Committee feels should take place in 1959.

**The President of the Institution.**—This report would be incomplete if it did not express particular thanks to the retiring President of the Institution.

During his two years of office, Mr. George A. Marriott has visited many of the Institution's Sections and has attended every meeting of the Professional Purposes Committee and the Council. By his representation of the Institution at many other gatherings, Mr. Marriott has personally done much to advance the prestige of the Institution and to strengthen its influence.

### PROGRAMME AND PAPERS COMMITTEE

The most notable item of the Institution's proceedings during 1957 was the very successful Convention on "Electronics in Automation", which was held in Cambridge.\* Well over 600 members and visitors attended the Convention, and it was again particularly pleasing to see so many radio engineers from overseas. The Convention was divided into six sessions comprising a total of 43 papers, nearly all of which

\* *J. Brit.I.R.E.*, 18, p. 505, August 1958.

† e.g. "Specialist Exhibitions," *J. Brit.I.R.E.*, 15, p. 593, December 1955.

\* A full account was given in *J. Brit.I.R.E.*, 17, pp. 345 et seq., July 1957

were available in pre-print form. This arrangement undoubtedly facilitated the high standard of discussion which followed the reading of the papers. The generous amount of time allowed for discussion was generally agreed to be a feature which contributed to the success of the Convention.

**The Journal.**—Although a measure of priority was given to publication of Convention papers, a fair balance has been maintained over the year between the various branches of radio and electronic engineering.

The larger format adopted at the beginning of 1957 has been maintained with only slight typographical alterations, and Volume 17 extended to 728 pages, an increase of 28 on the previous year. Such features as a calendar of conferences and exhibitions of interest to radio and electronics engineers, abstracts of papers published in European and Commonwealth journals, and news items from the fields of radio, electronic and allied engineering, have continued.

During 1957 the circulation of the *Journal* rose from 6,804 for the first half of the year to 6,925 for the second half year; these figures are certified by the Audit Bureau of Circulation (A.B.C.), to which the Institution subscribes. The distribution of the *Journal* to non-member subscribers has increased, and it is of interest to note that the *Journal* is sent to 90 countries throughout the world. It should be noted that neither sales of back numbers nor reprints are taken into account in determining the A.B.C. certified circulation.

The importance of the advertisement pages of the *Journal* as a source of revenue has been referred to in previous reports. Any increase in their number helps to offset the continually rising costs of printing and paper. It is hoped, therefore, that members who are in a position to do so will recommend to their companies the value of the *Journal* as an advertising medium.

**Consideration of Papers.**—During the year under review 93 papers were submitted to the Institution for publication in the *Journal*. The overall standard of the original submissions was better than for some years past, a little under half of them being approved by the Committee for publication without extensive

revision. Ten per cent. of the papers were finally accepted after revision.

The standard of papers submitted for publication in the *Journal* has risen, both in technical value and in the quality of style and presentation. This is indicative of the increasing status of the Institution, and the *Brit.I.R.E. Journal* is now one of the leading channels in Great Britain for the publication of original work in radio and electronics. Although the Committee's leaflet "Guidance for Authors of *Journal Papers*" was only published in June 1957, it has already proved its value, both to experienced and novice authors, in the preparation of their manuscripts in a form best suited to the *Journal* of a professional Institution.

Reference has been made in previous Annual Reports to the Committee's pleasure in receiving and accepting for publication contributions from authors not resident in Great Britain. While the 1957 volume does not include quite so many papers from overseas authors as has been the case in previous years, at the time of preparation of this report it seems likely that Volume 18 will contain a record number of overseas papers. The international publication of papers is a particularly valuable way of encouraging exchange of technical knowledge and one which the Institution, by virtue of its widespread membership, is well able to foster.

It is the intention of the Committee to encourage the submission of shorter contributions which will particularly help the engineer who, through pressure of work, or other considerations, is not able to prepare a full paper.\* Naturally such contributions do not prejudice the eventual submission of a longer account.

**Award of Premiums.**—The Committee has been asked by Council to review the terms of reference of all the Premiums awarded by the Institution and to make recommendations for the award of further Premiums. In consequence, it is hoped at the end of 1958 to increase the number of premiums and thereby give more adequate recognition to the very wide range of papers now being published by the Institution.

Details of the six Premiums awarded for papers published during 1957 have already

\* This type of paper was the subject of an editorial in the April 1958 *Journal* ("Contributions to the *Journal*").



appeared in the September 1958 *Journal*. The Committee especially regrets that it was not possible this year to make three awards. Particular mention is made of them in order to attract better papers coming within the terms of reference of *The Sir J. C. Bose Premium*, *The A. F. Bulgin Premium*, and *The Dr. Norman Partridge Memorial Award*.

**Meetings in London.**—The 1957 Session has been marked by an appreciable increase in the number of meetings held in London. In addition to the nine regular monthly meetings, five extra meetings were arranged between December and March 1958.

The Committee feels that the growing range of interests of radio and electronics engineers makes it essential that the Institution should hold more meetings in London. Mention is made elsewhere in this report of plans for the eventual establishment of specialized Groups, and it may well be that future extension of the London programme will be facilitated by the additional meetings which will be sponsored by the Groups.

**Section Activity.**—The seven Sections in Great Britain again arranged programmes of wide interest and, in general, satisfactory attendances were recorded. Altogether 46 meetings were arranged at eleven centres.

A particularly interesting innovation in the pattern of local activities was the holding of a programme of technical films in Cambridge at the request of members in that area. It has already been noted in the *Journal*\* that originally the meeting in Cambridge was to be a joint meeting with another Institution. Subsequently, the Council was advised that the other Institution had instructed their local Section to cancel the joint arrangements. The interposition of such obstacles to friendly and useful co-operation between engineers can only be a matter for regret.

The Committee welcomes plans for setting up new Sections; at the end of the year under review the Council authorized the formation of a South Western Section. This new Section will hold meetings at Bristol and its first programme of meetings will take place in 1958-59. Proposals have been made for other local

Sections, but before embarking on such expansion, there must of course be an assurance of adequate support from the corporate members in the areas concerned.

**Overseas.**—The Sections in India, New Zealand, Pakistan and South Africa have all held meetings during the year in spite of occasional difficulties due to the limited number of potential authors. This must continue to be a problem while the local electronics industries are comparatively small and under-developed, but the Institution's activities in this direction, as in others, will continue to increase with the expansion of industry.

**Acknowledgments.**—The Committee is grateful to the authorities of universities, colleges, etc. who have provided facilities for the holding of Institution meetings in London and of Sections in Great Britain and overseas.

Thanks are also due to authors of papers, particularly those who have read them at one or more Section meetings, and to firms who have co-operated in the provision of demonstration and other equipment. The Committee also wishes to thank the many members and certain specialists outside the Institution who have collaborated in providing expert opinions on the suitability of manuscripts for publication.

Appreciation is also expressed to the editors of very many technical and scientific journals who have published regular notices of Institution meetings and other activities.

### TECHNICAL COMMITTEE

The scope of the Committee's work appears to increase each year. The Council is glad to have this opportunity of expressing thanks for the very many ways in which the Committee co-operates with other Institution Committees, particularly in the matter of arranging meetings for members.

Indeed, two of the discussion meetings held in London were based on reports prepared by the Committee: "The Electro-deposition of Metals" and "Methods of Expressing the Characteristics of Signal Generators". At both meetings there was a high standard of discussion. In addition the Committee sponsored a showing of technical films.

As specialized groups are formed within the Institution, there will be some re-allocation of

\* *J. Brit. I.R.E.*, 18, p. 6, January 1958

the work which is at present done by the Technical Committee. The Committee has made a number of very useful recommendations to the Council in this regard.

**Visits.**—The Committee has also been the prime mover in arranging visits to research stations, etc. During the year members had the opportunity of visiting London Airport and the Southern Air Traffic Control Centre, the Radio Research Station, and the B.B.C. Technical Receiving and Measuring Station at Tatsfield.

**Reports on Materials and Draft Standards.**—Members will be well aware of the series of reports under the general heading "Materials used in Radio and Electronic Engineering", six sections of which have so far been produced by the Committee and published in the Institution's *Journal*, as follows:—

"Aluminium and Aluminium Alloys" (January 1955, p. 47.)

"Piezoelectric Crystals" (January 1955, p. 60.)

"Ceramics" (October 1955, p. 506.)

"Plastics" (May 1956, p. 283.)

"Electrodeposition of Metals" (January 1957, p. 35.)

"Magnetic Materials" (August 1958, p. 449.)

From the demand, it is obvious that these reports have been well received by the industry as a whole, and the Committee is continuing work under this heading. The various reports are being collated for publication as a separate handbook.

In the series of reports on "Recommended Standards", the Committee is not attempting, at present, to specify limits of operation. For example, the first report on "A.M. and F.M. Signal Generators"\* gave recommendations on standard methods of expressing characteristics, which will also enable easy comparison of the relative merits of similar equipment. This report was most timely, as the British Standards Institution and the International Electrotechnical Commission are now considering recommendations for signal generators. The Institution's report is being used as a basis for these discussions.

The Committee is publishing during the next few months reports on Cathode Ray Oscilloscopes and Valve Voltmeters. It also hopes to stimulate publication of draft standards on magnetic recording material.

\* *J.Brit.I.R.E.*, 18, p. 7, January 1958

Inevitably, the initial task of drafting falls on a few members; the Committee is especially grateful to those who have undertaken this duty, and also wishes to express thanks to the technical staff of various manufacturers who have co-operated by commenting upon first drafts.

**British Standards.**—Whilst the Committee continues to initiate standards, it must be emphasized that this work is in no wise intended to duplicate the functions of the British Standards Institution. Rather is the work of the Technical Committee directed toward assisting the activities of the B.S.I., and the example of "A.M. and F.M. Signal Generators", quoted above, is one way of how this assistance may be given.

It will be noted too that in its various reports and recommendations, the Committee ensures that agreed standards and specifications of the British Standards Institution and the Ministry of Supply are quoted.

The Institution is now represented on 17 Committees of the British Standards Institution; there is close collaboration between these representatives and the main Technical Committee. Details of the appropriate B.S.I. Committees are published on page 13 of the seventh edition of the "List of Members".

**Nomination of Assessors and Others.**—The Institution is now receiving an increasing number of requests for nomination of members especially qualified in one or more particular branches of radio engineering to act as consultants, expert witnesses, and assessors in disputed cases. All these requests are referred to the Technical Committee who, on behalf of the Council, nominates suitably qualified members.

As indicated in the last report, the Committee also gave assistance in the preparation of a new Library Index.

### LIBRARY COMMITTEE

During the year compilation of the material for the reference book "Library Services and Technical Information for the Radio and Electronics Engineer" was completed. It is a new Institution publication and arrangements have been made for all members to receive a copy.

Much more use is being made of the reference library and borrowing facilities. It was emphasized in the last report that it has become very difficult to allocate more space in 9 Bedford Square to the Library; the space available has, however, been very well utilized. The more important journals are displayed on periodical racks and this arrangement is most helpful to members who regularly use the Library.

Records show that visitors to the Library and borrowers of books are now fairly well distributed throughout the entire membership. Over 1,000 books have been borrowed from the Library, and in general the Librarian continues to be of service to companies in and outside the radio industry who seek reference information.

The publication "Library Services and Technical Information for the Radio and Electronics Engineer" catalogues the contents of the Library which comprises over 2,000 volumes.

**Periodicals.**—During the year a record number (149) of periodicals was added to the Library. They originate from 23 countries and are in 16 different languages, although the majority are in English. Members visiting the Library especially appreciate the availability of this literature.

Increasing use is also being made of other library services, such as supplying photocopies of papers which are out of print. This particular service is operated in conjunction with the Science Library.

**Acknowledgments.**—The Committee wishes to thank members who have presented books and periodicals, especially Mr. T. Toward and Mr. H. W. Shipton (Associate Members). The Ministry of Supply also donated to the library several books of historical interest.

Thanks are also due to publishers in this country and abroad who have supplied new technical books which have been reviewed and placed in the Institution's Library.

### EDUCATION AND EXAMINATIONS COMMITTEE

Opportunity for regular education and training in radio and electronic engineering is steadily increasing. Whilst there will always be debate on the question of course content, there has been steady improvement in the last few

years in the availability of suitable radio and electronic engineering courses. An increasing number of these courses meet the Institution's assessment of requirement for the professional radio engineer.

Although there are now more alternatives for securing exemption from the Graduateship Examination, the number of entries for the examination has been well maintained notwithstanding the revised syllabus.

**Examination Entries and Results.**—As stated in the last annual report, it was anticipated that one effect of revising and extending the examination syllabus would be to reduce, possibly only temporarily, the number of candidates submitting themselves for examination. The new syllabus, however, aimed at ensuring more thorough preparation for the examination. The achievement of that aim is borne out by the fact that, whilst the requirement is higher, a better pass percentage has been secured.

The statistics of the examinations held in May and November 1957 are given below; the comparative figures for 1956 are quoted in brackets.

|   | May       | November  |
|---|-----------|-----------|
| Entries received ... ..   | 509 (761) | 389 (467) |
| Candidates appearing ... ..   | 329 (564) | 284 (301) |
| Candidates succeeding in part of the examination ... ..   | 88 (183)  | 95 (88)   |
| Candidates who by their success completed the Graduateship Examination, and qualify for election to Graduateship or higher grade ... .. | 58 (48)   | 30 (30)   |

Notice has also been given that a new examination regulation comes into force in 1959. This requires that candidates must take all parts of each Section of the examination at one sitting, and candidates will not be permitted to write Section B until they have satisfied the requirements of Section A. Mathematics is a compulsory subject in each Section, and a further requirement is evidence of supervised laboratory work or appropriate industrial training and experience.

The new syllabus, which has been approved by the Council, is published in the current (25th) edition of the Regulations.

**Exemptions.**—By coincidence, the total number of applications received during the year

(468) was the same as in 1956. Of this number, 137 were this year granted exemption from the entire examination and 273 were granted partial exemption.

**Prize Winners.**—A notice of the prize winners for the 1957 examinations was given in the September, 1958 *Journal* (p. 510).

**Theses.**—Candidates wishing to submit a thesis in lieu of succeeding in a recognized examination are required to submit application for permission to lodge a thesis. This has resulted in considerable correspondence as the Committee does not encourage the submission of a thesis unless it can be proved that the candidate has had adequate opportunity to accomplish original work. Eventually, 11 theses were submitted during the year, but only five were accepted as showing a sufficiently high standard of original thought and work to justify exemption from the Graduateship Examination.

**Approval of Courses.**—The introduction of the Diploma in Technology has no doubt stimulated fresh ideas in technical colleges. The introduction of sandwich courses and other schemes, all of which permit of a greater number of student hours, is giving evidence of a higher standard and, it is hoped, of a more thorough training. Because of restricted accommodation, Principals are not always able to exercise their preference for a variety of courses; this fact alone helped to favour the general acceptance and professional acknowledgment of the National Certificate Scheme of technical training. The majority of professional engineering bodies have for years co-operated with the technical colleges in broadly accepting the Higher National Certificate as one means of qualifying for professional membership.

As frequently and emphatically stated, the Institution in no wise regards the Higher National Certificate Scheme in Electrical Engineering as the most suitable course for the radio and electronic engineer, and for the future requirements of the radio industry. Indeed, it has taken many years to secure the introduction of radio subjects into the scheme and its adoption throughout appropriate technical colleges has been tardy.

Appreciating the problem of both the technical college and the student, however, the

Institution has always, as far as reasonably possible, recognized the Higher National Certificate Scheme on a subject-for-subject basis in relation to the Graduateship Examination. It is with considerable pleasure, therefore, that the Council is able to report to members that an increasing number of technical colleges are adapting their Higher National Certificate Courses in order to give more time to radio and electronics subjects. Thus, the Institution is now in the position of giving a large measure of exemption to candidates who have taken a Higher National Certificate course which contains Mathematics and a radio or electronics subject in each of the final two years. The ruling is that candidates who obtain credits in all subjects in the final examination are able to claim exemption from the entire Graduateship Examination, provided they also obtain :—

- (a) an endorsement in Physics (Heat, Light and Sound) at the S.3 level.
- (b) an endorsement in an additional radio or electronics subject (A.2 or A.3) level.

A few courses providing at least three radio or electronics subjects in the A.1, and A.2 years, have been accepted for exemption without the need for the endorsement (b) above, but only after an inspection has satisfied the Committee that the College accommodation and laboratory facilities and equipment are adequate.

Details of the various colleges whose courses were approved have been published in the *Journal* and are contained in the membership regulations.

Defence services are also extending their technical training facilities. Among cases still before the Committee are the Royal Air Force Electronics Officers' Course, and the Long Electronic Engineering Course recently initiated by the Corps of Indian Electrical and Mechanical Engineers.

**Co-operation between engineering Institutions.**—The most outstanding form of co-operation between Institutions of engineers in Great Britain was undoubtedly the establishment of the Engineering Joint Examination Board in 1938. It was founded by seven of the engineering Institutions; administratively, it was hardly necessary to extend the number of representatives on the Board, but the aim of



securing a Common Preliminary Examination has met with a great measure of success.

Our own Institution abandoned its Studentship examination in 1945 and for the last 14 years applicants seeking registration as Students have been required to pass the Common Preliminary Examination, or to satisfy the alternative requirements laid down by the Engineering Joint Examination Board.

It is, therefore, with regret, but with understanding, that it must now be reported that the Common Preliminary Examination will not be held after 1960. A number of alternative examinations are, of course, now available; in Great Britain for example, there is wider opportunity for engineering students to succeed in the appropriate subjects of the General Certificate of Education. Whilst this does not apply overseas, the Institution's regulations show that the majority of countries now have equivalent examinations which make unnecessary the holding of a special preliminary examination.

In paying tribute to the valuable work of the Engineering Joint Examination Board, the Council expresses hope that co-operation between all the engineering Institutions may now be carried one step further. Augmented perhaps in representation, the Engineering Joint Examination Board is ideally suited as the forum for securing agreement on, for example, a joint Section A examination. This would embody all the essential subjects which are deemed imperative for those who wish to enter the engineering profession.

**The City and Guilds of London Institute.**— In previous Annual Reports the Council has paid tribute to the City and Guilds of London Institute for its pioneer work in encouraging the study of radio engineering. The 19th Annual Report of the Institution\* gave some detail of how the City and Guilds of London Institute scheme had grown since the first examinations in Radiocommunication were held in 1924. From the first total entry of 46 examinees, the scheme has attracted well over 50,000 candidates, notwithstanding the inevitable changes in syllabus which have kept pace with the development of both knowledge and industry.

Ever since the foundation of our own

Institution in 1925, an Institution representative has sat on the City and Guilds of London Institute Advisory Committee on Radio (subsequently named Telecommunications).

Eight years ago the Annual Report† commented on the fact that only 11·5 per cent. of the candidates sitting the Grade 3 examination obtained a first class pass; furthermore, only 42 out of 399 candidates obtained a first class pass in the Grade 4 examination which, at that time, led to the award of the full Certificate. There was also concern about the overall lack of candidates going on after the second year course.

The end of an epoch in the development of radio engineering education is therefore marked by the decision to revise the present scheme. The revision does in itself, however, mark a new and quite essential step toward providing encouragement and recognition of attainment for the *technician* engaged in telecommunications. In 1959, the present Telecommunications Engineering scheme will be replaced by new group examinations first leading to the Intermediate and then to the Final and Full Technological Certificates. Bearing in mind its limited purpose, the scheme has many valuable points; one change involves a first year course which will be common with the S.1 year of the Ordinary National Certificate; there will still be a second, third and fourth year course, but a new departure, in the fifth year, will be an opportunity to specialize in any two of 17 subjects. It is intended that the fifth year examination will be of a high standard—comparable with the last year of the old scheme; candidates will have the choice of a wide range of subjects, including radar and navigational aids, radio relay systems, sound and television broadcasting, etc.

It will be clear that the Institution will *not* be able to extend the same degree of exemption as hitherto to candidates who obtain the City and Guilds Certificates and who wish to go on to the Institution's Graduateship Examination.

Nevertheless, the Education and Examinations Committee is considering the later stages of the new scheme and particularly the work involved in the specialized subjects of the fifth year examination. A further announcement

\* *J.Brit.I.R.E.*, 5, p. 178, September 1945

† *J.Brit.I.R.E.*, 10, p. 265, September 1950

will be made in the *Journal* of the Institution after Council has considered the Committee's recommendations.

**Representation on Advisory Committees.**—In addition to the Colleges and other bodies given in the List of Members, the City of Birmingham Education Committee has invited an Institution representative to serve on that Committee. Council has nominated Mr. R. A. Lampitt (Honorary Secretary of the West Midlands Section). Apart from the official Institution representatives on such Committees, an increasing number of members are being invited in their personal capacities to serve on local education and training committees.

**Radio Trades Examination Board.**—As a contribution toward the encouragement of technicians, the Council is pleased to report the continued development of the Radio Trades Examination Board. In agreement with the other participating bodies, including the Radio Industry Council, the Institution continues to provide secretarial and administrative facilities.

The Board was incorporated in December 1955, and now issues its own independent Annual Report. It will, however, be of interest to the membership to learn that proposals which were originated by the Institution's Education Committee have largely been accepted by the Board; these provide for not only a more comprehensive test of the student's practical abilities, but for candidates to proceed to endorsement subjects in various branches of electronics.

The review of the syllabus of examinations has been an arduous task in which members of the Institution have played a prominent part. The new syllabus will provide for immediate introduction to radio and television techniques during the first year of study, and the whole of the new course will take four years and will be followed by endorsement subjects.

Whilst there is the advantage that standards are continually being raised to accord with the educational pattern throughout the country, completion of the Board's plans and programme must take time. In the interim sessions there will be a changing position, but no student will be penalised at any stage nor will training be upset or delayed.

## MEMBERSHIP COMMITTEE

The size of membership largely determines the Institution's activities. Size is necessarily controlled by the eligibility of candidates wishing to secure recognition as professional engineers—and this must always presuppose suitable means of securing eligibility or qualification. Within this premise, the Institution's membership development over the last twenty years has been one of regular, if not spectacular, annual growth. The advent of improved facilities for education, as already discussed in this report, gives every reason for anticipating that the scale of growth should be greater in the years to come.

As in past years, elections, transfers and losses are summarized in the accompanying table.

The total number of proposals considered by the Committee showed a slight decrease on the previous year; there was, however, a substantial increase in the number of proposals for transfer to higher grade membership; it is particularly satisfying to note that so many corporate members have, in fact, secured their election by reason of transfer from Graduateship. The number of transfers to Associate Membership was the highest for some years.

Over the year there was a net loss of 156 in registered students, notwithstanding the 336 new registrations and 11 reinstatements approved by the Committee. Part of the loss was accounted for by the transfer of 116 students to higher grades of membership.

The last two Annual Reports have commented on the experience of most professional bodies that Studentship Registration appears to be on the decline. This may be attributed to lack of ability to meet new requirements as, for example, in the extended syllabus of the Institution's Graduateship Examination. There seems, however, reasonable grounds for believing that those who are eligible for Studentship Registration tend to put off professional association until they are able to qualify. Whatever the reason, there are many cogent arguments in favour of bona fide students becoming associated with their professional bodies as early as practicable.

The Membership and Education Committees therefore collaborated in preparing documents for circulation to all Technical Colleges inviting

co-operation in securing registration of students studying for suitable qualifying examinations. It is hoped that all members who are in contact with students or apprentices in training will similarly encourage them to register as Students of the Institution as a very valuable preliminary to their eventual entry to full professional life.

**Associates.**—The last Annual Report made reference to the problem of the older engineer who lacks the academic qualifications necessary for corporate membership. The grade of Associate was designed to enable such an applicant to enjoy the privileges of membership, and has attracted more applications this year than since 1951.

**Enquiries.**—How widespread is the desire to secure membership of the Institution is best evidenced by the number of enquiries for regulations and application forms. During the year 1,901 enquiries were received compared with 1,617 in the previous twelve months. It must also be borne in mind that this excludes all enquiries emanating from India which are dealt with in Bangalore.

In addition—and again not included in the figures—is the considerable number of enquiries received on career possibilities. Mention has already been made of the career leaflets which are sent to Careers Masters, Schools and Technical Colleges. Many enquiries are also

received at the Technical Training Stand at the annual National Radio Show, for which the Institution supplies appropriate literature on careers in the radio and electronic industry.

**List of Members.**—By the time this report is read, every member, other than Registered Students, will have received a copy of the seventh issue of the Institution's List of Members. Corrected up to the 31st December, 1957, the handbook will facilitate contact between members.

This edition has unfortunately been severely delayed because of the difficulties of compilation and publishing. The demand for a constantly up-to-date list justifies more regular publication and it is proposed to issue the Eighth Edition in the spring of 1959.

**Honours.**—Notice has already been given in the *Journal* of honours conferred upon various members by Her Majesty The Queen. It is particularly pleasing to note that an Honours List is now seldom published without the inclusion of one or more members of the Institution.

**Loss of Past Presidents.**—Although obituary notices have already been published in the *Journal*, the Council wishes again, in this Annual Report, to express regret at the loss of two Past Presidents—Sir Arrol Moir, Bart., and Sir Louis Sterling.

**Elections and Transfers for the Year Ended March 31st, 1958**  
(Excluding Studentship Registrations)

|   | Total considered | Elections and transfers approved |        |                  |           |           |          |       |
|---|------------------|----------------------------------|--------|------------------|-----------|-----------|----------|-------|
|   |                  | Honorary Member                  | Member | Associate Member | Companion | Associate | Graduate | Total |
| Direct Elections                        | 249              | —                                | 13     | 55               | 2         | 63        | 74       | 207   |
| Proposals for Transfer                  | 347              | —                                | 16     | 124              | —         | 11        | 96       | 247   |
| Proposals for Reinstatement             | 4                | —                                | —      | 2                | —         | 1         | 1        | 4     |
| <i>Totals</i>                           | 600              | —                                | 29     | 181              | 2         | 75        | 171      | 458   |
| Losses During the Year                  |                  |                                  |        |                  |           |           |          |       |
| Loss by Resignation, Removal or Decease |                  | 1                                | 6      | 34               | 2         | 33        | 41       | 117   |
| Transfer to other grades                |                  | —                                | —      | 16               | —         | 28        | 87       | 131   |
| <i>Totals</i>                           |                  | 1                                | 6      | 50               | 2         | 61        | 128      | 248   |
| <b>Net gain in membership</b>           |                  | —1                               | 23     | 131              | 0         | 14        | 43       | 210   |

Although many years have passed since they served as Presidents of the Institution, both continued to have a very real and keen interest in the Institution's affairs right up to the time of their death. The Institution has lost two stalwart supporters.

**Appointments Register.**—Since 1939 the Institution has operated an Appointments Register under Licence by the London County Council. It has proved to be a service which is valued by members and other employers seeking staff, and by members wishing to change their employment. The continuous demand for the trained and qualified radio and electronics engineer still results in there being more vacancies on the registers than can be filled. If any difficulty has existed, it has been in placing the older member who wishes to secure employment for only a few years.

During the year, 55 members were directly assisted in changing their employment, and a total of 223 introductions were made to employers seeking staff.

In support of the services offered by the Appointments Register, publication of a *Supplement to the Journal* was started towards the end of 1957. This is devoted entirely to small advertisements of appointments vacant, and has proved to be of considerable help both to members and to employers. Members who are concerned with the recruitment of engineers are particularly reminded of the facilities which the *Supplement* offers.

**Appreciation.**—The Membership Committee wishes to record thanks to all members who have acted as proposers and seconders of applications and who have given confidential references on behalf of applicants. By the care which members give to these matters, much help is given to the Membership Committee in their difficult task of adjudicating fairly on proposals received.

### FINANCE COMMITTEE

Two main points were emphasized in the last Annual Report on finance: firstly, that it was essential to combat rising costs; secondly, that even more active steps be taken to ensure capital investment. In this latter connection, it was appreciated that the whole financial struc-

ture of the Institution would be more firmly based when a more suitable building had been acquired.

The Accounts for the year ended 31st March, 1959, appended to this Report, provide favourable evidence of the way in which the Institution has tackled these two points.

They show that a more satisfactory balance has been achieved on the Revenue Account, enabling the allocation to the Reserve Fund to be the highest ever in the history of the Institution.

**Income and Expenditure.**—The 1957-58 Accounts very much substantiate the recommendations made by the Finance Committee in 1956\*. It was then stated that revenue must increase by at least £4,000; the surplus for this year has partly been achieved by the membership accepting the need for some revisions to the basis of subscription, and partly by the normal growth of the Institution.

Although examination fees again show a slight decline, the figures for the first quarter of the 1958-59 financial year substantiate the Committee's view that this would be a temporary drop consequent upon the introduction of the new examination syllabus. The Committee is confident that this figure will now show a gradual rise.

All other items of income show an increase and *excluding* Building Appeal donations—which are reserved for the purchase of a new building—total income increased by £6,000 over the previous year.

A comparison of expenditure with the previous year shows that overall expenditure increased by only £2,336. The continually rising costs in printing, postage and telephone, together with the growth of the Institution, would have demanded a much larger increase had it not been for the stringent economies which have been made during the year. The Council emphasizes, however, that such economies cannot continue indefinitely without seriously impairing the services which must be provided for members and industry. Indeed, if the Institution is to proceed with future plans, involving the holding of more meetings, Con-

\* See *J.Brit.I.R.E.*, 16, p. 477, September 1956.



ventions, etc., expenditure will increase. A more rapid growth of the Institution's membership is, therefore, essential, and members are urged to give particular attention to the report of the Membership Committee in this respect.

**Assistance from Industry.**—A new—and extremely welcome—item in the Income Account is the donations made by a number of manufacturers toward the running costs of the Institution. These contributions help considerably in building up the working capital necessary for the Institution to expand its services to members and therefore to the radio and electronics industry. The Council wishes to express appreciation for this tangible support of the Institution's work.

**Building Appeal.**—Reiteration will emphasize the point made in previous Annual Reports that the minimum target of the Building Appeal cannot be less than £100,000. The moneys received and allocated by the Finance Committee to the Building Appeal now justify the preliminary plans being made by Council for the acquisition of suitable headquarters. Indeed, during the year, a tender was submitted for a suitable site, but the sum required by the vendors was, in the opinion of the special Committee appointed, not justified.

It is most unlikely that there will come on the market an established building providing the amenities required by the Institution; the advice of an architect is that a site for development, plus the cost of erecting a building, may well cost over £90,000.

Thus the target must remain at a minimum of £100,000, and the Council is especially grateful to those manufacturers who are making annual donations to the Institution by deed of covenant. In addition to the sum shown in the Balance Sheet as having been allocated to the Building Appeal, further payments to be made under existing covenants bring the total of the Appeal to just under £40,000.

Thirty-eight companies in the radio industry have now subscribed to the Institution's appeal.

Their initiative in enabling the appeal to be opened is to be recorded in a special Building Appeal booklet. A copy will be sent to any member on request.

The Council is mindful of, and much appreciates the support which members of all grades also continue to give to this important Appeal.

**Balance Sheet.**—The Balance Sheet shows how the Institution is gradually stabilizing its financial position. In previous Annual Reports there has been a reference to the desirability of revaluing the Library but it has not yet been possible for this work to be done. Certainly the present valuation of the Library is low.

Otherwise, Fixed and Current Assets are self-explanatory and show the increase in investments for the Building Appeal and General Fund. There has been an overall decrease in Current Liabilities and, as already stated, the Reserve Fund now stands at the highest in the Institution's history. In the opinion of the Finance Committee it is desirable to continue the trend shown in recent years towards improving this figure.

## CONCLUSION

In recommending the adoption of this Report, the Council believe that the entire membership will share their pleasure in being able to record a year of progress in spite of some hampering influences. If progress can be maintained in the various ways indicated in recent Annual Reports, then there is every prospect of the Institution being able to pursue more fully its declared objects.

All this work would be impossible of accomplishment were it not for a sound membership which in turn provides Committees of ability and enthusiasm to ensure fulfilment of the Institution's objects. It is to the Committees particularly that the Council directs its thanks.

In the carrying out of all the work arising from Committee activity, the Council also expresses thanks to the Institution's staff for their loyalty and perseverance.

**THE BRITISH INSTITUTION  
GENERAL**

**BALANCE SHEET**

| 1957   |  | £      | s. | d. | £      | s. | d. |
|--------|--|--------|----|----|--------|----|----|
|        | <i>RESERVE ACCOUNT</i>                               |        |    |    |        |    |    |
|        | Excess of Income over Expenditure                    |        |    |    |        |    |    |
|        | Balance at 1.4.1957 ... ..                           | 476    | 8  | 2  |        |    |    |
| 476    | Add Surplus for the year ... ..                      | 4,358  | 5  | 1  |        |    |    |
|        |  |        |    |    | 4,834  | 13 | 3  |
|        | <i>CURRENT LIABILITIES</i>                           |        |    |    |        |    |    |
| 7,349  | Sundry Creditors ... ..                              | 3,929  | 9  | 3  |        |    |    |
| 2,268  | Subscriptions and Examination Fees in Advance ... .. | 3,623  | 8  | 1  |        |    |    |
| 17,314 | Bank Overdraft ... ..                                | 16,660 | 6  | 3  |        |    |    |
|        |  |        |    |    | 24,213 | 3  | 7  |

Signed { G. A. MARRIOTT (*President*).  
G. A. TAYLOR (*Honorary Treasurer*).  
G. D. CLIFFORD (*General Secretary*).

£27,407

£29,047 16 10

**REPORT OF THE AUDITORS TO THE MEMBERS OF**

We have obtained all the information and explanations which to the best of our knowledge and belief were necessary for the purposes of our audit. In our opinion proper books of account have been kept by the Institution so far as appears from our examination of those books and proper Returns adequate for the purposes of our Audit have been received from the Sections Overseas.

We have examined the above Balance Sheet and annexed Income and Expenditure Account which are in agreement with the books of account. In our opinion and to the best of our information and according to the explanations given

**OF RADIO ENGINEERS  
ACCOUNT**

AS AT 31st MARCH, 1958

| 1957<br>£      |   | £     | s. | d. | £              | s.        | d.        |
|----------------|---|-------|----|----|----------------|-----------|-----------|
|                | <i>FIXED ASSETS</i>   |       |    |    |                |           |           |
|                | Office Furniture and Fittings at cost ... ..                | 6,384 | 17 | 2  |                |           |           |
|                | Less Depreciation to date ... ..                            | 3,099 | 17 | 2  |                |           |           |
| 3,219          |   |       |    |    | 3,285          | 0         | 0         |
|                | The Louis Sterling Library at cost ... ..                   | 1,635 | 3  | 5  |                |           |           |
|                | Less Depreciation to date ... ..                            | 783   | 3  | 5  |                |           |           |
| 785            |   |       |    |    | 852            | 0         | 0         |
|                | <i>INVESTMENTS AT COST</i>                                  |       |    |    |                |           |           |
|                | £200 3% Savings Bonds ... ..                                | 200   | 0  | 0  |                |           |           |
|                | £800 4% Consolidated Stock ... ..                           | 712   | 15 | 6  |                |           |           |
|                | £600 British Transport 4% Guaranteed Stock 1972/77 ... ..   | 544   | 1  | 4  |                |           |           |
| 1,297          | (Market Value 31st March, 1958 £1,221 0s. 0d.)              |       |    |    | 1,456          | 16        | 10        |
|                | <i>BUILDING APPEAL</i>                                      |       |    |    |                |           |           |
|                | <i>Investments:</i>   |       |    |    |                |           |           |
|                | £1,400 4% Consolidated Stock ... ..                         | 1,219 | 3  | 0  |                |           |           |
|                | £1,700 3½% War Loan ... ..                                  | 1,274 | 7  | 3  |                |           |           |
|                | £800 3% British Electricity Guaranteed Stock ... ..         | 597   | 6  | 0  |                |           |           |
|                | £2,400 4% British Transport Guaranteed Stock 1972/77 ... .. | 2,248 | 7  | 11 |                |           |           |
|                | (Market Value 31st March, 1958 £4,557 10s. 0d.)             |       |    |    |                |           |           |
| 4,648          |   | 5,339 | 4  | 2  |                |           |           |
| 2,600          | Halifax Building Society ... ..                             | 3,200 | 0  | 0  |                |           |           |
| 6,745          | Balance at Bank ... ..                                      | 7,605 | 17 | 1  | 16,145         | 1         | 3         |
|                | <i>CURRENT ASSETS</i>                                       |       |    |    |                |           |           |
|                | <i>General:</i>   |       |    |    |                |           |           |
|                | Stock of Stationery, Journals and Examination Papers at     |       |    |    |                |           |           |
| 3,856          | Valuation ... ..  | 3,704 | 7  | 4  |                |           |           |
| 876            | Income Tax Repayment Claim ..... ..                         | 554   | 12 | 11 |                |           |           |
| 2,900          | Sundry Debtors ... ..                                       | 2,325 | 19 | 3  |                |           |           |
| 479            | Sections—Balances at Bank and in Hand ... ..                | 703   | 7  | 4  |                |           |           |
| 2              | Cash in Hand ... ..   | 20    | 11 | 11 | 7,308          | 18        | 9         |
| <u>£27,407</u> |   |       |    |    | <u>£29,047</u> | <u>16</u> | <u>10</u> |

**THE BRITISH INSTITUTION OF RADIO ENGINEERS**

to us, the said accounts give the information required by the Companies Act, 1948, in the manner so required. The Balance Sheet gives a true and fair view of the state of the Institution's affairs as at 31st March 1958 and the Income and Expenditure Account gives a true and fair view of the excess of Income over Expenditure for the year ended on that date.

42, Bedford Avenue, London, W.C.1.  
19th September, 1958.

GLADSTONE, JENKINS & Co.  
Chartered Accountants, Auditors.

**GENERAL ACCOUNT**  
**INCOME AND EXPENDITURE ACCOUNT FOR THE YEAR ENDED 31st MARCH, 1958**

| 1957           |  | £ s. d.    | £ s. d.              |
|----------------|--|------------|----------------------|
| £              |  |            |                      |
|                | <b>Administration Expenses</b>   |            |                      |
| 9,282          | <i>Salaries and State Insurance</i> ... ..                                 | 10,167 0 9 |                      |
| 435            | <i>Pension Scheme</i> ... ..   | 435 1 3    |                      |
| 1,171          | <i>Postage and Telephone</i> ... ..  | 1,485 18 9 |                      |
| 1,502          | <i>Printing and Stationery</i> ... ..                                      | 1,100 6 0  |                      |
| 582            | <i>Travelling and Entertaining Expenses</i> ... ..                         | 794 3 11   |                      |
| 421            | <i>Delegates' Expenses</i> ... ..  | 563 14 2   |                      |
| 502            | <i>Council and Committee Expenses</i> ... ..                               | 552 6 11   |                      |
| 115            | <i>Audit Fees</i> ... ..   | 115 10 0   |                      |
| 653            | <i>Bank Interest and Charges</i> ... ..                                    | 444 18 3   |                      |
| —              | <i>Legal Expenses</i> ... ..   | 27 6 0     |                      |
| 247            | <i>Sundry Expenses</i> ... ..  | 179 13 0   |                      |
|                |  |            | 15,865 19 0          |
|                | <b>Institution Premises:</b>   |            |                      |
| 1,592          | <i>Rent, Rates and Insurance (Net)</i> ... ..                              | 1,651 0 5  |                      |
| 335            | <i>Lighting and Heating</i> ... ..   | 441 8 11   |                      |
| 612            | <i>Office Expenses and Cleaning</i> ... ..                                 | 625 1 1    |                      |
| 327            | <i>Repairs</i> ... ..  | 184 9 0    |                      |
|                |  |            | 2,901 19 5           |
|                | <b>Institution's Journal, List of Members and Reports:</b>                 |            |                      |
|                | <i>Printing and Publishing less Advertising</i>                            |            |                      |
| 5,686          | <i>Receipts</i> ... ..   | 6,450 10 5 |                      |
| 968            | <i>Postage</i> ... ..  | 1,430 5 6  |                      |
| 463            | <i>Envelopes and Wrappers</i> ... ..                                       | 175 15 7   |                      |
|                |  |            | 8,056 11 6           |
| —              | <i>Convention Expenses (Net)</i> ... ..                                    |            | 212 19 9             |
|                | <b>Examination Expenses:</b>   |            |                      |
| 554            | <i>Printing of Papers and Regulations</i> ... ..                           | 451 8 0    |                      |
| 518            | <i>Examiner's and Invigilators' Fees and Expenses</i> ... ..               | 493 9 7    |                      |
| 118            | <i>Hire of Accommodation</i> ... ..  | 105 14 7   |                      |
|                |  |            | 1,050 12 2           |
|                | <b>Section Expenses:</b>   |            |                      |
| 458            | <i>Printing, Stationery and Postage</i> ... ..                             | 661 11 3   |                      |
| 570            | <i>Hire of Accommodation, etc.</i> ... ..                                  | 495 3 2    |                      |
| 557            | <i>Travelling Expenses and Subsistence</i> ... ..                          | 777 10 6   | 1,934 4 11           |
| 42             | <i>Expenses for Coat of Arms</i> ... ..                                    |            | 197 5 0              |
| 193            | <i>Grants to other Institutions</i> ... ..                                 |            | 83 4 6               |
| 76             | <i>Premiums and Awards</i> ... ..  |            |                      |
|                | <b>Depreciation:</b>   |            |                      |
| 358            | <i>Office Furniture and Fittings</i> ... ..                                | 364 1 5    |                      |
| 88             | <i>Library</i> ... ..  | 94 16 1    |                      |
|                |  |            | 458 17 6             |
| 272            | <b>Excess of Income over Expenditure carried to Reserve Account</b> ... .. |            | 4,358 5 1            |
| <u>£28,697</u> |  |            | <u>£35,119 18 10</u> |

| 1957           |   | £ s. d.              |
|----------------|---|----------------------|
| £              |   |                      |
| 15,899         | <i>Subscriptions including Arrears Received</i> ... ..            | 19,885 2 7           |
| 126            | <i>Life Subscriptions</i> ... ..                                  | — — —                |
| 2,289          | <i>Building Appeal Donations</i> ... ..                           | 2,697 5 10           |
| —              | <i>Donations from Industry...</i> ... ..                          | 1,553 15 5           |
| 2,225          | <i>Examination and Exemption Fees</i> ... ..                      | 2,072 3 0            |
| 1,265          | <i>Entrance and Transfer Fees</i> ... ..                          | 1,320 18 0           |
| 5,223          | <i>Sale of Papers, Reports and Journals</i> ... ..                | 5,626 13 2           |
| 337            | <i>Interest on Investments (Gross)</i> ... ..                     | 347 7 6              |
| 1,333          | <i>Radio Trades Examination Board: Secretarial Charges</i> ... .. | 1,616 13 4           |
| <u>£28,697</u> |   | <u>£35,119 18 10</u> |



# INSTITUTION NOTICES

## Obituary

The Council has learned with regret of the death of the following member and has expressed sympathy with his relatives.

William Edward Howkins was killed on 20th September last when a Vulcan aircraft crashed at Syerston. He had been in the R.A.F. since 1951 and was a radar navigator. Mr. Howkins was 27 years of age and registered as a Student in February 1957.

## Tax Relief on Institution Subscriptions

The Council is pleased to advise members that under Section 16 of the Finance Act 1958, the whole of the annual subscription paid by a member who qualifies for relief under that Section will be allowable as a deduction from his emoluments assessable to income tax under Schedule E.

Particular attention is drawn to the fact that applications will only be accepted provided that the subscription is defrayed out of the emoluments of the office or employment. It is a further condition that membership should be relevant to the office or employment of the claimant, that is to say, the performance of the duties of the office or employment is directly affected by the knowledge concerned or involves the exercise of the profession of radio engineering.

Members should make application to their respective tax offices as soon as possible after 31st October 1958 for Form P358 in order to claim an allowance for the subscriptions paid to the Institution during the current year.

## Physical Society Exhibition

The 1959 Physical Society Exhibition will be held at the Royal Horticultural Society's Halls, London, S.W.1, from the 19th to 22nd January. As in previous years, the Physical Society kindly offer special admission tickets to enable Brit.I.R.E. members to visit the Exhibition on the morning of Monday, 19th January.

Members who wish to take advantage of this offer should write to the Institution without delay; requests for general tickets admitting at other times may also be made now. It should be noted, however, that tickets will *not* be despatched until a few days before the Exhibition is due to open.

## C. & G. Awards and Prizes

The 1957 list of City and Guilds Insignia Awards is given in the Annual Report of the Institute's Department of Technology. Included in the list is an Associate Member of the Institution, Mr. C. R. Dickenson, whose thesis was entitled "Adaptation of European Equipment and Methods to provide Telecommunications Facilities in an African Colony." Mr. Dickenson is Deputy Postmaster General and Nyasaland Regional Controller in the Post Office of the Federation of Rhodesia and Nyasaland.

Among the recipients of Awards made this year is Mr. G. M. Blair (Associate Member) whose thesis was on "Methods of effecting Cable-pair Economies with special reference to Line Concentrators and Shared Service". Formerly with the G.P.O., Mr. Blair is now Senior Communications Officer in the Communications Department of the Home Office.

In the announcement of Insignia Awards in the July issue of the *Journal* (page 446) it was stated that one of the conditions for the Insignia Award was the "possession of a Full Technological Certificate." This should have read "a Full Technological Certificate *or an acceptable equivalent*."

Three members of the Institution have been awarded prizes in Telecommunications Engineering subjects:

*Telecommunications Principles V.*

First Prize and Institute's Silver Medal:  
John Kenneth Binks (Graduate).

*Radio III.*

First Prize and Institute's Silver Medal:  
Wei Kung Hsu (Graduate).

Prize of £2 (awarded by the Institution of Post Office Electrical Engineers):  
Joseph William Hill (Graduate).

## Correction

The following corrections should be made in the paper "Design of Detector Stages for Signals with Symmetrical or Asymmetrical Sidebands" published in the September 1958 issue. Page 534, first column, line 21. After the word "resistance" *add* ". . . is about one-third of the second capacitance. . . ." Page 535, first column, line 4—cut off frequency *should read*  $2\pi \times 6.0 \times 10^6$  rad/sec.

# APPLICANTS FOR ELECTION AND TRANSFER

As a result of its October meeting the Membership Committee recommended to the Council the following elections and transfers.

In accordance with a resolution of Council, and in the absence of any objections, the election and transfer of the candidates to the class indicated will be confirmed fourteen days after the date of circulation of this list. Any objections or communications concerning these elections should be addressed to the General Secretary for submission to the Council.

## Transfer from Associate Member to Member

GREEN, Captain Philip Percival Mancha, R.N. *London, S.W.1.*

## Direct Election to Associate Member

ARCHENHOLD, Henry. *Renfrew.*  
 DAVIES, Christopher Sylvester.\* *Freetown, Sierra Leone.*  
 HANNAN, Major Abdul, B.Sc., Pakistan E.M.E. *London, W.8.*  
 HAWKINS, Stanley William Charles. *North Cheam.*  
 LENEY, Major Peter Harold, R. Sigs. *Hassocks.*  
 PRINCE, Morton B., B.A., Ph.D. *Morton Grove, Illinois, U.S.A.*  
 SALTER, Lt.-Col. Alick Steven Peter, R. Sigs. *Shrivenham.*  
 SKELTON, Roy Sydney. *New Barnet.*  
 TAYLOR, Frank Newland. *Leicester.*

## Transfer from Associate to Associate Member

CANNON, Charles William Douglas. *Bristol.*  
 JONES, Sidney Charles. *Cockfosters.*  
 NAMBIAR, Sqdn. Ldr. Kunhiraman Meethal Kunnummal, B.A., I.A.F. *New Delhi.*

## Transfer from Graduate to Associate Member

BELL, John Ramsey. *Edinburgh.*  
 BRONSTEIN, David. *Tel Aviv.*  
 CAMERON, Archibald. *Basra.*  
 DOREY, Cecil Frank. *Southampton.*  
 GARDE, Flt.Lt. Vinayak C., B.Sc., I.A.F. *Calcutta.*  
 HYDE, Norman George. *Epsom Downs.*  
 ITTER, Charles Walter. *Greenford.*  
 LINDSEY, Peter William. *Kings Lynn.*  
 SMITH, John Hugh. *Send.*

## Transfer from Student to Associate Member

CUTLER, George Donald. *Cambridge.*

## Direct Election to Associate

BILSBOROUGH, Gordon. *St. Albans.*  
 BRACHER, Richard William. *Nairobi.*  
 GANDHI, Flt. Lt. Jai Krishan, M.Sc., B.A., I.A.F. *Bangalore.*  
 GIBB, John Robert. *London, S.W.19.*  
 GRAYSON, Geoffrey William. *Ormskirk.*  
 LIGHT, Robert Basil. *Wimborne.*  
 MATLEY, Clive James. *Chelmsford.*  
 MILBURN, Matthew Ridley. *London, W.1.*

PRESTON, Alan. *Poynton.*  
 SILVER, Sqdn. Ldr. William E., M.Sc., R.A.F. *Wolverhampton.*  
 VALENTINE, Eric. *Northampton.*

## Transfer from Student to Associate

COPPACK, Kenneth Norman. *Chester.*  
 BRIGHT, John Alexander Sydney. *Surbiton.*  
 DAVIES, Roy Patrick. *Egham.*  
 GIDDENS, Leonard. *Hayes, Middlesex.*  
 GREENWOOD, John Dewhurst. *Busingstoke.*  
 HALL, Michael William George. *Watford.*  
 HODGSON, John Ernest, B.Sc.(Eng.). *Cowes.*  
 KHANU, Abdul Hakim. *London, S.W.4.*  
 MEARNS, James Robert. *Hayes, Middlesex.*  
 MORRISON, John Gordon. *Glasgow.*  
 MURPHY, Brian. *Harrow Weald.*  
 NEAL, Geoffrey Frederick. *Brighton.*  
 PHILADELPHIA, James Lambert. *Kitty, British Guiana.*  
 TRAVIS, Flt. Lt. Robert Charles, B.Sc., R.A.F. *Henlow.*  
 WINDSOR, Trevor Charles, B.Sc. *London, S.E.13.*

## Transfer from Student to Graduate

ANAND PRAKASH, M.Sc. *Varanasi.*  
 AWOMOLO, George Oludaisi. *London, N.7.*  
 BAKHSHI, Manohar Singh. *London, S.E.9.*  
 BANSAL, Vijai Kant. *B.Sc. Bihar.*  
 BIRD, Gordon Joseph Alexander. *Chard.*  
 DEAKIN, Barry. *Leeds.*  
 de RUYTER, Albertus Hermanus Maria. *Eindhoven.*  
 GREEN, John Owen. *Horseheath.*  
 GURCHARAN SINGH SURIE. *Bangalore.*  
 JAIN Naim Chand B.A.(Hons.). *New Delhi.*  
 JASTRZEMBSKI, Jerzy Andrzej. *London, S.W.19.*  
 KARAMJIT SINGH, B.Sc., M.Sc. *Bombay.*  
 MERCER, David Stanley. *Welwyn Garden City.*  
 NATARAJAN, Ramakrishnan Iyer. *London, N.W.6.*  
 NIRODI, Suresh Bhavanishanker, B.Sc. *Bombay.*  
 O'CONNELL, Terence Francis Kevin. *Aldersford.*  
 PANTHAKY, Jal-Khurshed. *Wallington.*  
 PATTABIRAMAN, A. K. *New Delhi.*  
 QUINN, Peter George. *Bushey.*  
 RAJAGOPAL, A. *Bangalore.*  
 RICE, Matthew Joseph. *Stillorgan, Co. Dublin.*  
 RYDER, Geoffrey. *Dagenham.*  
 WALKER, John Joseph. *Glasgow.*  
 WILKINSON, George Arthur. *Cambridge.*

# STUDENTSHIP REGISTRATIONS

AKINTOBI, Sunday Layi Akanbi. *London, S.W.4.*  
 ALLEN, Patrick Donald. *London, E.18.*  
 BENNETT, Richard Owen. *London, N.W.3.*  
 BONE, Thomas Neil. *Wembley.*  
 BOORE, David Leonard. *Rhondda.*  
 BRIDGES, William Francis. *Gillingham.*  
 BULL, Leslie Albert. *Aden.*  
 BUYKX, Wilhelmus Joseph. *Henley Beach, South Australia.*  
 CAPPS, Kenneth Charles. *Bracknell.*  
 CATER, Michael William. *Walsall.*  
 CHAWLA, Bhupendra Nath. *New Delhi.*  
 CRAWFORD, George Humc. *Broxburn.*  
 DE SCALLY, Thomas. *Helsinki.*  
 DESHPANDE, Prabhakar, Bhimrao, B.Sc.(Hons.). *Belgaum.*  
 ELLIS, Brian James. *Hayes, Middlesex.*  
 FORD, Hugh Dermot. *London, W.4.*  
 GAZDER, Dhunjishaw Cavasji, B.Sc. *Bombay.*  
 GLEDHILL, Stuart Paul. *London, S.E.23.*  
 GRIFFITH, Thomas Philip Hugh. *Raglan.*  
 HERZENBERG, Selwyn Justus. *London, N.5.*

IYER, Rama Padmanabha, B.Sc.(Hons.). *New Delhi.*  
 JOHNSTON, James Jardine. *Southampton.*  
 JONES, Mervyn. *Conway.*  
 KULSHRESHTHA, Satgur Sharan. *Mathwa.*  
 MENG FATT NG, George Lukas. *Singapore.*  
 ONYIA, Augustine Ndudi. *London, N.W.6.*  
 PATEL, Dara Erachshaw. *Secunderabad.*  
 PECK, Horace Cyril. *Enfield.*  
 RIVLIN, David. *Bradford.*  
 RIZVI, Syed Iqbal Husain, M.Sc., B.Sc. *Lucknow.*  
 SUBRAMANIAN, Sundareswar, M.Sc. *Madras.*  
 VEERANKUTTY, Karalamkunnath. *Madras.*  
 VENKATESH, Palghat Anantha. *Bombay.*  
 WATKINS, Kenneth Michael. *Coventry.*  
 WING KEUNG TSE. *Hong Kong.*  
 WOODCOCK, Terence Keith. *Luton.*  
 ZUGIC, Velimir. *London, S.E.27.*

\* Reinstatement

# NEW DEVELOPMENTS IN SILICON PHOTOVOLTAIC DEVICES\*

by

M. B. Prince, Ph.D., B.Sc. (Associate Member)† and M. Wolf, Dipl. Phys.†

*Read before a meeting of the Institution in London on 10th June 1958.*

*In the Chair: Mr. J. R. Brinkley (Member).*

## SUMMARY

The requirements which silicon photovoltaic devices have to meet in various applications are so widely different that it was necessary to develop three distinct types of devices:

- (1) A device which is operated in the forward biased condition, useful at moderately low to high light levels, known as a solar cell.
- (2) A device which is operated in the forward biased condition, useful at very low light levels, known as a low level cell.
- (3) A device operated in the reverse biased direction at low to high light levels, known as a photodiode.

All three types are  $p-n$  junction devices, prepared by solid state diffusion methods, with each type designed to yield special characteristics. The spectral response, transient response, and temperature dependence of these devices are considered.

### 1. Semi-conductor $p-n$ Junction

If a semi-conductor such as silicon or germanium is extremely pure it will have a slight amount of conductivity which is very much less than that found in metals such as copper or nickel but this conductivity is much greater than that found in insulators such as mica and quartz. By extremely pure is meant that there are no impurities present in quantities greater than one part in  $10^9$  that affect the electrical properties of the semi-conductor. Such material can be prepared with difficulty and is called intrinsic semi-conductor. However, practically all semi-conductor material has one type or another of impurities that makes it behave electrically different from intrinsic semi-conductor. This material is called extrinsic semi-conductor or impurity semi-conductor. These impurities can range in concentration from one part in  $10^9$  to one part in  $10^5$ , which is still extremely pure from a chemical point of view.

Germanium and silicon both have four valence electrons in their crystalline form. The impurity in the crystal may happen to have five valence electrons like arsenic, antimony or phosphorus. Here the impurity atom replaces a silicon atom and is left with an extra, unattached electron. The energy required to remove the electron from the impurity is quite small and the thermal energy in the crystal is sufficient for this purpose. Thus the electron moves about freely in the crystal and contributes to the electrical conductivity just as in metals, although in the semi-conductor case the conductivity is much smaller than in metals. The conductivity in the semi-conductor with group 5 impurities is due to these excess electrons, that is, negative charges, and the material is called  $n$ -type semi-conductor.

The impurity atom could happen to have only three valence electrons, as in a group 3 element, like boron, indium and gallium. Here the impurity atom replaces a silicon atom but does not have sufficient electrons to complete all the valence bonds. What happens in this case is that an electron from a nearby atom will move over to complete the bond leaving behind

\* Manuscript received 14th July 1958. (Paper No. 471.)

† Hoffman Electronics Corporation, Semiconductor Division, Evanston, Ill., U.S.A.

U.D.C. No. 621.383.8

another uncompleted bond. This empty position is called a hole. Its motion is really due to the collective motion of all the valence electrons and it can be shown to have a positive mass and a positive charge. Material with group 3 impurities has an increased conductivity due to these holes, positive charges, and is called *p*-type semi-conductor.

When *n*-type semi-conductor is next to *p*-type semi-conductor, a so-called *p-n* junction is obtained in which extra electrons are on the *n*-side and extra holes are on the *p*-side. Some of the holes and electrons in the vicinity of the junction intermingle by diffusion and recombine leaving behind a dipole layer due to the fixed charges of the impurities. This so-called built-in electric field is important for the operation of some devices like the solar cell.

Now consider what happens when a voltage is applied to the junction. First let the positive potential be applied to the *p*-side and the negative potential be applied to the *n*-side. The positive potential will cause the electrons to cross the junction into the *p*-side and contribute to current. Likewise, the negative potential will attract the holes from the *p*-side into the *n*-side which also contribute to the current. Now when the polarity of the voltage is reversed the negative potential on the *p*-side will not have any holes to attract from the *n*-side of the junction and likewise the positive potential on the *n*-side will not have any electrons to attract from the *p*-side. Therefore, essentially no current will flow. This description is only approximately true. The theory for a *p-n* junction yields the following form of the current-voltage characteristic:  $I = I_0 (\exp NV - 1)$  where  $N$  should be about 40 at room temperature. This relation is the ideal rectifier equation.

### 1.1. *p-n* Junction Devices

The *p-n* junction devices that are finding use today include rectifiers, voltage regulators, voltage clippers, and voltage reference devices. Rectifiers can be designed with inverse voltage ratings from 2 to 2,000 volts. These devices pass currents of amperes in the forward direction with small voltage drops of the order of 1 volt. Voltage regulators can be designed for the regulation of voltages from 2 to 2,000 volts; however, regulators for between 6 and 200 volts

are more usual. These devices have low impedances in the breakdown region which range from 0.2 to several tens of ohms. It is possible to build voltage reference devices by taking advantage of the temperature variations of the reverse breakdown voltage and the voltage for forward conductance. By properly choosing diodes so that one diode is in the reverse and at least one diode in the forward direction, it is possible to have a voltage drop across this assembly change less than one part in  $10^5$  per degree centigrade over temperature ranges of 200°C.

## 2. Photodevices

Light consists of photons, most of which contain sufficient energy when they fall on *p-n* junctions to break a valence bond and create a hole-electron pair. If the photons are absorbed near the junction, the hole-electron pairs will diffuse into the junction region where the built-in field will cause them to separate so that the holes will flow into the *p*-type material and electrons into the *n*-type material. This builds up an external voltage on the device and causes current to flow through a load. The light acts as a current generator and the current voltage characteristic of the device is shifted downward as is shown in Fig. 1. Part of the characteristic is now in the fourth quadrant and, therefore, power can be extracted from the device by operating at some point of the curve in this quadrant. The maximum power that can be obtained will be equal to the area of the maximum rectangle that can be drawn under the curve in the fourth quadrant. Another possible use of the photodevice just described is to apply a reverse bias on the diode and allow the increase in current with light to operate a circuit or a switch. This is the photodiode application. Increasing the intensity of illumination increases the reverse current flow.

With the rapid increase in applications for photovoltaic devices generally, developments in silicon photovoltaic devices have considerably advanced during the last few years. This has led partially to a better understanding, resulting in improvement of older devices like the silicon solar cell, partially to the development of new devices, like silicon diffused junction photodiodes and phototransistors. This paper will deal only with the solar cell, the low-



level solar cell, and the silicon diffused-junction photodiode. Important parameters in the design of these devices, their characteristics, and their special advantages for certain applications will be discussed.

### 3. General Description

The silicon photovoltaic devices described here are of the diffused junction type. Fig. 1 shows in its upper part the physical configuration of a solar cell on the left and a photodiode on the right. In both devices the  $p-n$  junction is in a plane parallel to the light exposed surface, and the  $p$ -layer is chosen to be the layer adjacent to this surface in order to utilize the longer diffusion length of electrons as minority carriers, which is of importance at high absorption coefficients. Since the solar cell is a low impedance device, special care has to be taken to reduce series resistance. Therefore, the whole back surface is used for contact

are identical with and without illumination, except for a displacement parallel to the ordinate. The amount of this displacement, called the light generated current  $I_L$ , is proportional to the incident light intensity. Since the solar cell is operated exclusively in forward bias direction, no attention has to be paid to the reverse characteristic of the device. In fact, the optimization of power conversion from light into electrical power resulted in devices with extremely "soft" reverse characteristics. The photodiode, however, which is operated in the reverse bias direction, has to have a very good diode reverse characteristic. The design of the photodiode has also to result in the best compromise between high light current  $I_L$  and good dark characteristic. The optimum load under given light conditions for a solar cell is that which results in the highest power output; for the photodiode it is that which results in the highest voltage change for a given change in light intensity. Thus, optimum operation of a photodiode is that with the largest load resistance. But it has to be observed that choosing an excessively large load resistance results in driving the photodiode into forward bias condition which leads to saturation and clipping of the signal.

Figure 2 shows the equivalent circuit diagrams of the solar cell and the photodiode. The most important properties of each one of the two devices can be represented by a constant-current generator  $I_L$  shunted by an ideal diode junction. Besides these two elements, the transition region capacitance  $C_j$  has to be considered for the transient response. The voltage across this junction capacitance is the applied voltage plus the built-in junction potential  $\phi$ . In normal operation of the solar cell, the junction is biased in the forward direction and drains off part of the current  $I_L$  delivered by the generator. In photodiode operation the junction is biased in the reverse direction by the external power supply, and the current through the junction is in the same direction as the current from the light current generator. The characteristic of the solar cell is usually modified by a series resistance  $R_s$ , and an effective shunt resistance  $R_{sh}$ . The outside circuit for the solar cell consists normally of a load resistance  $R_L$  which dissipates the power delivered by the cell.

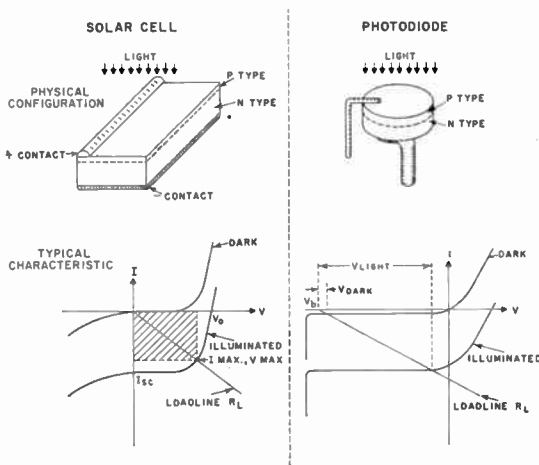

Fig. 1. Construction and characteristics of solar cell and photodiode.

and the contact to the  $p$ -layer extends parallel to the long edge of the device. In the photodiode, which is a high impedance device, no precautions for the reduction of series resistance have to be taken.

The lower part of the figure shows the typical current-voltage characteristic with and without illumination, and the application mode of the two devices. The solar cell is operated in its forward conduction region while the photodiode is shown in the typical operation in reverse bias direction. In both cases, the characteristics

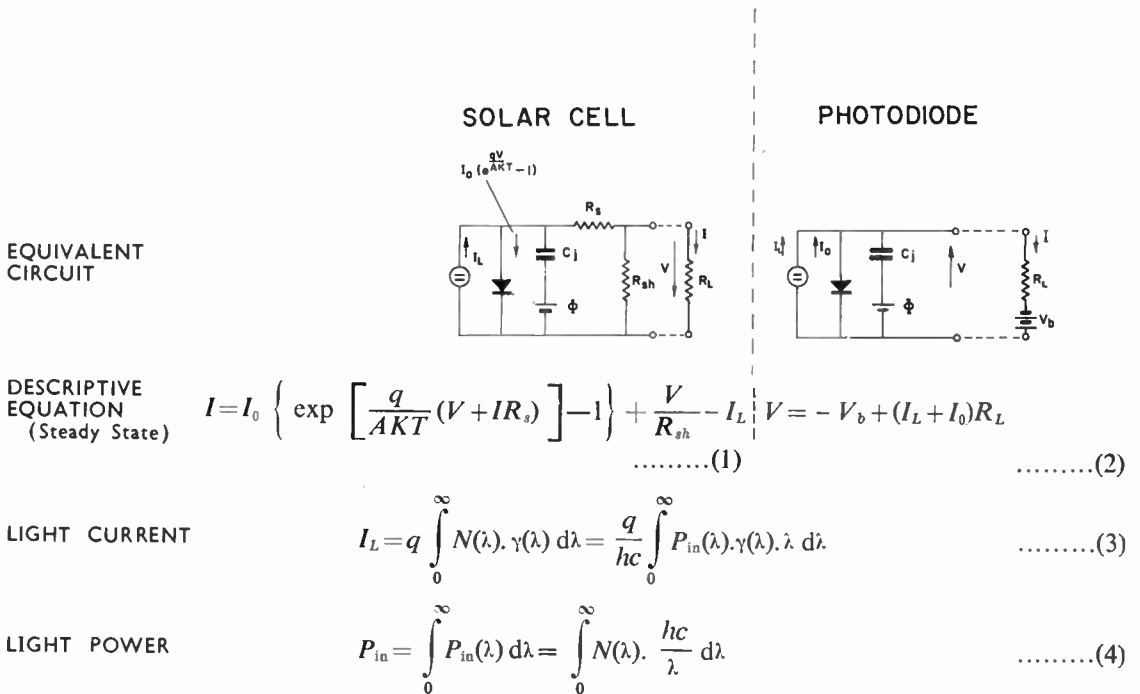

Fig. 2. Equivalent circuits and associated equations for solar cell and photodiode.

Below the equivalent circuit diagram are the equations describing the current-voltage characteristic of the two devices. The solar cell equation is given in terms of the current into the load  $I$  and the voltage  $V$  across the terminals. The equation consists of three terms describing the current delivered by the generator  $I_L$ , the current drained through the junction described by the diode equation with the junction voltage consisting of  $V$  minus the voltage drop in the series resistance  $R_s$ , and a term which represents the drain of the shunt resistance. The photodiode equation is given in terms of the terminal voltage  $V$  and the applied bias voltage  $V_b$ . Here the series resistance can always be neglected, and the current through the junction reduces to the saturation current  $I_0$ . Then the voltage generated across the load resistance is due to the sum of the light current  $I_L$  and the saturation current  $I_0$ .

At the bottom of the figure are two equations giving the light current  $I_L$  in terms of the incident light power  $P_{in}(\lambda)$  and the total incident light power ( $P_{in}$ ) in terms of the photon

density. Here  $q$  is the electronic charge,  $N(\lambda) \, d\lambda$  the number of photons incident on the surface of the cell per unit time in a range  $d\lambda$  around the wavelength  $\lambda$ , and  $\gamma(\lambda)$  is the overall collection efficiency at  $\lambda$ . This collection efficiency is defined as the ratio of the number of minority carriers collected by the junction to the number of photons incident on the surface of the cell. The total light power  $P_{in}$  incident on the device is given in terms of the number of photons  $N(\lambda) \, d\lambda$  and of the energy per photon  $hc/\lambda$ ,  $h$  being Planck's constant and  $c$  the velocity of light. It should be emphasized at this point that the solar cell and the photodiode are two completely different devices in regard to their application, the solar cell being a power converter and the photodiode an electronic amplifier controlled by a light signal.

There are a few quantities which characterize the performance of the two devices for their specific applications. These quantities are expressed in terms of the integrals given in eqns. (3) and (4). For the amplifier one of the main characteristics is the signal power gain  $g$ , defined as a change in output power  $\Delta P_{out}$  for

a given change in input power,  $\Delta P_{in}$ :

$$g = \frac{\Delta P_{out}}{\Delta P_{in}} = \frac{2R_L I_L \Delta I_L}{\Delta P_{in}} \dots\dots(5a)$$

where  $\Delta I_L$  is the change in light generated current. If the load resistance is chosen to fulfil the condition

$$I_L \cdot R_L = 0.9 V_b \dots\dots(6)$$

the largest possible gain consistent with safe avoidance of signal clipping will be obtained. Equation (5a) will then reduce to the simple expression:

$$g = 1.8 V_b \frac{\Delta I_L}{\Delta P_{in}} \dots\dots(5b)$$

These eqns.(5) are derived under the assumptions:

$$\Delta I_L \ll I_L \quad I_0 \ll I_L$$

This gain has been found to be capable of exceeding 16 db, depending on the light level.

In amplifiers it is frequently also of interest to know the efficiency of the circuit. This efficiency  $\eta$  is expressed as the available signal power output  $P_{out}$  divided by the power  $P_{bias}$  introduced into the circuit from the bias source plus the signal power input  $P_{in}$ .

$$\eta = \frac{P_{out}}{P_{in} + P_{bias}} = \frac{0.9}{1 + P_{in}/V_b \cdot I_L} \dots\dots(7)$$

Since the signal power input is small compared to the bias power input, the overall efficiency is close to 90 per cent.

For the solar cell the efficiency  $\eta$  is given as

power output divided by power input. The power output is expressed as the product of maximum power current  $I_{max}$  times maximum power voltage  $V_{max}$ . This product equals in good solar cells about 0.75 times the short circuit current  $I_{sc}$  times the open circuit voltage  $V_0$ . This approximation is introduced in eqn. (8) in order to express the efficiency  $\eta$  in terms of the collection efficiency  $\gamma(\lambda)$  and of the power input.

$$\eta = \frac{P_{out}}{P_{in}} = \frac{I_{max} V_{max}}{P_{in}} \approx \frac{0.75 AkT}{q} \frac{I_L}{P_{in}} \log \left( \frac{I_L}{I_0} + 1 \right) \dots\dots(8)$$

In an amplifier it is further of interest to know the sensitivity  $\sigma$  of the circuit. Sensitivity is usually taken to be the input signal necessary to give a 3 db rise in output signal over the "zero input signal" level. This 3 db rise is for the photodiode measured against the dark current level  $I_0$ .

$$\sigma = \frac{0.41 I_0 P_{in}}{I_L} \dots\dots(9)$$

Figure 3 summarizes the major methods of application of the two types of devices. The left half of the figure, (a) to (d), are devoted to the solar cell, and the right half, (e), typifies photodiode applications.

The first solar cell application is that as a power generator. The left part shows the solar

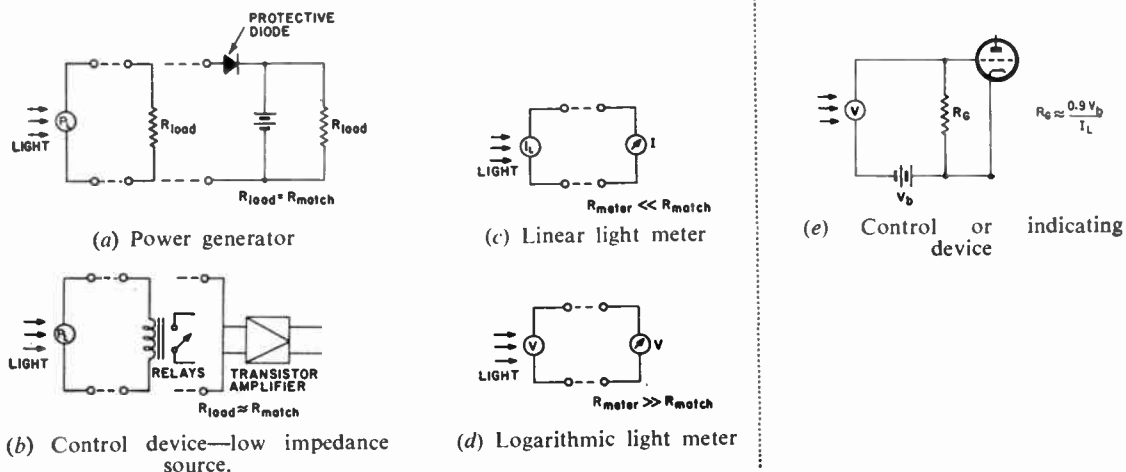

Fig. 3. Principal circuit arrangements used with solar cell and photodiode.

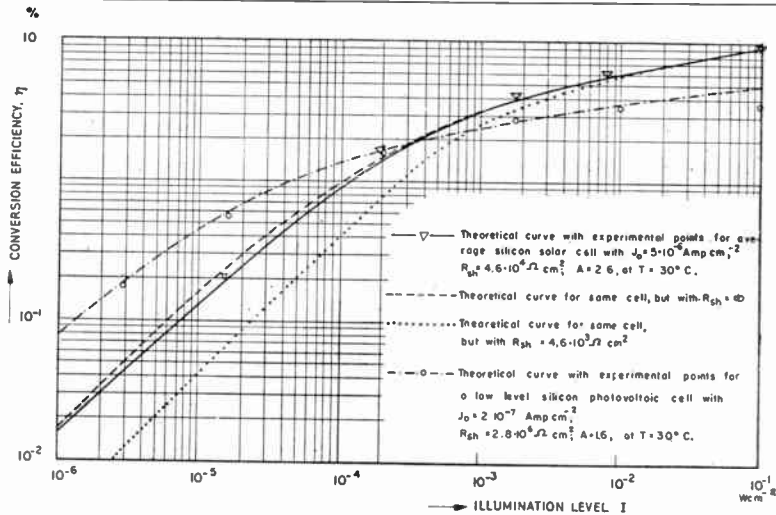

Fig. 4. Conversion efficiency of various cells under different conditions.

cell delivering the power directly into a dissipative load while the right part shows a load connected with a storage battery. In this case the power into the load will be available at all times with an intermittent light source. At times of light power input the solar cell supplies the load power and recharges the storage battery. In this type of application a protective diode has to be inserted between the solar cell and the storage battery in order to prevent discharge of the storage battery through the solar cell. This is necessary since the battery is connected in the forward bias direction of the solar cell.

The second important application is that of a control device that operates a relay directly or acts as an input system for a transistor amplifier. The transistor amplifier is especially suitable for operation with solar cells since both devices have a low terminal impedance resulting in an easy match between them.

The third and fourth application of the solar cells are as light meters. It may be desirable to have a meter as a linear indicator of the light level. In this case the meter resistance is made small compared to the optimum load resistance of the solar cell, thus measuring short circuit current which varies linearly with the light level. For logarithmic indication of the light level, the solar cell is used in the open circuit condition which would mean employing a high resistance voltmeter.

The major application of the photodiode is that of driving a vacuum tube amplifier. The load resistance of the photodiode acts simultaneously as the grid leak resistance for the vacuum tube.

There is no difference in principle of application between a normal solar cell and a low-level solar cell. However, the usual solar cell has been designed to give highest possible power conversion at high light levels, especially in the order of 2,000 to 10,000 foot-candles. The selection of the design parameters for this purpose led to a device which does not perform well with light levels under 10 foot-candles. Since substantial interest has been shown in a solar cell type device to be operated at fractions of foot-candles, a modification of the standard type of solar cell has been developed. This cell sacrifices conversion efficiency in order to improve the low-level performance. It is, therefore, not as suitable as the normal solar cell for high-level energy conversion, but gives essentially improved performance at light levels in the order of a foot-candle and below. (Fig. 4).

#### 4. Device Design Considerations

##### 4.1. Solar Cell

An important design consideration for solar cells is the achievement of high overall collection efficiency. The first possibility of losses is by reflection of photons from the surface.



An investigation into the reflection losses of solar cells showed that the losses from scattering on the surface are in some parts of the spectrum as significant as those from direct reflection. Fig. 5 shows curves of the direct reflection from a solar cell and of the total scatter radiation, both measured at normal incidence as a function of wavelength. Also given in the figure is the sum of these two curves which represents the total reflection losses. It can be seen that the reflection losses are rather small and only on the long wavelength end of the range do they reach a value of nearly 6 per cent. Since these losses are small, no significant improvement can be expected from using special surface treatments to reduce reflection.

The next consideration is that of the generation of electron-hole pairs from the photons penetrating into the silicon crystal. Since unit quantum efficiency exists for electron-photon interactions in silicon in the visible light region, one electron-hole pair is created for each photon absorbed in the crystal.

The final consideration is that of the diffusion of electron-hole pairs due to density gradients and the collection of the minority carriers by the junction, or of the recombination of the electron-hole pairs before reaching the junction. The diffusion differential equation for the steady state is

$$\frac{p_n - p}{\tau} + \alpha N e^{-\alpha x} + D_p \frac{\delta^2 p}{\delta x^2} = 0 \dots\dots(10)$$

The first term considers the recombination of excess carriers ( $p - p_n$ ) with the minority

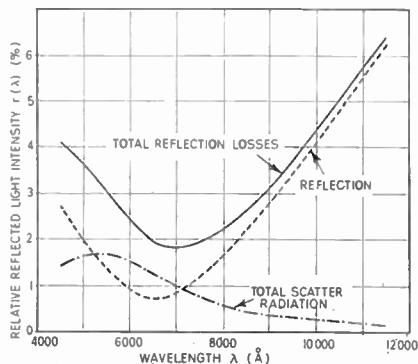

Fig. 5. Light reflection from a solar cell surface as a function of wavelength. (Normal incidence.)

carrier lifetime  $\tau$ , the second term takes account of the generation of minority carriers due to  $N$  photons incident on a unit area of surface per unit time, and the last term describes the diffusion rate. This differential equation has been solved with boundary conditions corresponding to the configuration of a solar cell.

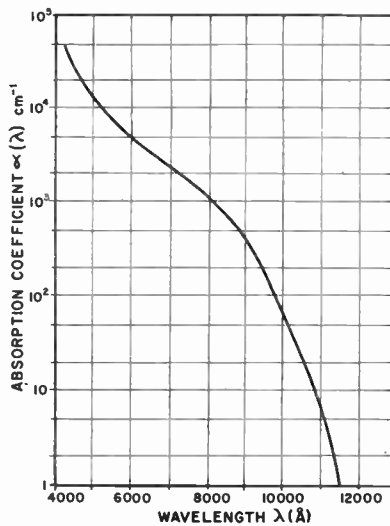

Fig. 6. Absorption coefficient  $\alpha$  of silicon as a function of wavelength. (Published data by H. Y. Fan and by Braunstein, Moore and Herman.)

These boundary conditions are determined by a surface recombination velocity  $s$  on the surfaces of the crystal and by zero carrier concentration at the junction, since the junction field removes any minority carrier reaching the junction in the case of zero or negative junction voltage.

Since the current into the junction is proportional to the gradient of the minority carrier concentration at the junction

$$I_p = qD_p \left( \frac{\delta p}{\delta x} \right)_{x=x_j} \dots\dots(11)$$

the collection efficiency can now be calculated. All quantities entering into these calculations, with one exception, are measurable material and device-constants. They are the junction depth, the  $n$ -layer thickness, the minority carrier lifetimes, the diffusion mobilities, the surface recombination velocities and the absorption coefficient. The exception is the life-time of the minority carriers in the heavily-doped  $p$ -region.

Values of the absorption coefficient at the different wavelengths were obtained from published data by H. Y. Fan<sup>2</sup> and by R. Braunstein, A. R. Moore and F. Herman<sup>2</sup> and are shown in Fig. 6. The absorption coefficient varies over nearly five orders of magnitude in the visible light and near infra-red region.

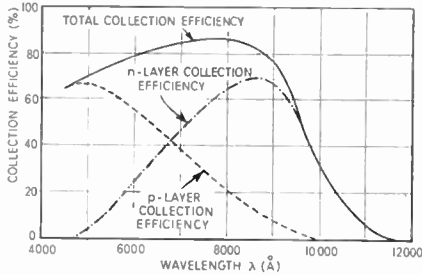

Fig. 7. Collection efficiency  $\eta(\lambda)$  as a function of wavelength, calculated for solar cell No. 3-329.

Figure 7 gives the results of the calculations of collection efficiency for a typical solar cell. On this cell, the spectral response has been measured first. Then the junction depth has been determined by the bevel-polishing and stain etching method. Finally, plateaus have been etched into the *p*-layer in order to determine the minority carrier life-time of the *n*-layer. The method used for this measurement is that described by R. H. Kingston<sup>3</sup>, using injection of minority carriers by application of a forward current pulse and extraction in a reverse voltage pulse, measuring the time duration of the recovery phase. The mobilities were determined from the resistivities, using data from M. B. Prince<sup>4</sup> and G. Backenstoss<sup>5</sup>.

The calculated data reveal a predominant contribution of minority carriers from the *n*-layer in the long wavelength region, while the collection from the *p*-layer is of importance only at the short wavelength range. Since all spectral response curves are taken for constant light intensity, the collection efficiency curves from Fig. 7 have to be multiplied with the number of photons contained in every wavelength interval for constant light intensity.

$$N(\lambda) = \frac{P_{in}(\lambda)}{hc} \lambda \quad \dots\dots(12)$$

The resulting curves are shown in Fig. 8. The figure shows reasonably good agreement between the calculated curve and the measured points for the spectral response of the cell con-

sidered. It can be further seen from this figure that the importance of the *n*-layer response is still larger than revealed in the previous figure.

This investigation proved the importance of both *p*-layer and *n*-layer for the achievement of high collection efficiencies. In particular, it substantiated experimentally found results that high *n*-layer minority carrier life-times are necessary for high collection efficiencies. The calculations confirm also previous statements that the *p*-layer should be as thin as possible in order to get high collection efficiency in the short and medium wavelength regions. With this very small junction depth the achievement of large diffusion lengths in the *n*-layer becomes more important for improved long wavelength response.

The surface recombination velocity does not enter into the collection efficiency in a very significant manner. Since treatments for reduction of surface recombination velocity, like etching, result in a higher reflection coefficient, a significant improvement cannot be expected from these treatments.

Experience showed that the achievement of a high collection efficiency for a particular solar

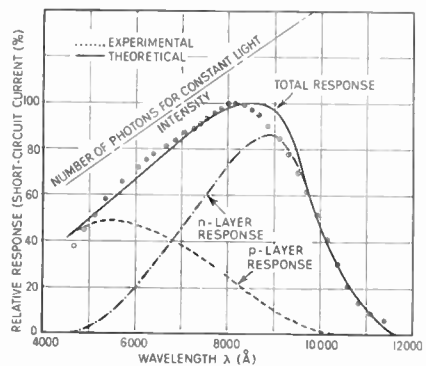

Fig. 8. Spectral response of solar cell No. 3-329.

cell type is not always compatible with the largest overall efficiency of the device. It has previously been stated that the product of maximum power current times maximum power voltage may equal 0.75 times the short circuit current times the open circuit voltage. The factor 0.75 will be reduced considerably if the *p*-layer is too shallow or the acceptor concentration in the *p*-layer is too small. Both conditions would lead to a larger collection

efficiency; the first due to a more favourable minority carrier distribution, the second to a larger diffusion length in the  $p$ -layer. However, the series resistance of the  $p$ -layer will be increased, resulting in a reduction of the factor in this relationship by a sufficiently large amount in order to overcome the improvement in collection efficiency. This improved understanding of the solar cell performance led to a better selection of the processing parameters and resulted in higher conversion efficiencies. Solar cells with conversion efficiencies as high as 14 per cent. have been obtained not infrequently in the laboratory.

#### 4.2. The Low-Level Solar Cell

It has been experimentally established that some internal field emission takes place in the extremely narrow junction regions obtained in normal solar cells. The width of the transition region in these cells has been found to be only a few thousand angstroms. The internal field emission decreases the effective resistance of the junction at small bias voltages, making the cell inefficient at extremely low light levels. In order to overcome this deficiency, the junction transition width has to be increased. Since this can be done only by increasing the thickness of the  $p$ -layer, some collection efficiency has to be sacrificed. The considerable increase in the low-level impedance of the cell obtained in this manner improved the very low light-level performance of the low-level cell appreciably. This appears to be the only important design consideration for the low-level solar cells. Cells operating successfully at short circuit currents in the order of fractions of a microampere per  $\text{cm}^2$  have been prepared in this manner.

#### 4.3. Photodiode

Important for a good photodiode are high reverse voltages in order to obtain high gain, low saturation current for good sensitivity, and good collection efficiency. High reverse bias voltages require a large junction width. Low saturation current will require as low a resistivity for the base region as is compatible with high reverse working voltage. Since the depth of the  $p$ -layer cannot be made sufficiently small due to the previous requirements, the minority carrier life-time of the  $p$ -layer has to be made as large as possible. Even if all these parameters are chosen properly, the

spectral response will be a fairly narrow one limited principally to the red and infra-red regions, where the absorption co-efficient is rather small. The difference in energy gap between silicon and germanium has a two-fold effect on a photodiode. The larger energy gap results in the loss of a part of the infra-red spectrum in the response of a silicon photodiode, thus yielding a lower light current than an otherwise equivalent germanium device. But since the saturation current of a silicon diode is much lower due to the larger energy gap, the sensitivity of the silicon photodiode is nearly two orders of magnitude better than that of a comparable germanium device. Furthermore, the larger energy gap permits operation of any silicon device at essentially higher temperatures than its counterpart made from germanium.

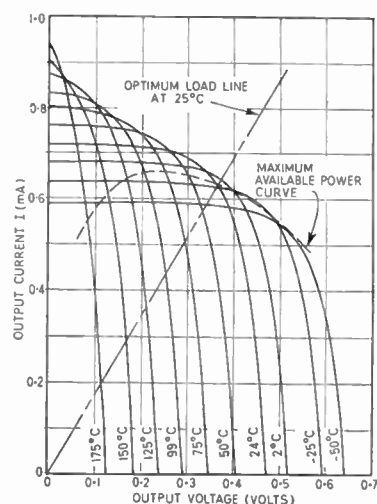

Fig. 9. Output characteristics of solar cell No. 239 at different device temperatures.

The physical configuration of the new diffused junction silicon photodiode has resulted in a device of essentially superior collection efficiency compared to older designs, which utilize alloyed junctions or diffused or grown junctions in bars, with the junction located in a plane perpendicular to the light exposed surface. The newly developed silicon diffused junction photodiode has a sensitivity of a few foot-candles (tungsten  $2800^{\circ}\text{K}$ ) at room temperature, can operate on 150 V bias voltages and at temperatures around  $150^{\circ}\text{C}$  with less sensitivity.

**5. Temperature Dependence**

Figure 9 shows a plot of solar cell current-voltage output characteristics for temperatures between  $-50^{\circ}$  and  $+175^{\circ}\text{C}$ . The plot indicates that open-circuit voltage decreases in a linear fashion with temperature, while the short-circuit current increases, also linearly. The locus for the individual maximum power points in the different characteristics has been drawn in the figure, and a load line for constant load resistance is also shown. Fig. 10 gives the maximum available power of the cell in this temperature range as well as the power delivered into a constant load resistance which was matched to the cell at  $25^{\circ}\text{C}$ . While the maximum available power increases toward lower temperatures, the power into a constant load falls off to both sides from the match point.

It has been found that the temperature dependence is the same over three orders of magnitude in light level. The change in open-circuit voltage can be mainly attributed to the rapid increase of the saturation current  $I_0$  with increasing temperature. The increase in short-circuit current with temperature has not previously been well known; it is in the same order of magnitude as the voltage change and can be explained by the displacement of the absorption curve with regard to wavelength as has been shown to exist by H. Y. Fan and M. Becker<sup>6</sup>. The cause of this shift of the absorption curve is the decrease of the energy gap with increasing temperature, which has the value of  $4 \cdot 10^{-4}\text{eV}$  per degree C for silicon. Thus the whole collection efficiency curve is

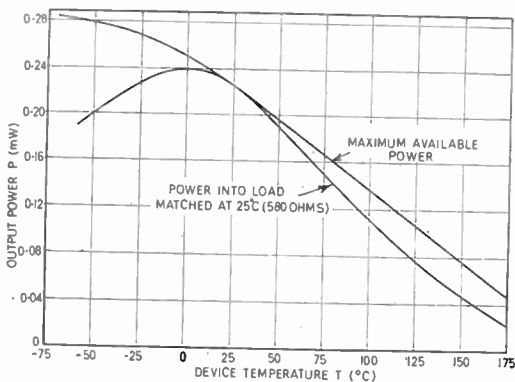

**Fig. 10.** Output power vs. device temperature for solar cell No. 239. Measured at 100 foot-candles (Tungsten  $2800^{\circ}\text{K}$ ).

effectively displaced towards longer wavelengths, taking in an additional number of photons on the long wavelength end of the range if the incident light intensity is constant

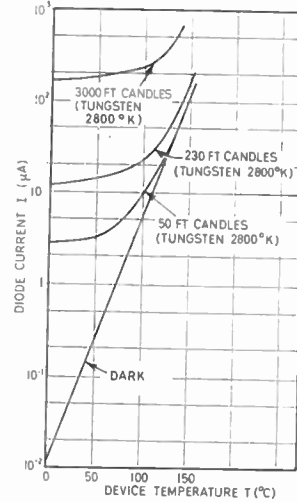

**Fig. 11.** Photodiode current as a function of device temperature at different light levels. Photodiode No. 37. Bias voltage—70 volts.

with wavelength. If a light source of low colour temperature is used this effect is considerably increased. A zero-order approximation calculation gave changes of light current in the same order of magnitude as observed.

Values for the variation of the open-circuit voltage of 1.9 to 2.5 millivolts per degree C have been experienced, varying somewhat from cell to cell. The values are fairly constant for the individual device over the whole light and temperature range investigated. The change in short-circuit current also is a device constant if expressed as a relative variation

$$\frac{\Delta I_L}{\Delta T} / \left( I_L \right)_{T=\text{const.}}$$

This variation has been found to be  $1.5$  to  $3 \times 10^{-3}$  per  $^{\circ}\text{C}$  and is constant in the range investigated, but varies from cell to cell.

For the photodiode a similar variation in the light current exists, but the variation of the saturation current  $I_0$  is much more important. Fig. 11 shows the variation of dark and light current between  $0^{\circ}\text{C}$  and  $+150^{\circ}\text{C}$ . It should be noted that the light current of a photodiode is usually measured as the sum of the dark current and the true light current  $I_L$ . As is



evident from the figure, the sensitivity of the device is greatly impaired by an increase in temperature. It should be emphasized, however, that the dark current at room temperature is extremely low compared to that observed in presently available germanium photodiodes.

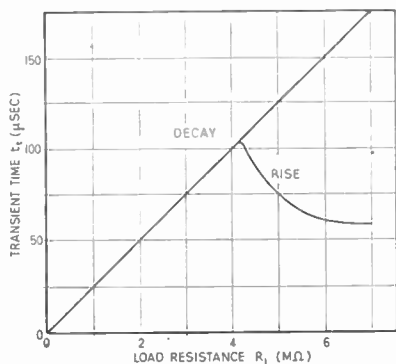

**Fig. 12.** Transient time  $t_r$  as a function of load resistance  $R_L$ . Measured on photodiode No. 37 at 100 volt bias voltage and at a light level of 45 foot-candles (Tungsten 2800°K).

Therefore, the silicon diffused-junction photodiode can be operated advantageously at temperatures not permissible for germanium photodiodes.

**6. Transient Response**

An important property of the photodiode is its transient response. In the application of photodiodes for punched tape read-outs in computers or for sound pickups in motion picture projectors, a sufficiently short transient time is of importance. Fig. 12 shows the rise and the decay times  $t_r$  and  $t_d$  respectively of the photodiode response to a light pulse as a function of load resistance  $R_L$ . In the left part of the range plotted here the transient response is determined by the transition region capacitance and the load resistance  $R_L$ .

The silicon photodiode with its wide transition region has a rather small junction capacitance. Thus, it is well suited for fast response operation. Since the light pulse used had rise and decay times of 7 microseconds, a low light level was purposely chosen for the measurements represented in this figure in order to obtain sufficiently long rise and decay times to show the dependence on the load resistance. In fact, the junction capacitance of the photo-

diode investigated was so small that a nearly equal amount of capacitance was added in the measuring circuit despite all precautions. This is also the reason why an expected deviation from the proportionality between rise and decay times and load resistance could not be observed in the measurements. This deviation was theoretically predicted due to the fact that the junction capacitance varies with the applied voltage. The photodiode junction approaches quite closely the linear graded junction which obeys the law:

$$C^3 \cdot V = \text{constant} \quad \dots\dots(13)$$

Due to this voltage dependence of the junction capacitance, a deviation from the linearity of the transient time by about 10 per cent. over the range plotted was expected. Furthermore, a deviation from the truly exponential characteristic of the curve was expected; but this deviation is very small and cannot be observed on an oscilloscope screen.

With the onset of clipping at high load resistances, a marked split between the rise and decay times occurs. Here the load resistance is so large that the signal drives the photodiode into forward conduction. With this the

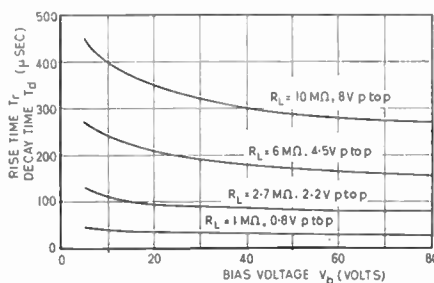

**Fig. 13.** Rise-time and decay-time vs. bias voltage at low light level. Measured on photodiode No. 40 at constant load resistances at a light level of 15 foot-candles (Tungsten 2800°K).

junction goes into a low impedance state, where the junction resistance depends on the junction voltage. The decay time follows nearly the original dependence of transient time on load resistance but the rise time falls to essentially smaller values.

Below the region of transient times plotted, where these times depend mainly on the capacitance resistance effects, there will be a



region where minority carrier storage in the silicon material will determine the transient response. This means that lowering the load resistance will finally lead to a constant value of rise and decay time. This value is in the same order of magnitude as the minority carrier life-time in the material.

It should be noted that the transient times mentioned in this section are the times observed for a change between 90 per cent. of signal amplitude and 10 per cent. of signal amplitude. Fig. 13 shows the dependence of the transient time on the bias voltage applied to the diode. Since the capacitance is voltage dependent as shown in eqn. (13) a large bias voltage lowers the junction capacitance and with it the transient times. This relationship is borne out in the measured data (Fig. 13).

The solar cell principally follows the same transient behaviour as the clipping photodiode in which the same split between rise and decay time is observed.

### 7. Conclusions

The improved understanding of the process of photon absorption and minority carrier collection has led to the improvement of the solar cells. On the other hand, recognizing the limitations of the normal solar cell and the cause of these limitations resulted in the development of the low-level solar cell. Finally, a silicon diffused-junction photodiode has been developed which should greatly out-perform presently available germanium devices. Temperature and transient behaviour of all devices mentioned were investigated and are at least qualitatively understood.

### 8. Acknowledgments

The authors wish to express their appreciation for helpful discussions with J. R. Madigan, and for measurements carried out by H. Mann and H. Rauschenbach.

A part of the work reported herein was carried out in partial fulfilment of the requirements for the Ph.D. degree at the Illinois Institute of Technology in Chicago, Illinois, for one of the authors (M. W.).

### 9. References

1. H. Y. Fan, M. L. Shepherd and W. Spitzer, "Infra-red absorption and energy-band structure of germanium and silicon." "Photoconductivity Conference," R. G. Breckenridge, B. R. Russell and E. E. Hahn (editors). (Wiley, New York, 1956.)
2. R. Braunstein, A. R. Moore and F. Herman, "Intrinsic optical absorption in germanium-silicon alloys," *Physical Review*, **109**, p. 695, 1st February 1958.
3. R. H. Kingston, "Switching time in junction diodes and junction transistors," *Proc. Inst. Radio Engrs*, **42**, pp. 829-834, May 1954.
4. M. B. Prince, "Drift mobilities in semiconductors: part 2—silicon," *Physical Review*, **93**, pp. 1204-1206, 15th March 1954.
5. G. Backenstoss, "Conductivity mobilities of electrons and holes in heavily-doped silicon," *Physical Review*, **108**, p. 1416, 15th December 1957.
6. H. Y. Fan and M. Becker, "Semi-conducting Materials." (Academic Press, New York, 1951.)

## DISCUSSION

**H. C. Spencer** (Associate Member): The first question I should like to ask Dr. Prince is, what likelihood exists of increasing the output of the solar cells at high light intensities? If this could be done the difficulties of making accurate predictions for the cell's output on an annual basis would be considerably eased. Furthermore, the output does fall off appreciably at high light intensities, contrary to what one would expect.

Secondly, how are the figures for overall efficiency obtained? These measurements are most difficult to make, especially at low light intensities. Further, it has been my experience that the performance of these cells at low light intensities does not behave in the manner given in Figure 4. The shape of the curve appears to be inverted which may be due to a different spectral distribution of the light used in our tests to that used by the author. Are these

measurements made in bright sunlight? If so, the overall efficiency must be lower, as the output is now falling off.

My last question relates to the price and quantities. Can Dr. Prince say how many kilowatts of solar cells have been installed and what does he predict the trend of prices will be?

**Dr. Prince (in reply):** As long as the temperature of the solar cell remains constant the output power increases linearly with increasing light intensity until at least ten times the solar radiation level.

The figures for overall efficiency of solar cells is obtained by measuring the input power with the aid of a pyrheliometer and measuring the output power into an optimum load resistance. The measurements given in Fig. 4 have been reproduced several times using a tungsten light source with neutral filters to reduce the intensities of the radiation but not change the spectral distribution.

At the present time (October 1958) approximately one kilowatt equivalent of solar cells have been installed; the present price is about £35 per watt of output power. With our expected reduction in the cost of silicon and with better production yields it is expected that this price will become £10 in about two years and about £3 per watt in about ten years.

**C. Hilsum :** What is the smallest quantity of radiant energy that can be detected by your photocells, and is it preferable when trying to detect small quantities of energy to use the cell with bias applied or not?

We have found in our experiments that germanium, silicon and gallium arsenide are capable of detecting about  $10^{-11}$  watts of energy. Theoretically, silicon should be capable of better performance than this and I would be glad to know the performance of Dr. Prince's cells.

**Dr. Prince (in reply):** The smallest quantity of radiant energy that can be detected depends more on the circuitry than on the particular type of photocell used and thus I do not wish to give a direct answer to this question.

**J. Cunningham-Sands (Associate Member):** At this state of the art, what current density

can be expected per centimetre squared when the solar cell is exposed to bright sunlight? Secondly, what is the cut-off frequency, and the self-capacitance at 1000 c/s of the cell?

**Dr. Prince (in reply):** The current density that can be expected with a solar cell exposed to bright sunlight is 25 mA per  $\text{cm}^2$ . The self-capacitance of this cell is directly proportional to this area and is about 10,000 pF per  $\text{cm}^2$ .

**Dr. H. P. Williams (Associate Member)** pointed out that the different results obtained by workers in England from those of Dr. Prince could not have anything to do with the sun's spectrum since this did not vary much between this country and, say, Washington. The equivalent black body temperature was approximately the same for both countries.

**J. R. Brinkley (Member):** It would be helpful if Dr. Prince could say whether any efforts have been made to devise means of making a battery of solar cells "home" on the sun so as to catch maximum energy?

**Dr. Prince (in reply):** Efforts have been made to have a battery of solar cells follow the sun in order to obtain maximum energy from the system. However, in order to drive a rugged enough mounting, it was found that the required energy for the drive mechanism was equal to the extra energy obtained by following the sun. Thus at the present time we do not believe it is economically suitable to use such a system.

**Colonel J. D. Parker (Member):** Has Dr. Prince any information regarding the variation of sensitivity of the photo-conductor devices to the angle of incidence of the radiation preferably in the form of polar diagrams?

**Dr. Prince (in reply):** It has been found that the solar cells follow the cosine law in their response to radiant energy; that is, the response is proportional to the cosine of the angle between the radiation and the normal to the solar cell.

At the close of the discussion, a vote of thanks to Dr. Prince was proposed by Mr. B. C. Fleming-Williams (Member).

## STANDARDIZATION TECHNIQUES IN RADIO

**D**URING recent years the practice in Government and other research establishments of holding an "Open Day" has become a valuable means of promoting collaboration with industry. On 8th October last there was an Open Day at the Aeronautical Inspection Directorate Laboratories of the Ministry of Supply at Harefield, Middlesex, to which the President of the Institution and the Publications Officer were invited. The function of these Laboratories is to establish standards and carry out check tests in a wide range of Services equipment. As a result of the integration of the Ministry of Supply Inspectorates, the Physics and Radio and Electricity Sections at Harefield have been placed under the Inspectorate of Electrical and Mechanical Equipment.

The engineer in charge of the Radio and Electricity Section is Mr. I. A. Harris (Associate Member), and the standardization work in this Section covers a wider range of radio frequency quantities than is dealt with in any other establishment in this country. The increasing use of v.h.f., u.h.f. and microwave equipment, and the numerous inspection problems arising from the manufacture of such equipment in different places, together with the relative lack of standardizing facilities for these frequency ranges elsewhere, have led to the development of new apparatus and techniques.

Broadly, the standardization of radio frequency quantities is a process based on reference to local direct-current standards, using transfer elements, or on length or length and time measurements. Examples of the use of transfer elements were shown by the use of a thermistor bead to transfer low power from d.c. to the range 200 Mc/s to 1,250 Mc/s; in addition, the use of a thermocouple for voltage transfer from d.c. to 1 Mc/s, and silicon crystals for direct transfer from 1 Mc/s to 500 Mc/s, or 500-900 Mc/s with intermediate calibration, were also demonstrated.

In both these methods, the measurement of impedance is necessary to assess the quality of the transfer elements. The measurement of impedance at u.h.f. depends largely on the accurate measurement of the ratios of lengths, for instance using the slotted line; at v.h.f.

it depends on length and frequency measurements together with reference to standards of capacitance at 1 kc/s, in this case using an admittance bridge.

The accurate determination of the impedance of the slotted line provided an excellent example of the need for precise mechanical measurements in standardizing u.h.f. quantities which, in this case, were carried out by the Metrology Section at Harefield, who measured the uniformity of bore of the long outer conductor using an autocollimator. The importance of suitably designed connectors in making impedance measurements was also illustrated; electroforming has been used for the larger connectors.

**Electronic inspection methods.** — Other sections at the laboratories are concerned only very indirectly with electronic techniques and usually then as measuring instruments. In the Guided Weapons laboratory assessments are made of the transfer function of servo mechanisms. In the method used a sinusoidal input signal is derived from a variable frequency oscillator together with a phase-reference signal. Measurement of the phase and amplitude relationship, input to output, is obtained from a resolved component indicator.

Finally, ultrasonic flaw detection techniques find considerable value in the work of the Non-Destructive Testing and Radiology Sections which are particularly concerned with providing comparative examples for the guidance of inspectors of metal components including welded items.

**An N.P.L. Publication.**—The general importance of rigorous techniques in the standardization and calibration of r.f. test equipment such as are discussed above, is emphasized in the publication by the National Physical Laboratory of a new "Note on Applied Science", which deals with signal generators.\* It explains the procedures which have been adopted by the N.P.L. and the information includes the calibration of attenuators and a discussion of the behaviour of voltmeters and ammeters at r.f.

\* "Notes on Applied Science No. 19: Signal Generators, Attenuators, Voltmeters and Ammeters at Radio Frequencies". Published for D.S.I.R. by H.M.S.O. price 1s. 6d.

# ELECTROMAGNETIC WAVE PROPAGATION IN CYLINDRICAL WAVEGUIDES CONTAINING GYROMAGNETIC MEDIA\*

by

R. A. Waldron, B.A. (Cantab.) (Associate Member)†

## SUMMARY

A comprehensive treatment of the subject is given, with a large number of computed results of cut-off points and phase constants for the case of a guide containing a concentric ferrite rod of arbitrary radius. The wave equation for the ferrite is derived in cylindrical co-ordinates, and solved. The wave equation for the isotropic medium surrounding the ferrite is also solved. The boundary conditions are then applied and the characteristic equations obtained for the case of the filled guide, the partly filled guide, and the guide filled with dielectric.

By putting the phase constant  $\beta$  equal to 0 in the characteristic equation, it has been possible to solve for the ratio of ferrite radius to guide radius at cut-off. By plotting cut-off curves, a study of the normal mode spectrum can be made. This paves the way for an attack upon the characteristic equation proper, and curves of phase constant against radius ratio are obtained for various values of the properties of the ferrite and the geometry of the system.

Faraday rotation, power flow, and losses are next discussed. The paper ends with an account of checking methods and accuracy of the computed results.

## TABLE OF CONTENTS

|  |   |
|--|---|
| PART 1   |   |
| List of Symbols  | 7.3. The Normal Modes   |
| 1. Introduction  | 7.4. Primary and Secondary Solutions of the Cut-off Equations |
| 1.1. The Sign Convention   | 7.5. $E_{p0}$ Modes   |
| 2. Derivation of the Wave Equations                                | 7.6. Secondary $E_{0q}$ Modes                                 |
| 3. The Characteristic Equation for the Filled Guide                | 7.7. Secondary $E_{pq}$ Modes                                 |
| 4. The Characteristic Equation for the Partly-filled Guide         | 7.8. Primary Solutions of the Cut-off Equations               |
| 5. The Field Equations   | 7.9. Cut-off Curves for Large Values of $a/\lambda_0$         |
| 5.1. Arbitrary Constants for the Filled Guide                      | 7.10. Effect of Varying the Polarizing Field                  |
| 5.2. Arbitrary Constants for the Guide Containing a Dielectric Rod | References  |
| 6. Parameter Values for Computation                                |   |
| 6.1. Waveguide Radius  |   |
| 6.2. Relative Permittivity   |   |
| 6.3. Elements of the Permeability Tensor                           |   |
| 6.4. The Radius Ratio $b/a$  |   |
| References   |   |
| PART 2   |   |
| 7. A Study of Cut-offs   |   |
| 7.1. Introduction  |   |
| 7.2. The Cut-off Equations   |   |
| PART 3   |   |
| 8. Solutions of the Characteristic Equation                        |   |
| 9. Faraday Rotation  |   |
| 9.1. Specific Rotation   |   |
| 9.2. Non-Reciprocity of Faraday Rotation                           |   |
| 9.3. Results   |   |
| 10. Power Flow   |   |
| 11. Losses   |   |
| 12. Approximate Methods  |   |
| 13. Accuracy and Checks  |   |
| 14. Acknowledgments  |   |
| References   |   |

*Note.*—Parts 2 and 3 will be published in subsequent issues of the *Journal*. Certain tables which are referred to in Part 2 are given at the end of Part 1. Similarly some of the Part 3 tables will be found at the end of Part 2.

\* Manuscript received 2nd May 1958. (Paper No. 472.)

† Marconi's Wireless Telegraph Co. Ltd., Baddow Research Laboratories, Chelmsford, Essex.  
U.D.C. No. 621.372.852.22

LIST OF SYMBOLS

The symbols which are used throughout this work are defined here with their usual meanings. Those symbols which are used only in one Section, or any of those listed below which are used in one place with a different meaning from their usual meaning, are defined at the points where they are introduced. Symbols whose meaning is obvious are not defined.

$r, \theta, z$  Cylindrical co-ordinate system.

$\mu_0, \epsilon_0$  Permeability and permittivity of the medium which surrounds the ferrite in the waveguide.

$\mu, \alpha, \epsilon$  Respectively the diagonal and off-diagonal elements of the relative permeability tensor and the relative permittivity of the ferrite rod; these quantities are relative to the properties of the medium surrounding the ferrite in the guide, which may not be vacuum (or air). A discussion of the significance of the sign of  $\alpha$  is given in Section 1.

$\lambda_0$  Wavelength of electromagnetic waves in an infinite extent of the medium which surrounds the ferrite. Thus  $\lambda_0 = 2\pi / \omega \sqrt{\epsilon_0 \mu_0}$

$a, b$  Radii of waveguide and ferrite respectively. It is sometimes convenient to normalize  $a$  and  $b$  with respect to  $\lambda_0$ , thus:

$$A = 2\pi a / \lambda_0$$

$$B = 2\pi b / \lambda_0$$

$A$  and  $B$ , so defined, should not be confused with  $A_p, B_p, A_p', B_p'$ , and  $B$ .

$\beta, \bar{\beta}$   $\beta$  is the phase constant in the waveguide. It is convenient to normalize this with respect to  $1/\lambda_0$ , thus  $\bar{\beta} = \beta / \omega \sqrt{\epsilon_0 \mu_0} = \lambda_0 \beta / 2\pi = \lambda_0 / \lambda_g$  where  $\lambda_g$  is the guide wavelength.

**E, H, D, B** Electric and magnetic fields and inductions. The suffix  $t$  denotes the transverse component of these quantities.

**u, v, w** Unit vectors in the direction of the transverse components of **E, H, B**, respectively.

**n** Unit vector in the  $z$ -direction.

$\nabla_t$  Transverse component of  $\nabla$ , regarded as a formal vector.

$A_p, B_p, A_p', B_p', C_p, D_p, F_p, G_p$ —arbitrary constants.

$p$  Integer giving the  $\theta$ -dependence of electromagnetic fields. A discussion of the significance of the sign of  $p$  is given in Section 1.1.

$$k_0^2 = \omega^2 \epsilon_0 \mu_0 - \beta^2 = \omega^2 \epsilon_0 \mu_0 (1 - \bar{\beta}^2)$$

$$k_1^2 = \omega^2 \epsilon_0 \mu_0 \cdot \epsilon \mu - \beta^2 = \omega^2 \epsilon_0 \mu_0 (\epsilon \mu - \bar{\beta}^2)$$

$$f = k_1^2 / \mu$$

$$g = \omega \beta \alpha \epsilon_0 \cdot \epsilon / \mu$$

$$c = k_1^2 - \omega^2 \epsilon_0 \mu_0 \alpha^2 \epsilon / \mu$$

$$= \omega^2 \epsilon_0 \mu_0 [\epsilon \mu (1 - \alpha^2 / \mu^2) - \bar{\beta}^2]$$

$$d = \omega \beta \alpha \mu_0 / \mu$$

$f$  and  $d$  are also used as suffices to indicate the value of a field component in the ferrite or surrounding medium, respectively.

$$s^2 = \frac{1}{2} \left\{ (f + c) \pm \sqrt{(f - c)^2 + 4gd} \right\}$$

$s_1$  takes the + sign,  $s_2$  the - sign.

$$S_1 = \frac{J_p'(k_0 b)}{\sqrt{1 - \bar{\beta}^2}} \cdot \sqrt{\frac{\mu_0}{\epsilon_0}} \quad S_2 = \frac{Y_p'(k_0 b)}{\sqrt{1 - \bar{\beta}^2}} \cdot \sqrt{\frac{\mu_0}{\epsilon_0}}$$

$$T_1 = \frac{\lambda_0 \beta^2 J_p(k_0 b)}{2\pi b (\epsilon \mu - \bar{\beta}^2) (1 - \bar{\beta}^2)} \cdot \sqrt{\frac{\mu_0}{\epsilon_0}}$$

$$T_2 = \frac{\lambda_0 \bar{\beta}^2 Y_p(k_0 b)}{2\pi b (\epsilon \mu - \bar{\beta}^2) (1 - \bar{\beta}^2)} \cdot \sqrt{\frac{\mu_0}{\epsilon_0}}$$

$$L = \frac{\sqrt{\epsilon_0 / \mu_0}}{\sqrt{1 - \bar{\beta}^2}}$$

$$M = \frac{\epsilon^2 \mu^2 \sqrt{\epsilon_0 / \mu_0}}{(\epsilon \mu - \bar{\beta}^2)^2 \sqrt{1 - \bar{\beta}^2}}$$

$$R = \frac{\bar{\beta}}{(\epsilon \mu - \bar{\beta}^2) \sqrt{1 - \bar{\beta}^2}}$$

In all the following, the symbols defined take the suffix 1 or 2 according as  $s$  takes the suffix 1 or 2.

$$\tau = -jg / (s^2 - f)$$

$$\xi = j \sqrt{\frac{\mu_0}{\epsilon_0}} \frac{\alpha p \bar{\beta}^2}{a} \cdot \tau \cdot J_p(as) + \alpha \bar{\beta} \epsilon s \cdot J_p'(as) - j \sqrt{\frac{\mu_0}{\epsilon_0}} \left\{ \mu (\epsilon \mu - \bar{\beta}^2) - \epsilon \alpha^2 \right\} \tau s \cdot J_p'(as)$$

$$K = \omega \epsilon_0 \epsilon \beta / (s^2 - f)$$

$$P = \frac{\lambda_0 \bar{\beta}}{2\pi b} \left\{ \frac{1 - \epsilon \mu}{(1 - \bar{\beta}^2) (\epsilon \mu - \bar{\beta}^2)} \right\} \cdot J_p(bs)$$

$$Q = \frac{2\pi \bar{\beta} \cdot \epsilon \mu \cdot s \cdot J_p'(bs)}{\lambda_0 (s^2 - f) (\epsilon \mu - \bar{\beta}^2)}$$



$$U = \frac{\epsilon_s J_p'(bs)}{\omega \mu_0 (\epsilon \mu - \bar{\mu})} \quad V = \frac{\lambda_0 \epsilon_s J_p'(bs) \sqrt{\epsilon_0 / \mu_0}}{2\pi b (\epsilon \mu - \bar{\mu}^2)^2 (1 - \bar{\mu}^2) (s^2 - f)} \cdot \left\{ \omega^2 \epsilon_0 \mu_0 \bar{\mu}^2 (1 - \epsilon \mu) (\epsilon \mu - \bar{\mu}) - \epsilon \mu (1 - \bar{\mu}^2) (s^2 - f) \right\}$$

$$W = \frac{\omega^2 \epsilon_0 \mu_0 \bar{\mu}^2 \epsilon^2 \mu \lambda_0 J_p'(bs)}{2\pi (\epsilon \mu - \bar{\mu}^2)^2 (s^2 - f)} \cdot \sqrt{\frac{\epsilon_0}{\mu_0}} \quad X = \frac{\omega^2 \epsilon_0 \mu_0 \bar{\mu}^2 \epsilon^2 \mu^2 \lambda_0 J_p'(bs)}{2\pi b (\epsilon \mu - \bar{\mu}^2)^2 (1 - \bar{\mu}^2) (s^2 - f)} \cdot \sqrt{\frac{\epsilon_0}{\mu_0}}$$

1. Introduction

The characteristic property of a gyromagnetic substance is that, while having a scalar dielectric constant, it has a tensor permeability at microwave frequencies when subjected to a direct magnetic polarizing field, as was shown by Polder<sup>1</sup>. The presence of imaginary off-diagonal components in this tensor causes waves which are circularly polarized in opposite senses, and which have a component of their direction of travel parallel to the polarizing field, to travel with different velocities. Thus when a plane-polarized wave, which may be regarded as the resultant of two circularly-polarized waves, travels in a gyromagnetic medium its plane of polarization changes progressively with increasing distance of travel, i.e. is rotated. This phenomenon is known as Faraday rotation, and occurs at any frequency in any paramagnetic or ferromagnetic medium under the action of a direct polarizing field. It is usually difficult to observe, but at microwave frequencies, with ferromagnetic media, the parameters involved are such that large rotations, of the order of tens of degrees, take place in path-lengths of the order of some millimetres, so that measurements can be conveniently made. An account of the cause of the phenomenon is outside the scope of the present work; it has been dealt with by Kittel<sup>2,3</sup>, Polder<sup>1</sup> and Hogan<sup>4</sup>. Of course, for wave propagation to take place at all, the medium must be non-conducting, which rules out metallic ferromagnetics—iron, cobalt, nickel—and so this phenomenon has only been intensively studied comparatively recently with the advent of ferrites.

In practice, for purposes of Faraday rotation, the ferrite is employed in the form of a cylindrical rod, concentrically placed in a cylindrical waveguide to prevent radiation losses, and the polarizing field is applied parallel to the axis of the system. The present work is concerned with propagation phenomena in such concentric systems, which are assumed

to be infinitely long. If the transitions from empty waveguide to the ferrite region, and vice versa, are well matched, it may be expected that experimental results will agree with the present theory. An important feature of Faraday rotation is that it is non-reciprocal, and in a waveguide-ferrite system this gives rise to a new circuit element, the gyrator<sup>4</sup>.

Actually, one cannot speak of circularly-polarized waves in a waveguide. The author has previously pointed out that the waves into which the normal modes of cylindrical waveguide can be split are better spoken of as helically polarized<sup>5</sup>. In the case of a guide containing ferrite, the helical waves of opposite hand travel with different velocities, so that the line of symmetry of the wavefront of the resultant wave rotates as it progresses along the guide.

The first theoretical treatment of cylindrical waveguides containing gyromagnetic media was given by Hideya Gamo<sup>6</sup>, who restricted himself to the case of the guide filled homogeneously, but took the permittivity as well as the permeability to be a tensor quantity. He gives a study of cut-off frequencies when  $|\alpha| < |\mu|$  and draws some curves of propagation constant against waveguide radius.

Suhl and Walker<sup>7</sup> have undertaken a more detailed study of the homogeneously-filled guide, and give a large number of results of calculations of cut-off frequencies and phase constants. They work in terms of two parameters  $\sigma$  and  $p$ , which represent, respectively, the normalized polarizing field applied to the ferrite and the normalized (d.c.) saturation magnetization of the ferrite, whereas Gamo has worked in terms of  $\alpha$  and  $\mu$ . ( $p$ , as used by Suhl and Walker, should not be confused with  $p$  as generally used in the present work.) Since  $\mu$  and  $\alpha$  can be expressed in terms of  $\sigma$  and  $p$ , according to Polder<sup>1</sup> and Hogan<sup>4</sup>, these treatments are equally valid, and which one is preferred depends on the point of view adopted.

Kales<sup>6</sup> and Chambers<sup>9</sup> have given derivations, by a slightly different method from Gamo, of the characteristic equation for the filled guide in terms of  $\mu$  and  $\alpha$ . Kales also indicates how the method may be extended to the case of the partly filled guide with which we shall be concerned in the present paper. Suhl and Walker<sup>7</sup> and Berk<sup>10</sup> have discussed approximate methods for calculating the propagation constant for the partly-filled guide. These methods are of use only for very limited ranges of values of the parameters, and in practice waveguide-ferrite systems are used which lie well outside the limits of validity of approximate methods. Some mention of approximate methods will be made in Section 12 because they have been of use as checks on the computations carried out in the present work.

In the present paper, results are given of calculations of propagation constants from the exact characteristic equation for the partly-filled guide. A detailed account of the theory will first be given, and, by putting  $\beta=0$  in the characteristic equation, a study of cut-offs will be made which will give an idea of the general form of mode spectra. These results were necessary in order to plan and carry out the calculations of propagation constants, which were performed on the electronic computer "DEUCE". The limitations of this machine, by virtue of its nature as a machine, have imposed certain restrictions on the accuracy of the results obtained. This is discussed in Section 13.

In the following "ferrite" means a ferrite with applied magnetic field in the  $z$ -direction, i.e. the gyrotropic substance. In the absence of a polarizing field, a ferrite becomes a dielectric, and for the purposes of this paper will be referred to as such. M.K.S. units will be used throughout.

### 1.1. The Sign Convention

A note on the sign convention used in the present work is appropriate here.  $p$  is so defined as to be positive for right-handed helically-polarized waves, negative for left-handed waves, in a right-handed cylindrical co-ordinate system.  $\beta$  is positive for waves travelling in the positive  $z$ -direction. The magnetic polarizing field is to be regarded as positive when directed in the positive

$z$ -direction.  $\alpha$  is then negative for a positive polarizing field, if this is smaller than that which gives ferromagnetic resonance, as can be seen from eqns. (51).

Now, in the characteristic equation (eqn. (34)) and its subsidiary forms (eqns. (23), (24), (41), (52) and (53)),  $\alpha$  only occurs to an odd power when it is multiplied or divided by an odd power of  $p$ , and  $p$  occurs to an odd power only if multiplied or divided by an odd power of  $\alpha$ . Thus a change in sign of  $p$  is equivalent to a change in sign of  $\alpha$ . It is convenient to think of  $p$  as always positive (or zero), and to take  $\alpha$  to be either positive or negative although the direction of the polarizing field does not change. The positive  $z$ -direction will be taken to be the direction of the polarizing field. Right- and left-helically polarized waves are defined with respect to the polarizing field; thus negative  $\alpha$  indicates a right-helically polarized wave, positive  $\alpha$  a left-helically polarized wave, irrespective of the direction of travel, which only affects the sign of  $\beta$ .

It is more convenient to adopt this sign convention than to relate the sign of  $\alpha$  to the direction of the polarizing field and allow  $p$  to take negative as well as positive values, although the latter convention may appear more logical. The  $E_{pq}$  or  $H_{pq}$  mode of the empty guide can be regarded as composed of two helically polarized components of opposite hand. When a ferrite rod is introduced into the guide, these two components travel with different velocities; however, it is logical to regard the two waves as belonging to the  $E_{pq}$  or  $H_{pq}$  mode, rather than re-define them, one as the  $E_{pq}$  or  $H_{pq}$  mode, the other as the  $E_{-pq}$  or  $H_{-pq}$  mode. Our convention also enables the results to be presented more simply, since it would have been necessary in any case to give results for negative  $\alpha$ , which in the more orthodox convention would correspond to a reversed polarizing field, as well as for positive  $\alpha$ .

It should be remembered that this convention only applies to calculations of phase constants and cut-off points from the characteristic equation; for other purposes, e.g. in calculations of the field components (Section 5),  $\alpha$  should be taken to be negative for values of the polarizing field (in the positive  $z$ -direction) less

than that required to give ferromagnetic resonance.  $\beta$  is then positive or negative according as the wave is travelling in the positive or negative  $z$ -direction, and  $p$  is positive or negative according as the wave is right- or left-handedly polarized (as seen by an observer looking along the direction of travel of the wave).

In the present work, only positive values of  $\beta$  will be considered; for waves in the negative  $z$ -direction, the values of  $\beta$  are numerically the same, only a change of sign being involved.

2. Derivation of the Wave Equations

We shall start by deriving the wave equation for electromagnetic waves travelling in a ferrite parallel to the direction of the polarizing field. Although this derivation has previously been carried out by several authors<sup>6,7,8,9</sup>, it is given again here because several equations arise in the course of the analysis which we shall want to refer to later; also there are some points of difference between the present derivation and those given previously.

In the ferrite, we have

$$\mathbf{B} = \begin{bmatrix} B_r \\ B_\theta \\ B_z \end{bmatrix} = \mu_0 \begin{bmatrix} \mu & -j\alpha & 0 \\ j\alpha & \mu & 0 \\ 0 & 0 & 1 \end{bmatrix} \begin{bmatrix} H_r \\ H_\theta \\ H_z \end{bmatrix} \dots\dots(1)$$

and  $\mathbf{D} = \epsilon \cdot \epsilon_0 \mathbf{E} \dots\dots(2)$

It should be remembered that  $\epsilon_0$  and  $\mu_0$  are the permittivity and permeability of the material, supposed isotropic, which surrounds the ferrite in the guide; this may be air, a dielectric, or a hard ferrite (i.e. one which is permanently magnetized, and independent of the polarizing field). Following Kales, we write, for the electric and magnetic fields

$$\mathbf{E} = (\mathbf{u} E_t + \mathbf{n} E_z) \cdot e^{-j\beta z} \cdot e^{j\omega t} \dots\dots(3)$$

$$\mathbf{H} = (\mathbf{v} H_t + \mathbf{n} H_z) \cdot e^{-j\beta z} \cdot e^{j\omega t} \dots\dots(4)$$

and for the magnetic induction

$$\mathbf{B} = (\mathbf{w} B_t + \mathbf{n} B_z) \cdot e^{-j\beta z} \cdot e^{j\omega t} \dots\dots(5)$$

From eqns. (1), (4), and (5),

$$\begin{aligned} \mathbf{w} B_t &= \mu_0 \{ \mu \mathbf{v} H_t + j\alpha \mathbf{n} \times \mathbf{v} H_t \} \\ B_z &= \mu_0 H_z \end{aligned} \dots\dots(6)$$

These relations will be substituted into Maxwell's equations to obtain a pair of differential equations in  $E_z$  and  $H_z$ .

Maxwell's equations are:

$$\left. \begin{aligned} (a) \operatorname{div} \mathbf{D} &= 0 \\ (b) \operatorname{div} \mathbf{B} &= 0 \\ (c) \operatorname{curl} \mathbf{H} &= \frac{\partial \mathbf{D}}{\partial t} \\ (d) \operatorname{curl} \mathbf{E} &= -\frac{\partial \mathbf{B}}{\partial t} \end{aligned} \right\} \dots\dots(7)$$

If a time variation of the form  $e^{j\omega t}$  is assumed, as in eqns. (3), (4) and (5), eqn. (7c) may be written

$$\nabla \times \mathbf{H} = j\omega \mathbf{D} \dots\dots(8)$$

Following Kales,  $\nabla$  may be split into a transverse component  $\nabla_t$  and a longitudinal component  $\mathbf{n} \partial / \partial z = -j\beta \mathbf{n}$ . Eqn. (8) becomes

$$\nabla_t \times \mathbf{v} H_t - j\beta \mathbf{n} \times \mathbf{v} H_t + \nabla_t \times \mathbf{n} H_z = j\omega \epsilon \epsilon_0 \mathbf{E} \dots\dots(9)$$

Similarly, from eqn. (7d), using eqns. (5) and (6),

$$\begin{aligned} \nabla_t \times \mathbf{u} E_t - j\beta \mathbf{n} \times \mathbf{u} E_t + \nabla_t \times \mathbf{n} E_z \\ = -j\omega \mu_0 [\mu \mathbf{v} H_t + j\alpha \mathbf{n} \times \mathbf{v} H_t + \mathbf{n} H_z] \end{aligned} \dots\dots(10)$$

The transverse components of eqns. (9) and (10) are now taken and  $E_t$  and  $H_t$  eliminated in turn, giving

$$\begin{aligned} k_1^2 \mathbf{v} H_t + j\omega^2 \epsilon_0 \mu_0 \epsilon \alpha \mathbf{n} \times \mathbf{v} H_t + \\ + j\beta \nabla_t H_z + j\omega \epsilon_0 \epsilon \mathbf{n} \times \nabla_t E_z = 0 \end{aligned} \dots\dots(11)$$

and

$$\begin{aligned} k_1^2 \mathbf{u} E_t + j\omega^2 \epsilon_0 \mu_0 \epsilon \alpha \mathbf{n} \times \mathbf{u} E_t + j\beta \nabla_t E_z - \\ - j\omega \mu_0 \mu \mathbf{n} \times \nabla_t H_z - \omega \mu_0 \alpha \nabla_t H_z = 0 \end{aligned} \dots\dots(12)$$

Eqns. (11) and (12) will be required later.

From eqn. (7b),

$$\mu \nabla_t \cdot \mathbf{v} H_t + j\alpha \nabla_t \cdot (\mathbf{n} \times \mathbf{v}) H_t = j\beta H_z$$

Taking the divergence of eqn. (11), and using this, we find

$$(\mu \nabla_t^2 + k_1^2) H_z - j\omega \epsilon_0 \epsilon \alpha \beta E_z = 0 \dots\dots(13)$$

From eqn. (10),

$$\nabla_t \cdot \mathbf{u} E_t = j\beta E_z$$

Taking the divergence of eqn. (12), and using this, and using also eqn. (13), we obtain

$$\mu (\nabla_t^2 + k_1^2) E_z + j\beta \omega \mu_0 \alpha H_z - \omega^2 \epsilon_0 \mu_0 \epsilon \alpha^2 E_z = 0 \dots\dots(14)$$

With  $c, d, f, g$ , defined as in the List of Symbols, eqns. (13) and (14) become

$$\left. \begin{aligned} (\nabla_t^2 + f)H_z - jgE_z = 0 \\ (\nabla_t^2 + c)E_z + jdH_z = 0 \end{aligned} \right\} \dots\dots\dots(15)$$

Our treatment will now diverge from that of Kales. Eliminating, in turn,  $E_z$  and  $H_z$  from eqns. (15), we obtain

$$\left. \begin{aligned} (\nabla_t^2 + s_1^2)(\nabla_t^2 + s_2^2)E_z = 0 \\ (\nabla_t^2 + s_1^2)(\nabla_t^2 + s_2^2)H_z = 0 \end{aligned} \right\} \dots\dots\dots(16)$$

where

$$\left. \begin{aligned} s_1^2 &= \frac{1}{2} \left\{ (f+c) + \sqrt{(f-c)^2 + 4gd} \right\} \\ s_2^2 &= \frac{1}{2} \left\{ (f+c) - \sqrt{(f-c)^2 + 4gd} \right\} \end{aligned} \right\} \dots\dots\dots(17)$$

The solutions of eqns. (16) can be written down immediately in the forms

$$\left. \begin{aligned} E_{z1} &= [A_p J_p(rs_1) + B_p J_p(rs_2)].e^{-j\theta} \\ H_{z1} &= [\tau_1 A_p J_p(rs_1) + \tau_2 B_p J_p(rs_2)].e^{-j\theta} \end{aligned} \right\} \dots\dots\dots(18)$$

where  $A_p$  and  $B_p$  are arbitrary constants and  $\tau_1, \tau_2$ , are determined by substituting from eqns. (18) into the first of eqns. (15). Thus

$$\tau_1 A_p (\nabla_t^2 + f) J_p(rs_1) + \tau_2 B_p (\nabla_t^2 + f) J_p(rs_2) - jg [A_p J_p(rs_1) + B_p J_p(rs_2)] = 0$$

i.e.

$$\tau_1 A_p (s_1^2 - f) J_p(rs_1) + \tau_2 B_p (s_2^2 - f) J_p(rs_2) + jg [A_p J_p(rs_1) + B_p J_p(rs_2)] = 0$$

Since  $A_p$  and  $B_p$  are arbitrary, either may be put equal to 0, giving

$$\tau_1 = \frac{-jg}{s_1^2 - f}; \quad \tau_2 = \frac{-jg}{s_2^2 - f} \dots\dots\dots(19)$$

If the substitutions had been made in the second of eqns. (15) instead of the first, an equivalent result would have been obtained.

The second suffix  $f$  in  $E_{z1}, H_{z1}$ , indicates that it is the values of  $E_z$  and  $H_z$  in the ferrite that are meant. In the medium which surrounds the ferrite we shall use a second suffix  $d$ , writing  $E_{zd}, H_{zd}$ . Since this medium occupies an annular space, Bessel functions of the second kind are involved in the solution of the wave equation, and we have

$$\left. \begin{aligned} E_{zd} &= [C_p J_p(k_0 r) + D_p Y_p(k_0 r)].e^{-j\theta} \\ H_{zd} &= [F_p J_p(k_0 r) + G_p Y_p(k_0 r)].e^{-j\theta} \end{aligned} \right\} \dots\dots\dots(20)$$

The factors  $e^{-j\theta}, e^{j\omega t}$ , are to be understood in eqns. (18) and (20).

### 3. The Characteristic Equation for the Filled Guide

We have required the characteristic equation for the filled guide in order to calculate values of propagation constants which have been used to check those obtained from the characteristic equation for the partly-filled guide. Although this equation has been given before in various forms<sup>6,7,8,9</sup>, it seems worth while to repeat it here, in the notation of the present paper, for the sake of completeness of the present treatment. It is derived quite straightforwardly from eqns. (12) and (18) by substituting the boundary conditions, which are that at  $r=a$ , i.e. on the surface of the waveguide,  $E_z$  and  $E_\theta$  vanish. The first of these gives immediately, from eqn. (18).

$$A_p J_p(as_1) + B_p J_p(as_2) = 0 \dots\dots\dots(21)$$

An expression for  $E_\theta$  may be obtained by splitting eqn. (12) into a radial and an azimuthal component, and eliminating  $E_r$ . The result is, at  $r=a$ ,

$$\begin{aligned} \frac{2\pi}{\lambda_0} [(\epsilon\mu - \bar{\beta}^2) - \epsilon^2\alpha^2].E_\theta - \frac{p\bar{\beta}}{a} (\epsilon\mu - \bar{\beta}^2).E_z + \epsilon\alpha\bar{\beta} \frac{\partial E_z}{\partial r} + \\ + \frac{jpa\bar{\beta}^2}{a} \sqrt{\frac{\mu_0}{\epsilon_0}} . H_z + j \sqrt{\frac{\mu_0}{\epsilon_0}} [\epsilon\alpha^2 - \epsilon\mu^2 + \mu\bar{\beta}^2] \frac{\partial H_z}{\partial r} = 0 \end{aligned}$$

We now put  $E_\theta = E_z = 0$ , and substitute from eqn. (18) for  $\partial E_z / \partial r, H_z, \partial H_z / \partial r$ . The result may be written

$$\xi_1 A_p + \xi_2 B_p = 0 \dots\dots\dots(22)$$

where

$$\begin{aligned} \xi = -j \sqrt{\frac{\mu_0}{\epsilon_0}} [\mu(\epsilon\mu - \bar{\beta}^2) - \epsilon\alpha^2] \tau_s J_p'(as) + \\ + \alpha\bar{\beta}\epsilon_s J_p'(as) + j \sqrt{\frac{\mu_0}{\epsilon_0}} \frac{p\alpha\bar{\beta}^2}{a} \tau J_p(as), \end{aligned}$$

$\xi$  and  $\tau$  taking the suffices 1, 2, according as  $s$  takes the suffix 1 or 2.

The characteristic equation expresses the consistency of eqns. (21) and (22), thus

$$\begin{vmatrix} J_p(as_1) & J_p(as_2) \\ \xi_1 & \xi_2 \end{vmatrix} = 0$$

Following Suhl and Walker<sup>7</sup>, we write

$$F_p(x) = x.J_p'(x)/J_p(x)$$

Multiplying out the determinant, substituting for  $\xi_1, \xi_2, \tau_1$ , and  $\tau_2$ , and using this definition, we obtain finally

$$[F_p(as_2) - F_p(as_1)] + \frac{4\pi^2}{\lambda_0^2} [\epsilon\mu(1 - \alpha^2/\mu^2) - \beta^2] \left[ \frac{F_p(as_1)}{s_1^2 - f} - \frac{F_p(as_2)}{s_2^2 - f} \right] + \frac{4\pi^2}{\lambda_0^2} \cdot p \cdot (\alpha/\mu) \cdot \frac{\beta^2(s_1^2 - s_2^2)}{(s_1^2 - f)(s_2^2 - f)} = 0 \tag{23}$$

The function  $F_p(x)$  has been discussed by Suhl and Walker<sup>7</sup>. Discussion of eqn. (23) will be postponed until Sections 7 and 8 in the succeeding parts of this paper.

When the ferrite is reduced to a dielectric by putting  $\mu=1$  and  $\alpha=0$ , the left-hand side of eqn. (23) vanishes identically, so that this equation cannot be used to obtain  $\beta$ . However, the case of a waveguide filled with dielectric is trivial, and the characteristic equation may be stated immediately. It is

$$J_p(k_1a) \cdot J_p'(k_1a) = 0$$

which gives the two well-known expressions

$$\left. \begin{aligned} J_p(k_1a) = 0 \\ J_p'(k_1a) = 0 \end{aligned} \right\} \text{for } E \text{ modes, and} \tag{24}$$

$$\left. \begin{aligned} J_p(k_1a) = 0 \\ J_p'(k_1a) = 0 \end{aligned} \right\} \text{for } H \text{ modes.}$$

**4. The Characteristic Equation for the Partly-Filled Guide**

We now take six boundary conditions and substitute them into eqns. (18) and (20) to give six equations for the arbitrary constants.

*1st Boundary Condition*: at the surface of the waveguide,  $E_z$  is zero. From eqn. (20), we thus have

$$C_p J_p(k_0a) + D_p Y_p(k_0a) = 0 \tag{25}$$

*2nd Boundary Condition*: at the surface of the waveguide,  $E_\theta$  is zero. In the medium surrounding the ferrite, we put  $\mu=1$ ,  $\alpha=0$ ,  $\epsilon=1$ ; substituting these values into eqn. (12), taking the azimuthal component, and putting  $E_\theta = \partial E_z / \partial \theta = 0$ , we obtain

$$\left( \frac{\partial H_z}{\partial r} \right)_{r=a} = 0$$

Substituting for  $H_z$  from eqn. (20), this gives

$$F_p J_p'(k_0a) + G_p Y_p'(k_0a) = 0 \tag{26}$$

*3rd Boundary Condition*: at the surface of the ferrite,  $E_z$  is continuous. From eqns. (18) and (20), this requires

$$A_p J_p(bs_1) + B_p J_p(bs_2) = C_p J_p(k_0b) + D_p Y_p(k_0b) \tag{27}$$

*4th Boundary Condition*: at the surface of the ferrite,  $H_z$  is continuous. From eqns. (18) and (20), this requires

$$\tau_1 A_p J_p(bs_1) + \tau_2 B_p J_p(bs_2) = F_p J_p(k_0b) + G_p Y_p(k_0b) \tag{28}$$

*5th Boundary Condition*: The two facts used here are that at the surface of the ferrite  $E_\theta$  and  $D_r$  are continuous. It may appear at first sight that this amounts to two boundary conditions, but this is not the case. If two boundary conditions are

$$\begin{aligned} A &= 0 \\ B &= 0 \end{aligned}$$

we may equally well take the two conditions

$$\begin{aligned} A + \lambda B &= 0 \\ A + \mu B &= 0 \end{aligned}$$

with  $\lambda \neq \mu$ . This second pair of equations is just as valid a representation of the physical facts as the first pair, and if a value is assigned to  $\lambda$ , it is automatically implied that some other value must be assigned to  $\mu$ . In the present instance this is equivalent to assigning a non-zero value to  $\lambda$ , instead of carrying out a number of complicated algebraic operations on the field equations to express them all in terms of, in our analogy,  $A$ . It is, however, implicit that a value of  $\mu$  exists,  $\neq \lambda$ , so that there is still an independent boundary condition that has not been used.

The azimuthal component of eqn. (12) is

$$k_1^2 (\mathbf{u}E_{t1})_\theta = -j\omega^2 \epsilon_0 \mu_0 \alpha \epsilon \mathbf{n} \times (\mathbf{u}E_{t1})_r - j\beta (\nabla_t E_z)_\theta + j\omega \mu_0 \alpha \mathbf{n} \times (\nabla_t H_z)_r + \omega \mu_0 \alpha (\nabla_t H_z)_\theta \tag{29}$$

The radial and azimuthal components of the equivalent equation to eqn. (12) that applies in the medium surrounding the ferrite are

$$k_0^2 (\mathbf{u}'E_{t0})_r = -j\beta (\nabla_t E_z)_r + j\omega \mu_0 \mathbf{n} \times (\nabla_t H_z)_\theta \tag{30}$$

and

$$k_0^2 (\mathbf{u}'E_{t0})_\theta = -j\beta (\nabla_t E_z)_\theta + j\omega \mu_0 \mathbf{n} \times (\nabla_t H_z)_r \tag{31}$$

In eqn. (29), we put  $(\mathbf{u}E_{t1})_r = (1/\epsilon) (\mathbf{u}'E_{t0})_r$  and  $(\mathbf{u}E_{t1})_\theta = (\mathbf{u}'E_{t0})_\theta$ , and substitute for  $(\mathbf{u}'E_{t0})_r$  and  $(\mathbf{u}'E_{t0})_\theta$  from eqns. (30) and (31). Using the facts that  $E_{z1} = E_{z0}$  and  $H_{z1} = H_{z0}$  at  $r=b$ ,



although the derivatives of  $E_z$  and  $H_z$  are not continuous, and finally substituting for  $E_{zf}$ ,  $E_{zd}$ ,  $H_{zf}$ ,  $H_{zd}$ , from eqns. (18) and (20), we obtain

$$\begin{aligned} & \frac{p\beta}{b} (k_0^2 - k_1^2) [A_p J_p(s_1 b) + B_p J_p(s_2 b)] - \\ & - \alpha \beta \omega^2 \epsilon_0 \mu_0 k_0 [C_p J_p'(k_0 b) + D_p Y_p'(k_0 b)] - \\ & - j \omega \mu_0 k_1^2 k_0 [F_p J_p'(k_0 b) + G_p Y_p'(k_0 b)] - \\ & - \frac{j \omega \mu_0 p \alpha \beta^2}{b} [F_p J_p(k_0 b) + G_p Y_p(k_0 b)] + \\ & + j \omega \mu_0 \mu k_0^2 [\tau_1 s_1 A_p J_p'(s_1 b) + \tau_2 s_2 B_p J_p'(s_2 b)] = 0 \end{aligned} \tag{32}$$

**6th Boundary Condition:** As in the case of the fifth boundary condition, two facts are used here, namely, that at the surface of the ferrite  $H_\theta$  and  $D_r$  are continuous. We proceed in an analogous way to that of the fifth boundary condition, and finally obtain

$$\begin{aligned} & A_p \left\{ U_1 + \frac{\alpha p V_1}{\mu} - \frac{\alpha^2 W_1}{\mu^2} + \frac{\alpha^3 p X_1}{\mu^3} \right\} + B_p \left\{ U_2 + \frac{\alpha p V_2}{\mu} - \frac{\alpha^2 W_2}{\mu^2} + \frac{\alpha^3 p X_2}{\mu^3} \right\} - \\ & - \sqrt{\frac{\epsilon_0}{\mu_0(1 - \beta^2)}} \left\{ 1 - \frac{\alpha^2}{\mu^2} \cdot \frac{\epsilon^2 \mu^2}{(\epsilon \mu - \beta^2)^2} \right\} [C_p J_p'(k_0 b) + D_p Y_p'(k_0 b)] = 0 \end{aligned} \tag{33}$$

Equations (25), (26), (27), (28), (32), (33), now form a homogeneous linear set in the variables  $A_p$ ,  $B_p$ ,  $C_p$ ,  $D_p$ ,  $F_p$ ,  $G_p$ . The condition for consistency is that the determinant of the coefficients shall vanish, and this condition gives the characteristic equation. After some simplification, we obtain

$$\begin{vmatrix} 0 & 0 & J_p(k_0 a) & Y_p(k_0 a) & 0 & 0 \\ 0 & 0 & 0 & 0 & J_p'(k_0 a) & Y_p'(k_0 a) \\ J_p(s_1 b) & J_p(s_2 b) & -J_p(k_0 b) & -Y_p(k_0 b) & 0 & 0 \\ \frac{\alpha K_1}{\mu p} \cdot J_p(s_1 b) & \frac{\alpha K_2}{\mu p} \cdot J_p(s_2 b) & 0 & 0 & J_p(k_0 b) & Y_p(k_0 b) \\ [P_1 + \frac{\alpha}{\mu p} \cdot Q_1] & [P_2 + \frac{\alpha}{\mu p} \cdot Q_2] & \frac{-\alpha R}{p} \cdot J_p'(k_0 b) & \frac{-\alpha R}{p} Y_p'(k_0 b) & (S_1 + \alpha p T_1) & (S_2 + \alpha p T_2) \\ \left\{ U_1 + \frac{\alpha p V_1}{\mu} - \frac{\alpha^2 W_1}{\mu^2} + \frac{\alpha^3 p X_1}{\mu^3} \right\} & \left\{ U_2 + \frac{\alpha p V_2}{\mu} - \frac{\alpha^2 W_2}{\mu^2} + \frac{\alpha^3 p X_2}{\mu^3} \right\} & \left\{ -L J_p'(k_0 b) + \frac{\alpha^2 M J_p'(k_0 b)}{\mu^2} \right\} & \left\{ -L Y_p'(k_0 b) + \frac{\alpha^2 M Y_p'(k_0 b)}{\mu^2} \right\} & 0 & 0 \end{vmatrix} = 0 \tag{34}$$

When the ferrite reduces to a dielectric ( $\mu=1$ ,  $\alpha=0$ ), the determinant becomes identically zero, so that eqn. (34) cannot be used to calculate  $\beta$ . The derivation must be repeated for this case, and a different characteristic equation obtained which is related to eqn. (34), but cannot be directly derived from it. It is easily seen that on putting  $\mu=1$ ,  $\alpha=0$ ,  $s_1$  and  $s_2$  reduce to  $k_1$ , and the wave equations become

$$\begin{cases} (\nabla^2 + k_1^2) E_{zf} = 0 \\ (\nabla^2 + k_1^2) E_{zd} = 0 \end{cases} \tag{35}$$

so that the solutions are

$$\begin{cases} E_{zf} = A_p' J_p(k_1 b) e^{-j p \theta} \\ H_{zf} = B_p' J_p(k_1 b) e^{-j p \theta} \end{cases} \tag{36}$$

Alternatively, we may consider the effect of putting  $\alpha=0$ ,  $\mu=1$ , in eqn. (18), and we see that

$$\begin{aligned} A_p' &= A_p + B_p \\ B_p' &= \tau_1 A_p + \tau_2 B_p \end{aligned}$$

But  $\tau_1$  and  $\tau_2$  become indeterminate, so that  $A_p'$  and  $B_p'$  cannot be related to each other and must be retained as distinct arbitrary constants in eqn. (36).

We now use eqn. (36) instead of eqn. (18) in the boundary conditions, and so obtain, respectively, for eqns. (27), (28), (32) and (33), the following:

$$A_p' J_p(k_1 b) = C_p J_p(k_0 b) + D_p Y_p(k_0 b) \quad \dots\dots\dots(37)$$

$$B_p' J_p(k_1 b) = F_p J_p(k_0 b) + G_p Y_p(k_0 b) \quad \dots\dots\dots(38)$$

$$\frac{p\bar{\beta}}{2\pi b/\lambda_0} (1 - \epsilon) A_p' J_p(k_1 b) - j \sqrt{\frac{\mu_0}{\epsilon_0}} (\epsilon - \bar{\beta}^2) \sqrt{1 - \bar{\beta}^2} \left[ F_p J_p'(k_0 b) + G_p Y_p'(k_0 b) \right] + j \sqrt{\frac{\mu_0}{\epsilon_0}} (1 - \bar{\beta}^2) \sqrt{\epsilon - \bar{\beta}^2} B_p' J_p'(k_1 b) = 0 \quad \dots\dots\dots(39)$$

$$j\omega\epsilon_0 k_0^2 k_1 A_p' J_p'(k_1 b) + \frac{p\bar{\beta}}{b} (k_1^2 - k_0^2) B_p' J_p'(k_1 b) - j\omega\epsilon_0 k_1^2 k_0 [C_p J_p'(k_0 b) + D_p Y_p(k_0 b)] = 0 \quad \dots\dots\dots(40)$$

The characteristic equation, which is the condition for the consistency of eqns. (25), (26), (37), (38), (39) and (40), can be written, after some simplification.

$$\begin{vmatrix} 0 & 0 & J_p(k_0 a) & Y_p(k_0 a) & 0 & 0 \\ 0 & 0 & 0 & 0 & J_p'(k_0 a) & Y_p(k_0 a) \\ J_p(k_1 b) & 0 & -J_p(k_0 b) & -Y_p(k_0 b) & 0 & 0 \\ 0 & J_p(k_1 b) & 0 & 0 & -J_p(k_0 b) & -Y_p(k_0 b) \\ -j\psi \sqrt{\frac{\epsilon_0}{\mu_0}} \cdot J_p(k_1 b) & \frac{k_0}{k_1} \cdot J_p'(k_1 b) & 0 & 0 & -J_p'(k_0 b) & -Y_p'(k_0 b) \\ \frac{\epsilon k_0}{k_1} \cdot J_p'(k_1 b) & j\psi \sqrt{\frac{\mu_0}{\epsilon_0}} \cdot J_p'(k_0 b) - Y_p'(k_0 b) - Y_p(k_0 b) & 0 & 0 & 0 & 0 \end{vmatrix} = 0 \quad \dots\dots\dots(41)$$

where  $\Psi = p\bar{\beta}(k_1^2 - k_0^2)/k_1^2 k_0 b$ . We shall postpone discussion of eqns. (34) and (41) to Sections 7 and 8.

**5. The Field Equations**

In principle, the field equations may be obtained quite straightforwardly. The method is first to solve any five of eqns. (25), (26), (27), (28), (32) and (33) for the arbitrary constants  $B_p$ ,  $C_p$ ,  $D_p$ ,  $F_p$  and  $G_p$ , after assigning some arbitrary value, e.g. unity, to  $A_p$ . Numerical values for these quantities can be obtained if  $\bar{\beta}$  is known;  $\bar{\beta}$  is obtained by solving eqn. (34). When the arbitrary constants have been evaluated, the fields  $E_{z1}$ ,  $H_{z1}$ ,  $E_{z2}$  and  $H_{z2}$  are automatically known; we may note here that imaginary

parts in the arbitrary constants may be taken up in the factor  $e^{-j\psi\theta}$ , and so give sinusoidal or cosinusoidal  $\theta$ -dependence.

The radial and azimuthal field components can be obtained from eqns. (11) and (12), in the case of the ferrite, by splitting into radial and azimuthal components and then eliminating  $H_r$  and  $H_\theta$ , in turn, from eqn. (11) and  $E_r$  and  $E_\theta$ , in turn, from eqn. (12).  $E_{z1}$  and  $H_{z1}$  may then be substituted for  $E_z$  and  $H_z$ . We thus obtain, for both the filled and the partly-filled guides,

$$\frac{2\pi}{\lambda_0} [(\epsilon\mu - \bar{\beta}^2)^2 - \epsilon^2\alpha^2] \cdot H_r = \epsilon \sqrt{\frac{\epsilon_0}{\mu_0}} \left\{ \frac{p}{r} (\epsilon\mu - \bar{\beta}^2) E_{z1} + \epsilon\alpha \frac{\partial H_{z1}}{\partial r} \right\} - j\bar{\beta} \left\{ \frac{\epsilon\alpha p H_{z1}}{r} + (\epsilon\mu - \bar{\beta}^2) \frac{\partial E_{z1}}{\partial r} \right\} \quad \dots\dots\dots(42)$$

$$\frac{2\pi}{\lambda_0} [(\epsilon\mu - \bar{\beta}^2)^2 - \epsilon^2\alpha^2] \cdot H_\theta = -j\epsilon \sqrt{\frac{\epsilon_0}{\mu_0}} \left\{ \frac{\epsilon\alpha p E_{z1}}{r} + (\epsilon\mu - \bar{\beta}^2) \frac{\partial E_{z1}}{\partial r} \right\} - \bar{\beta} \left\{ \alpha\epsilon \frac{\partial H_{z1}}{\partial r} + \frac{p}{r} (\epsilon\mu - \bar{\beta}^2) H_{z1} \right\} \quad \dots\dots\dots(43)$$

$$\frac{2\pi}{\lambda_0} [(\epsilon\mu - \bar{\beta}^2)^2 - \epsilon^2\alpha^2] \cdot E_r = - \sqrt{\frac{\mu_0}{\epsilon_0}} \left\{ \frac{\alpha\bar{\beta}^2 \partial H_{zf}}{\partial r} + \frac{\mu p}{r} \left( \epsilon\mu - \beta^2 - \frac{\alpha^2 \epsilon}{\mu} \right) H_{zf} \right\} - j\bar{\beta} \left\{ (\epsilon\mu - \bar{\beta}^2) \frac{\partial E_{zf}}{\partial r} + \frac{\alpha \epsilon p E_{zf}}{r} \right\} \dots\dots\dots(44)$$

$$\frac{2\pi}{\lambda_0} \left\{ (\epsilon\mu - \beta^2)^2 - \epsilon^2\alpha^2 \right\} \cdot E_\theta = -\bar{\beta} \left\{ \frac{p}{r} (\epsilon\mu - \bar{\beta}^2) E_{zf} + \alpha \epsilon \frac{\partial E_{zf}}{\partial r} \right\} + j \sqrt{\frac{\mu_0}{\epsilon_0}} \left\{ \frac{\alpha p \bar{\beta}^2 H_{zf}}{r} + \mu \left( \epsilon\mu - \bar{\beta}^2 - \frac{\alpha^2 \epsilon}{\mu} \right) \frac{\partial H_{zf}}{\partial r} \right\} \dots\dots\dots(45)$$

The radial and azimuthal field components for the medium surrounding the ferrite, in the case of the partly-filled guide, are obtained in terms of  $E_{zd}$  and  $H_{zd}$  either directly from Maxwell's equations or by substituting these quantities for  $H_{zf}$ ,  $E_{zf}$ , in eqns. (42), (43), (44) and (45), at the same time putting  $\mu = \epsilon = 1$ ,  $\alpha = 0$ . We thus obtain

$$\left. \begin{aligned} k_0^2 H_r &= \frac{2\pi}{\lambda_0} \left\{ \frac{p}{r} \sqrt{\frac{\epsilon_0}{\mu_0}} \cdot E_{zd} - \frac{j\bar{\beta} \partial H_{zd}}{\partial r} \right\} \\ k_0^2 H_\theta &= - \frac{2\pi}{\lambda_0} \left\{ j \sqrt{\frac{\epsilon_0}{\mu_0}} \cdot \frac{\partial E_{zd}}{\partial r} + \frac{p\bar{\beta} \cdot H_{zd}}{r} \right\} \\ k_0^2 E_r &= - \frac{2\pi}{\lambda_0} \left\{ \frac{j\bar{\beta} \partial E_{zd}}{\partial r} + \frac{p}{r} \sqrt{\frac{\mu_0}{\epsilon_0}} \cdot H_{zd} \right\} \\ k_0^2 E_\theta &= \frac{2\pi}{\lambda_0} \left\{ \frac{-p\bar{\beta} \cdot E_{zd}}{r} + j \sqrt{\frac{\mu_0}{\epsilon_0}} \cdot \frac{\partial H_{zd}}{\partial r} \right\} \end{aligned} \right\} \dots\dots\dots(46)$$

The calculation of  $\bar{\beta}$  from the characteristic equation will be dealt with separately in Section 8. It does not seem to be a good idea to obtain analytical expressions for the arbitrary constants in the general case of a ferrite rod of smaller radius than the waveguide. It is easier to take, for a given set of values of the parameters  $a/\lambda_0$ ,  $b/\lambda_0$ ,  $\epsilon$ ,  $\mu$ , and  $\alpha$ , the value of  $\bar{\beta}$  given in the results of Section 8, and substitute it into eqns. (25), (26), (27), (28), (32) and (33). The arbitrary constants can then be obtained quite easily.

There is, however, some simplification of the analysis in the special cases of a guide filled with ferrite and a guide partly filled with dielectric, i.e. a ferrite in the absence of a polarizing field, when  $\mu$  becomes 1 and  $\alpha$  becomes 0, and these two cases will now be discussed.

5.1. Arbitrary Constants for the Filled Guide

In this case, all that is required is the ratio  $B_p/A_p$ , which is, from eqn. (21),

$$B_p/A_p = -J_p(as_1)/J_p(as_2) \dots\dots\dots(47)$$

Thus for eqns. (18) we may write

$$\left. \begin{aligned} E_{zf} &= [J_p(as_2) \cdot J_p(rs_1) - J_p(as_1) \cdot J_p(rs_2)] \cdot e^{-j p \theta} \\ H_{zf} &= [\tau_1 J_p(as_2) \cdot J_p(rs_1) - \tau_2 J_p(as_1) \cdot J_p(rs_2)] \cdot e^{-j p \theta} \end{aligned} \right\} \dots\dots\dots(48)$$

and these expressions may be substituted into eqns. (42), (43), (44) and (45), to give the other field components.

5.2. Arbitrary Constants for the Guide

Containing a Dielectric Rod

We can assign a value to  $A_p'$  arbitrarily. The other arbitrary constants  $B_p'$ ,  $C_p$ ,  $D_p$ ,  $F_p$ ,  $G_p$ , can then be obtained by solving any five of eqns. (25), (26), (37), (38), (39) and (40). Hence

$$\left. \begin{aligned} \frac{B_p'}{A_p'} &= \frac{-jQS \sqrt{\epsilon_0/\mu_0}}{RJ_p(k_1b) - QKJ_p'(k_1b)} \\ \frac{C_p}{A_p'} &= \frac{Y_p(k_0a) \cdot J_p(k_1b)}{P} \\ \frac{D_p}{A_p'} &= \frac{J_p(k_0a) \cdot J_p(k_1b)}{P} \\ \frac{F_p}{A_p'} &= \frac{jS \cdot Y_p'(k_0a) \cdot J_p(k_1b) \cdot \sqrt{\epsilon_0/\mu_0}}{RJ_p(k_1b) - QKJ_p'(k_1b)} \\ \frac{G_p}{A_p'} &= \frac{-jS \cdot J_p'(k_0a) \cdot J_p(k_1b) \cdot \sqrt{\epsilon_0/\mu_0}}{RJ_p(k_1b) - QKJ_p'(k_1b)} \end{aligned} \right\} \dots\dots\dots(49)$$

where  $K = k_0/k_1$ ,  $S = \frac{p\beta(k_1^2 - k_0^2) \cdot J_p(k_1b)}{\omega \sqrt{\epsilon_0\mu_0} \cdot b k_1^2 k_0}$ ;

$$P = \begin{vmatrix} J_p(k_0a) & Y_p(k_0a) \\ J_p(k_0b) & Y_p(k_0b) \end{vmatrix} \quad Q = \begin{vmatrix} J_p'(k_0a) & Y_p'(k_0a) \\ J_p(k_0b) & Y_p(k_0b) \end{vmatrix}$$

$$R = \begin{vmatrix} J_p'(k_0 a) & Y_p'(k_0 a) \\ J_p'(k_0 b) & Y_p'(k_0 b) \end{vmatrix}$$

The meanings of  $P$ ,  $Q$ ,  $R$ ,  $S$  and  $K$  in eqns. (49) should not be confused with the meanings of these quantities elsewhere in this paper.

### 6. Parameter Values for Computation

The main purpose of this paper is to present the results of computations of the normalized phase constant  $\bar{\beta}$  for various values of the parameters  $a/\lambda_0$ ,  $b/\lambda_0$ ,  $\epsilon$ ,  $\mu$ , and  $\alpha$ . Because all quantities involving lengths are normalized with respect to the wavelength  $\lambda_0$ , it is unnecessary to consider the frequency as a sixth parameter. It will be apparent from the results given in Sections 7 and 8 what values of parameters have been chosen, but it is felt that some explanation of the choice is called for, and we shall give this in the present Section.

A limited amount of time on an electronic computing machine was made available for the computation of propagation constants: it has therefore been necessary to choose parameter values in such a way as to give the maximum amount of information for the minimum number of calculated values. Also, it was not possible to know at the commencement of the work what form the results were to take, so that instead of conceiving an overall plan and following it, it has been necessary to formulate a very elastic scheme and to revise it continually as fresh information has been obtained.

#### 6.1. Waveguide Radius

A typical value of  $a/\lambda_0$  that is commonly used in practice is 0.4; however, this is rather a large value, and is likely to introduce the possibility of propagating more than one mode. This value has therefore been taken as an upper limit, and the values 0.1, 0.2, 0.3 and 0.4 chosen quite arbitrarily for calculations of cut-offs. The choice appears to have been a good one, judging by the cut-off curves obtained, but it could be improved upon by taking some intermediate values. The value 0.1 is rather small, and we have contented ourselves with only a brief indication of the behaviour of the phase constant curves for this value. Intermediate values of  $a/\lambda_0$  would give more information about the way the phase constant curves behave as  $a/\lambda_0$  varies through a value for which

$\bar{\beta}=0$  in the empty guide, but owing to the limited number of calculations that could be made, it was not possible to do this for a large number of values of other parameters. However, some curves were obtained for one case for values of  $a/\lambda_0$  between 0.2 and 0.3.

#### 6.2. Relative Permittivity

Typically, ferrites have permittivities relative to free space ranging from about 8 to about 20. However, in the programme for which the present work was carried out, values as high as 20 are not required, and 15 has therefore been taken as the highest value. This decision was made after many of the cut-off curves had been computed, so that in some cases curves are given for values of  $\epsilon$  up to 20, while in others they terminate at  $\epsilon=15$ . Values of  $\epsilon$  below 8 have been taken because if the ferrite is surrounded by a medium other than air (or free space), the value of  $\epsilon$  is the ratio of the permittivities of the ferrite and this substance. For example, if a ferrite of permittivity 9 relative to free space is surrounded by distrene, having a dielectric constant of 2.56, the value of  $\epsilon$  appropriate to the system is  $9/2.56=3.52$ . The value of  $\epsilon$  may even be less than unity, for example if a soft ferrite is surrounded by a hard ferrite of higher permittivity.

Our first thought was to take values of  $\epsilon$  equal to 5, 10, and 15. However, after computing some values for the cut-off curves, it became apparent that the properties of a guide containing a ferrite depend importantly—even critically—on the value of  $\epsilon$  when  $\epsilon$  is fairly small, and it was decided to take also the value  $\epsilon=3$ . For some cases the values  $\epsilon=1$ ,  $\epsilon=0.5$ , have also been taken, to cover the possibility of a soft ferrite being surrounded by a hard ferrite of higher permittivity. There is no need to consider values of  $\epsilon$  approaching zero, because  $\epsilon$  could only be near zero in the case of anomalous dispersion, and there would be heavy losses. In the present paper we are restricting ourselves to the lossless case.

#### 6.3. Elements of the Permeability Tensor

Before deciding what values of  $\mu$  and  $\alpha$  to take for our computations, we must know what values these parameters are able to take, and so we shall first discuss their behaviour as the polarizing field varies. Following Suhl and

Walker<sup>7</sup>, we normalize the saturation magnetization and polarizing field with respect to the working frequency thus:

$$\left. \begin{aligned} p &= \gamma M_s / \mu_0 \omega \\ \sigma &= \gamma h / \omega \end{aligned} \right\} \dots\dots\dots(50)$$

where  $h$  is the polarizing field inside the ferrite.  $p$  is used with this meaning only in the present Section, so there will be no confusion with its use in the remainder of this paper. Hogan<sup>4</sup> has given  $\mu$  and  $\alpha$  in terms of  $p$  and  $\sigma$ , together with another quantity which represents a loss mechanism. However, for the present purpose it will be sufficiently accurate to consider the lossless case, and we use Polder's equations<sup>1</sup> for  $\mu$  and  $\alpha$ . These may be written:

$$\left. \begin{aligned} \alpha &= \frac{p}{\sigma^2 - 1} \\ \mu &= 1 + \frac{\sigma p}{\sigma^2 - 1} = 1 + \sigma \alpha \end{aligned} \right\} \dots\dots\dots(51)$$

Ferromagnetic resonance is then given by  $\sigma = 1$ . If the polarizing field is reversed,  $M_s$ , and therefore  $p$ , are unchanged in magnitude but change in sign, so that  $\sigma$  and  $p$  always have the same sign. Thus  $\mu$  is independent of the direction of the polarizing field, while  $\alpha$  has always the opposite sign to that of the field  $\sigma$ ; that is,  $\mu$  is an even function of  $\sigma$ ,  $\alpha$  an odd function. However, in view of the note in the Introduction on the sign convention, this will be disregarded.

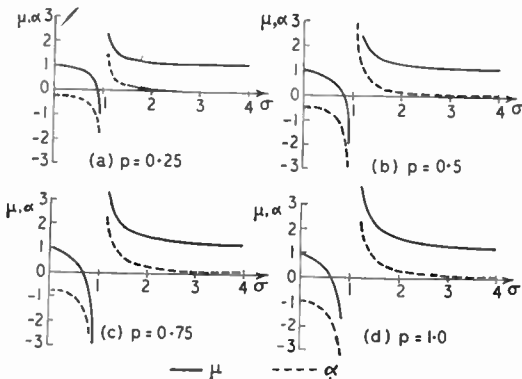

Fig. 1. Elements of the permeability tensor as functions of the polarizing field for various values of the saturation magnetization.

Figures 1 (a), (b), (c) and (d) show  $\mu$  and  $\alpha$  as functions of  $\sigma$  for various values of  $p$ .

Suhl and Walker have stated<sup>7</sup> that in practice  $p$  is found not to exceed unity, so that except near ferromagnetic resonance  $|\alpha|$  takes values up to about unity.  $\mu$  is unity at  $\sigma = 0$ , and is near to this value except over a limited region about  $\sigma = 1$ . Since losses are heavy near ferromagnetic resonance, values of  $\sigma$  near unity will not be considered in this paper, but even so  $\mu$  can take values numerically less than  $|\alpha|$ , and become negative, while  $\sigma$  is still well away from unity. Some discussion of this situation will be given in Section 7, but in the main we shall concern ourselves there with values of  $\mu$  of the order of unity. In Section 8 only values of  $\mu$  of the order of unity will be considered.

We wish to choose values of  $\mu$  that on the one hand are widely different from unity so as to give information over as wide a range as possible, and on the other hand are sufficiently close together to permit interpolation and to enable the value of  $\partial \bar{\beta} / \partial \mu$  to be calculated fairly accurately at  $\mu = 1$ . Because of the limited time available on the electronic computer, it has only been possible to take three values of  $\mu$ —unity itself, and one value above, one below, unity. We have therefore compromised by taking the values 0.8 and 1.2; these values have been chosen to be equidistant from unity for convenience in interpolating from the results of Section 8.

The ferrite substances in use in the programme of which this work forms part have values of  $|\alpha|$  up to about 0.6 or 0.7. The values  $\alpha = 0, \pm 0.25, \pm 0.5, \pm 0.75$ , have therefore been chosen to give a good coverage of the range required and avoid the case  $|\mu| < |\alpha|$  which, as will be seen in Section 7, is difficult to deal with.

#### 6.4. The Radius Ratio $b/a$

In Section 7, the radius ratio is calculated that satisfies the cut-off equations, when the parameters  $a/\lambda_0$ ,  $\epsilon$ ,  $\mu$ , and  $\alpha$  are given. For a given set of values of  $a/\lambda_0$ ,  $\mu$ , and  $\alpha$ , a family of curves of  $b/a$  against  $\epsilon$  is obtained, and from these the value of  $b/a$  can be found, for a given mode, at which  $\bar{\beta} = 0$ . This point forms the starting-point for computations of phase constant  $\bar{\beta}$ , unless for the mode in question propagation takes place in the empty guide, when the starting value of  $b/a$  is 0.



We shall usually be concerned with the  $H_{11}$  mode, this being the lowest if we ignore the  $H_{0q}$  and  $E_{0q}$  modes. In practice, the latter modes are only set up if the circular symmetry is very good, which is rarely the case. The highest value of  $b/a$  to be taken will usually be slightly above that at which the second mode has its cut-off, although in a few cases higher values of  $b/a$  will be taken and values of  $\bar{\beta}$  calculated for all modes, in order to illustrate the general behaviour.

References

1. D. Polder, "On the theory of ferromagnetic resonance," *Phil. Mag.*, **40**, pp. 99-115, 1949.
2. C. Kittel, "Interpretation of anomalous Larmor frequencies in ferromagnetic resonance experiment." *Phys. Rev.*, **71**, pp. 270-1, 1947.
3. C. Kittel, "On the theory of ferromagnetic resonance absorption," *Phys. Rev.*, **73**, pp. 155-161, 1948.

4. C. L. Hogan, "The ferromagnetic Faraday effect at microwave frequencies and its applications. The microwave gyrator," *Bell Syst. Tech. J.*, **31**, pp. 1-31, 1952.
5. R. A. Waldron, "A helical co-ordinate system and its applications in electromagnetic theory," *Quart. J. Mech. Appl. Maths.* To be published.
6. Hideya Gamo, "The Faraday rotation of waves in a circular waveguide," *J. Phys. Soc., Japan*, **8**, pp. 176-182, 1953.
7. H. Suhl and L. R. Walker, "Topics in guided wave propagation through gyromagnetic media," *Bell Syst. Tech. J.*, **33**, pp. 579-659, pp. 939-986, 1133-1194, 1954.
8. M. L. Kales, "Modes in wave guides containing ferrites," *J. Appl. Phys.*, **24**, 604-8, 1953.
9. Li. G. Chambers, "Propagation in a ferrite-filled waveguide," *Quart. J. Mech. Appl. Maths.*, **8A**, pp. 435-447 (1955).
10. A. D. Berk, "Cavities and Waveguides with Inhomogeneous and Anisotropic Media," Massachusetts Institute of Technology Technical Report 284 (February 11, 1955).

The following tables will be discussed in Part 2 of the paper.

Table 1: Cut-off Values of  $\mu$  in the Filled Guide

(For H-modes, the cut-offs are independent of  $\mu$ , so this table only contains results for E-modes).

(a)  $E_{01}$  Mode

| $c$ | $a$        | $a/\lambda_0$<br>= 0.2 | $a/\lambda_0$<br>= 0.3 | $a/\lambda_0$<br>= 0.4 | Type of Solution |
|-----|------------|------------------------|------------------------|------------------------|------------------|
| 1   | 0          | 3.662                  | 1.628                  | 0.916                  | Primary          |
|     | $\pm 0.25$ | 3.679                  | 1.665                  | 0.979                  |                  |
|     | $\pm 0.5$  | 3.729                  | 1.769                  | 1.136                  |                  |
|     | $\pm 0.75$ | 3.810                  | 1.921                  | 1.336                  |                  |
| 3   | 0          | 1.221                  | 0.543                  | 0.305                  | Primary          |
|     | $\pm 0.25$ | 1.270                  | 0.640                  | 0.445                  |                  |
|     | $\pm 0.5$  | 1.399                  | 0.840                  | 0.675                  |                  |
|     | $\pm 0.75$ | 1.577                  | 1.069                  | 0.918                  |                  |
| 5   | 0          | 0.732                  | 0.326                  | 0.183                  | Primary          |
|     | $\pm 0.25$ | 0.810                  | 0.461                  | 0.358                  |                  |
|     | $\pm 0.5$  | 0.986                  | 0.689                  | 0.600                  |                  |
|     | $\pm 0.75$ | 1.201                  | 0.930                  | 0.847                  |                  |
| 10  | 0          | 0.366                  | 0.163                  | 0.092                  | Primary          |
|     | $\pm 0.25$ | 0.493                  | 0.344                  | 0.300                  |                  |
|     | $\pm 0.5$  | 0.716                  | 0.588                  | 0.548                  |                  |
|     | $\pm 0.75$ | 0.955                  | 0.836                  | 0.798                  |                  |
| 15  | 0          | 0.244                  | 0.109                  | 0.061                  | Primary          |
|     | $\pm 0.25$ | 0.400                  | 0.310                  | 0.282                  |                  |
|     | $\pm 0.5$  | 0.637                  | 0.557                  | 0.531                  |                  |
|     | $\pm 0.75$ | 0.882                  | 0.806                  | 0.781                  |                  |
| 1   | 0          | 0                      | 0                      | 0                      | Secondary        |
|     | $\pm 0.25$ | -0.017                 | -0.038                 | -0.064                 |                  |
|     | $\pm 0.5$  | -0.067                 | -0.141                 | -0.220                 |                  |
|     | $\pm 0.75$ | -0.148                 | -0.293                 | -0.421                 |                  |
| 3   | 0          | 0                      | 0                      | 0                      | Secondary        |
|     | $\pm 0.25$ | -0.049                 | -0.098                 | -0.140                 |                  |
|     | $\pm 0.5$  | -0.179                 | -0.298                 | -0.370                 |                  |
|     | $\pm 0.75$ | -0.357                 | -0.526                 | -0.613                 |                  |
| 5   | 0          | 0                      | 0                      | 0                      | Secondary        |
|     | $\pm 0.25$ | -0.077                 | -0.136                 | -0.175                 |                  |
|     | $\pm 0.5$  | -0.254                 | -0.363                 | -0.417                 |                  |
|     | $\pm 0.75$ | -0.463                 | -0.605                 | -0.664                 |                  |
| 10  | 0          | 0                      | 0                      | 0                      | Secondary        |
|     | $\pm 0.25$ | -0.127                 | -0.182                 | -0.208                 |                  |
|     | $\pm 0.5$  | -0.349                 | -0.425                 | -0.456                 |                  |
|     | $\pm 0.75$ | -0.589                 | -0.673                 | -0.705                 |                  |
| 15  | 0          | 0                      | 0                      | 0                      | Secondary        |
|     | $\pm 0.25$ | -0.156                 | -0.202                 | -0.221                 |                  |
|     | $\pm 0.5$  | -0.393                 | -0.449                 | -0.470                 |                  |
|     | $\pm 0.75$ | -0.638                 | -0.698                 | -0.720                 |                  |

(b)  $E_{02}$  Mode

| $c$ | $a$        | $a/\lambda_0$<br>= 0.2 | $a/\lambda_0$<br>= 0.3 | $a/\lambda_0$<br>= 0.4 | Type of Solution |
|-----|------------|------------------------|------------------------|------------------------|------------------|
| 1   | 0          | 19.3                   | 8.6                    | 4.8                    | Primary          |
|     | $\pm 0.25$ | 19.3                   | 8.6                    | 4.8                    |                  |
|     | $\pm 0.5$  | 19.3                   | 8.6                    | 4.9                    |                  |
|     | $\pm 0.75$ | 19.3                   | 8.6                    | 4.9                    |                  |
| 3   | 0          | 6.4                    | 2.9                    | 1.6                    | Primary          |
|     | $\pm 0.25$ | 6.4                    | 2.9                    | 1.6                    |                  |
|     | $\pm 0.5$  | 6.5                    | 2.9                    | 1.8                    |                  |
|     | $\pm 0.75$ | 6.5                    | 3.0                    | 1.9                    |                  |
| 5   | 0          | 3.9                    | 1.7                    | 0.96                   | Primary          |
|     | $\pm 0.25$ | 3.9                    | 1.8                    | 1.03                   |                  |
|     | $\pm 0.5$  | 3.9                    | 1.9                    | 1.18                   |                  |
|     | $\pm 0.75$ | 4.0                    | 2.0                    | 1.37                   |                  |
| 10  | 0          | 1.9                    | 0.86                   | 0.48                   | Primary          |
|     | $\pm 0.25$ | 2.0                    | 0.98                   | 0.59                   |                  |
|     | $\pm 0.5$  | 2.1                    | 1.09                   | 0.80                   |                  |
|     | $\pm 0.75$ | 2.2                    | 1.29                   | 1.03                   |                  |
| 15  | 0          | 1.3                    | 0.57                   | 0.32                   | Primary          |
|     | $\pm 0.25$ | 1.3                    | 0.67                   | 0.46                   |                  |
|     | $\pm 0.5$  | 1.5                    | 0.86                   | 0.69                   |                  |
|     | $\pm 0.75$ | 1.6                    | 1.08                   | 0.93                   |                  |
| 1   | 0          | 0                      | 0                      | 0                      | Secondary        |
|     | $\pm 0.25$ | -0.01                  | -0.01                  | -0.01                  |                  |
|     | $\pm 0.5$  | -0.03                  | -0.03                  | -0.05                  |                  |
|     | $\pm 0.75$ | -0.06                  | -0.07                  | -0.11                  |                  |
| 3   | 0          | 0                      | 0                      | 0                      | Secondary        |
|     | $\pm 0.25$ | -0.01                  | -0.02                  | -0.04                  |                  |
|     | $\pm 0.5$  | -0.04                  | -0.08                  | -0.14                  |                  |
|     | $\pm 0.75$ | -0.09                  | -0.18                  | -0.30                  |                  |
| 5   | 0          | 0                      | 0                      | 0                      | Secondary        |
|     | $\pm 0.25$ | -0.02                  | -0.04                  | -0.06                  |                  |
|     | $\pm 0.5$  | -0.06                  | -0.14                  | -0.21                  |                  |
|     | $\pm 0.75$ | -0.14                  | -0.28                  | -0.41                  |                  |
| 10  | 0          | 0                      | 0                      | 0                      | Secondary        |
|     | $\pm 0.25$ | -0.03                  | -0.07                  | -0.11                  |                  |
|     | $\pm 0.5$  | -0.12                  | -0.23                  | -0.31                  |                  |
|     | $\pm 0.75$ | -0.26                  | -0.44                  | -0.55                  |                  |
| 15  | 0          | 0                      | 0                      | 0                      | Secondary        |
|     | $\pm 0.25$ | -0.05                  | -0.09                  | -0.14                  |                  |
|     | $\pm 0.5$  | -0.17                  | -0.29                  | -0.36                  |                  |
|     | $\pm 0.75$ | -0.34                  | -0.57                  | -0.61                  |                  |

Table 1 (cont.)

(c)  $E_{11}$  Mode

(d)  $E_{12}$  Mode

| $\epsilon$ | $\alpha$   | $a/\lambda_0$<br>= 0.2 | $a/\lambda_0$<br>= 0.3 | $a/\lambda_0$<br>= 0.4 | Type of Solution |
|------------|------------|------------------------|------------------------|------------------------|------------------|
| 1          | 0          | 9.30                   | 4.132                  | 2.324                  | Primary          |
|            | $\pm 0.25$ | 9.30                   | 4.147                  | 2.351                  |                  |
|            | $\pm 0.5$  | 9.32                   | 4.192                  | 2.427                  |                  |
|            | $\pm 0.75$ | 9.36                   | 4.264                  | 2.545                  |                  |
| 3          | 0          | 3.10                   | 1.377                  | 0.775                  | Primary          |
|            | $\pm 0.25$ | 3.12                   | 1.421                  | 0.848                  |                  |
|            | $\pm 0.5$  | 3.18                   | 1.540                  | 1.035                  |                  |
|            | $\pm 0.75$ | 3.27                   | 1.707                  | 1.232                  |                  |
| 5          | 0          | 1.859                  | 0.826                  | 0.465                  | Primary          |
|            | $\pm 0.25$ | 1.892                  | 0.896                  | 0.574                  |                  |
|            | $\pm 0.5$  | 1.985                  | 1.062                  | 0.784                  |                  |
|            | $\pm 0.75$ | 2.124                  | 1.270                  | 1.018                  |                  |
| 10         | 0          | 0.930                  | 0.413                  | 0.232                  | Primary          |
|            | $\pm 0.25$ | 0.993                  | 0.531                  | 0.392                  |                  |
|            | $\pm 0.5$  | 1.148                  | 0.748                  | 0.630                  |                  |
|            | $\pm 0.75$ | 1.347                  | 0.985                  | 0.875                  |                  |
| 15         | 0          | 0.620                  | 0.275                  | 0.155                  | Primary          |
|            | $\pm 0.25$ | 0.708                  | 0.423                  | 0.339                  |                  |
|            | $\pm 0.5$  | 0.898                  | 0.656                  | 0.583                  |                  |
|            | $\pm 0.75$ | 1.121                  | 0.900                  | 0.831                  |                  |
| 1          | 0          | 0                      | 0                      | 0                      | Secondary        |
|            | $\pm 0.25$ | -0.007                 | -0.015                 | -0.027                 |                  |
|            | $\pm 0.5$  | -0.027                 | -0.060                 | -0.103                 |                  |
|            | $\pm 0.75$ | -0.060                 | -0.132                 | -0.221                 |                  |
| 3          | 0          | 0                      | 0                      | 0                      | Secondary        |
|            | $\pm 0.25$ | -0.020                 | -0.044                 | -0.074                 |                  |
|            | $\pm 0.5$  | -0.078                 | -0.162                 | -0.260                 |                  |
|            | $\pm 0.75$ | -0.172                 | -0.330                 | -0.457                 |                  |
| 5          | 0          | 0                      | 0                      | 0                      | Secondary        |
|            | $\pm 0.25$ | -0.033                 | -0.070                 | -0.109                 |                  |
|            | $\pm 0.5$  | -0.126                 | -0.235                 | -0.319                 |                  |
|            | $\pm 0.75$ | -0.265                 | -0.443                 | -0.553                 |                  |
| 10         | 0          | 0                      | 0                      | 0                      | Secondary        |
|            | $\pm 0.25$ | -0.063                 | -0.118                 | -0.159                 |                  |
|            | $\pm 0.5$  | -0.218                 | -0.334                 | -0.397                 |                  |
|            | $\pm 0.75$ | -0.418                 | -0.571                 | -0.643                 |                  |
| 15         | 0          | 0                      | 0                      | 0                      | Secondary        |
|            | $\pm 0.25$ | -0.088                 | -0.148                 | -0.184                 |                  |
|            | $\pm 0.5$  | -0.278                 | -0.381                 | -0.428                 |                  |
|            | $\pm 0.75$ | -0.502                 | -0.625                 | -0.677                 |                  |

| $\epsilon$ | $\alpha$   | $a/\lambda_0$<br>= 0.2 | $a/\lambda_0$<br>= 0.3 | $a/\lambda_0$<br>= 0.4 | Type of Solution |
|------------|------------|------------------------|------------------------|------------------------|------------------|
| 1          | 0          | 27.9                   | 12.4                   | 7.0                    | Primary          |
|            | $\pm 0.25$ | 27.9                   | 12.4                   | 7.0                    |                  |
|            | $\pm 0.5$  | 27.9                   | 12.4                   | 7.0                    |                  |
|            | $\pm 0.75$ | 27.9                   | 12.5                   | 7.1                    |                  |
| 3          | 0          | 9.3                    | 4.1                    | 2.3                    | Primary          |
|            | $\pm 0.25$ | 9.3                    | 4.2                    | 2.4                    |                  |
|            | $\pm 0.5$  | 9.3                    | 4.2                    | 2.4                    |                  |
|            | $\pm 0.75$ | 9.4                    | 4.3                    | 2.5                    |                  |
| 5          | 0          | 5.6                    | 2.5                    | 1.4                    | Primary          |
|            | $\pm 0.25$ | 5.6                    | 2.5                    | 1.4                    |                  |
|            | $\pm 0.5$  | 5.6                    | 2.6                    | 1.6                    |                  |
|            | $\pm 0.75$ | 5.7                    | 2.7                    | 1.7                    |                  |
| 10         | 0          | 2.8                    | 1.24                   | 0.70                   | Primary          |
|            | $\pm 0.25$ | 2.8                    | 1.29                   | 0.78                   |                  |
|            | $\pm 0.5$  | 2.9                    | 1.42                   | 0.96                   |                  |
|            | $\pm 0.75$ | 3.0                    | 1.59                   | 1.18                   |                  |
| 15         | 0          | 1.9                    | 0.83                   | 0.47                   | Primary          |
|            | $\pm 0.25$ | 1.9                    | 0.90                   | 0.57                   |                  |
|            | $\pm 0.5$  | 2.0                    | 1.06                   | 0.78                   |                  |
|            | $\pm 0.75$ | 2.1                    | 1.27                   | 1.02                   |                  |
| 1          | 0          | 0                      | 0                      | 0                      | Secondary        |
|            | $\pm 0.25$ | -0.00                  | -0.005                 | -0.01                  |                  |
|            | $\pm 0.5$  | -0.01                  | -0.02                  | -0.04                  |                  |
|            | $\pm 0.75$ | -0.04                  | -0.05                  | -0.08                  |                  |
| 3          | 0          | 0                      | 0                      | 0                      | Secondary        |
|            | $\pm 0.25$ | -0.01                  | -0.02                  | -0.03                  |                  |
|            | $\pm 0.5$  | -0.03                  | -0.06                  | -0.10                  |                  |
|            | $\pm 0.75$ | -0.06                  | -0.13                  | -0.22                  |                  |
| 5          | 0          | 0                      | 0                      | 0                      | Secondary        |
|            | $\pm 0.25$ | -0.01                  | -0.02                  | -0.04                  |                  |
|            | $\pm 0.5$  | -0.04                  | -0.10                  | -0.16                  |                  |
|            | $\pm 0.75$ | -0.10                  | -0.21                  | -0.33                  |                  |
| 10         | 0          | 0                      | 0                      | 0                      | Secondary        |
|            | $\pm 0.25$ | -0.02                  | -0.05                  | -0.08                  |                  |
|            | $\pm 0.5$  | -0.09                  | -0.18                  | -0.26                  |                  |
|            | $\pm 0.75$ | -0.19                  | -0.35                  | -0.48                  |                  |
| 15         | 0          | 0                      | 0                      | 0                      | Secondary        |
|            | $\pm 0.25$ | -0.03                  | -0.07                  | -0.11                  |                  |
|            | $\pm 0.5$  | -0.13                  | -0.24                  | -0.32                  |                  |
|            | $\pm 0.75$ | -0.26                  | -0.44                  | -0.55                  |                  |

(e)  $E_{10}$  Mode

These values are independent of  $\epsilon$  and  $a/\lambda_0$ . There is no distinction between primary and secondary modes.

|          |            |           |            |   |            |           |            |
|----------|------------|-----------|------------|---|------------|-----------|------------|
| $\alpha$ | -0.75      | -0.5      | -0.25      | 0 | +0.25      | +0.5      | +0.75      |
| $\mu$    | $\pm 0.75$ | $\pm 0.5$ | $\pm 0.25$ | 0 | $\pm 0.25$ | $\pm 0.5$ | $\pm 0.75$ |

Table 2: Cut-off Values of  $\epsilon$  in the Filled Guide

(a)  $E_{01}$  Mode

(b)  $E_{11}$  Mode

| $\mu$ | $\alpha$   | $a/\lambda_0$<br>= 0.1 | $a/\lambda_0$<br>= 0.2 | $a/\lambda_0$<br>= 0.3 | $a/\lambda_0$<br>= 0.4 |
|-------|------------|------------------------|------------------------|------------------------|------------------------|
| 0.5   | 0          | 29.298                 | 7.324                  | 3.255                  | 1.831                  |
|       | $\pm 0.25$ | 39.064                 | 9.766                  | 4.340                  | 2.441                  |
|       | $\pm 0.5$  | -                      | -                      | -                      | -                      |
|       | $\pm 0.75$ | -23.438                | -5.860                 | -2.604                 | -1.465                 |
| 0.8   | 0          | 18.311                 | 4.578                  | 2.035                  | 1.144                  |
|       | $\pm 0.25$ | 20.293                 | 5.073                  | 2.255                  | 1.268                  |
|       | $\pm 0.5$  | 30.049                 | 7.512                  | 3.339                  | 1.878                  |
|       | $\pm 0.75$ | 151.215                | 37.804                 | 16.802                 | 9.451                  |
| 1     | 0          | 14.649                 | 3.662                  | 1.628                  | 0.916                  |
|       | $\pm 0.25$ | 15.626                 | 3.906                  | 1.736                  | 0.977                  |
|       | $\pm 0.5$  | 19.532                 | 4.883                  | 2.170                  | 1.221                  |
|       | $\pm 0.75$ | 33.483                 | 8.371                  | 3.720                  | 2.093                  |
| 1.2   | 0          | 12.207                 | 3.052                  | 1.356                  | 0.763                  |
|       | $\pm 0.25$ | 12.761                 | 3.190                  | 1.418                  | 0.798                  |
|       | $\pm 0.5$  | 14.772                 | 3.693                  | 1.641                  | 0.923                  |
|       | $\pm 0.75$ | 20.033                 | 5.008                  | 2.226                  | 1.252                  |
| 1.5   | 0          | 9.766                  | 2.4415                 | 1.085                  | 0.610                  |
|       | $\pm 0.25$ | 10.045                 | 2.5133                 | 1.116                  | 0.628                  |
|       | $\pm 0.5$  | 10.987                 | 2.7467                 | 1.221                  | 0.687                  |
|       | $\pm 0.75$ | 13.021                 | 3.2553                 | 1.447                  | 0.814                  |

| $\mu$ | $\alpha$   | $a/\lambda_0$<br>= 0.1 | $a/\lambda_0$<br>= 0.2 | $a/\lambda_0$<br>= 0.3 | $a/\lambda_0$<br>= 0.4 |
|-------|------------|------------------------|------------------------|------------------------|------------------------|
| 0.5   | 0          | 74.380                 | 18.595                 | 8.264                  | 4.649                  |
|       | $\pm 0.25$ | 99.173                 | 24.793                 | 11.019                 | 6.198                  |
|       | $\pm 0.5$  | -                      | -                      | -                      | -                      |
|       | $\pm 0.75$ | -59.504                | -14.876                | -6.612                 | -3.719                 |
| 0.8   | 0          | 46.487                 | 11.622                 | 5.165                  | 2.905                  |
|       | $\pm 0.25$ | 51.518                 | 12.880                 | 5.724                  | 3.220                  |
|       | $\pm 0.5$  | 76.287                 | 19.072                 | 8.476                  | 4.768                  |
|       | $\pm 0.75$ | 383.895                | 95.974                 | 42.655                 | 23.993                 |
| 1     | 0          | 37.190                 | 9.297                  | 4.132                  | 2.324                  |
|       | $\pm 0.25$ | 39.669                 | 9.917                  | 4.408                  | 2.479                  |
|       | $\pm 0.5$  | 49.586                 | 12.397                 | 5.510                  | 3.099                  |
|       | $\pm 0.75$ | 85.005                 | 21.251                 | 9.445                  | 5.313                  |
| 1.2   | 0          | 30.992                 | 7.748                  | 3.443                  | 1.937                  |
|       | $\pm 0.25$ | 32.398                 | 8.099                  | 3.600                  | 2.025                  |
|       | $\pm 0.5$  | 37.502                 | 9.376                  | 4.167                  | 2.344                  |
|       | $\pm 0.75$ | 50.858                 | 12.714                 | 5.651                  | 3.179                  |
| 1.5   | 0          | 24.793                 | 6.198                  | 2.755                  | 1.550                  |
|       | $\pm 0.25$ | 25.502                 | 6.375                  | 2.834                  | 1.594                  |
|       | $\pm 0.5$  | 27.892                 | 6.973                  | 3.099                  | 1.743                  |
|       | $\pm 0.75$ | 33.058                 | 8.264                  | 3.673                  | 2.066                  |

Table 2 (cont.)

(c)  $E_{02}$  Mode

| $\mu$ | $a$        | $a/\lambda_0$<br>= 0.1 | $a/\lambda_0$<br>= 0.2 | $a/\lambda_0$<br>= 0.3 | $a/\lambda_0$<br>= 0.4 |
|-------|------------|------------------------|------------------------|------------------------|------------------------|
| 0.8   | 0          | 96.5                   | 24.121                 | 10.722                 | 6.03                   |
|       | $\pm 0.25$ | 106.9                  | 26.73                  | 11.88                  | 6.68                   |
|       | $\pm 0.5$  | 158.3                  | 39.58                  | 17.59                  | 9.90                   |
|       | $\pm 0.75$ | 797                    | 199.2                  | 88.53                  | 49.8                   |
| 1     | 0          | 77.2                   | 19.29                  | 8.58                   | 4.83                   |
|       | $\pm 0.25$ | 82.3                   | 20.58                  | 9.15                   | 5.15                   |
|       | $\pm 0.5$  | 102.9                  | 25.73                  | 11.43                  | 6.43                   |
|       | $\pm 0.75$ | 176.4                  | 44.11                  | 19.60                  | 11.03                  |
| 1.2   | 0          | 64.32                  | 16.08                  | 7.14(5)                | 4.02                   |
|       | $\pm 0.25$ | 67.24                  | 16.81                  | 7.47                   | 4.20(5)                |
|       | $\pm 0.5$  | 77.83                  | 19.46                  | 8.65                   | 4.86                   |
|       | $\pm 0.75$ | 105.6                  | 26.39                  | 11.73                  | 6.60                   |

(d)  $E_{12}$  Mode

| $\mu$ | $a$        | $a/\lambda_0$<br>= 0.1 | $a/\lambda_0$<br>= 0.2 | $a/\lambda_0$<br>= 0.3 | $a/\lambda_0$<br>= 0.4 |
|-------|------------|------------------------|------------------------|------------------------|------------------------|
| 0.8   | 0          | 156                    | 39.0                   | 17.31                  | 9.74                   |
|       | $\pm 0.25$ | 173                    | 43.2                   | 19.19                  | 10.79                  |
|       | $\pm 0.5$  | 256                    | 63.9                   | 28.41                  | 15.98                  |
|       | $\pm 0.75$ | 1287                   | 322                    | 143.0                  | 80.43                  |
| 1     | 0          | 125                    | 31.2                   | 13.85                  | 7.79                   |
|       | $\pm 0.25$ | 133                    | 33.2                   | 14.78                  | 8.31                   |
|       | $\pm 0.5$  | 166                    | 41.6                   | 18.47                  | 10.39                  |
|       | $\pm 0.75$ | 285                    | 71.2                   | 31.66                  | 17.81                  |
| 1.2   | 0          | 103.9                  | 26.0                   | 11.51                  | 6.49                   |
|       | $\pm 0.25$ | 108.3                  | 27.2                   | 12.07                  | 6.79                   |
|       | $\pm 0.5$  | 125.7                  | 31.4                   | 13.97                  | 7.86                   |
|       | $\pm 0.75$ | 170.5                  | 42.6                   | 18.94                  | 10.66                  |

(e) H Modes (All values of  $\mu$  and  $a$ ).

| MODE     | $a/\lambda_0$<br>= 0.1 | $a/\lambda_0$<br>= 0.2 | $a/\lambda_0$<br>= 0.3 | $a/\lambda_0$<br>= 0.4 |
|----------|------------------------|------------------------|------------------------|------------------------|
| $H_{01}$ | 37.19                  | 9.297                  | 4.132                  | 2.324                  |
| $H_{02}$ | 125                    | 31.2                   | 13.85                  | 7.79                   |
| $H_{11}$ | 8.587                  | 2.147                  | 0.954                  | 0.537                  |
| $H_{12}$ | 72.0                   | 18.0                   | 8.00                   | 4.50                   |
| $H_{21}$ | 66.81                  | 16.70                  | 7.42                   | 4.175                  |

Table 3: Cut-off Values of  $b/a$

(a)  $H_{01}$  Mode (All values of  $\mu$  and  $a$ )

| $a/\lambda_0$<br>= 0.2 |       | $a/\lambda_0$<br>= 0.3 |       | $a/\lambda_0$<br>= 0.4 |                   |
|------------------------|-------|------------------------|-------|------------------------|-------------------|
| $\epsilon$             | $b/a$ | $\epsilon$             | $b/a$ | $\epsilon$             | $b/a$             |
| 10                     | 0.781 | 5                      | 0.670 | 3                      | 0.605 $\pm 0.005$ |
| 15                     | 0.546 | 10                     | 0.413 | 5                      | 0.418             |
| 20                     | 0.455 | 15                     | 0.329 | 10                     | 0.288             |
|                        |       | 20                     | 0.283 | 15                     | 0.235             |
|                        |       |                        |       | 20                     | 0.205             |

(b)  $H_{11}$  Mode (All values of  $\mu$  and  $a$ )

| $a/\lambda_0$<br>= 0.1 |       | $a/\lambda_0$<br>= 0.2 |       | $a/\lambda_0$<br>= 0.3                      |       | $a/\lambda_0$<br>= 0.4                      |       |
|------------------------|-------|------------------------|-------|---|-------|---|-------|
| $\epsilon$             | $b/a$ | $\epsilon$             | $b/a$ | $\epsilon$                                  | $b/a$ | $\epsilon$                                  | $b/a$ |
| 10                     | 0.978 | 5                      | 0.632 | Propagation takes place in the empty guide. |       | 0   | 0.40  |
| 15                     | 0.931 | 10                     | 0.546 |   |       | 0.5   | 0.86  |
| 20                     | 0.878 | 15                     | 0.514 |   |       | Propagation takes place in the empty guide. |       |
|                        |       | 20                     | 0.492 |   |       |   |       |

(c)  $H_{21}$  Mode (All values of  $\mu$  and  $a$ ).

| $a/\lambda_0$<br>= 0.2 |       | $a/\lambda_0$<br>= 0.3 |       |
|------------------------|-------|------------------------|-------|
| $\epsilon$             | $b/a$ | $\epsilon$             | $b/a$ |
| 18                     | 0.89  | 8                      | 0.76  |
| 20                     | 0.84  | 9                      | 0.74  |
|                        |       | 10                     | 0.72  |
|                        |       | 15                     | 0.66  |
|                        |       | 18                     | 0.63  |
|                        |       | 19                     | 0.60  |
|                        |       | 20                     | 0.58  |

Table 3 (cont.)

(e)  $E_{01}$  Mode,  $\mu = 1$

(d)  $E_{01}$  Mode,  $\mu = 0.8$

| a          | $a/\lambda_0 = 0.2$              |  | $a/\lambda_0 = 0.3$                   |  | $a/\lambda_0 = 0.4$                          |  |  |
|------------|----------------------------------|--|---------------------------------------|--|--|--|--|
|            | $\epsilon$                       | b/a  | $\epsilon$                            | b/a  | $\epsilon$                                   | b/a  |  |
|            | 0                                | 4.5<br>4.5<br>5.0<br>10<br>15                | 0.96<br>0.62<br>0.52<br>0.26<br>0.20  | 2<br>2<br>3<br>5<br>10<br>15                         | 0.97<br>0.53<br>0.30<br>0.19<br>0.12<br>0.09 | 1<br>1<br>1<br>1<br>1<br>1                           | 0.72<br>0.72<br>0.72<br>0.72<br>0.72<br>0.72 |
| $\pm 0.25$ | 5<br>4.5<br>4.5<br>5<br>10<br>15 | 0.99<br>0.80<br>0.70<br>0.54<br>0.27<br>0.20 | 2<br>2<br>3<br>5<br>10<br>15          | 0.86<br>0.52<br>0.30<br>0.19<br>0.12<br>0.10         | 1<br>1<br>1<br>1<br>1<br>1                   | 0.65<br>0.65<br>0.65<br>0.65<br>0.65<br>0.65         | Propagation takes place in the empty guide.  |
| $\pm 0.5$  | 7<br>6<br>6<br>7<br>10<br>15     | 0.97<br>0.88<br>0.46<br>0.38<br>0.27<br>0.20 | 3<br>2.5<br>2.5<br>3<br>5<br>10<br>15 | 0.95<br>0.85<br>0.39<br>0.31<br>0.20<br>0.12<br>0.09 | 1.5<br>1<br>1<br>1<br>1<br>1<br>1            | 0.87<br>0.54<br>0.54<br>0.54<br>0.54<br>0.54<br>0.54 | Propagation takes place in the empty guide.  |

| a          | $a/\lambda_0 = 0.1$ |                       | $a/\lambda_0 = 0.2$                |   | $a/\lambda_0 = 0.3$                   |   | $a/\lambda_0 = 0.4$                              |  |
|------------|---------------------|-----------------------|------------------------------------|---|---------------------------------------|---|--|--|
|            | $\epsilon$          | b/a                   | $\epsilon$                         | b/a   | $\epsilon$                            | b/a   | $\epsilon$                                       | b/a  |
|            | 0                   | 15<br>16<br>20        | 0.807<br>0.69<br>0.516             | 5<br>10<br>15<br>20                                     | 0.486<br>0.261<br>0.195<br>0.161      | 2<br>3<br>5<br>10<br>15<br>20                           | 0.47<br>0.29<br>0.189<br>0.118<br>0.094<br>0.075 | 0<br>0.5<br>0.5<br>0.5<br>0.5<br>0.5                 |
| $\pm 0.25$ | 16<br>20            | 0.75<br>0.52(1)       | 5<br>10<br>15<br>20                | 0.495<br>0.263<br>0.196<br>0.161                        | 2<br>3<br>5<br>10<br>15<br>20         | 0.49<br>0.29<br>0.190<br>0.118<br>0.092<br>0.084        | 0<br>0.5<br>0.5<br>0.5<br>0.5<br>0.5             | 0.16<br>0.24<br>0.24<br>0.24<br>0.24<br>0.24         |
| $\pm 0.5$  | 18<br>18<br>20      | 0.85<br>0.71<br>0.560 | 5<br>10<br>15<br>20                | 0.534<br>0.269<br>0.199<br>0.164                        | 2<br>3<br>5<br>10<br>15               | 0.87<br>0.54<br>0.192<br>0.119<br>0.093                 | 0<br>0.5<br>1<br>1<br>1                          | 0.16<br>0.24<br>0.67<br>0.67<br>0.67                 |
| $\pm 0.75$ |                     |                       | 7<br>6<br>6<br>7<br>10<br>15<br>20 | 0.93<br>0.88<br>0.47<br>0.38<br>0.280<br>0.205<br>0.168 | 3<br>2.5<br>2.5<br>3<br>5<br>10<br>15 | 0.91<br>0.81<br>0.39<br>0.32<br>0.196<br>0.121<br>0.094 | 0<br>0.5<br>1<br>1.5<br>2<br>2<br>2              | 0.16<br>0.24<br>0.53<br>0.86<br>0.98<br>0.98<br>0.98 |

(f)  $E_{01}$  Mode,  $\mu = 1.2$

| a          | $a/\lambda_0 = 0.1$ |                | $a/\lambda_0 = 0.2$  |                      | $a/\lambda_0 = 0.3$       |                                      | $a/\lambda_0 = 0.4$                         |   |
|------------|---------------------|----------------|----------------------|----------------------|---------------------------|--------------------------------------|---|---|
|            | $\epsilon$          | b/a            | $\epsilon$           | b/a                  | $\epsilon$                | b/a                                  | $\epsilon$                                  | b/a   |
|            | 0                   | 13<br>15<br>20 | 0.86<br>0.67<br>0.49 | 5<br>10<br>15        | 0.46<br>0.25<br>0.20      | 2<br>5<br>10<br>15                   | 0.45<br>0.19<br>0.12<br>0.10                | Propagation takes place in the empty guide. |
| $\pm 0.25$ |                     |                | 5<br>10<br>15        | 0.47<br>0.26<br>0.20 | 1.5<br>3<br>5<br>10<br>15 | 0.82<br>0.28<br>0.19<br>0.12<br>0.09 | Propagation takes place in the empty guide. |   |
| $\pm 0.5$  |                     |                | 5<br>10<br>15        | 0.49<br>0.27<br>0.20 | 2<br>5<br>10<br>15        | 0.47<br>0.19<br>0.12<br>0.09         | Propagation takes place in the empty guide. |   |

(h)  $E_{11}$  Mode,  $\mu = 1.0$

| a      | $a/\lambda_0 = 0.2$                  |   | $a/\lambda_0 = 0.3$                    |  | $a/\lambda_0 = 0.4$                          |  |
|--------|--------------------------------------|---|--|--|--|--|
|        | $\epsilon$                           | b/a   | $\epsilon$                             | b/a  | $\epsilon$                                   | b/a  |
|        | 0                                    | 10<br>15<br>20                                | 0.781<br>0.546<br>0.455                | 5<br>10<br>15<br>20  | 0.670<br>0.413<br>0.329<br>0.283             | 3<br>5<br>10<br>15<br>20                             |
| + 0.25 | 10<br>15<br>20                       | 0.819<br>0.537<br>0.445                       | 5<br>10<br>15                          | 0.665<br>0.405<br>0.324  | 3<br>5<br>10<br>15                           | 0.59<br>0.40<br>0.28<br>0.23                         |
| - 0.25 | 10<br>15<br>20                       | 0.877<br>0.582<br>0.484                       | 5<br>10<br>15                          | 0.724<br>0.44<br>0.352   | 3<br>5<br>10<br>15                           | 0.66<br>0.45<br>0.31<br>0.25                         |
| + 0.5  | 12<br>12<br>13<br>15<br>20           | 0.95<br>0.68<br>0.63<br>0.552<br>0.450        | 5<br>5<br>10<br>15<br>20               | 0.85<br>0.749<br>0.400<br>0.317<br>0.22                        | 3<br>3<br>5<br>10<br>15                      | 0.96<br>0.60<br>0.40<br>0.27<br>0.22                 |
| - 0.5  | 12<br>12<br>13<br>15<br>20           | 0.94<br>0.86<br>0.76<br>0.671<br>0.540        | 5.5<br>10<br>15<br>15<br>20            | 0.81<br>0.505<br>0.401   | 3<br>3<br>5<br>10<br>15                      | 0.95<br>0.78<br>0.52<br>0.35<br>0.29                 |
| + 0.75 | 20<br>15<br>14<br>14<br>15<br>20     | 0.98<br>0.85<br>0.82<br>0.65<br>0.60<br>0.467 | 8<br>7<br>6<br>6<br>7<br>8<br>10<br>15 | 0.94<br>0.89<br>0.77<br>0.66<br>0.54<br>0.48<br>0.411<br>0.323 | 5<br>4.5<br>3.5<br>3.5<br>5<br>5<br>10<br>15 | 0.97<br>0.94<br>0.83<br>0.55<br>0.40<br>0.27<br>0.22 |
| - 0.75 | 20<br>18.5<br>18.5<br>19<br>20<br>21 | 0.97<br>0.92<br>0.83<br>0.80<br>0.756<br>0.72 | 9<br>9<br>10<br>15<br>15               | 0.98<br>0.74<br>0.679<br>0.53                                  | 5<br>5<br>6<br>10<br>15                      | 0.97<br>0.74<br>0.64<br>0.47<br>0.38                 |

(g)  $E_{11}$  Mode,  $\mu = 0.8$ ,  $a/\lambda_0 = 0.2$

| a      | $a/\lambda_0 = 0.2$                  |  |
|--------|--------------------------------------|--|
|        | $\epsilon$                           | b/a  |
|        | 0                                    | 11.5<br>11.5<br>12<br>15<br>20               |
| + 0.25 | 12.5<br>12<br>12<br>12.5<br>15<br>20 | 0.97<br>0.90<br>0.77<br>0.65<br>0.57<br>0.48 |
| - 0.25 | 12.5<br>12.5<br>15<br>20             | 0.96<br>0.73<br>0.64<br>0.55                 |

# THERMALLY COMPENSATED CRYSTAL OSCILLATORS\*

by

R. A. Spears (Associate Member) †

## SUMMARY

The paper describes a new approach to the problem of "frequency-versus-temperature" stability. The principle involved is particularly suitable for the special requirements of mobile and portable communications equipment. In contrast to oven-controlled crystal oscillators the technique requires neither the expenditure of power nor the use of thermostats in any form. Frequency stability is achieved by a temperature-sensitive phase-shifting network incorporated in the oscillator circuit. A stability approaching 1 part in  $10^6$  is obtained over a wide temperature range.

### 1. Introduction

In general, the type of oscillator largely determines the generated frequency stability; in addition, the harmonic content of the output is similarly dependent upon the type of circuit employed. The stability of frequency is an extremely important design feature and specifications are becoming more stringent in this respect. This paper will be concerned only with the stability aspect of crystal oscillators used in the broad field of telecommunications.

The stability of the average crystal oscillator usually depends upon certain factors in the following approximate order of severity:—

- (a) Temperature.
- (b) Stability of circuit parameters.
- (c) Crystal mounting.
- (d) Stability of power supplies.
- (e) Long period ageing effects.

There are also a few other minor but contributory factors.

Independent efforts at improvements on the part of both the crystal designer and the equipment designer can make very appreciable reductions in the normal magnitude of these effects.

Despite these efforts the variations of frequency due to surrounding temperature changes may still be a remaining obstacle to the overall frequency stability desired. In such cases it is

usual to provide some form of temperature control for the crystal unit. This generally takes the form of an electric oven, thermostatically controlled to temperature values, the limits of which are controlled by the specified limits of frequency deviation. Disadvantages of the oven are its weight and bulk, the necessity of providing the electrical energy for its operation, and the cost. In fixed sites, however, such a solution is quite practicable although it can prove an expensive maintenance proposition unless circuits are provided for a thermostat failure alarm. Otherwise thermostat failure usually results in continuous application of current to the heater elements with consequent burn-out and, more seriously, irreparable damage to the crystal through rapid overheating.

The provision of temperature control to portable and mobile equipments present a much greater problem than it does to fixed equipment having special regard to the limitations of space and power consumption imposed by portable equipment.

The design and manufacture of crystals is invariably a separate and independent industry: crystal oscillators are designed and manufactured as another independent industry. Crystals are procured as self-contained units which are then adapted into the design of the oscillator.

This independent designing of crystals and oscillators was considered unlikely to provide a reasonable and economic solution to the problem of securing stability by temperature control. It became known that mobile radio

\* Based on a paper read before the A.T.E Technical Society on 11th November 1957. Manuscript received 10th July 1958. (Paper No. 473.)

† Automatic Telephone & Electric Co. Ltd., Strowler Works, Liverpool 7.  
U.D.C. No. 621.373.421.13



frequency tolerances were to be still further reduced and so investigations were started to evolve a new and better approach to the whole problem.

Because of its impracticability for portable equipment, the temperature-controlled oven was discarded and efforts were concentrated on making the oscillator provide its own automatic compensation. The result was the development of an integral unit comprising crystal and special oscillator circuit in which the whole assembly has its temperature characteristic corrected over a substantial temperature range.

**2. Automatic Compensation Possibilities**

The curve shown in Fig. 1 is typical of the frequency behaviour of quartz crystal oscillators when the capacitance appearing in parallel with the crystal element varies. An increase in the capacitance lowers the output frequency of the oscillator and vice-versa. From this fact it would appear possible to achieve compensation by the application of a high temperature-coefficient capacitor as part of the crystal load capacitance. Such a capacitor would automatically change capacitance value through an increase in temperature. As a temperature increase would also cause the crystal to vary its frequency, the two effects would be designed to counter each other and so tend to stabilize the frequency. This possibility will be briefly examined.

Titanium oxide capacitors are now available having temperature-coefficients up to a maximum of -800 parts per million per degree Centigrade rise. The European normal temperature range is generally considered to be -5°C to +45°C. This will cause a capacitance variation of ±2 per cent. with respect to that obtaining at 20°C, the normal ambient temperature.

A convenient nominal value for the load capacitance is 20 pF. In this event the ±2 per cent. variation would result in an effective crystal load capacitance variation of from 19.6 pF to 20.4 pF through temperature variation. An examination of the slope of the curve of Fig. 1 at the point corresponding to 20 pF shows that a total frequency shift of the order of 12 parts per million would occur over this capacitance variation of 0.8 pF.

Over this range of -5°C to +45°C, the rate of change of frequency with temperature would be substantially linear. Unfortunately, except for a very small part of this temperature range, the frequency-temperature characteristic

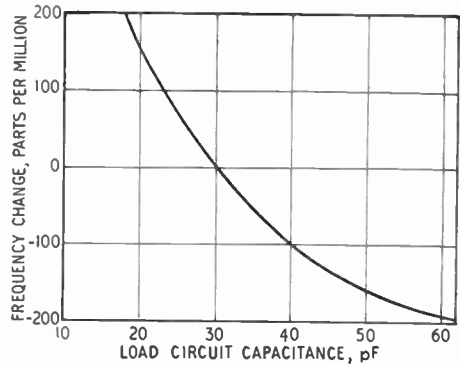

**Fig. 1.** Frequency deviation introduced by effective crystal load capacitance. Crystal: AT plate B7G at 10 Mc/s.

of the crystal element, which it is desired to balance or nullify in order to achieve compensation, is not linear. Fig. 2 shows two types of characteristic. Curve (a) is typical of the group of crystal elements usually classified as "AT" and (b) is typical of a larger number of elements, which includes the "BT" types.

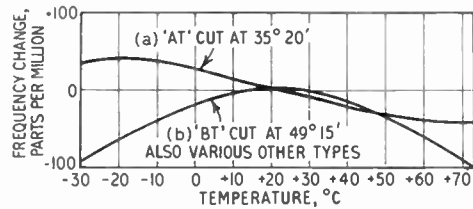

**Fig. 2.** Typical behaviour of crystal units over temperature range.

With the AT series, the magnitude and direction of the slope is determined by the production line cutting and machining tolerances. One could reasonably expect normal production units to show a total frequency excursion of not more than 50 parts per million over a temperature variation between -5°C and +45°C. The inflexion point of the characteristic occurs at about 23°C.

An examination of this information as a whole will show that compensation by titanium-oxide capacitors suffers from the following deficiencies:—

- (a) The magnitude of compensation is inadequate to meet the practical requirements.
- (b) Only negative temperature-coefficient crystals could be so compensated, due to the very small swing of positive coefficient capacitors.
- (c) The degree of compensation is not readily adjustable.
- (d) The law or shape of the frequency compensation does not follow the inverse law of the crystal element sufficiently for good action.

**3. Principles of Thermally Compensated Crystal Oscillators**

The deficiencies just outlined can largely be overcome by the adoption of a method of frequency control which is entirely new.

It is well known in the crystal industry that the rate of change of oscillator frequency for a certain change in the load capacitance of a crystal unit may be given as:—

$$df = \frac{-C_1 dC' \times 10^6}{2(C_0 + C')^2} \text{ parts per million} \dots\dots\dots(1)$$

where  $C_1$  is the crystal equivalent series capacitance  
 $C_0$  is the crystal equivalent shunt capacitance  
 $C'$  is the crystal load circuit shunt capacitance.

For example, the behaviour of an AT-cut element with respect to load capacitance variation is as illustrated in Fig. 1. It is possible therefore to cause the oscillator frequency to change as required, within limits, by the direct or indirect control of load circuit reactance.

For any one type of crystal element and a fixed nominal load capacitance (e.g. 20 pF) eqn. (1) becomes a constant,  $K$ , taking  $dC'$  as 1 pF. The values of the constant  $K$ , in parts per million per pF, for several crystal element types are given in Table 1.

Now if the effective crystal load is changed in a manner which results in an increase of reactive current in that load circuit, then the oscillator will change its frequency up or down. If the increased reactive current is inductive, the frequency will increase; if it is capacitive, the frequency will decrease.

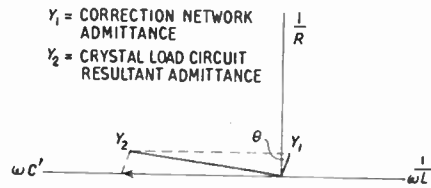

**Fig. 3.** Admittance vector diagram  $R > \omega L$  crystal oscillator.

It is, however, unnecessary to cause a change in the actual capacitance of the load as the same result may be achieved by varying, or causing to be varied, the phase angle of the load circuit. If, for example, an admittance vector diagram is drawn for a fixed load

**Table 1**

| Type of Crystal Element | Total Load Capacitance $C'$ |      |       |      |       |      |
|-------------------------|-----------------------------|------|-------|------|-------|------|
|                         | 20 pF                       |      | 30 pF |      | 50 pF |      |
|                         | $K =$                       |      | $K =$ |      | $K =$ |      |
|                         | Min.                        | Max. | Min.  | Max. | Min.  | Max. |
| AT Fundamental          | 9.5                         | 19.6 | 4.3   | 12.5 | 1.7   | 5.2  |
| AT 3rd Overtone         | 1.5                         | 2.4  | 0.8   | 1.3  | 0.3   | 0.6  |
| BT Fundamental          | 5.8                         | 14.3 | 2.8   | 7.9  | 1.1   | 3.4  |
| CT Fundamental          | 4.1                         | 11.1 | 1.9   | 6.2  | 0.7   | 2.8  |
| DT Fundamental          | 4.9                         | 15.6 | 2.4   | 8.9  | 0.9   | 4.0  |
| +5° X-cut Bar           | 20.5                        | 38.5 | 12.4  | 27.0 | 5.9   | 15.4 |

capacitance  $C'$  with which has been associated a resistance and inductive reactance combination, the vector will appear as in Fig. 3. In this case the resistor and inductor are connected in series and across the load capacitance. In this Figure,  $R$  is much greater than  $\omega L$  so that both phase angle  $\theta$  and admittance  $Y_1$  are small. The resultant  $Y_2$  in this example is substantially equivalent to a capacitive reactance, having a phase angle and magnitude somewhat less than those of the original load capacitance  $C'$ . This resultant can be shown to be equivalent to a slight reduction in the capacitive component of current in the network, and consequently the corresponding effect upon the oscillator frequency will also be slight. The oscillator frequency therefore rises very slightly.

Alternatively when, in Fig. 4,  $\omega L$  is much greater than  $R$ , the admittance vector for the  $R$ - $L$  arm will have  $\theta$  near  $90^\circ$  and  $Y_1$  will be large, assuming  $L$  has remained constant. When in combination with the original load capacitance  $C'$ , the effective result is a considerable decrease in the capacitive component of the current. Consequently the frequency rises substantially.

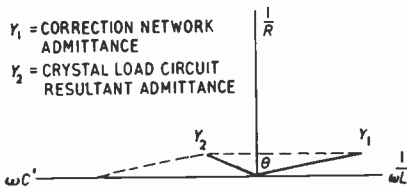

Fig. 4. Admittance vector diagram  $R < \omega L$  crystal oscillator.

By the same reasoning, the use of a resistance and capacitance in series across the crystal load circuit causes the frequency to fall progressively as the phase angle nears  $-90^\circ$  and the admittance increases.

Directly from the vector diagrams and eqn. (1) it is possible to show that the change in frequency brought about in this manner may be expressed as:—

$$df \cong \frac{159 \cdot 1 \times 10^3 K (Y_1 \sin \theta)}{F} \dots\dots(2)$$

in parts per million.

( $F$  represents frequency in megacycles per second.)

For the two cases mentioned, that is, inductive or capacitive reactance in association with resistance, it is more informative to rewrite eqn. (2) in the alternative forms:—

*Inductive*

$$df \cong \frac{159 \cdot 1 \times 10^3 K}{\omega L} \sin^2 \left( \tan^{-1} \frac{\omega L}{R} \right) c/s \dots\dots(3)$$

*Capacitive*

$$df \cong - \frac{K \omega C}{2\pi} \sin^2 \left( \tan^{-1} \frac{1}{\omega CR} \right) c/s \dots\dots(4)$$

It is now seen that the second part of both eqns. (3) and (4) may be otherwise expressed as:—

$$\sin^2(\tan^{-1} Q) \dots\dots(5)$$

**4. Thermal Effects**

Throughout the foregoing it has been assumed that the elements remain at a constant value for temperature variations. This in fact does not occur. For example, the AT-cut crystal frequency may fall with increasing temperature over the range applicable.

In the designs under consideration the value of  $R$  in eqns. (3) and (4) is arranged to be a function of temperature, so that in eqn. (5)  $Q$  also becomes a function of temperature.

To a close approximation the first part of eqns. (3) and (4) will remain constant with temperature. It is therefore possible to calculate values of inductance or capacitance to produce an equal and opposite frequency change with temperature to that caused by the crystal.

It only remains to ensure that  $Q$  varies with temperature in the correct manner to allow eqn. (5) to have the inverse law to that of the crystal over the relevant temperature range.

Control of  $Q$  may be effected by controlling (a) the value of the inductor or capacitor, or (b) the value of the resistor used.

As a means of correction (a) has already been discarded owing to the inadequacy of the range of variation.

The resistor method (b) will now be examined.

Certain types of semi-conductor materials exhibit features which lend themselves admirably to this application. For example, over a temperature range between 0°C and 50°C one "mix" of semi-conductor material shows a change in resistance of about 10 to 1 ratio. This fact, together with the appropriate selection of values for  $L$  and  $C$ , becomes the basis for the novel compensation circuit under discussion.

In Fig. 5,  $\sin^2(\tan^{-1} Q)$  is plotted as a function of temperature and the general shape of the resulting curve is of particular interest when viewed in conjunction with a typical AT crystal characteristic, Fig. 2(a).

Examination of Fig. 2(a) shows that over the greater part of the curve between the turnover points there is a very close resemblance to the inverse behaviour of Fig. 5 between about -20°C and +70°C. This would indicate that good compensation should be obtainable using this approach.

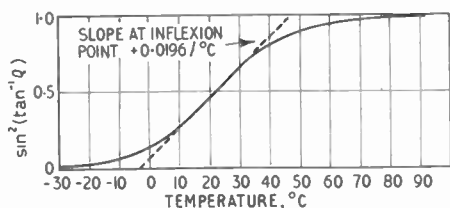

Fig. 5. Graphical presentation of the equation  $\sin^2(\tan^{-1} Q)$  as a function of temperature. Bead-type thermistor (non-limited) for case when  $Q=1$  at 22°C.

The temperature range may be shifted as required by the expedient of making  $Q=1$  at the mid-point of the desired temperature band.

The secondary effects of the temperature-coefficient of inductance or capacitance in the compensation network are negligible. This will become obvious when considering eqns. (3) and (4) in terms of small variations of  $L$  or  $C$  respectively.

### 5. Practical Results

Several complete oscillators have been constructed on the foregoing principles. All have been based on conventional crystal oscillator circuits.

Figure 6 shows a typical complete oscillator unit suitable for inclusion as a component in

a communication system. Models such as this have been produced for frequencies between 4 Mc/s and 50 Mc/s.



Fig. 6. Crystal oscillator: thermally-compensated type.

The very considerable economy in space secured by the application of the principle is effectively illustrated in Fig. 7. In this figure a completely self-contained thermally controlled unit is shown adjacent to a conventional oven-controlled oscillator.

When the characteristic of the crystal element differs from that discussed, a slightly different approach is required.

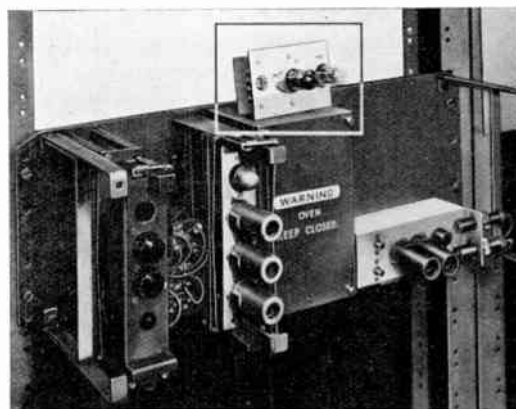

Fig. 7. Crystal oscillators: oven-controlled and thermally-compensated types.

In practice, the exact shape of the frequency-temperature characteristic for a particular AT element may not conform exactly to that indicated in Fig. 2(a). Minor angular errors and dimensional variations can cause irregularities

in the form of the characteristics. In such circumstances it is useful to make use of series- or shunt-limiting resistors coupled to the thermally-sensitive resistance elements. The effect of the two methods of limiting are indicated in Fig. 8. Here the dotted lines show the non-limited condition, identical with Fig. 5, while the solid lines show the results of both series and shunt limiting.

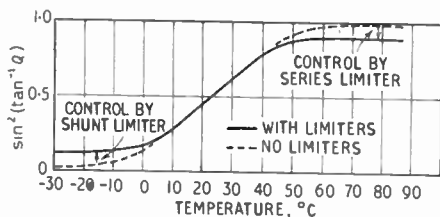

Fig. 8. Effect of limiters.

At this point it is useful to note that the slope of the central temperature zone is controlled by the magnitude of the compensating arm reactance and the nominal crystal load circuit conditions. As has just been demonstrated, the point at which this slope reduces to zero may be controlled by resistance limiters. This adds quite a useful flexibility to the method.

Frequency-temperature characteristics similar to that indicated in Fig. 2(b) can also be compensated, but a more complex network becomes

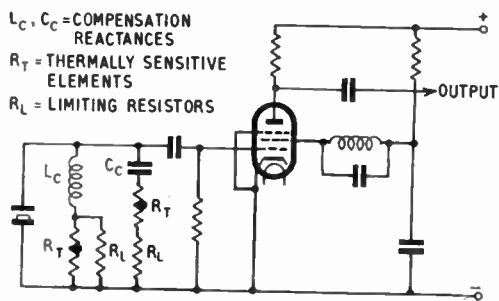

Fig. 9. "Cross-over" circuit.

necessary. The crystal elements of this group are treated as though the temperature range was, in fact, divided into two roughly equal parts, with the "turn-over" or inflexion point

becoming the upper limit of the first part and the lower limit of the second part. At this junction the temperature-coefficient is zero and so no compensation effects are desired. As the temperature deviates further from this point, in either upward or downward directions, the amount of required compensation increases.

Referring again to Fig. 5 and ignoring the temperature scale for the moment, it may be seen that the part of the curve between, for example,  $B=0.02$  and  $B=0.50$  bears a close similarity to the inverse of the second part of the curve in Fig. 2(b). To make use of this possibility, it is now essential to make  $B=0.02$  at the same temperature as the turn-over point in Fig. 2(b). Shunt limiting resistors may be used to make minor adjustments to the slope at this point. An inductive compensation network would satisfy the sense of the compensation requirements.

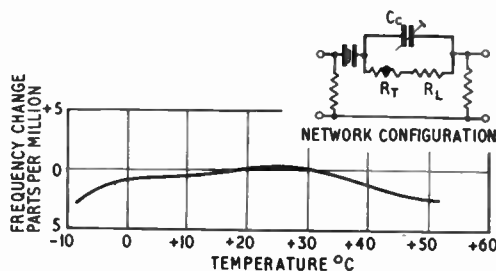

Fig. 10. Thermally-compensated oscillator—37.033 Mc/s frequency stability curve.

For the region below the turn-over point the part of the curve Fig. 5 between  $B=0.50$  and  $B=0.98$  is suitable, series limiting resistors providing the smaller adjustments. In this instance, capacitive compensation is required.

These two circuits, when combined, produce a "cross-over" network, theoretically capable of substantial compensation up to more than  $\pm 40^\circ\text{C}$ , with reference to the original crystal element's turn-over point. Fig. 9 shows the basic resulting circuit using a simple "cross-over" scheme.

However, for frequencies below a few hundred kilocycles per second, it is difficult to design an inductor of small physical dimensions having a sufficiently high inductance/capacitance reactance ratio.



One of the principal applications of thermally compensated crystal oscillators is in mobile v.h.f. equipment. Here, as in a number of other applications, the supply of power is a very major problem. The only previously known way of maintaining a high radio-frequency within  $\pm 5$  parts per million was by housing the crystal element in a continuously running oven unit. Quite a simple oven would require between 3 and 10 watts to maintain a reasonable steady interior temperature for ambient ranges between  $-10^\circ$  and  $+50^\circ\text{C}$ .

Figure 10 shows the frequency-temperature behaviour of an oscillator utilizing a 1.25 volt heater valve. The total power drain for this complete oscillator is 0.15 watt with an overall stability of considerably better than  $\pm 5$  parts per million. This particular oscillator was of the overtone type operating at 37.033 Mc/s.

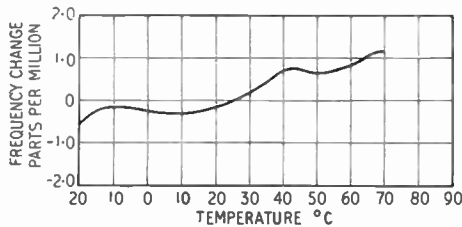

Fig. 11. Thermally-compensated oscillator—5 Mc/s frequency stability curve.

Figure 11 gives the behaviour of a 5 Mc/s thermally compensated oscillator. It will be seen that the resulting frequency remains within a few parts per million over a wide range of temperature. This curve is typical of the bulk of the frequency range between 2 to 16 Mc/s after compensation. Fig. 12 illustrates graphically the extent of stability improvement achieved by taking corrective action in the manner described.

In each of these models the temperature sensitive element is a bead-type thermistor. This requires to be mounted in close proximity to the crystal element and certainly within the confines of the crystal assembly. Such a step is most important to achieve good correlation in the respective rates of rise of temperature in both crystal element and thermistor bead. This mounting of the thermistor bead within

the crystal assembly and in close proximity to the crystal element is illustrated in Fig. 13.

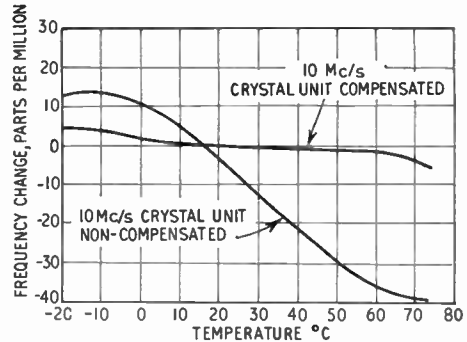

Fig. 12. Crystal unit frequency comparison curves. Thermally compensated and non-compensated.

It would, in fact, be desirable to produce a crystal element upon which the thermistor bead is situated in immediate contact. A combination assembled in this manner would, undoubtedly, satisfactorily cope with the rate of temperature change encountered in the projection of a guided missile. This "immediate contact" method of bead mounting has been found to be quite practicable and is shown in Fig. 14.

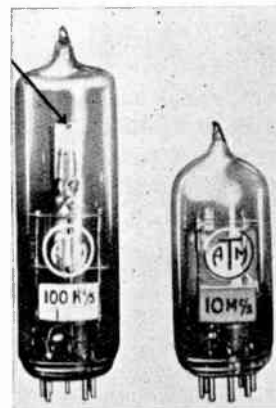

Fig. 13. Crystal assemblies. Thermistor bead and crystal element integral.

Circumstances may possibly arise in which the magnitude of compensation desired is embarrassingly large. It may then be worth while considering the combined use of a

thermally sensitive semi-conductor and a high temperature-coefficient capacitor or inductor.

The design of this oscillators must take into account the dissipation of power in both crystal element and thermistor. Fortunately, the two have similar limitations and a figure of 1 milli-watt maximum dissipation is acceptable to both. No permanent damage would be done to either by temporary overloads of several times this figure, but in the interests of high stability, the limits should never be exceeded.



Fig. 14. Crystal assembly. Thermistor bead and crystal element contiguous.

### 6. Future Trends in Development

It is obvious that further miniaturization will be a progressive aim of development. There has been a general tendency in crystal design as a whole for a reduction in space occupied. The addition, in this new product, of the thermally sensitive element does not materially alter this trend. Indeed, the completed oscillator already occupies no more space than many earlier crystal units alone.

The application of the new oscillator to frequency shift keying networks presents a few technical and practical problems.

Whether frequency shift is brought about electronically or by conventionally adding reactance via relay contacts, there is an immediate effect upon the constant  $K$  as used in eqns. (2), (3) and (4).

As an example: a frequency shift of the order of 500 c/s at a nominal frequency of 5 Mc/s would probably effect an alteration in the value of  $K$  from 12 to 15.

Such a change, according to eqns. (3) and (4), would entail over-compensation in the "keyed" state. This may be corrected by similarly keying "in" and "out" a restriction upon the value of  $L$  and  $C$  as necessary.

As well as these developments, a transistorized version of the oscillator is a project for the near future.

### 7. Conclusions

The insistence upon very high degrees of stability, coupled with the exclusion of the only known practicable means of procuring this stability, forced research into possible alternative control methods.

The evolution of this novel and practical solution, embodying additional advantages in cost, bulk, reliability and maintenance demands, is no small cause for satisfaction.

Experience has already shown that, over wide temperature limits, stability does in fact approach  $\pm 1$  part per million. Means have also been found to avoid the conditions of poor power factor which undoubtedly arose in the early designs. Multiple frequency oscillators are now under construction.

As indicated, there is still scope for further research into refinements of this principle and this research is being energetically pursued.

# A NEW METHOD OF COOLING HIGH-POWER VALVES BY VAPORIZATION OF WATER\*

by

P. E. Cane† and W. E. Taylor (Associate)‡

## SUMMARY

The problem of disposing of the heat generated in the anodes of high power valves is discussed, and brief reference is made to the different methods of construction adopted in valves of this class. Existing methods of cooling are examined and their limitations stated. The mechanism of transfer of heat from a copper anode to the surrounding water is considered, and its application to valve cooling is discussed. A new method of cooling by vaporization of water is then dealt with. Consideration is given to the construction of vapour cooled valves, followed by an explanation of the complete system.

### 1. Introduction

Users of thermionic valves will be familiar with the problem of dissipating the heat generated in the anode. This heat, being a function of the valve's operation, is unavoidable, and while with small "receiving" type valves no special arrangements are required, the problem of the removal of this heat becomes increasingly difficult as the power increases.

This problem of heat dissipation is a very major one in the "large" valve industry and considerable effort is always being made to find improved methods of overcoming this, and at the same time reducing the physical dimensions of the valve. A further problem with large valves is the provision of adequate connections to the internal electrodes. Such connections must in most cases, for circuit reasons, be as short as possible and this presents additional cooling problems.

These problems of cooling, etc., have led to the necessity for separate engineering sections in most valve manufacturing organizations since the problems involved are outside the scope of those normally encountered in small valve production, i.e. valves below approximately 100 W anode dissipation.

\* Manuscript first received 2nd April, 1958 and in final form on 9th August 1958. (Paper No. 474.)

† Siemens Edison Swan Ltd., Cosmos Works, Brimsdown, Enfield, Middlesex.

‡ Siemens Edison Swan Ltd., Industrial Valve Division, 155 Charing Cross Road, London, W.C.2. U.D.C. No. 621.385.2/3.035.4

### 2. Methods for Removal of Heat

Until recently three methods have been generally employed for the disposal of heat generated, namely

- (1) Direct radiation.
- (2) Water cooling.
- (3) Forced air cooling.

These three methods will be briefly discussed before considering a fourth method.

#### 2.1. Direct Radiation

Valves of this type are probably the most familiar as the technique of allowing the heat from the anode to escape by radiation through the bulb can be applied to valves of up to approximately 1.5 kW rating. The limiting factor is the temperature of the glass and it is not considered safe to operate valves with bulb temperatures in excess of 200°C, because of the danger of gas evolution and possible collapse of the bulb owing to softening of the glass.

Overheating of the glass in the vicinity of the lead-throughs must also be avoided. Where the larger types of all-glass envelope valves are operated at or near their maximum rating it is usual to direct low velocity air streams at the critical areas.

Once the anode dissipation exceeds approximately 1.5 kW, all-glass construction valves tend to become very large physically and proportionately more fragile, with the added complication of undesirable long leads. Therefore the method of valve construction changes.

The anode now becomes part of the valve envelope (Fig. 1), and is usually made of high conductivity oxygen-free copper. This makes possible a material reduction in the physical dimensions of the valve and the hot anode can be immersed directly in the cooling medium, i.e. water or air.

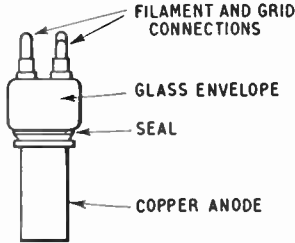

Fig. 1. High power valve with anode as part of valve envelope.

2.2. Water Cooling

This method makes use of external anode valves, mounted in jackets (Fig. 2) through which water is pumped at high velocity. Valves using this method of cooling have been made with anode dissipations of the order of 200 kW,

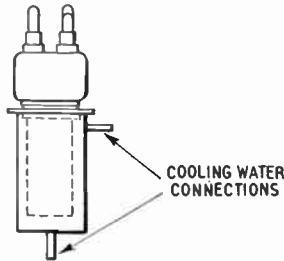

Fig. 2. Water-cooled valve.

and dissipation rates of approximately 60 W/cm<sup>2</sup> of anode surface and, in very special designs, up to 100 W/cm<sup>2</sup>. Steam bubbles must not be allowed to remain in contact with the copper anode since these will lead to the formation of local hot spots; this necessitates the employment of high velocity water circulation with attendant mechanical complications in the form of special pumps, filters, and plumbing, etc. (Fig. 3). A considerable amount of circulating water is required, for instance, a valve of 100 kW dissipation requires approximately 25 gallons/min of water at 30 lb/in<sup>2</sup>.

2.3. Forced Air Cooling

For this method, external anode valves are again used. The water jacket is replaced by a

finned copper radiator which is soldered to the copper anode (Fig. 4), the cooling air being passed through the radiator at several hundred cubic feet per minute. With modern high efficiency radiators it is possible to make valves of this type having ratings up to about 20 kW, but above this figure the weight and size of the radiator tends to become excessive. Due to the small passages in the radiator it is essential to provide filters in the intake to the blowers to

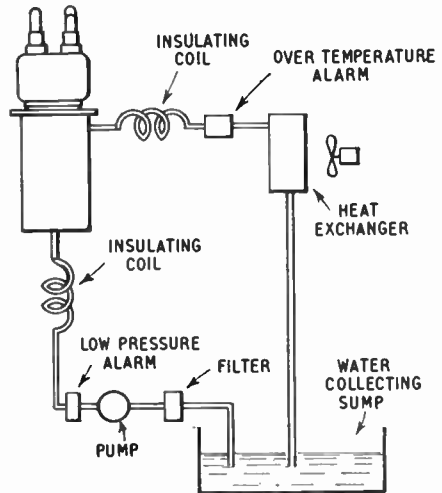

Fig. 3. Water circulation system for high power valve.

prevent blocking of the radiator passages by foreign material drawn in by the air stream, and because of the high velocity air stream the systems are inclined to be very noisy in

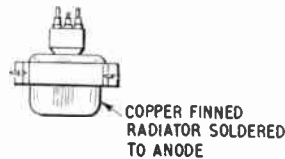

Fig. 4. Forced air cooled valve.

operation. Further problems also arise when air cooled valves are operated in high ambient temperatures. Fig. 5 shows a typical installation. With valves of this type it is possible to dissipate up to 50 W/cm<sup>2</sup> of anode surface.

3. Vapour Cooling

Continual efforts to find an alternative cooling system or to improve on the existing methods

led Compagnie Française Thomson Houston (C.F.T.H.)\* to re-explore the possibilities of

of operation at 125°C and a typical safe operating temperature is 110°C. If the anode is allowed to exceed 125°C serious damage can result.

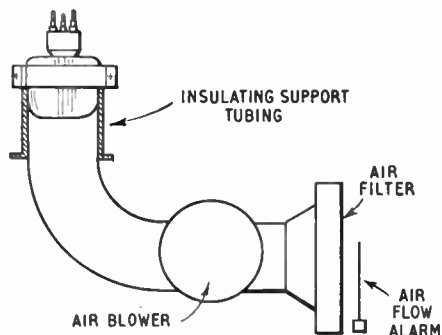

Fig. 5. Forced air cooling system.

vapour cooling. Work on this problem by earlier engineers had not been very successful due to a lack of appreciation of the principles involved, but in 1950 C.F.T.H. succeeded in overcoming the difficulties.†

This method, known as the Vapotron system, while using water as the cooling medium, eliminates the need for special pumps, etc., and makes possible anode dissipations far in excess of those obtainable with conventional water-cooled valves.

It is a well known fact that to change the state of matter from say a liquid to a gas requires energy, and in the Vapotron system it is this physical fact which is used, i.e. the power to be dissipated by the valve anode is absorbed in the conversion of water into steam.

Before going on to discuss the practical arrangement of the system, it is necessary to consider the mechanism of the transfer of heat from a copper anode to the surrounding water.

From the curve shown in Fig. 6,‡ it will be seen that the rate of heat transfer from the anode to the surrounding water increases rapidly up to a point where the difference in temperature between the anode and the water is approximately 25°C, and then decreases rapidly. There is thus an optimum temperature

To illustrate this point, consider the conventional copper anode valve immersed in a tank of water. As the steam bubbles begin to form on the surface of the metal at a rate increasing with temperature, some areas will be partially insulated from the water by steam bubbles. This will allow a local increase in temperature of the anode to above 125°C with a resulting decrease in heat transfer rate, and unless the power is reduced and the steam bubbles removed, these points will increase in area and temperature until the centre parts reach red heat. The valve would then be destroyed. It is this fact that makes it necessary to pump large quantities of water at high velocity within the jackets of water cooled valves primarily to “scrub off” steam bubbles as soon as they form, and ensure adequate wetting of the metal by water.

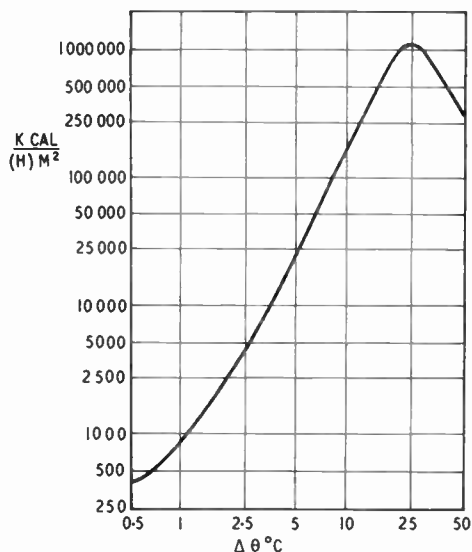

Fig. 6. Rate of heat transfer.

Thus if use is to be made of the latent heat of steam and the valve allowed to boil, some means must be adopted to prevent the formation of dangerous areas of local overheating.

#### 4. The Vapotron Valve

This need to prevent local overheating is achieved in the Vapotron by providing the

\* C. Beurtheret, “La technique des vapotrons,” *Revue Technique C.F.T.H.*, No. 24, December 1956

† C.F.T.H. Patent Nos. 706209; 718859; 725282

‡ W. H. McAdams, “Heat Transmission,” (McGraw-Hill, New York, 1955)



external surface of the anode with massive teeth (Fig. 7), the function of which are as follows.

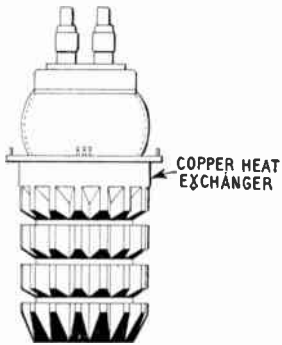

Fig. 7. Typical Vapotron valve.

Due to the thermal conductivity of the copper there is a temperature gradient between the roots and tips of the teeth (Fig. 8). Thus boiling first occurs at the roots. As the volume occupied by steam is 2,000 times that of water, considerable turbulence occurs and as the steam bubbles begin to move upwards they are directed out along the underside of the teeth away from the anode and thence to the surface of the water. Meanwhile, heat is conducted by the massive copper teeth away from the danger area at the root and transferred to the cooling water from those areas of the teeth not covered by steam bubbles, so preventing the root areas reaching the critical temperature of above 125°C. The limiting point is that at which serious boiling occurs at the tip of the teeth, thus entirely preventing wetting of the teeth by the water.

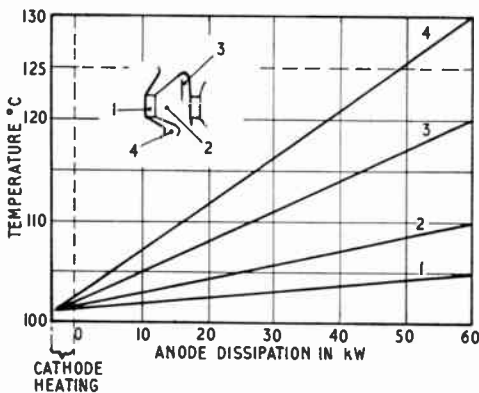

Fig. 8. Temperature variation on teeth of Vapotron anode.

Many tests have been performed on various teeth formations and also with coolers consisting of heavy copper tubing with holes parallel to the anode axis (Fig. 9), but the most efficient form is with individual teeth. Fig. 10 shows three typical types of Vapotron that are in operation in this country.

With this method it is possible to operate the anode at a dissipation of 150 W/cm<sup>2</sup> and even as high as 400 W/cm<sup>2</sup> for periods of several minutes. Thus from the point of view of valve design, anode dissipation can be virtually ignored, because the output which can be obtained from any given type of valve is limited by other factors, such as grid dissipation, filament emission, etc.

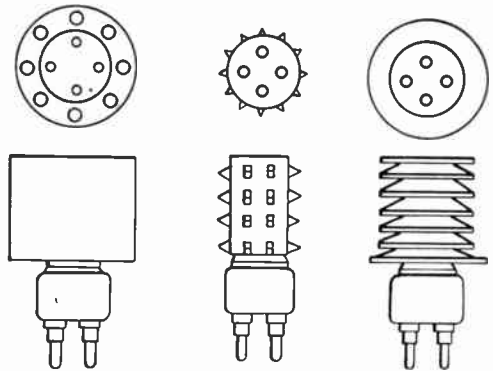

Fig. 9. Various teeth formations used with Vapotron.

### 5. Practical Arrangement

The practical application of this method of cooling is extremely simple (Fig. 11). The valve sits through an opening in the top of the boiler which is filled with water to the desired level. The boiler is in metallic contact with the anode and is, therefore, at full anode potential, being supported on suitable insulators. It can, however, be used in "earthed anode" arrangements.

The steam generated rises via the large pipe, which is of glass or similar insulating material, and passes into the heat exchanger. The condensed steam then returns by gravity via the small pipe to the bottom of the boiler. The system is open to atmosphere at the cool end of the condenser so preventing the build-up of dangerous pressures within the system. As the amount of water actually circulating is quite

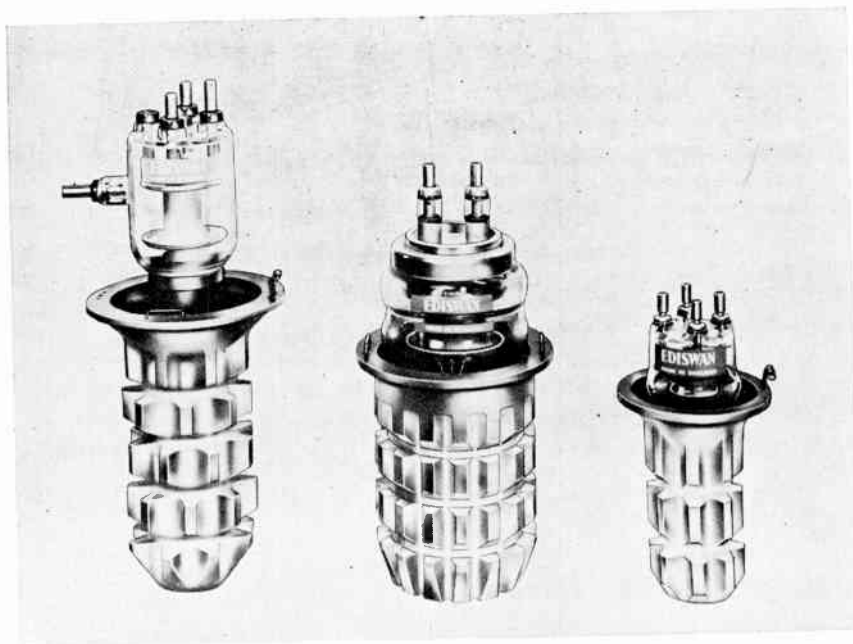

Fig. 10. Typical Vapotron valves in current use.

small and is, of course, distilled, the need for long insulating feed pipes is obviated; lengths of approximately 24 in. for the steam riser, and 36 in. for the water returns, are quite satisfactory for voltages up to 12 kV.

All that is necessary fully to protect the system against accidental damage are the following devices: (1) A thermal relay at the outlet end of the heat exchanger, set to operate

if steam reaches this point, which could happen with continuous overloading. (2) Pull-out lugs secured to the anode by suitable low temperature solder which will release a safety mechanism if the anode itself reaches a dangerous temperature due to loss of water in the boiler. The locations of these two safety devices are labelled (1) and (2) in the cooling circuits shown in Figs. 11 and 12.

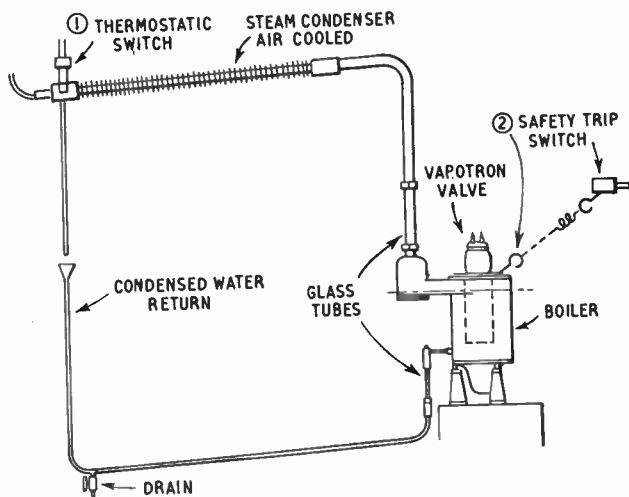

Fig. 11. Cooling circuit used with Vapotron.

Figure 12 shows a more elaborate system for high power installations, such as radio stations, etc. Either air- or water-cooled heat exchangers, or a combination of both may be used. The air-cooled heat exchanger can make use of natural convection or forced air cooling, depending upon the particular application.

### 6. The Boiler Condenser

For installations where the provision of a comparatively modest amount of cooling water is not an embarrassment (such as in induction heaters) there is a further system available (Fig. 13). In this the steam is condensed within the boiler by water flowing around the internal

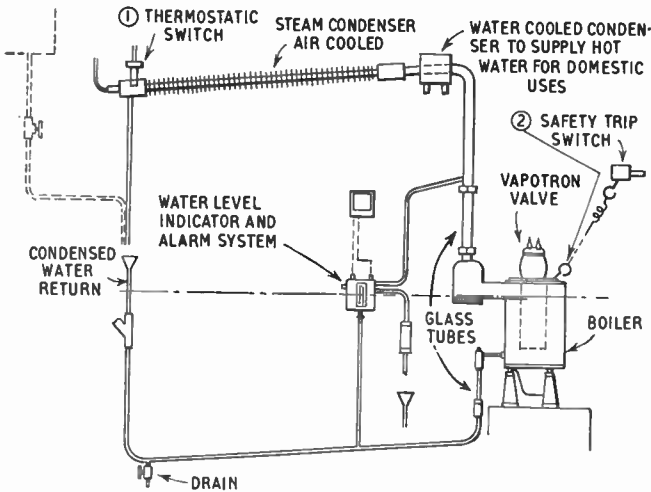

Fig. 12. Cooling system used with very high power installations of the Vapotron valve.

cooling pipes, which makes an extremely compact and efficient unit requiring only approximately one litre per minute of cooling water for every 4 kW dissipated at the anode of the valve. The equipment can be fully protected by pull-out lugs against the loss of water, and a simple pressure operated switch against continuous overload or failure of water circulation. Equipments are in use in this country with output powers exceeding 100 kW.

In operation the water level is not very critical since the boiling action causes violent upsurging of a steam and water emulsion adjacent to the anode surface which in turn

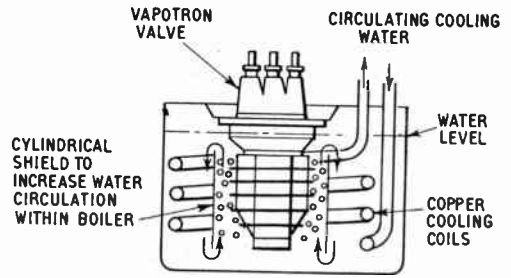

Fig. 13. Boiler condenser system.

causes the anode and its support collar to be effectively cooled, even though the collar is well above the normal cold water level.

Valves using the "Vapotron" method of cooling have now been in operation for several years in both radio and industrial equipments at frequencies varying from 500 kc/s to 200 Mc/s with completely satisfactory results.

### 7. Conclusions

The advantages of the system can be summarized as follows.

- (1) Increased dissipation for a given anode area.
- (2) Complete mechanical simplicity, as no pumps or boilers need be used.
- (3) The valve is completely silent in operation.
- (4) Very high overload capacity of approximately 100 per cent. for several minutes.
- (5) No lime formation on the anode surface. Even if tap water is used initially, it rapidly distils and deposits its small solid content.
- (6) Waste heat can easily be used, e.g. for space heating.
- (7) Short insulating path from valve to "earth".
- (8) Valves can easily be replaced without draining the system.
- (9) Little or no maintenance required.

### 8. Acknowledgment.

The authors would like to thank the management of Siemens Edison Swan Ltd., for permission to publish this paper.

523.164

**Site survey for a national radio astronomy observatory.** C. F. PATTENSON, N. W. BROTEN and G. AITKEN. *National Research Council of Canada, Radio and Electrical Engineering Division Report*. N.R.C. No. 4778, 27 pp., April 1958.

A search for possible sites for a radio astronomy observatory was made in British Columbia, and in Ontario and Quebec. Radio noise measurements in the frequency range 55 to 4,000 Mc/s were made at fifteen of the sites investigated. A suitable site was found near Penticton, B.C., and three possible sites were found in Ontario, all of which are subject to some radar interference.

523.164:523.5

**Analysis of meteoric body doppler radar records taken during a Geminid shower period.** M. SRIRAMO RAO. *Canadian Journal of Physics*, 36, pp. 840-854, 1958.

The determination of the prevailing wind in the 80-100 km region of the upper atmosphere by a new method, involving the simultaneous use of a c.w. doppler radar at 30.02 Mc/s and three-station pulsed radars at about the same frequencies, is presented. This method involves the determination of the exact location of each observed meteor train and the component of the velocity of its horizontal drift in the direction of the azimuth from Ottawa. A forty-minute period during the Geminid shower on the night of December 10/11, 1948, has been selected for this investigation. Theory of the analysis of the body doppler records is briefly outlined. The prevailing wind speed obtained from the body doppler frequencies ( $f_d$ ) is 54 m/sec. The observed linear variation in the average  $f_d$  with time, in the case of each meteor, has been explained as caused by the effective point of reflection drifting along its train towards the maximum echo duration level. Periodic fluctuations of  $f_d$  of the order of 1-3 c/s, on the average, have also been observed. The above two phenomena can be explained from a postulate of atmospheric turbulence on a scale of about 1 km or above.

621.318.13:621.317.4.029.5

**Studies on ferrite behaviour at radio frequencies.** I. TEODORESCU. *Telecomunicatii, Bucharest*, 11, pp. 108-113, May-June 1958.

The essential properties of ferrite materials in radio frequency electromagnetic fields are reviewed, as well as the associated measuring techniques. A new experimental method, permitting measurements in very weak r.f. fields to be made, is proposed. Due to its high sensibility, with this method some particular phenomena were observed, which had not been reported previously.

621.372.22

**The properties of lossy inhomogeneous transmission lines under matched conditions.** H. MEINKE. *Nachrichtentechnische Zeitschrift*, 11, pp. 333-339, July 1958.

The paper contains a summary of the possible technical applications of inhomogeneous lossy lines. The behaviour of a line with only series losses is based on the known behaviour of an equivalent lossless line. Various examples are used to demonstrate the increase in bandwidth of transformation circuits

*A selection of abstracts from European and Commonwealth journals received in the Library of the Institution. Members who wish to borrow any of these journals should apply to the Librarian, stating full bibliographical details, i.e. title, author, journal and date, of the paper required. All papers are in the language of the country of origin of the Journal unless otherwise stated. The Institution regrets that translations cannot be supplied.*

due to the presence of losses. A particularly simple individual case has no longer a lower cut-off frequency and exhibits an impedance transformation with low-pass properties.

621.373.44.018.756

**Three-phase pulse generator.** V. CHLOUBA. *Slaboproudny Obzor, Prague*, 19, pp. 217-221, April 1958.

The article describes a generator of three-phase square waves intended for experimental work with logical and arithmetic circuits employing the three-phase technique. The reasons which lead to the choice of principles are explained—a three-phase RC generator with shaping and power stages. On the basis of the vector diagram the expression for the frequency of the RC generator is derived and the procedure for designing the individual circuit elements is indicated. The amplitude of the output stage is regulated by a cathode-follower limiter. In conclusion the results of measurements on the completed instrument are presented.

621.375.132

**Measuring stability of feedback amplifiers.** S. VOJTASEK and V. ILSBERG. *Slaboproudny Obzor, Prague*, 19, pp. 201-205, April 1958.

The article explains the concept of "feedback margin of safety". Using the example of a simple amplifier, the method of computing the effective impedances at the point of opening the feedback loop is indicated. Three amplifier schematic diagrams and graphs of laboratory measurements are presented for the comparison of various methods. An interesting method of measurement which does not require the measurement of phase-shift is given.

621.391

**Transmission of speech with quantizing in only a few stages.** K. KUPFMULLER and W. ANDRICH. *Nachrichtentechnische Zeitschrift*, 11, pp. 389-392, August 1958.

The effect of quantizing of speech in only a few stages is investigated. The threshold values of the input voltages and of the reproduced amplitudes of the output voltages are used for the quantizing process. Both values are normalized to the maximum voltage amplitudes. The best threshold values and the best reproduction voltages for a small number of threshold levels can be determined experimentally. The intelligibility is better for an even number of threshold levels than in the case of an odd number of levels because of the interval noise in the latter case. Four threshold levels are alone sufficient for a useful intelligibility of speech in case of optimum adjustments.



621.395.52  
**A contribution to the theorem for adding noise voltages in long distance communication systems using amplitude modulation.** H. ZUHRT. *Nachrichtentechnische Zeitschrift*, 11, pp. 424-428, August 1958.

Steinbuch and Marko published in 1955 a general formula in the form of a double integral for the theorem of adding third order noise voltages in case of square law and cube law phase characteristics in repeater sections, and they evaluated this formula by graphical methods. For the purpose of supplementing this work the present paper contains a derivation for a numerical solution of the double integral for a square law phase characteristic. The result is in agreement with the graphical solution given by Steinbuch and Marko as long as the number  $n$  of repeaters is relatively small, while the result is somewhat more favourable in the case of larger values for  $n$ . A similarly favourable result is obtained for a cube law phase characteristic by means of a direct graphical integration of the initial integral.

621.396.621  
**Investigations into diversity reception using the method of aerial selection.** R. HEIDESTER and K. VOGT. *Nachrichtentechnische Zeitschrift*, 11, pp. 315-319, June 1958.

Diversity methods with receiver selection are compared with a method using aerial selection. The effects of delay in the receiver and of transient time responses on the method of aerial diversity equipment are described. A fully transistorized aerial diversity equipment is described with the aid of a block diagram and waveform diagrams. The measurements and operational experiences with this equipment are reported.

621.396.674.3  
**Measured self-impedance of a dipole antenna near a conducting cylinder of elliptical cross-section.** J. Y. WONG. *Canadian Journal of Physics*, 36, pp. 855-857, 1958.

This paper presents the results of an experimental investigation of the impedance of an axial dipole antenna located near a conducting cylinder of elliptical cross-section. Measurements were carried out for various spacings of the antenna from the cylinder along the major and minor axes, and for four different values of cylinder ellipticity. For a cylinder having a maximum dimension of 0.76 wavelength it is found that the impedance (resistive and reactive components) is an oscillating function of the antenna-to-cylinder spacing, having a period of approximately one-half wavelength. For spacings greater than one wavelength, the impedance is within 5% of the free-space dipole impedance.

621.396.677  
**The theory of helical antennas.** W. PETERS. *Nachrichtentechnische Zeitschrift*, 11, pp. 405-410, August 1958.

The characteristic properties such as beamwidth, bandwidth and matching of helical antennas for circular polarization are calculated. Various means for increasing the gain are investigated and a number of novel applications are mentioned.

621.396.677.3  
**Disc antenna.** J. VOKURKA. *Slaboproudy Obzor*, Prague, 19, pp. 511-515, August 1958.

The article presents an analysis of the radiation properties of surface wave antennas and derives an dichroic mirrors, is 20 cd/m<sup>2</sup>.

expression for optimum dimensions with constant surface waves. Introducing modulation of amplitude or phase velocity of the surface wave improves the properties of the antenna. For the realisation of a line with the prescribed phase velocity characteristics a periodic medium has been chosen composed of metal discs. The dependence of the surface-wave phase velocity of this structure on its geometric dimensions is derived in the second part of the article.

621.396.812  
**Determination of a value for the absorption of the ionosphere by an automatic statistical analysis of field strength records.** H. SCHWENCK. *Archiv der Elektrischen Übertragung*, 12, pp. 301-308, July 1958.

A simple method is described by which the non-deviative absorption of the ionosphere can be determined continuously by field-strength measurements at oblique incidence. The conditions of a suitable transmission path are discussed. An analysis of the field-strength's frequency-distortion measured by a statistical counter renders possible the separation of the main transmission paths from each other. Thus absorption values (A-values) for hourly-intervals can be determined immediately. For this purpose the absorption values are reduced to vertical incidence. Furthermore the state of the ionosphere may be derived from the distributions. Thus the mean reflection coefficient of the E<sub>s</sub>-layer at night as well as its frequency are immediately obtained. For the delayed diurnal variation of absorption dependent on the sun's zenith angle a simple formula is suggested.

621.396.821  
**Automatic recorder of the waveforms of atmospherics.** B. A. P. TANTRY. *Indian Journal of Physics*, 32, pp. 267-275, June 1958.

An automatic atmospherics recorder was constructed for recording the electric field-changes during the various lightning discharges. It consisted of several suitable units which were designed for obtaining complete, accurate and non-overlapping oscillograms with minimum waste of the recording film. The details of the component units and of the various associated circuits are described in the paper.

621.397.2:621.397.62:535.881  
**The projection of colour-television pictures.** T. POORTER and F. W. DE VRIJER. *Philips Technical Review*, 19, No. 12, pp. 338-355, 1958.

For reproducing colour-television images by projection methods three projection-type cathode-ray tubes are used with respectively red, green and blue fluorescing phosphors. Each is mounted in a Schmidt optical system (either of the "folded" type or of the "in-line" type). The superposition of the three primary-colour images is effected either by means of dichroic mirrors or by mounting the three primary-colour projectors side by side. In the latter case it is necessary to correct trapezium distortion; this and various other necessary corrections are discussed in detail. The authors conclude with some details about four colour-television projectors: two studio monitoring sets projecting pictures measuring 22 cm × 29 cm and 35 cm × 46 cm, the maximum luminance being 200 cd/m<sup>2</sup>; and two large-screen sets giving pictures 2.25 m × 3 m. The maximum luminance obtained from one of these large-screen sets, which embodies dichroic mirrors, is 10 cd/m<sup>2</sup>; that of the other, in which the three projectors are side by side, with no