

# The Journal of THE BRITISH INSTITUTION OF RADIO ENGINEERS

FOUNDED 1925

INCORPORATED 1932

*"To promote the advancement of radio, electronics and kindred subjects  
by the exchange of information in these branches of engineering."*

VOLUME 17

SEPTEMBER 1957

NUMBER 9

## NOTICE OF THE THIRTY-SECOND ANNUAL GENERAL MEETING

NOTICE IS HEREBY GIVEN that the THIRTY-SECOND ANNUAL GENERAL MEETING (the twenty-fourth since Incorporation) of the Institution will be held on WEDNESDAY, NOVEMBER 27th, 1957, at 6 p.m., at the London School of Hygiene and Tropical Medicine, Keppel Street, Gower Street, London, W.C.1.

### AGENDA

1. To confirm the Minutes of the 31st Annual General Meeting held on October 31st, 1956. (Reported on pages 587-589 of Volume 16 of *Journal* dated November, 1956.)
2. To receive the Annual Report of the Council. (To be published in October, 1957, *Journal*.)
3. To elect the President.

The Council is unanimous in recommending the re-election of George A. Marriott, B.A.(CANTAB.), as President of the Institution for the year 1957-8.

4. To elect the Vice-Presidents of the Institution.

The Council unanimously recommends the re-election of:

Leslie H. Paddle, John L. Thompson, Professor Emrys Williams, PH.D., B.ENG., and Professor E. E. Zepler, PH.D.

5. To elect the Ordinary Members of the Council.

The retiring members of the Council are:

Air Vice-Marshal C. P. Brown, C.B., C.B.E., D.F.C. (*Member*).

R. N. Lord, M.A. (*Associate Member*).

J. W. Ridgeway, O.B.E. (*Member*).

A. H. Whiteley, M.B.E. (*Companion*).

Consequently, under Article 28, vacancies arise for ordinary members of Council as follows:—

- 2 Members; 1 Associate Member; 1 Companion.

In accordance with Article 30, the Council nominates:—

(a) Member for re-election: Air Vice-Marshal C. P. Brown, C.B., C.B.E., D.F.C.

(b) Member for election: Col. G. W. Raby, C.B.E.

(c) Associate Member for election: S. J. H. Stevens, B.SC.(ENG.).

(d) Companion for re-election: A. H. Whiteley, M.B.E.

Any member who wishes to nominate a member or members for election must deliver such nomination in writing to the Secretary, together with the written consent of such person or persons to accept office if elected, not later than October 7th, 1957. Such nomination must be supported by not less than 10 corporate members.

6. To elect the Honorary Treasurer.

The Council unanimously recommends the re-election of G. A. Taylor (*Member*).

7. To receive the Auditors' Report, Accounts and Balance Sheets for the year ended March 31st, 1957.

The Accounts for the General and other Funds of the Institution will be published in the October, 1957, *Journal*.

8. To fix the remuneration of the Auditors.

9. To appoint Solicitors.

Council recommends the reappointment of Messrs. Braund & Hill, 6 Grays Inn Square, London, W.C.1.

10. Awards to Premium and Prize Winners.

11. Any other business. (*Notice of any other business must reach the Secretary 40 days before the meeting.*)

## SIR ARROL MOIR

The Council records with deep regret the death of Sir Arrol Moir, Bart. (Member), who was the Fifth President of the Institution.

Sir Arrol Moir was educated at Repton School and Cambridge University (Gonville and Caius College); he became president of the Cambridge University Engineering Society and graduated just before the outbreak of the first world war, in which he was commissioned in the Royal Engineers.

After the war, he qualified as an Associate Member of the Institution of Civil Engineers, subsequently being elected a Member of that Institution.

Sir Arrol became a Director of the Sir Ernest William Moir Company, founded by his father, the first Baronet; stimulated, no doubt, by his contacts and work at Cambridge, Sir Arrol's interests were, however, very much directed toward light engineering and physics. He was associated with a number of companies working in this field, and some years before the outbreak of the last world war acted as a consultant. He also gave a great deal of time and financial help to inventors, and was a Vice-President of the Institute of Patentees.

Sir Arrol's first interest in the work of the Institution was in connection with the stimulation of the education of what he termed "the engineer of the future," and his addresses and communications to the Institution stressed the importance of physics. Thus he contributed greatly to the Institution's work at a time when the Institution's policy regarding examination and qualifications for membership were being so thoroughly revised.

He became President of the Institution in 1940 and did much to help the Institution during the critical and first two years of the War.

He endowed the President's Prize, which is awarded annually to the most outstanding candidate in the Institution's examinations, but it was typical of his modesty that he did not want his name associated with the award.

Sir Arrol had been ill for very many years but always retained a keen interest in the Institution's work. He was particularly concerned with a system of analysis of abstracts of scientific papers which, in part, forms the basis of the Institution's own library service. He died at his home in London at the age of 62 on August 8th last.

## INSTITUTION NOTICES

### Proposed Institution Visit to Germany

The Institution has been invited to arrange for a party of members to visit Western Germany during 1958 to see factories, research laboratories and other establishments of interest to the radio and electronics engineer.

Before any definite plans are made it is necessary to know the support which would be given to such a tour and members interested are invited to advise the Secretary.

The visit will probably take place during May or June 1958 and will last about ten days, including travel to and from Germany. Ladies may be included in the party. In general, the mornings would be taken up with technical visits while some afternoons may be devoted to sight-seeing, etc. The cost would be approximately £68, including all travel charges, hotel accommodation and meals.

### Back Copies of the Journal

The Publications Department of the Institution wishes to acquire copies of the *Journal* dated July and August 1956. Members willing to dispose of their copies are invited to return them to the Institution; a payment of 5s. will be made for each copy. Please note that these are the *only* issues which are at present required.

### Closing Dates for Graduateship Examination

The last date for receiving entries from candidates wishing to sit the November 1957 Graduateship Examination at centres in the United Kingdom is October 1st. The examination will take place on November 21st-22nd.

Overseas candidates are reminded that entries for the May 1958 examination should be received by the Institution by November 1st, 1957.

# THE THIRD CLERK MAXWELL MEMORIAL LECTURE

## “The Diffraction of Short Electromagnetic Waves” \*

by

Sir Lawrence Bragg, O.B.E., M.C., F.R.S.†

*Delivered on June 27th, 1957, in the Clerk Maxwell Lecture Theatre,  
The Cavendish Laboratory of the University of Cambridge.*

I wish to thank you very warmly for the compliment you have paid me in asking me to give this lecture. I would like to begin by paying my tribute to Clerk Maxwell. My predecessors have done this so adequately that I feel some diffidence in adding my own contribution, yet I think it is fitting to do so because on an occasion like this we ought to remind ourselves what we owe to his genius. I will refer to two aspects of his work, the intellectual barrier which he broke through in founding the electromagnetic theory of light, and his contribution to establishing physics as a subject of university study.

To take the latter aspect first, this I feel is a case when it is appropriate to quote Wren's epitaph in St. Paul's—*Si monumentum requiris circumspecte*. We meet for this occasion in the Clerk Maxwell lecture room of the Cavendish Laboratory which he designed. The Cavendish was the first physics laboratory in this country to be planned for experimental work by students, and was a pattern for further university laboratories. I am not forgetting that Oxford built the Clarendon Laboratory just previously, and going farther back, that soon after Kelvin was appointed Professor of Natural Philosophy at Glasgow University in 1846 he fitted up a class-room in which students could learn experimental methods. But I think it is fair to say that the Clarendon was designed to demonstrate physical apparatus to students rather than as a place in which they could work

themselves. Now that physics has become so important a part of university training, it is hard for us to realize that before 1870 no university had a special building devoted to it. Though this Cavendish building in which we now are has a somewhat old-fashioned air, yet we recognize it as a real physics laboratory. Maxwell's notebooks in which he records his plans for the various rooms, for the lighting, sinks, electrical connections and so forth, are preserved in the Cavendish archives and have quite a modern ring. Maxwell was a great theoretical physicist, yet also a born experimenter of an ingenious and practical turn, and a firm believer in the value of experimental studies for students. He carved out a new realm of physics from what had been the province of mathematics on the one hand and chemistry on the other, and made it a subject in its own right.

Maxwell devoted most of his energies while at Cambridge to this creation of a laboratory. He only had eight years here before his early death at 48. His whole university life indeed was very short, three years at Aberdeen and five years at King's College, London, in addition to the tenure of the Cambridge Chair. He had begun his work on the Dynamical Theory of Gases before coming to King's College, but most of his great scientific work was done there between the ages of 29 and 34. It was remarkable in that he was responsible for starting two independent revolutions in scientific thought. The theory of gases was a first venture into statistical mechanics, the working of the laws of averages in vastly complicated mechanical systems. The electromagnetic theory was a “field” theory, an

\* Address No. 14.

† Director, The Royal Institution, London, W.1.

U.D.C. No. 535.4:539.26:621.37.029.65:92 Clerk Maxwell.

application of mathematics to the properties of space and not to the action between points at a distance. With these two contributions he gave physics an entirely new trend. Slow as the scientific world was to recognize the significance of his work, it might have been even slower had he not already made his reputation in a brilliant solution of the nature of Saturn's rings, a classical Newtonian analysis which established him, as people would now say, as "definitely U." Radical though his new ideas were, they could not be lightly dismissed by his contemporaries as the work of a crank.

His development of the electromagnetic theory is a fascinating example of imaginative scientific thought. Here is his statement of it, taken from the summary of his paper in the Royal Society *Proceedings* for 1864.

"Faraday, in his 'Thoughts on Ray Vibrations,' has described the effect of the sudden movement of a magnetic or electric body, and the propagation of the disturbance through the field, and has stated his opinion that such a disturbance must be entirely transverse to the direction of propagation. In 1846 there were no data to calculate the mathematical laws of such propagation, or to determine the velocity.

"The equations of this paper, however, show that transverse disturbances, and transverse disturbances only, will be propagated through the field, and that the number which expresses the velocity of propagation must be the same as that which expresses the number of electrostatic units of electricity in one electromagnetic unit, the standards of space and time being the same."

Faraday had intuitively guessed the existence of electromagnetic waves. May I remind you of the famous occasion at the Royal Institution in 1846 when Wheatstone, due to give the lecture of the evening, got stage fright and ran away? Ever since then we have kept up the practice of immuring our lecturer in a small room before he starts, guarded by the senior lecture assistant, and it is the Resident Professor's duty to take over the victim from his guard and duly deliver him in the lecture theatre. Faraday had to give Wheatstone's lecture for him and then at the shortest notice, Faraday dared to express thoughts he had hitherto kept to himself—the possibility of the propagation of

electromagnetic waves. Maxwell acknowledges his indebtedness to Faraday: "The electromagnetic theory of light, as proposed by him, is the same in substance as that which I have begun to develop in this paper," but it required Maxwell's mathematical skill to put it into precise form. He arrived at his relationships by a strange path. He needed some mechanical model which produced a sideways repulsion between the magnetic lines of force and a tension along them, so he filled the tubes of force with spinning liquid vortices, whose centrifugal force produced the repulsion and simultaneously the negative pressure along their length. To link together such spinning vortices, all turning the same way, he had idle wheels between them which transmitted the rotation from each to its neighbours. The model showed that if these wheels were set in motion in one part of an electromagnetic field, they would tend to start a counter-current in a neighbouring conductor through the intermediate action of the vortices they set in motion—Faraday's electromagnetic induction. But the model worked in a reciprocal way, it suggested that a change in an electric field should produce a magnetomotive force. Then he expressed the reciprocal relationship as a set of equations and discarded the model. The complex model is like the intricate and unwieldy mass of wooden props and casing into which Maxwell poured the liquid concrete of his ideas. When the concrete has set, the mould is knocked away and one is left with the slender symmetrical arch of the bridge linking the electric and magnetic fields, a bridge spanning a gulf of thought across which he has made it easy for us to pass. The change in magnetic induction produces an electromotive force in space, the change in electric induction a magnetomotive force in space. Action between points at a distance has gone. The waves, once launched, exist in space of their own right independent of their source and destination. This is the grand and revolutionary conception which we owe to him.

In the remainder of my lecture I propose to show you some experiments with short electromagnetic waves. I confess that I chose the title for my lecture because my very first scientific paper, read to the Cambridge Philosophical Society just 45 years ago, was

“The Diffraction of Short Electromagnetic Waves by Crystals.” As you know, we deal nowadays with a vast range of electromagnetic waves, from the radio waves which you study, to heat, light, X-rays, and the extremely short waves in cosmic rays. I plan to do some experiments with what I suppose you would call short waves, which are less than 1 cm in length. With these I shall show some of the classical interference effects of optics, and then when I have coaxed you into regarding them without suspicion, ask you to follow the extension of the same ideas to waves one hundred million times less in wavelength, the X-rays.

The centimetre wave equipment which I shall use in these interference experiments is a generous gift to the Royal Institution by Messrs. Marconi. The Royal Institution arranges demonstration lectures for boys and girls from schools in the London area throughout the school year. We show experiments to illustrate the fundamental principles of physics, chemistry and biology to large audiences of these young people. Since it is difficult to show interference effects with light to a large audience, the centimetre wave equipment has been a very valuable way of illustrating them. With it, one can illustrate practically any type of optical effect. For instance, in a waveguide lens, made of packed tubes, the phase waves travel faster in the tubes than in air, hence the converging lens is thin in the middle and thick at the outside.

[In the first experiment, the waveguide lens was mounted on an optical bench with an emitter of 0.87 cm waves at one end and a detector on the other. The amount of energy received by the detector was shown (a) by the lighting up of a lamp, (b) by the volume of noise from a loudspeaker, and (c) by the deflection on a large milliammeter. By sliding the lens along the bench, energy was focused on to the detector.]

My next illustration is of Young’s classical experiment, which established the wave theory of light.

[A plate with two slots was then placed in front of the emitter and a detector probe used. When only one slot was open the response was found over a wide area behind the plate with a maximum in line with slot and emitter. When the second slot was uncovered, the detector passed

through a series of maxima and minima—the Young interference fringes (Fig. 1).]

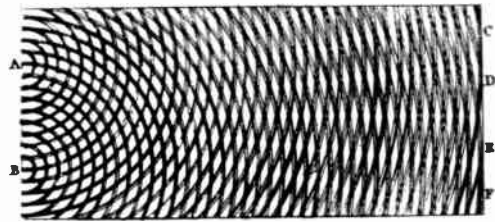

Fig. 267. Two equal series of waves, diverging from the centres A and B, and crossing each other in such a manner, that in the lines tending towards C, D, E, and F, they counteract each other’s effects, and the water remains nearly smooth, while in the intermediate spaces it is agitated P. 290, 464.

Fig. 1. Young’s interference patterns from his “Lectures in Natural Philosophy and the Mechanical Arts” (1807).

The next experiment demonstrates the well-known fringes outside the shadow of a sharp edge, first explained by Fresnel.

[A screen was placed half-way between emitter and detector. With the detector in the shadow of the screen, no appreciable effect was noticed. As the screen was moved across, the amount of energy received by the detector increased until it was about a quarter of normal when the edge was just in line with emitter and detector. Withdrawing the screen still further, the energy rose to above normal and then went through a series of fluctuations ending in the normal value.]

Another classical experiment is the existence of the bright spot of light at the centre of the shadow of a circular disc. You will remember how Fresnel, when he enunciated his theories of diffraction, was challenged by his critics, who pointed out that if he were right, there would be a bright spot of light at the centre of the shadow: they regarded this argument as a *reductio ad absurdum*, disproving Fresnel’s theory. Fresnel tried the experiment and triumphantly demonstrated the existence of the spot.

[In the fourth experiment a circular disc was moved across the path of the waves. When its centre came in line with emitter and detector a strong response was obtained due to the waves passing round the edge of the disc to reinforce each other on the axis.]

Let us pass now to waves a hundred million times as short—the X-rays used in experiments

on diffraction by crystals. A crystal is a set of scattering points arranged in a three-dimensional pattern, each point only scattering a minute fraction of the incident radiation. We are familiar with the diffraction of light by the regularly arranged lines on a grating, which is a one-dimensional pattern. It is rather more complex to understand how a three-dimensional grating diffracts waves. A helpful idea is to consider the waves as being reflected by the sheets of atoms in the crystal and then take

plates of potassium chlorate crystals. These have a habit of repeatedly twinning at short regular intervals comparable with the wavelength of light. A small proportion of the amplitude is reflected at each twin interface owing to the slight change in refractive index.

[A number of crystals, mounted on a piece of black velvet, were turned in the light from an arc lamp to throw reflected beams on a screen; the brilliantly coloured patches of light changed hue as the crystals were turned.]

In X-ray analysis, the crystal is placed in a collimated beam of monochromatic X-rays. As it is turned round, reflected beams flash out at appropriate angles of incidence for each set of reflecting planes. In talking about X-ray diffraction, I have often asked the audience to imagine they had X-ray sensitive eyes, and have asked them to realize that in this case they would see a mass of crystals glowing with pure colours as the crystals were turned about. I find it fascinating that quite recently a crystal has been produced the pattern of which is on so large a scale that the diffraction effects are actually observed with visible light. It is a form of virus discovered by Dr. Kenneth M. Smith and Professor Robley C. Williams. The virus molecules are very large indeed and the planes of the crystal pattern are comparable with the wavelength of light. These investigators have kindly lent me a coloured photograph of the mass of the virus crystals showing them glowing with most striking colours when illuminated with white light.

[These diffraction effects were then repeated using the centimetre wave equipment with the emitter representing the X-ray tube. A set of vertical rods to scatter the waves represented the crystal and the detector was mounted on a rotating arm with the "crystal" on the axis of rotation. The energy received was shown on a cathode-ray tube; as the "crystal" was rotated, a servomechanism enabled the direction of displacement of the trace from the centre of the screen to rotate in step with the "crystal." As the receiver was moved round the "crystal," strong reflected beams were found in certain places. Owing to the four-fold symmetry of the "crystal" corresponding planes came into position four times during rotation, so that the cathode-ray beam showed four loops at the corners of a square. By moving the receiver around the "crystal" a number of characteristic groups of diffracted beams could be shown.]

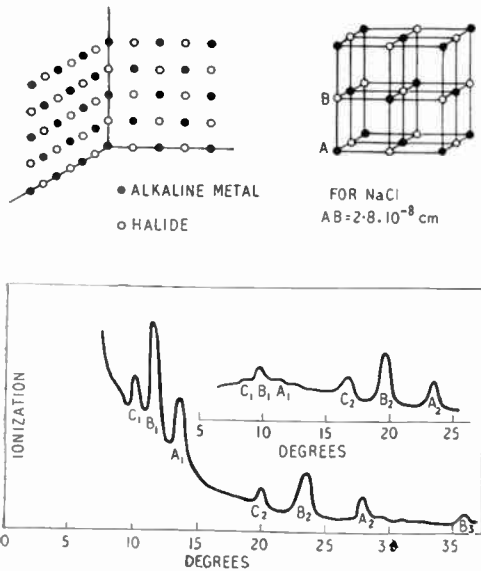
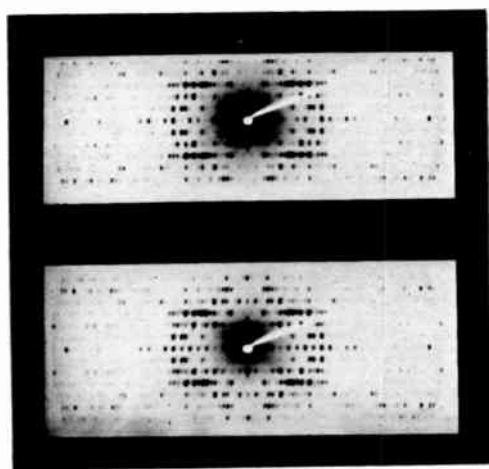

Fig. 2. X-ray reflections from two faces of rock salt crystal. The lower curve refers to the reflection from the (100) or cube face parallel to which the successive sheets of atoms are identical; the upper curve to the (111) or octahedral face parallel to which there are alternate planes of sodium and chlorine atoms.

into consideration that we will only get a strong reflected beam if the waves from successive sheets are in phase. We get similar effects with light. Opal and mother-of-pearl owe their colours to the reflection of light by a series of planes where there are slight changes in refractive index. When white light of all wavelengths falls on an opal, the wavelength of the component which is reinforced on reflection depends on the spacing of the planes and the angle of incidence—hence the play of colour as an opal is turned about in the light. The effect is rather beautifully shown by thin



0 10 20 30 40 50 A

**Fig. 3.** (a) (above). The photographs show the diffraction effects produced by a protein crystal, and by the same crystal when a pair of mercury atoms has been attached to each molecule. They are very similar, but if examined carefully it will be noted that there are differences in the intensities of the spots. These differences reveal the positions of the heavy atoms, and enable us to unravel the diffraction pattern and form a picture of the molecule.

(b) (right) The molecule of the protein haemoglobin, as seen from two points of view at right angles. The contours outline the parts of the molecule which are denser than the water by which they are surrounded. The small unit marked Fe shows the relative size of the haeme group in the molecule which transports the oxygen in the blood.

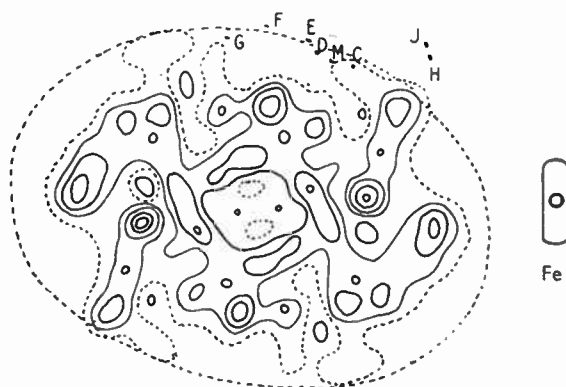

10 20 30 40 50 60 70 80 A

The first crystal to be analysed was sodium chloride. This has a simple chequer-board alternation of sodium and chloride atoms. Fig. 2 shows how the diffraction effects indicated the structure. We may regard it as almost the simplest possible structure for a crystal, with the position of every atom fixed by symmetry. Contrast this with the kind of crystal we are now trying to analyse in the work in which I have been especially interested. They are crystals composed of protein molecules, each molecule containing some 10,000 atoms. They are of fascinating interest because they are constituents of living matter, but the complexity of the X-ray analysis is very great indeed. They give very regular diffraction effects and one can measure many thousands

of diffracted beams. To me, one of the most exciting events in X-ray analysis has been the successful extension of it to such problems. A powerful way of tackling the problems has been devised by Dr. Perutz working in the Cavendish Laboratory. Heavy atoms are attached to the molecule in known positions, rather like staining a section on a microscope slide. The difference in the strength of the diffracted beams due to the addition of the heavy atom can be made the basis of an analysis, and Fig. 3 shows briefly how the method works.

In conclusion may I once more thank you very much for your kind invitation to give this lecture and say how much I appreciate it.

## THE 1957 NATIONAL RADIO SHOW

MUCH of this year's Show was associated with the 21st anniversary of the world's first high-definition television broadcast, made by the B.B.C. on August 26th, 1936, and a display of several 1936 receivers gave an idea of the advances in this period. The exhibits as a whole continue to be dominated by domestic radio and television receivers which represent only part of the industry's activities.

This year's attendance, which was 330,455, only 8,000 fewer than last year, indicates its public appeal and the Show is becoming increasingly more useful as a "shop window" from the point of view of exports; the attendance of overseas visitors, nearly 6,000, was an increase of 1,150 over 1956. From the viewpoint of the engineer, however, there is regret that the industry's other activities are not more prominently featured. The alternative of more specialized events mentioned in earlier issues of the *Journal*\* is only partly answered by the individual participation of radio industry firms in exhibitions such as that organized by the Society of British Aircraft Constructors at Farnborough (see page 480).

From the viewpoint of the "domestic" industry, as it might be termed, main interest centres around miniaturization of both radio and television receivers. Transistors are being used in several portable receiver designs as well as in gramophone amplifiers. The trend in television receivers is to reduce the amount of cabinet around the edges of the cathode-ray tube screen to give an impression of maximum tube size and this has necessitated much ingenuity in "wrap-round" chassis and miniaturization of circuits; printed wiring is used in a number of models to achieve this. Another feature in this year's show which was barely apparent last year is the inclusion of the Band II v.h.f. f.m. sound broadcasting channels on three of the positions of the tuner. The portable, or more accurately, transportable television receiver has continued to develop and over half a dozen different models were on show. Technically the receivers are in general miniaturized versions of standard television receivers and most models use 14 in. tubes.

\* "Mirror of progress," 13, p. 289, June 1953; "Specialist exhibitions," 15, p. 593, December 1955.

The size of tube used in television receivers continues to increase and the 21-in. tube receiver has this year been introduced in numbers almost as great as the now standard 17-in. There must be some limit to the size of screen as determined by the viewing distance in ordinary dwelling houses and since there is as yet little indication of a tube larger than 21 in. this may well be that limit. The main advance in tube design is the greater use of 90 deg. scanning which will enable the depth of sets using these larger tubes to be little more than the smaller size tubes employing 70 deg. scanning. It is probable that the 110 deg. tube will be seen in the near future in production models although its utilization naturally calls for higher power time-base circuits.

The industry is well aware of the shortage of trainees and it is encouraging to note the policy of the Radio Industry Council in continuing to include in the official exhibits a Technical Training Stand. As an enquiry bureau, it can serve a useful purpose in attracting the attention of the general public to the openings available in the radio industry. It is a pity, therefore, that this stand also tended to over-emphasize the domestic side of the industry and failed to give a very clear indication of the means of training and qualifying in the profession itself. The sections hitherto provided by Technical Colleges in the London area were much reduced and the impact and practical interest of the stand to the potential entrant to the Industry was thereby lessened.

A static exhibit drew attention to the radio investigations associated with the Geophysical Year, while the General Post Office this year showed their random number equipment ERNIE. The only Services stand this year was that of the Royal Air Force, who provided a certain amount of information about the role of guided weapons. The opportunity was taken to emphasize that whilst the Armed Services may be cut in actual manpower, the recruitment of high-grade technicians, engineers, and other scientific personnel is increasing. The technical exhibits by the Post Office and the B.B.C. also were concerned with recruitment and aimed to show the type of work which the new entrant might expect to do.



# THE ROLE OF GAMMA-RAY LEVEL DETECTION SYSTEMS IN CHEMICAL PLANT INSTRUMENTATION\*

by

E. W. Jones†

*A paper presented at the Convention on "Electronics in Automation" in Cambridge on 28th June, 1957. In the Chair: Dr. Denis Taylor.*

## SUMMARY

There is a wide diversity of requirements for fluid level gauges in chemical manufacturing processes. Gamma-ray instruments have the outstanding feature that they can operate entirely from outside the vessel. While they are admirably suited to on/off control at a fixed level or continuous indication over a short range, installations become expensive and cumbersome for continuous vertical ranges greater than about 3 ft. Radiation safety aspects are discussed and a typical installation for a glass melting furnace is described.

### 1. Introduction

The need for indication and control of the level of vessel contents occurs widely throughout chemical manufacture, both in continuous processes and in those carried out on a batch basis.

In batch processes, it is necessary to ensure that the correct quantities of ingredients are measured out—perhaps before they are introduced into the reaction vessel—and although these quantities must sometimes be measured by weight, it is often sufficient to use a simple volume measurement. In the reaction vessel itself, it may be important to ensure that overflow or boiling over does not occur, and it may be essential to detect automatically the point at which the vessel is completely emptied at the end of the reaction.

In continuous flow processes it is frequently necessary to employ reservoirs or surge tanks to take up short-term differences in flow-rate between stages of the system and it may be important to initiate an alarm or automatic control action when the contents level in the surge tank exceeds the normal working limits. In the reaction vessel itself it may be necessary, in the interests of reaction efficiency, to control the contents level to fine limits by regulating automatically the input or output flow-rate in response to signals from a level detecting

element. Apart from the normal raw materials of the process, it may be important to control the level of a continuously replenished, or regenerated catalyst in a cracking column or synthesis plant.

In nearly all types of large-scale manufacturing process, it is also essential to have storage space, in the form of bunkers, hoppers, or tanks, to receive the incoming raw materials and to hold the outgoing product before shipment. Filling large quantities of bulk materials into such silos calls for some form of instrumentation to indicate and control contents level.

There is an extremely wide diversity of vessels, fluid materials, and working conditions to be catered for. Containers may range from glass-lined steel drums to refractory-walled furnace tanks or gasifiers, and contents may include corrosive chemicals at high pressure, slurries which set like cement on settling, molten metals or glass, viscous liquids such as latex, tar, etc.

The conventional methods of level measurement or detection include purely mechanical devices such as dipsticks and floats, hydrostatic systems measuring differences in pressure head or buoyancy, electrical conductivity detectors, electrical capacitance measuring systems, optical systems depending on the interruption of light beams, pneumatic systems which measure back pressure built up as the liquid surface approaches an air jet, etc., etc. Each of these systems has its own advantages and disadvantages and it is, of course, good practice to select the instrument best suited to the process conditions. The most

\* Manuscript received 14th June 1957. (Paper No. 413.)

† Isotope Developments Ltd., Beenham Grange, Aldermaston Wharf, Berkshire.  
U.D.C. No. 621.384.7.

outstanding property of the gamma-ray method, compared with all the other systems mentioned above, is that it can operate entirely from outside the vessel and usually requires no special ports, diaphragms, windows, lenses or probes to be fitted in the vessel walls. This implies four useful advantages:

Firstly, the design and construction of the vessel can be simplified—an important consideration for high pressure vessels, glass-lined tanks, refractory-lined furnace tanks, etc.

Secondly, it facilitates the installation of the measuring element on existing plant, even under working conditions, so that the instrumentation can, if necessary, be installed and subsequently serviced without causing any “down-time”, when the plant is already operating.

Thirdly, it means that satisfactory instrument performance is almost entirely independent of the nature of the vessel contents provided that they have sufficient mass to absorb gamma-rays appreciably. The methods can, therefore, be used with very viscous fluids, with bubbling or agitated liquids, with explosive materials, granular solids, fluidized powders, etc.

Finally, the instrument components themselves can be readily protected against mechanical or chemical damage due to drastic conditions obtaining within the vessel, such as severe vibration, abrasion by lump solids, corrosive action, high temperature, etc.

## 2. The Gamma-ray Level Measuring System

The basic components of a gamma-ray level measuring system are:

(1) A long-lived radio-active source, in a suitable holder.

This isotope is usually cobalt 60 (half-life 5.3 years), caesium 137 (half-life 33 years) or radium (1600 years).

(2) A gamma-ray detector.

This is usually a Geiger-Müller counter tube, but may be an ionization chamber or even a scintillation counter.

(3) An electronic unit.

This converts the detector output to a useful electrical indicating or control signal. In the case of Geiger-Müller tube detectors, the electronic unit comprises a pulse-rate meter whose d.c. output can be displayed on a meter or recorder, can be used to operate relays, or

can be fed into a proportional or 3-term controller.

Owing to the physical size of the components and the way in which gamma-rays are absorbed, the method is particularly suited to “two-step” detection or control, at a fixed level. It is also suitable for continuous level indication over small ranges up to, say, two or three feet. For continuous indication over greater ranges than this, the system generally becomes clumsy or completely impracticable, depending on the type of vessel.

For two-step, or on/off control, it is simply necessary to mount source and detector on opposite sides of the vessel at the critical level. The increase of signal strength as the contents fall below this level, is usually more than sufficient for reliable operation of a control relay. Thus, the trip level of the relay can be set so that there is no further need for adjustment over the period of one source half-life. Re-calibration is not required, and no access to the contents is necessary in order to determine the level at which control is taking place. Generally accuracy within  $\pm \frac{1}{4}$  in. is easily achieved.

Figure 1 shows schemes which can be used for continuous level indication over a moderate range. The difficulty with these schemes for continuous level indication is that calibration curves are not always linear unless special care is taken to distribute the source activity or the detector sensitivity. Furthermore, it is always necessary to calibrate the instrument in the first place by making absolute determinations of the contents level over the whole range. There is the additional drawback that the meter calibration becomes inaccurate as the source decays, and this must be compensated for by adjusting the ratemeter sensitivity at intervals. A cobalt 60 source decays by 1 per cent. in about 24 days, and a caesium 137 source in about 6 months. Since pulse ratemeters can be expected to operate with an accuracy of  $\pm 1$  per cent., the overall accuracy on a continuous level indicator may be about  $\pm 2$  per cent. of the range.

It is possible to extend the range of level measurement still further by using long vertical sources (e.g. of cobalt wire) and long detectors, but, in practice, these long sources are difficult

and cumbersome to shield, and long detectors are not readily available commercially.

Measurement of level in terms of gamma-ray absorption by projecting gamma-rays vertically through the tank contents is limited by practical considerations to about 3 or 4 ft. (of water) and this absorption method results in a logarithmic law giving poor accuracy over the high level part of the range. Furthermore, readings are dependent on the density of contents so that the instrument measures weight of contents rather than volume.

voltage (400V) halogen quenched type. These tubes are very robust and have a working life which is independent of the number of pulses conducted. Their temperature rating is from  $-55^{\circ}\text{C}$  to  $+70^{\circ}\text{C}$  approximately, so that they may be operated at the outside of many industrial vessels without artificial cooling. Reliability and component life is thus comparable with the best types of equipment employing electronic valves. The maximum pulse-rate of operation is about 1000 counts/second, but in the interests of radiation safety,

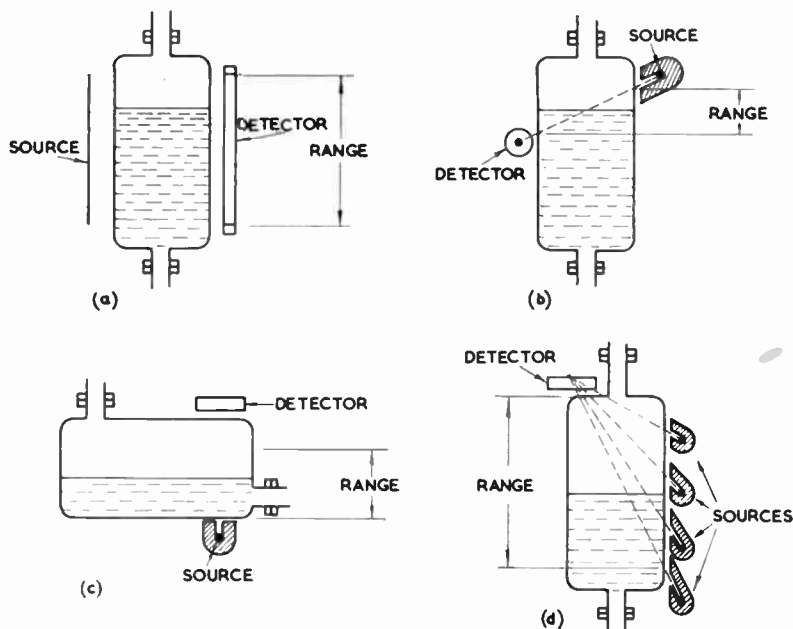

Fig. 1. Alternative schemes for gamma-ray level detection.

Probably the best practical way of covering a large vertical range of level variation by the gamma-ray method, is to employ an on/off system and arrange for both source and detector to be traversed vertically together. The traversing gear can be driven by a reversing motor controlled by the detector relay, so that source and detector follow any changes in level and are always positioned in line with the liquid surface. For a large vessel the main cost of the installation would be in the mechanical traversing gear and electrical drive.

The Geiger counters commonly used as detectors for level measurement are of the low

they are normally operated at about 100 counts/second or less.

Owing to the random nature of radio-active emissions, the detector signal has a statistical fluctuation for which the standard deviation is related to the square root of the number of pulses received during the integrating time of the ratemeter.

For simple on/off systems, a count-rate of 30 counts/sec, with a response time constant of 8 seconds, gives a signal fluctuation of about  $\pm 7$  per cent., while the change in signal for control action is usually of the order of 100 per

cent. or more. It is good practice to introduce artificial backlash into the relay system to prevent any chattering of relay contacts due to statistical fluctuations as the control level is approached. Response times are easily adjustable by changing a resistor or capacitor in the circuit. For more accurate continuous level indicators, the response time is usually of the order of 40-80 seconds, so that statistical fluctuations are not apparent on output recorder traces.

**3. Safety Precautions**

Any measuring equipment which is employed for automatic control in industry should be designed in such a way that it fails to safety, or gives immediate warning in the case of a breakdown. The fact that there is always a small natural background of ionizing radiation, due to natural radioactivity and cosmic rays, makes it possible to provide a foolproof safety system since, no matter what level conditions exist in the vessel, there should always be a small background signal, at least, at the detector. It can be arranged that a relay is kept energized by this signal so that any failure of the equipment causes the relay to drop out and thus actuate safety circuit or alarms.

In considering the question of radiation safety in conjunction with radio-active sources installed on industrial plant, two types of radio-active hazard must usually be taken into account:

Firstly, there is the danger of ingestion or contamination due to radioactive materials escaping from the source container. This risk can be eliminated if standard radiographic source capsules are used—as supplied by the Atomic Energy Research Establishment, Harwell (cobalt 60), or The Radiochemical Centre, Amersham (caesium 137 and radium). These capsules are very carefully sealed so that there is no risk of any escape of the radio-active material, and the pellet itself is then housed in an aluminium alloy source holder, and provided with a tag which carries a serial number for identification. The tag can be used for securing the source in its lead housing.

Secondly, there is the hazard due to direct exposure of the body to external gamma radiation. This has been dealt with in special Recommendations made by the International Commission on Radiological Protection and endorsed in Factory Form 342, issued by Her Majesty's Stationery Office. It is understood that Regulations are being worked out based on these Recommendations and that they may be incorporated in the Factory Act in due course. The Recommendations lay down a Maximum Permissible Level (M.P.L.) for gamma-ray dose to be received in any working week by persons who may be exposed to radiation in the course of their work. Over a 40-hour week, this Maximum Permissible Level corresponds to 7.5 mr/hr. Obviously all steps should be taken to ensure that the actual dose received is below this maximum permissible level.

A dose-rate of 7.5 mr/hr. corresponds to about 750 counts/second in a typical Geiger-Müller counter tube, for gamma-rays from cobalt 60 or caesium 137. A level detector or level indicator can, therefore, operate satisfactorily with a dose-rate of about 0.3-1.0 mr/hr. at the detector site.

Source holders are designed so as to surround the source pellet with a shielding material (usually lead) on all sides except for an aperture directed towards the detector. Within the "beam"

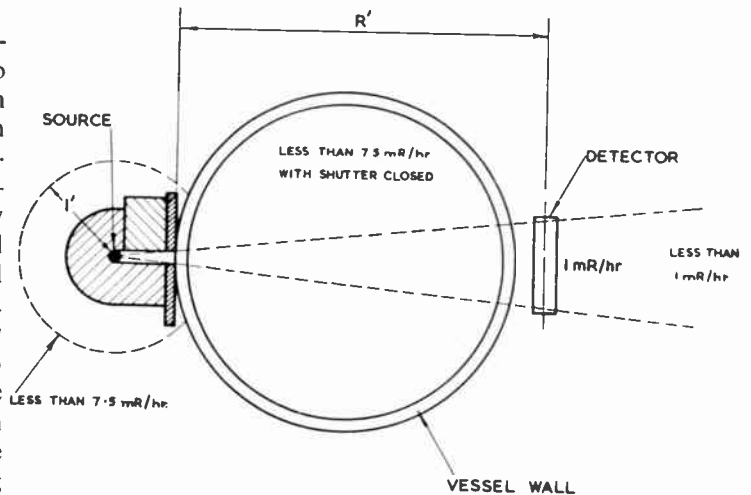

Fig. 2. Specified radiation levels in the vicinity of a tank equipped with a gamma-ray level detector.

from this aperture, the radiation intensity is below M.P.L. at all points beyond the detector, but may be above M.P.L. inside the vessel.

In order that the radiation level outside the "beam", and at 1 ft from the source holder, shall be no greater than the M.P.L., the source shield must attenuate the radiation by a factor  $7.5\alpha/R^2$  approx., where  $R$  is the source-detector distance in feet and  $\alpha$  the attenuation factor due to the vessel walls (see Fig. 2). In practice it is found that source strengths ranging from 0.5 to 250 mc are required, and the lead thickness necessary to shield these may range from 1 in. to 5 in.

In order to permit workers to enter the vessel from time to time for maintenance purposes, some form of removable shield must be provided at the front of the source unit to cut off radiation beams when required. Source housings are, therefore, often fitted with an internal shutter device controlled by a handle from the back,

which makes it possible to open up a collimating radiation aperture at the front. Thus the holder, when closed, forms a suitable container for storage or transit, and facility is provided for switching off the beam during maintenance periods, etc.

Where large sources are required, the source unit itself accounts for a substantial part of the cost of the equipment and it may call for specially constructed mounting brackets. On the other hand, a large number of applications can be dealt with by small source holders which can be carried in the hand and are usually mounted with four bolts.

The source activity required depends, of course, on the diameter of the vessel, the material and thickness of its walls, and the signal strength required to give the desired accuracy and response speed.

**Table 1**  
Source Strengths in millicuries

DISTANCE (feet) Source/Detector:		2	3	5	8	10	15	20	30
3"	Co60	1	1	3	10	10	20	40	80
	Cs137	2	4	10	30	40	90	160	360
1 1/2"	Co60	1	2	5	20	20	40	80	160
	Cs137	10	20	40	100	160	360	—	—
2 1/4"	Co60	2	4	10	30	40	80	150	—
	Cs137	30	60	160	—	—	—	—	—
3"	Co60	3	10	20	50	70	—	—	—
	Cs137	100	230	—	—	—	—	—	—
4 1/2"	Co60	20	30	70	180	—	—	—	—
	Cs137	—	—	—	—	—	—	—	—
5 1/4"	Co60	30	50	150	—	—	—	—	—
	Cs137	—	—	—	—	—	—	—	—
6"	Co60	50	100	—	—	—	—	—	—
	Cs137	—	—	—	—	—	—	—	—

*N.B.*—In each case, radiation through empty container is less than 1 tolerance at detector (calculated for each source strength and each application).

4. Applications

Table 1 gives a list of cobalt 60 and caesium 137 activities for various vessel diameters and wall thicknesses. The wall thicknesses are given in terms of steel. Table 2 gives appropriate factors for converting other wall materials to the equivalent thickness of steel.

A typical case of industrial level instrumentation by gamma-ray methods, is the indication of level of molten glass in melting furnaces, such as are used in the bottle-making industry. The furnace tanks normally contain about 70-100 tons of glass at a temperature of 1100°C, and this is distributed through a number of feeder channels to bottle-making machines. The level of glass in the channels is closely related to that in the main furnace tank, so it is possible to site the measuring element on one of the channels rather than on the tank itself.

At the end of the feeder channel a reciprocating plunger allows "gobs" of glass to escape to the moulding machines and it is necessary to control level fairly accurately in the feeder so as to ensure that the raw materials are being fed into the furnace tank at a steady rate equivalent to the output rate, and also to ensure that the size of "gob" does not vary due to changes in hydro-static head. Under typical conditions it is considered necessary to control the glass level within  $\pm \frac{1}{16}$  in. throughout a production run, and to have indication of any extreme deviations which may occur up to  $\pm \frac{1}{2}$  in.

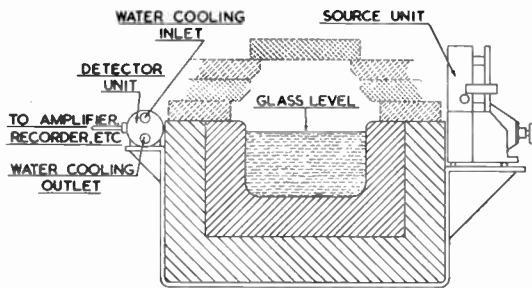

Fig. 3. Method of mounting source and detector unit on feeder.

Figure 3 shows the cross-section through a typical feeder channel, the walls of which consist of 5 in. of Sillimanite refractory with an equal thickness of insulating brick-work and a casing of  $\frac{3}{8}$  in. mild steel. The internal width

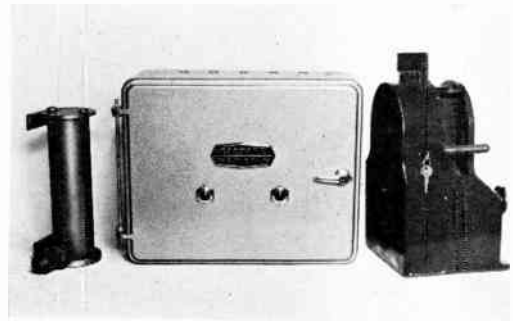

Fig. 4. Flame-proof detector, electronic unit, and source unit as used for continuous level indication on glass furnace fore-hearth.

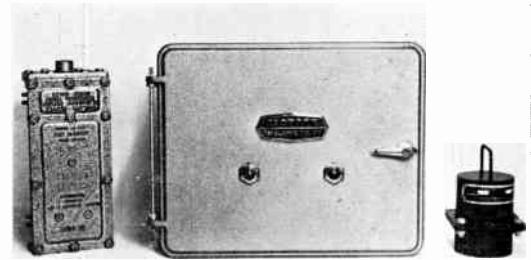

Fig. 5. Detector, electronic unit, and source unit suitable for on/off level detection.

of the feeder is about 18 in.

Instruments which have been introduced previously for glass level control, suffer from the fact that some component (e.g. electrical con-

Table 2

To convert the thickness of any material to the equivalent thickness of steel, multiply by the conversion factor given below:

Aluminium	0.35	Limestone	0.35
Asbestos	0.31	Nickel	1.12
Asphalt	0.17	Porcelain	0.31
Brass	1.09	Rubber	0.15
Brick	0.23	Silica	0.31
Cardboard	0.09	Sillimanite	0.29
Cement	0.36	Slag	0.38
Cork	0.03	Slate	0.38
Glass	0.33	Steel	1.00
Iron (cast)	0.94	Water	0.13
Iron (wrought)	1.00	Wood (hard)	0.10
Lead	1.41	Wood (soft)	0.06

tact probe) must be introduced into the hot atmosphere inside the feeder and be subjected to corrosion due to the furnace gas flames above the glass. A gamma-ray level gauge can be installed without shutting down the feeder, since the external temperatures are usually not more than 150°C. It is, however, necessary to water-cool the detector unit. The source strength required to give a useful signal at the detector is about 150 mc cobalt 60, and this must be contained in a lead housing which weighs some 170 lb. The source unit and water cooled detector are shown in Fig. 4 together with the electronic unit. Similar components sometimes used for on/off control are shown in Fig. 5.

The signal from the detector unit can be connected to a remote ratemeter whose output may be displayed on a recorder calibrated in inches of level. The response time-constant of such a gauge is usually about 80 seconds and the type of calibration obtained with the counter tube horizontal is shown in Fig. 6.

Using a vertical Geiger counter tube the calibration can be made linear over a wider range with a slight decrease in accuracy at the centre of the scale.

In most of the installations carried out to date, it has been found that considerable improvement in operating conditions is achieved when the operators responsible for feeding in raw material are provided with a continuous record of level changes, and it is an obvious subject for automatic control.

The type of batch feeding equipment varies from one furnace to another, and in some cases the machinery is only suitable for on/off control. In other cases it would be possible to provide a continuous 3-term control system by feeding the output of the ratemeter into a self-balancing

potentiometer recorder/controller with pneumatic output—the pneumatic signal being used to regulate feed speed through a variable gear drive.

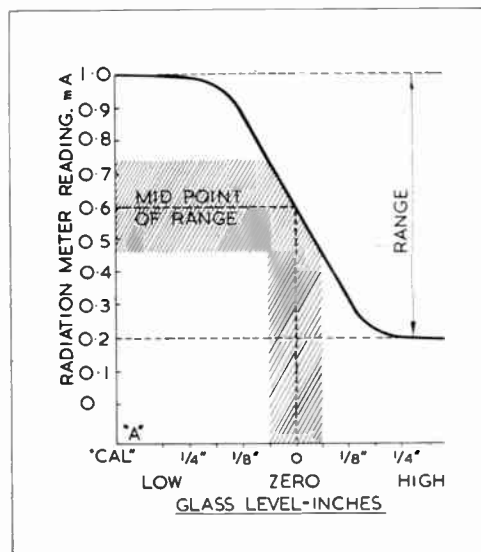

Fig. 6. Straight line relationship between glass level and radiation meter reading.

Gamma-ray level gauges are already regarded as standard equipment in the glass-container industry and fully automatic control systems are becoming available.

In many other processes where the gamma-ray method is being evaluated in comparison with existing systems, it would appear that, since complete radiation safety can usually be attained, the main disadvantage is in the relatively high cost of the equipment. Its most important role may, therefore, be for plant where simplicity of installation procedure and easy accessibility represent an appreciable economic saving.

## FARNBOROUGH 1957

**T**HE British electronics industry was well represented at this year's Exhibition of the Society of British Aircraft Constructors held at Farnborough, Hampshire, from September 2nd to 8th last; over 60 of the 300 odd stands were those of firms active in the radio industry. The items shown by many of the exhibitors pointed the fact that this Exhibition provides virtually the only opportunity for the industry to show communications, radar and allied equipment as opposed to that for domestic broadcasting and industrial applications.

Electronics now plays an essential part in both civil and military aircraft and this year saw the partial disclosure of details of guided weapons now in production for the Services. Details of the electronic circuits which transform a rocket into a guided missile were necessarily meagre and mainly confined to a demonstration of how the scanner in the radar homing head of a ground-to-air general purpose test vehicle locks on to its target, following its evasive action, and operates the control fins so as to steer towards the target. This type of missile is operated in conjunction with a ground radar which illuminates the target, the homing head picking up the reflected pulses.

Two typical air-to-air missiles were also shown, one of which is directed by radar from the launching aircraft while the other has a passive homing system using infra-red sensitive photocell. Parts of this second missile, the Firestreak, were shown, though not the infra-red homing device, and some idea could be gained of the electronic techniques employed which include the use of transistors, printed wiring and miniature components, and resin encapsulation of sub-assemblies.

New radar equipment included the latest models of search radar for use in aircraft and a medium range 10 cm surveillance radar incorporating moving target indication and the elimination of rain responses by means of circular polarization. A simplified radar approach aid for use in conjunction with a v.h.f. d.f. system was demonstrated which enables aircraft to be "talked down" by a single ground operator. The 3 cm radar aerial is mounted on a common rotatable shaft with the direction-finding aerial to which it is per-

manently coupled in azimuth. The display is an A-scope presentation and scales show the elevation of the paraboloid and its azimuth angle, while a series of adjustable contacts indicate whether the aircraft is within prescribed narrow limits of the desired course.

Another interesting display showed the incorporation of radar information with non-radar position reports to provide a large projection display for air traffic control in dense traffic conditions. A feature of this radar was the facility for adding distinctive symbols to the radar echoes on the screen to identify each aircraft; these symbols are locked on to the echoes. The presentation of written information on the display is alongside the picture of the control and was achieved by means of a facsimile transmitter. In the demonstration the system was provided with responses of six aircraft from a radar simulator but in practice many more could be dealt with.

The most notable development in airborne navigational aids was the release of detailed information on the Doppler Navigator in which data on aircraft position, distance, track, wind velocity and estimated time of arrival can be provided independently of ground-based aids. The equipment basically consists of four aeriels, directed fore and aft of the aircraft and to port and starboard. The radiated signal is frequency modulated and so the ground reflections on the four beams will give rise to differing beat frequencies which depend on the speed and heading of the aircraft. The computer unit then presents the various navigational data on meters. The navigator has been in use in the R.A.F. for three years and civil versions are now being produced; the manufacturers point out that the civil type is a completely new design and that its weight is only 130 lb. compared with 240 lb.

It is claimed that the accuracy of this Doppler system is not sufficiently great to meet the requirements of traffic control in high density areas due to dependence of heading information on the aircraft compass. Another manufacturer has therefore integrated a Doppler system with a hyperbolic c.w. aid which, it is stated, will make the most of the advantages of both systems.



# AN INTRODUCTION TO RADIO AIDS TO AIR/SEA RESCUE\*

by

G. W. Hosie†

## SUMMARY

The paper surveys developments in radio aids to air/sea rescue since 1940, and discusses the medium frequency c.w. and v.h.f. radar beacons in general use during the second world war, together with later post-war developments of these equipments. The development of a v.h.f. c.w. dinghy beacon and the use of the airborne v.h.f. homer as the search equipment are discussed together with the change in operational requirements for a personal equipment with communication facilities. The author suggests that a crystal-controlled v.h.f. beacon having a low duty cycle may most readily satisfy international requirements for future radio aids to air/sea rescue. The desirability for a crash location beacon is also put forward.

### 1. Introduction

The purpose of this paper is to review the past development and changing requirements of radio aids to air/sea rescue of survivors from aircraft. These radio aids have formed a part of the emergency survivor stores since 1940-42. The paper will be restricted to the military application of these aids. Their development is by no means static and a new generation of aids may be expected to be necessary in the next few years. It is perhaps timely that this and the two associated papers‡ should focus attention on the subject.

### 2. Advantages of Radio Aids

Where normal distress procedure has been carried out, the Search and Rescue Organization will know the approximate position of the incident and the rôle of the emergency radio equipment is to allow the organization to home quickly on to the survivors even in conditions of very poor visibility. In Service aircraft, especially in time of war, this procedure cannot always be carried out, and the area to be searched is then necessarily large. If a visual search is undertaken, the search aircraft is restricted to a maximum search altitude of some 500 feet, and the visual range of a dinghy even in conditions of good visibility, is probably less than two miles. If the survivor's emergency

aid takes the form of a radio beacon, greater ranges will be attainable at higher search altitude. Modern aids have a range of greater than 60 miles at search altitude of 10,000 ft which would give the radio aid a thirty-to-one advantage in search time over visual aids.

Table 1 is of interest in showing what can be achieved by visual search under the best conditions.

Table 1

Maximum Visual Range obtainable by a Search Aircraft at an altitude of 500 ft.

Target	Maximum Range
Man in life jacket	Chance of sighting remote
Man with dye marker	2 miles
Dinghy	1¾ miles
Heliograph	5½ miles
Orange smoke	7 miles
White smoke	11 miles
Verrey light (at night)	17 miles

These ranges, however, can fall to zero under very bad weather conditions. The case for radio aids, even if they have short range, can be established in that they are relatively unaffected by weather conditions.

\* Manuscript received 11th March, 1957. (Paper No. 414.)

† Ministry of Supply, Royal Aircraft Establishment, Farnborough, Hants.

U.D.C. No. 621.396.933.2

‡ W. Kiryluk, "The TALBE C.W. radio aid for air/sea rescue," pages 489-500.

D. Kerr, "SARAH, a coded pulse beacon for air/sea rescue," *J.Brit.I.R.E.*, 17. (To be published.)

### 3. Environment of Radio Aids

The development of emergency radio aids for aircrew survivors has been largely determined by the expected environment of the emergency. The first equipment developed was for use of survivors from "ditched" aircraft. The equipment took the form of jettisonable packs and was suitable for use on multi-seater dinghies where several survivors could co-operate in its operation. There were no great restrictions on weight or bulk. This was followed by an equipment suitable for operation on single seater dinghies and had to be sufficiently compact for stowage in the pilot's seat pack together with the emergency store. In the latest developments, the equipment must be intimately attached to the survivor to ensure that, in escaping from the high-speed aircraft, the equipment does not become detached from his person. This equipment must be capable of operating from survivors whose only means of flotation is an inflatable waistcoat or a survival suit. The equipment has to be partly self-erecting and to require the minimum attention from the survivor.

### 4. Radio Aids (1940-1945)

#### 4.1. *M.F. Aids*

In the early stages of the last war, the German Luftwaffe was found to be using a hand powered medium frequency beacon transmitter suitable for dinghy to ship or shore use. This transmitter operated only on the International Marine Distress Frequency of 500 Kc/s. A constant listening watch, with direction finding facilities, is maintained on this channel by all coastal and most ship stations. At that time, most medium and long range aircraft were also equipped to take d.f. bearings on this channel. With these services already available no special search equipment had to be developed. The duration of the beacon transmissions was limited only by the endurance of the operator and the range of its transmissions under reasonable conditions was sufficient to give d.f. bearings of upwards of 200 miles. Altogether the equipment appeared to offer many advantages and was further developed by the Allied Services during the last war. This series of equipment became well known under the general name of "Gibson Girl."

The British version of this series of emergency transmitter, which was produced in quantity, was known as Transmitter T.1333B (see Fig. 1). It differed from the original mainly in that it is crystal-controlled. The equipment comprises a transmitter and modulator unit, a hand-operated power unit, and the aerial and earth wires, all housed in a light steel container. The container is watertight and of sufficient volume to give flotation. The container was of such a shape that it could be conveniently held between the legs with the operator squatting in the dinghy, and knee and shoulder straps were provided to secure it to the operator. The aerial consisted of some 208 feet of stainless steel wire which was supported by a box kite. This kite, which was stowed in a separate pack, could be launched by means of a special launching pistol and special cartridges. This launching method was found to be necessary in conditions of low wind velocity and ensured that the kite was launched clear of the water.

The transmitter unit (Fig. 1) consists of a single valve stage (V1) with provision for grid modulation from a tone generator (V2) for use on modulated c.w. service. The r.f. stage consists of an electron-coupled oscillator stage, the cathode and screen circuits forming an inverted Hartley oscillator circuit, and the anode circuit consisting of a tuned secondary transformer. Both output and oscillator circuits are tuned to 500 kc/s. Stability of the carrier frequency is ensured by a 500kc/s crystal (XL1) which is series connected in the oscillator grid circuit. The secondary of the aerial transformer is tuned in part by the variable capacitor and part by the aerial reactance. A tap in the transformer secondary ensures that resonance can be obtained over a wide range of aerial reactance, indication of resonance being given by means of a neon lamp, N1. The circuit is capable of delivering some 5 watts r.f. to the aerial on c.w. or modulated c.w. The screen circuit only is keyed; the keying may be manual or automatic. The automatic signal consists of sending the S O S signal three times followed by twelve long dashes. These dashes are suitable for operating the automatic distress alarm fitted to ships and shore stations and consequently have to be accurately timed. Timing is achieved by means of an electro-mechanical escapement which has a time

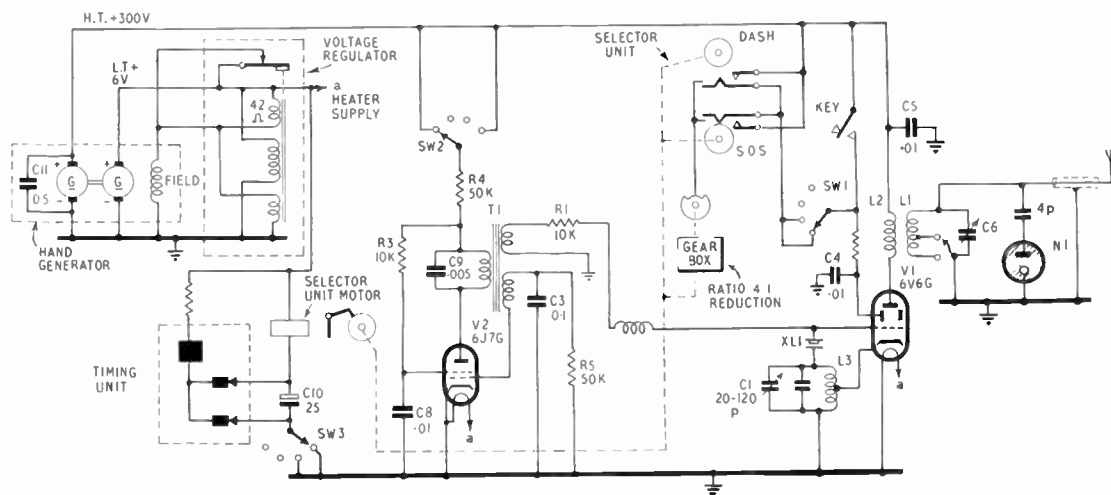

Fig. 1. Circuit of transmitter T.1333B.

constant of some five seconds which drives a selector unit motor. The motor drives two signal wheels which carry respectively the SOS signals and three dashes. Two spring sets, which operate on the periphery of the signal wheels, are controlled by a cam which is also driven by the selector unit motor through a 4:1 gear train. This cam allows the spring set operating on the SOS signal wheel to be operative for one revolution and during the following three revolutions the spring set operating on the dash signal wheel is operative. These spring sets are paralleled and directly key the screen circuit. The hand driven generator provides a voltage controlled output of 330 volts h.t. supply and a 6.3 volt heater supply. The output voltages are controlled by a simple reed armature regulator operating on the field coil.

The equipment has been described to indicate the ambitious specification which had been set. The equipment was stowed near aircraft emergency exits and could be thrown into the sea from "ditched" aircraft and recovered after the dinghy had been manned.

#### 4.2. V.H.F. Aids

The weight and volume of the m.f. beacon transmitter made it unsuitable for fighter aircraft use. In an emergency, fighter pilots were more likely to escape from the aircraft by parachute

and consequently the complete emergency kit, which included his dinghy, had to be stowed within his seat pack. The 175 Mc/s airborne ASV\* radar equipment was, at this time, in current use and it was considered that a simple "squegger" oscillator transmitter operating in this frequency band would provide the simplest radio beacon. Since the duty cycle was low, the power requirements could be obtained from a Leclanché battery supply.

A beacon transmitter was developed under the code name of "Walter" (T.3180) consisting of a single valve self-quenching oscillator (Fig. 2) having a pulse repetition frequency of between 25 and 60 kc/s, the signal consisting of pulses of some 5 microseconds duration. The equipment consisted of two tubular cases connected to the ends of a telescopic tubular mast. The smaller case contained the transmitter unit and carried a spring-loaded aerial. The larger case contained a battery which provided a 90 volt h.t. supply and a 1.5 volt filament supply. The aerial mast consisted of seven sections of light alloy interlocking tubing. On erection, the half-wave dipole aerial was automatically extended. The dipole was held horizontally some seven feet above the level of

\* ASV: air to surface vessels; airborne radar equipment used for detection of ships, surfaced submarines, etc.

the sea and a system of string guys assisted in stabilizing the mast in an upright position. The oscillator circuit is a simple Hartley oscillator circuit; the tuned circuit capacitance is mainly due to stray capacitance, the capacitor C1 consisting of the capacitance between two wires, which were adjusted to resonate at 176 Mc/s. The capacitor C2 and the associated grid resistor R determine the grid circuit time constant. The grid resistance has a value of several megohms and is returned to the h.t. supply to ensure a sharp rise in the pulse waveform. The unit had an overall weight of some 2½ lb which compares favourably with approximately 30 lb for the m.f. transmitter. The range of the equipment was low, being about 20 miles at 5,000 feet search altitude or 8 miles at 500 feet.

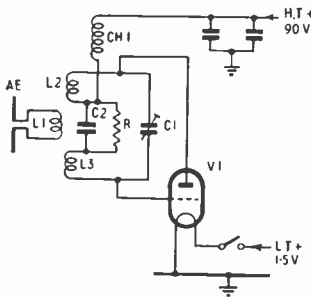

Fig. 2. Circuit of transmitter T.3180 ("Walter").

The search receiver gave an A type radar presentation in the ASV receiver cathode ray screen. "On course" indication was given when the aircraft course was such as to give equal amplitude from the port and starboard aerial signals. Some estimate of range could be obtained from the amplitude of the signal.

### 5. Immediate Post-War Developments

At the end of hostilities in 1945 these radio aids were redesigned. The reason in the case of the m.f. beacon was, in part, due to the disappointing results obtained. In the case of the v.h.f.-radar beacon it was because of the obsolescence of the 175 Mc/s airborne radar equipment which had now been superseded by the new centimetre radar in all but specially equipped search aircraft. Although both

equipments reached a high state of development they were never produced in other than a prototype form.

The m.f. beacon, in its new form, included two further crystal controlled transmission channels in the 4 Mc/s and 8 Mc/s band, and reception was possible on all these channels. The receiver was of a superhet type. Switching was incorporated to allow the manually-operated generator to power a visual signal lamp. The box kite, as used in the earlier versions, was found to be unreliable in wind speeds below 10 knots. An attempt to overcome this defect took the form of a "Kiteoon." This was a hydrogen-filled balloon fitted with stabilizer fins similar to the once familiar barrage balloon. It was hoped by this means to obtain the more desirable qualities of the kite and the balloon under all wind conditions. It was proposed to carry a lithium hydride generator which would actuate by immersion into the sea water similar to that supplied with some American type m.f. beacons which made use of a 4 foot diameter hydrogen-filled balloon as the aerial support. Propagation trials indicated that ranges in excess of 200 miles could be obtained under reasonable conditions, but they also indicated the need for a battery supply for the receiver, as it was found that the generator could only be cranked for a few minutes before the operator became exhausted.

The v.h.f. radar beacon "Walter" was redesigned mechanically and adapted by increasing the operating frequency so that the "Rebecca" airborne responder might be used as the search equipment. The range of the new equipment was similar to the original "Walter."

An interesting attempt was made to use silver-impregnated net as a radar reflector for use in dinghies. This did not appear to meet with much success due to the limited target area which could be exposed and to its low angle to the sea.

### 6. V.H.F. Homing System and Dinghy Beacon

It may be noted that each of the emergency radio aids so far described relied on existing facilities which were used as a search system. In the case of the m.f. beacon transmitter, the existing marine airborne d.f. facilities were

used; in the case of the v.h.f. beacon transmitter, the existing airborne radar equipment was used. The thinking behind possible future aids has still been biased towards using equipment in current use for searching. There are several strong reasons for this. If the search system is to operate on a global basis some measure of international agreement is necessary to ensure the successful operation of the system. This is more readily achieved if equipment in common use can be pressed into the search service. Sufficient search and rescue craft, both air and marine, have to be equipped to ensure that several are available in any one area so that reliance on a single specially-equipped craft does not prejudice the operation. The cost of equipping these craft may form the major cost of the radio aid system. The search equipment, if it is in common squadron use, has a considerable morale value to the survivor since he knows that his comrades can co-operate in the search.

When the introduction of a v.h.f. homing system was considered, the possibility of its use as a search equipment was noted. An operational requirement was put forward for a dinghy beacon to operate on the v.h.f. distress channel of 121.5 Mc/s. A range requirement of 20 miles at a search altitude of 500 feet and a duration of continuous operation of 24 hours was specified. The overall weight was to be 6½ lb and the overall dimensions 15 in. × 4½ in. × 2 in.

Since the homing equipment formed part of the normal v.h.f. communication, its frequency of operation was determined by the crystal-controlled local oscillator. The receiver has a bandwidth of ±40 kc/s but due to the existing tolerances it was found necessary to specify an overall beacon carrier stability of ±10 kc/s to ensure that the signal was within the pass-band. Preliminary tests, using an early v.h.f. homing equipment indicated that accurate homing could only be achieved using a vertically polarized aerial and a grounded λ/4 aerial was chosen as offering the best compromise of simple erection and maximum range. The sensitivity of the airborne receiver was that of its muting level and varied between 3 and 15 microvolts; the latter figure being a squadron reject level. From considerations of battery

requirements and limitations of overall bulk and weight and duration, a radio-frequency power level of some 0.4 watts was the maximum possible.

The results of experimental flying from an early prototype homing installation indicated that a system power gain (ratio of beacon transmitter power to search receiver threshold power) of some 120 db was necessary to achieve the target range. This called for a receiver having a threshold sensitivity of some 5 microvolts. It was found that the receiver gain could be increased by some 6 db by a muting disabling switch and this was incorporated. On this particular search installation having a threshold sensitivity of 5 microvolt the expected sea range was found to be expressed by the following relationship:

$$\text{Range (nautical miles)} = 8.8 \times 10^{-7} \sqrt{G_p h_s}$$

where  $G_p$  is the system power gain and  $h_s$  is the receiver search altitude in feet. These results were obtained well within optical range.

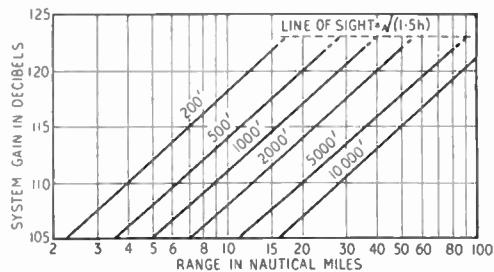

Fig. 3. Beacon range for various heights

The relationship is shown graphically in Fig. 3. These results will vary with aerial installations on various types of aircraft due to variations which may be expected in aerial efficiency and are quoted only as being indicative of what may be expected. Ranges over land varied widely but those over flat, open country indicated a drop in gain of some 6 db compared with that obtained over the sea. The biggest variable in use was found to be the receiver sensitivity and it is necessary to ensure that the receiver is correctly aligned on this channel if these ranges are to be realized. Valuable gain may be easily lost by careless alignment of the search receiver.

## 7. Personal Equipment

During the development of the dinghy v.h.f.-c.w. beacon various developments in military aviation indicated the need for a personal beacon with communication facilities. Due to the higher aircraft speeds, the escaping aircrew enter airstreams of high turbulence which may cause loss of personal effects; thus the emergency store should be more closely attached to the body. This, and other reasons, led to the development of waterproof survival suits which could give considerable protection to the survivor on entering sea water and reduce the need for a dinghy at least in areas of moderate sea temperature. The Korean campaign also indicated the need for a two-way speech communication system for use between survivors and the search and rescue services. Survivors, especially from multi-seater aircraft, found a communication system useful when scattered from their comrades after the parachute descent, for arranging a common rendezvous where they could pool their resources while awaiting rescue. This period also saw a growing realization of the potentialities of the helicopter as a search and rescue vehicle. This type of aircraft, equipped with winches or trawl nets, could if suitably equipped with radio search equipment considerably reduce the time taken to effect a rescue in areas within its flying duration.

The new requirements for Service emergency radio aids have been met by equipment developed privately by industry. The two equipments, which have been developed separately, are known as "SARAH" (Search and Rescue and Homing) and "TALBE" (Talk and Listen Beacon). Both of these radio aids will be discussed fully in the accompanying papers and will be dealt with only briefly here.

### 7.1. *The SARAH System* (243 Mc/s)

This is a complete search equipment and includes a fully miniaturized search equipment for airborne or marine use; it is broadly similar to the "Walter" radar beacon. By using a specially designed search equipment, the survivor's beacon equipment can be made extremely small and light. By the use of a coded-pulse beacon system, homing can readily be achieved on to a single beacon in an area of high beacon density. (This problem can

be difficult with a simple c.w. homing equipment). Speech modulation of the beacon is by variation of pulse rate and the search equipment has a suitably designed receiver for its reception. A simple receiver on the beacon can receive normal amplitude modulated signals from the aircraft.

### 7.2. *The TALBE System* (121.5 Mc/s)

This equipment can be considered as the logical development of the c.w.-v.h.f. dinghy beacon adapted for personal use and with the additional facilities of amplitude modulated speech transmission and reception. This system makes use of the v.h.f. homing receiver as the search equipment similar to the dinghy version. Since the beacon radiates a continuous c.w. signal, probably the greatest problem is to obtain sufficient duration from a battery of sufficiently small bulk as to be suitable for personal use.

Both equipments are coming into current use in the British Services. The SARAH system has found general acceptance for use with the Royal Air Force and the TALBE with the Royal Navy. The reason for the Royal Navy's choice was mainly the practical one of being unable to install the admittedly small search equipment of the SARAH system into their aircraft. In such carrier based aircraft, space is normally at a premium.

### 7.3. *General Considerations of Personal Beacons*

The problem of the installation of a personal equipment on a survivor is not an easy one. The first prerequisite is that the attachment of such radio aids will not interfere in any way with the functioning of the aircrew in normal operations and secondly that such attachment will not cause injury to the wearer while escaping from the aircraft. The present "Mae West" inflatable waistcoat allows the wearer just sufficient visibility to read the aircraft instruments when in a normal seated position. Any increase in the thickness of the front of the waistcoat has to be avoided for this reason. Any bulk at his back or shoulders would cause considerable discomfort and possible injury. In practice, two pockets have been made available at the sides of the waistcoat slightly above the waistline. Provided that these are positioned slightly forward and do not appreciably exceed

one inch in thickness they have been found to be acceptable. In these pockets must be housed the main equipment and its power supplies. The vertical aerial must be fitted to the "lung" of the waistcoat if it is to remain vertical in use. In spite of the small size of such equipment, the controls must be such as to allow easy operation with numb and possibly injured hands. In practice, the equipment is self operating once erected and the controls "fail safe" in the beacon position.

The environment of these equipments may be worthy of comment. The units may be expected to be flown to high altitudes and to be immersed to some depth in the sea before use. If the sealing is incomplete the units in breathing may draw in moisture. The sealings should therefore be effective at 60,000 ft (1/10th atmospheres) and for 12 ft immersion in sea water (1½ atmospheres). The units being small, the problem of sealing is mainly restricted to controls and cable entries. The supply cables must be well insulated and waterproof to protect the user in very wet conditions.

As the equipment forms part of the aircrew's personal gear, it must be expected to withstand the normal usage—or misuse—of the crew room and of combat flight, and the high acceleration of the ejector seat. The equipment must also be capable of operating within the ambient temperature range of 60°C and -18°C. The greatest difficulty is in obtaining operational life at the low temperature from the batteries. In general the Leclanché and mercury oxide batteries have a marked reduction in their capacity at temperatures below 0°C. As the survival time of a user in sea water at or just below 0°C is likely to be less than that of the batteries, this problem might be considered purely academic. On land or ice rescues, however, this might not be so and increased battery duration may be obtained by the application of body heat.

Due to the low transmission power and the low effective height of the beacon (used in the c.w. systems) aerial, it is necessary for these equipments to operate on a clear channel. Any other traffic in a given area is likely to have a very much higher signal level and consequently the beacon signal would be lost. In this connection communication from

the search craft to the survivor should ideally be on another frequency. This could be easily arranged by tuning the beacon receiver to some other fixed communication channel. This, however, would mean that contact between survivors would be lost unless the beacon receiver was capable of tuning to both frequencies which would increase the operating complexity of the beacon equipment. Provided that the searchers realize this problem and restrict their communications to a minimum, the loss of homing intelligence to any other search craft is likely to be small, and on this basis common frequency working between search and survivor equipment is acceptable.

### 8. Crash Location Beacon

To complete this review of air/sea rescue equipment it may be pertinent to refer to an item which, in the author's opinion, would be a valuable aid in location of crashed aircraft. The cost in time and material in location of a sea crash, where there are no survivors, may considerably exceed that where survivors have been found. If the adoption of a crash location beacon in aircraft were general, it would aid considerably in locating quickly the position of crashed aircraft and provide a valuable adjunct to the present personal equipment. It would allow high altitude search to be undertaken with more confidence. Such a beacon could have considerably more power and its release and operation would have to be automatic.

### 9. Future Developments

Both the SARAH and the TALBE equipments appear to be necessary to meet the present requirements as emergency radio aids in British military aviation. In the next few years, military aviation may be expected to be using the u.h.f. communication band. In this band, the 243 Mc/s channel has been allocated as the Distress channel.

The SARAH pulse system is at present operating on this frequency and if it is to operate effectively it will be necessary to reserve five channels (100 kc/s channel spacings) above and below the 243 Mc/s channel. Since the SARAH system has some measure of international acceptance, the problem of releasing these channels will have to be seriously considered. The alternative is to find some new

operating frequency which will not cause loss of communication channels.

In the case of the c.w. TALBE system (121.5 Mc/s) it will be necessary to double the operating frequency to 243 Mc/s to make use of the future homing systems. This will accentuate the problem of power requirements.

For a search and rescue system to be economically effective it is necessary for it to have a large measure of international acceptance. Since the maximum availability of equipment suitable for search is likely to be the homing equipment on the v.h.f. band, a beacon operating in this band is most likely to obtain international acceptance. Since the homing equipment will be crystal controlled, it will be necessary for the beacon to be similarly stabilized. In the author's opinion the most profitable line of approach would appear to reduce the duty cycle of the c.w. system, the amount of this reduction being controlled by the bandwidth of the receiver and the method of presentation of the homing information in the search aircraft. Such a system, provided it does not unduly complicate the homing system, may be capable of combining, or at least compromising between, the various advantages of the pulse and c.w. systems.

## 10. Conclusions

The changing requirements for air/sea rescue have now evolved a personal type of radio equipment. This is likely to remain so long as the present method of emergency escape from aircraft continues. The immediate problem for the future development of these equipments lies largely in finding a system which will obtain international acceptance.

The greatest scope for development lies in reducing the size and weight of the present power supplies. This may be done by increasing the efficiency of the circuit and/or the system. The use of transistors, especially as d.c. convertors, may allow the use of sea cells or storage batteries which would allow greater shelf-life of the power supplies. The overall size of the radio equipment is likely to be fixed more by the size of the operating controls than by the circuit.

## 11. Acknowledgments

The author acknowledges the help given in the preparation of this paper by his colleagues in the Radio Department, Royal Aircraft Establishment and in the Institute of Aviation Medicine, Farnborough. Acknowledgment is made to the Chief Scientist, Ministry of Supply, for permission to publish.



# THE TALBE : A V.H.F. C.W. RADIO AID FOR AIR/SEA RESCUE\*

by

W. Kiryluk<sub>1</sub>(Associate Member) †

## SUMMARY

General consideration of personal beacons for air/sea rescue are discussed, and the search techniques briefly described. Suitable battery types are reviewed. The mechanical and circuit design of two c.w. beacons is described: a dinghy transmitter without speech or reception facilities, and a personal type (TALBE—Talk and Listen Beacon) giving these facilities.

### 1. Introduction

The general principles and the gradual development of the art of air/sea rescue have been described in a companion paper by G. W. Hosie.‡

In this paper a particular type of personal beacon which is in use, and is commercially available at the present time, will be discussed, namely the TALBE (Talk and Listen Beacon) and the intermediate stages leading to its development briefly detailed. A beacon for use in an aircraft's dinghy will also be described. As both these beacons transmit essentially c.w. signals, the case in favour of c.w. beacons will be considered.

### 2. General Considerations

The main design criterion of a radio rescue beacon is simplicity. This usually implies compactness and ease of operation with as little participation by the survivor as possible.

If the radio beacon is stripped of all its frills then the outcome is a single valve oscillator, sending out a c.w. signal on an agreed distress frequency. Although a beacon of this kind is very useful, it suffers from frequency instability, which is especially important at v.h.f. with channels only 100 kc/s wide.

It is not practical to control the frequency of a single valve beacon oscillator even with overtone crystals, as the r.f. power output at the overtone frequency would be very low. The frequency of a single valve beacon will wander outside the allocated channel depending, amongst other things, on the proximity of the aerial to other objects. This cannot be tolerated on the already overcrowded v.h.f. band. If the aircraft has not been reported missing, then the survivor's chances of being located depend mainly on the possibility that any aircraft flying in the vicinity will intercept the distress call. Most aircraft carry a channelized receiver which, when not in use for normal duties, is switched to "listen" position on 121.5 Mc/s. Indeed, most military aircraft installations have a separate distress channel receiver/transmitter. A number of listening stations are also present which may receive the distress call if the beacon is within range.

It is thus required that the beacon transmission be designed to suit the most common v.h.f. receiving equipment in use which is, at the present time, a channelized set capable of c.w. or a.m. reception only.

To ensure that the beacon signal shall be picked up by such a receiver, the following conditions must be met:—

- (a) the beacon frequency must be crystal controlled,
- (b) the transmission must be c.w. or amplitude modulated c.w.

\* Manuscript received 11th April, 1957. (Paper No. 415.)

† Electronics Division, Burndept Ltd., Riverside Works, Erith, Kent.

U.D.C. No. 621.396.933.2

‡ G. W. Hosie, "An introduction to radio aids to air/sea rescue," pages 481-488.

Modulation of the c.w. carrier is only necessary for recognition purposes, so that a beacon transmission can be distinguished from other interfering signals which may be present in the distress channel.

Forms of modulation other than a.m. could be used but they usually involve:—

- (a) complications at the beacon end,
- (b) special receiving equipment in the aircraft,
- (c) reduction in range.

Complications at the beacon end usually imply larger battery power consumption and lowering of the reliability of the set.

The necessity for special receiving equipment in the aircraft constitutes a large drawback on account of space and weight, especially in the case of present day aircraft already overloaded with various electronic gear. Special equipment only in the search aircraft can be considered as a practical proposition, but this limits the number of possible interceptors of the distress call.

The range reduction occurs because the standard v.h.f. communication set is being used to receive signals for which it was not designed. For example, if a pulse system of beacon transmission is used of low mark-to-space ratio, the average power radiated is very small and to the standard communications set the signal appears very weak or, for the same signal strength, the range is reduced.

The requirements of stable carrier frequency and the provision of modulation for recognition purposes impose a difficult design problem, as these features cannot be achieved without using more valves and other components. This, in turn, imposes a larger drain on the batteries which form almost an integral part of the beacon.

Overtone crystals are available in a range of about 30 to 80 Mc/s and so comparatively few frequency multiplying stages are required to obtain the international distress frequency of 121.5 Mc/s.

Modulation for recognition can be achieved very economically by a single valve "squegging" oscillator amplitude modulating the final r.f. output stage. A typical beacon arrangement meeting these requirements is shown in Fig. 1.

At first thought the speech communication between the survivor and the search craft seems to be unnecessary complication of the personal beacon, as it is possible for the search craft to locate the beacon-equipped survivor with the airborne homer. However, the speech facility is of great assistance to the survivor, especially when contact is established with an aircraft without a homer. The survivor can then report his position relative to the aircraft and, if necessary, give directions during the final rescue stages. This last point is also of great value to the search craft even if it is equipped with a homer.

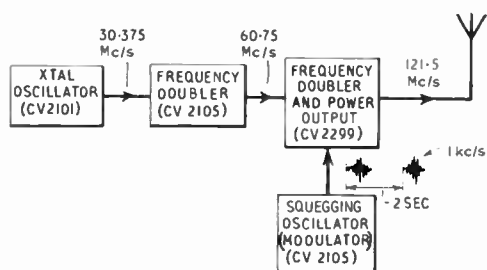

Fig. 1. Block schematic of dinghy transmitter BE 221.

If amplitude modulation for speech communication is accepted then in the case of several survivors in proximity to each other, a possibility arises of intercommunication amongst the survivors. This may be of some help to the morale of the survivors, but it can also be wasteful in battery power, as the beacon increases the battery drain when it is switched to r/t. The unnecessary use of r/t can be eliminated by training of the aircrews.

When several survivors are very close together the intercommunication between them may be of distinct advantage as, by agreement, all but one survivor could remain on the air, thus conserving the battery supply of the group as a whole without impairing the homing procedure.

The range between a pair of beacons at sea level is very low, and it usually does not exceed 1 to 2 miles.

### 3. Homers for Air/Sea Rescue Work

Homing is an essential part of any air/sea rescue system and a standard homer used for landing approach can be used for locating a

survivor carrying a c.w. beacon. Homing may provide guidance in the horizontal plane, the vertical plane or both, but for air/sea rescue purposes homing in horizontal plane only is required. The technique of "heading on a narrow beam" cannot be used because the air/sea rescue beacon transmission must be omni-directional.

A suitable homer for use with a c.w. beacon will be considered (Fig. 2). Such a homer can take the form of an adaptor which can be placed in front of a standard v.h.f. communication receiver, which constitutes already part of the existing installation in most aircraft.

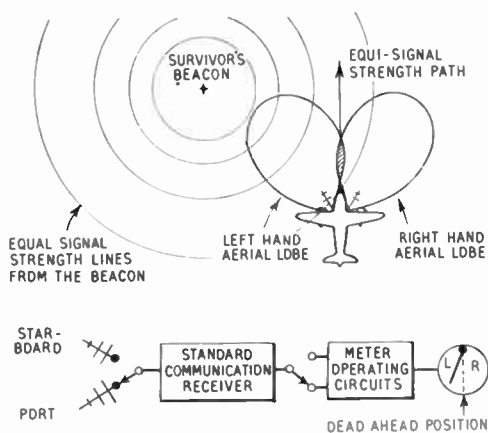

Fig. 2. Schematic of a lobe switching homer.

To obtain the directional information the search craft must carry two aerials. These aerials can have such directional characteristics that their polar diagram lobes will just overlap in the "dead on course" position when the signal amplitudes received by each aerial are equal. If the aircraft is off course, the signal amplitudes are unequal. Thus this method relies on the amplitude comparison of signals. The same two aerials, if spaced closer together, can be utilized to obtain the directional information by a "phase difference" method, which gives much more accurate results. Essentially this method consists of adding the signals received by each aerial via a network of constant phase shift ( $90^\circ$ ). The resultant information is then fed into a phase-sensitive detector which translates it into corresponding amplitude variations, which in turn are applied to a homing indicator

meter. In both methods the output from the aerials must be switched, as shown schematically in Fig. 2, and a convenient way to perform this is by means of an electronic gating circuit. The v.h.f. communication receiver is then acting as a selective filter eliminating other transmissions which may be picked up by the homer aerials.

The homing meter can be a standard ILS meter (Indicator Type 7) which is used for landing approach, and is installed in most aircraft.

Using a good communication receiver and a homer attachment of this kind, it was possible during the trials for the aircraft to fly within 10 feet over the survivor, which illustrates the accuracy which can be obtained in good conditions. Normally, accuracy of 10 to 20 yards or so should be easily achieved in difficult circumstances. The ranges obtained were 75 to 100 miles at 10,000 feet, and two-way voice communication could be established at 25-30 miles when the craft was flying at 3,000 feet. The "on top" indication is given by the cone of silence which manifests itself easily to the search personnel, as the beacon signal fades out in a definite manner over the survivor.

In practice pilots have found no difficulty in operation of the equipment. The identifying signal (beacon "pips") can be heard in the phones, the pilot then directs the aircraft until the homing indicator shows "on course." This course is then held until the cone of silence is struck.

A survivor can be located by an aircraft without a homer, carrying only a communications receiver. This can be accomplished by one of the following methods:—

(i) *Simple bisected chord technique* (Fig. 3(a))

The aircraft is flying through the coverage of the beacon at a height of about 500 ft. The navigator notes the positions (A and B) where the beacon can no longer be heard. Having determined the chord AB, the aircraft is then navigated to its centre C, where a turn at right angle should take the aircraft either over the beacon or out of its coverage. If the coverage is lost the aircraft is flown along the reverse track. For this method to be fully successful it is essential to navigate accurately, taking full

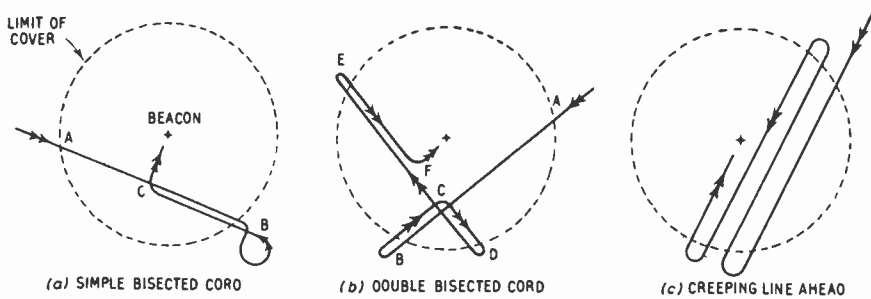

Fig. 3. Methods of locating c.w. beacon without d/f equipment.

account of the wind throughout the whole procedure.

At a height of 500 ft. the radius of the beacon coverage equals approximately the line of sight which is 30 miles. With an aircraft flying at 300 miles per hour the whole search procedure need not take longer than 10 minutes once the beacon signal has been picked up.

(ii) *Double bisected chord technique*

This method is a more advanced version of the simple bisected technique. It was devised by the Civil Aviation Flying Unit so as to determine the beacon's position relative to the aircraft at an early stage in the search.

This method is shown in Fig. 3(b). A chord A-B is flown during which the aircraft descends from a searching height (about 10,000 ft.) down to 500 ft. When the coverage is lost at B a steep turn is made so as to return the aircraft approximately along the same track.

After being in coverage again for two minutes, a turn of 90° to starboard is made and that heading held until the coverage is lost at D.

According to the length C-D it is possible to determine approximately the direction of the beacon, but is obviously insufficiently accurate to locate the beacon immediately. As with the simple method, a chord D-E is now flown, timing the flight accurately so that the aircraft can return to the centre F. It is then flown along the bisector of the chord from point F to the beacon, since the ambiguity inherent with the previous method has already been eliminated. As

before, navigation must be accurately carried out, taking full account of the local wind.

(iii) *Creeping line ahead search*

This method is not as elegant as the latter, but is very effective although it can be time consuming. However, where accurate navigation is not possible, this method is most useful.

The aircraft descends to 500 ft. once within the beacon's coverage and continues to the limit of coverage (Fig. 3(c)). It then returns flying parallel to its original track but removed from it by a distance equal to slightly less than twice the estimated effective visibility. This procedure is repeated as necessary until the beacon is located.

The "creeping line ahead" technique is also used as a standard method in initial search stages where the beacon signal has not yet been picked up. In such a case the distance between the parallel lines is about 50 to 60 miles when the search aircraft is flying at 10,000 feet.

In all the above cases the final location of the survivor is accomplished visually, by cone of silence, or by instructions from the survivor who can inform the search crew as to their relative position. Once the survivor is located a helicopter or rescue launch can be directed towards the spot for actual rescue.

If the aircraft is carrying a homer, which can be switched to the distress channel, the location of the survivor becomes very much easier, as once the beacon signal has been intercepted the aircraft can head straight towards the beacon. Such present day homers are very accurate and

the aircraft usually flies over the survivor within a matter of tens of feet.

As can be seen from the above discussion an aircraft equipped only with a standard communication receiver can participate in air/sea rescue operations, and indeed locate the survivor. This is only possible if the beacon transmission is of a crystal controlled c.w. or amplitude modulated c.w. type. Naturally, the accuracy of location using only a communication set is not as good as in the case of an aircraft carrying a v.h.f. homer installation.

In the case of single seater aircraft, there is only one survivor likely to be in the same area. If an aircraft is ditched with several members of the crew, all carrying a c.w. beacon, the search craft can still locate them as a group. At a large distance from the distress area the c.w. signals will appear as if they were coming from a single point and the search craft can fix its course on the group.

As the search aircraft is approaching the distress area the homer indications can no longer be relied upon if several beacons are present. However, if the previously fixed course is maintained, the aircraft is bound to fly over the middle of the distress area. Having established the distress area the search craft can then proceed to traverse it and finally locate the survivors by visual means.

A certain amount of interference between several beacons can be eliminated by lowering the height of the search craft over the distress area, thus reducing the effective coverage of beacons, e.g. at an aircraft height of 100 feet the radius of beacon transmission would be in the region of 14 miles only.

#### 4. Batteries Suitable for Air/Sea Rescue Radio Beacons

A form of battery is required as the only convenient source of power for the personal beacon. Hand or wind driven generators are ruled out, as far as the personal set is concerned, although they may be considered suitable for dinghy work. The primary type of battery only will be considered as being the most reliable and convenient for life saving applications.

The battery plays a very important role in the beacon design as it usually exceeds the size

and weight of the beacon itself. It is thus extremely important that the design of the beacon is such that power consumption is kept to a minimum. The minimum size of the battery is determined by the load and operating life required, while its maximum size is mainly limited by considerations of danger of injury to the personnel during automatic ejection at high speed.

The battery must supply the necessary l.t. and h.t. powers. Two ways of approach are possible:—

- (a) by using a low voltage cell only and generating the h.t. by a vibrator or similar converter,
- (b) by providing two separate batteries within one case, comprising low voltage high current, and high voltage low current sections.

The use of a mechanical vibrator should be discouraged as it represents one more component part which can go wrong, and it occupies a considerable space which can be filled with battery cells, thus offsetting any advantage offered by the vibrator. It is clear that (b) is more suitable for compact radio beacon operation at the present state of the art.

#### 4.1. Types of Batteries

The present battery techniques offer three types which may be suitable for beacon work.

- (a) Leclanché type (carbon / manganese dioxide/zinc).
- (b) Kalium (potassium hydroxide/mercuric oxide/zinc).
- (c) Sea water (magnesium/cuprous chloride).

Table 1 sets out their various features.

The complete beacon battery can be built up in several ways, of which the following are the most practical examples:

- (a) l.t. Kalium, h.t. Leclanché;
- (b) l.t. and h.t. Kalium;
- (c) l.t. sea water battery plus converter to h.t.;
- (d) l.t. and h.t. sea water battery.

The design should be such as to make the life of l.t. and h.t. sections roughly the same. It is usual to make the l.t. battery last slightly longer than the h.t. section.

#### 4.2. Life and Size Considerations

Theoretically any battery life is attainable by

making the battery of suitable size (capacity) to meet the load demand for a given duration. In practice the battery size has to be limited and it must be kept as low as possible.

The weight is also important, especially in view of the use of ejector seats in military aircraft. A concentrated weight in a small volume near a human body may be dangerous during ejection. The harness holding the battery and beacon must be suitably designed taking this factor into consideration.

In the case of the v.h.f. TALBE battery the following satisfactory compromise solution has been reached:—

Size:  $6\frac{1}{2}'' \times 4\frac{3}{4}'' \times 1\frac{3}{16}''$ , i.e. 35 cubic inches (575 cm<sup>3</sup>).  
 Weight: 26½ oz. (0.81 kg).

Endurance: 7 hours on beacon plus 1 hour on r/t.

Construction: L.t. Kalium,  
 H.t. Leclanché.

A typical electrical performance of such a battery is shown in Fig. 4. The flatness of the characteristic of the Kalium l.t. section is striking.

The effect on r.f. power output of the beacon as a function of battery life is also shown in Fig. 4. It can be seen that the transmitted power output drops from initial 0.6 watt down to 0.2 watt after 8 hours. This should not make the search procedure very difficult as it is assumed that by that time the rescue crafts are near the survivor. The gradual decrease in r.f. power output could be eliminated if the h.t.

**Table 1**  
 Comparison of Battery Types Suitable for Radio Beacons

Type	Theoretical watt hours per cubic inch	Storage life	Effect of switching load on life	Temperature Characteristics under load	Weight	Voltage stability over useful life
Leclanché (carbon/manganese dioxide/zinc)	1.1	6 months at temperate temperatures or 3 months in tropical conditions	Recovery effect present, but it is offset by the necessary continuous h.t. load	Satisfactory up to +60° C. Output tends to increase with temperature	Present v.h.f. TALBE battery comprising h.t. Leclanché l.t. Kalium weighs 28½ oz.	Not existent
Kalium (mercuric oxide/potassium hydroxide/zinc)	2.0	6 months stored at up to 50° C. After 6 months under tropical conditions depreciation 25%	Increases life in proportion to time the load is off	Should not be used below 0° C. Satisfactory performance up to +60° C.	25% heavier than Leclanché	Substantially flat
Sea water. (magnesium/cuprous chloride)						
(a) Sea water battery	2.2	Indefinitely long, provided the battery is sealed	As Kalium	Satisfactory over range +4° C. to +30° C.	As Kalium	Slightly inferior to Kalium
(b) Sea water cell (Vibrator to obtain h.t. must be used)	4.0					

battery section was also of the Kalium type. This, in fact, will be probably done in the near future.

To increase the useful life of a radio beacon without increasing the size of batteries, it is possible to periodically interrupt the transmission.

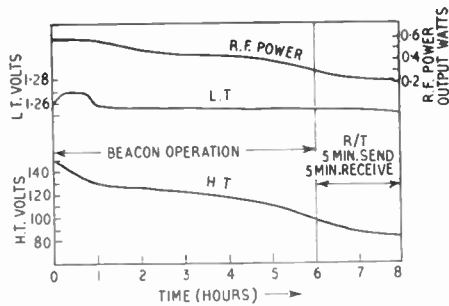

Fig. 4. V.H.F. TALBE performance.

## 5. The V.H.F. Dinghy Transmitter

This equipment was the first development undertaken by the author's company specifically for use in air/sea rescue work. It comprises a miniature crystal controlled transmitter stowed in a dinghy rescue equipment and is capable of providing automatic beacon transmission of distress signals without attention. The equipment is extremely simple and no skill whatsoever is required to operate it. The power radiated is of the order of 0.3 watt and is c.w., modulated by a pulse of 1,000 c/s tone once every two seconds, for identification purposes. No facilities for receiving or speech transmission are provided.

The equipment operates on the v.h.f. International Distress Frequency of 121.5 Mc/s. The power supply for the transmitter is provided by a Kalium battery also specially designed for this type of work. The equipment is capable of operation for 24 hours at 0° C ambient temperature and for 30 hours at +20° C.

The aerial consists of a quarter wave collapsible rod which packs neatly into the kit. The erection of the aerial automatically switches on the transmitter and this is the only operation necessary to start the transmitter.

The signal is capable of being received within a radius of 60 nautical miles when the

searching aircraft is flying at 5,000 ft.

The size of the transmitter does not exceed 4½ in. by 2 in. × 2 in. (11.4 × 5.1 × 5.1 cm) and the specified battery is 9½ in. × 2 in. × 4 in. (24 × 5.1 × 10.2 cm). The weight of the transmitter is 10½ oz. (0.3 kg) and the 30 hour battery weighs 5½ lb. (2.5 kg). A means of checking the performance of the transmitter is available by a "Go/No Go" test set specially designed for this purpose.

### 5.1. Mechanical features

The design of the dinghy transmitter BE.221 departed from the conventional air/sea rescue radio sets as used previously on lower frequencies. The chief aims of the designers were:—

- size as small as possible.
- simplicity of operation,
- no hand generator,
- 24-hour operation without any attention by the survivors.

The compactness was achieved by using subminiature valves and components. The lay-

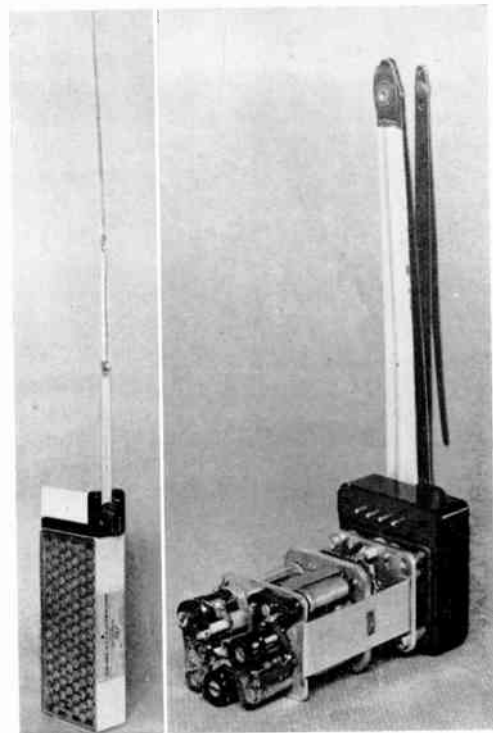

Fig. 5. (a) (left) The dinghy transmitter, Type BE 221, with 30 hour Kalium battery.

(b) (right) Inside view of dinghy transmitter.

out, although very compact (see Fig. 5(b)) still enabled access to components, and thus servicing of the unit is possible.

To enable absolute simplicity of operation it was decided to provide only a beacon signal without any facilities for speech communication.

When the equipment is operating a 1 kc/s "pip" can be heard by the survivor to inspire confidence in the equipment and raise his morale. The audible tone is generated by the vibrating laminations of the modulating transformer.

The Kalium battery was chosen for the power supply because of its ideal characteristics and high capacity per cubic inch of volume. This eliminated the need for a hand generator which very often is a burden to confused and tired personnel.

The transmitter comprises four valves and each valve forms a sub-unit with its associated circuitry and can be replaced as such. Some of the components are mounted in polyester resin, thus enabling very compact and mechanically stable construction.

There is no conventional chassis in the true sense of the word, but the whole unit is mounted around an aluminium "U" bracket which is fixed to a moulded Nestorite base. The base carries plug contacts which mate with their counter parts on the battery (see Fig. 5(a)). The aerial with its associated on/off switch is also mounted on the moulded base. As the unit must be watertight, the Nestorite base carries a

moulded rubber seal which mates with an extruded square can, fitting over the whole transmitter.

### 5.2. Circuit description

The dinghy transmitter comprises four stages (see Figs. 1 and 6). Three valves are used to generate the 121.5 Mc/s carrier and the fourth valve is used as a squegging oscillator to provide the identification pips. The crystal oscillator stage comprises a CV2101 (DF72) and the crystal of 30.375 Mc/s. The crystal oscillator drives a frequency doubler CV2105 (DL70) which drives another doubler and power output stage CV2299 (DL73). The squegging oscillator valve CV2105 anode modulates the last r.f. stage. All three r.f. stages operate in Class C. A protective bias is employed to prevent damage to the valves should the r.f. drive disappear. In all there are 14 resistors, 9 capacitors and 4 inductances.

The power consumption is 1.25 V at 0.425 amps (l.t.) and 36 mA at 140 V (h.t.), giving an overall efficiency (r.f. power radiated/d.c. consumed) of 5.5 per cent.

No variations in the power supply are expected throughout its life as it is of the Kalium type, thus maximum stability of operation is obtained as all circuits operate at a constant h.t. and l.t. voltage.

To facilitate the checking of the Dinghy Transmitter by unskilled personnel, the Performance Tester was devised. Its use is based

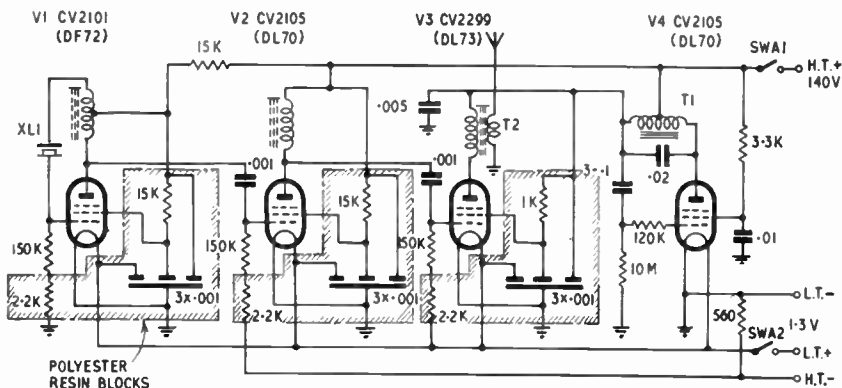

Fig. 6. Circuit diagram for dinghy transmitter, Type BE 221.



on "Go/No Go" principles, i.e. the various performance factors are displayed on a single meter with a scale divided in such a way that one sector represents the pass and the other the reject performance. The factors which can be checked are radiated power, modulation and power consumed by the transmitter, i.e. h.t. current, h.t. voltage and l.t. voltage. The Performance Tester can also assess the state of the transmitter battery under load.

During the trials it has been found that the comparatively large battery was acting as an earth reflector for the dinghy set aerial and if the set was energized by a much smaller battery the aerial matching was upset, thus resulting in reduction of radiated power.

### 6. V.H.F. TALBE Development

When the development started on the Dinghy Transmitter it was thought at the time it would be impossible to provide a sufficiently small personal beacon and the importance of the r/t facility was only fully appreciated during the Korean conflict. Towards the end of the development of the Dinghy Set it was realized that a compact personal set is feasible with a provision for r/t communication. It was then decided to drop the production of the Dinghy Transmitter and concentrate on a compact set which became the V.H.F. TALBE (Talk and Listen Beacon). It went through three stages of mechanical development. The first model was made in a plastic case and with a stiff aerial (see Fig. 7(a)). The survivor was expected to

remove the aerial sections from the harness and interconnect them. This was not acceptable and the set was redesigned in a metal case and the aerial was made more flexible (Fig. 7(b)).

The main disadvantage of the second model was that it could not be switched by a survivor using gloved or stiff hand, and also that he might have been hurt by the aerial components during ejection. The third model (Fig. 7(c)) eliminated all these disadvantages using special lever switches and steel tape aerial which was extremely flexible and soft, yet of sufficient resilience to stand up to gales. The aerial was taken off the T/R unit and it has been attached to the microphone/loudspeaker unit. This enables the battery and main T/R units to stay submerged in the water while the speech unit and the aerial could be placed near the face of the survivor.

#### 6.1. Description of the TALBE Beacon

The TALBE beacon operates on the international v.h.f. emergency frequency of 121.5 Mc/s and produces a c.w. signal modulated with a 1 kc/s identification "pip" once every two seconds.

The personal equipment comprises:—

- (a) transmitter-receiver unit ( $4\frac{1}{2}'' \times 4'' \times 1\frac{1}{4}''$ ) ( $11.4 \times 10.2 \times 3.14$  cm),
- (b) microphone/loudspeaker unit which incorporates the aerial and on-off switch ( $4\frac{1}{2}'' \times 2\frac{1}{2}'' \times 1\frac{1}{4}''$ ) ( $11.4 \times 6.3 \times 3.14$  cm),
- (c) battery unit ( $6'' \times 4\frac{1}{4}'' \times 1\frac{1}{2}''$ ) ( $15.1 \times 12 \times 3.8$  cm).

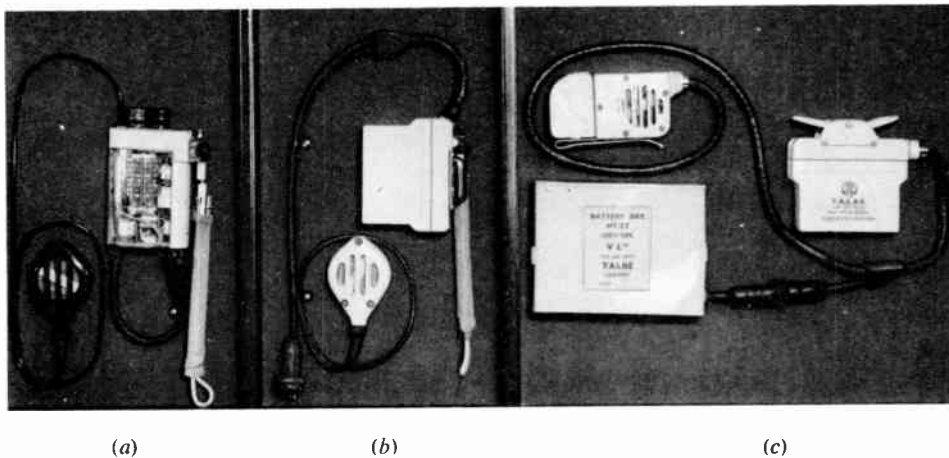

Fig. 7. Three stages in the development of TALBE.

The total weight of all units is 4 lb 5 oz. (1.95 kg).

The equipment is carried in a body-belt worn under the life-jacket (see Figs. 8 and 9) in such a manner that the top part of the belt is masked by the life jacket, the reason for this being the extra protection given by the life-jacket to the TALBE during descent. The equipment is thus firmly attached to the survivor and if everything else is lost, he has still got the radio equipment.

In use the microphone/loudspeaker unit is clipped on to a strap mounted on either of the inflated lobes of the life jacket. The survivor is thus not required to hold this unit in his hand, as its position on the life jacket is sufficiently close to his face to provide satisfactory speech transmission or reception.

The flexible metal tape antenna is self-erecting when the protective cover is removed by a simple action of pulling a cord. This action also switches on the equipment which automatically commences the beacon transmission.

The transmitter receiver unit incorporates two switches, one for "listen" and the other for speech transmission. When neither switch is operated the equipment is transmitting the beacon signal, the speech transmission and reception being only used by the survivor when the search aircraft or boat are in sight, or can be heard.

Whilst the TALBE is emitting its characteristic recognition pip, it can be also heard from the microphone/loudspeaker unit by the survivor, with obvious effect on his morale.

If the "transmit" key is depressed at the survivor's waist, no sound is heard from the microphone/loudspeaker unit, whereas if the "receiver" switch is operated, the background noise of the super-regenerative receiver is audible. This provides a positive indication to the survivor as to which underwater switch has been pressed. If both keys are depressed simultaneously, the "transmit" switch exercises the over-ruling action. The switch keys are so designed that a survivor with gloved or frozen hand is able to operate them.

The power output when on "beacon" is of the order of  $\frac{1}{2}$  watt. This gives an operational range over the sea of the order of 60 miles with a search aircraft at 10,000 ft. The r/t range extends to about 10 miles.

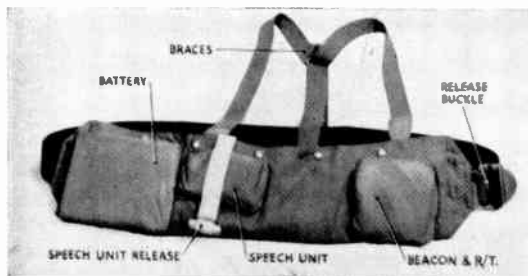

Fig. 8. Belt as worn showing TALBE equipment in "stowed" position.



Fig. 9. The complete equipment is fitted in a waist belt worn under the Mae West.

The TALBE receiver is of the super-regenerative type giving readable output (20 to 30 milliwatts) for about a 10 microvolt input signal with a signal-to-noise ratio of 14 db.

The microphone/loudspeaker unit utilizes a moving iron unit which serves the dual function, depending on the method of connection into the circuit.

The whole equipment comprises 5 valves, one crystal, 27 capacitors and 17 resistors in addition to inductances and transformers, all the parts being of subminiature construction. From the dimensions of the equipment given previously it can be seen that only with great

difficulty it is possible to accommodate all the parts within the permissible space.

The functions of the various valves are as follows:—

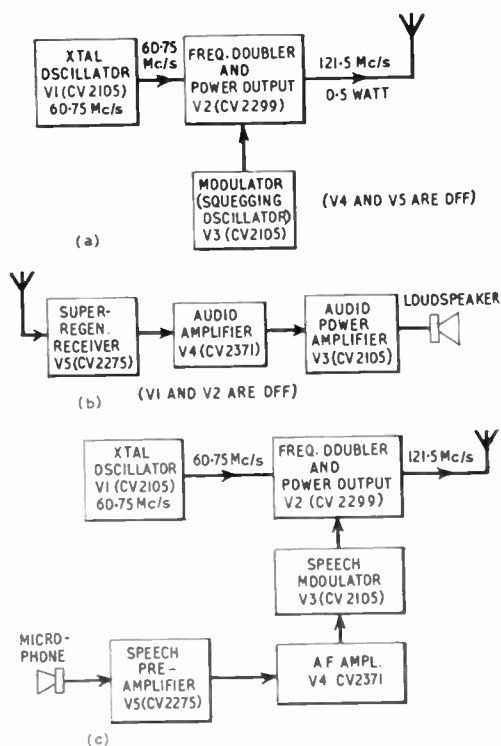

Fig. 10. Block schematic of V.H.F. TALBE.

V1 (CV2105; DL70) acts as a crystal oscillator.

V2 (CV2299; DL73) acts as a frequency doubler and a power output stage.

The valves V3, V4 and V5 perform multiple functions (shown in Fig. 10) as follows:—

(a) *When the equipment is on beacon transmission*

V3 (CV2105; DL70) acts as a modulator valve.

V4 (CV2371) and V5 (CV2275) are switched off.

(b) *When the equipment is on "receive"*

V3 acts as audio output amplifier.

V4 acts as an a.f. amplifier.

V5 acts as a super-regenerative receiver and detector.

(c) *When the equipment is on "transmit"*

V3 acts as a speech modulator.

V4 acts as an a.f. amplifier driving the modulator.

V5 acts as a speech pre-amplifier.

The transmitter is crystal controlled, but the receiver has a bandwidth of about 2 Mc/s, so that there is no need for tuning controls.

The a.g.c. characteristic of the receiver is so effective that the volume control has been also eliminated.

## 6.2. Mechanical aspects of the equipment

The TALBE equipment will withstand pressure of ejection at 40,000 ft. and immersion in 40 feet of sea water. The operating temperature is limited mainly by the battery, which operates without difficulty between 10 and 40° C. Operation in the region of 0° C results in shortening of the useful life. However, the six-monthly storage temperatures can range from 0° C to 60° C.

Sealing of the equipment presented the main practical difficulty. The T/R switch levers operate actuating rods which pass through the die-cast aluminium alloy case of the T/R unit and are sealed against the ingress of moisture by pressure sealing washers lubricated by a suitable grease.

To seal the T/R and the microphone/loudspeaker units a similar technique is used. A gasket is fitted between the lid and cover case and is sealed with an approved compound to allow for good pressure sealing.

The microphone/loudspeaker inset is enclosed in a separate container in such a way that the ON/OFF switch contacts, connector terminations and aerial connections are separately sealed with a gasket between the flange of the microphone/loudspeaker case and the outside case. The microphone/loudspeaker inset is retained in position in its case by a synthetic rubber ring between the outer gasket and the inset. A film of plastic material between the outer gasket and the cover completes the pressure seal of the microphone/loudspeaker inset. The thin (2/1000") membrane enables the sound to reach the microphone/loudspeaker unit with minimum of attenuation.

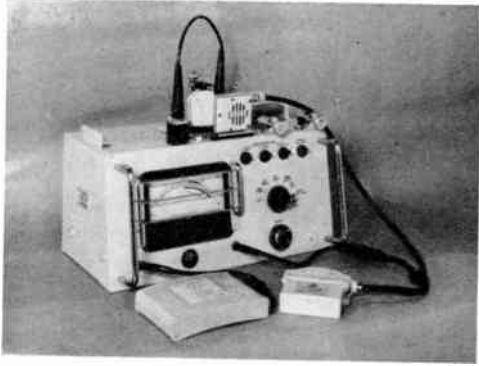

Fig. 11. The TALBE performance tester. (Type BE 9166.)

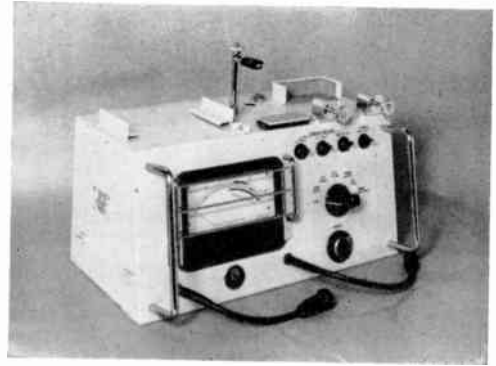

Fig. 12. The performance tester. Type BE 9166 with TALBE mounted, ready for test.

The battery, T/R and microphone/loudspeaker units are all interconnected with a rubber moulded cable using a self-sealing plug on the battery case.

Most moving parts which come in contact with sea water are made of stainless steel to prevent corrosion.

The battery switch and the aerial are associated with the microphone/loudspeaker unit. The switch is a two-pole ON/OFF type operated by a spring-retained plunger. It is held in the OFF position by the aerial cover which depresses the plunger when in position on the aerial block.

For stowage, the aerial may be rolled and held under the aerial cover, so that the release of this cover allows the aerial to uncoil and also the switch to operate. The aerial extends to 24 inches when released and is constructed from four lengths of flexible steel tape which are kept together by plastic sleeves. To release it the aerial cover must be removed by pulling the attached nylon cord. The aerial is designed to withstand winds up to 50 miles/hr under operational conditions.

A suitable Performance Tester Type 9166 was also developed covering all the necessary tests as for the Dinghy Set. (See Figs. 11 and 12.)

### 7. Conclusions

The TALBE beacon was primarily designed for military operations, where the survivor is partially immersed in the sea, supported by an inflated lifejacket.

The applications for civil aviation use are obvious. The emergency radio equipment is only carried when inflatable dinghies are available in the civil aircraft. The TALBE beacon, although primarily a personal equipment, is also admirably suited for dinghy use. A larger battery could be used with dinghy equipment if required.

The operational life of the battery of 8 hours is acceptable to some services; the Navy, for example, find 8 hours quite sufficient.

The main feature of the TALBE beacon is the possibility of assistance which can be given by a normally equipped civil aircraft without an airborne homer. Because of the very compact construction TALBE beacons can also be used as short range "walkie-talkie" sets. The trials on aircraft carriers have proved very successful.

Recovery of valuable objects, such as cameras and recorders mounted to weather balloons can be eased if a TALBE beacon is used.

### 8. Acknowledgments

The author wishes to thank Dr. R. H. Barker of the Ministry of Supply for his advice on various aspects of air/sea rescue problems, and the Chief Engineer of the Electronics Division, Burndept Ltd., Mr. P. E. Leventhall, who helpfully criticized the manuscript.

The author also wishes to express his appreciation of the help of his colleagues throughout the Electronics Division and to thank the Chief Engineer of the Company, Mr. R. G. D. Holmes, and the Directors of Burndept Ltd., for the permission to publish this paper.

# RECENT ADVANCES IN AUTOMATIC ASSEMBLY\*

by

L. H. Gipps† and K. M. McKee, B.Sc.‡

*A paper presented at the Convention on "Electronics in Automation" in Cambridge on 29th June, 1957. In the Chair: Mr. L. H. Bedford, C.B.E.*

## SUMMARY

Reference is made to recent and probable future development of machines for the preparation of electronic components and their automatic assembly into printed wiring boards. The design of components and the processing of printed wiring boards is discussed in relation to the requirements of automatic assembly and mention is made of current practice with regard to the problem of interconnection and the incorporation of sub-assemblies. The field of application of fully automatic machines and that of semi-automatic machines using manually-operated bench machines is surveyed in the light of production experience gained up to the present date, concluding with some indication of possible future trends in mechanized production.

## PART 1.—AUTOMATIC COMPONENT ASSEMBLY EQUIPMENT FOR PRINTED CIRCUITS

### 1. The Philosophy of Automatic Assembly

The automatic assembly of radio components has been made possible largely by the introduction of printed circuits. The automatic production of radio assemblies is not new, but earlier systems in this country and in the United States suffered from being too ambitious. Thus, attempts were made to produce both components and wiring in the same equipment. By contrast, the "Dynasert" equipment which we shall describe uses components of conventional types, and it is only concerned with their assembly to previously prepared printed circuit boards. It was developed in the first instance in the United States, where it is now being widely used in the radio and allied industries. Development, based on information from the United States, is proceeding along parallel lines in this country.

The equipment can be considered in two parts: firstly, that for the preparation and orderly arrangement of components where they are susceptible to such treatment; and, secondly, that for their assembly.

### 2. Handling and Preparation of Components

It is, in theory, possible to design a machine to perform any function, but in practice complexity and cost rule out such a course. It must, therefore, be expected that a practical machine will be less adaptable than a pair of human hands. Provided a machine is required to deal with a product which is substantially uniform, in respect of geometric dimensions, it can be reasonably simple, and it will function satisfactorily. In the type of machine under discussion, therefore, it is essential that the components are reasonably uniform in size and shape: the greater the degree of uniformity, the more reliable is the machine likely to be. Any particular type of radio component is, of course, made to a standard pattern, and it might be reasonable to suppose that such components would be adequately uniform from sample to sample. While this is the case with some components, others—notably small capacitors—vary sufficiently within a batch to cause appreciable difficulties in handling for automatic assembly. To take the simplest case, the leads are generally bent to a greater or less degree, and to such an extent as to preclude bulk feeding until they have been mechanically straightened. It therefore appears to us inevitable that, at least in such cases, some actual handling of the components will be necessary in

\* Manuscript received 26th May, 1957 (Paper No. 416.)

† British United Shoe Machinery Co. Ltd., Union Works, Leicester.

‡ Geo. Tucker Eyelet Co., Ltd., Walsall Road, Birmingham 22.

U.D.C. No. 621.396.69.

the process of preparing them for automatic assembly. It is convenient in this context to consider axial-lead components, since these are the type of which we have at present most experience. However, the same argument, of course, applies to any other component which it is desired to deal with on automatic machinery. The fact emerges, therefore, that components to be dealt with by reasonably simple automatic machinery must be substantially uniform as regards all physical dimensions. In particular, the leads should be co-axial with the component, flash-on mouldings should be reduced to a minimum, or desirably avoided entirely, and superficial coatings of wax and the like should be of constant thickness and evenly applied. It is also desirable, although admittedly difficult to achieve in many cases, that lead wires should be sufficiently stiff to provide satisfactory mechanical stability of the component when it is held by its wires and subjected to normal transport and handling.

This difficulty can, to some extent, be overcome by adopting body belting of components rather than lead belting; this matter is referred to later. In general, automatic assembly is facilitated, and the machine simplified, if the components can be arranged in an orderly manner before being offered to the machine. Our experience is at present mainly confined to axial lead components, which are belted by tapes attached to their leads after they have been suitably straightened. The components are thus held at equal spacings along the tapes in a convenient manner for subsequent operations. As an alternative to lead taping, the components may be stuck on to suitable tape by their bodies. This may be an advantage in the case of components with thin leads, since no strain is placed on the leads. However, this method provides somewhat less precise control of the component position, since the components are more likely to move during storage and handling.

Once the components have been attached to tapes by either of the above methods, they can be wound on to suitable reels, or, alternatively, placed in boxes in the same manner as a belt of machine-gun ammunition. Our experience in this country is at present confined to belted components on reels, but some work is being done in the United States on the alternative box method of stowage. In the case of com-

ponents other than those with cylindrical bodies and axial leads, belting on tapes appears less satisfactory, although it is still possible to envisage cases in which such a system might be used. In general, such components as disc capacitors, flat mica capacitors, valve holders or electronic sub-assemblies lend themselves more readily to stowage in some form of magazine, which, for convenience, could well be the package in which they are transported from the manufacturers. It is, of course, a help in the design of the automatic assembly machine if the components can be offered to it in a pre-arranged and orderly stack—e.g. valve holders can, we hope, be supplied stacked in tubes and correctly oriented. In these respects, co-operation between the manufacturers of components and the designers of automatic assembly equipment is quite essential.

### 3. Methods of Automatic Assembly

Fully automatic assembly can be achieved by two different systems: a machine which is programmed to carry out a series of operations in sequence on a single printed circuit board, or some form of conveyor. The former (the programmed machine) can be designed, but in our view, it will be cumbersome, complex and very expensive. Further, it will almost certainly suffer from lack of flexibility in regard to the ability to change rapidly from one circuit arrangement or type of component to another. The conveyor system, in which each machine is designed to carry out one operation only, is, in our opinion, preferable. Each machine can be relatively simple and, since each machine carries out only one operation, the cycle time will be shorter. We also believe that this system is inherently more flexible.

The paragraphs which follow describe, firstly, "Dynasert" machines under development for the handling and arrangement of components, and, secondly, the conveyor machine, prototypes of which are already in use in the radio industry.

#### 3.1. Component Handling

The starting point for, and the crux of, satisfactory automatic assembly is component handling. As has been pointed out earlier, components must be presented to the machine in a pre-arranged and orderly manner. The human

operator can make final adjustments to, for example, the straightness of the leads if it is obvious that they will not fit into the holes provided in the circuit board; if the first attempt is unsuccessful, a further adjustment can be made. A machine, unless it is extremely complex, cannot exercise discretion in this manner; either the component fits into the space provided for it at the first attempt, or it fails entirely. Moreover, one failure may lead to subsequent failures by the interruption of the normal sequence of operations. Correct and uniform preparation of the components is, therefore, all-important. If we seem to labour this point, it is because we have too often seen the results of lack of uniformity of components or of inadequate or faulty preparation, and because we hope thereby to impress on component manufacturers the need for a higher standard, in certain instances, of dimensional consistency if automatic assembly is to be successful.

### 3.2. Lead Straightening

In the case of components which are connected to the circuit by integral wire leads, it is necessary, as a first step, to straighten the leads. A number of lead straightening devices are in existence, and work with more or less efficiency. In our experience there is a limit to the amount of bending, particularly close to the component body, which such devices will cope with; if leads become really badly bent during the manufacturing process, some measure of hand-straightening appears inevitable. Further, we have been unsuccessful in devising—or, indeed, imagining—any system for the bulk feeding of components with seriously bent leads. The basis of the straightening machines which we are currently developing for axial lead components is, therefore, that the components are fed by hand with the more acute bends removed. Of the various systems which we have tried, we have found straightening by rolling to be the most successful. The component body is free to rotate while the leads are progressively rolled from the roots outwards between fixed and moving spring-loaded plates. We have found it convenient to mount the moving plates on a drum which is rotated through gearing at an appropriate speed as the component is carried round on the drum, supported in feed plates. A feeding device assures that the component

is fed into the gap between the fixed and moving plates at the right moment. The component emerges on the far side of the drum with the leads straight and co-axial, and is placed in a bulk reservoir before passing to the Belting Machine.

### 3.3. Component Belting

Axial lead components are at present belted by placing the leads between adhesive tapes on each side of the body, at a distance from the body suitable for the Component Inserting Machines. The pitch of the components on the tapes is controlled by slotted spacing wheels which take one component at a time from the bulk reservoir. As the components are carried round in the spacing wheels, adhesive tapes, drawn from reels, pass above and below the leads and are pressed together and on to the leads by spring-loaded rollers. The components, now evenly spaced between the tapes in the familiar "ladder" form, are then reeled up on to the reels from which they are subsequently fed to the Component Inserting Machines. This description refers to "lead taping"; "body taping" of axial lead components is an alternative system. In this case, the bodies of the components are uniformly spaced out by suitable feed wheels, and are then placed on a single adhesive tape which is pressed on to them by a rubber roller. As mentioned earlier, this system has certain advantages in the case of the heavier components where the leads provided are insufficiently rigid support. It also uses less tape.

### 3.4. Handling Other Components

The methods of preparation and handling so far described refer to axial lead components. A brief reference has already been made to possible methods of dealing with unsymmetrical components—flat mica capacitors, valve holders and the like—by arranging them in magazines. Whatever system is adopted the same principles hold good: the components must be reasonably uniform in shape and size, the leads (or other forms of connection to the circuit) must either be initially straight, or must be straightened, and the components must be oriented correctly for presentation to the inserting machine. Such components, due to their diversity of shape and size, require, in general, more individually designed machines as compared with those used for axial lead components, and the economy of

designing such special purpose machines has to be carefully considered in the light of the numbers of such components likely to be used.

### 3.5. *The Conveyor* (Fig. 1)

The system with which we are concerned consists of an "in-line" belt-driven conveyor on which is mounted a number of transportable machines, each of which performs a single function. By this means, the design of individual machines is simplified, and changes of circuit arrangement are easily effected. The Conveyor itself is built up of a number of standard sections, each 3 ft. long, and arranged to carry two

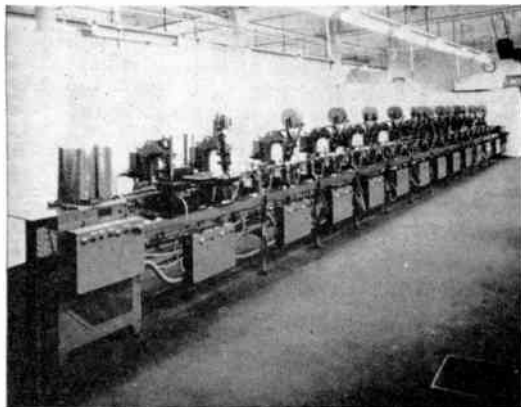

Fig. 1. An Automatic Conveyor with fourteen component inserting stations, Pallet Stack, Board Loading and Unloading Machines.

Component Inserting Machines (to a total of 40) on adjustable base plates, clamped to the frame-work. At each end are special sections 4½ ft. long, carrying, respectively, the Printed Circuit Board Loading Machine and one Component Inserting Machine, and one Component Inserting Machine and the Board Unloading Machine. On extensions beyond these at either end are a Pallet Stack, or, alternatively, an Automatic Pallet Lift, and the Belt Drive Unit which will be described later. The Conveyor is fitted with two endless belts which are driven continuously at constant speed by the main drive motor (¾ h.p.) in the Belt Drive Unit. The belts move from left to right (viewed from the front) along the top of the Conveyor and beneath the heads of the Component Inserting Machines, and from right to left along the bottom of the Conveyor. The Component Inserting and other machines on the Conveyor are operated pneumatically, and

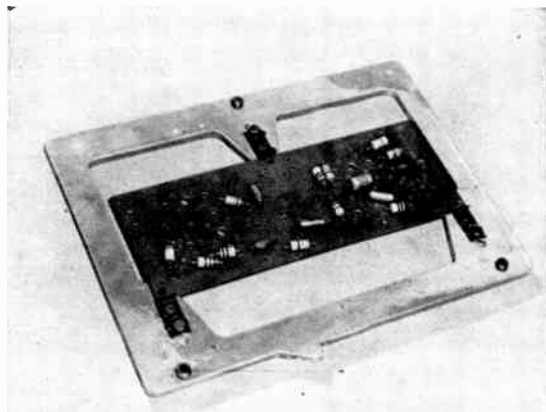

Fig. 2. Conveyor Pallet, complete with printed wiring board and assembled components.

controlled electrically by means of appropriate switches, relays and solenoid-operated valves.

The printed circuit boards are supported on Pallets (Fig. 2) (light metal frames with accurate location features), which are carried on the belts by friction. The boards are held on the Pallets by spring clips and located on dowel pins. The dowel holes in the boards must be accurately punched in relation to the circuit, but the external dimensions of the boards are comparatively unimportant. The geometry of the Conveyor limits the size of printed circuit boards to 10 in. by 5¼ in.

As each Pallet carrying the printed circuit boards comes into position under one of the

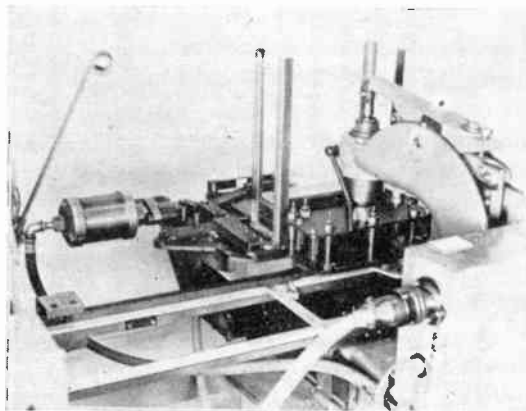

Fig. 3. The Board Loading Machine for mounting the printed wiring boards on the Pallets prior to component assembly.



machines, it is raised off the belts by cam faces, and locked in position by a pneumatically operated locking bar which runs the length of the Conveyor, and operates locking catches at each station. When, and only when, all the Pallets are locked in position, each machine makes one downward stroke, all operating simultaneously. When, and only when, all the machines have returned to their rest positions, the Pallets are unlocked, are pressed back into contact with the belts, and move on to the next station, where the cycle is repeated. Thus, the Pallets, carrying the printed circuit boards, progress along the Conveyor, one operation occurring at each station, with a cycle time (which is adjustable) of about three seconds.

### 3.5.1. The Board Loading Machine (Fig. 3)

At the first station on the Conveyor is the Board Loading Machine. Here the printed circuit boards are stacked (to the number of about 200) and are picked off, one at a time, by a pneumatically operated slide from the

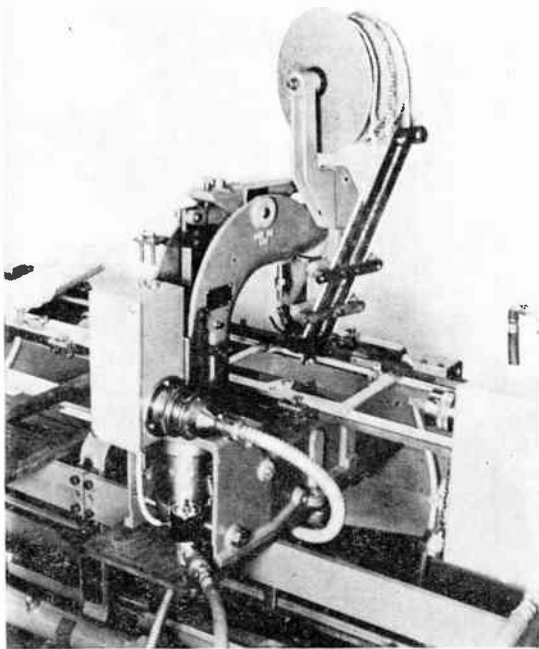

Fig. 4. A rear view of an Axial-Lead Component Inserting Machine about to place a component. The inserting head has been rotated to align the component leads to the appropriate holes in the printed wiring board.

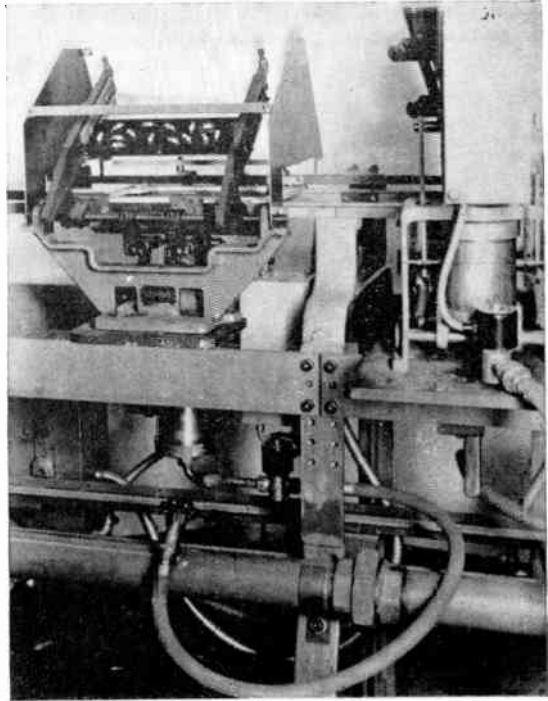

Fig. 5. The Board Unloading Machine, which removes the printed wiring boards from the Pallets on completion of the assembly operation.

bottom of the stack. A vertical ram then takes charge and presses the board onto the Pallet. If the supply of boards fails for any reason, an electrical interlock maintains the "Pallet lock" and thus brings the transfer of Pallets to a standstill until the fault is corrected.

### 3.5.2. Component Inserting Machines (Fig. 4)

Component Inserting Machines at present fitted on prototype Conveyors deal only with axial lead components with body diameters up to  $\frac{3}{8}$  in., and body lengths up to  $1\frac{1}{8}$  in., for insertion at centre distances up to  $1\frac{1}{4}$  in. Two sizes of machine are in use : Component Inserting Machine No. 1 deals with components up to  $\frac{1}{4}$  in. in diameter and  $\frac{9}{16}$  in. long ; Component Inserting Machine No. 2 deals with the larger sizes. (Other machines which can be mounted on the Conveyor are referred to later.) These machines draw the belted components from the reels by means of an indexing feed mechanism, crop the leads to the correct length, form them at right angles to the axis of the component, place the component in the appropriate holes in the printed circuit board, and clinch the leads,

which protrude through the board, onto the circuit. The position of the machine is adjustable on its base plate to suit the position and orientation of the component on the board.

### 3.5.3. Board Unloading Machine (Fig. 5)

The last station on the Conveyor carries the Board Unloading Machine. Here the boards are pushed off the Pallets from below by a pneumatically operated ram, and are held between spring-loaded plates when the ram withdraws. The board is then tilted and slides out into a chute, clear of the Conveyor.

### 3.5.4. Automatic Pallet Lift (Fig. 6)

It will be appreciated, from what has already been said, that the Pallets circulate continuously. After the boards have been unloaded, the Pallets travel onwards, and are deflected off the belts by a cam face. They then pass down a chute to the bottom of the Conveyor, where they encounter the belts now travelling in the opposite direction. The Pallets thus travel back to the head of the Conveyor, where they may be manually lifted onto a Pallet Stack. With a

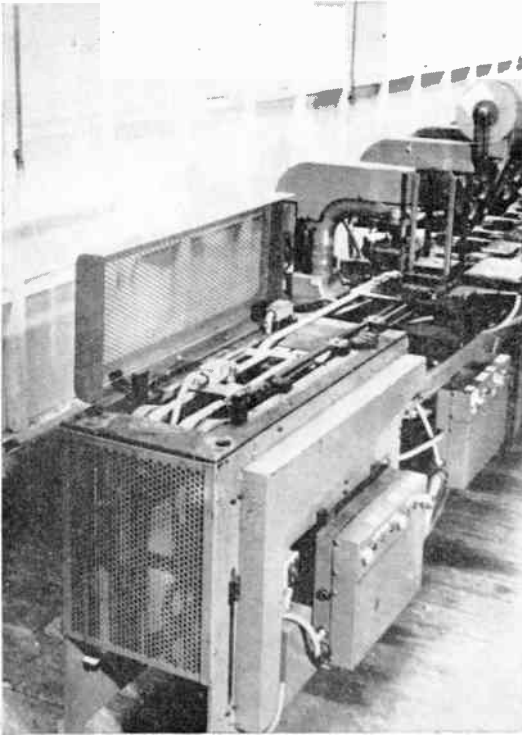

Fig. 6. The Automatic Pallet Lift with the top cover open showing a Pallet which has been raised from the lower return conveyor belts to the level of the upper forward moving belts.

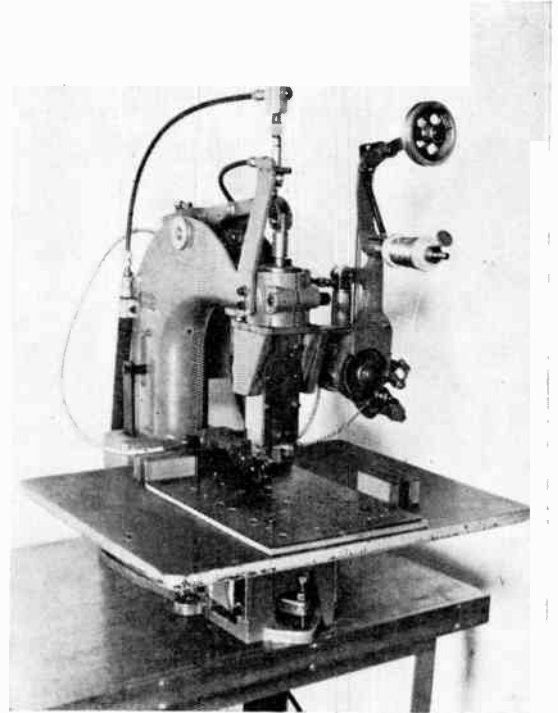

Fig. 7. The Jumper Wire Inserting Machine (bench model) fitted with the optical locating attachment and magnetic stops, to position the printed wiring board accurately for the insertion of jumper wires.

fully automatic installation they pass through a gating mechanism, which allows one Pallet at a time to be carried on to the Automatic Pallet Lift. This consists of a pneumatically operated hinged arm, fitted with auxiliary belts which are arranged to be driven by friction only when the arm is pushed upwards to the horizontal position where it is in line with the top surface of the Conveyor. Thus, one Pallet at a time is carried on to the lift arm in the down position by the main belts moving from right to left. When the Pallet is in position on the arm a switch is closed and the arm rises. When it reaches the horizontal the auxiliary belts are driven by friction from left to right, carrying the Pallet off the lift and back on to the main belts on the top of the Conveyor. Not until the Pallet is completely clear of the lift is the latter allowed to return to the down position, when the gate is operated, and another Pallet moves on to the lift. It will be seen, therefore, that the total number of Pallets required is equal to the number of stations on the Conveyor, plus about ten Pallets to maintain the return circulation.

3.6. *Other Conveyor Machines*

Further machines for fitting on the Dynasert Conveyor are under development, both in this country and in the United States. They are briefly described below.

3.6.1. *Component Inserting Machine No. 3*

This is a scaled-up version of the Nos. 1 and 2 machines, designed primarily to take larger components—up to 1 in. diameter and 2½ in. long—but also capable of handling small components at large centre distances.

3.6.2. *Jumper Wire Inserting Machine (Fig. 7)*

This machine, which is in the prototype stage in this country, takes wire from a reel and cuts and forms it to make jumper wires for purposes of cross connections on the upper side of the printed circuit board. The jumper wires are inserted, and the protruding ends clinched in the same way as for axial lead components.

3.6.3. *Tagging Machine (Fig. 8)*

This machine, also in the prototype stage, places and sets standard wiring tags in printed circuit boards.

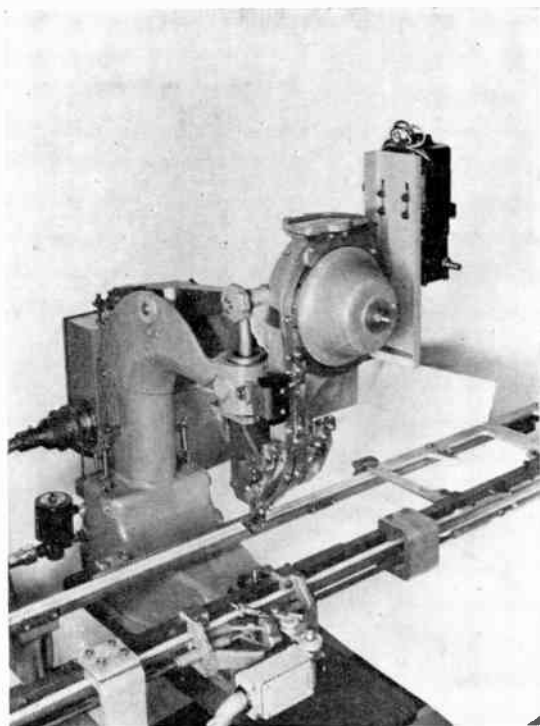

Fig. 8. A Tagging Machine positioned on the Conveyor showing the feed hopper and driving motor.

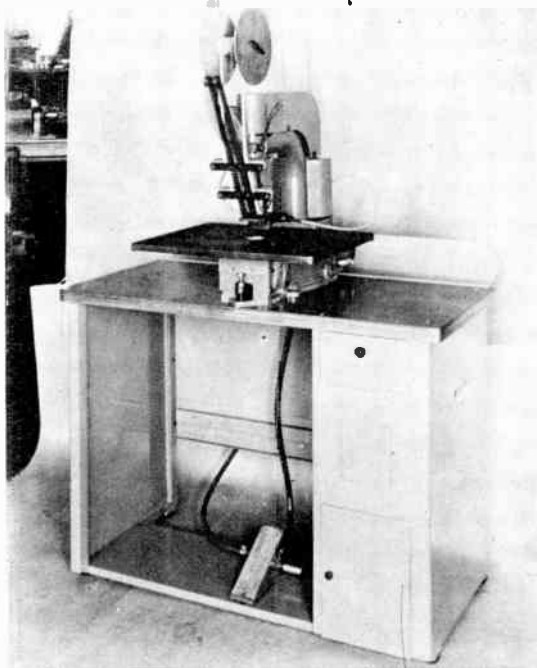

Fig. 9. A Component Inserting Machine mounted on a bench for semi-automatic assembly of axial-lead components on to printed wiring boards.

3.6.4. *Printed Assembly Inserting Machine*

As its name implies, this machine has been designed to deal with printed circuit sub-assemblies to be placed edge-wise on the main board. It can also be adapted to place rectangular flat mica capacitors in a similar manner. The sub-assemblies are stacked in magazines, whence they are passed singly down a raceway to be inserted into the board and the leads clinched.

3.6.5. *Valve Holder Inserting Machine and Wiring Post Inserting Machine.*

Machines to perform these functions are in the design study stage.

3.7. *Semi-Automatic Production*

All the machines described above for use on the Conveyor can be used individually as bench machines (Fig. 9), with "single-shot" operation. In this role, the location of the printed circuit board is, of course, no longer performed automatically. Two methods of location can be used: in the first case, where only one component of each type is to be inserted into each board, location can most easily be obtained by

using fixed stops. In practice magnetic stops, whose position can readily be adjusted on the table of the machine, provide a very convenient form of stop (Fig. 7); for the case where a number of the same components is to be inserted in each board during one pass, and fixed stops cannot therefore be used, an optical locating device has been developed (Figs. 7 and 9). This consists of two light sources which are focused and projected on to the printed circuit board to

form spots of light of the same diameter, and at the same spacing as the holes into which the component is to enter, and at a position on the board immediately below the component leads. The board is manipulated until the light spots coincide with (i.e. disappear into) the holes, when the board is correctly located and the machine is tripped. By this means components can be inserted and clinched at a rate of about 30 a minute.

## PART 2.—SOME GENERAL CONSIDERATIONS ON AUTOMATIC COMPONENT ASSEMBLY

### 4. Printed Wiring Boards

It will readily be appreciated that component insertion with automatic assembly machinery will depend primarily on accurate alignment of the component terminations with the appropriate holes in the printed wiring board. Two factors govern alignment: one is setting accuracy with associated machine tolerances, and the other is the positional stability of the holes in the laminate material. With well designed and carefully constructed machines the inserting head can be positioned within very narrow limits. Dimensional variations in laminate material are often due to changes in the moisture content in different parts of the board, and from one board to another, which may be introduced during processing or due to subsequent ambient temperature conditions in storage. The problem offers no simple solution, but much may be done to minimize the effects and to obtain satisfactory insertion reliability.

Positional errors naturally increase with the lateral dimensions of the board and a limit must be set to the maximum size of the board. With the "Dynasert" Conveyor already described, an area of 10 in.  $\times$  5½ in. has been found to be a convenient upper limit, though small increases, particularly in the direction of the length of the Conveyor, can be accommodated. Punching of the holes in a single shot press is preferred to drilling or piercing the holes one at a time or in batches, unless an equivalent consistency can be maintained. Single shot punching is considerably facilitated and breakages reduced by keeping the board area within the maximum limits. The storage time between punching or drilling and component insertion should be kept

as short as possible and care taken to avoid undue variation in temperature or humidity.

Cold punching laminates and the new fibre-glass laminates provide a much more stable base for accurate punching and drilling, although in the case of the latter group of materials general application will be restricted by reasons of cost. Recently, a supplier of processed printed wiring board claims to have evolved a technique for the cold punching of all the present grades of phenolic laminate used for printed wiring. If the cost of punching by this method compares favourably with hot punching, a significant step will have been taken towards greater accuracy in hole location.

An alternative approach is to allow for expansion or contraction by increasing the difference between the hole diameters and those of the component leads. Here, the limits are set by the requirements of good soldering. The clearance must not be too large, or too great a stress will be placed on the solder, which may not adequately bridge the gap. On the other hand, more robust and more durable punching dies are involved with the larger size holes. A clearance of 0.014 in. to 0.028 in. in the case of round leads gives a high insertion probability with "Dynasert" Machines, and at the same time ensures a good mechanical and dip-soldering connection. A further aid to reliable insertion is to countersink slightly the holes on the component side of the board during drilling or punching. The lead will then be guided into the holes, so permitting a smaller diameter to be used without impairing insertion efficiency.

Bowing or warp is another form of distortion resulting from the difference in the co-efficient

of expansion between the copper foil and its phenolic base. As would be expected from its asymmetrical construction, single-sided copper-clad laminate suffers seriously from this defect. Unless special care is taken in the choice of base material, and in manufacture and subsequent processing, boards are likely to be presented for component assembly with a marked degree of warp. It might be mentioned that it is mechanically impracticable to attempt to hold the board flat by the edges without interfering with the area available for component placement. The fact remains that if the laminate material is obtained sufficiently flat in the first instance, it is usually possible to keep within the required tolerance, due mainly to the general tendency for stresses to be relieved during the etching process.

Apart from the obvious difficulty of mounting and precisely locating a warped board in a conveyor pallet, the effective diameter of lead holes will be reduced and their location will be altered relative to the inserting machine head. If curvature varies from board to board it may well be impossible to place components towards the extremities of the board. In the case of "Dynasert" Inserting Machines, the combined action of the inserting tools acting on the upper surface and the anvils from beneath tends to clamp the board flat during insertion, so that a curvature of up to  $\frac{3}{32}$  in. per foot length of laminate can normally be tolerated.

**5. Interconnection**

For the reasons previously discussed, most manufacturers in the United States and this country divide the larger circuits, like those involved in television receivers, into several small boards mounted on a metal frame. It is here that the question arises of interconnection between these boards and also between the boards and other assemblies. A range of printed wiring connectors exists which make contact with the printed conductors at the board edges, but unfortunately these are too expensive to incorporate in most of the volume-produced products for the domestic market.

The simplest form of interconnector is a length of insulated wire inserted into a hole in the printed wiring board, which is usually bent over in the form of a clinch, and soldered into position along the printed conductor. While costing very little, such an interconnector

is not easy to disconnect without danger of damaging the board if removal is necessary, say, for servicing. It is often safer to cut the lead and remake the connection with a joint in the wire, but this cannot be repeated many times without detriment to the insulation.

A variety of terminal posts are available, some of which are designed for solderless wire-wrap connection and others for soldered connection. The operation of setting the posts in the board normally involves swaging by a heavy press before assembly, and thereafter the boards cannot conveniently be stacked. Automatic board loading is then not possible and boards have to be loaded into the conveyor pallets by hand. The final interconnections are carried out by the application of a wire-wrap gun prior to mounting in a cabinet or on a panel.

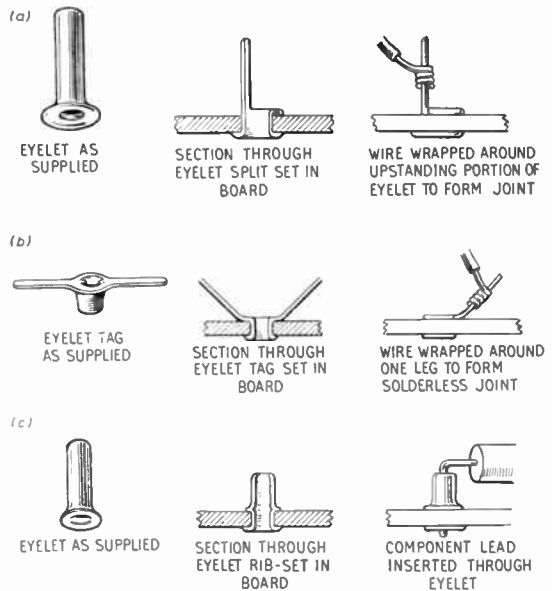

Fig. 10. Eyelets and tags for special-purpose applications in construction of printed wiring boards.

Special types of tag and eyelet have been developed for insertion into printed wiring boards as a part of the assembly process and provide a useful means of interconnection. Some of these are shown in Fig. 10. (a) illustrates an eyelet which is split and one half rolled, and set into the board to form a soldered terminal post, the flange being dip-soldered to the printed conductor on the underside. If required, the eyelet could equally well be

inverted and set to protrude in the reverse direction on the underside of the board and, as before, connected to the printed wiring by dip-soldering. One of the largest producers of radios in the United States has for some time past been automatically setting eyelets in this way on a 40-station conveyor at the same time as the components are assembled by the insertion machines.

The tag shown in (b) may be used for a solderless wire-wrap or a soldered connection. The two long ends may be set so that they stand vertically off the board or at any desired angle. Because of the difficulty of feeding an unbalanced single-ended tag, it is preferable to set the double-ended tag, and the opposite end may easily be snipped off with a pair of pliers if it is not required. For certain applications it is sometimes specified that the component must not be allowed to come in contact with the surface of the panel; for instance, if it operates at a high temperature there is a danger of damaging the phenolic material of the panel. The eyelet (c) is rib set into the board, and the lead passing through the eyelet may be soldered on the underside to the eyelet flange and printed conductor. The two eyelets and the tag shown in the drawing could be automatically set by a suitably modified machine on an automatic conveyor.

#### 6. Sub-assemblies

In order to increase the component density over a given area of printed wiring board it is, in certain cases, advantageous to incorporate in the layout one or more sub-assemblies. The sub-assemblies may be supplied to order in quantity from a component maker, or, alternatively, assembled by means of a conveyor system. Sub-assemblies provided by component manufacturers may take the form of a number of printed capacitive or resistive elements dipped in hard wax or potted in epoxy resin, and are usually rectangular in shape, with leads or tags along one edge. Another type consists of a number of resistor and capacitor bodies mounted in rows on a miniature printed wiring board and the whole assembly moulded together as a unit. In both cases connection to the printed wiring board is made by a series of leads or tags along the lower edge. A "Dynasert" machine, as mentioned earlier in this paper, has been designed for inserting these types of sub-

assemblies automatically on a conveyor, although the machine is not available as yet in this country.

Where the manufacturer wishes to make up sub-assemblies using only components of his designer's choice, four or six sub-assemblies can be assembled by a conveyor on a single composite board, which is subsequently divided into the separate units. As in the previously mentioned type, it is convenient to arrange the components side by side in rows with the printed wiring board as the base and the printed conductors providing interconnection between component terminations. The leads on any desired component may be left sufficiently long, so that when they are turned against the underside of the board by the action of the inserting machine anvils, they will extend beyond the edge of the board. After guillotining the composite board into separate sub-assemblies, these leads can then act as the terminations for the sub-assembly. Again, an automatic machine could be modified to insert the units vertically into a larger printed wiring panel, and clinch over the lead ends in the normal manner.

It might be mentioned here that, apart from the question of compactness and maximum utilization of board area, a further advantage of this method of layout lies in the fact that sub-assemblies to meet particular design requirements may be based on any special laminate material. For instance, where a high dielectric constant was indicated, the sub-assembly laminate could be of epoxy fibre glass, which is approximately four times the price of phenolic laminate and would be too costly to use for the whole printed panel. In conclusion, it may be said that sub-assemblies provide the designer with a new means of effecting economy and increasing flexibility in the printed wiring layout.

#### 7. The Field for Automatic Assembly

In order to illustrate the advantage of using machinery in different kinds of assembly work, it might be appropriate to quote three examples from the application of "Dynasert" machinery in the United States, where it has now been in day-to-day operation for over three years. A typical example of semi-automatic production is the case of a producer with an output per day of 100 boards. Sixteen half-watt resistors, 10 diodes and four one-watt resistors were used, together with several special components. One

bench machine with one operator was easily able to insert and clinch all 30 components with a total of 3,000 insertions, working a few hours each day. The firm estimated that savings were made which paid off the initial cost of the machine in under one year.

Another manufacturer with a fairly level output rate never had a production run which exceeded 1,000 printed boards, but he used a large number of the same components. He was able to use profitably a conveyor of 16 stations, passing each board down the line of machines up to, in some cases, as many as four times in order to complete assembly. This was proved to be a practical proposition due to the ability of automatic in-line machines to be reset in such a remarkably short period. Naturally, with greater volume, outstanding economies may be achieved. A larger manufacturer whose product consisted of several printed wiring boards had a requirement for the assembly of 6,000 boards per day. A "Dynasert" conveyor with 32 stations was installed in this factory and the number of operatives on assembly work was reduced to one-twentieth of what had formerly been required to maintain the same output. It has frequently happened that the savings involved have enabled prices to be reduced, and the resulting increased demand has absorbed the surplus labour force in the same plant on work unsuited to mechanization.

#### 8. Automatic Assembly in the Future

Over the period of the next five to ten years it seems likely that a certain amount of integration will take place within the industry, so that production runs of electronic equipment required in volume will be larger to enable the full benefits of automatic assembly plant to be exploited. At the same time there will be an increasing demand for professional electronic equipment to meet the needs of a wider application of electronics to industry for the latter type of production. Rapid changeover assembly units with lower output will be needed often by quite small concerns to carry out batch assembly work, aiding production and improving the quality of the product.

It is reasonable to assume that the present combination of printed wiring and standard components will be augmented by the addition

of new types of printed component and sub-assembly. Only where extremely long production runs can be guaranteed and the panel regarded as expendable from the servicing viewpoint would electronic circuits of any size be printed as a complete unit. It is suggested that this form of construction will not be widely employed as it is inflexible from almost every aspect. Nevertheless, there will be a tendency to standardize, and print as a sub-unit, suitable sections which occur repeatedly in different circuits. Wherever sub-sections and their associated component parts have to be assembled in sufficient volume, automatic machinery could be applied to raise standards of consistency and lower production costs.

There is little doubt that the development of new assembly machines will be required to keep abreast of new developments in circuit construction. Due to the large floor area occupied by apparatus like telephone exchanges and computers, there is a distinct advantage in miniaturization provided reliability can be maintained or improved. A definite trend in this direction will result in assembly machinery also being reduced in size with an even higher degree of operating precision. Then, as now, the machine applied to repetition tasks will offer speed, accuracy and endurance, unobtainable from motion of the human hand.

#### 9. References

1. "New Horizons for Electronic Assembly." Navord Report 5143, Department of U.S. Navy, Bureau of Ordnance, Washington 25, D.C.
2. J. Harrington, "Obtaining reliability and versatility in high production mechanized assembly equipment." *Proceedings of the RETMA Symposium on Automation*, September 1955.
3. K. M. McKee, "Automatic component assembly for printed circuits." *Journal of the Institution of Electrical Engineers (New series)* 2, p. 515, September 1956.
4. K. M. McKee, "Dynasert automatic component assembly machine." *Machinery*, 16th November, 1956.
5. K. M. McKee, "Automatic component assembly." *Wireless World*, 63, p. 63, February 1957.

# APPLICANTS FOR ELECTION AND TRANSFER

As a result of its July meeting the Membership Committee recommended the following elections and transfers to the Council.

In accordance with a resolution of Council and in the absence of any objections, the election or transfer of the candidates to the class indicated will be confirmed fourteen days after the date of circulation of this list. Any objections or communications concerning these elections should be addressed to the General Secretary for submission to the Council.

## Direct Election to Member

ARNABOLDI, Roland Vincent Blair. *Romford.*  
WHITFIELD, Harold Raymond. *Bishops Stortford.*

## Transfer from Associate Member to Member

HEYS, Cyril. *Farnworth.*

## Direct Election to Associate Member

DASGUPTA, Fit. Lt. Manoranjan, M.Sc. *Bangalore.*  
GAUNT, Harry Maskery, B.Sc. *Stannmore.*  
LANE, Major James Barrie Dedrick, M.B.E., Royal Signals. *London, W.1.*  
STEVENS, Fit. Lt. Ivor Gordon Cecil, R.A.F. *Malvern.*  
VERMA, Jai Krishna Das, B.Sc.(Hons.), M.Sc. *Cambridge, Massachusetts.*

## Transfer from Associate to Associate Member

ALTMANN, Helmut Nachman. *Kfar Shmaryahu, Israel.*  
GOODAY, Robert Allen Herbert. *Brentwood.*  
JOHN, Lieut.-Com. Stuart Wilson, R.N. *Belfast.*

## Transfer from Graduate to Associate Member

BETTINSON, Fit. Lt. Sydney Francis, R.A.F. *Portsmouth.*  
BOWLES, Mervyn Edward. *Sydney, Nova Scotia.*  
EVANS, Geoffrey Stephen. *Welwyn Garden City.*  
HODGSON, John. *Bournemouth.*  
LAL, Fit. Lt. Satish Chandra, B.Sc., I.A.F. *Jalahalli.*  
MARKLEW, Stanley Sidney Peter. *Preston.*  
REANEY, Donald. *Cheltenham.*

## Transfer from Student to Associate Member

CURTIS, Peter George, B.Sc. *Solihull.*  
FLECK, William. *Lisburn, Northern Ireland.*  
HIGGINS, Gordon Leonard. *Rugby.*  
TIERNEY, John Redington. B.Sc. *Sidcup.*  
WEEDON, Antony John, B.Sc. *Amersham.*

## Direct Election to Associate

GILLON, Major Kenneth Etrick Cecil, Indian Corps of Signals. *Bombay.*  
LAWFORD, Robert H. *Old Windsor.*  
LEGG, Ernest Frank. *St. Albans.*  
LONGHURST, Sidney Arthur Earl. *Buckhurst Hill.*  
PASCH, Gerhard Nathan Edward. *London, N.W.2.*

## Transfer from Student to Associate

COSTON, Geoffrey William Edward. *Bracknell.*  
DORMEHL, Capt. William John, S.A.A.F. *Lyttelton, South Africa.*  
PRABHU, Manjeshwar Achyutha, B.A. *London, S.W.15.*

## Direct Election to Graduate

BROOK, Denis. *Huddersfield.*  
CHADWICK, Geoffrey Alan. *Sheffield.*  
FOTHERINGHAM, Peter Ernest Albert. *London, S.E.19.*  
HART, Ronald Ernest. *Chelmsford.*  
MULDOWNEY, Gerrard Charles. *Reading.*  
PAWLING, John Francis, B.Sc. *Purley.*

## Transfer from Associate to Graduate

HAMILTON, William Ian. *Salisbury, Rhodesia.*

## Transfer from Student to Graduate

AZAR, Yoram. *Hatta.*  
BARNARD, Clifford Albert. *Hastingsfield.*  
CARREYETT, Trevor Walter. *Bristol.*  
GABOR, Reuben Peter. *Maoz-Aviv.*  
GODSI, Mayer. *Tel-Aviv.*  
HOLDEN, Dennis George. *Wokingham.*  
JAROSZ, Jerzy Jan. *Slough.*  
MATHEWS, Abraham. *Agra.*  
SENIOR, Eric. *Huddersfield.*

## STUDENTSHIP REGISTRATIONS

AHUJA, Om Prakash. *Kanpur.*  
ASWATHANARAYANA, Karur Ramaswamiah, B.Sc. *Bangalore.*

BAYFIELD, Alan John. *West Drayton.*  
BEHL, Banbir Sahai. *Kanpur.*  
BHALLA, Narendra Pratap. *London, W.14.*

CARLISLE, James Allison, B.Sc. *South Shields.*  
CHANDRAMOULI, C. S. *Madras.*  
CHANDRASEKHARAN, Chempath. *Madras.*  
CORBETT, John Richard Galliers. *Swindon.*

DEEKSHITULU, R. S. V. Y. *Guntur.*  
DREW, Frederick Charles. *Ramsbottom, Lancs.*

EVANS, Maurice Rayner Thomas. *Lagos.*

GOVINDASWAMY, Gunti. *Chandragiri.*

HEMAN, Das Ralwani. *New Delhi.*  
HODGES, Charles Henry. *Birchington.*  
HORN, Peter Jack. *Hitchin.*  
HOSSEIN, Kermanshahani. *Teheran.*

LANHAM, Noel Walter John. *Southampton.*  
LAWRENCE, Tennyson Bancroft. *London, N.W.6.*  
LEONARD, Allan George. *Hadleigh.*  
LOVE, Peter Victor. *London, N.W.5.*

OBERAL, Capt. Harbans Singh, Indian Corps of Signals. *Bangalore.*

MALHOTRA, Prem Kumar. *Bangalore.*  
MESHAT Mansour. *Teheran.*  
MOHAMAD, Ghorban. *Teheran.*  
MORGAN, David Sydney. *Pant Dowlais, Glamorgan.*

PARDOCCHI, George. *Leghorn, Italy.*  
PEPPER, Derek. *London, S.W.4.*

SHAER, Victor. *London, N.W.3.*  
SOTHERAN, Walter Donald Nicholas. *Auckland, New Zealand.*

TAHIR, Major Abdul Wahab, B.A., Royal Pakistan Signals. *Rawalpindi.*

THAM, Siew Kai. *Kuching, Sarawak.*  
THOMAS, Philip Robinson. *Plymouth.*

WHITELEY, Ronald Cooper. *Port Elizabeth, South Africa.*



# AUTOMATIC POSITIONING SYSTEMS FOR MACHINE TOOLS\*

by

C. R. Borley, B.Sc.† C. H. Braybrook, B.A.† and L. Coates, M.A.†

*A paper presented at the Convention on "Electronics in Automation" in Cambridge on 27th June 1957. In the Chair: Mr. E. E. Webster.*

## SUMMARY

The factors affecting the selection of numerical input automatic positioning systems are considered. A review of current technique is given to indicate the order of system cost and complexity. Various economic and operational features, such as cost, speed, accuracy, life and flexibility are emphasized and input, measurement and control schemes are classified according to basic principles. The need for unity of conception in new machine design is stressed and the adaption or conversion of existing machines is considered. A novel requirement for a co-ordinate positioning machine allowed an integrated approach to the electronic and mechanical design of the "machine." The resulting design is discussed in detail as an illustration.

## 1. Introduction

The automatic positioning systems considered in this paper are those in which a machine table moves from one position to another under control of a numerical input, without regard to the path followed between the positions. Continuous numerical control systems suited to cam milling and similar operations are not considered. The system block-diagram is shown in Fig. 1. Basically, digital data is converted to the analogue quantity, table position. The numerical input and the table position are brought to a common form, differenced, and used to control the speed and direction of the table positioning motor. Practical schemes employ digital and analogue components in differing proportions.

The input, (1), can be presented as the setting of ten-way dial switches or on a punched card. In either case the switches or card act as the information store while positioning is in progress. Punched tape input can also be used, but in this case a

store, (2), may be needed as it is generally impracticable to read more than a few digits on the tape simultaneously. The input converter (3) may perform a change in digital code or a digital to analogue conversion before the difference is taken. The table position transducer (7) can present an analogue or digital signal to the difference unit (8) to match the output from (3). The output of the difference detector (8) may consist of a continuously variable signal proportional in sign and magnitude to the error between desired and actual table position. Alternatively a coded digital representation of the error may be made available. In its simplest form, the output of (8) may consist of one of two signals only,

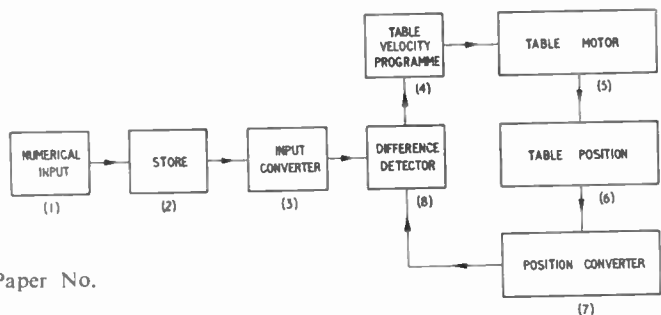

Fig. 1. Automatic positioning system—block diagram.

\* Manuscript received 1st June 1957. (Paper No. 417.)

† Mullard's Research Laboratories, Salfords, near Redhill, Surrey.

U.D.C. No. 621/52.

stating whether the error is or is not zero. The unit (4) controlling the table motor speed and direction determines the manner in which the table actuator acts to reduce the error to zero. Its action will depend on whether the difference unit supplies the sign or magnitude or both of the error signal. The table actuator (5) may comprise one or more motors and possibly speed change gear boxes. The mechanism used to produce table motion which may be a lead screw and nut, a rack and pinion or a hydraulic ram, may also be used to indicate table position and so form part of the position converter unit (7). On the other hand an independent position indicator may be used.

The purpose for which a new or converted machine is required will reduce the choice of the designer on technical, operational and economic grounds. The machine tool buyer is, or will be, faced with a selection of machines and systems. This paper attempts to indicate the factors affecting the choice of a positioning system. Several positioning systems are briefly described, and a medium accuracy positioning machine described in detail.

## 2. Factors Affecting the Choice of a System

### 2.1. General Remarks

The field of automatic positioning machines can be divided into two main sections, jig borers and machines for marking hole centres and/or drilling holes to an accuracy of about a thousandth of an inch. Such machines are suitable for use on sheet metal and similar work.

A jig borer measurement system should be accurate to 1/10,000th in. or better. The reliability is very important because of the cost of the parts that will be machined on a jig borer. Speed of positioning is of secondary importance owing to the relatively long time taken to set up a work-piece on the table and to bore a hole. Reliable auto-positioning relieves the operator of much of the responsibility connected with table setting and position checking.

In a medium accuracy automatic marking and drilling machine, accuracy and reliability must be balanced against cost. Positioning speed is most important, because automatic positioning is used mainly to speed production.

### 2.2. Positioning Speed

Most discrete positioning systems use a few fixed speeds of table motion during fast and final approach. Generally, this is less costly than a control system using proportional servo control. The speed range required in a jig borer is very large. Fast speed will be about one inch per second and final approach speed a few tenths of thousands of an inch per second. Three or four speeds may be needed. In a medium accuracy machine two speeds are sufficient, the run speed being as high as wear of machine parts will allow. The final approach is low enough to allow the brakes to bring the machine table to rest within the accuracy of the measuring system.

### 2.3. Accuracy

In a jig borer, the measurement accuracy must be maintained throughout a long life, since overhaul of such machines is a costly business and not within the capacity of the majority of users. In consequence, measurement systems which are independent of the table drive mechanism must be used. Non-contacting systems based on optical, magnetic or inductive pick-ups are preferred.<sup>1,2,3,4,5</sup>

Measurement systems based on measurement of lead-screw rotation may be used for less accurate work. The lead-screw must be accurately made and anti-backlash devices incorporated in the machine drive so that the position of the machine head is accurately related to the lead-screw rotation. The lead-screw loading should be minimized to reduce wear.

The positioning system must be at least as accurate as the measurement system. For most accurate positioning, the final approach to position is always done in the same manner, i.e. from the same direction and at the same speed.

### 2.4. Life

A jig-borer measurement and control system should maintain its accuracy for 10–20 years with routine maintenance. The life expectancy of a rapid positioning machine, because of its more arduous duties is 5–10 years. It should continue to operate at reduced accuracy for longer than this.

The life of mechanical moving parts is

increased by the use of low friction bearings to reduce frictional forces and wear, and by the reduction of the moving mass to a minimum to reduce inertia forces.

Important points in electrical design are:

- (1) The use of long-life components operated well below their ratings.
- (2) The active elements are preferably transistors, magnetic core devices or special quality, professional and cold cathode valves.
- (3) Circuit design should allow for at least 10 per cent. change in the value of components before circuit failure.
- (4) Electro-mechanical components with rubbing contacts or small clearances should be avoided where possible, unless they are well-proved components.

#### 2.5. Type of Input

In many cases, the co-ordinates of the required position are set in on 10-way switches, there being a switch for each digit of the dimension. It is possible to feed the information to the machine in the form of holes in punched cards or punched tape. Input of this type is most useful when small numbers of similar components are to be produced or small batches are produced at irregular intervals, so that the same information is used several times. The use of punched card or tape input results in reduced overall operation time because of the time required to set up switches, however errors in setting in dimensions are not possible provided the card or tape is punched correctly. The value of punched card input for repetitive work on co-ordinate positioning machines seems uncertain particularly where jigs or templates can be produced cheaply and then used on a copying machine.

#### 2.6. Adjustable Datum

The ability of adjust the datum from which measurements are made is valuable since accurate positioning of a work-piece on the machine table is then unnecessary. The work-piece may be positioned approximately and the measurement datum moved to correspond with the work-piece position.

The machine may also be used with drawings that contain secondary datum points.

#### 2.7. Use as a Measuring Instrument

In some measurement and control systems,

the measurement may be easily displayed. If a microscope is mounted on the moving part of the machine it may be used as a measuring instrument, e.g. for inspection of finished work.

#### 2.8. Other Facilities

A machine operator usually requires to move the machine table or head under his own control. Hand-wheels, or power assisted controls are usually provided for this purpose.

### 3. Measurement Systems

In attempting to classify methods of measurement, they will be divided into digital and analogue systems and further sub-divided into methods based on measurement of the lead-screw rotation and those using independent scales.

#### 3.1. Digital Systems independent of the Lead-screw

##### 3.1.1. Repetitive scan method

The distance to be digitized is traversed repetitively by an element which is simultaneously picking up a signal from a fixed, graduated scale. The scale graduations are placed at intervals corresponding to the resolution required. The graduations are counted from a fixed reference mark to a reference mark mounted on the machine table. Linear digitizers are more practicable if the scanned distance is small as in fine measuring systems.<sup>1</sup> Unless the scanning rate can be made high, scanning methods are not suited to continuous control of a machine table. In this application position must be available continuously to accuracies of one thousandth of an inch or better despite rapid table motion. In positional control systems, security of measurement is afforded despite power failures and electrical interference.

##### 3.1.2. Direct pulse counting method using moiré fringes<sup>6,7</sup>

If two similar linear scales are tilted slightly so that the scale divisions are at a small angle and illuminated from behind by parallel light, the scales appear to be crossed by a series of dark lines where the opaque sections of one scale cover the transparent sections of the other. Relative motion of the scales perpendicular to the scale divisions causes the dark lines to move up or down the scales, so that one dark line has apparently been replaced by

the next for a relative movement of one scale division. The light passing through a small area of the scales may be detected photo-electrically and the number of dark bands passing the photo-electric cell counted. Two photo-electric cells suitably placed will provide information to determine the direction of relative motion of the scales so that pulses are added into the counter for one direction of motion and subtracted for motion in the opposite direction. The application of this principle to the measurement of machine motion is obvious, the lamp, optical system, one scale and the photocells being mounted on the fixed part of the machine and the other scale mounted on the moving machine part (Fig. 2). Scales of reasonable length (10 in.) are now available with 5,000 lines to the inch and they are not expensive. One scale length has to be at least as great as the machine motion, but short lengths of scale can be joined end to end with small gaps between and satisfactory moiré fringes are obtained.

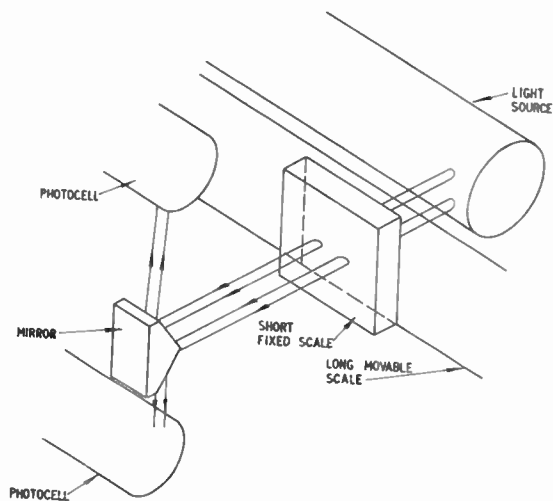

Fig. 2. Moiré fringe counting arrangement.

This measurement system enables the measurement datum to be moved to any point in the machine's range. The datum is however lost if the counters are switched off temporarily and is moved if any pulses are picked up or lost. The accuracy is dependent on the

accuracy of the optical scales, which can be quite high. An error signal is easily obtained if the required changes in position are fed into the counter and the number of fringes subtracted from the counter.

### 3.1.3. Linear coded scale

The position of a machine tool head relative to the table may be determined unambiguously by use of a coded scale. Such a scale in its simplest form consists of a series of transparent and opaque bands or conducting and insulating

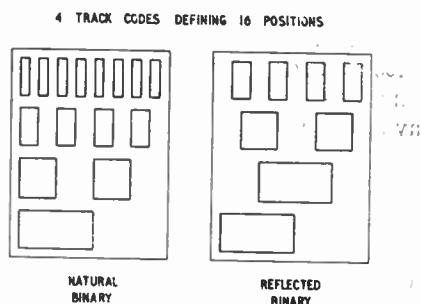

Fig. 3. Linear coded scale.

bands (Fig. 3). These bands are sensed by photo-electric reading heads or electrical contacts. Successive tracks of the scale are divided more and more finely, the finest track determining the resolution of the measuring system. The scaling is such that a given combination of outputs from the reading heads occurs at only one relative position of scale and reading heads. Scales are not often coded in plain binary or binary coded decimal, but in one of the special codes (Gray, cyclic progressive, etc.) in which the output never changes on more than one track at a time. This eliminates gross reading errors, but also increases the cost of the system because of the decoding equipment required.

As there are no linear coded scales commercially available in this country, the resolution would probably be limited a thousandth of an inch at the best, because of the difficulty in making cheap sensing heads to resolve the finest scale divisions. The life of the mechanical contact scale is a function of the mechanical design. However provided the scale is protected, the light source is the most unreliable

element of the optical scale, and lamps are usually easily replaceable. An error signal is not easily obtained, and the measurement datum is most easily altered mechanically, i.e. by moving scale or reading head relative to their mountings.

### 3.1.4. Other methods involving logic

Another interesting measurement system is one which was used for selecting records in a "juke box."<sup>8</sup> In its simplest form, it involves the use of one sensing device for each identifiable position. The moving head searches through all the sensing devices until it finds the one selected by the input, and is stopped. The selection of a sensing device from the input information may be simplified by such logical systems as coincident current matrices<sup>15</sup> (using square loop cores). The resolution of such a measuring system is limited by cost.

## 3.2. Digital Systems Based on the Lead-Screw

### 3.2.1. Direct counting

The number of rotations and fractions of a rotation of the lead-screw may be counted mechanically or electronically. Mechanical counters can be made robust and reliable and they maintain their measurement datum. However their speed of operation is limited (to about 20-40 rev/sec) so that a positioning system using them is either of low resolution or slow.

Electronic counters are capable of much higher speed operation (special designs will count up to several megacycles per second). They require a transducer to convert the mechanical motion into electrical impulses and this must usually be direction sensing<sup>16</sup> so that pulses are added into the counter for rotation of the lead-screw in one direction and subtracted for the opposite direction of rotation.

The measurement datum in any counting system may be altered by zeroing the counters at any position. Electronic counters usually lose their zero if there is a mains failure and they must be carefully designed to avoid pulse pick-up or loss.

### 3.2.2. Repetitive scan

A repetitive scan counting technique similar to that described in section 3.1.1 may be used to determine the angular position of a lead screw or gear wheel shaft. The scanning mechanism is simpler to design since a rotary rather than a linear scan is required.<sup>9</sup>

### 3.2.3. Coded disc

Lead screw rotation may be measured using a coded disc.<sup>10,11</sup> This is similar in principle to the linear coded scale but the scales are concentric annular rings on discs (Fig. 4) and the coded disc and reading head assembly can be used to measure the angular rotation of one shaft relative to a datum. More accurate measurements may be obtained if the disc is driven by an accurate rack and pinion independent of the machine drive lead screw. Such optical coded discs with a resolution of up to 10,000 and mechanical coded discs with at least 1,000 divisions are commercially available.

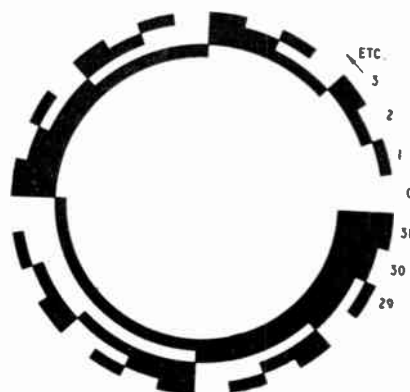

Fig. 4. Five track natural binary coded disc.

## 3.3. Analogue Measuring Systems Independent of the Lead-screw

### 3.3.1. Inductosyn<sup>17</sup>

The rotary Inductosyn is essentially a multi-pole magflip with an accuracy of 5 secs of arc.<sup>4</sup> The linear Inductosyn is effectively a section of a rotary Inductosyn of infinite radius. It has an absolute accuracy of 1/10,000th in. over 12 in. The physical form of Inductosyn elements are metallic patterns on glass plates and for the most accurate work, the temperature coefficient of expansion of the glass may be made close to that of steel. The Inductosyn must be operated with a 10 kc/s supply frequency. It is normally used as a fine measurement system of range 0.1 inch and must be used in conjunction with a coarse measurement system, probably a magflip system.

In the Inductosyn system, the digital input data must be converted to sinusoidal analogue form before it can be compared with the output from the measuring element. Change of measurement datum is easily achieved if differential resolvers are inserted between Inductosyn and the input but these resolvers add appreciably to the cost of the system.

### 3.3.2. Nultrax

The "Nultrax" transducer is another fine measurement device depending on the inductive coupling between its two elements.<sup>5</sup> It is a helical differential transformer as shown in Fig. 5. The primary and secondary consist of helical bifilar windings of the same pitch, which are movable relative to one another. The primary is usually a long coil fixed to the stationary machine member and extending over

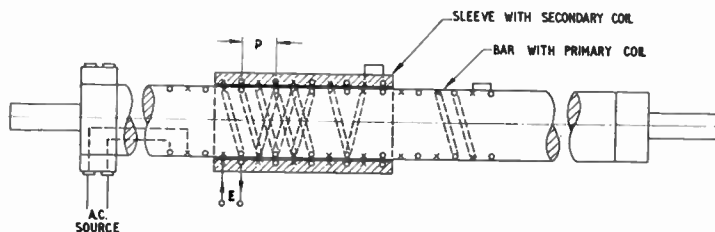

Fig. 5. Helical differential transformer.

a distance greater than the movement of the moving part. The secondary is normally automatically positioned so that there is no pick up from the primary. This occurs when the turns on the secondary are placed symmetrically relative to the primary turns. This rotation of the primary alters the relative positions of the windings and changes the position of the secondary for null output. The moving machine member can then be positioned accurately (over the range of the helix pitch) from an input determined by the angular setting of the primary.

The accuracy may be high, about 0.0001 in., because of the averaging effect of the multi-turn secondary. Alteration of measurement datum must be achieved by moving primary or secondary on its mountings. Programming from cards or tape would normally be achieved by use of a potentiometer follow-up system, rotating the primary to the required position.

### 3.3.3. Linear potentiometer

An accurate potentiometer wound on a straight former with its slider mounted on the moving machine member may be used to measure position of that member. This has not found widespread use on machine tools because of the technical problems involved in designing an accurate component with long life. Using this system adjustment of measurement datum is easily achieved, for instance, by connecting additional resistance in series with one end of the potentiometer. The potentiometer is usually connected in a Wheatstone bridge, which is automatically balanced by the servo drive.

Linear potentiometers have been used in some commercially available plotting tables and potentiometric recorders.

## 3.4. Analogue Systems based on the Lead-screw

### 3.4.1. Magslip

A magslip follow-up system may be used in automatic positioning devices but fine/coarse systems are required if it is necessary to measure to a high accuracy over a wide range.

In one measuring system<sup>3</sup> based on magslips, the fine measurement is referred to an accurate micrometer lead-screw instead of the machine power lead-screw. The micrometer lead-screw is mounted on the machine bed and it positions a differential transformer sensing head relative to this. A servo system operates to position an accurate inch scale on the moving machine member over the sensing head. Since it positions only a light sensing head the wear on the micrometer head is low.

Magslip systems are most easily operated from punched card or tape input by means of a reader with an electro-mechanical linkage from the reader to the input magslips. Input is

normally set in by rotation of the magflip rotors and change of measurement datum can be produced by rotation of the stators. These magflip systems are fairly expensive because of the cost of magflips and associated amplifiers.

3.4.2. Rotary potentiometers

Rotary potentiometers driven from the lead-screw of a machine tool may be used to measure position of the moving member.<sup>12, 13, 14</sup> The most accurate commercially available potentiometers have an accuracy of about 0.1 per cent. so that a coarse and fine measurement system is required for measurements to a high accuracy over a wide range. In this system measurement potentiometers and input potentiometers are usually connected in a Wheatstone bridge arrangement. The bridge output is a minimum when the machine tool is positioned.

4. The Importance of Unity of Conception of Measurement System and Machine Tool

If possible the design of the machine tool and the measurement system should be considered in conjunction. Space and suitable mountings can then be provided in the machine tool for the measurement system. In measurement systems independent of the lead screw, the measurement can be made at the centre line, say, of the machine table instead of the side of the table (which is normally necessary on "adapted" machines). This usually provides more accurate measurement of work-piece position. Where the lead-screw forms part of the measurement system, an accurate lead-screw can be used, the loading on it can be minimized and anti-backlash devices incorporated in the drive. On an adapted machine, none of these may be possible.

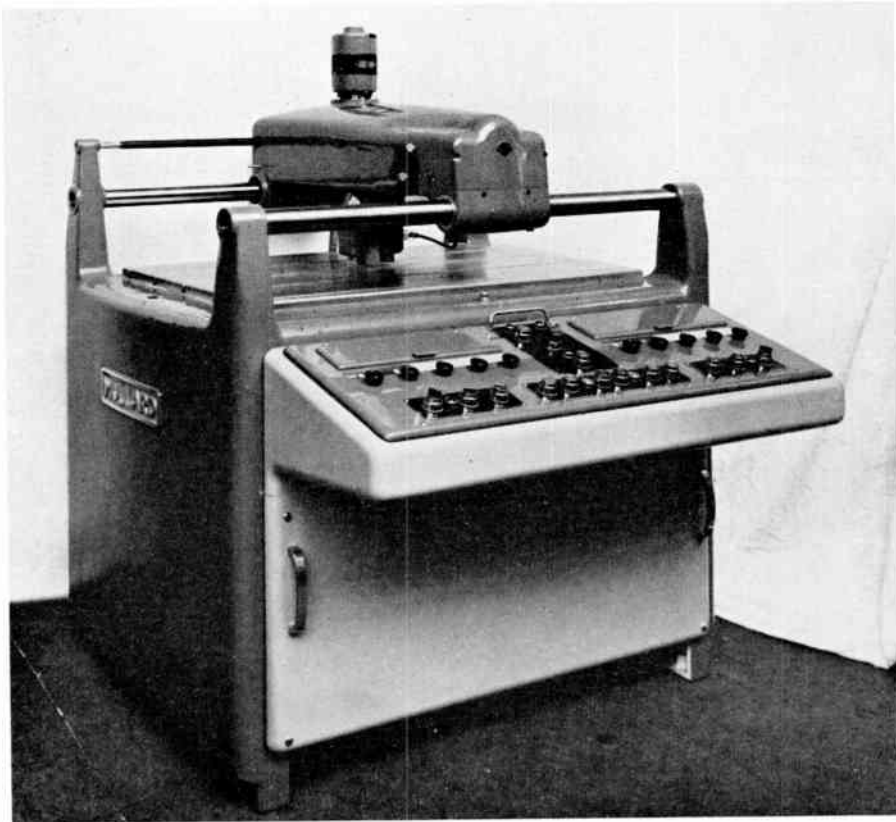

Fig. 6. Medium accuracy positioning machine.

The power drives to the machine motions and their control systems can also be designed with automatic positioning in mind and speeds of traverse can be optimized to provide rapid accurate positioning.

In some types of machine, it may be possible to reduce the mass of the moving member. This reduces both frictional and inertial forces, and particularly in on-off servos, makes it easier to bring the machine rapidly to rest.

### 5. Illustration of Integrated Approach to Design. Fig. 6.

A design problem with which the authors were concerned was a requirement for a high speed positioning machine for marking out sheet metal parts and drawings and for drilling chassis and templates to an accuracy of about 0.001 in. Dimensions were to be set in on switches, and punched card or tape input later. The machine was intended to be used mainly for prototype and small batch production and its specification is given below.

#### Working Range:

Table working surface 40 in. × 27 in.

Longitudinal travel of gantry 30 in.

Transverse travel of tool carriage 20 in.

Accuracy: For all displacements of gantry and tool carriage, ±0.002 in.

Gantry and Tool Carriage Clamps, Electromagnetic.

Drilling Capacity, ¼ in. diameter.

Traverse Speeds—Rapid, 60 in./min.

Slow, 1.2 in./min.

The cost of the machine was kept to a minimum consistent with good reliability.

#### 5.1. Choice of Measurement System

The cheapest measuring systems of about 0.001 in. accuracy to manufacture are those based on the lead-screw using direct pulse counting or potentiometers. The pulse counting method was adopted for the following reasons:—

(a) Apart from the lead-screw, there is nothing in the measurement system which will wear out. Potentiometers have a finite life in terms of shaft rotations and although the valves used in the counters have a finite life in terms of operating hours, electronic counters of potentially longer life are under development.

(b) The measurement datum is easily moved to any point on a work-piece and measurements can easily be made in both forward and reverse directions from the datum.

(c) The count can usually be displayed so that the measurement system can be used solely for measurement.

(d) The measuring head is a small, light device which helps in minimizing the weight of the moving machine members.

It was felt that the loss of measurement datum when the machine was switched off, was not important, because a mechanical datum can be provided if necessary and the time spent on a piece of work is small.

#### 5.2. Machine Design

The emphasis in the machine design has been to minimize wear on the lead screw. The machine tool head is moved rather than the machine table, to reduce inertia and frictional forces, and the machine table can then be made as substantial as necessary, to carry heavy work. The tool-head gantry and tool head are carried on horizontal tubes using recirculating ball bushings for bearings to reduce frictional forces and wear. As a result the floor area occupied by the machine thus is reduced compared with a moving table machine which needs a base area of at least four times the table area. An incidental advantage is that work can be fed in from any side of the machine. The low resistance to motion allows the use of a small (¼ h.p.) motor to drive both motions simultaneously.

To reduce backlash the lead-screw nut is split and spring-loaded.

The automatic positioning sequence used is a fast approach followed by a small overshoot and slow return to position where a brake is applied. The sequence is achieved by the use of a two-speed gear-box using magnetic clutches and brakes. The change from fast approach to slow return is obtained by suitable gearing and a change-over clutch and the brakes clamp the head when position is reached. The complete gearbox for both longitudinal and transverse drives is a very compact unit mounted in the gantry.

The maximum positioning error due to mechanical inaccuracies (lead-screw errors, axes out-of-square, bending of support bars) is



about 0.001 in., i.e. of the same order as the accuracy of the measuring system. Using the method of construction adopted, it would have been difficult to increase the accuracy without considerable increase in cost and the machine accuracy is more than adequate for its intended use, i.e. marking out drawings and sheet metal parts.

### 5.3. Electronic Design

#### 5.3.1. Measuring head

The present head consists of a thin aluminium disc with  $\frac{1}{8}$  in. diameter holes drilled near its circumference, geared to the lead screw or nut. A lamp and two phototransistors count the number of holes passing between them and sense the direction of rotation.

#### 5.3.2. Counters

The pulses from the measuring head are counted by reversible dekatron counters to provide long-life. Associated valves are of the professional or special quality types and all components are worked well below their maximum ratings. Dekatron counter units are readily replaceable for rapid servicing.

#### 5.3.3. Error-detecting circuit

An indication of the sense of positional error is obtained by comparison of counter contents with switch settings. Control of the error signal is handed over from the most significant digit to the next significant and so on, as the correct count is obtained in each decade.

#### 5.3.4. Maintenance

Several of the more expensive electronic machine tool control systems incorporate marginal checking facilities for detecting imminent electronic faults and alarm circuits for indication of faults. The expense of these facilities is unjustified in this case, because faulty operation spoils comparatively inexpensive work-pieces. It is felt that faulty operation will be obvious in most cases to the operator. Replacement of valves after 5000 working hours (about two years assuming a 45-hour week) will result in low fault incidence due to valve failure.

## 6. Acknowledgments

The authors wish to thank the Director of the Mullard Research Laboratories for permission to publish this paper.

## 7. References

1. C. R. Borley, "An electronic measuring system for a jig borer," *Electronic Engineering*, **29**, pp. 128-131, March 1957.
2. E. E. Kirkham, "Digital positioning control," *Electrical Manufacturing*, **58**, p. 118, March 1957.
3. "Automatic co-ordinate setting on a horizontal boring machine." *The Engineer*, **201**, p. 290, No. 5228, April 6th, 1956.
4. D. A. Findlay, "Electronic controls for machine tools," *Electronics*, **29**, pp. 122-129, February 1956 (see p. 128).
5. "The Nultrax Transducer Unit." Canadian Westinghouse Company publication.
6. "Computer control of milling machines," *The Engineer*, **201**, p. 326, 13th April 1956.
7. D. T. N. Williamson, "Computer controlled machine tools," *British Communications and Electronics*, **2**, p. 70, August 1955.
8. C. W. Schultz and G. F. Boesen, "Juke box uses ferrite-core memory," *Electronics*, **28**, p. 138, October 1955.
9. G. C. Bower, "Analogue to digital converters," *Control Engineering*, **4**, pp. 109-116, April 1957.
10. W. S. Elliott, R. C. Robbins and D. S. Evans, "Remote position control and indication by digital means," *Proc. Instn Elect. Engrs*, **103**, Part B Supplements, p. 437, 1956.
11. R. H. Barker, "A transducer for digital data transmission systems," *Proc. Instn Elect. Engrs*, **103**, Part B., p. 42, 1956.
12. J. J. Rudolf, "Knob controlled servos speed and simplify panel drilling," *Control Engineering*, **3**, p. 88, January 1956.
13. "Co-ordinate drilling," *Aircraft Production*, **19**, p. 195, May 1957.
14. "Instruments, electronics and automation," *The Engineer*, **203**, p. 765, May 17, 1957.
15. J. A. Rajchman, "A myriabit magnetic-core matrix memory," *Proc. Inst. Radio Engrs*, **41**, p. 1407, October 1953.
16. W. J. Bane and D. L. A. Barber, "A simple direction-sensitive phototransistor circuit for use in optical pulse counting systems," *J. Sci. Instrum.*, **33**, p. 483, December 1956.
17. H. J. Finden and B. A. Horlock, "The Inductosyn and its application," *J. Brit. I.R.E.*, **17**, p. 369, July 1957.

## of current interest . . .

### **Opening of the I.T.A.'s Scottish Transmitter**

The new transmitting station built by the Independent Television Authority at Black Hill, Lanarkshire, commenced programme transmission on August 31st. Its service area covers the central lowlands of Scotland 100 miles by 50 miles. A directional aerial array is employed to cover the most populated areas; towards the North-East the effective radiated power is 475 kW, 200 kW to the South-West and 65 kW towards the North-West and South-East. The mast is 750 ft. high and the site is 850 ft. above sea level giving an aerial height of 1,600 ft. The station operates on Channel 10 (vision 199.7305 Mc/s, sound 196.2395 Mc/s).

### **Arrangements for Second Geneva Conference**

The British Government have accepted an invitation from the Secretary-General of the United Nations to participate in a second International Conference on the Peaceful Uses of Atomic Energy, to be held in Geneva in 1958 from September 1st to September 13th, inclusive. The last Conference, in 1955, occurred at a time when a great deal of work previously held classified by the U.K., America and Canada was released for publication, and the same will be true of the next one since further important fields of work have recently been declassified.

Provisionally, the Conference will consist of 12 Plenary Sessions embodying papers of a general survey type, and four parallel series of Technical Sessions (68 3-hour Sessions in all).

The Technical Sessions cover the following subjects:—

Series 1: Chemistry and the chemical processing of irradiated fuel; reactor technology; radiation damage in reactor materials; handling of highly irradiated materials; treatment of radioactive wastes.

Series 2: Nuclear physics, including the physics of fission and fusion reactors; reactor theory; fuel cycles and the economics of nuclear power; research, test and prototype power reactors; reactor experiments.

Series 3: Production and uses of isotopes and ionizing radiations in research, medicine, agriculture and industry; dosimetry; bio-

logical effects of radiation; radiological protection; reactor safety and location; meteorological and oceanographical aspects of the large-scale use of atomic energy.

Series 4: Raw material supplies; winning and refining of uranium and thorium; methods of separation of isotopes; metallurgy and fabrication of fuel elements; processing of other nuclear materials.

Further information may be obtained from the United Kingdom Atomic Energy Authority, St. Giles Court, London, W.C.2.

### **Progress Reports on Research**

Instances frequently occur of research work being carried out in ignorance of similar work which has already been completed and reported in papers or articles in the technical press. One way of attempting to reduce such wastage of effort is for research organizations to issue regularly reports on the work in hand and the progress so far achieved.

In this connection the British Electrical and Allied Industries Research Association (E.R.A.) is especially commended on its last Annual Report in which details are given of work in progress on a wide range of subjects. Those of particular interest to radio and electronics engineers include investigations on insulation and dielectrics including gaseous discharge phenomena, and more particularly communication interference. In this latter aspect, the E.R.A. works in close collaboration with the Post Office and other interested bodies.

More frequent and rather fuller details of unclassified research are issued quarterly in the Bulletin of the Radio and Electrical Engineering Division, National Research Council of Canada. In the latest issue accounts are given of the Division's work in microwave applications of ferrites, navigational aids and radomes and antennas. The upper atmosphere research work and the radio astronomy investigations are of course closely related to the I.G.Y. programme and observations are being made on meteors, aurora and the sun. Other important projects include work on an omegatron (mass spectrometer).

Both the above publications may be consulted in the Institution's Library.

# APPLICATION OF X-RAY IMAGE INTENSIFICATION TO INDUSTRIAL PROBLEMS\*

by

A. Nemet, Dr.Sc.Tech.(Member)<sup>†</sup> and A. Hewett-Emmett<sup>†</sup>

*A paper presented at the Convention on "Electronics in Automation" in Cambridge on 28th June 1957. In the Chair: Mr. E. E. Webster.*

## SUMMARY

The improvements in resolution that can be achieved with the X-ray image intensifier compared with conventional fluoroscopic methods are considered. Industrial applications in which the intensifier has been successfully used include examination of engineering stores in their packages, continuous weld examination of pipelines, and inspection of castings and reactor fuel elements. The economy of some of the methods is pointed out.

### 1. Introduction

X-ray image intensifying tubes have now been used successfully for some five years in both medical and industrial fluoroscopy and, in the medical field, for miniature radiography.<sup>1,2,3</sup>

Figure 1 shows a cross-section of a well-known make of tube, the diameter of the screen being 5 in. and the electron-image reduction ratio 9:1. The viewing screen is observed by a microscope, preferably of the binocular type, during fluoroscopy, or is photographed in radiography and cine-radiography. The total

brightness intensification is about 1000:1, of which the image reduction accounts for a factor of 80. The remaining intensification—between 12 and 15—is due to acceleration of the photoelectrons, subject to the efficiency of the conversion process in the X-ray screen and in the viewing screen.

The application of the tube to industrial fluoroscopy offers some valuable advantages over conventional fluoroscopy and radiography which may be briefly examined as follows:

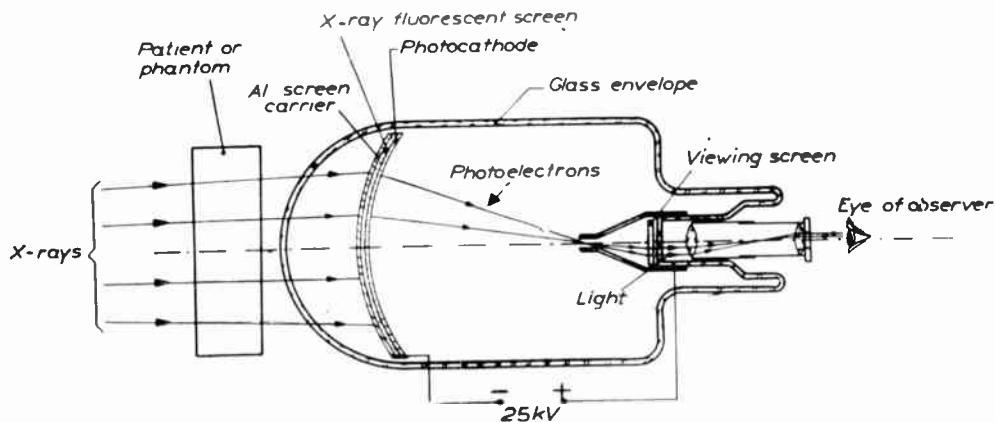

Fig. 1. Sectional sketch demonstrating principle of the image intensifier tube.

\* Manuscript received 1st June 1957. (Paper No. 418.)

<sup>†</sup> Philips Electrical, Ltd., London, W.C.2  
U.D.C. No. 621.386:620.179.15.

Due to the intensification, the brightness of the fluoroscopic image allows observation in dim daylight, whereas in ordinary fluoroscopy complete darkness is essential. This generally results in considerable economy and opens up possibilities of application which are otherwise prohibitive.

Another limiting factor in normal fluoroscopy is the poor contrast. This is partly due to the excessively high kilovoltages used in fluoroscopy which are approximately 50 kV above those used in radiography of the same specimen. This in turn is necessitated by the lack of brightness in ordinary fluoroscopy at low kilovoltages. Using the image intensifier one finds that it is possible to use kilovoltages of the order of not much more than one-half of those used in conventional fluoroscopy, resulting in improved contrast. Finally, the screen blurring of the tube is only 0.3 mm, that is, about one-half of that of normal fluoroscopic screens.

For these reasons, a significant improvement in detail perceptibility may be expected and is in fact borne out by penetrameter measurements. The sensitivities for aluminium are in

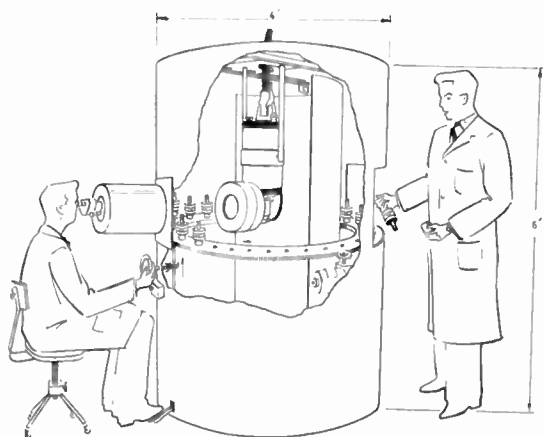

Fig. 2. Examination of fuse links with the X-ray image intensifier.

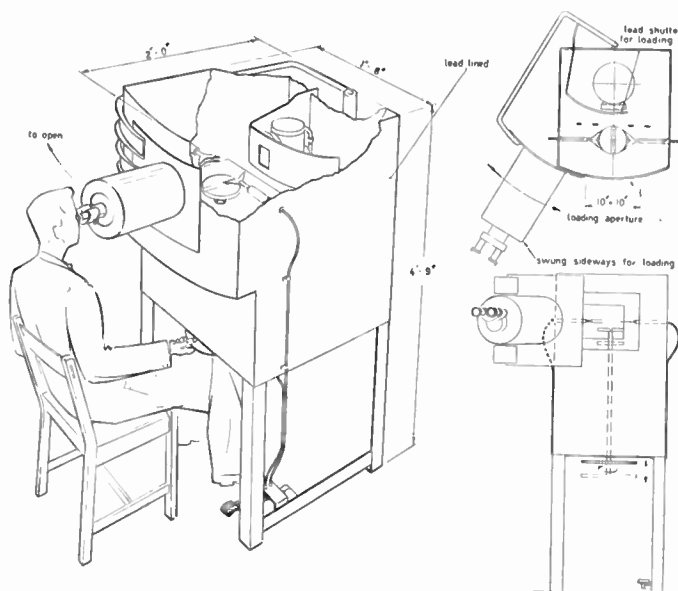

Fig. 3. Piston examination with X-ray image intensifier. Castings may be fed from the front by the operator without switching off X-rays.

the range of 1-2 per cent, and for steel 3-4 per cent, with an accompanying increase of the thickness penetrated for a given voltage. The maximum thickness that can be penetrated at 150 kV d.c. is of the order 1½ in. steel and 5 in. aluminium. Work is in hand to extend the range by using X-rays up to 300 kV, in connection with the image intensifier.

X-ray protection up to about 150 kV is simple and the binoculars may be observed directly without exceeding the maximum permissible limit at the eyes. For higher voltages, special precautions have to be taken.

## 2. Applications

A few typical practical applications in which the image intensifier has already proved its value or promises to afford valuable economy will be described.

### 2.1. Stores Check

In some instances of large engineering stores, it is important to be able to check contents of sealed packages without opening them. A fluoroscopic cage can be set up to house a conveyor belt which slowly carries the sealed packages before the image intensifier tube and

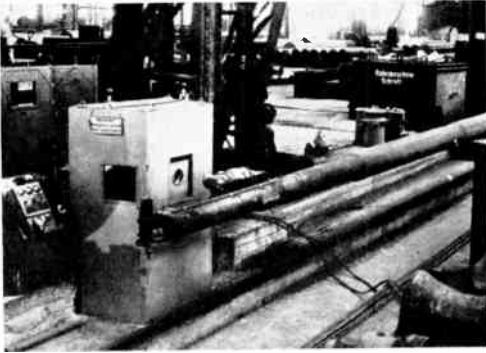

Fig. 4. The X-ray tube is mounted on a long horizontal mandrel facing the aperture in the operator's cabin in which the image intensifier is mounted.



Fig. 5. Shows the operator in his cabin and the steel pipe in position. This is automatically moved slowly in and out in front of the stationary cabin.

so allows identification in dim daylight and without breaking the seal. The method is especially valuable when tropical sealing and relatively dense packing materials are used.

### 2.2. Megawatt Fuse Links

Large fuses are often made with helical silver elements wound on ceramic cores. During the course of assembly, these elements may become open-circuited or have an uneven helix. To prevent delivery of faulty fuses, it has been found that fluoroscopy with the image intensifier is a convenient method. It is important to know that in both this and the previous application, good design of the handling equipment is an essential part of the method.

Figure 2 shows a schematic design of a handling equipment. The intensifier is built into a lead-lined cylindrical drum together with the X-ray tube and rotating shelf on which the fuse links are placed by an assistant through an opening at the back. The operator observes the fuses one by one by means of a binocular microscope and scans vertically over the length of the longer types of fuses by means of a handle. The fuses may also be rotated. The image is enlarged by a factor 2. A 100 per cent. production test is likely to be used on this particular inspection.

### 2.3. Piston Castings

Another application of the image intensifier is the examination of light alloy piston castings before machining. This presents quite a problem to the foundry as batches of castings

tend to exhibit porosity and other defects which are normally only detected after the piston is sectioned or machined, so that valuable machining hours and production are wasted.

Figure 3 shows the arrangement which must again be based on sound design of the handling gear. The image intensifier is mounted on a hinged flap and can be swung out of the way to allow the pistons to be fed on to the turntable from the front. The pistons are centred by clamps on the turntable. The clamps are operated by a foot pedal and are removed by springs after centring. The operator can scan the casting by turning it and by moving the counterweighted turntable up and down. The housing is lead-lined for X-ray protection and it is so arranged that when the image intensifier is swung out of the way, the path of the X-rays is automatically obstructed by a lead shutter.

Hitherto small-batch, destructive, sampling techniques have been used which are to be replaced by a much larger-batch inspection, representing about 10 per cent. of production. The arrangement allows inspection at a rate of 50 pistons an hour but it will be appreciated that higher speeds to increase output are possible by employing further mechanization.

### 2.4. Fluoroscopy of Horizontal Pipe Welds

Figures 4 and 5 show the fluoroscopic arrangement for weld examination of large section steel pipes up to 30 ft. long. The X-ray tube is mounted on a long stem and is stationary so that the tube window is opposite the image intensifier. This latter is mounted

in an observation cabin having protective walls. The pipes pass on rails in front of the image intensifier and surround the X-ray tube. The longitudinal weld to be examined is observed during the travel and doubtful places are marked. The X-ray tube operates at 150 kV d.c. and has a focal spot of 0.4 mm. The picture enlargement used is again 2:1, the distance between the intensifier screen and the tube focus being approximately 40 cm. This method is in regular use by at least two manufacturing firms in Germany.

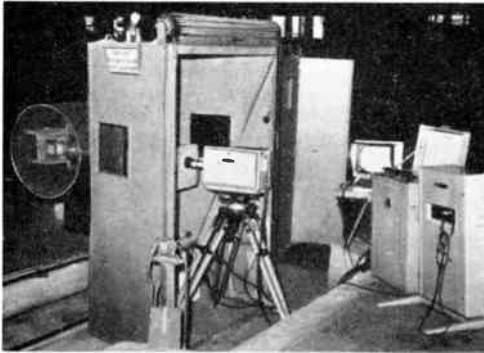

**Fig. 6.** Shows a television camera for closed circuit television erected in place of the operator. The television screen may be seen on the left of the X-ray controls.

Figure 6 shows a television camera to replace the observer at the viewing end. Closed circuit television offers many advantages in connection with the image intensifier. It allows observation by any desired number of persons and removes the radiation hazard. It also removes eye fatigue which is a practical limitation for observation through the microscope. A limited amount of extra blurring is inevitably introduced when using a television system. In many applications, however, the advantages far outweigh the disadvantages.

### 2.5. General Development Applications and Research

Clearly, laboratories occupied with non-destructive testing have here an additional tool by which new processes and production methods—mainly foundry and welding techniques but also assembly, packaging and other

types of problems—can be investigated. For this type of use the intensifier is mounted in a simple square lead-lined container and the test piece is mounted on a plastic platform that can be moved by means of a handwheel at the outside of the protective container, by the operator, during observation. The X-ray tube is placed at the bottom of the container with the window pointing upwards. For general work a 150 kV tube having a 0.4 mm focus has been found very suitable. A magnification of 2x usually gives best results; for small articles a focus-object distance of 20 cm is used. It is found that for most applications individually-controlled diaphragm blades offer a distinct advantage and masking may be dispensed with in consequence.

Another favoured way of mounting the image intensifier in an experimental arrangement is to use a protective wall of an existing fluoroscopic room and to fix the intensifier with its lead-lined casing at eye level for a seated observer. Fig. 7 shows a photograph of such an arrangement.

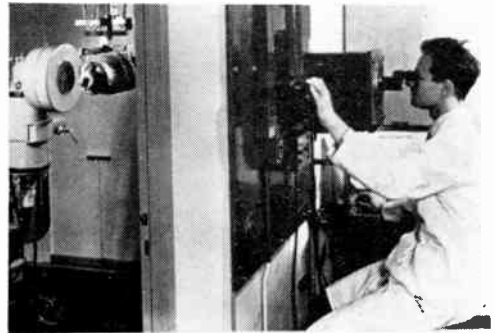

**Fig. 7.** The intensifier, in its protective casing, is mounted in an X-ray protected wall between the high-tension room and the operator's room. The X-ray tube is on the left and the specimen may be remotely controlled by a push-button by means of an electrically-operated crane.

Diffraction mottling is a phenomenon encountered mainly in conjunction with stainless steel and "nimonic" alloy radiography. It is a striking demonstration of the Laue diffraction due to the presence of very large single crystals in the metal. In image intensifier fluoroscopy the diffraction spots can easily be distinguished from flaws by slightly rotating the object, when

the flaw and the object move slowly and the Laue spots fly across the picture very much faster.

It is hoped that the image intensifier will also prove useful in connection with semi-conductor research and production, particularly connected with the cutting of germanium and silicon in desired crystal planes.

### 2.6. Large Welded Oil Tanks

Some of these oil storage tanks may have a diameter of 150 ft and present difficult and rather expensive radiographic problems. The tank is welded from large steel sheets and it is now found necessary to examine the cross junctions of these sheets radiographically. It is suggested that a travelling carriage containing the image intensifier, the X-ray tube and a television camera should be constructed so that fluoroscopy can replace radiography.

### 2.7. Examination of Fuel Elements from Nuclear Reactors

One of the most interesting applications of the tube which has been successfully tried is the detection of distortion and pitting of fuel elements in nuclear reactors. To be really economical, this examination should be carried out immediately after their removal from the reactor, that is to say, when the fuel element is still intensely radioactive. This means that gamma radiation of various energies up to about 1.5 MeV is emitted. The problem thus is to detect an X-ray image in the presence of a very strong gamma field. This may vary from 40 curies to 3000 curies at a distance of a few inches from the X-ray screen of the image intensifier.

Figure 8 shows the arrangement of the X-ray tube and fuel element and the image intensifier. It is essential to obstruct the gamma radiation as much as possible and it is helpful to remember that the efficiency of the X-ray screen is poor for high energy radiation. The degree of activity is a matter of compromise between the time delay of the examination after the elements are removed from the reactor and the protection required during handling and examination. Observation of the X-ray screen may be made by a telescope from a ray-protected room or by closed-circuit television.

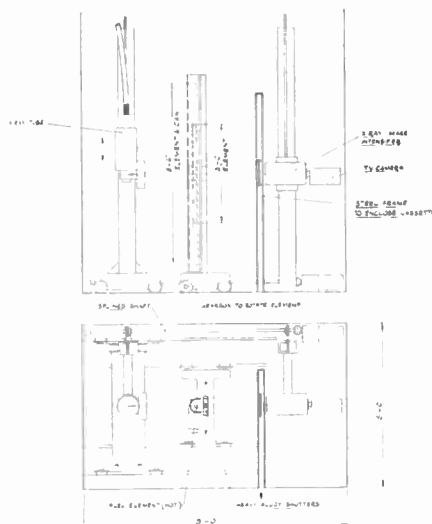

**Fig. 8.** Examination of radioactive fuel elements with the X-ray image intensifier. *Top:* Elevation. *Bottom:* Plan view. The fuel element is mounted vertically in its can on the centre trolley, moving on rails. The X-ray tube is also mounted on a mobile trolley shown on the left. The image intensifier and associated television camera are mounted on a stationary column on the right. The X-ray tube and intensifier plus camera move vertically in unison, scanning the fuel element over its length of 3 ft. All movements, vertical and horizontal, are remotely controlled from a radiation-protected area (not shown) housing the observer and the television screen. Radiography may be carried out by a film cassette in front of the image intensifier. The cassette is brought into position and removed for development by means of a chain drive. The lead-lined channel containing the cassette is shown between the image intensifier and the fuel element column.

### 3. Conclusion

Summarizing, it should be noted that image intensifier fluoroscopy cannot claim to be equivalent to ordinary contact radiography in resolution. It offers, however, a valuable new application of fluoroscopy to non-destructive testing in cases where normal radiography is too expensive and ordinary fluoroscopy is not good enough.

### 4. References

1. M. C. Teves and T. Tol, "Electronic intensification of fluoroscopic images," *Philips Technical Review*, **14**, p. 33, 1952.
2. R. E. Sturm and R. H. Morgan, "Screen intensification systems and their limitations," *American Journal of Roentgenology and Radium Therapy*, **52**, p. 617, 1949.
3. A. Nemet and W. F. Cox, "Intensification of the X-ray image in industrial radiology," *Proceedings of the Institution of Electrical Engineers*, **103**, Part B, p. 345, 1956.

621.373.5  
**Improving the frequency stability of quartz oscillators by compensation.** G. BECKER. *Archiv der Elektrischen Übertragung*, 11, pp. 289-294, July 1957.

By reference to the example of the known Pierce circuit a method devised by W. Herzog for improving by compensation the frequency stability of crystal oscillators is examined with respect to its usefulness by intercomparing dependences, calculated with and without compensation, of the generated frequency on the circuit parameters. It is shown that the advantages that can be attained by compensation are opposed by serious drawbacks that militate against an application of the compensation method in the case of highly constant crystal oscillators such as those of crystal clocks.

621.375.4  
**The junction transistor as a network element at low frequencies, I. Characteristics and  $h$  parameters.** J. P. BEIJERSBERGEN, M. BEUN and J. TE WINKEL. *Philips Technical Review*, 19, pp. 15-27, No. 1, July 1957.

The low-frequency properties of a transistor can be expressed by pairs of families of curves; some of the many possible pairs are discussed. The transistor, like other network elements with three terminals (e.g. vacuum tubes) can be turned into a fourpole in three different ways, corresponding to the common-emitter, common-base and common-collector configurations. The active fourpole thus obtained can be characterized by four parameters. In simple cases, the so-called  $h$  parameters are often used. Illustrative examples are given, using graphs of input resistance and current gain as functions of load resistance, and output resistance as a function of source resistance. The concept of operating gain is explained.

621.385.16  
**The helical line with coaxial, cylindrical attenuating walls.** G. LANDAUER. *Archiv der Elektrischen Übertragung*, 11, pp. 267-277, July 1957.

The damped helical line is analysed with the aid of Maxwell's theory. This analysis is based on the following model: the helical line is replaced by sheet model, an obliquely conducting cylinder with infinitely thin walls. At a certain distance a cylindrical semi-conducting outer shell is arranged to give a coaxial system, for which the wave propagation is calculated. Attenuation and phase rotation in the direction of propagation is presented as a function of the surface resistance of the damping cylinder, under the assumption that its sheet is thin with respect to the depth of penetration. For the helices preferred as delay lines in travelling-wave tubes ( $\beta_0 a \cot \psi = 1.5$ ;  $\beta_0$  phase constant of the empty space,  $a$  radius of the helix,  $\psi$  angle of pitch of the helix) the attenuation reaches a maximum in the range of 2 to 3 k $\Omega$ . For very high and for very low surface resistance the attenuation approaches zero. With very high surface resistances the phase velocity has approximately the value corresponding to the undamped helix, and it diminishes with decreasing surface resistance. Two different surface resistances can give the same attenuation, but different phase velocities.

621.396.812.5  
**Reflection of short and ultra-short waves by the aurora.** G. LANGE-HESSE. *Archiv der Elektrischen Übertragung*, 11, pp. 283-288, July 1957.

Conclusion of paper abstracted in August 1957 *Journal*.

*A selection of abstracts from European and Commonwealth journals received in the Library of the Institution. All papers are in the language of the country of origin of the journal unless otherwise stated. The Institution regrets that translations cannot be supplied.*

621.396.812.5  
**The effect of solar ultra-radiation on radio propagation on the 23rd February, 1956.** B. BECKMANN, P. DIETRICH and H. SALOW. *Nachrichtentechnische Zeitschrift*, 10, pp. 329-334, July 1957.

A report on the ionizing influence of solar ultra-radiation in the ionosphere during and after strong solar eruptions. This influence becomes perceptible as a strong increase in the attenuation in the propagation of radio waves. While on the day-light side of the earth a Mögel-Dellinger effect was released by the ultraviolet radiation of the eruption, the night-side (Europe and America) showed at the same time attenuation obviously caused by the corpuscular ultra-radiation. This attenuation continued for many hours during the following day. The field strengths on the short-wave radio links to North-America were so low in spite of normal m.u.f., that strong traffic interferences occurred.

621.397.5  
**Performance tests on colour television systems and apparatus.** F. A. BOUTRY and P. BILLARD. *Onde Electrique*, 37, pp. 658-670, July 1957.

This paper presents the results of experiments for determining the amount of degradation in the reproduction of the original caused by television systems or apparatus. Specially planned tests were made, in which the observers were limited to the expression of opinion in the terms "yes" or "no." The experiments dealt with the linearity and extent of the luminance scale, the crosstalk that can exist between the primaries, the colorimetric fidelity of the reproduction, and the resolution of detail in the presence or in the absence of luminance contrast. Crosstalk was measured by means of a specially constructed colorimeter. The other tests used photographic methods. Results are given for recording and reproducing apparatus on the one hand and for a television system (double message) on the other. The method can be applied to the study of different colour television systems.

621.397.5  
**Reproduction of colours in the double message system.** P. BILLARD. *Onde Electrique*, 37, pp. 671-678, July 1957.

This article concerns the colorimetric properties of a double-message colour television system. First, the method of obtaining correct colour reproduction by additive synthesis is reviewed, and from this the spectral sensitivities necessary for the analysing apparatus is deduced, taking account of the primaries that are chosen. The distortion in colour and luminance due to the equipment used and to the system is then studied. In particular it is shown that the gamma correction must be carried out very carefully. Crosstalk produces distortions both of colour and of luminance but it is shown that by means of a simple correction these distortions can be made practically negligible.