

The Journal of THE BRITISH INSTITUTION OF RADIO ENGINEERS

FOUNDED 1925

INCORPORATED 1932

*"To promote the advancement of radio, electronics and kindred subjects
by the exchange of information in these branches of engineering."*

VOLUME 17

JUNE 1957

NUMBER 6

MAINTAINING INTEREST

WHEN these notes are read the 1957 Convention will be in progress. The problems of selecting papers, arranging venues and accommodation will be over. Regretfully it must be recorded that it has not been possible to accommodate all who would have liked to attend the most successful Convention the Institution has ever held.

After the Convention members will return to the normal work involved in the arrangement of Institution meetings in London and the various local Sections. Because of the crowded programme, there will not be the usual meeting of Chairmen of local Sections during the Convention. Instead, a special one day meeting will be held in London of local Section Chairmen, or their representatives, in order to permit of a full discussion of ways and means in which the Institution can best serve the interests of members wherever they may be situated.

There are three main objects in forming a local Section—(a) holding lecture and discussion meetings; (b) arranging works and similar visits of interest to the radio and electronic engineer; (c) organizing social functions.

These activities are designed to stimulate an exchange of experience and ideas between members engaged in a common profession and especially through (a), to contribute to the general proceedings and *Journal* of the Institution papers of interest and importance to the radio engineer.

It cannot be emphasized too often that without the valuable work of the local Section Committees the Institution's activities would be very limited; indeed, the vast majority of members would only have the *Journal* as their

main contact with the Institution unless they were able to visit London frequently. A conference of Section Chairmen will, therefore, materially promote understanding and provide an opportunity to discuss mutual problems with the Officers and members of the Institution's standing Committees.

The Chairmen of all local Sections are, of course, ex-officio members of the General Council, and thereby provide a direct link between members and the Council. It may be, however, that more can be done in directly assisting the local Sections to play their part in fulfilling the objects of the Institution.

Every professional body makes occasional comment on the proportion of its members who do attend meetings and otherwise support local Section activities. It is certain that members can do more to give impetus to the work of the Institution by participating in meetings, and by otherwise using their influence to assist local Section Committees.

Every member might, in fact, ask himself, "Are you satisfied with the activities of your local Section, and have you any suggestions for increasing its effectiveness?" In one Section there has been comment by members as to whether more could not be done to welcome new members at meetings. It is certainly important to make a new member feel at home with his professional colleagues.

Suggestions from members on ways of increasing the usefulness of local Sections and the Institution generally are encouraged. A note to the Chairman or Secretary of a local Section, or direct to the Institution in London, may well help to make the forthcoming meeting of local Chairmen a successful one viewed from the interests of every individual member.

NOTICES

OBITUARY

It is with deep regret that the Council has learned of the death of John Wilson at the early age of 47, as a result of heart failure.

Mr. Wilson, who was elected an Associate Member of the Institution in 1952, had been with Murphy Radio Ltd. for most of his professional life. In 1949 he was appointed General Manager of Murphy Radio, India, Ltd. In 1953 he joined Sankey Electrical Stampings, Ltd., Calcutta, as Works Manager, and had served on both the Bombay and Calcutta Sections of the Institution.

Brit.I.R.E. Visit to Harwell

On April 24th, forty members of the Institution took part in a visit to the Atomic Energy Research Establishment, Harwell. The party was welcomed by Mr. Denis Taylor (Member), Head of the Electronics Division. A short lecture by Dr. G. B. B. Chaplin on the use of transistors in nucleonic instrumentation preceded visits to a number of installations.

Members were able to see the following:—

The materials testing reactor DIDO which is a high flux, heavy water moderated thermal reactor fuelled with highly-enriched uranium.

Two d.c. analogue computers developed as simulators for solving problems of reactor design and control.

Some of the work of the ferrite stores and kicksorters group which included a 1000-channel neutron velocity spectrometer using ferrite data storage.

Health physics instrumentation, such as radiation monitoring with ion chambers, photographic film, Geiger and scintillation counters.

The arrangements made by Dr. Taylor and his staff to make the visit a success were greatly appreciated by those taking part.

It is hoped that it will be possible for the Technical Committee to arrange during the coming months further visits to places of interest.

The Institution Tie

For many years members have advocated the adoption of an official Institution tie. These representations were renewed after publication of the January 1957 *Journal*.

The Council therefore appointed a sub-committee to consider special designs incorporating reference to the Coat of Arms. The design formally approved by the Council is shown in the accompanying illustration.

The principal colours of red and gold are shown on a dark blue background. As is customary in such designs, the two tinctures mentioned in the blazon of the Coat of Arms are predominant. The shield of the Coat of Arms provides the motif of the tie, as shown in the inset illustration. The shield design is, of course, an allusion to the family Arms of Clerk Maxwell and has a background of blue to represent the sky and the atmosphere through which radio waves are transmitted.

The gold wedge shape shown on the shield, together with a heart, are also canting allusions to Henrich Hertz, whose work in the field of radio propagation was based on the scientific discoveries of Clerk Maxwell. Members who have read a description of the Armorial Bearings—published in the January 1957 *Journal*, together with a colour reproduction of the Coat of Arms—will appreciate the principal points brought out in the design of the tie.

The wearing of the Institution's tie is, of course, restricted to members of the Institution. It is woven in Terylene and can be obtained from the offices of the Institution, price 25s. including postage and packing.

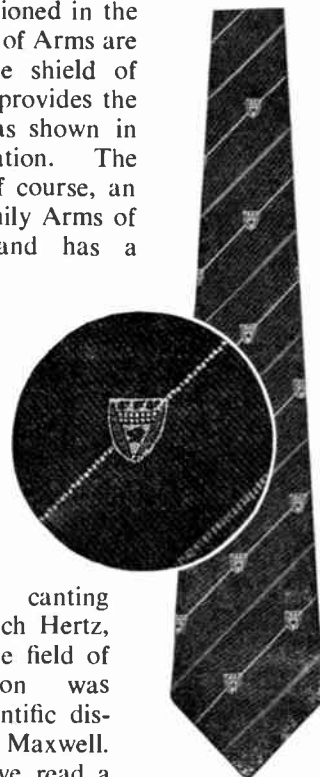

SOME NUCLEONIC INSTRUMENTS FOR CLINICAL USE*

by

E. W. Pulsford, B.Sc. (Associate Member)[†] and N. Veall, B.Sc.[‡]

Read before the Institution in London on 27th February 1957.

In the chair: Mr. G. W. Raby, C.B.E. (Member).

SUMMARY

The electrical and mechanical requirements are discussed from the points of view of designer and user. Instruments described in detail are: (1) A 4-channel logarithmic ratemeter employing Geiger counters and used typically for blood circulation investigations; (2) Clinical monitor, using a Geiger counter, for tests not requiring high accuracy and where compactness and portability are desirable; (3) Recording count-rate meter employing a scintillation counter, particularly useful for recording transient phenomena lasting only a few seconds; (4) Standard β - γ ionization chamber for checking the activities of solutions of radioactive isotopes.

1. Introduction

Radioactive tracer techniques are now being increasingly widely employed in industry and in scientific research generally. It was however in the biological sciences that their value was first generally recognized and it would be difficult to find a single branch of clinical research where radioisotope methods have not found numerous applications. As a result of their use in medical research, a fair number of procedures have been developed which are known to be of value as diagnostic tests, and these are, in fact, so used in most of the major hospitals in this country. There remains a far larger number of tests whose value can only be assessed after they have been in general use for some time.

There is no reason in principle why radioisotope techniques should not be more widely available particularly in those hospitals which already provide radiological and pathology laboratory services. One of the factors which is tending to limit the application of tracer techniques in medicine is the fact that most of the work done to date has involved the use of nucleonic apparatus which was intended

in the first place for use by physicists. This is not a serious difficulty in hospitals which have adequately staffed physics departments, though it may be argued that routine radioactivity measurements are not necessarily the most useful activity to which a hospital physicist can devote his time. In most cases the actual radioactivity measurements only account for a small fraction of the time and effort involved in carrying out a particular test, which may involve a fair amount of chemistry and the use of other specialized techniques such as flame photometry, electrophoresis or chromatography. Consequently, there is much to be said for attempting to integrate the routine isotope tests with the existing diagnostic services rather than to create a special department. If this course is adopted, it is desirable that some effort be directed towards the design and production of nucleonic apparatus which is designed to carry out specific clinical tests, and which can be operated by non-specialist staff with the minimum of preliminary training.

The instruments discussed below have been developed with this object in mind. In each case the equipment was initially designed to carry out one specific test in a centre where the volume of work was sufficient to justify the use of a special instrument. In most cases the apparatus has subsequently been modified by the addition of additional facilities in order to increase its range of applications.

* Manuscript first received 6th February 1957, and in final form on 10th May 1957. (Paper No. 399.)

[†] Atomic Energy Research Establishment, Harwell, Berkshire.

[‡] Physics Department, Guy's Hospital, London, S.E.1.

U.D.C. No. 621.387.4:612.

In the design of two of the instruments to be discussed (Clinical Monitor, Type 1294; Recording Ratemeter, Type 1418) certain principles have been adopted in order to make the instruments easily operated by non-specialists. These principles will be enlarged upon later, but, in general, they may be summarized as follows:—

Provide all necessary functions with simple circuits in one box to ensure portability and reliability.

Arrange all controls and meters on the front panel, and relegate setting up and calibration controls to the rear.

It is now proposed to give details concerning a special installation of which one model was made for specific research investigations, and of several other instruments specially designed for clinical work.

2. Logarithmic Ratemeter Installation

The isotope technique is particularly applicable to biological work because it can be used to study the absorption, distribution and transport of various materials as dynamic phenomena. In many applications, particularly those involving the measure of "turnover rates," the system under study can be regarded as a one- or two-compartment system, and the experimental results obtained fit simple exponential curves. The continuous removal and replacement of an ion such as that of sodium in the tissues by the blood stream is such a process, and a small quantity of sodium 24 injected in a tissue is found to be removed exponentially.¹ Changes in the slope of a semi-logarithmic plot connecting activity with time will reflect changes in capillary blood flow, and this technique is the basis of a practical clinical test in patients where a knowledge of the state of the circulation in a particular region is necessary. In particular, it has been found of considerable value in research on some practical problems in plastic surgery.²

Much biological work involves the resolution of mixtures of various substances by ion exchange columns and by one-dimensional paper electrophoresis. Continuous recordings of the radioactivity of the eluate from a column, or along a paper strip can be effected

by means of a counting ratemeter, but since peaks of widely varying activities have to be recorded it has been usual to employ some sort of range switching in order to keep the record on the scale. The use of a logarithmic ratemeter with two or more decades represents a convenient and inexpensive method of overcoming this problem.

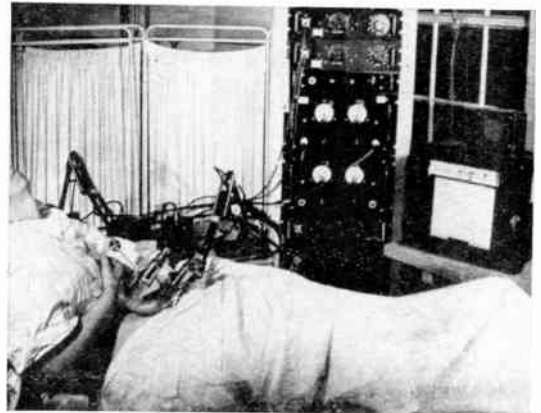

Fig. 1. Four-channel logarithmic ratemeter installation for studies on circulation in skin grafts. (Plastic Surgery Centre, Oldstock Hospital, Salisbury.)

The logarithmic ratemeter and recorder shown in Fig. 1 was the first specially-designed nucleonic installation made for a specific clinical investigation (determination of the capillary circulation index²). The results obtained with it have led to the establishment of routine tests which are now performed with simpler equipment in centres where the volume of work is small, as mentioned later in Section 3 on the Clinical Monitor.

This installation was built before the formulation of the design ideals mentioned above and elaborated later, so that these do not apply in this case. The four-channel instrument is built according to standard practice for rack mounted equipments, occupying all of a six-foot rack, necessitating its installation in a special room to which the patients are brought. In this case, this is not a great disadvantage, since the room has to be temperature controlled.

The details of the principle of the logarithmic ratemeter are to be found in reference 3.

This type of ratemeter is of special utility because in this case the phenomenon being

studied is the clearance rate of a small subcutaneous injection of sodium 24 by the capillary bloodstream, and a record of the count rate plotted logarithmically against time is a straight line. The four-point recorder plotting the four channels of this installation draws these straight lines on a chart, and the essential information, or clearance rate, is observed from the slope of the lines. The four channels enable up to four test sites to be investigated simultaneously.

The radioactivity detectors used are all-glass end-window Geiger counters (EW3HG), held with the windows in contact with the skin to preserve a fixed geometry, and to reduce to a minimum the effect of small movements of the patient such as those due to breathing. Special flexible and counterbalanced stands are used, and light bandaging maintains the contact between counter and skin. The output from the Geiger counters is fed to quench-probe units Type 1014,⁴ which in turn provide an input for the logarithmic ratemeter channels.

Here, then, we have an example of a specially designed and built research instrument on which a routine test has been established, and which has also been used to establish a number of other previously unknown facts about the capillary circulation.

3. Clinical Monitor Type 1294

This equipment was designed to meet the requirement for a simple compact apparatus which could be used in conjunction with a needle counter (20th Century Electronics Type N1b) for testing the blood supply to the hip joint in cases of fractured neck of femur, using phosphorus 32 as a tracer.⁵ Similar apparatus may also be used for the localization of brain tumours at operation.⁶

The apparatus, after having been somewhat extended in scope, has been found to be extremely useful for a large number of clinical tests where a Geiger counter or counter system can be used as the radiation detector. These include a number of metabolic studies, circulation tests and blood volume determinations. In many clinical tests a high degree of accuracy in measurement is not essential since small variations in the quantity measured are of no clinical significance, and the accuracy obtained

with simple circuits is perfectly adequate. As there are only two operating controls on this instrument, the apparatus once set up, can be used by non-specialist staff after only a few minutes instruction.

If we consider the standard equipment that is needed to build a beta-gamma counting installation, we find we need:—

- (i) A Geiger counter, chosen to suit the work.
- (ii) An e.h.t. stabilized power unit to polarize the Geiger counter.
- (iii) A quench probe unit, to impose a known paralysis time on the counter, and to remove secondary discharges.
- (iv) A scaler, to record the number of pulses.
- (v) A timing unit, to measure the time of counting. This is a labour-saving alternative to a stop watch.

The three major units in this list, the power unit, scaler and timing unit occupy at least a three-foot standard Post Office rack, and are much too bulky, together, to be moved easily. By the use of modern methods of producing a stabilized high tension supply; of the pulse integrating type of scaling circuit, and of an electronic timing circuit depending on the feedback time-constant, it has been found possible to get all the essential features into one reasonably sized, easily portable box.

In order to achieve this compact form some sacrifice has been necessary. In general this comprises a small loss of accuracy in the scaling function, and a restriction of the available instrument ranges to those really needed. Also, because the timing is determined by resistors and capacitors, there is a further sacrifice of accuracy because these cannot be relied upon to remain extremely stable over lengthy periods. No sacrifice of accuracy or stability is necessary in the e.h.t. section, compact form being achieved by the use of voltage multiplying circuits and corona stabilizers. Against this sacrifice of accuracy must be set the fact of the statistical variations found in experimental work involving random pulse counting. In general, the uncertainties arising because of these statistical effects are greater than the inaccuracies inherent in the simple circuits of the compact instrument, and so the experimenter is not, in fact, much worse off than if he had instruments of greater precision.

It is found possible to provide all the facilities needed for clinical beta-gamma counting with electronic circuits briefly described as follows:—

The Geiger-counter quench probe circuit used is identical with the well-tried circuit of the Probe Units, Type 1014,⁴ but, instead of building it as a separate unit, the four valve circuit is built inside the main box, and the Geiger counter connected to it by a reasonable length (up to nine feet) of low-capacitance concentric cable. This arrangement is found to work satisfactorily, even for the small needle counters. The sensitivity of this trigger circuit can be as low as 0.25 volt, and it has a rise-time of the order of one or two micro-seconds. Furthermore, from the quench-probe circuit it is possible to obtain a voltage pulse of defined amplitude (and duration) for operating the subsequent scaling circuit, consisting of a diode-pump (one double diode) and pulse integrating circuit (two valves). The function of these two circuits together is to transfer to a capacitor a fixed charge per pulse with the result that the voltage on the capacitor rises linearly (or in equal steps) with the number of counted pulses. A panel meter indicates this voltage, and hence its reading is a linear measure of the number of counted pulses, the action of the whole being that of a scaler. Simple switching, governed by an automatic timing circuit, is used to start and stop the action, and to cancel the indication of one experiment before starting the next. The drift of the integrating circuit is usually about two or three per cent. of full-scale per hour, which introduces a negligible error under normal conditions of use.

The automatic timing circuit is an adaptation of the well-known fed-back time constant, or Miller integration circuit, in which a capacitor, connected between anode and grid of an amplifying pentode, is charged linearly by passing a steady current into it at the grid terminal. When the anode "bottoms" the screen rapidly takes a large current, used to operate the "stop" relays which switch off the count and break the anode circuit of the timing valve allowing the timing capacitor to recharge ready for the next run. To start timing, it is merely necessary to connect the anode circuit

momentarily. This type of timing circuit is found to have an accuracy of repetition within a few parts in a thousand; arrangements are included to enable the nominal interval to be set up against a stop-watch and, by switching in a choice of two capacitors, two time intervals, (half-minute and one minute) may be selected. When longer intervals are required, the timing circuit may be operated from an external key, a stop-watch being used in the normal way. For functional testing purposes, a simple 15 c/s neon oscillator is included (V1) and is brought into action by a biased panel switch.

The power unit section consists of the usual mains transformer, rectifier and filter, followed by discharge tube stabilizing of the main power supply lines. The e.h.t. supply is obtained from the same mains transformer by means of a voltage quadrupling circuit feeding a system of corona discharge tubes. By choosing two of these operating at different voltages and arranging by switching that either one, or the other, or both in series are in use, and also arranging smooth control of the output level by connecting the cathode terminal to a potentiometer connected across the supply lines of the main circuit, the whole range of voltages from 350 to 1400 can be covered. All the popular Geiger counters fall within this range. An electrostatic meter indicates the voltage.

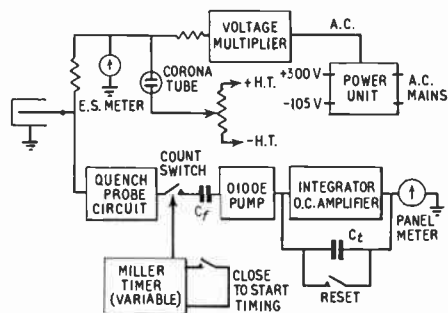

Fig. 2. Clinical monitor. Block diagram.

It should now be clear that a minimum of electronic circuits have been used to cover the functions of a complete and self-contained counting installation. Some details of instrument ranges and mechanical construction are also of interest.

It has already been said that the timing interval may be either a half or one minute.

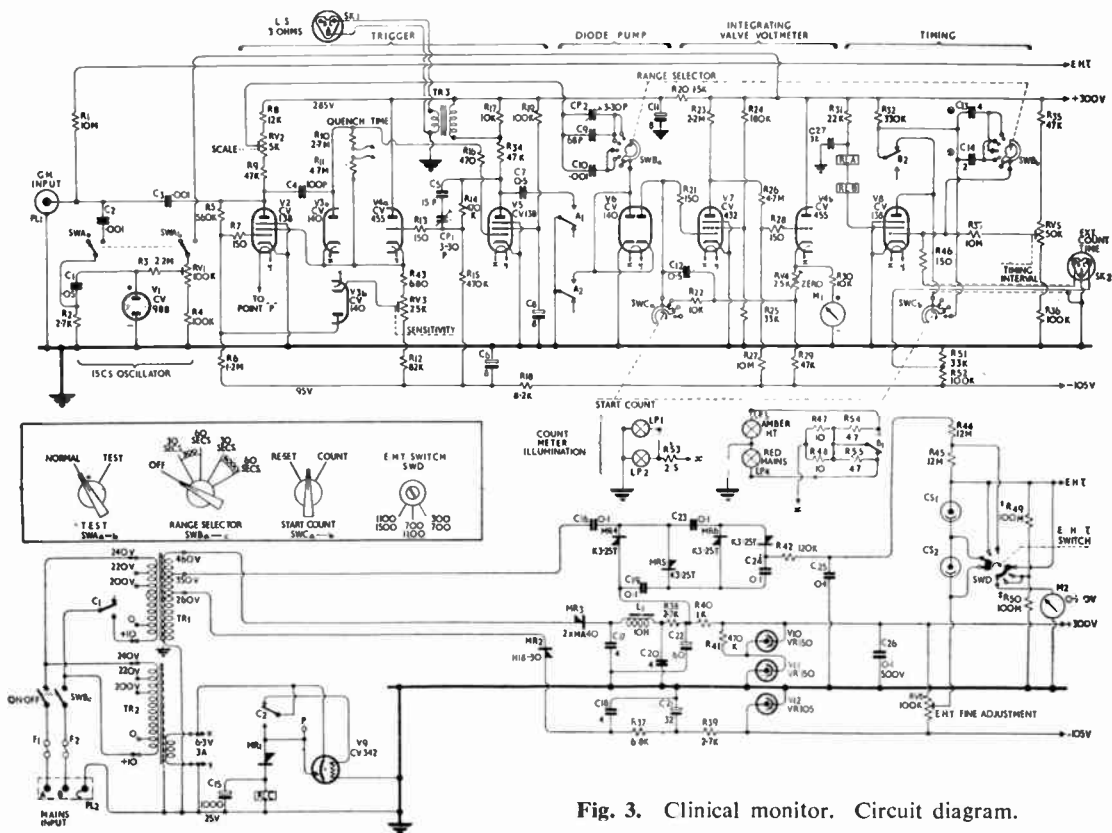

Fig. 3. Clinical monitor. Circuit diagram.

These two intervals cover those clinical applications where automatic timing is of value. The counts for full scale deflection are arranged to be either 500 or 5,000, and since either time may be used on either scaling range a wide range of pulse rates may be catered for.

A block diagram, Fig. 2, and a full circuit diagram, Fig. 3, are given to illustrate the points of electronic circuit design.

In designing the external layout of the instrument, the principle has been adhered to that only controls of interest to the operator shall appear on the front panel, while those of interest to the technician (setting-up and calibrating controls for example) shall be arranged on the rear panel. As it is possible to cover all the functions of switching on and choice of range and time interval on one five-position rotary switch, and to have one other centrally biased switch which is turned clockwise to start

the count and anticlockwise to cancel it, only two controls of immediate use appear on the panel, and their mode of operation is quickly appreciated.

The chassis of the instrument is sealed into the case, which may be sponged down if necessary. This sealing in does not result in overheating, since the total power consumption is only about 30 watts, which is easily dissipated by the surface of the outer case.

From what has been said, the main points kept in mind in designing this general purpose instrument for use in a specialized field of use should now be evident.

To summarize, we:—

- (i) Provide all necessary functions in the simplest possible manner, in one box.
- (ii) Accept a relatively low absolute accuracy, provided it is not too low for the known type of work.

- (iii) Arrange all necessary controls and meters where the operator wants them, on a minimum number of easily operated switches.
- (iv) Relegate setting up and calibration controls to the rear for the technician only.
- (v) Put all into a closed box, which has a number of advantages, not least that of preventing easy access to the interior by the unauthorized.

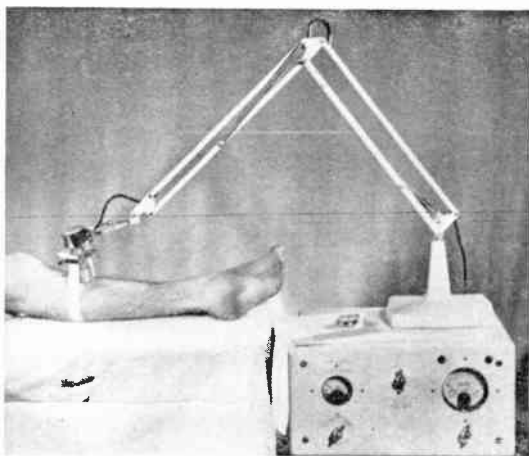

Fig. 4. Clinical monitor 1294 DY used to provide a simple bedside equipment for peripheral circulation tests.

This instrument has been used for a variety of measurements using various Geiger counters, including:—

- (1) Determination of the uptake of phosphorus 32 in bone, *in vivo*, using the needle counter, N1b.⁵
- (2) Determination of the state of skin, stored at low temperature, by the uptake of phosphorus 32 from solution, using a thin end window counter, e.g. EW3HG.⁷
- (3) Thyroid mapping by directional counter, e.g. collimated G4Pb.
- (4) Sodium clearance rates (from subcutaneous injection of sodium 24) and circulation index determinations in plastic surgery work, using an all-glass end window counter, e.g. EW3HG.² (Fig. 4.)
- (5) Routine iodine 131 excretion tests on large samples of urine, using 6 or 8 G26Pb counters in parallel.⁸

4. Recording Count-rate Meter, Type 1418

Ratemeters are useful for measurements which involve the recording of data over long periods, as in the scanning of low activity chromatograms, but they are essential for studies which involve the recording of transient phenomena which may last only a few seconds. The latter situation arises particularly in some studies of the circulation, since the passage of blood from the right to left heart through the lungs takes only about 5–10 sec. By using plasma labelled with iodine 131, and recording the mixing curve of the blood in the heart by means of an externally mounted scintillation counter, it is possible to measure the volume of blood ejected by the heart each minute.⁹ The Recording Ratemeter Type 1418A is an instrument designed to provide all the necessary facilities for carrying out these and similar measurements with a self-contained unit. As such it is very convenient for use at the bedside or in the operating theatre.

The same ideals of design, both electronic and mechanical, have been kept in mind as for the Clinical Monitor, except that in this case the box is not sealed (at any rate in the few laboratory models which have been built so far). The one-box ideal has been adhered to, even the recorder being included on the tall front panel. A suitable small pen recorder with a robust movement and a three-inch chart obtainable commercially, has been used. Portability is not quite so good as in the case of the Clinical Monitor, but one person can still manage the instrument; alternatively, a hospital trolley can comfortably take it and the scintillation counter mounted on adjustable arms. (See Fig. 5.)

The detector is a commercial scintillation counter having a directional shield. The output from this feeds into the main unit where the pulses are amplified by a linear amplifying stage (ring-of-three) and the amplified pulses are passed to a standard count-rate meter circuit described elsewhere.¹⁰ The output of the count-rate meter circuit drives a panel meter and the pen recorder as required. A special feature of the particular circuit used is that a wide range of control of zero is provided, which may be used to back off any steady background level which may be present, and so enable the recorder chart to be used to best advantage in

the observation of transients above this steady background. Two ranges (0-100 and 0-1000 p.p.s. for f.s.d.) and two integrating time constants (0.5 and 5 seconds) are provided. The latter are intentionally short because in the uses of the instrument, fidelity in following the transient is as important as the reduction of statistical fluctuations in the output. The values quoted are found suitable for this, although they may seem short in comparison with general count-rate meter practice.

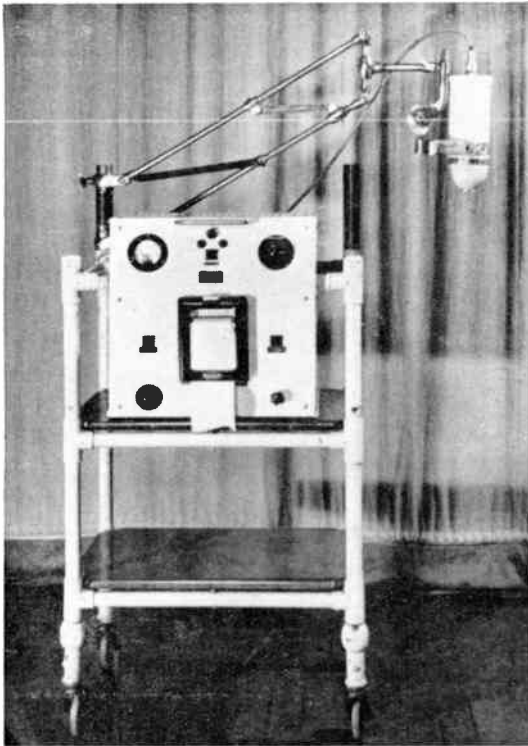

Fig. 5. Recording ratemeter 1418 and scintillation counter as a mobile unit for cardiac and other circulation studies

Since relatively short lived transients are to be observed (in the cardiac output technique, the main observations are completed in under one minute), the recorder speeds are chosen accordingly, being 6 in. and 0.5 in. per minute.

In the power unit section, which is situated on the upper deck of the instrument, similar techniques are used for the generation and stabilization of h.t. and e.h.t. as in the Clinical Monitor except that the e.h.t. range switching

arrangements are a little more complex because both scintillation and Geiger counters are catered for.

A block diagram of the instrument is shown in Fig. 6.

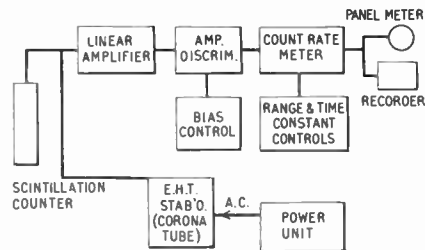

Fig. 6. Recording ratemeter. Block diagram.

5. Standard Beta/Gamma Ionization Chamber, Type 1383A

The chief isotopes which are used therapeutically (iodine 131, gold 198, and phosphorus 32) are supplied by the Radiochemical Centre and the number of millicuries in a given shipment is specified. Most of the short lived isotopes which are used in clinical work (sodium 24, potassium 42, and bromine 82) are obtained direct from the Isotopes Division, A.E.R.E., as irradiation units. The activity of these shipments is not given, but an approximate estimate can be obtained from the reactor neutron flux and period of irradiation. In either case, it is highly desirable that there should be provision for determining the strength of a radioactive shipment before any of it is administered to patients.

Although it is a simple matter to compare the activities of two sources of the same isotope, accurate absolute measurements are not so easy as would first appear, and in the earlier years there were surprisingly large discrepancies between the values obtained by different laboratories for the activity of a given source of radioactive material. As the result of some years of intensive work, there is now a substantial measure of agreement between the results obtained by various laboratories in this country and abroad. In order that the individual user can assay the more important isotopes in terms of a generally agreed standard of radioactivity, the National Physical Laboratory distributes calibrated sources of these

isotopes at regular intervals; these can then be used to calibrate the user's own equipment. This is not the most convenient system in practice, and the N.P.L. Advisory Committee on Radioactive Standards has adopted a policy whereby the individual user can obtain a reference ionization chamber for absolute assays. Thus, instead of sending out numerous



Fig. 7. Reference ion chamber and d.c. amplifier.

samples of a solution of specified strength, it is then only necessary for the N.P.L. to issue a statement to the effect that 1 millicurie of a certain isotope is that amount which gives a certain ionization current in the reference chamber. Alternatively, if only comparative current measurements are possible, the current can be specified in terms of that produced by a known amount of radium.

It is apparent that the main requirement which has to be met in the design of such a chamber is that it should be possible to manufacture these instruments in quantity but that there should be little or no variation in their performance, either with time or when compared with one another. This has necessitated an extensive programme of careful measurements by the National Physical Laboratory in order that the dimensional tolerances might be specified, and an equally intensive series of tests on the instruments as produced by the manufacturer.

Figure 7 shows the standard ionization chamber together with a d.c. amplifier capable of measuring ionization currents down to 10^{-13} amperes, and Fig. 8 shows a sectionalized view of the ionization chamber. The radioactive

material is held in a perspex jig at the centre of a re-entrant cavity for gamma measurements, so that a small axial or radial displacement from the geometrically optimum position will cause but a small measurement error. The gamma rays produce ionization in the body of the chamber, which is suitably polarized (100–120 V) and has a highly insulated concentric collecting electrode whence the ion current is led by a coaxial polythene insulated connector to some low-current measuring instrument. The order of sensitivity of the gamma portion for some isotopes in common use is quoted as follows:—

Radium (platinum tube 250 μ g)	3.5×10^{-11} amp/mg.
Cobalt 60 (ampoule of solution 100 μ c, 1 mc)	5.4×10^{-11} amp/mc.
Iodine 131 (ampoule of solution 100 μ c.)	1.1×10^{-11} amp/mc.

The beta-ray sensitivity for phosphorus 32 is approximately 2.7×10^{-10} amp/mc.

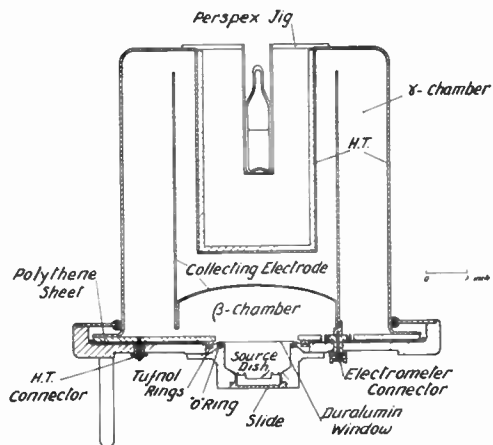

Fig. 8. Reference ion chamber in section

Beta measurements are carried out by placing (usually) liquid samples in standard polythene dishes slid into position beneath the very thin duralumin beta window, and causing ionization in that portion of the chamber below the domed part of the collector electrode. Beta measurements are more difficult to make accurately, but a standard procedure removes some of the errors.

A standard of uniformity between samples of the ionization chamber is aimed at which will give a reliability of a few per cent. in the measurements, and this calls for careful control in the manufacturing stage.

The ionization current may be measured on any suitable d.c. amplifier. Many hospitals will already have something of the sort; for example, a vibrating reed electrometer. If not, then there are commercial amplifiers available, one of which, the D.C. Amplifier Type 1388, is made to A.E.R.E. design.

This ionization chamber is, in general, not sufficiently sensitive to measure isotope-bearing biological samples, because of the great dilution which ordinarily takes place. Counting instruments such as those already described are normally needed.

6. Conclusion

Radio-isotopes have a growing field of utility in clinical investigation and research techniques. The measuring instruments necessary in such work are essentially electronic, and the aim of the designer must be to put suitable instruments into the hands of the clinical workers. The way some of the problems of design have been considered and carried out has been illustrated; the success and general acceptance of such principles, and their embodiment in the design of other instruments which may be demanded for future work in this field, may stimulate electronics engineers to play a part in clinical research and diagnosis by putting into the hands of the users convenient, reliable and useful instruments.

7. Acknowledgments

The authors are indebted in general to a large number of people who have contributed at one time or another to the work described, in particular to Mrs. A. L. Pope and Mr. J. P. Kerry who helped with electronic design and prototype construction; to Mr. W. Emery who suggested the form of the Reference Ion Chamber, and to Dr. B. W. Robinson and his staff at N.P.L. for further design suggestions and all calibration work.

One of the authors (N.V.) is in receipt of an expenses grant from the Medical Research Council.

8. References

1. S. S. Kety, "Measurement of regional circulation by the local clearance of radioactive sodium," *American Heart Journal*, **38**, p. 321, 1949.
2. J. N. Barron and N. Veall, "Application of radioactive sodium to problems of plastic surgery," *British Medical Bulletin*, **8**, p. 197, 1952.
3. E. H. Cooke-Yarborough and E. W. Pulsford, "An accurate logarithmic counting rate meter covering a wide range," *Proceedings of the Institution of Electrical Engineers*, **98**, Part II, p. 196, 1951.
4. E. H. Cooke-Yarborough, C. D. Florida and C. N. Davey, "An improved quench circuit for geiger counters," *Journal of Scientific Instruments*, **26**, p. 124, April 1949.
5. G. P. Arden and N. Veall, "The use of radioactive phosphorus in early detection of a vascular necrosis in the femoral head in fractured neck of femur," *Proceedings of the Royal Society of Medicine*, **46**, p. 344, 1953.
6. B. Selverstone, W. H. Sweet, and C. V. Robinson, "The clinical use of radioactive phosphorus in the surgery of brain tumours," *Annals of Surgery*, **130**, pp. 643-651, 1949.
7. W. Gemmell, J. E. Laing, and N. Veall, "The uptake of ^{32}P as an "in vitro" test of the viability of stored skin," Radioisotopes Conference 1954, Volume 1, page 107. (Butterworths, London, 1954.)
8. N. Veall and H. Vetter, "An apparatus for the rapid estimation of tracer quantities of radioactive isotopes in excreta," *British Journal of Radiology*, **25**, p. 85, 1952.
9. N. Veall, J. D. Pearson, T. Hanley and A. E. Lowe, "A method for the determination of cardiac output (preliminary report)." Radioisotope Conference, 1954, Volume 1, page 183. (Butterworths, London, 1954.)
10. E. H. Cooke-Yarborough and E. W. Pulsford, "A counting ratemeter of high accuracy," *Proceedings of the Institution of Electrical Engineers*, **98**, Part II, p. 191, 1951.

THE DOUNREAY ATOMIC ENERGY ESTABLISHMENT*

by

R. H. Garner, B.Sc.(Eng.), (Associate Member)*

A description based on information obtained during an official visit as a representative of the Institution. Details of electronic instrumentation and other installations are not yet available but it is thought that members will be interested to learn the basic engineering problems associated with this important project.

1. Introduction

Much has already been written on the growing number of atomic energy establishments operating for one purpose or another throughout Britain, but the purpose and principle of the Dounreay establishment is so different that it is felt that this further account is justified.

Britain's industrial nuclear power programme may be regarded as having three distinct phases—

The *first* is based on the gas-cooled, graphite-moderated reactor of the type installed and working at Calder Hall.

The *second stage* it is expected will be the liquid-cooled thermal reactors.

The *third stage* will be the advanced fast-breeder reactors with a "positive gain factor" which will permit a much higher utilization of fuel.

There is a big step between the present research and development stage of such advanced reactors and their operation on an industrial scale; the experimental behaviour of fuel elements has to be investigated, cooling systems tried, control techniques perfected, and operating experience gained—in short engineering, thermodynamic, chemical irradiation and safety problems have to be investigated and solved, and Dounreay will play an important part in their solution.

The landscape at Dounreay is now dominated by a number of well-defined landmarks of which the 135 ft. diameter sphere of the

experimental fast breeder reactor is the most prominent. This "stage 3 type" reactor will yield the actual operating experience necessary for commissioning such plant and it will also provide valuable information on the problems mentioned above.

The fuel cycle in such a reactor is complicated (Fig. 1) and involves not only a fuel-element manufacturing plant but also a chemical processing plant for re-fabricating the fuel into new fuel-elements, plant for recovering the residues and facilities for storing and treating active effluent until it is safe to discharge.

An equally important phase of work however is the work concerning the irradiation testing of new materials and of cooling systems and their accessories, and the initial exploratory tests on fast reactor materials will be carried out in the Dounreay Materials Testing Reactor (D.M.T.R.) before being used in the fast reactor itself.

The importance of the Dounreay project can therefore be judged by the fact that it not only contributes the construction and operation of a fast reactor to stage 3 of the nuclear power programme, but the irradiation testing of materials contributes to stage 1, 2 and 3 to say nothing of the experience which will be gained in the manufacture of fuel elements.

2. The Fast Reactor—General Description (Fig. 2)

It must be emphasized that the Dounreay fast reactor has been designed as an experimental breeder reactor utilizing enriched uranium 235 or plutonium as fuel in the core and the relatively plentiful uranium 238 or thorium as fertile material in the blanket.

* Principal, Coatbridge Technical College, Lanarkshire. Mr. Garner is a member of the Institution's Council. (Paper No. 400.)

U.D.C. No. 621.039.

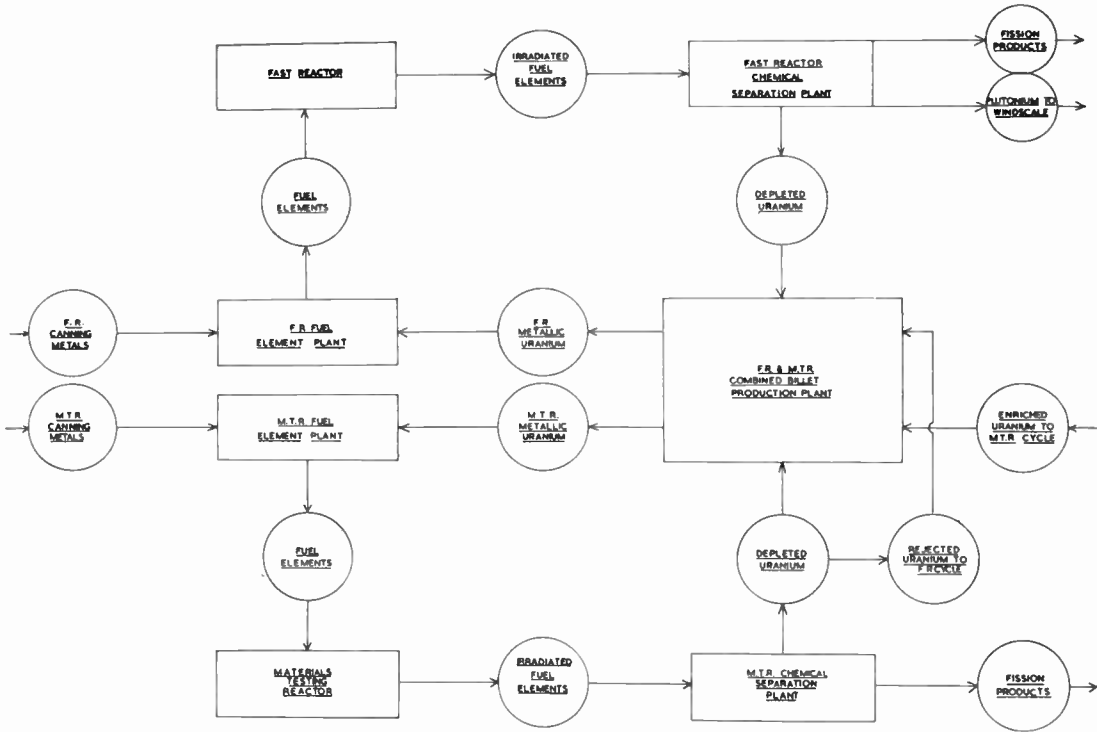

Fig. 1. Dounreay fuel cycle.

More fissile material will be formed in the breeding blanket than will be “burned” in the reactor core.

The source of power in the Fast Reactor is the fission of uranium 235 and uranium 238 in the reactor core. Since the fast neutron chain reaction cannot be sustained in natural uranium 238 the Fast Reactor core contains a higher proportion of uranium 235.

Surrounding the reactor core is the breeder consisting of about 2000 rods of natural uranium arranged vertically, each rod being 8 ft long by 1¼ in. in diameter.

The reactor core and breeder are housed in a stainless steel pot, known as the reactor vessel, 10 ft 6 in. in diameter and 20 ft in length. Into the top of the reactor vessel is pumped the liquid sodium-potassium coolant which flows down over the core and breeder removing the heat generated by fission and transferring it to a series of concentric tube heat exchangers located inside the reactor

vault. The reactor vault is a concrete structure within the reactor sphere and supports the reactor vessel and houses all the heat exchangers and coolant pipework associated with the primary cooling of the reactor core and breeder.

Heat is transferred from the primary liquid metal coolant to liquid metal in a secondary coolant circuit in the concentric tube heat exchangers. The secondary coolant then passes out of the reactor sphere in stainless steel pipes to the Heat Exchanger House where the heat in the secondary liquid metal coolant is transferred to water in a set of copper-bonded heat exchangers of novel design. The steam produced will eventually be used to drive a 15 MW turbo-alternator in the turbine hall. One of two buildings adjacent to the Heat Exchanger House contains electrical equipment and switchgear primarily for instrument supplies whilst the other houses two groups of diesel-generator sets—one set supplying power to all pumps and equipment in the main

reactor cooling circuit, the other acting as a stand-by for auxiliary reactor plant in the event of a failure of the National Grid supply.

The reactor is controlled from the Control Room in the Administration Building at the rear of which is situated the Fuel Element Storage Building—here new fuel elements are stored and irradiated elements handled prior to going into the cooling pond.

2.1. *Sphere and Vault Shielding*

The reactor sphere, 135 ft in diameter, 1500 tons in weight and of about $1\frac{1}{2}$ acres surface area constitutes a pressure vessel serving two purposes. Firstly, it will stop the spread of fission products formed during reactor operation, should they be accidentally released within the sphere. Secondly, it has been designed to withstand any pressure variations that might occur as a result of a liquid metal fire within the sphere. Such an occurrence should not increase the pressure inside the sphere by more than 18 lb/in.² or reduce it by more than 3 lb/in.²

To prevent any radiation hazard inside the sphere the reactor and primary cooling circuits are contained in a concrete biological shield known as the reactor vault in the form of a bowl 90 ft in diameter and 45 ft high with 5 ft thick walls. The roof slab has a central hole immediately above the reactor vessel.

Further shielding is provided around the reactor vessel to prevent the secondary liquid metal coolant and the pipework within the vault from becoming radioactive. This shielding consists of a 4 ft layer of borated graphite in which an equatorial region of pure graphite permits fission rate measurements to be taken.

2.2. *Core and Blanket*

The Fast Reactor core is comprised of fissile material in which the majority of the fission processes occur, surrounded by a "blanket" of fertile material which serves to reflect neutrons back into the core as they try to escape, and in which fresh fissile material is generated. The main heat generation occurs in the central portion, the core proper, which is a hexagonal prism 21 in. high and 21 in. across the flats made up of several hundred fuel elements of annular cross-section. Each contains, at either

end, a length of natural uranium which acts as a blanket or breeder material. The blanket is completed by surrounding this central portion with approximately 2000 natural uranium rods 8 ft long and $1\frac{1}{4}$ in. in diameter.

When the reactor is operating at its designed power output, the 60 MW of heat generated is removed by the liquid metal heat transfer medium which also cools the blanket. This liquid metal flows down between the fuel elements and blanket elements and down the inner tubes of the fuel elements. Each element is positioned in, and supported by, the stainless steel bottom plate of the reactor, while adequate space for the flow of the liquid metal coolant between the elements is maintained by the fins on each outer can.

The fuel and blanket elements are canned in niobium and stainless steel respectively to contain the fissile material and fission products, and to give dimensional stability to the core and blanket lattice. Niobium has a high melting point and a good resistance to hot uranium and sodium. Stainless steel is used for canning the blanket elements since the conditions are less severe but it is worth noting that these "less severe" conditions are, in the case of the blanket elements nearer the reactor core, more severe than those experienced by thermal reactor fuel elements.

The neutron flux and, therefore, the heat generated in the core, is controlled by moving groups of fuel elements into and out of the core, the former movement giving increased reactivity. The fuel elements used for this purpose are identical with those in the normal reactor charge.

The essential feature of this Fast Reactor is that it is an experimental tool and, for this reason it has been designed so that minor and major components may be easily replaced if different component designs have to be tested. This interchangeability is, in fact, so great that the whole of the assembly within the double walled reactor vessel can be removed and replaced if this is desired.

2.3. *Heat-Exchange System*

The liquid metal to be used initially for heat removal is an alloy of sodium and potassium. It becomes radioactive on passing through the

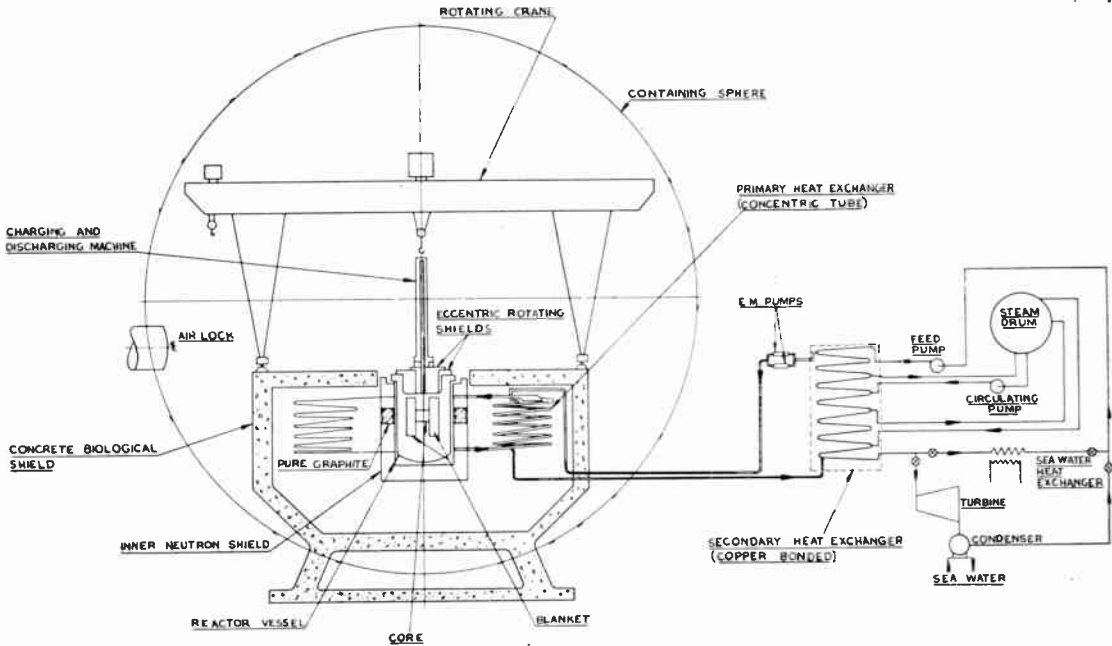

Fig. 2. Schematic arrangement of the Dounreay Fast Reactor plant (F.R.).

reactor, and it is also contaminated by fission products so that it must be contained within the concrete biological shield. Its heat is therefore transferred to liquid metal in a secondary system. This secondary liquid carries the heat through the biological shield and out of the sphere to the Heat Exchange House, where heat is given up in a steam raising plant. The liquid metal is circulated by electromagnetic pumps having no moving parts, the only maintenance being upon the insulation of the windings. The windings can be removed without opening the liquid metal system; in the primary system this is done by remote operation through the biological shield. The system contains no valves nor any other part requiring mechanical maintenance.

Complete failure of the heat removal plant would very quickly result in the overheating of the reactor, and to prevent such a failure the heat removal is shared among twelve independent and identical units. A unit comprises two primary liquid metal circuits, one secondary liquid metal circuit, a steam raising plant and a dump condenser. Each unit has

an independent electrical supply from its own diesel alternator, so that the risk of a large scale electrical failure is remote. If, in spite of the above precautions, a widespread failure of heat exchange plant occurred, it would not be sufficient to shut down the reactor, because some heat would be generated by fission product activity after shut-down. A thermal syphon system of heat removal is therefore provided which uses no electrical power but relies solely on convection effects to dissipate heat to the atmosphere.

The heat exchangers which transfer heat from the primary coolant circuits to the secondary circuits are all of tube and annulus design. Since the liquid metal reacts violently with water, the steam raising exchanger has been designed to prevent leaks from one side to the other. Stainless steel tubes carrying the liquid metal and the water are bonded in a common copper matrix which allows a leak of either fluid to escape to atmosphere. Apart from the heat exchangers, the twelve steam raising plants are similar in design to conventional boiler systems.

2.4. *Charging and Discharging Arrangements*

Fuel elements in the reactor must be periodically discharged because prolonged irradiation causes physical distortion of the elements and the fuel element efficiency falls due to depletion of the fissionable material and the build up of fission products in the elements. Similar considerations apply to a lesser degree to the breeder elements. The elements are therefore removed periodically from the reactor in shielded containers and placed in the cooling pond to await chemical processing. New or re-fabricated elements are loaded into the reactor in their place.

Removal of these extremely radioactive elements presents a number of difficulties because they are immersed in liquid metal which becomes radioactive after irradiation in addition to its being chemically active—they thus continue to generate heat for a considerable time after the reactor is shut down. Furthermore the blanket gas above the liquid metal in the reactor is highly contaminated with radioactive fission products and cannot be allowed to escape to atmosphere.

These problems are overcome by the charge machine which removes and replaces fuel elements. The machine is lowered on to a seal door on the rotating shields above the reactor vessel and elements are moved vertically in or out of the reactor. The charge machine is heavily shielded to avoid any radiation hazard to personnel. Embodied in the machine is a cooling system for removing residual heat from the elements after withdrawal from the liquid metal. At the base of the machine a gas-tight door is fitted and this is interlocked to ensure that the corresponding seal door on the rotating shields are closed before the charge machine can be removed from the rotating shields, thus preventing direct escape of blanket gas into the sphere. When an irradiated element has been raised into the charge machine the machine is transported by the large rotary crane to the canning station at the side of the reactor vault.

Reprocessed elements are returned from the chemical plant to the element store building. When required for use the elements are put in a stainless steel can, which is filled with inert

gas, and raised into the canning station in the sphere. The charge machine, having discharged an irradiated element into the canning station now re-loads with a re-processed element and is transported to the rotating shields where the re-processed element is lowered into the reactor.

2.5. *Control and Instrumentation*

Control of the Fast Reactor is achieved by movement of parts of the core. Twelve groups of fuel elements located at the corners of the core hexagon form the control rods which may be moved in or out of the core. These fuel elements are held in a metal frame rotating on a support arm within the liquid metal, enabling the control rods to be raised into the core to increase its reactivity or dropped below the core to shut the reactor down. A magnetic clutch is incorporated in each control rod drive to allow the drive to be transmitted through the reactor vessel without leakage of fission products. Each control rod and support within the reactor vessel is supported by an electromagnet, so that interruption of electrical supply to the electromagnets allows the rods to fall rapidly out of the core thereby shutting down the reactor. As all twelve control rods are of identical design it is feasible that a common fault could develop in the mechanism which would prevent their satisfactory operation in an emergency. To provide a reserve control enabling the reactor to be shut down under these abnormal conditions, three rods containing neutron-absorbing boron may be dropped into the inner row of breeder elements surrounding the core. The design of these boron safety rods differs from that of the control rods, so that the possibility of their failure at the same time as that of the control rods is remote. The positioning of the control and safety rods is controlled from the desk in the Control Room by means of a selector switch and push buttons. Operation of an emergency push button on the desk cuts the current to all hold-on electromagnets and drops all the control rods and boron safety rods simultaneously. In addition to normal and emergency shut-downs controlled by the operator from the control desk, automatic shut-down occurs in the following circumstances—failure of pressure in the primary gas

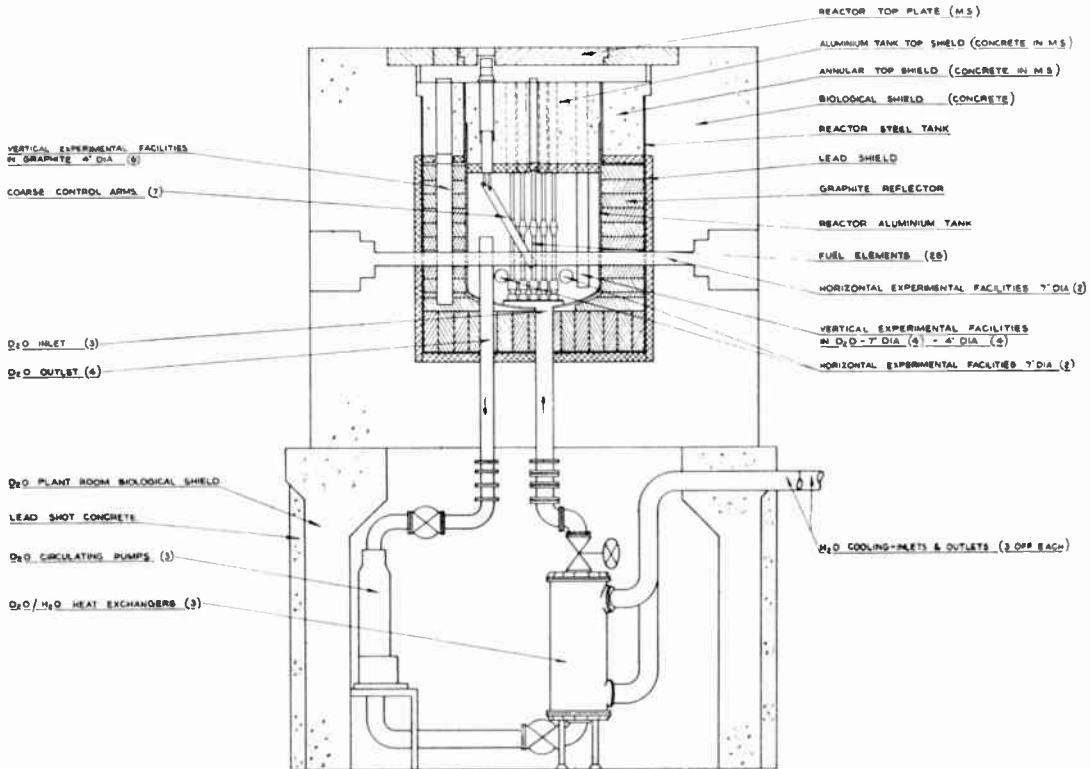

Fig. 3. Simplified sectional elevation of the Dounreay Materials Testing Reactor (DMTR). (Not to scale.)

blanket, high temperature in the centre of the core,—low flow of liquid metal coolant through the core and breeder,—a high level of neutron flux, or—an abnormally rapid rate of increase of neutron flux. Electromagnetic flowmeters measure the flow of liquid metal coolant in the primary and secondary circuits, and the nuclear behaviour of the reactor is followed by means of ion chambers located in the graphite shield surrounding the reactor vessel.

All operations involving a change in reactivity are controlled from the desk in the Control Room. Here are the switches and push-buttons enabling the power of the reactor to be varied by adjustment of the control rods and here also are the controls determining the rate at which liquid metal is pumped through the coolant circuits. Instruments are provided indicating and recording the behaviour of the reactor and its heat extraction circuits and others give warning of fault conditions and assist in their location.

3. The Materials Testing Reactor (Fig.3)

To speed research into problems associated with the design and construction of reactors planned in the development of the nuclear power programme, the Industrial Group of the U.K.A.E.A. is constructing a research reactor at Dounreay known as the Dounreay Materials Testing Reactor (D.M.T.R.). It is designed to enable materials of construction, fuels and their canning materials, coolants and heat transfer media to be irradiated in its neutron flux under specific design conditions which can be related to those in a full-scale power producing reactor.

The method of testing materials is to incorporate them into "test rigs" which in turn are inserted into "DMTR" and irradiated to the required degree. The test-rigs are then removed and dismantled and the test materials examined. Since the reactor has a high neutron flux, research work previously requiring a long period of irradiation due to lack of large

neutron sources can be completed in a much shorter time.

The reactor is an enriched uranium-heavy water moderated and cooled thermal reactor with a peak flux of 10^{14} thermal neutrons per cm^2/sec at a total output of 10 MW. It is similar to DIDO inaugurated at Harwell last November but with the major difference that the experimental facilities are fewer but are designed for large engineering test rigs.

The experimental facilities consist of four vertical 7 in. diameter and four vertical 4 in. diameter tubes in the heavy water and six vertical 4 in. diameter tubes in the graphite reflector. In addition there are four horizontal 7 in. diameter tubes which pass through the reactor close to the reactor core.

3.1. Control

There are seven signal-arm type controls suspended at 1 ft intervals along both 3 ft sides of the core and they operate downwards from a fully horizontal position over an arc of 60 deg., controlling up to 25 per cent. reactivity. Each arm contains a strip of cadmium, enclosed in stainless steel. Normal operating time for the full movement is 24 minutes but an emergency free fall takes less than one second. In addition there is a vertical fine control rod controlling $\frac{1}{4}$ per cent. reactivity located at an unoccupied corner of the core. It consists of a cadmium sheet formed into a long tube sandwiched between stainless steel tubes—the full travel taking 15 sec. Two safety rods are also provided in diagonally opposite corners, formed of a similar tube of cadmium sheet sandwiched between two aluminium tubes.

5. Criticality Control

Dounreay works will store and process large quantities of fissile material and indiscriminate accumulation of this material could give rise to a criticality incident. All work involving fissile material is therefore subject to strict regulation and inspection.

At the present time the Group is engaged upon a series of experimental measurements of the critical sizes of cylinders containing aqueous or hydrocarbon solutions of enriched U235.

Cases of interest are bare cylinders, cylinders fully reflected by water (such as might occur when an item of plant becomes accidentally flooded or when it is approached by several human beings simultaneously) and cylinders containing concentric voids or air spaces, and concentric rods or hollow tubes of neutron absorbing materials.

In the present facility, the critical assemblies are made by remote control, and all the control mechanisms are very carefully interlocked so as to ensure that no accident can take place. The control room is situated close to the sea edge and the experimental cell is placed 300 ft further along the coast.

6. Health Physics and Safety

It is well known that everywhere there exists a natural radioactive background, arising from natural sources such as

- cosmic radiation from interstellar space;
- radiation from naturally occurring radioactive elements such as thorium, uranium and potassium found in minute amounts in soils and rocks;
- atmosphere radioactivity arising from gaseous decay products of thorium and uranium.

A background survey on the site and in the surrounding area was carried out on natural gamma radiation, and the activity of the atmosphere dust. Samples of soil, vegetation, roots, sand, seaweed, shell fish, sea-water and edible fish were examined to determine their normal level of radioactivity and reference levels established. No unexpected or unusual level was found in the Dounreay area.

Stations have been established up to 30 miles distant from the works and along the sea shore up to 10 miles on either side. The measurements are carried out by mobile radiation laboratories, each fitted with v.h.f. radio telephone equipment. Regular surveys are carried out in all plants and operating areas where radioactive materials are handled. All personnel working in a radioactive area wear a radiation monitoring film badge and in some cases this is augmented by a quartz fibre electrometer for an instantaneous measure of radiation received.

BACKLASH AND HYSTERESIS EFFECTS IN AUTOMATION SYSTEMS*

by

Associate Professor L. M. Vallese, D.Sc.†

This paper was submitted for inclusion in the Convention on "Electronics in Automation," and is published so that it can be discussed during Session 2

SUMMARY

Non-linearities of backlash and of hysteresis type provide generally different types of stability limits in feedback control systems. These limits and the corresponding frequencies of oscillation may be expressed in terms of characteristic adimensional system parameters. Examples of application to second and third order systems are shown.

1. Introduction

The analysis of the limits of instability of feedback control systems with backlash or hysteresis is generally complicated by the multivalued nature of the characteristics of the nonlinearities. For example if the dynamic behaviour of a feedback control system is represented by the differential equation

$$\frac{d^n}{dt^n} x + a_1 \frac{d^{n-1} x}{dt^{n-1}} + \dots + a_{n-1} \frac{dx}{dt} + a_n y(x) = 0 \quad \dots\dots\dots(1)$$

where $y(x)$ is the characteristic of backlash or of hysteresis, the function $y(x)$ is found to depend upon the magnitude and upon the time rate of change of the input quantity x . As an approximation it is usual practice¹ to assume that $x(t)$ varies monotonically with time, in particular as a sinusoidal function of time; the characteristics of backlash and of hysteresis then assume the form of the envelopes of all the possible loci.

In the following it will be assumed that the input quantity is represented by $x = A_x \sin \Omega t$. Suitable idealizations will be introduced in the expressions of the backlash and hysteresis characteristics and the corresponding behaviours of systems represented by equations of type (1) will be analysed.

2. Idealized Analytical Representations of the Characteristics of Backlash and Hysteresis

The typical idealized characteristics considered in this investigation are shown in Figs. 1 and 2 respectively for backlash and for hysteresis. They differ with respect to the horizontal intercept x_0 , which is constant for backlash and is a function of the amplitude of the input quantity for hysteresis, and for the saturation phenomenon which appears only in the case of hysteresis. Accordingly the analytical representations with reference to a sinusoidal input of equation $x = A_x \sin \psi$ are assumed as follows.

For the case of backlash or of non-saturating hysteresis one lets

$$y = kx + f_1(x) \quad \dots\dots\dots(2)$$

where

$$\begin{aligned} f_1(x) &= kx_0 && \text{for } \psi_1 \leq \psi \leq \pi/2 \\ &= k(A_x - x_0 - x) && \pi/2 \leq \psi \leq \pi + \psi_1 \\ &= kx_0 && \pi + \psi_1 \leq \psi \leq 3\pi/2 \\ &= -k(A_x - x_0 + x) && 3\pi/2 \leq \psi \leq 2\pi/\psi_1 \end{aligned}$$

In these expressions the angle ψ_1 satisfies the condition

$$\sin \psi_1 = 2x_0/A_x - 1 \quad \dots\dots\dots(3)$$

i.e. ψ_1 is positive or negative according if A_x is less or larger than $2x_0$. Furthermore in the case of backlash x_0 is a constant, and in the case of hysteresis x_0 is assumed to vary linearly with A_x , i.e.

$$x_0 = \alpha A_x \quad \dots\dots\dots(4)$$

where $0 \leq \alpha \leq 1$ and, in particular, $\frac{1}{2} \leq \alpha \leq 1$

* Manuscript received 11th March 1957. (Paper No. 401.)

† Department of Electrical Engineering, Polytechnic Institute of Brooklyn, Brooklyn 1, New York, U.S.A. U.D.C. No. 621-526.

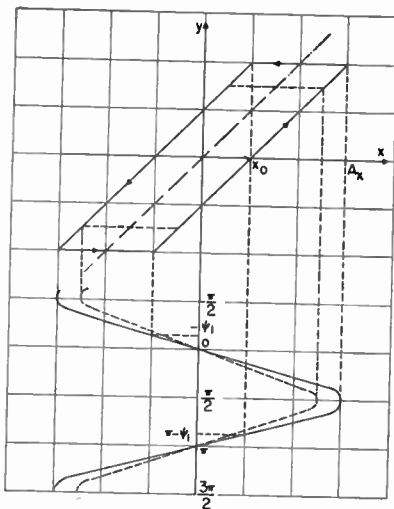

Fig. 1. Idealized analytical representation of the characteristics of backlash.

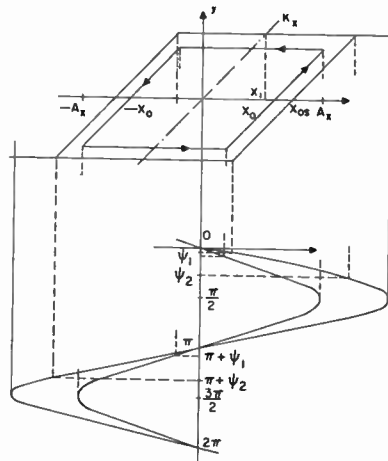

Fig. 2. Idealized analytical representation of the characteristics of hysteresis.

for the case of Fig. 2. Correspondingly there follows that the angle ψ_1 may be positive or negative in the case of backlash, but is always positive in the case of hysteresis shown in Fig. 2.

Saturating hysteresis occurs when the amplitude A_x exceeds the value $x_{0s}/\alpha = x_1/(1 - \alpha)$ (see Fig. 2). In this case the analytical representation of the characteristic is

$$y(x) = kx + f_2(x) \quad \dots\dots\dots(5)$$

where

$$\begin{aligned} f_2(x) &= kx_{0s} & \text{for } \psi_1 \leq \psi \leq \psi_2 \\ &= k(x_1 - x) & \psi_2 \leq \psi \leq \pi + \psi_1 \\ &= kx_{0s} & \pi + \psi_1 \leq \psi \leq \pi + \psi_2 \\ &= -k(x_1 - x) & \pi + \psi_2 \leq \psi \leq 2\pi + \psi_1 \end{aligned}$$

In these expressions

$$\sin \psi_1 = \frac{2\alpha - 1}{1 - \alpha} \frac{x_1}{A_x} \quad \sin \psi_2 = \frac{1}{1 - \alpha} \frac{x_1}{A_x} \quad \dots\dots\dots(6)$$

There follows that the angles ψ_1 and ψ_2 are functions of the amplitude A_x when saturation occurs.

3. Analysis of Feedback Control Systems of Second Order

Consider first a feedback control system of second order (Fig. 3) whose representative differential equation is

$$\frac{d^2x}{dt^2} + a_1 \frac{dx}{dt} + a_2 y(x) = 0 \quad \dots\dots\dots(7)$$

It is assumed that a_2 is small enough to justify in first approximation the assumption that x varies sinusoidally with time. Applying the Kryloff-Bogoliuboff procedure (with slight modifications) one assumes that

$$x = A_x \sin \psi, \quad \frac{dx}{dt} = \Omega A_x \cos \psi \quad \dots\dots\dots(8)$$

where $\psi = \omega t + \varphi(t)$, $\omega = \sqrt{ka_2}$ and $\Omega = \omega + \frac{d\varphi}{dt} = \frac{d\psi}{dt}$. Substituting these relations into

(7) one obtains expressions for $\frac{dA_x}{dt}$ and Ω .

If, in line with the approximations made, one considers only the time average of $\frac{dA_x}{dt}$ and

$\frac{d\psi}{dt}$, the following relationships are obtained:

$$\left. \begin{aligned} \frac{dA_x}{dt} &\cong \frac{-1}{2\pi\Omega} \int_0^{2\pi} \left[a_1 \frac{dx}{dt} + a_2 y(x) \right] \cos \psi \, d\psi \\ \frac{d\psi}{dt} &\cong \omega + \frac{1}{2\pi\omega A_x} \int_0^{2\pi} \left[a_1 \frac{dx}{dt} + a_2 y(x) \right] \sin \psi \, d\psi \end{aligned} \right\} \dots\dots\dots(9)$$

If sustained oscillations occur in the system, correspondingly $dA_x/dt = 0$. Therefore the solution of the latter equation provides the

conditions of the limit of oscillation, namely

$$a_1 \Omega A_x \pi \cong - a_2 \int_0^{2\pi} y(x) \cos \psi \, d\psi \dots\dots\dots(10)$$

On the other hand the nature of the oscillations, whether stable or unstable, is determined from investigation of the sign of $\frac{d}{dA_x} \left(\frac{dA_x}{dt} \right)$ for the values of A_x corresponding to the oscillatory condition. According if the sign of $\frac{d}{dA_x} \left(\frac{dA_x}{dt} \right)$ is negative or positive the oscillations are stable or not.

The application of this procedure to the case of backlash or of non-saturating hysteresis provides the following equations:

$$\left. \begin{aligned} \frac{dA_x}{dt} &\cong \frac{-1}{2\pi\Omega} \left[A_x a_1 \Omega \pi - 4x_0 k a_2 + \frac{4x_0^2 k a_2}{A_x} \right] \\ \frac{d\psi}{dt} &\cong \Omega = \omega \left[\frac{5}{4} - \frac{1}{4\pi} (\sin 2\psi_1 + 2\psi_1) \right] \end{aligned} \right\} \dots\dots\dots(11)$$

In the case of backlash³, for which x_0 is a constant, indicating with ξ the adimensional parameter

$$\xi = k a_2 / a_1^2$$

one finds that the amplitude of the sustained oscillation is given by

$$A_x \cong x_0 \frac{2\xi a_1}{\pi \Omega} \left[1 \pm \sqrt{\left(1 - \frac{\pi \Omega}{\xi a_1} \right)} \right] \dots\dots\dots(12)$$

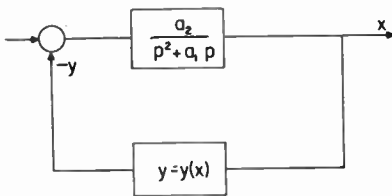

Fig. 3. Feedback control system of the second order.

This equation shows that for each value of ξ larger than $\pi \Omega / a_1$ there exist two sustained oscillations. However, from the sign of $\frac{d}{dA_x} \left(\frac{dA_x}{dt} \right)$, it may be shown that only one of these oscillations, namely that corresponding to

$A_x \cong 2x_0$, is stable. In the limiting condition $A_x = 2x_0$ one finds

$$\psi_1 = 0, \Omega = \frac{5}{4} \omega_1, \xi = \xi_{crit} = \frac{\pi \Omega}{a_1} = \frac{5\pi}{4} \dots\dots\dots(13)$$

In conclusion the system does not oscillate if $\xi < \xi_{crit}$ and goes spontaneously into a stable oscillation of amplitude $A_x \cong 2x_0$ if $\xi \geq \xi_{crit}$. The correct value of ξ_{crit} , obtained by use of a step-by-step method,⁴ is 3.046.

Consider now the case of non-saturating hysteresis. With the assumption of $x_0 = a A_x$ one finds from equation (11) that the solution of $\frac{dA_x}{dt} = 0$ is $A_x = 0$. In addition the frequency

Ω is found to be independent of A_x . Since

$$\frac{d}{dA_x} \left(\frac{dA_x}{dt} \right) = \frac{-1}{2\pi\Omega} \left[a_1 \Omega \pi - 4a k a_2 (1 - \alpha) \right]$$

it is seen that the rest position is stable or not according if $a_1 \Omega \pi$ is larger or smaller than $4a k a_2 (1 - \alpha)$, i.e. according if the parameter $\sqrt{\xi_{crit}} = [\sqrt{(k a_2)}] / a_1$ is less or larger than

$$\sqrt{\xi'_{crit}} = \frac{\pi \Omega}{4a(1 - \alpha)\omega} \dots\dots\dots(14)$$

For example, if $a = 1/2$, $\sqrt{\xi'_{crit}} = 5/4$.

When the system is unstable at the rest position, i.e. $\xi > \xi_{crit}$, any disturbance will result in passage into the saturation region. Substituting equation (5) in equation (9) one finds

$$\frac{dA_x}{dt} = \frac{-1}{2\pi\Omega} \left(a_1 \Omega A_x \pi - \frac{4k a_2 \alpha x_1^2}{A_x (1 - \alpha)} \right) \dots\dots\dots(15)$$

$$\Omega = \omega \left\{ 1 + \frac{1}{\pi} \left[2(\psi_2 - \psi_1) + \sin 2\psi_1 - \sin 2\psi_2 + \frac{x_1}{(1 - \alpha)A_x} (\cos \psi_2 + (1 - 2\alpha) \cos \psi_1) \right] \right\} \dots\dots\dots(16)$$

where ψ_1 and ψ_2 are given by equation (6).

Letting $\frac{dA_x}{dt} = 0$, there follows that the amplitude of the stable oscillation is

$$A_x \cong 2x_1 \sqrt{\left(\frac{\xi a_1 \alpha}{\pi \Omega (1 - \alpha)} \right)} \dots\dots\dots(17)$$

In conclusion the system with hysteresis is stable at the rest position when $\xi < \xi'_{crit}$ and goes into a stable oscillation of amplitude (17) if $\xi > \xi'_{crit}$. The frequency of oscillation depends upon the value of ξ .

4. Extension to Higher Order Systems

The previous results obtained by application of the Kryloff-Bogoliuboff procedure could be extended similarly to higher order systems. For this purpose, assuming in equation (1) that

$$\begin{aligned}
 x &= A_x \sin \psi \\
 \frac{dx}{dt} &= A_x \Omega \cos \psi \\
 \frac{d^{n-1}x}{dt^{n-1}} &= \Omega^{n-1} A_x \frac{d^{n-1} \sin \psi}{d\psi^{n-1}} \\
 \frac{d^n x}{dt^n} &= \Omega^{n-1} \frac{dA_x}{dt} \frac{d^{n-1} \sin \psi}{d\psi^{n-1}} + A_x \Omega^n \frac{d^n \sin \psi}{d\psi^n} \dots\dots\dots(18)
 \end{aligned}$$

and replacing $y(x)$ with its fundamental terms of the Fourier series expansion, i.e.

$$\left[\frac{1}{\pi} \int_0^{2\pi} y(x) \cos \psi d\psi \right] \cos \psi + \left[\frac{1}{\pi} \int_0^{2\pi} y(x) \sin \psi d\psi \right] \sin \psi$$

one obtains approximate expressions for dA_x/dt and Ω . From $dA_x/dt=0$ and from Ω one derives the amplitude and the frequency of the possible sustained oscillations and from the sign acquired correspondingly by $\frac{d}{dA_x} \left(\frac{dA_x}{dt} \right)$ one has information concerning the stability of such oscillations.

For example for $n=2$ this method provides

$$\begin{aligned}
 \frac{dA_x}{dt} &= -a_1 A_x - \frac{a_2}{\pi \Omega} \int_0^{2\pi} y(x) \cos \psi d\psi \\
 \Omega^2 &= \frac{a_2}{\pi A_x} \int_0^{2\pi} y(x) \sin \psi d\psi
 \end{aligned}$$

Here dA_x/dt is twice the value obtained with the Kryloff-Bogoliuboff procedure. This however has no consequence with respect to the values of A_x and the sign of $\frac{d}{dA_x} \left(\frac{dA_x}{dt} \right)$.

For $n=3$ one has

$$\begin{aligned}
 \frac{dA_x}{dt} &\cong -a_1 A_x + \frac{a_3}{\pi \Omega^2} \int_0^{2\pi} y(x) \sin \psi d\psi \\
 \Omega^3 - a_2 \Omega - \frac{a_3}{\pi A_x} \int_0^{2\pi} y(x) \cos \psi d\psi &= 0
 \end{aligned}$$

The detailed analysis of these equations is straightforward.

5. Conclusion

The problem of the analysis of the limits of stability of feedback control systems involving backlash or hysteresis has been investigated by application of a time domain procedure that may be considered derived from that of Kryloff and Bogoliuboff. This procedure provides analytical rather than graphical solutions for the amplitude and the frequency of the possible sustained oscillations.

6. Acknowledgments

This work was performed at the Microwave Research Institute of the Polytechnic Institute of Brooklyn, under a contract sponsored by the Office of Naval Research and the Air Force Office of Scientific Research, U.S.A. The author gratefully acknowledges the encouragement and advice received from Dr. E. Weber.

7. References

1. A. Tustin, "The effects of backlash and of speed dependent friction on the stability of closed cycle control systems," *Journal of the Institution of Electrical Engineers*, **94**, Part II, pp. 143-151, 1947.
2. N. Kryloff and N. Bogoliuboff, "Introduction to Nonlinear Mechanics." (Princeton University Press, 1942.)
3. L. M. Vallese, "An analysis of backlash in feedback control systems with one degree of freedom," *Transactions of the American Institute of Electrical Engineers*, **74**, Part II, pp. 1-4, 1955.
4. N. B. Nichols, "Backlash in a velocity lag servomechanism," *Transactions of the American Institute of Electrical Engineers*, **72**, Part II, pp. 462-467, 1953.

DETECTION OF PULSE SIGNALS IN NOISE: TRACE-TO-TRACE CORRELATION IN VISUAL DISPLAYS*

by

Professor D. G. Tucker, D.Sc. (Member)†

SUMMARY

Available experimental data (some previously published, some new) are reviewed, and some theoretical considerations discussed, with a view to establishing the nature of the phenomena whereby side-by-side presentation of traces, or serial presentation of p.p.i. pictures at intervals great enough to eliminate electrical or visual integration, gives much superior detection to that obtained by true integration. Although no complete explanation has been achieved, nevertheless a number of definite conclusions are arrived at.

1. Introduction

It is generally accepted that the linear superposition (or "integration") of successive traces or scans* in a visual display (e.g. a radar cathode-ray display) leads to improved detection of a pulse signal against a noise background, provided the signal pulse remains at the same point in successive scans. The rate at which the threshold of detection is lowered is usually taken as 1.5 db per doubling of the number of scans, and this is justified for true addition—such as can occur in an intensity-modulated display—if the rectifier input-to-output signal/noise characteristic is square-law (as is that of a so-called linear rectifier if the signal/noise ratio is small) and if the criterion of constant detectability at threshold is taken *objectively* as a constant ratio between the increase in d.c. level when the signal is present and the r.m.s. noise level when the signal is absent. (See Appendix.) There is, moreover, some experimental evidence⁹ to show that such a result is actually obtained with intensity-modulated displays when *subjective* tests are made, i.e. using human observers to say when the signal is just detectable. In addition, Lawson and Uhlenbeck¹ report conclusive experimental results to show that depression of threshold at the rate of 1.2 to 1.5 db per doubling of the number of scans is actually obtained subjectively when successive A-scans are rapidly superposed.

This process is virtually intensity-integration in a deflection- (and not intensity-) modulated display.

If, instead of being superposed or "integrated," the successive intensity-modulated traces are displayed side-by-side as in a chemical recorder,² there is ample evidence³ (which will be reviewed later) that an improvement of detection takes place as the number of traces is increased, at a rate of about 2.2 to 2.5 db per doubling of the number of scans. This is higher than that associated with integration of successive traces, but no theoretical explanation of this has been put forward, nor is one offered in the present paper. The term "visual correlation" has been used for this effect, as there is no doubt the observer looks for the regular repetition of the signal pulse in the same position in the scan; one might say he correlates successive traces by a visual process. But correlation in the mathematical sense, as will be shown later, cannot explain the high rate of improvement of threshold.

In a radar p.p.i. presentation, the same (or almost the same) signal information is repeated every time the aerial completes its rotation, but the random noise appears differently on each rotation. Although the afterglow of the cathode-ray-tube screen is hardly effective in retaining one set of information until it is

* Manuscript received 1st April 1957. (Paper No. 402.)

† Electrical Engineering Department, University of Birmingham.

U.D.C. No. 621.396.963.3 : 621.396.822.

* The words "traces" and "scans" are generally used as synonyms, and will be so used in this paper. A trace or scan means the record obtained from one pulse-transmission, i.e. a record of received amplitude against echo-range.

repeated, yet it has been found by experiment⁴ that the detection threshold is depressed by about 2.2 db per doubling of the number of aerial rotations up to a total period of at least two minutes. There is clearly no question of integration, and the human memory is invoked in making a sort of visual correlation.

In the case of side-by-side presentation of successive traces, the signal is detected more easily as the length of the signal "paint" increases in the direction perpendicular to the line of the trace. As the background is random in all directions, McGregor³ has suggested that increase in the dimensions of the signal paint due to increased pulse-duration (also to increased beamwidth in the case of the p.p.i. display) would have a similar effect, namely, a depression of threshold of detection by about 2.2 to 2.5 db per doubling of each dimension. This is actually confirmed by other experimental work.⁹

In this paper, the relevant experimental results available (some previously published, some new) are reviewed and co-ordinated, and some theoretical considerations are discussed.

2. Review of Experimental Data

2.1. *A-Scans*

A very full account of subjective detection experiments with A-scans has been given by Lawson and Uhlenbeck,¹ the experiments having been carried out by a forced choice method, that is to say, the observer has to state where he thinks the signal occurs in the scan without having the option of saying he cannot see the signal. Six possible positions of signal were used and twenty observations were made for every combination of conditions. In this way a measure of the threshold of detection could be made which depended only to a comparatively small extent on the individual judgment of the observer. Although for most purposes the threshold is commonly defined as the signal/noise ratio at which a 50 per cent. probability of detection is obtained, yet in the experiments quoted by Lawson and Uhlenbeck the threshold was taken at 90 per cent. probability. It is unlikely that this affects the relative effects of different factors, but merely the actual level of the threshold.

Before dealing with results for repetition and superposition of traces, it is worth observing

that the results of the experiments indicated that the brightness of the traces can be dismissed as a factor affecting detection, since the variation of brightness over a ratio of 10⁶:1 affects the threshold by no more than about 3 db. Moreover the size of the deflection of the A-scan has comparatively little effect on threshold, provided the mean noise deflection exceeds about 0.2 mm.

Experiments involving repetition of traces were carried out by presenting the signal for a fixed time of 3 seconds and varying the pulse repetition rate; four different values of the latter were used to give 1, 38, 600 and 9,600 traces in the 3-seconds period. Under these conditions the depression of signal threshold remained in the range from 1.2 to 1.5 db per doubling of the number of traces for values of the product (bandwidth × pulse length) between 0.1 and 10.

It is often thought that the rate of rise of probability of detection with increasing signal/noise ratio becomes steeper as the number of superposed traces increases. Little information on this subject appears to have been published, but Lawson and Uhlenbeck show experimental curves for cases where many traces have been superposed; one of these where 40 traces have been used shows a slope through the 50 per cent. probability of 22% per db. Another curve where the number of repetitions is not stated shows the same slope. Data on single traces obtained by the author's colleagues⁶ under similar conditions show a slope of under 10% per db. This is, however, very flimsy evidence on which to base any conclusions.

2.2. *Intensity-Modulated Displays*

2.2.1. Side-by-side presentation of successive traces

The paper by McGregor,³ previously referred to, gave a description of the conditions and methods of a series of tests, and a brief summary of the results which showed that the rate of depression of threshold was about 2.2 db per doubling of the number of traces. Many other results were available from these experiments (with which the present author was associated), but they were not fully examined at the time. The author has now completed a study of them, and they are

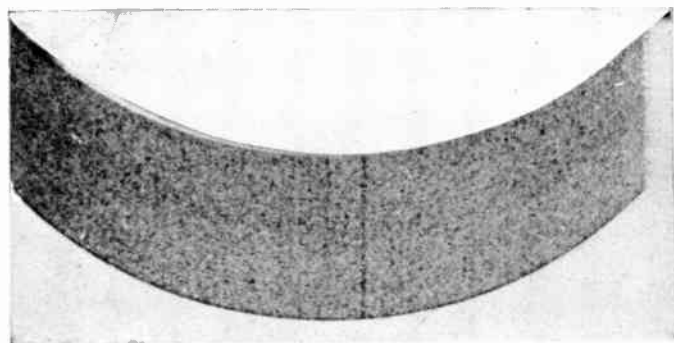

SIGNAL PULSE

Fig. 1.
(a) Photograph of typical chemical recorder chart showing pulse signal. Signal/noise ratio -3db.

This instrument records the signal amplitudes by the release of iodine in paper impregnated with potassium iodide. The paper travels slowly in a direction at right-angles to the time-base deflection of the stylus which carries the signal current. The position of the mark along the trace thus indicates the range of the echo, and the intensity of the mark represents its amplitude.



SIGNAL PULSE

(b) Cathode-ray tube display. Signal/noise ratio -3 db

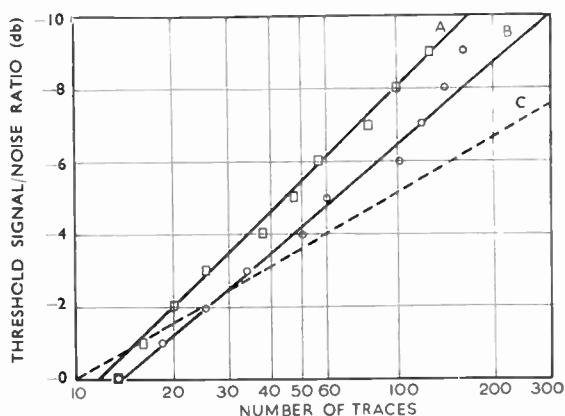

(c) Improvement of threshold with number of traces for chemical recorder and cathode-ray display. Curve A: Chemical recorder } best fitting straight lines. Curve B: Cathode-ray display } Curve C: Line of slope 1.5 db/doubling as given by true integration.

discussed in this section.

The tests should first be briefly described. Twenty observers were used, and the signals were 2 msec pulses of 10 kc/s carrier against a background of white noise filtered by a circuit with 1 kc/s bandwidth centred around 10 kc/s. Input signal/noise ratios ranged from 0 to -10 db. The rectifier was of the "linear" type. The scan duration was 700 msec and the paper speed was such that successive traces were roughly contiguous, i.e. there was no gap

and little overlap. An exactly similar display using the same signals was also set up on a large cathode-ray tube with long afterglow, the successive traces being written one below the other, contiguously, by the use of a Y-timebase corresponding to the paper speed of the recorder. Dimensions, bias, dynamic range, etc., were kept approximately the same in both cases, but the recorder was used in normal room lighting, and the cathode-ray tube in complete darkness. A photograph of a chemical recorder chart is shown in Fig. 1 (a). The scan rate was eighty-four scans per minute. Fig. 1 (b) shows a cathode-ray tube display.

For each value of the input signal/noise ratio, starting from the lowest and rising in 1 db steps, and for each display, each operator was asked to look for the signal and prove correct detection by stating its range, or

distance along the trace, which was varied from one test to another. The time taken for detection to be achieved was recorded up to a maximum of three minutes.

The probability of detection was given by the percentage of the twenty observers obtaining detection under given conditions in a given time. Taking the threshold of detection as the signal/noise ratio corresponding to 50 per cent. probability of detection, the relationship between threshold and the number of traces is shown in Fig. 1 (c).^{*} The results for the chemical recorder give a rate of improvement of threshold of about 2.5 db per doubling of the number of traces. For the cathode-ray display the rate is about 2.2 db per doubling. For a small number of traces, the actual thresholds are very similar for the two displays.

In Fig. 2 is plotted, for the chemical recorder, the relationship between probability of detection and the number of traces (the latter

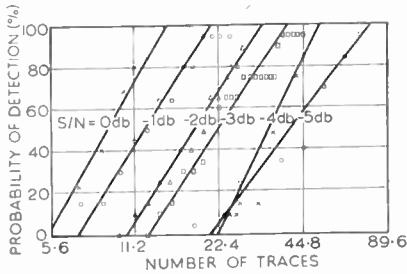

Fig. 2. Chemical recorder: probability of detection against number of traces.

being on a logarithmic scale) at a number of signal/noise ratios. It will be seen that the relations on this logarithmic basis are reasonably represented by straight lines and that the slope of these lines is reasonably constant as the number of traces covered gets larger. This slope is about 70% per doubling of the number of traces. In Fig. 3 is shown the corresponding set of curves for the cathode ray display. Here the relationships are again reasonably represented by straight lines, but it

^{*} Actually, for each value of the signal/noise ratio, the average number of traces, instead of the median, is shown; but the difference is small, and the averages give a better fit to the straight lines.

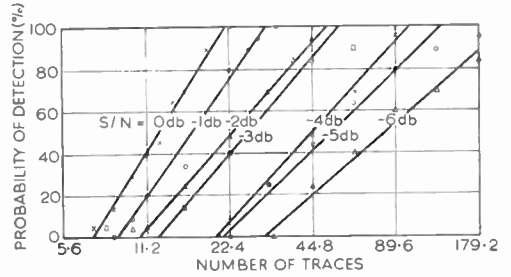

Fig. 3. Cathode-ray tube display: probability of detection against number of traces.

is very apparent that the slope decreases at the lower signal/noise ratios where a much larger number of traces is involved. For small numbers of traces the slope is about 70% per doubling of the number of traces, as for the chemical recorder; but at a signal/noise ratio of -6 db, where the number of traces runs from about 20 to 150, the slope is only about 35% per doubling, i.e. it is reduced to half. This is not unreasonable in view of the fact that the cathode-ray tube display has an imperfect memory as compared with the relatively perfect memory of the chemical recorder. It seems clear that the full advantages of increasing the number of traces cannot be obtained unless they all remain equally visible throughout.

The relationships between probability of detection and signal/noise ratio for different numbers of traces are shown in Figs. 4 and 5 for the chemical recorder and cathode ray display respectively. Owing to the scatter of experimental points on these graphs it is hard to be definite about the slope of these curves through the 50 per cent. threshold. It is, however, perfectly clear that the slope does not increase with increasing number of traces and remains reasonably constant at just under 20% per db. It should be pointed out, however, that no results are available for less than 14 traces and that this slope of about 20% per db corresponds closely to that quoted in 2.1 for the superposition of 40 A-scans.

2.2.2. Visual correlation of successive p.p.i. presentations

The results of experiments have been published by Harriman⁴ in which the time required to detect the pulse was related to input

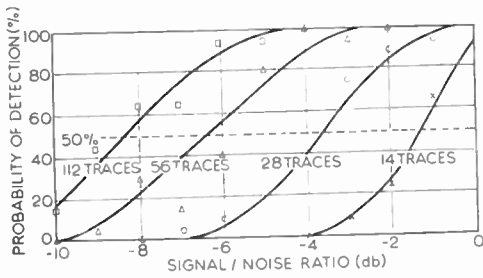

Fig. 4. Chemical recorder: probability of detection against signal/noise ratio.

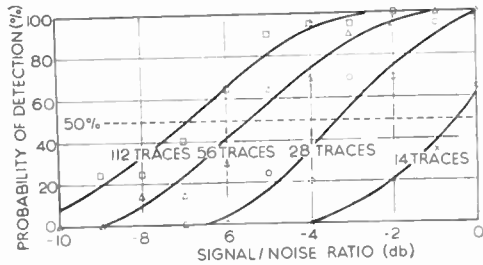

Fig. 5. Cathode-ray tube display: probability of detection against signal/noise ratio.

signal/noise ratio on a p.p.i. radar display with an aerial rotation rate of 30 rev/min. It is clear that in a case like this where the whole picture is repeated at intervals of as much as 2 seconds there is no question of successive pictures being integrated on the screen itself; nor can the afterglow give any real information by the time the next-but-one picture is painted. Any improvement of detection as the number of pictures is increased must clearly depend on the human memory retaining relevant information from one picture to another. Harriman's results re-plotted on a logarithmic scale of time are shown in Fig. 6. It will be seen that the threshold is improved by an amount very close to 2.2 db per doubling of the time of observation, which is of course proportional to the number of pictures painted. These results, being so closely in agreement with those obtained by side-to-side presentation of successive traces, suggest that the improvement of detection in these cases is entirely a function of the human brain.

2.2.3. The effect of size of pulse on a display relative to the structure of the noise

McGregor's suggestion³ that an increase in linear dimensions of the signal pip would be

expected to improve the detection threshold at the rate of 2.2-2.5 db per doubling has already been referred to. Experimental work related to this subject has been published by Bartlett *et al.*,⁵ by Payne-Scott⁹ and by Langmuir and Westendorp⁸, among others, but the conditions of the experiments are difficult to interpret in the terms of the present paper. Certainly an improvement of threshold is always found as the area of pip is increased. The matter is fully discussed in a companion paper by Griffiths.¹²

2.2.4. Relevant experimental data not based on signal/noise tests

A discussion of some of the optical effects in cathode-ray tube displays is given by Bischoff.⁷ One of the important factors discussed is the experimental verification of the Bunson-Roscoe law which states that if the product of the intensity and the duration is held constant then the visual effect is constant. It has apparently been demonstrated that this holds true over durations from 0.001 to 3 sec. This means of course that the eye is an integrator over this period, and, moreover, it has apparently also been proved that the effect is independent of waveform within the range

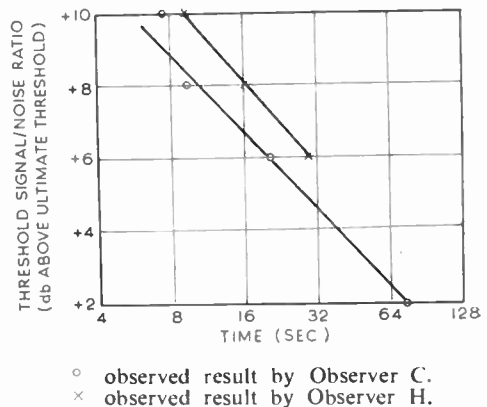

Fig. 6. P.P.I. radar display: improvement of threshold with time of observation (i.e. with number of successive aerial rotations). Data from Harriman,⁴ replotted on log scale.

of square to triangular. These results would suggest that the effect of superposition of traces over short periods of time would lead to an improvement of threshold for the detection of signal in noise of around 1.5 db per doubling. These cases of repeated superposition over very short periods should of course be distinguished

from the tests described in previous sections where the times involved were very much greater and where the human memory could reasonably be called into play. Bischoff also discusses the non-linearity of the relation between the brightness and the current in a cathode ray tube. The degree of non-linearity is very large and it would therefore not be expected that for repeated superposition of traces an improvement of threshold would be particularly close to 1.5 db per doubling.

2.2.5. Experimental results for integration on intensity-modulated displays

Payne-Scott⁹ describes experiments on a radar p.p.i display which include measurements of the threshold of detection for different pulse repetition rates. For all tests the aerial rotation rate was fixed at 4 rev/min, which means that the integration time was small and constant. The integration was presumably partly visual, but mainly by addition of brightness on the phosphor. The results show clearly that over a 100:1 range of pulse repetition rates, the rate of improvement of threshold is very close to 1.5 db per doubling of the number of pulses integrated, and on the highest possible interpretation of the experimental points as published the rate of improvement is under 1.8 db per doubling.

3. Theoretical Considerations

3.1. Visual Correlation: Mathematical Considerations

The previous section has reviewed a considerable amount of experimental evidence which shows that when successive traces are displayed side-by-side an improvement in threshold of between 2.0 and 2.5 db per doubling of the number of traces is obtained. A similar improvement is obtained if successive p.p.i. pictures are observed at such intervals that there can be no integration on the screen. Again a similar improvement in threshold is found when instead of successive traces being concerned the echo point on one picture is increased in area. These are all clearly closely related effects.

The process of improvement of threshold in the first two cases seems to be clearly associated with the observer's correlation of one trace or of one picture with its

predecessors, that is to say, the observer notices that a particular mark or point is repeating in the same place on successive traces, while the random background does not repeat consistently. It is natural therefore to refer to the process of improvement in threshold in this case as visual correlation. It can be seen that the third case—that of increase of area of the point—is closely related to the other two and can be included with them in this discussion. While the term visual correlation is convenient to distinguish the mechanism from that of integration (whether visual or otherwise), it is important to determine whether the process corresponds to correlation in the ordinary mathematical sense. It seems fairly certain that it does not.

Mathematically the correlation process would consist of the multiplication together* of the successive traces, whereas integration is the addition of the traces. In both of these processes subsequent smoothing is implied, but as its effect is to a first order the same in both cases it need not be considered here. Calculations of the effects of the multiplication together and of the addition of two waveforms of the type we are concerned with have been given in ref. 6, and in the Appendix to the present paper the relevant analytical results have been put in a form suitable for the present purpose. Numerical results are plotted over a range of values of the input signal/noise ratio in Fig. 7. The signal/noise criteria considered are the ratios ($R_{\mu 1}$ and $R_{\mu 2}$ respectively) of the change in d.c. level produced by the application of the signal to r.m.s. noise level when the signal is present or alternatively when it is absent. On the basis of these criteria it is clear from the results that multiplication and addition give performances very little different from one another at input signal/noise ratios below unity, and in any case at these low signal/noise ratios multiplication gives a smaller improvement of threshold than addition. It may be concluded therefore that correlation of the mathematical type cannot be the explanation—at any rate not a full

* Since the signal pulses occur at the same point in successive displays, there is no object in introducing the idea of correlation as a function of relative time delay, and only the correlation factor is calculated.

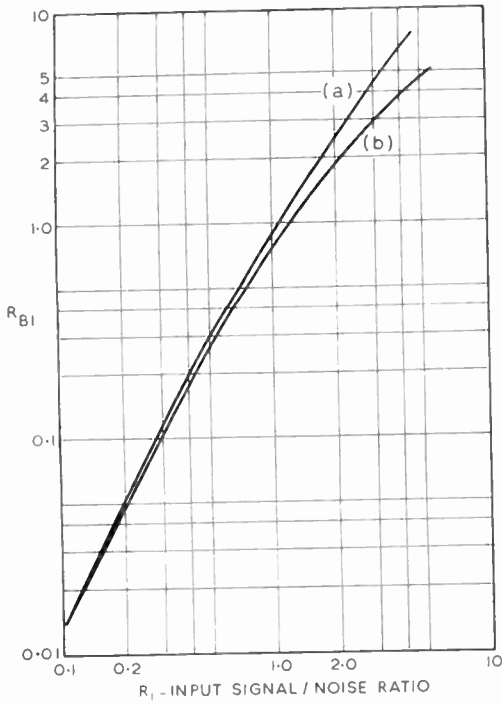

(i) for detection criterion R_{B1}

$$R_{B1} = \frac{\text{change in d.c. level on applying signal}}{\text{r.m.s. noise when signal present}}$$

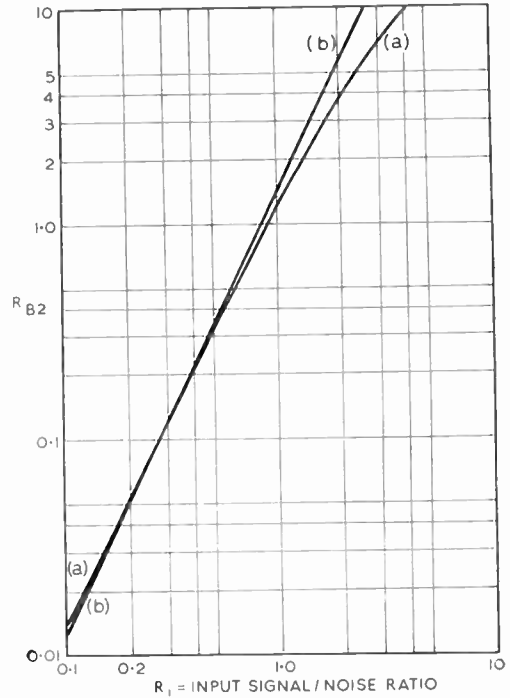

(ii) for detection criterion R_{B2}

$$R_{B2} = \frac{\text{change in d.c. level on applying signal}}{\text{r.m.s. noise when signal absent}}$$

Fig. 7. Comparison of signal/noise performance of addition and multiplication processes. Curves (a) for addition; Curves (b) for multiplication.

explanation—of what is called visual correlation.

We have so far taken account of the observer's impressions of the mechanism of detection as a succession of traces is built up, and have consequently developed an idea of trace-to-trace correlation. But if we had ignored these impressions, we might have been led to the idea that detection was improved because the signal might be detected on one trace or another, or on more than one, independently; this, by giving more chances of making a detection, would improve the overall probability (P) of detection according to the following relation:

$$P = 1 - (1 - p)^n$$

where p = probability of detection on a single trace and n = number of traces. The same relation could clearly be applied also where p is the probability of detection in a group of traces.

Figure 8 shows that this theory does not fit the facts at all. The observed relationship of probability of detection to signal/noise ratio

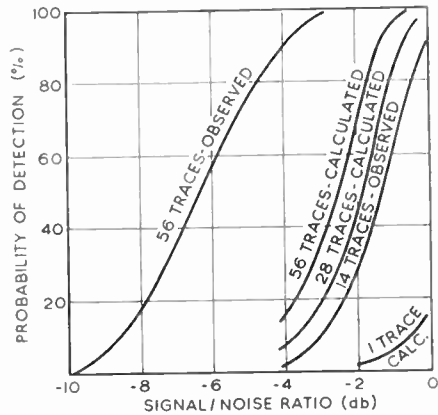

Fig. 8. Comparison of observed results in Fig. 4 with those calculated from $P = 1 - (1 - p)^n$.

for 14 traces on the chemical recorder (from Fig. 4) is shown, and also the probabilities calculated from it by the above equation for 28 and 56 traces (a few points are also shown for a single trace). It is clear that the observed probabilities for 28 and 56 traces are vastly different from those given by this calculation, and this simple explanation can evidently be completely dismissed. Clearly something considerable is gained by the visual juxtaposition of the traces above that given by merely additional individual judgments.

3.2. *Visual Correlation in Advertising*

The processes of detection of signal against noise appear in many ways analogous to those of the observation of advertisements. If we confine our consideration to advertisements printed in, say, a newspaper, we can consider the "signal strength" of the advertisement as its inherent interest to the reader, and we can define the "noise background" in terms of the mean signal strength and fluctuation of the other advertisements which surround the one considered.

An interesting advertisement, like a strong signal, will be detected on its first appearance. An uninteresting advertisement, like a weak signal, may become noticed after many repetitions. It might be worthwhile to carry out some experiments with advertisements in the following form:

We could take, say, 20 strips, each containing, say, 50 small advertisements, from *The Times* personal column, all the advertisements being different throughout the 20 strips, except for one which is the same in every strip. Using, say, 20 observers, we would ask each one to read a strip, and after some specified interval of time to record those advertisements which they remembered. If the "signal" advertisement has not been observed, the experiment is repeated with a new strip and so on until the signal is detected. A graph can then be drawn showing the proportion of the subjects who detected the signal against the number of readings required. Two different conditions would be tried in successive series of experiments. In one condition the signal advertisement would appear in exactly the same position in the strip each time. This clearly corresponds to the trace to trace

correlation in an ordinary visual display, and results of the type shown in Figs. 2-5 might reasonably be expected. The other condition is where the signal advertisement appears in random positions, and it is not at all certain whether successive readings in this condition will give improved detection.

There are two main differences between these experiments and the electrical ones:

- (a) With advertisements there is no way of measuring the signal and noise strengths objectively.
- (b) The amount of information in the signal is much greater than in the electrical case.

This latter point, however can be overcome by making experiments with intermediate cases in which numbers or other simple signals are used in place of sentences.

3.3. *Other Types of Measurement on Chemical Recorder and Cathode-Ray Displays*

The experiments suggested with advertisements in which we compared the detection of repetition in the same place with repetition in different places can be represented on a chemical recorder display by making the signal distinguishable from the noise by virtue of its pulse length and then causing it to occur at random positions in successive traces. It is possible the observer will detect this signal more readily on repetition than on a single trace, in spite of the random positions. If this is so, it might be supposed that this improvement is a contribution made by the observer's intellect, and the improvement obtained by the repetition of the signal in the same position may well be the sum of this and of the improvement produced by plain addition.

4. **The Relation between Trace-to-Trace Correlation and the Dynamic Range of the Display expressed in Just Noticeable Differences**

It has been shown in a previous paper¹⁰ that in the detection of pulse signals in noise on a visual display an important factor is the dynamic range of the display expressed in terms of just noticeable differences (j.n.d.'s). While a full theory of the effect of j.n.d.'s on detection has not yet been worked out, it is clear from the paper cited that the number of j.n.d.'s in the dynamic range can have a

considerable effect on the detection performance of a single trace. It is important to consider what effect the number of j.n.d.'s may have on the phenomenon of trace-to-trace correlation or visual correlation.

4.1. *The Measurement of J.N.D.'s*

Before considering the effect of the number of j.n.d.'s on trace-to-trace correlation it is worth observing that trace-to-trace correlation plays an important part in the measurement of j.n.d.'s. The technique of measurement is to arrange for a small area of an otherwise uniform background on the display to have a slightly larger amplitude or brilliance, or density of mark in the case of the chemical recorder. The increment in signal amplitude represented by the brilliance or density of the small area is increased in successive observations until the observer is able to detect it with the desired degree of certainty, and it is then called a j.n.d. The process of detection of the increased signal is obviously one of detection of signal in noise, since although the background is produced by a uniform voltage, the degree of contrast required for detection is clearly determined by the fluctuation or noise in what is nominally a uniform background. One would therefore expect the area of the mark produced by the increased amplitude to have a marked influence on the size of the just-detectable increment of amplitude or j.n.d. as for signal and noise in Section 2.2.3. For purely optical tests this is confirmed by the experiments of Langmuir and Westendorp⁸ previously quoted, and for a cathode-ray tube is confirmed qualitatively by direct measurements of j.n.d.'s although in this latter case quantitative agreement with the previous results was not obtained. It is clear therefore that the size of the j.n.d. itself is a function of visual correlation.

4.2. *The Influence of the Number of J.N.D.'s on Trace-to-Trace Correlation*

Assuming that the area of the signal point or echo is fixed, then we can consider whether the results previously quoted for side-by-side presentation of successive traces should be influenced by the dynamic range measured as the number of j.n.d.'s of the display medium. The simplest way to demonstrate that it must have an effect is to take the extreme case of

a display which has only two levels, i.e. mark or no-mark; one could say that the dynamic range of such a display was 1 j.n.d. In this case the level at which the transition occurs must be pre-set and any peak whether of noise or of signal-plus-noise will give a mark only when it exceeds this level. Each trace, for example on a chemical recorder display, would then consist only of a succession of marks. When several traces of this kind are placed side-by-side the only way in which the presence of the signal can be detected is to look for the coincidence in position of the maximum number of marks on successive traces. One must assume that this position represents the signal and from the data available on the display it would be possible to calculate the probability that such coincidence of marks had in fact represented the signal. However, if the successive traces were added together instead of being displayed side-by-side—i.e. they are integrated—then the signal would be said to correspond to the largest peak of the resultant trace. This largest peak would of course be obtained where the largest number of marks have coincided on successive traces and it is quite clear that the probability of this being the true signal is identical whether the traces are visually correlated or truly integrated.

The conclusion is thus reached that when the dynamic range is restricted to 1 j.n.d. visual correlation and integration give identical results, but when the number of j.n.d.'s is comparatively large, as it was in the cases described in Section 2, visual correlation gives evidently better results than integration. Thus, although the argument has been greatly simplified, it seems certain that visual correlation is a function of the dynamic range measured in j.n.d.'s.

5. Conclusions

It can fairly be said that this paper poses as many questions as it answers. However, from the experimental data and theoretical considerations reviewed the following conclusions regarding intensity-modulated displays emerge with reasonable clarity:

- (a) If successive traces containing a pulse signal against a noise background are integrated or added together (after linear rectification) then the threshold of detection

is improved by about 1.5 db per doubling of the number of traces.

- (b) When successive traces are presented side-by-side or one after the other in such a way that visual correlation can take place, then the threshold is improved by between 2.0 and 2.5 db per doubling of the number of traces.
- (c) When the area of the mark produced by the signal is increased, then the detection threshold is improved, but the exact relationships of the effect are a little uncertain.
- (d) Visual correlation cannot be accounted for in terms of mathematical correlation.
- (e) The relative effects of visual correlation and of integration are dependent on the dynamic range of the display measured in terms of the number of j.n.d.'s available.
- (f) When the probability of detection is plotted against signal/noise ratio it is possible that the steepness of the curve increases as the number of correlated or integrated traces increases. The amount of such increase is however relatively small and once several traces are involved no further steepening appears to take place.
- (g) While it seems that the human memory is effective in the visual correlation process, there is evidence from tests on chemical recorders with perfect memory and cathode-ray tube displays with imperfect memory that for periods of time of the order of minutes the human memory becomes less effective than the perfect memory.

6. References

1. J. L. Lawson and G. E. Uhlenbeck, "Threshold Signals." M.I.T. Radiation Laboratory Series, Vol. 24 (McGraw-Hill, New York, 1950).
2. J. W. R. Griffiths and I. G. Morgan, "The chemical recorder and its use in detecting pulse signals in noise," *Transactions of the Society of Instrument Technology*, **8**, p. 62, 1956.
3. P. McGregor, "A note on trace-to-trace correlation in visual displays," *J. Brit. I.R.E.*, **15**, p. 329, 1955.
4. M. Harriman, "Visibility on Cathode-Ray Tube Screens: Search Time as a Function of Signal Strength," Johns Hopkins

University, Systems Research Laboratory; report summarized in Ref. 11.

5. N. R. Bartlett, S. B. Williams and R. M. Hanes, "Visibility on Cathode-Ray Tube Screens: The Effect of Size and Shape of Pip," Johns Hopkins University, Systems Research Laboratory; report summarized in ref. 11.
6. D. G. Tucker, "Signal/noise performance of multiplier (or correlation) and addition (or integrating) types of detector," *Institution of Electrical Engineers*, Monograph No. 120R, 1955.
7. A. F. Bischoff, "A quality factor for radar cathode-ray tube presentations," *Proceeding of the National Electronics Conference, Chicago*, **8**, p. 387, 1952.
8. I. Langmuir and W. F. Westendorp, "A study of light signals in aviation and navigation," *Physics*, **1**, p. 273, 1931.
9. R. Payne-Scott, "The visibility of small echoes on radar p.p.i. displays," *Proceedings of the Institute of Radio Engineers*, **36**, p. 180, 1948.
10. D. G. Tucker and J. W. R. Griffiths, "Detection of pulse signals in noise: theory of intensity-modulated displays in terms of just-noticeable differences," *Wireless Engineer*, **32**, p. 290, 1955.
11. S. B. Williams, "Visibility on Radar Scopes," Chap. 4 of "Human Factors in Undersea Warfare." (National Research Council, Washington, D.C., 1949.)
12. J. W. R. Griffiths, "Detection of pulse signals in noise: the effect on visual detection of the area of the signal paint," *J. Brit.I.R.E.*, **17**, pp. 330-338, June 1957.

7. Appendix: Improvement of Detection by Adding after Rectification and by Multiplying

Two criteria of detection which may be considered are

$$R_{#1} = \frac{\text{change in d.c. on application of signal}}{\text{l.f. noise when signal absent}}$$

and

$$R_{#2} = \frac{\text{change in d.c. on application of signal}}{\text{l.f. noise when signal present}}$$

Reference 6 shows that for *addition of traces* (after "linear" rectification)

$$R_{B1} = \frac{2 \left[{}_1F_1 - 1 \right]}{\sqrt{\left(\frac{4}{\pi}\right) \left[2(1 + R_1^2) - \frac{\pi}{2} ({}_1F_1)^2 \right]}} \dots\dots(1)$$

and

$$R_{B2} = \frac{2 \left[{}_1F_1 - 1 \right]}{\sqrt{\left(\frac{4}{\pi}\right) \left(2 - \frac{\pi}{2} \right)}} \dots\dots(2)$$

where R_1 = input r.m.s. signal/noise ratio on each trace

${}_1F_1$ = confluent hypergeometric function
 ${}_1F_1 \left(-\frac{1}{2}; 1; -R_1^2 \right)$

For *multiplication of traces* (after "linear" rectification)

To compare addition and multiplication, it should be observed that

$$\sqrt{\left(\frac{16}{\pi^2} - 1\right)} = 0.79$$

and $\sqrt{\left(\frac{4}{\pi} \left(2 - \frac{\pi}{2} \right)\right)} = 0.74$

and that for $R_1 \ll 1$,

$${}_1F_1 \cong 1 + \frac{1}{2}R_1^2 \dots\dots(7)$$

For example, compare values of R_{B2} when $R_1 \ll 1$; then

$$R_{B1} = \frac{({}_1F_1)^2 - 1}{\sqrt{\left(\frac{4}{\pi}\right) \left[2(1 + R_1^2) - \frac{\pi}{2} ({}_1F_1)^2 \right]}} \left[({}_1F_1)^2 + \frac{1}{\pi} \left\{ 2(1 + R_1^2) - \frac{\pi}{2} \cdot ({}_1F_1)^2 \right\} \right]^{\frac{1}{2}} \dots\dots(3)$$

and

$$R_{B2} = \frac{({}_1F_1)^2 - 1}{\sqrt{\left(\frac{16}{\pi^2} - 1\right)}} \dots\dots(4)$$

For a *single trace* (after "linear" rectification)

$$R_{B1} = \frac{{}_1F_1 - 1}{\sqrt{\left(\frac{2}{\pi}\right) \left[2(1 + R_1^2) - \frac{\pi}{2} ({}_1F_1)^2 \right]}} \dots\dots(5)$$

and

$$R_{B2} = \frac{{}_1F_1 - 1}{\sqrt{\left(\frac{2}{\pi}\right) \left(2 - \frac{\pi}{2} \right)}} \dots\dots(6)$$

Clearly (1) is exactly $\sqrt{2}$ times (5) and (2) is exactly $\sqrt{2}$ times (6), whatever the value of R_1 .

(a) for a single trace

$$R_{B2} = \frac{R_1^2}{1.05} \dots\dots(8)$$

(b) for addition of two traces,

$$R_{B2} = \frac{R_1^2}{0.74} \dots\dots(9)$$

(c) for multiplication of two traces

$$R_{B2} = \frac{R_1^2}{0.79} \dots\dots(10)$$

Thus, for equal values of R_{B2} to be obtained in the three cases, the value of R_1 required when adding two traces together must be 1.50 db below that for a single trace, and the value of R_1 required when multiplying two traces together must be 1.21 db below that for a single trace.

DETECTION OF PULSE SIGNALS IN NOISE: THE EFFECT ON VISUAL DETECTION OF THE AREA OF THE SIGNAL PAINT*

by

J. W. R. Griffiths, B.Sc.†

SUMMARY

The problem of trace-to-trace correlation is reviewed in the light of some physiological experiments on the relationship between the area of an illuminated patch and the contrast required for its detection. It is concluded that the improvement in detection of a signal in noise obtained by trace-to-trace correlation can be largely accounted for by the increase in the solid angle subtended at the eye by the signal "paint."

1. Introduction

There is considerable experimental evidence and qualitative theoretical justification to show that an improvement in detection results from utilization of more than one scan‡ of a pulsed echo-ranging device such as radar or asdic, provided of course that the wanted echo or signal is present on each individual scan. If the latter condition is not fulfilled the problem is rather more complex but should not affect the general arguments set out below other than in the absolute levels of detection.

The best way of using the increase in information obtained from more than one scan is not immediately obvious, but two methods are fairly well recognized:

- (a) Trace-to-trace§ integration in which the voltage or current waveforms representing successive traces are added linearly.
- (b) Trace-to-trace§ correlation (alternatively called visual correlation) in which successive scans on an intensity modulated display are placed side-by-side. To some extent this is done in a p.p.i. display—although here there is often a mixture of both integration and correlation since the screen phosphor can integrate traces that overlap.

A discussion of these matters in relation to direct experimental evidence of their effects is

given in a companion paper.¹⁴ The present paper attempts to relate them to experimental work in a different field, namely that of physiological optics.

Theoretical analysis of both methods (a) and (b) is hampered by the need for an objective criterion of detection, i.e. it is necessary to pick out the property of the displayed information which the observer uses in the detection of the signal. This subject of suitable criteria has been discussed elsewhere.⁹ A well-accepted criterion for output signal/noise ratio is the ratio of the change of the average level when the signal is applied, to the standard deviation of the background fluctuation. Using this criterion it is possible to get a solution for case (a) which shows that for signal/noise ratios below unity an improvement should occur in the threshold signal/noise ratio of about 1.5 db/doubling of the number of traces. There is some rather scanty practical evidence to substantiate this³ but as far as the author is aware no experiments have been carried out with the specific object of substantiating this figure, probably because of the difficulty of making a linear integrator and storage device. Waters¹⁰ and Harrington and Rogers¹¹ achieved some results with integration on a storage tube, but the former only showed the improvement in a qualitative manner and Harrington used

* Manuscript received 3rd April 1957. (Paper No. 403.)

† Electrical Engineering Department, University of Birmingham.

U.D.C. No. 621.396.963.

‡ "Scan" or "trace" is the information returning from the transmission of one pulse.

§ The terms "pulse-to-pulse" and "scan-to-scan" are sometimes used in place of trace-to-trace.

high signal/noise ratios, i.e. above the level at which the 1.5 db/doubling would apply.

Turning to case (b) the problem of obtaining a suitable criterion is much more difficult and little theoretical work has been done. However, there is quite a considerable amount of experimental evidence^{1,2,3,4,14} and the remarkable conclusion is that this method of displaying the information produces a higher improvement with increase in number of traces, the results varying between 2.2 and 2.5 db/doubling. It is the purpose of this paper to consider the nature of this improvement and compare the results with some experimental evidence obtained by physiologists^{5,6,12} on the contrast in light intensity required for the detection of small areas on a uniform background. It is, of course, clear that in side-by-side presentation of traces, the signal appears as an area of increasing size as the number of traces is increased. It is suggested here that the improved detectability is directly related to the area effect.

2. Input and Output Signal/Noise Ratios

The value of 1.5 db/doubling for the improvement in threshold results from the performance of the detector circuits necessary for the display of information in an echoing device. For signal/noise ratios less than unity the mean output voltage or current is proportional to the power in the input⁷, thus when the signal is present the mean output voltage is proportional to $S+N$ where S and N are the input signal and noise powers respectively. This applies approximately to all detectors of the rectifying type, e.g., square law, "linear," no matter what the law of rectification. Thus, since the mean output is N when the noise alone is present, and since the output fluctuation without the signal present is fixed by N , it hence follows that the output signal/noise voltage ratio is proportional to the input signal/noise power ratio. Expressed alternatively, this means that the output signal/noise voltage ratio is proportional to the square of the input signal/noise voltage ratio.

Now when we add successive traces after detection, the mean voltages add directly whereas the fluctuations must be added on a power basis. Thus, if we add two traces in which the background is random noise, we

double the mean voltage but only increase the fluctuation by $\sqrt{2}$. Thus the output signal/noise voltage ratio is increased by $\sqrt{2}$ or, in general, when n traces are added, by \sqrt{n} . However, we are normally concerned with the threshold signal/noise ratio, i.e. the input signal/noise ratio required for a given percentage of correct detections. Assuming that this requires a constant *output* signal/noise ratio, we can find the reduction that can be made in the input signal/noise ratio as the number of traces superimposed is increased. Because of the square law relation between input and output signal/noise ratios it is obvious that if we increase the output signal/noise ratio by \sqrt{n} by adding n traces and wish to return it to its original value by reducing the input signal/noise ratio then we must reduce the latter by $\sqrt[4]{n}$. Thus if we double the number of traces we increase the output signal/noise ratio by 3 db. We can reduce this to its original value by decreasing the input signal/noise ratio by 1.5 db, i.e. we get an improvement in threshold of 1.5 db for each doubling of the number of traces.

For high signal/noise ratios in the input the detector behaves in a linear manner such that the output voltage signal/noise ratio is proportional to the input signal/noise ratio and hence the improvement in threshold would then be 3 db/doubling. In many practical cases this region is of little importance since signal/noise ratios at the input are usually less than unity. A coherent detector⁹ has a linear relation between input signal/noise ratio and output signal/noise ratio over the whole range, and, hence, the improvement in threshold by increasing the number of traces using this type of detector should be at the rate of 3 db/doubling.

It can thus be seen that this expected improvement depends both on the relation between input and output signal/noise ratio, and, of course, on the definition of output signal/noise ratio. In the light of this and realizing that the criterion of detection is hardly likely to be the same for visual correlation as for integration, it does not seem strange that we obtain a different figure of improvement. However, from the information point of view there is obviously a limit to the improvement we obtain by considering more than one trace

and the important point is to decide whether or not the visual correlation type of display is more efficient.

3. Experimental Evidence

The fourth-root law of improvement derived in the last section is so widely accepted that one would expect a considerable amount of experimental evidence to be available: in fact the evidence is rather sparse for trace-to-trace integration and the only example known to the author is part of reference 3. Lawson and Uhlenbeck⁷ have shown that the law is approximately true for an A-scan, but the nature of the integration here is rather different from linear addition—although the general effect is somewhat similar in that the combined traces tend to smooth out the fluctuations, thus making it easier to detect the change in mean when the signal is present. (See Fig. 1.)

Much more evidence exists for visual correlation,¹⁻⁴ and taking into account the wide variation in experimental conditions under which these results were obtained, the similarity in the figures—all in the range of 2.2–2.5 db per doubling—suggests that the agreement is more than a coincidence.

Because of the difficulty of maintaining all parameters constant under operational conditions, nearly all subjective experiments on echo-ranging displays are carried out in laboratories under simulated conditions. The complexity of the operational situation is reduced to a much simpler experiment in which it is possible to vary each parameter individually and note its effect on an easily measurable threshold. As a step towards such simplification of an intensity-modulated display we could make the background smooth instead of the more usual practical background of noise. This simplifies but does not really change the problem, which remains a statistical one, because, due partly to unavoidable inhomogeneities in the background and partly perhaps to the physiological mechanism of vision, the detection of a signal area of increased brightness requires a definite contrast to exist between the mean brightness levels of signal and background areas. On the basis that the mechanism of vision appears to introduce its own noise background, Gregory⁸ has developed a theory

which gives fairly good agreement with experimental results.

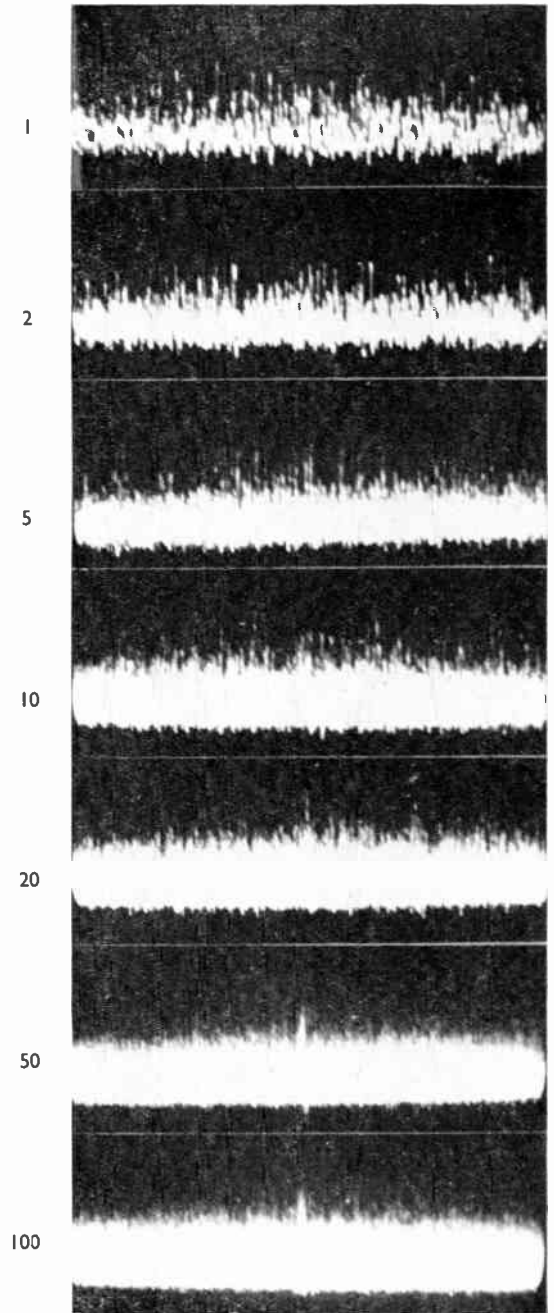

Fig. 1. Showing the improvement obtained in detectability on an A scan as the number of traces superimposed is increased. The signal-to-noise ratio is the same for each trace. The number of traces superimposed is indicated.

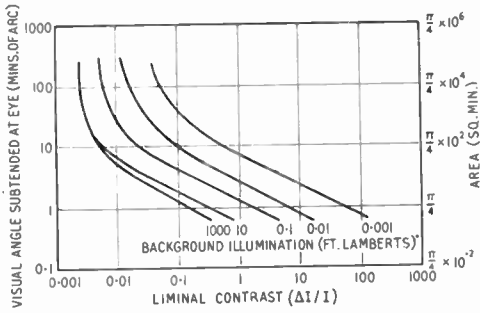

Fig. 2. Curves showing the dependence of liminal contrast on area and adaption brightness (circular area on a uniform background). Single area method. (After Blackwell's).

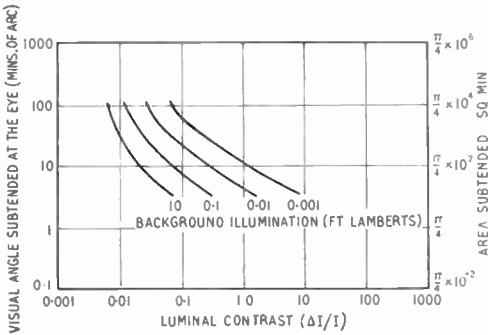

Fig. 3. Curves showing the dependence of liminal contrast on area and adaption brightness (circular area on a uniform background). Forced choice method. (After Blackwell's).

When the number of traces in an intensity-modulated display using visual correlation is increased, we are effectively increasing the area occupied by the signal—this also applies if we increase the pulse duration of the signal on the trace. It is fortunate that there is a considerable amount of data available on the relation between area*, adaption field brightness, i.e. the brightness of the background, and the threshold contrast required between the area and background illumination to give a fixed percentage of correct detections. Some of these results obtained by Blackwell are shown in Figs. 2 and 3. The two sets of results differ in the method used. In Fig. 2 the observer was required to state whether the intensity of a single area had increased or not, whilst for the results in Fig. 3, he was asked to choose which one of

* Area is measured throughout in terms of the solid angle subtended at the eye.

a number of areas had increased in brightness. The latter method is very similar to the forced choice method used by Lawson and Uhlenbeck, and various other workers, in the testing of detection of signals in noise. Threshold contrast is obviously related to signal/noise ratio but the absolute relation is influenced by the internal noise of the eye which is difficult to assess. However, contrast is defined as:

$$\frac{\text{mean area illumination} - \text{mean background illumination}}{\text{mean background illumination}}$$

and so for a constant background we should imagine the "noise" to be constant and hence we are involved in measuring a change in mean. This coincides with the usual definition of the output signal/noise ratio of a detector and so we could argue that the threshold contrast is the same as the output signal/noise ratio. Thus since an increase in area causes a reduction in the threshold contrast it means that detection is occurring with a smaller output signal/noise ratio. If the area and background illumination resulted from the rectification of noise and signal we would expect a square law relationship between contrast and input signal/noise ratio.

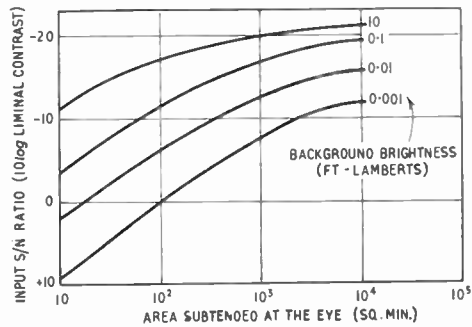

Fig. 4. Blackwell's results plotted as signal-to-noise ratio versus area for various values of background illumination. (From Fig. 3).

Making the assumption of a square law relationship between contrast and input signal/noise ratio, Blackwell's data has been re-drawn in Fig. 4, and it can be seen that the effect of increasing the area varies from 3 db/doubling for small areas and low on medium illumination to 0 db for large areas and high illumination. Examination of some of the existing evidence on trace-to-trace correlation

shows that the signal areas concerned are located at the most critical parts of the curves obtained by Blackwell, and hence the agreement on an improvement of 2.2-2.5 db/doubling seems to have been purely fortuitous. Later evaluations of experiments always prove difficult because some piece of information, not thought important at the time, is generally missing.

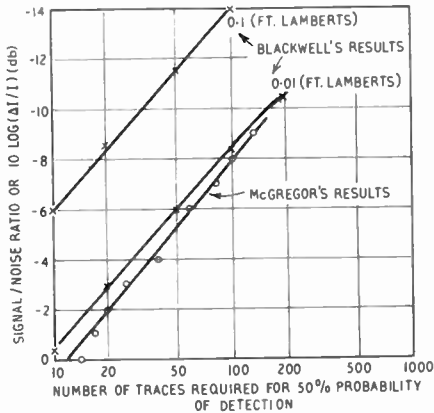

Fig. 5. Comparison of McGregor's results with those of Blackwell for two values of background illumination. The observer in McGregor's experiments was assumed to be about 18 in. from the display.

However, by some judicious guessing, the conditions of McGregor's experiment were fitted into Blackwell's results, producing the curve shown in Fig. 5. McGregor's results are plotted on the same curve and it can be seen that the slopes are identical. (Of course, we cannot identify the scales of threshold contrast with threshold signal/noise ratio since we do not know the ratio of the mean signal to fluctuation in the experiments of Blackwell.) It might be concluded from this that the improvement obtained in visual correlation is directly related to the increase in area, but before making this conclusion it is worthwhile outlining the main differences between those experiments which use a more realistic simulation of the operational display, e.g. a noise background, pulsed signals, etc., and those which have been mainly concerned with the physiological aspect. For simplicity we will call the echo-ranging experiments Type A and the physiological experiments Type B.

4. Differences between the Physiological and the Echo-ranging Experiments

The major differences between the two types of experiments are:

- (a) Type B uses a substantially homogeneous background.
- (b) Results for Type B are all in terms of light intensity received by the eye whereas Type A are either in terms of the voltage applied to the grid of a cathode-ray tube, or, more usually, in terms of the signal/noise ratio in the receiver preceding the detector.
- (c) The way in which the background and area is built up temporarily (i.e. the time relationship) is different in the two experiments.

Considering these points more fully:—

(a) When the background is said to be homogeneous it means that there is no deliberate addition of noise causing variation in illumination over the surface. However, perfect homogeneity is unobtainable, and it is reasonable that the contrast required for detection should, within limits, be smaller for large areas than for small areas because it is easier to judge the difference in mean brightness when the area is large.

Experiments made by Bartlett² are to some extent a cross between Types A and B since, although he used a cathode-ray tube display and simulated pulsed signals, his background had no added noise and he kept the bias on the c.r.t. constant. Of course the phosphor itself plus imperfections in the c.r.t. would produce considerable inhomogeneity in the background. Both Bartlett² and Hopkinson¹² expressed the opinion that the inhomogeneity of the background would affect only the absolute level at which detection was made and not the way in which the threshold depended on such parameters as area.

(b) Since the intensity of the light output from the screen of a cathode-ray tube is not necessarily linearly related to the potential on the grid of the tube it would appear this might seriously affect comparison of the two types of experiment. For example, let us consider two tubes, one in which the intensity I is proportional to the grid voltage V and the other in which $I \propto V^2$.

Tube (1)—

Say $I = kV$. Then a small change ΔV in grid voltage gives a change of intensity

$$\Delta I = k\Delta V.$$

$$\text{Thus } \frac{\Delta I}{I} = \frac{\Delta V}{V}$$

Tube (2)—

$$\text{Here } I = KV^2$$

$$\text{so that } \Delta I = 2KV\Delta V.$$

$$\text{Thus } \frac{\Delta I}{I} = \frac{2\Delta V}{V}$$

i.e. for the same output contrast the second tube requires half the input contrast, but what is important is that for small changes the input and output contrasts are still linearly related. Hence the effect of a non-linear intensity/grid voltage relation is only to affect the absolute level of detection and not the relative level unless the changes in intensity are comparable with the actual intensity.

It is important to note that since light intensity is directly related to grid voltage and we consider light intensity as an output signal (see Section 3) then the grid voltage must be represented as an output signal when we try to relate the results of Bartlett to those obtained in signal and noise experiments using a rectifier.

Bartlett obtained results for three levels of background illumination, namely, dim (0.0001 ft lamberts), optimum (0.1 ft lamberts) and bright (2.0 ft lamberts). From the figures given in his paper the solid angle subtended at the eye has been calculated for various values of beam width and pulse duration and so the required change in grid bias to produce detection can be plotted against area of the "signal" expressed in solid angle. This has been done in Figs. 6, 7 and 8, for the three levels of background illumination.

Before these results can be compared with those of Blackwell we must relate the two scales "changes in grid bias" and "contrast." It was shown above that if the change is small the law relating intensity of illumination to grid bias is only important in determining the absolute relations between changes in these two quantities. It does not affect the slope of the curve relating the changes to variation of parameters, such as area of trace. However,

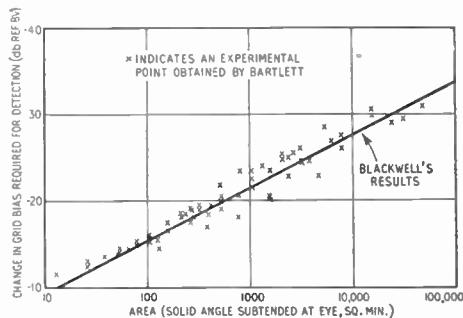

Fig. 6. Bartlett's results for the dim background (0.0001 ft. lamberts) plotted against solid angle subtended at the eye (results derived from Blackwell's experiments are also shown).

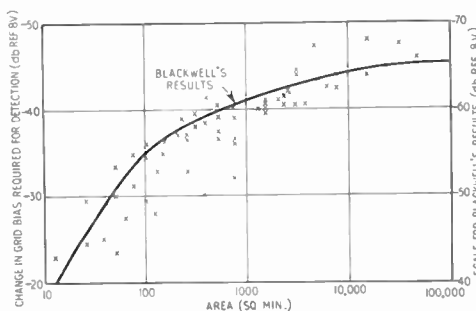

Fig. 7. Bartlett's results for the optimum background (0.1 ft. lamberts)

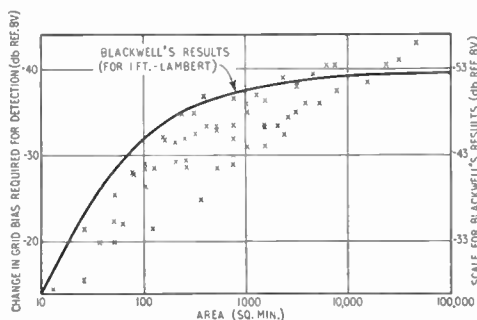

Fig. 8. Bartlett's results for the bright background (2 ft. lamberts).

the "dim" level of illumination was so small that the changes required for detection were of the same order or greater than this actual level, and hence it cannot be assumed $\Delta I/I \ll 1$. Thus the relation between the scale of contrast and change in grid bias is not necessarily linear. It is possible to derive a relation between

illumination and grid bias such that the results obtained by Bartlett for the change in grid bias required for detection agree with the results obtained by Blackwell for the contrast in illumination required. Such a curve is shown in Fig. 9 on a log scale of intensity and in Fig. 10 on a linear scale; it can be seen to be a reasonable approximation to the type of curve normally encountered with cathode-ray tubes. The relation is roughly logarithmic for small values of illumination and tends to be linear for higher values. Assuming such a relationship the solid curve on Fig. 6 indicates Blackwell's results and shows no essential disagreement between the two sets of results.

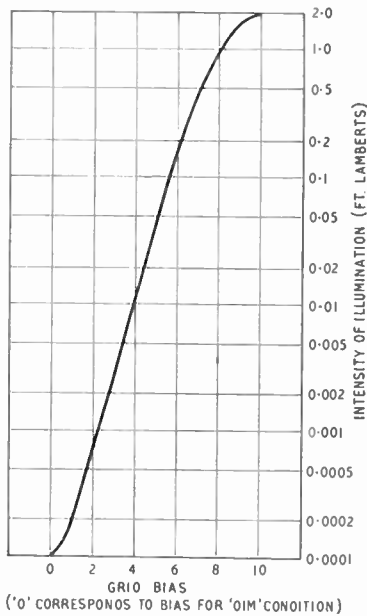

Fig. 9. Postulated relation between intensity of illumination and grid bias for Bartlett's experiments (log scale of I).

However, having fixed the shape of the illumination/grid bias curve at low intensity, and having been given the grid bias for the other two fixed levels of illumination (for the optimum and bright conditions), the general shape of the whole curve—assuming there are no discontinuities—is fixed. This fixes the constant in the expression

$$\Delta I/I = K \frac{\Delta V}{V}$$

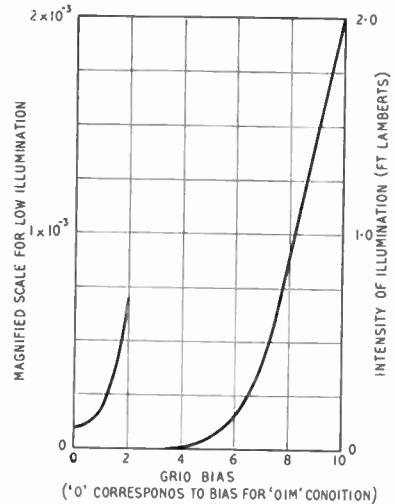

Fig. 10. Postulated relation between intensity of illumination and grid bias for Bartlett's experiments (linear scale of I).

for each of the two cases and unfortunately the value of K is not such as to make the absolute scales of Bartlett's and Blackwell's results agree. But, as can be seen from Figs. 7 and 8, the slopes of the curves are very similar. Only the absolute levels are in disagreement. This could be explained to some extent by assuming an increase in background noise for the higher intensity. The "dim" condition is of such a low illumination that the background noise is probably controlled by the eye whereas for higher illumination a substantial proportion may be due to the grain of the phosphor and the cathode-ray-tube screen.

(c) In Blackwell's experiments the whole of the background was present continuously and the increased signal stimulus appeared for a given time over a given area. In such experiments as McGregor's, the background is built up at the same rate as the signal area and hence this may have an effect on the threshold. The magnitude of this effect is not known but the fairly good comparison between McGregor's and Blackwell's results suggests that the effect is not important as far as the effect of area is concerned. The difference would probably be more important should the signal be present for only relatively short durations.

5. Mathematical Treatment of the Problem

So far we have tried to compare experimental results in one field with experimental results in another field. We can of course approach the problem mathematically but to do so requires some subjective criterion of performance, such as the signal/noise ratio discussed in Section 2. The important point is that the validity of our results calculated in this way is completely dependent on the initial criterion and hence must be interpreted with due care. With this in mind we may consider the simplified problem of a background made up of discreet elements corresponding to, say, the smallest area resolvable by the eye, or alternatively limited by some other factor such as "spot" size on the display or bandwidth in the receiver. The intensity of each of these elementary areas is assumed to be varying randomly. Over a restricted area we apply a signal, represented by an increase in the mean intensity of those elements of area contained in the signal area. If the average of the intensity of these signal elements exceeds the average of the intensity of the background elements by an amount kN^* we decide a signal is present. The value of k is determined by the number of false alarms that can be tolerated, i.e. the number of times the average is by chance, with no signal present greater than the background average. Obviously for a small number of false alarms k must be large which will require a large change in the true mean of the signal area to give detection; conversely, if k is small, detection is improved but we get a large number of false alarms. Notice that we have not only had to simplify the problem considerably but also have had to decide on our own criterion guided by intuition and some knowledge of the way in which the eye and brain perform.

Using the method outlined in the last paragraph, Kaplan¹³ obtained some results which are summarized by the curves in Fig. 11. It will be noticed that the slope of most of the curves is of the order of 1.5-1.8 db/doubling, but that the slope of Shannon's ideal curve† exceeds 3 db/doubling. This is an

* N = average level of background intensity.

† This curve was obtained by applying Shannon's Information Theory.

interesting result since it has been suggested that the best achievable by any method would be 3db/doubling of the number of traces. It is, however, worth pointing out that any slope could be achieved if the efficiency of the subjective operation of detection was increasing as the number of traces increased.

An alternative criterion, for a display such as the chemical recorder used by McGregor, might be based on the number of marks in a line exceeding a given level of intensity; the choice of the particular level and the number required for recognition of the signal would appear to be very arbitrary and it is questionable as to whether the large effort required to achieve any results from this approach is really worth while.

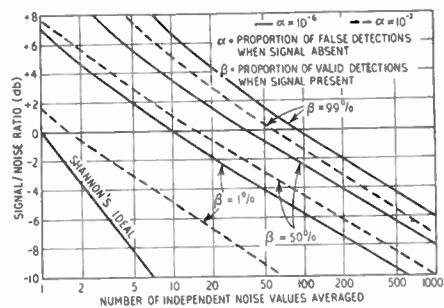

Fig. 11. Kaplan's results showing how the signal-to-noise ratio required for a given percentage of correct detections varies as the number of independent noise samples is increased. This increase is effectively an increase in area of the signal.

6. Discussion of Results

It would seem that from the evidence available we would have good ground for assuming the phenomena of visual correlation in echo-ranging displays to be "explained" by the physiological results relating threshold contrast to stimulus area. This being so the problem of the true mechanism of the phenomena falls in the realm of the physiologist rather than the echo-ranging engineer. Given the conclusion that Blackwell's results can be applied to the visual correlation problem then the echo-ranging engineer is enabled to predict the performance of his display, which, after all, is his problem. There are, however, one or two points which still require investigation. It has not hitherto been the experience of the author that the position relative to the display

of the operator observing the display has a pronounced effect on the threshold; whereas should the above conclusion be true there should be a direct effect unless the minimum resolving area on the display is fixed by the display or receiver or both, and not by the resolving power of the eye. There is also the effect that moving away from a display sometimes improves detection, possibly because the background fluctuation is smoothed proportionally; but one would have predicted the opposite effect from Blackwell's results.

A further subjective experiment that still requires explanation is that when a long chemical recorder trace containing a signal is tilted so that the horizontal angle subtended at the eye is reduced an apparent improvement in visibility results.

None of these quoted observations can be called scientific evidence in the true sense, and more controlled experiments would be required to substantiate any suggested effect. However, these experiments complicate the general conclusion that improvement in detection results from an increased subtended angle at the eye.

7. Conclusion

It is concluded from the majority of the evidence that the improvement obtained by visual correlation can be accounted for by the increase in the solid angle subtended at the eye by the signal area.

8. Acknowledgments

The author has much pleasure in acknowledging helpful discussions with Professor D. G. Tucker and Mr. J. T. Allanson.

9. References

1. P. McGregor, "A note on trace-to-trace correlation in visual displays," *J.Brit. I.R.E.*, **15**, pp. 329-331, June 1955.
2. N. R. Bartlett, S. B. Williams and R. M. Hanes, "Visibility on cathode-ray tube screens: the effect of size and shape of pip," *Journal of the Optical Society of America*, **39**, pp. 463-70, June 1949.
3. R. Payne-Scott, "The visibility of small echoes on radar p.p.i. displays," *Proceedings of the Institute of Radio Engineers*, **36**, pp. 180-196, February 1948.
4. M. Harriman, "Human Factors in Undersea Warfare," p. 125, Fig. 12. (National Research Council, Washington, D.C., 1949.)
5. H. R. Blackwell, "Contrast thresholds of the human eye," *Journal of the Optical Society of America*, **36**, p. 624-642, November 1946.
6. S. S. Stevens, "Handbook of Experimental Psychology." (Wiley, New York, 1951.)
7. J. L. Lawson and G. E. Uhlenbeck, "Threshold Signals." Volume 24, M.I.T. Radiation Laboratory Series. (McGraw-Hill, New York, 1950.)
8. R. L. Gregory, "An Experimental Treatment of Vision as an Information Source and Noisy Channel." "Information Theory, 3rd London Symposium, September 1955," p. 287. (Butterworths, London, 1956.)
9. D. G. Tucker and J. W. R. Griffiths, "Detection of pulse signals in noise," *Wireless Engineer*, **32**, pp. 290-297, November 1955.
10. P. L. Waters, "Video Signal Integration using a Storage Tube." "Communication Theory Symposium, September 1952," p. 236. (Butterworths, London, 1953.)
11. J. V. Harrington and T. F. Rogers, "Signal-to-noise improvement through integration in a storage tube," *Proceedings of the Institution of Radio Engineers*, **38**, pp. 1197-1203, October 1950.
12. R. G. Hopkinson, "Visibility of cathode-ray-tube traces in radar displays," *Journal of the Institution of Electrical Engineers*, **93**, Part IIIA, pp. 795-807, 1946.
13. E. L. Kaplan, "Signal detection studies with applications," *Bell System Technical Journal*, **34**, pp. 403-437, March 1955.
14. D. G. Tucker, "Detection of pulse signals in noise: trace-to-trace correlation in visual displays," *J.Brit.I.R.E.*, **17**, pp. 319-329, June 1957.

GUIDANCE FOR AUTHORS OF JOURNAL PAPERS*

*Prepared by the Publications Officer under the direction
of the Institution's Programme and Papers Committee*

1. Submission of Papers

It is desirable that a synopsis of the proposed contribution (up to 200-300 words) should be submitted to the Programme and Papers Committee so that the form of the paper can be agreed well in advance. Papers intended for presentation at a meeting in the first half of the Session (September to January) should be in the Institution's hands by 31st May, and those to be read in the second half (February to May) by 31st October.

All papers are submitted to at least two referees who report independently to the Committee. This process usually takes about two months, and is hastened if two or more copies of the manuscript are available; it is also helpful if illustrations are supplied in the form of photographic prints, or pencil copies, rather than as original linens, which may suffer loss or damage in the post to and from referees.

The Committee's judgment on the paper will state that it is either (a) accepted for publication or reading, subject perhaps to minor amendments; (b) returned for revision and re-submission; or (c) rejected as unsuitable for publication or reading. In the second case, the Committee always gives constructive criticism and advice regarding the re-submitted contribution.

2. Practical Advice on the Preparation of the Paper

It is impossible to give advice which will answer all the questions raised by a prospective author although a number of excellent books have been written on this subject.^{1, 10, 13, 18} It may be of some help to know that referees are asked to comment specifically on the following:

Technical Value and Originality of Content: Most papers will be on original topics; however, in a survey paper, technical value and originality of *approach* are expected.

Readability and General Literary Style: The paper should be written concisely but in normal English, rather than in the terse language of an internal report. It should be written in the third person, the writer being referred to as "The author," and care should be taken not to mix tenses. Jargon, unnecessary contractions and proprietary names should be avoided, and British Standard terms used wherever these have been laid down.^{3, 17} Standard reference books on general aspects of spelling, phraseology, etc., are listed later.^{7, 8, 9, 11, 12, 15}

Logicity of Presentation: Apart from the physical construction of the paper—its lay-out, section headings etc.—the development of its ideas should follow a logical pattern, and the reader should be able to follow the argument without having to refer to matter later in the paper. There are, however, occasions when mathematical and other theoretical arguments (or perhaps, in a theoretical paper, practical details) can best be placed at the end of the paper in appendices. In this way they do not interrupt the orderly development of the paper.

Manuscripts should be carefully checked by the author before submission; the informal comments of a colleague, preferably one unfamiliar with the details of the author's work, are especially useful.

3. Preparation of the Manuscript

3.1. General

The manuscript should preferably be type-written in double spacing on one side of the paper only, with a left-hand margin of about 1½ inches, and about 1 inch at the top and bottom of the page. An original and at least two carbon copies should be prepared, one copy being retained by the author. The pages of the manuscript, including any tables, appendices, bibliography and list of captions, should be numbered consecutively.

3.2. Mathematical symbols and formulae

In most cases it is preferable for mathematical symbols and formulae to be written in by hand. A list of symbols, identifying Greek

* Approved by the Council for publication on 5th March 1957. (Report No. 13.)

U.D.C. No. 002:621.37/9.

letters by name, is helpful to both the referee and the printer. Authors of highly mathematical papers should bear in mind the limitations of type-setting, and are recommended to consult publications such as "Notes on the Preparation of Mathematical Papers"¹⁴ or "The Printing of Mathematics."⁶ The symbols used should be in accordance with B.S. 1991:1954.⁵

3.3. General lay-out

Arrangement of the text of the paper should be broadly as follows: title; summary; table of contents; list of symbols; introduction; main text (divided into sections and sub-sections); conclusions; acknowledgments; references or bibliography; appendices. Other papers of a similar nature published in the Institution's *Journal* will show the form usually adopted, and this Guide for Authors follows the general style particularly with regard to decimal numbering of sections. Important equations should be numbered consecutively through the paper, including those in the appendices. Tables should also be numbered consecutively, and should be as simple as possible. In every case, the alternative of presenting tabular matter graphically should be considered.

3.3.1. Summary

The summary, or abstract, is essential to the paper and is intended to convey briefly its content. It should not be merely a list of section headings, and should be written in concise, normal English. In many cases it will be used by abstracting authorities as it stands. The title is usually read as part of the abstract, and its repetition in the opening sentence is unnecessary. The length of the abstract should be not more than 200 words. Recommendations for the preparation of abstracts or synopses have been prepared by the Royal Society¹⁶ and these have been published by UNESCO as a leaflet; copies may be obtained on application to the Institution.

3.3.2. Introduction

In addition to acquainting the reader briefly with the background of the paper in simple terms, the introduction should make reference to previous work on which the paper depends.

3.3.3. References

References are normally printed as a separate section at the end of the paper, and should

preferably be numbered in the order in which they occur in the text, indices being inserted at the appropriate points. When there are fewer than four or five references, these are printed as footnotes, related to the text by asterisks. In all cases the following details should be given in the order shown:—

- (i) For a reference to a paper in a technical journal—Author, title of paper, name of publication (given in full), volume number and part number (if any), page numbers, date (month and year). Example:—
J. A. Sargrove, "New methods of radio production," *Journal of the British Institution of Radio Engineers*, 7, pp. 2-33, January 1947.
- (ii) For a book or technical report—Author, title, page reference (if any), edition (if other than first), publisher, place of publication, date. Example:—
F. E. Terman, "Electronic and Radio Engineering," p. 323, 4th Edition (McGraw-Hill, New York, 1955).

The aim should be to make the tracing of the reference as easy as possible.

3.3.4. Bibliographies

It is usually preferable to arrange the items in bibliographies in date order. The same details as for references are included except that the title of the book or paper is given first.

4. Preparation of Illustrations

Illustrations may be incorporated in papers, but it is essential that they should fulfil a definite purpose in elucidating the text. Line drawings are, in most cases, preferable to photographs, which should only be used where a line drawing is impracticable. However, photographs of racks of equipment, instrument cases etc., seldom add much to the value of a paper.

In preparing circuit and block diagrams, the symbols and recommendations laid down in BS. 530:1948, Graphical Symbols for Telecommunications (and supplements),⁴ should be followed. Component values should be given, as well as component references. Valve types should also be included, commercial equivalents being quoted rather than Service numbers.

All diagrams should be on separate sheets detached from the manuscript. Line drawings

should preferably be submitted in finished form, drawn in black ink on tracing linen or white card. The probable size of the illustration when printed should be borne in mind; this will in most cases be either column or double-column width ($2\frac{3}{4}$ inches or $5\frac{3}{4}$ inches wide), and the drawing should be made two or three times this size. It should be remembered that the line thickness, as well as the overall size of the drawing, will be reduced accordingly. Any lettering on original drawings prepared in this way should be in pencil only, so that the correct size and style of lettering can be inserted by the Institution's draughtsman. If an author's facilities are limited, the Institution can arrange the preparation of illustrations for blockmaking from the author's rough drawings. Photographs should be in the form of contrasty, sharp, glossy prints, and at least quarter-plate size ($4\frac{1}{4}$ in. \times $3\frac{1}{4}$ in.).

All illustrations should be numbered in their correct sequence as the main references to them occur throughout the paper. Every illustration, however small, should have an explanatory caption. The figure number, caption, and author's name should be written lightly on the back of each illustration, and a separate list made of all the captions; this will be sent to the printer for setting in type while the blocks are being prepared.

5. Proofs and Reprints

After a paper has been accepted for publication, and any final revisions have been made by the author, the manuscript is prepared for the printer by the Institution staff; diagrams are lettered or redrawn as necessary, and sent to the blockmaker. Two sets of galley proofs of the text and block pulls of the illustrations are sent to the author in due course for checking and approval. Any alterations to the original copy should be kept to the minimum; these, and corrections of printers' errors, should be marked clearly² in the margin of the set of proofs which is returned, and need not also be listed in a separate letter. Amendments to blocks usually entail the making of a new block, and authors are asked to co-operate in reducing the risk of errors on illustrations, as well as in their original manuscript. Proofs should always be returned within 48 hours.

The paper is then made up into page form, and, if extensive corrections have been necessary, page proofs will be sent to the author for final checking. Alterations at this stage are particularly expensive and difficult, and will only be made if absolutely essential.

On publication the author will be sent fifty complimentary reprints of his paper. Enquiries about the supply of reprints in larger quantities should be made to the Institution when returning galley proofs.

6. The Oral Presentation of Papers

6.1. Content and Style

The paper submitted for publication in the *Journal* should not be read word for word at a meeting; Institution meetings normally last $1\frac{1}{2}$ hours, and in preparing his notes for oral presentation the author should aim at a speaking time of about 45 minutes. Hence, he should not attempt to convey to his audience all the information which is in the published paper, especially sections such as mathematical proofs which are difficult to appreciate without detailed consideration. It should be remembered that pre-prints may be available and that the paper in any case will be published in the *Journal*; hence, the audience can be specifically referred to such proofs as being in the published paper. A colloquial style should be adopted, and this will be made easier if the presentation of the paper is based on a well-chosen sequence of slides.

It is desirable for the author to rehearse the oral presentation as fully as possible beforehand; it will be necessary to do this to obtain a definite idea of its length. When speaking, the voice should be raised sufficiently to carry to the people at the back of the lecture theatre. The speed of delivery is most important—a slow speaking rate is as tedious as a too rapid rate is incomprehensible.

6.2. Lantern Slides

Illustrations may be in the form of lantern slides, film strips, or diagrams projected by episcopes, and should be simplified as far as possible. The size of lettering is important—it should be free from embellishments and clearly readable at the back of the theatre. In general, lettering, when reduced on the slide, should not be less than 2 mm in height. The

standard size for lantern slides is $3\frac{1}{4}$ in. \times $3\frac{1}{4}$ in., and any reputable slide-maker will give advice on the suitability of illustrations for the purpose. It is desirable for the slides to be numbered for the guidance of the operator, in addition to being placed in the right order beforehand.

Illustrations may also be prepared in the form of 35 mm film strips, in which case a special film strip projector will be required; this same projector is also suitable for 2 in. \times 2 in. slides.

The use of the episcopes should only be resorted to if absolutely necessary; lantern slides are far more satisfactory since the level of illumination is much greater. It is not normally possible to project photographs clearly by episcopes, and they may suffer damage from the very great heat of the lamp.

Projection equipment, as well as blackboards for the display of formulae, will be supplied by the Institution on request.

6.3. Demonstrations

The inclusion of a carefully prepared demonstration adds considerably to the interest and value of a paper. It will be necessary to ensure that the significance of an experiment is visible to the audience at the back of the theatre, and where possible the use of larger-than-average meters and cathode-ray oscilloscope screens is advocated. The use of a laboratory mirror galvanometer with a large scale is helpful, and aural indication from a loudspeaker may sometimes be employed.

Access to the hall for the purpose of fitting up apparatus prior to the meeting can be arranged with the Institution.

6.4. Local Section Meetings

The foregoing points apply with equal force to meetings of local sections of the Institution. Authors should get in touch with the Local Honorary Secretary regarding arrangements.

7. References

1. C. Baker, "Technical Publications, their Purpose, Preparation and Production." (Chapman and Hall, London, 1955.)*
2. British Standards Institution, "Printers' and Authors' Proof Corrections." B.S. 1219: 1945.*
3. British Standards Institution, "Glossary of Terms used in Telecommunication (with supplements)." B.S. 204: 1943.*
4. British Standards Institution, "Graphical Symbols for Telecommunications (with supplements)." B.S. 530: 1948.*
5. British Standards Institution, "Letter Symbols, Signs and Abbreviations—Part 1 General." B.S. 1991 Part 1: 1954.*
6. T. W. Chaundy, P. R. Barrett and C. Batey, "The Printing of Mathematics." (Oxford University Press, 1954.)*
7. F. Howard Collins, "Authors' and Printers' Dictionary," 10th ed. (Oxford University Press, 1956.)
8. H. W. Fowler, "A Dictionary of Modern English Usage." (Clarendon Press, Oxford, 1926.)
9. H. W. Fowler and F. G. Fowler, "Concise Oxford Dictionary of Current English," 4th ed. (Clarendon Press, Oxford, 1951.)
10. John Gloag, "How to Write Technical Books, with some Pertinent Remarks about Planning Technical Papers and Forms." (Allen & Unwin, London, 1950.)*
11. Sir Ernest Gowers, "ABC of Plain Words." (H.M.S.O., London, 1951.)
12. Sir Ernest Gowers, "Plain Words; a Guide to the Use of English." (H.M.S.O., London, 1948.)
13. Reginald O. Kapp, "The Presentation of Technical Information." (Constable, London, 1948.)*
14. London Mathematical Society, "Notes on the Preparation of Mathematic Papers." (Hodgson, London, 1932.)*
15. Eric Partridge, "Usage and Abuse; a Guide to Good English," 4th ed. (Hamish Hamilton, London, 1948.)
16. The Royal Society, "General Notes on the Composition of Scientific Papers." (Cambridge University Press, 1950.)*
17. C. F. Tweney and L. E. C. Hughes (Ed.), "Chambers's Technical Dictionary." (W. & R. Chambers, Edinburgh, 1953.)
18. G. E. Williams, "Technical Literature: its Preparation and Presentation." (Allen & Unwin, London, 1948.)*

Items in this list marked with an asterisk (*) are in the Institution's Library.

. . . Radio Engineering Overseas

621.314.7

Transistor characteristics at very low temperatures. SHINTARO UDA. *Journal of the Institution of Telecommunication Engineers*, 3, pp. 97-109, March 1957.

Terminal characteristic curves of common-base $p-n-p$ junction transistors at liquid air temperature and liquid helium temperatures are given and compared with those obtained at room temperature. As specimens, three $p-n-p$ junction transistors of different companies have been tested. A remarkable decrease of the current amplification factor has been observed at liquid helium temperature. Also in order to get the same emitter current, the lower the temperature, the larger is the emitter d.c. voltage required.

The values of four parameters, i.e. input, feedback, transfer and output resistance, change with decrease of temperature. The maximum gain of the transistor decreases with decrease of temperature, but at liquid air temperature the decrease is comparatively small, while at liquid helium temperature considerable decrease occurs. Instability sometimes occurs at liquid helium temperature under certain operating regions. The cut-off point of the collector in the output characteristic curve extends more and more towards greater positive collector voltage with decrease of temperature.

621.318.134

Switching time of ferrites with rectangular hysteresis loop. H. VAN DER HEIDE, H. G. BRUJNING and H. P. J. WIJN. *Philips Technical Review*, 18, pp. 336-346, May 1957.

A method is described for measuring, as a function of time, the reversal of magnetization caused by the sudden application of a magnetic field to ferrite cores with a rectangular hysteresis loop (used as "memory" elements in electronic computers). Thyratons are used to produce the powerful current pulses needed for measurements on large ferrite rings. The variation of dB/dt during the reversal process is measured on an oscilloscope. As a function of time, dB/dt usually shows a sharp peak, followed by a second, flatter maximum, which is used for defining the "switching time." Some results are set out in graphs and tables. Beyond a certain magnetic field strength the reciprocal of the switching time is a linear function of the field strength. Separate consideration is given to the influence of external stress and temperature. The comparison of different materials as well as the study of the same material under different stresses lead to the rule: the better the squareness ratio the longer the switching time.

An attempt is made to interpret the phenomena in physical terms, the assumption being made that dB/dt is proportional to $(H-H_{st})$, where H_{st} is the value of H as a function of B , according to the statically measured hysteresis loop. In this way a reasonable explanation is given for the observed variation of dB/dt as a function of t . To explain the second peak in dB/dt , the question is discussed as to how far the reversal is effected by rotations of the magnetization vectors in the Weiss domains and wall displacements in these domains; the first sharp maximum in dB/dt is attributed to rotations, and the second peak to wall displacements. At strong fields (and hence short reversal times) there is often no second peak, in which case the entire reversal is presumably due to rotations.

A selection of abstracts from European and Commonwealth journals received in the Library of the Institution. All papers are in the language of the country of origin of the journal unless otherwise stated. The Institution regrets that translations cannot be supplied.

621.319.4

Tropicalization—results of experiments on sealing capacitors. C. V. GANAPATHY, R. KRISHNAN and T. V. RAMAMURTI. *Journal of the Institution of Telecommunication Engineers*, 3, pp. 116-122, March 1957.

To test the efficacy of sealing ceramic capacitors against the ingress of moisture and consequent deterioration of its electrical characteristics, capacitors were coated with different materials and of varying thickness and subjected to standard accelerated tests in a humidity chamber. The temperature of the chamber was 60°C and the humidity over 98 per cent. The adherence of the coating, thickness, uniformity and effect of shape with relation to thickness, to provide effective sealing was studied experimentally.

621.355

Some problems associated with the charging of dry batteries. P. H. ADAMS. *Proceedings of the Institution of Radio Engineers, Australia*, 18, pp. 113-118, April 1957.

The effects of the periodic application of a reverse e.m.f. to dry batteries, with the object of increasing their service life, are discussed and the optimum conditions to minimize the possibility of damage to both flat and round cells are laid down. The application of this process in a.s.c./battery portable radio receivers is examined and it is shown that the extent to which battery service life is likely to be dependent on the conditions of use of the receiver in question.

621.372.4

R-C network analogue. A. K. CHOUDHURY and B. R. NAG. *Indian Journal of Physics*, 31, pp. 121-134, March 1957.

An R-C analogue for obtaining the steady state and transient response of networks is described. The zeros and poles of the network function are realized by a system of cascade feedback amplifiers, the input and feedback networks of the amplifiers being so arranged that the zeroes and poles of the transfer function of the system are identical with those of the network function. The root loci of a few basic networks for the feedback amplifiers have been studied. A method of solving polynomial equations using the analogue is also described.

621.372.8

On a novel surface waveguide with bandpass properties. DIETRICH MARCUSE. *Archiv der Elektrischen Uebertragung*, 11, pp. 146-148, April 1957.

The surface waveguide whose properties are investigated has the following make-up: thin circular metal discs alternate with discs of some dielectric material in a stack that can be used for guiding surface waves in a way similar to that of the surface waveguide devised by Goubau. It is found that this axially stacked waveguide can carry surface waves only in certain frequency bands, not throughout the frequency range. Phase constant and attenuation as well as the limit radius of the field in the space surrounding the waveguide are calculated.

621.373.421

Further studies on asymmetrical three phase oscillator for very wide frequency deviation. P. KUNDU. *Indian Journal of Physics*, 31, pp. 83-98, February 1957.

A three-stage oscillator is described here which has been developed on the principle of the asymmetrical three-phase oscillator. Like a conventional system only three stages are used here, each of which produces a phase shift, but only one stage is used as an amplifier to produce the loop gain required by the system to oscillate. The performance of this oscillator has been found to be uniform and the adjustment less critical for optimum operating condition, unlike the other types of RC oscillator. Oscillations of quite good waveform have been obtained over a frequency range of a few hundred cycles to a few tens of megacycles.

This system has been investigated from the point of view of producing very wide frequency deviation with uniformity of performance over a wide frequency range of few hundred cycles to few tens of megacycles, amplitude modulation have also been derived for different operating conditions. A maximum frequency deviation of about four to one has been achieved over a frequency range of few kc/s to few Mc/s without necessitating any adjustments other than the tuning capacitances.

621.375.123

Zero overshoot in degenerative R-C amplifiers. KURT FRANZ, *Archiv der Elektrischen Übertragung*, 11, pp. 159-162, April 1957.

The paper calculates for the n anode time constants of a degenerative R-C amplifier with n stages a distribution for which no overshoot occurs when the negative feedback path is activated with a loop gain $BA_0 \gg 1$. Zero overshoot can be obtained, if the ratio of the highest time constant to the lowest exceeds the value $n^2 BA_0$.

621.385.16

Mutuality of coupling in travelling-wave tubes. FRITZ PASCHKE. *Archiv der Elektrischen Übertragung*, 11, pp. 137-145. April 1957.

The mutuality law for coupling in travelling-wave tubes states that, to obtain a coupled wave and amplification, not only must the field of the undisturbed circuit wave be present at the beam, but also the field of the undisturbed space-charge wave must be present at the slow-wave structure. The coupling from the structure to the beam is given by the well-known coupling impedance K . The coupling from the beam to the circuit is described by the factor $(1 - q^2)$, q being the reduction factor of the plasma frequency due to the delay line. The analysis shows that for low-noise operation the amplifier should have: (1) large beam diameter, (2) low beam velocity and (3) large coupling impedance K . Physically this means that a major part of the noise is coupled into the non-amplified passive modes. Furthermore, the maximum attainable gain per beam wavelength of an ideal travelling-wave tube is shown to be $G/N = 37.5(\omega p \infty / \omega)^{2/3}$ decibel.

621.396.11

Multi-path distortion in short-, medium-, and long-wave reception. F. VON RAUTENFELD. *European Broadcasting Union Bulletin*, 43, pp. 257-271, May-June 1957.

The paper discusses scientific experiments undertaken in Germany to evaluate the subjective quality

of reception and to relate the results to measurable parameters such as the harmonic content and the dispersion of the field-strength. Conclusions are drawn concerning the reception of synchronized groups of transmitters. Such experiments merit being followed up on a larger scale, making use of automatic equipment for the statistical analysis of the observations.

621.396.11

Tables for the vertical ordinary group-velocities of ionospheric echoes. WALTER BECKER. *Archiv der Elektrischen Übertragung*, 11, pp. 166-172, April 1957.

For a calculation of the apparent heights of reflection or ordinary pulses in a plane ionospheric layer or that of the true distribution of electron density throughout such a layer from its ionograms, the vertical ordinary group velocities must be known in a tabulated form. Thirty per cent. of the values could be taken over from D. H. Shinn ("The Physics of the Ionosphere," pp. 332-339, Cambridge, 1954), the remainder had to be calculated. The notation used by Shinn proved suitable and was thus adopted. The accuracy of the values given by that author has been improved by at least one order.

621.396.67.012.12

Distortion of polar diagram due to interposition of wooden screen in the vicinity of a v.h.f. radiator. H. R. BAPU SEETHARAM and M. N. GADRE. *Journal of the Institution of Telecommunication Engineers*, 3, pp. 140-156, March 1957.

A teak wood structure in the proximity of a v.h.f. radiator distorts the polar diagram. Experiments showed that the distortion in the polar diagram is due to the "reflection" and "transmission" properties of teak wood and "absorption" is only of a second order of magnitude. The relationship between the reflection coefficient, frequency, dielectric constant and thickness of wood is determined. The agreement between the theoretically calculated and experimentally observed values of distortion is close. The distortion due to deal wood, perspex, wetting and painting of teak wood was also measured. Laboratory measurement of dielectric constants substantiated the field measurements. The optimum dimensions of a shelter enclosing the radiator for minimum distortion are indicated.

621.396.822

Minimum signal to interference ratio required for broadcasting. S. C. MAZUMDAR, G. V. PADHYE and W. V. B. RAMALINGAM. *Journal of the Institution of Telecommunication Engineers*, 3, pp. 110-115, March 1957.

In order to determine the level of maximum interference at which a satisfactory broadcasting service is possible, a large number of listening tests were conducted. The study has been confined to the determination of protection required for a speech modulated broadcast signal against interference from speech and music and also against c.w. morse. The experimental set-up is described in detail in the paper. More than 750 recordings were made about 12,000 individual opinions collected. The analysis of the listeners indicated that minimum protection of about 33 db is required for zero-beat operation and 52-54 db at frequency separation of 2-3 kc/s. Beyond 3 kc/s the protection becomes gradually lower and after 5 kc/s it drops sharply. Other factors influencing the desired protection have been discussed.