

JOURNAL OF The British Institution of Radio Engineers

(FOUNDED IN 1925- INCORPORATED IN 1932)

"To promote the general advancement of and to facilitate the exchange of information and ideas on Radio Science."

Vol. VII (New Series) No. 3

MAY-JUNE 1947



CONVENTION AND OTHER PAPERS

The reading and discussing of fifteen technical papers, supplemented by several technical demonstrations on land, sea and in the air, made a very active three days for members who attended the 1947 Convention at Bournemouth. Before considering the advantages to the radio engineer of such a gathering, it is right to recall the thanks expressed by Mr. Leslie McMichael (Immediate Past President) and Mr. W. E. Miller (Chairman of Council) when on the last night they summarized the work of the Convention.

Members who have served on the Papers Committee in the last two years were sincerely congratulated on their choice of papers and on the way they had planned the visits. It is impossible to single out any of the papers for individual mention, and the Council has expressed thanks to all the authors for the painstaking hours of work which they devoted to writing their papers and for their co-operation in keeping most punctually to the times arranged for the reading of those papers. Co-operation was, indeed, the keyword of several of the speeches made during the Convention functions and admirably expressed the underlying cause for the success of the Convention.

It was stated at the Civic Luncheon held on Tuesday, May 20th, that the Council arranged the Convention as a possible forerunner to International Radio Conventions which should be held annually throughout the world. The attendance at the Bournemouth Convention was a happy augury for the success of an International Convention, for apart from the Institution's members from France and Belgium, a hearty welcome was given to representative engineers from America, Australia, Canada, Holland and China. The French contingent was especially large and the Société des Radio Electriciens gave splendid support in enabling many of their members to be present.

Inevitably, conversations and later speeches

referred to the next Convention to be convened by the Institution. Many were in favour of annual Conventions in Great Britain, with annual but larger International Conventions taking place alternately in various parts of the world. The year 1950 has, for various reasons, been favoured as a year in which the Institution might be the hosts in Great Britain, not only to its membership spread throughout the Commonwealth and Empire, but also to representatives from other countries, particularly America.

The Council is now examining these proposals, and it would be helpful to have comments on the suggestion, not only from members in Great Britain, but especially from members overseas. The views of the Council and members might well be discussed at the Annual General Meeting to be held in October next.

Meanwhile, the urgent need is for all members, whether or not they were able to attend the Convention, to derive the utmost technical benefit from the proceedings of the 1947 Convention. It is not considered that a mere summary of the papers presented would satisfy, since all of the contributions represented a considerable amount of original work, and in many cases the discussions which followed the reading of the papers were most instructive.

Present limitations of paper supply do not, however, permit the publication of what might be termed "Proceedings of the Convention," and reluctantly the decision must be that Convention papers can only be published in the *Journal* as and when opportunity occurs. The first of these papers is included in the current issue.

A number of papers still await publication, and it is impossible to estimate when these arrears will be cleared, but every opportunity will be sought to shorten delays and enable all members to benefit from studying the papers which have already been read before the Institution.

THE A.C. BEHAVIOUR OF THE BARRIER LAYER PHOTO CELL.†

by

J. A. Sargrove (Member)*

A Paper read before the North-Eastern Section on October 9th, 1946, and the Midland Section on December 12th, 1946.

SUMMARY

This paper describes the behaviour of Barrier Layer Photo electric cells in A.C. circuits and it is shown that whilst they behave as rectifiers in darkness they act as non-linear conductors to current in both directions when exposed to light. This change from uni-directional to duo-directional conductivity is used directly without amplifier valves, for operating relays in industrial devices used for switching, counting, grading and other operations. Used in this way, i.e. as a relay valve, the cell is some 300 times more sensitive than when used, as hitherto, as a detector. A further advantage of this novel method is that the cell may be small and can, if necessary, be mounted at some distance from the associated electrical equipment, thus permitting the cell to be used in places unsuitable for present equipment. If the cell is operated from the same A.C. supply as the lamp which illuminates it, a very high degree of electrical stability may be obtained. The paper ends with descriptions of circuits required for various industrial applications and some suggestions for future developments are made.

Introduction

For some time a need has been felt for a simpler means of photo-electric switching, counting, grading and similar industrial operations.

It was desirable that such new means (if any) should be inherently more robust and more reliable in operation than present methods using glass envelope photo-emissive cells, amplifier valves and the like. Furthermore, it should be possible to mount the detecting photo cell unit (preferably a small one) at some considerable distance from the switching (or other application) unit, to permit the cell to be situated in small inaccessible spaces inside complicated machinery. Here, it is not possible to use the older means because of the need of mounting the cell quite close to the grid of the following valve or thyatron.

Partly with the above ultimate objectives in view, but also in an endeavour to learn more about the behaviour of the Barrier Layer Photo Cell, tentative investigations were started by the author as early as 1938; with somewhat more vigour in 1942 and with really encouraging results in 1943-44. Now, completely developed industrial devices exist and many years' running test records have been obtained, proving that these new means fulfil all the stipulations.

The development which followed the earlier research has resulted in circuit arrangements

which are essentially simple compared with earlier ones, they are less expensive initially and also require less maintenance.

The latter feature is of particular value in industrial control and inspection applications, in which it is very important to reduce the number of circuit components (all of which are liable to have a certain degree of variability) to an absolute minimum.

In general terms the power output obtained by using the Barrier Layer Cell as a relay instead of as a detector is some 300 times as great, and is thus capable of direct operation of a relay of comparatively robust and reliable construction.

Theoretical

It has been known for some time that the photo-sensitive barrier layer between a conductor and a semi-conductor can behave as a converter of radiation energy into electrical energy with an efficiency of the order of 50 per cent and can also act as a rectifier when there is no incident radiation.

These two basic characteristics have each given rise to separate industries, making on the one hand, the Cuprous Oxide-Copper cells, Selenium Sub-Oxide-Gold film and similar photo cells; and on the other hand, the so-called metal or dry plate rectifier cells in which the barrier layer on the semi-conductor is covered by an opaque layer of metal. These two industries proceeded quite

† U.D.C. No. 621.383.5 : 621.318.57.
Manuscript received, August, 1946.

* Sargrove Electronics Ltd.

separately. It did not seem to be generally known that these basic phenomena are mutually decremental. Apparently no one published volt-amp. characteristics of the Barrier Layer Cell, except for small potentials and the investigators (1), (2), (3), have apparently abandoned the study in some cases with the outspoken comment that "no useful purpose would be served in its pursuance as the cells showed very marked fatigue effect with applied D.C. voltage, and no appreciable improvement in sensitivity" (4).

By using a form of Pulse Technique, described by the author and one of his collaborators some years ago (5), which at the time was intended for measuring the remote characteristics of transmitting valves far above the dissipation limit, i.e. in a condition in which the device would be destroyed if allowed to continue for any length of time, it has been possible to investigate this hitherto unknown region of Barrier Layer Cell characteristic.

Briefly, the procedure consists of the application of the measuring potential in short pulses with large idle intervals and multiplying the measured

current flow by the ratio of total period over the working pulse time, thus obtaining the resultant points on the characteristic in their true positions.

Looking at Fig. 1A, which shows the characteristic as a three-dimensional solid in perspective, we have voltage as the horizontal "X" axis, the polarity being that of the voltage applied to the selenium layer (via the iron back plate) with respect to the transparent gold top film. The horizontal "Y" axis is the current co-ordinate, whilst the vertical axis is incident light illumination, showing increasing illumination values as one descends into the interior of the solid characteristic. Thus, the horizontal top plane comprising the voltage and current axes of this three-dimensional picture is the plane representing darkness. It is marked 0 Lux and contains horizontal voltage and current axes, and the usual well-known rectifier characteristic of the so-called "dry-plate" or "metal rectifier." This characteristic is also typical of the transparent gold-film covered photo-cell when it is in darkness.

The vertical axis is calibrated in light units ($10^3 \times \text{Lux}$) and corresponds to increasing

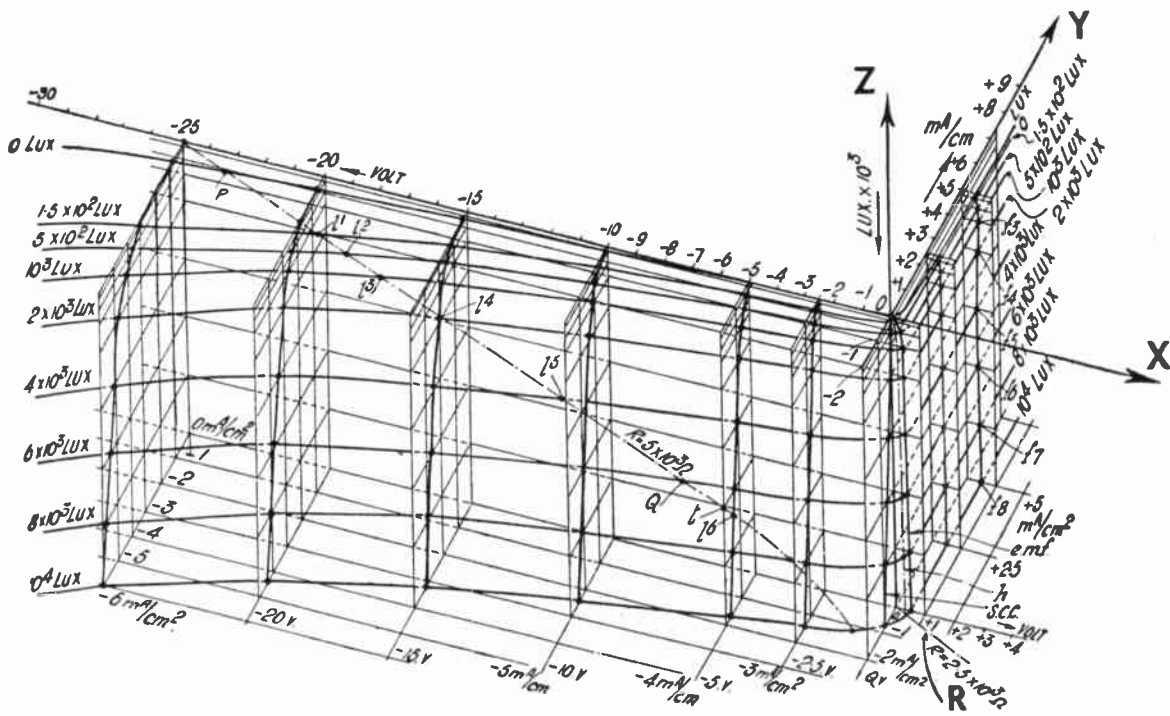

Fig. 1A.—Three dimensional volt-ampere characteristic of a selenium sub-oxide gold-film photo-cell.

incident light upon the cell, as one descends in the diagram the several horizontal planes representing various constant illumination levels.

Figure 1B shows the same curves projected on a horizontal plane. In practical design work it is better to use this projection, but in this theoretical consideration more information can be derived from the complete diagram as illustrated in Figure 1A. The many vertical planes depending from the voltage axis represent constant voltage, and those depending from the current axis represent constant current planes and are so indicated by the appropriate voltage or current values in the lower plane of the figure.

It will be noted that the very small vertical plane containing the positive voltage and light axes is the familiar "open circuit voltage characteristic" of the barrier layer photo cell, from which the well-known term "photo-voltaic-cell" is derived. The very small vertical plane containing the negative current and light axes is the familiar "short circuit" or "no voltage" characteristic of the same device.

The small space quadrant in this three-dimensional figure, embraced by the light axis and the positive voltage and negative current axes, contains the hitherto known region of the Barrier Layer Cell characteristic. Here, the negative current

implies that it is a generator when illuminated, hence the name sometimes used, "photo-element." This known part of the characteristic is extensively used in light meters, exposure meters and the like.

Any vertical plane lying between these two major vertical planes, but at an angle to them, would here represent the meter resistance in ohms. The direction of such a plane is exemplified by a typical line $R = 2.4 \times 10^3 \Omega$ in the base plane, and would contain this and the light axis. The curve L in this plane would resemble the above-mentioned "open-circuit" or E.M.F. curve, being a small parabola from which one can deduce the power in micro-watts developed in the meter due to the known action of the cell as a generator (or as a direct converter of "light quanta" or "photon" energy into "electron" energy). It will be noted that this hitherto known region of the characteristic is only a very small part of the whole now revealed. This also applies to its energy content compared to the whole.

The plane region delimited by the positive voltage and positive current axes is the almost ohmic domain, well known as the "forward current" of the metal rectifier. If we descend from this plane into the space quadrant embraced by a positive voltage, positive current and light

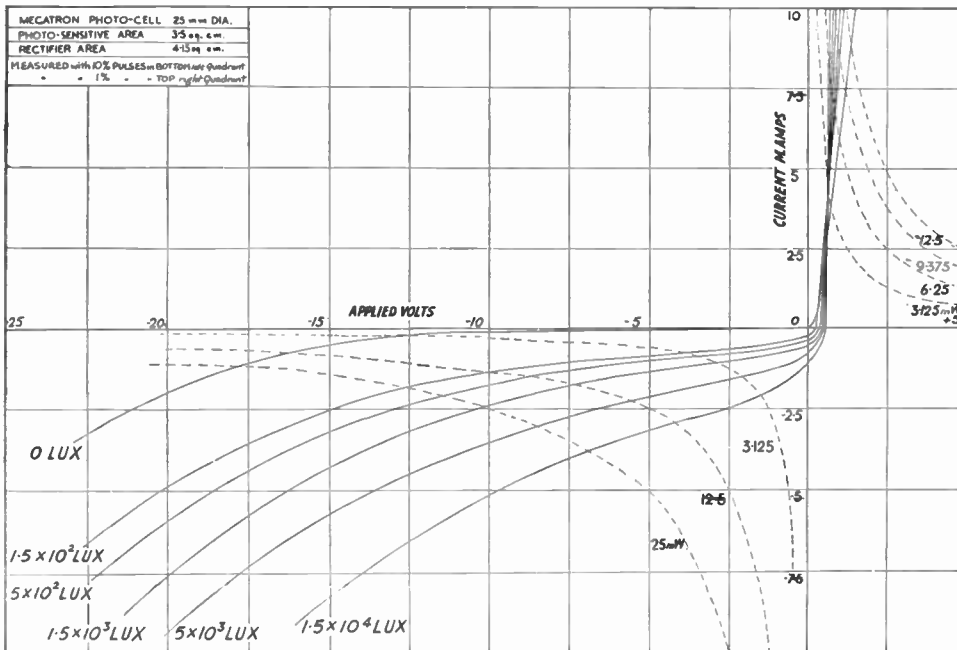

Fig. 1B.— Light modulated characteristic "Megatron" type "N" of barrier-layer photo-cell.

axes, the ohmic value behaves peculiarly with relation to light. Very near to the vertical light axis the resistance increases with increase in the amount of light. Far away from the light axis, in the hitherto unexplored region, the resistance decreases with increase in the amount of light, and there is a known cross-over point where the barrier layer has a resistance which is almost constant and independent of the amount of illumination. This causes the curves in the various horizontal planes to be almost parallel to each other in this space quadrant except those for low, and no illumination. This is a most interesting region and will be discussed later.

The top plane region, delimited by the negative voltage and negative current axes, contains the known "reverse-current" characteristic of the metal rectifier. Here we see that the resistance at low values of applied voltage is very high, some thousand times greater than in the forward direction, and this is the factor relied upon in the production of metal rectifiers. However, increasing the applied voltage beyond a certain point results in a decrease of the resistance. At the value where this decrease in resistance becomes serious, the term "break-down voltage" is used. Here the power dissipated in the cell rapidly increases and the cell becomes destroyed by heat. For this reason the makers of such cells limit the recommended voltage at this point; e.g. in some cases at 15 volts peak for selenium. Descending from the horizontal dark plane into the hitherto unknown space region embraced by the negative voltage, negative current and light axes, it will be noted that the resistance very rapidly decreases with even low values of illumination. The first such horizontal plane shown represents only 1.5×10^2 Lux, or about 15 foot candles. Even this region alone could be applied industrially, working below the break-down voltage. For example, the cell could be used with a battery voltage applied through a load resistance. A large voltage variation would occur across a load resistance of 50,000 ohms fed by a 30-volt battery, by changing from darkness to a small amount of light.

The output, i.e. the change in voltage caused by change from light to dark, produced by the cell with this small change of light, is about 12 volts.

On the other hand, using the cell in the orthodox manner as a generator, it would produce an open circuit voltage change of about 0.25 volts. Therefore, even this region of the characteristic the use

of an external voltage produces about 50 times more voltage change than with no voltage applied, though the improvement in current change is negligible. The improvement is, however, considerable when the above is expressed as increased power change developed in the external load resistance. It seems safe to say that the earlier investigators must have been only observing the current change when they dismissed the improvement in sensitivity as unimportant. (1) and (4).

A load resistance of 5,000 ohms is shown in this same space quadrant in Fig. 1A, traversing all the light values and the voltage values produced by the degree of illumination is indicated by points 11, 12, 13 along this line.

With a small amount of light and a high load resistance, constant direct current voltage can be applied with some success, but this method is not very satisfactory with a low resistance and a lot of light, as the cell possesses a hysteresis effect or fatigue, in this region. For slow operational sequences it could be used, of course, even in spite of this hysteresis effect.

If, however, the direct current voltage is applied in short pulses, the deleterious effect of the hysteresis is materially reduced.

In this condition the "fatigue effect" is negligible. This fact seems to suggest that fatigue is purely a temperature effect; the increase in temperature not necessarily originating in the light source, but can be caused by the power dissipation in the cell of the current flowing during illumination. The well-known "fatigue effect" with continuous D.C. applied without a load resistance (except that of the current meter) which dogged earlier workers.

This can probably be explained on the basis of two separate phenomena. Firstly, the fact that light falling on the cell warms it and thus gives a smaller margin for the heat generated in the barrier layer before the temperature becomes destructive to the cell.

The second point is more involved, but has an important bearing on the long life obtained from cells in this new way with cold light irradiation. This somewhat obscure point is worth careful consideration.

If one imagines a diagrammatic cross-sectional view of a Barrier Layer Cell, it is clear that there must, of necessity, be two barrier layers; the top one called the "front wall" barrier layer, and the bottom one the "rear wall" barrier layer. All

the previous characteristics discussed relate to the "front wall" barrier layer, which can be illuminated with visible light. The characteristic of the "rear wall" has necessarily the opposite polarity and though, of course, the rear wall barrier layer need not have the same degree of rectifying properties, it is decremental to the "front wall" characteristic, as it is electrically in series with it and working in opposition. This is mainly of importance in measurements of the forward current characteristic of the "front wall," as this is in series with the reverse current characteristic of the "rear wall." It is clear that the rectifier property of the "rear wall" cannot be as good as that of the "front wall," as otherwise one could not even measure the "front wall" characteristic. The high resistance part of the "rear wall" characteristic would completely swamp that of the low resistance part of the "front wall" characteristic.

However, whatever the shape of this "rear wall" characteristic, one thing is certain, and that is that its own heat dissipation is added to that of the "front wall."

As selenium in the black state is completely transparent to infra-red and heat rays, and in the grey state partially transparent, some heat radiated from the source of light will penetrate the selenium to the "rear wall" barrier layer and these set up thermo-electric effects which have an opposite polarity in the output circuit. It will also add to the total temperature increment of the cell.

For these reasons, as will be shown, water filters are used in projectors to reduce the external heat reaching the photo cells.

However when using the Barrier Layer Photo Cell in an alternating current circuit the temperature rise due to current flow is much smaller and the cell does not show any appreciable "fatigue

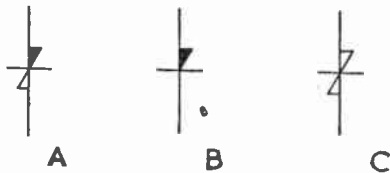

Fig. 2.—A suggested new symbol for barrier layer photo-cell more fully indicating its function. It is derived from B in the dark stage and C when illuminated.

effect." This can be explained by the following considerations: If an alternating voltage is applied through a load resistance the operating point continuously traverses the entire character-

istic in the three space regions described above in connection with Figure 1A within a horizontal plane corresponding to the degree of illumination. The cell is only in the heat-increasing region (that is the bottom left hand quadrant Fig. 1B) for part of the cycle and it is in the heat-losing region (that is the part, above the cross over point in the top right hand quadrant Fig. 1B where increasing illumination actually decreases the internally generated heat) for another part of the cycle. In this last named quadrant we seem to be observing a new physical effect having similarities to the effects occurring in cold junctions of thermo-couples.

Theoretical Summary

Summarising the above, the main theory underlying the new system is that the photo cell will

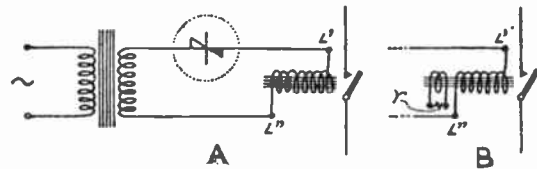

Fig. 3A.—Simplest A.C. circuit utilising new effect. Fig. 3B.—Heavily loaded secondary on relay absorbs A.C. leaving D.C. content to operate relay.

not become as hot under the action of alternating current as under direct current conditions. It is noteworthy that with alternating current the cell does not appear to exhibit any appreciable "memory or fatigue effect." This may be due to the cooling action mentioned above, or possibly due to the cyclically commutating voltage causing a cancellation of the hysteresis phenomenon.

Practical Applications

This method of employing the cell has great industrial significance. Various methods of using this physical characteristic will be described and are given by way of example only. They are by no means an exhaustive series; they merely exemplify specific practical applications of the inventions based on this phenomenon.

In order to facilitate comprehension of the circuit action, a new circuit symbol has been adopted for the device as none of the older recognized symbols is appropriate. This new symbol is shown in Fig. 2A, and is partly derived from the old accepted British Standard Institute symbol for a dry plate rectifier (Fig. 2B) and partly from the recently introduced British Standard Institute symbol (Fig. 2C) which symbolizes a symmetrical

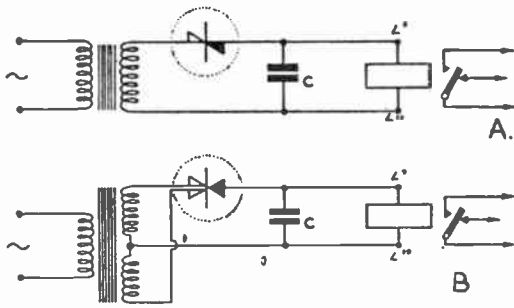

Fig. 4A.—Capacitor C by-passes A.C., leaving D.C. content to operate relay.

Fig. 4B.—Full-wave cell with split transparent top plate. Somewhat faster in operating relay.

bi-directional conductor element having a non-ohmic behaviour. In Fig. 2A the black or full part of the new symbol represents the darkness characteristic of the photo-cell which becomes the complete symbol when illuminated, hence the white (or open) triangle. This is justified, since with very much incident light the barrier layer approaches the symmetrical condition, i.e. when illuminated, the symbol represents a very bad rectifier conducting both ways. As seen above, this is just what the device does. In this new symbol the full part represents the non-transparent back plate of the cell.

Practical Applications of the New Effect

Figure 3A shows the simplest circuit in which this new phenomenon is applied. In this a mains transformer delivers a voltage sufficient to cause

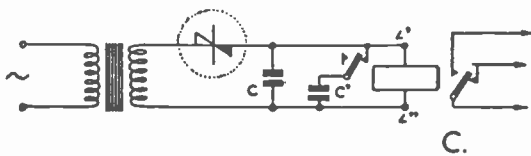

Fig. 4C.—Method of increasing sensitivity to small changes of illumination.

the rectified current flowing through the relay coil and the dark cell to close the relay. When illuminated with a sufficient intensity the rectifying action of the cell decreases and the rectified current delivered is insufficient to hold the relay closed. Hence, the relay opens. Ripple in the current can be reduced, as shown in Fig. 3B, by using an extra low resistance secondary winding on the relay, which is short-circuited or connected to a low value of resistance, r . This also increases

the rectified power derived from the cell as a consequence of the reduced reactance of the primary load inductance.

Figure 4A shows the relay coil shunted with a reservoir capacitor causing the power developed in the relay solenoid to be larger both in darkness and also when the cell is illuminated. In this case the alternating potential is applied to the cell mainly through the capacitor, and the alternating voltage built up on the cell is largely the resultant obtained from the capacitor potentiometer formed by the above capacitor C and the internal capacitance of the barrier layer. The D.C. output current in darkness, as well as the differential D.C. current due to illumination, can be adjusted by suitably varying the load resistance, the feed capacitor, the supply voltage, its frequency and the illumination.

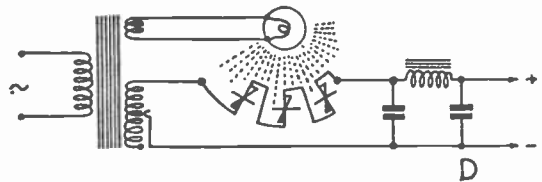

Fig. 4D.—Low voltage stabilised power unit using new effect.

From a commercial point of view it is interesting to note that the smaller-sized cells, i.e. those of lower first cost, are particularly suitable for this circuit arrangement. This may be due to the fact that the transparent sputtered metal film on top of the small area barrier layer cells, which is in series with the load, is of comparatively high conductivity and, hence, does not waste output power as is the case with the larger cells, where the larger surface area involves a higher resistance top film.

The speed of opening and closing the relay is mainly determined by the time constant of the resultant reactance and resistance of the above network and the supply frequency. Normally, the opening and closing of the relay is accomplished in a few cycles of the supply frequency. If a very rapid action is required, the supply frequency can be chosen at a high value and the feed condenser made smaller. Extra relay contacts can be employed, as shown in Fig. 4C, for changing the circuit values from light to dark conditions, or vice versa. Also, by the aid of extra contacts on the relay, one can change from the circuit of Fig. 3A to that of Fig. 3B or Fig. 4A, when open-

ing and closing, thus using different time constants and powers for action and rest. By using a split top-layer type of barrier layer cell, multi-phase operation can be adopted, thus permitting a reduction of time constant in the load (see Fig. 4B). Furthermore, the opening and closing time can be varied by having extra contacts on the relay which can switch in the extra capacitors C' into the feed

self-generated output was 0.65 mA, i.e. about 0.3 milliwatts. Hence, the differential power in the solenoid was $(88 - 3) = 85$ milliwatts, whilst the differential power in the orthodox circuit with the same light-to-darkness difference, was only 0.3 milliwatts. This corresponds to a power magnification of 280 times. It will be agreed that this is very remarkable considering the very simple

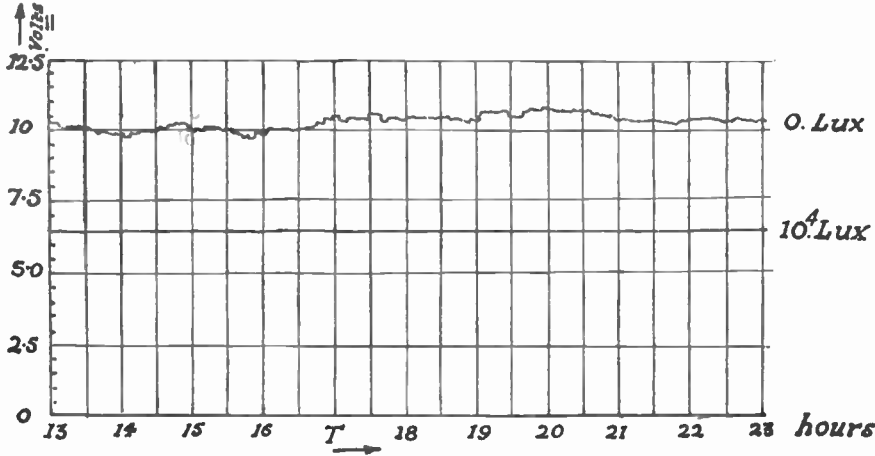

Fig. 5A.—Long term behaviour of circuit. Fig. 4A at no light output voltage follows mains fluctuations, when illuminated with 10^4 Lux (mean) output is quite uniform.

circuit, when the relay is open, in readiness for the change of lighting, causing the relay to close more quickly when the illumination on the cell is reduced. This feature is shown in Fig. 4C and is of value where the light differences to be used are small.

In a practical case of the circuit shown in Fig. 4A the following values were used :

A selenium sub-oxide gold-film barrier layer cell was employed ("Megatron" type N), having a sensitive area of 3cm^2 , the supply from the transformer was rated at 50 cycles per second at 29 volts r.m.s. The capacitor was 2.5 microfarads and the relay solenoid had a resistance of 700 ohms and was of the usual Post Office type. Operated in darkness as a half-wave rectifier, the circuit gave 88 milliwatts, which was ample to close the relay even when loaded by a multiple contact set with 15 springs. (It requires only about 30 milliwatts to operate one pair of contacts.) When illuminated with white light from a tungsten filament lamp, somewhat under-run, and fed from the same frequency supply having a light intensity of about 10^4 Lux, the relay opened. The power dissipated in the solenoid when the cell was illuminated was only 3.0 milliwatts. Using the photo-cell in the orthodox way (with a 700-ohms meter circuit) the

means. The above is quoted only as a practical example and is not by any means the maximum amplification obtainable.

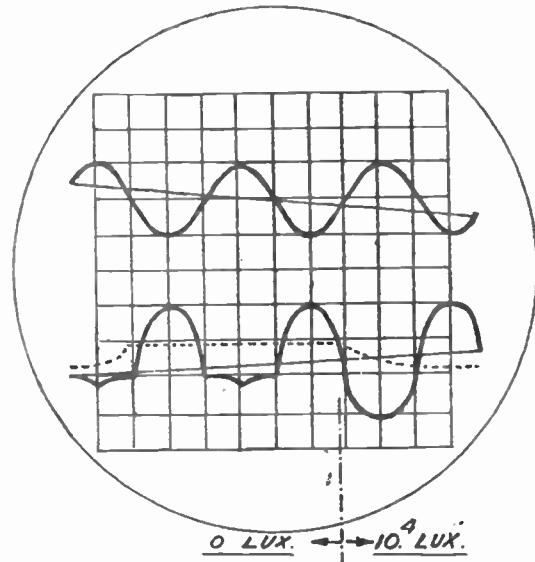

Fig. 5B.—Oscillogram of cell voltage at the moment of switching on light. Top wave is reference voltage on transformer secondary.

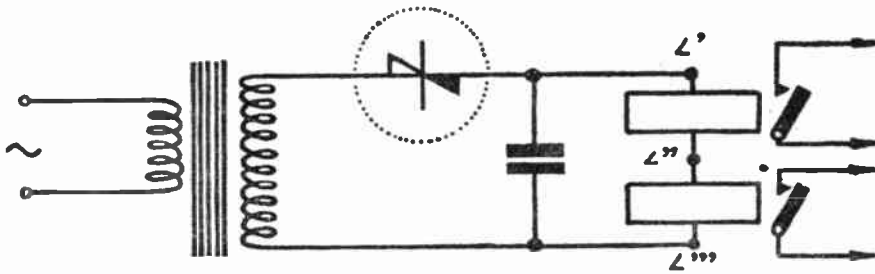

Fig. 6.—Simplest grading circuit (both relays inoperative in light) L'L'' one relay operates with darkness. L''L''' the other relay with not complete darkness.

A further very interesting feature of this circuit is that whilst the power obtained in darkness is a function of the mains voltage variation, as with normal metal rectifiers, the power output in the illuminated state is compensated, i.e. stabilized. This is due to the fact that whilst an increase in mains voltage would tend to raise the output, the increased light output of the lamp at the higher mains voltage decreases the output. This is one of the features which make these devices so reliable. The relay opening power is substantially constant whilst the closing power can be adjusted independently so that it is always greater than required, thus ensuring sufficient overlap for reliability.

Low voltage power supply units can be made with this stabilizing feature utilized to compensate for mains voltage fluctuations. If required, several barrier layer cells can be connected in

series, all arranged around a central lamp, which is preferably surrounded by cooling water or other means of keeping the cells at temperatures around 50° C. Such an arrangement is illustrated in Fig. 4D, where three disc cells are shown.

Figure 5A shows an extract from a time record of the light and dark outputs in volts per disc of such a device. The readings alternate once per second from light to dark, the light and dark periods being indicated on the diagram. This record shows clearly the remarkable stability of the light curve.

Figure 5B shows a cathode ray oscillogram of the dark and light output voltage trace at the moment of change from dark to light. The top curve shows the main input voltage to the transformer, and the lower curve the output voltage after passing through the barrier layer cell. This diagram also shows the mean direct current output superimposed on the oscillogram as a dotted line, which is large during the dark period and small during the light period.

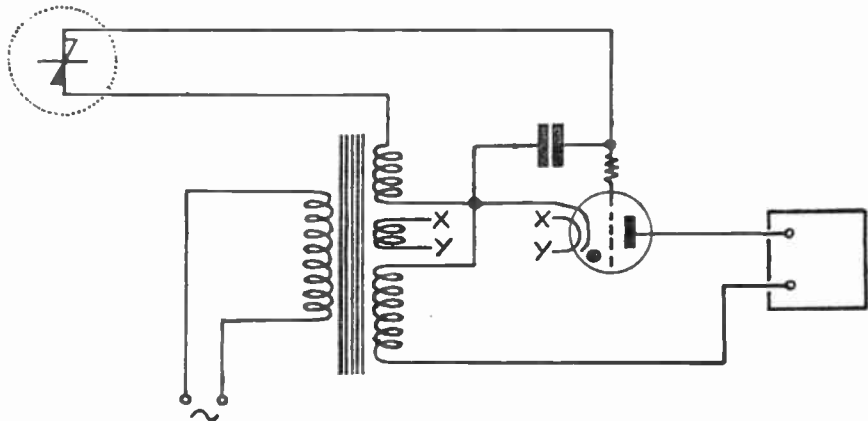

Fig. 7.—Simple circuit with gas relay to strike on being illuminated.

series, all arranged around a central lamp, which is preferably surrounded by cooling water or other means of keeping the cells at temperatures around 50° C. Such an arrangement is illustrated in Fig. 4D, where three disc cells are shown.

Figure 5A shows an extract from a time record of the light and dark outputs in volts per disc of such a device. The readings alternate once per

light and both will remain open with more light. This and similar arrangements can be used for grading purposes by means of light.

Cell at a Distance

Another group of applications utilizes a gas-filled relay or thyatron as the medium to be controlled by the barrier layer cell. Whilst

superficially these circuits resemble those used in conjunction with emissive (vacuum or gas-filled) photo cells, the function of the whole is completely different, since the characteristics of the light-sensitive components are quite unlike each other. Furthermore, the use of the comparatively low

shunted by the grid cathode path of a gas-filled relay valve. The alternating anode voltage of this relay valve is in opposite phase to the large negative voltage developed across the capacitor when the cell is illuminated and thus the relay remains inoperative in light. In darkness the

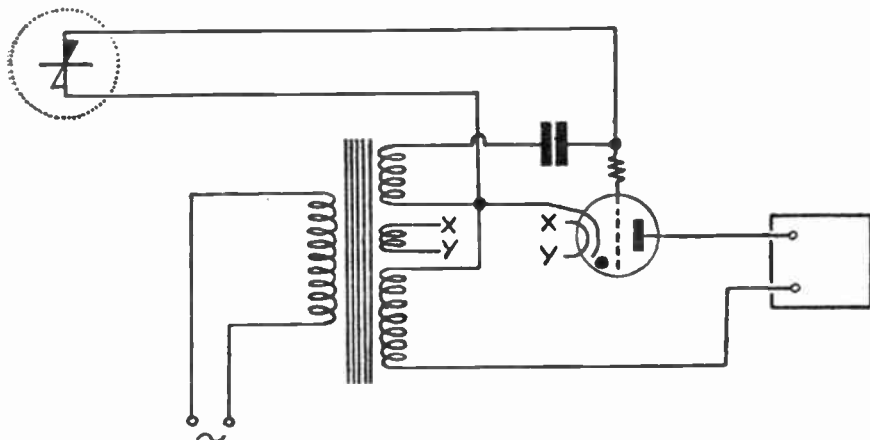

Fig. 8.—Simple circuit with gas relay to strike on illumination being removed.

impedance barrier layer photo cell permits it to be at a distance from the gas-filled relay and switch gear, unlike the high-impedance emissive photo cell which has to be in the same assembly as the gas-filled relay, or very close to it, and screened.

negative half-cycle appearing on the feed capacitor is insufficient to keep the relay inoperative and the relay works. As the capacitor has an impedance of the same order as the reverse current resistance of the cell, even with very little light, the voltage across it is sufficient to render the gas relay inoperative. Thus, this device is very sensitive to low illuminations. The speed of operation is very

In Fig. 7 (which shows an example of this arrangement) the feed capacitor is small and is

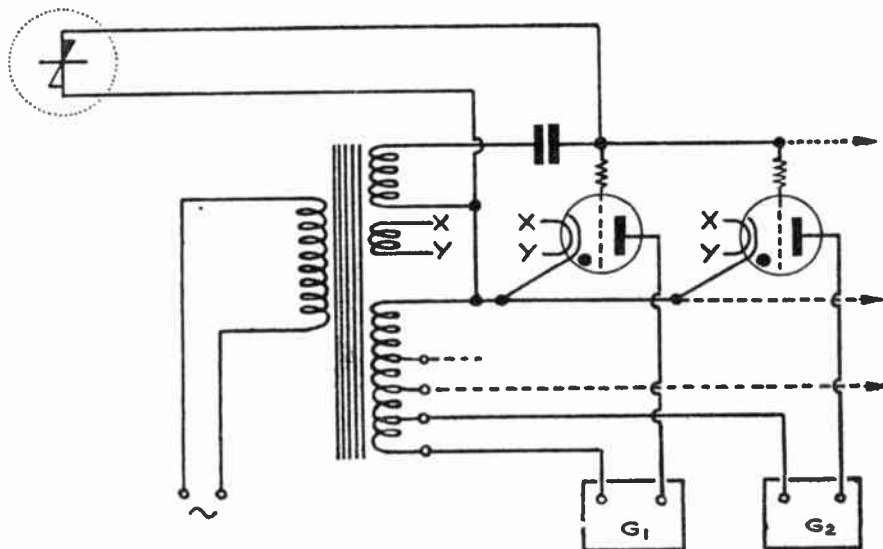

Fig. 9.—Grading circuit to strike each gas relay at different low levels of illumination, both gas relays are inoperative with much illumination.

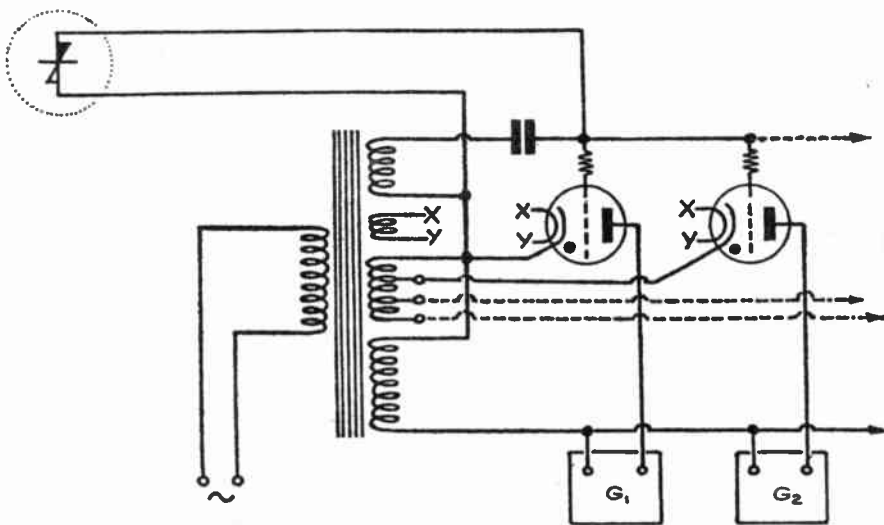

Fig. 10.—Grading circuit to strike each gas relay at a different illumination level.

good, for it can differentiate darkness from light within a single half cycle, on 50-cycle mains, i.e. 1/100th second.

To operate the relay on "light" instead of on "dark," as above, the components can be connected as shown in Fig. 8. The input circuit of the gas-filled relay is shunted across the cell itself, the capacitor still acting as the feed element.

As the capacitor has a constant reactance at a given supply frequency, the grid-cathode voltage cycle is a direct function of the cyclically varying cell resistance. In this arrangement, when the cell is illuminated, the operating point traverses regions

of high resistance during the same time interval when the varying anode potential of the gas relay is high. Therefore, the high negative voltage that appears across the cell is sufficient to keep the relay inoperative in darkness. However, from Fig. 1A it is clear that even with a small amount of light the cell characteristic is such that regions of high

resistance are not traversed, and thus the voltage cycle across it will not be sufficiently high to keep the gas relay inoperative all the time, so that the relay will close. (In both Figs. 7 and 8 a resistance or inductance can take the place of the capacitance.)

This operation will occur with quite a small amount of light (of the order of 100 Lux), depending on individual cell characteristic and the cell-aging procedure. The cells that are most effective are those which have a large "goodness" factor. The "goodness" factor is best expressed as the product of the dark reverse resistance, the ratio

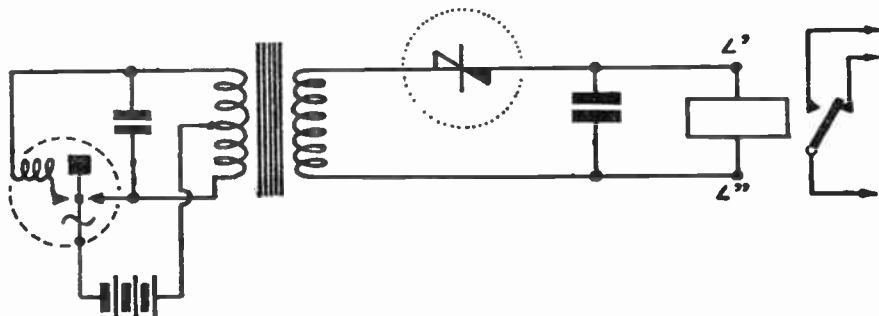

Fig. 11.—Battery fed A.C. switching current.

of high resistance during the same time interval when the varying anode potential of the gas relay is high. Therefore, the high negative voltage that appears across the cell is sufficient to keep the relay inoperative in darkness. However, from Fig. 1A it is clear that even with a small amount of light the cell characteristic is such that regions of high

of reverse to forward resistance and the open circuit voltage. In symbols $G = \frac{R_d^2 e_0}{r_d}$

where : R_d = dark reverse resistance
 r_d = dark forward resistance
 e_0 = open circuit voltage at one Phot illumination (approx. = 10^4 Lux.)

In a practical example of this system the input transformer secondary voltage was 50 V. r.m.s., and the feed capacitor was .003 μ F, having a reactance at 50 cycles of about

Fig. 9 as blocks G1, G2. . . . Such circuits can be readily used in grading machinery.

Figure 10 shows how a similar grading function can be performed, but here the values of grid are

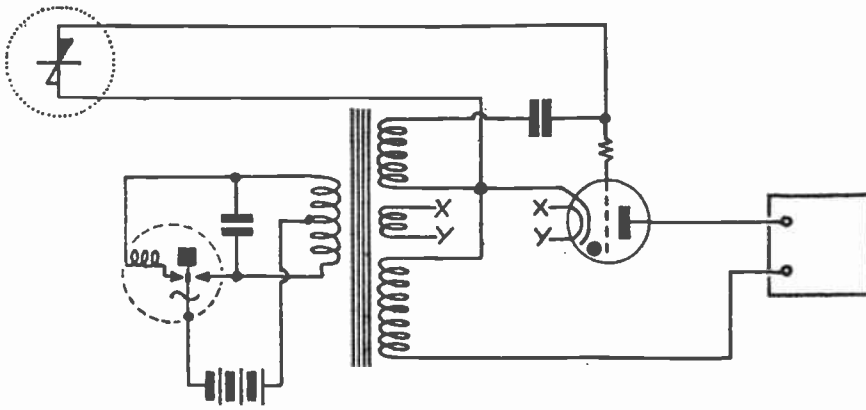

Fig. 12.—Battery fed A.C. high speed switching circuit using gas relay to fire on being illuminated

1 megohm. The gas relay had an alternating anode supply of 250 volts r.m.s. If a potentiometer of, say, 1,000 ohms is used across the 50-volt secondary in circuit arrangements as shown in Figs. 7 and 8, it can be adjusted so that the circuit will differentiate between darkness and 500 Lux in 1/100th second with an

different and the anode supply is common.

By the simple addition of an electro-mechanical vibrator-interrupter to the above circuits they can be operated from a battery. Figures 11 and 12 show such arrangements, the former being basically similar to Fig. 4A and the latter to Fig. 8. The system then becomes independent of any mains supply. (The vibrator can be very simple, since it has to switch only minute currents and does not have to rectify the output.) Such modified circuits are of particular use for motor car-parking light control, street lighting control, automatic light beacons, and the like.

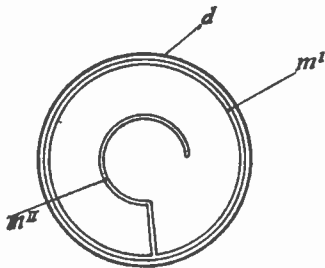

Fig. 13.—Contact area m^I increased by addition of m^{II} to decrease gold-film resistance.

average cell. (With many normal cells this illumination can be as low as 100 Lux, and with some special megatron cells as low as 10 Lux.)

Cells for use in the circuits shown in Figs. 3, 4 and 6 should have a transparent metal film of very low resistance, so as to reduce power loss at the comparatively large peak currents which occur

Figure 9 shows an arrangement based on Fig. 8 in which several gas relays (only two are shown) are controlled by the same cell circuit, each arranged with their anodes at different operating supply voltages. These relays will operate at different levels of illumination, that with the highest anode voltage operating first with small amounts of light, the next one operating also with an increased amount of light, and so on, until they are all conducting with the maximum intended illumination. The grading circuits are shown in

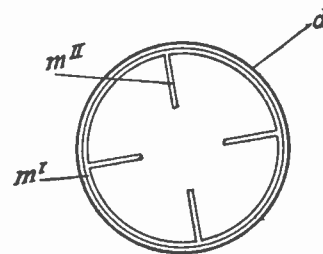

Fig. 14.—Alternative method of achieving same result shown in Fig 13.

in the circuit. Hence, long narrow cells or circular ones with high conductive top film are suitable.

With this end in view special cells can be produced in which the conductivity of the top collector metallic film is increased, without

appreciably affecting its transparency. One method consists in applying to the top layer a pattern of opaque metallic deposit so as to reduce the voltage gradient in this film. Examples of such disc-like cells are illustrated at *d* in Figs. 13 and 14, the additional metal depositions being indicated by the letter *m*' ; *m*' illustrates the conventional collecting ring to which the additional deposit *m*" must be connected. Figure 13 is an example of one form the additional deposit may take, and Fig. 14 shows another form.

In larger cells the deposited pattern can be more extensive, the principle involved being to subdivide the total transparent area into smaller areas, thus reducing the length of current paths in the transparent film without unduly reducing its transparency to incident radiation. The most effective cell of this kind would be produced by rendering inactive those parts of the barrier layer beneath the deposit. Other methods of improving the cell characteristic for this use exist, and their description would be a suitable subject for a paper to be read before this Institution by a cell-making specialist.

A further advantage of such cells—apart from the reduced power loss—is that the voltage gradient in the metallic top film is small, and hence the barrier layer is more uniformly stressed. All this has the effect of reducing the operating temperature, which should be kept as low as possible to ensure a long cell life.

For this purpose also, if the illuminated periods are relatively long, the light should be cold, i.e. passed through water to trap the infra-red rays. With judicious construction the cooling water can actually be allowed to touch the top layer of the cell. In this case, however, care must be taken that the water is maintained at the same electrical potential as the layer of the cell. The cooling water may be contained in glass vessels, which themselves act as the focusing lenses. This idea has been used in our type S.760 light projector.

In conclusion, it should be mentioned that as the barrier layer in these circuits operates as a light modulated rectifier the time delay can be controlled by choosing the time constants of the various circuit elements, including the cell itself, so that they are small compared with the particular supply frequency chosen. It is possible that this new technique may find application in photo-teletypewriter and photo-telegraph communication, using a high audio or supersonic carrier frequency.

It is also possible that speech-modulated light could be more effectively demodulated by the aid of the effect discussed in the paper than without it.

Bibliography

1. *J. T. MacGregor-Morris and R. M. Billington.* "The Selenium Rectifier Photo-Electric Cell ; its characteristics and Response to Intermittent Illumination."—*Journal I.E.E.*, October, 1936, pp. 435-453.
2. *Mme. Roy-Pochon.* "Des Cellules Photo-Electriques dites à Contact Rectifiant ou à Couche d'Arrêt."—*Bulletin de la Société Française des Electriciens*, Vol. 4, pp. 11, 99-1210.
Curves produced to illustrate effect of varying cell temperature, with applied voltages limited to 0.4v. in positive direction and 1.4v. in negative direction.
3. *O. V. Auwers and H. Kerschbaum.* "Über Spenschichtphotozellen."—*Annalen Der Physik*, Series 5, Vol. 7, part 2, 1930, pp. 129-175.
Limits of applied E.M.F. : Positive direction 0.15v. and negative direction 0.05v.
4. *R. A. Houston.* "The Electro-Motive Force of the Selenium Barrier Layer Photo Cells."—*Phil. Mag.*, Vol. 36, No. 255, pp. 279-287, April, 1945.
At about 5 volts the difference between the ordinates of the two curves becomes constant and the sensitivity obtained by using an applied E.M.F. is not worth the extra trouble entailed.
5. *A. Becker and E. Kruppke.* "Zur Kenntnis des Selenphotoelemente."—*Zeitschrift für Physik*, a—Part I: Vol. 107, pp. 474-484, 1937.
Limits : In positive direction 1.5v. In negative direction 2.2v. ; b—Part II : Vol. 112, p. 629, 1939.
Cross-over points illustrated points shown.
Light intensity 550 Lux.
6. *G. Stolzer and J. A. Sargrove.* "Measurement of Transmitting Valve Characteristics Above the Dissipation Limit Employing Pulse Technique."—*Electronics and Television and Short Wave World (Electronic Engineering)*, Vol. 13, pp. 153-156, April, 1940.

ELECTIONS AND TRANSFERS TO MEMBERSHIP

The following elections and transfers were recommended by the Membership Committee at their meetings of April 24th and June 3rd, 1947.

Elected to Full Member

BARLOW, Professor Harold Banstead, Surrey
Everard Monteagle, B.Sc.
(Hons.) Eng., Ph.D.
ECKERSLEY, Peter Pendleton London, S.W.3.
TREWMAN, Professor Harry Chislehurst
Frederick, M.A.(Cantab.)

Transferred from Associate Member to Full Member
HANCOCK, George Norman, Beeston, Notts.
C.B.E.

Elected to Associate Member

BERRY, Philip Harvey Pinner, Middlesex
BOOTH, Percy, Lieut-Com- Stockport, Cheshire
mander, B.A.(Hons.)
BROWN, William John Eric Three Bridges, Sussex
DAVIES, Henry Neville Oswaldtwistle, Lancs.
HASSON, John Singapore
MEDCALFE-MOORE, John Kuala Lumpur, Malaya
PALMER, Edward James Wellington, N.Z.
SHORT, Herbert Frank Portsmouth
THOMAS, William John, Ph.D. London, S.E.27
B.Sc.(Hons.)
VOISIN, Georges Auguste Rhone, France
Henri

Transferred from Associate to Associate Member
CONYERS-BROWN, John Ashburton, N.Z.
Percival
NICHOLSON, Philip Ian Potters Bar, Middlesex
STIBBE, Harry London, S.E.20
WOOLDRIDGE, Geoffrey Weybridge

Transferred from Graduate to Associate Member
JOSEPH, Kianantha Chelmsford
Alexander, B.Sc.

Elected to Associateship

BATTEN, Daryl Castleford, Yorks.
BRAY, Donald Harry Arthur, Aldershot
B.E.M.
FAIRFAX, Osmond Maurice Southsea, Hants

FREEBORN, Ronald Malcolm, Bickley, Kent
B.A.(Hons.)
HERSEE, George London, N.3
KINCAID, Norman South Shields
PATERSON, Robert Gordon, Glasgow
B.Sc.(Eng.)
STEPHENSON, Raymond Wakefield, Yorks
Harrison

Transferred from Graduate to Associate
FORD, Edmund Alfred Nottingham

Transferred from Student to Associate
BAKER, Ransome Charles Mitcham, Surrey
Lawrence
FIGGEST, Harry John London, S.W.17
McNAMARA, Staunton Port Augusta, Australia
PECK, Charles Owen Cambridge
ROHAN, Pavel Prague
SHACKLE, George Edward Bolton, Lancs.
WADDELL, William Angus, Glasgow
B.Sc.(Hons.)

Elected to Companion

BROWN, John Rogers Jarrow
ROBINSON, Frederick Henry New Malden, Surrey

Studentship Registration

BLACK, Walter Stuart Leighton Buzzard
BOOTY, Martyn Eastbourne
BURNS, John Fotheringham Berwick-on-Tweed
CHESTER, Alan Sydney Blackpool
CLARKE, Donald Attleborough
CRAGGS, Robert Newcastle-on-Tyne
DARLING, Peter James Brighton
DAVIES, John Howard, M.A. Stoke-on-Trent
DOYLE, Eamon Daly Eire
GREGORY, Henry Darwen, Lancs.
HILLSLEY, Stanley Philip Hatfield
HORNEGOLD, William West Ewell
Malachi Robert
JARMAN, Richard Hounslow
JONES, George William Wooburn Green, Bucks
KENNY, Ernest Swindon
LEVY, Solly Johannesburg

(Other lists will be published in subsequent issues)

SOME NOTES ON PULSE TECHNIQUE†

by

M. M. LEVY (Member)*

A Paper read before the London Section on January 16th, 1947, and the Midland Section on March 27th, 1947.

SUMMARY

This paper contains an accumulation of notes which, although in appearance are independent one from another, are parts of a new technique which has been built up in designing new pulse equipments.

It contains a detailed study of the transmission of pulses through ideal filters and through delay lines; a study of the working conditions and efficiency of pulsed valves (with applications to the design of power pulse generators and power pulse multivibrators); a study of pulse modulation and demodulation, with particular reference to the choice of conveniently shaped modulator and demodulator pulses in order to simplify the circuit design and, at the same time, eliminate harmonic distortions.

CONTENTS

Summary.

- (1) *Introduction.*
- (2) *Transmission of Pulses through Filters and Delay Lines.*
 - (2.1)—Distortions produced by transmission through filters.
 - (2.2)—Distortions produced by transmission through delay networks.
 - (2.2.1) Propagation through delay networks—Theoretical formulæ.
 - (2.2.2) Practical results—Delay network with minimum pulse distortion.
- (3) *Pulsed Valves, Power Pulse Generators and Power Multivibrators.*
 - (3.1)—Pulsed valves.
 - (3.2)—Power pulse generators.
 - (3.3)—Power multivibrators.
- (4) *Some notes on Pulse Methods of Modulation and Demodulation.*
 - (4.1)—Modulation Process.
 - (4.2)—Demodulation Process.
 - (4.3)—Elimination of harmonic distortion in pulse modulation.
- (5) *Bibliography.*

1.—Transmission of Pulses through Filters and Delay Lines

When a square pulse travels through filters, its shape is progressively distorted, overshoots and undershoots appear, its contours are wavy and the general shape becomes roughly more like a triangle or a trapezoid.

The distortion by transmission through ideal low-pass filters is studied and it is shown that although the general shape is distorted, the width of the pulse at mid-height remain very nearly constant as long as the pulse width is greater than the duration of the cut-off period. This property is used in the design of delay-network distributors for multi-channel pulse systems.

Formulæ are given for the design of delay lines. It is shown that the use of mutual inductance improves the general characteristics of the line and reduces the pulse shape distortions. Measurements show that the theoretical mutual coupling required do not give the best practical results. Details are given of an experimental study made in view of reducing the pulse shape distortions to a minimum. Mutual inductance between distant coils is used to advantage.

2.—Pulsed Valves, Power Pulse Generators and Power Multivibrators

In pulse technique, valves need not have linear characteristics since they have to produce sharp

* *The General Electric Co., Wembley, England, and its subsidiary Standard Telephones and Cables Ltd.*

† *U.D.C. No. 621.396.615.17 : 621.396.619.16. Manuscript received December, 1946.*

edge pulses only. But for good efficiency the pulsed valves must produce currents of the greatest permissible values since they are working intermittently. The efficiency of pulsed valves is considered and it is shown that with oxide-coated filaments or cathodes, for which there is in principle no limit for the saturation value, peak pulse currents of considerable value can be obtained with suitable circuits.

Three highly efficient pulse circuits are described.

The first is Kallmann's blocking-oscillator circuit. With a small receiver valve giving a normal anode current of 5 milliamperes, this circuit gives sharp anode current pulses of 5 amperes, that is, a thousand times greater than the normal current.

The second is a peak power pulse generator in which all voltage amplification is avoided. The pulses are generated directly at a greater amplitude than required. These pulses are, by necessity, produced in a high impedance. The impedance is lowered successively by cathode followers in successive stages. Each cathode follower lowers the impedance and increases the peak power without affecting the amplitude too much. For the circuit described, the pulses are generated directly at an amplitude of 2,000 volts in an impedance of 1,000 ohms. This impedance is lowered successively to 500 and 150 ohms. Output voltages of about 1,000 volts are obtained, corresponding to a cathode current of 6.5 amperes and a peak power of 6.5 kilowatts. The valves used are rated for a normal anode dissipation of 25 watts.

The third circuit is a power pulse multivibrator. By adding a cathode follower between the anode of the first valve and the grid of the second, the driving power of the first valve is considerably increased and the grid of the last valve can be driven into grid current corresponding to anode currents of considerable value. A practical circuit is described.

3.—Pulse Modulation and Demodulation Processes.

Elimination of Harmonic Distortion by the use of conveniently shaped Modulator and Demodulator Pulses

Pulse modulation and demodulation processes are typical examples of pulse technique. It is shown that the modulation can be done by means of trapezoidal recurrent pulses and the demodulation by means of rectangular recurrent pulses,

combined in each case with a convenient multivibrator.

Perfectly shaped trapezoidal and rectangular pulses are not easy to produce. Usually the tops are exponentially shaped. This introduces harmonic distortion at the modulation and demodulation. It is shown, however, that if the time constants of the circuits producing the exponential tops are equal for modulation and demodulation, the distortion produced at modulation cancels exactly the distortion produced at demodulation. This is a simple way of reducing the harmonic distortion to a minimum.

(1) Introduction

Pulse technique is very different from the usual A.C. technique because it is based on intermittent work. Instead of continuous waves we have very sharp and narrow pulses appearing and disappearing rapidly. Between pulses the whole system is at rest. Because of these conditions this technique has its own requirements for high efficiency: the pulses must travel through networks and delay lines with no appreciable distortion of their shape; the valves must be strongly overloaded when pulsed because they work intermittently and conduct only during a small percentage of the total time; the circuits must be designed in view of this overload with its consequent high grid current; the modulation and demodulation processes are of a new type, since the information to be transmitted must first be translated into terms of time shift and then re-translated into terms of signal amplitude; finally, these processes must be effected in such ways that distortion is reduced to a minimum.

These requirements can only be satisfied by new conceptions and special designs. Some examples will be given which, although in appearance independent of one another, are parts of the same technique which helped the writer to build his multi-channel pulse system.

(2) Transmission of Pulses through Filters and Delay Lines

When a pulse travels through a filter or a delay line, its shape becomes distorted. The distortion is produced by both the phase and amplitude of each frequency component of the pulse being altered during transmission through the network. It is very important to have a clear picture of the

process of distortion. With this object in view, the propagation of pulses is studied first through ideal filters and then through delay networks.

(2.1) Distortions produced by transmission through filters

Since a square pulse can be considered as the sum of positive and negative step voltages, both of equal amplitude, but with the latter delayed with respect to the former by an amount equal to the width of the pulse (Fig. 1), the process of pulse distortion can be understood by studying the distortion of a step voltage.

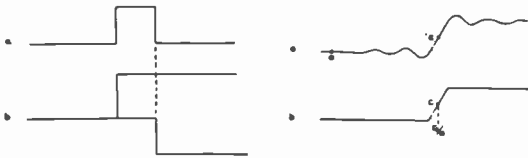

Fig. 1.—A square pulse, is the resultant of two step voltages.

Fig. 2.—Response of an ideal low-pass filter to a step voltage and shape of the response in first approximation.

Distortion of a step voltage travelling through networks and filters has already been studied extensively. The distortion is easy to calculate in case of ideal filters, that is, filters having a constant attenuation in the pass-band, a sharp cut-off and a linear phase-shift.

The Fourier Transform theory shows that the equation of a unit step function starting at time $t = 0$ is :

$$S_1(t) = \frac{1}{2} + \frac{1}{\pi} \int_0^{\infty} \frac{\sin \omega t}{\omega} d\omega$$

This means that the step function is the resultant of an infinite number of sine waves in phase at $t = 0$ and whose amplitude is inversely proportional to the frequency. When travelling through an ideal low-pass filter of cut-off frequency f_c , the step voltage loses all its components of frequency higher than f_c and has all other components delayed by a constant amount $\tau = \phi/\omega$ because the phase shift is proportional to frequency in the filter. Hence the output signal is :

$$S_0(t) = \frac{1}{2} + \frac{1}{\pi} \int_0^{\omega_c} \frac{\sin \omega (t - \tau)}{\omega} d\omega$$

The right-hand side is the well-known sine-integral tabulated in many books. The output signal is represented in Fig. 2a. The centre C of the slope appears with a delay τ after the step of the original signal. The step is replaced by a slope lasting about $T_c/2$ seconds, T_c being the period of the cut-off frequency, f_c . At the same time damped oscillations appear on each side of the step. Note that the frequency of these oscillations is that of the cut-off frequency. If these oscillations are neglected, one obtains the signal pictured in Fig. 2b. From these results the response of an ideal filter to a square pulse can be easily determined graphically since the pulse is the sum of two step voltages.

To get a general result, applicable to any type of filter, let us do the graphical construction, assuming that the response to a step voltage has any shape. Figure 3 represents this construction. The pulse is the resultant of two step voltages appearing, one at time t_1 and the other at time t_2 . To the first one corresponds a response whose centre C'_1 appears at time $t_1 + \tau$, τ being what we may call conventionally the delay produced by the filter (curve 1' of Fig. 3). If the second step was identical to the first one and simply translated by a time Δt , the response will be the first response translated by Δt . This curve is represented in dotted lines in Fig. 3. The centre C'_1 is now C'_2 and $C'_1 C'_2 = \Delta t$. However, since the second step is inverted compared to the first one, we have

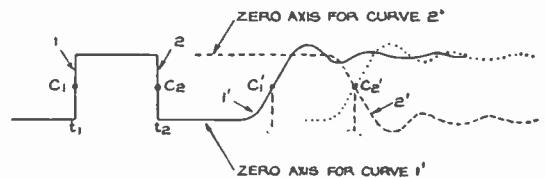

Fig. 3.—Response of a low-pass filter to a square pulse for first approximation $C_1 C_2 = C'_1 C'_2$.

to invert the response. The new curve is curve 2' of Fig. 3. It is important to observe that it still passes through C'_2 . If we now add curves (1') and (2') we get the response to the pulse. In this conversion, point C'_1 will be shifted vertically by an amount equal to the amplitude of curve (2') at the moment when C_1 appears. In the same way point C'_2 will be shifted vertically by an amount equal to the amplitude of curve (1') above or below its asymptotic value. As long as Δt is great compared to the build-up time of the

response to the step voltage, these shifts will be small. In general, we must assume $\Delta t > T_c$.

These results can be seen very clearly on the curves of Figs. 4 and 5. Figure 4 shows the

The second type of distortion is shown by progressively damped oscillations appearing on each end of the slopes, the frequency of these oscillations being equal to the cut-off frequency.

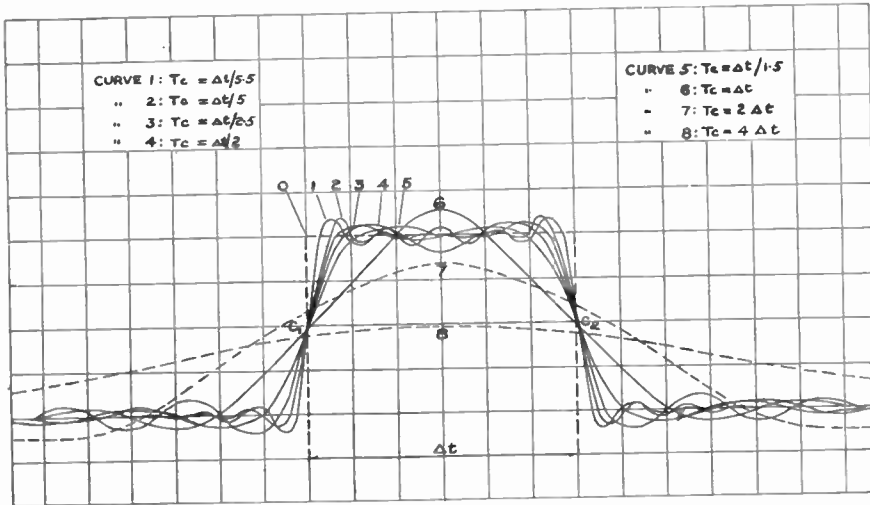
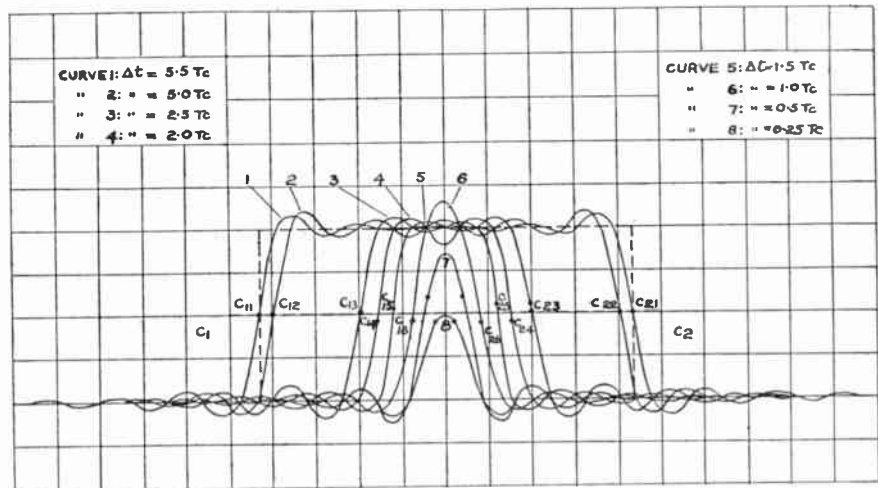

Fig. 4.—Response of an ideal low-pass filter to a square pulse for various values of the cut-off frequency. For $T_c > \Delta t$ the width at mid-height is equal to the pulse width.

response of an ideal filter to a square pulse for different values of the cut-off frequency. When the cut-off frequency is infinite, the square pulse is transmitted without distortion (curve 0). When

So long as the cut-off frequency is greater than $1/\Delta t$ (curves 0 to 6), the response passes very near the centres C_1 and C_2 , and the width of the curve at the height of line $C_1' C_2'$ is very nearly

Fig. 5.—Response of an ideal low-pass filter to a square pulse for various values of the pulse width. Same conclusions as for Fig. 4.



the cut-off frequency becomes finite two types of distortion appear. The first type is a progressive rotation of each edge round its centre C_1 or C_2 .

equal to $C_1 C_2$. But, when the cut-off frequency becomes smaller than $1/\Delta t$ (curves 7 and 8) the response do not meet the edges of the square

pulse near points C_1 and C_2 , and the width at the height of line $C'_1 C'_2$ is no longer nearly equal to $C_1 C_2$.

Figure 5 shows the response of an ideal low-pass filter of cut-off frequency f_c to a pulse of variable width. Each curve cuts the edges of its corresponding square pulse at two points clearly represented on each curve. For instance, for curve 1 these points are C_{11} and C_{21} , for curve 2, C_{12} and C_{22} . The distance between two points on the same curve is equal to the width of the corresponding square pulse. It can be seen from the curves of Fig. 5 that as long as the pulse width is greater than the cut-off period $1/f_c$ (curves 1 to 6) the pulse width is very nearly equal to the width of the response at mid-height (intersection between the response and line $C_1 C_2$). The height of each pair of points mentioned above oscillated around the mid-height. When the width is smaller than the cut-off period, the width at mid-height of the response may differ very largely from the width of the corresponding square pulse. Figure 5 shows the same phenomenon as Fig. 4, but from a different view and gives the same conclusions.

The above general result, illustrated clearly by Figs. 4 and 5 for ideal filters, is of fundamental importance when applied to delay networks, since when a pulse travels through a delay network its shape is distorted progressively and may become very different from the initial square pulse.

However, in spite of this considerable distortion, the width at mid-height of the pulse remains nearly constant. This remarkable property has an important application in the use of a delay line as distributor for the multi-channel pulse system.

When a delay line is used as distributor in a multi-channel pulse system a recurrent square pulse is applied at the input of the line. Each pulse travels through the line and arrives at the end when the next pulse appears at the input. Tappings are taken on the line, each one corresponding to a channel. When a pulse arrives at one tapping, the time allocated to this channel starts. In general, the width of each square pulse is equal to the width of the channel, so that if there was no pulse distortion the end of the time allocated to the channel will correspond to the moment when the pulse disappears at the corresponding channel. Because the pulse is distorted by travelling through the line, the beginning and end of the pulse have no meaning, but by taking a narrow slice of the

pulse at mid-height off the input pulse, we have a width which coincides, approximately, with the width of the corresponding channel. This slice can be isolated very easily by connecting the tapping to the grid of a valve biased negatively beyond the cut-off by an amount equal to half the original square pulse amplitude. Current flows when the required slice appears and, if the amplitude of the pulse is great compared to the swing of the grid from cut-off to saturation or grid current, the plate current will be square with a width very nearly equal to the channel width. If the grid swing is, say, 5 or 10 volts the amplitude of the pulses must be of the order of one hundred volts to obtain good results.

In the multi-channel system (described by the writer in another paper⁴), the boundaries of the channels are determined by a more accurate method. However, the above considerations remain fundamental in that they help to approximate the region where the boundaries are located.

(2.2). Distortions produced by Transmission through Delay Networks

Since pulses are distorted by transmission through delay networks, it is essential to determine the nature and elements of the delay network in order to obtain the minimum shape distortion. We shall first establish some general formulæ and then study the design of delay lines giving the minimum pulse shape distortion.

(2.2.1) Design of Delay Networks—Some approximate Formulæ

Formulæ for delay networks are very simple to establish if we start from the filter network theory. Taking a T section whose configuration is represented on (a) Fig. 6, we have :

$$L_1 = m L_K$$

$$L_2 = \frac{1-m^2}{4m} L_{1K}$$

$$C_3 = m C_{2K}$$

where L_{1K} and C_{2K} are given by the fundamental relations :

$$L_{1K} = \frac{Z}{\pi f_c}, \quad C_{2K} = \frac{1}{\pi f_c Z}$$

Z being the characteristic impedance and f_c the cut-off frequency.

The group delay per section is given by the formula :

$$\tau = \frac{1}{f_c} \frac{.3183}{\sqrt{1-x^2}} \frac{m}{1-(1-m^2)x^2}$$

where $x = f/f_c$.

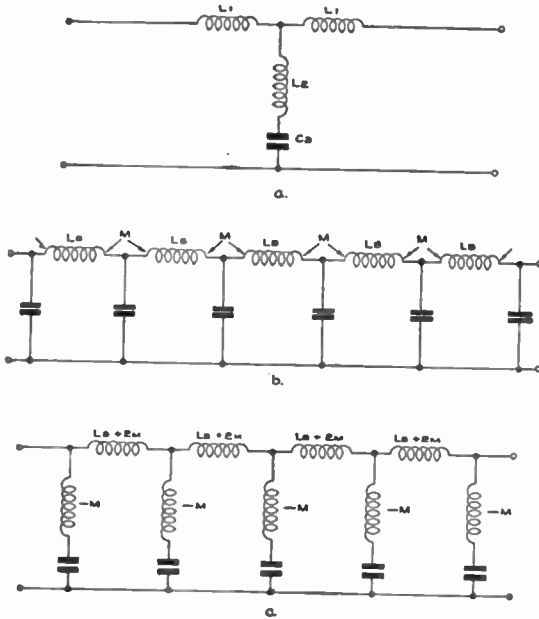

Fig. 6.—Design of a delay line with mutual inductance between successive sections.

Figure 7 shows how to vary the delay with frequency. It will be observed that the delay is nearly independent of frequency up to frequencies equal to about half the cut-off frequency for $m = 1.25$. This value of m gives an inductance L_2 negative. Such an inductance cannot be produced but can be simulated by using mutual inductance between the coils of successive sections. In Fig. 6(b), some sections of such a network are represented and in (c) the equivalent circuit is shown. Comparing with (a), the above formulæ become :

$$L_B + 2M = m L_{1K}$$

$$M = \frac{m^2 - 1}{4m} L_{1K}$$

$$L_B = \frac{1 + m^2}{4m} L_{1K}$$

Since we are only interested by a network giving as constant a delay with frequency as possibly we must replace m by 1.25. We get :

$$\tau_1 = \frac{0.4}{f_c}$$

$$L_B = \frac{Z}{\pi f_c}$$

$$M = 0.1 L_B$$

$$C_2 = \frac{.4}{Z f_c}$$

The writer found that in many practical cases these formulæ give only approximate values. He has not made a detailed investigation to find the reason.

(2.2.2) Design of a Delay Line giving a minimum Pulse Shape Distortion

Let us assume that we want to build a delay line as distributor for a 20-channel system. If the recurrent frequency $f_r = 9$ Kc/s, $T_r = 110$ microseconds, and the time allocated to each channel is $110/20 = 5.5$ microseconds. The total delay of the line must be 110 microseconds and the recurrent pulse applied to the line must have a width of about 5.5 microseconds. If we accept at the end of the line a slope of about 2 microseconds, this gives for an ideal low-pass filter a cut-off period of 4 microseconds or a cut-off frequency of 250 Kc/s.

However, due to the great number of sections, a line is not as perfect as an ideal low-pass filter ; the attenuation starts much earlier than the cut-off frequency. Furthermore, the phase characteristic is not linear beyond 0.3 of the cut-off frequency unless mutual inductance is used. Even in this case the curve is only linear up to 0.5 or 0.6 of the cut-off frequency. It is thus wise to take a cut-off frequency at least twice or three times 250 Kc/s. Taking 800 Kc/s, the time delay per section is given approximately by the formula :

$$\tau_1 = \frac{0.36}{0.8} = 0.45 \text{ microseconds,}$$

and the number of sections is :

$$N = \frac{100}{0.45} = 245$$

The inductance, capacity and mutual inductance are given by the formulae :

$$L = \frac{Z}{2\pi f_c}, \quad C = \frac{f_c Z}{0.36}, \quad M = 0.1L$$

Fig. 7. This delay increases continuously with frequency. When a mutual inductance is used, one obtains the other curves of the same fig. For $m = 1.275$, the delay is constant up to more

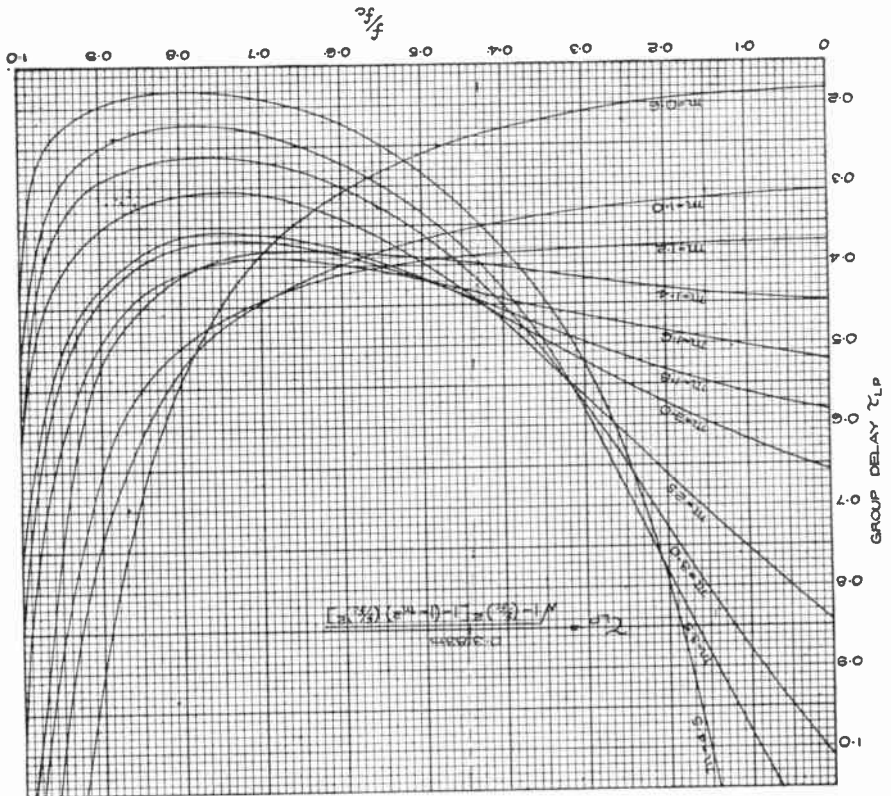

Fig. 7.—Variation of the group delay with frequency in a delay line for different values of the mutual coupling. For $m = 1.275$ the delay is constant for frequencies lower than 0.6 fc.

For a capacity of 100 micro-microfarads, we get an impedance Z , of 4,500 ohms and an inductance L , of 0.9 millihenry. Such an inductance can be easily made with a small dust core coil, and the number of 250 dust-core coils is not prohibitive. The writer made a line, using the above theoretical formulae, and found that the pulse distortion at the end of the line was much greater than that expected by the theory (Figs. 8 and 9). It is important first to explain why mutual inductance is essential in a delay line. If there is no mutual inductance between coils of adjacent sections, the phase characteristic is given by the low-pass filter theory and one obtains the delay characteristic curve corresponding to $m = 1$ in

than 0.6 fc. For $m = 1.275$, $M = 0.1 L$ and it would seem that this mutual inductance should give the best results. For the line made by the writer this was not the case and he experimentally varied the mutual inductance until the distortion was reduced to a minimum. He found that this is obtained for $M = 0.35$ per cent approximately. Some results are reproduced in Figs. 8 and 9; Fig. 8 corresponding to the right value of mutual inductance and Fig. 9 to high values. No detailed theoretical investigation has been made to explain this contradiction. The influence of mutual inductance on the velocity of propagation can be easily visualized. If there is no mutual inductance, the waves have to travel from one coil to the next one and, as

shown by curve $m = 1$ of Fig. 7, the velocity decreases when the frequency increases. If there is mutual inductance, a fraction of the wave will appear in a coil before the body of the wave has time to arrive, and this is equivalent to an increase of velocity. This effect will be very marked at very high frequencies when the inertia of the coils is appreciable. Hence, the mutual inductance will tend to reduce the decrease of velocity with frequency produced by the inertia of the coils.

A very interesting consequence of this is that, if we produce mutual inductance between every other coil or between each coil and the n^{th} next one, we could have a more marked effect and increase considerably the velocity at very high frequencies.

These conclusions have a practical application.

Figure 10 represents in (a) part of a long delay line using dust-core coils. About 15 coils are assembled together in one unit and the units are assembled together as shown in (b). The mutual inductance is obtained by leaving a small gap between adjacent coils. The gap is determined experimentally in order to obtain the required mutual inductance. However, it is very difficult to obtain just the right gap because the required mutual inductance is not very well known. When all the units are completed it is necessary to vary slightly the mutual inductance in order to obtain the minimum pulse distortion. It is very impractical to change progressively 250 gaps. It is here that the property explained above can be used. The units are assembled close to one another, as shown in *b* Fig. 10, so that mutual

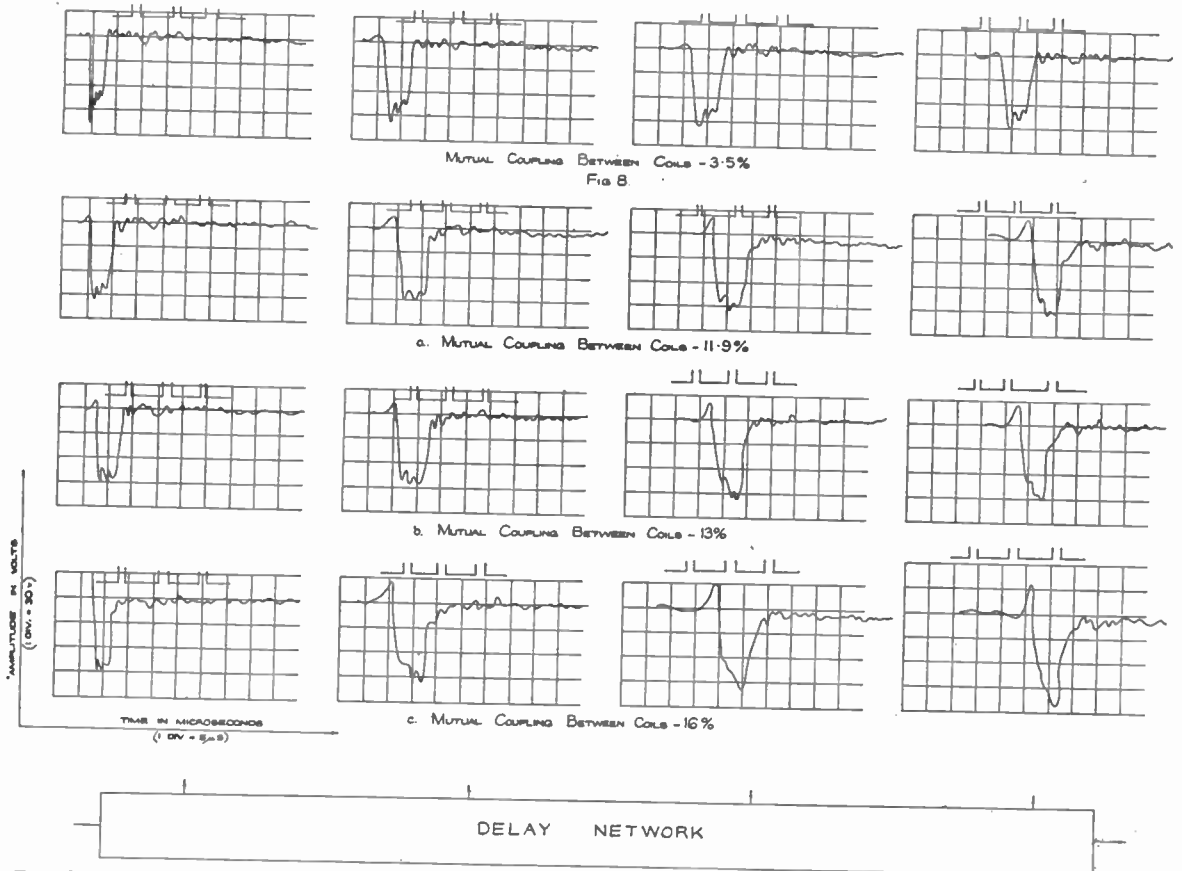

Figs. 8 and 9.—Distortions produced on a square wave by travelling through a delay network. The delay network is of the type shown in Fig. 10a. Each unit comprises 15 dust-core inductances and there are four units. The pulse shape is recorded at the end of each unit. A time scale is shown on each record. Except for the first 10 microseconds, the scale is approximately linear.

inductance exists between the nearest coils of two successive units, and they are connected in zig-zag. The spacing between the units is then varied until the pulse distortion is reduced to a minimum. If the initial mutual inductance between successive coils is greater than required, the mutual inductance between units is arranged to be of the

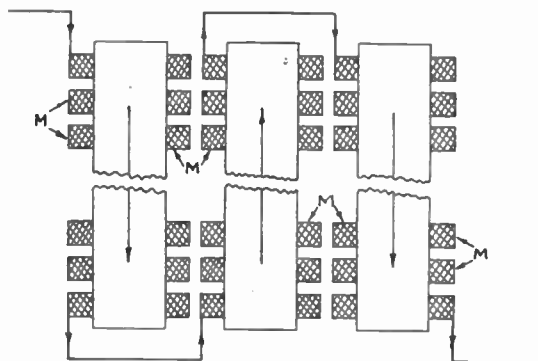
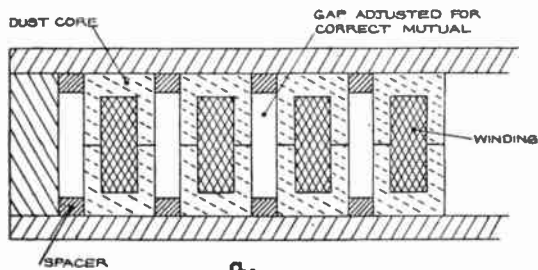

Fig. 10.—Practical design of a delay network with dust-core inductances. (a) shows how the correct mutual between successive sections is obtained. (b) shows how mutual inductance between successive units is used as final adjustment to obtain the minimum pulse distortion (see Figs. 8 and 9).

opposite sign ; and if the initial mutual inductance is smaller than required, the mutual inductance between units is arranged to be of the same sign. These adjustments are very easy to do experimentally. The use of mutual inductance between units has the further advantage of reducing the size of the whole line, because the units can be placed very close together.

When all these precautions are taken the pulse at the end of the line has a very good shape, very nearly as shown for the fourth section in Fig. 8.

(3) Pulsed Valves, Power Pulse Generators and Power Multivibrators (2)

In pulse circuits many valves work intermittently, and sometimes the working period is a very small fraction of the time, such as 1 or 0.1 per cent. Under these conditions the efficiency of the valves is very low if average rated valves are used. To increase the efficiency high grid current must be admitted and this introduces a new problem in pulse circuit design. The writer succeeded in obtaining a reasonable efficiency from pulsed valves by the extensive use of cathode followers. In the next sections two typical examples are given.

(3.1) Pulsed Valves

When a valve is working intermittently, its efficiency becomes low unless the cathode current is increased to much more than the average rated value. This is possible only with oxide-coated filaments and cathodes because oxide has practically no saturation value. Kallmann gives a remarkable practical application of this property in his stroboscopic-light source. The circuit is represented in Fig. 11. It is based on a modification of the well-known blocking-oscillator circuit. It is known that such a circuit produces short, strong anode current pulses. The triode differs from any normal tube only in having the bombarded side of the anode coated with fluorescent material and this anode is so arranged that the light of its

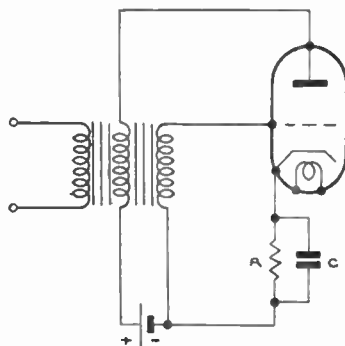

Fig 11.—Blocking oscillator circuit with which can be obtained peak pulse current about 1,000 times greater than the mean rated current.

fluorescence may radiate outwards. In order to get very strong light flashes, Kallmann designs the circuit to get the maximum peak current possible. The amount of current he obtains, even from a small receiver tube, is remarkably large. With a small indirectly heated MH41 triode, which has a

heater consumption of 4 volts, 1 ampere, and a normal rated anode current of 5 milliamperes, Kallmann gets peak anode currents as high as 5 amperes with an anode voltage of 1,000 volts. These currents are observed with an oscillograph on a small resistance in the anode circuit. No deterioration or other signs of overload are observed. The duration of each pulse is about 1 microsecond and the recurrent frequency about 1 Kc/s.

The grid current in this circuit is considerable and the production of large grid currents is the only way to get high efficiency from pulsed valves. In circuits where the source impedance is high, cathode followers can be used as impedance transformers—or more exactly power amplifiers, in opposition to voltage amplifiers—between the driving source and the grid of the pulsed valve. Two examples of this technique are given in the next sections: the first is a pulse generator and the second is a multivibrator of high efficiency named by the author "power multivibrator."

(3.2) Power Pulse Generator

The circuit described in this section is a power pulse generator producing sharp, narrow pulses of 1,000 volts amplitude in a resistance of 150 ohms at a recurrent frequency of 50 cycles. The peak power produced is 6.5 kilowatts, with a mean power of the order of 50 watts. To obtain a high efficiency only low power tubes were used. The difficulty was to obtain such high voltages with

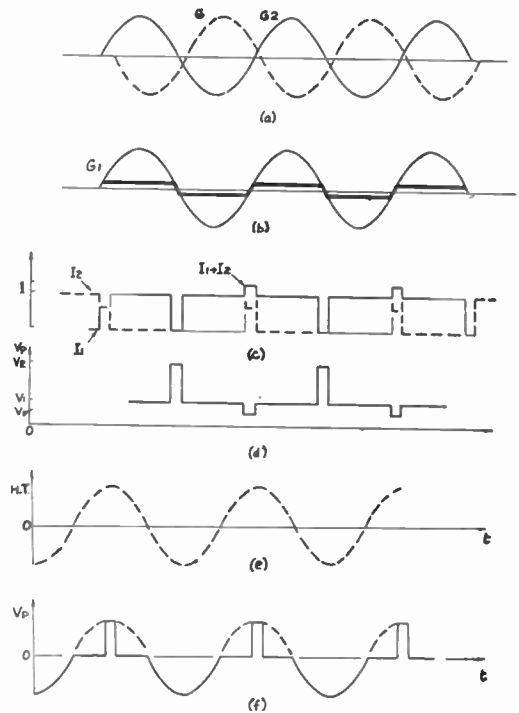

Fig. 13.—Working diagrams of the power pulse generator of Fig. 12.

these tubes. The solution adopted was to avoid any amplification in voltage and produce high voltage pulses directly. It was found that this was possible efficiently only if a low peak power

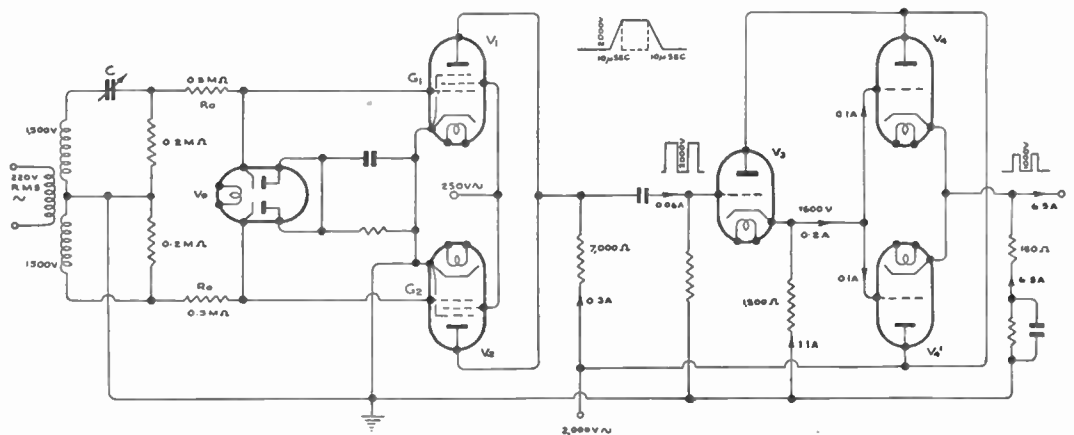

Fig. 12.—Power pulse generator producing pulses of great peak power with small receiver valves.

was required. Once these pulses were produced, the great peak power was obtained by cathode followers working as impedance transformers.

The circuit is shown in Fig. 12. A step-up transformer produces on its two secondary windings a voltage of about 1,500 volts peak at the recurrent frequency required. Each voltage is applied on the grid of a high-slope pentode, V_1 or V_2 , through a high resistance R_o . The two grids are supplied nearly in opposition of phase, the difference being adjusted by a small variable capacitor C . Resistor R_o stops the grids becoming too positive. If R_o is of the order of half a megohm, a grid current of 3 milliamperes will produce a drop of voltage of 1,500 volts. A double diode is used in order to stop the grids becoming too negative, since it may damage the valves.

The pentodes are of the high-slope type so that grid, screen and suppressor are very close to the cathode, while the anode is far off. Normal voltages are applied on the grids (through R_o), screens and suppressors so that very high voltages can be applied on the anode, especially when no current is flowing, without damaging the valves. This is obtained by applying a very high voltage, of the order of 2,000 volts on the anodes connected in parallel, through a relatively high resistor R_p . When current flows in one valve, the drop of voltage in R_p is very nearly equal to 2,000 volts so that the effective anode voltage and the power dissipated in the valves are low.→. The working diagram of this part of the

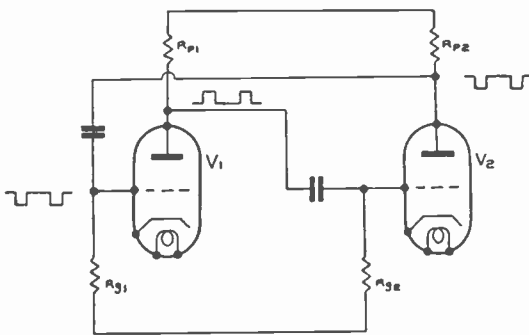

Fig. 14.—Usual multivibrator circuit used as square pulse generator.

circuit is represented in Fig. 13: (a) represents the two voltages nearly in opposition of phase applied on the grids G_1 and G_2 of the pentode

valves, V_1 and V_2 , through the resistors R_o ; (b) shows the effective voltage applied on grid G_2 ; (c) shows the anode currents I_1 and I_2 ; (d) shows the effective anode voltage; (e) shows the voltage which could be applied on the anodes through resistor R_p if A.C. supply is possible, and (f) shows the anode voltages in the latter event.

It must be observed that when the pulses appear no current flows in the pentodes and no damage to the valves by the high voltage appearing on the anodes has been noted. For valves of the Standard Telephones & Cables type 5A, 103B, R_p must be of the order of 7,000 ohms or higher.

To increase the peak power of these pulses cathode followers are used. The pulses are applied on the grid of a triode type 4033A (8.5 watts filament dissipation, 25 watts anode dissipation, slope 9) whose anode is at 2,000 volts. Output pulses are produced in the cathode across a resistor of, say, 1,500 ohms. Lower values for this resistor can be used if this valve is used as an output valve. With 500 ohms it is easy to obtain pulses of about 1,600 volts with a grid current of about 50 milliamperes. When this valve is followed by a second cathode-follower stage, it is preferable to use higher values. The output stage is formed by two 4033A valves in parallel. Pulses of about 1,000 volts are obtained in a resistor of 150 ohms. This corresponds to a peak power of 6.5 kilowatts, a cathode current of 6.5 amperes and a grid current of 200 milliamperes. For a recurrent frequency of 50 cycles it is convenient to supply all anodes in A.C. by means of transformers. Three transformers of about 75 watts each are sufficient for the whole circuit. The transformers must be designed in order to obtain a very small time constant. The build-up time of the pulses is about one-thousandth of the recurrent period, that is about 10 microseconds for a recurrent frequency of 50 cycles. The width of the pulses is adjustable by means of capacitor C .

(3.3) Power Multivibrators

By adding a cathode follower between the plate of the first valve and the grid of the second, in a multivibrator circuit, the characteristics are appreciably improved. If the multivibrator is producing sharp pulses and if the second valve works only during the duration of each pulse, the cathode follower enables this valve to be driven with considerable grid and peak cathode current. The valve then produces peak pulses of considerable

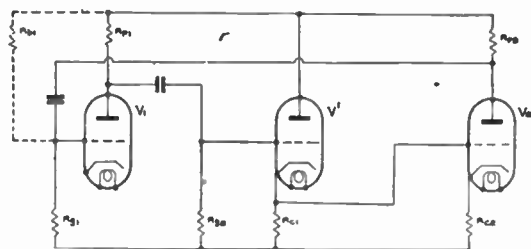

Fig. 15.—Power multivibrator. By adding a cathode follower between the first and second valve of the multivibrator of Fig. 14, the peak power of the pulses generated is considerably increased.

power, although the mean power is the rated one.

To show this, consider first a multivibrator circuit such as the one represented in Fig. 14. Assume that valve V_1 is saturated and that no current is flowing in valve V_2 . If a negative pulse is applied on the grid of V_1 , a positive pulse will appear on the grid of V_2 and current will flow in this valve. To get at this moment a sharp edge, R_{p1} and the amplifying factor of V_2 must be as great as possible. But, if R_{p1} is great, the grid-cathode capacity of V_2 affects the operation, and if the slope of V_2 is great, the grid current will become very important, thus introducing a shunt resistance across R_{p1} .

This circuit is also not very efficient when it produces pulses having a duration smaller than half the repetition period. In this case, one of the valves is working all the time except during the occurrence of the pulses and the other only during

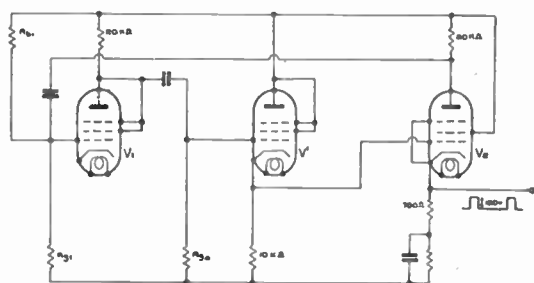

Fig. 16.—Practical power pulse multivibrator circuit.

the occurrence of the pulses. If the current flow in the first one is nearly equal to (or not too much greater than) the normal rated value, the valve will be used at about its normal dissipation rate. The second valve working only during a short fraction of time will have only a small fraction of its

normal dissipation, unless the current during the occurrence of the pulses is much greater than the normal value. But this requires a large grid current, and we have shown that this is not possible with the normal multivibrator circuit.

Add a cathode follower between the anode of the first valve and the grid of the second valve and one gets the circuit of Fig. 15. The cathode follower will transfer the pulses appearing across R_{p1} to the grid of V_2 . The load on R_{p1} will be very small because of the cathode resistor R_{c1} , and the power applied on the grid of V_2 will be great because the cathode follower impedance is usually much smaller than R_p . Besides, the capacity shunting R_p , and due to the connection of R_{p1} to the following valve, is considerably reduced.

If V_1 is an EF50 or a high-slope valve, the impedance looking from the grid of V_2 is of the order of one to some hundred ohms. This impedance is comparatively small and enables the grid of V_2 to be driven with high grid current. Thus, the peak current in valve V_2 can be made very great, easily equal to 10 or 20 times the normal rated current.

A practical example of the circuit is represented in Fig. 16. The mean cathode current in V_1 is equal to about 13 milliamps and the peak current is nearly equal to the mean current. The peak cathode current of V_1 is about 15 milliamps and the mean current less than 2 milliamps (the pulse width was about 1/20th of the repetition period). Valve V_2 had a peak cathode current of about 200 milliamps and a mean current of about 10 milliamps. Peak cathode currents as high as 300 milliamps can easily be obtained in valve V_2 .

This example shows clearly the considerable

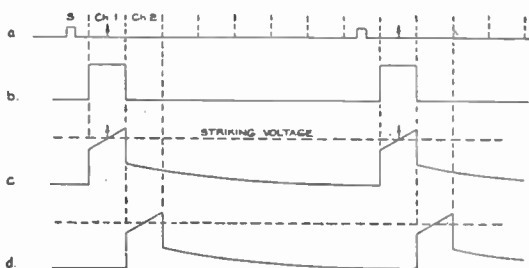

Fig. 17.—Modulation process, using trapezoidal pulses. The modulation cannot exceed the channel boundaries.

increase of power which can be obtained by the addition of a cathode follower in a multivibrator circuit.

Resistor R_{p1} in Fig. 15 is used to bias positively the grid of V_1 so that this valve becomes sensitive only to negative pulses.

This circuit has been used extensively in the Multi-channel Pulse System described in (4). For instance, the master-multivibrator feeding

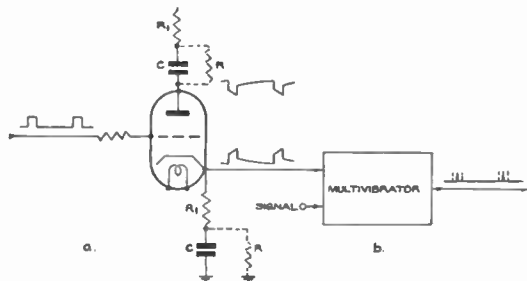

Fig. 18.—Principle of a pulse time modulator using a multivibrator and trapezoidal pulses.

the delay network distributor is a power multivibrator. It gives pulses of about 150 volts amplitude in an impedance of about 3,000 ohms, that is a peak current of 50 milliamps. The demodulator multivibrator is also of this type in order to get the required audio output without audio amplification. In general, nearly all multivibrators in the circuit are of this type.

(4) Some Notes on Pulse Modulation and Demodulation Processes

The methods of pulse modulation and demodulation have been extensively studied by the writer

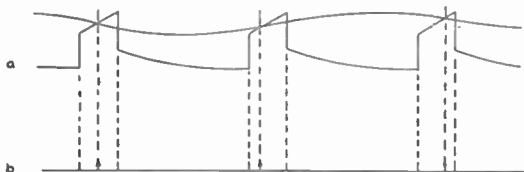

Fig. 19.—Pulse time modulation.

in a previous paper³. They will be summarily described here for completeness, the main object

of this section being to show that practical difficulties encountered when trying to produce modulator trapezoid pulses and demodulator rectangular pulses of ideal shape can be avoided by using exponential tops for these pulses. It is shown that this is a very practical solution and introduces no additional harmonic distortion.

(4.1) Modulation Process

This is a typical example of pulse technique. Consider a multi-channel system as represented in Fig. 17 and assume that we want to produce and time-modulate the pulse corresponding to channel 1. The pulse must appear in the middle position of the channel space when not modulated and must be modulated only within the boundaries of the channel.

To satisfy these requirements, we start first from the recurrent square pulse of Fig. 17(b), appearing at the beginning of the channel and disappearing

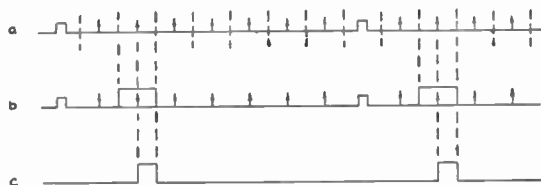

Fig. 20.—Demodulation process.

at the end. This recurrent pulse is usually supplied by the distributor, as has been explained in the preceding paragraph. This pulse is applied on the grid of a valve and is of sufficient amplitude to saturate the valve (Fig. 18a). A resistance in series with a capacity is placed either in the cathode or anode path, then the current flowing is constant during each pulse and a trapezoidal recurrent pulse of positive sign will appear on the cathode and of negative sign on the anode.

To produce the time pulse modulation, we apply this trapezoidal pulse in series with the signal on the grid of the first valve of a multivibrator. This grid is biased negatively beyond the cut-off so that normally no current flows in the valve. The bias is such that when the trapezoidal pulse appears, in the absence of signal, the grid voltage attains the striking voltage at the mid-position of the trapezoidal pulse as shown on c and d, Fig. 17. When the signal appears, the trapezoidal pulse is modulated up and down and the striking point

oscillates between the boundaries of the channel. This is clearly shown in *a* and *b*, Fig. 19. Here the striking line is represented as modulated by the signal and the trapezoidal pulses are fixed in position. It is obvious that the result is the same in both cases.

The multivibrator must be designed either to produce a very sharp pulse when striking or to strike and stop striking when the trapezoidal pulse disappears. In this case the sharp pulse is obtained by differentiation. The writer tried both solutions.

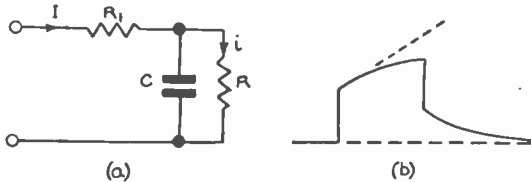

Fig. 21.—Use of an exponential top in the modulation process.

It is outside the scope of this Paper to describe these multivibrators in detail.

(4.2) Demodulation Process

The principle of the process of demodulation is to change the time modulation into width modulation. The process has some similarities with the process of modulation. We start first with a train of channel selector pulses given by the distributor in the receiver. Such a train, corresponding to channel No. 2, is represented in *b*, Fig. 20. This pulse is applied in series with the train of channel pulses on the grid of one valve of a multivibrator. This grid is biased negatively beyond cut-off so that when the selector pulse appears, the grid is just below the striking voltage. This is shown in *b*, Fig. 20. The selector pulses are adjusted to be much greater in amplitude than the channel pulses. In this way the striking line will be crossed only when the required channel pulse appears. The multivibrator will then strike and will come back to its initial state when the selector pulse will disappear. Thus we get the variable width pulses of *c*, Fig. 20. By sending these pulses through a low-pass filter, the transmitted signal is isolated.

(4.3) Elimination of Harmonic Distortion in Pulse Modulation

It would seem that because in pulse modulation information on the signals is transmitted intermittently, the harmonic distortion after demodula-

tion must be considerable. The writer studied carefully this operation and showed that the theoretical harmonic distortion for voice frequencies is almost negligible, and it has been shown later that no harmonic distortion is produced in pulse modulation.

This result is obtained by assuming that the trapezoid modulating pulses and the rectangular demodulating pulses of Figs. 15 and 16 have a perfect shape. In other words, it has been assumed that the rising top of the trapezoidal pulses is a straight line and that the top of the rectangular pulses is a straight line perfectly horizontal.

If this is not the case, harmonic distortion may occur. In practice, the pulses are never perfect because they are built by means of valves and networks. If the circuit is conveniently designed, the distortion produced by the valves can be reduced to a very small percentage since in pulse technique the valves work mainly as relays below the cut-off or at full saturation. But the networks have time constants and the pulses are distorted in passing through them. In many cases the design of distortionless circuits presents some important disadvantages, and in others the distortion is considerable and unavoidable.

As an example, consider the production of trapezoidal pulses. Fig. 18*a* shows a type of valve circuit which can be used for producing trapezoidal pulses of positive sign on the cathode and of negative sign on the anode. To the grid are applied, across a resistance of high value, pulses of amplitudes that are very great compared with the voltage swing of the grid between cut-off and grid current, so that the cathode current remains constant during the appearance of each pulse. This current will flow through resistance R_1 and condenser C . Resistor R_1 will produce the rectangular part of the trapezoidal pulse and capacitor C the rising part, but capacitor C must be shunted by a resistor R in order to discharge between the pulses and, unless R has a very great value, the shape of the triangle will be distorted and the desired linear rise will be replaced by an exponential curve.

Referring to Fig. 21, the voltage V across capacitor C is proportional to the current i flowing in resistor R , and this current is given by the differential equation :

$$R \frac{di}{dt} + \frac{i}{C} = \frac{I}{C}$$

where I is the valve current.

The corresponding operational equation is :

$$i = \frac{I}{RCp + 2} \quad \dots\dots\dots(2)$$

which gives the solution :

$$V = Ri = V_0 \left(1 - e^{-\frac{t}{RC}} \right) \dots\dots\dots(3)$$

with $V_0 = RI$. This is the exponential curve forming the top of the pulse, as shown on Fig. 21(b).

Let t_0 be the half-width of the trapezoidal pulse. Shifting the origin of time at $t = t_0$ and putting $\tau = t - t_0$ gives :

$$V = V_0 \left(1 - e^{-\frac{t_0}{RC}} e^{-\frac{\tau}{RC}} \right) = V_0 \left(1 - \alpha e^{-\frac{\tau}{RC}} \right) \dots\dots\dots(4)$$

where

$$\alpha = e^{-\frac{t_0}{RC}}$$

To evaluate how much this curve differs from a straight line, expand formula (4) :

$$V - V_0(1 - \alpha) = V_0 \frac{\alpha \tau}{RC} \left[1 - \frac{1}{2!} \frac{\tau}{RC} + \frac{1}{3!} \left(\frac{\tau}{RC} \right)^2 - \dots \right] \dots\dots\dots(5)$$

If τ is small compared with RC , formula (5) can be written in first approximation :

$$V - V_0(1 - \alpha) = V_0 \frac{\alpha}{RC} \tau \left(1 - \frac{1}{2} \frac{\tau}{RC} \right) \dots\dots\dots(6)$$

This formula shows that the second order distortion at the modulation is smaller than $\frac{1}{2}$ per cent. if τ

is smaller than 1 per cent of RC . Assume a modulation width equal to 2.5 microseconds, this means that RC must be greater than 250 microseconds. In many cases this condition can be easily fulfilled, but it has in practice some disadvantages. Referring to Fig. 19(a), the train of trapezoidal pulses has been drawn assuming the above condition and a recurrent period of 100 microseconds, which is small compared with the time constant RC . When the trapezoidal pulse reappears, capacitor C is not completely discharged. In fact, the voltage drop is equal to the voltage rise during the trapezoidal build up. Now, if the time constant RC is, say, 300 microseconds, the charge on the capacitor when a new trapezoidal pulse appears is of the order of three times the voltage drop. If distortions lower than $\frac{1}{2}$ per cent. are required, RC will have to be increased still more and the remaining voltage across C will be still greater. This voltage is a constant bias voltage on the cathode of the trapezoidal generator valve and determines the position in height of the lower boundary of the slice cut by the valve out of the applied selector pulses. If this bias voltage is very great, input pulses of great amplitude will be required.

Another important disadvantage is due to the cathode of the trapezoid generator valve being connected to the grid of a multivibrator modulator. When the trapezoid pulse appears, the grid is lifted up in voltage and attains at a certain moment the striking voltage. The multivibrator strikes and grid current appears. This current will discharge condenser C . Assume that the trapezoidal generator valve produces a current of, say, 30 milliamps during the trapezoidal pulses ; if the grid current appearing at the modulator multivibrator is of the order of 3 milliamps, and if the modulator strikes at the middle position of the trapezoidal

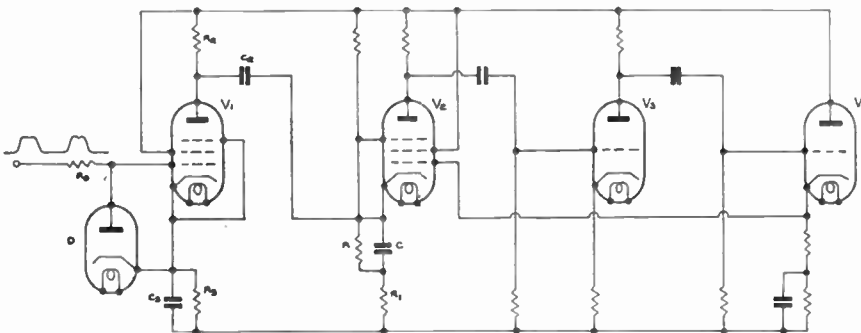

Fig. 22—Improved modulator circuit.

pulse, the discharge due to the grid current will be equal to about 5 per cent. of the build-up voltage and a great portion of this voltage will affect the height of the next trapezoidal pulse, thus shifting the position of the corresponding channel pulse and producing a harmonic distortion.

This disadvantage becomes more appreciable if the improved modulator circuit of Fig. 22 is used. In this circuit the cathode is at a fixed potential and the trapezoid is generated by the constant anode current of the pentode valve V_1 flowing in the circuit C, R, R_1 through capacitor C_2 . The resistor R_2 is used only to supply the H.T.

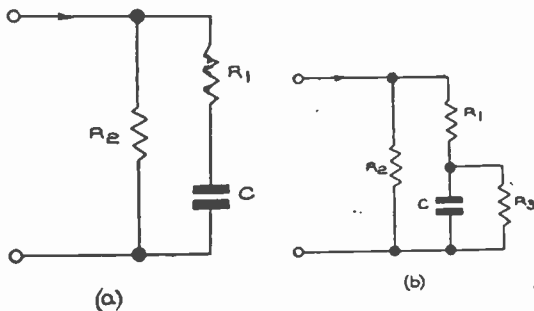

Fig. 23.—Elaborate networks. They all produce exponential shaped tops.

voltage to the anode. These trapezoidal pulses are negative and must be applied on the cathode of the first valve V_2 of the modulator-multivibrator. The modulating signal is applied on one of the grids of V_2 .

The advantage of having a fixed voltage on the cathode of V_1 is that the cathode swing is zero, and the grid swing is very small compared to the selector pulse amplitude applied through the high resistance R_0 (Fig. 22), thus the anode current is constant during the pulse. When there is an impedance in the cathode circuit, the cathode swing is equal to the trapezoid amplitude and can be of the order of 50 volts. The grid swing is no longer small compared to the selector pulse amplitude and the anode current is not absolutely constant during the presence of the selector pulses.

When the modulator multivibrator strikes, the current flowing in C is of considerable amplitude and the disadvantage mentioned above is so great that considerable harmonic distortion will appear. To avoid this distortion RC must be small com-

pared with the chopping period in order that capacitor C discharges completely before a new pulse appears. But then, as explained, the trapezoidal pulse has a very bad shape. This consideration applies also to many other types of modulator multivibrators and these circuits cannot be used without producing badly shaped pulses and considerable harmonic distortion.

It is here that a new conception must be introduced in order to avoid all these difficulties. It happens that the new conception is a very simple one and an interesting example of pulse technique. Instead of trying to produce perfectly shaped trapezoidal pulses, pulses with an exponential top are deliberately used and the harmonic distortion produced at the modulation is balanced by using conveniently shaped selector pulses at the demodulator producing the same amount of harmonic distortion but with an opposite sign. *It happens that to obtain this balance the selector demodulator pulses must have an exponential shaped top produced by a circuit having the same time constant as at the modulation.*

Before explaining the reason for this, it is emphasized that even for very complicated networks, one can always manage to obtain an exponential top built up at the transmitter. Figure 23, for example, shows two different types of more elaborate networks supplied by the constant current I flowing from the trapezoid generator valve V_1 . It can be shown that the voltage across the condenser in each of these circuits rises according to an exponential law. For Fig. 23(a), the time constant is $(R_1 + R_2)C$ and for Fig. 23(b) :

$$\frac{R_3 (R_1 + R_2)}{R_1 + R_2 + R_3} C$$

If the trapezoid and demodulator pulses are of perfect shape, when a signal of amplitude V volts is applied at the transmitter, the channel pulse will be shifted from its normal position of τ microseconds, τ being proportional to V . At the receiver the demodulator pulse will increase its width by τ microseconds, and the amount of current supplied by the pulse to the low-pass filter will be equal to a constant plus an amount proportional to τ , that is to say, to V . The same result can be obtained with exponentially shaped pulses if the time constants are nearly equal at transmitter and receiver.

If the trapezoidal pulse is exponentially built up,

when a signal voltage V is applied, the shift τ is given by :

$$V = V_0 \left(1 - \alpha e^{-\frac{\tau}{RC}} \right) \dots\dots\dots(7)$$

which is similar to equation (4).

This means that the top part of the demodulator pulses must drop slowly according to an exponential law with a time constant equal to RC .

It must be emphasized that this demonstration is correct only in first approximation, since the

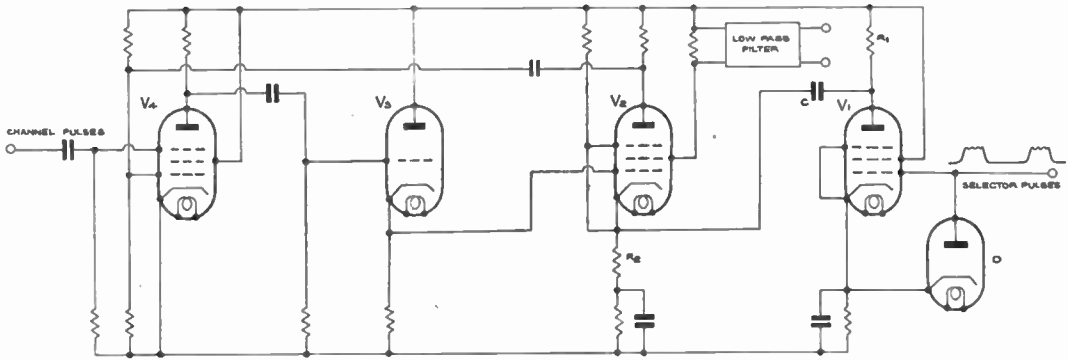

Fig. 24.—Demodulator circuit.

Now we want to find out which is the convenient shape $Y = f(\tau)$ for the variable width demodulator pulse which will give an amount of current equal to a constant plus a quantity proportional to V . This means that $Y = f(\tau)$ must be such that :

$$\int_{-t_0}^{\tau} Y d\tau = C^0 + \lambda V \dots\dots\dots(8)$$

where C^0 and λ are constants.

Replacing V by the value given by (7) gives :

$$\int_{-t_0}^{\tau} Y d\tau = C^0 + \lambda V_0 \left(1 - \alpha e^{-\frac{\tau}{RC}} \right) \dots\dots(9)$$

This equality is satisfied if :

$$Y = f(\tau) = -\alpha \lambda V_0 e^{-\frac{\tau}{RC}} \dots\dots\dots(10)$$

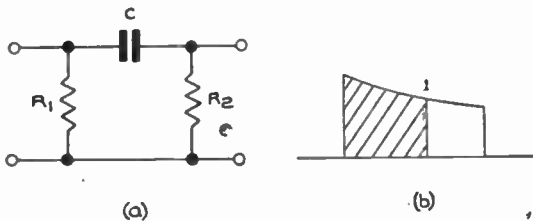

Fig. 25.—Exponential tops in the demodulation process.

above integration must be replaced by a Fourier Integral to obtain a very accurate result. The calculation is then more elaborate. For this reason it is better to consider the above result as

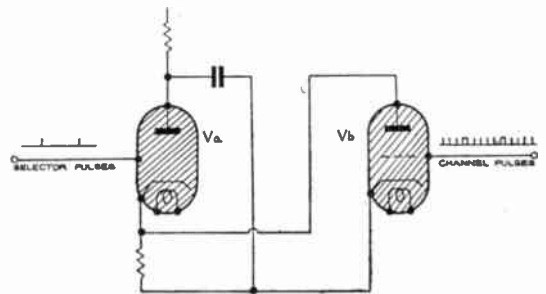

Fig. 26.—Demodulator circuit using gas-filled triodes.

correct in a first approximation and to make a final adjustment of the time constant RC at the receiver in order to get the lowest distortion possible.

For the same reason, it is advisable, where possible, not to decrease too much the time constant RC . For instance, with a chopping period of 100 microseconds and a width of modulation of 2.5 microseconds, a value of RC of the order of 25 microseconds will give good results.

The above demonstration has been done in assuming the supplying current I constant. Referring again to Fig. 8, if the selector pulse is badly shaped this will not be obtained perfectly even if R_0 is great. An improvement can be obtained by stabilizing still more the maximum grid voltage by means of a diode D connected as shown. The cathode of the diode must be biased conveniently in order to get the best results, but for simplicity in Fig. 18 it has been connected directly to the cathode of valve V_1 . Another reason why the current I supplied by V_1 can vary is that the plate voltage is dropping progressively during the trapezoid pulses. The corresponding variation is small, of the order of less than $\frac{1}{2}$ per cent of I . To balance all these variations, the time constant RC at the receiver must be slightly varied from the theoretical value.

Demodulator circuits will now be described, showing how simply can be applied the principles of exponentially shaped modulator and demodulator pulses.

Figure 24 shows a gating pulse generator connected to a demodulator multivibrator. During the gate, valve V_1 produces a constant current supplying resistor R_2 through capacitor C . The equivalent circuit is shown on Fig. 25(a), and the gating pulse produced across R_2 is shown on Fig. 25(b). The demodulator multivibrator strikes

at point 1 and the pulse is stopped at that point. This point can move from one end to the other of the gate. It is clear that the shape of the top portion of the gating pulse is exponential with a time constant equal to $C(R_1 + R_2)$. If this time constant is equal to RC the distortion will be minimum. This condition can be satisfied very easily.

Figure 26 shows a type of demodulator using gas-filled triodes, producing the same type of pulses as on Fig. 25 (b). Here, when a sharp selector pulse appears, valve V_a strikes and capacitor C discharges slowly through resistor R_1 , until the next channel pulse appears on the grid of V_b , strikes this valve, and short circuits R , thus discharging C completely.

(5) Bibliography

1. M. Levy. "Fourier Series." *Journal of the Brit. I.R.E.*, March-May, 1946, pp. 64-73.
2. M. Levy. "Power Pulse Generator." *Wireless Engineer*. Vol. XXIII, July 1946, p. 192.
3. M. Levy. "Pulse Modulation and Demodulation Theory." *Journal of the Brit. I.R.E.* Vol. VII, March-April, 1947, p. 64.
4. M. Levy. "Transmission by Pulse Modulation." A new method for the design of pulse multi-channel systems. (A paper awaiting permission to be published.)

THE KLYSTRON AS AMPLIFIER AT CENTIMETRIC WAVELENGTHS†

by

R. Kompfner, Dipl. Ing.*

A Paper read before the Institution's Radio Convention, held at Bournemouth in May, 1947

(1) Introduction

It is well known that considerable improvement in sensitivity is obtained with receivers at the longer wavelengths when one or more stages of R.F. amplification are added. At the shorter wavelengths, between the decimetric and centimetric ranges, little improvement is obtained from the use of ordinary triodes, partly due to difficulties connected with transit times, which now become an appreciable fraction of the period. Here the crystal rectifier, used as a converter or mixer, enables sensitivities to be obtained which are not approached by any conventional type of valve. However, a receiver employing a crystal mixer is commonly still somewhere between 10 and 100 times less sensitive than an ideal receiver could be. It seemed therefore of some importance to make an investigation of various unconventional types of R.F. amplifiers, in the hope of finding one which would enable a gain over the crystal mixer to be obtained.

The klystron is an obvious first choice for such an amplifier and the following sections are devoted to a detailed examination of its properties with special regard to its sensitivity, expressed by the so-called noise factor. Very little of the theoretical treatment is new, as the klystron has already been treated extensively in the literature. However, it has been thought advisable to include everything in the interests of continuity and clarity.

No specific suggestions about klystron design are made and no possible values of parameter likely to be obtained in practice are suggested. Such will depend to a very great extent on the precise construction which might be adopted, and a little experience has made it obvious that usable values are not easy to obtain. However, it is hoped that the results of the theory given will show that, in principle, the case of the klystron as a sensitive amplifier is by no means hopeless, and this may be taken as a justification for presenting the theory of the klystron in such detail.

† U.D.C. No. 621.385.831.029.64.
 Manuscript received March, 1947.
 * Clarendon Laboratory.

(2) Amplification

Consider the simplified model of a klystron shown in Fig. 1. An equipotential cathode of a cm² area is emitting a space-charge limited parallel stream of electrons, current density j_0 , total current $I_0 = aj_0$. Let the cathode potential be $-U$ volts in respect of the first grid of the buncher (grid 1), so that the current density at 1 is given by Child's equation.

$$j_0 = \frac{1}{9\pi} \left(\frac{2e}{m} \right)^{\frac{1}{2}} U^{\frac{3}{2}} I_0^{-2} \dots \dots \dots (1)$$

electrons arriving at 1 with the velocity v_0 where

$$v_0 = \left(\frac{2e}{m} U \right)^{\frac{1}{2}} \dots \dots \dots (2)$$

It is assumed that the electrons are flowing in a parallel uniform stream, as if all electrodes were infinite planes with the electron flow extending throughout the space between them.⁽¹⁾

Let a signal voltage exist across the buncher grids 1 and 2 of the form

$$V \sin \omega t \dots \dots \dots (3)$$

where

$$\omega/2\pi = \text{signal frequency.}$$

The actual energy increments given to the electrons during their passage from 1 to 2 will correspond to a voltage less than V by factor commonly denoted by β . This factor will depend on the geometry of the grids and is not easily calculated in the general case. However, if the grids were ideal, that is, perfectly plane transmitting membranes a distance d cms apart,

$$\beta = \frac{\sin \omega d/2v_0}{\omega d/2v_0} \dots \dots \dots (4)$$

Thus the voltage acting on the electron beam at the buncher is

$$\beta_B V \sin \omega t \dots \dots \dots (5)$$

⁽¹⁾ J. R. Pierce, J. Appl. Phys. 11, 548 (1940) has shown that this is indeed physically realisable.

which voltage we can imagine to be located at a plane somewhere between 1 and 2. Similarly there is a plane somewhere between 3 and 4 which we take to be the effective location of the voltage between the catcher grids. The space between these two reference planes, distance l cms apart, will be referred to as the drift-space. No particular assumptions are made at present about the drift-space, except that all electrons traverse it in the time T in the absence of any signal in the buncher.

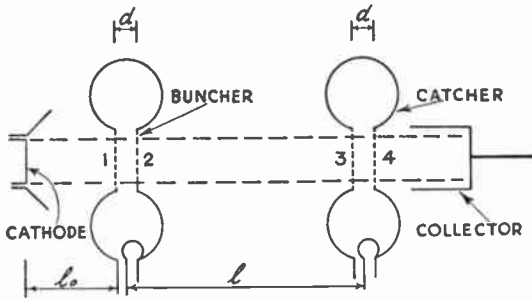

Fig. 1—Diagram of klystron

It has been shown⁽²⁾ that under certain conditions, usually met in practice, the current density at l is given by

$$j(l) = j_0 \left[1 + \frac{\beta_B V \omega T}{2U} \cos \omega(t - T) \right] \dots (6)$$

Hence the amplitude of the A.C. convection current flowing through the catcher is

$$\frac{I_0 \beta_B V \omega T}{2U} \dots (7)$$

It can be shown that the amplitude of the current flowing in the catcher, which is matched to the output line and the impedance of which is Z_c , is reduced by the same kind of coupling factor β as occurs in connection with the buncher grids. Thus, an equivalent trans-conductance can be defined, connecting the voltage in the buncher with the current in the catcher :

$$G = \frac{I_0 \beta_B \beta_C \omega T}{2U} \dots (8)$$

The power in the catcher is

$$\frac{1}{2} (GV)^2 Z_c \dots (9)$$

one half of which is at most available as output power, denoted by W_{OUT} . If V , the peak voltage across the buncher, is expressed in terms of the available input power W_{IN} and the buncher impedance Z_B , (the buncher being matched to the input line) namely,

$$|V| = \left(2W_{IN} Z_B \right)^{\frac{1}{2}} \dots (10)$$

we obtain for the power amplification of the klystron

$$A = \frac{W_{OUT}}{W_{IN}} = \frac{1}{2} G^2 Z_B Z_c \dots (11)$$

At frequencies where klystrons are likely to be employed voltages are difficult to measure and are often indeed meaningless. That is why it is preferred to express conclusions in terms more amenable to measurement, such as power.

Since G is inversely proportional to U , the power amplification appears to be inversely proportional to the square of U , the beam voltage. However, this would be taking too simple a view of the matter since U also enters implicitly into I_0 , T and β . The fact that klystrons, in practice, do not amplify below a certain voltage can be explained by the very rapid decrease of β with U . On the other hand an increase in U will cause no further increase in A once β approaches its maximum value of unity. Thus, is explained the importance of the β -factor in practice.

If space-charge effects could be neglected, T is simply given by l/v_0 ; however, such a klystron will have but a low amplification. In practice I_0 is made as large as possible and space-charge repulsion sets a definite limit on l and consequently on T . As the current is increased from a low value, a potential minimum develops at the middle of the drift-space, causing a slowing-down of the electrons there until a point is reached when conditions become unstable and some of the beam current is returned to the cathode. Just short of reaching this state of affairs the transit time T is exactly 1.5 times the no-space-charge transit-time and the current density is equal to that flowing in a planar Langmuir diode having an electrode separation $\sqrt{2}/4.l$ at a p.d. of U volts. The potential at the minimum is then exactly $\frac{1}{2}U$. Hence, it should be possible to estimate T to a fair degree of accuracy once the geometry of the valve is known.

⁽²⁾ W. H. J. Fuchs and R. Kompfner, Proc.Phys.Soc. 54, 135 (1942)

(3) Noise

In any process of amplification noise is inevitably added to the signal and the klystron is no exception to this rule. In order to assess the magnitude of the deterioration we define the noise factor N of a klystron amplifier by

$$N = \frac{S/N - \text{ratio at input}}{S/N - \text{ratio at output}} \dots\dots(12)$$

(S/N standing for signal-to-noise).

The requisite S/N ratios will be obtained from a more detailed examination of the klystron as follows.

There is a Johnson-noise voltage across the buncher grids expressed by the mean square voltage

$$\overline{V_B^2} = 4kTBZ_B \dots\dots\dots(13)$$

where k = Boltzmann's konstant = $1.37 \cdot 10^{-23}$ joule/degree

T = Temperature of the resistive component of the buncher impedance, usually room temperature (290°K)

B = Bandwidth in cycles over which noise competes with the signal.

We restrict our analysis to a narrow band of frequencies around the resonant frequency of the buncher and catcher, and we regard Z_B and Z_C as purely resistive impedances.

$\overline{V_B^2}$ will be amplified in the same way as a signal, giving rise to a mean square voltage in the catcher of

$$Z_C^2 G^2 \overline{V_B^2} \dots\dots\dots(14)$$

A beam current I_0 passing through the buncher will excite a noise voltage there due to its having fluctuational components, the so-called shot-noise. The latter is defined by the mean square current

$$\overline{I_B^2} = 2eI_0 B \Gamma^2 \dots\dots\dots(15)$$

Γ^2 is the so-called space-charge smoothing factor which normally applies when current is taken from a cathode under space-charge limited conditions.

The noise voltage excited in the buncher by the shot-noise is then

$$\overline{V_{BB}^2} = 2eI_0 B \Gamma^2 \beta_B^2 Z_B^2 \dots\dots\dots(16)$$

This is also amplified in the same way as the signal and will appear as a noise voltage in the catcher the mean square of which is

$$Z_C^2 G^2 \overline{V_{BB}^2} \dots\dots\dots(17)$$

This noise contribution is usually called the "amplified" shot-noise, a very apt description.

The beam also excites the catcher directly by virtue of its shot-noise component, giving rise there to a mean square voltage of

$$\overline{V_{BO}^2} = 2eI_0 B \Gamma^2 \beta_C^2 Z_C^2 \dots\dots\dots(18)$$

Lastly, there is the Johnson-noise voltage in the catcher, given by

$$V_C^2 = 4kTBZ_C \dots\dots\dots(19)$$

Adding all the separate mean square noise voltages in the catcher gives the total noise voltage there, i.e.

$$\overline{V_{TOTAL}^2} = Z_C^2 G^2 (\overline{V_B^2} + \overline{V_{BB}^2}) + \overline{V_C^2} + \overline{V_{BO}^2} \dots\dots(20)$$

Let the signal power available at the input to the buncher equal

$$kTB \dots\dots\dots(21)$$

that is, equal to the noise power generated in an aerial at temperature T which is matched to the buncher. Then the S/N ratio at the input, is unity. The S/N ratio at the output from the catcher is

$$\frac{kTBA}{\overline{V_{TOTAL}^2}/2Z_C} \dots\dots\dots(22)$$

Hence

$$N = \frac{\overline{V_{TOTAL}^2}/2Z_C}{kTBA} \dots\dots\dots(23)$$

To simplify matters let

$$Z_B = Z_C = Z \dots\dots\dots(24)$$

$$\beta_B = \beta_C = \beta$$

The expression for the noise factor can then be written

$$N = 4 \left(1 + \frac{e}{2kT} \Gamma^2 I_0 \beta^2 Z \right) \left(\frac{1}{2A} + 1 \right) \dots(25)$$

For practical purposes, since $A \gg 1$

$$N = \frac{2e}{kT} \Gamma^2 I_0 \beta^2 Z \dots\dots\dots(26)$$

The preceding analysis is based on the assumption that the squares of the noise voltages just add. This, however, is a rather pessimistic view to take as will be shown in the next section. Both the shot-noise induced in the catcher and the so-called amplified shot-noise owe their origin to the same electrons; that is to say to the same fluctuations in the electron stream. Hence, it should be possible, in principle, to play out one against the other with

ensuing mutual destruction or, at least, with partial compensation. This does not contradict any law of nature as might perhaps be suggested. Admittedly, thermal fluctuation noise, (Johnson-noise), will always be present. Shot-noise, however, is in a different category and the amount of such noise is purely a function of the particular mechanism of amplification adopted. Triodes at medium frequencies, for instance, are very near to being ideal amplifiers with values of N near to the best possible value of unity.

(4) Noise Reduction

In order to see how at least a partial compensation of shot-noise can be achieved it is necessary to take a somewhat more microscopic view of the process of velocity-modulation as applied to shot-noise.

We shall make some simplifying assumptions : shot-noise will be represented by a purely sinusoidal amplitude modulation of signal-frequency on the beam current, its r.m.s. value being equal to

$$\Gamma(2eI_0B)^{\frac{1}{2}} \dots \dots \dots (27)$$

Further, the Q values of buncher and catcher are assumed to be equal and very high ; at resonance, that is, at the signal frequency, buncher and catcher are pure resistive impedances of equal magnitude.

With velocity-modulation those electrons which pass through the buncher grids when the voltage there is zero (changing from negative to positive) form the centre of a bunch and form the peaks of the resulting amplitude modulation. The reason is that only then have we a sequence in time of electrons with gradually increasing velocities ; such electrons drift closer together, and eventually they may even overtake each other. However, this is equivalent to introducing a 90 degrees phase-shift which can also be deduced by comparing equations (3) and (6) in section 2.

Let the initial shot-current at the buncher be represented by

$$\Gamma(4eI_0B)^{\frac{1}{2}} \sin \omega t = i_s \sin \omega t \dots \dots \dots (28)$$

The shot-current induced in the catcher can be written

$$i_o = \beta i_s \sin (\omega t - \omega T) \dots \dots \dots (29)$$

Now, i_s induces a shot-voltage in the buncher of

$$i_s \beta Z_B \sin \omega t \dots \dots \dots (30)$$

According to (6) and (8) this gives rise to a current in the catcher of

$$i_o' = G i_s \beta Z_B \cos (\omega t - \omega T) \dots (31)$$

which is what has been called the amplified shot-noise current, and it seen that it is 90 degrees out of phase with the primary shot-current i_o in the catcher.

Suppose it were possible to shift i_o' by a further 90 degrees, making 180 degrees in all, and also choose the klystron parameters such that

$$GZ_B' = 1 \dots \dots \dots (32)$$

(where $Z_B' \ll Z_B$) at the same time, then

$$i_o = -i_o' \dots \dots \dots (33)$$

that is, the two currents would be equal in amplitude and opposite in phase, and the net shot-noise in the catcher would be zero.

A question immediately arises : would there be any useful amplification left ? The answer is : yes. Referring to equation (11) it will be seen that the power amplification is only reduced to

$$A' = \frac{1}{2} GZ_0 \dots \dots \dots (34)$$

so that if, initially, there were an amplification by, say, a factor 200, we should still expect an amplification, after shot-noise had been " compensated", by about 10, which is worth having.

In fact, complete compensation of shot-noise cannot be achieved, and to find the resultant noise factor of the klystron let us examine a possible mechanism by means of which the additional phase shift of the amplified shot-noise can be achieved. An extra phase-shift of nearly 90 degrees can be achieved simply by detuning the buncher by a certain frequency, making it a capacitive reactance. Let the buncher be represented by a parallel resonant circuit having a very high " Q " (around 1,000), and a shunt-impedance Z_B at resonance, that is at the signal frequency $\omega/2\pi$. By detuning the buncher to the frequency $\omega'/2\pi$, we will reduce the absolute magnitude of the shunt-impedance to Z'_B such that

$$Z'_B = \frac{1}{G} \dots \dots \dots (35)$$

producing a phase shift ϕ at the same time where

$$\tan \phi = Q \left[\left(\frac{\omega}{\omega'} \right)^2 - 1 \right] \dots \dots \dots (36)$$

We have at frequencies sufficiently far from resonance⁽³⁾

$$Z'_B = Z_B \left[Q \frac{\omega'}{\omega} \left\{ \left(\frac{\omega}{\omega'} \right)^2 - 1 \right\} \right]^{-1} \dots \dots \dots (37)$$

⁽³⁾ See Terman. Radio Engineer's Handbook. p. 141

which can be solved approximately for ω' ; $(\omega' - \omega)/2\pi$ gives the amount by which the buncher frequency has to be changed, i.e.

$$\omega' - \omega = \frac{Z_B G}{2Q} \omega \dots\dots\dots(38)$$

When this is inserted into (36) we obtain the phase shift,

$$\tan \varphi = \frac{Z_B}{Z'_B} = Z_B G \dots\dots\dots(39)$$

A consideration of the vector diagram, Fig. 2, shows that the amplitude of the residual shot-noise current in the catcher i_r is given sufficiently well by

$$|i_r| \sim \frac{i_c}{\tan \varphi} = \frac{\beta i_s}{Z_B G} \dots\dots\dots(40)$$

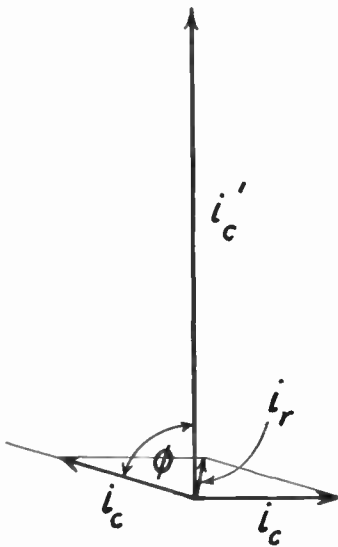

Fig. 2.—Vector diagram of shot currents in catcher

Without detuning, the amplitude of the amplified shot-noise current in the catcher would have been

$$i_s \beta Z_B G \dots\dots\dots(41)$$

Hence the principal noise component has been reduced by a factor

$$Z_B^2 G^2 \dots\dots\dots(42)$$

in voltage, or

$$Z_B^4 G^4 \dots\dots\dots(43)$$

in power.

Introducing the new values into equation (23)

we obtain now for the noise factor N' with shot-noise compensation

$$N' = 4 \left(1 + \frac{1}{2A'} \right) + \frac{2e}{kT} \Gamma^2 \frac{\beta^2 Z_B I}{(2A')^3} \dots(44)$$

This represents a considerable improvement indeed, even taking into account that the power amplification A has been reduced to

$$A' = \sqrt{\frac{A}{2}}$$

The foregoing calculation is only a rough estimate. Strictly speaking, we should have assumed a value for Z_B , the impedance at resonance of the buncher, and proceeded to vary φ until minimum shot-noise is obtained in the catcher, or better still, until the S/N ratio at the output is a maximum. This is, of course, the way in which experiment would proceed, but to carry out the calculation in this way is considered to be over-meticulous, in view of the difficulties which stand in the way of a practical realisation of such a scheme.

For this scheme of noise compensation to succeed, the following points are of importance :

- (a) the klystron must have a large amplification initially.
- (b) Z_B before detuning, must be much larger than $1/G$.
- (c) The Q-values of buncher and catcher must be identical.⁽⁴⁾
- (d) The β -values of the electron beam should be the same in respect of the buncher and in respect of the catcher, both on the average, and for individual current filaments.
- (e) Transit times should be equal for all electrons, in the absence of a signal. This is very difficult of fulfilment if for no other reason than that of the spread of initial velocities of emission due to the mechanism of thermionic emission.

Non-realisation of any of these points will make the possible S/N-gain due to shot-noise compensation very much less than theoretically expected. This may also account for the

⁽⁴⁾ This has been pointed out by Dr. R. R. Nimmo of Birmingham University, in an unpublished note, where the subject of noise compensation is treated on the basis of shock-excitation of circuits by the passage of single electrons.

remarkable fact that, up to the present time no experiments have been reported in which a noise reduction had been observed in consequence of detuning of the buncher.

The possibility of noise reduction in klystrons by detuning the buncher has been discussed theoretically by J. Müller,⁽⁵⁾ and by F. Lüdi,⁽⁶⁾ who arrive at results disagreeing between themselves, and also disagreeing with the analysis given above. The cause of the disagreement can, perhaps, be found in the adoption of divergent basic assumptions by everybody.

(5) Experimental

When in 1941 experimental work was started on the klystron as an R.F. amplifier, it was generally understood that the klystron was very bad as an amplifier of very small signals, with noise factors between 1,000 and 10,000. From an unpublished study by Professor P. B. Moon, it appeared that a klystron with a not unreasonably bad noise factor could be made, provided the beam voltage was chosen low enough. However, views were current at the time that some "extra" noise was unavoidably present in any device employing a long electron beam, such as used in a klystron, i.e. shot-current over and above $2eIB$. Hence, as a preliminary, it was decided to measure the noise in a long beam as a function of distance from the cathode.

A klystron was constructed using the now well-known copper-disc, glass seal technique, having grid-less apertures in the rhumbatrons (to prevent interception of the beam), 10 cms apart. The electron gun was of the Pierce-type, and it was endeavoured to produce a field between buncher and catcher which would simulate conditions prevailing when there is parallel flow of electrons between two infinite plane electrodes. To improve the β -factors of buncher and catcher these electrodes were held at a substantially higher potential than the rest of the electrodes. Typical running conditions were :

Beam voltage	80 volts
Total beam current	0.5 mA
Collector current	0.45 mA
Rhumbatron voltage	500 volts
Power amplification between 1/10 and 1/100	

The measurement consisted in comparing the noise power coupled out of the beam by the

buncher, with that coupled out of the beam by the catcher, and finally comparing both with the receiver noise power, the last being measured periodically in absolute terms.

The measurements established that there is no significant increase in noise power of the beam at the catcher over that in the buncher. The highest increase was of the order of 10 per cent, which was about the experimental error. Further, it was found that the beam is considerably less "random" than purely random,—in other words, Γ^2 , the space-charge smoothing factor was less than unity,—about 1/5 to 1/10,—if there was no turning back of electrons. When the collector was made negative in respect of the cathode, Γ^2 increased occasionally, to well above unity.

The effective shunt impedances of the rhumbatrons proved to be the parameters most difficult to measure. A knowledge of this parameter is essential for a correct estimate of Γ^2 and also for checking the performance of the klystron with theory. Various methods were used and the most reliable was found to be the so-called "slide-back" method, provided it was ensured that electrons did not traverse the rhumbatron gap more than once.

A brief description of the "slide-back" method is as follows: An electron beam of constant current and voltage is shot across the gap of a rhumbatron, the shunt-impedance of which is required. The beam is collected by an electrode and a plot is made of the current collected by this electrode against its potential, (in respect to cathode). In principle, if that potential is just equal to the potential of the cathode whence the beam emerges, no current should be collected. A slight increase in collector potential should cause the whole beam to be collected. In practice, because of contact potentials, misalignments, etc., the plot usually takes the form of an S-curve, with a short "tail" extending to negative potentials.

Let a known amount of R.F. power W be injected into the rhumbatron under investigation. This will give rise to an R.F. voltage across the gap, which in turn will cause an energy modulation of the beam, some electrons gaining energy, some losing. It will be observed now that the shape of the plot is changed, the "tail" being elongated by a definite amount. That is to say, to reduce the collector current to zero, we have to increase the negative potential of the collector by ΔV . It is

⁽⁵⁾ Zeitschr. für Hochfr. 60, 20 (1942)

⁽⁶⁾ Helv. Phys. Acta 19, 355 (1946)

clear that this is equal in magnitude to the peak "voltage" given to the electrons. Let the real R.F. voltage be given by

$$\frac{V^2}{Z} = W$$

Then we have

$$\Delta V = \beta\sqrt{2} V$$

and

$$\beta^2 Z = \frac{(\Delta V)^2}{2W}$$

Unfortunately, this method always over-estimates the shunt impedance, and the error may be quite large, depending a great deal on the distribution of the beam current while passing through the gap.

Sufficient data were obtained however to show that to make a klystron which would give a significant improvement in the S/N-ratio over other known devices would be a very difficult task indeed. The chief difficulty seemed to be connected with the impossibility of obtaining high

enough β -factors without causing partial interception of the beam, which in turn would introduce yet another source of noise, namely, the so-called division noise.

Therefore, a good deal of attention was given to other possible means of R.F. amplification, such as beam deflection tubes, and eventually to a tube of the travelling wave type. The latter⁽⁷⁾ did, indeed, soon give the promise of a fairly sensitive R.F. amplifier and no further work was done on the klystron.

(6) Acknowledgments

The work described above was carried out at Birmingham University, Physics Department, during the years 1941-1942 on behalf of the Admiralty, and is published with their permission.

The author wishes to express his sense of obligation to Professor P. B. Moon, of Birmingham University, for guidance and many discussions.

⁽⁷⁾ R. Kompfner. The Travelling Wave Tube as a Amplifier at Microwaves. Proc. I.R.E. 35, p.124 (1947).

CONVENTION DISCUSSION

Mr. W. H. Aldous : It was very interesting to hear the author's exposition on noise reduction by detuning of the buncher resonator. Similar effects can be predicted and have been observed in pentode short wave circuits at frequencies where shot-noise is induced in the grid circuit. Here, detuning from the position of maximum gain will give an increase in signal-to-noise ratio.

A comparable effect can occur in diode mixers where the total shot-noise is due, not only to that directly produced in the I.F. circuit, but also to that produced in the R.F. circuit, which is frequency-changed, to appear in the I.F. circuit. Under suitable circuit conditions, since both components of noise are due to the same electrons, theoretically there can be considerable reduction of the total noise. This is because a vectorial summation must be made of the components, as in the author's case, and not a mean square summation as is often assumed.

Mr. J. A. Sargrove (Member) : If the experi-

ment showed that there appeared to be no increase in noise in the catcher, compared to the buncher ; but this experiment was conducted in a klystron having an effective amplification less than unity ; hence, does this not mean that if the tube had had a greater amplification it would have produced larger noise. Does this not render the actual conclusion in this case valueless ?

Mr. A. V. J. Martin (Associate) : Would there be any improvement brought about by the use of some magnetic field acting upon the electron beam ?

Dr. M. J. O. Strutt : Was the value of Γ^2 in the beautiful experiment carried out by Mr. Kompfner, ascertaining the homogeneous character of the noise along the electron beam, about 0.1 ?

Was any pre-circuit ever tried theoretically or experimentally in the noise-reduction work on klystrons ?

REPLY TO THE DISCUSSION

Mr. R. Kompfner : Referring to Mr. J. A. Sargrove's query : when measuring the shot-noise at the catcher, the buncher was always adjusted to have a resonant frequency far away from that of the buncher. Hence, the shot-noise measured at the catcher was practically only that due to the inherent shot-noise in the beam itself, and this was compared with the similar shot-noise measured at the buncher. Thus, the question of "amplified shot-noise" does not arise.

In reply to Mr. A. V. J. Martin, the author said that with comparatively weak electron beams, say under one milliampere beam current, a homogeneous magnetic field may well result in some improvement in respect of focusing. With stronger beams, such as could be needed to give considerable

amplification, difficulties might arise due to the influence of the space-charge in the beam on the potential distribution in the drift-space, resulting in inequalities of transit-time of different filaments of the beam, which in turn would result in a loss of amplification.

In answer to Dr. M. J. O. Strutt : the experiment on the homogeneity of the electron beam in respect of noise was carried out with several values of Γ^2 , (the space-charge smoothing factor), one of which was of the order of 0.1.

A pre-circuit, that is, a third rhumbatron, was investigated theoretically at one time, with a view to obtaining noise-reduction, but no experiments have been carried out with such an arrangement.

THE INSTITUTION'S LIBRARY

Additions

The following books are amongst those added to the Institution's Library since the publication of the Catalogue. They are available on loan to all members.

	Index No.
Aharoni, J. <i>Antennae. An Introduction to their theory</i> , 1946	706
Amos, S. W. and Kellaway, F. W. <i>Radio Receivers and Transmitters</i> , 1944	596
Brainerd, J. G., Koehler, G., Reich, H. J., and Woodruff, L. F. <i>Ultra-High Frequency Techniques</i> , 1942	660
Cady, W. G. <i>Piezo-electricity</i> , 1946	696
Cocking, W. T. <i>Television Receiving Equipment. 2nd Edition</i> , 1947	695
Colebrook, F. M. <i>Basic Mathematics for Radio Students</i> , 1946	680
Gabor, D. <i>The Electron Microscope</i> , 1944	661
Massachusetts Institute of Technology. <i>Principles of Radar. 2nd Edition</i> , 1946	692
Pender, H., and McIlwain, K. <i>Electrical Engineers' Handbook. Electric Communication and Electronics. 3rd Edition</i>	639
Smith, C. E. <i>Applied Mathematics for Radio and Communication Engineers</i> , 1945	687
Sommer, A. <i>Photo-electric Cells</i> , 1946	703
Warren, A. G. <i>Mathematics applied to Electrical Engineering</i> , 1944	686
Watson, W. H. <i>The Physical Principles of Wave Guide Transmission and Antenna Systems</i> , 1947	714

Zepler, E. E. <i>The Technique of Radio Design</i> , 1945	671
Zworykin, V. K., Morton, G. A., Ramberg, E. G., Hillier, J., and Vance, A. W. <i>Electron Optics and the Electron Microscope</i> , 1945	701

Journals Wanted

Back numbers of various Journals are required in the Library to complete volumes for binding. Members who have any of the following issues for disposal, please inform the Librarian, who will be glad to refund postage.

Bell System Technical Journal, 1943, No. 4. Any issues before 1943.

Electronic Engineering, September, 1944.

Proceedings of Institute of Radio Engineers, January, April, June, August, September, 1943. Any issues from 1936 to 1939.

Wireless Engineer, 1940, 1942 and 1944.

Books on loan

The following books have been out on loan for some considerable time and their return is now overdue. They are in demand by other members of the Institution and the Librarian would be grateful for their early return.

High Frequency Thermionic Tubes. No. 514.

Proceedings of the Institute of Radio Engineers, 1937.

Radio Designers' Handbook, No. 630.

Wave Guides, No. 493.

Wave Motion and Sound, No. 495.

Wireless Engineer, Volumes XVII, 1940 and XIX, 1942.