

02744  
C

\$1.00

# RADIO TV REPAIR 1973

Another  
**Science &  
Mechanics**  
Do-It-Yourself  
Consumer Guide



## DOLLAR SAVING REPAIR IDEAS

- Replace a TV Tuner!
- Install a Color Tube!
- Build a Speaker System!
- Repair an AM Radio!
- Erect a Rooftop TV Tower!
- Put the Color back!

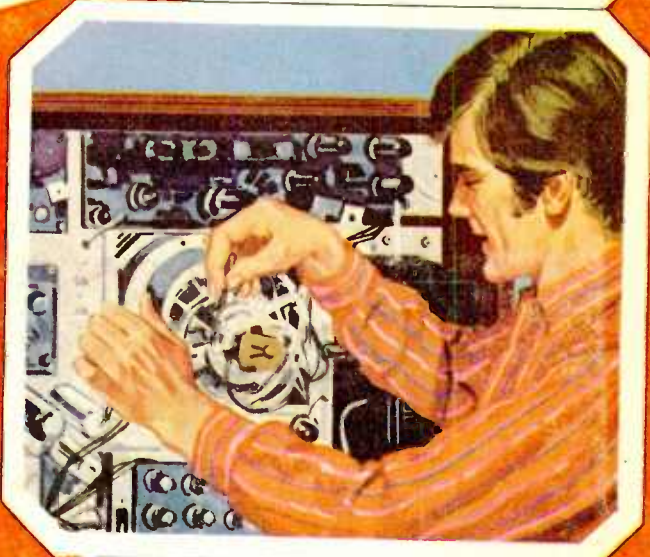

## PLUS

- 8 steps to Cartridge Player Repair
- 10 steps to Cassette Player Repair
- 1 steps to Walkie-Talkie Repair
- 21 steps to TV Set Cure Alls



...and much more!

# Discover the ease and excitement of learning Electronics with programmed equipment NRI Sends you

When you train at home with NRI, you train with your hands as well as your head. You learn the WHY of Electronics, Communications, TV-Radio the NRI pioneering "3-Dimensional" way. NRI training is the result of more than half a century of simplifying, organizing, dramatizing subject matter, and providing personal services unique for a home study school. You get the kind of technical training that gives you priceless confidence as you gain experience equal to many, many months of training on the job.



*NRI—The Leader in Electronics Training for more than Fifty Years*

## APPROVED UNDER NEW GI BILL

If you served since January 31, 1955, or are in service, check GI line in postage-free card.



*Earn \$5 to \$7 an hour  
spare or full time in*

## **TV-RADIO SERVICING**

Color television sales are soaring. And so is the demand for trained repairmen. If you can service TV sets, portable radios, tape recorders, hi-fi sets, phonographs and auto radios, you'll always be in demand. It's one of your best routes to spare-time earnings, a good paying job or a business of your own. NRI trains you quickly and expertly, showing you how to get started in servicing soon after you enroll, earning as you learn. NRI trains you in today's method of installing and repairing all electronic equipment for the home—including solid state Color TV. You even build, experiment with and keep to enjoy your own solid-state radio plus your choice of black-and-white or the new 25" solid state Color TV receiver NRI developed from the chassis up for training. Like thousands of others, you can soon be earning good money in your spare time . . . the easy NRI way.

*There's money and  
success awaiting you in*

## **BROADCASTING— COMMUNICATIONS**

The experience you gain from intensely practical NRI training in Complete Communications equals as much as two years of training on the job. With NRI, you can train for a choice of careers ranging from mobile, marine and aviation radio to TV broadcasting and space communications. You learn how to install, maintain and operate today's remarkable transmitting and receiving equipment by actually *doing* it. You build and experiment with test equipment, like a VTVM you keep. You build and operate amplifier circuits, transmission line and antenna systems, even build and use a phone-cw transmitter suitable for transmission on the 80-meter amateur band. Whichever of five NRI Communications courses you choose, you prepare for your FCC License exams, and you must pass your FCC exams or NRI refunds your tuition in full.

*Move ahead in America's  
fast growing industry as*

## **ELECTRONICS TECHNICIAN**

Electronics touches everyone's lives. This vast field of opportunity is open to you with NRI training. Industrial/Military Electronics training—like all NRI courses—prepares you quickly, thoroughly the practical "hands on" way. You build with, and learn to understand the functions of, today's miracle solid-state components like printed circuits, diodes and transistors. You build and experiment with Electronic circuitry used in automation, data processing, ultrasonics, telemetry. Bite-size texts make studying easier. Whatever your interest in Electronics, NRI training can fill your needs. Prove to yourself what nearly a million NRI students could tell you . . . that you get more for your money from NRI. Check the postage-free card and mail it today for your FREE NRI Color Catalog. NO SALESMAN WILL CALL. NRI Training, 3939 Wisconsin Ave., Washington, D.C. 20016.

# **YOU GET MORE FOR YOUR MONEY FROM NRI**



## **NRI Kits and Equipment**

Dollar for dollar, you get more value from NRI training kits, because they are designed as educational tools. In the TV-Radio Servicing Course, for instance, the end product is a superb 25" color TV your whole family will enjoy. The set is designed so that, while building it, you can introduce and correct defects . . . for trouble-shooting and hands-on experience in circuitry and servicing. The kits include, at no additional cost, a wide-band service type oscilloscope and color crosshatch generator, and other valuable equipment that will let you start earning money in your spare time making repairs . . . even before the course is completed.

# RADIO TV REPAIR

1973

EDITION

## FEATURES

- 15 *Save Big Money on TV Repairs***  
Mail order your TV Tuner troubles away
- 18 *10 Steps to Cassette Player Repair***  
Fix those totables that get bounced too often
- 22 *Photographing the TV Scene***  
A featurette on adjusting your TV for photography
- 25 *21-Second TV Cure-All***  
It's as simple as looking at the picture tube
- 31 *Erecting a Rooftop Tower***  
Save a buck and pull in more picture power
- 38 *Your TV Set Will Get You if You Don't Watch Out***  
The big eye is a big killer so learn how to handle it
- 40 *8 Steps to Car Tape Player Repair***  
Keep 'em playing for better road work
- 44 *Those Minor Tape Troubles***  
These repair tips are the reel thing
- 47 *CTS Futura V Speaker System***  
Build a best buy for your hi-fi
- 48 *11 Steps to Walkie-Talkie Repair***  
Keep the kiddies on the air and out of your hair
- 51 *9th Life for a Kiddie Phono***  
The easiest gadget to fix—don't put it aside
- 53 *When Color Won't Stay Put***  
What to do when you see a purple banana
- 59 *Ten Timely Tips on Resistance Measurements***  
We tell you how to take them correctly
- 64 *Superheterodyne***  
How the table AM radio really works
- 71 *Tuning Up the All American 5***  
Step up your receivers performance with a twist
- 77 *How to Change a Color TV Tube***  
Replace it yourself and save fifty dollars minimum
- 83 *Get Your CB Signal All Put Out***  
Get more power per bucks for better contacts
- 88 *Foreign Tube Replacement Guide***  
The replacement is easier to find at the drugstore
- 89 *Pop-Up TV Makes the Scene***  
One man's answer to "down with the big eye"

## DEPARTMENTS

- 5 *New Products***—our consumer marketplace
- 11 *Literature Library***—Goodies for a quarter
- 13 *Reader Service Page***—Get all the facts from the maker
- 14 *Ask Hank, He Knows***—just about everything
- 91 *Reader Service Page***—Get more more facts from the maker
- 94 *Classified Ads***—tiny type, big bargains

# It's old enough to vote. You haven't seen one like it since 1954. Now you've got to service it.



No sweat. PHOTOFACT\* gives you complete service data on 87,000 different radio/TV circuits . . . including Rip Van Winkle, here.

Sams Photofact is the most comprehensive Radio/TV/Audio circuit source in the world. Photofact supplies complete service information on over 87,000 models produced since 1946—color and b-w TV, AM and FM radios, stereos and record changers. Plus service data on auto radios and tape players, CB radios, modular hi-fi and tape recorders. Quite a package!

And more data keeps coming. Every month, Photofact produces new Photofact data containing easy-to-follow service information on up to 65 of the latest chassis.

This data includes the manufacturers' own printed board callout numbers, detailed circuits, photos, standard notation schematics, replacement parts lists and descriptions, etc., etc., for each model. It'll save you hours of time and frustration.

And it's available in two ways: (1) Photofact-of-the-Month Club members receive regular monthly deliveries of the latest data; (2) or you can purchase whatever service data you need as you need it from your local electronic parts distributor.

The cost? A bargain either way. Photofact-of-the-Month Club members pay just \$13.50 a month—a \$56.00 a year saving for the entire service package. And if you need a Photofact on Rip Van Winkle, above, the price is only \$3.

1. Ask your Sams Distributor, or . . .
2. Fill out this coupon for membership in the Photofact-of-the-Month Club . . . get service data on up to 65 new chassis every month, delivered in 6 handy file folders . . . plus monthly "Bonus" certificate coupons toward a file cabinet of your choice.

HOWARD W. SAMS & CO., INC. 4300 West 62nd St.,  
Indianapolis, Indiana 46268 RR-023

Please enroll me as a new member of the Photofact-of-the-Month Club. I agree to pay \$13.50 per month for my membership and understand my subscription will begin with the 6 current Photofact Sets, plus the Photofact Index, free, to be delivered by my Sams Distributor.

Name \_\_\_\_\_  
Business name \_\_\_\_\_  
Address \_\_\_\_\_  
City \_\_\_\_\_ State \_\_\_\_\_ Zip \_\_\_\_\_  
My Sams Distributor is \_\_\_\_\_  
Sign here \_\_\_\_\_

CIRCLE NO. 2 ON PAGE 13 OR 91

# NEW 5-ELEMENT

## CB MINI- BEAM

Model GA-5D

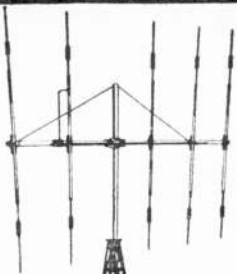

### 9.5db Gain .... 500Watt Power Rating

The secret of success in this five-element miniature beam is in its coils. Ten High "Q" coils molded on each element-extension limit the mechanical size of the GA-5D without limiting its electrical capability.

These coils are built to take a powerful beating----in fact, the same coils are used in the construction of 10-meter amateur antennas. The GA-5D is lightweight. Erect on TV antenna mount and turn with an inexpensive TV rotor. Get all the facts: see your Dealer or write factory direct, Dept. 211-RTV

*Mosley Electronics, Inc.*

4610 N. LINDBERGH BLVD., BRIDGETON MO. 63044

CIRCLE NO. 3 ON PAGE 13 OR 91

### THOUSANDS OF BARGAINS TOP VALUES IN ELECTRONIC PARTS

Transistors, Modules, C. B., Speaker, Stereo, Hi-Fi, Photo Cells and Thousands of Other Electronic Parts.

Send for FREE Catalogue

#### ELECTRONIC DISTRIBUTORS INC.



#### EDI

Dept. TA-2, 4900 Elston  
Chicago, Ill. 60630  
 RUSH CATALOGUE

Name.....  
Address.....  
City.....  
State..... Zip Code.....

CIRCLE NO. 8 ON PAGE 13 OR 91

## Be in Profitable Business, Earn CASH FILING SAWS

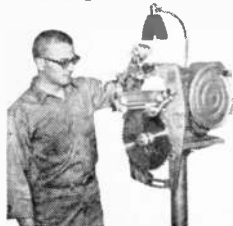

Make from \$3 to \$6 an hour in your spare time. Start saw filing shop in basement or garage. No experience needed to turn out perfect cutting saws with machine accuracy of Foley Automatic Saw Filer. No canvassing—steady year round CASH business. Ideal for small towns. Free booklet—"MONEY MAKING FACTS"—shows how to start. Easy payments. No salesman will call.  
Send postcard today.

Foley Mfg., 362-3 Foley Bldg., Minneapolis, Minn. 55418

CIRCLE NO. 7 ON PAGE 13 OR 91

19

# RADIO TV REPAIR

73

*Editor-in Chief*

JULIAN S. MARTIN, WA2CQL

*Technical Editor*

PETER L. DEXNIS, WA3LOQ

*Repair Editor*

STEPHEN B. GRAY

*News Editor*

BARBARA E. WILLIAMS

*Workbench Editor*

HANK SCOTT

*Citizens Band Editor*

KATHI MARTIN, KAIØ614

*Art Director*

JIM MEDLER

*Cover Art Director*

IRVING BERNSTEIN

*Associate Art Director*

ANDY STEIGMEIER

*Advertising Director*

DAVID J. MILLER

*Production Director*

CARL BARTEE

*Production Manager*

GERTRUD BORCHARDT

*Assistant Production Manager*

MARILYN BONILLA

*Newsstand Circulation Manager*

DON GABREE

*Subscription Circulation—Marketing Director*

ROBERT V. ENLOW

*Instruments Discussion Manager*

WILFRED M. BROWN

*Chairman of the Board (1969-1972)*

B. G. DAVIS

*President and Publisher*

JOEL DAVIS

*Vice-President and General Manager*

LEONARD F. PINTO

*Vice President and Treasurer*

VICTOR C. STABILE, KBPØ681

RADIO-TV REPAIR is published annually by Davis Publications, Inc. Editorial business offices: 229 Park Ave. South, New York, N.Y. 10003. Advertising offices: New York: 229 Park Ave. South, 212-673-1300; Chicago: 520 N. Michigan Ave., 312-527-0330; Los Angeles: J. E. Publishers Rep. Co., 8380 Melrose Ave., 213-653-5841; Long Island: Len Osten, 9 Garden Street, Great Neck, N.Y. 516-487-3305; Southwestern advertising representative: Jim Wright, 4 N. Eighth St., St. Louis, 314-241-1965.

EDITORIAL CONTRIBUTIONS must be accompanied by return postage and will be handled with reasonable care; however, publisher assumes no responsibility for return or safety of manuscripts, art work, or photographs. Contributions should be addressed to the Editor, RADIO-TV REPAIR, 229 Park Ave. South, New York, New York 10003.

© Copyright 1973 by Davis Publications, Inc.

# Something for everyone

## Digital Multimeter

Dynascan Corp. has added a new solid-state digital multimeter to its popular B&K line of test instruments. It's the Model 281. Features include a large, 2½ digit numerical display with automatically positioned decimal point, 100% overrange capability, full overload protection, positive overrange and wrong polarity indication, high sensitivity, 1% ac-

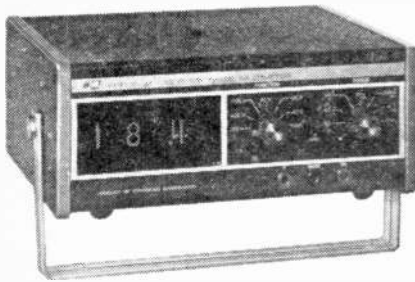

curacy and 10 megohms input impedance. The large readout is easily read at a distance, making it unnecessary to be right on top of the unit to take a reading. This is a great advantage at all times, but especially when monitoring—you can be working on something else and still be able to read the 281 without being close to it. The 281 is lightweight and easily portable; the convenient 5-position handle doubles as a stand, for comfortable eye-level viewing. It operates from 105-125 VAC, 50-60 Hz and is supplied with test leads and B&K's PR-21 probe with switchable 100K ohm isolation resistor that prevents capacitive loading when measuring DC in RF circuits. Selling price of the Model 281 Digital Multimeter is \$169.95. For more information, circle No. 36 on Reader Service Page.

## Engine Analyzer

Now Saturday "do-it-yourselfers" can achieve professional-grade results on a budget by assembling the new Heathkit CM-1050 Engine Analyzer. This instrument tests conventional, magneto, transistor and most capacitive discharge ignition systems, regardless of voltage or grounding, on any 3, 4, 6 or 8-cylinder engine. It permits rapid servicing of storage battery, generator or alternator, voltage regulator, starter, distributor, ignition circuit (points, condenser and coil), accessories and all electrical wiring. The large 6-inch meter is color coded for easy reading on any measurement range. A function switch elects the proper range for each application. With the

# new 19-piece midget reversible ratchet offset screwdriver set



3-3/4" heavy duty, stainless steel reversible 20-tooth ratchet with short turning radius for close work.

Unique 6" spinner/extension has drive socket insert in handle for ratchet. Use also as regular screwdriver with bits.

1/4" hex to 1/4" square adapter bit permits use of ratchet or spinner/extension with Xcelite Series 1000 or other 1/4" sq. drive sockets.

16 precision made, alloy steel bits with knurled spinner tops... 12 Allen hex type, 2 slotted screw bits, 2 Phillips bits.

**FREE STICK-ON INITIALS** personalize the sturdy plastic case and help prevent loss or mix-up.

No. XL-70 Set

Made in U.S.A.

### Also 5-Piece Kit (No. XL-75)

Reversible ratchet with 3/16" and 1/4" slotted screw bits, #1 and #2 Phillips bits, all in a durable plastic, pocket size, snap fastener case.

*nationwide availability through local distributors*

REQUEST BULLETIN N770

# XCELITE

XCELITE, INC. • 90 BANK ST., ORCHARD PARK, N.Y. 14127  
Send Bulletin N770 on Reversible Ratchet Offset Screwdriver Set.

name \_\_\_\_\_

address \_\_\_\_\_

city \_\_\_\_\_

state & zone \_\_\_\_\_

CIRCLE NO. 6 ON PAGE 13 OR 91

# How many more opportunities

# can you afford to miss in the next 9 months?

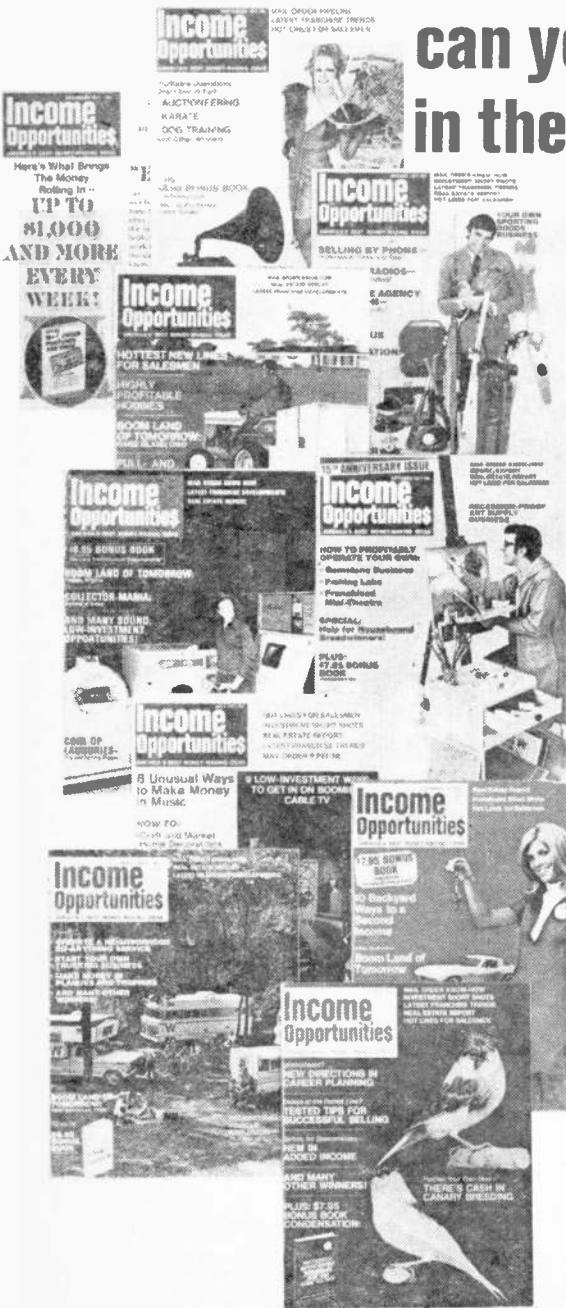

Now, you can discover for yourself the amazing variety of money-making opportunities that are still yours for the taking... if you know where to look to find them!

For more than 15 years, *Income Opportunities* has shown thousands of people the newest, proved ways for cashing in on hobbies, sidelines, and the coming trends in consumer-buying habits. For that extra income each month—in your spare time—or full time, here is where you'll find these opportunities for personal or business gain.

See the independent business opportunities for a second income... the franchise opportunities still open in many fields today (with more coming!)... the profits in a service business you can start at home... the hot lines for salesmen, reports on winners in real estate, tips on investments.

*Income Opportunities* is the country's leading magazine of money-making ideas. It brings you unusual ways to make money in such fields as music and auctioneering—even in karate and dog training. And you'll learn the professional techniques of others who are making it big in mail order and selling by telephone—how to start, how to operate profitably!

You'll find a wealth of opportunities in *Income Opportunities* during the next 9 months that can get you started now toward that second income or your own independent business. Can you afford to miss them?

## SAVE WITH THIS INTRODUCTORY OFFER

9 OPPORTUNITY-PACKED MONTHS ONLY \$2.98

- Enter my trial subscription for 9 months for \$2.98. I save \$2.77 off the regular subscription price! I save \$3.77 off the newsstand price!
- I prefer 12 months for \$3.98. I save \$5.27 off the single copy price!
- Please bill me.
- Payment enclosed

name \_\_\_\_\_ (please print)  
 address \_\_\_\_\_  
 city \_\_\_\_\_ state \_\_\_\_\_ zip \_\_\_\_\_

MAIL COUPON **INCOME OPPORTUNITIES**  
 229 Park Avenue South  
 TODAY TO: New York, N.Y. 10003  
 B904



## Something for everyone

exception of an easy ohmmeter adjust, recalibration has been eliminated with the CM-1050. You calibrate the meter when you build the kit, and it stays calibrated. Accuracy is  $\pm 3\%$  on all measurement ranges. The CM-1050 is a completely portable, self-powered

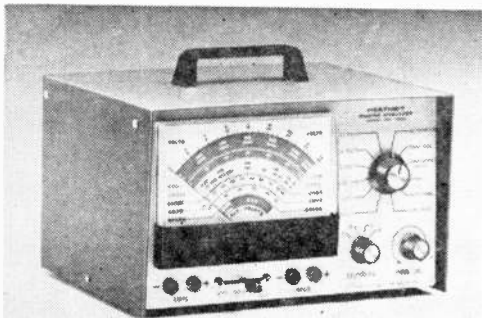

(three C cells) instrument which can be assembled in two evenings. The handy storage compartment in the rear easily holds all leads and accessories supplied with the kit. A complete engine tune-up specifications book for American cars and light trucks is also included. Cost of the new Heathkit Engine Analyzer is \$64.95 mail order. For more information, circle No. 1 on Reader Service Page.

### Clamp on to This!

For electric and electronic technicians, testers, inspectors, field maintenance people, etc., the ability to measure AC current and AC voltage quickly and accurately without breaking the circuit is vital. EICO's new 300C Clamp-On Current Tester provides that capability with ease, speed, precision, and low cost—only \$49.95 (wired). To measure current, the operator just snaps the trigger-actuated Clamp-On insulated jaws around a single conductor of the circuit under test and the meter instantly reads. To measure volt-

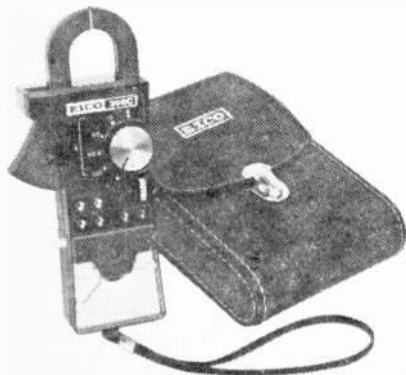

1973 EDITION

# FREE

## LAFAYETTE 1973 CATALOG 730



Ready  
Now!

### The World's Largest Consumer Electronics Catalog

#### Everything In Electronics for Home, Business, Industry

• Stereo/Hi-Fi Components • Musical Instruments and Amplifiers • CB & Ham Equipment • Tools and Test Equipment • Police and Fire Monitor Receivers • Public Address Systems • Photography Equipment • Semiconductors, Books, Parts • Plus Much More!

### Your Complete Electronics Buying Guide

**Send  
Today!**

Lafayette Radio Electronics  
P.O. Box 10, Dept. 24033  
Syosset, L.I., N.Y. 11791

Send FREE 1973 Catalog

24033

NAME \_\_\_\_\_

ADDRESS \_\_\_\_\_

CITY \_\_\_\_\_

STATE \_\_\_\_\_

ZIP \_\_\_\_\_

CIRCLE NO. 4 ON PAGE 13 OR 91

How to subscribe to:

# elementary Electronics

**MAIL COUPON  
TODAY AND  
SAVE!  
SPECIAL  
INTRODUCTORY  
OFFER TO  
NEW READERS**

Simply check the money-saving subscription you prefer. 1 YEAR (6 issues) ONLY \$2.47

- Enter my trial subscription for 1 year. (I save \$2.03 off the newsstand price.)
- I prefer 1½ years (9 issues) for \$3.67. (On the newsstand \$6.75).
- Bill me
- Payment enclosed

Name \_\_\_\_\_ (please print)

Address \_\_\_\_\_

City \_\_\_\_\_ State \_\_\_\_\_ Zip \_\_\_\_\_ B679

**ELEMENTARY ELECTRONICS**  
229 Park Avenue South  
New York, N.Y. 10003

**PARTS! CORNELL TUBES!**

FREE Send For FREE  
CORNELL'S  
New Color  
Catalog  
48 Pgs. New Items

**33¢** per tube  
IN LOTS OF 100

**36¢** per tube  
ORDER FREE  
IF NOT SHIPPED  
IN 24 HOURS!

4219 E UNIVERSITY AVE. SAN DIEGO, CALIF. 92105

CIRCLE NO. 5 ON PAGE 13 OR 91

**MAIL EARLY  
IN THE DAY!**

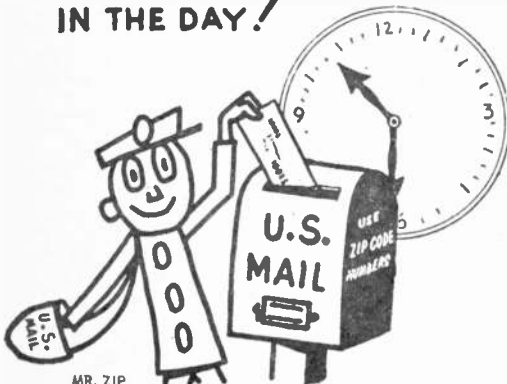

MR. ZIP  
**ZIP CODE NUMBERS  
BELONG  
IN ALL ADDRESSES**



YOUR POSTMASTER

## Something for everyone

age and resistance, simply plug in the supplied safety test leads. The "no mistake" rotary scale reveals only one range at a time, with accuracy of  $\pm 3\%$ . Convenient pointer lock "freezes" readings enabling both "memorizing" and measuring in darkness to read in later light. It comes complete with battery, leads, carrying case. Measurement ranges are: AC AMPS: 0-6, 15, 60, 150, 300. AC VOLTS: 0-150, 300, 600. OHMS: 0-1,000 (mid-scale 30 ohms). For more information, circle No. 42 on Reader Service Page.

### Peeper's Lamp

Put an end to the frustration of attempting to look into a small opening while shining a flashlight into that same opening. Spacetron's ultra miniature inspection lamp on its 18 inches of wire can be inserted into the opening and will illuminate the entire interior and yet not block one's vision. You'll find the

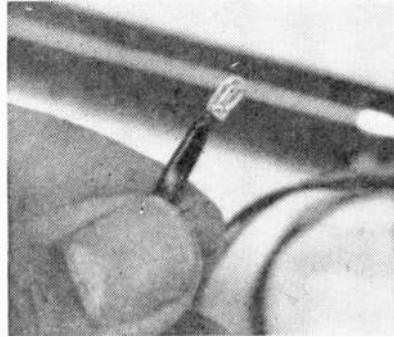

inspection light is a very handy and inexpensive tool for the home or business. It can be used in the repair of TV's, typewriters, engines and other mechanical gadgets, as well as the inspection of gun barrels, dies, machined parts, plumbing, etc. The lamp connects to a standard flashlight. The price for the inspection lamp and flashlight is \$2.50 postpaid. Spacetron, Box 84, Broadview, Ill. 60153.

### Pro Scope Kit for Hobbyists

A solid-state dual trace, triggered sweep DC-15 MHz oscilloscope is available in kit form for \$399.95, mail order from Heath Company, Benton Harbor, Michigan. Designated the 10-105, this new kit provides complete dual trace and X-Y capability. Two separate inputs can be individually displayed in Channel 1 or Channel 2 modes. Alternate and Chopped modes allow both signals to be displayed at once for direct comparison. Alternate mode displays on alternate successive sweeps; in chop, both signals are sampled at 50 kHz rate and appears as a function of the same time base. X-Y capability permits

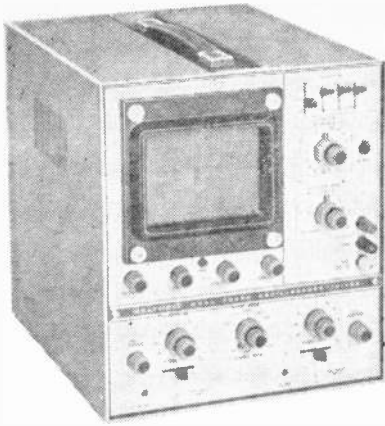

each input to be displayed as a function of the other, with Channel 1 controlling the Y axis and Channel 2 controlling the X axis. Both input channels are precisely balanced for less than 5% phase shift to 50 kHz. It is impossible to list all the features in one paragraph. Why not circle No. 1 on the Reader Service Page and let Heath Company send the facts today.

#### Build a Better Soldering Iron

Introducing a new experience in soldering—an all-new 20-40 watt pencil soldering iron with a built-in operating light. Designed for constant use in electronic production, repair and maintenance, and for “do-it-yourself”

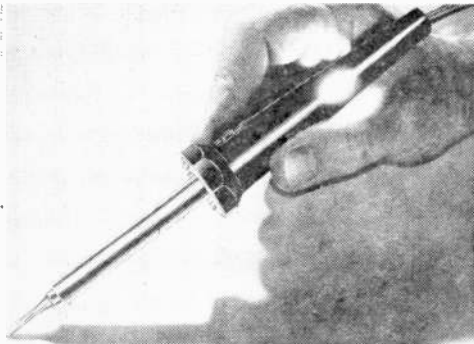

kit building, the iron, Model 540, is part of the Endeco 1973 line of soldering and desoldering equipment known as the 500 series. Located inside the handle, the light shows operation at either 20 or 40 watts. A unique 3-way handle switch controls operation at both heats, and turns the unit off so unplugging is unnecessary. The new 500 series includes soldering and desoldering irons and kits, plus a special attachment that converts the Model 540 soldering iron into a desoldering iron. Among other features of Model 540 are an unbreakable polycarbonate handle,

*(Continued on page 90)*

## TO: Radio-TV Repair readers from the Editor of HI-FI STEREO BUYERS' GUIDE

“When you play your recordings you want the best hi-fi components you can get. HI-FI STEREO BUYERS' GUIDE tells you what they are, and whose equipment to buy. In addition to useful, authoritative articles on hi-fi componentry, every issue includes a new products Show Case, unbiased Tested in the Lab reports on quality hi-fi components, and Record and Tape Reviews on the Classics and Pops.”

Let HI-FI STEREO BUYERS' GUIDE into your music life right now. Published four times a year, every issue is jammed full of information to aid you in a fuller enjoyment of your records and tapes.



Make certain you get each exciting issue by taking advantage TODAY of a special MONEY- SAVING introductory offer. Instead of receiving four issues, a full year subscription at the regular \$5.00 rate, you receive an extra issue, an immediate saving to you of \$1.25. Just mail the coupon below, with your payment, to HI-FI STEREO BUYERS' GUIDE, 229 Park Avenue South, New York, New York 10003.

#### PAY CASH & SAVE UP TO \$2.50

HI-FI STEREO BUYERS' GUIDE,  
229 Park Avenue South,  
New York, New York 10003

Special Introductory offer for Radio-TV  
Repair Readers.

Okay! Enter my subscription to HI-FI  
STEREO BUYERS' GUIDE at the money-  
saving cash payment rate below:

One year (4 issues) PLUS ONE BONUS  
ISSUE. I enclose payment of \$5.00 and  
save \$1.25 off the newsstand and regular  
subscription rate.

DOUBLE MY SAVINGS! I prefer a two  
year subscription (8 issues) PLUS TWO  
BONUS ISSUES, a total of 10 issues. I  
enclose \$10.00 and save \$2.50 off the  
regular rates. B403

Enclosed is \$ \_\_\_\_\_.

Name \_\_\_\_\_ (please print)

Address \_\_\_\_\_

City \_\_\_\_\_ State \_\_\_\_\_ Zip Code \_\_\_\_\_

# Earn Hundreds of Dollars More

With the S&M  
Supersensitive Photo Meters

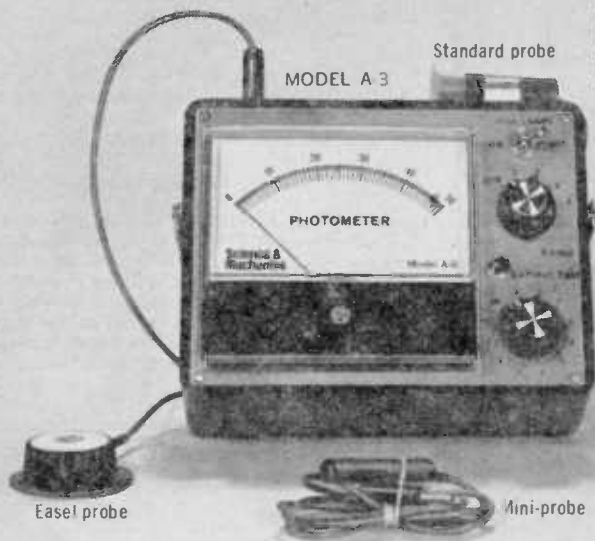

MODEL A 3

Standard probe

Easel probe

Mini-probe



MODEL 102



Exposure computer

Use the MODEL A-3 DARKROOM METER with dial lights to become a darkroom PRO. It is EASY to use at the enlarger with the  $\frac{3}{8}$  in. high EASEL probe to determine accurate exposures for B & W or color photography.

Use the A-3 to improve your darkroom skills, to eliminate waste of prints, chemicals and time; to standardize your work for increasing productivity and earning by HUNDREDS OF DOLLARS.

Use the MODEL 102 LIGHT METER with STANDARD probe to determine exposures from dawn to twilight, to moonlight! SPECIAL FEATURES? Four sensitivity ranges, EV-EVS LV settings; ASA settings from 3 to 25,000, f stops from 0.7 to 90, exposure times from 1/15,000 sec. to 8 hours.

Use the A-3 or Model 102 as a densitometer to find the highlights and shadow densities of your negatives and the CORRECT paper for printing.

OTHER APPLICATIONS? Ground glass, slides, photomicrography, holography and MORE!

These marvelously accurate and extremely sensitive battery powered Meters use plug-in probes. Each is supplied here with the probe of your choice, exposure computer, carrying case and manual. This is your opportunity to use one free for 10 days without obligation. Mail the coupon today.

**SCIENCE & MECHANICS**  
Instruments Division, Dept. RTV-3  
229 Park Avenue South  
New York, N.Y. 10003

Send the S & M Photo Meter with probe indicated, computer, case and manual. Complete instructions supplied to make your own densitometer. If not satisfied, I may return the Meter within 10 days for a complete refund. (Add 10% for Canadian and Foreign orders; N.Y.C. residents add 7% for sales tax.)

- Darkroom Model A-3 @ \$75.00 with  
 Light Meter Model 102 @ \$57.50 with  
 Standard probe;  Easel probe; or  
 Mini-probe.

For additional probes:

- $\frac{3}{8}$  in. diameter Standard probe @ \$7.50  
  $\frac{3}{8}$  in. high Easel probe @ \$7.50  
  $\frac{3}{8}$  in. diameter Mini-probe @ \$7.50

- Check or money order enclosed, ship ppd.  
 Company Purchase Order attached.

NAME \_\_\_\_\_  
ADDRESS \_\_\_\_\_  
CITY \_\_\_\_\_  
STATE \_\_\_\_\_ ZIP \_\_\_\_\_

Dealer Inquiries Invited!



# LITERATURE LIBRARY

101. Kit builder? Like weird products? EICO's 1973 catalog takes care of both breeds of buyers at prices you will like.
102. International Crystal has a free catalog for experimenters (crystals, PC boards, transistor RF mixers & amps, and other comm. products).
103. See brochures on Regency's 1973 lineup of CB transceivers & VHF UHF receivers (public service/business bands—police, fire, etc.)
104. A pamphlet from Electra details the 6 models of the Bearcat III, a scanning monitor receiver.
105. Dynascan's new B&K catalog features test equipment for industrial labs, schools, and TV servicing.
106. Before you build from scratch, check the Fair Radio Sales latest catalog for surplus gear.
107. Get Antenna Specialists' cat. of latest CB and VHF/UHF innovations: base & mobile antennas, test equipment (wattmeters, etc.), accessories
108. Want a deluxe CB base station? Then get the specs on Tram's super CB rigs
109. Learn how you can do all kinds of jobs with Excelite's new 19-piece midjet reversible ratchet offset screwdriver set and 5-piece pocket kit.
110. Bomar claims to have C/B crystal for every transceiver... for every channel. The catalog gives list of crystal to set interchangeability.
111. A Turner amplified mike helps get the most from a CB rig. This free brochure describes line of base & mobile station models.
112. Midland has recently published a 4-color brochure that folds out to 17" x 21". printed on both sides. Over 40 CB and scanner products are featured.
113. For everything in electronics—get the 1973 catalog from EDI (Electronic Distributors, Inc.). 152 pages of leading brands at bargain prices.

114. Get all the facts on Progressive Edu-Kits Home Radio Course. Build 20 radios and electronic circuits; parts, tools, and instructions included.
115. Olson Electronics' 188-p. fully-illustrated 1973 catalog has leading national brands, all in the electronic product categories.
116. Trigger Electronics has a complete catalog of equipment for those in electronics. Included are kits, parts, ham gear, CB, hi fi and recording equipment.
117. Get the free, new twenty-four page HUSTLER CB and Monitor antenna catalog featuring improved antennas and accessories for base station and mobile operation.
118. Teaberry Electronics has information on CB radios—Twin "T," Big "T," Mini "T" II, and Five by Five; also information on Scan "T" Monitor radio receiver.
119. Burstein-Applebee's new 1973 catalog has over 280 pages of Radio-TV/Electronics bargains. Selling for \$2, it is offered free to our readers.
120. For a colorful leaflet on the Golden Eagle Mark III SSB receiver and the Mark III SSB transmitter, write to Browning Laboratories.
121. Edmund Scientific's new catalog contains over 4000 products that embrace many sciences and fields.
122. Cornell Electronics' "Imperial Thrift Tag Sale" Catalog features TV and radio tubes. You can also find almost anything in electronics.
123. Radio Shack's 50 Anniv. cat. has 180 pages, colorfully illustrated, of complete range of hi fi, CB, SWL, ham equip. and parts (kits or wired) for electronics enthusiasts.
124. It's just off the press—Lafayette's all-new 1973 illustrated catalog packed with CB gear, hi-fi components, test equipment, tools, ham rigs, and more.

125. Mosley Electronics, Inc. is introducing 78 CB Mobile Antenna Systems. They are described and illustrated in a 9-page, 2-color brochure.
126. RCA Experimenter's Kits for hobbyists, hams, technicians and students are the answer for successful and enjoyable projects.
127. You can become an electrical engineer only if you take the first step. Let ICS send you their free illustrated catalog describing 17 special programs.
128. Avanti antennas (mobile and base for CB and VHF/UHF) are fully described and illustrated in new catalog.
129. A new free catalog is available from McGee Radio. It contains electronic product bargains.
130. Semiconductor Supermart is a new 1973 catalog listing project builders' parts, popular CB gear, and test equipment. It features semiconductor.—all from Circuit Specialists.
131. Heath's new 1973 full-color catalog is a shopper's dream—chockful of gadgets and goodies everyone would want to own.
132. E. F. Johnson's 1973 line of CB transceivers and CB accessory equipment is featured in a new all-line brochure. Send for your free copy today.
133. If you want courses in assembling your own TV kits, National Schools has 10 from which to choose. There is a plan for GIs.
134. Free 1973 Catalog describes 100s of Howard W. Sams books for the hobbyist and technician. It includes books on projects, basic electronics and many related subjects.

## RADIO-TV REPAIR

Box 886  
Ansonia Station  
New York, N.Y. 10023

Please arrange to have this literature whose numbers I have circled at right sent to me as soon as possible. I am enclosing 25¢ to cover handling. (No stamps, please).

RTV73



- 101 102 103 104 105 106 107 108 109 110  
111 112 113 114 115 116 117 118 119 120  
121 122 123 124 125 126 127 128 129 130  
131 132 133 134

Indicate total number of booklets requested  
Sorry, only 15 circled items maximum.

NAME \_\_\_\_\_

ADDRESS \_\_\_\_\_

CITY \_\_\_\_\_

STATE \_\_\_\_\_ ZIP \_\_\_\_\_

Not Valid After September 30, 1973

# DON'T BUY A NEW CAR! UNTIL YOU BUY A COPY OF...

AutoFacts, a new consumer car pricing guide, gives you the knowledge that can save you up to \$1,000 on a new car!

In AutoFacts you find a complete listing of dealer's cost on all U.S. make cars and options.

Quickly and easily you compare prices of makes and models and price out the car for *your* pocketbook!

## KNOW WHETHER YOU'RE BEING OFFERED A GOOD DEAL OR NOT!

"... valuable for the consumer in the market for a car. Car/Puter's AutoFacts lists the 'dealer' (wholesale) costs of new cars with all optional extras itemized and of many used cars. For comparison shopping or nitty-gritty haggling—invaluable."

—from The New York Times Book Review



### SPECIAL BONUS FOR AUTOFACTS READERS!

✧ How to get a new car for only \$125 over dealer's cost.

Through the United Auto Brokers' Car/Puter organization, you can take delivery, without delay, of a brand new car for just \$125 over cost. Your purchase includes freight and pre-delivery service. You take delivery of a new car of your choice from a local dealer and you get the same new car warranty and service as if you had paid full list. The Bonus Coupon in your AUTO-FACTS entitles you to a 20% discount off the Car/Puter 48-hour computerized service that helps you make the best new car deal on your own. ✧ Certain limited production or specialty models priced higher. Some foreign models not available.

## NOW ON ALL LEADING NEWSSTANDS

If you prefer, complete and mail this coupon to Car/Puter's AUTOFACTS, Davis Publications, 229 Park Avenue South, New York, New York 10003.

- Send Actual 1973 New Car Prices edition. Payment enclosed of \$1.50 plus 25¢ for postage and handling.
- Send Spring/Summer edition of Used Car Prices. Payment enclosed of \$1.50 plus 25¢ for postage and handling.

**NOTE:** Write publisher for bulk rates. Add \$1.00 per issue for orders outside Continental U.S.A. and Canada.

- I prefer a full year's subscription of four issues (Actual '73 New Car Prices edition; Spring/Summer '73 Used Car Prices edition; in September '73 the 1974 New Car Yearbook and Buying Guide; followed by the 1974 New Car Prices edition.) \$6.00 for full subscription is enclosed.

name \_\_\_\_\_ (please print)

address \_\_\_\_\_

city \_\_\_\_\_ state \_\_\_\_\_ zip code \_\_\_\_\_

CHAFX

## READER SERVICE PAGE

• The Editor of RADIO-TV REPAIR — 1972 ISSUE offers readers an easy way to get additional information about products and services advertised in this issue. To become proficient in your home and repair projects you must obtain the correct quality parts, knowledge, test gear, tools and many other items. Become a knowledgeable buyer by obtaining information on the products and services mentioned in this issue and keyed with a Reader Service Number, it's yours for the asking. Just follow the instructions below and the literature you requested will be sent to you promptly and at no cost. It will be a pleasure to serve you.

• The coupon below is designed for your convenience. Just circle the numbers that appear next to the advertisement or editorial mention that interests you. Please limit your selections to 20 or less. Then, carefully print your name and address on the coupon. Cut out the coupon and mail to RADIO-TV REPAIR, Box 886, Ansonia Station, New York, N.Y. 10023. Do it today!

# Service shop tips

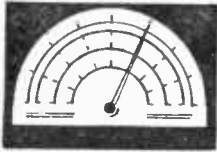

by Hank Scott, Workshop Editor

## Has Me Guessing

*I purchased a new fluorescent lamp fixture for my den, installed the bulbs from the old fixture, and the bulbs didn't come on. I installed two brand new lamps I had as spares, and they didn't light up. Can a new fluorescent fixture be bad?*

—S.D., Blue Ridge Summit PA

Yes, it can. But before you tear it down to replace the ballast (which you should have done in the old fixture to save some money), check the bulbs. Bulbs designed for fluorescent fixtures with starter elements can not be used in the new "rapid-start" fixtures. If your new fixture has no starters, buy the "rapid-start" bulbs and get rid of the others.

## Schools Fall Behind

*They come together at one end and fan out. This antenna is supposed to be an excellent antenna, but my original 85-foot long-wire antenna completely out-performed it. Do you have any ideas what might be wrong with it?*

—J.C., Spartanburg SC

The insulation (aluminum foil) in your roof may shield out weak signals. Go back to that 85 footer.

## Just Prying

*I'm an electronics hobbyist who plans to make electronics my career. In reading your column "Ask Hank, He Knows" I find great humor, and good info tips. That's what the tech mags need, more good column writers like you. By the way, are you a ham or CBER?*

—W.C., Moscow, Idaho

I'm both—ham and CBER—but get very little time on the air. I do my thing with construction projects provided I can get the parts. Thanks for the kind remark.

## He'll Grow Anything!

*I may be new in electronics, but like the hill-billy bride on her wedding night said, "Ma, I would rather do it myself!". I would like to know if there is a book or was there ever an article that could tell me how to grow my own upn Germanium crystals?*

—D.S., Las Vegas NV

Many years ago we ran an article on how to grow a crystal. However, this crystal had a water structure and was useful only for Science Fair projects. Next, we ran an article on how to make your own cat-whisker crystal. This was great except it was too expensive, difficult to do and readers by the hundreds wrote telling us to use a store-bought diode. As for growing

ystal for transistor  
how to draw gold  
tell you the rest.

parents bought a  
speakers) on a deal  
s a package deal in  
e unit was simply  
eader's Digest. My  
n it, and wondered  
ating some new info  
you know who it's  
would you kindly

R.Y., Livonia MI  
s Digest? They are  
organization and  
their customers. As  
uld be anyone from  
Kong.

the new metric sys-  
knows what a myri-  
continued on page 95)

RADIO-TV REPAIR



# SAVE BIG MONEY ON TV REPAIRS

DO WHAT YOUR SERVICEMAN SHOULD DO . . .  
AND SAVE OVER ONE-HALF THE REPAIR BILL!

**O**THER than replacing a color CRT one of the most expensive TV repairs is the tuner—the *front end* as it is often termed. Most repair shops charge to “fix” a tuner, yet in most instances the repair shop will send the tuner off to a professional tuner rebuilding service such as PTS Electronics, Inc., who for something like \$9.50 will rebuild the tuner to like new performance. *(Turn page)*

by the RADIO-TV REPAIR  
EDITORIAL STAFF



# TIRED OF TV TUNER TROUBLES?

In short, less than \$10 represents the cost of repair, the remaining \$20 or so is charged for simply changing the tuner. Since changing a tuner usually involves nothing more than a few screws and some minor soldering, you might as well do it yourself and put the \$20 or so in *your* pocket.

The important thing to keep in mind before you tackle your tuner is that contrary to rumor you do not have to make any electrical adjustments if you use a tuner repair service, such as PTS Electronics. The tuner is returned to you completely overhauled, aligned and air-checked. A certificate included with the repaired tuner indicates exactly what checks were made, and the best you can do is to keep your hands off the adjustments. In fact, worn components that don't cause trouble at the present will also most likely be replaced. In the tuner shown, new coils were substituted for coils with worn, though operable, contacts.

**How to.** First step is to remove the tuner from its mount. This usually involves simply removing two to four screws. Next, remove any plug-in cables which might come from an associated tuner, or which might be the connection to the main IF amplifier.

Make a diagram or sketch of the tuner and indicate where the plug-in cable was connected. Then, using a small soldering iron or gun, remove the power and control wires. To avoid a mixup when the "new" tuner is installed, tag each wire as it is removed and indicate its connection.

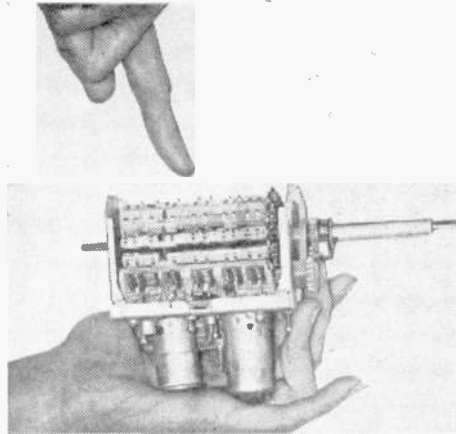
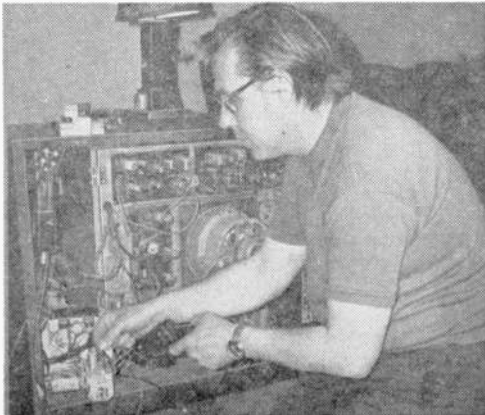

PTS Electronics, Inc. replaced tuner coils  
Circle No. 48 on the Reader Service Page.

Remove all knobs, drive shafts, etc. from the tuner—but leave the tubes in place—and ship the tuner off to the repair service. If the repair service has sent you a complaint card, make certain you check off those complaints that most accurately reflect what is wrong. If you don't have a complaint card be sure to include a *short* description of the problem.

**Back in.** In about a week you'll have your tuner back rebuilt to like-new specs. You'll note it is packaged for a trip to the moon! It is now a delicate instrument and should be handled as such.

Resolder the connecting wires, taking extreme care to double-check the tags and your sketch. Plug in the wires with connectors and secure the tuner to the cabinet or chassis with the original hardware. That's the whole bit. Your TV is ready for use.

(Continued on page 93)



Three easy steps save you TV tuner repair money: 1. Remove the defective tuner. 2. Mail to tuner repair center. 3. Solder and remount repaired tuner in TV set.

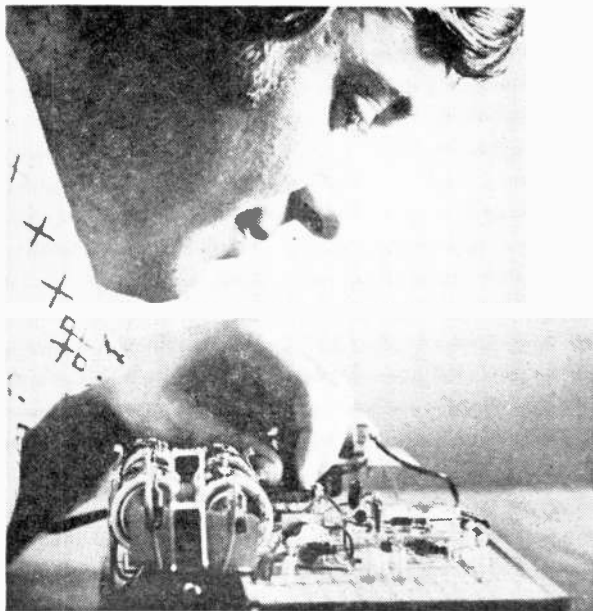

# You Learn to Make Money ...with CIE's Electronics Laboratory!

Now you can learn Electronics by performing more than 200 practical, skill-producing experiments...with authentic industrial components...at home...in your spare time.

You learn by doing! This 161-piece Laboratory includes the up-to-date equipment you'll need — such things as an IC (integrated circuit), printed circuit board, FET (field effect transistor), photovoltaic cell, DC motor, microphone, multimeter, soldering iron and power supply.

You put theory into practice right in your own home... in your spare time...while you go right on pulling down your present pay. It's CIE's exciting space-age "Electronics Technology with Laboratory" program... a unique combination of CIE's special AUTO-PROGRAMMED® Lessons and laboratory equipment. It is the practical way to learn Electronics!

### Prepare for a High-paying Career

You see, when you "learn by doing," you're ready to do...you're armed with the know-how to meet the challenges of a high-paying career in Electronics... prepared to go after an exciting, relevant job in a growing field such as medical technology, pollution control, radio and TV broadcasting, computers...just to name a few. Once you have some experience, you can make \$12,000 a year or more.

*But that's not all!* When you successfully complete your Electronics Laboratory course, you'll get a CIE Diploma. And, you'll be able to pass the Government FCC examination or be entitled to a full refund of all tuition paid! CIE's Money-Back Warranty is valid during the completion time allowed for your course.

Send today for CIE's 2 FREE BOOKS about opportunities in Electronics. For your convenience, we will try to have a representative call. Mail reply card or coupon to CIE...or write: Cleveland Institute of Electronics, Inc., 1776 E. 17th St., Cleveland, Ohio 44114.

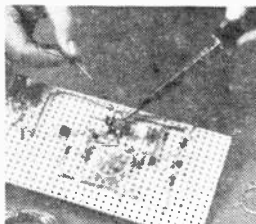

You learn how to construct circuits and connect them with a soldering iron, which is part of your CIE laboratory equipment. This "hands on" experience is extremely valuable.

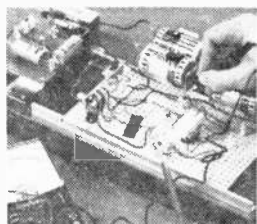

Testing and troubleshooting are an important part of your learning experience. Your laboratory has a precision multimeter to diagnose electronic troubles quickly and accurately.

### APPROVED UNDER G.I. BILL

All CIE career courses are approved for educational benefits under the G.I. Bill. If you are a Veteran or in service now, check box for G.I. Bill information.

## CIE Cleveland Institute of Electronics, Inc.

1776 East 17th Street, Cleveland, Ohio 44114  
Accredited Member National Home Study Council

Please send me your 2 FREE BOOKS—The CIE school catalog, "Succeed in Electronics" and "How To Get a Commercial FCC License."



Name \_\_\_\_\_ (Please Print)  
Address \_\_\_\_\_  
City \_\_\_\_\_  
State \_\_\_\_\_ Zip \_\_\_\_\_ Age \_\_\_\_\_

Veterans and Servicemen:  
 Check here for G.I. Bill information.

RT-03

CIRCLE NO. 10 ON PAGE 13 OR 91

# 10 STEPS TO CASSETTE PLAYER REPAIR

by Homer L. Davidson

Cassette recorders come in every size and shape. They play on dry cells, AC line or operate right in the car. Generally, the portables are monophonic while table and console models are stereophonic. New cassette decks may feature "pop-up" cassette loading, level meter, remote control mike, push-button controls, tag-along speakers, and AC bias erasing system, to name only a few. After many hours of rough handling these cassette units will require servicing. Our 10-step approach to troubleshooting will give you an edge in the unknown world of cassette repair.

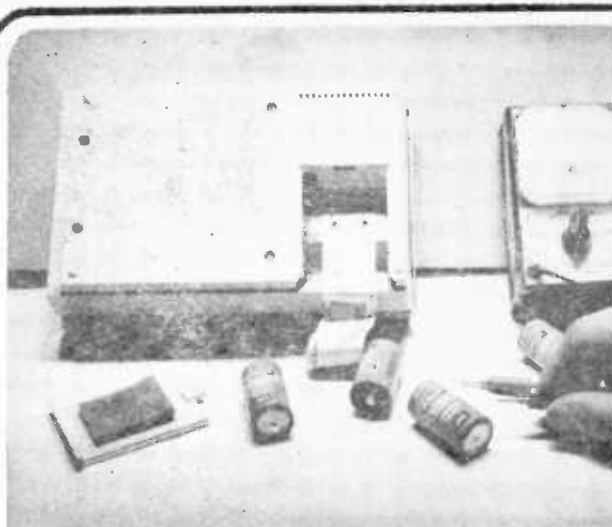

**1** In case the recorder will not play, check the batteries. Check for corroded battery terminals or broken wires. Clean battery terminals with a knife or emery board. Disconnect one battery wire and insert VOM switched to low milliammeter scale. No current indicates a defective on/off switch, bad battery connections or dead batteries. Excessive current indicates a short in motor or amp circuit. If unit works on batteries and not on AC suspect trouble in the power supply. A step-down transformer and rectifier produces this DC. Check AC voltage at rectifier and DC voltage at motor.

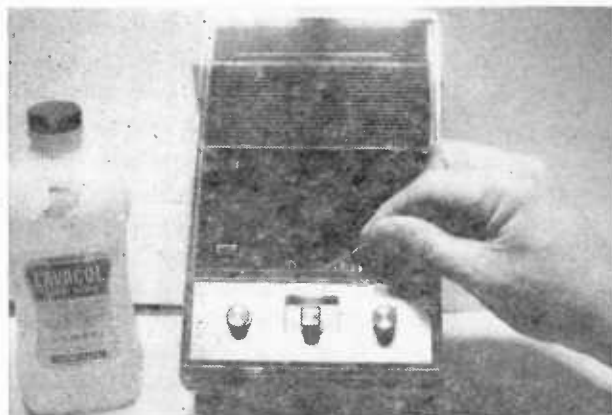

**2** Low volume and background noise caused by a dirty tape head. Excessive oxide dust will accumulate and pack upon the tape head. Tape heads should be cleaned every sixty days to keep them in tip-top condition. Clean head with tape-head cleaner or just plain rubbing alcohol. Use a cotton swab, dip in alcohol and remove the oxide dust. A special tape head cleansing cassette can also be inserted in place of the cassette. Don't forget to clean around and under the tape head assembly. Always try to keep magnetized screwdrivers away from the tape head.

If the tape plays slow, suspect a worn or stretched drive belt. In case the tape won't move, check for a broken belt. Oil on the drive belt or capstan pulley will result in slow tape movement. Clean the belt, idler, and motor pulleys with rubbing alcohol. If the speed is erratic (wow), check for oil upon belt and capstan drive pulley. A belt partially off the track or a misaligned capstan assembly can cause wow conditions. Defective cassette or motor can produce erratic speed or wow conditions. After a good clean-up with alcohol, check the capstan flywheel for dry bearings. A drop of light oil on motor bearings will clear up a noisy motor. Some small motors are self-contained and do not require oiling. Just a drop will do; do not over-lubricate any bearing. Wipe off excess oil to prevent dripping upon drive belt.

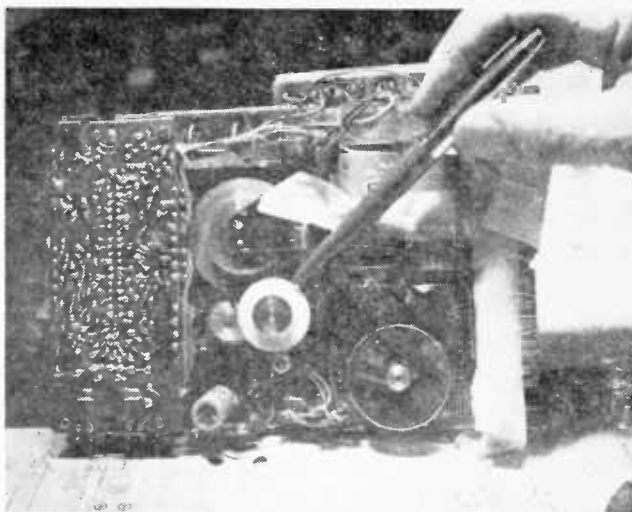

**4** Suspect mechanical trouble when there is no tape motion and power is applied to the motor. Spin motor belt and see if the capstan drive wheel takes off. If not, remove the drive belt and see if the motor shaft is free. If not, clean out motor and bearings with alcohol, assemble and lubricate bearings. If starting is intermittent, remove drive belt and hold the motor pulley between fingers. Switch the power off and on. Sometimes under load, the motor armature will have a flat side and will not rotate. Replace defective motor. A frozen or binding capstan drive wheel will result in slow or no tape motion. Remove the capstan flywheel assembly, clean and lubricate. Wipe off excess oil. Especially, suspect dry bearings on plastic pulleys working on metal posts. Don't overlook a possible defective cassette.

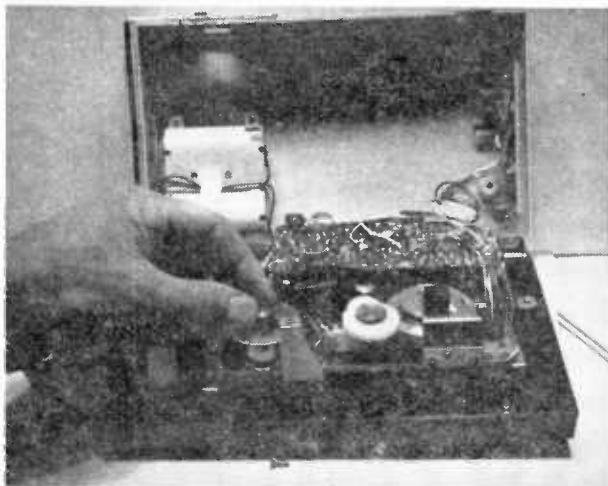

Most mechanical troubles are related to the drive or switch cassette mechanism. Remove the outside case of the cassette player so you can see the mechanical action. Check the sequence of operation and try to isolate the cause of trouble. For instance, if the record button will not stay down suspect a bent lever or locking pin. In some of these small recorders the thin levers are quite fragile and bend rather easily. Remove the lever and bend back in shape. Be careful not to compound the trouble. Many of these metal parts are rather difficult to obtain and you may have to repair them. Check for broken or loose springs. You can spot these springs rolling around in the case and fall out in removing the outside covers. Spring replacement is rather difficult unless you have an exploded drawing of the mechanism.



# CASSETTE PLAYER

**6** A broken remote mike cable will result in intermittent or no power supplied to the cassette player. When hum or intermittent recording is noted, suspect a defective cable. These breaks are found where the wire enters the mike or at the male plug. If the remote unit will not shut off the recorder, check for a bent female plug or defective switch. Check to see if the cassette recorder will operate without a remote unit plugged in. If not, check shorting contacts of female remote-control jack. Continuity of the remote power switch can be checked with an ohmmeter. Cut off the broken section of cable and resolder mike or plug. Be real careful in soldering the small shielded cable so that you do not solder the shield to the shielded wire. Recheck continuity with an ohmmeter.

If the unit will not record, **7** check the microphone and mike jack. If the unit will play back a cassette, the amplifier and speaker are functioning. The trouble must be in the microphone circuit, play/record switch or switch transfer linkage. Clean and spray the play/record switch contacts. Then, check for poor soldered switch connections on PC board. Make sure the switch can be fully engaged and make contact. In case the unit will not play or record, turn volume wide open and touch the ungrounded wire from the tap head to the amplifier. You should hear a loud hum if the amplifier is working. If not, inject a signal from an audio generator at the volume control. Signal trace the defective amplifier by going from base to collector terminal of each transistor. Make voltage and transistor tests where the signal is lost. If you hear hum and the recorder will not play or record suspect the tape head

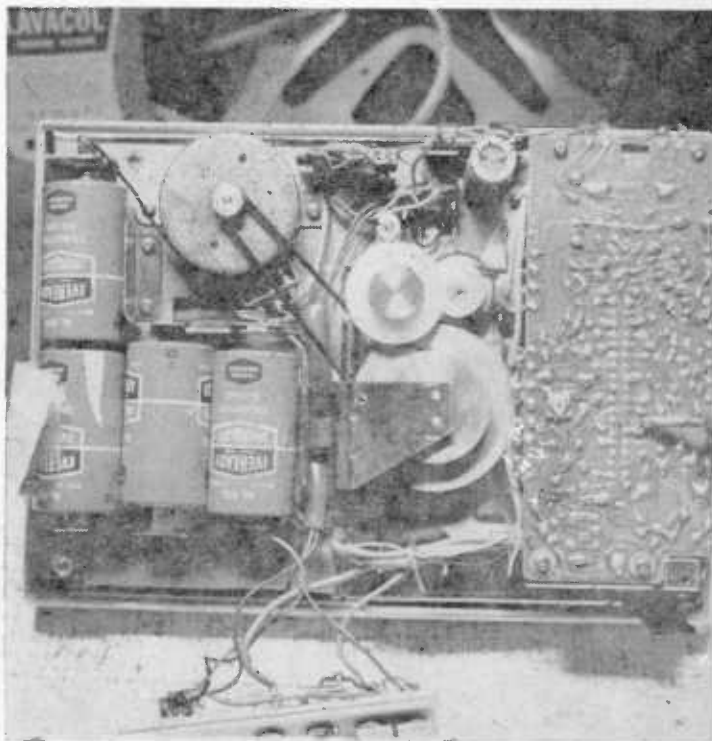

Suspect a scored or rough tape drive assembly when the unit repeatedly tears tape. **8**

Check for sticky substance on capstan (tape drive) shaft. Clean the tape drive with alcohol and check for roughness. Packed tape oxide or small pieces of tape may be wound around the drive shaft and will pull or tear tapes. Make sure the drive belt is properly installed. If a new drive belt has been installed, it may be around the wrong idler pulley. This will let the tape bunch up, pull and tear out the tape. Bunching and tearing of tape may be caused by a defective cassette. Some tapes will bind and cause wow conditions. Stop the recorder if the tape has bunched up in the small plastic window. Quickly, rewind the tape and start once again. In case the tape pulls or seems to form a loop, check the rubber drive belt and take-up pulley

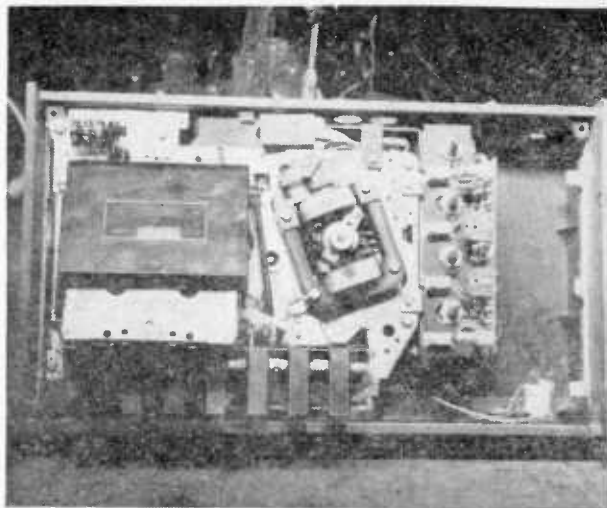

**9** Is your cassette player unusually noisy?

Try to isolate the noisy condition in amplifier or tape head assembly. Make sure the tape head is clean and demagnetized. If the player is still noisy, see if the noise exists in a pre-recorded tape cassette. Try a few new pre-recorded cassettes. Now, turn the volume down and see if noise is still present. Generally, noise produced in the amplifier is caused by leaky AF or driver transistors. Also, check for a poor ground on the PC board. The noisy transistor can be isolated by substitution or removing the collector terminal from the circuit. When the noise disappears you have located the noisy transistor or stage. A popping noise can be caused by a defective output transistor or burned resistor.



Two recordings heard at the same time indicate crosstalk. Excessive crosstalk and poor frequency response are caused by either poor erase or improper tape head alignment. **10** Adjust the height and azimuth screws, located at the rear and side of the tape head, to correct. Use a cassette audio test cartridge in making these adjustments. Before performing these tests clean up the tape head. Connect a 40, 47 or 49 bulb across the speaker leads. Adjust the volume control so the bulb rarely glows and then adjust the tape head height and azimuth. ■



# PHOTOGRAPHING

**H**ow would you like to photograph President Nixon in the White House? Hank Aaron clouting one over the fence? A U.S. Olympic track star winning a Gold Medal? Or how about your favorite actress receiving an Academy Award? You can snap your camera's shutter at home while focused at your black-and-white or color television set.

**Camera and Film.** You can use almost any camera for taking black-and-white pictures of television images. However, you'll get better results with an automatic or adjustable camera. If you have a simple camera without exposure or distance settings, you must use a high-speed film, such as Kodak Tri-X Pan Film. For taking color pictures, you should use a camera with an  $f/2.8$  or faster lens and a shutter that you can set at  $1/8$  second or slower. If you want to take movies, you'll need a movie camera with an  $f/1.9$  or faster lens. Check your cameras now!

To determine the correct exposure, you can use an automatic camera or a *reflected-light* exposure meter. If you don't have either of these, you can set your camera according to the Exposure Table.

TV images are quite dim compared to average subjects in daylight. Therefore, to avoid using large lens openings and very slow shutter speeds, you may want to use a high-speed film such as Kodak Tri-X Pan Film—ASA 400—for black-and-white prints, or *Kodak High Speed Ektachrome Film (Daylight)*—ASA 160—for color slides.

**TV Set Set-Up.** To obtain the best quality in your photographs, adjust your TV set so that the contrast of the television picture is slightly lower than normal. Adjust the brightness control so that both the high light and shadow areas of the TV image show detail. The shadows should not be light gray or completely black. Adjust the controls on a color set for a pleasing color picture on the screen.

Reflections on the face of the television tube can ruin your photographic attempt! To help eliminate reflections, turn off all of the room lights. Eliminating the light in

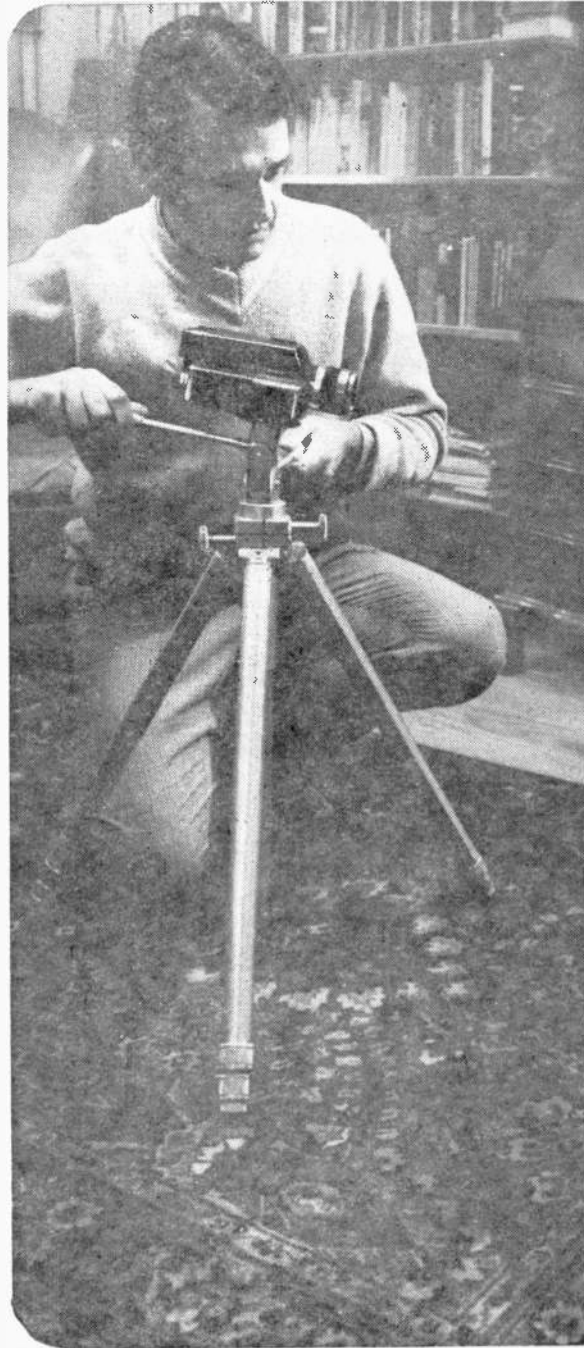



# THE TV SCENE

Jackson Kaye

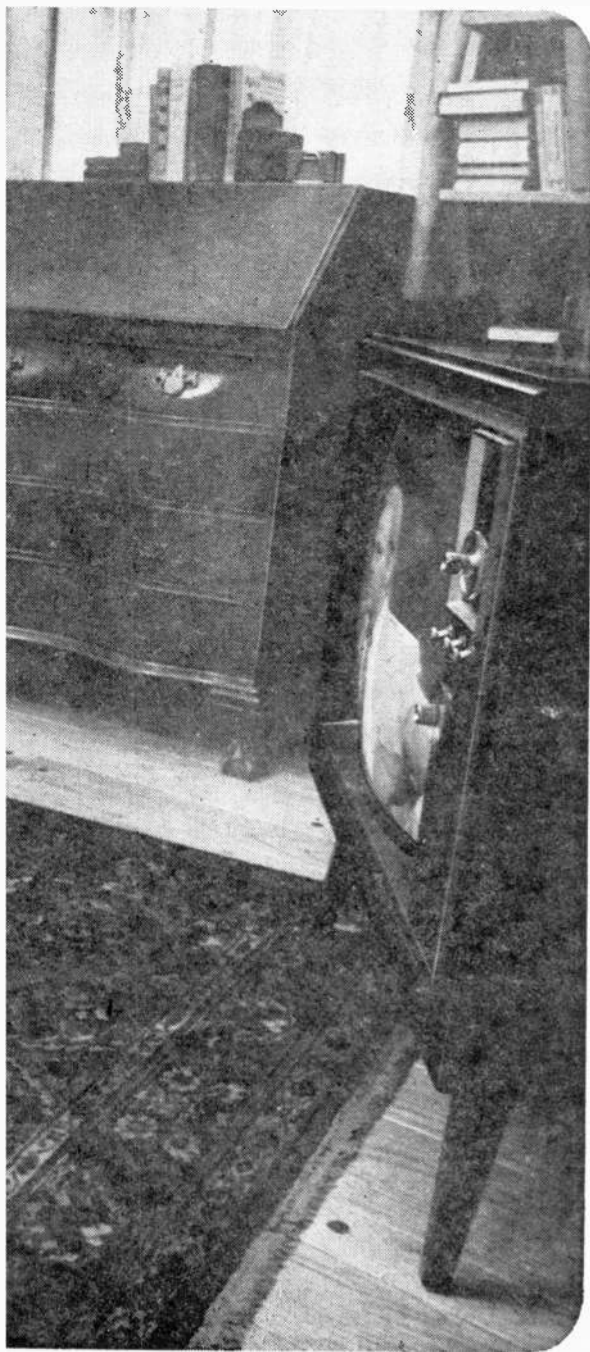

the room also helps make the area surrounding the TV image appear black in your photographs. A black area surrounding the TV image is usually more pleasing than a lighter area showing part of the room or the border around the picture tube.

Don't use flash or flood lighting to photograph television images. These light sources actually reduce the brightness of the TV image, and your pictures would show a blank television screen.

**Shutter Snapping.** Move in close to the television screen with your camera. If the minimum focusing distance for your camera will allow it, move in until the TV screen fills the picture area in your viewfinder.

If your camera is a single-lens reflex with through-the-lens viewing, when you look through the viewfinder you'll see exactly what you'll get in your close-up pictures. But if the viewfinder on your camera is separate from the lens, it may not show you exactly what will be included in the picture.

**Shutter Speed.** Television images are composed of 525 straight horizontal lines called "scanning lines." The image is formed in your TV set by a moving electron beam which scans the picture in two sections. All the odd-numbered lines are traced in  $1/60$  second to produce an image. As soon as this cycle is completed, the picture is scanned again in  $1/60$  second, this time tracing the even-numbered lines. Therefore, it takes  $1/30$  second to make a complete picture on the screen. That's why you must use a shutter speed of  $1/30$  second or slower to record at least one complete picture cycle. Otherwise you may get a dark band across your photograph. If your camera has a focal-plane shutter, you should use a shutter speed of  $1/8$  second or slower to obtain uniform exposure. For sharp pictures, make the exposure when the subject on the screen is not moving. Put your camera on a tripod or other firm support, such as a table. Books and boxes can be used if the tables you have are too tall. Do not tilt camera up or down to capture picture. Rather, raise or lower

# Photographing TV

camera until picture is framed properly.

**Color Pictures.** Use *daylight* color film for photographing TV images. Color pictures of color television will have a somewhat blue-green appearance because the film's sensitivity to the TV picture is different from the eye's sensitivity. You can improve color rendition in your pictures by using a Kodak color compensating filter, CC40R (gelatin), over your camera lens to help bring out the reds. When you use the CC40R filter, increase exposure by 1 stop. You can pick up this filter from your photo dealer.

**Automatic Cameras.** Fill the picture area in the viewfinder with the TV image so that the exposure meter in your camera "sees" only the TV screen. If your automatic camera (with built-in exposure meter) is too far away from the TV screen, the exposure meter "sees" too much of the dark area surrounding the TV image, resulting in overexposure on your film.

When you're taking pictures, the low-light indicator may appear in your camera viewfinder. Usually you can ignore this "warning" and take pictures anyway. You'll probably get satisfactory results, although your pictures may be on the dark side.

If your automatic camera has a separate peep hole for the light meter, you must cover this peep hole with the CC40R filter when the lens is so covered. If not, your photos will be overexposed.

**Adjustable Cameras.** If you have an adjustable camera with a built-in exposure meter, when you make the meter reading be sure the TV screen fills the picture area as recommended for automatic cameras. If your camera doesn't have a built-in meter, you can use a separate reflected-light exposure meter to determine the exposure. Hold the meter close to the TV screen so that it reads only the screen. Position your meter to read approximately equal parts of light and dark areas of the TV picture.

**For Simple Cameras.** The camera settings in the Exposure Table apply to most television sets. However, since individual adjustments of TV pictures can vary, and since improvements are continually being made in the picture tubes for color television, the suggested exposures are approximate. You may want to bracket your exposure to be sure of getting a properly exposed picture

of an especially important subject. Take one picture at the suggested exposure, one at  $\frac{1}{2}$  the exposure and another at 2 times the suggested exposure. Remember do not use shutter speeds higher than  $\frac{1}{30}$  second or  $\frac{1}{8}$  second for a camera with a focal plane shutter.

**Movie Cameras.** To make good-quality movies of television images, you would need a special camera synchronized with the television set to record successive picture cycles on successive frames of movie film. Of course this isn't practical for the amateur-



**New high speed Super-8 makes color TV movie photography a snap. You can also use regular Kodachrome II, see how below.**

movie maker. However, you can still obtain satisfactory results with an ordinary movie camera that has an  $f/1.9$  or faster lens.

Operate your camera at the normal camera speed of 16 or 18 frames per second. Since your movie camera is not synchronized with the TV picture cycle, your projected movie will show a slightly uneven, or banding, effect.

With a camera that has an  $f/1.9$  lens, you can make recognizable, though somewhat dark movies of black-and-white and color TV images when you use Kodachrome II Movie Film (Daylight); or Kodachrome II Movie Film (Type A) with a No. 85 filter. This filter is built into all super 8 cameras and some 8mm cameras. When using these films, turn up the brightness control on your TV set for maximum brightness without losing too much detail. If your camera has manually adjustable lens openings, set the lens at its largest opening.

You can obtain brighter movies of *black-and-white images* by using the Type A film without a No. 85 filter. The black-and-white  
(Continued on page 96)

# 21-SECOND TV CURE-ALL

By Homer L. Davidson

Nothing pleases like an AOK TV set (well, almost nothing, let's say), and nothing irks like a TV set on the fritz. Thing is, TVs have a way of telling you what—if anything—ails them with a message plain as the nose on your face. It's the image on the picture tube that tells the story; the problem lies in interpreting what it's trying to say. But that's easy—our 21-Second TV Cure-all includes 21 of the most frequently encountered TV ills, tells where the fault lies and how to go about correcting it. Let's start with the nicest story of all—a properly displayed test pattern on an AOK TV set.

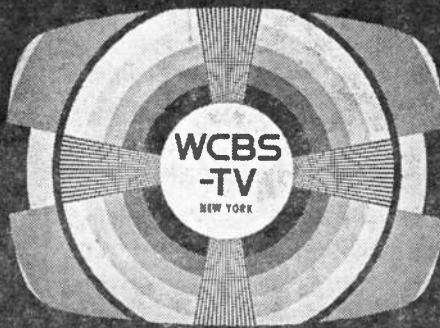

**1** Typical TV test pattern is transmitted perfectly round, perfectly centered, and with all wedges of equal length. Height and width have 3:4 ratio.

*(Continued overleaf)*

# TV CURE-ALL

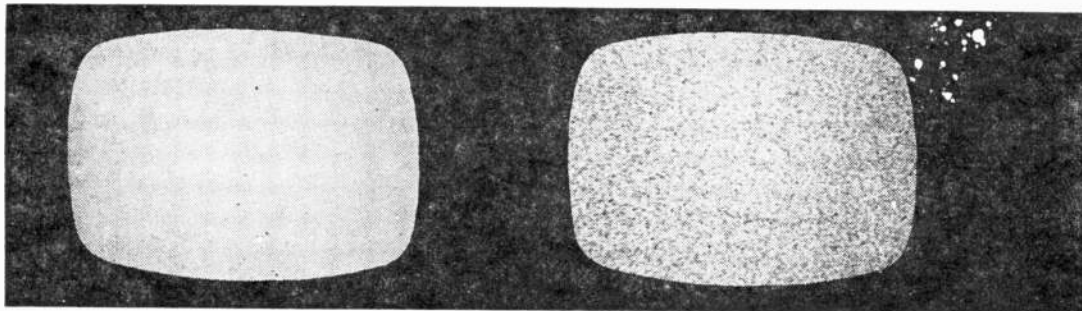

**2 WHITE ALL OVER.** OK, so your set isn't pouring forth with the beautiful TV test pattern shown on the preceding page. Let's say all you can see is a white screen with raster lines. There may be a tweeting sound or perhaps no sound at all coming from the speaker. First thing to check is the local oscillator tube. Next, check the first RF tube. If there's still no picture, check the IF and first video tubes. If you're still up the TV creek, check the IF tuner cable between tuner and chassis; a loose or poor soldered connection will result in no picture or an intermittent picture on the TV screen. As a last resort, check the AGC and second detector tube. And if yours is an older set, check even the sound output tube. Reason is that sets have been made where the sound tube actually furnished voltage to the tuner and IF stages.

**3 RUSH, RUSH, RUSH!** Here we have a TV screen with no picture, snowy screen, and a loud rushing sound issuing from the speaker. Switching the tuning selector from channel to channel has no effect whatever. And while the screen can be lightened or darkened, there's still no picture or intelligible sound. Thing to do is check the first RF amplifier tube in the tuner (most RF tubes are located at the rear of the tuner). If the oscillator tube in the tuner were defective, there would be no snow on the screen or rushing sound in the speaker. And since we have plenty of both in this picture, replacing the RF tube should do it. If not, check the antenna lead-in. Assuming this passes with flying colors, take a close look at the antenna matching coils on the top of the tuner next to the lead-in. These may be shorted or open.

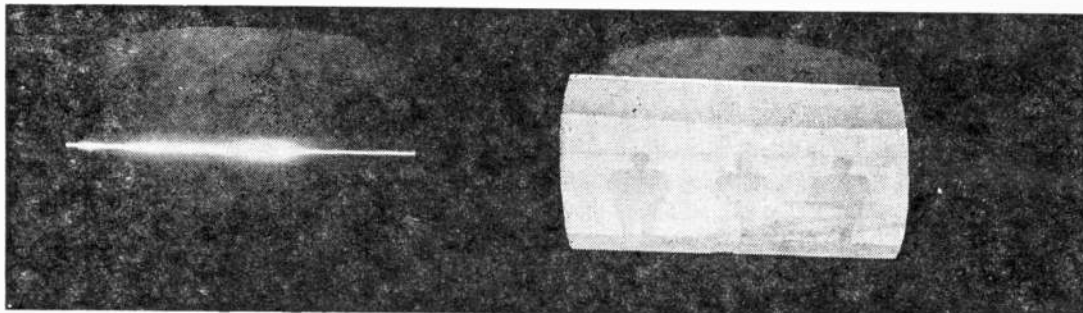

**6 LIKE A LASER BEAM.** A horizontal white line on the screen indicates lack of vertical sweep. First things to check are the vertical oscillator and vertical output tubes (dual-purpose tubes are often found in late-model TV receivers). Also check adjustment of vertical linearity height controls. Be sure to first turn the brightness control down so only a faint white line remains, however, since leaving a bright horizontal line on the screen can easily burn a line across the phosphor on the pic-tube face. If you're handy with a VOM, you may want to pull the TV chassis. This done, check voltages on the vertical oscillator and output tubes, then give the vertical output transformer a resistance test.

**7 SHORT AND SQUATTY.** Trouble here is plain and simple: insufficient vertical sweep. Best bet for locating culprits is to check both the vertical output and oscillator tubes, though you might start by checking the settings of the vertical linearity and height controls. A shorted or vertical transformer winding will cause the same trouble. Can't find the vertical output tube? Here's a quick rundown—in consoles: 6AQ5, 6BL7, 6CG7, 6CM6, 6CM7, 6CS7, 6CW5, 6CZ5, 6CY7, 6DE7, 6DR7, 6EA7, 6EM7, 6EW7, 6FD7, 6GE7, 6GL7, 6K6GT, 6KY8, 6S4, 6SL7, 6SN7, 6U8, 12AT7, 12AU7, 12AX7, 12BH7, 12BZ7, 12B4; and in portables: 5AQ5, 5CZ5, 5V6, 7AV7, 8CG7, 8CM7, 8CW5, 8CS7, 10CW5, 10DE7, 10DR7, 10EM7, 10GF7, 11CY7, 13DE7, 13DR7, 13FD7, 13GF7, 15KY8.



**4 ALL WASHED UP.** Even with the contrast control wide open, the best we can get out of this one is a light, washed-out picture. While local stations can be picked up, distant stations come in ever so faintly or not at all. The problem is likely a weak video or IF tube or perhaps the AGC control setting. In the event the picture has a slight trace of snow, check the RF tube or TV antenna. For the record, common video tubes for AC sets are 6AC7, 6AG5, 6AG7, 6AM8, 6AN8, 6AW5, 6AS8, 6AU8, 6AW8, 6AZ8, 6BA8, 6BH8, 6BK5, 6BK8, 6CB6, 6CH8, 6CL6, 6CL8, 6CV8, 6CX8, 6EB8, 6GN8, 6FH8, 6HL8, 6JV8, 6K6GT, 6KV8, 6LF8, 6U8, 6V6GT, 6W6GT, 12BH7, 12BY7, 12GH7; common video tubes in portables are 3BU8, 5AM8, 5AN8, 5AQ5, 5AS8, 5U8, 5V6, 8AU8, 8AW8, 8BA8A, 8BH8, 8CX8, 8EB8, 8GN8, 8JV8, 10GN8, 10HF8, 10JA8, 11KV8, 11LQ8, 12AT7, 12L6, 12W6, 16GK6, 25BK5.



**5 LOOKS LIKE SNOW.** A snowy picture can be caused by a weak RF or oscillator tube. First step is to replace the RF tube, and, if that doesn't pay off, replace the oscillator tube. Also, check the lead-in going to the TV tuner and try rotating the fine-tuning control to clear up the picture. If a lightning- or thunderstorm has been in the area, check for a burned or open antenna coil. Some coils are mounted on top of the tuner close to the lead-in cable; others are mounted within the TV tuner itself. Still another thing to check is the outside antenna for a broken lead-in wire. Then, too, wind or rotator may have turned the antenna in the wrong direction. And, last but not least, the antenna may actually have damaged elements.



**8 TALLER THAN TALL.** A distortion of the sort pictured here would never be the case with a properly adjusted TV set, so it's obvious that this set's owner didn't take full advantage of the TV test pattern shown in case No. 1. If you go in for fun-house mirrors, you may also dig the TV equivalent. Lacking this rather rare proclivity, you'll no doubt want to adjust the set so it displays an image as faithful to the original as possible. The vertical linearity control is your tool in this case. And while you could try to alter its setting until heads here assumed reasonable proportions, you would be far better advised to make such adjustment with a test pattern. Also, remember that many sets incorporate not one but two controls affecting vertical linearity (the second is usually termed an auxiliary control), so both must be adjusted.



**9 RUNNING UPHILL.** Though a picture can roll both up and down, the site of the trouble is almost always the same: the vertical sync section. Best remedy is to replace both the vertical oscillator and sync tubes (often found in the one and same envelope). If this doesn't solve the problem, try adjusting both the vertical height and linearity control settings. In some TV sets, incorrect adjustment of these two controls will result in a rolling picture. Physically check the vertical hold control for possible loose or poorly soldered connections. Should the vertical hold control let the picture roll in one direction only, look for a defective resistor or capacitor in the plate circuit of the vertical oscillator tube. And should vertical fold-over occur only at the bottom of the TV screen, it's a safe bet that the trouble is the vertical output tube.

*(Continued overleaf)*

# TV CURE-ALL

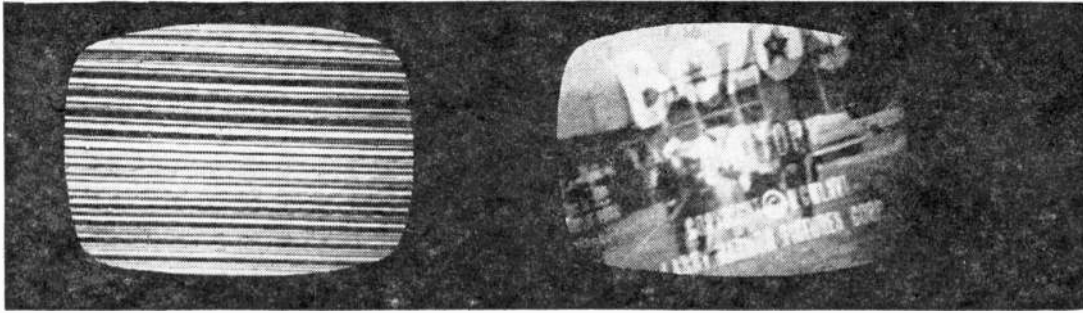

**10 THE LINES HAVE IT.** A screenful of black and white lines can be caused by a defective horizontal oscillator tube. First, check to see if the horizontal hold control is properly set. Once it is, check the horizontal oscillator frequency setting as well as the AFC and sync clipper tube. Since the AFC tube has been replaced by a dual-diode solid-state receiver in many of the newer sets, you may discover such a unit either plugged into a socket or soldered directly into the PC board. However, all is not lost—you can replace the soldered job by snipping off the three leads close to the body of the diodes, then forming small loops in new diode rectifier leads and soldering them to the ends of the leads you just snipped off. Bear in mind that there are two basic types of hookups: a series and a parallel.

**11 TILT!** A tilted picture can be caused by only one thing: a loose mounting screw on the deflection yoke assembly. In other words, the deflection yoke has turned on the neck of the picture tube, which can easily happen if the mounting bolt on the deflection yoke is the least bit loose. Most older TV sets have a wing nut at the top of the yoke assembly; newer ones generally have a metal yoke band with a 1/4-in. cinch-nut tightener. In the latter case, the metal band fits over the plastic tabs of the yoke assembly and snugs against the neck of the picture tube. In both instances, the procedure is exactly the same: you first set the yoke level with the frame of a picture at the top of the TV screen, then adjust this picture into position with the vertical hold control. You then recheck the level, and lock the yoke in place.

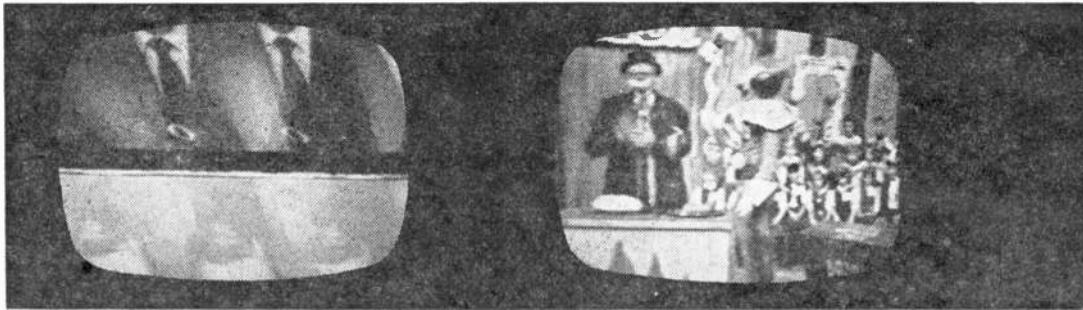

**14 BOTTOMS UP!** Any TV picture running sideways or up-and-down is sure indication that sync trouble is at hand. Check both the horizontal and vertical sync tubes, bearing in mind that these tubes may be in two separate envelopes or, conversely, snug as a bug in a rug in but a single vacuum bottle. Can't find the sync tubes? In consoles, the most probable types are 6AL8, 6AM8, 6AN8, 6AU6, 6AU8, 6AX8, 6HZ8, 6BE6, 6BH8, 6BU8, 6BY6, 6CG7, 6CH8, 6CS6, 6CQ8, 6CU8, 6CX8, 6EA8, 6EB8, 6GN8, 6GW8, 6GY6, 6HF8, 6JV8, 6KA8, 6LC8, 6SN7, 6U8, 12AU7, 12AX7, 12BZ7; and in portables, 3BU8, 3BY6, 3CS6, 3GS8, 4BU8, 4CS6, 4GS8, 4HS8, 5AM8, 5AN8, 5EA8, 5U8, 7AU7, 8AU8, 8AW8, 8CG7, 8CN7, 8CX8, 8EB8, 8GN8, 8JV8, 8KA8, 8LC8, 9AU7, 10GN8, 10HF8, 10JA8, 11KV8, 11LQ8, 12AT7, 12AU7, 12BH7, 12SN7.

**15 SQUEEZED AND SQUASHED.** Bigger-than-life objects on an advertised-in-Life TV are normally the result of a defect in the low-voltage power supply. In older consoles, you can suspect a rectifier tube of some description; in later model sets and portables, you can expect to find a selenium rectifier or a silicon diode in its place. Pinpointing a defective solid-state job with a voltmeter is a pretty simple task: with the lead between the positive terminal and chassis ground, a half-wave rectifier should produce a voltage of 125 to 150 VDC. And given a full-wave job or a voltage-doubler, output should be something on the order of 225 to 260 VDC. Should this approach prove fruitless, you might also check for improper setting of the tube positioning magnet on the rear of the deflection yoke (it can also produce roughly the same symptoms).

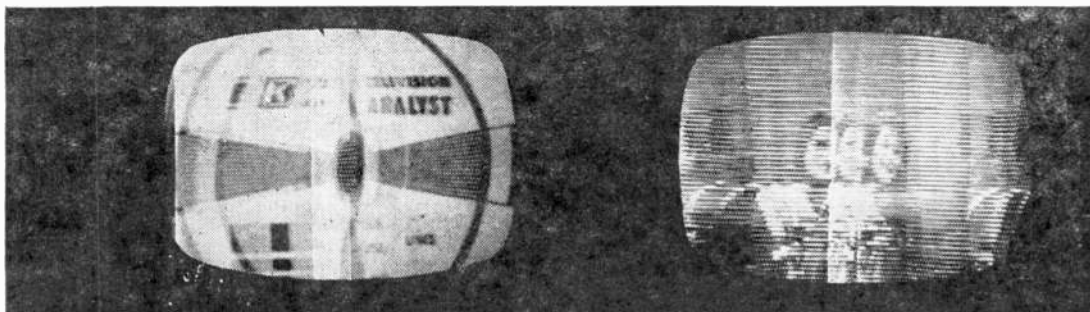

**12 CHRISTMAS IS HERE!** An extreme condition known as the Christmas tree effect, this problem stems from a horizontal oscillator tube or a horizontal output tube. (It generally takes the form of a vertical white bar somewhere on the screen.) Also worth checking are the horizontal drive and horizontal frequency controls. First, make sure that the horizontal drive trimmer isn't more than  $\frac{1}{2}$ -turn from its tight-up position. Next, set the horizontal hold control to its center-rotation position, then adjust the horizontal frequency slug within the horizontal oscillator coil with a plastic adjustment tool. Turn the slug until the fine horizontal lines become wider and then plop into a full picture (if the slug is turned too far, the lines will slant in the opposite direction). Once this looks satisfactory, try rotating the station selector to see if the picture stays in view.

**13 FOLDED GRILLE.** Looking much like the dented grille of a brand-spanking new chrome-plated gas-eating chariot, this condition can result from the very same ills that were responsible for the problems in photo 12. The demon may be the horizontal oscillator tube. Again, it may be the dual-diode AFC rectifier, so if replacing the horizontal oscillator tube doesn't help, the next thing to tackle is the AFC diodes. Should a shorted or leaky dual-diode rectifier be the defective component, you'll generally hear a high-pitched whistle or peeping sound from the speaker. In this case, your course of action is to replace those lousy diodes as outlined previously, turn on the set, and search for a folded grille that hopefully will be no more.

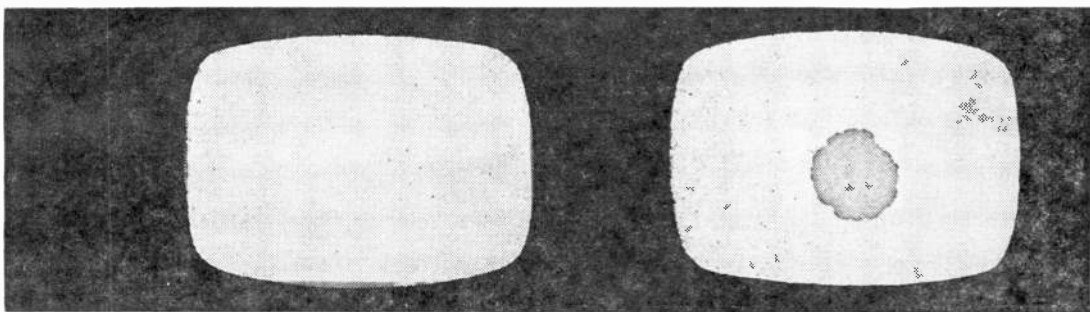

**16 WIGGLE WORM.** Though a trifle hard to show photographically, wiggles on a TV screen are ordinarily due to a 60- or 120-Hz component in the low-voltage power supply. They normally evidence themselves by causing the image to wobble back and forth; oftentimes, there will also be one or two dark stripes across the screen. First thing to suspect is an electrolytic capacitor in the doubler circuits. To remedy the situation, simply bridge a 100- $\mu$ F, 450-V electrolytic capacitor across the suspect. Should things improve, replace the tired and testy old job with a brand-new one, having the exact capacity and voltage ratings. Also worth knowing is the fact that a defective input filter capacitor in AC/DC portables can even result in no picture, no sound, or no raster!

**17 SPOTTED SCREEN.** The trouble shown above started with a spot the size of a pin head, which, within two weeks, had grown to be big as an orange. Wha happen? Simple! The phosphor on the pic-tube was burning off. And the only remedy is replacement of the pic tube itself. Thing to watch for here, with older TVs at least, is incorrect setting of the ion trap (newer TVs are devoid of this device). The ion trap should always be set as close as possible to the picture-tube pin base so as to produce the greatest possible brightness. Sift! another way to ruin a pic tube is to operate a set having a defective vertical oscillator tube. As pointed out in case No. 6, the single horizontal white line across the screen will produce devastating destruction in short order, unless the brightness control is turned way, way down.

*(Continued overleaf)*

# TV CURE-ALL

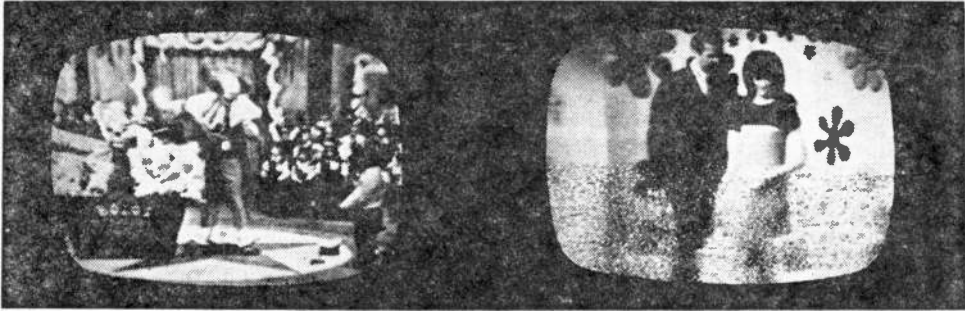

**18** **BLURRY, FUZZY, AND OIM.** TV pic tubes that come on with all the speed of a turtle in Tipperary are probably tired as a fleet-footed floozy after an 8000-meter race. For like all tubes, boob tubes begin their journey to tube burying ground the first time they're turned on. Eventually, images are blurred and fuzzy, even though brightness and contrast controls are wide open; closeups of faces reveal extreme white and blotchy areas even though such blemishes aren't present in the flesh. Tube brighteners or a special process called charging can stave off the inevitable for a time, but stalling for time is only delaying the inevitable. Best bet is to do the thing you'll eventually have to do—replace the picture tube.

**19** **ROAR! ROAR! ROAR!** Though images of this sort make for anything but pleasurable viewing, there's really little you can do to relieve the situation. The particular form of TV interference (TVI) shown here was caused by a defective power transformer somewhere on the same power line; roughly half the picture is covered with dots and dashes, and there is a good deal of picture tearing. Since there are so many causes of TVI—police radio, CB equipment, hams, even radio-TV stations—pinpointing the culprit may take some time. Installing a TVI trap in series with the antenna lead-in sometimes helps. And anything you can do to increase signal strength at the receiver itself is also worth trying. Among the various steps in this direction are installing a narrow-band (yagi) antenna; raising the antenna in height; and using shielded lead-in cable between antenna and TV set.

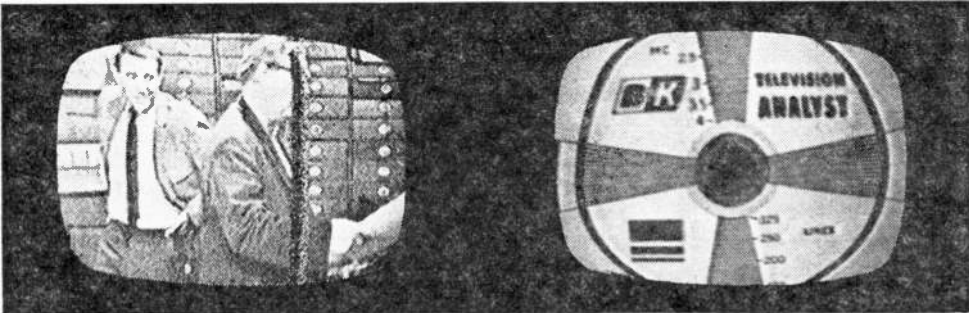

**20** **STRING OF ROPE.** A vertical weaving line down the TV screen is generally evidence of Barkhausen, snivets, or RF oscillation (Barkhausen and snivet lines predominate on VHF channels). First step is to replace the horizontal output tube, which, though it may check out OK in a tube tester, may still be oscillating and causing interference. In many cases, this same type of oscillation will become more pronounced on weak or distant stations. Dressing the antenna leads away from the high-voltage cage should help. Should there be a white drive line present on the screen, the horizontal drive control should be backed off until the line disappears. In extreme conditions, it may also be necessary to replace the horizontal output and oscillator tubes.

**21** **TEST PATTERNS, AGAIN!** Having examined case after case of typical TV ills, we're back again to the faithful test pattern. The reason is easy to explain: nothing else tells you half as much about a TV set's performance—good or bad. When you come right down to it, there are dozens of TV test patterns, since each station transmits its own particular version (the one shown in case No. 1 is that transmitted by New York's WCBS-TV; the one above is that produced by the B&K Television Analyst). But regardless of which pattern you have at your disposal, you can use it to determine whether your set is properly adjusted for aspect ratio, linearity, and contrast; and how it stacks up in terms of line count, line resolution, and low-frequency phase shift. In short, TV happiness is a properly displayed test pattern!



# ERECTING A ROOFTOP TOWER

Forget about masts, guy wires, and dizzying heights—a rooftop TV antenna require less money,

By Homer L. Davidson  
wires, and dizzying heights will take less time, and give plenty of zonk!

**D**o you really want to climb Mount Everest to get good TV reception? Are you waiting for the moment when your mast gets the shakes and comes toppling down during a storm that was never supposed to show up?

If you get the wim-wams thinking about all the complications that might come up when erecting a mile-high TV antenna—or if you've already been through the mill—this guide to erecting a roof-

top antenna should give you courage. Actually, it's not as bad as it first seems. If you're willing to sacrifice some height to gain a goof-proof installation, not only will you sleep better at night and feel better in your pocket, but your neighbors will appreciate a good job.

We've come up with some groovy photos that show a young fella going about his work. As you can see, he's got a sturdy roof (good shingles and joists), a few tools, and the roof mounting antenna. That's it.

With screwdriver, pliers, and crescent wrench in hand, all you do is select the right tower for your particular receiving area. This depends on the kind of signals you wish to receive (uhf, vhf, FM, etc.), distance from the transmitter, and the obstructions in between. Your local TV shop will probably give you some advice on just what you need.

**Here To Stay.** A rooftop tower has many advantages over a mast. It's easier to install, it has a much better appearance, it's more secure, and you eliminate vibrating guy wires that run endlessly from the

(Turn to page 34)



# PREPARE FOR A WHOLE NEW CAREER IN HOME ENTERTAINMENT ELECTRONICS

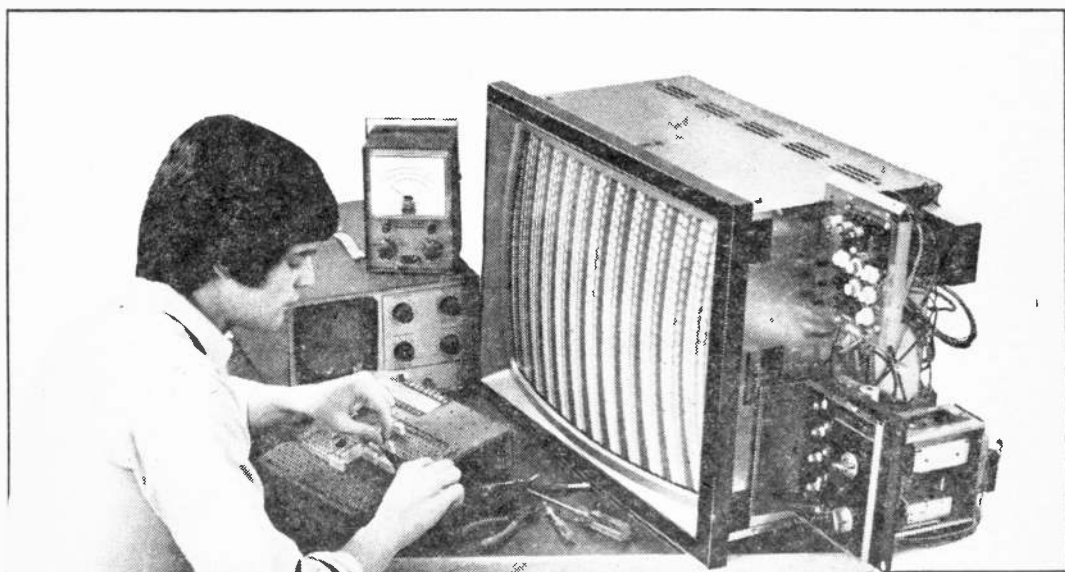

## ...AS YOU BUILD YOURSELF A BELL & HOWELL SOLID STATE COLOR TV!

Detach, fill out and mail postage-free card today!

## A complete at-home learning program in home entertainment electronics!

Start preparing now for a new career—with this complete, learn-at-home program in home entertainment electronics prepared for you by skilled instructors. Our Bell & Howell Schools representative is ready to bring you all the facts you need. Mail the card now.

### Work on this exciting "hands on" project integrated into your learn-at-home program!

As part of your complete electronics education, you build and keep a Bell & Howell solid state color television set. This important project gives you valuable "hands on" experience with solid state circuitry—the kind of *practical* experience you'll need to build a successful career.

### Attend special "help sessions" ... talk to your instructors in person!

If you'd like some personal advice at any point in your program, you can arrange to attend a special "help session" and talk over special problems with a qualified Bell & Howell Schools instructor.

### Master the most up-to-date solid-state circuitry

As color TV moves more and more in the direction of *total* solid-state circuitry, you'll be thoroughly familiar with the most advanced "trouble-shooting" techniques for these sophisticated circuits.

### Fix stereo systems ... FM-AM radios ... phonographs ... tape recorders

The thorough knowledge of electronics you gain from completing this course and building your own color TV set will be enough to service almost *any* type of home entertainment electronic device—even some that aren't on the market yet!

### Earn extra part time income—or start a business of your own!

The skills you acquire through this unique program can help you earn extra money—or start a business of your own in color TV servicing. We've helped thousands of people start new careers or businesses of their own in electronics.

### Exclusive Electro-Lab®—yours to keep!

To make sure you get practical experience with instruments used daily by professionals, we've integrated into your program three precision instruments you assemble yourself and keep: a Design Console, an Oscilloscope and a Transistorized Meter. (See details at right.)



25-inch picture (measured diagonally)

**Detach, fill out and mail postage-free card today!**

■ **Bell & Howell Solid State Color TV.** Ultra-rectangular tube ... 25-inch picture measured diagonally ... full 315 sq. inch viewing area. Solid state modular circuitry ... 4 advanced IC's ... 100 transistors ... 72 diodes ... individual plug-in circuit boards. Special UHF/VHF tuning features ... built-in self-service components.

■ **Design Console** Use this to rapidly "bread-board" circuits without soldering. Equipped with built-in power supply ... test light ... speaker ... patented plug-in modular connectors.

■ **Oscilloscope** Portable 5-inch wide-band oscilloscope offers bright, sharp screen images ... calibrated for peak-to-peak voltage and time measurements ... 3-way jacks for leads, plugs, wires.

■ **Transistorized Meter** Combines most desired features of vacuum-tube voltmeter and quality multimeter. Registers current, voltage and resistance measurements on a large, easily-read dial. Features sensitive, 4-inch, jewel bearing d'Arsonval meter movement.

If card has been removed, write:

352R

An Electronics Home Study School  
DEVRY INSTITUTE OF TECHNOLOGY



ONE OF THE  
**BELL & HOWELL SCHOOLS**

4141 Belmont, Chicago, Illinois 60641

**Mail postage-free card today!**

# TV Tower

(Continued from page 31)

mast to your house. Very few rooftop antennas blow over during severe storms, so they prevent additional damage to your roof. Should the boom or any of the elements be damaged they can be reached with no trouble at all.

Only a few holes are needed to install the tower on your roof. Before you get started, check and make sure that your antenna will be no higher than other installations in your neighborhood. If necessary, check the local city ordinance for TV antenna installations. Some cities have very exact requirements and even a permit fee. Better to be safe now than sorry later.

Small TV towers come in lengths of 18, 30, and 36 in., as well as 5- and 10-ft. lengths. While they are sturdy and cost little, a tower mounted on a 1½- to 2-story home should provide adequate reception even in a fringe area. If you're really out in the cold, a hi-gain Yagi-type antenna will help to put you in the ball park.

**Selecting a Sight.** Once on the roof, select a likely spot for a three-legged tower. We'll help you out by recommending dead center on the roof peak (you get a ground-plane effect this way that will reduce local RF interference somewhat); just count the total number of shingles and divide by two to reach *Ground Zero*. Mounting the antenna to one side of the roof is possible, but less effective.

Make sure you're clear of tree limbs, etc., and in the line of sight of some TV stations. At all cost, keep away from power lines of any description.

In extreme fringe areas you can mount the tower on the highest part of your roof. But if you've got more than 10 ft. of antenna skyward (extending above the tower), it will have to be guyed properly. Under normal circumstances, however, guy wires shouldn't be necessary. A good rule of thumb is: a 5-ft. mast extended out of a 30- to 36-in. tower; a 10-ft. mast extended out of a 5- to 10-ft. tower.

If you're mounting the tower on a flat surface (with no peak), simply center it by using the roof corners as a guide. A friend can hold the boom at the approximate dead center while you take sightings from alternate corners.

**Mounting Boom.** Before securing the

three-legged tower, check that all three legs are located *over* a roof joist (i.e., supporting beam). The towers have adjustable legs so this is possible. You can locate the joist by taking a hammer and tapping lightly over the surface of the roof. The first solid thump indicates you've got a beam where you need it.

Temporarily place the legs of the tower on the corresponding joists. Place the two adjoining legs (i.e., the two that form the base of the triangle) in the direction where winds are excessive. It's usually north winds or northwesterlies that cause most problems, but it pays to make sure for your particular area.

Level the tower before securing (lagging) it to the joists. A carpenter's level will prove to be a worthwhile investment, but should one be lacking, place the boom on the tower anyway and sight it against house outlines and other reference points. When using a level, level the tower in two opposite directions with the boom installed.

Now you can secure the legs to the joists using the supplied screws. Be sure to place at least two screws in the base of each supporting leg. If they don't go directly into the joist you will have to sound out the joist's location again. Probably a shift of ¼ in. is all that will be needed. Make sure that all screws are flush with the roof surface and as tight as possible.

**Antenna Up and Away.** Remove the antenna from the packing carton and prepare it for mounting. Most TV antennas can be unfolded in a second and the antenna rods will lock into position. Simply push or pull the elements into the correct configuration and clip them into place. You'll find it easier to assemble the antenna on the roof, but take care not to damage shingles while you're working. Wherever you work, leave plenty of space for the job.

To connect the 300-ohm lead-in wire to the assembled antenna, use either small eyelet connectors or form an eyelet with the bare wire. Place the lead under a lock washer, tighten the connection, and place some electrical tape over the antenna terminals. This will insulate the antenna connections from erosion due to wind and moisture.

If the antenna has a fairly long boom, two brace supports should be used to support it. Place a standoff on the front support brace while the antenna is still being prepared for mounting.

**Two Types.** In this installation a uhf *bow-tie* antenna will be mounted below the

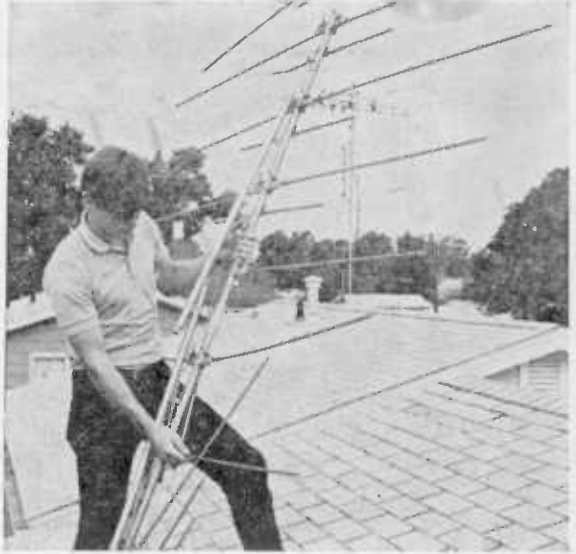

*Before securing tower to roof, place TV mast in position so that tower can be properly leveled (see photo on previous page). Once antenna has been installed, final leveling can be achieved with small set screws on support braces. At least two screws should be used to secure legs to joist. Carefully remove vhf antenna from carton, fold out all elements, check their configuration, and then lock them into place. Hook up lead-in cable to antenna, and with cable in place, mount a standoff on one arm brace to hold it in position. Now that antenna lead-in is installed, mount antenna to 5 or 10 ft. mast. Tighten all bolts and pull up brace supports so that antenna will be level.*

# TV Antenna

all-channel vhf boom. Since the latter is the basic unit it is mounted first. *Remember*—many antennas combine elements for both uhf and vhf reception, so you'll only need the bow-tie (or equivalent) if you're in a fringe area or the uhf signals are not in the same plane with the vhf signals.

Choose the correct length of mast to install in the tower. This will depend on reception requirements (also, check rule of thumb already mentioned for tower measurements). Most likely it will be either a 5- or 10-ft. piece. Bolt the antenna to the mast, level the bay, and tighten the mounting bolts. Pull up the brace supports so the antenna is in a level line and snug up the "U" bolts on the brace. Try not to flatten out any of the aluminum pipe.

Once you've lowered the mast into the tower, you can raise or lower it to get best reception. Rotate it so that the smallest elements on the boom are pointing toward desired stations; in fringe areas this may simply mean *snow-free* reception.

Some receiving areas require a uhf translator antenna. This is usually a bow-tie having several "V" elements and a reflecting screen. Gain is sometimes as high as 12 dB at distances up to 50 miles. If a translator antenna isn't required (as mentioned before), you can forget about the next steps.

Unfold the uhf antenna's mounting elements and bolt them into place. Connect the polyethylene lead-in cable to the antenna terminals and feed it through standoffs down the front of the antenna (or back through the screen). Now mount the bow-tie on the mast with two clamps just below the vhf boom. Point the bows toward the station you want; reflector remains flush behind them.

**Leading Question.** The lead-in cables for both antennas are fed down the mast and tower by way of standoffs (one for each lead). Bring the cables down one leg of the tower, pull them tight, and rotate the twin lead until you have a spiral that's taut so it won't flap in the wind. Crimp the insulating washers in the standoffs to hold the spiral in place. If you've got coax, however, you can tape it to the mast (see section on rotators).

Check to see at what point your leads will come off the roof and start down to the set. Position two screw standoffs here, fasten

down the two leads, and pull them tight. Keep on making a taut spiral with the twin lead as before.

Going across the roof, place a screw stand-off every 4 ft. and keep the two leads taut as they are inserted. This should make for a neat installation.

Once the tower legs, screw standoffs, etc., are in place, use plastic roof cement to cover up all the screws for a weather-proof installation. Smear the stuff over any metal part that penetrates the roof's surface.

The antenna leads should now be brought down the side of the house. Place two screw standoffs just under the roof overhang and two more standoffs at the bottom where the leads will be fed into the house proper (through a window or the siding). Again, the leads should be taut, with more standoffs added wherever necessary. Try to keep the cables away from metal rain spouts, power lines, or other obstructions.

**Rotating the Beam.** If an antenna rotator is added to your installation it should be mounted *before* the vhf boom. Place the mast into the tower brace supports and mount the assembled rotator to this piece of pipe. If you use a 10-ft. tower, place the rotator on the tower mast as opposed to the antenna mast. This way it's easier to lower the vhf boom into the rotator assembly.

Connect the 4-, 5-, or 8-wire cable to the rotator. Make a note of the correct terminals for both ends of the cable. Terminal 1 on a flat 4- or 5-wire cable will be silver so start with it. Connect each wire to the rotator and tape the cable to the mounting bracket. The rotator's cable can be brought down either by taping it to the mast or using more standoffs.

Be sure to leave a 1½- to 2-ft. loop in your antenna leads where they run past the rotator. This permits the antenna to turn a full 360 degrees without binding or pulling the leads out of position. Use a standoff above and below the rotator to hold the loop in position. These standoffs should be in position before you tape the rotator cable to the mast. This way you won't pierce these wires with one of the standoffs; this could ground the rotator's cable.

Check the correct direction for the rotator before leaving the antenna in one position. Rotator mechanisms have either a north or south starting position. When the antenna is in its correct starting position, bolt it into place. See if the antenna loop is free so it will rotate through a full 360 degrees. ■

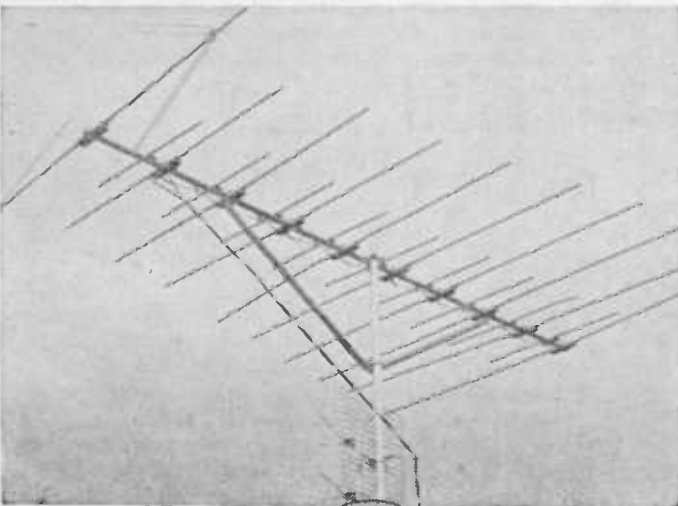
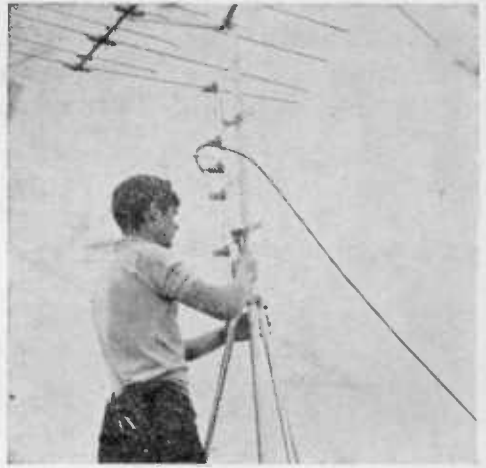

Remove uht antenna from carton (if needed—see text) and fold out all elements. Remember, if you're going to install a rotator it should be mounted before either the vhf or uht arrays are bolted to tower's boom. Mount uht antenna below vhf array and point bow ties towards desired TV stations. Now bring two lead-in cables down mast along one leg of tower. Standoffs should be used to keep leads in position. Loop of 1½ to 2 ft. is necessary to allow rotator to turn full 360 degrees. If you have no rotator, leads may be taut. Use plastic cement to cover all metal surfaces that penetrate roof's surface. At left, both antenna arrays have been mounted on boom and pointed towards major TV stations in area. Final leveling adjustment can now be made.

# YOUR TV SET WILL GET YOU IF YOU DON'T WATCH OUT

by Jackson Kay



**S**creaming sirens and tires tear down the street with skinner lights flashing red. Dark red hulks rumble past your home to a conflagration elsewhere. Lucky? You bet you are if you didn't give your television receiver the care and protection it needs and deserves. Ambulances can give you the same scare action as they whiz by, but they are painted white. No matter what the color, keep these emergency vehicles away from your door by following the safety points and tips that'll keep your TV set safe and operable.

## Location and Protection

- Never place your TV set on an unstable TV cart or stand. Should it fall, pull out the power plug at once and call your TV service technician. Do not move the set!

- Your TV set has slots in the cabinet for ventilation purposes, to provide adequate convection cooling to prevent overheating. Don't cover these slots with cloth, plastic or any other material.

- Never block the bottom ventilation slots of a portable TV set by placing it on a bed, sofa, plush rug, towel, etc.

- Never place your TV set near or on a radiator, heat register, oven, dishwasher, toaster or any appliance that gives off heat.

- Avoid exposing the TV set to rain or extreme moisture as this may result in a fire or shock hazard. Never operate a TV set if liquid has spilled into it. Have your TV service technician check out the set before you turn the power on.

- When installing an outside antenna, use a lightning arrester which is U. L. listed.

- For added protection during a lightning storm, and when the set is to be left unattended for a long period of time, unplug it. Old man weather can zap your house and TV set with lightning or cause extreme power line surges. Either action will cause damage to your set and possibly start a fire.

## Operation and Service

Everyone is a TV set repair expert simply because they own one. Yet everyone has an appendix, but how many friends would you trust to remove yours? Here is some advice on how to operate and service your TV set and stay alive to enjoy it.

- Some sets are equipped with a polarized AC line plug—one blade is wider than the other. This polarized plug will fit into a power outlet only one way. If you have trouble fitting it into a power outlet or require a special polarized extension cord, contact the TV dealer who sold you the set.

- TV sets equipped with a polarized plug or



three-prong plug should not be tampered with to defeat the safety purpose of the specialized plug. Do not replace these plugs with standard two-prong plugs—you'll cause a severe shock hazard in many cases.

- Do not remove the back cover of the TV set as this will expose you to very high voltages. Voltages above 100, 200, 300, even 400 volts are common, not to mention picture tube voltages over 20,000 volts. Remember, 100 volts or more can kill, if not burn or seriously injure your body!

- Never push or poke objects into the TV set through cabinet slots, as it is possible to contact dangerous voltages or short circuits.

- Be sure the TV receiver is turned off before you clean the face of the picture tube. Do not use water or excessive liquids. Do not use scouring powders packaged for sinks—they may scratch the tube.

- Adjust only those controls on the back of the set that are covered in the operating instructions. Mess with anything else and your TV service technician will present you with a larger bill.

- Do not defeat the fuse or circuit breaker by jumping the circuit. When replacing fuses be sure to use the exact replacement.

- Turn the set "off" when it is not being viewed. This procedure will increase the set's useful life.

### Call the Service Technician Now!

- There will be a time when your television receiver needs the expert servicing of a technician. You will know this is a certainty when you're unable to restore normal operation by adjusting the user's controls. When this happens, call your TV service technician.

- It is normal for some TV sets to make popping or snapping sounds, particularly when being switched on or off. If sounds are frequent, call your service technician.

- Always request your service technician verify that the replacements have the same safety characteristics as the original part.

- Never add, or permit a technician to add extension speakers, or jacks for record players or tape recorders to a TV set that has not been designed for this purpose. Such additions may result in an electrical shock hazard.

### Safety First

One good guide by which you should govern yourself when puttering about an apparently defective TV set, is not to perform any adjustment, poking, prying, snooping cleaning, etc., that you would not permit a six-year-old child do. After all, why is a child's life dearer than yours when TV service technicians are available to do the task efficiently and safely? ■

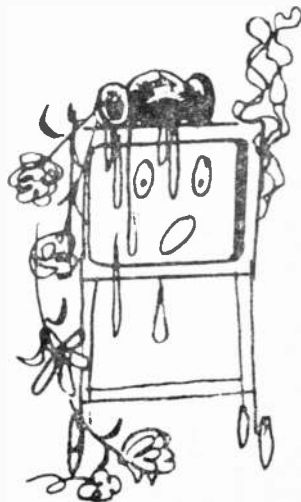
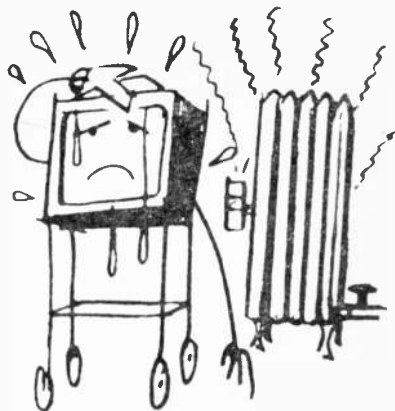



# 8 STEPS TO CAR

**U**NCLE SAM is spending millions to place men on the moon (rumor has it, in fact, that Rosemary's baby is scheduled for a moon landing, though nobody's saying just when). No one's denying that the Apollo missions are expensive and quite complicated electronically. Auto tape player repairs are expensive too, though unlike Apollo missions they needn't be—not if you fix your own.

In the Eight Steps you're about to see, you'll find meat enough to move you well along the way toward truly enjoyable music on the move. Only a few hand tools will be

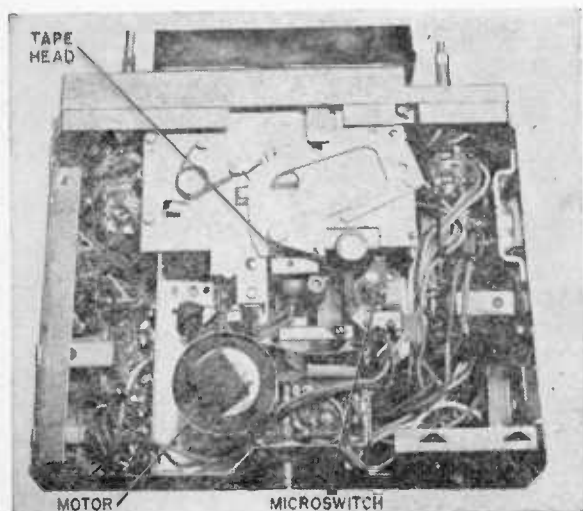

**1** Keep your eyes open as well as your mind when you remove the car tape player from under your dash, to the time you remove the chassis covers on your workbench. Very often a loose connection or screw can be fixed putting the player in tip top playing form. Once the covers are off, do some eyeball poking to turn up the trouble. Remember, most stereo tape player troubles are mechanical. Stop, think and try to isolate the trouble quickly before digging any deeper. And be sure not to misplace any hardware.

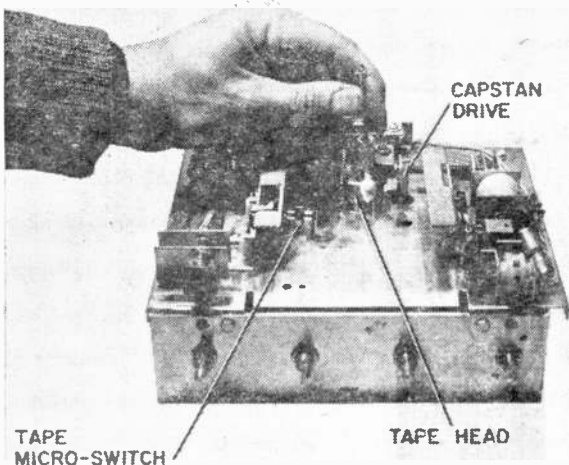

**2** The most common trouble with auto tape machines is excessive dirt and dust. To ensure crisp tape reproduction, keep that tape head clean. A handy gadget to own is a tape head cleaning cartridge. At least once a week insert the cartridge to clean the head. At least once a year, or whenever playback reproduction is not up to par, do a thorough cleaning job. Clean tape head and tape guides with tape cleaning fluid. Apply fluid with a Q-tip. Denatured alcohol can be used. Also, remove tape oxide dust from head and motor capstan drive. Poke around and clean it all up. However, be sure not to throw any tape guides out of position.

by Homer L. Davidson

# TAPE PLAYER REPAIR

needed for most repairs. Just remember to use a pencil-type soldering iron when working in solid-state circuit boards, and don't forget that adage about fools rushing in where angels wouldn't be caught dead. Take your time, take things easy, and think! If you have a signal tracer, VTVM, and/or transistor tester around the shop, by all means drag 'em out and put 'em to work—if you can find work for them. But since most tape player troubles are mechanical in nature, the bulk of the problem rests with you. Ready to take the time to stop, think, and try to isolate that trouble? Then read on.

**3** In many cases, dirt and grease will collect on the motor drive pulley and nearby metal parts. Simply remove all dirt and grease with denatured alcohol. Also, check that capstan flywheel and clean it if necessary. A bright slick-looking flywheel indicates slippage between the drive belt and flywheel. Clean thoroughly. If at all possible, try to find a replacement drive belt. You may have to write to the manufacturer. Power output transistors are installed with hardware that can loosen, causing poor electrical connection. Also, if not seated tightly on their heatsink surface, the power output transistors can overheat and destroy themselves. Be sure they are secured in their sockets.

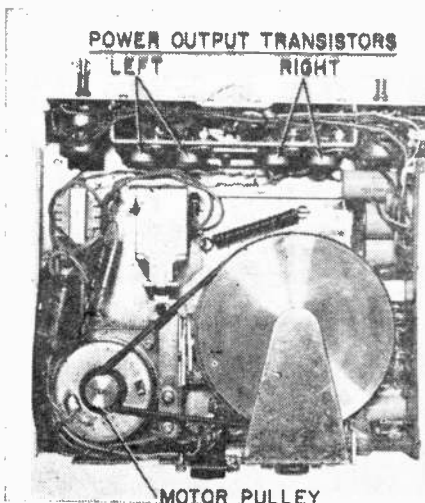

## TAPE PLAYER REPAIR

**4** Excessive tape oxide dust within the flywheel bearing will cause slow and erratic tape speeds. Most capstan flywheels can be removed by pulling out a small keeper pin at the bottom bearing assembly. Now it will be easy to clean all bearing parts and surfaces nearby. Put a drop of oil into both bearings and re-assemble. Let the tape player run for a few minutes on the test bench and check for any oil that may work on the flywheel drive surface. Over lubrication may undo any good achieved.

**5** Does the tape refuse to change to another channel? Or perhaps, the solenoid is working and the channel indicator does not move? To find out what's up, connect power to the unit and listen to determine whether the solenoid is operating or not. A channel change can easily be heard while watching the ratchet. Determine whether the ratchet is turning over a small cam that lifts and lowers the tape head. Eyeballing it here will pinpoint simple mechanical problems that you can adjust to

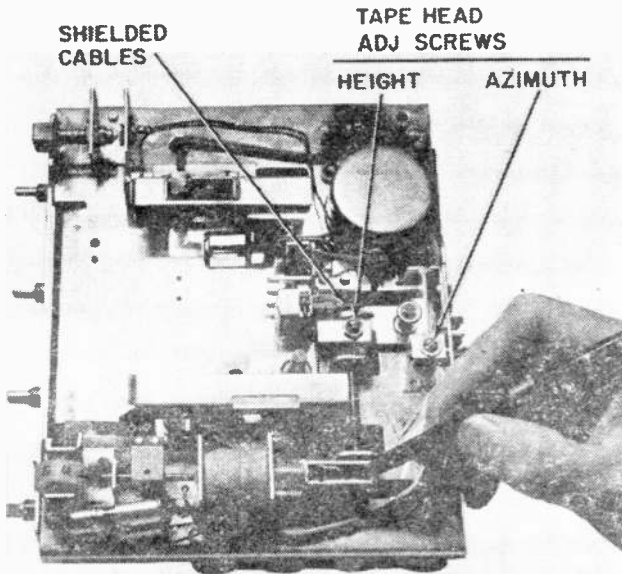
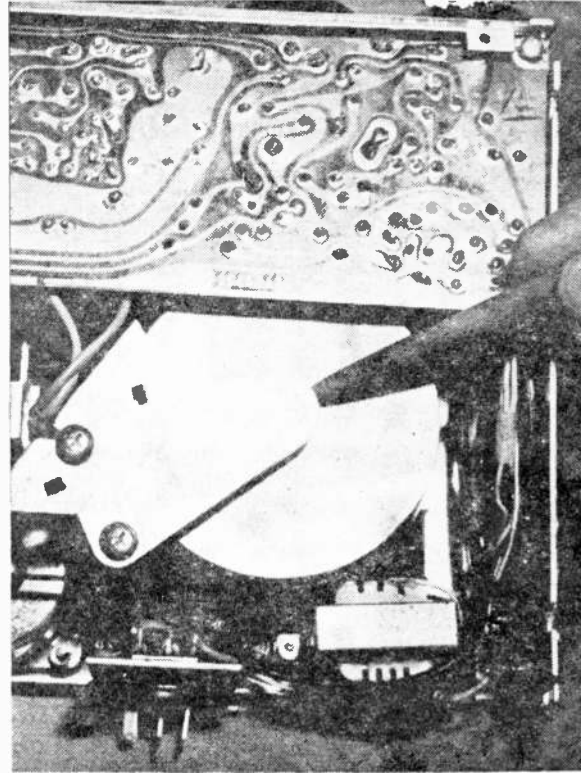

normal operation order. If the solenoid does not operate, it may be shorted out or have an open coil—call your VOM into action. If your playback is erratic or dead, check the shielded cables to the tape head. They can cause lots of trouble. If inspection does not pinpoint the cause of the trouble, you'll need the services of a signal tracer or injector. Be sure the volume control is set wide open.

**6** In case the stereo tape player will not manually change channels, suspect a dirty or broken manual change switch. Momentarily short the two contacts at the back of the change switch. If the solenoid is operating, the tape head will change positions. If not, trace out the wiring and look for a cold solder joint or break. If the switch is loose, it will promote frayed and broken wires. Try to determine cause of failure to prevent its recurrence.

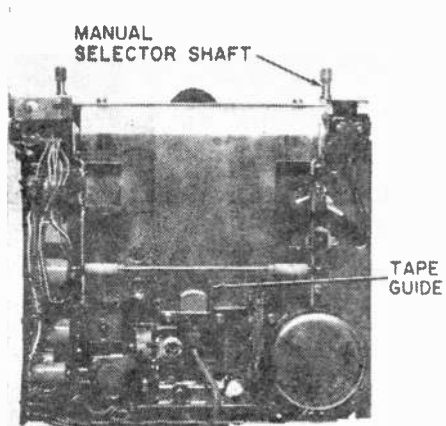

**7** Generally, when the tape becomes wound up into the capstan drive assembly, suspect a rough capstan drive or a poor cartridge. Do not allow the machine to run when jammed with tape. The motor will overheat. In this particular model, the motor protection resistor in series with the power supply burned out and was replaced. Most values are low—like 2.2 ohms. However, check the unit's schematic diagram to determine correct value and wattage. Of course, overheated motors often become defective and replacement is mandatory.

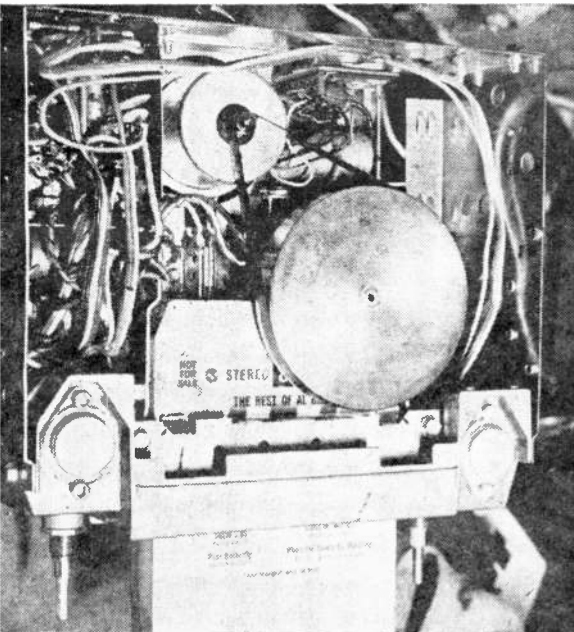
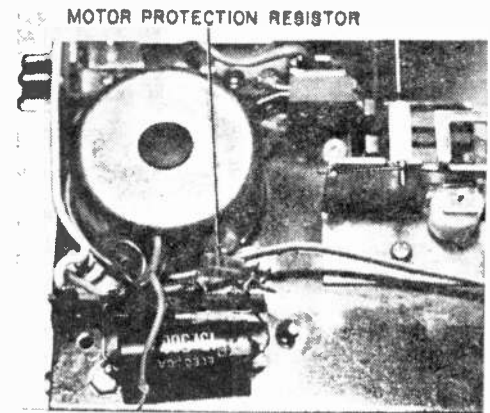

**8** Before clamping the lid on a stereo tape player, give it a good bench preventative maintenance checkup. First, demagnetize the tape head. There are several inexpensive demagnetizers on the market. Second, use a test tape and check both amplifier channels and speakers for proper functioning. If you have the know how and manufacturer specs, check and align the tape head in azimuth and height. Next, install the machine under your dash, make power and speaker connections, snap in a tape cartridge. Now sit back and enjoy good stereo. ■

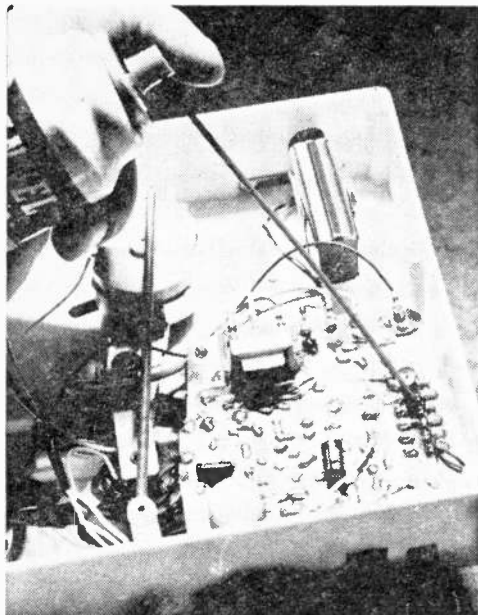

Oil has caused more tape troubles than it has cured, though it can be a godsend if used sparingly. But oil mechanical parts only.

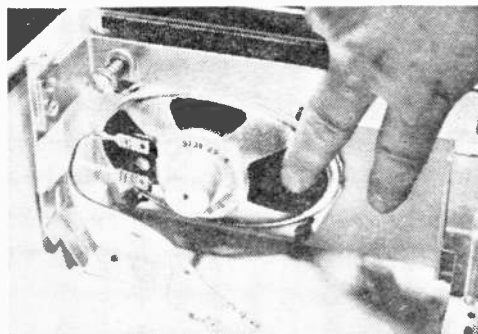

Speaker is often responsible for distorted sound, particularly if finger pressed against cone corrects trouble. Remedy is new speaker.

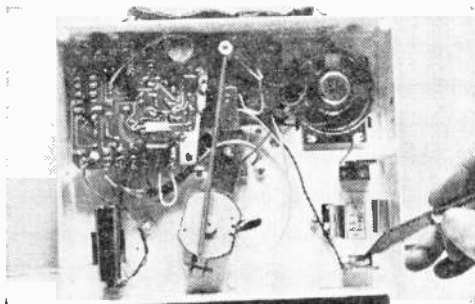

Batteries (if used) should be replaced often and removed whenever recorder is stored. Knife here points to corroded terminals.

# THOSE MINOR TAPE TROUBLES

... and what you  
can do about them

By HOMER L. DAVIDSON

■ Ben Franklin wasn't thinking of tape-recorder repair when he observed that "a penny saved is a penny earned," but the fact is that you *can* cut service calls by making minor recorder repairs yourself. Our photos present a rogue's gallery of common tape-recorder ills, with the suggested remedy indicated in each case. A quick perusal will no doubt reveal what you have long suspected—that the answer to your tape troubles lies right in your own two hands. ■

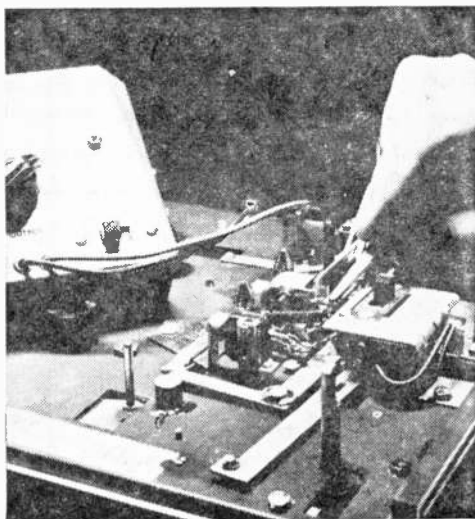

Tubes or transistors are chief reason for loss of record/play functions. Audio generator should quickly pinpoint defective one.

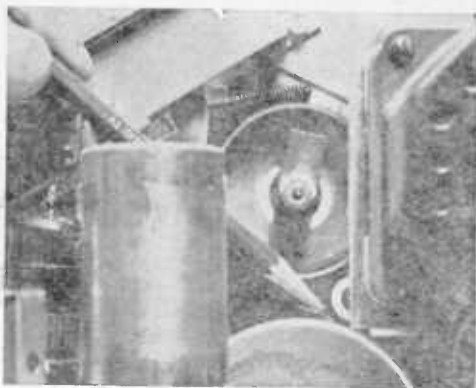
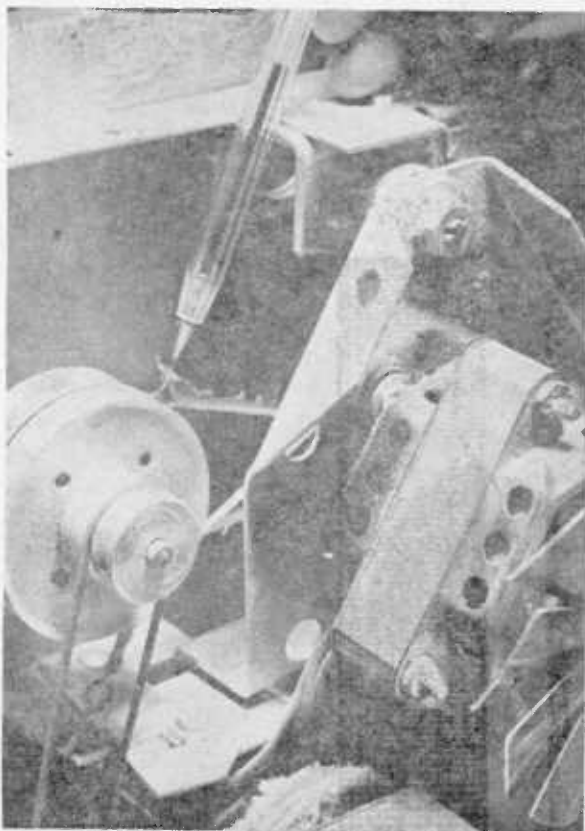

Capstan flywheel, if oily, can result in slippage, as can hardened rubber drive assembly. Remedies: clean flywheel, replace drive



Drive belt may be culprit in recorder with too-slow tape speed. Clean belt with fluid; be certain idler pulley(s) are well oiled.

Tape guides and levers can slow tape, even stop recorder if bent or otherwise damaged. To fix, check and correct tape path.

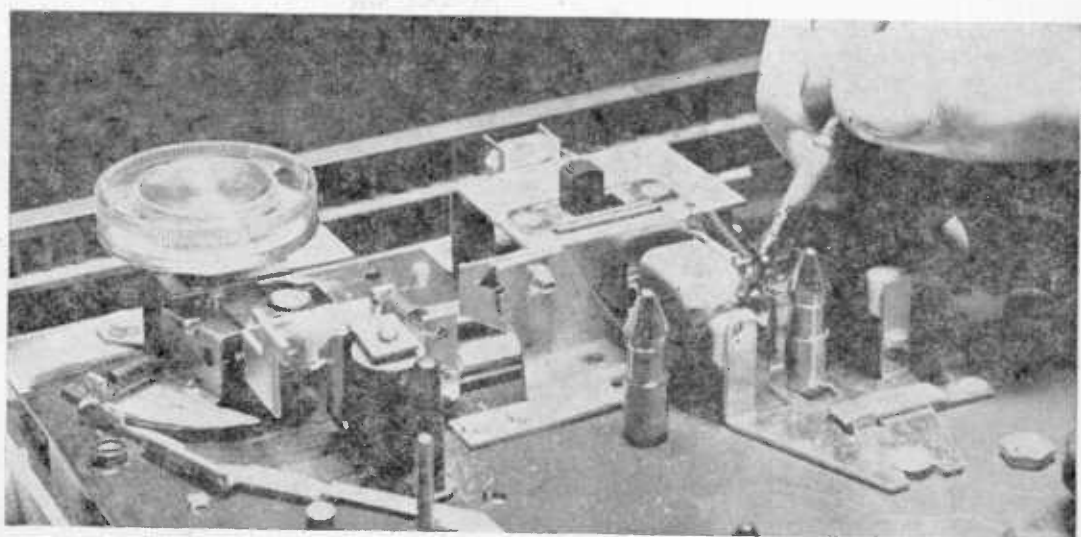

Record/play head holds key to proper operation of any recorder and can be source of weak, noisy, or distorted recordings. Use Q-tip moistened in head cleaner to remove dirt; use demagnetizer to remove residual magnetism and place head in neutral state. (Turn page.)

# TAPE TROUBLES

*Continued*

Rubber pressure roller can result in uneven tape motion, particularly if badly worn (as is roller being held by hand in photo). Since a worn roller cannot be repaired, an exact replacement must be secured from either the manufacturer or his agent.

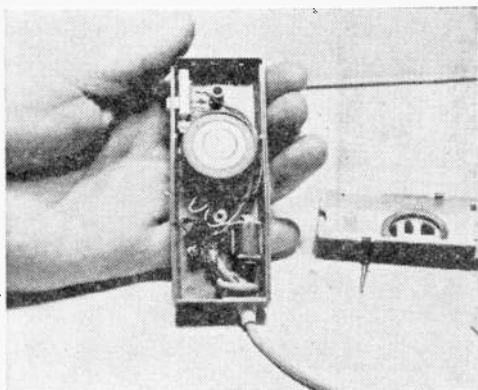
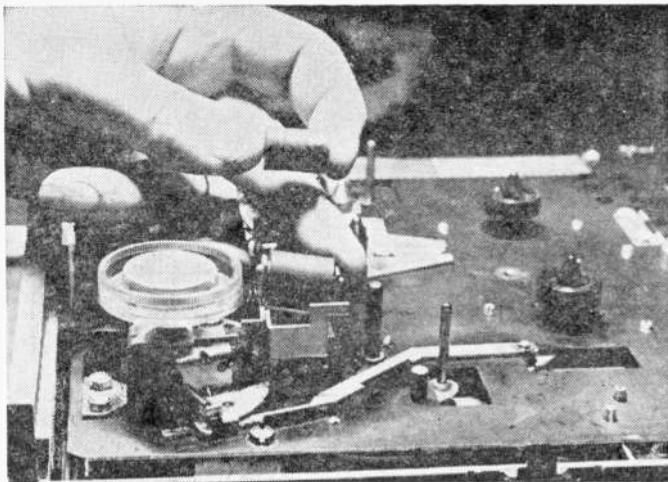

Mike cord can be explanation for intermittent recording, and mike can go completely dead if one or more wires in cable are broken. New cord or mike will solve problem.

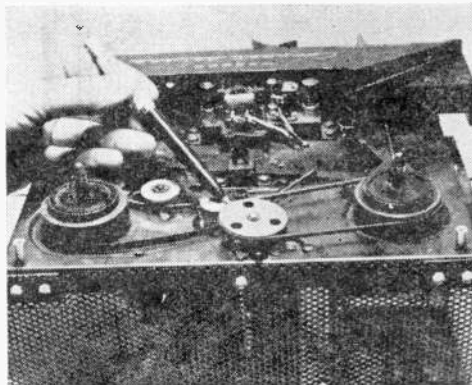

Rewind drive wheel can prevent proper operation during rewind function if it is bent or otherwise defective. In portable units, batteries can also be to blame.

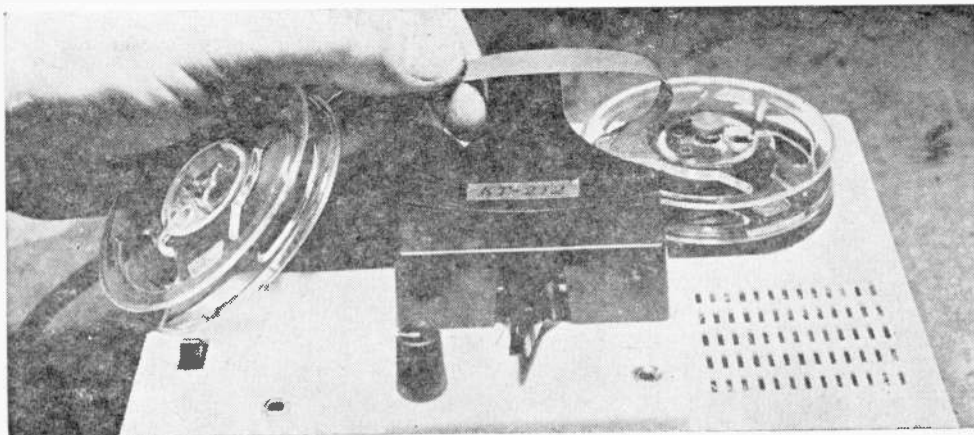

Tape itself holds clue to many a minor trouble. Dull side of tape must face heads if recorder is to function properly; tape must be fully erased if recording is to be clean and unblemished (virgin or bulk-erased tape being the best bet for good recordings).



# Save a buck by building the...

## CTS FUTURA V SPEAKER SYSTEM

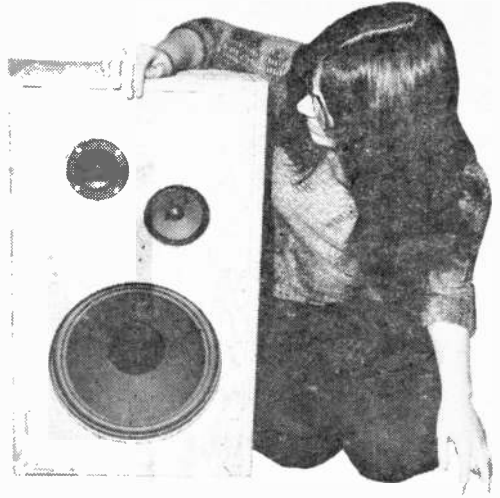

It's a sure bet for console sound

Do you look at your pip-squeak sound system and vicariously substitute an ultimate supersound layout you've been planning for years? And whenever your buddy takes the plunge and comes up with a new stereo console, do you drool?

Keep cool, friend. With a reasonably good hi-fi stereo amplifier you can update your speaker system to sound as good as those speakers in his multi-\$ console. Here's how.

A manufacturer of literally millions of custom-design loudspeakers—who until now dealt with manufacturers only—offers seven speakers from its line for home construction through mail order. The company, CTS, has supplied its speakers to every major home equipment manufacturer in the U.S. Now CTS offers both the speakers and applicable crossover components for use in a do-it-yourself enclosure.

The Futura V system includes hardware needed for a complete high quality speaker

except for the cabinet. Priced at \$63.91 it includes a 12 in. woofer, 4½ in. honker (midrange) and 3 in. tweeter. Also included are three coils and three condensers for the crossover network, and two level controls—one for the honker and one for the tweeter.

Basically, the builder does what we all did back in the early days of hi-fi, he uses component hardware with an enclosure built and finished to his own specifications. If the wife wants a Mediterranean, or even Roman finishing, there's no hassle; you simply add the necessary cabinet trim and stain or paint lacquer. If you don't feel like paying for finishing material because the speaker will be used in the shop or playroom, simply leave the cabinet *au naturel*. Unlike complete factory assembled speaker systems you don't have to pay for finishing if you don't need it.

**Woofed Sound Spreads.** The photographs show a typical unfinished enclosure assembled with the Futura V components. As usual, the woofer is mounted near the bottom of the cabinet; it has no directional characteristics so its position is really unimportant. But if placed near the top, the center of gravity would be much too high for good cabinet stability—it would easily be tipped over.

The midrange honker is positioned above the woofer, and the tweeter is located near  
*(Continued on page 93)*

**Three way crossover has full control over high and midrange speakers. Mount crossover components on rear panel for strength. Circle No. 46 on page 13 or 91 for info.**

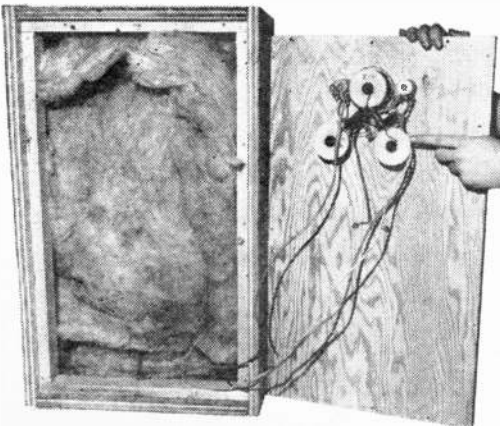

# 11 STEPS TO WALKIE-TALKIE REPAIR

by Homer L. Davidson

**D**on't give up on that sick walkie-talkie! You can fix it yourself by following our 11 steps to CB walkie-talkie repair. You don't have to be a CB expert nor an expert technician to make minor repairs. Most troubles are simple and easy to locate. Only a few hand tools are needed, and five will get you ten they're in your workshop now! Have a little patience and proceed with our step-by-step guide. Remember, most CB troubles are easy to repair. It's finding the trouble that takes knowledge, and this we offer you in steps.

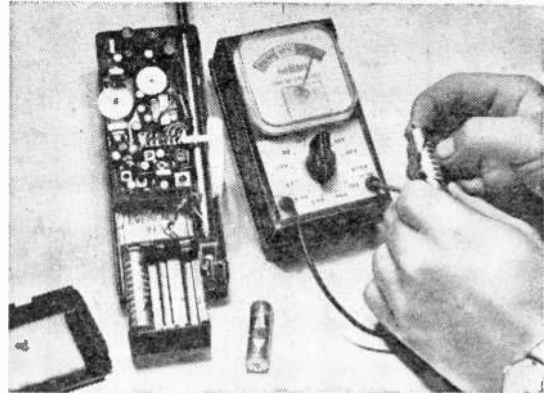
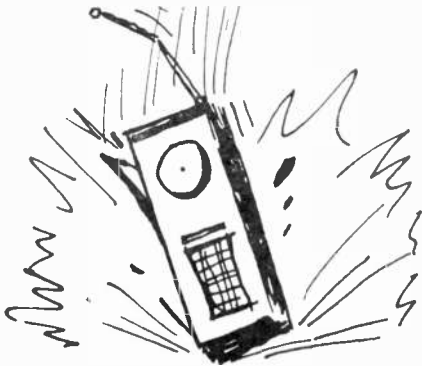

**1** Check those small dry cells first! If you don't have a battery tester, check voltage with the "talk" button depressed. If one or more dry cells are low, replace all. Be sure dry cell contact surfaces are shiny bright or else you lose volts.

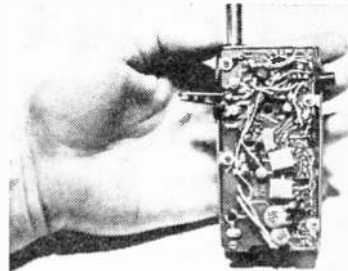

**4** If you can't turn your walkie-talkie on and the batteries are good, then you got switch trouble. The on-off switches in most portables are flimsy and break easily. Use an alligator clip across the switch connections—if this works, a new switch is needed.

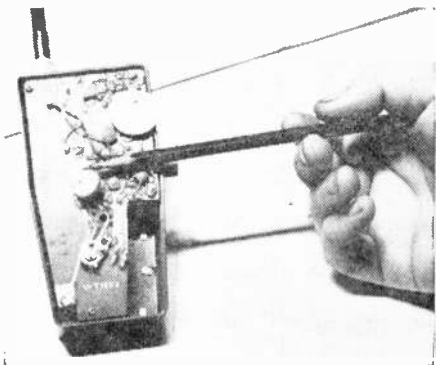

**5** If your unit will not go on the air, then it's time to push, poke, and pull to detect loose components, snapped wires, etc. Poor or marginal connections are responsible for most transmitter problems. Better go back to Step 2 and do some careful inspecting and soldering.

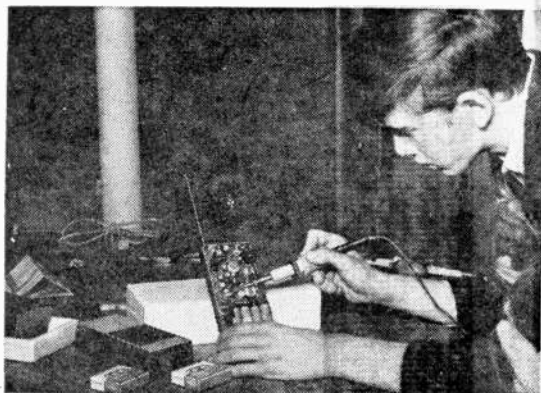

**2** One big headache common to battery equipment is loose battery leads. Use a small-tip, low-wattage solder iron while making repairs. Apply enough heat to make a good solder joint and stop. Nose around for other loose connections or cold solder joints in the printed circuit board. Check switch connections, too!



**3** Walkie-talkie antennas usually break with time because of the abuse they take. Don't toss out the unit because its sky hook snapped. Multi-section antennas are available at most parts suppliers and can be installed in your unit. Be sure to select an antenna that comes close in length to the original. A longer antenna does not mean better reception or more signal out—it may mean poorer operation because of detuning.

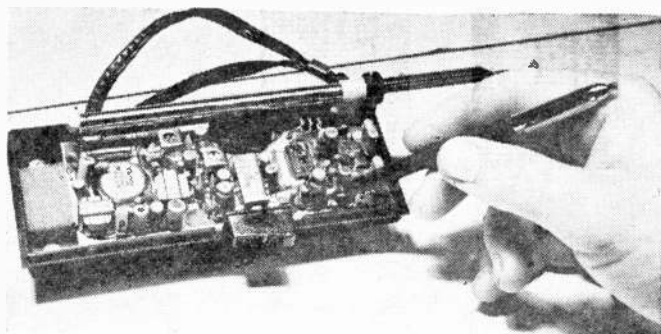

**6** No reception? In super-hot models this means trouble in unit's front end as a rule. Check antenna coil for broken leads or loose connections. Travel from antenna to audio section touching transistor leads as you go. As soon as buzz comes from speaker, you know trouble is in previous transistor stage. Check for physical defects and damage before yanking out any transistors.

**7** One good way to get rid of bugs is to spray them dead with electronic Raid. Push-to-talk switches cause a lot of trouble because of dirty contacts. It's not the switch's fault. The unit's low cost prevents use of hermetically-sealed switches, so dirt and dust will louse up the contacts. Use one of the many contact cleaners currently on the market place. A short spray and a dozen switch pushes should clean up any trouble in your rig.

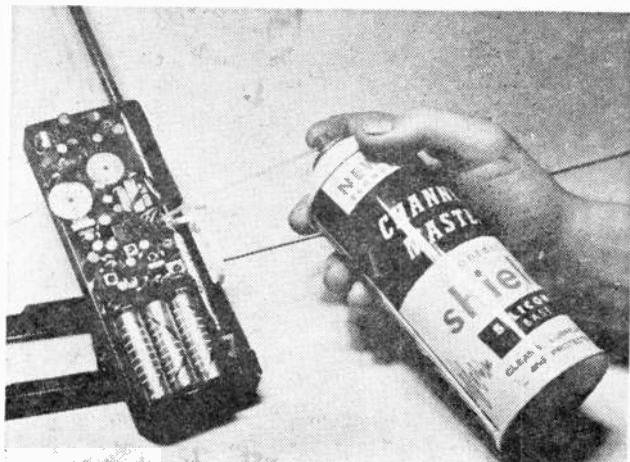

(Turn page)

# WALKIE-TALKIE

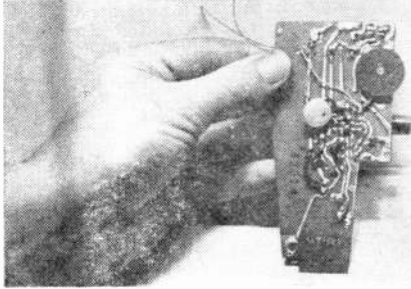

**8** Let's face it, you drop a walkie-talkie and you have to pay the price. In this case it means removing the printed circuit board and patching it up if necessary not to mention the epoxy work needed on the case.

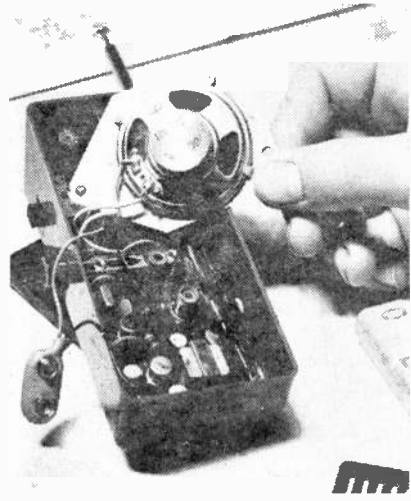
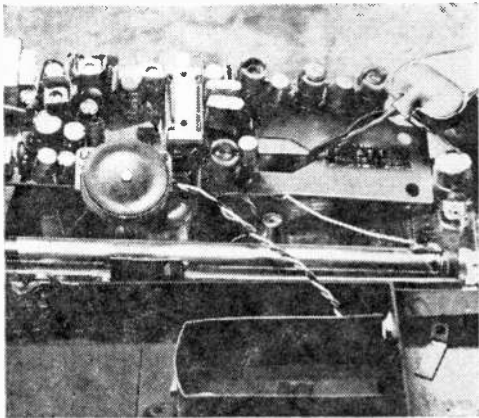

**9** The sound from walkie-talkies is never hi-fi, but it can get worse with time because dirt, dust, humidity, and what-not tear, jam, warp, etc., the speaker cone. A quick test is to listen to the receiver at low volume—if it still sounds bad, it's time for a new speaker. Most jobs are 8-10 ohm units available from electronic supply houses. Pick a PM speaker replacement with the exact dimensions as the original.

**10** If your receiver looks like it was salvaged from a vacuum cleaner bag, it's due for a thorough cleaning. Here's where old-fashioned GI spit and polish will pay off. Use Q-tips and water-color brushes to wipe and brush away the gunk. You'll be surprised at the defects that can be uncovered this way.

**11** If the first ten steps do not get your walkie-talkie on the air, you're in for some dog work. Most rigs come supplied with schematic diagrams—use them to pinpoint troubles. Make resistance measurements and continuity checks. Use the lowest scale setting when possible and likewise for voltage checks. If a transistor tester is available, check each transistor. It's a good idea to compare measurements against your other unit if you own a pair. It's up to you now, we ran out of space.

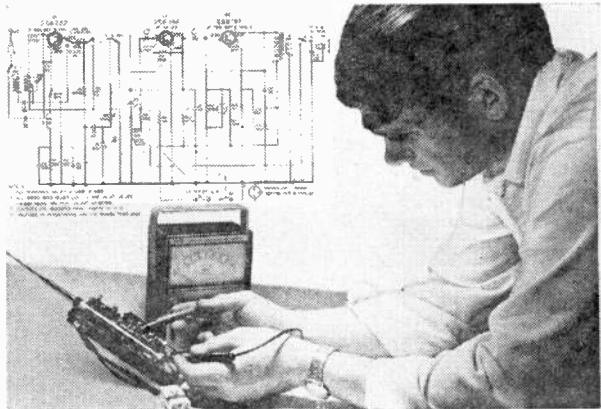

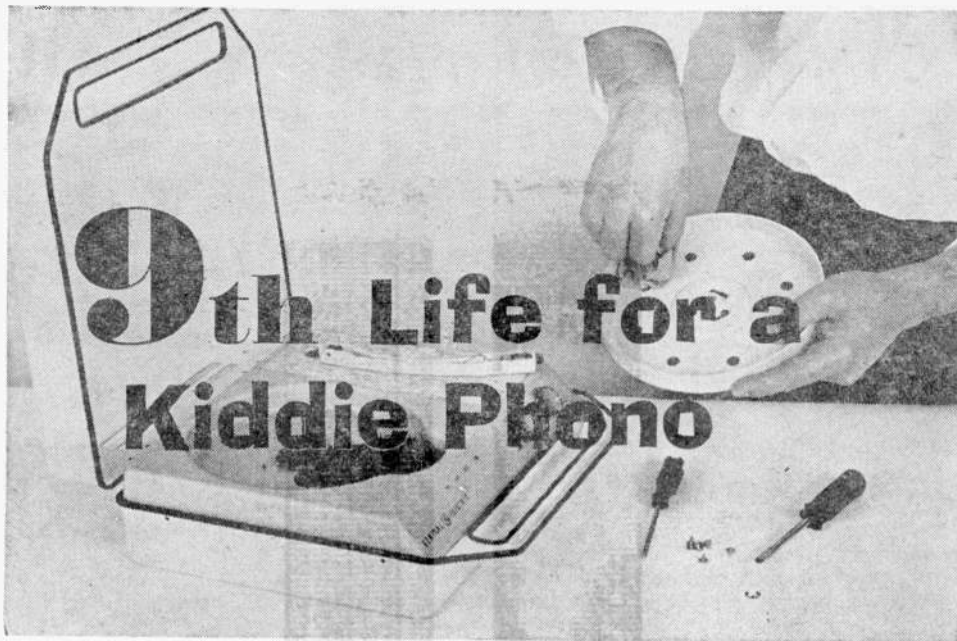

■ If your child's phonograph has given up the ghost for what you insist *has* to be the last time, think again. For a kiddie phono is so simple a gadget it's bound to have nine lives (perhaps even ninety-nine) before it ends in the trash can. And whether due for its ninth or its ninety-ninth life, any kiddie phono requires a minimum of skill to return to working order.

One of the reasons kiddie phonos are such a breeze to repair stems from the fact that there is really very little that can go wrong. Basically, any kiddie phono consists of a

motor and turntable, a pickup and cartridge, an amplifier and speaker—plus a cabinet to house the lot! And aside from a broken cabinet, most repairs to kiddie phonos center around one of these three basic areas. In other words, it's either the motor and turntable, the pickup and cartridge, or the amplifier and speaker that the due for your servicing attention.

Unless the motor has conked out completely—in which case the entire assembly should be replaced, a general cleanup will probably put things back in the AOK cate-

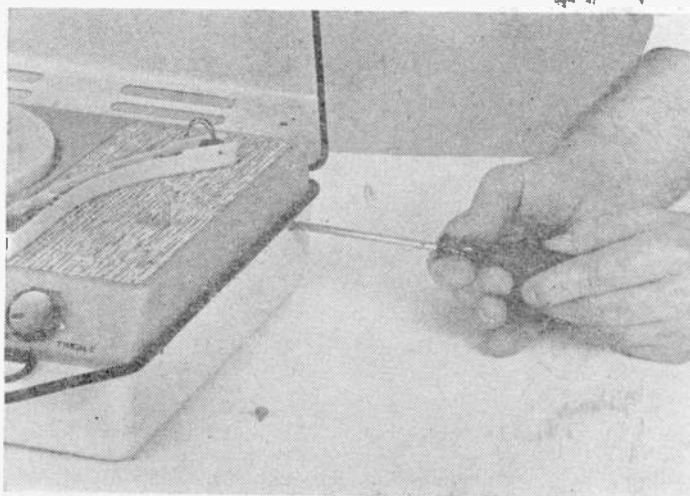

Kiddie phonos vary widely in general mechanical layout and construction, but this General Electric player is not unlike several other brands that have been on the market at one time or another. Disassembling this unit required unplugging line cord from socket at rear, then removing series of Phillips-head screws with a screwdriver.

# Kiddie Phono Repair

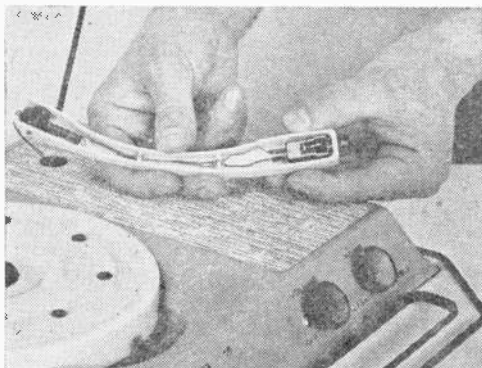

Cartridge and tone arm easily fall prey to injury (note absence of tone-arm base in player above). Needle should almost always be renewed with exact replacement, as should both tone arm and cartridge, if condition warrants.

gory. This can easily be accomplished by removing the pin or E-ring from the turntable, carefully pulling the turntable from the spindle, then cleaning the underside of the turntable as well as the motor shaft and idler assembly with a suitable solvent—a small bottle of GC carbon tetrachloride being a good choice. Use the cleaner sparingly on rubber parts, and be certain to clean the rim of the turntable thoroughly (see photo at top of facing page).

A new needle (now generally referred to as a *stylus*) should put the arm-and-cartridge

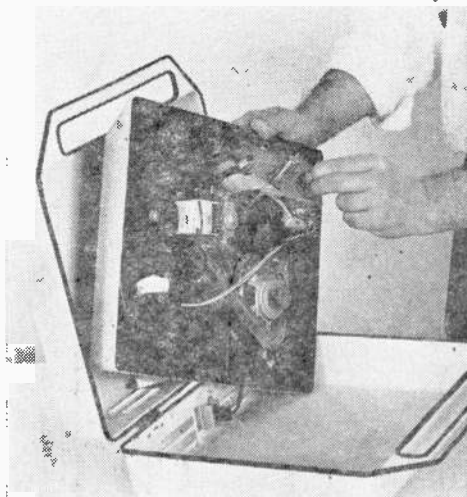

Amplifier/speaker section of kiddie phono generally contains one or two tubes in an AC/DC circuit. Inoperative amplifier usually stems from burned-out tube; damaged speaker often proves to be the cause of distorted sound.

combo back in like-new condition unless either or both has been damaged. If they have, it's usually best to replace both with a new arm-and-cartridge assembly as shown in the photos.

As for the amplifier and speaker, burned out tubes and punctured speaker cones account for something like 90% of kiddie phono troubles in this area. Effecting a cure is almost child's play—plug in a new tube or toss in a new speaker, and you'll have every reason to expect that the set will play like new again.—Ron Michell

After carefully noting wiring of leads running into amplifier from cartridge, leads were unsoldered, then single hex nut was unscrewed to permit removal of tone-arm assembly. Since new tone arm was virtual duplicate of damaged unit, fitting it in place called for little more than a reversal of disassembly procedure.

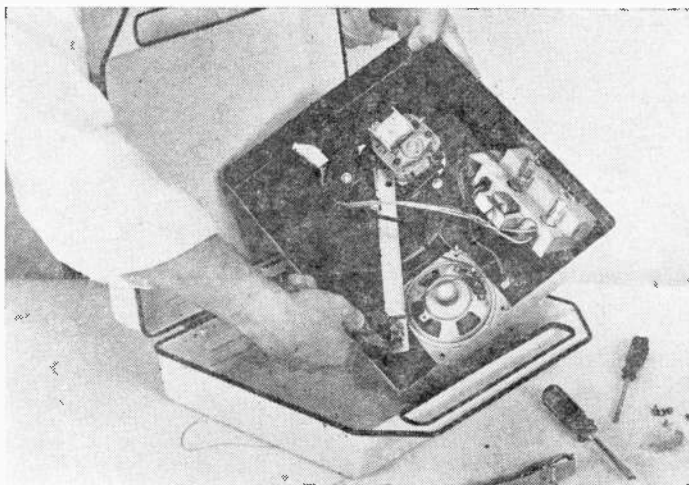



Color sync has been the cause of many a good man's cop-out, but take heart! Here's what to do

# WHEN COLOR WON'T STAY PUT

By Len Buckwalter, K1ODH

**O**f all the troubles that attack the color TV screen, running hue is one of the easiest to spot. It produces a number of weird patterns, but there's always one revealing symptom—color seems to separate from the black-and-white image. The monochrome picture keeps operating normally while color washes in waves across the screen. Stripes can drift horizontally, vertically, or diagonally. They might rush by at dizzying speed or float lazily to and fro. Worse yet, width of roaming color stripes often varies from narrow to broad.

This classic symptom—separation of color from the black-and-white picture—is strong evidence that the problem is “lack of color sync” (synchronization). A similar effect in a black-and-white receiver is uncontrolled vertical rolling, or a slashing of the image into horizontal lines. In those troubles, the receiver's vertical and horizontal stages are not in step with signals transmitted by the TV station. When color sync is lost, the receiver also fails to mesh with transmitted signals.

**Sync-ing Fast.** There's good reason why the color set must latch onto the transmitting station. When today's color system was approved, the FCC decided color must not interfere with regular black-and-white reception. To fulfill the requirement, engineers created a vehicle to carry color in a manner the black-and-white set would ignore. They came up with the “color subcarrier.” When color voltages from the studio camera are modulated onto a frequency of 3.58 MHz, the color subcarrier, it was found they would drop into “holes” already existing in the black-and-white signal. Now color and monochrome receivers could co-exist in a compatible system.

But the color receiver must have special circuits to recover the subcarrier. Reason is that color *modulation* is transmitted, but the subcarrier remains behind. (Color modulation exists just above and below 3.58 MHz.) This system proves technically economical. Since the subcarrier is killed at the transmitting end (after it's done its job of creating color modulation frequencies), it simply

# COLOR WON'T STAY

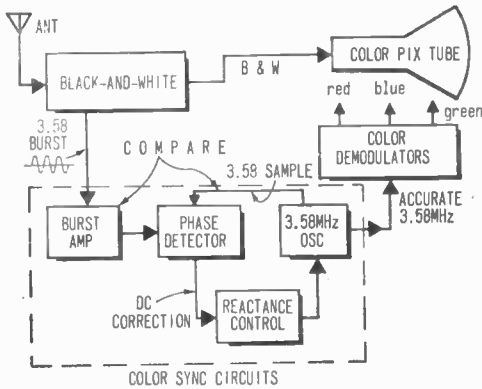

Fig. 1. Color sync circuits are enclosed in dotted line. To maintain correct color on screen, both frequency and phase of 3.58-MHz Oscillator is locked-on to station signal.

isn't present to interfere with black-and-white reception. The color receiver, however, must create a *local* subcarrier to serve as a key for decoding, or demodulating, the original color signal generated at the studio.

**Just Like CW.** This action can be compared to tuning a ham or shortwave receiver for code reception. Code enters the receiver as a radio-frequency signal which can't be fed directly to the speaker. So the receiver provides a local radio signal (from a BFO, or beat-frequency oscillator) and the resulting mixture creates an audio tone. In the color receiver, the subcarrier reconstructs the original camera signals so they can be fed to the picture tube.

Because of incredible accuracy needed for good color, the color circuits have a few refinements.

For one thing, the station transmits only a tiny sampling of the 3.58 subcarrier. Since it's about 8 cycles long, it's aptly called the "burst." So brief is the signal that it can be squeezed in during the time the screen is dark for a fraction of a second at the end of each horizontal scanning line. The burst, though, is long enough to inform the receiver of the correct subcarrier frequency. This is the initial step in synchronizing color between transmitter and receiver.

As for that subcarrier, the color receiver generates its own on 3.58 MHz. It's done with a stable, crystal-controlled oscillator.

Nevertheless, the oscillator can't approach the required accuracy, and the incoming burst is used to kick it on frequency.

Another element of the color sync system is a control "loop." As we'll see, this will tie the incoming burst—the reference—to the local crystal oscillator. Anything which disturbs this system causes running color, an aimless spilling of tints off the basic black-and-white image.

**A Trip On AFPC.** In Fig. 1 is a block diagram of major stages for color sync. This is the set's AFPC, or Automatic Frequency Phase Control system. As the name implies it controls both frequency and phase of the receiver's locally generated subcarrier. Actually, frequency and phase are mostly a matter of degree. When the oscillator is a few dozen cycles above or below 3.58 MHz the system may be considered controlling frequency.

But as the burst signal and oscillator start

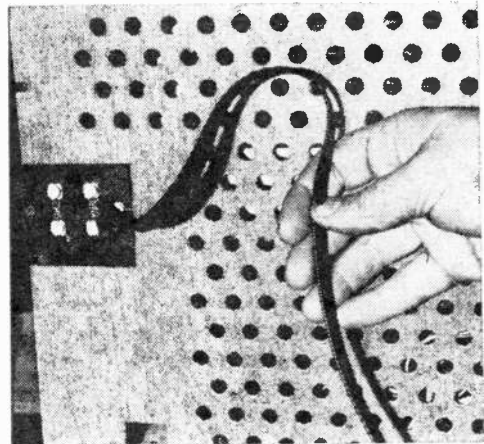
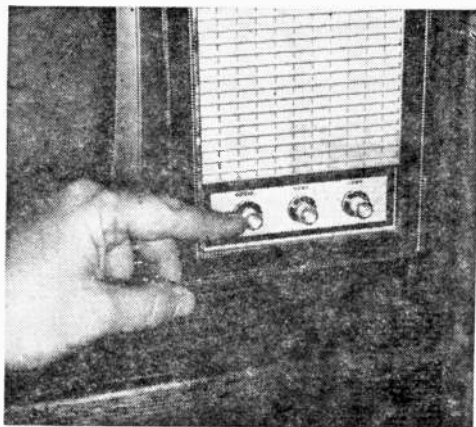

Fig. 2. Poor sync or runny color can sometimes be traced to a defective antenna or lead-in. Flat twin-lead exposed to the elements is especially subject to color-wrecking damage.

to get into step, the control system operates on the more precise level of phase: that is, both signals must begin at zero at exactly the same instant, then alternate through 360 degrees together. Unless locking action is total, picture hues may shift toward the green or purple end of the scale. Major functions of the color-sync section, blocked in Fig. 1, are as follows.

**Burst Amp.** An incoming colorcast travels through the conventional part of the receiver at upper left. Note that it is basically a black-and-white receiver that feeds



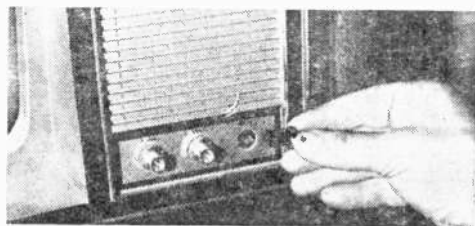

*Fig. 3. Before tearing into the color TV to look for causes of poor color sync, make sure that all the controls are properly set—especially the horizontal hold control.*

the specialized color circuits found below. Synchronizing action begins as an incoming burst signal reaches the Burst Amp. This is the rapid-fire group of cycles sent as a reference by the TV station and thus they become the reference for the complete control system. They are strengthened by the Burst Amplifier before proceeding further. Notice that the burst is next applied to the Phase Detector.

**Phase Detector.** An electronic comparison occurs here. The stage is designed to accept two signals, then produce one output voltage which encodes any differences between the original signals. The burst is one signal; the other is from the 3.58 MHz Oscillator.

**3.58 MHz Oscillator.** This crystal-controlled oscillator generates the local color subcarrier. As mentioned earlier, it is stable, but not accurate enough. A small portion of oscillator signal is sent to the Phase Detector as a 3.58 MHz sample. The Phase Detector is now receiving two signals for

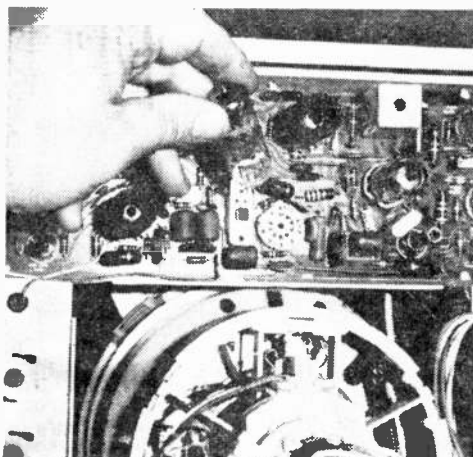

*Fig. 4. Another adjustment that can affect color sync is the AGC. Here, control is located behind a front-panel knob, though usually it's on the rear apron. Set AGC as described in text.*

comparison and it produces an output (shown as the DC correction).

**Reactance Control.** This tube serves as an electronic tuning capacitor, much the same as the tuning capacitor used to tune any radio. Only it has no moving plates. Its capacity can be controlled by the DC correction voltage supplied by the Phase Detector. Further, the Reactance Tube is connected as a variable capacitor across the tuning circuits of the 3.58 MHz Oscillator.

To sum up the overall action of Fig. 1: an incoming burst signal is compared with the local 3.58 MHz Oscillator at the outset. The Phase Detector senses error between the two, then operates the Reactance Control. Capacity changes then re-tune the 3.58 MHz Oscillator until it is on the exact subcarrier frequency. Note that the oscillator produces a continuous signal, though it is being controlled by the burst.



*Fig. 5. Tubes account for most sync circuit troubles. They will usually all be found on the set's chroma board; checking by substitution is the easiest way to find a bad one.*

The 3.58 signal, now precisely correct, goes to the Color Demodulators which produce correct voltages for operating the picture tube guns. At this point, any loss of sync detaches color from the black-and-white image.

**Manual Control.** When color sync acts up, there are a couple of initial checks which will determine whether it's caused by something outside the chassis. We'll assume the set is receiving a normal black-and-white picture in order to rule out problems which might originate in other sections of the receiver. The antenna and lead-in (Fig. 2) are also considered to be in good condition and aren't deteriorating the color signal before it enters the receiver.

# COLOR WON'T STAY

Turn to a color program and carefully adjust the fine-tuning control. This is critical to stable color reception since it places the burst into correct position within the set's tuning circuits. If the burst is attenuated, it won't be available to control the crystal oscillator. Another adjustment that might

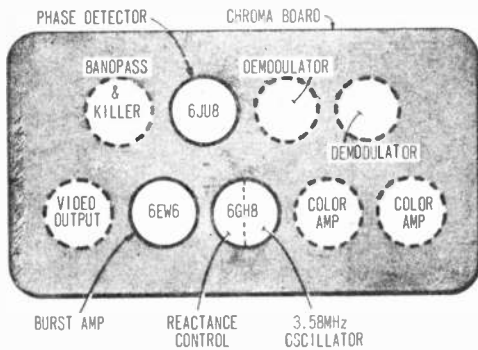

Fig. 6. On this typical chroma board, stages directly concerned with color sync are shown in solid circles. Poor sync is usually caused by one or more of these tubes being defective.

affect the burst signal is the horizontal hold control (Fig. 3).

Though these circuits occur in different sections of the receiver, there is some interaction. You may recall that a burst occurs at the end of every horizontal scanning line. To help keep the Burst Amplifier firing properly, it is locked into the set's horizontal scanning section. Mistuning of the horizontal hold control is apt to disturb the timing. For this reason, always set the horizontal hold

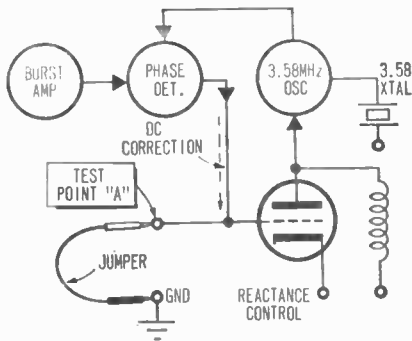

Fig. 7. If tubes are not the problem, shorting the grid of the reactance tube to ground may isolate trouble. Manufacturer's service literature may be needed to locate test point.

so the picture is centered on the screen. (You'll note the hold is able to shift the picture slightly left or right before the image breaks up.)

**Consider The Killer.** Another adjustment to check is the Color Killer. This circuit doesn't directly participate in color sync but it could have an effect. The "killer" is a stage which closes off the receiver's color stages during black-and-white reception to keep color from accidentally spilling through and disturbing the image.

If the killer is set at a critical point, it's possible for a part of the color signal to be wiped away, which could lead to unstable operation. Turn the control fully off to check if this is the sync problem. The correct setting is one that doesn't produce colored "confetti" on the screen when the set is tuned to an unused channel. Location of the killer control is usually along the rear

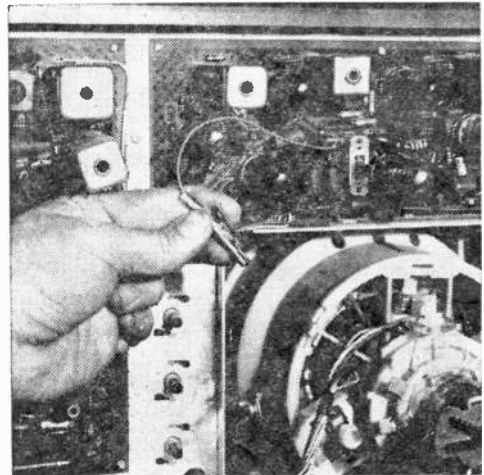

Fig. 8. If color sync improves when reactance tube grid is grounded, reactance and oscillator stages are probably alright. Be careful not to disturb yoke components while working on set.

chassis apron: on some sets it's accessible when one of the front-panel knobs is removed.

Finally, check the AGC (automatic gain control) adjustment if the set has one (Fig. 4). Should AGC be set too high (thereby severely reducing gain of the receiver's front-end), there could be partial clipping of the color signal. The usual adjustment for AGC is done while viewing the strongest local channel. The control is turned until the picture starts tearing or turns negative, which indicates overload. Then the control is re-

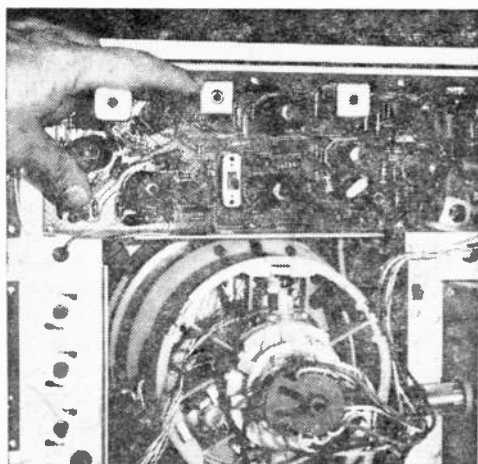

Fig. 9. Alignment of transformers in the color section should not be disturbed since realignment is complicated. However, transformer windings can readily be checked for continuity.

One useful test point indicates whether the fault is in the Burst Amp and Phase Detector stages or the Reactance Control and 3.58 Oscillator stages. If the simplified diagram in Fig. 7 is traced, it is seen that a test point (A) occurs in the grid of the Reactance Control tube. This is the stage that acts like a variable capacitor across the oscillator and continuously adjusts frequency with a DC correction voltage.

The test point enables you to ground the DC correction voltage and observe certain effects. Watch the color picture when you ground the test point with a clip lead to the chassis (Fig. 8). If it improves color sync—color stops moving through the picture—it's a good sign the Reactance Control and oscillator stages are not at fault.

**No Reactance Volts.** During this test, you removed the action of the Burst Amplifier and Phase Detector from the circuit. Further, in grounding the test point, you

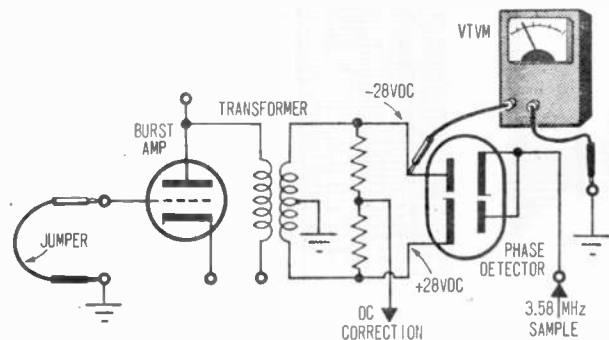

Fig. 10. To determine if Burst Amp and Phase Detector are working properly, ground the Burst Amp grid as shown, then measure the voltages (with a VTVM) on the transformer side of the diode. The actual voltages will vary from set to set, but should be equal and of opposite polarity.

tarded slightly until a normal image is obtained. If these preliminaries don't cure a case of color instability, the back cover of the set is removed for the next step.

**Troublesome Tubes.** As in most other circuits, tubes account for the bulk of color-sync faults. You can locate tubes (Fig. 5) associated with color sync by examining the set's chroma (or color) board. It's usually a subchassis or printed circuit that bears most circuitry for processing color signals. The layout of a color board used in a recent Westinghouse receiver is shown in Fig. 6. When color sync acts up, check those tubes by substituting known good ones before probing more deeply into the set.

Manufacturers often provide convenient test points on a color chassis to help pinpoint troublespots. Thus, it's a good idea to obtain the service literature for a particular set if you wish to probe further into a color sync problem.

placed zero volts on the grid of the Reactance Control stage, a voltage which is about right during normal reception. If color sync improves, you have proved that both reactance and oscillator stages are capable of approximately normal operation.

We say "approximate" since color may

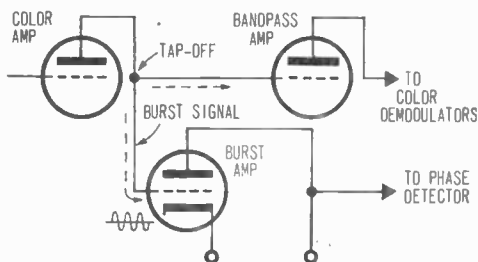

Fig. 11. The next circuit to have a close look at is the Burst Amp. If Phase Detector voltages are incorrect, perhaps the burst signal is being interrupted between Color and Burst Amp. The only way to find out is with a scope.

# COLOR WON'T STAY

not lock completely in place, but possibly drift slowly across the screen. If you get this action, shift suspicion to the burst and detector stages. Measure tube-socket values of voltage and resistance to find the faulty component. Leaky capacitors are frequently the trouble, followed by resistors which have changed value (rarely will a 3.58 crystal go bad). Alignment of various coils or transformers in this section (Fig. 9) shouldn't be touched unless you've exhausted all other test possibilities.

**Slap In The Phase.** One shortcut helps tell whether Phase Detector or Burst Amp is at fault. In Fig. 10 is a simplified schematic of these stages, as used in an RCA color chassis. During operation, the Burst Amp is boosting the received burst signal and applying it to the Phase Detector. Here the signal is split in the transformer leading to a tube with a pair of detector diodes. At the same time, a 3.58 MHz Sample is applied to the other side of the diodes. This circuit com-

(Continued on page 92)

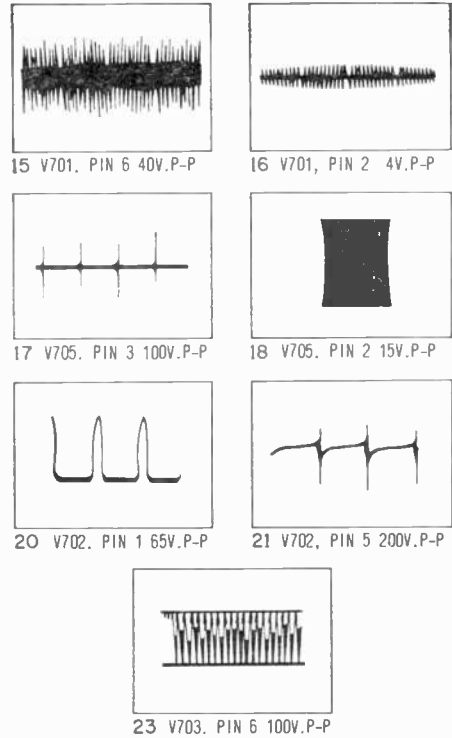
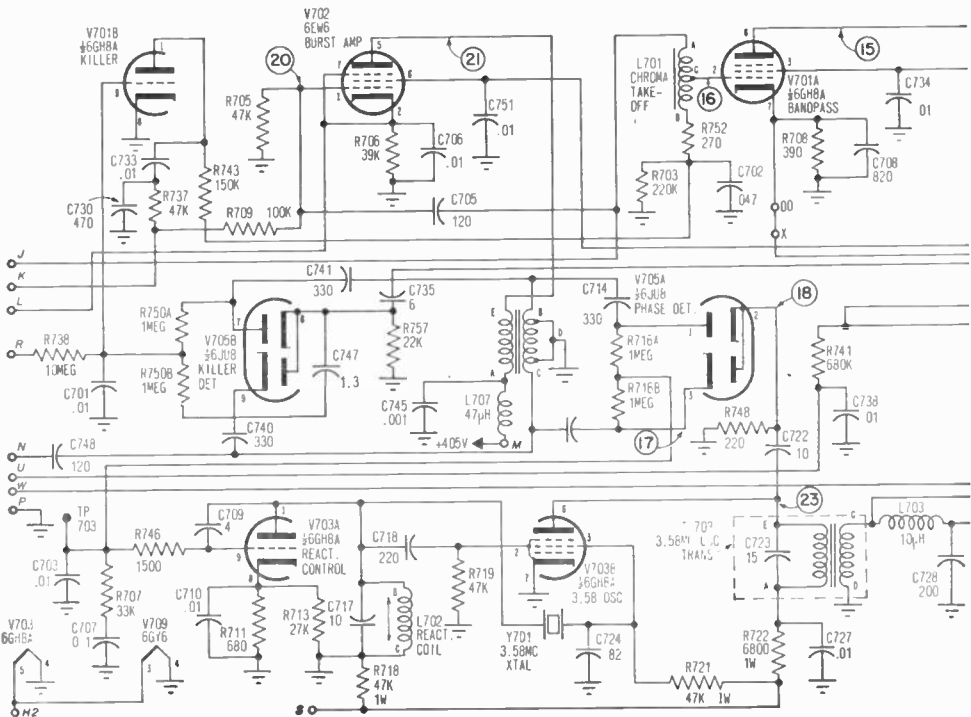

Fig. 12. Typical service literature provides waveforms at different circuit points so that burst and other signals can readily be traced through various stages with an oscilloscope.



# Ten timely tips for resistance measurement

By Marchall Lincoln, W7DQX

Resistance measurements must be one of the most misunderstood tasks undertaken by electronic's buffs. Why? Because a good many of us don't really understand how resistance is actually measured.

Since the meter we use can't think for itself, we must use it properly to obtain the correct results. Like all electrical instruments, of course, a meter performs according to electrical laws which cannot be violated. But it may not give us the results we want, or the results *we think we're getting*, unless we use it properly.

**1** For our first tip, all we need do is look at the ohmmeter scale on the face of our handy VOM. Notice how the numbers indicating resistance are squeezed

together near the high end of the scale? Down at the low end, the numbers are spread out where we can easily read them—the number 1 is a fair distance from 2, and 2 is almost as far from 3 and so on.

But up at the high end, we see that 200 is about as close to 500 as 1 is to 2. And 1k and 2k are practically on top of each other.

This compression at the high end of the scale is normal for an ohmmeter, and there's nothing we can do about it. But what we can do is make use of this situation so it works to our advantage.

How? Very simple—just remember to use the right two-thirds or so of the scale, where the numbers are spread out the most, whenever possible. This will allow you to read much more clearly just exactly what calibration is being indicated by the meter needle. If the pointer stops far to the left, where the

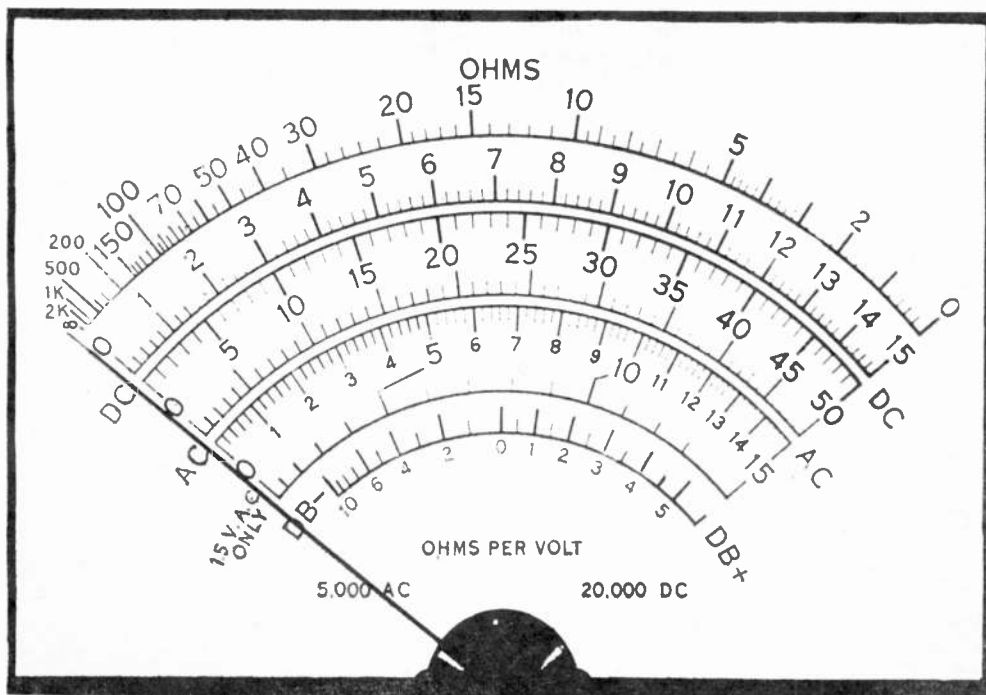

# 10 TIPS

scale calibration is greatly compressed, the thing to do is switch the meter's range switch to a higher resistance range so the needle will drop to a more usable part of the scale. And don't forget to re-check the zero-set adjustment when you do this, since it may need re-setting for the new range.

If you're already using the highest resistance range, then to achieve a more accurate reading you'll have to use a different method for measuring high resistance, as explained in *Tips 8 and 9* which follow.

**2** Our second tip is another simple item often overlooked. Did you ever notice, when holding ohmmeter prods tightly against the leads of a resistor, that the ohmmeter needle couldn't seem to make up its mind just where to stop? Then you probably discovered that as you pressed the test prods tighter against the resistor leads, you got an indication of lower resistance on the meter.

*Ah ha, you thought, there's some corrosion on the resistor leads and I'm pressing the test prod through it and getting better contact with the wire.* This may have been true. But there more probably was another reason for this occurrence, or for the major part of the effect.

It's simply that the meter was measuring not only the resistance of the little resistor you held against the prods, but the resistance of your body as well! When you pressed harder on the prods, you also brought more skin area into contact with them.

So, you should be sure, especially when using a high-resistance range, that you don't touch the metal tip of the test prods. Or if you do touch a prod, touch only one—never both. Use an alligator clip on one lead so

you don't have to hold it in contact with the resistor lead.

On low-resistance ranges, the effect won't be noticeable, since your body resistance is rather high. For this reason, connecting it in parallel with the resistor you're measuring will have little effect.

**3** Another often-overlooked item that can have a large effect on the accuracy of an ohmmeter is the condition of its battery. Every ohmmeter has a small battery inside its case to supply the small current which passes through the resistance being measured. The amount of current which flows gives us the ohmmeter indication.

However, if the battery is weak, the indication may become false if we hold the test prods on the resistor for any length of time. Reason is that the battery voltage may drop during this time. And if the battery voltage changes after we set the meter to zero, we'll get a false meter indication.

There's a simple way to check the battery condition without opening up the meter case and removing the battery. When you touch the prods together and adjust the zero-set knob to prepare to make resistance measurement, hold the prods together for several seconds longer and watch the meter

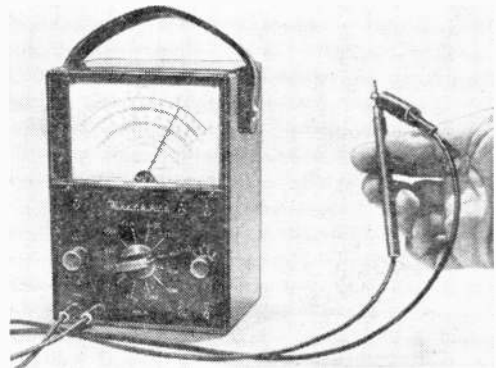

**Above**—Be sure battery in your VOM is putting out enough voltage if you want accurate resistance readings. Keep test leads together for a few seconds to be sure zero setting remains constant. **Left**—Never hold both test probes in your hand when checking resistance, your body resistance in parallel with resistor being measured affects reading.

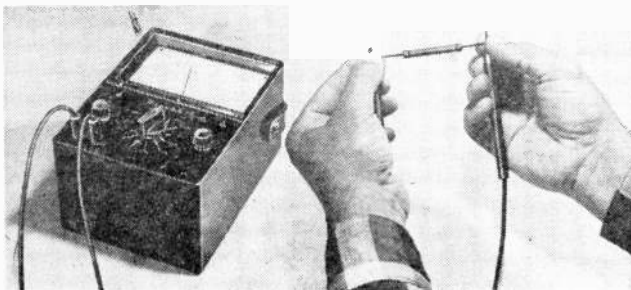

needle closely. If it stays at zero, the battery voltage is holding steady. But if the needle begins to slowly move upscale, the battery voltage is dropping, and the battery should be replaced.

Make a habit of performing this test each time you use your ohmmeter. This way, you'll always know for sure if the battery is in condition to give you accurate measurements.

**4** An ohmmeter can be put to handy use in checking for one of the peskiest of all troubles that may occur in a vacuum tube—an intermittent short between elements. This is a condition that may not show up on a conventional check in a tube tester.

This test is made with the tube plugged into its regular socket in radio or amplifier or whatever. The heater should be lit, but there should be no voltage on either plate or screen. After the tube is thoroughly warmed up, use the ohmmeter to check for continuity between each pair of tube socket terminals in all possible combinations. Be careful, though—don't connect the ohmmeter across the heater pins!

Tap the tube firmly with the rubber eraser on the end of a pencil while making each of these checks, and watch the ohmmeter closely. If there's a momentary flicker of the ohmmeter needle, there is contact between tube elements, and the tube should be scrapped. A stable resistance reading between two tube pins could indicate a resistive short between two tube elements. Then, too, it could merely be caused by a resistor, capacitor, or coil in the circuit. Check the stage's wiring to be sure.

**5** Got a box full of battered and scraggly-looking diodes—and you don't know which ones are good and which ones are open or shorted? Fortunately, there's a quick way to tell. And while you're at it, you can find out the correct polarity of those that have the cathode marking band rubbed off.

To make this simple test, you'll need to know which ohmmeter lead goes to the positive terminal of the ohmmeter battery and which goes to the negative battery terminal. Generally, the ohmmeter in a VOM is wired so that positive (+ or red) jack on the meter case goes to the negative

battery terminal, and the common or negative (— or black) jack goes to the positive battery terminal.

If you have the wiring diagram for the meter, or care to open the case and trace the wiring, you can find out for sure. Or, you can make this check: switch the ohmmeter to a medium range and touch the prods to the leads of a rectifier which you know is good. You'll get the lowest resistance indication when you have the positive lead touching the anode and the negative lead touching the cathode.

To test unknown diodes, connect the ohmmeter to their leads first one way, then the reverse. The two resistance indications you obtain should be considerably different—one should be quite high and the other rather low. If this occurs, you have reasonable assurance the rectifier is good, since it passes current much more readily in one direction than it does in the opposite direction. If you get resistance indications that are nearly the same, the diode is shorted. And should you get indications of a high resistance in both directions, the diode is open. When you get the lower resistance reading, you have the positive ohmmeter lead connected to the anode and the negative lead connected to the cathode.

**6** Transistors also can be checked with an ohmmeter . . . or can they? Yes, they can . . . sometimes. (How's that for a straight-forward answer?)

The reason it's impossible to give an absolute *yes* or *no* is that there are so many types of transistors in the world today. Many of them can be safely checked with an ohmmeter: others, being on the delicate side, can't be. Assuming you want to be perfectly safe, you should never touch an ohmmeter lead to a transistor. But if you follow this precaution, you'll be passing up many golden opportunities to check transistors which can be safely tested with an ohmmeter—if you do it properly.

To determine whether or not to even try it, you'll have to refer to a transistor manual for the particular type of transistor you want to check, then do a few calculations. Always use the lowest ohmmeter range available for the test. This will assure minimum current flowing through the transistor as you make the check.

By knowing the polarity of your ohmmeter battery, as explained in *Tip 5*, you

# 10 TIPS

can determine if each section of the transistor has the proper relationship of low resistance in one direction and high in another. Which way is which will of course be determined by whether you're checking a *pnp* or *npn* transistor, and which leads you're touching with the ohmmeter prods.

For example, with the positive ohmmeter lead connected to an *n* lead and the negative ohmmeter lead connected to a *p* lead, you'll get a higher resistance indication than with the leads reversed, if all is normal. As with a diode, equal readings would indicate a short, and excessively high readings would indicate an open.

## 7

Some rudimentary checks of capacitors can also be made with an ohmmeter. Most common of these is checking an electrolytic capacitor. Even so, you can learn at least a little about the health and well-being of coupling and bypass capacitors as well.

A capacitor, unless shorted or leaking shouldn't conduct current. When a ohmmeter is connected across a capacitor, the battery in the ohmmeter supplies current which charges the capacitor. As this is done, the meter seems to indicate that the capacitor is conducting current. But once the charge begins to build up on the capacitor plates, this charging current drops off.

In the case of an electrolytic capacitor, which has a fairly large capacity, enough current flows when you first connect the ohmmeter prods to the capacitor leads that you will get an indication of very low resistance. This is normal, as long as this resistance indication quickly increases, within a few seconds, to a value of several hundred thousand ohms.

However, if the apparent resistance remains rather low, then the capacitor has excessive leakage and probably should be discarded.

Other types of capacitors, such as coupling capacitors, have much lower capacity. This means that usually you'll get no indication on the meter that the capacitor is charging. Reason is that the capacitor requires so little current to take on a full charge that the ohmmeter battery supplies this current very quickly. The meter movement barely flick-

ers—if it budes at all.

With such capacitors, you should get an indication of infinite resistance with the ohmmeter. If you do get an indication of low or medium resistance, then the capacitor is leaking or shorted, and should be discarded.

## 8

By adding a simple external modification to your ohmmeter, you can extend its range upward to accurately measure resistances much higher than what you normally can read on the meter scale.

Fig. 1 shows how this is done. What you do is add a battery and resistor in series with one ohmmeter lead. The positive battery terminal is connected to the negative ohmmeter lead, so that the internal and external battery voltages add. The external battery voltage should be nine times the voltage of the ohmmeter battery; similarly, the external resistor, *R*, should be nine times the total resistance of the ohmmeter high resistance range circuit.

The result of this external range extender will be to multiply the ohmmeter's high range by 10 times. With this hookup, for instance, a resistance which produces an indication on the meter of 2 megohms would actually be 20 megohms.

The exact external battery voltage and resistance needed will vary, depending on the meter you're using. For the Simpson 260 VOM, for instance, the manufacturer gives the values as 67.5 Volts and 1.08 megohms. But keep in mind that other meters may require different values.

To determine what you must add to your meter to use this range extension method, consult the operating manual for the meter. If this fails to cover the matter, write the manufacturer, enclose a copy of the dia-

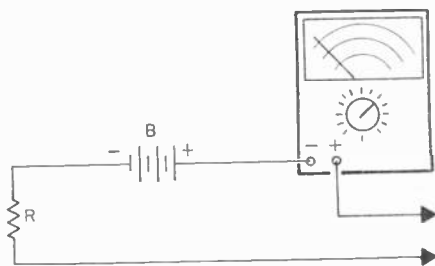

Fig. 1—External battery and resistor are used in this manner to extend range of your VOM for resistance measurements beyond normal range of your test set.



gram in Fig. 1, and explain what you want to do.

In case you find you need a rather peculiar external battery voltage, such as 54 or 13.5 Volts, remember that this doesn't have to be just one battery—you can connect a series of flashlight cells together to add up to the required voltage.

**9** There's an alternate method of accomplishing high-resistance measurements which, unlike Tip 8 just given, doesn't even involve using an ohmmeter. The circuit for this method is shown in Fig. 2.

For clarity, the diagram shows two meters. However, you can use a single VOM to make the two measurements required. The unknown resistance is connected in series with the VOM and with a DC power supply of several hundred volts.

Start with the highest current range your meter offers so as to guard against the possibility of throwing the meter off scale, then switch down to lower ranges until you obtain a usable reading.

After measuring the current flowing through the unknown resistor, you now need to measure the voltage across the resistor. If you use the same VOM to make this voltage measurement, remember to close the circuit where the current meter is shown in the diagram when you remove this meter to connect it across the resistor.

With these two measurements made, apply Ohm's law to determine the value of the unknown resistance. If, for example, you measured 700 volts across the unknown resistor and 10 microamps flowing through it, your calculations would be:

$$R = \frac{E}{I} = \frac{700}{.00001} = 70 \text{ megohms}$$

Before trying this method, be sure you are really dealing with a large amount of DC

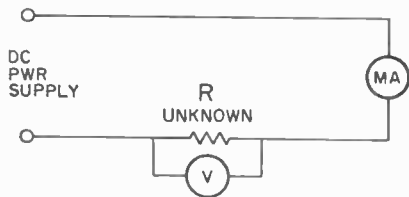

Fig. 2—Here's how to measure high resistance. Using a high voltage source, measure current and voltage and then apply Ohm's Law to calculate resistance value.

resistance. With the voltages you'll have to use, you could easily damage your meter or burn out the unknown component if it turned out to actually have only a medium amount of resistance.

**10** A technique very similar to that illustrated in Tip 9 can be used to measure very low values of resistance using a low voltage. A pair of dry cells connected in series will be fine, though you may get by with a single dry cell if your VOM has a millivolt range.

The test hookup is shown in Fig. 3. In addition to having the unknown resistance connected in series with the current meter and the flashlight cell, there's also a second resistor, about 5 to 10 ohms, in the series loop to limit the current flow. The value of this resistor isn't critical. However, if it's too large, you'll have difficulty getting meter readings large enough to be usable.

First, measure the current in the circuit. Then remove the meter, close the circuit again, and measure the voltage across the unknown resistance. Again, a simple calculation with Ohm's Law gives the value of the unknown resistance.

For example, suppose you got a current indication of 160 milliamperes and measured 0.08 volts across the unknown resistor. The calculation would be:

$$R = \frac{E}{I} = \frac{0.08}{0.16} = 0.5 \text{ ohm.}$$

Since you'll be measuring a pretty small voltage across a tiny resistance, a VOM with a millivolt scale would be handy. However, if your meter doesn't have such a scale, try using two or three dry cells instead of one. This will cause more current to flow, which will increase the voltage drop across the unknown resistance to the point where it should be easier to measure. ■

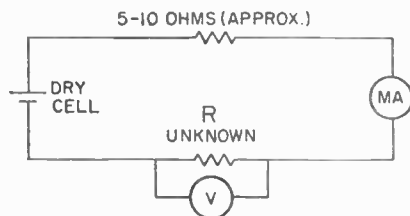

Fig. 3—Very low resistance values require higher current than available from VOM cell; with external source as shown in Fig. 2 read V and A and apply Ohm's Law.

# SUPER-HETERO-DYNE

WHY THE LAST WORD IN RECEIVERS TERRORIZED THE RED BARON  
by LEN BUCKWALTER, K10DH

**B**ORN out of necessity during World War I, the superheterodyne receiver circuit toppled all existing conventional receiver types on electronics' popularity chart. And to this day, none of the "conventional" radios of that era were able to recapture electronics' limelight. Stranger yet, every branch of electronics is still being swept along Progress' Path by a circuit that—predictably—should have gone the way of the Flivver and Flapper. From military and industrial, to commercial and consumer—everybody who's ever seen a radio, and certainly a television set, has found himself staring face to face with a superheterodyne receiver. Fact is, you'd be hard-pressed to find any up-to-date radio—even the integrated-circuit-and-ceramic-transformer variety—that doesn't somehow utilize the superhet circuit.

After the First World War, the "All-American Five," as it was dubbed, took its place in living room and parlor from coast-to-coast. And it continues to be built today as its inventor generally conceived of it, way back when the circuit was made to track and help locate enemy aircraft spitting fire over French skies.

**Narrow Squeeze.** The superheterodyne found itself ruling the receiver roost largely because it had a redeeming quality no other receiver of that vintage era could boast of. Called *selectivity*, this hitherto unheard of quality endowed the superhet with the ability

to select the particular station a listener wanted to hear (and later see), and reject all others. Indeed, it was a revolutionary step forward in receiver design. But selectivity was hardly a quality needed back in grandfather's day. Why?

First, grandpop used to listen to signals sent by spark-gap transmitters. The primitive spark signals generated by those common-as-apple-pie transmitters were extraordinarily broad. It was like listening to the lightning crashes you can pick up as you tune across the dial of an AM radio during a thunderstorm. More important, though, there were fewer signals on the air. So, selectivity wasn't too important.

The year 1922 saw the meteoric rise of radio for entertainment and communication. As hundreds of stations took to the air, it became apparent that the primitive receiving gear capable only of broad-bandwidth reception couldn't even begin to handle the impending traffic jam beginning to build on the airwaves. And the problems of receiving but one station, without an electronic cacaphony drowning it out, takes us back even further in electronics' primeval time.

**Cat's Whiskers and TRF.** Digging through to the bottom of the Twentieth Century, we uncover two electronic fossils; the cat's whisker crystal receiver, and tuned radio frequency (TRF) receiver. These were popular predecessors of the superhet circuit.

*(This theory feature continues on page 66)*

# a FREE catalog for people who like to make it on their own



Below are only a few of the more than 350 money-saving kits fully described in your free 1973 Heathkit Catalog. There are more than a dozen pages devoted to kit-form test instruments alone. Plus, you'll find color TVs, stereo systems, electronic organs, marine electronics, a kitchen waste compactor, microwave oven, home intercoms and protection systems, garage door openers, portable radios and phonographs, guitar amplifiers and accessories, amateur and shortwave radio gear, and radio-control modeling equipment.

And every Heathkit project is designed to be built by a beginner. For 25 years people from every walk of life have been building them successfully. Each kit includes a comprehensive assembly manual that reduces even the most complex operation to a simple step-by-step procedure that has you checking the work as you go. Add to that the availability of the technical correspondence department at the factory and service people in Heathkit Electronic Centers across the country, and you see why we promise "we won't let you fail". The coupon below can get you in on the fun and the savings — with your free '73 Heathkit Catalog.



**Deluxe Metal Locator** has submersible sensing head. **\$89.95\***

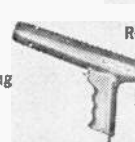

**50-watt Stereo Receiver.** **\$169.95\***

**VHF/FM Band-Scanning 8 channel Receiver.** **\$119.95\***

**5" Solid-State Scope.** **\$119.95\***

**25V Solid-state Color TV with detent power tuning.** **\$599.95\***

**Inductive Timing Light.** **\$29.95\***

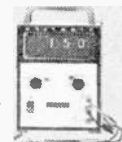
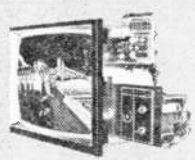

**2 1/2 Digit VOM.** **\$79.95\***



**6-Digit Electronic Clock-Alarm.** **\$34.95\***



**Visible/Audible Depth Sounder.** **\$99.95\***

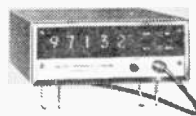

**30MHz Frequency Counter.** **\$169.95\***



**Color Bar/Pattern Generator.** **\$79.95\***



**Dolby Cassette Deck.** **\$249.95\***

See them all at your Heathkit Electronic Center... or send for Free '73 Heathkit Catalog

## HEATHKIT ELECTRONIC CENTERS

ARIZ.: Phoenix, 2127 W. Indian School Rd.; CALIF.: Anaheim, 330 E. Ball Rd.; El Cerrito, 6000 Potrero Ave.; Los Angeles, 2309 S. Flower St.; Pomona, 1555 Orange Grove Ave. N.; Redwood City, 2001 Middlefield Rd.; San Diego (La Mesa), 8363 Center Dr.; Woodland Hills, 22504 Ventura Blvd.; COLO.: Denver, 5940 W. 38th Ave.; CONN.: Hartford (Avon), 395 W. Main St. (Rte 44); FLA.: Miami (Hialeah), 4705 W. 16th Ave.; GA.: Atlanta, 5285 Roswell Rd.; ILL.: Chicago, 3462-66 W. Devon Ave.; Downers Grove, 224 Ogden Ave.; IND.: Indianapolis, 2112 E. 62nd Ave.; KANSAS: Kansas City (Mission), 5960 Lamar Ave.; MD.: Baltimore, 1713 E. Joppa Rd.; Rockville, 5542 Nicholson Lane; MASS.: Boston (Wellesley), 165 Worcester St.; MICH.: Detroit, 18645 W. Eight Mile Rd. & 18149 E. Eight Mile Rd.; MINN.: Minneapolis (Hopkins), 101 Shady Oak Rd.; MO.: St. Louis, 9296 Gravois Ave.; N.J.: Fair Lawn, 35-07 Broadway (Rte. 4); N.Y.: Buffalo (Amherst), 3476 Sheridan Dr.; New York City, 35 W. 45th St.; Jericho, L.I., 15 Jericho Turnpike; Rochester, Long Ridge Plaza; OHIO: Cincinnati (Woodlawn), 10133 Springfield Pike; Cleveland, 5444 Pearl Rd.; PA.: Philadelphia, 6318 Roosevelt Blvd.; Pittsburgh, 3482 Wm. Penn Hwy.; TEXAS: Dallas, 2715 Ross Ave.; Houston, 3705 Westheimer; WASH.: Seattle, 221 Third Ave.; WIS.: Milwaukee, 5215 Fond du Lac.

HEATH <b>Schlumberger</b>	
HEATH COMPANY, Dept. 117-3 Benton Harbor, Michigan 49022	
<input type="checkbox"/> Please send FREE Heathkit Catalog.	
Name _____	_____
Address _____	
City _____	State _____ Zip _____
Prices & specifications subject to change without notice *Mail order prices: F.O.B. factory CL-458	

CIRCLE NO. 1 ON PAGE 13 OR 91

# SUPERHETERODYNE

(Continued from page 64)

The crystal set had the least selectivity of either circuit, and what it did have was obtained mostly from one measly tuning circuit. Consisting of a coil and homemade variable capacitor, these crude tuning devices could barely pick out a desired radio signal and, hopefully, reject all RF intruders trying to elbow their way into the listener's headphone on either side of the signal. The cat's whisker consisted of a strand of fine wire for gently probing, or tickling, the crystal's natural galena surface in order to locate its most sensitive point. Though the cat's whisker detector could extract audio signals from the amplitude-modulated radio frequency signal, the galena detector couldn't help but ruin the radio's selectivity. It loaded the tuning circuit, increasing the listener's chances of picking up stations other than the desired one.

Matters improved with the TRF receiver. It aimed for, and hit, sharper reception dead center, by adding more tuned circuits. This feat wasn't practical with crystal sets, because this circuit's inherent losses ran too high to gain any benefit from any additional coils.

The invention of the triode vacuum tube

gave an engineer the perfect amplifying device. Circuit losses could now be overcome with ease; the TRF took over where the cat's whisker left off, dooming the crystal set to mantelpiece and museum.

Three or four amplified radio-frequency stages were customarily added prior to the TRF's detector, all the while adding to selectivity's cause. However, all wasn't perfect in TRFville.

The amount of noise introduced by the tubes limited the number of TRF stages. So the Silver-Masked Tenor's strains could still be heard with those of the Clicquot Club Eskimos—but not by his choice, or that of the listener.

**Pitching the Low Curve.** The public soon learned that these newfangled TRF receivers weren't exactly the living end. The TRFs, as a rule, failed to perform satisfactorily as frequencies inched higher into kiloHertz land. Seems that as the frequency of the signal went up, the TRF's tuned circuit efficiency for that frequency dropped almost proportionately.

To demonstrate this, look at our example. The bell-shaped curve represents response of a tuned circuit selecting some low-frequency station. The circuit delivers good selectivity, and interference on a slightly higher frequency is rejected.

But examine what happens when a similar

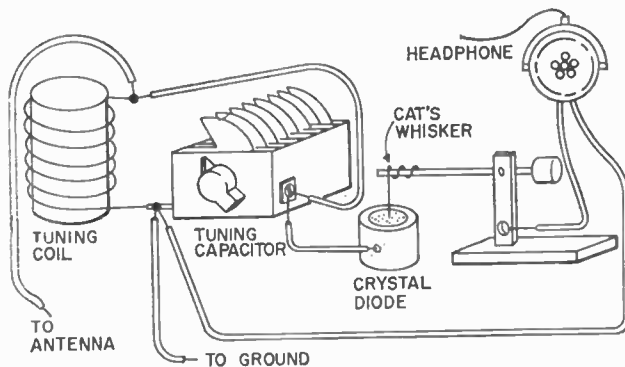

*Schematic representation of crystal radio shows how cat's whisker gently contacted diode surface in order to achieve demodulation of RF signal. Earliest semiconductor diodes made were miniature crystal diode/cat's whisker affairs encased in glass package.*

*Our schematic shows relatively advanced tuned radio frequency receiver. First TRFs had individually adjusted tuning capacitors; ganged units were still to be invented. By adjusting battery voltage 'twixt ground, tuning circuit, radio gain's varied.*

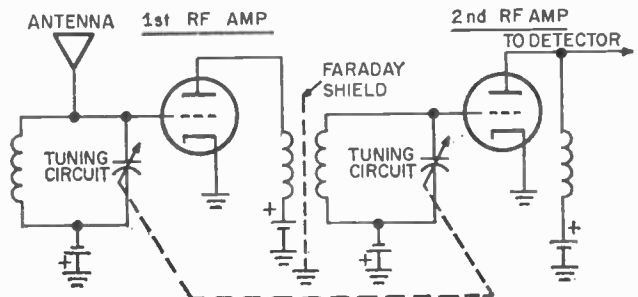

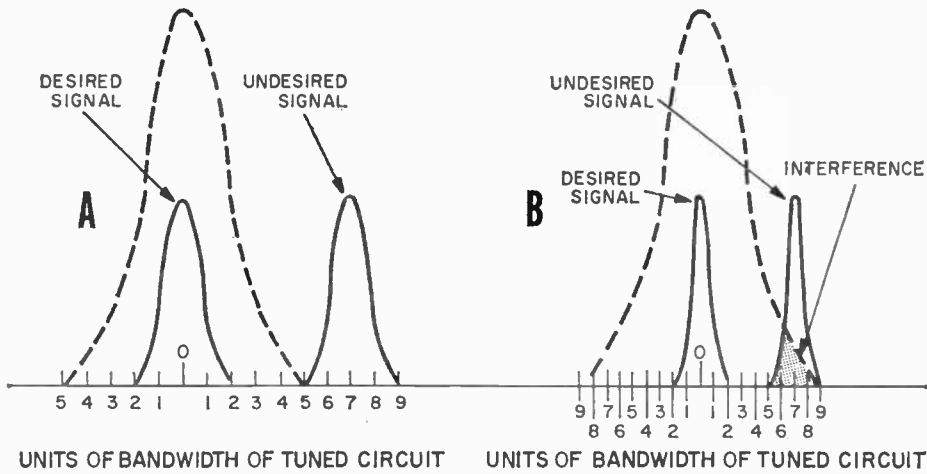

**Tuned-circuit bandwidth varies proportionally with frequency. Tuned circuit A, working at low frequency, rejects unwanted signal. Tuned circuit B, working at high frequency, can't completely reject undesired signal; interference results.**

tuned circuit is operated on a higher frequency. Although the curve's proportions remain the same, it's actually responding to a much greater span of frequencies. Now it's possible for two closely spaced stations to enter the response curve and ultimately be heard in the speaker.

Since tuned circuits grow more selective as frequency is lowered, wouldn't it be to our technical advantage to receive only low-frequency signals? This idea probably oc-

curred to Major Edwin Armstrong, because his invention, the superheterodyne circuit, does just that.

**Superselectivity.** By stepping signals down to a lower frequency than they were originally, the new circuit could deliver neat-as-a-pin selectivity on almost any band. Fact is; this development helped open the high-frequency bands, and by the 1930s virtually every receiver adopted the Major's superheterodyne idea.

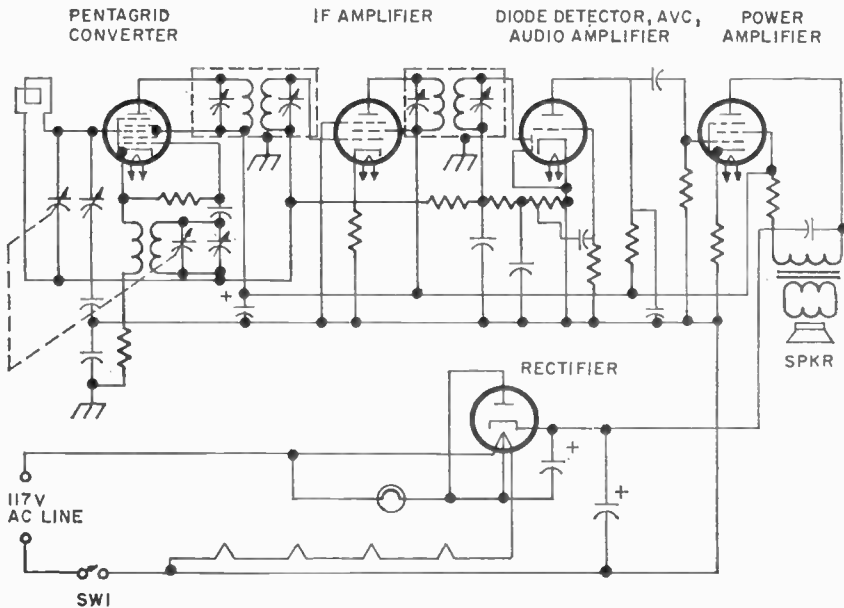

**Schematic of tubed superheterodyne receiver. Virtually all superhets sold commercially are five tube rigs; most are also design-wise electrically and mechanically equivalent.**

# SUPERHETERODYNE

The word "superheterodyne," by itself is revealing. It begins with *super*, for super-sonic, referring to a new signal created within the radio. The generated signal is neither in the audio, nor higher radio-frequency range, but in between. *Hetero* means combining, the *dyne* is force. The newly-created ten-dollar term, *superheterodyne*, neatly sums up this circuit's action.

**Major Blocks.** You can get a good picture of the superhet in its natural habitat if you look at our block diagram. Though our schematic shows a tubed receiver, all equivalent stages tend to do the same job regardless of whether the receiver is transistor or tube. Now that you know what the superhet does and how it looks, let's take a peek at how it works.

For sake of illustration, assume a signal of 1010 kHz in the standard BC band enters the antenna, and from there, is sent down the line to the mixer. But what, you ask, is mixed?

Our frequency mish-mash consists of the different frequencies made up of the desired station on 1010 kHz, and a second signal generated internally by the local oscillator. This oscillator perks at a frequency of 1465 kHz, for reasons which you'll understand in a moment.

True to its name, our mixer combines both signals from antenna and oscillator. And from these two frequencies, it delivers yet another frequency that is the *difference* between them—namely 455 kiloHertz. So far, our superhet circuit changed, or reduced the desired signal to a frequency having an intermediate value. Beating two frequencies together in order to produce a third signal is known by members of the Frequency

Fraternity as mixing, heterodyning, or beating. And some engineers prefer to call the lowly mixer a converter; this term often appears in schematics. But whatever name you throw its way, the result is the intermediate frequency.

There's something else you should know about the intermediate, or IF, frequency. It always remains the same no matter what station you tune to. If you sweep the dial across the broadcast band in one continuous motion, the IF frequency remains constant. How's this accomplished?

It's done by tuning the incoming signal simultaneously with the local oscillator. That's something akin to the mechanical rabbit which paces greyhounds at a race track. In the superhet a ganged tuning capacitor performs this dynamic-duo feat.

Take a close look at the tuning capacitor, and you'll see physically smaller plates assigned to the local oscillator. Since these plates are smaller than the antenna stage capacitor plates, the effect is to lower the capacity, and *raise* the frequency of the oscillator stage. That's how the oscillator stage consistently produces a signal which is 455 kHz above the incoming frequency. But, why bother, you ask?

**More Muscle, Too.** When we convert each incoming station's frequency to the same IF, we gain yet another advantage besides better selectivity. A *fixed-tuned* amplifier always operates at higher efficiency than one which needs to muscle a multitude of frequencies. There are fewer technical bugaboos in a one-frequency amplifier, so our tubes or transistors can operate more effectively at this lower frequency. And last but not least, circuit layout and wiring are less critical. All of this is well and fine, but how do we actually extract our Top-Forty tunes, news, and weather from our super-duper-het?

**Sound Sniffing.** The detector stage recovers original audio voltage from the station's signal. Since we're cranking the RF voltages through a superhet circuit, the RF signal did a quick disappearing act, only to appear as an IF frequency of 455 kHz. Though the original carrier (1010 kHz) is converted downward in frequency to 455 kHz, any audio voltage variations impressed upon the carrier remain the same. So if a musical note of 1000 Hz was sounded back in the radio studio, the note still remains that value in both RF and IF circuits, despite the mixing process.

Like a ladle skimming heavy cream off

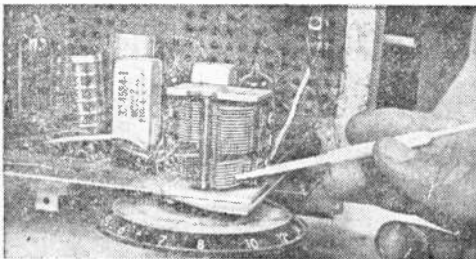

Alignment tool is pointing to oscillator section of superhet tuning capacitor. Smaller, fewer plates mean high oscillator frequency.

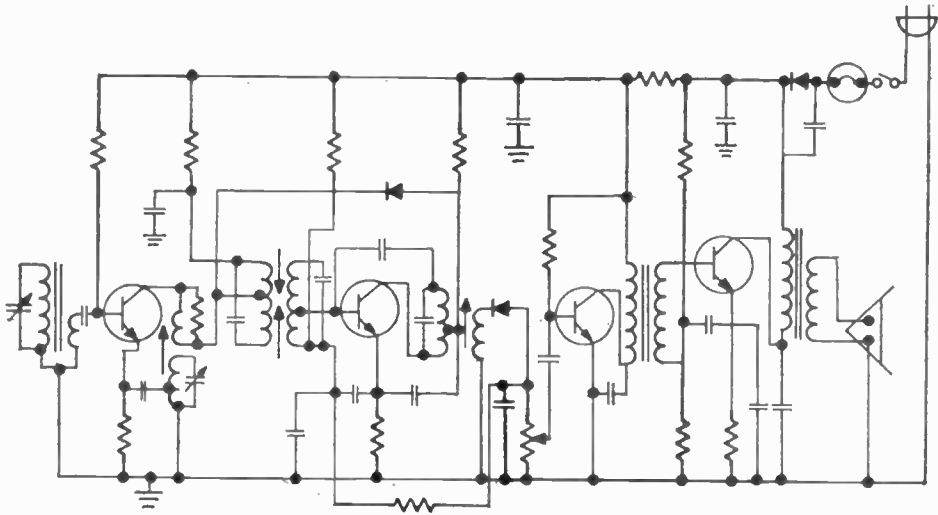

**Our schematic of transistorized superheterodyne receiver is similar in function to tubed superhet found on page 47. Biggest differences between two are semiconductor diodes found in audio detector, AVC loop, power rectifier stages.**

the top of a jug of fresh milk, the detector rectifies either the positive-, or negative-going portion of the carrier, skimming off the audio signals from the carrier. Though audio modulation appears during both positive and negative swings of an amplitude-modulated carrier, only one half of the available signal is used. If both positive and

negative portions of the RF signal were detected simultaneously, the audio signals would cancel each other at the output!

Now let's look at the stages of an ordinary solid-state superhet circuit that might be found in a common table radio or transistor portable.

**Simplified Schematic.** Our diagram is

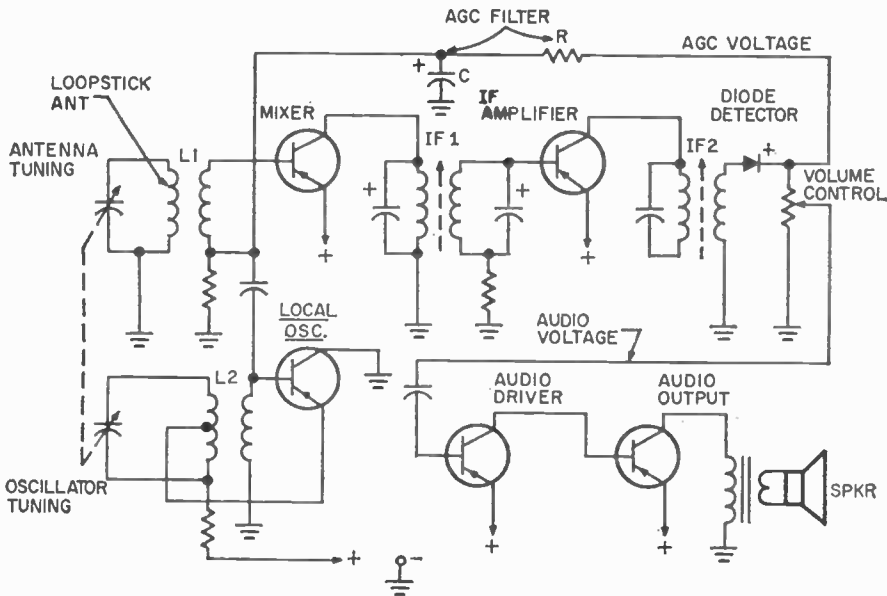

**Most common superhets don't have separate local oscillator, mixer function; schematic above is more typical of BCB set. Communications-type receiver needs added usefulness of separate stages—it's easier to suppress images, input-signal overload this way.**

# SUPERHETERODYNE

pretty typical of transistorized superheterodyne circuits. Of course, there may be variations on this circuit's theme, like addition of an RF amplifier ahead of the mixer to improve sensitivity. The number of IF stages also varies with receiver quality, and specialized items such as filters may appear in ham and SWL rigs.

If you can follow our basic block diagram, you'll have the key to virtually any solid-state superhet. In order to further simplify matters, many resistors and capacitors not essential to our tour through solid-state superhet country have been omitted.

Leading the pack on our superhet speedway is the antenna tuning circuit. Loopstick antenna L1 grabs the RF signal out of the ether, and also serves in partnership with the tuning capacitor in the tuning circuit. You sharpies will also notice that the antenna tuning capacitor is mechanically joined to the oscillator tuning capacitor. (This is represented schematically by a dotted line.) Remember now, we want to develop the IF frequency. This ganged antenna/oscillator capacitor ensures the necessary *tracking* of the local oscillator with the radio-frequency signal.

The oscillator frequency is developed by the oscillator portion of our variable capacitor, and coil L2. In our superhet's schematic, the oscillator signal is capacitively coupled from the oscillator transistor base and sent on its way to the mixer stage. The mixer, therefore, "sees" both oscillator and incoming station frequencies. The electrons from oscillator and antenna circuit get it all together in the mixer's base, producing our intermediate frequency.

If you could look at the mixer's output, you'd see more than just the IF signal. Fact is, the mixer's load contains a jumble of frequency byproducts. As signals combine in this circuit, they add, subtract, and recombine in many ways. It's as if you had to separate the wheat from the chaff with a pair of tweezers!

Only the desired signal emerges from the mixer stage because intermediate-frequency transformer IF1 picks the proper signal to the exclusion of all the others. Now our freshly-created signal passes through a stage of IF amplification, and receiver selectivity is further whipped into shape by the second

intermediate-frequency transformer IF2.

As we've already described, the detection process takes place at the diode, regaining the radio station's original audio signal. This audio voltage is fed from the volume control to both audio stages where they're further amplified and sent to the loudspeaker.

The detector diode doesn't merely extract soul sounds from the ether; it also delivers a second voltage output. Called AGC (Automatic Gain Control), this voltage controls our mixer's amplification, preventing the speaker from blasting when you suddenly tune your radio to a strong station. In our simplified schematic, our AGC voltage is a positive-going voltage which increases proportionately with rising signal strength. But before AGC can control receiver gain, it's filtered for pure DC in a resistor and capacitor network.

Result is a DC signal which can be used to control the gain of the mixer transistor. Thus, if a strong RF signal tries to muscle its way through this stage, the mixer is subjected to a higher bias voltage on its base terminal, which tends to put the brakes on our mixer's gain.

**Pitfalls, Yet.** Let's not lionize the king of receivers, though, for sometimes its growl turns to a puny purr. Biggest problem, and most annoying, is a form of interference peculiar to the superhet known as an *image*. Produced by a mathematical mixup, images are all of those undesired signals finding easy routes to travel through your receiver. Take a look at our image explanation; you'll see the receiver is tuned to a desired signal of 8000 kHz.

The local oscillator generates a frequency  
(Continued on page 90)

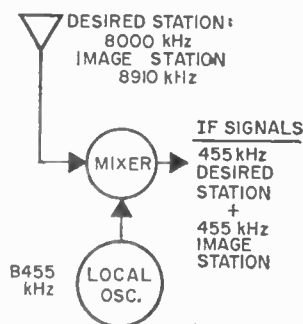

**Mixer is superhet's weakest link as signal handler. Too strong input signal can develop image frequency. Too much local oscillator signal pumped into mixer has same effect.**



# TUNING UP THE ALL AMERICAN 5



By Mannie Horowitz

**M**odern radio as we know it today, is due to one great invention—namely the superheterodyne receiver. Sure people used radios before the circuit was widely adapted. The multi-dial TRF (tuned radio frequency) set was quite popular in the '20's—especially if you could afford one. However, commercial five tube radios as we know them today, originated with the low cost superheterodyne circuit. This circuit has proven itself so fine and effective that it has been adopted for use in practically every FM receiver as well as for the popular five-tube, AM radios flooding this country.

As was the case with the TRF receiver, the RF signal is selected by varying the capacitor in the resonant circuit. This signal

is fed to the first tube, known as the mixer, converter, first detector, or anything else you may wish to call it. Along with this RF signal, a second signal, which is generated in the receiver, is fed to the mixer. The frequency of the signal generated by this local oscillator in the receiver, is 455 kHz above the frequency of the radio station. Thus, if the radio station broadcasts on a frequency of 1100 kHz, the oscillator frequency is set to  $1100 + 455$  or 1555 kHz. If the radio station broadcasts on a frequency of 880 kc, the frequency of the oscillator is set to  $880 + 455$  or 1335 kHz. The frequency generated by the local oscillator is varied by a capacitor in the oscillator circuit, as shown in Fig. 1.

It is quite simple to accomplish the varia-

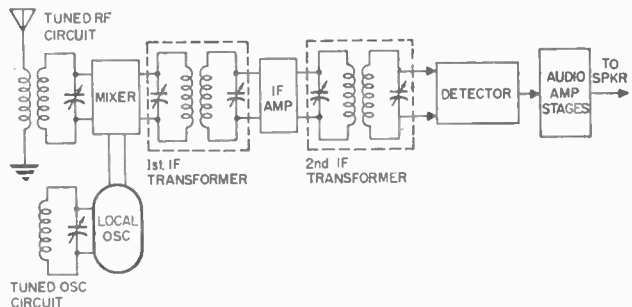

Fig. 1. In the superheterodyne receiver, the incoming RF signal is reduced to an intermediate frequency in the mixer.

# All American 5

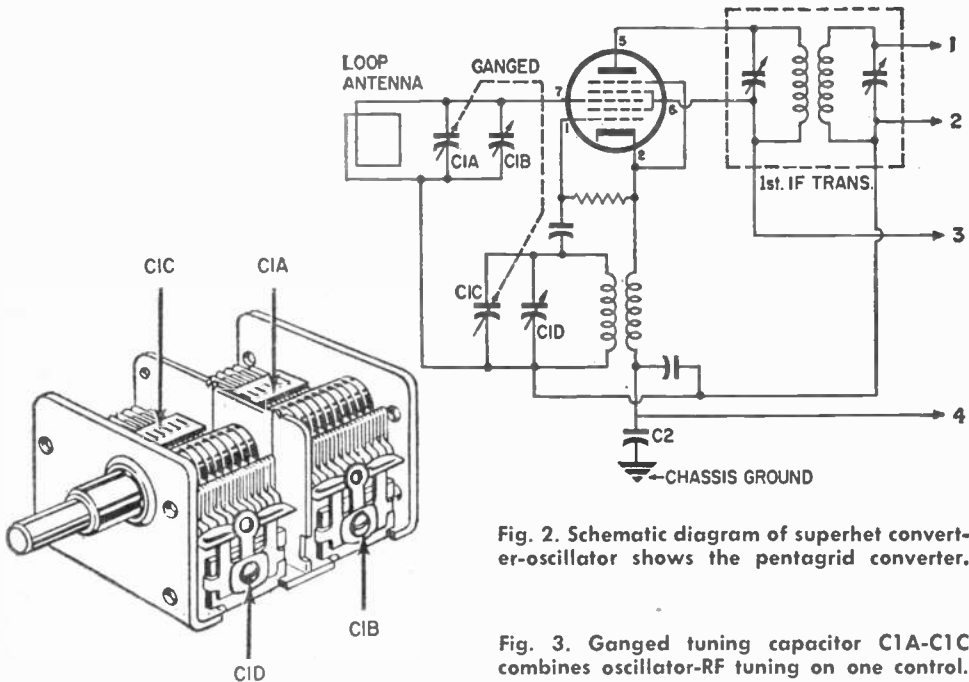

Fig. 2. Schematic diagram of superhet converter-oscillator shows the pentagrid converter.

Fig. 3. Ganged tuning capacitor C1A-C1C combines oscillator-RF tuning on one control.

tion of the oscillator frequency with the variation of the frequency of the resonant circuit in the RF section. The capacitors which tune the oscillator and the RF signal are actuated by one knob. Thus, when a specific station is selected by the RF section of the capacitor, the corresponding oscillator frequency is selected by the oscillator section of the capacitor.

The two signals are combined in the mixer stage. The output from this stage is the 455 kHz difference between the two signals. The 455 kHz difference in frequency is maintained between the oscillator and radio station; thus the difference frequency is available for all radio stations over the tuning range. It should be noted that the audio signal, which was received by the antenna as intelligence riding on top of the RF signal, is now transferred to the 455 kHz signal. It rides on top of this 455 kHz IF or *intermediate frequency* signal.

**IF Amplifiers.** This 455 kHz signal must now be amplified. The 455 kHz is carefully selected by two IF transformers. Between these two transformers is a stage of IF gain involving a vacuum tube or transistor. This

is not unlike a standard tuned RF stage, except here, only one frequency must be selected and only one frequency must be amplified. This can be done most efficiently.

In the remainder of the unit, the IF signal is detected to separate the audio from the IF carrier, the IF is discarded, the audio is amplified, and sent on to the speaker.

Why the choice of any specific IF frequency, is difficult to determine. It seems that 450 kHz or 500 kHz would be a more logical choice. Is there less interference or better sensitivity using 455 kHz? Or is it just a choice someone made and the number happened to stick? Whatever the reason, the industry has accepted this as the standard. We have no choice but to use this figure when aligning a radio.

**Alignment Requirements.** Although no outline of exact procedures has been described, the above discussion of the superheterodyne radio indicates the alignment requirements. There are two precise factors which must be satisfied.

*First*, the IF transformers must be aligned so that they will pass the 455 kHz IF frequency while rejecting all other signals.

*Second*, the variable capacitor must be adjusted so that the difference in frequency between the RF signal and oscillator is 455 kHz over the entire broadcast band.

Exact procedures using a signal generator and an output meter will be discussed below. However, before this is done, it would be helpful to discuss the circuit of a typical superheterodyne receiver. We will consider the receiver one stage at a time. If you would hook-up the leads (with arrowheads) represented by identical numbers in two successive stages (or two successive schematic figures), you have the schematic diagram of a complete superheterodyne receiver.

**Typical 5-Tube Superhet.** The first tube of the superhet (see Fig. 2) serves several functions. First, it is the oscillator—pins 1 and 2. Then, it receives the RF signal at pin 7. Finally, the two signals mix through the maze of grids to give the final IF frequency—455 kHz at the plate. The first IF transformer is tuned to this 455 kHz. Other RF frequencies that happen to get to the plate circuit are bypassed to ground via the power supply by the action of the 1st IF transformer.

Because these receivers are quite sensitive, the RF signal does not have to be picked up by an antenna on the roof. Instead, a loop antenna at the receiver is usually used. This may consist of several turns of wire on a flat piece of cardboard, or several turns of wire on a ferrite rod. The ferrite material is composed of iron and other metallic oxides combined with ceramic material for rigidity. This ferrite rod is also known as a loopstick.

The loop antenna works in conjunction with capacitor C1A (see Fig. 3) to form a resonant circuit to tune to the radio station. A small variable mica capacitor, C1B, is usually mounted on C1A and connected in parallel with it by the manufacturer of the capacitor. This C1B is used in the alignment procedure. It is known as a trimmer capacitor and is used to trim the combined values of C1A and C1B so that it will resonate at the proper frequency with the loop antenna coil, and at the proper setting of the tuning dial.

The oscillator coil, in junction with C1C and C1D form the resonant circuit to determine the frequency which the oscillator will generate. Capacitor C1C (see Fig. 3) is the main tuning capacitor for the oscillator, and C1D is the trimmer, arranged very

much like the combination discussed above for C1A and C1B in the RF section.

Capacitors C1A and C1C are attached to one shaft. One knob is used to turn both capacitors simultaneously. Screwdriver adjustment screws are set in the variable mica capacitors which are mounted on its respective large air capacitor.

You can usually tell which section of the capacitor refers to the oscillator and which to the RF circuit. The oscillator resonates at a higher frequency than does the RF circuit. Therefore the oscillator section usually has less or smaller plates than does the RF section. This is very much like musical instruments where higher pitched notes come from smaller instruments.

In Fig. 4, a simple IF amplifier stage using the 12BA6 and a second IF transformer, is shown. These are used to amplify the signal from the converter and first IF transformer and provide better selection of the IF frequency. These, in turn, are connected to the detector diodes in the 12AV6, the triode voltage amplifier in the 12AV6 and finally the power amplifier 50C5 which drives the speaker. All this is shown in Fig. 5.

The AC-DC power supply used to provide the necessary DC voltages to operate the radio circuit, is shown in Fig. 6, using a 35W4. Some radios used selenium or silicon rectifiers instead of a tube.

The various interconnections between sections are self-evident. Lead 1 is the link connecting the output from the IF transformer in Fig. 2 to the input of the IF amplifier tube in Fig. 4. Lead 3 in Fig. 2, 4, 5 and 6 is used to interconnect the B+ supply to all stages. Lead 4 in these figures is the common B- ground. (*Turn page*)

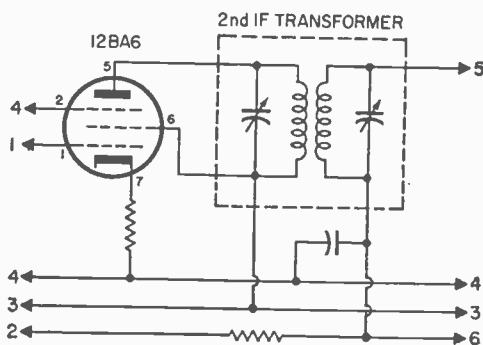

Fig. 4. IF amplifier tube 12BA6 boosts signal; second IF transformer increases selectivity.

# All American 5

Lead 5 in Figs. 4 and 5 connect the second IF transformer to the detector, while lead 6 connects the audio to the volume control through a resistor.

**Introducing AVC.** Only lead 2 requires some additional discussion. This lead is used to conduct part of the detected signal back, as DC, to the earlier stages. This DC controls the gain of these stages. On strong signals, the gain of the IF and mixer amplifiers is reduced due to this DC. Thus, this lead completes an Automatic Volume Control (AVC) circuit. It sort of equalizes the strength of the final output signal for all stations. In alignment procedures, AVC action is undesirable, for it limits variations in gain at the output. During alignment, the test signal levels are kept low so that AVC action will be negligible.

One other factor should be observed in this circuit. The chassis is not used as a ground for the B- Because B- is connected to the AC line, grounding the chassis to B- and hence the AC line, can be hazardous. To keep the chassis from floating, it is connected to B- ground through a small capacitor. This is shown as C2 in Fig. 2.

**Aligning Instruments.** Two instruments are necessary in this procedure. One is to be used as a signal source. The second is to be used to measure the output.

In the alignment procedure, three signals should be used. An audio signal should be fed to the audio amplifier section of the receiver (Fig. 5) to be certain that it is operating.

Next, a 455 kHz signal modulated by an audio tone should be fed to the IF stages. The IF stages are adjusted for maximum

output by monitoring the audio signal strength at the speaker.

Finally, two modulated RF signals are required to permit adjustment of the RF and oscillator circuits. One RF signal must be at the high end of the band and the other RF signal must be at the low end of the band.

Several signal generators are available that are capable of producing all these signals. They are shown in the photograph in Fig. 7. The switch positions given in the following text are for the EICO 324 unit which is typical of the units available.

The audio output can be gotten from the two jacks at the lower left hand corner of the unit. The Signal Selector knob is to be set at the "Int. Mod/AF Out" position to get an internally modulated audio output. The "AF Mod/Output" control is used to adjust the amplitude or strength of the modulated audio signal output from the generator. None of the other controls have any effect on the audio. They are concerned only with the RF signal.

The connector at the lower right hand corner of the unit is used for the RF and IF output. The Signal Selector knob is set at its previous position for a modulated output signal. The frequency is selected by use of the Band Selector switch and the rotary frequency control knob. Thus if 455 kHz is required, the Band Selector is set at "B," for this band covers the range from 400 kHz to 1.2 MHz (marked near the tuning scales). The tuning knob is then rotated until 455 kHz appears under the pointer in the window. A similar procedure must be followed for any RF frequency that may be required.

The amount of RF signal output is controlled by the RF Course and RF Fine controls. These are usually kept near minimum during the alignment procedure.

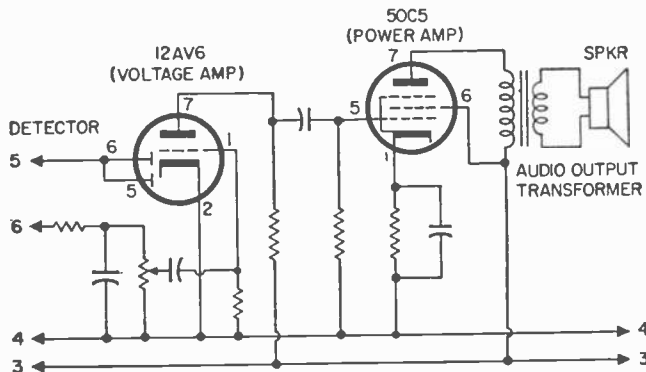
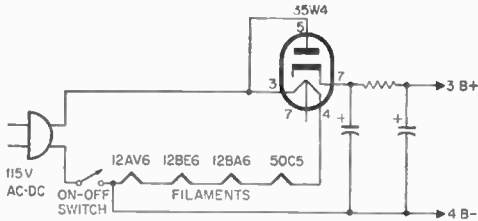

Fig. 5. The audio amplifier section of the receiver combines detection and voltage amplification in the 12AC6 tube, and power amplification in 50C5.



**Fig. 6. The power supply that provides the DC voltages for receiver utilizes 35W4 diode tube in filtered half-wave rectifier circuit.**

Finally, the output from the radio must be monitored in some way or other to perform a proper alignment. The low voltage AC scale on any multimeter can be used to measure the output voltage.

If no meter is available to monitor the output, the signal level may be checked audibly by listening to the speaker and judging the levels.

**The Test Setup.** When the receiver, generator, and meter are interconnected, details and precautions should be carefully observed.

The meter should be connected to the speaker leads in Fig. 6. If one of the speaker leads is connected to a chassis of B- ground, connect the common lead from the meter to this point. If you use the instrument illustrated, it is the lead with the alligator clip.

Connect the AC probe to the remaining lead to the speaker. If the speaker has no grounded leads, the meter may be connected in either direction. If you use a meter which does not have to be connected to the AC power supply, such as a VOM, the leads may be connected in either direction to the speaker.

Now set the Function switch on your meter so that it will read AC. Set the range switch to the lowest range above 1 volt. The output meter is now set up for the entire alignment procedure.

The common from the signal generator must be connected to the B- ground. During the alignment procedure, the signal will be injected from the Audio and RF outputs to various points in the radio. Just where to inject the signal will be discussed in the procedure methods.

Several precautions must be observed when making this setup.

1. Make all connections to the receiver when it is turned off.

2. Excess hum during test may be reduced by reversing the position of the AC power plug in its socket.

3. Never connect an external ground (radiator, water pipe, etc.) to any point on the receiver.

4. In conjunction with caution #3, never place the chassis on a metal bench, steam heat radiator, or any grounded object. If you must use a metal bench, be certain that the power plug is not in the socket or that there is some insulating material between the receiver with the instruments and the table. A large piece of cardboard will do. To avoid shock, do not touch the metal bench and the receiver or instruments simultaneously.

5. To avoid shock when aligning the unit, do not touch any grounded electrical conductors.

6. Use insulated or special aligning tools so that the alignment will not change when you remove the tool from the adjustment screws. A small insulated metal screwdriver may be used.

With this in mind, we can now proceed with the actual alignment procedure.

**Aligning the IF's.** Before touching the IF cans, you must be certain that the audio section is working properly. Connect the top (hot) lead from the audio output of the generator to the hot side of the volume control. This is the top, ungrounded end of the control in Fig. 5. Turn the volume control on the radio and the gain control on the generator to give the maximum output. Now, turn the output level control on your generator down until the sound comes through clean and undistorted to the ear. Note the voltage. During the remainder of the procedure, never let this meter read more than 1/2 this voltage. If it should rise above this value, decrease the output from

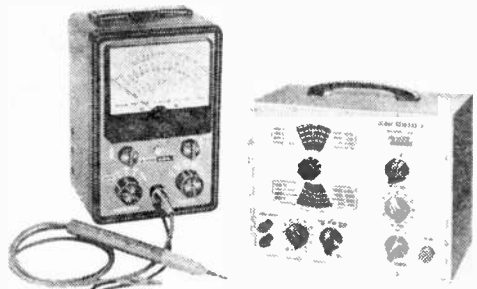

**Fig. 7. VTVM and signal generator are all you need to align superheterodyne receivers.**

# All American 5

the generator with the appropriate control.

Now set the generator to produce a modulated 455 kHz signal. Adjust the modulation control to less than 100% modulation. This is easy with most generators, since they are either not capable of this much modulation or use fixed modulation with no front panel controls.

Connect the RF output from the generator, through a .01  $\mu$ F capacitor, to the grid of the tube preceding the final IF transformer. In Fig. 4, it would be pin 1 of the 12BA6. Adjust the trimmers in the final IF transformer for the maximum output. Keep the oscillator output low enough so that the maximum desirable output voltage level, discussed above, will not be exceeded.

Now, connect the same probe to the RF grid of the converter stage. In Fig. 2, it is pin 7 of the 12BE6. Because of impedance conditions, the level of the output from the generator will probably have to be increased to get a reading on the meter. If no reading can still be made, it will be necessary to temporarily disconnect the tuned RF circuit. This tuned circuit consists of C1A, C1B and the loop antenna in Fig. 2. Now adjust the trimmers in the first IF transformer for the maximum output. Be certain to reconnect RF circuit after alignment is complete.

**RF Alignment.** The big problem with RF alignment is to find a convenient point at which to inject the RF signal.

If there is an antenna terminal, connect the output from the generator to it, through a capacitor. If there is no antenna terminal, as is the usual case, wind several turns of wire into a small coil or "hank." The size is only important in that it should be convenient to place it a few inches away from the flat loop or loopstick antenna, without shifting its position relative to the antenna. A small hank of four loops or turns of ordinary insulated hook-up wire wound in circles of about 3 inches in diameter will do nicely for this coil. The various turns can be held together at several points with masking tape. The masking tape can be used to hold it near the antenna during the alignment procedure.

If you made the RF loop discussed, disconnect both the RF and AF generator leads

from the chassis or B- ground. Connect the two leads from the hook-up wire loop to the RF leads from the generator. Should this loop stop the generator from oscillating (as noted by no output in the receiver) more turns will be required. Just how many turns can be found by trial and error.

If there is an antenna terminal on the receiver, do not disconnect the generator from ground, but connect the RF lead through a 200  $\mu$ F capacitor to the antenna terminal.

Feed a 1400 kHz modulated signal to the receiver. Set the dial on the receiver to 1400 kHz. Adjust the oscillator trimmer condenser, C1D, for the maximum output.

Now feed a 600 kHz modulated signal to the receiver and set the dial on the radio to 600 kHz. Adjust the oscillator padder condenser,\* if any, for maximum output. If there is no padder condenser, there is usually a screwdriver adjustable slug in the oscillator coil. Adjust this for maximum output.

Next, recheck the 1400 kHz adjustment. Repeat both adjustments (the one at 1400 kHz and the one at 600 kHz) until you get the maximum output and best tracking.

Now that the oscillator section has been adjusted, the RF circuit must be adjusted. Once again, feed a 1400 kHz modulated signal to the receiver. Tune the radio to 1400 kHz. Adjust the RF trimmer condenser (C1B in Fig. 2) for maximum output.

Next, feed the 600 kHz signal to the receiver and set the dial to 600 kHz. Adjust the padder condenser or slug in the antenna coil, if either exists. In some units, it is possible to adjust the position of the coin on the loopstick for maximum output signal. In other units, where no padder facilities exist, the trimmer must be adjusted to give the best maximum output compromise at 600 kHz and 1400 kHz.

If your listening habits favor one end of the band over the other, or one station more than another, it is best to adjust the RF trimmer for the maximum output at the frequency of the favored station.

Repeat the RF alignments at 1400 kHz and 600 kHz until the best compromise is achieved. Alignment is complete when you remove the leads from the signal generator and the RF coil you made. ■

\* Some receivers have a capacitor between the parallel combination of C1C-C1D and the oscillator coil. This is the padder condenser. A padder condenser may be placed in a similar position in the RF circuit.

# HOW TO CHANGE

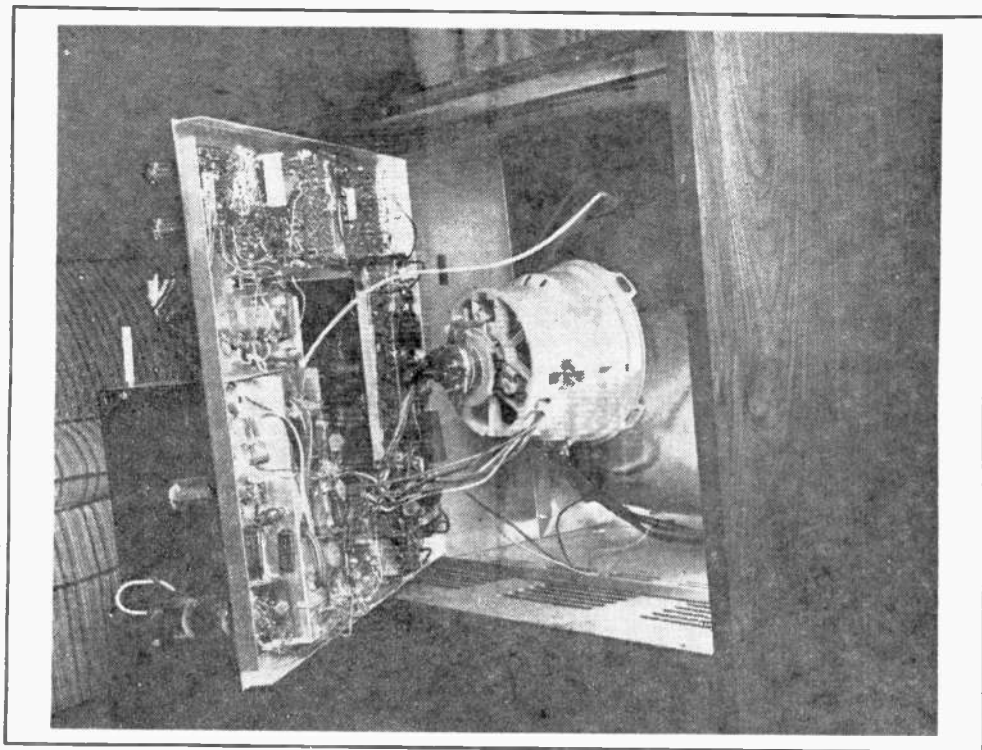

## A COLOR TV TUBE

By HOMER L. DAVIDSON

■ When your color picture tube becomes dim and one or two colors are real weak, you can replace that color tube yourself. Follow the photos and text in this article and you can save yourself some dough. This article shows how to replace the round and rectangular color picture tubes. The sizes are 21-inch round, 25-, 23-, and the 19-inch rectangular color CRT's.

The initial preparation consists of taking the TV chassis from the cabinet. First, remove all knobs and the rear cabinet cover from the TV receiver (Fig. 1). Discharge the high-voltage charge of the tube with a long, insulated-handle screwdriver—from anode connection to the TV chassis. Be real careful, and do a good job of grounding out the high-voltage cable. In older TV re-

ceivers, the high-voltage cable must be unfastened from the metal box before you open the lid of the box. This lead will pull out of a pin socket. In newer TV sets, the high-voltage lead unplugs from the glass picture tube. Unbolt the TV chassis and unplug all wires going to the TV chassis.

This includes the picture tube cap or socket, yoke leads, and speaker leads. All the colored wires going to the deflection yoke are marked on the yoke where they are plugged in. There is little danger of getting them wrong when replacing them. Unhook the blue grounding lead from the blue lateral magnet. Unplug the convergence yoke-cable from the TV chassis and also loosen the antenna terminal assembly.

Before pulling out the chassis, be sure

# Change Color Tube

all cables and wires are disconnected. On the older models, pull out the chassis three or four inches and loosen the 1/4-inch metal screw, holding down the small-controls assembly. Slide the assembly back and pull up. Now the chassis is free (Fig. 2).

**The Tube Comes Out.** The cabinet should be turned over on its face before removing the color tube. Be sure to lay a blanket or thick padding upon the floor to keep the cabinet in ship shape. Have a friend (Fig. 3), or the wife, help place the TV cabinet front down upon the padding.

In the older color sets the dynamic convergence magnet assembly (Fig. 4) slides

separately off the neck of the tube. In the rectangular 25-inch sets the yoke assembly also contains the convergence coils and fits tightly against the color tube.

Four nuts hold the picture tube in place—two at the top and two at the bottom. A metal flange surrounds most tubes, near the face of the tube. In the newer color sets, the automatic degaussing coils (ADG) are fastened to this framework. In the 25-inch sets the metal flange must be removed before you can get to the nuts holding the color tube in place.

Now remove the components from the neck of the color picture tube. In case you are not familiar with the location of these components, measure their position (Fig. 5) on the neck of the color picture tube. This procedure is quite helpful when replacing

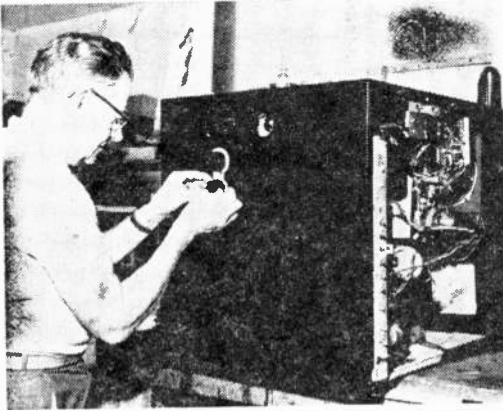

Fig. 1. (top, left) Removing the control knobs.

Fig. 3. (below) Place cabinet face down on folded blanket to protect pic tube and finish.

Fig. 4. (right) Point of pencil indicates the setting of convergence yoke and red band.

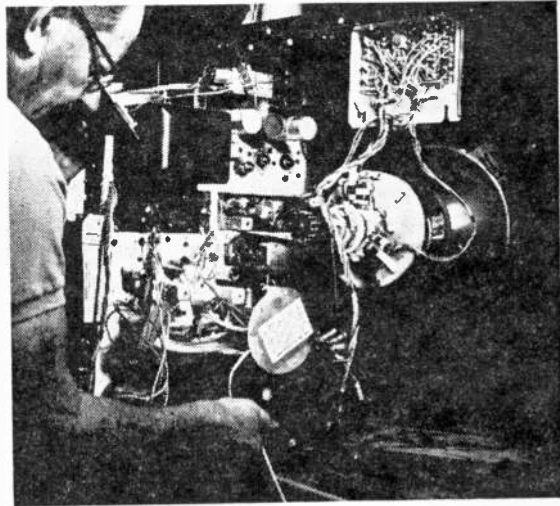
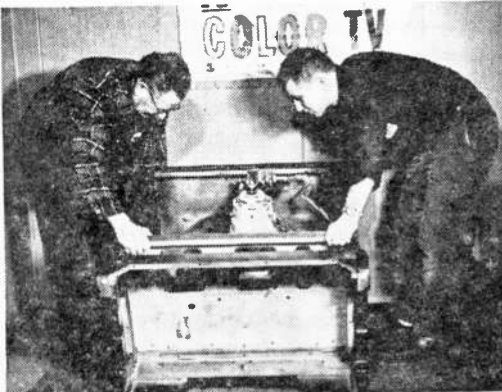
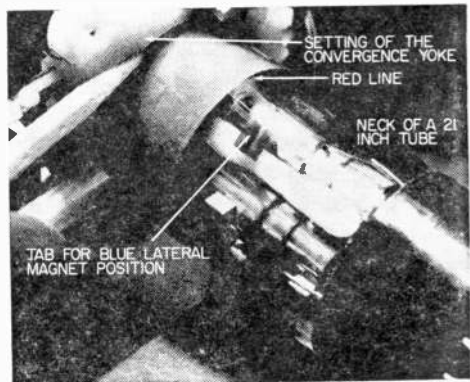

Fig. 2. (above) Don't be afraid to make notes about various connections as you disconnect chassis from CRT and yoke. It can save you a little hunting later.





these components to the neck of the new color tube. *As a safety precaution, wear safety glasses when working close to the picture tube. Do not put pressure on neck of CRT or let tube rest on neck.*

**Clear the Neck.** Place the kinescope face down on a drop cloth or newspaper to protect the face from scratches. Now remove the components from the neck of the tube. When you remove the blue lateral magnet, you will notice that it sets over a tab or clip inside the tube neck (Fig. 6).

In the older sets, the purity ring sets over the red ring marked inside the tube. Note that the blue wires from the convergence assembly (Fig. 7) go to the top of the picture tube over the blue gun, the red wires at the left side, and the green wires on the right going to the green dynamic convergence coils.

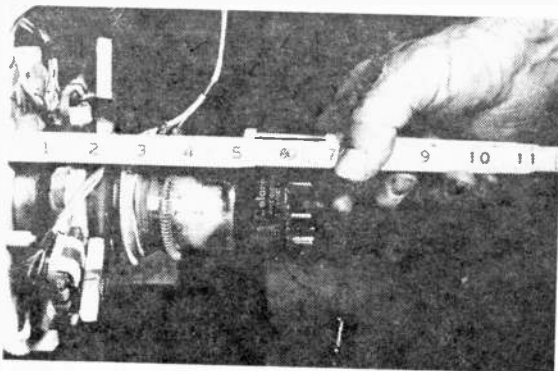
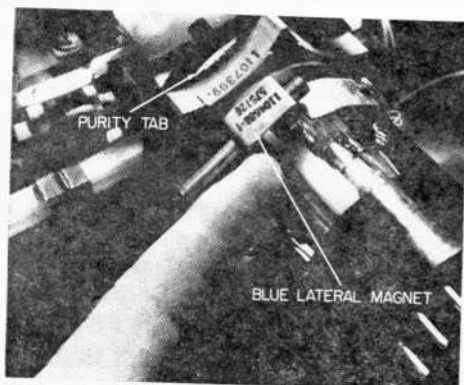

Fig. 5. (top) Be sure to mark down measurements so you can replace the yoke assembly.

Fig. 6. (below) Here author is pointing to blue lateral magnet and the tab inside the neck of the CRT. Tab is not obscured by blue lateral magnet in Fig. 4. By first replacing the components according to the measurements most adjustments are minor.



The large deflection yoke is loosened with a 1/4-inch nutdriver (Fig. 8) and can be lifted off the neck of the tube. It is very heavy; do not drop it! Be especially careful not to rap the CRT with a tool or heavy object. *The CRT must be handled with care since it can implode and cause serious damage to you and the set.*

The masking must be removed from the front edge of the CRT, as in Fig. 9. On the rectangular tubes, a strap with corner flanges must be removed by loosening a side-bracket bolt. Remove the bracket (i.e., masking) assembly from the old CRT and place it upon the new tube.

Be sure the CRT is laying in the same position as mounted in the TV cabinet. Now place the strap in place on the new CRT and tighten up the bracket assembly. Be sure the high-voltage (anode) button is at

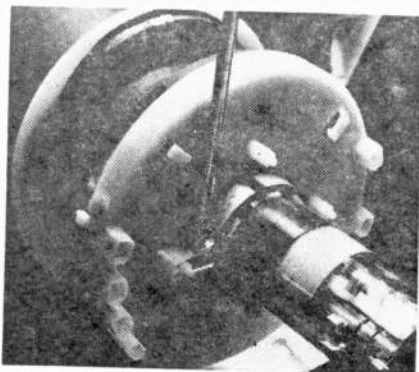
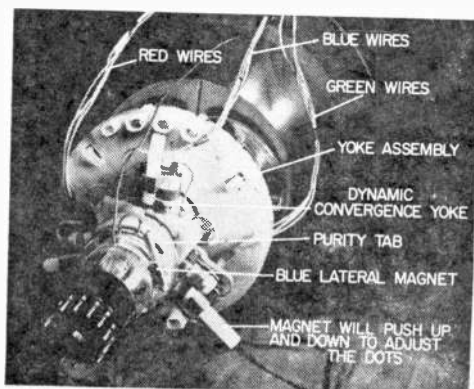

Fig. 8. (above) After yoke assembly has been loosened with nutdriver it can be removed. Assembly is quite heavy—don't drop it.

Fig. 7. (below) All components of the yoke assembly are indicated. Once you can tell the difference between a dynamic convergence yoke and a purity magnet you have an easier job of following these instructions.



# Change Color Tube

the top of the set on a 25-inch picture tube (Fig. 10). The 23-inch and 21-inch round-CRT anode connections (Fig. 11) are on the side of the tube.

**Reassembly.** Place all components back on the neck of the CRT. Use the previously taken measurement for their approximate position. In the older sets the yoke must be mounted so it will slide back and forward for purity checks. The 25-inch yoke assembly fits snugly against the bell of the tube. This yoke slides back and forward inside of the large yoke assembly. Two small screws are loosened on each side of the plastic yoke assembly.

Tubes that are not bonded have a safety

glass—be sure the glass is clean. Wash it with soap and then rinse with clear water. Make sure there is no lint or dirt on the face of the new CRT (Fig. 12). Seat the tube in its place in the cabinet and bolt it to the front brackets. Replace the metal shield and degaussing-coil assembly, if the set has one.

Now set the cabinet upright and fasten the convergence board in place (Fig. 13). Install the TV chassis and connect all cables. Make certain that all parts are replaced and tightened. Banging against metal parts will sometimes induce magnetism into these parts and a second job of degaussing may be required. Be sure that all cables are connected and in place. Turn on the color receiver and leave it on for 15 to 20 minutes before purity or convergence checks are made.

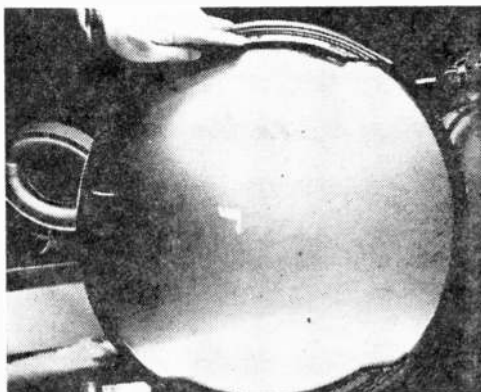
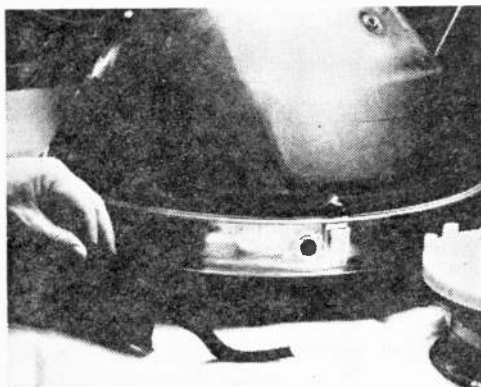

Fig. 9. (top, left) Make careful note of how the front protective mask is removed from CRT to make replacement much easier. Plastic mask on 21-inch CRT must be placed evenly (top, right) before taping in place.

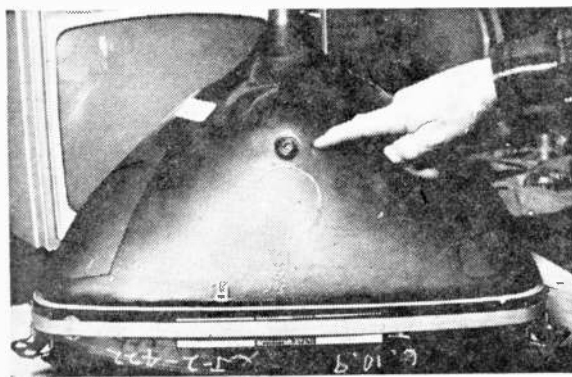

Fig. 10. High-voltage connector is at top of 25-inch CRT's—on side of 19- and 23-inch CRT's. Make sure!

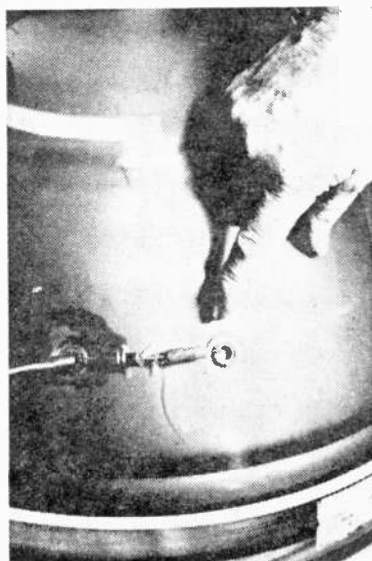

Fig. 11. Resistor, with spring, bridges anode buttons.

**Basic Adjustments.** Color-TV convergence can take time and may require skill. You may want to degauss and converge the color TV yourself, if correct equipment is available. If not, get help from a good reliable color-TV serviceman and pay him to finish the job.

If you want to do it yourself; here goes: Position a degaussing coil near the picture tube (Fig. 14) to completely neutralize any induced magnetism. This step will help insure proper purity and convergence when the picture tube is converged. Hook up the Dot-Bar color generator and let it warm up as the color-TV set warms up. When replacing the CRT, even sets with built-in degaussing coils should be degaussed just as if one was not built into the TV cabinet.

Take a quick look at the TV screen and if there are any color shaded areas the set

should be put through a purity check up.

To start the purity adjustment (Fig. 15), turn off the set and unplug the IF cable going to the tuner. Plug the AC-interlock cord back in, let the receiver warm up, and short out the green and blue grids through a 100K resistor. (There are commercial kinescope grid-shorting switch boxes on the market for just this purpose.) At the moment the screen should be red. Adjust the center purity ring for a center red coloring. Then push the yoke back and forth and adjust the purity ring until the entire screen has an even red tint. The red-, blue-, and green-grid connections are generally on the top of the chassis. These three colored wires go to the picture-tube socket.

If the purity adjustments are done correctly, the green and blue shading will fall in line. It is always best to check each one

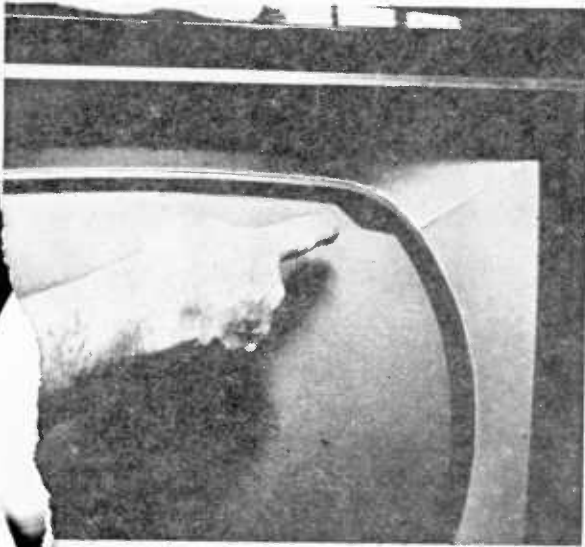

Fig. 12. (top, left) When replacing CRT's that are not bonded, safety glass must be cleaned of fingerprints and lint. Double check mask to make sure it is aligned properly in set.



Fig. 13. (top, right) When convergence board has been reinstalled and all nuts and machine screws have been tightened the chassis can be returned to the cabinet and secured too.

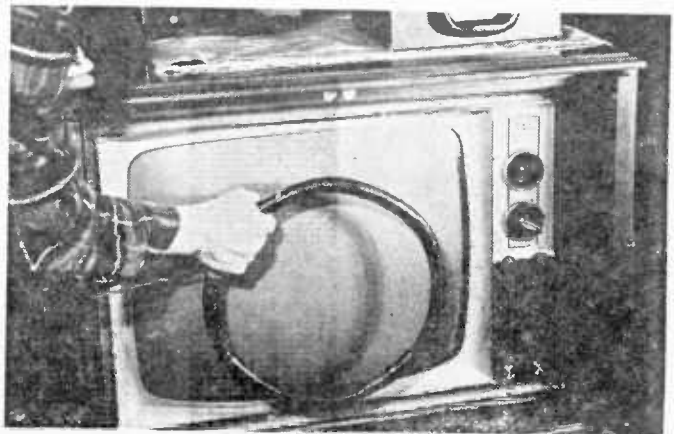

Fig. 14. (right) Degauss the CRT even if there is a built-in degaussing coil.

# Change Color Tube

separately by shorting the other two grids to ground through a 100K resistor. If a little shading persists, try degaussing the CRT again and start over with the red adjustment procedure again.

At this time, check the level of the picture and see if the picture is in focus. Sometimes it is difficult to do a good job of convergence with the set out of focus. When you reset the focus control, convergence dots are way off.

**Getting a Picture.** Convergence is relatively easy on the new color receivers. The older models require patience and plenty of time. Connect the Dot-Bar generator to the antenna terminals. Remove the convergence board from the back of the set and place it on the slots at the top and back of the set. Tighten the two metal screws so the board is solidly in place. Watch the wires that connect the board to the yoke assembly so that they do not get tangled.

If the receiver was in convergence when the color CRT went bad, the dynamic convergence controls will generally need only a touch up. Set the generator to get dots on the CRT screen and check the dots down through the center of the screen. Short out the blue gun with the 100K resistor. Bring the red and green dots together on a center dot. Slide the red and green magnets in on top of one another. Readjust the setting, if needed.

If they won't quite come together, remove

and rotate the red magnet a half turn and reinsert it, and adjust again. Now, once the red and green dots are centered, short the green grid and line up the red and blue dots. (The blue-beam magnet moves the blue dot up and down. The blue lateral-beam moves the blue dot horizontally. Place them on top of one another). Go back and check the red and green guns once again. Check that all three dots are together. You should now have a white dot. The amplitude and tilt controls should not be adjusted unless the dots fail to converge.

Now, step back and take a look at the screen from a distance. Tune in a black-and-white program from a local station and check for color fringing. Generally, the convergence board does not need to be adjusted unless tampered with.

If the dots do not converge at the ends, top, and bottom, the vertical and horizontal adjustments must be made. Use the manufacturer's convergence and adjustment information and follow their alignment procedure. It is best to go over color convergence several times and then get away from the dots. Go back in a few minutes and recheck.

Follow the factory adjustment for black-and-white setup. The newer TV color receivers have a *service-normal* switch mounted at the rear of the chassis. When this control is thrown to the *service* position the raster collapses into a thin white line. You adjust the three screen controls until the vertical line is perfectly white. Now flip the switch to *normal* and the picture is black and white. ■

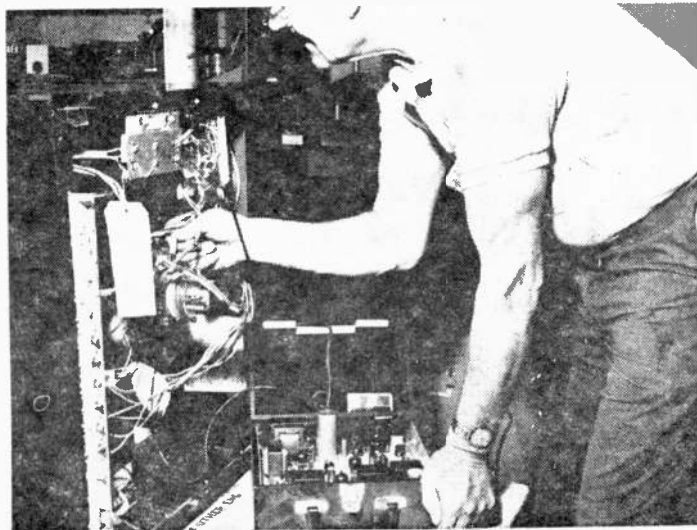
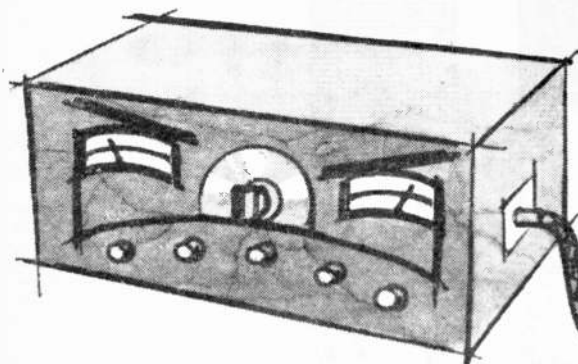

Fig. 15. The last step is the most crucial of all the steps in the replacement of a color CRT. Color purity has a lot to do with the overall enjoyment you get when watching your favorite programs. No one can thrill to faces that are tinged with green, or grass that has a purplish tinge. If you don't have the necessary equipment you can have your local TV service technician do both the color purity and convergence adjustments. Fee is much less than paying for complete job by TV technician.

# GET YOUR CB SIGNAL



## ALL PUT OUT!

free—and legal ways—  
to boost your CB signal

by Len Buckwalter, K1ODH/KQA5012

**A**n old timer in the radio game once cleared up the mystery of CB antenna matching this way: "Imagine driving a car on an icy road. You gun the accelerator but the rear wheels spin uselessly and you don't go anywhere. Throw sand under the wheels and away you go. What you've done is matched power to load—just like matching a CB rig to an antenna."

There may be little connection between Edsels and electrons, but there's truth to the old timer's analogy. His spinning wheels represent the final radio-frequency amplifier acting as a power generator. Ice represents the load, or CB antenna, while sand is equivalent to a matching device which enables the wheels to bite into the ice—much like an amplifier delivering watts to an antenna. When matching is poor in either case (rig or car) the result is often useless heat.

The need for CB antenna matching springs from the differing impedance of various elements along the line. Measured in ohms, impedance is the AC resistance encountered by the radio signal in going from RF amplifier to transmission line to antenna, and finally to the air. Each element harbors its own characteristic impedance and maximum power transfer won't occur unless all impedances agree—which is to say "matched." What determines impedance

value is often the internal nature of the device. Fortunately, it's possible to tamper with impedances and electronically juggle the numbers. As a rule-of-thumb, a transmitter stage that operates at fairly high voltage and low current displays high impedance. Thus, the final stage of a tube-type CB rig is generally considered high impedance because plate voltage is about 250 and current flow only about 20 milliamperes. These conditions help drive impedance up to thousands of ohms. The impedance of a transistor output, on the other hand, is typically low and current flow high. These shifting possibilities challenge the CB designer, who must build his creations to feed a 50-ohm impedance. Why that figure?

**Picks a Number.** Fifty ohms is a standard value which grew out of fifty-odd years of two-way mobile radio. It's handy for several reasons. One is that a transmission line (connecting rig to antenna) can operate at low impedance, which gives it low operating voltage. The line can safely snake up to a roof or through the car trunk. Also, a standard mobile whip has an impedance of about 50 ohms and there's less of a matching consideration.

As you can see in Fig. 1, the main points for antenna matching start at the RF am-

# CB SIGNAL

plifier final. In this circuit there's a matching device between the output stage and the 50-ohm coaxial cable. The "matcher" is supplied inside the rig by the manufacturer and is usually adjustable by the buyer, but more on this in a moment. The circuit transforms high tube impedance down to the low value of the cable. The second "matcher" is shown as an optional component because, in many instances, coaxial cable hooks directly to the antenna. (Antenna makers also adhere to that 50-ohm value for input impedance of a CB antenna.) An optional matcher, however, could be used between the line and antenna. Some antennas (beams, for example) may need tuning, and accessory antenna matchers are sold for those who want to squeeze the last bit of energy out of the cable running to the antenna.

**Figure 1. Matcher transforms impedance of final RF amp to that of antenna. Optional matcher lowers Standing Wave Ratio (SWR) of voltage within coax cable. Tune both matchers for lowest SWR reading with field strength meter.**

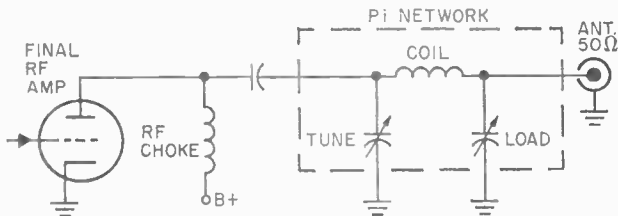
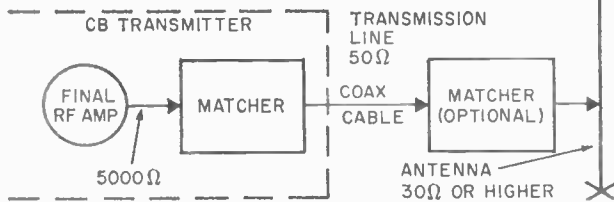

**Figure 2. Schematic of pi-type output impedance matcher found in tubed CB transceivers. Network has two jobs; matching antenna to final RF amp, reducing second-harmonic content in output signal. Adjust load capacitor for lowest SWR.**

**Got a Match.** Unless these major points are matched, maximum power cannot flow. For example, if a high impedance source directly feeds a low impedance load, there'll be a loss because the load acts to short-circuit the energy. If the condition is reversed—low to high connection—then the load can't absorb full power. Further, whenever a bad mismatch occurs, the system suffers "standing waves." These demons develop if power fails to be soaked up by the load. Signals reflect back to the transmitter and cancel part of the power.

Bad mismatch in a solid-state rig can

also blow the final transistors. This often happens as excessive voltages appear at transistor collectors and puncture the semiconductor material. Only through correct antenna matching will the 5-watt CB signal—weak enough to begin with—reach out for maximum range.

**Have Some Pi.** How designers accomplish matching from final amp to the line in a typical rig is shown in Fig. 2. It's the popular pi network formed by two variable capacitors around the final tuning coil. It permits an adjustable match between the tube and a reasonably wide range of impedances in the line. Impedance-transforming action occurs when the capacitors are varied and the output checked on a meter. You tune each control for maximum, being sure to repeat the adjustments several times back and forth to find the combination that produces best power output.

A similar circuit, found in transistorized circuits, is shown in Fig. 3; a double-pi network. The difference is that a tuning ca-

pacitor is joined by two coils with tunable slugs. The combination of components not only resonates the final amplifier to the desired output frequency (27 MHz) but transforms final transistor impedance down to that of the transmission line. A double-pi is used because it provides good opposition to the passage of second-harmonic signals from the final stage. These harmonics fall on 54 MHz and could cause considerable interference to TV channel 2.

In many instances, that's all the matching circuitry you'll find in a CB antenna system. Since line and antenna are each 50 ohms.

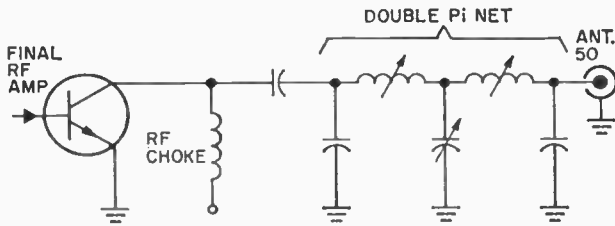

**Figure 3. Schematic of pi-type output impedance matcher found in solid state CB transceiver. As with network found in Fig. 2, double pi network not only lowers impedance of output signal, it also resonates final amp to output frequency on CB band.**

they connect directly together with no further matching. If the transmitter output adjustments are correctly done, the rig should be driving the antenna with maximum energy.

**The Meter Dead-out.** But are the matching controls properly adjusted? Manufacturers usually preset the rig's output controls for a 50-ohm load at the factory, but this might not be the precise value for your installation. The position of an antenna and cable may affect impedance so to be sure antenna adjustments are satisfactory, you'll need some touching up. Some rigs have output indicators (Fig. 4) which tell if the final is putting out maximum signal, but they read indirectly and could be misleading.

A field strength meter (Fig. 5) can more accurately reveal the effect of transmitter adjustments. It's actually a primitive receiver that gives steady indication of carrier strength. Try to place the meter as far as possible from the antenna while taking readings since it's possible to sense magnetic radiation from the antenna, and this energy doesn't contribute much to range. With the rig on, and the mike button keyed, tune the output controls (Fig. 6) for highest field strength. If you have a solid-state rig, don't turn any control more than a turn or so if there's no change in output. You don't want to risk a severe mismatch and possible damage to the semiconductors.

The field-strength meter suffices for tune-up, but an SWR (standing-wave ratio) meter will do an even better job. Its operation is based on the condition that when all components of the system are working at highest efficiency, SWR is lowest. The meter (Fig. 7) is inserted in the line and adjustments made for least SWR reading. When making these adjustments it's a good idea to also monitor relative output on the same meter (either reading is possible). You might mistake the controls enough to knock down RF output and believe efficiency is fine because of low SWR. A constant check on relative output prevents this error.

The SWR meter is also a handy trouble-

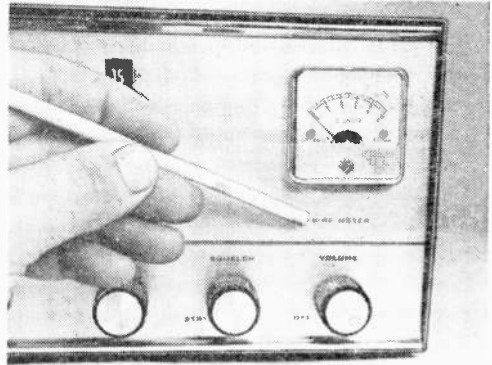

**Figure 4. Indirectly-read S/RF meter can't tell you output SWR. Tune up this kind of rig with aid of field strength meter (FSM).**

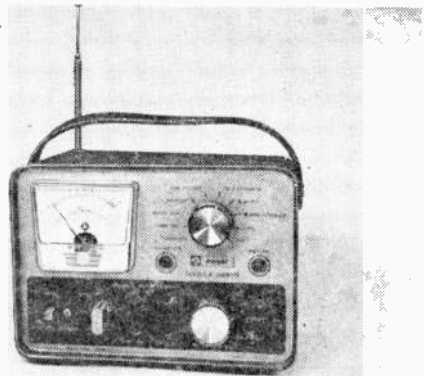

**Figure 5. This mini test lab checks health of entire CB rig from mike connector to antenna. Shown is Knight's Ten-2 CB Checker.**

shooter. If you develop a short circuit in an antenna element or transmission line, the SWR reading will shoot up and spell trouble. A perfect SWR ration is 1-to-1, but this is impossible in practical circuits. Anything below, say, 2-to-1 is acceptable and means that little power is wasted in the system.

**Before the Antenna.** There are a number of accessory antenna matchers on the mar-

# CB SIGNAL

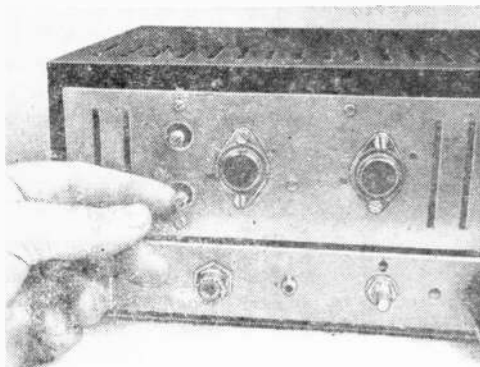

Figure 6. With your rig on, mike button depressed, adjust output loading, tuning controls for highest field, strength reading.

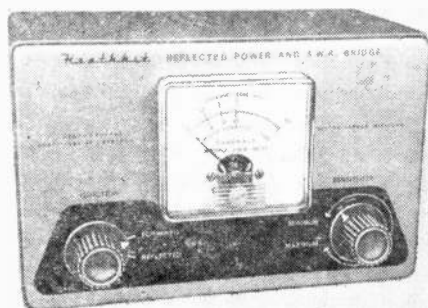

Figure 7. Keep tabs on your CB rig with Heathkit's Model AM-2 Reflected Power and SWR Bridge. Hams also find it useful.

ket and they can be installed by anyone who wants to squeeze the last milliwatt out of his rig (Fig. 8). They are similar to the matching circuits inside the CB rig: usually consisting of tuning capacitors and coils. The difference is that you can install a matcher at the point where the line connects to the antenna.

Inserting a matcher at the output of a transmitter shouldn't be necessary because matching adjustments are already provided by the manufacturer. A good spot for these external matchers is at the base of a mobile antenna (in the trunk, for example). The reason is that mobile whips are rated at 50 ohms, but the car's shape and the height of

the antenna may alter their value. In general, a whip suffers a mismatch because its impedance drops to below that of the coaxial cable when mounted on a car. A matcher can take care of this discrepancy by transforming impedances between line and whip until they agree. This is done by turning the matcher controls while observing either the RF output for maximum or for least SWR indication, as already described.

**Coaxial Cable.** There's a bit of controversy surrounding coaxial cable and how it's matched to the rest of the system. If you purchase the most popular cable—RG/58U—the manufacturer guarantees about 50

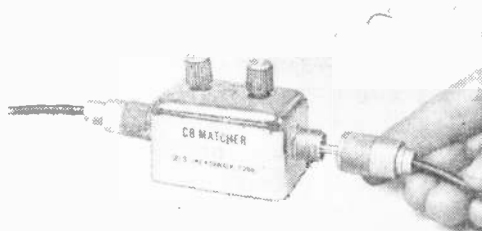

Figure 8. Think you can wring more power from your rig with an optional matcher? Here's one made by Gold Line.

ohms impedance. This is implicit in the cable's construction: its center wire and shield act electrically as a series of tiny distributed coils and capacitors. No matter where you cut the cable, it presents a 50-ohm value (at either end). For this reason, a transmission line doesn't have to be tuned or matched, but merely cut to any desired physical length.

Here's where the hassle begins. The cable is 50 ohms—but only if you connect it to 50-ohm devices at both ends. Unless your transmitter and antenna are each operating at 50 ohms, the cable is knocked for an electrical loop and runs at some other impedance. Standing waves created along the mismatched line rock those little coils and capacitors formed by the coaxial conductors. These problems should be cured when you tune the transmitter output controls, adjust the antenna (if possible in your model) or install an antenna-matching box.

Some authorities claim, however, that



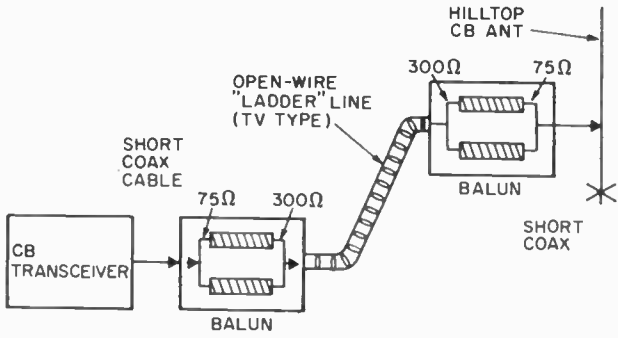

**Figure 9. Open wire lead-in offers CBer one distinct advantage. Signal losses with this kind of lead-in are very low—hundreds of feet of cable can snake between rig, antenna without CBER encountering extreme signal loss. Only problem with "ladder" line is problem of impedance matching; easily solved with balun coils terminating cable at both ends.**

cutting the coaxial cable to a specific length cures some of the loss from cable mismatch in a system that's less than perfect. The cure is based on the fact that a coaxial cable can function as an impedance-matching device when cut to an electrical half-wave length of the signal. To turn this into practical numbers, you'd cut the cable to 11 feet 10 inches—or any multiple of that figure if a longer run is required. The next two length possibilities, for example, would be 23 feet 8 inches, then 35 feet 6 inches. You may not enjoy sensational improvement from this trick, but it should do no harm, and possibly overcome a problem of poor transmitter loading into the coaxial cable because of mismatch.

**Over the Mountain.** The unfortunate CB operator who lives at the bottom of a box canyon or is hemmed in by tall obstacles can leap-frog out of his dilemma by another matching trick. This is the case where you want to run a very long cable to an antenna which clears the obstructions—on an adjacent hill or other high formation. If the run is less than about 200 feet, the easiest way out is to install RG/8U cable. It's 50 ohms, but it operates at less loss per foot than the RG/58U style. But if you must run hundreds of feet, it would probably be cheaper

to try another possibility. It's "open-wire" line; a ladder-like pair of conductors spaced about an inch apart by plastic insulators (the "rungs" of the ladder). This feeder type is sold for TV use on UHF channels because its loss is extremely low. Remember, though, the first limitation of open-wire feeders is that they must be insulated by standoffs all along the way (coax can run anywhere).

The other pitfall is impedance matching. These lines reduce loss by wide spacing and impedances of several hundred ohms. It means you can't connect the feeder directly to a CB rig or antenna since standard ratings are 50 ohms. Yet, if you must run open line to keep cost and losses down, you can transform impedance at either end and come up with a good match. It's done by "balun" coils that are sold for TV tuner repair.

The term "balun" derives from "balanced-unbalanced." These coils enable you to connect together unbalanced devices (CB rig and antenna) to a balanced device (the open-wire line). Secondly, the baluns provide about a four-to-one impedance transformation to allow these various devices to connect together with no mismatch. We experimented successfully with some inexpensive

*(Continued on page 90)*

**Figure 10. Tuning your CB transceiver for maximum watts per mile takes time, knowledge of test gear used. Here's complete test set-up—keep Field Strength Meter as far from antenna as is practicable.**

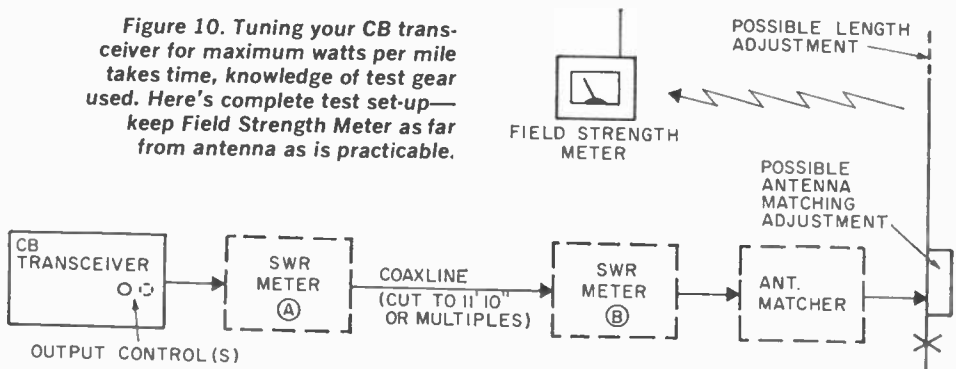

# FOREIGN TUBE REPLACEMENT GUIDE

Anyone who's gone past the tuning knob of a foreign-built shortwave receiver has discovered an unexpected twist or three—unorthodox-looking capacitors, metal-film resistors, possibly some outstanding point-to-point wiring. Another distinguishing feature of foreign electronic gear is tube designations, which often bear no resemblance whatever to those current in American circles. The following listing equates foreign tube types with their closest American equivalent. Though slight differences exist in some cases, in general any tube of a pair is directly interchangeable with its mate.

1C1	1R5	CV578	6A8	CV1938	6K6GT	DL91	1S4	KT32	25L6GT
1F3	1T4	CV580	6A8	CV1941	6K7	DL92	3S4	KT63	6F6G
1FD9	1S5	CV581	6C5	CV1943	6K7	DL94	3V4	KT66	6L6GC
1P10	3S4	CV585	6C6	CV1944	6K8	DL95	3Q4	KT71	50L6GT
1P11	3V4	CV587	6O7G	CV1946	6K8	DM70	1M3	KTW63	6K7
5B250A	807	CV589	6O7	CV1947	6L6GC	DP61	6AK5	KTW74M	12K7GT
6BK8	6267	CV591	6S17	CV1950	6L7	DY86	1S2	KTZ63	6K7
6C16	6BL8	CV614	75	CV1956	6N7GT	DY87	1S2A	L63	6J5GT
6D2	6AL5	CV617	80	CV1958	6N7GT	E2157	12A77	L77	6C4
6F22	6267	CV686	0C3	CV1959	50C5	E2163	12AU7A	LZ319	9A8
6F29	6EH7	CV692	024	CV1961	12AU6	E2164	12AX7A	LZ329	9A8
6F30	6E17	CV697	12S17	CV1969	6SC7	EB34	6H6	M8212	5726
6FD12	6DC8	CV717	5R4GYB	CV1970	6SC7	EB91	6AL5	N16	3Q5GT
6G5G	6U5G	CV728	5V4GA	CV1978	6SG7	EBC90	6AT6	N17	3S4
6H5	6U5G	CV753	1A3	CV1981	6SK7	EBC91	6AV6	N18	3Q4
6L12	6AQ8	CV755	1A5GT	CV1985	6SL7GT	EBF89	6DC8	N19	3V4
6L13	12AX7	CV756	1A5GT	CV1988	6SN7GTB	EC90	6C4	N148	7C5
6M1	6U5G	CV782	1R5	CV1990	6SQ7	EC97	6FY5	N379	15CW5
6P15	6B05	CV783	1S4	CV2129	5763	ECC32	6SN7GTB	N709	6BQ5
6P12	6BM8	CV784	1S5	CV2500	35Z4GT	ECC81	12A77	N727	6AQ5A
12D77	12AX7	CV785	1T4	CV2514	43	ECC82	12AU7A	OM10	6K8
13D2	6SN7GT	CV797	2D21	CV2524	6AU6A	ECC83	12AX7A	PCF80	9A8
30C1	9A8	CV818	3Q4	CV2526	6AV6	ECC85	6AQ8	PCF82	9UBA
30P18	15CW5	CV819	3Q5GT	CV2747	6U5	ECC88	6DJ8	PCF801	8G17
30PL12	16A8	CV820	3S4	CV2901	6267	ECC91	6J6A	PCL82	16A8
63ME	6U5G	CV850	6AK5	CV2975	6BQ5	ECC189	6ES8	PCL84	15DQ8
150C2	0A2	CV858	616A	CV2984	6080	ECC230	6080	PL84	15CW5
150C3	0D3	CV877	7A7	CV3523	6146A	ECF80	6BL8	PL500	27GB5
B36	12SN7GTA	CV885	7C5	CV3908	6BH6	ECF82	6U8A	PM04	6BA6
B65	6SN7GTB	CV887	7C6	CV3909	6BJ6	ECF86	6HG8	PM05	6AK5
B152	12A77	CV901	7Y4	CV3912	1U5	ECH35	6K8	QV03-12	5763
B309	12A77	CV918	12K7GT	CV3998	6688	ECL82	6BM8	QV05-25	807
B329	12AU7A	CV924	12SL7GT	CV4007	5726	ECL85	6GV8	QV06-20	6146
B339	12AX7A	CV925	12SN7GTA	CV4009	5749	ECL86	6GW8	R52	5Z4
B719	6A08	CV1186	6F6G	CV4012	5750	EF86	6267	STV150/30	0A2
BPM04	6AQ5A	CV1287	25L6GT	CV5041	6CL6	EF93	6BA6	U51	5Y3GT
CV124	807	CV1347	6K8	CV5042	12BH7A	EF94	6AU6A	U52	5U4G
CV133	6C4	CV1377	5AR4	CV5072	6CA4	EF95	6AK5	U70	6X5GT
CV140	6AL5	CV1633	3V4	CV5073	6AM4	EF183	6EH7	U74	35Z4GT
CV283	6AL5	CV1741	6CA7	CV5074	6AF4A	EF184	6E17	U76	35Z4GT
CV452	6AT6	CV1800	1A7GT	CV5215	6BL8	EH90	6CS6	U78	6X4
CV453	6BE6	CV1802	1A7GT	CV5307	807	EK90	6BE6	U147	6X5GT
CV454	6BA6	CV1818	1H5GT	CV5331	6ES8	EL34	6CA7	U709	6CA4
CV455	12A77	CV1820	1H5GT	CV5358	6DJ8	EL84	6BQ5	UU12	6CA4
CV491	12AU7A	CV1823	1N5GT	CV5365	6BQ7A	EL90	6AQ5A	VFT6	6U5
CV492	12AX7A	CV1831	2A3	CV5434	6FG6	EM84	6FG6	W17	1T4
CV493	6X4	CV1832	0A2	CV5810	6E17	EN91	2D21	W63	6K7
CV504	6U5	CV1833	0B2	CV5831	6EH7	EZ35	6X5GT	W76	12K7GT
CV509	6V6GTA	CV1856	5Y3GT	D63	6H6	EZ80	6V4	W727	6BA6
CV511	6V6GTA	CV1862	6AQ5A	D77	6AL5	EZ81	6CA4	X14	1A7GT
CV522	7B7	CV1863	524	D152	6AL5	EZ90	6X4	X17	1R5
CV525	12A6	CV1870	6A7	DAC32	1H5GT	GZ30	524	X61M	6K8
CV543	12SK7	CV1893	6B8	DAF91	1S5	GZ31	5U4G	X63	6A8
CV544	12SK7GT	CV1900	6D6	DD6	6AL5	GZ34	5AR4	X65	6K8
CV546	12SQ7	CV1906	6E5	DF33	1N5GT	HBC90	12AT6	X77	6BE6
CV547	12SQ7GT	CV1911	6F6G	DF91	1T4	HBC91	12AV6	X147	6K8
CV553	25L6GT	CV1928	12BA8	DH63	6Q7	HD14	1H5GT	X727	6BE6
CV562	35L6GT	CV1929	6H6	DH77	6AT6	HF93	12BA6	Y61	6U5
CV564	35Z3	CV1931	6H6	DH118	14L7	HF94	12AU6	Y63	6U5
CV571	50L6GT	CV1932	6J5GT	DH149	7C6	HK90	12BE6	Z14	1N5GT
CV572	6X5GT	CV1934	6J5GT	DK32	1A7GT	HL92	50C5	Z63	617
CV574	6X5GT	CV1935	6J7	DK91	1R5	HM04	6BE6	Z729	6267
CV575	5U4G	CV1937	6J7	DL33	3Q5GT	HY90	35W4	ZD17	1S5

# POP-UP TV MAKES THE SCENE

**TV**'s big eye can bug the decor out of any room setting. The Mrs. spends considerable time and your hard cash to make the living room or play room an attractive area for the family to meet, entertain and be entertained. But the big ugly eye scans the scene even when not in use. So, H. L. Miller of Sarasota, Florida tells his TV to bug out.

It is easy to do provided you take the pains. Mr. Miller cut a hole in the top of his hi-fi console and installed a movable platform that goes up and down at the press of a button. Guide rails eliminate the shimmy and shake as the TV is raised and lowered on the platform. A fractional horsepower motor does the work by turning a drum that winds or unwinds a pulley system.

A limit switch at the top and bottom travel position of the platform turns off the motor automatically reversing it for the next trip. No modifications are required on the TV whatsoever—just be sure to leave enough slack in the power cord and antenna lead-in wire. Also, the platform trips an on/off power switch that controls the juice to the TV. Think of pop-up TV the next time you want to say, "Bye-bye," to the big eye!

By Emmett Fluffin

## Something for everyone

*Continued from page 9*

burn-resistant neoprene cord set, stainless steel element, solid state control and iron-clad tips. Suggested net price of Model 540 with one tip is under \$8.00. For more information, write to Enterprize Development Corp., 5127 E. 65th St., Indianapolis, ID 46220.

### Stereo Generator

Precision and stability are the important features of the Model LSG-231 Multiplex Stereo Generator introduced by Leader Instruments Corporation. The LSG-231 has a pilot signal frequency of 19 kHz with  $\pm 2$  Hz accuracy. The 1 kHz audio signal is accurate to  $\pm 1\%$ . Signal separation is rated at 50 db with output voltage at 0 to 3 V rms continuously

variable. Specifically useful in the field or on the workbench, this new product offers such high reliability that many technicians may not find it necessary to use a scope. It is easy to

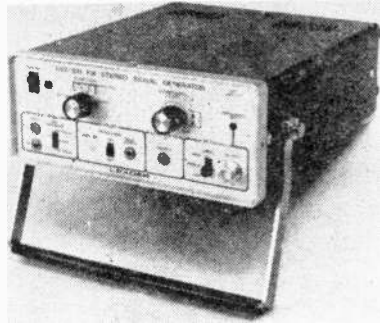

operate, compact and complete with a handy tilt stand. The LSG-231 is priced at \$229.95. For all the facts circle No. 39 on Reader Service Page. ■

## CB Signal All Put Out

*Continued from page 87*

Saxton Model BC-2 baluns ordered from Lafayette Radio-Electronics. If you try these coils, use the following schematic, supplied in the coil package: "Circuit A—75 ohm to 300 ohm". One pair of coils connects the 75-ohm side to the CB transmitter; the second pair connects the 75 ohms to the antenna base. (Although 75 ohms is specified, the coils operate at very low SWR at CB's 50 ohms.) See Fig. 9 on page 87.

**It's Round Up Time.** Finally, whatever

matching technique or adjustment you follow in your CB rig, don't run the "ratio race". Although standing waves should have the lowest ratio indicated on an SWR meter inserted in the transmission line, anything below 2-to-1 is all you need for good signals on both transmitting and receiving sides. An overall look at the major matching points is shown in Fig. 10 on page 87.

Antenna matching is a must for CBers. Admittedly you can transmit far beyond 150 miles on 5-watts input to your rig's final, but, far too many stations can't get past the next hill because their radiated RF is used to heat up the coax line. Get with it and match up! ■

## Superheterodyne

*Continued from page 70*

of 8455 kHz, which places it exactly in our IF signal ball park. But note that a second station—a pop fly on 8910 kHz—also happens to be 455 kHz away from the local oscillator. For each oscillator frequency, now there are two station frequencies giving identical IF frequencies. It's up to your receiver to strike out the image station. Otherwise, the RF ball game will turn into a rout!

You might expect the receiver's antenna tuning circuit to completely reject the image signal. After all, it's supposed to be tuned

*(Continued on page 92)*



## READER SERVICE PAGE

• The Editor of RADIO-TV REPAIR — 1972 ISSUE offers readers an easy way to get additional information about products and services advertised in this issue. To become proficient in your home and repair projects you must obtain the correct quality parts, knowledge, test gear, tools and many other items. Become a knowledgeable buyer by obtaining information on the products and services mentioned in this issue and keyed with a Reader Service Number, it's yours for the asking. Just follow the instructions below and the literature you requested will be sent to you promptly and at no cost. It will be a pleasure to serve you.

• The coupon below is designed for your convenience. Just circle the numbers that appear next to the advertisement or editorial mention that interests you. Please limit your selections to 20 or less. Then, carefully print your name and address on the coupon. Cut out the coupon and mail to RADIO-TV REPAIR, Box 886, Ansonia Station, New York, N.Y. 10023. Do it today!

Mail Coupon to: **This offer expires September 30, 1973**

### RADIO-TV REPAIR

Box 886 Ansonia Station, New York, N.Y. 10023

• Okay, I want some information and I want it fast. Please arrange to have the literature whose numbers I've circled at right sent to me as soon as possible. I understand this is a free service; however, I must limit the circled items to 20.

1	2	3	4	5	6	7	8
9	10	11	12	13	14	15	16
17	18	19	20	21	22	23	24
25	26	27	28	29	30	31	32
33	34	35	36	37	38	39	40
41	42	43	44	45	46	47	48

Name \_\_\_\_\_

Address \_\_\_\_\_

City \_\_\_\_\_ State \_\_\_\_\_ Zip \_\_\_\_\_

(Continued from page 90)

generate a very high IF frequency, positioning any images developed by the mixer well outside the tuning range of the antenna circuit. Looking at our example of a double superhet, you'll see one IF amplifier perking at 5000 kHz and another working on 455 kHz. Now if we receive an incoming signal on 8000 kHz, the local oscillator, now called a high-frequency oscillator, generates a frequency at 13,000 kHz, so the first IF signal works out to 5000 kHz. Your receiver would have to pick up a signal falling on 18,000 kHz to produce any image. Naturally, the image frequency in this instance is significantly removed from the antenna circuit, so the image is greatly attenuated.

While high IF frequencies work well against image interference, they also revive Nagging Problem Number One: the higher the frequency of a tuned circuit, the poorer its selectivity. Since this situation also applies to IF stages, a *second* conversion is required, bringing the first IF signal down to 455 kHz, where we can sharpen our receiver's selectivity curve. That's how the double-conversion receiver solves both image and selectivity hassles. Any ham or

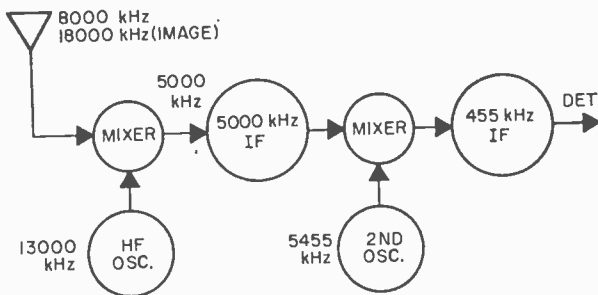

**Any superhet worthy of warming an amateur shack works around image problem with dual conversion. Combination of IFs puts image out of range of either stage.**

SWL rig worthy of an on/off switch is sure to have this feature. But don't think of dual conversion as a receiver cure-all.

Dual conversion is *not* usually found in entertainment receivers—radio broadcast and TV for example, because it's too sharp! High selectivity could easily slice away sidebands in an FM stereo program and kill its multiplexed channel, or rob a TV image of its fine picture detail.

But for all its faults, the basic superhet circuit we've been talking about must be doing something right. Last year over 50 million superhets were sold in the U.S. Not bad for a circuit that might have gone the way of the hip flask, eh? ■

## When Color Won't Stay Put

Continued from page 58

compares burst and 3.58 oscillator frequencies and creates the DC correction voltage.

But for comparison action to occur, the diodes in the Phase Detector must be electrically balanced, even when no burst is present. This provides a basis for a simple test. First, place a shorting jumper from grid to ground of the Burst Amp, as shown. This kills any incoming burst which would disturb the test.

Then place a VTVM across the plate of the Phase Detector and to ground. If your circuit is typical of many, you should read approximately  $-28$  VDC at this point. Next measure the diode cathode to ground for a reading of  $+28$  VDC. Voltages in different circuits may vary, but the important feature is that they are typically equal and opposite.

This is a good indication of proper balance in the stage. Resistors and capacitors should be checked if voltages are unequal.

**O.K. Phase.** If there's good voltage balance in the Phase Detector, shift attention to the Burst Amplifier. Voltage and resistance checks here stand a good chance of revealing the trouble. If you can't pinpoint the culprit, perhaps the incoming burst signal isn't reaching the Burst Amp.

We've shown the source of the burst in Fig. 11. Note that it's from a tap-off point from the Color Amp. If any components between this point and the grid of the Burst Amp are defective, there could be an interruption of the burst signal. So check resistors, capacitors, or coils in this part of the circuit. If you're getting color on the screen, even if it's out-of-sync, chances are the other stages shown in Fig. 11 are functioning. Explanation for this fact is that the color signal must traverse those stages in order to reach the picture tube.

Thus, with little more than a VTVM and a jumper wire, you should be able to track down most troubles in color sync circuits. The simple tests described help locate the general area, or even a particular stage that's upsetting color stability.

If you run into an exotic problem that won't yield to these tests, chances are you'll

need an oscilloscope to examine actual signals in transit through color-sync stages.

A typical schematic by RCA is illustrated in Fig. 12. Note that the scope waveforms seen at the bottom correspond to numbered points in the diagram. Both the shape of wave and its P-P (peak-to-peak) voltage are given for comparisons. ■

## CTS Futura V

*Continued from page 47*

the top to spread the highs which are more directional and, require top billing.

A crossover network is mounted on the rear panel. Note that the coils are large and are wound with heavy wire, so connections can be simply twisted and soldered; there's no need for terminal strips or fancy lead dress.

When everything is mounted and connected, you simply fill the enclosure with loose-packed fiberglass (the type used for house insulation will do), screw in the back, and the speaker is ready for use. If you intend to finish the cabinet we suggest you get everything assembled for a trial run. If all is okay, remove the components before the final finishing operations. No useful purpose is served by loading speaker cones with sawdust, varnish or stain!

Both the honker and tweeter level controls have a full off-to-on range, so just about any degree of midrange and high frequency performance can be user adjusted—unlike many commercial speaker systems with

*brilliance* and *brightness* controls that have a limited adjustment range.

**Listener's Report.** Our listening panel judged the finished system—in the cabinet we built from scratch—to have a good “console” sound, comparing favorably or even better than the systems supplied in many high-cost complete equipment consoles. The low end goes down low enough for a full, rich sound, but not so low to produce an annoying rumble from low cost turntables or record changers.

The overall sound quality is well suited for modern sounds; the *hard* midrange sound being well suited to rock, soul and folk music. The wide range of honker and tweeter level adjustments proved particularly good at adjusting the overall sound to match what each listener considered optimum for modern music.

The Futura V speaker system is rated at 8 ohms so it can be used with just about every solid-state and tube-type amplifier made. It can even be used to improve the performance from portable phonographs and compacts.

For additional information circle No. 46 on the Reader Service Coupon on page 13 or 91. ■

## Save Big Money

*Continued from page 16*

and you have an extra \$20 or so in your pocket.

Of course, the question comes up: “What happens if my tuner is just beyond repair?” Such an instance is rare, but if it happens the professional repair service will tell you so and will generally offer you a brand new tuner replacement for about \$5 additional; a lot cheaper than you'll get from a TV repair shop.

Rebuilt or all new, doing your own tuner repairs keeps lot of extra money in your pocket. ■

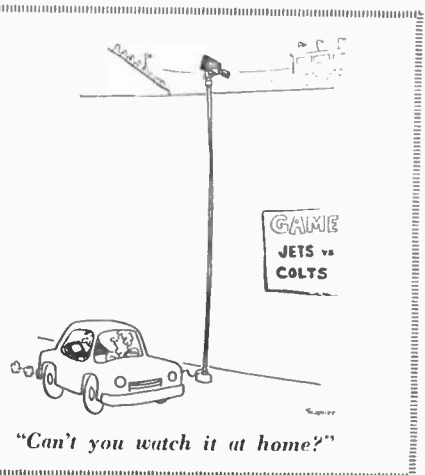

# CLASSIFIED Market Place

FOR BIGGER PROFITS! NEW CAREER OPPORTUNITIES!  
READ AND REPLY TO THESE CLASSIFIED ADS

Classified Ads 65¢ per word, each insertion, minimum 15 words, payable in advance. For information on Classified ads—to be included in our next RADIO-TV REPAIR—write to R. S. Wayner, Mgr., Classified Ad Dept. 229 Park Avenue South, New York, N.Y. 10003.

## ADDITIONAL INCOME

TELEPHONE Reporters needed immediately. Set own fees. Enjoy prestige. Information \$2.00. Dollarsavers. Ten Paddock, Hudson, New York 12534.

FORTUNES IN MAIL ORDER. Start part time. Unlimited Potential. Details \$1.00. Shopper, Box 4198D, South Daytona, Florida 32021.

## AGENTS WANTED

SELL: Personalized, Colored, Social Security Plates, Choice of Fifty-nine Emblems! Big Profits! Free Sample! DRS Specialties, Dept. 201C, 73 Hunter Place, Pompton Lakes, New Jersey 07442.

## AUTHORS SERVICE

PUBLISH your book! Join our successful authors: publicity advertising promotion, beautiful books. All subjects invited. Send for free manuscript report and detailed booklet. Carlton Press, SMH, 84 Fifth Avenue, New York 10011.

## AUTO PARTS & ACCESSORIES

AMAZING new, Chemically Impregnated auto cloth does over 50 car cleanings—using no water. Guaranteed. \$2.98. AR-NOR, 20 Bulwer Place, B'klyn, N.Y. 11207

## BOOKS & PERIODICALS

WIRETAPPING—National scandal—your privacy invaded. Free brochure. Don-O, Box 548, Seattle, Wash. 98111.

FREE Catalog of Amplifiers, Inverters, Burglar Alarms, Car Accessories, Etc. Write: CPA Radio, 2115 Norris Canyon Road, San Ramon, Ca. 94583.

8000 THINGS. Use any kind scrap. Illustrated book, \$2.95. Variety Mart, Box H331, McKeesport, Penna. 15134.

1973 HOBBY ELECTRONICS DIRECTORY Hundreds of companies, products, and services. Parts, test equipment, surplus, plans, kits, and more. \$1.50 Newcal Enterprises, Box 323-D, El Segundo, Cal. 90245.

## BUSINESS OPPORTUNITIES

I made \$40,000.00 Year by Mailorder! Help others make money! Start with \$10.00—Free Prof! Torrey, Box 318-T, Ypsilanti, Michigan 48197

1000% PROFIT Bronzing Keepsakes. Free Literature. NBC, Box C-4-0, Coral Springs, Florida 33065

FREE BOOK "999 Successful, Little-Known Businesses" Work Home! Plymouth P3, Brooklyn, New York 11218

MAKE Money. Full or Spare time your choice of home income Producing Businesses. Free List low cost books. Health, Wealth, Happiness, Brokwa's Country Corner, Dept. 23, Route 3, Marengo, Ohio 43334.

## BUSINESS OPPORTUNITIES—Cont.

HERBALISM! The home gold mine! Free lesson. Herbalism Institute-D. 1339 Remuda, Glendora, Ca. 91740.

MAKE Magnetic Signs, Big profits. Details. Universal, Lenora, Kansas 67645.

ADDRESSERS and Mailers needed. Details 10¢ Lindbloom Services. 3636 Peterson, Chicago 60659.

FREE—Wholesale Catalog and Sales Plan. JAM Enterprises, 3100M Liberty Avenue, Pittsburgh, Pa. 15201.

MAILORDER BEGINNERS LIBRARY. Proven Moneymaking Publications. Literature 25¢. Refundable. HOW, Box 4457 HW3, Downey, Ca. 90241.

GET Rich fast. Retire young. Free report and proof. Send Self-addressed stamped envelope. Morgan, Box 25053-AAB, Los Angeles, California 90025.

AMAZING Profit on Government Surplus. Send 75¢ today! Leskens, 1709 West Miner, Arlington Heights, Ill. 60005.

\$1000 MONTHLY from your own home. Write: Jordan, 27495 Road 176, Dept. DC1, Exeter, Calif. 93221.

COMPLETE MAILORDER BUSINESS COURSE \$10.00. Information SASE. Raymond Brooks, 7147D, St. Petersburg 33734.

## DO-IT-YOURSELF

PROJECTION TV—Convert your portable to SEVENTY INCH TV projector for under \$10.00 Free details: Macrocoma, Dept. SMC, Washington Crossing, Pennsylvania 18977.

DISCOVER how to avoid calling the serviceman. Save by servicing home equipment yourself. Send \$1.25 for magazine. RADIO-TV REPAIR—229 Park Avenue South, New York, New York 10003

SOLID STATE & HOBBY CIRCUITS MANUAL. \$1.95 postpaid to your door. The new Manual HM 91 offers over 400 pages of circuits for the hobbyist, engineer, experimenter and do it yourself kit builder HURRY—Supply limited. Free catalog. FRAZER & ASSOCIATES, 3809 Surtwood Rd., Malibu, Calif. 90265.

APPLIANCE REPAIR BOOKS. Written in easy-to-understand language by experts in the service field with illustrations and diagrams! Acclaimed by instructors and professionals alike! How to diagnose and repair refrigerators, air conditioners, washers, dryers, tanagers, dishwashers, vacuum cleaners, motors, water heaters, coffeemakers, hair dryers, food mixers, can openers electric irons, floor polishers and many others. Also fundamentals of solid state, setting up a shop, using test equipment and a lot more. Only \$2.65 to \$4.90 each! Free price list. C & N, 5841 Montrose, Chicago 60634.

## EDUCATION & INSTRUCTION

UNIVERSITY Degrees By Mail, Free Information, Norman, Dept. 63, Box 3199, Pasadena, California 91103.

LIFETIME Ordination D.D. Charters, Details 25¢. Life Science, 2207 Cardinal, Rolling Meadows, Illinois 60008.

## FARMS, ACREAGE & REAL ESTATE

GOVERNMENT LANDS—Low as \$125 Acre! Buy, lease or homestead—Free Details! LANDS DIGEST, Box 1555-JC, Tacoma, Washington 98401.

## FOR VETERANS

COLLECT \$1,000's in G.I. benefits, services! WW-II, Korean, Vietnam veterans still qualify—even 30 years after discharge! Details, 25¢. Viscount, Box 620-D, N.Y., N.Y. 10003.

## GIFTS THAT PLEASE

FREE Illustrated Gift Catalog. Irving Dunn, Old Turnpike, Woodridge, N. Y. 12789.

## HOME WORKSHOP SUPPLIES

25 WEEKEND BUILD-IT PROJECTS—Practical designs for home/shop buffs who enjoy working with wood, tools, materials and techniques. Send \$1.00 for your copy (includes postage) to Davis Publications, Inc., 229 Park Avenue South, New York, New York 10003.

## HEARING AIDS

HUGE SAVINGS! BUY DIRECT! Eliminate dealer markups, 20 days FREE Trial. Terms arranged. No salesman will call. LLOYD'S-79, Rockford, Illinois 61108.

## INVENTIONS WANTED

WE either sell your invention or pay cash bonus. Write for details Universal Inventions, 298-3, Marion, Ohio 43302

## MAIL-ORDER OPPORTUNITIES

100% PROFIT. SETL SECURITY products by mail. Details, samples free. CSA, Dept. 2A, Box 12177, Dallas, Texas 75225.

## MONEYMAKING OPPORTUNITIES

MAKE BIG MONEY raising Chinchillas, Cavies, Rabbits for us. Catalog 25¢. Keeney Brothers, New Freedom, Penna. 17349.

START small, highly profitable electronic production in your basement. Investment, knowledge unnecessary. Postcard brings facts. Barta-SME, Box 248, Walnut Creek, California 94597.

THERE IS NO CHARGE FOR THE ZIP CODE — PLEASE USE IT IN YOUR CLASSIFIED AD



# CLASSIFIED MARKET PLACE—Cont.

## MONEYMAKING OPPORTUNITIES— Con't.

**MAKE MONEY** Writing Short Articles at Home. Begin Immediately! Copyrighted Report Reveals How and Where. Send \$1.00. Jay-Bees Enterprises, Dept. F, 12 New York Avenue, Bergenfield, New Jersey 07621.

**INCOME** Guaranteed raising Chin-chillas at home, 25¢. Chinchilla, 11 DCC, Port Richey, Florida 33568.

**BANISH** unemployment fears forever. Start now to make steady profits from tiny investments. Amazingly easy. See "An Independent Income for Beginner's in Low Priced Stocks." \$2.98 postpaid S. D. Rush Company, 306 Ramona Place, Costa Mesa, Calif. 92627, No C.O.D.s.

Make Your Classified Ad Pay. Get "How To Write a Classified Ad That Pulls" Includes certificate worth \$2.00 toward classified ad in S & M. Send \$1.25 (includes postage) to R. S. Wayner, Science & Mechanics, 229 Park Ave., South, New York 10003

## OF INTEREST TO WOMEN

\$25.00 DAILY Possible addressing-stuffing envelopes Typewriter-longhand, also Clipping News items at home. Information: Send stamped addressed envelope Ane-7, Box 310, Le Mars, Iowa 51031.

## PERSONAL

**ELIMINATE** Debts Without Borrowing! Particulars 25¢. Helper, Box 9308, No. Hollywood, California 91609.

**ORIENTAL** introductions! Photographs, descriptions, questionnaire, brochure, details, \$1.00. INTER-PACIFIC, Box 30 SC, Birmingham, Michigan 48012.

**DON'T DIE WITHOUT A WILL!** BLANK WILL FORM PROTECTS YOUR FAMILY. Only \$1.98—guaranteed! Order today! Warnock, 116 Williams, Winder, Georgia 30680.

**LONELY?** Find Your Lifemate! Nationwide Datematching. Details \$1.00—ELITE, Box 64, New York City 10019.

## PHOTOGRAPHY—PHOTO FINISHING

Make your own S & M Denstometer. Send \$3.00 for detailed drawings and instructions. A must for successful photography in your darkroom. Order direct from S & M Instruments, Dept. TV3, 229 Park Avenue South, New York, New York 10003

## RADIO & TELEVISION

**HEAR POLICE FIRE** Dispatchers, catalog shows receivers; exclusive directories of "confidential" channels. Send 8¢ stamp Communications, Box 56-DA, Commack, New York 11725.

## RADIO & TELEVISION—Con't.

**TV TUBES** 36¢ each. Send for Free 48 page color catalog. Cornell, 4217-W University, San Diego, California 92105.

## REMAILING SERVICE

**RECEIVING** - Forwarding - Remailing, monthly rates, Nortex, Drawer 430, Weatherford, Texas 76086.

**ST. PETERSBURG, Florida, Branch** 25¢. rate information SASE, Raymond Brooks, 7147D 33734.

## SONGWriters

**SONGS, POEMS WANTED!** For publishing, recording at our expense! TALENT, 17-HW Longwood Road, Quiney, Massachusetts 02169.

## SPECIAL SERVICES

**INFORMATION ON anything!** Authoritative! \$2.00 (deductible). Metzler Research, Box 220631M, Long Island City, New York 11102.

## TIPS FOR THE HOME, ETC.

**PRACTICAL tips** for home, garden and workshop are in "1001 How-To Ideas." Send \$1.25 for your copy includes Postage, to 1001 How-To Ideas, 229 Park Avenue South, New York, New York 10003

## FOR GREATER CLASSIFIED PROFITS, RESULTS AND SAVINGS

Place your ad in one of our SPECIAL COMBINATIONS: Business, Science & Mechanics, or Davis Combination. Each Combination is designed to give you the largest audience available. For further information write to: R. S. Wayner, Manager, Classified Advertising, Science & Mechanics, 229 Park Avenue South, New York, N.Y. 10003.

## Service Shop Tips

(Continued from page 14)

*anometer is. What is it?*

—K.G., Denver CO

First, the metric system is not new. In fact, our founding fathers came to within one centimeter of adopting it over the English system for use in the U.S. Second, a myriameter equals 10 kilometers or 10,000 meters. I never heard of it until you mentioned it. Chances are, it will not get into common usage.

**How Many Watt?**

*How many watts equal one horsepower?*

—V.P., Washington DC

745.7 watts.

**Skylook Gain**

*How can a CB antenna increase the wattage of a CB rig?*

—J.M., Raritan NJ

Your question is the type I would have asked when I started in electronics. After all, how can a few pieces of wire amplify a signal? Actually, Jim, the antenna gathers the signal that would be scattered all over and beams it into a general direction. This characteristic puts more signal in a given direction than there

would be normally. Hence, the antenna has a gain of so many times what it would be if it were not directional. Antenna gain is great provided you want the directional quality.

**Inflation—Phase 3**

*Does a CB license cost \$25?*

—L.T., Estes Park CO

The price is only \$20, but the inside talk is a boost in the works.

**Black Light**

*I want to experiment with ultra-violet light. Where can I get parts and materials?*

—A.G., Smithers, B.C.

Write to Edmund Scientific at Dept. JM, 300 Edscorp Bldg., Barrington NJ 08007. They have an advertisement in this issue for their catalog, which, by the way, lists many ultra-violet supplies.

**Newsstand Buyer**

*Okay, where can I get a Fall/Winter 1972 COMMUNICATIONS WORLD? I've checked all the newsstands in my area.*

—A.M., Farmington CT

No where! We didn't publish one last year. However, look for two issues in 1973. In fact, if you can't find a copy on your newsstand today, write to the Publisher of this magazine and enclose \$1.25. ■

## Photographing TV

*Continued from page 24*

images in your movies will be somewhat bluish, but will certainly be acceptable. Your camera manual will tell you how to move the No. 85 filter out of the light path in the camera.

If you have a super 8 camera, you can



Expensive equipment is nice but not necessary. Ordinary fixed focus camera is fine for photographing live-from-the-moon TV at home from large-screen set.

use a high-speed black-and-white movie film—Kodak Tri-X Reversal Film 7278—ASA 200. Your photo dealer may have to order this film for you. Although some cameras are not designed to expose this film properly under normal lighting conditions, most cameras will give satisfactory exposure for movies of television programs. To make movies on this film, you can leave the TV brightness control at its normal setting. If you have a manually adjustable camera, try a lens opening halfway between  $f/2.8$  and  $f/4$  for both black-and-white and color television.

**A New QSL Idea.** Here's a good idea which will pay off rich rewards in the future. Collect autographed pictures of people who will soon become famous. Photograph first-year professional athletes while they are competing in a game. Send a print to the player addressed to care of the player's club. You'll receive an autographed photo with a personal note, in most cases. Imagine snapping Willie Mays twenty years ago. Don't shoot superstars—they have too much mail to answer. Results will be poor. ■

### EXPOSURE TABLE

(Suggested Camera Settings for Pictures of Television Images)

Film (Use)	Black-and-White Television Set		Color Television Set	
	Leaf-Type Shutter	Focal-Plane Shutter	Leaf-Type Shutter	Focal-Plane Shutter
Verichrome Pan Plus-X Pan (Black-and-White)	1/30 sec f/4	1/8 sec f/8	1/30 sec f/2.8	1/8 sec f/5.6
Tri-X Pan (Black-and-White)	1/30 sec f/5.6-8	1/8 sec f/11-16	1/30 sec f/4-5.6	1/8 sec f/8-11
Kodacolor-X (1) (Color Prints)	1/8 sec f/2.8	1/8 sec f/2.8	1/4 sec f/2.8	1/4 sec f/2.8
Kodachrome-X (1) Ektachrome-X (1) (Color Slides)	1/15 sec f/2		1/8 sec f/2	1/8 sec f/2
High Speed Ektachrome (1) (Daylight)—with Normal Processing ASA 160 (Color Slides)	1/15 sec f/2.8-4	1/8 sec f/4-5.6	1/8 sec f/2.8-4	1/8 sec f/2.8-4
High Speed Ektachrome (1) (Daylight)—with ESP-1 Processing for a Speed of ASA 400 (Color Slides)	1/30 sec f/4	1/8 sec f/8	1/30 sec f/2.8	1/8 sec f/5.6

NOTE: When two lens openings are given, such as  $f/4-5.8$ , lens setting is midway between these stops.

(1) Pictures of color television taken without a filter will look blue-green. With the color films in the table, you can use a Kodak color compensating filter, CC40R, over your camera lens to help bring out the reds in your pictures. Increase the exposure suggested in the table by 1 stop.

# RCA Institutes Home Training may be your best investment for a rewarding career in electronics:

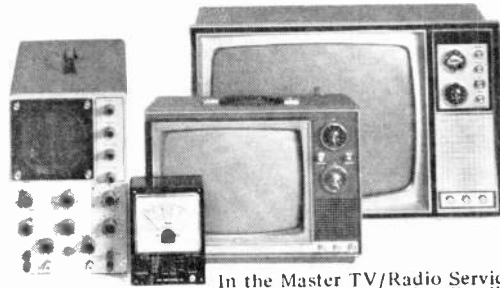
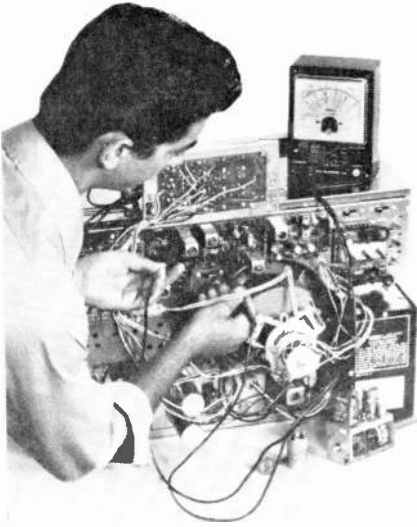

In the Master TV/Radio Servicing Program, you build and keep the all solid-state black and white TV set, the color TV set, the oscilloscope and multimeter shown above.

## 1 LEADER IN ELECTRONICS TRAINING

For over half a century, RCA Institutes, Inc. has been a leader in resident school technical training in electronics, and for many years, it has offered home study training in electronics.

## 2 RCA AUTOTEXT TEACHES ELECTRONICS RAPIDLY, EASILY

Beginner or refresher—"AUTOTEXT," RCA Institutes' own Home Training method helps you learn electronics rapidly, easily.

## 3 WIDE CHOICE OF CAREER PROGRAMS

Select from a wide choice of career programs, each of which starts with the amazing "AUTOTEXT" method of programmed instruction. Check over the attached card.

## 4 CASSETTE SYSTEM

An exciting concept - It's almost like having an instructor right in your home.

## 5 PERSONAL SUPERVISION THROUGHOUT

All during your program of home study, your exams are reviewed and commented upon and questions answered by RCA Institutes instructors personally involved in your efforts and ready to help you over any "rough spots" that may develop.

## 6 HANDS-ON TRAINING

To give practical application to your studies, a variety of valuable kits is included in many programs. In RCA's Master TV/Radio Servicing Program, you actually build and keep an all solid-state black and white TV set, and a color TV set. You also construct an oscillo-

scope and multimeter which are yours to keep and use on the job.

## 7 FCC LICENSE TRAINING - MONEY-BACK AGREEMENT

RCA Institutes' money-back agreement assures you your money back if you take and fail to pass the FCC exams within 6 months after completing the course.

## 8 CONVENIENT PAYMENT PLANS

You get a selection of tuition plans. And, we are an "Eligible Institution" under the Federally Insured Student Loan Program.

## 9 RCA INSTITUTES IS FULLY ACCREDITED

Accredited member National Home Study Council, Licensed by N.Y. State - courses of study and instructional facilities approved by the State Education Department.

Approved by N.Y. State Education Dept. for the training of Veterans.

# RCA Institutes, Inc.

Home Study Dept. 767-303-0  
320 West 31st Street  
New York, N.Y. 10001

Name \_\_\_\_\_

Address \_\_\_\_\_

City \_\_\_\_\_

State \_\_\_\_\_ Zip \_\_\_\_\_

Check here if interested in Classroom Training

# BUILD YOUR OWN RADIO

## and Electronics Circuits

Reg. U. S.  
Pat. Off.



Training Electronics Technicians Since 1946

### PROGRESSIVE HOME RADIO-T.V. COURSE

#### Now Includes

- ★ 12 RECEIVERS
- ★ 3 TRANSMITTERS
- ★ SQ. WAVE GENERATOR
- ★ SIGNAL TRACER
- ★ AMPLIFIER
- ★ SIGNAL INJECTOR
- ★ CODE OSCILLATOR

- ★ No Knowledge of Radio Necessary
- ★ No Additional Parts or Tools Needed
- ★ EXCELLENT BACKGROUND FOR TV
- ★ SCHOOL INQUIRIES INVITED
- ★ Sold In 79 Countries

### YOU DON'T HAVE TO SPEND HUNDREDS OF DOLLARS FOR A RADIO COURSE

The "Edu-Kit" offers you an outstanding PRACTICAL HOME RADIO COURSE at a rock-bottom price. Our Kit is designed to train Radio & Electronics technicians, making use of the most modern methods of home training. You will learn radio theory, construction practice and servicing. THIS IS THE HOME RADIO COURSE IN EVERY DETAIL. You will learn how to build radios, using regular schematics, how to wire and solder in a professional manner; how to service radios. You will work with the standard type of punched metal chassis as well as the latest development of Printed Circuit chassis. You will learn the basic principles of radio. You will construct, study and work with RF and AF amplifiers and oscillators, detectors, rectifiers, test equipment. You will learn trouble-shooting, using the Progressive Signal Tracer, Progressive Signal Injector, Progressive Dynamic Radio & Electronics Tester, Square Wave Generator and the accompanying instructional material.

You will receive training for the Novice, Technician and General Classes of F.C.C. Radio Amateur License. You will build Receiver, Transmitter, Square Wave Generator, Code Oscillator, Signal Tracer and Signal Injector Circuits, and learn how to operate them. You will receive an excellent background for television, Hi-Fi and Electronics.

Absolutely no previous knowledge of radio or science is required. The "Edu-Kit" is the product of many years of teaching and engineering experience. The "Edu-Kit" will provide you with a basic education in Electronics and Radio, worth many times the low price you pay. The Signal Tracer alone is worth more than the price of the kit.

### THE KIT FOR EVERYONE

You do not need the slightest background in radio or science. Whether you are interested in Radio & Electronics because you want an interesting hobby, a new career business or a job with a future, you will find the "Edu-Kit" a worth-while investment. Many thousands of individuals of all

ages and backgrounds have successfully used the "Edu-Kit" in more than 79 countries of the world. The "Edu-Kit" has been carefully designed in a step by step, so that you cannot make a mistake. The "Edu-Kit" allows you to teach yourself at your own rate. No instructor is necessary.

### PROGRESSIVE TEACHING METHOD

The Progressive Radio "Edu-Kit" is the foremost educational radio kit in the world, and is universally accepted as the standard in the field of electronics training. The "Edu-Kit" uses the modern educational principle of "Learn by Doing." Therefore you construct, learn schematics, study theory, practice trouble-shooting—all in a closely integrated program designed to provide an easily-learned, thorough and interesting background in radio.

You begin by examining the various radio parts of the "Edu-Kit." You then learn the function, theory and wiring of these parts. Then you build a simple radio. With this first set you will enjoy listening to regular broadcast stations, learn theory, practice testing and trouble-shooting. Then you build a more advanced radio, learn more advanced theory and techniques. Gradually, in a progressive manner, and at your own rate, you will find yourself constructing more advanced multi-tube radio circuits, and doing work like a professional Radio Technician.

Included in the "Edu-Kit" course are Receiver, Transmitter, Code Oscillator, Signal Tracer, Square Wave Generator and Signal Injector Circuits. These are not unprofessional "breadboard" experiments, but genuine radio circuits, constructed by means of professional wiring and soldering on metal chassis, plus the new method of radio construction known as "Printed Circuitry." These circuits operate on your regular AC or DC house current.

### THE "EDU-KIT" IS COMPLETE

You will receive all parts and instructions necessary to build twenty different radio and electronics circuits, each guaranteed to operate. Our Kits contain tubes, tube sockets, variable, electronic, mica, ceramic and paper dielectric condensers, resistors, tie strips, hardware, tubing, punched metal chassis, Instruction Manuals, hook-up wire, solder, selenium rectifiers, coils, volume controls and switches, etc.

In addition you receive Printed Circuit materials, including Printed Circuit chassis, special tube sockets, hardware and instructions. You also receive a useful set of tools, a professional electric soldering iron, and a self-powered Dynamic Radio and Electronics Tester. The "Edu-Kit" also includes Code Oscillator Instructions and Progressive Code Oscillator, in addition to F.C.C. Radio Amateur License training. You will also receive lessons for servicing with the Progressive Signal Tracer and the Progressive Signal Injector, a High Fidelity Guide and a Quiz Book. You receive Membership in Radio-TV Club, Free Consultation Service, Certificate of Merit and Discount Privileges. You receive all parts, tools, instructions, etc. Everything is yours to keep.

Progressive "Edu-Kits" Inc., 1189 Broadway, Dept. S16DK, Hewlett, N.Y. 11557

### UNCONDITIONAL MONEY-BACK GUARANTEE

Please rush my Expanded Radio-TV Course with "Edu-Kits" to me.

- Send Course with Edu-Kits postpaid. I enclose full payment of \$34.95.
- I enclose \$5.00 deposit. Send Course with Edu-Kits C.O.D. for balance of \$29.95 plus postage.
- Send me FREE additional information describing Course with Edu-Kits.

NAME .....

ADDRESS .....

CITY & STATE .....

ZIP .....

### PROGRESSIVE "EDU-KITS" INC.

1189 Broadway, Dept. S16DK, Hewlett, N.Y. 11557

### FREE EXTRAS

#### • SET OF TOOLS

- SOLDERING IRON
- ELECTRONICS TESTER
- PLIERS-CUTTERS
- VALUABLE DISCOUNT CARD
- CERTIFICATE OF MERIT
- TESTER INSTRUCTION MANUAL
- HIGH FIDELITY GUIDE • QUIZZES
- TELEVISION BOOK • RADIO TROUBLE-SHOOTING BOOK
- MEMBERSHIP IN RADIO-TV CLUB: CONSULTATION SERVICE • FCC AMATEUR LICENSE TRAINING
- PRINTED CIRCUITRY

### SERVICING LESSONS

You will learn trouble-shooting and servicing in a progressive manner. You will practice repairs on the sets that you construct. You will learn symptoms and causes of trouble in home, portable and car radios. You will learn how to use the professional Signal Tracer, the unique Signal Injector and the dynamic Radio & Electronics Tester. While you are learning in this practical way, you will be able to do many a repair job for your friends and neighbors, and charge fees which will far exceed the price of the "Edu-Kit." Our Consultation Service will help you with any technical problems you may have.

### FROM OUR MAIL BAG

J. Staltis, of 25 Poplar Pl., Waterbury, Conn., writes: "I have repaired several sets for my friends, and made money. The "Edu-Kit" paid for itself. I was ready to spend \$20 for a course, but I found your ad and sent for your kit."

Ben Valerio, P. O. Box 21, Magna, Utah: "The Edu-Kits are wonderful. Here I am sending you my questions and also the answers for them. I have been in Radio for the last seven years, but like to work with Radio Kits and like to build Radio Testing Equipment. I enjoyed every minute I worked with the different kits; the Signal Tracer works fine. Also like to let you know that I feel proud of becoming a member of your Radio-TV Club."

Robert L. Shuff, 1534 Monroe Ave., Huntington, W. Va.: "Thought I would drop you a few lines to say that I received my Edu-Kit, and was really amazed that such a bargain can be had at such a low price. I have already started repairing radios and phonographs. My friends were really surprised to see me get into the swing of it so quickly. The Trouble-shooting Tester that comes with the kit is the best I have ever used. I had trouble, if there is any to be found."

### PRINTED CIRCUITRY

At no increase in price, the "Edu-Kit" now includes Printed Circuitry. You build a Printed Circuit Signal Injector, a unique servicing instrument that can detect many Radio and TV troubles. This revolutionary new technique of radio construction is now becoming popular in commercial radio and TV sets.

A Printed Circuit is a special insulated chassis on which has been deposited a conducting material which takes the place of wiring. The various parts are merely plugged in and soldered to terminals.

Printed Circuitry is the basis of modern Automation Electronics. A knowledge of this subject is a necessity today for anyone interested in Electronics.