

THE *New*

694  
A  
**FAWCETT**  
BOOK  
95¢

# TV REPAIRS YOU CAN DO



by Art Margolis

**Fixing Color TV**

**Installing UHF**

**Replacing Picture Tubes**

**Tune-Up Your Sound**

**The New Antennas**

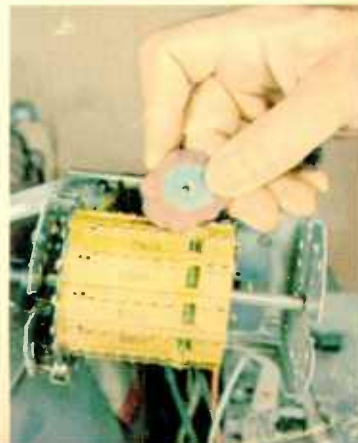

**One sure way to save yourself time,  
money and aggravation is by learning  
how to make your own electrical repairs.  
Here's how...**

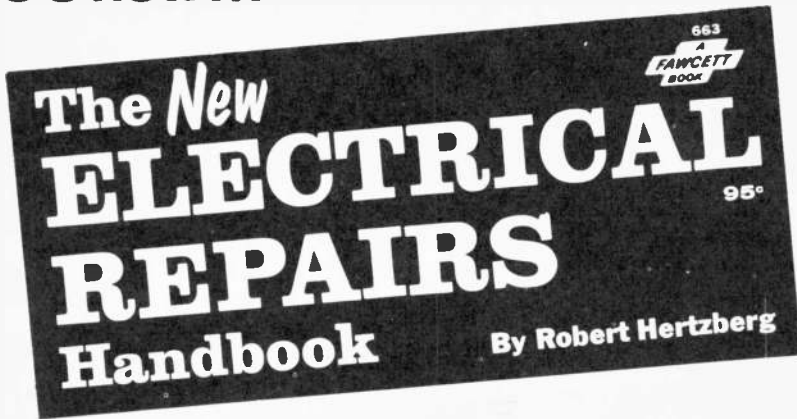

Only 95 cents at leading newsstands, drugstores, super-  
markets—wherever magazines are sold.

To order send 95¢ plus 10¢ mailing charge for each copy to  
FAWCETT BOOKS, Greenwich, Conn. 06830. Specify THE NEW  
ELECTRICAL REPAIRS HANDBOOK, Fawcett Book #663.



# INTERNATIONAL CORRESPONDENCE SCHOOLS Dept. N3351J, Scranton, Penna. 18515

(In Hawaii: P. O. Box 418, Honolulu Canadian residents mail to Scranton address—further service handled by ICS Canadian Ltd.)

I'm interested in a program of independent study. Send me, without cost, your booklet on the principles of success, your illustrated brochure on the ICS method, and your catalog for \_\_\_\_\_ (Print name of course. See list.)

Approved for veterans under the G.I. Bill.

Accredited member, National Home Study Council.

Convenient payment plan.

Special Canadian courses in French and English.

Special rates to members of the U.S. Armed Forces.

Miss \_\_\_\_\_ Age \_\_\_\_\_  
 Mrs. \_\_\_\_\_  
 Mr. \_\_\_\_\_  
 Address \_\_\_\_\_  
 City \_\_\_\_\_ State \_\_\_\_\_ Zip Code \_\_\_\_\_  
 Occupation \_\_\_\_\_ Employed by \_\_\_\_\_ Working Hours \_\_\_\_\_ A.M. to \_\_\_\_\_ P.M.

## Cast your ballot for a successful future!

# 266 ICS COURSES



You get the widest choice from ICS—oldest, largest home study school. Check the list. (Also available, programs tailored to your special needs.) You receive individual instruction, plus success-proved facts

and theory you can apply immediately. Mastery of subject is assured. No skimping. You earn your diploma.

Why mark time when you can mark the coupon and get a fast, sure fix on your best course to success.

**ACCOUNTING**  
 Accounting (U.S.A.)  
 Accounting (Canadian)  
 Accounting for Business Programmers  
 Accounting for Management Decisions  
 Auditing  
 Business Law (U.S.A.)  
 Cost Accounting  
 CPA Review (U.S.A.)  
 General Accounting  
 Income Tax (U.S.A.)  
 Industrial Accounting  
 Junior Accounting  
 Office Accounting  
 Practical Accounting  
 Public Accounting  
 Small Business Accounting (U.S.A.)  
 Starting and Managing a Small Bookkeeping Service (U.S.A.)

**ARCHITECTURE AND BUILDING**  
 Architectural Drawing and Designing  
 Architecture  
 Building Contractor  
 Building Estimator  
 Building Inspector  
 Building Maintenance  
 Carpenter-Building  
 Carpentry and Millwork  
 Fundamentals of Urban Planning  
 House Planning and Interior Design  
 Mason  
 Painting Contractor  
 Reading Arch. Blueprints  
 Review in Architectural Design and Practice  
 Review of Mechanical Systems in Buildings

**ART**  
 Amateur Artist  
 Commercial Art  
 Commercial Cartooning  
 Illustrating with Options: Magazine  
 Advertising Layout and Illustration  
 Interior Decorating  
 Oil Painting for Pleasure  
 Show Card and Sign Production  
 Show Card Writing  
 Sign Painting and Design's  
 Sketching and Painting

**AUTOMOTIVE**  
 Automatic Transmission Specialist  
 Automobile Body Rebuilding & Refinishing  
 Automobile Elec. Tech'n  
 Automobile Engine Tune-Up  
 Automobile Mechanic  
 Automobile Technician  
 Diesel-Gas Motor Vehicle Engines

**BUSINESS**  
 Advertising  
 Business Administration  
 Business Practice (Cont.)  
 Canadian Business Course  
 Condensed Marketing  
 Direct Mail and Mail Order Advertising  
 Industrial Psychology  
 Inventory Control  
 Mag. & News'p'r Adv.  
 Managing a Retail Business  
 Managing a Small Store  
 Marketing Management  
 Marketing Research  
 Modern Executive Mgmt.  
 Office Automation  
 Office Management  
 Production Management  
 Purchasing Agent  
 Retail & Local Advertising  
 Retail Bus. Management  
 Retail Merchandising  
 Retail Selling  
 Systems and Procedures Analysis

**BUSINESS: SALES**  
 Creative Salesmanship  
 Real Estate Salesmanship  
 Salesmanship  
 Sales Management

**BUSINESS: SUPERVISION**  
 Basic Supervision  
 Industrial Foremanship  
 Industrial Supervision  
 Management  
 Salesmanship and Sales  
 Modern Woman as a Supervisor  
 Personality Development  
 Personnel-Labor Relations (U.S.A.)  
 Supervision

**CHEMICAL**  
 Chemical Engineering  
 Analytical Chemistry  
 Chemical Engineering Unit Operations

Chemical Laboratory Tech'n  
 Chemical Process Operator  
 Elements of Nuclear Energy  
 General Chemistry  
 Instrumental Laboratory Analysis

**CIVIL ENGINEERING**  
 Civil Engineering  
 Construction Eng'g Tech.  
 Highway Engineering Tech.  
 Principles of Surveying  
 Reading Highway B'pts  
 Reading Structural B'pts  
 Sanitary Engineering Tech.  
 Sewage Plant Operator  
 Structural Eng'g Tech.  
 Surveying and Mapping  
 Water Works Operator

**COLLEGE COURSES**  
 American History  
 Calculus  
 Economics

**COMPUTERS**  
 COBOL Programming  
 Fortran Programming for Engineers  
 Programming for Digital Computers  
 Programming the IBM 1401 Computer  
 Programming the IBM System 360 Computer, Introduction

**DRAFTING**  
 Aircraft Drafting  
 Architectural Drafting  
 Design Drafting  
 Drafting Technology  
 Electrical Drafting  
 Electrical Eng'g Drafting  
 Electronic Drafting  
 Introductory Mech. Drafting  
 Mechanical Drafting  
 Pressure-Vessel and Tank  
 Print Reading  
 Sheet Metal Layout for Air Conditioning  
 Structural Drafting

**ELECTRICAL**  
 Electrical Engineering—Electronics Option  
 —Power Option  
 Electrical Appliance Serv'g with Equipment Training  
 Electrical Contractor  
 Electrical Eng'g Tech.  
 Electrical Home Maint.

Electrical Home Maint. with Equipment Training  
 Electrical Instrument Tech  
 Electric Motor Repairman  
 Industrial Electrical Tech.  
 Power-Line Design & Const  
 Power Plant Operator  
 Hydro Option  
 —Steam Option  
 Practical Electrician  
 Practical Electrician with Equipment Training  
 Practical Lineman  
 Reading Electrical B'pts

**ENGINEERING (Refresher Courses for Graduate Engineers)**  
 Chemical  
 Civil  
 Electrical  
 Industrial  
 Mechanical  
 Sanitary  
 Structural

**ENGLISH AND BETTER WRITING**  
 Better Business Writing  
 English for Spanish (U.S.A.)  
 Free Lance Writing for Fun and Profit  
 Introductory Tech. Writing  
 Modern Letter Writing  
 Practical English  
 Short Story Writing

**HIGH SCHOOL**  
 High School Business  
 High School (Canadian)  
 High School General  
 High School Mathematics  
 High School Secretarial  
 High School Vocational  
 High School College Preparatory—Arts  
 High School College Prep—Eng'g and Science  
 Preparatory Course for High School Equiv. Test

**MACHINE SHOP PRACTICE**  
 Drill Operator  
 Foundry Practice  
 Industrial Metallurgy  
 Lathe Operator  
 Machine Shop Inspection  
 Machine Shop Practice  
 Metallurgical Eng'g Tech.  
 Milling Machine Operator  
 Multitask Maint. Mech.  
 Practical Millwrighting  
 Reading Shop Prints  
 Rigging  
 Tool Engineering Tech.  
 Tool Grinder  
 Tool Making

Turret Lathe Operator  
 Welding Engineering Tech  
 Welding Process

**MATHEMATICS**  
 Advanced Mathematics  
 Math and Mechanics for Engineering Technicians  
 Math and Physics for Engineering Technicians

**MECHANICAL**  
 Mechanical Engineering  
 Aircraft and Power  
 Plant Mechanic  
 Hydraulic & Pneu. Power  
 Stationary Engineering  
 Industrial Eng'g Tech.  
 Industrial Instrumentation  
 Machine Design  
 Quality Control  
 Safety Engineering Tech.  
 Tool Design  
 Vibration Analysis and Control

**PETROLEUM**  
 Natural Gas Production and Transmission  
 Oil Field Technology  
 Petroleum Production  
 Petroleum Production Engineering Technology  
 Petroleum Refinery Oper  
 Pipeline Engineering Tech

**PLASTICS**  
 Design of Plastic Products  
 Plastics Technician

**PLUMBING, HEATING AND AIR CONDITIONING**  
 Air Conditioning  
 Air Conditioning Maint.  
 Domestic Heating with Gas and Oil  
 Domestic Refrigeration  
 Heating  
 Heating & Air Conditioning with Drawing  
 Industrial Air Conditioning  
 Industrial Heating  
 Pipe Fitting  
 Plumbing  
 Plumbing and Heating  
 Plumbing & Heating Est.  
 Practical Plumbing  
 Refrigeration  
 Refrigeration and Air Conditioning

**PULP AND PAPER**  
 Paper Machine Operator  
 Paper Making  
 Pulp Mill  
 Pulp & Paper Eng'g Tech

**SECRETARIAL**  
 Clerk-Typist  
 Commercial Secretary, Engineering Secretary, Legal Secretary, Medical Secretary, Professional Shorthand  
 Stenographic Typewriting

**STEAM AND DIESEL POWER**  
 Boiler Inspector  
 Industrial Building Eng'r  
 Power Plant Engineering  
 Stationary Diesel Engines  
 Stationary Fireman  
 Stationary Steam Eng'g

**TEXTILES**  
 Carding  
 Carding and Spinning  
 Dyeing and Finishing  
 Loom Fixing  
 Textile Designing  
 Textile Mill Supervision  
 Textile Technology  
 Warping and Weaving

**TRAFFIC**  
 Motor Traffic Management  
 Railway Rate Clerk  
 Traffic Management

**TV-RADIO-ELECTRONICS**  
 Color Television Principles and Servicing  
 Electronics Instrumentation and Servo Fundamentals  
 Electronics Technician  
 First Class Radio-telephone License  
 Fundamentals of Electronic Computers  
 General Electronics  
 General Electronics with Equipment Training  
 Hi-Fi Stereo and Sound System Servicing  
 Industrial Electronics Tech.  
 Numerical Control  
 Electronics and Maint.  
 Practical Telephony  
 Principles of Semiconductor Radio & TV Servicing with Equipment Training  
 Second Class Radio-telephone License  
 Sound Systems Specialist  
 TV Servicing and Repair  
 Telephony, Electronics, & Radio Communications



# The New TV Repairs You Can Do

By Art Margolis

A FAWCETT BOOK • NUMBER 664  
 LARRY EISINGER • EDITOR-IN-CHIEF  
 GEORGE TILTON • MANAGING EDITOR  
 SILVIO LEMBO • ART EDITOR  
 HAROLD E. PRICE • ASSOC. ART EDITOR

W. H. Fawcett, Jr. . . . . President  
 Roger Fawcett . . . . . General Manager  
 Gordon Fawcett . . . . . Secretary-Treasurer  
 Roscoe K. Fawcett . . . . . Circulation Director  
 Donald P. Hanson . . . Assistant General Manager  
 George H. Allen . . . . . Vice President  
 Ralph Daigh . . . . . Vice President  
 R. Bruce Besten . . . . . Production Director  
 Al Allard, Ralph Mattison . . . . . Art Directors  
 Nancy Kay . . . . . Production Manager

FRANK BOWERS . . . . . EDITOR

STAFF ARTISTS

Mike Gaynor • John Selvaggio  
 Alex Santiago • Herbert Jonas  
 Paul Howard • John Cervasio

Lawrence Flanagan

Elaine E. Sapoff . . . . . Production Editor

The NEW TV REPAIRS YOU CAN DO, Fawcett Book 664, is published by Fawcett Publications, Inc., Greenwich, Connecticut. Editorial and Advertising Offices: 67 West 44th Street, New York, New York 10036. General Offices: Fawcett Building, Greenwich, Connecticut 06830. Printed in U.S.A. Copyright © 1968 by Fawcett Publications, Inc.

Cover and inside photos by DENNY MARGOLIS

Printed by Fawcett-Haynes Printing Corp., Louisville, Ky.

Fawcett Publications, Inc., is a member of American Book Publishers Council, Inc.

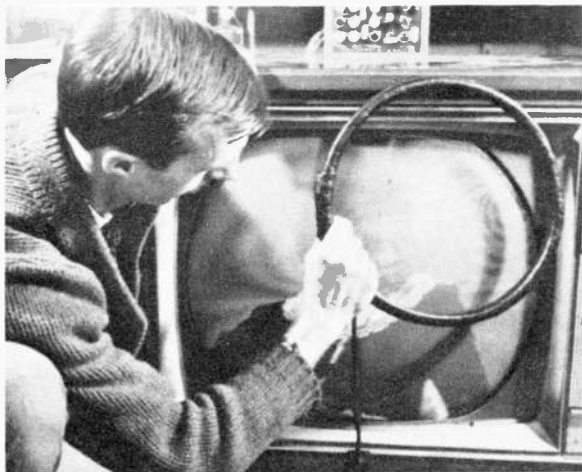
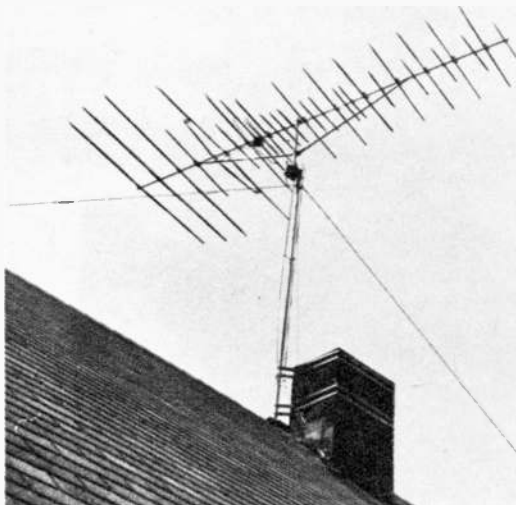

This  
valuable  
draftsman's  
equipment  
is given  
to you...



Drafting is the open  
door to success in  
any industry

- The draftsman is the link between engineering and production. No project, big or small, gets "off the ground" before it comes from the draftsman's board.
- Look at the columns and columns of "Help Wanted—Draftsman" ads that appear in a single issue of a city newspaper. They are evidence of the heavy demand that exists for draftsmen in every technical field today.
- No previous drawing skills are required to become a draftsman. The draftsman's tools can be quickly mastered by anyone.
- During more than sixty years, LaSalle has enrolled over 1,500,000 students for success training in business and industry. A LaSalle diploma is respected by employers.
- You owe it to yourself to find out now what LaSalle Drafting training can do for you. Mail the coupon today.



when you train with LaSalle  
for a big-pay job as a technical

# DRAFTSMAN

*Learn at home in spare time. No previous skills required!*

**E**VERYTHING you need to get started in the lucrative drafting profession—instruction and full equipment—is supplied to you by LaSalle. All you are expected to supply is an interest in technical subjects and the ambition to qualify for a bigger future.

Draftsmen are in heavy demand in America's booming industries. They are needed in aeronautics, in architectural work, in electrical, mechanical, and structural fields.

Not a single new production improvement, not a single building or mechanical project, gets under way without the skilled help of the modern draftsman.

Why don't you get started in this busy field and prepare to earn big pay? LaSalle trains you by mail; expert instructors start you at the beginning and give your work personal attention until your course is completed. The cost of instruction is remarkably low.

*Free*

Booklet gives facts on opportunities in drafting and describes LaSalle training. Mail coupon to LaSalle, 417 S. Dearborn, Chicago, Ill. 60605.

## LA SALLE EXTENSION UNIVERSITY

*A Correspondence Institution*

417 S. Dearborn, Dept. 81-085, Chicago, Illinois 60605



Please send Free booklet, "Opportunities in Drafting," and full information on training at home.

Print Name ..... Age .....

Address ..... Apt. No. ....

City .....

State ..... Zip No. ....

923

## Contents

1. How to Start Right . . . . .	6
2. The Common TV Troubles . . . . .	14
3. Safely Fixing High Voltage . . . . .	22
4. Other High Voltage Troubles . . . . .	26
5. What to Do About Flopover . . . . .	34
6. When Your Picture Whites Out . . . . .	42
7. All About Fixing TV Sound . . . . .	52
8. How to Really Adjust the Colors . . . . .	56
9. Touching Up the Colors . . . . .	60
10. When Your Color Quits . . . . .	68
11. The Trouble With Antennas . . . . .	74
12. Those Wonderful New Antennas . . . . .	82
13. Eliminating TV Interference . . . . .	92
14. The Latest About Picture Tube Repairs . . . . .	98
15. Actually Replacing Picture Tubes . . . . .	104
16. Installing UHF on an Older TV . . . . .	110

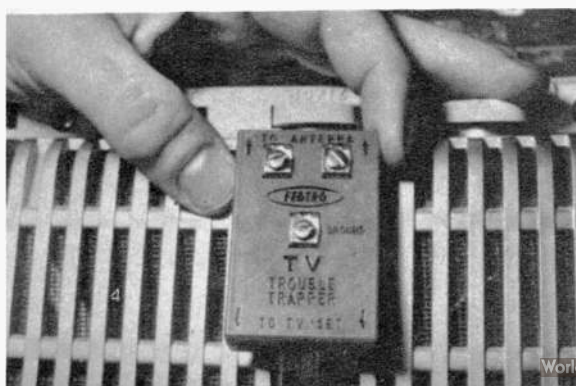

# LEARNING TELEVISION-RADIO, ELECTRONICS IS FAST, EASY, INTERESTING WITH NRI



All the material you see above is included in a typical NRI home-study course. Other courses are equally complete. But NRI training is more than kits and texts. It's unique personal services which have made NRI the 50-year leader in training at home for fast growing TV-Radio, Electronics.

## Choose From 12 NRI Training Plans

NRI has a training plan to fit every interest, every need in TV-Radio, Color TV and Electronics. Be your own boss in a TV-Radio servicing business or make \$4 to \$6 an hour fixing sets in spare time. Or be a part of the electronics "revolution" in business and industry. Or get into the fascinating fields of broadcasting-communications. Or take part in missile, rocket, satellite or other government programs. An understanding of computers may be necessary in your work. Perhaps you want to "brush up" on math, electronic terms or basic principles. Whatever your interest, you'll find an NRI course tailored to your needs.

## Revolutionary "3-Dimensional" Method

NRI makes training at home easy, interesting. Catalog gives you complete information. Read about the exclusive Achievement Kit NRI sends you, about custom designed training equipment NRI gives you at no extra cost, about NRI's unique "bite-size" lesson texts.

The demand for skilled technicians is great and growing. Discover how you can be a part of the Electronics Age—starting soon. Mail coupon now for free NRI Catalog. NATIONAL RADIO INSTITUTE, Electronics Division, Washington, D. C. 20016. No salesman will call. No obligation.



Over 50 years of leadership in Electronics training

**AVAILABLE UNDER NEW GI BILL—**  
If you served since Jan. 31, 1955, or are in service, check GI line in coupon.

## CASH IN ON THE COLOR TV BOOM

NRI—the home-study school that pioneered learn-by-doing training kits—is now first to bring you Color TV training equipment. Learn Color TV the only practical way—by building your own high-quality Color TV set. You get on-the-job experience as you train; and your family enjoys the thrills of vibrant color shows for years to come. And, thanks to NRI, you'll do your own servicing—no costly service contracts. You can cash in now on the booming Color TV market as a well-trained Service Technician. Get the facts. Mail coupon for FREE NRI Color Catalog. Choose from 12 training plans.



## Mail Now for FREE Catalog

NATIONAL RADIO INSTITUTE 8-098  
Electronics Division, Washington, D. C. 20016

Send me your FREE Catalog. (No salesman will call.)

Name \_\_\_\_\_ Are \_\_\_\_\_  
Please print)

Address \_\_\_\_\_

City \_\_\_\_\_ State \_\_\_\_\_ Zip \_\_\_\_\_  
Code \_\_\_\_\_

Check for facts on new GI Bill

ACCREDITED MEMBER NATIONAL HOME STUDY COUNCIL





Tube tester found in many stores guides you to the troublesome circuit and the defective TV part.

## How to Start Right

Tube tester, hand tools and common sense can handle the 55 troubles

**A**S MANY TV's as I've worked on, at least once a week I'll open up a chassis and find a repair situation that perplexes me. What do I do? I pull the service notes of that set out of my repair library and begin looking over the schematic. This primes the flow of my experience and I get underway again toward the completion of the repair.

This book, used correctly, will do the same thing for you. It will prime your activity, guide you to the troublesome circuit and most of the time to the actual defective part.

You can actually repair nine out of ten TV breakdowns with nothing more than your brains, eyes, ears, nose, a few special hand tools and drug store tube tester. That is, if you follow directions carefully.

A repair consists of four steps.

1.—Name the trouble. This means matching up the TV trouble with its counterpart in the IDENTIFICATION CENTER and giving your trouble a name.

2.—Locating the suspected circuit or circuits. In the IDENTIFICATION CENTER alongside each trouble is a list of chapters wherein the trouble is explained and the indicated circuits are listed in their order of probability.

3.—Locating the defective component in the suspect circuit. In the indicated chapter you'll find troubleshooting techniques and typical components that go bad and cause the troubles shown in the IDENTIFICATION CENTER.

4.—Once located, the bad component has to be replaced with an exact or substitute component. Once this is done the trouble is gone.



## 55 TV TROUBLES

CHAPTERS	TROUBLES & NUMBERS
2 Low Voltage	1. Dead set—no heaters 2. Dead set—heaters lit
3 High Voltage	3. No brightness—sound okay
4 High Voltage	4. 2 Sided shrink 5. 4 Sided shrink 6. Blooming 7. Defocused 8. Keystone 9. Arc Lines 10. Corona 11. Pie crust 12. Barkhausen
5 Sync	13. Horizontal lines 14. Christmas tree 15. Horizontal split picture 16. Bends 17. Poor horizontal linearity 18. Vertical roll 19. No vertical sweep 20. Top and bottom shrink 21. Vertical foldover 22. Vertical retrace at top 23. Poor vertical linearity 24. No sync 25. Barber pole 26. Light green picture
6 Contrast	27. Raster only, no sound or picture 28. Raster, sound okay 29. Weak contrast 30. Too much contrast 31. Smeary picture 32. Negative picture 33. Pulsating picture 34. Hum bars 35. Snow 36. No high band 37. Sound and picture won't tune 38. No UHF 39. No VHF 40. Tunable ghosts
7 Sound	41. No sound 42. Poor sound 43. Sound bars
9 Color Adjustments	44. Tinted pix 45. Poor purity 46. Poor convergence
10 Color	47. No color 48. No video, color okay 49. Weak color 50. Overly bright, 1 color pix 51. Loss of one color 52. Worms 53. Color snow in B & W pix
14 Picture Tubes	54. Dim pix 55. Fixed brightness

## Identification Center

When I had chemistry in High School there were 92 elements, no more, no less. Today at latest count students are told there are 104 elements, maybe a few more unnamed.

By my latest count there are 55 TV troubles, no more, no less. As time goes by I'm sure more troubles will be discovered. At any rate I'm going to dwell on the 55 I know of.

They break down into six general types. They are:

1.—Dead Set troubles. (By definition this grouping comprises the troubles evidenced by the symptoms of no light on the screen and no sound issuing from the speaker. The pilot light might be lit or a glance in the back reveals the tubes might be lighting up. Even so, the sound and picture—

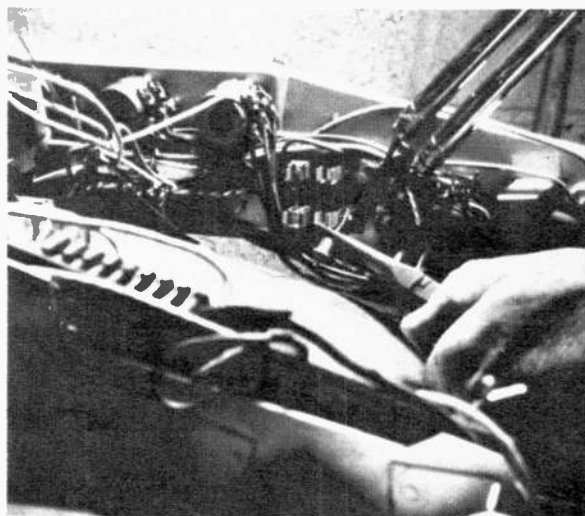

Once the defective part is located, replace it with an exact or substitute replacement part.

Newer TV's are being built with space age-type components that provide much more reliability.

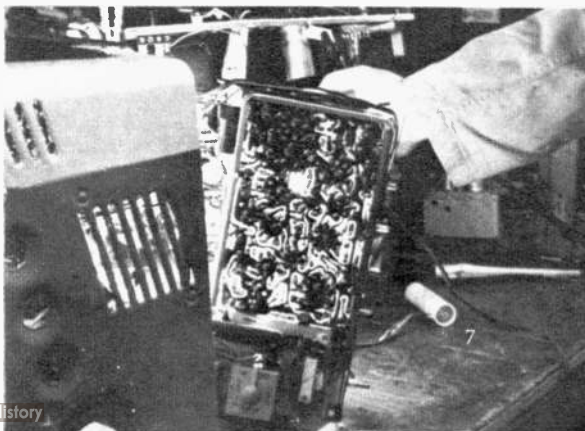

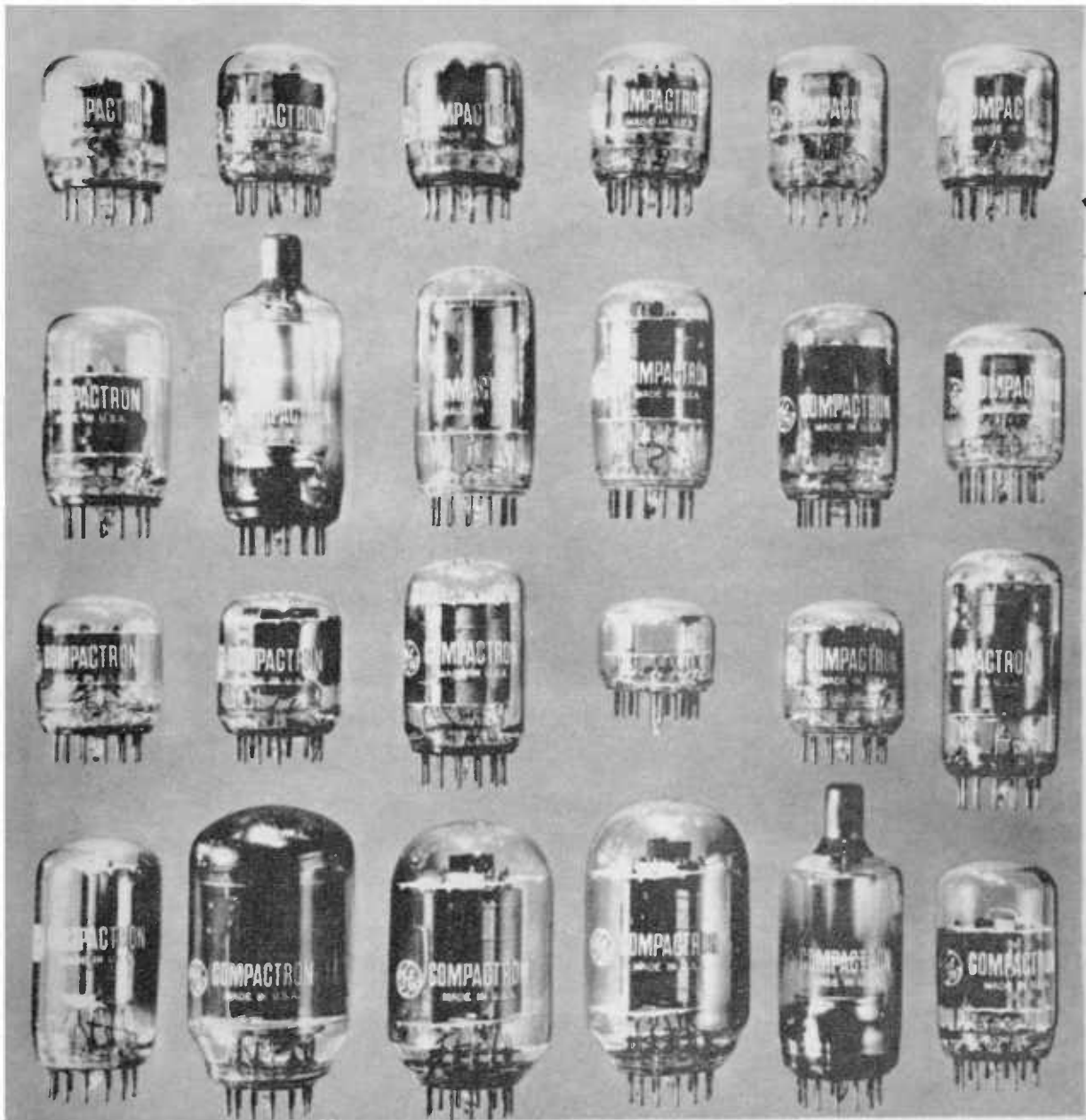

There are hundreds of new-type tubes, all sizes and shapes—and various transistors and diodes.

making qualities of the TV is not operating and the trouble comes under the heading of "Dead Set.")

2.—Brightness troubles. (This grouping includes all variation from the normal picture brightness. It includes all shades of trouble from a black screen to an overly bright one. It is directly tied in to a brightness control that doesn't work correctly. Some of the troubles are obvious and others are subtle.)

3.—Synchronization troubles. (These are the troubles known as flopover, bends, lines, rolling, or just some jiggling. It has to do with keeping the picture locked solidly in place. Unless your picture is so locked, you have a sync problem. No compromise will do.)

4.—Contrast troubles. (These are the troubles that can be confused with brightness troubles. Your first step is to separate the two. Contrast troubles are no contrast.



There are now a few hundred different commercial picture tubes and 12 or so color picture tubes.

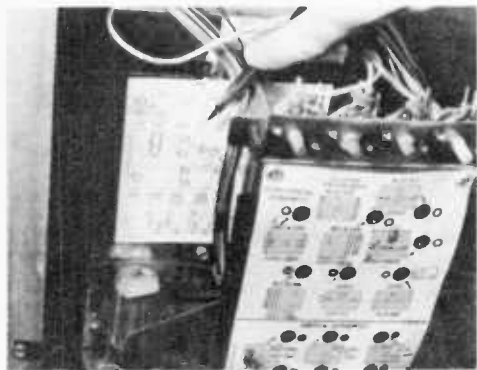

Practically all TV's have a tube location guide pasted somewhere in the set. It's a valuable aid.

Guide lays out pictorially the tubes as they are placed in the TV, plus other vital information.

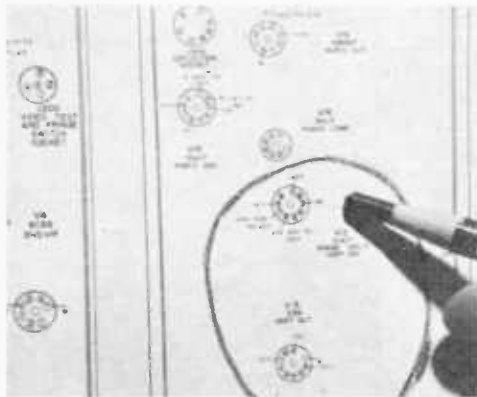

too much contrast, smeared blacks and whites and variations on this theme.)

5.—Sound troubles. (There is no difficulty diagnosing these.) It's quite obvious when the sound is dead, low, too high, muffled, garbled or squealing.

6.—Color troubles. (This group can be difficult to identify.) Keep in mind a color trouble is somehow tied in with the color controls. When you have no color, wrong colors, blurred colors, moving colors or what have you, and the color controls won't help, look for the trouble in the color group.

The newer TV's are being built with a lot more reliability than older models. The reliability is especially evident in the fixed components such as resistors, capacitors and coils. This makes for a higher completion of repairs for you the do-it-yourselfer.

However, there are hundreds of new type tubes. While there used to be in general just three kinds of tubes, seven pin miniatures, nine pin miniatures and octals, there are now many more. There are ten pin miniatures, twelve pin miniatures, novars, compactrons and others. Also instead of tubes, in some circuits you'll find diodes, dual diodes, transistors and other items.

While there used to be 70-degree and 90-degree picture tubes, all with a universal twelve pin base, there are now 110-degree, 114-degree, all sizes, shapes and different kinds of bases, plus many different color picture tubes containing many different kinds of bases.

With it all you can still score more repairs than you were able to with just the older type TV's. You'll have to adapt yourself to the changes and pay a little more attention than previously but the complications do not change the fact that tubes

A schematic differs from a tube location guide as a good road map differs from a street guide.

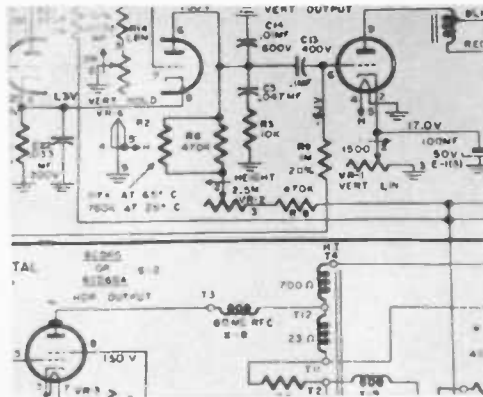



Tube tester provides good service information, but take its results with caution. It's not infallible.

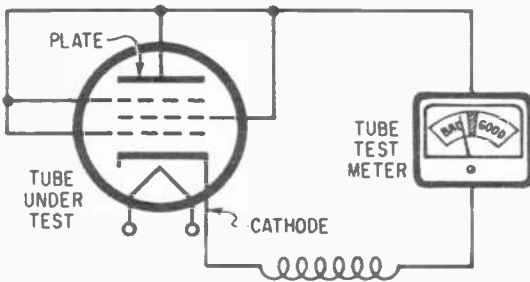
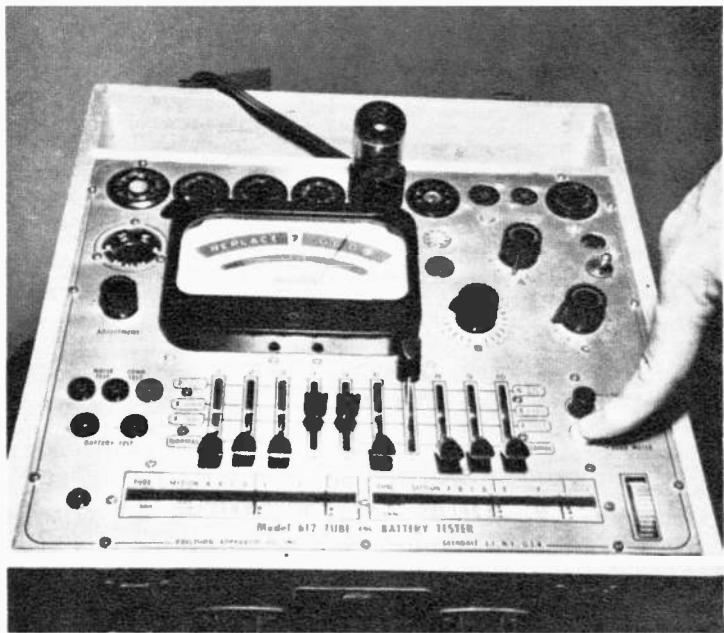

Emission testers turn all tubes into diodes by tying all the elements together except cathode.

Below, if either of these bulbs light up, tube is defective—no matter what the meter reads.

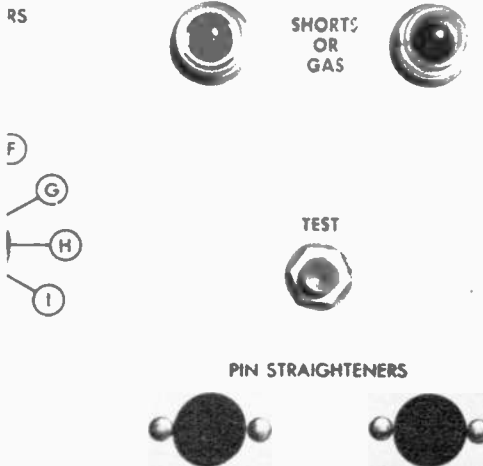

plug in and adjustments just need manipulation.

### Service Information

Just as you can't tell the players without a program you can't tell tube functions without service information. The first and most important service sheet for you is the tube location guide.

After you name the trouble, the IDENTIFICATION CENTER tells you the circuit under suspect. The only way you can find the suspected circuit among all that mumbo jumbo in the TV is to consult the tube location guide. You'll find it pasted somewhere inside the TV, either on the rear of the chassis or on the wall of the cabinet. Sometimes it's on the inside of the back cover.

The guide lays out the tubes pictorially as they actually exist in the TV. Near the tube is an abbreviation of the job the tube is doing.

While that is the most important piece of news you want, if you look close you can also find a pictorial view of the tubes' key way, where the chassis adjustments are, fuse sizes and location, heater circuit paths, signal paths, location of other plug-in units such as dual diodes and germanium diodes, and other common offender components such as power rectifiers and heater resistors.

The tube location guide differs from a schematic like a street guide differs from a map. The tube location guide provides you with all the service information for quick check repairs. The schematic package gives you all the information available for your

TV. You use the guide for the nine out of ten easy repairs. The schematic is needed for the other ten percent, the really tough repairs.

It wouldn't hurt to own the full service folder for your TV. You can get it by writing to the manufacturer of your TV and requesting it. They might charge you or might not. Another source is to buy the Sams Photofact folder containing your TV's schematic. Only thing is the folder contains a lot of other service information concerning other TV's that you have no interest in.

It's worth it though because the service folder contains the following valuable information. Step by step, take apart and put together instructions, servicing tips peculiar to your TV, detailed schematic, pictures of top and bottom of all vital sections of the TV with numbered callouts showing every part, detailed parts list with suitable replacements, two tube location guides top and bottom view, detailed tuner schematic



Double-check all bad tubes on your set. If you make just one mistake in setting, it reads BAD.

By using one of these little hot tube pullers you can spare yourself a nasty burn off a red hot tube.

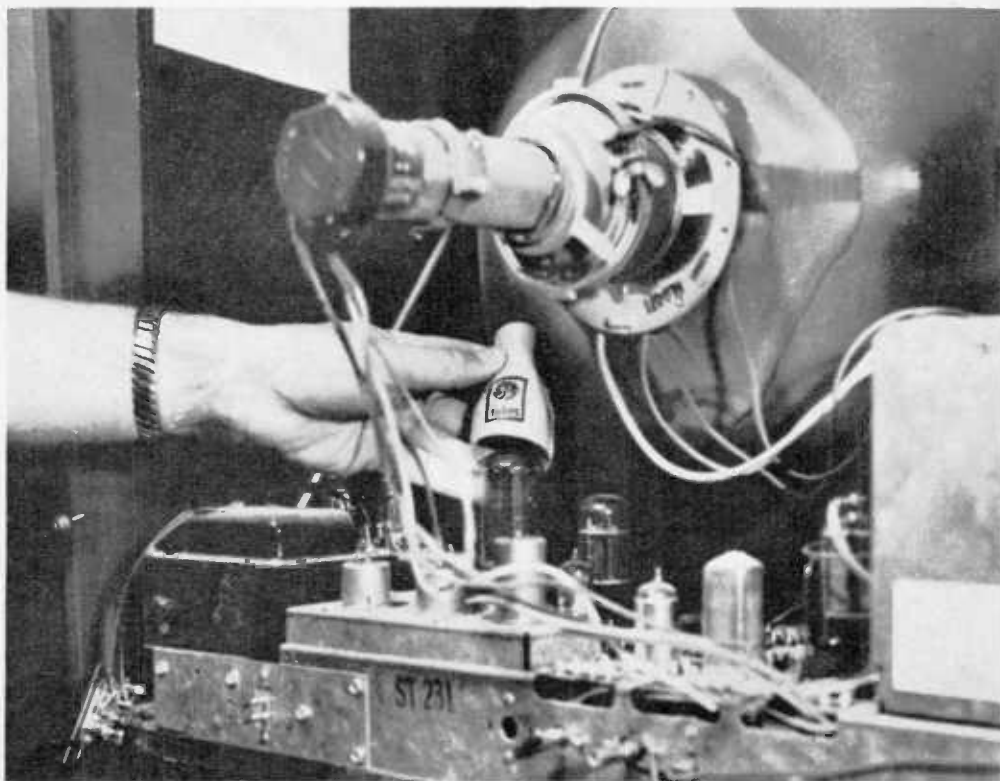

and parts list, detailed alignment instruction for the tuner, IF strip, horizontal phase, AGC, color setups all step by step, other things.

### Truth About Tube Testing

I use a tube tester under one set of circumstances. That is when I suspect a tube and do not have a new one in stock to stick in its place. If I have the replacement for the suspect tube I do not use the tester, I put the replacement in and see what happens. If the trouble clears, the tube was bad. If the trouble stays, the tube was probably good.

You probably can't perform the direct substitution technique since you are not in the business and do not stock replacement tubes. You are in the position of having to use a tube tester most of the time.

The tube tester is useful. It provides the operator with a certain amount of service information. However, it is not a cure-all for TV troubles. It can tell you a tube is good when it's really bad. It can tell you a tube is bad when it's good. There can be mistakes on the tube chart that give you wrong settings and if you make one wrong move in the settings your reading will be inaccurate.

Fortunately, it's right the majority of times so as long as you are on the lookout and doublecheck all tubes that read bad, the tube tester is a valuable aid.

All the tube testers you will come in contact with are emission checkers. There are lots of other characteristics in a tube too but emission—that is, the amount of electrons that flows in the tube—is a good indicator. It follows that as the emission goes so go the rest of the tubes' characteristics. Good emission usually but not always means the tube qualifies for TV duty.

The actual test makes all tubes act like a two-element diode. When you make your settings you are shorting all the elements except the cathode and heater together. Then as the tube heats up you press a button. This puts a positive voltage on the tied elements. Electrons flow from the cathode and heater to all the rest of the elements and the flow is measured on the meter where the GOOD—BAD is indicated.

In addition to emission tests there are usually a couple of neon bulbs labeled SHORTS and GAS. If either bulb lights, the tube is defective no matter what the emission reads.

Owning one of these heater testers lets you check tube troubles, fuses and make easy ohmmeter tests.

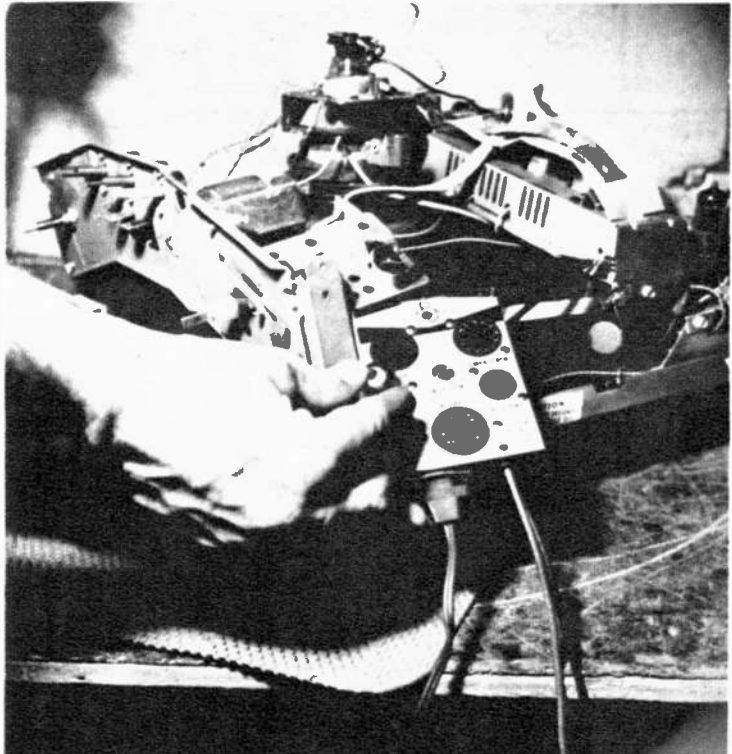



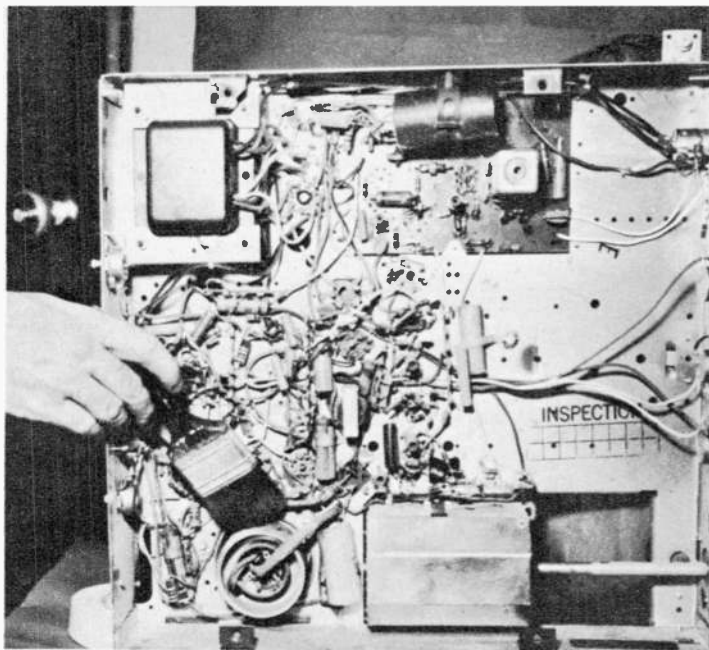

The first step in any TV repair is to clean away dust so you can work in a clean, efficient manner.

Below, a spray can of quick-drying solution will freeze a component within seconds, reveal the defects.

Be sure to leave the tube in the test position as short a time as possible. With all the elements tied together a tube can over-heat and burn out as you stand and watch hoping for the needle to go higher.

Double check all bad tubes and then as a further check test the new tube you buy too. Besides the fact that the new tube can be bad you won't have to buy a tube because the tube tester is inaccurate or you made a mistake in your settings. Should the new tube also read bad that's probably the case.

On occasion the tester, even though you do everything perfect and the tester is fine, will not single out a bad tube. There are intermittent shorts that only occur after a tube is on awhile, tubes with loose elements that vibrate in action but read good on a tester, tubes that have severe interelectrode defects that alter other characteristics, etc. The main thing is to realize the tester has many limitations and does not preach gospel.

### Talking About Tools

Your everyday tools will be needed in a TV repair. In addition, there are a few items that I would deem a must if you are a serious electronic do-it-yourselfer. They really don't come to too much money and you can use some of them for other home repairs besides TV and radio.

There are 17 of them. 1) Soldering gun with two speeds. 2) Roll of 60/40 solder. 3) Neon test lamp. 4) Hot tube puller. 5) Cheater cord for your TV. 6) Roll of high dielectric tape. 7) Plastic hex head alignment tool. 8) Phillips head screwdriver.



9) Set of nut drivers especially the  $\frac{1}{4}$  inch. 10) Filament Continuity Checker that includes latest sockets. 11) Paint brush to loosen dust. 12) Wire strippers. 13) Diagonal cutters. 14) Long nose pliers. 15) Jumper cord with alligator clips on each end. 16) Spray can of tuner lubricant. 17) Spray can of freeze mist.

As you go through the book you'll see how the ownership of these items solves a lot of problems. Of course there are many other items that can be useful but these are a must. •

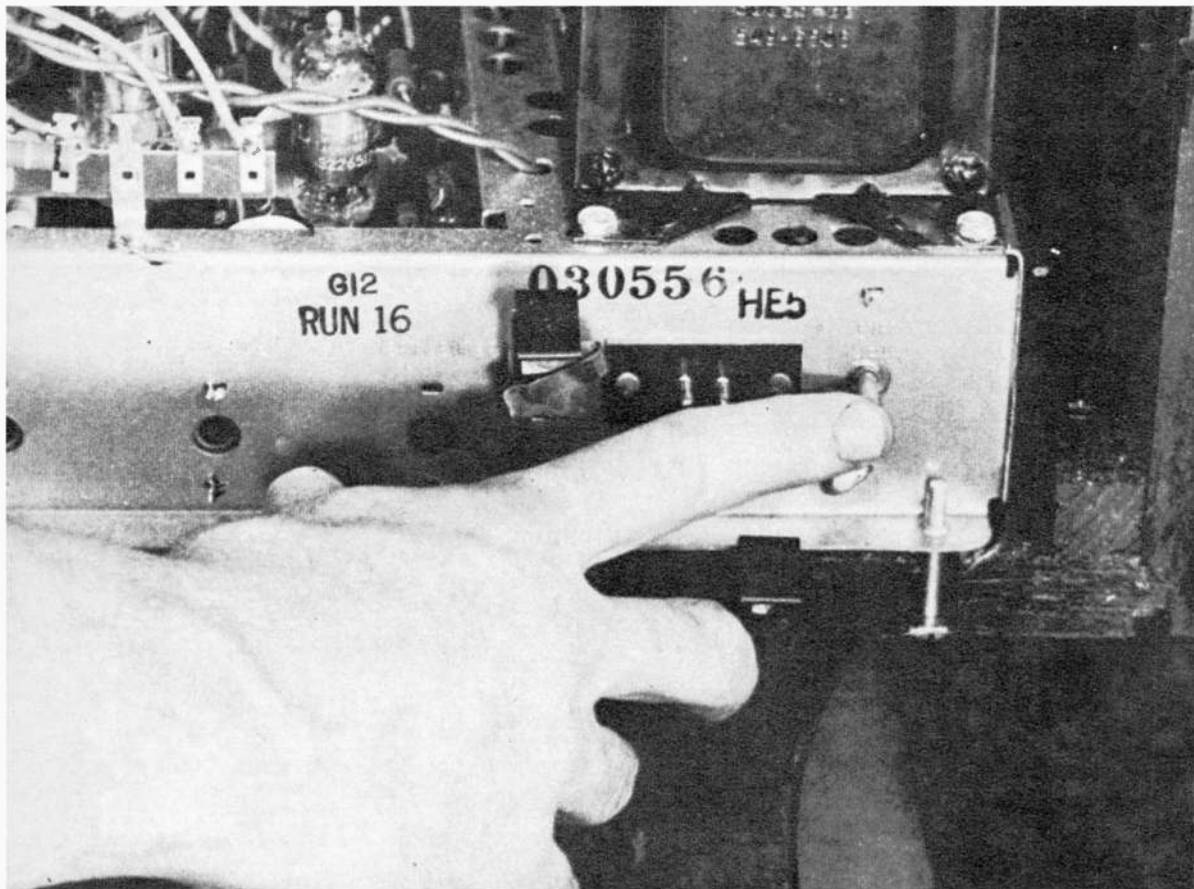

Typical of the newer type "Dead Set" troubles is an open circuit breaker. First step is to reset.

# The Common TV Troubles

What to do with a dead set when tubes are lit or out

**O**UT OF the fifty-five varieties of TV trouble symptoms, two of them are worth devoting an entire chapter to. That's because one out of every two troubles I encounter is either a DEAD SET with tubes lit or a DEAD SET with tubes out cold.

This repair situation is different than it was a few years ago. That's because the power supplies you'll find in present day TV's use silicon rectifiers instead of the tube or selenium rectifiers that were once the standard.

Fortunately these power supplies, even though they break down the most, are the simplest circuits in the TV. They only contain a few components and the heater string of the tubes.

The do-it-yourselfer can score high in the power supply. Let me brief you on the repair techniques on these latest circuits and then I'll review briefly, at the end, the older power supplies.

## Trouble No. 1—Dead Set, Tubes Out

After making sure your wall plug is working and the TV's circuit breaker is reset get ready to use two pieces of test gear. Your jumper wire with the alligator clips and your neon test lamp.

It is indicated that the heater string is in trouble. In the heater string there is 1) the line cord, 2) the off-on switch, 3) the circuit breaker or heater fuse, 4) the heater dropping resistor, 5) the heaters in each tube.

**The Line Cord:** Unplug the line cord from the TV but not from the wall socket. Stick the test prongs of the neon bulb into the line cord holes and see if the neon lights. If it does the line cord is good. Another check is to substitute for the line cord with your cheater cord.

**The Off-On Switch:** Once the line cord is exonerated the next suspect is the off-on switch. As the name implies it is either on or off. The test is to short the switch so it is on. This is done by taking your jumper wire and attaching it across the two terminals with the TV unplugged. If there are four terminals, either locate the two that go to the line or short all four of them together. Then momentarily plug the TV on. Should the tubes start lighting, that's it! Unplug the TV immediately, you have a bad off-on switch. If nothing happens, the switch is probably good.

**The Circuit Breaker:** When the off-on switch is determined good the next suspect in line is the circuit breaker. Widespread use of the circuit breaker in TV sets has occurred in the last few years. It's a good item, more convenient than a fuse but it carries complications that a fuse avoids.

The common conception is that a short in the TV causes a breaker to open just as a fuse pops. However, if a breaker keeps reopening it is not necessarily due to a short. In fact, it is only due to a short in about one out of four cases.

Most of the time when a breaker keeps opening it's a problem in the breaker itself. The circuit breaker has lost some of its current-carrying ability and cannot stay open during normal operation of the TV.

There are two fixes. One, if there is a screw adjustment on the breaker, turn it in a turn or two. That increases its amperage.

If there is no screw adjustment change the breaker with a correct replacement. Should the fix not take, then it is possible a short circuit is causing the opening. (We'll cover the shorts you can fix in the rectifier section of this chapter.)

While the continual necessity of resetting the breaker is the main way the breaker fails, on occasion it just quits and won't be reset. It might feel broken or it might click into position five yet the TV still stays dead.

The quick check is easy like the off-on switch. A jumper wire is shorted across the two terminals and the TV is plugged in. If the tubes start to light the breaker is bad and needs a new one.

A word of caution. During these quick checks on the breaker, the off-on switch, etc., be careful not to short the terminals to the wrong place or let the alligator clip accidentally touch the chassis or pow! Also do not leave the short in as a permanent fix. You must have the part replaced or you're flirting with electrical troubles.

While the line cord, off-on switch circuit breakers and fuses are in all sets, heater fuses are only in parallel heater wired TV's and heater dropping resistors are only in series heater wired TV's. You must know which is which. This knowledge is also useful for the tube servicing.

**Parallel Wired Heaters:** This type heater circuit has a heater transformer. This is a separate transformer or a part of a power transformer that takes the 110 volts from the line and steps it down to 6.3 volts. You

Note that the simple heater string has only a few parts. You must always test them one at a time.

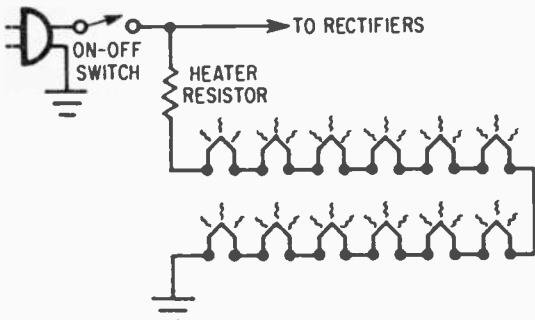

The latest type TV's employ solid state rectifiers like these little jobs instead of a large tube.

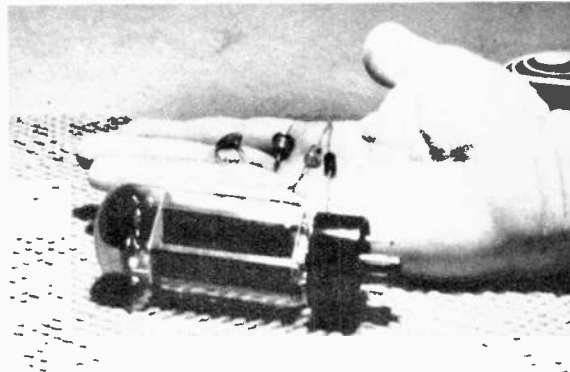



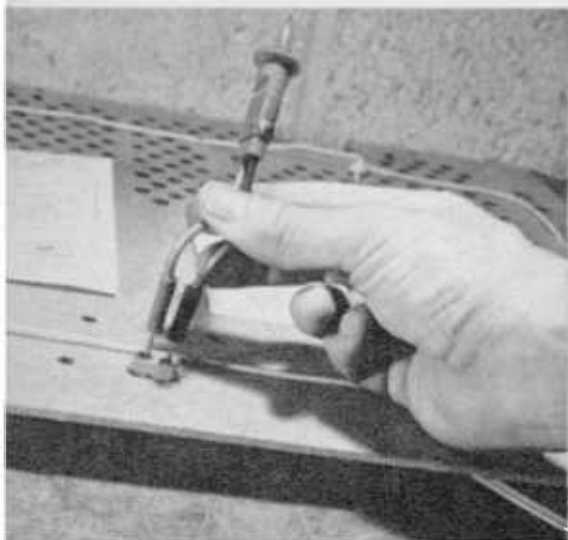

A quick check of the incoming AC and the cheater cord is to put your neon tester into the holes.

A quick check of the circuit breaker is to short it out. If the TV comes back on, breaker is bad.

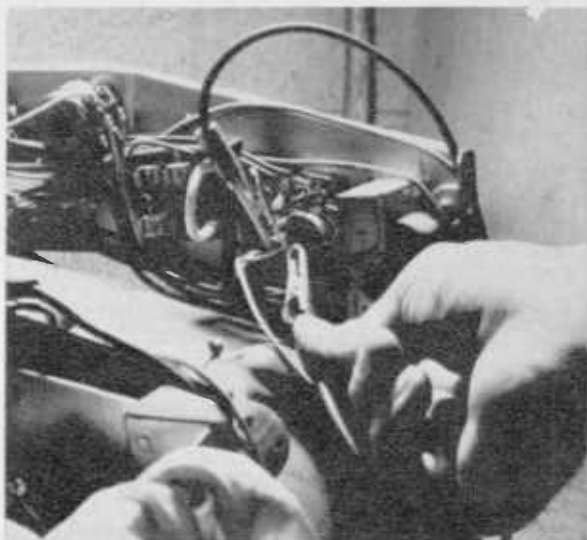

Quick check of the OFF-ON switch is to short it. That way it automatically is in ON position.

Some circuit breakers have a screw-type adjustment. By turning it in, its amperage is increased.

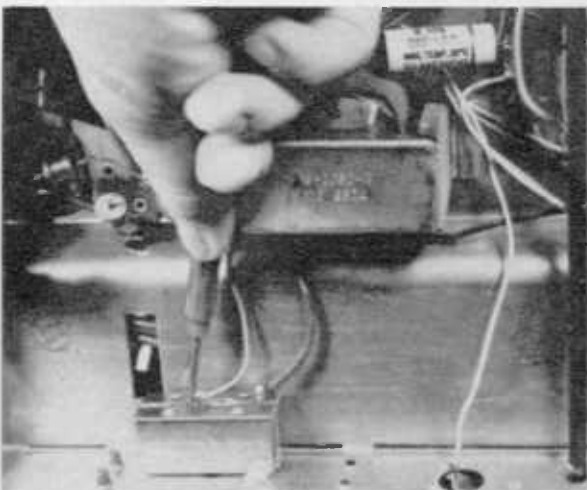
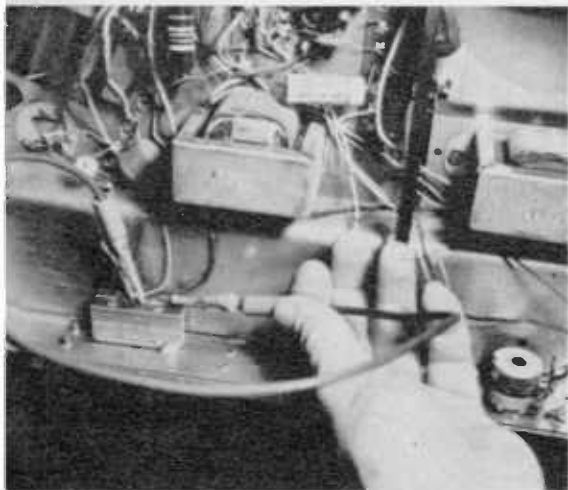

can tell a parallel heater setup by the numbers on the tubes. Look on the tube location guide. Parallel wired type tubes all have a six leading off the numbers. There might be a couple of tubes there with a twelve lead off number. There won't be any other numbers. Should you see any twos, threes, nineteens, etc., it's not a parallel job but a series string.

**The Heater Fuse:** This particular com-

ponent is one of the most hidden in the TV. It is nothing but a piece of fine wire contained in a sleeve of insulation linking the heater transformer to the parallel heater string. It might be shown on the tube location guide and it is displayed on schematic.

When it opens you can spot the break visually if you remove the sleeve. Sometimes it breaks when there is a short in the TV, but most of the time it breaks just be-

## DEAD SET

TROUBLE	REMEDY
Dead Set—Tubes Out— All Sets	Wall plug—line cord— Off On Switch—Circuit breaker—line fuse
Dead Set—Tubes Out— Parallel Wired Heaters	Heater fuse links
Dead Set—Tubes Out— Series Wired Heaters	Heater dropping resistor—Series heater choke—Bad tube—Tube in wrong socket
Dead Set—Some Tubes Lit Normally—Others Out— Parallel Wired Heaters	Loss of one of the heater fuse links
Dead Set—Some Tubes Lit Bright—Others Out— Series Wired Heaters	Shorted tube in heater string
Dead Set—All Tubes Lit Normally	Fusistor—Rectifier tube —Silicon rectifier—Input filter—Circuit breaker high voltage fuse

## TUBE COMPLEMENT

RF—6EA8	AGC, Sync—8BA11
Osc. Mixer—3HA5	Vert.—10GK6
1st IF—4BZ6	(CRT—19GAP4—6 volts)
2nd IF—4BZ6	Hor. Osc.—6GH8
3rd IF—4BZ6	Horiz. Out.—17JN8
Audio, video—10GN8	Damper—22BW3
Audio—13Z10	Total Volts equal 113

cause it is a fine piece of wire. Replacing it is easy. Get the same gauge wire.

**Series Wired Heaters:** This type heater circuit is transformerless. This feat is accomplished by wiring all the heaters together like Christmas tree bulbs. Effectively, then, the two ends of the heater string is hooked into the AC line and the circuit is complete.

When the string is operating normally all the heaters light, not too bright, not too dull but with a normal healthy glow. The tubes are not just thrown in but are placed in line, each tube absorbing a certain amount of voltage. Two volt tubes (like a 2CY5) absorb two volts from the line, twenty-five volt tubes (like a 25CD6) absorb twenty-five volts from the line and so on. Exactly the right amount of tubes with exactly the right voltage dropping is placed in the line to drop the 117 volts from the wall plug.

**The Heater Tube Test:** In a parallel wired

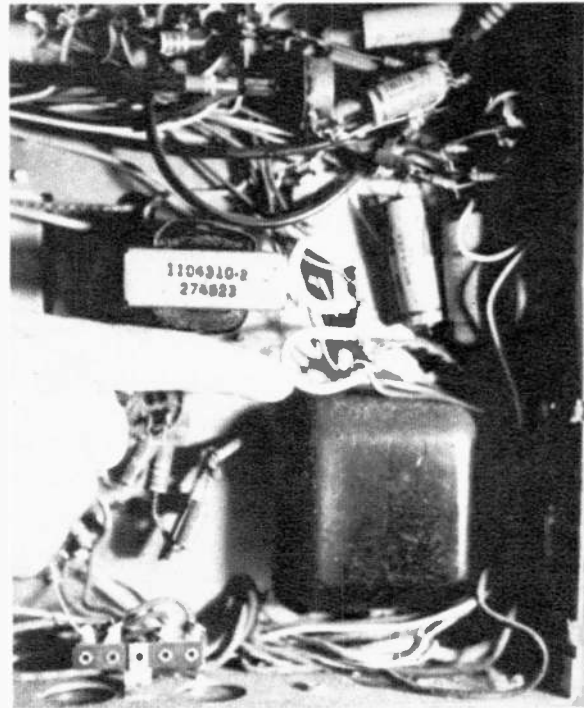

This fine wire covered by insulation is actually a heater fuse, found only in parallel wired TV's.

This large wire wound resistor is in series with tube heaters. It is a common cause of "Dead Set."

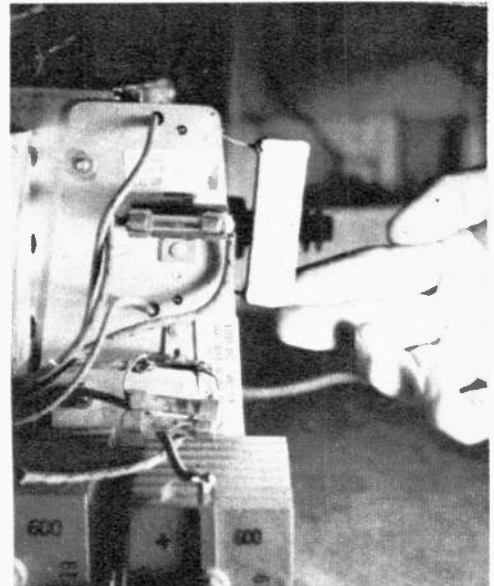

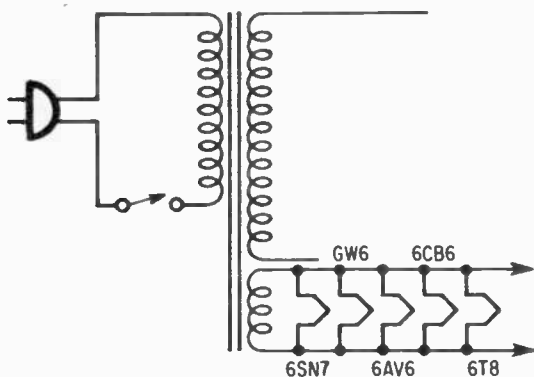

TV, when one tube loses its heater that tube goes out and is quite easily spotted. In a series wired TV when one tube loses its heater, all the tubes go out. You can't tell by looking that one is bad. Just as you would troubleshoot a Christmas tree light string—that is, look for a dead one—that's just the way you seek out a bad tube in a dead series string.

You could pull all the tubes out and head for the nearest do-it-yourself tube tester. However, if you have one of those heater testers I mentioned in Chapter 1, here is where it becomes useful.

Since you are only testing for a bad heater, you simply plug tube after tube into the little tester. The indicator will tell you when you have discovered the bad tube.

**The Heater Dropping Resistor:** There is one difference between a Christmas tree bulb line and a TV series string. That is the heater dropping resistor. For in actuality the TV tubes usually are designed to drop only about eighty or ninety volts. A large wattage resistor is then also placed into the series string to absorb the remainder of the voltage.

It dies by breaking open. It is wire wound and the wire breaks. When it conks out all the heaters in series with it also go out. Thus when you test all the tubes and they are good, chances are high that you've lost your heater resistor.

Once you locate it you'll find it is one of the largest resistors in the TV and has a value something around 50 ohms at 30 watts. You can quick-check it by shorting it out momentarily with your jumper wire. However, don't keep the wire on more than a second or two for as the tubes light, they will get overly bright since 117 volts is coming in, where only eighty or ninety should be. When you replace the resistor



Series wired heater strings might have any number on its tubes. They can be 2, 19 or anything.

Left, you can tell parallel wired heater string by numbers on the tube. Most lead off with a six.

be sure to get one with the same ohmage and wattage. Otherwise you can burn up tubes in a wholesale fashion.

### Variation of Trouble No. 1—Dead Set, Some Tubes Lit

This is a case of some tubes lit and some tubes out. This trouble clears the off-on switch, the circuit breaker and the heater resistor. If it is a parallel wired TV the trouble is usually a heater fuse link. In lots of these TV's there are two or more heater transformer windings, each one with its own fuse link. When one of the tube links open up it kills the light in that one string and the other tubes off the other windings stay lit. The tip-off that it is a fuse link is the fact that the tubes that stay on are lit normal;

On the other hand when you find this condition in a series wired TV the tubes that are lit will be overly bright. This is because the trouble is one of the tubes that is lit. It has shorted and stopped the normal heater voltage flow in itself. That puts the full 117 volts across the tubes that are lit and they light bright;

The heater tester won't show up this trouble since it only reveals open heaters and not shorted heaters. The drugstore tester is the one you'll have to use. However, you only have to test the tubes that are lighting. The ones that are out cold are probably OK.

### Trouble No. 2—Dead Set, Tubes All Lit

When you have a dead set but the tubes are lit, it's because you've lost use of the other part of the power supply, the B plus source. In the B plus line of the supply there is 1) the fusistor, 2) the rectifiers, 3) the input filter, 4) on occasion a circuit breaker.



**The Fusistor:** The fusistor is a plug-in resistor that is used instead of a fuse. They have become very common and their job is to burn up during a short circuit instead of the rest of the TV.

They do the job nicely; however, they have thrown a complication into TV service similar to the circuit breaker complication. The fusistors burn out during normal use without anything being wrong with the TV.

Therefore first step when you lose power and the tubes are still lit is to change the fusistor. Most of the time you have completed the repair.

If the new fusistor also burns up quickly then you know there is other trouble in

the TV. Fusistors come in many sizes, shapes and colors. They come in wire-wound and chemical states. You can usually find them easily and they are usually spotted on the tube location guides.

Most heater testers or tube testers will check them for you.

**The Rectifiers:** B plus voltage is the DC output from the rectifiers in a TV. The rectifier changes the line voltage AC to DC. Rectifiers come mostly in solid state form today; however, there are still plenty of tube rectifiers around. Typical tube numbers are 3DG4, 5U4, 5BC3, 5AS4, etc.

Rectifier tubes display their trouble lots of times. They get pink or purple or go out cold. Other times they won't tip you off

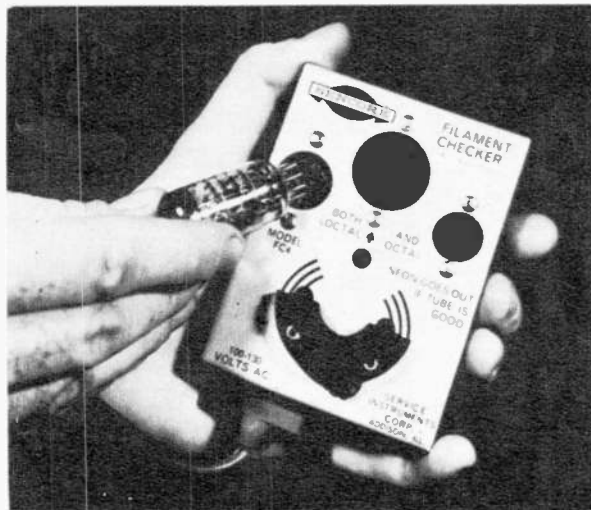

If you own a heater tester now's the time it becomes most useful. The test locates the bad tube.

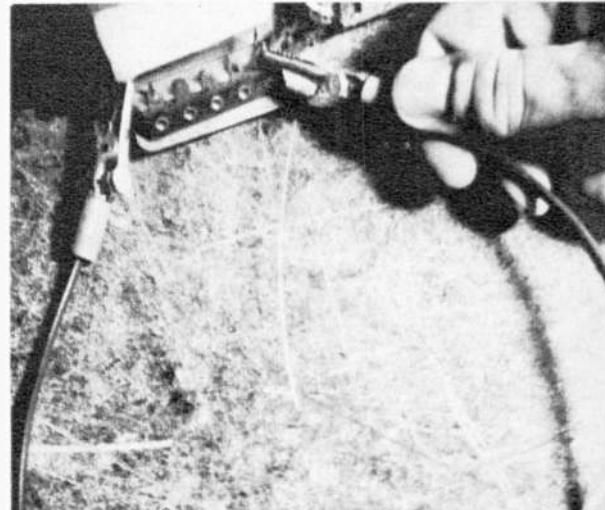

In checking resistor, clamp only one end, touch down with the other. Get off fast if tubes light.

In series wired TV should the tubes light overly bright, a lit tube is shorted, causing trouble.

Other part of the power supply, the B plus line, contains a fusistor, rectifiers and input filter.

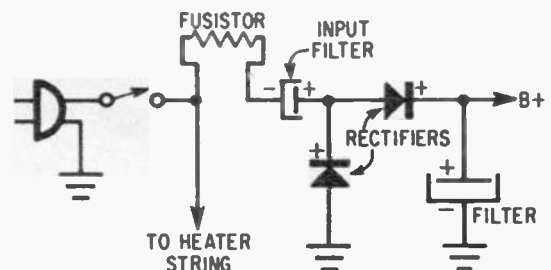
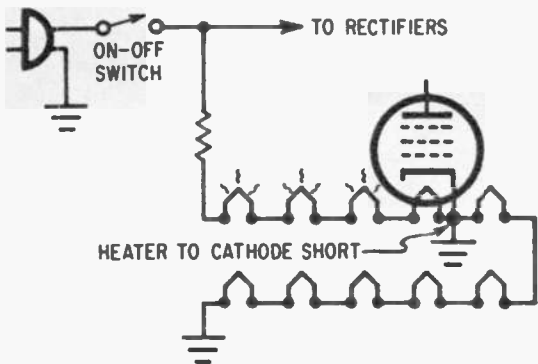

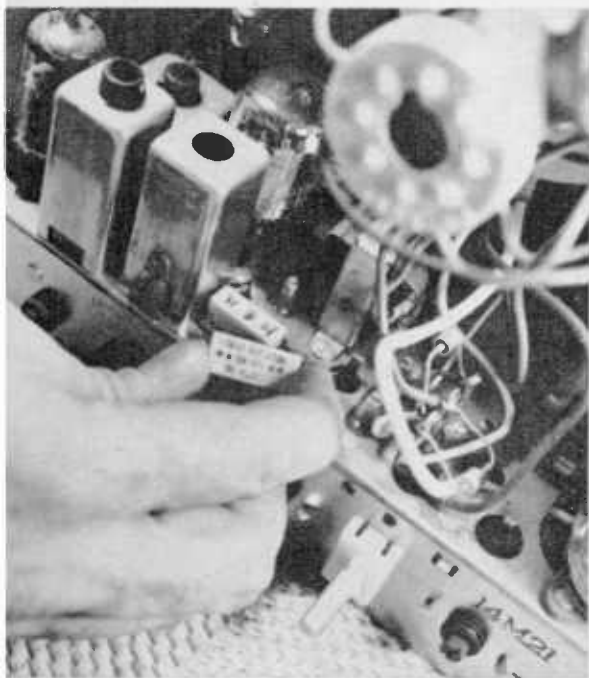

Commonest B plus symptom is blown fusistor. Most times it just opens itself or is caused by short.

The typical low voltage rectifier tubes come in large glass envelopes. Press clip to release.



Fusistors come in many sizes, shapes and colors. They come in wire wound and also chemical state.

that way and light normally even though they have died. The best test is to put another tube in its place. Restoration will be instantaneous when the tube is bad.

Silicon solid state rectifiers are not so easily pinpointed as bad. You must first locate them. They are unbelievably tiny, in comparison to their tube counterparts, and come in many different types. Some look like top hats, others like little bullets, and others like small capacitors. They are all the same, however, and are all interchangeable as long as you use the same current rating. Typical values are 500 MILS, 750 MILS or 1 AMP.

The big problem you will have is with their POLARITY. Like a battery, there is a plus and a minus. You must observe the correct polarity or the TV will start smoking.

Once you have located them and made provisions to observe polarity you can unsolder them from the TV. Now during the heating process no heat from the iron is allowed to get into the body of the rectifier or else the tiny one will be ruined. This is accomplished with a heat sink—that is, attach a clip lead, say from your jumper

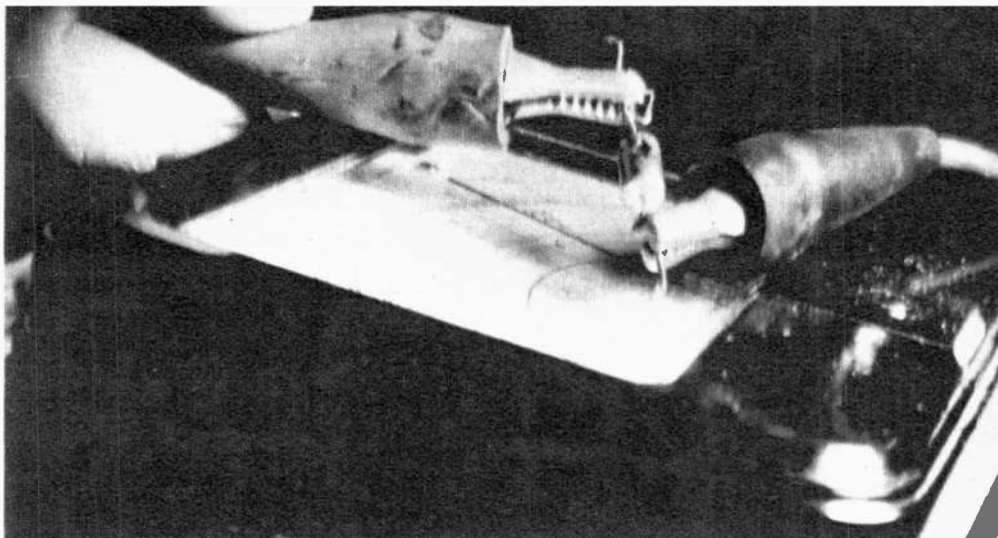

You can test silicon with an ohmmeter. Good one will read short in one direction, open in other.

Right, common trouble causing "Dead Set" is open input filter. Observe polarity when replacing it.

It is most important to observe polarity when replacing rectifier, otherwise TV might smoke.

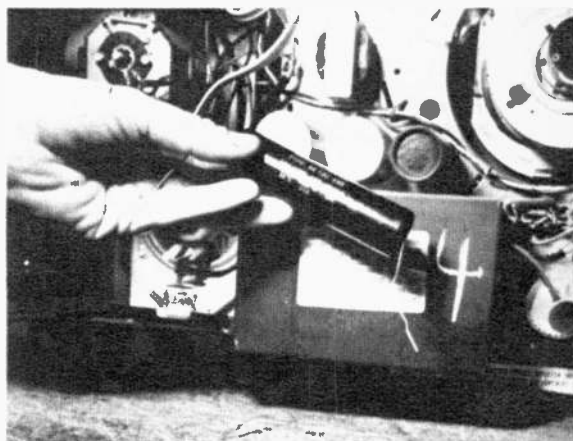
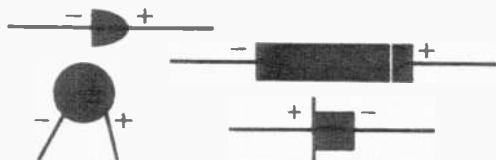

wire between the body of the rectifier and point of contact of the solder gun. That way the heat is siphoned off before it can run down the rectifier lead into the innards of the rectifier.

Rectifiers either short or open. You can test a silicon on the heater tester on the drugstore tester or on an ohmmeter. A good rectifier will show a short in one direction and an open in the other on the heater tester. All you have to do is attach the rectifier to the fuse test and then reverse it. In one instance the tester will read it like a good fuse, and in the other it will read like an open fuse.

With an ohmmeter perform the same test. In one direction the silicon will read a low resistance, and in the other a high resistance when it is good.

Should the rectifier read the same, either good or bad, it's bad. When it reads a low resistance both ways it's shorted. When it reads a high resistance both ways it's open.

**The Input Filter:** In series with the fusistor is a filter capacitor with a value around 200 MFD @ 200 WORKING VOLTS. It is also a common offender causing this DEAD SET—TUBES LIT trouble. After you have exhausted the fusistor and rectifiers as suspects, you stand a very good chance of fixing the trouble if you can locate and replace this filter. You needn't worry about heat sinks. You do have to concern yourself with POLARITY and making sure all the wires you remove from the old filter you put back onto the new replacement. I won't go into the details of location and replacement but this measure will cure this type trouble. If you feel it's over your head call for skilled help and at least you'll have a good idea what he's doing.

**Circuit Breakers:** On occasion a circuit breaker is installed into the B plus line, so when all else fails, before calling the doctor follow the same instructions as outlined in the beginning of this chapter. •



# Safely Fixing High Voltage

This is the problem when brightness goes but sound remains

**T**HE trouble symptom of NO BRIGHTNESS—SOUND OK is the second commonest TV trouble after DEAD SET and is worth two complete chapters. Between the two symptoms about three out of four TV troubles are encompassed. While DEAD SET concerned itself with the low voltage power supply, NO BRIGHTNESS—SOUND OK indicates troubles in the high voltage power supply.

The low voltage supply produces heater and B plus voltage for all the tubes in the TV except the high voltage rectifier and the focus rectifier. The high voltage supply produces heater voltage for these two tubes, a sawtooth waveshape to drive the yoke and the very high voltage needed to power the picture tube; hence its name.

That's why when the high voltage quits, it shuts the light off the picture tube face yet leaves the sound blare merrily along.

Other symptoms such as TWO and

FOUR SIDED SHRINK, DEFOCUSING, KEYSTONE, BLOOMING, ARC LINES, CORONA EFFECT, PIE CRUST AND VERTICAL RINGING BARS (See Chapter 4) occur when the high voltage gets weak or begins to leak. All these symptoms are common to color as well as black-and-white TV's.

The high voltage itself is produced for the sole purpose of being applied to the well of the picture tube. About twenty-six thousand volts are made for a color picture tube and about twenty thousand for a black and white.

The high voltage production starts two circuits ahead of the actual power supply in the horizontal frequency network. Troubles in the horizontal network also can cause the classic NO BRIGHTNESS—SOUND OK symptom. In addition, the horizontal circuits can cause a few other symptoms such as HORIZONTAL SPLIT

The high voltage in a color TV must be set exactly in order for the picture to come in clear and crisp.

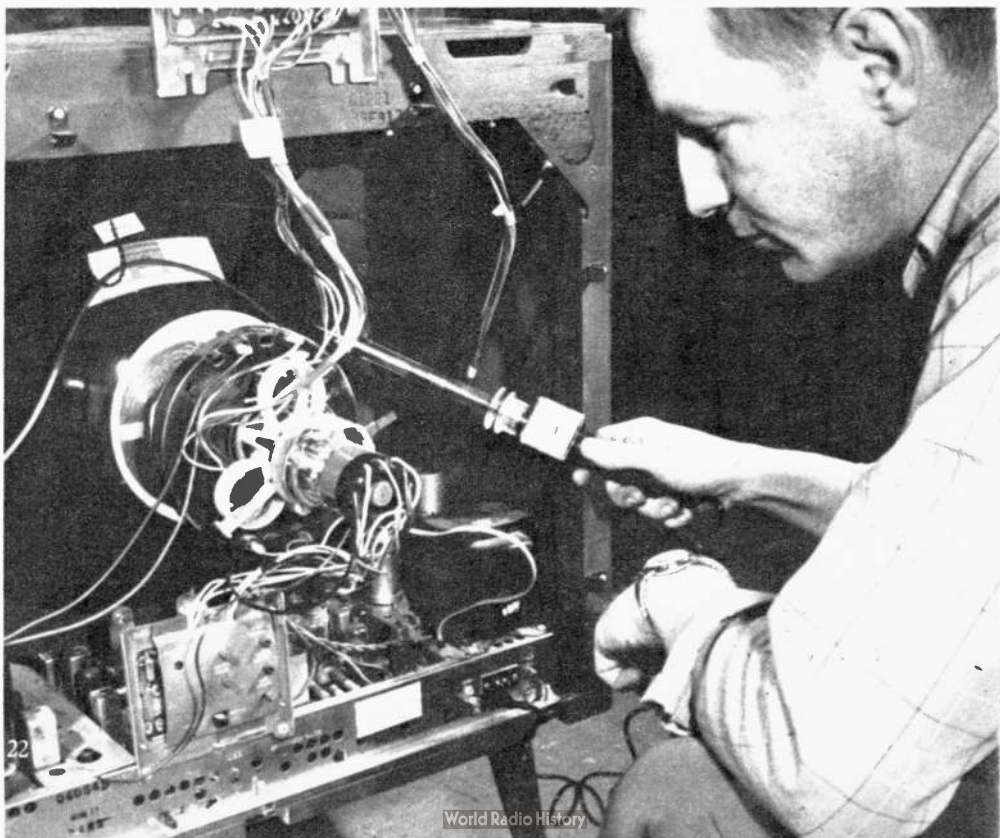

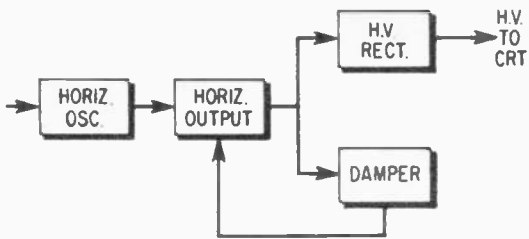

High voltage system in a black-and-white set is relatively simple and has the job of making 18KV.

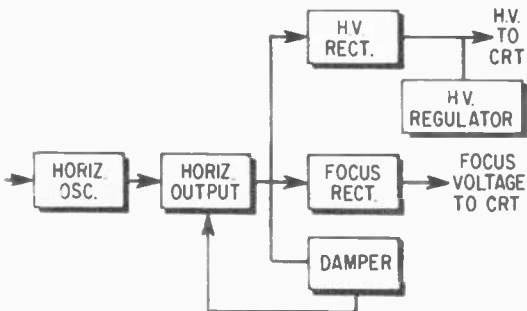

High voltage in a color TV becomes complicated, since it is much higher and needs regulation.

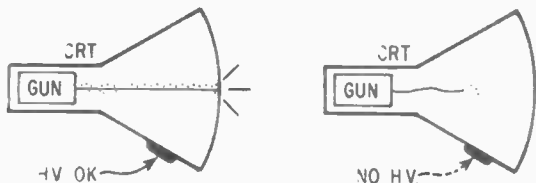

Screen goes black and sound stays on when high voltage quits and extinguishes the cathode ray.

PICTURE, POOR HORIZONTAL LINEARITY and THE BENDS (See Chapter 5). Also keep in mind the fact that the horizontal circuits work so close with the high voltage power supply, all the listed symptoms can occur due to defects in either area although they are commoner in the circuits I've indicated them under.

The high voltage has its beginnings in the HORIZONTAL OSCILLATOR. This is a free-running circuit that runs continually as long as the TV is turned on whether a TV program is on or not. It makes a sawtooth waveshape with a frequency of 15,750 cycles per second. The HORIZONTAL OUTPUT is the next circuit in line. It is fed the oscillator output and amplifies the sawtooth from about 400 volts to about

## NO BRIGHTNESS—SOUND OK

TEST RESULTS	REMEDY
Neon Bulb Lights Brightly	High voltage rectifier High voltage regulator Picture Tube Video Output Tube
Neon Bulb Lights Dimly Pull Rectifier & Regulator, Then Neon Lights Brightly	High voltage rectifier High voltage regulator
Neon Bulb Lights Dimly Pull Rectifier & Regulator, Neon Still Lights Dimly	Horizontal Output Damper Horizontal Oscillator High voltage fuse ckt. bkr.
If Horizontal Oscillator is bad	Replace horizontal output tube also
If High Voltage Fuse is bad	Replace damper tube also
If High Voltage Rectifier in Color TV is bad	Replace horizontal output tube also
Flyback Feels Hot to The Touch	Replace flyback
Width Coil Feels Hot to The Touch	Replace Width Coil
Neon Bulb Lights Dimly or Not At All, Pull Yoke Plug then Neon Lights Brighter	Replace Yoke



Yoke is mounted around neck of picture tube. It sweeps cathode ray, helps in making high voltage.

3000 volts. The 3000-volt output is fed in the horizontal winding of the YOKE.

The yoke then transfers the sawtooth to the FLYBACK or HIGH VOLTAGE transformer. In the transformer the 3000-volt sawtooth is stepped up to 20 kilovolts for black-and-white picture tubes and 26 KV for color.

As the sawtooth is thrown back and forth between the yoke and flyback it tends to take off into further oscillation. The DAMPER circuit dampens these oscillations. Without the DAMPER circuit standing guard there between the yoke and

flyback these spurious oscillations would kill the high voltage.

From the flyback the high AC voltage is fed in the HIGH VOLTAGE RECTIFIER. There the AC is changed to DC and sent directly to the well of the picture tube.

In color TV's a FOCUS RECTIFIER might be found. It acts like the high voltage rectifier except its output (about 5000 volts) is sent to the neck of the picture tube for focusing purposes.

Also in color TV's a HIGH VOLTAGE REGULATOR might be found. It is located

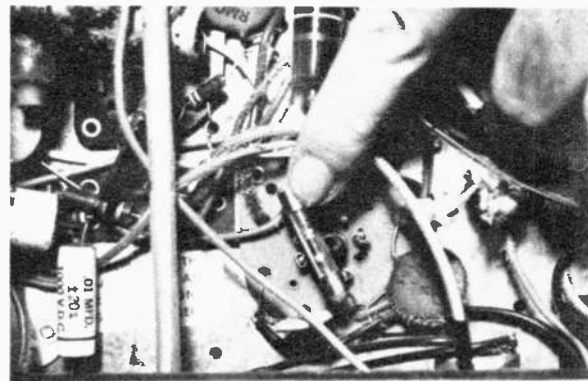
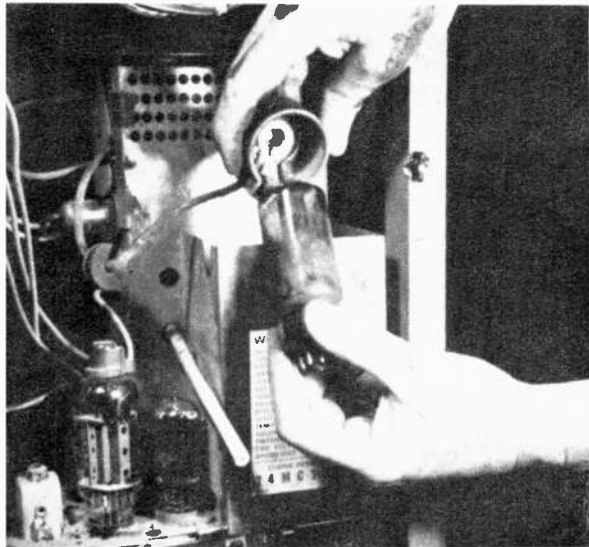

Blown high voltage fuse is a common trouble. You must always replace damper tube as insurance.

Left, high voltage regulator tube is found only in color TV's, keeps high voltage at even level.

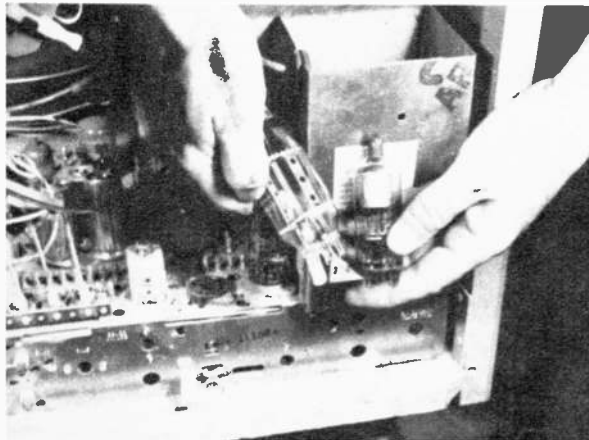

Very common trouble in color TV is shorted H.V. rectifier that also burns up horizontal output.

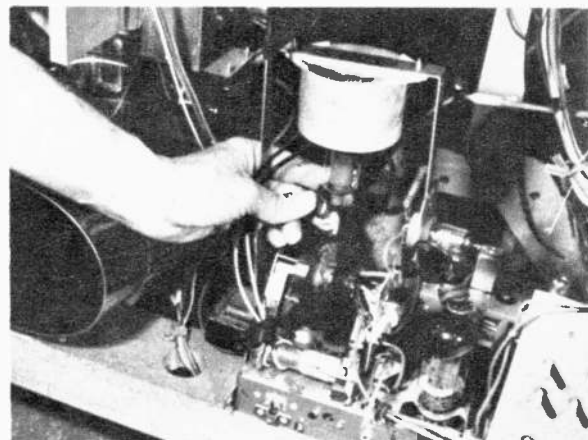

Cutaneous test for heat in a flyback with the TV turned off is useful. It cannot run overly warm.





Be sure to continually discharge both anode lead and well every time you place your hands there.



Be careful when removing caps from high voltage tubes. Male and female parts corrode, can crack.

between the high voltage rectifier and the picture tube well. It keeps the picture tube input at a steady 26KV no matter how bright the picture might be. Bright pictures tend to lower the high voltage.

When you develop NO BRIGHTNESS—SOUND OK these eight circuits all become suspect. Let's go through the step-by-step approach that will narrow down and then pinpoint the actual bad component.

### Trouble No. 3—No Brightness, Sound OK

Since there is such a vast circuit area to investigate when this symptom appears, you must make some tests to accumulate some service information so you can head for the right circuit.

Take your neon tester in hand and turn the TV on with your cheater cord. Place the neon near the cap of the horizontal output tube. The bulb will light bright, light dimly or not light at all. There is RF energy generated around the output tube when it's working, causing the neon to light brightly. The neon lights dimly when the high voltage is weak, and doesn't light when there is no high voltage at all.

When the bulb lights bright it means the high voltage AC areas are cleared. The trouble is in the high voltage DC circuits. These are the HIGH VOLTAGE RECTIFIER and HIGH VOLTAGE REGULATOR. Test these two tubes. There are two other possibilities but they are not connected with the high voltage. One, a bad PICTURE TUBE (see Chapter 14 for further information) and two, a bad VIDEO OUTPUT tube in color sets. See

Chapter 6 for further information on this.

When the bulb lights dimly or not at all disconnect the DC area by pulling the high voltage rectifier and regulators out of the TV. Then try the neon test again. If it lights up now one of these two DC tubes is probably bad. Test them for the AC area is clear.

Should the bulb still light dimly or not at all the DC area is probably clear. Now it's time to test the HORIZONTAL OSCILLATOR and the HIGH VOLTAGE FUSE or CIRCUIT BREAKER.

If you do find a bad fuse change the damper tube as insurance. It is usually the cause of blown high voltage fuses.

Should you find the horizontal oscillator is bad, change the horizontal output as insurance. It usually burns up when the oscillator kills high voltage. If you find a bad high voltage rectifier tube in a color TV, replace the horizontal output as insurance. It's probably bad, too.

After running the TV for awhile, turn it off and feel the flyback and width coil. They must run cool. If either one is overly warm or hot it is the troublemaker.

Your last quick check can be made if your yoke is the plug in type. If so, pull out the plug and try the neon test again. Should the neon come on bright the yoke becomes a prime suspect. It is not necessarily bad but is worth a replacement try. You don't have to install the new yoke around the picture tube neck for a test. Simply plug the new yoke in and try the neon test again. If the neon still lights bright you can be sure the old yoke was bad •

# Other High Voltage Troubles

Blooming, defocusing and keystone are some resulting irregularities

**B**ESIDES NO BRIGHTNESS there are nine other brightness symptoms that occur when troubles appear in the high voltage environs. Five are due to weakened high voltage and the other four happen with high voltage going full strength. Let's go through them.

## **Trouble No. 4—Two Sided Shrink**

This is a common trouble that happens

when the sweep is restricted on the two sides but there is enough output from the sweep circuits to keep the high voltage high enough to show light. The trouble has degrees from a slight space on either side to three or four inches on either side. If the shrink develops any further than that, the picture usually blacks out altogether.

A variation of this trouble happens like this. The picture comes on fine. After a minute or so, as the TV heats up, the picture begins to shrink from the sides. Suddenly the picture collapses into a white vertical line, then disappears altogether.

Invariably this trouble is caused by a weak HORIZONTAL OUTPUT tube. Other suspects are the HORIZONTAL OSCILLATOR and the DAMPER. On occasion the FLYBACK or YOKE can cause this condition.

## **Trouble No. 5—Four Sided Shrink**

Go back to chapter 2 and read the rectifier section. The high voltage is being weakened because there is not enough low voltage. If the rectifier is a tube it's most likely weak and a new one will restore a

Neon bulb, by its intensity of light, tells a technician whether high voltage is strong or weak.





There are many degrees of this two sided shrink condition. As shrink increases, brightness dims.



In some TV's the horizontal shrinking takes appearance of four sided shrinking rather than two.

### THE OTHER BRIGHTNESS TROUBLES

TROUBLE	REMEDY
Two Sided Shrink	Horizontal output tube Horizontal oscillator & damper Flyback or Yoke
Four Sided Shrink	Low voltage rectifier Damper horizontal output
Blooming	High voltage rectifier Horizontal output damper High voltage regulator Focus rectifier
Defocused	Focus rectifier High voltage rectifier High voltage regulator Horizontal output
Keystone	Replace yoke

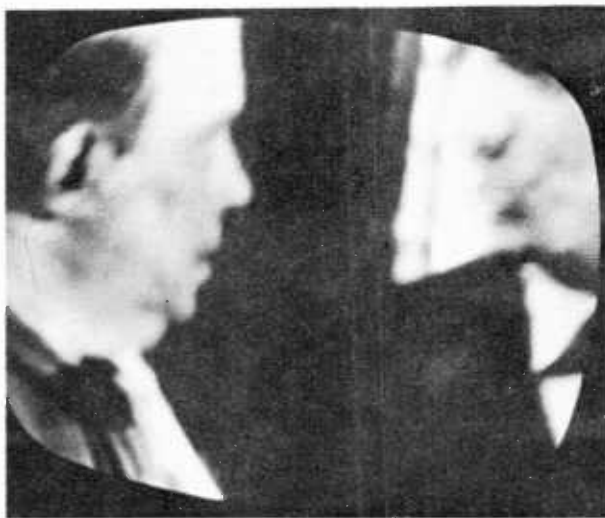

Blooming occurs from low high voltage. Adjusting the brightness control reveals this condition.

### YOKE REPLACEMENT TROUBLES

Mirror Image	Reverse horizontal yoke leads
Upside Down	Reverse vertical yoke leads
Vertical Ringing Bars	Replace anti-ringing network with original
Arcing Lines on Screen	Damper tube Any other tube showing sparks
Corona Effect	Flyback insulation CRT well area cleaning
Piecrust Effect	Horizontal Output Tube
Barkhausen Effect	Tighten flyback horizontal oscillator Horizontal phase detector damper

Defocusing is not a common monochrome problem but it happens quite often in color high voltage.





Common cause of defocusing in a color television is this small focus diode tube mounted near flyback.

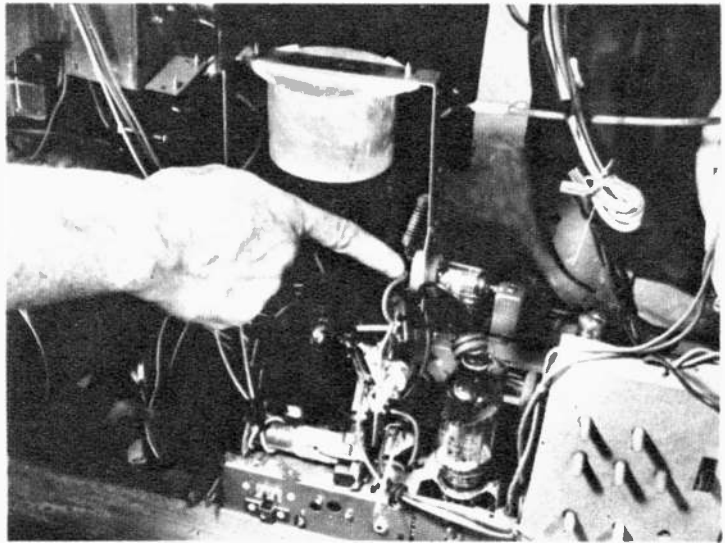

This is a classic symptom mostly found in black-and-white TV's. It is 99 per cent caused by yoke.

There are four yoke windings. You can tell which winding has shorted by where narrow picture is.

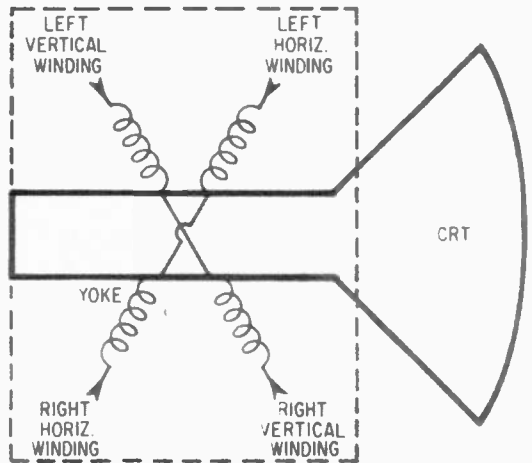

full picture. If the set has silicons one of them is probably open. Should the low voltage troubleshooting not help the next suspects are the DAMPER and HORIZONTAL OUTPUT tubes.

### Trouble No. 6—Blooming

The condition of blooming—that is, the picture puffs up as you advance the brightness control and shrinks as you turn the control back—is due to low high voltage. As the potential decreases the condition becomes more and more pronounced.

In black and white TV's whenever that condition occurred a fast replacement of the HIGH VOLTAGE RECTIFIER usually

effected a cure. It gets a little more sticky with a color set. The rectifier is still a prime suspect, but the HORIZONTAL OUTPUT tube, the DAMPER, the HIGH VOLTAGE REGULATOR, and the FOCUS RECTIFIER are also consistent troublemakers. Anything that will lower the regulated 26 kilovolts just a little bit causes the blooming. The monochrome TV could become lowered a great deal before it would display blooming.

### Trouble No. 7—Defocused

When you lose focus try the brightness control. If the picture blooms too, the blooming is the real symptom, with the de-

focusing a secondary result. If the picture doesn't bloom you have a true focus symptom. Turn the focus control in the back. On color TV's it usually sticks out of the high voltage cage. If the control has no effect, replace the FOCUS RECTIFIER. It can be a tube or a small skinny selenium rectifier. In most cases it will probably cure the trouble.

When the control does have some effect but won't quite bring the picture back into sharpness, first test the focus rectifier again, but chances are good the HIGH

VOLTAGE RECTIFIER, HIGH VOLTAGE REGULATOR or HORIZONTAL OUTPUT is at fault.

### Trouble No. 8—Keystone

This classic picture-book symptom happens if one of the windings of the yoke shorts. There are four windings, two horizontal and two vertical. The horizontal has one winding for the left side and the other for the right side of the screen. The vertical has one for the top and one for the bottom. When one of these shorts, that side narrows



When you replace a yoke and your picture is like this, you must reverse leads in order to restore.

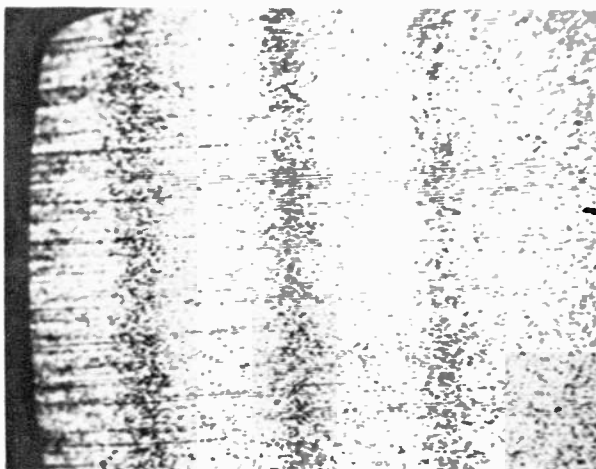

Should you replace a yoke and these ringing bars appear, install the old network into the new yoke.



Arc lines across the screen are common black-and-white trouble. Mostly they're caused by damper.

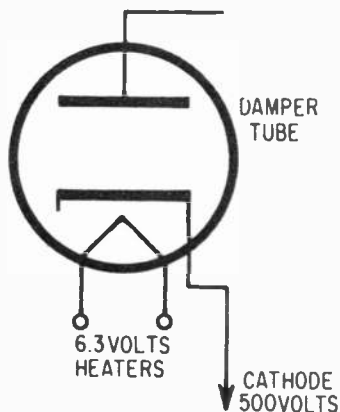

Potential between heater and cathode in damper is high. This subjects it to constant breakdown.

and the picture develops a keystone look. The condition can be accompanied by blooming, defocusing and low brightness. However, forget these secondary symptoms. Whenever you see a keystone picture, change or repair the yoke.

The next two troubles are due to full strength high voltage that is leaking from the circuits.

Saying "change the yoke" and actually replacing it are not quite the same thing.

Quite often I change a yoke, the keystone is cured but I find the TV now exhibits one or more of three post-yoke troubles.

They are **MIRROR IMAGE**—all writing on the screen reads backwards like it does in a mirror. **UPSIDE DOWN**—the picture shows heads at the bottom and feet at the top. **VERTICAL RINGING BARS**—the picture shows four or five vertical white bars superimposed on the picture.

Mirror image occurs when the horizontal

Quite often the insulation breakdown between this anode lead and metal areas causes corona. The remedy is move lead and insulate.

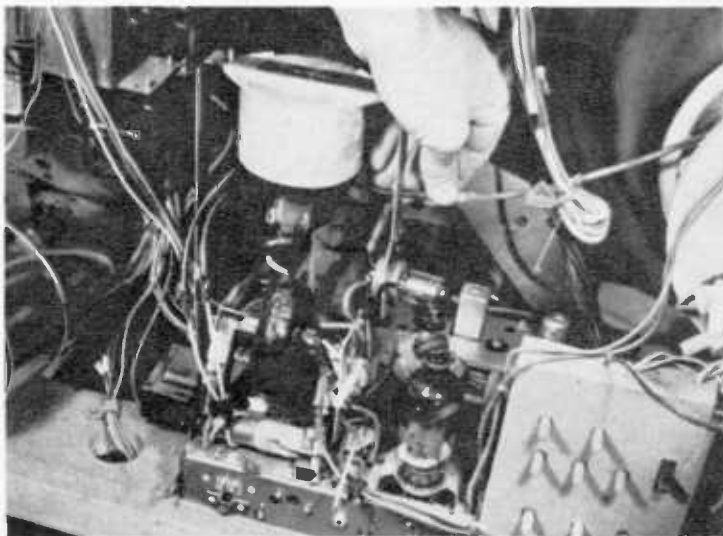

If there are any sharp points, high voltage can spew out. Smooth all parts with hot iron to cure.



Clean off all dust near well, especially on color TV. Otherwise a corona discharge will take place.



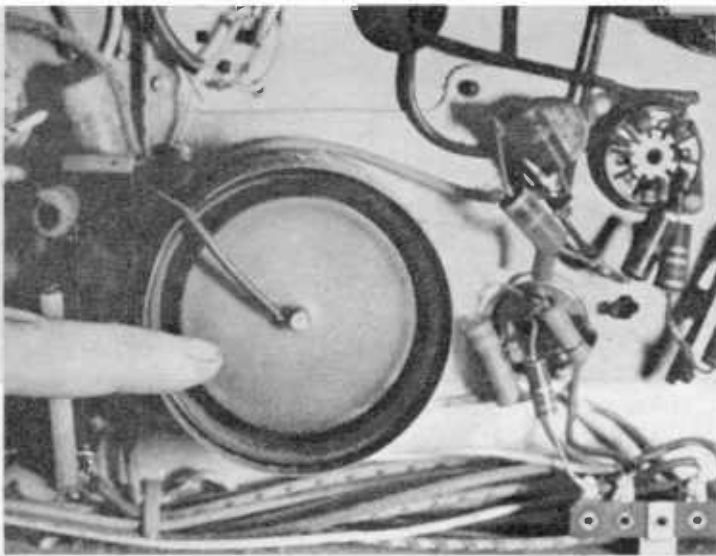

Thick plastic covers are placed on rectifier bottoms to insulate it from chassis. Breaks can cause corona.

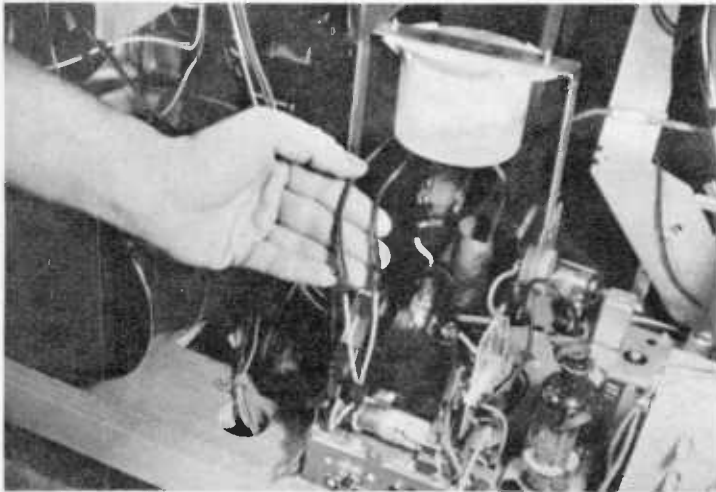

Common cause of high voltage leaking is this rectifier heater winding. Its one turn is easily replaced.



When a circle looks like a plecrust, try replacing horizontal output tube or tightening flyback.

yoke leads are reversed. To cure, simply switch them.

Upside down happens when the vertical yoke leads are reversed. To cure switch them.

Vertical ringing bars show up when the new yoke has the wrong anti-ringing network inside the yoke. These are all the little capacitors and resistors you'll see as you peel off the yoke cover. Each component is on a numbered tie point. Make a sketch of their positions and install the old components on the new yoke. The ringing bars will disappear.

If all three conditions appear together proceed with all three repair measures.

### Trouble No. 9—Arcing Lines Across Screen

The damper circuit has a rough voltage



These two troubles are caused by output tube. It will test GOOD in a checker but still be bad.

arrangement imposed on it. 600 volts is taken off at the cathode. The heaters run around six volts. This makes the potential between the cathode and heaters close to 600 volts.

The heaters physically touch the cathode with only a ceramic sleeve between them. The insulation sleeve is subject to breakdown. When it does break, the voltage leaks across to the heaters. This causes the arc lines on the screen. If the arcing continues or develops into a dead short, the high voltage fuse will blow.

To cure arcing, try replacing the DAMPER tube. Also, should the high voltage fuse blow out periodically, change the damper tube.

In rare cases, other tubes can cause similar troubles. Fortunately you can get a visual tipoff by looking for sparks in the tube. Look in all the tubes. Any such spark indication in any tube means the tube must be replaced.

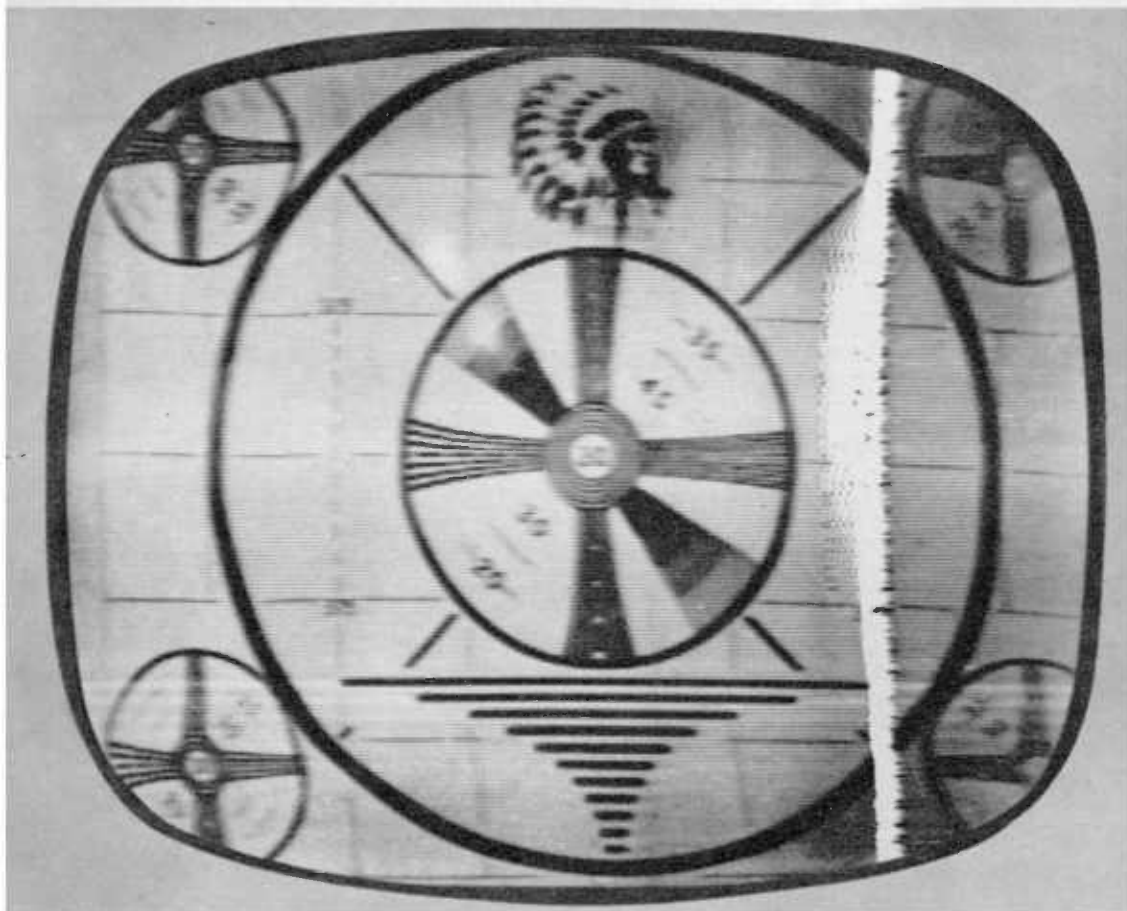

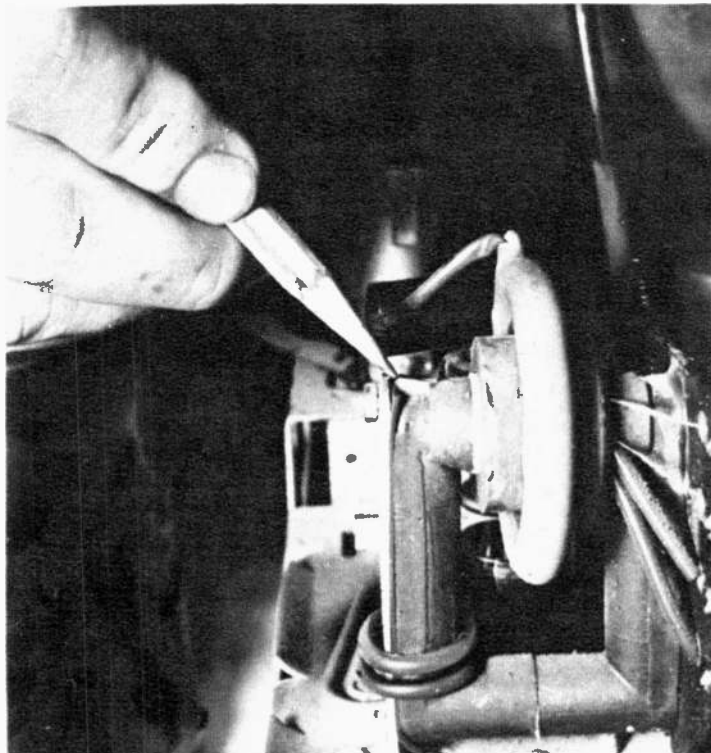

Tamping a few pieces of wood between core and winding tightens flyback, stops mechanical vibration.

### Trouble No. 10—Corona Effect

This is caused by the high voltage spilling out of its circuit to the nearest ground point. When it happens you can hear the hissing, smell some ozone, and if you darken the room, see a blue trail of electricity somewhere in the high voltage or sweep circuits.

This trouble is especially prevalent in hot humid weather and will occur around the picture tube well or cap of the high voltage rectifier. The cure is usually easy. Place a piece of high voltage insulation material like plastic, or fish paper, between the emitting surface and the ground point.

If the bottom of the high voltage rectifier socket is emitting to the chassis there are plastic cups made especially to be placed there.

If the picture tube well is emitting, clean the surrounding surface thoroughly and wipe it dry. That should cure it.

Should you cure one corona discharge and another one starts up, there is complication. There is a short some place else. It usually is in the anode lead from the rectifier to the picture tube well or in the rectifier heater winding in the flyback. Taping up the anode lead short usually

cures the condition but the heater winding must be replaced.

There are two troubles that occur when the horizontal output tubes' internal structure gets loose and begins to vibrate mechanically as the sawtooth wave is processed through it. When that happens you'll see on the screen:

### Trouble No. 11—Piecrust Effect

(It gets its name from the raggedy appearance of any circle that might show on the screen.)

### Trouble No. 12—Barkhausen Effect

(This name comes from the man who first noticed the condition.)

A new HORIZONTAL OUTPUT tube will usually cure both conditions. If it doesn't, the FLYBACK transformer might have a loose core. You could try tamping little wooden sticks between the core and the metal frame to halt any physical vibration.

As a last resort before turning these troubles over to the TV man test the HORIZONTAL OSCILLATOR, HORIZONTAL PHASE DETECTOR and the DAMPER. •



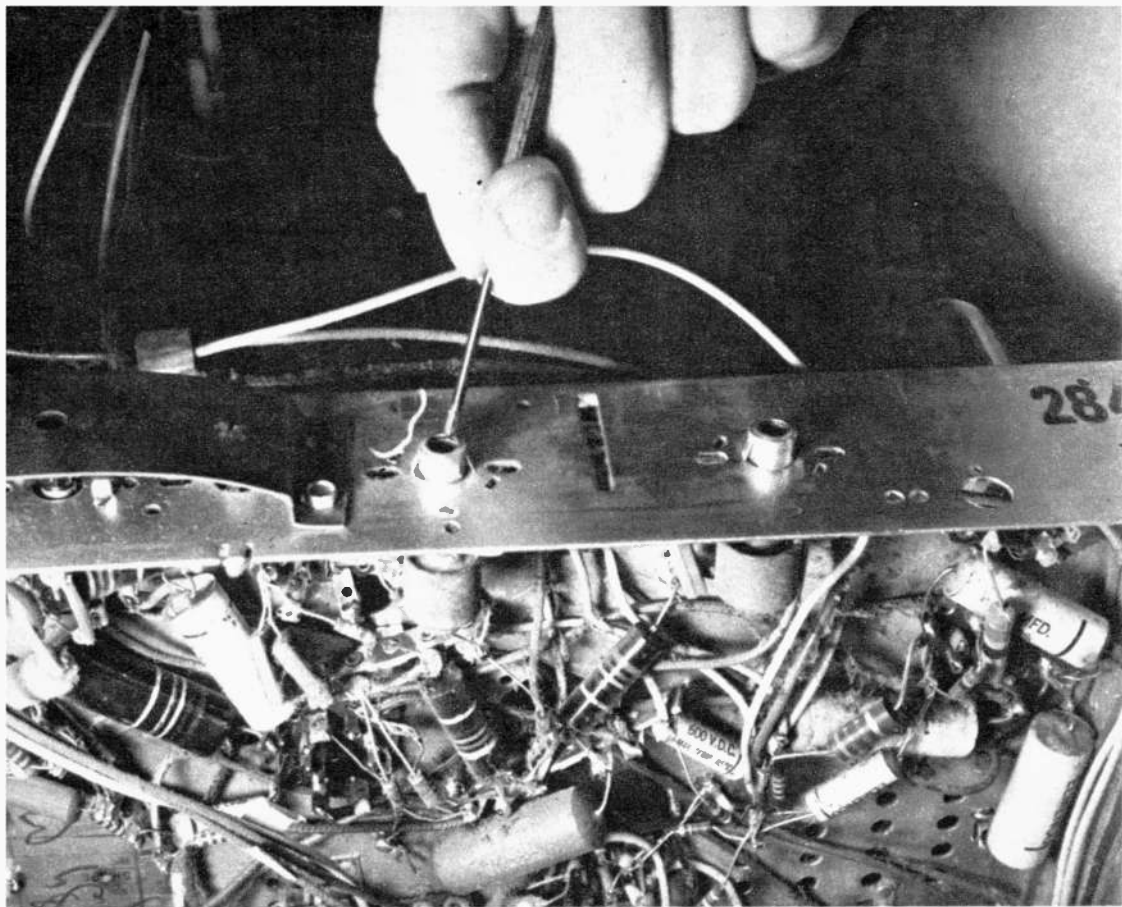

The common "Christmas tree" problem can be cured by backing off the horizontal core a turn or two.

# What to Do About Flopover

Counteracting horizontal, vertical and color sync trouble

**T**HERE are three different types of TV flopover, each with its own little family of troubles. There is horizontal sync trouble, vertical sync trouble and color sync trouble.

Horizontal sync trouble is most easily recognized as HORIZONTAL LINES. Its close relatives are CHRISTMAS TREE EFFECT, HORIZONTAL SPLIT PICTURE, THE BENDS and POOR HORIZONTAL LINEARITY.

Vertical sync trouble is most evident as VERTICAL ROLL. Its brothers and sisters are NO VERTICAL SWEEP, TOP AND BOTTOM SHRINK, VERTICAL FLOP-OVER AT BOTTOM, VERTICAL RE-TRACE AT TOP and POOR VERTICAL LINEARITY.

A variation of both horizontal and vertical SYNC TROUBLE happens when the two of them are combined and the picture won't lock in either horizontally or vertically.

Color sync trouble becomes noticeable when your color picture displays a rainbow. The rainbow can be fixed onto the screen in three thick swaths of color or it can be rolling through the picture. It's named BARBER POLE EFFECT. It has only one close relative—and it is hard to recognize because there is no family resemblance. Its name is LIGHT GREEN SCREEN and when it's appearing it does so at all times whether a color or a black and white picture is supposed to be showing.

**What the Oscillators Should Do:** I mentioned the production of the sawtooth waveform (in Chapter 3) by the horizontal oscillator, its amplification by the horizontal output and its transference into the yoke where it helps make the high voltage.

The sawtooth does a second job in the yoke, having nothing to do with high voltage. In fact, this second job is really what the sawtooth was designed for. The high voltage production is really just a by-product.

The yoke is in effect around the picture tube neck and has a magnetic influence on

the electron beam that is traveling from the electron gun to the phosphor. The sawtooth waveshape's job is to cause the beam to sweep side to side across the screen. The horizontal sweep causes 15,750 horizontal lines per second to appear on the picture tube face.

At the same time, the vertical oscillator is also making a sawtooth waveshape—that is, amplified in the vertical output and transferred to the vertical windings of the yoke. The vertical frequency is only 60 cycles per second and causes the horizontal lines to be pulled up and snapped back 60 times every second.

To be exact, there are 30 full picture frames drawn on your TV screen every second. First the odd number lines 1 through 525 are drawn. Next the even number lines are drawn 2 through 524. These two line fields make one picture frame. The result of the 60 fields is the 30 frames.

The two oscillators run free and produce this precise screen full of light as long as your TV is on, regardless of whether the TV transmitter is on or not.

Now that's what your horizontal and vertical circuits should be doing. Let's see what happens when they start doing what they're not supposed to.

### Trouble No. 13—Horizontal Lines

When the horizontal oscillator begins drifting away from the 15,750 CPS, instead of a picture your TV displays a screen full of horizontal lines. The further away from 15,750 the oscillator gets the more lines appear on your screen.

In older TV's this circuit was quite unstable and there were many components and horizontal frequency controls. In the past few years the TV's dispense with all that and the circuits are quite stable. If you have an old TV, refer to the old alignment notes for your particular set. However, if your TV is under six years old the following quick checks are applicable.

Replace the HORIZONTAL OSCILLATOR tube. Next major suspect is the HORIZONTAL PHASE DETECTOR. In some sets it's a tube but in most sets it's a silicon dual diode. Some of them plug in, others must be soldered in. Be sure to get the right type. There are three types and they all look physically the same. They are not interchangeable.

Next step is to try adjusting the HORIZONTAL FREQUENCY and HORIZONTAL PHASE coils. Be sure to use only the correct tool: a hex head neut stick for powered cores (otherwise you'll crumble

## FLOPOVER

TROUBLE	REMEDY
Horizontal Lines	Replace horizontal oscillator Horizontal Phase detector tube or dual diode
Christmas Tree Effect	Adjust horizontal frequency phase coils with neut stick Freeze mist all associated components
Horizontal Split Picture	Replace those that cause extreme change or clear trouble
The Bends	Horizontal output, oscillator, phase detector, sync sep., noise cancellor, sync Freeze mist
Poor Horizontal Linearity	Damper—Horizontal output, adjust horizontal drive, linearity, width, pull width sleeve
Vertical Roll	Vertical oscillator out, sync tubes
No Vertical Sweep	Vertical oscillator out Vertical linearity pot
Top & Bottom Shrink Vertical Bottom Foldover Vertical Top Retrace Poor Vertical Linearity	Vertical Height pot, Yoke Freeze mist
Sync Trouble	Sync separator, noise inverter, horiz. phase detector, vertical integrator, vertical oscillator
Barberpole Effect	Reactance tubes, burst amplifier, burst keyer 3.58 mc oscillator
Light Green Screen	

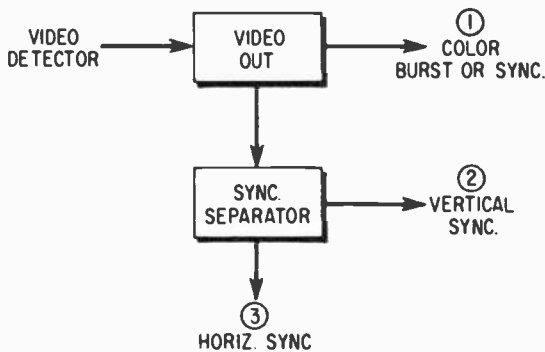

There are three types of flopover because there are three kinds of sync: horizontal, vertical and color.

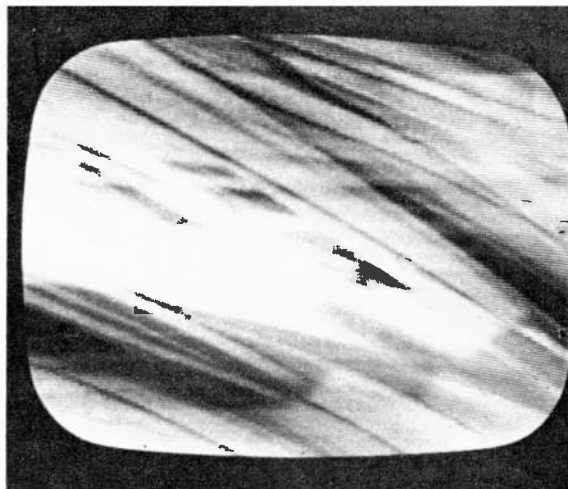

When horizontal sync is lost, the picture whirls off into horizontal lines. There are many degrees.

them) and a screwdriver for metal adjustments.

Should none of these measures cause a fix you have one last chance and it's a good one. Take your spray can of FREEZE MIST, and with the TV on, spray all the little components, one at a time, in the area of the horizontal oscillator and phase detector circuits.

Should your picture clear or change its appearance drastically as you freeze a component, change that component. It's probably the troublemaker.

There are two variations of this same trouble. In older TV's they had a separate cure, but in more recent models use the same technique I just covered. These two troubles are **Trouble No. 14—Christmas Tree Effect** and **Trouble No. 15—Horizontal Split Picture**. The next trouble in line is called:

### Trouble No. 16—The Bends

When the TV performers get twisted faces or spinal curvatures it can be a horizontal circuit or sync circuit problem. Try replacing the HORIZONTAL OUTPUT, the HORIZONTAL OSCILLATOR, HORIZONTAL PHASE DETECTOR, SYNC SEPARATOR, NOISE CANCELLER and any other tubes with the word SYNC in its nomenclature.

A heater to cathode short or change in any of these tubes causes this problem. Also try the freeze mist spray on associated components. This trouble sometimes responds to this technique.

### Trouble No. 17—Poor Horizontal Linearity

The damper circuit, in addition to dampening spurious flyback oscillations, ends up with a rectified output like a power supply. Its output is higher than the low voltage supply and is called boost B-plus. It produces about 600 volts DC. This volt-

age is fed to output tubes such as the horizontal, vertical and audio.

When the damper circuit weakens, especially because of a weak DAMPER tube this boost B-plus lowers and one of the results is poor horizontal sweeping of the CRT screen. An extreme case is a picture that exhibits a shrink from one side and an oversweep on the other. A circle on the screen looks like a flat-headed egg lying on its side.

Also, white vertical lines can appear. A slightly weak damper just pulls the picture out of shape slightly. A TV performer will have one large shoulder and one narrow one.

You can attempt the cure by replacing the DAMPER and the HORIZONTAL OUTPUT. Also by adjusting the HORIZONTAL DRIVE CONTROLS, LINEARITY and WIDTH CONTROLS.

### Trouble No. 18—Vertical Roll

The vertical problems can be a little less obvious than the horizontal. Analyze them a little further before you attack. Try adjusting the vertical hold control to see if you can stop this movie film type slipping action. If the picture can be stopped but won't lock in, test the SYNC tubes first and the VERTICAL OSCILLATOR-OUTPUT second. The oscillator is running at the right frequency but there is no lock-in action. When the picture is running and can't be slowed or stopped, check the VERTICAL OSCILLATOR OUTPUT first and the SYNC tubes next, for the oscillator is nowhere near 60 CPS.

### Trouble No. 19—No Vertical Sweep

This clear-cut trouble of one bright white horizontal line needs one immediate





The TV picture can slip down, roll up or whirl past. Either way the trouble is a vertical one.

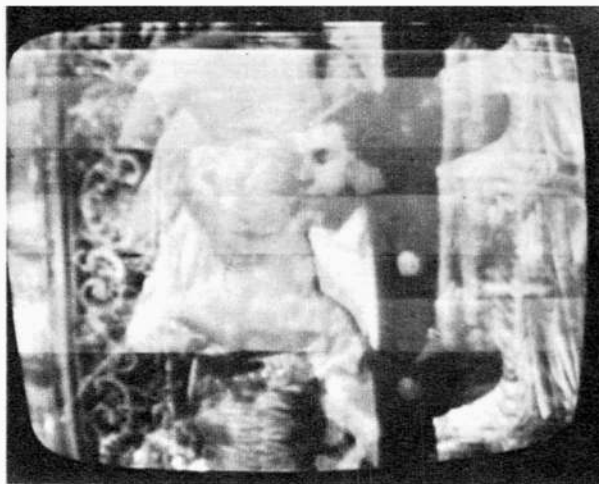

Try adjusting vertical hold control to see if you can stop this movie film-type slipping action.

service move. Turn the brightness down! All the 525 lines of TV picture are being concentrated on one section of phosphor. Prolonged TV operation in this defective manner will burn a mark across your screen that can only be remedied with a new picture tube.

After that you can try restoring your vertical sweep. Test the VERTICAL OSCILLATOR OUTPUT and try adjusting the VERTICAL LINEARITY and VERTICAL HEIGHT controls.

Lastly, you can try freezing the associated components. Should you freeze one and the sweep is returned, even slightly, replace that indicated component. It is probably the bad one.

If none of these measures restore, you can try a new YOKE, then call for skilled help.

There are four variations of this trouble, actually minor degrees of no vertical sweep. The exact same repair measures apply. They are **Trouble No. 20—Top and Bottom Shrink**, **Trouble No. 21—Vertical Foldover at Bottom**, **Trouble No. 22—Vertical Retrace at Top**, and **Trouble No. 23—Poor Vertical Linearity**.

There are three points about the LIN and HEIGHT controls to remember. 1) Lots of times adjusting these controls throws the vertical frequency off and you must continually readjust the vertical hold control to see where you are. 2) The VERTICAL LINEARITY control tends to spread the top section of the picture. 3) The VERTICAL HEIGHT control tends to spread the bottom section of the picture.

#### Trouble No. 24—Sync Trouble

While the two oscillators run free and produce a fine screen full of light the TV

transmitter sends a picture to be displayed on the lit screen. It's as if the TV is like a movie projector. The screen full of light is analogous to the bulb in the projector and the TV picture does the same job as the movie film. That is, it intercepts the light to produce different shades of gray on the screen.

The TV transmission also contains three special lock-in signals. One to lock the horizontal oscillator, two to lock the vertical oscillator and three to lock the color oscillator.

Should you lose the horizontal sync signal you'll lose horizontal sync causing all the aforementioned horizontal troubles. The same also applies for vertical and color sync.

There is a special hookup into the path the signal takes that siphons off a portion of the signal. This sampling is then sent into the SYNC SEPARATOR and its associate circuit the NOISE CANCELLER or NOISE INVERTER.

In these circuits the horizontal and vertical sync components are separated and the horizontal signal is sent to the HORIZONTAL PHASE DETECTOR as the ver-

The raster is caused by two sweeps. The 15,750 CPS horizontal line sweep and 60 CPS vertical.

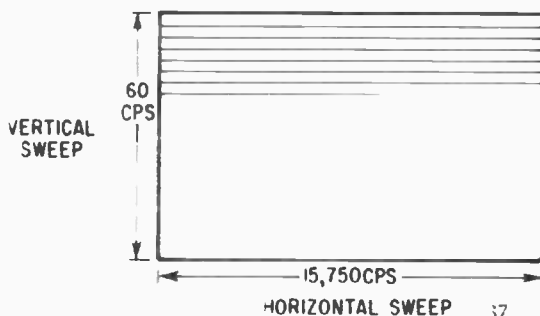

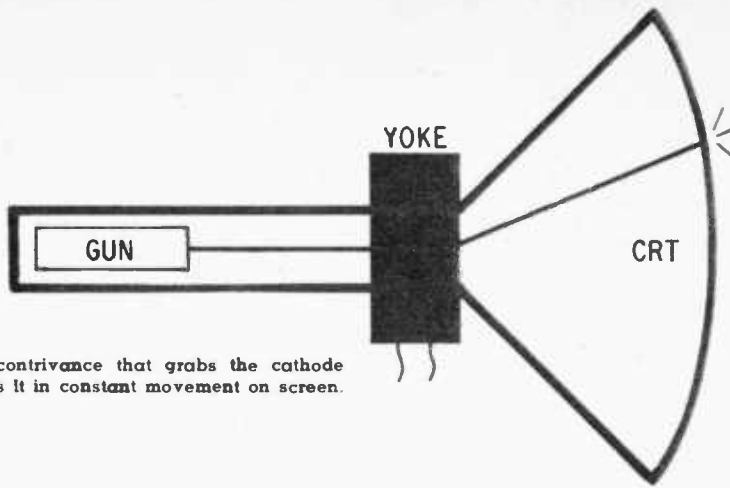

Yoke is the contrivance that grabs the cathode ray and keeps it in constant movement on screen.

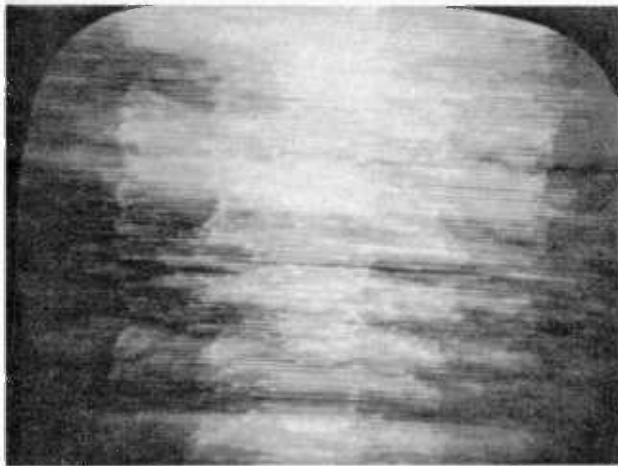

When the horizontal oscillator either drifts from 15.750 CPS or gets out of phase, this occurs.

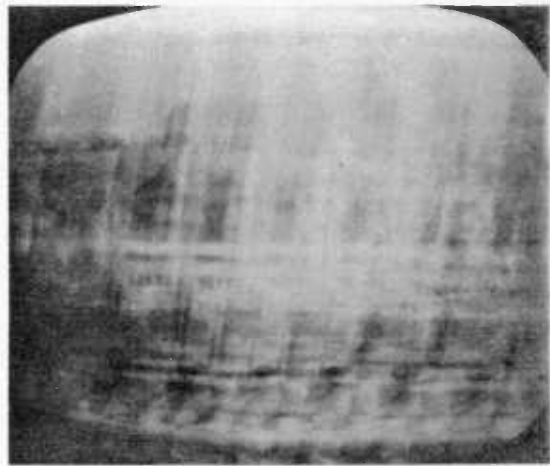

The further away from 15.750 the horizontal oscillator gets the more lines appear on your screen.

These diodes replace the horizontal phase detector tube. Some plug in but most require soldering.

Never use metal screwdriver in horizontal phase coil. It has electrical effects, can crumble coil.

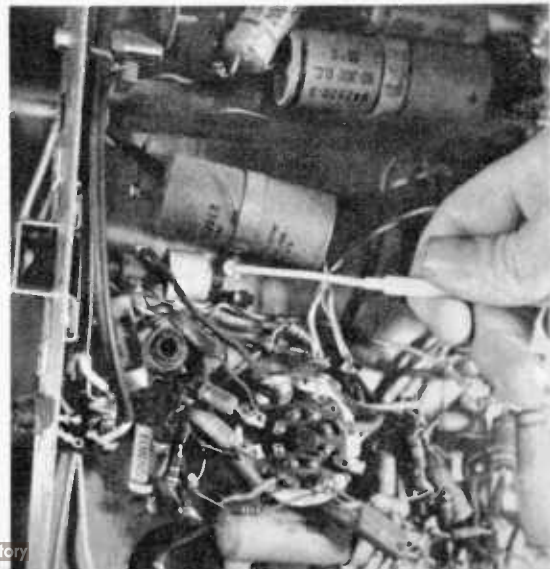
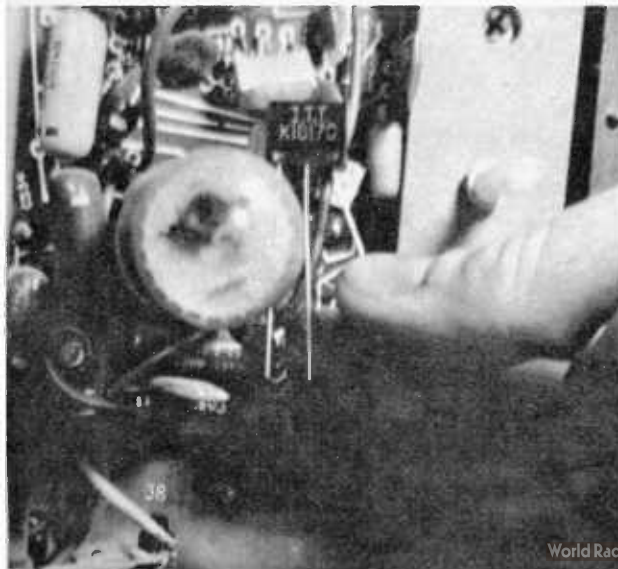

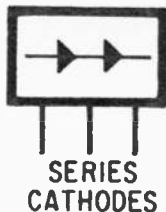
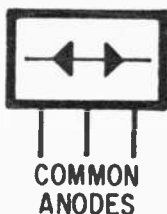
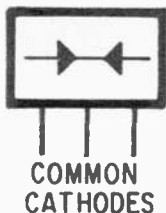

There are three kinds of diodes: common cathodes, common anodes and series cathodes. Install right one.

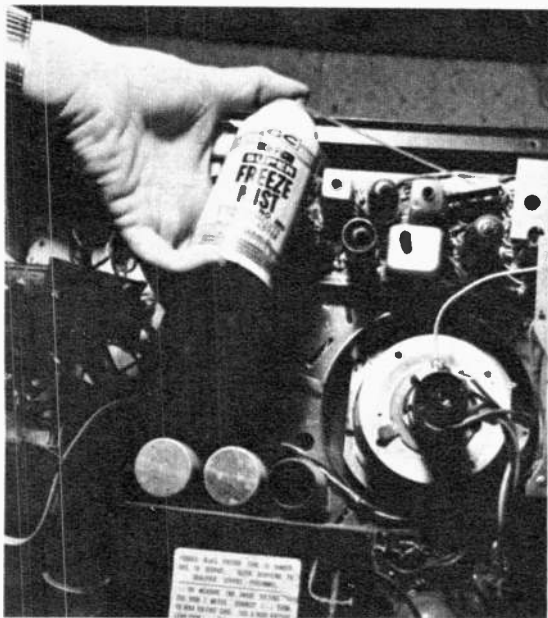

If you freeze a capacitor and it has large effect on picture, chances are good it is the bad one.

Poor horizontal linearity that makes circle look like egg lying on its side may be damper trouble.

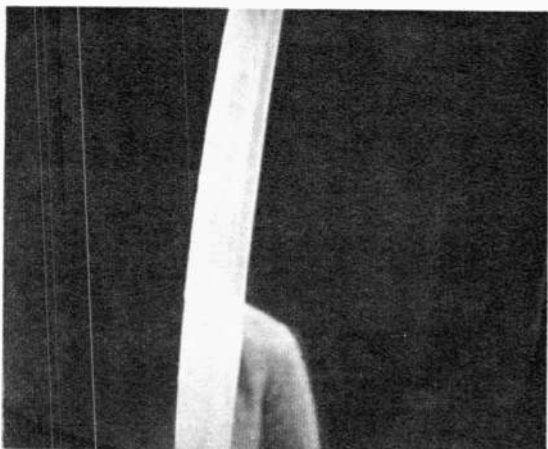

When bends appear without heavy black hum bars, trouble is usually found in the sync circuits.

tical signal is sent to the VERTICAL INTEGRATOR and on to the VERTICAL OSCILLATOR.

Should your TV display sync trouble those are the tubes to change. The VERTICAL INTEGRATOR is not a tube or solid state diode. It is a little printed circuit component that contains a bunch of resistors and capacitors and is soldered into place between the separator and the vertical oscillator. It shapes and gives the proper voltage to the vertical sync pulse and then feeds it to the vertical oscillator.

#### Trouble No. 25—Barber Pole Effect

This trouble gets its name from one variation of the trouble. That is when the colors roll slowly through the picture. The barber pole is laying on its side, however, since the colors roll from a horizontal plane. Other forms of the same thing are





All the pictures of this page indicate a loss of vertical sweep. First step: turn brightness down.



Prolonged TV operation will burn a mark across screen that only a new picture tube can remedy.



Pointed heads and stubby legs indicate vertical linearity and height control require adjustment.

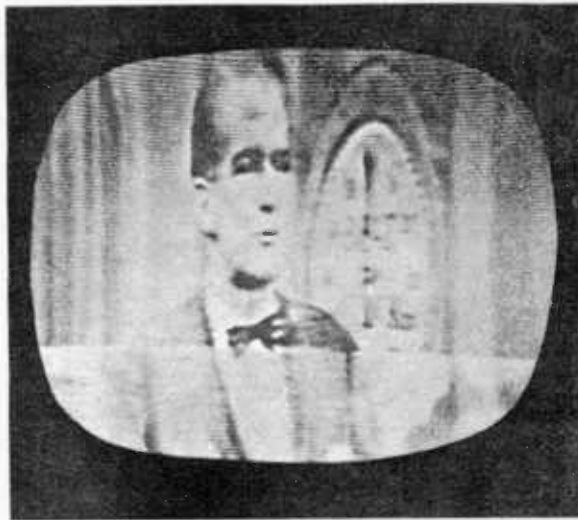

Pointed heads, long legs with whitish haze at bottom of screen indicate gassy vertical output tube.

stationary stripes across the picture or quick intermittent shimmering of the rainbow from top to bottom.

Any of the color sync tubes will cause the condition. They are the REACTANCE tubes, BURST AMPLIFIER, BURST KEYER and 3.58 MC OSCILLATOR.

Loss of color sync occurs only while the black and white picture itself remains locked firmly in place. Should the horizontal and/or vertical sync also be out, you probably do not have a color sync problem but conventional sync trouble.

### Trouble No. 26—Light Green Screen

This trouble does not in any respect look like loss of color sync. Yet it is caused by the loss of the burst signal (color sync). The barber pole occurs when the burst is weak, the light green screen by the burst being missing.

This light green screen problem is entirely different from the bright green screen trouble that will be covered in Chapter 10.

To cure a light green screen use exact measures as needed for barber pole.

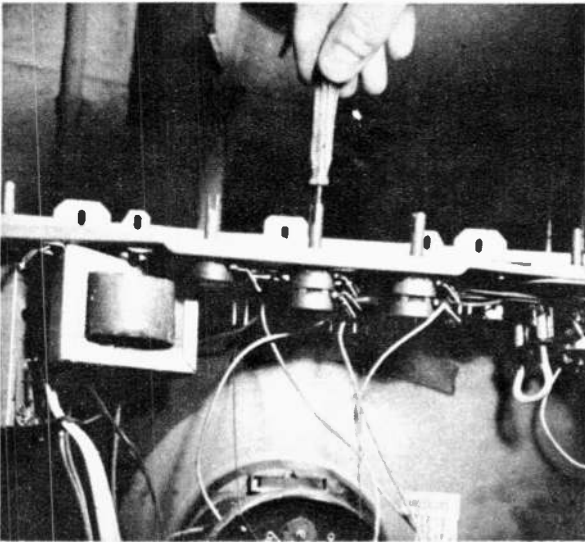

Vertical line and height controls are usually hidden on chassis. This one is beneath horizontal.

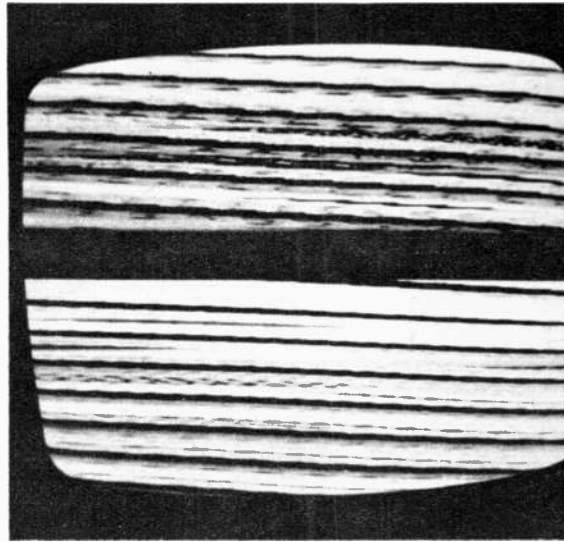

When vertical and horizontal aren't locked in you have pure sync trouble. Sync circuit is suspect.

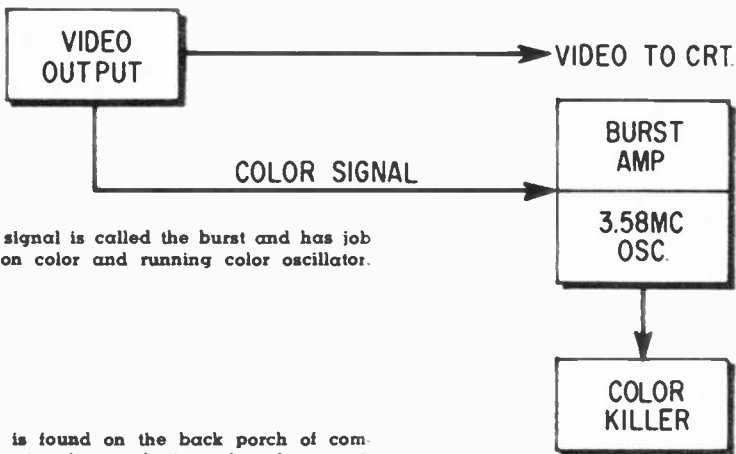

Color sync signal is called the burst and has job of turning on color and running color oscillator.

Color burst is found on the back porch of composite color signal near horizontal and vertical.

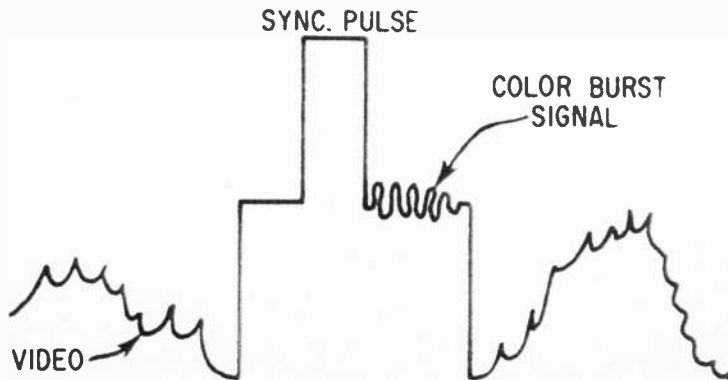

# When Your Picture Whites Out

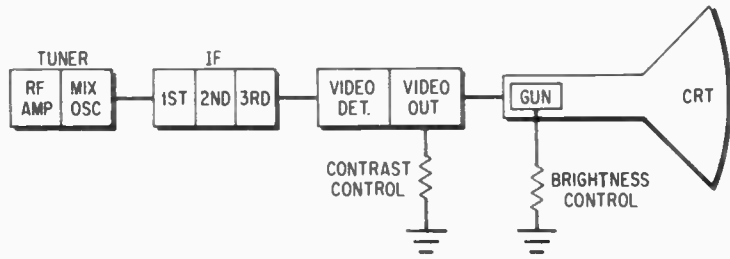

TV signal travels this route. Contrast control adjusts its strength. Brightness is in the CRT.

Contrast is the  
culprit here—  
not brightness.

The Y signal fails  
to have good  
frequency response

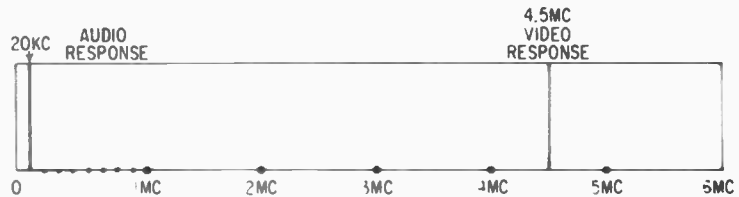

To get good sharp TV picture, its frequency response must be 4.5 MC. Sound-only needs 20 KC.

CHAPTERS 3 and 4 dealt with the brightness troubles in a TV set. This chapter is about the CONTRAST troubles that occur. There is much confusion in telling the difference between brightness and contrast. The old analogy comparing a TV set with a movie projector applies here. Just as a movie projector has a bulb causing brightness and film intercepting the brightness to cause contrast, so a TV set has a raster which is brightness and TV transmitted signal called contrast which intercepts the raster.

You can further separate them by realizing that the brightness is affected by the brightness control and the contrast affected by the contrast control.

This brings us to the title of this chapter. When your brightness quits the TV picture blacks out. When the contrast quits the TV picture whites out leaving the raster.

The contrast enters your TV through the antenna terminals and is fed directly into the tuner. First circuit is the RF AMPLIFIER. Next it passes through the MIXER-OSCILLATOR. From there it leaves the tuner and is further amplified in the first, second and third IF's. From

there it goes to a VIDEO DETECTOR and then on into the VIDEO AMPLIFIER and VIDEO OUTPUT. Then it is injected into the cathode of the picture tube. This is true in both black and white and color TV's. In a color TV the contrast is called the Y signal.

This contrast or Y signal causes the electron beam in the picture tube to flow in full force (a bright spot), cut the flow off altogether (a black spot), or simply reduce some of the electron flow (a gray spot).

The Y signal contains frequencies all the way up to 4.5 million cycles per second (megacycles). For when a change in a TV picture takes place from black to white, the change is taking place in one four millionth of a second. If it doesn't the picture will smear.

As you can see, a video change in a TV is much higher than an audio change since the highest audible audio is only 20,000 cycles per second (kilocycles).

When the Y signal has good frequency response a good sharp picture appears. When it doesn't you'll see one of the following 14 contrast troubles.



## PICTURE WHITES OUT

TROUBLE	REMEDY
Raster Only No sound or Pix	Video Detector, IF's, Mixer-Oscillator, Sound Output, Video Amp, Video Output, Picture Tube, AGC
Raster—Sound OK Weak Contrast	
Too Much Contrast	AGC, Noise, Inverter, RF Amp, IF, Video Detector, Amp, Output
Smeary Picture	Video Detector, Amp, Output, Peaking Coil
Negative Picture	Freeze Mist
Pulsating Picture Motorboating	IF Tube, Mixer-Oscillator, RF Amp
Hum Bars	Tuner, IF, Video, Sync, Sound, Color Tubes Picture Tube
Snow	RF Amp—Clean Tuner, B Plus Resistor
No High Band	Mixer-Oscillator
Sound & Pic Won't Tune	RF Amp, Mixer-Oscillator
No UHF	RF—Amp, Mixer-Oscillator, UHF Mix, Oscillator, UHF Diode, UHF Xsistor
No VHF	
Tunable Ghosts	IF, RF Amp, Mixer-Oscillator, Video Detector, Amplifier Output

A common cause of loss of contrast is this tiny solid state diode. Some of them simply plug in.

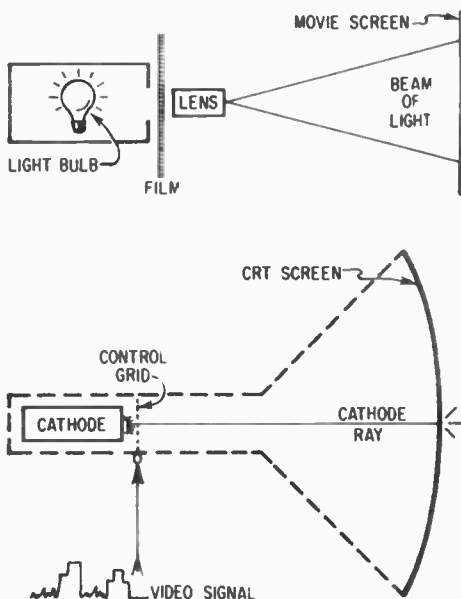
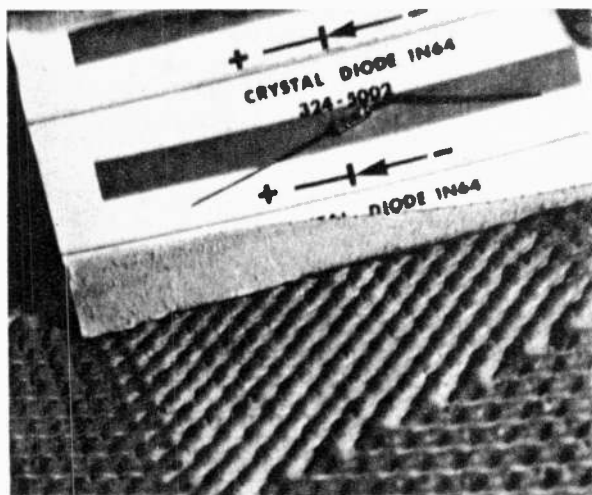

Just as film is able to intercept a projector's light beam, TV signal can intercept cathode ray.

### Trouble No. 27—No Contrast, No Sound

When the light is on the screen but there is no contrast and no sound, the trouble usually has occurred in an area before the contrast and sound are separated from one another. This would mean testing the VIDEO DETECTOR, the IF's and the MIXER-OSCILLATOR. As a fast try you can test the RF AMPLIFIER, but when it goes it usually is accompanied by a snow symptom.

Another cause that seems unusual, but is common, is the SOUND OUTPUT tube. In many of the recent TV's the IF's are powered from the sound output circuit, so a fault here causes IF type symptoms.

Lastly, every now and then there is the occasion where two faults occur—one in the sound circuits and another in the picture circuits. As a last resort look for this double trouble that causes this symptom.

### Trouble No. 28—No Contrast, Sound OK

This trouble, though resembling the last, is quite different. If the sound is good the



Lots of new TV's are using transistorized tuners and IF stages. Save those repairs for repairman.

When the picture whites out, that is, only leaves the brightness, first check is to test for audio.

trouble spot is probably after the place where the sound and picture are separated. This makes the VIDEO AMPLIFIER, VIDEO OUTPUT and PICTURE TUBE prime suspects. In some color TV's there are separate audio and video detectors. In these sets the VIDEO DETECTOR becomes a suspect.

#### **Trouble No. 29—Weak Contrast**

The common reasons for this condition are the VIDEO OUTPUT tube or SOUND OUTPUT tube getting weak. Otherwise this is the same as the last two troubles except it's not as severe. To really pinpoint the trouble try to analyze whether the sound is lower, too. If it is, then you have a variation of NO CONTRAST, NO SOUND. If the sound is good then you have a variation of NO CONTRAST, SOUND OK. Don't try to analyze the audio too carefully. If it's not apparently bad or good, test out all systems in both of the trouble types.

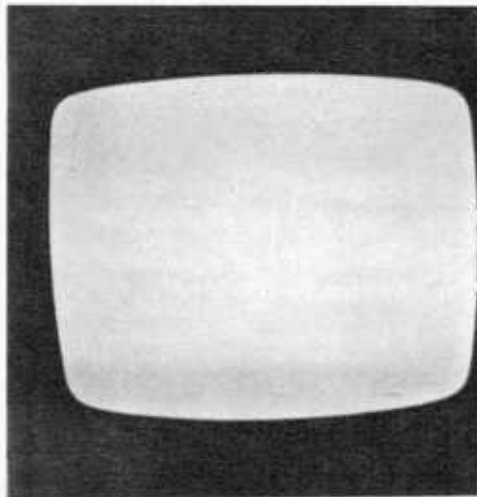

## B+ FEED FROM AUDIO OUTPUT TO IF STRIP

Common cause of no contrast is the audio output tube since its cathode feeds B plus to the IF's.

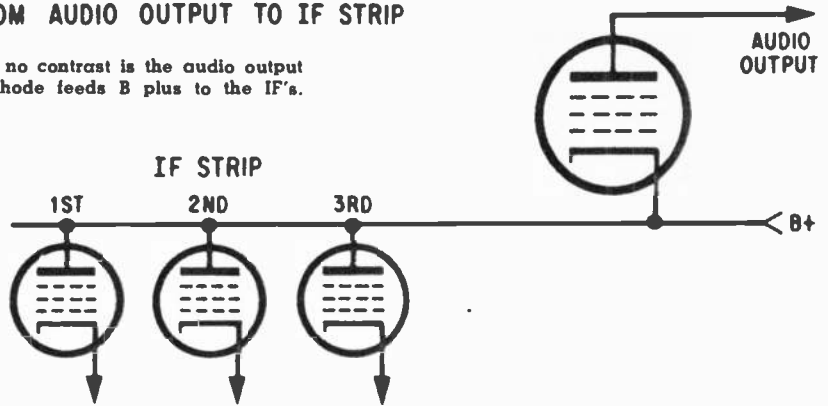

If there is sound, no contrast condition is after detector. No sound says trouble is before.

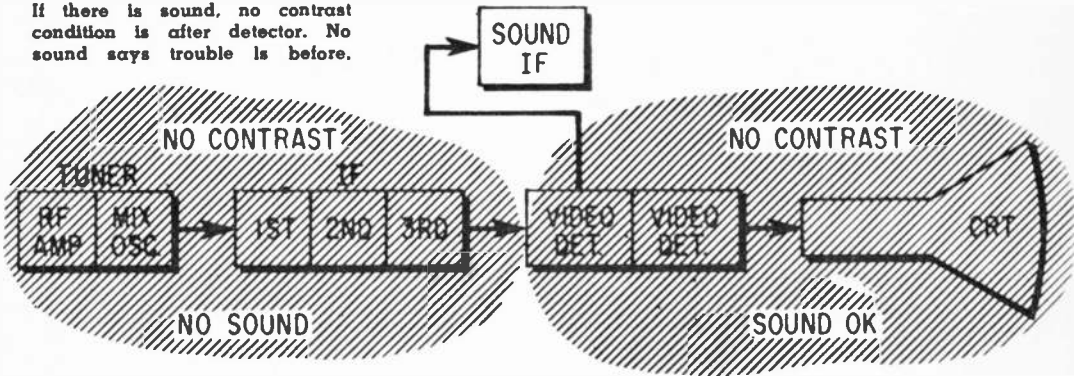

At right, the causes of weak contrast range from tuner input all the way to picture tube input.

When there is snow in the picture accompanied by audible static, it's usually the RF amplifier.

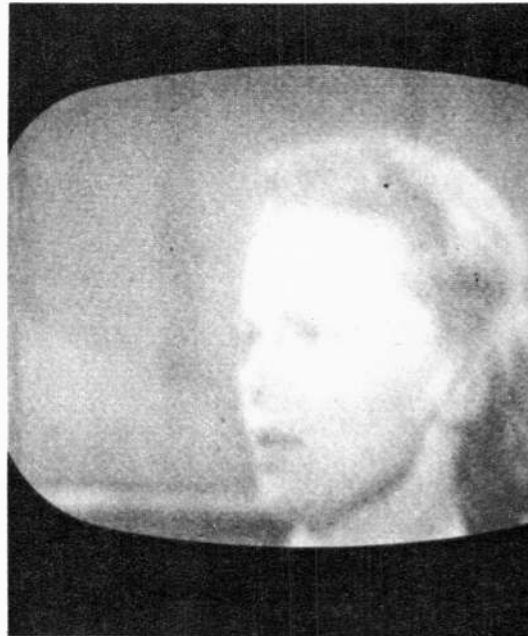



The main reason for overloaded contrast is usually AGC circuit. First step is to adjust control.

AGC circuit has job of reducing gain in the RF Amp and first two IF's during strong signals.

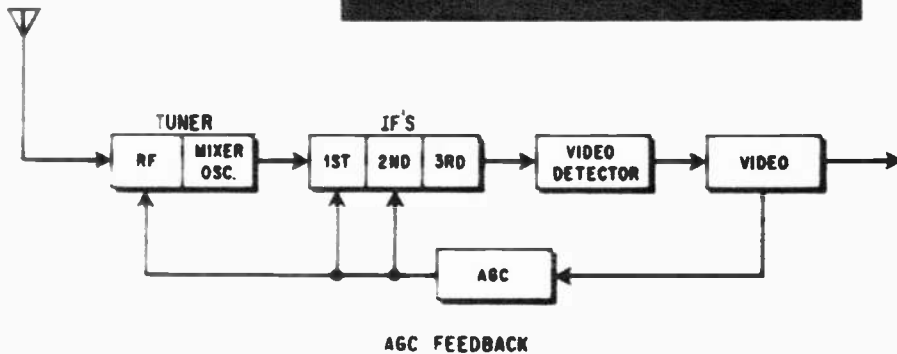
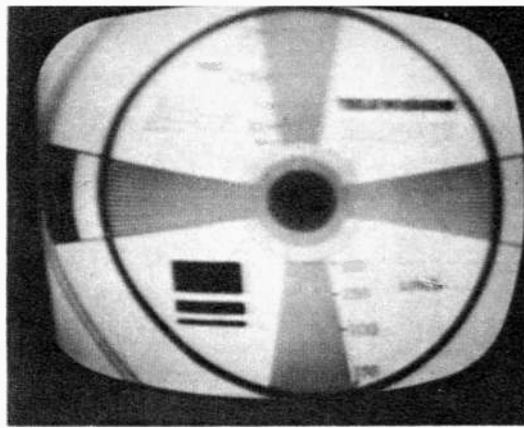

### Trouble No. 30—Too Much Contrast

Too much contrast usually occurs when there is an AGC problem. The Automatic Gain Control, better thought of as an automatic contrast control, is supplementary to the regular contrast control. It works like a thermostat. When the picture signal gets too strong it turns it down a bit.

The AGC circuit takes a continuous sampling of the contrast signal from the video output. The AGC circuit also has a hookup into the RF amplifier and first two IF's. When the AGC senses that the contrast is getting too strong it instantaneously sends an impulse to the RF-IF that cuts back on their amplification, thus reducing the contrast.

When the AGC circuit fails, the contrast gets too strong. There is an AGC control. First step is to adjust it. Next test the AGC keyer, AGC amplifier, AGC clamper or any other circuit calling itself AGC. Next test the NOISE INVERTER and then the RF AMPLIFIER and IF tubes. Lastly, try the VIDEO DETECTOR and VIDEO AMP and OUTPUT. They are all involved and can all cause this symptom.

### Trouble No. 31—Smeary Picture and Trouble No. 32—Negative Picture

While these two troubles are different phenomena they are for the most part

caused by the same defective components. A smeary picture occurs when the video frequency response is lost. A negative picture occurs due to whites going black and vice versa.

However, both troubles happen when a defect develops in the VIDEO DETECTOR, VIDEO AMPLIFIER, VIDEO OUTPUT, IF strip or the PICTURE TUBE itself.

Test those tubes and circuits in that order. Should you discover that your problem is the VIDEO DETECTOR and it happens to be a tiny germanium diode, be sure you install the new one with the correct polarity. If you should reverse it the same trouble is likely to appear on the screen and you'll think you have another bad part in there. You'll never find that other bad part and will be frustrated in the repair.

If you have a smeary picture and it's not a tube, chances are good it's a PEAKING COIL. The test is easy. Jump the peaking coils one by one with your jumper wire. A noticeable improvement will appear on the screen when you jump the bad one.

As a last resort you can try freezing the components in these circuits. Odds are you'll stumble on the bad one.

### Trouble No. 33—Pulsating Picture

The symptoms in this trouble can be quite disconcerting. It comes in three

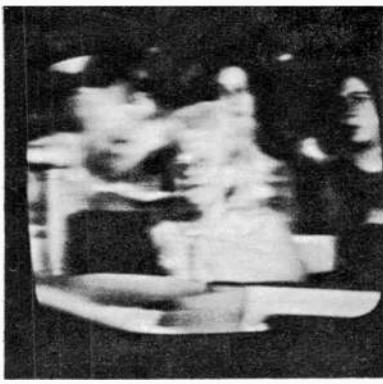

Smeary black-and-white picture is caused by loss of frequency response. Check out video circuits.

Below left, negative picture is usually a weak picture tube. IF and video can cause it, though.

All diodes have polarity and this tiny video one does, too. Installing it wrong spells trouble.

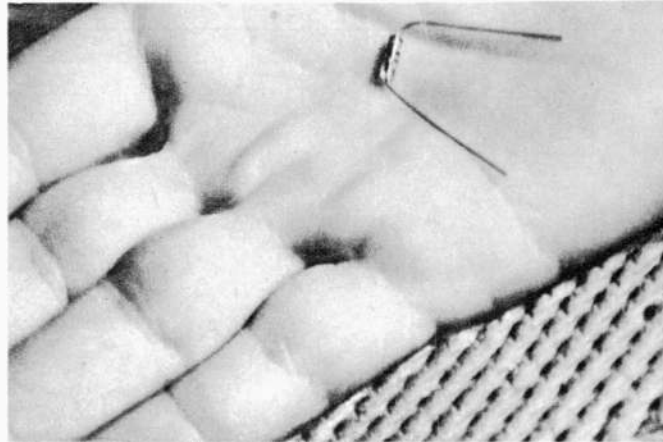
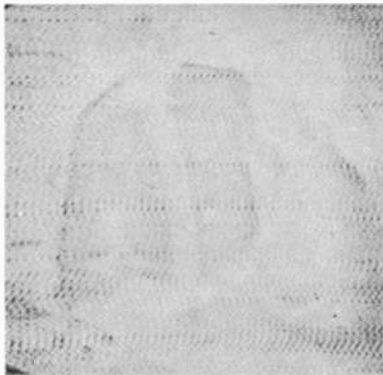

variations. 1) the sound and picture can be popping in and out. While it's in, it's perfect, while it's out just a raster remains. 2) the TV will come on perfectly, then little by little the picture becomes more contrasting, then it begins to pulse and vibrate. 3) no sound or picture will come on at all, just a motorboat noise from the speaker and a pulsating raster on the screen with a lot of black bars in it.

Most of the time one and two turns out to be a bad IF tube, and number three turns out to be the MIXER-OSCILLATOR tube. Try these tubes for both troubles. As a last resort try the RF AMPLIFIER. If none of these help you probably have a serious bench repair in the tuner or IF strip.

### Trouble No. 34—Hum Bars

Whether the hum bars are in black and white or color they are in nine out of ten cases caused by a heater to cathode short in a tube. If it's not a tube it's a filter and needs filter capacitor techniques as reviewed in Chapter 2's INPUT FILTER section. Only you must test all the filters, not just the input.

The tube testing is best accomplished by direct substitution, although the drug store tester might pick out the bad one for you. The little heater tester is of no use with this trouble.

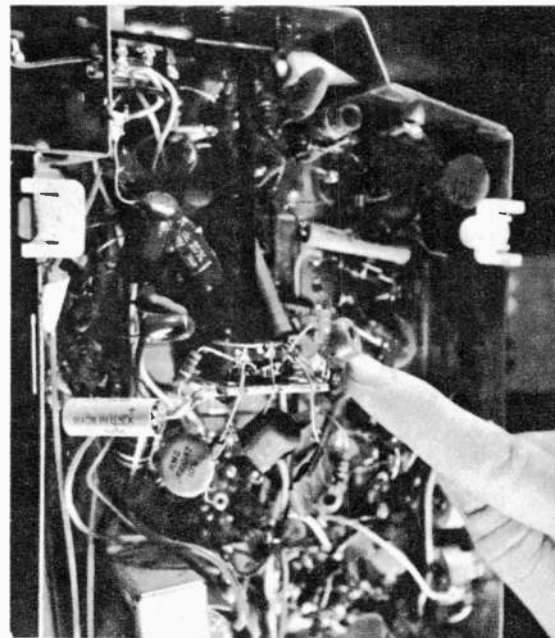

Open peaking coil often causes smeary or negative picture, jumper wire quick test confirms it.



A pulsating picture that is vibrating horizontally is usually an IF tube that is oscillating.

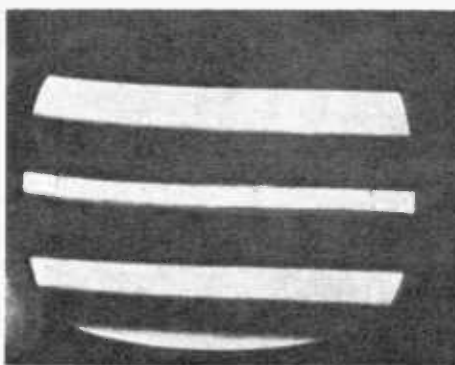

If many hum bars appear along with a motorboat noise, change the mixer-oscillator or IF tubes.

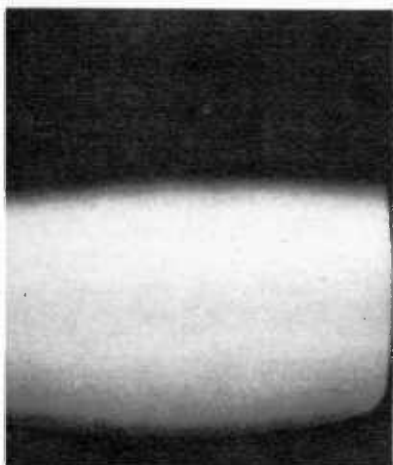

In either black and white or color these hum bars are usually caused by heater to cathode tube short.

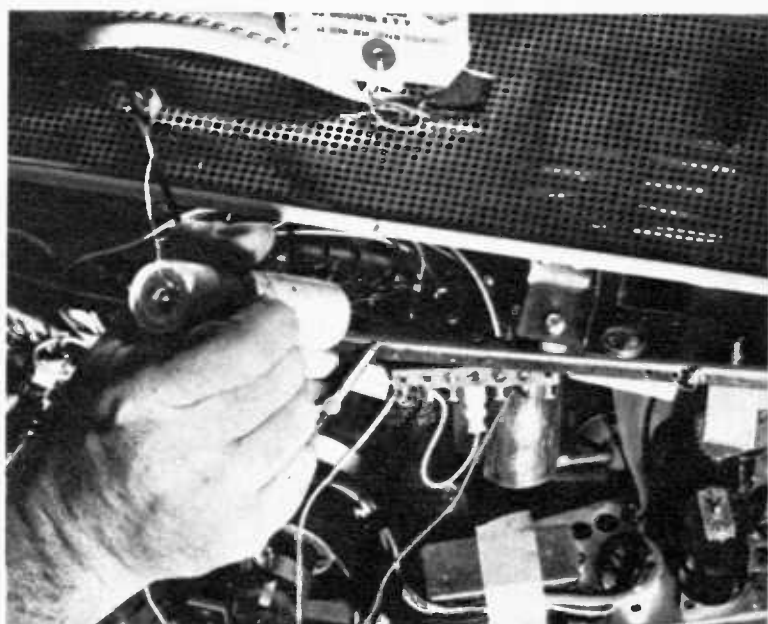

Upper right, check TV filters by jumping another one across it. If bars go away, that's bad one.

A quick clean job for minor erratic action is to spray tuner tube into tuner, rotate slowly.

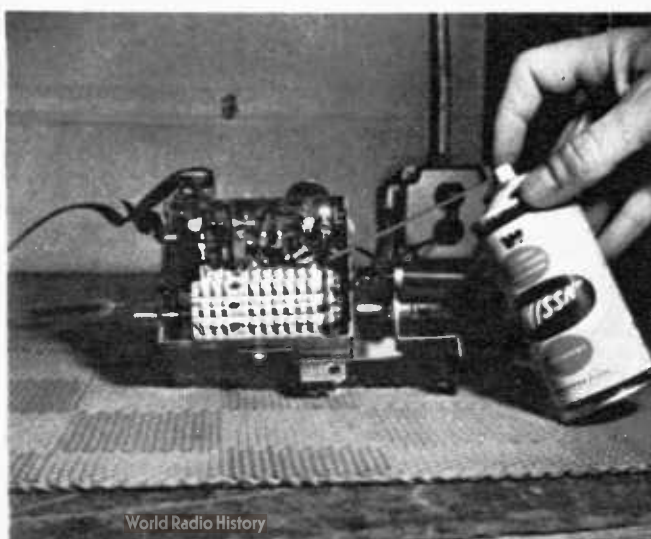



There are a lot of suspects. You'll have to check every tube in the tuner, IF strip, video circuits, sound circuits, sync circuits and color circuits and picture tube. The only tubes you won't have to check are the vertical and horizontal sweep and high voltage.

**Front End Fixes:** The big confusion in front end troubles is deciding whether the trouble is due to problems in the tuner or in the antenna. Then once you decide it is a tuner trouble you must ascertain whether it is an electrical problem or a mechanical problem.

### Trouble No. 35—Snow

This is the main tuner trouble symptom. It can occur with or without sound or picture, only on certain channels, be intermittent, erratic or what have you. The main thing is, no matter what else is occurring there is a snow fall.

The first step is to eliminate the antenna as the trouble source since it too causes exactly the same kind of snow. Attach a spare pair of rabbit ears to the antenna terminals instead of the antenna being used. This goes for UHF as well as VHF. If the trouble clears, the tuner is not at fault. Should the same condition persist, the tuner is the troublemaker.

An alternative procedure is to take another known good TV and attach it to the suspect antenna. If the second TV does the same thing it's the antenna. However, should the second TV work well the first TV contains the trouble.

Next step is to decide whether the trouble is electronic or mechanical. Rotate the tuner and press it a little bit. If a good picture returns, even momentarily, the trouble is probably mechanical.

After all that, here is what you'll probably find. The trouble is a combination of mechanical and electrical problems. The RF AMPLIFIER tube is weak and the tuner could use a cleaning. Replace the RF AMP and take some tuner lube and spray it into the tuner innards. Then rotate the channel selector knob. This blanket approach is usually a cure-all.

Should the snow and erratic action be a little more stubborn you can go further. Remove the cover from the tuner, take a pencil eraser and gently erase the black spots on the electrical contacts in the tuner. Then respray with the tuner lube. That should do the trick. If it doesn't there is one more little trick.

With the TV still on feel the RF AMP tube. It should run quite hot. If it runs lukewarm it means the heaters are on but

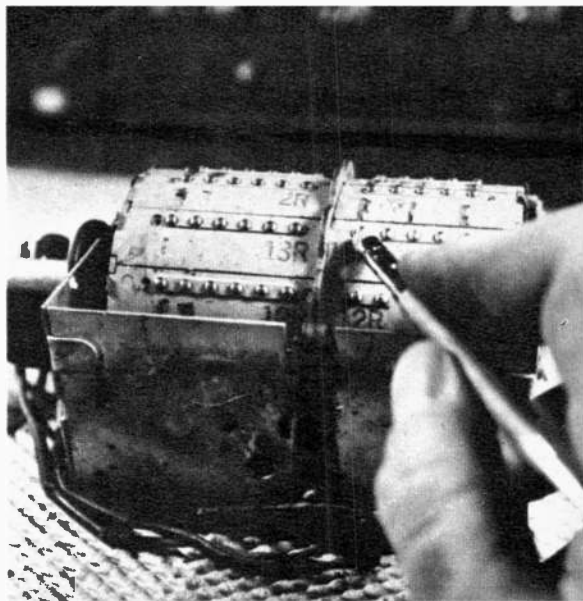

If spray won't work, use ordinary eraser to get the carbon off the contacts and then spray them.

Look for broken charred resistors going into tuner. When these open they kill B plus, cause snow.

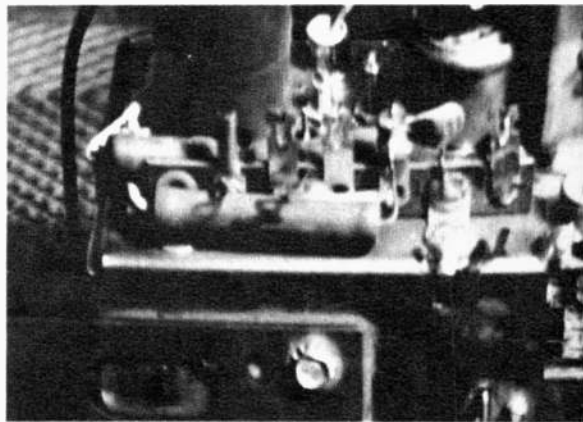

This trouble is usually an alignment job. Don't do any more than simply replace the tuner tubes.



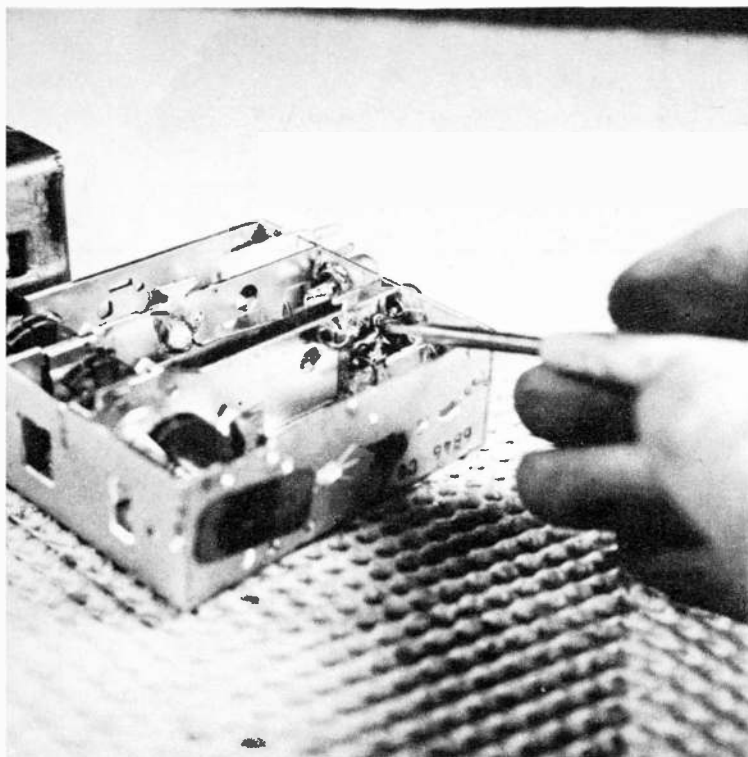

Above, a tunable ghost is being caused by trouble in the TV set. Try the IF and video tubes first.

A common cause of no UHF stations is bad UHF transistor. Replacing it is worth careful try.

the B plus voltage is not reaching it. Take a bright light and look over the outside and inside of the tuner for a charred resistor. Quite often you can spot it visually. Then determine its value and replace it. You'll probably effect a cure. Be sure to replace the RF AMP tube too. It has shorted and burnt out the resistor.

Should the trouble remain, stop and call for skilled help. You are getting into deep water

#### **Trouble No. 36—No High Band**

As the channel numbers go up, the MIXER-OSCILLATOR must run at higher and higher frequencies. Sometimes a tube becomes defective and won't run too high. In fact it might run good on the low band, channels 2 through 6, but quit in the high band, 7 through 13. A new MIXER-OSCILLATOR will usually cure. If it doesn't, don't go any further in this trouble.

#### **Trouble No. 37—Sound & Picture Won't Tune**

This trouble is usually due to a tuner being out of alignment. Sometimes it goes out of alignment due to the tuner tubes. Try replacing the RF AMPLIFIER and the

MIXER-OSCILLATOR. If the trouble clears, fine; if not, that's the end of the line for the do-it-yourselfer on this trouble.

#### **Trouble No. 38—No UHF, VHF Good and Trouble No. 39—No VHF, UHF Good**

This requires testing of the tubes in the respective tuners as the first quick step. Then in No. 38 NO UHF there are two more attempts that produce high percentage results. There is a germanium diode resembling a video detector. Try replacing it observing polarity. Lastly, most UHF tuners today use a transistor. It goes bad more often than the other components in the tuner. Obtain a correct replacement and install it. Chances are good you'll cure No. 38

#### **Trouble No. 40—Tunable Ghosts**

The only ghosts that can occur due to tuner trouble is a tunable ghost. That is with the ghosts in full view try adjusting the fine tuner control. If the ghosts do not change they are due to antenna difficulties. Should they change drastically as you rotate the fine tuner they are being caused by the TV.

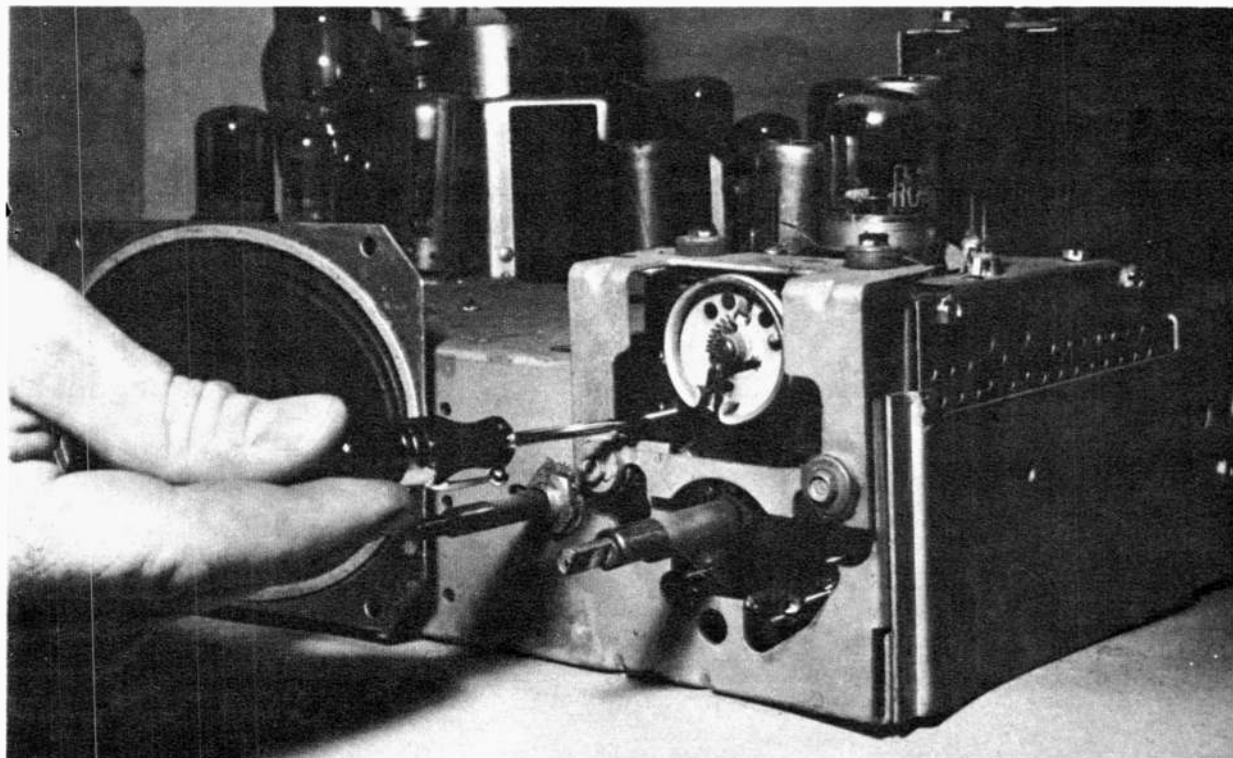

Tunable ghosts is a sister trouble to No. 33 PULSATING PICTURE and the exact same repair measures are used. Test the IF tube, the tuner tubes and also check the VIDEO DETECTOR, VIDEO AMPLIFIER and VIDEO OUTPUT. If none of these measures cure, you probably have an RF-IF alignment job on your hands. Call for help if that is the case.

Now about those little screws and hex head adjustments sticking out all over the tuner. Don't touch them unless you have the proper tools and factory service notes. In the older TV's a do-it-yourselfer could line up the oscillator slugs from the front. Not today, however. The newer portable and color tuners have all kinds of unusual ways of adjustments. By turning the wrong screw, you can cause all kind of trouble from losing a channel to killing color.

One thing you can do, however. Once you determine for sure that you do have tuner troubles either electrical or mechanical you can take or mail it to a tuner repair center. Just remove the defective tuner from your TV (be sure you sketch the connections) and send it off to a repair center. For a nominal fee they will repair it and send it back. •

Older TV's were easily adjustable around the oscillator cores. Newer ones aren't, so stay clear.

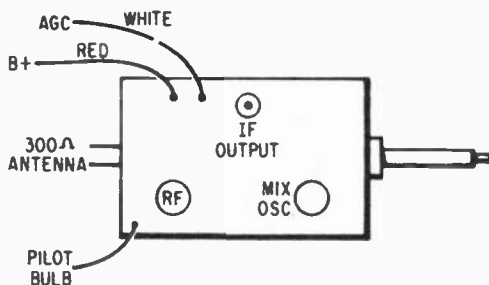

If you remove a tuner be sure to make a sketch of the inputs so you won't make a wiring error.



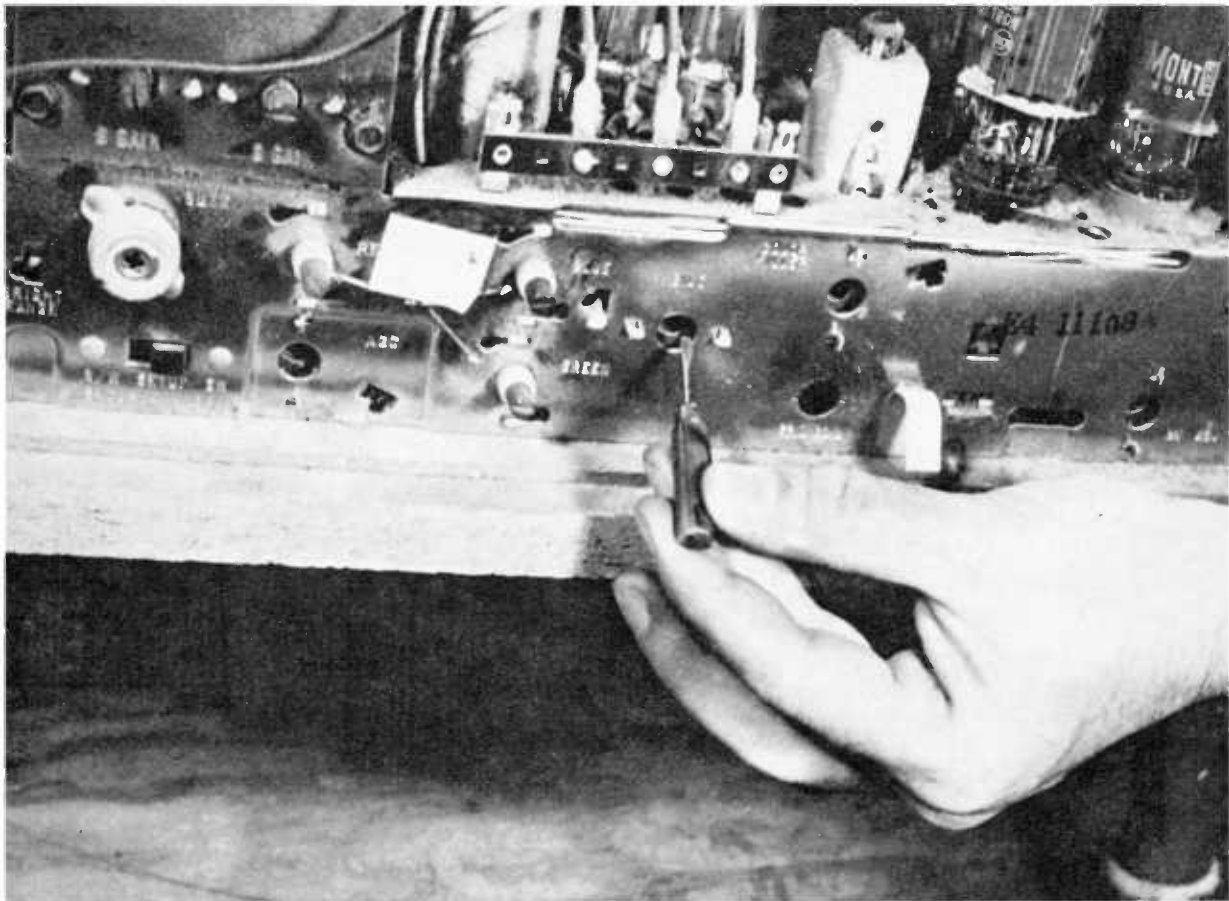

Buzz controls on chassis rear aprons are becoming more popular in newer TV's. They're easy to adjust.

# All About Fixing TV Sound

Probe begins at 4.5 MC transformer or germanium detector

**T**HE sound section of a TV is almost exactly like the rear end of an FM radio. It gets its signal in a black-and-white TV from a sound takeoff transformer in the video output stage labeled 4.5 MC takeoff. It gets its signal in a color set from a separate sound detector that works like a video detector and is located right near the video detector.

When you have a sound-only trouble you start investigations at the 4.5 MC transformer in a monochrome set and at the germanium sound detector in a color set.

## Trouble No. 41—No Sound

When this condition happens in a radio, usual technique has as its first step placing

one's finger on the center top of the volume control. The control is about dead center in a radio circuit. A finger touch induces a hum. If one hears the hum it means sound can go from there to the speaker. Therefore the rear half of the radio is good and the trouble is indicated to be in the front half.

Should no hum emanate from the speaker the rear half is indicated as the bad half.

In a TV, though, touching your finger to the center top does not induce a hum and might even produce a shock. However, another procedure using the same logic can be used.

Place your ear near the speaker and rotate the volume control with the TV on. There will be one of three results: no

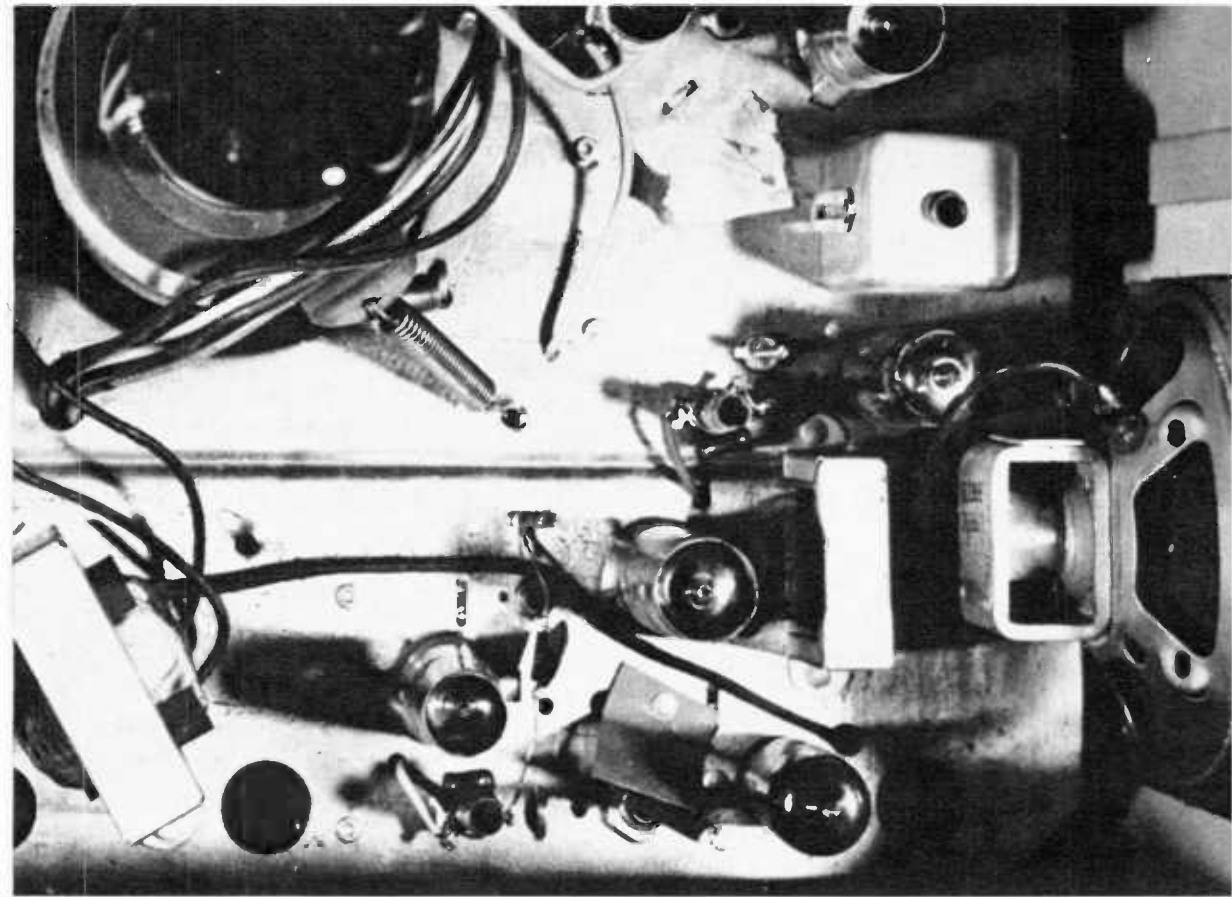

Business end of the audio section is the audio output transformer, large resistors and the speaker.

Excellent test for spotting microphonic tubes is to tap them. Bad ones will cause racket from speaker.

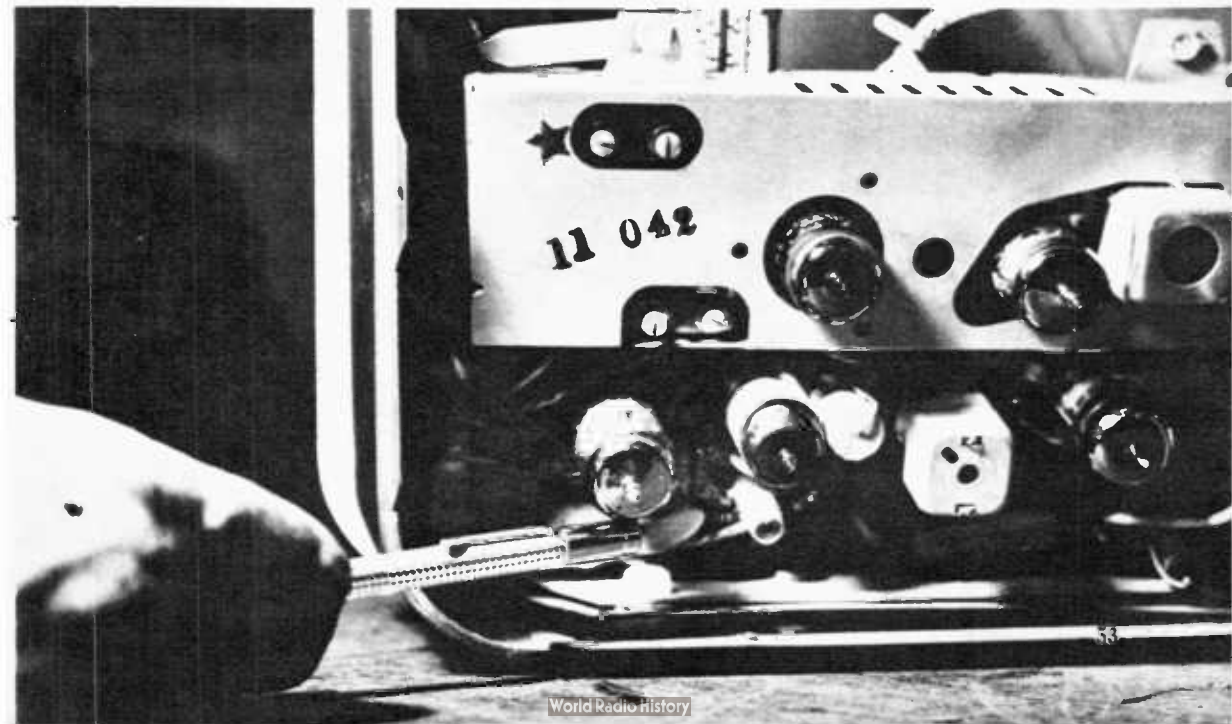

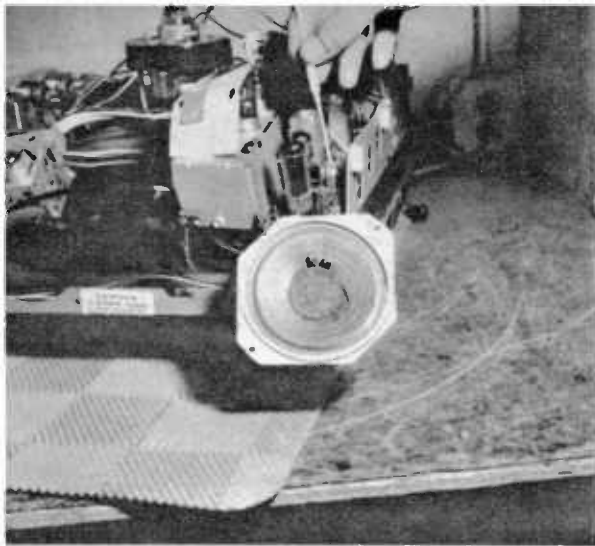

Quite often a minute adjustment of the FM detector will clear up a low or muffled TV sound.

When bars appear in picture in step with sound, try all the output tubes. Gassy one can cause it.

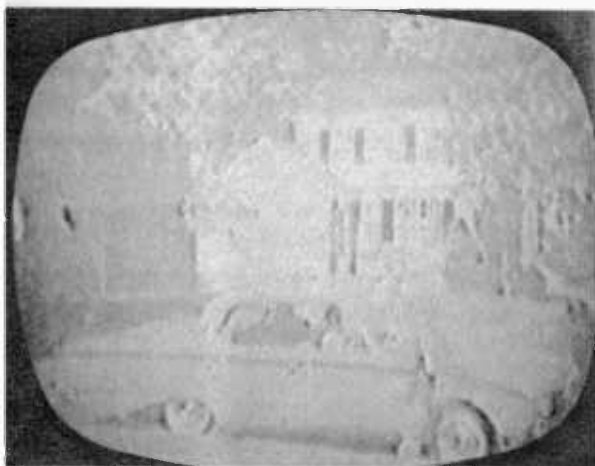

A rubbing cone or voice coil can cause muffling. The only cure is to install a new replacement.

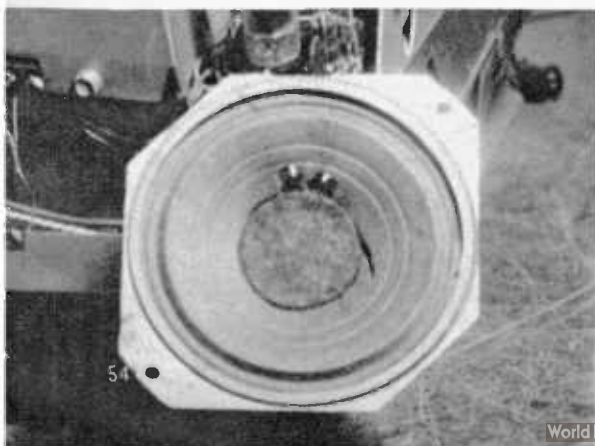

## ALL ABOUT FIXING TV SOUND

TROUBLE	REMEDY
No sound Dead Speaker	Audio Output Tube, Audio Output Transformer, High Wattage B Plus Audio Output Resistors
No Sound Background Noise, Inoperative Volume Control	Audio Output Tube, Audio Amp Tube
No sound, Background Noise, Volume Control Works	Audio IF, Audio Detector
Poor Sound	Audio Output, Amp, Detector, Audio IF, Adjust FM Detector, Speaker
Sound Bars in Picture	Audio Output, Vertical Output, Horizontal Output, Mixer-Oscillator, IF Tubes



In case the FM detector needs constant adjustment, it's the coil itself that needs replacing.



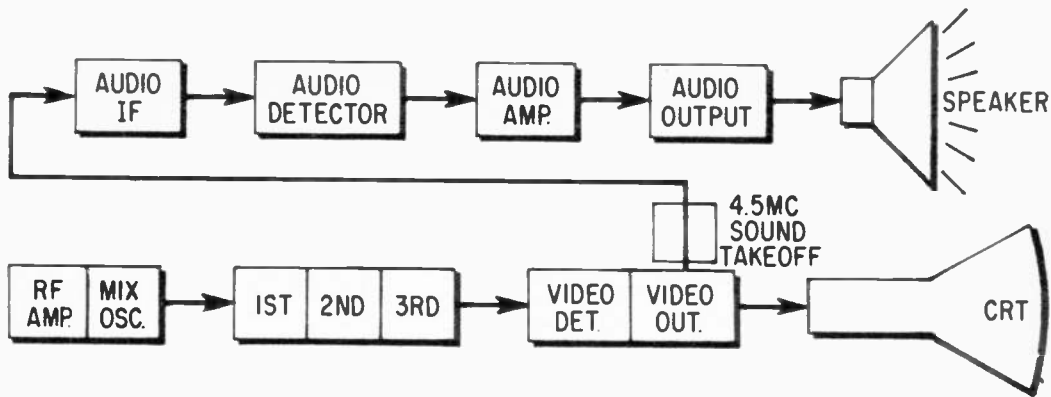

The audio in a black-and-white TV is usually taken off in the video output with a 4.5 MC sound can. The audio in a color TV has its own separate sound detector that works alongside the video detector.

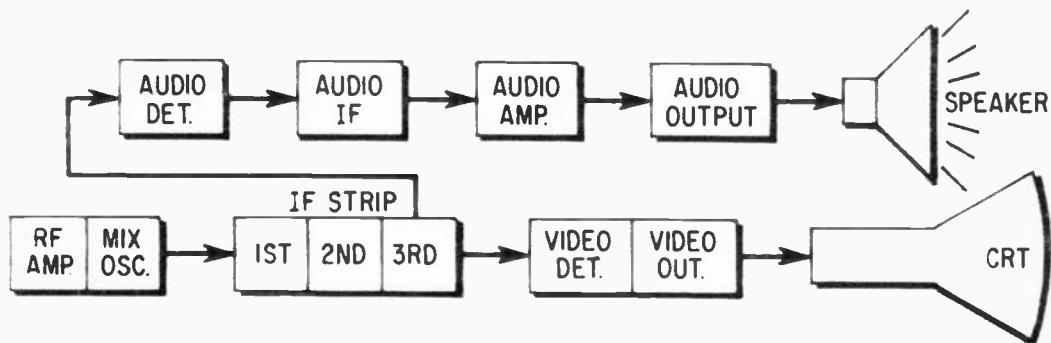

sound, background noise but no volume control effect, or a noticeable effect as you crank up the control.

When the speaker is dead test the AUDIO OUTPUT tube, the audio output transformer and any large wattage resistors feeding B plus to the output stage.

If there is some background noise but no volume control effect test the AUDIO OUTPUT and AUDIO AMPLIFIER tubes.

Should the volume control have some effect test the AUDIO IF and AUDIO DETECTOR.

As a last resort test all the audio sections mentioned even though they are not indicated by professional technique.

#### Trouble No. 42—Poor Sound

When the TV performers speak in garbled tones, test all the audio circuits right off. First test is to tap the audio tubes with a pencil. If any of them ping or crackle it's probably bad and needs replacement. Be careful, though, that you catch the right one. The noisy tube is that way because it has loose elements and if you tap an adjoining tube the bad one might still ping.

When a tube doesn't cure the condition,

examine the speaker. It might have a hole or tear in it that is causing the problem. It could also have a sticky voice coil. Substituting a good one tells the tale.

Lastly, muffled sound is caused by FM detector drift. Find the FM detector can and adjust it with a hex-head alignment stick. Just a slight turn of the top or bottom core will cure the condition. Should the touch-up alignment cure for a while, but the trouble returns, you'll probably need a new detector can.

#### Trouble No. 43—Sound Bars in Picture

If you have a good picture but the picture quivers in time with the sound, some of the sound output is getting into the video circuit. The sound can get in there due to a defect in one of the output tubes. They are all fed from the same boost B plus supply and when they draw too much current they affect each other.

For sound bars, try a new AUDIO OUTPUT tube, a new VERTICAL OUTPUT tube and a new HORIZONTAL OUTPUT tube. It will probably be one of them. If it's not, try the MIXER-OSCILLATOR and IF strip tubes as a last resort. •

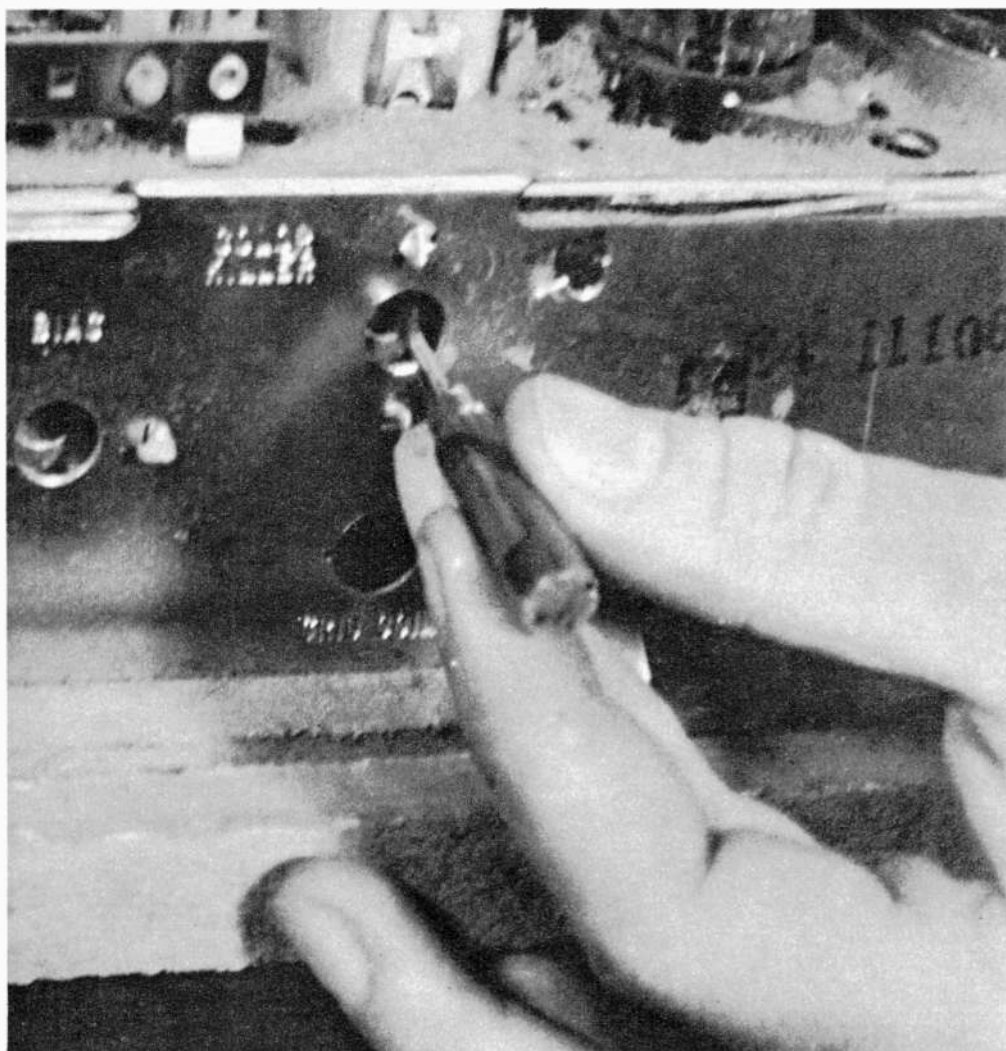

The only color control on the rear panel is the color killer. It sets threshold for color signal input.

## How to Really Adjust the Colors

The four key areas deal with hue control,  
color level, color killer and tint control

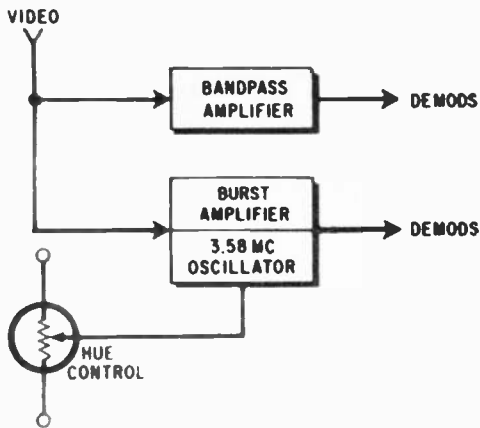

This hue control is hooked directly into color oscillator and changes actual color of the picture.

The color level control is hooked directly into the color amplifiers and changes color intensity.

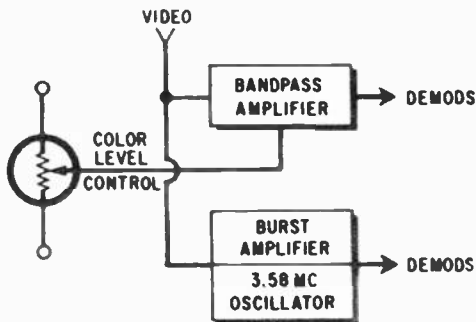

**T**HERE are only three and occasionally four adjustments that deal exclusively with color. All the rest of the many adjustments have to do with setting up a good black and white picture on a color screen. These are dealt with in the next chapter.

The color-only adjustments are the HUE control, the COLOR LEVEL control, the COLOR KILLER control and on some TV's a TINT control.

As a color TV set owner and do-it-yourself repairman you must have an idea of their workings.

**Fine Tuner:** Before touching any of the color adjustments you must be sure the fine tuner is set properly. On a black and white there is quite a bit of range where a satisfactory picture is received. Not so on a color TV. There is only one setting and quite often it is critical.



On this particular set the color tint is a duo control in combination with the brightness knob.

With a strong channel on, rotate the fine tuner through its range. The picture will vary from a dull, interference-free picture, through a center point where sound bars and picture both appear, to a screen full of sound bars only. The correct setting for color is to back off the control till the sound bars just disappear.

**Hue Control:** The hue control is a front of the cabinet knob that changes the actual color on the screen. The control was designed to control the change by using human flesh tones as the reference point. Therefore a good flesh tone appears near midrange of the control. As you vary the control from one end to another the flesh tones change from purple through normal to green.

Actually you are varying the phase of the color oscillator around its 3.58 MC



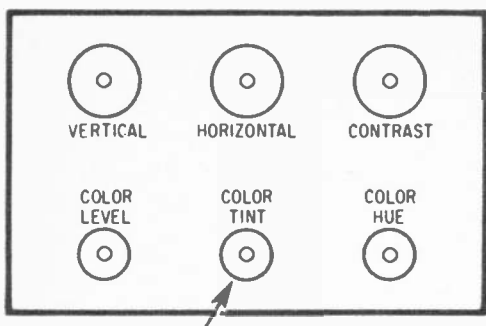

On some sets there is a color tint control. It changes the background coloring from cool to warm.

operating frequency. Don't try to do anything with the HUE control except get a normal flesh tone.

**Color Intensity Control:** This is the other companion front of the set control. You can set it after or before you adjust the hue control. It varies the amount of color in the picture from none to weak to intense. Once you have a normal flesh tone, adjusting this control will vary that flesh tone from pale through ruddy to orange. Normal should be about midrange. The control works passably as long as you can get enjoyable colors even though cranking it all the way up won't produce orange.

There is quite a bit of confusion among set owners as to the use of these two controls. Get these two simple adjustments down pat and you'll eliminate a lot of TV service false alarms.

**Tint Control:** In a lot of new color TV's, Admiral and Motorola, for instance, a third front of the set control is installed. It is called TINT or COLOR FIDELITY. (This is not to be confused with some HUE controls that are labeled TINT. In those cases there is no third control.)

This TINT control is not truly a color-only control since it works all the time whether a color show is on or not. The HUE and COLOR INTENSITY are completely inoperative when a black and white show is being presented. They only work when a color show is on.

This TINT control does this all the time. It varies the black and white picture from shades of green through black and white through shades of blue.

This tint control enables you to vary the tint of the picture from warm (by adding the greens) to cool (by adding the blues).

If you have one of these controls, realize its operation or else you'll cause the wrong colors to appear on the screen. Frankly it's a feature I can't see much use to. Best thing to do is set it on black and white and forget about it.

**Color Killer:** The color killer is covered in Chapter 10 with its troubles. The color killer has this job: During a black and white program it turns on. As it goes on it shuts down the entire group of color circuits; otherwise color interference will appear on the black and white picture. Such things as colored snow, colored sound bars, colored auto ignition noise, etc., would flash annoyingly across the screen except for the color killer.

When a color show starts, the color killer circuit shuts off and allows the rest of the



The fine tuner serves an important function for color. With a wrong setting you can lose color.

color circuits to come back on normally.

The killer circuit is critical and needs an adjustment in case minor changes occur in the killer's components. The control is located mostly on the chassis rear apron but sometimes it can be found on the front of the TV under a service panel or behind one of the knobs. Your service notes will tell you where.

It is adjusted like this. Turn on a black and white program. Turn the killer control up till color streaks come through the picture. Then slowly turn the killer down just till the streaks disappear. That's the correct setting.

If you overadjust you'll place it at a setting where the killer won't permit the color programming to appear at all. Set it right. •

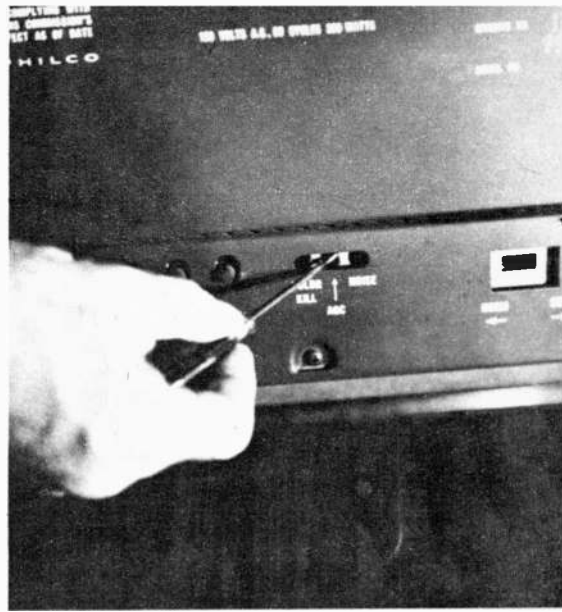

Washed out color could be a result of a low setting of the AGC control. Always double check it.

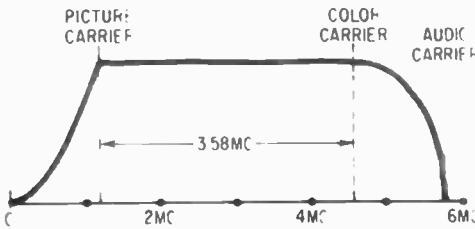

Left, color subcarrier rides 3.58 MC away from the picture carrier on transmitted TV signal.

On older sets let the rear controls strictly alone. They are used to set up black-and-white pix.

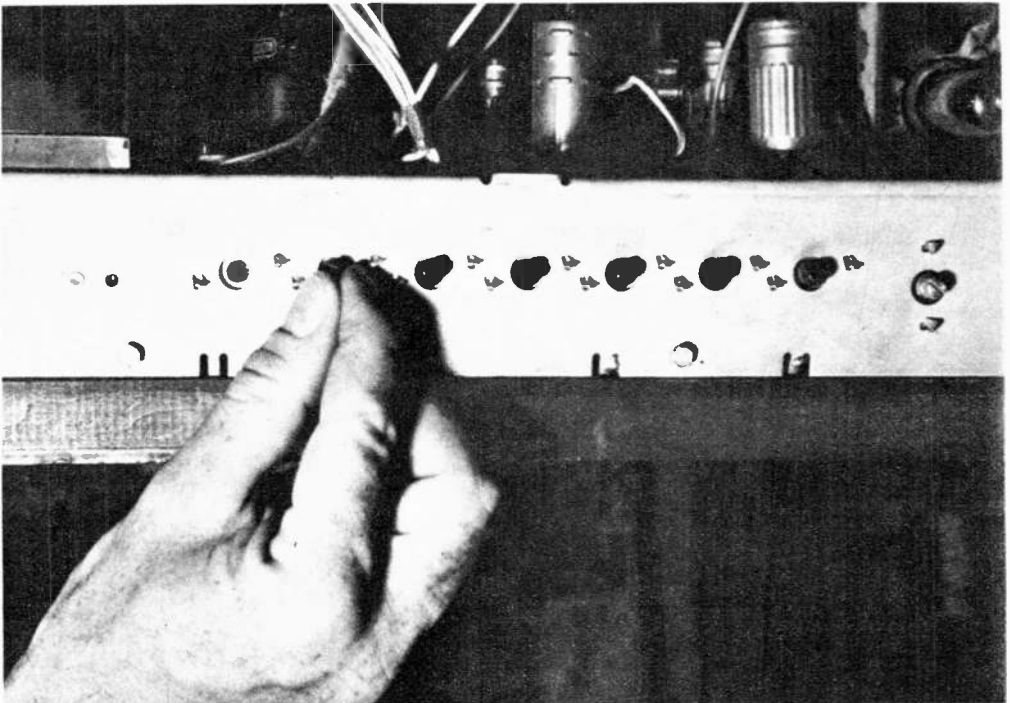



To cure the old bugaboo of color impurities after moving a color TV, simply demagnetize the CRT.

# Touching Up the Colors

Good black and white automatically assures good color picture

**T**HE NAME of this chapter is really misleading. For all these controls we're going to discuss, although they are exclusively color TV adjustments, are not really color adjustments. They are manipulated strictly to produce a black and white picture on the color TV. Once a satisfactory black and white picture is produced, the color picture will automatically come in beautifully.

These controls that work you toward a perfect black and white picture on a color TV are there to eliminate four color troubles. Let's go through them one by one.

## Trouble No. 44—Tinted Screen

Ideally, you shouldn't be able to tell a color TV from a black and white TV during a black and white show. While you'll probably never be able to achieve such perfection you can come close.

A color TV reveals its identity when a black and white picture comes in tinted. It can be tinted pink, green, blue, yellow or what have you. When it's tinted thereby, all over the screen the obvious service attempts are directed at restoring real blacks, grays and whites instead of the tinting.

The restoration is accomplished by ma-



## COLOR ADJUSTMENT CHART

TROUBLE	REMEDY
No Color	Fine Tuner—Color Intensity Color Killer
Wrong Colors	Hue—Tint—Purity Procedure
Color Interference	Fine Tuner—Color Killer
Tinted Screen (All Over Screen)	Gray Scale Tracking
Color Splotches	(Defective Auto Degoussing coil) Degouss—Purity Procedure (Purity Tabs, Screen Center-Yoke, Perimeter
Bleeding Colors (Screen Center)	Stotic Convergence (Red Stotic, Blue Stotic, Green Stotic, Blue Loterol
Bleeding Colors (Around Screen Edges)	Dynamic Convergence (12 controls on Conver- gence Board

Flick service switch to get a good gray scale. Doing this causes three colored horizontal lines.

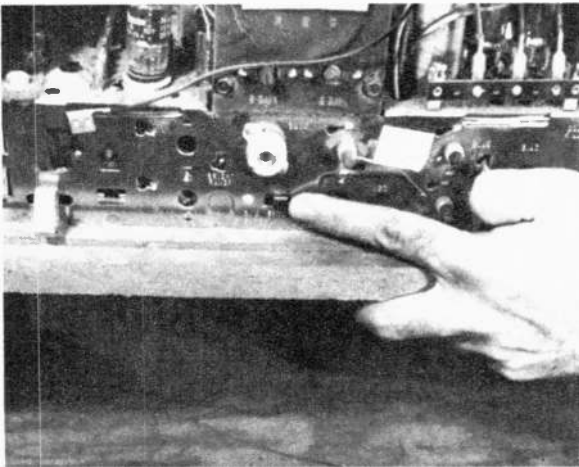

nipulation of the seven GRAY SCALE adjustments. They are found on the rear apron of the TV chassis or under a panel in the front. They are named the SERVICE SWITCH, RED SCREEN, BLUE SCREEN, GREEN SCREEN, CRT BIAS, BLUE DRIVE and GREEN DRIVE. Most of the time only the first four mentioned are needed.

You have a tinted picture because the three primary light colors—red, green and blue—are not properly mixed on your TV screen. Here's how you can remix to get a good gray scale.

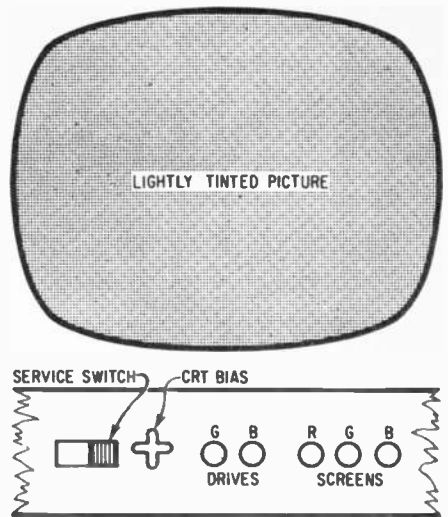

There are controls to eliminate a tinted picture. In effect, they mix color lights properly.

Next step is adjustment of three screen controls to mix the red, green and blue lights properly.

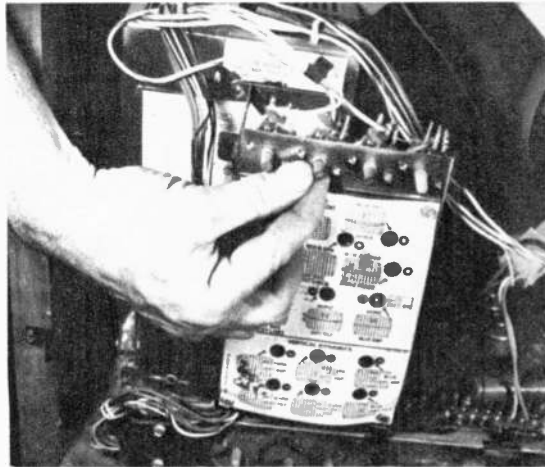

With normal brightness and contrast, turn on the service switch. The picture will collapse into a horizontal line at screen center. Rotate into three lines, one red, one green and one blue. Next turn all three screen controls completely off. The three colored lines should disappear one by one. Then try each screen control on its own by turning it up, then back down. You should be able to produce each color line.

As long as all three lines do appear all you are going to need are the three screen adjustments. Turn up red till you can just see it in a normally lighted room. Then turn

up green to the same intensity. Where the lines touch they'll mix to produce yellow. Next turn up the blue till you can just see it. Where all three lines touch, a white line will be produced. Finally, turn off the service switch. A good black and white picture will appear. All tinting will be gone.

**CRT BIAS:** In the event one or more of the color lines did not appear, it usually means your color picture tube is showing wear and needs a boosting of brightness.

Begin the gray scale procedure again. Turn down all three controls. Then turn the screen up that's not making a line. For instance, let's say there is no red horizontal line. Turn up the red screen control all the way while the blue and green screen controls are turned down all the way. There will be no light on the picture tube face. Adjust the CRT BIAS till the red just appears. Then readjust the blue and green for your gray scale mixture.

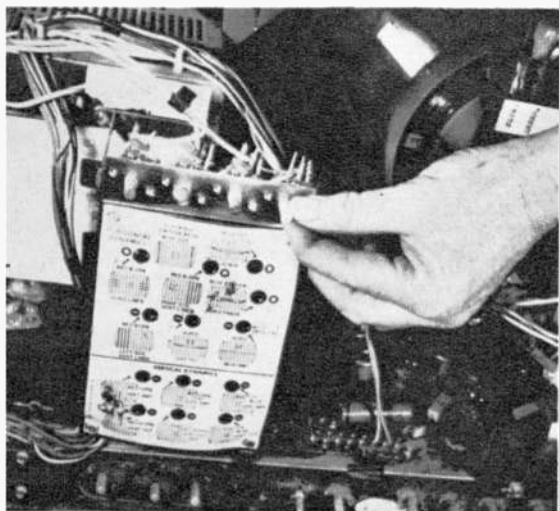

When one screen control won't cause light, turn up CRT bias till that screen can show light.

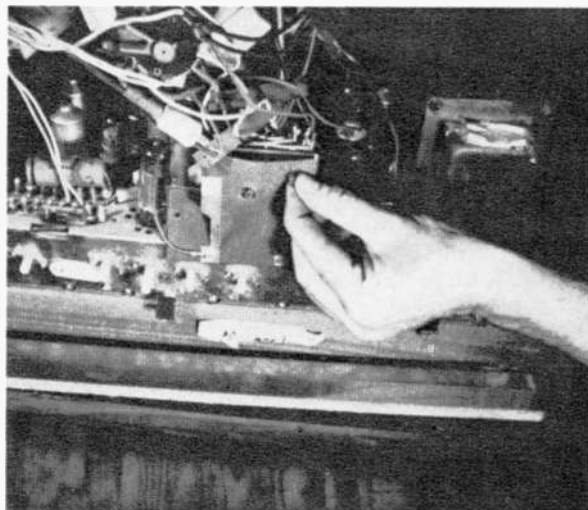

The two drive controls are supplementary to the three screen controls. They mix lights further.

Screen controls turn screen grids up and down. Drive control turns control grids up and down.

When the picture gets color splotches in one or more spots it's because the purity is not right.

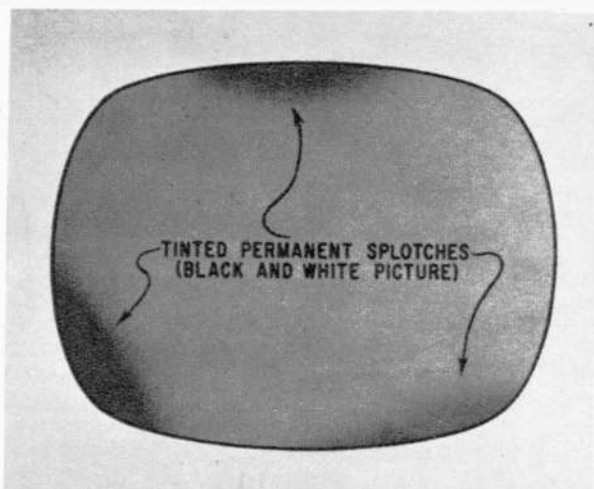
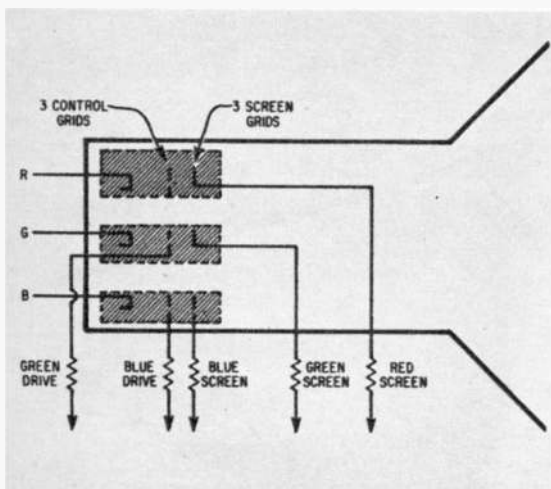

That takes care of all the controls except the blue and green drives. These act like supplementary blue and green screen controls. Therefore should you perform gray scale procedure and still note a hint of tint in the picture you can go to these two controls. Don't turn them far. Try to turn them up as little as possible.

If the picture has hints of blue, turn the blue drive down a bit. If there are hints of green turn the green drive down a bit. If

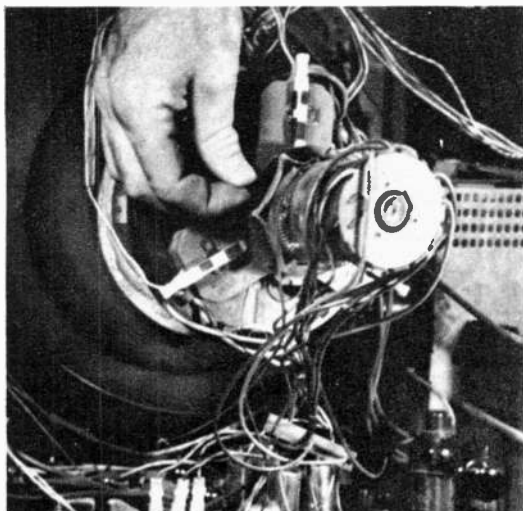

When the splotches appear near screen center, it's usually adjusted out with the purity tabs.

When the splotches appear around the edge of the screen, it's easily adjusted by moving the yoke.

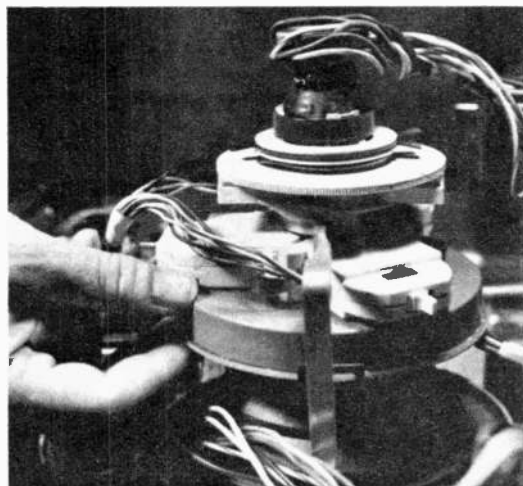

the picture is pinkish, turn both blue and green drive up a bit to mix with the pink to produce grays.

### Trouble No. 45—Poor Purity

The most popular misconception of all color TV rumors is, "you can't move it, once it's set." Like all other rumors, there is a grain of truth to it. The three electron beams in the color picture tube are affected in a slight manner by the earth's magnetic field, just like a magnetic compass. The effect in the TV picture is permanent color splotches, especially around the perimeter of the tube.

The same type of trouble can happen with the TV just sitting in place. Some service manuals advise placing the TV so the picture tube lies in a north-south position. That way there is a minimum magnetic force against the electron beams.

Yes, this does happen and quite often. However, it is usually not too noticeable. Also there are three easy procedures to eliminate poor purity. It turns out also that the easiest one of the three is the one that is needed the most. The other two are not usually necessary unless someone was fooling around with them.

**Degaussing:** The easiest main purity procedure is degaussing or, to state it simply, demagnetizing. If you take a small pocket magnet and hold it near a color TV picture you'll see the picture distort. This is what happens when a small magnetic field develops somewhere on the bell of the picture tube.

If you demagnetize it, like a jeweler does to a watch, you'll clear the poor purity.

Lots of the newer TV's come equipped with automatic degaussing. One type activates every time you turn the TV on. Another type has a button and you can degauss manually by simply pressing the button. Other TV's have no provision.

Unfortunately the set-equipped degaussers are usually weak and will not dislodge a stubborn case of poor purity. It's a good idea for all color TV set owners to own a separate degaussing coil. There are small ones and large ones available at electronic stores.

With a coil, every so often all you have to do is rotate the activated coil around the perimeter of the picture tube. You can do it with the set on or off, before, during, or after any repair. It won't hurt a thing. Just keep the coil away from the rear of the TV. You don't want to demagnetize magnets in the set.

**Purity Tabs:** After degaussing, if some localized splotches still remain, analyze



their screen position. Are they around the rim of the tube or near screen center?

You can adjust screen center impurity by adjustment of the purity tabs. Follow this procedure: Turn the blue and green screen controls off. This leaves a red picture. If the picture isn't bright enough turn the red screen up till you get a nicely lit red picture. Then analyze the red picture. It should be uniform throughout the entire face of the tube. If there are any impurities at screen center adjust the two purity tabs that look like centering devices. They will clear center impurities.

**Deflection Yoke:** The third poor purity procedure is movement back and forth of the yoke. Loosen the bolt that holds it secure. Now, are there any impurities around the edges of the red screen? You can adjust rim and corner impurities by moving the yoke.

There is considerable interaction between the purity tabs and the yoke. The tabs can have some effect on the perimeter and the yoke can cause effect at screen center. Therefore go back and forth from tabs to yoke till a uniform red field is shown. If you like you could even degauss again.

Once satisfied, you can double-check the green and blue by turning down the red screen and turning up the other two one at a time. If the red field was uniform the other two will be too. They are easier to obtain good purity for than the red. However, should you find blue or green impurities go back and check the red. You probably missed a spot on it. Once you get good purity, reset the picture to its proper gray scales with your gray scale adjustments.

### **Trouble No. 46—Bleeding Colors**

Bleeding colors are most noticeable during a black and white program on your color TV. Red, green or blue outlines will appear around figures. It looks almost like a ghost image but it's quite different.

As you noticed during manipulation of the screen controls, there are three separate pictures on a color TV—one red, one green and one blue. Each picture must be placed exactly on top of the other. If it's not, one or more of the colors will bleed through. If not, some adjustments are in order.

First step is to analyze where on the picture tube face the trouble is occurring. Is the bleeding taking place at screen center or nearer the rim of the picture? If the bleeding is at screen center the cure is going to be **STATIC CONVERGENCE**.

Should the bleeding be near the rim of the CRT the cure is going to be **DYNAMIC CONVERGENCE**.

There are four adjustable permanent magnets, called static magnets, stationed strategically on the CRT neck. They adjust screen center. There are twelve adjustable electromagnets also on the CRT neck mounted in a convergence yoke. They cure outer edge bleeding. Their controls are mounted on a printed circuit board called the convergence board.

At this point we run into a complication. You can't make any convergence adjustments unless there is a display of dots and bars on the TV face. The static magnets and convergence board cannot be sensibly touched without the display, for they were designed to be used **ONLY** with such a display.

Servicemen use a dot-bar generator. Some color TV's have a special circuit you can switch on that produces dots and bars. Some TV stations transmit a dot-bar pattern. You must get that dot-bar pattern or don't touch the convergence adjustments.

Let's assume you manage to obtain the proper dot-bar pattern. A perfect pattern shows all dots and bars white and the background black. If that's what is seen no adjustments are needed. However, more than likely you'll see in varying degrees red, green and blue bleeding out of the dots and bars. On the still pattern it is then easy to determine where on the screen the misconvergence is taking place.

**Static Convergence:** For the misconvergence at screen center there are four magnets—**RED STATIC**, **GREEN STATIC**, **BLUE STATIC** and **BLUE LATERAL**. The magnets come in various shapes such as movable sleeves, screwdriver adjustments and knobs. The blue lateral is on the neck, looks like an ion trap and is the closest object to the plastic socket.

The red static moves the entire red field diagonally. The green static moves the entire green field diagonally across the red field's path. The blue static moves the entire blue field up and down. The blue lateral moves the entire blue field from side to side.

If you watch the three colored dots at screen center as you manipulate the controls you can get them to merge and form one white dot accomplishing static convergence.

**Dynamic Convergence:** While you can use either dots or bars to converge screen center, it is easier to use bars around the edges. There are two kinds of bars—vertical and horizontal. There are three color

An automatic degaussing circuit (right and below) built in around the CRT's perimeter, helps a color TV by demagnetizing the CRT almost every day.

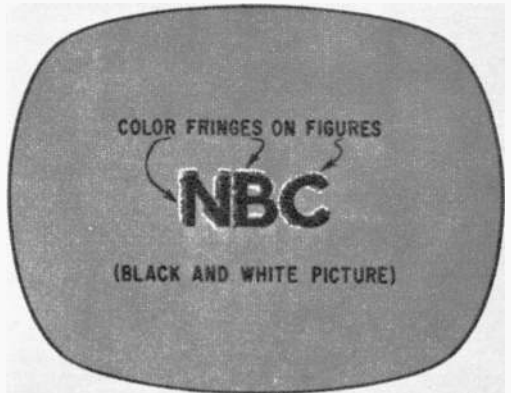
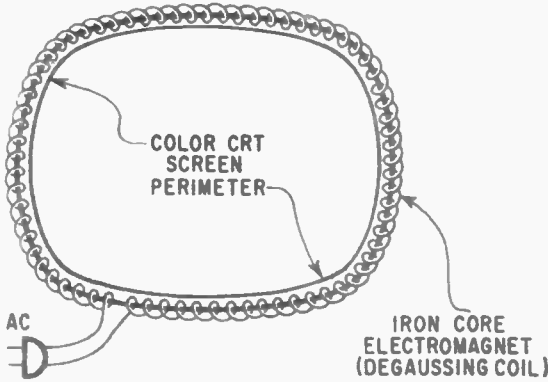
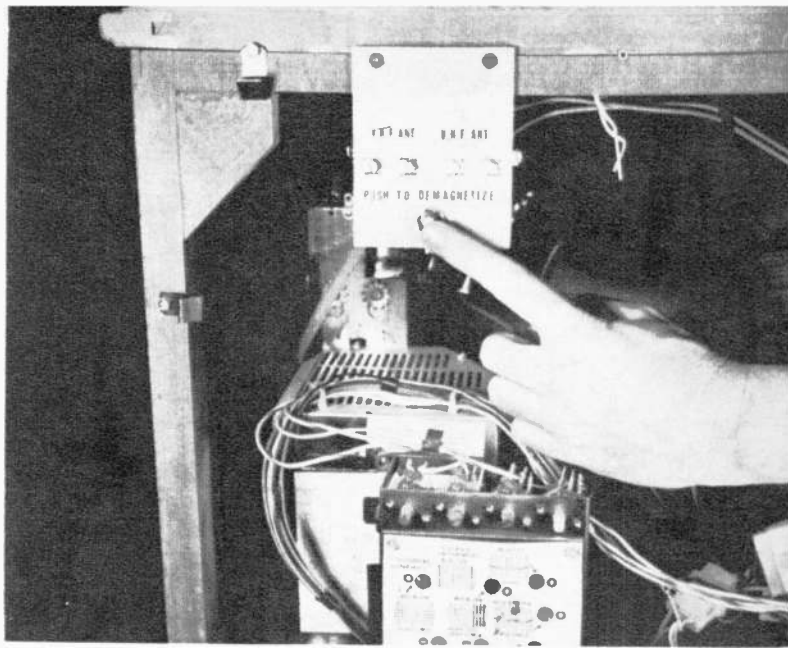

Right, colors will bleed out around the figures when convergence is off. Analyze the trouble.

Below right, there are controls for five face sections: center, top, bottom, left, right side.

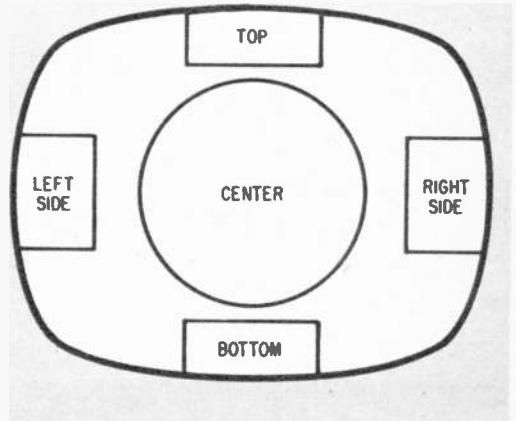

types. This gives us the following six forms of bars: vertical blue, vertical red, vertical green, horizontal blue, horizontal red and horizontal green. If we can merge the horizontals together, the three will turn into one white. If we can merge the verticals together, the three will also turn into one white.

There are controls to do this. There are three controls to adjust the top of the pic-

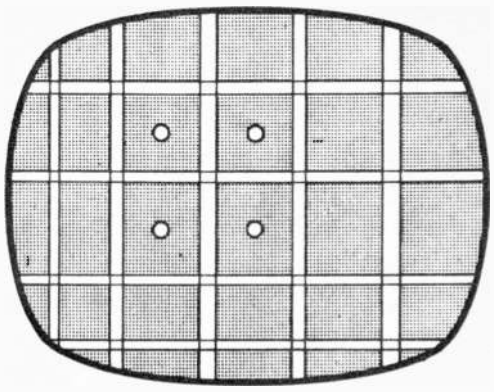
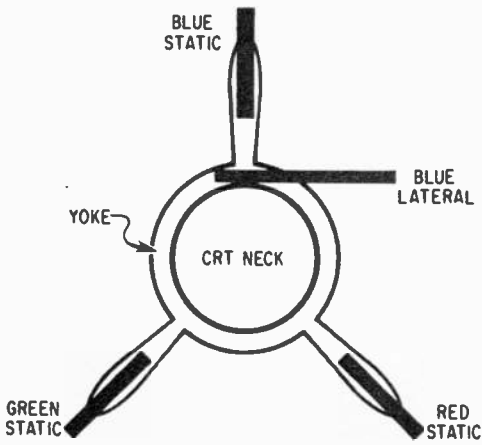

There are four static magnets: red, green and blue statics on convergence yoke, blue lateral.

A perfect television picture will show all dots and bars white and reveal background as black.

ture, three to adjust the bottom, three for the left side and three for the right side. The controls are all marked and here is what they do.

1) TOP, HORIZONTAL RED-GREEN: Rocking this control moves the red and green horizontal lines at screen top, up and down.

2) BOTTOM, HORIZONTAL RED-GREEN: Rocking this control moves the red and green horizontal lines at screen bottom, up and down. (Adjust these two together as there is some interaction.)

3) TOP, VERTICAL RED-GREEN: Rocking this control moves the red and green vertical lines at screen top, side to side.

4) BOTTOM, VERTICAL RED-GREEN: Rocking this control moves the red and green vertical lines at screen bottom side to side. (Adjust these two together as there is considerable interaction.)

5) TOP, HORIZONTAL BLUE: Rocking this control moves the blue horizontal lines at screen top, up and down.

6) BOTTOM, HORIZONTAL BLUE: Rocking this control moves the blue horizontal lines at screen bottom, up and down. (Adjust these two together as there is some interaction.)

7) LEFT SIDE, HORIZONTAL RED-GREEN: Rocking this control moves the red and green horizontal lines at screen left side, up and down.

8) RIGHT SIDE, HORIZONTAL RED-GREEN: Rocking this control with a hex head neut stick moves the red and green

horizontal lines at screen right side, up and down. (Adjust these two together as there is considerable interaction.)

9) LEFT SIDE, VERTICAL RED-GREEN: Rocking this control moves the red and green vertical lines at screen left side, side to side.

10) RIGHT SIDE, VERTICAL RED-GREEN: Rocking this control with a hex head neut stick moves the red and green vertical lines at screen right side, side to side. (Adjust these two together as there is some interaction.)

11) LEFT SIDE, HORIZONTAL BLUE: Rocking this control moves the blue horizontal lines at screen left side, up and down.

12) RIGHT SIDE, HORIZONTAL BLUE: Rocking this control with a hex head neut stick moves the blue horizontal lines at screen right side, up and down. (Adjust these two together as there is considerable interaction.)

There are no blue vertical adjustments. Blue vertical is the reference all the rest of the lines are set upon. If need be you can move blue vertical with the blue static and blue lateral adjustments.

There is quite a bit of interaction between the static and dynamic convergence adjustments. Even though I have them laid out as separate procedures you will probably have to work back and forth between them.

This chapter, if you can master it, will be worth a lot of money in the years you own a color TV. •



### STATIC ADJUSTMENTS

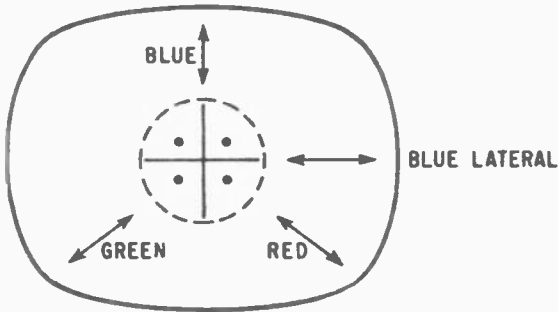

Above, static magnets move red and green diagonally and move blue up and down or side to side.

Right, three controls for top, bottom, left and right side, two for horizontal, one for vertical.

### CONVERGENCE BOARD AND SCREEN

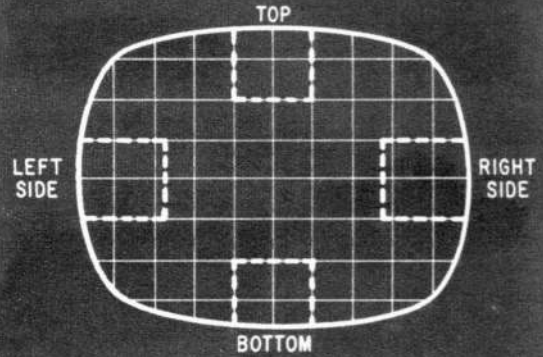

	TOP	BOTTOM	LEFT SIDE	RIGHT SIDE
RED-GREEN HORIZONTAL				
RED-GREEN VERTICAL				
BLUE HORIZONTAL				

Convergence board has nine screwdriver or hand controls, three right side hex head coil controls.

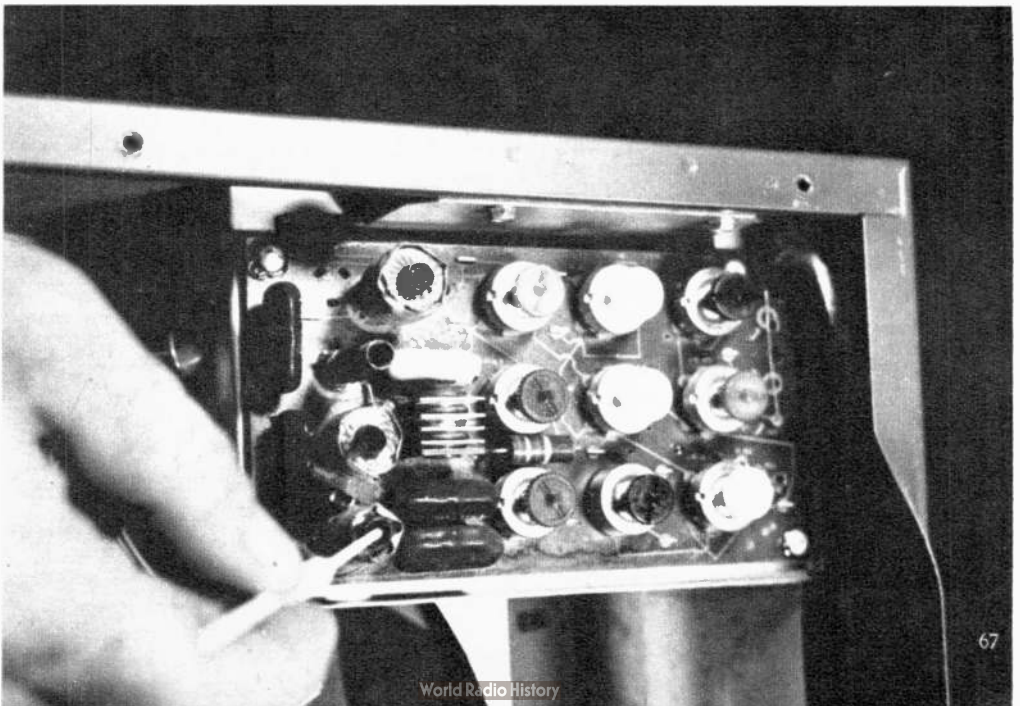

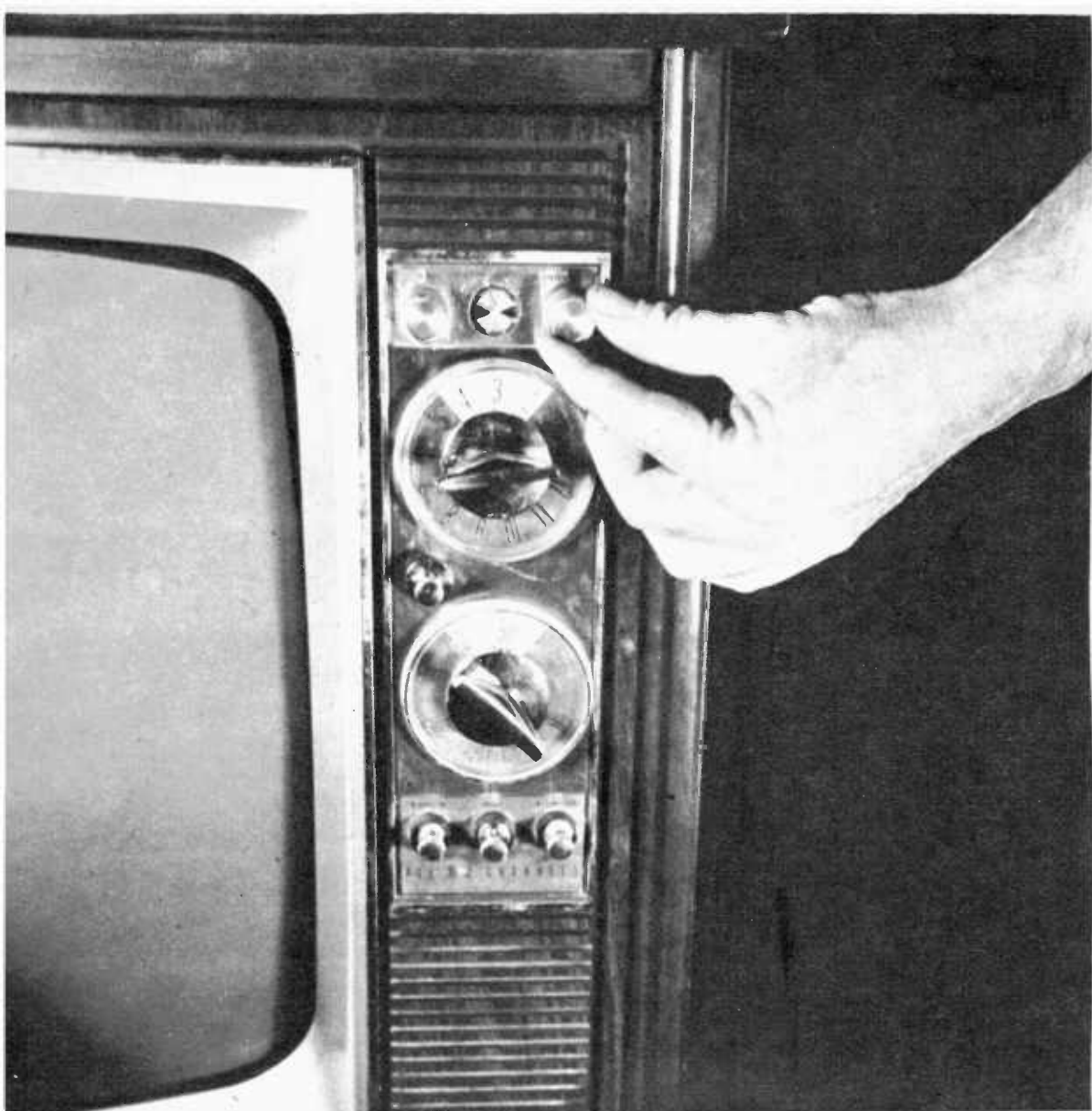

When you crank up color intensity control and picture stays black and white, look at color circuits.

## When Your Color Quits

Combatting smearing, weak colors, overly bright one color and worms

**T**HE COLOR TV from a service point of view is almost exactly like a black-and-white TV except for the additional color-only circuits.

There are about five circuit areas for color and they are usually clumped together. The color signal contains two parts. One is the color sidebands that are going to be processed and then added to the black-and-white picture. The second is the color sync signal, whose troubles we discussed in Chapter 5.

**Color Circuit Operation:** A sampling of the complete TV signal is taken off at the first VIDEO AMPLIFIER. It is sent to the two entrances in the color circuit area, the BANDPASS AMPLIFIER and the BURST AMPLIFIER. In the bandpass amplifier the color sidebands are extracted from the TV signal, amplified and sent on to the DEMODULATORS. In the burst amplifier the color sync or color burst is separated from the TV signal and sent to the 3.58 MC color oscillator to lock it in step with the station's color. The output of the bandpass amplifier and the color oscillator are both fed into the demodulators.

In the demodulators the color sidebands and the oscillator output are combined and construct the color signal. The demodulator outputs are then sent to the three different amplifiers. The three outputs containing R, G and B are applied to their respective control grids in the picture tube.

Meanwhile, back at the first video amplifier the TV signal is amplified, sent to the second video amplifier and then sent into the DELAY LINE.

The black-and-white signal, called Y, travels faster through the video circuits than the color signal tracks through the color circuits. The Y signal is slowed in the delay line. Then the Y signal is amplified once more in the VIDEO OUTPUT and is applied simultaneously to all three cathodes of the picture tube.

## TUBE LOCATION GUIDE

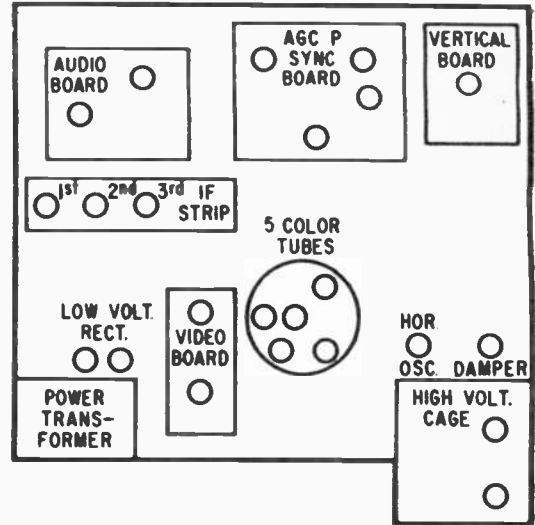

There are about five color circuit tubes and they are usually placed together in a close group.

The actual color circuits are straightforward and present no real tube-changing problems to you.

## COLOR CIRCUIT BLOCK DIAGRAM

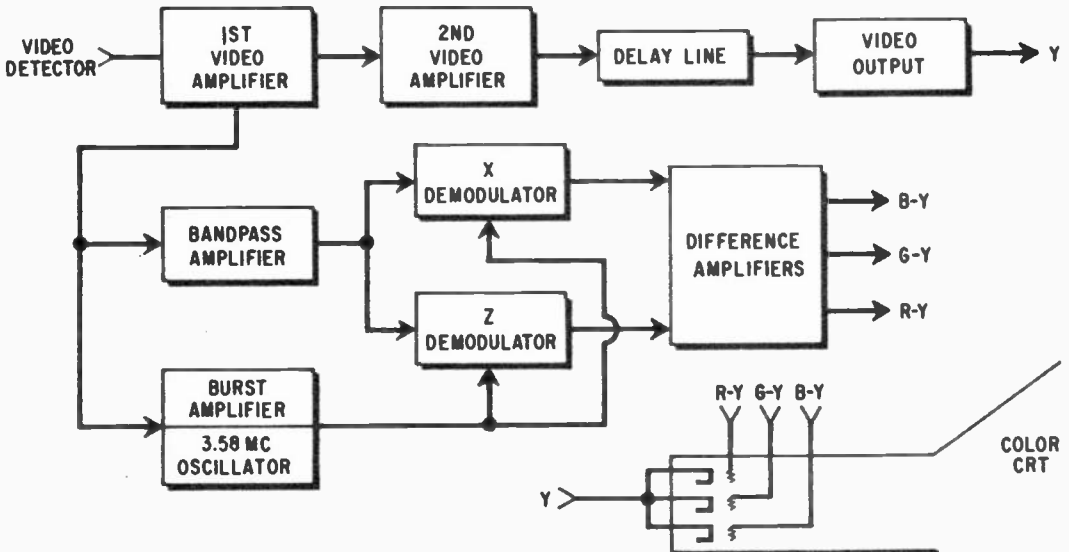



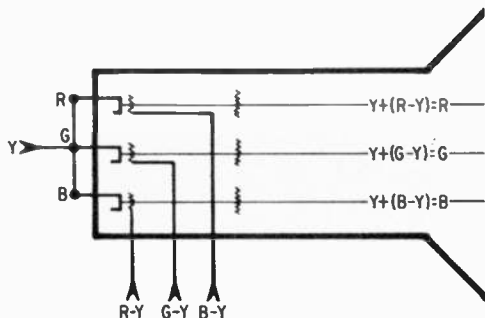

In the electron guns the Y is mixed with R-Y, B-Y and G-Y to produce pure red, green and blue.

During a black-and-white program, the color killer, as discussed in Chapter 8, shuts down all the color circuits. At that time the only signal that gets to the picture tube is Y, producing a monochrome show.

During a color program, the color killer shuts off, the color circuits come on and the color signal gets to the picture tube control grids. The color signal adds to the Y producing a color show.

Troubles occur to the color when there is a circuit problem in these circuits. Let's go through the color-only troubles.

#### **Trouble No. 47—No Color, Black & White OK**

This trouble is to be differentiated from the other losses of color. This is occurring only when there is a good black and white picture. Try the COLOR INTENSITY control first. Next there are the tube suspects in order, BANDPASS AMPLIFIER, 3.58 MC OSCILLATOR, BURST AMP and BURST KEYS. If the oscillator gets off frequency the color killer gets an impulse that it interprets as no color burst and shuts down the color circuits.

Lastly, try a new COLOR KILLER tube since it has it in its power to kill color.

Should the color be missing on one or more channels, especially weak channels, but appear on others test the RF AMPLIFIER, MIXER-OSCILLATOR and IF tubes. (Also see Chapter 11.)

#### **Trouble No. 48—Color Smeared, No Black & White**

This is a weird looking trouble. If you

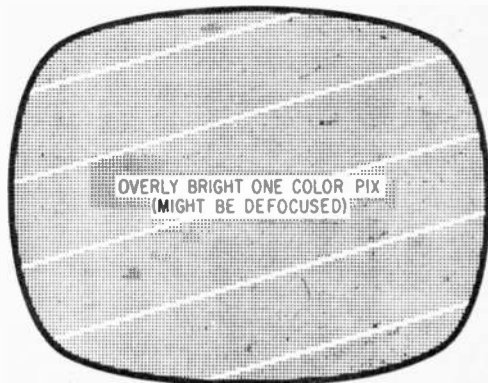

If picture suddenly turns an intense single color it's because color difference tube like G-Y died.

look at the block diagram of the color circuits, at the top you'll see the path of the Y signal. It travels through the first VIDEO AMPLIFIER, second VIDEO AMPLIFIER, DELAY LINE and VIDEO OUTPUT into the COLOR CRT.

Since this trouble is loss of the Y signal they are the prime suspects. The colors are actually good. They appear smeared because all you are seeing is the R-Y, G-Y and B-Y that is usually added to the Y to produce pure R, G and B.

#### **Trouble No. 49—Weak Color**

When your colors get weak the degrees of the symptom are a dull red instead of a vivid one, to a washed out picture that almost looks like a black and white except for the fact that the sky is a dull blue and flesh tones are almost correct.

First suspect is the BANDPASS AMPLIFIERS. Next try the RF AMPLIFIER, MIXER-OSCILLATOR, IF tubes and VIDEO AMPLIFIERS. Another common cause of weak color is a detuned IF strip. Better call for help on that one though. (Also see Chapter 11.)

#### **Trouble No. 50—Overly Bright One Color Picture**

Should your TV picture suddenly go vivid, blurry, red, green or blue, that particular circuit is running wide open. This is a different trouble than a lightly tinted picture. Test the color difference amplifier indicating the color. For instance, if the picture is vivid red, test the R-Y amplifier and so on.

## COLOR TROUBLES

TROUBLE	REMEDY
No Color	Band Pass Amp—Color Killer—Burst Amp—3.58 MC—Reactance Amp Antenna—RF Amp—IF's
No Video—Color OK Color Smeared	Video Output—Delay Line—Color CRT
Weak Color	Bandpass Amp—RF Amp—Mixer-Oscillator—IF's Video Amplifiers Detuned IF Strip
Overly Bright One Color Screen	For Red R-Y For Blue B-Y For Green G-Y For Yellow R-Y, G-Y
Loss of One Color	Gray Scale Adjustments R-Y, B-Y, G-Y, Color Picture Tube
920 KC Beat-Worms	Adjust Color Killer Bandpass Amps, RF Amp, Mixer-Oscillator, IF's
Color Interference in B & W Picture	Adjust Color Killer Color Killer Tube Bandpass Amp

A visual tipoff of a bad tube is a milky top. This usually happens when glass tip cracks open.

The smeary color picture is due to loss of Y and a prime suspect is the delay line in the chassis.

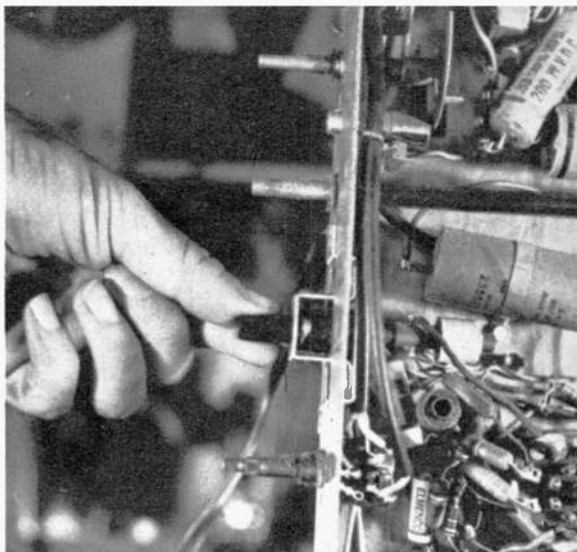

The apparently unrelated horizontal hold control when slightly misadjusted causes loss of color.



Common cause of no color is a misadjusted color killer. Make sure you check it at all settings.

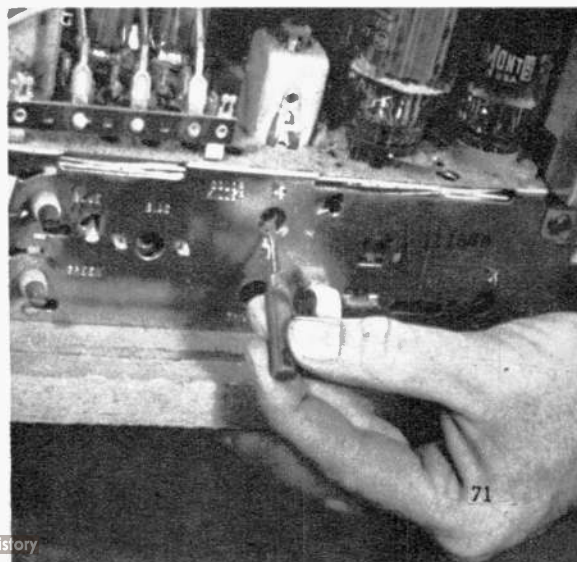
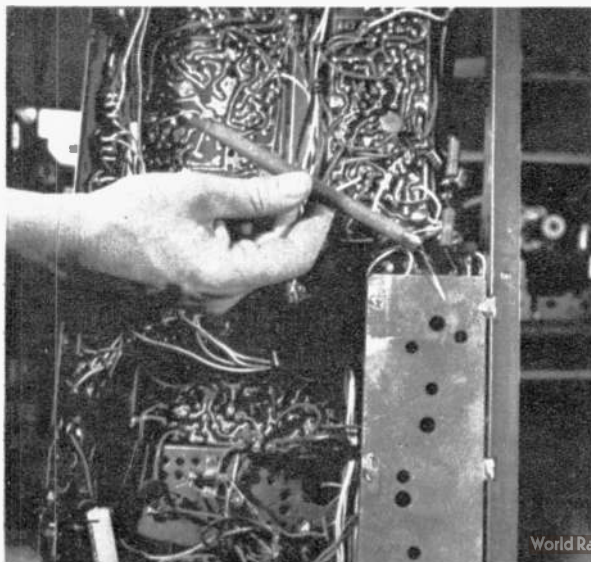

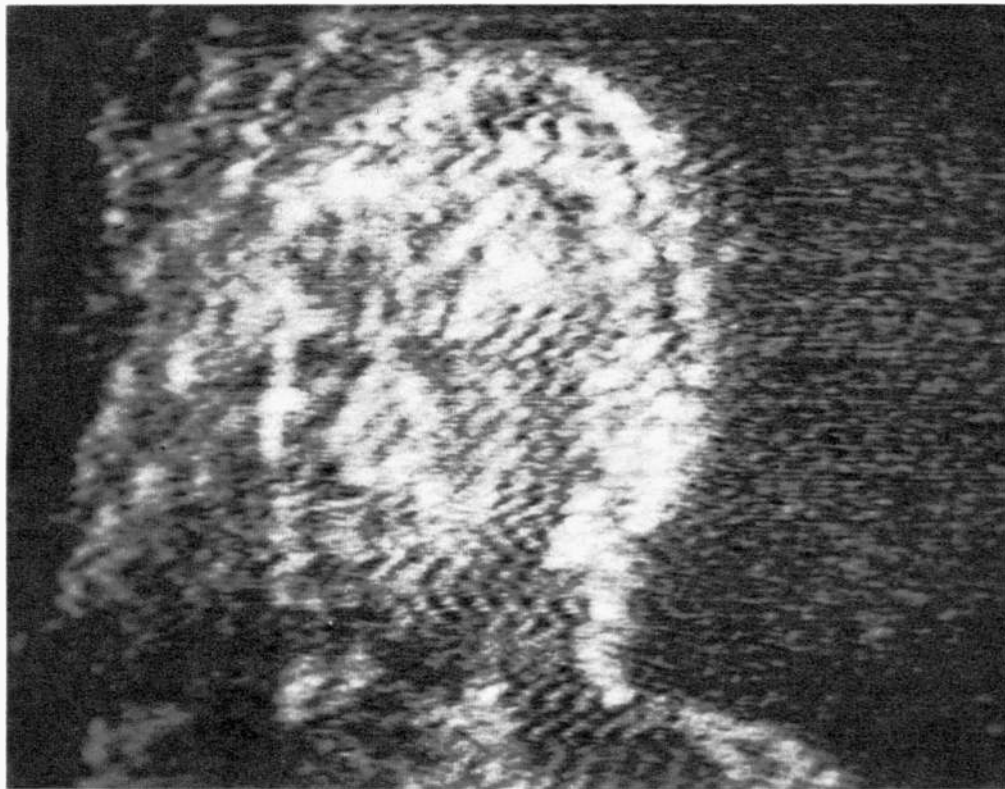

If your color picture deteriorates into color worms, there is an unwanted mixing of color and sound.

A confusing one of these might be a vivid yellow picture. Since yellow is made up of green and red test the R-Y and G-Y amplifier.

#### **Trouble No. 51—Loss of One Color**

When you lose one color it's a bit confusing to analyze. For instance, when you lose green, your black-and-white picture is lost. It changes to shades of blue, red and purple. When you lose red your picture changes to shades of blue, green and cyan. When you lose blue, your picture changes to shades of red, green and yellow. Black and white becomes impossible.

First step is to try the gray scale adjustments (TROUBLE No. 44—TINTED PICTURE). If that doesn't cure, try the B-Y, G-Y, R-Y COLOR DIFFERENCE AMPLIFIERS. Next step is to look at the neck of the picture tube to see if all three guns are lit. If one is out that's probably it. A bad picture tube.

Should you not be able to pin down the trouble with the above analysis it's probably bad news. There is a weak gun in the

picture tube even though all three guns are lit.

#### **Trouble No. 52—Worms**

If you misadjust your fine tuner you can usually produce color worms in small objects. This is a 920 KC beat between the color subcarrier and the sound carrier in the transmitted color program.

As long as you can fine tune it out there is no trouble. If these worms won't come out you can try adjusting the COLOR KILLER, try replacing the BANDPASS AMPLIFIERS, RF AMPLIFIER, MIXER-OSCILLATOR and IF tubes. If none of these help, your IF strip might be overtuned but you should call for help with knowhow. (Also see Chapter 11.)

#### **Trouble No. 53—Color Snow and Color Interference in Black & White Picture**

This trouble was mentioned in Chapter 8 under the COLOR KILLER adjustments. Another cause would be the COLOR KILLER tube and the BANDPASS AMPLIFIERS. •



# Take this big 196- page "Fix-it" book

## FREE!

When you try this program—  
No obligation to buy even one book  
save money by making home improvements and car tune-ups  
and repairs yourself, often doing them better than "high-  
priced" outside help and far easier than you might think.

Yes, entirely FREE —  
and packed with  
plans, projects and  
ideas for make-it-  
yourself fun, ways to

ACTUAL SIZE  
7<sup>3</sup>/<sub>4</sub>" x 11<sup>1</sup>/<sub>4</sub>"

ALL This and More in  
Your FREE Book:

ADDITIONAL BEDROOM  
BUILT-IN CLOSETS  
MODERN FURNITURE  
TV REPAIRS  
ANTENNA PROBLEMS  
HOME VENTILATION  
BURGLAR ALARMS  
ALUMINUM PROJECTS  
ATTIC EXPANSION  
HOUSE FRAMING  
GARDEN ACCESSORIES  
BOOSTING GAS MILEAGE  
WINDOW FRAMING  
SKYLIGHTS  
PLYWOOD PROJECTS  
POWER TOOLS  
AIR CONDITIONING  
HOME AND CAR  
TRANSMISSIONS  
DRIVE SHAFTS,  
AND DIFFERENTIALS  
SPRAY PAINTING  
OUTDOOR FURNITURE  
WEBBING  
DORMERS  
WEATHERPROOFING  
ATTIC FANS  
BAR CART  
PATIOS  
BARBECUES  
EMERGENCY  
CAR REPAIRS  
AUTO TUNE-UPS  
STARTING PROBLEMS  
CAR COOLING SYSTEM  
ROOFING  
SHEATHING  
APPLIANCE  
REPAIRS  
GUTTERS  
& FLASHING

PRACTICAL HANDYMAN'S ENCYCLOPEDIA

WHY DO WE GIVE AWAY THIS  
LARGE VOLUME—containing  
over 100 projects, 400 how-to  
pictures, 50,000 words— with-  
out "strings" To demonstrate  
to home owners and hobbyists  
the dollars-and-cents value of our  
famous "how-to" Encyclopedia.

Which project do you want  
to start right away?

Want an extra room? Air condi-  
tion your home? Trouble-free  
your TV antenna forever? Car  
tune-up, gas-saving tips? Build  
bar cart? Barbecue? Attic venti-  
lator? Modern arm-chair? Free  
Volume I's experts guide your  
hands with clear photos... in-  
siders' secrets... diagrams...  
checklists. Even beginners can't  
go wrong, waste time or mate-  
rials. Save \$2.50—\$4.96 HOUR-  
LY LABOR — DO CRAFTS-  
MANSHIP JOBS! Now even  
amateurs can handle "skilled"  
jobs. Save \$9 TV house calls.  
\$4.25 carpenters' hourly rate. Big  
car mechanics' bills.

How to have Vol. I  
shipped FREE immediately:

Fill out and mail shipping label  
below today. We'll send Vol. I  
right away FREE. Do not send  
it back or pay anything for it  
ever. Large 7<sup>3</sup>/<sub>4</sub>" x 11<sup>1</sup>/<sub>4</sub>" book  
is typical of all 22 volumes in  
Practical Handyman's Encyclo-  
pedia. 4,256 pages, 7,250 show-  
how pictures, thousands of ideas  
and projects: gardening, furni-  
ture, plumbing, electrical, hi-fi,  
electronics... boats... cabins,  
cottages... photography...  
built-ins, kitchens, bath... con-  
crete... etc.

After examining Vol. I, you  
may receive Vols. 2, 3, 4 about  
a month apart, the rest of the  
volumes in 2 shipments on ap-  
proval. Examine them for 7 days,  
then either remit only \$2.98 plus  
postage for each or return and  
owe nothing. Buy one, two, as  
many books as you like... or  
whole set... or none at all. No  
pressure, no "catches." We stop  
sending books any time you write  
us.

Send shipping label now for  
FREE VOLUME I to: Practi-  
cal Handyman's Encyclopedia,  
Dept. TV 9, Box 77, Cos Cob,  
Conn. 06807.

### SHIPPING LABEL

FROM: The Practical Handyman's Encyclopedia  
Dept. TV 9, Box 77, Cos Cob, Conn. 06807

TO:

Name \_\_\_\_\_  
(please print)

Address \_\_\_\_\_

City \_\_\_\_\_ Zone \_\_\_\_\_ State \_\_\_\_\_

CONTENTS: BOOK, Volume I of The Practical Handyman's  
Encyclopedia. 1<sup>3</sup>/<sub>4</sub> lbs., 196 pages, over 400 pictures,  
50,000 words.

### NO RISK NO OBLIGATION. WHAT YOU GET:

1. FREE 196-page, over 400-  
picture, over 100-project Vol-  
ume I of The Practical Hand-  
yman's Encyclopedia. No  
cost at any time, no "catch,"  
no obligation.
2. You are entitled to receive  
each new volume for 7 days'  
free approval. For those you  
decide to keep, you pay only  
\$2.98 plus shipping.
3. You never have to buy any  
books at all... or you can  
choose one or a few... or the  
complete matched Library set,  
if you wish... the choice is  
yours.
4. You may instruct us to stop  
shipping books simply by writ-  
ing us and we'll cease ship-  
ment immediately.

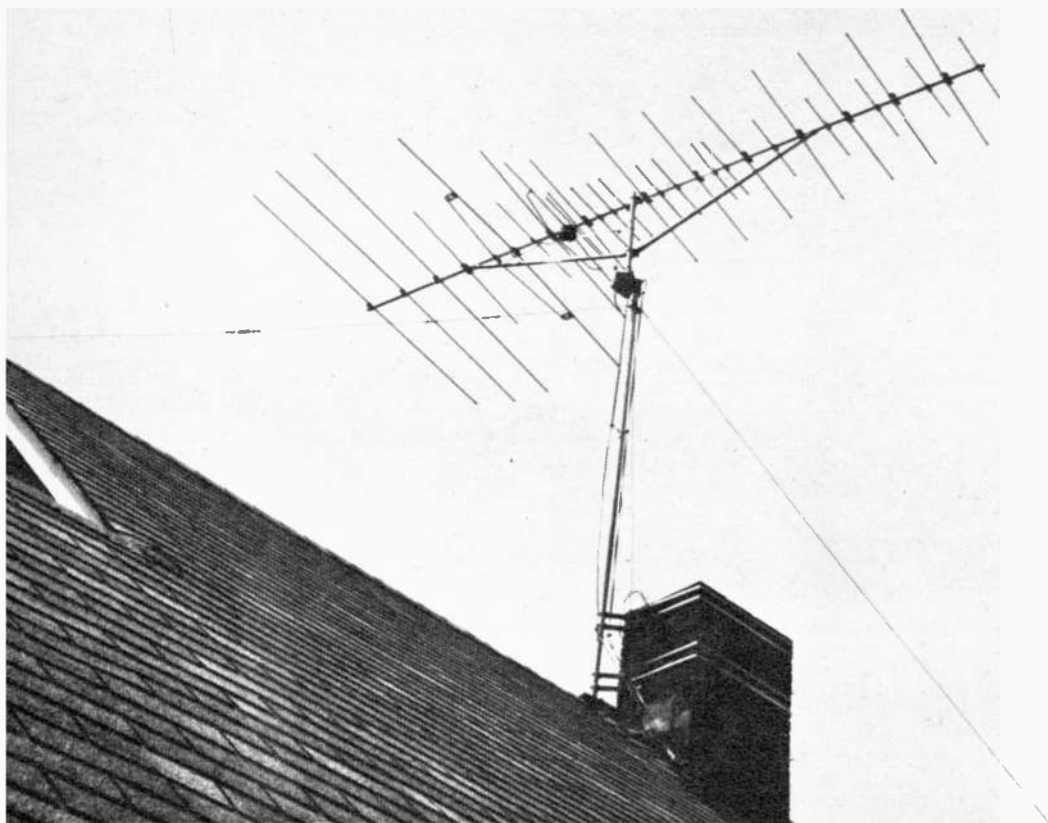

When a small, cheap antenna won't pull the desired reception, you can choose a large expensive rig.

# The Trouble With Antennas

It's safety first with rooftop work. Focus your attention on lead-in wire

A TV antenna can cause snow, ghosts, overloading, flashing, static, loss of fine detail, weak color, no color, worms and other troubles closely resembling set troubles. Therefore your first antenna troubleshooting move is to make sure it is really antenna trouble.

## ANTENNA TROUBLES

TROUBLE	REMEDY
Snow, Ghosts, No Color, Flashing, Rolling, Bouncing	Replace Wire Check for Poor Connections Snug Down Wire Replace old Standoffs Install More Standoffs Repair or Replace Old Antenna Heads Orient Antenna for Best Heading
Motor Stops or Becomes Erratic	Check connections at Motor and Control box Replace filter capacitor in motor Replace motor Repair or replace control box
Booster Troubles—Snow, Hum Bars, Rolling	Replace Tubes, Transistor or Nuvistors, Replace filter capacitors

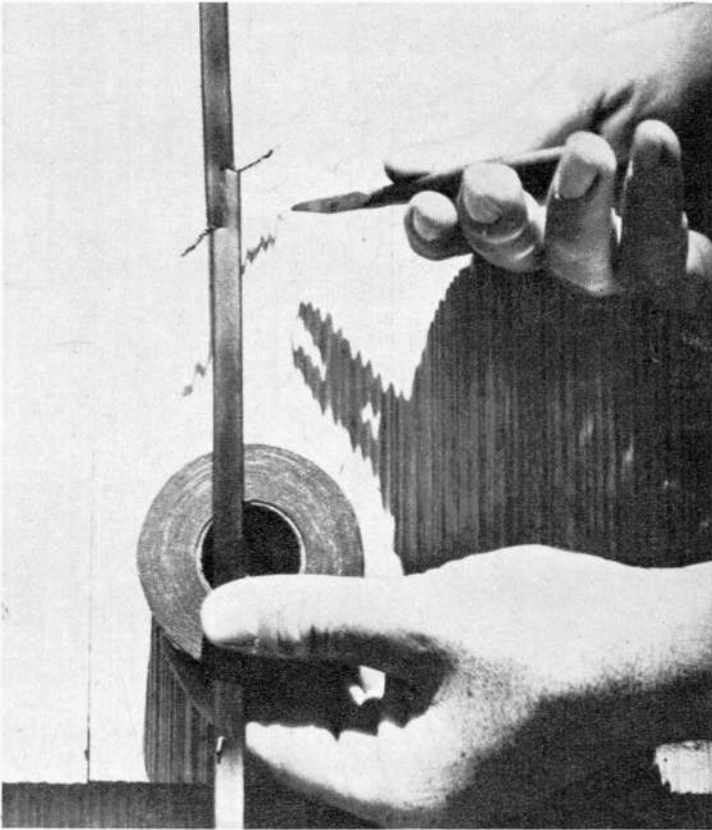

**Twin lead breaks are easily spliced to form a permanent repair. The trick is merely to locate break site.**



**The quick test to determine whether the trouble is in the outdoor antenna is made with rabbit ears.**



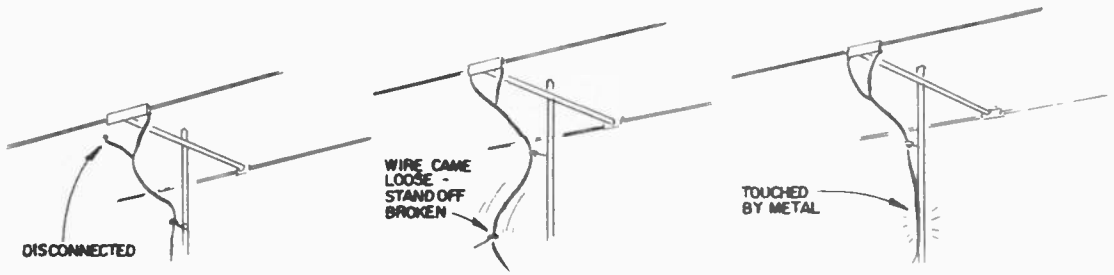

Look for disconnected wire at TV terminals, antenna head or at any coupling devices. When lead-in loosens it will flap in even the slightest breeze. Broken wire is easy to see. If wire's new, splice it.

The photo demonstrates various things your picture might exhibit when the lead-in is faulty, defective.

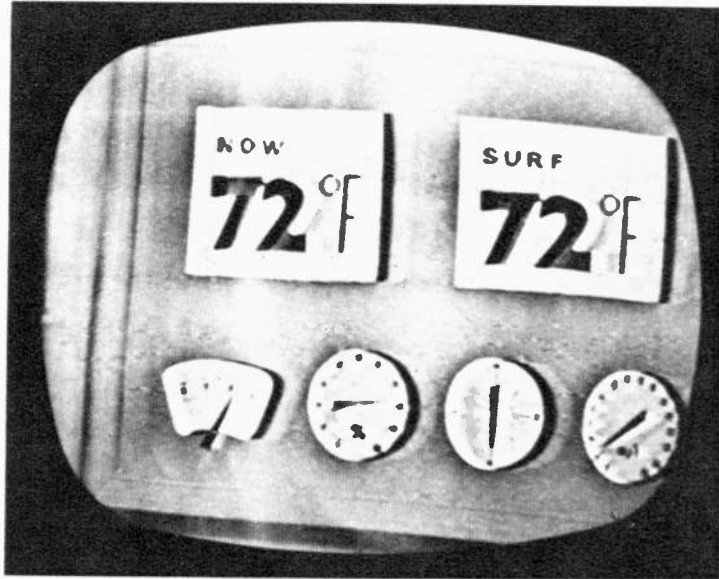

A quick test is easy. Take a pair of rabbit ears, indoor antenna, disconnect the outdoor antenna and install the indoor in its place.

Has the trouble disappeared? Are you now getting normal indoor antenna reception? If so the outdoor antenna is really at fault. If the trouble is still as apparent as before, the TV set is causing the symptoms.

Once you have decided it's really the outdoor antenna system that needs work, you are ready to go. Let's go through the various reasons an antenna fails and the techniques required for the repair.

**Safety First:** Your number one consideration is SAFETY FIRST! Rooftop work should only be performed by people who have experience with a ladder. It's always the novice who gets hurt. There are two main dangers on a roof, falling and bare electrical wires. Be careful!

**Commonest Antenna Breakdown:** Unlike the TV that sits indoors like one of the family, the antenna system is exposed to the elements day in, day out. Wind, rain, snow and sun takes it toll. Your LEAD-IN WIRE has a limited life. The wire is subject to deterioration and as a result becomes disconnected, loose, waterlogged, touched by metal, frayed and broke.

Each one of these forms of wear causes TV trouble symptoms to appear on your screen. Each form of wear has its own family of symptoms. A good approach is to simply pull out the old wire and install a complete new length. There are new types of lead-in wire being developed all the time. Therefore if your wire is more than two years old, that's what you should do.

However, if your wire is newer, or was a strong type to begin with, maybe you can repair it. Let's go through the lead-in wire troubles.

**Loose Wire:** From the connection on the antenna head to the TV set terminals the wire, ideally, should be snug. However, wind over a period of time loosens it. When this happens the wire flaps from even the slightest breeze. The TV picture becomes erratic. The picture flashes, flops and has color fading in and out. These troubles will have a degree of seriousness in direct relation to the amount of looseness. The remedy: snug down all loose sections of wire.

**Disconnected:** The wire is vulnerable at connection points—at the antenna head, at any two set couplers, splitters etc., and at the terminals of all the TV's, FM sets or anything else it's connected to. Just one poor connection will cause snow, loss of sound or color, rolling, barberpole effect, worms or ghosts. Check all connections for a complete disconnection, partial disconnection, fraying connection or accidental shorting across terminals by frayed lead-in wire.

It's a good idea to install spade lugs at all connection terminals.

**Touched by Metal:** If you are using coaxial or shielded cable you can forget about this trouble. With regular twin lead

though this is an important consideration. The lead must not touch any rain gutters, drain pipes, TV masts or even lay flat on a roof. Take pains to be sure that the wire is run through enough standoff insulators.

When twin lead touches metal an impedance bump develops at that point. An impedance bump blocks off TV signal like dirt does in a water pipe. The bump not only blocks but bounces the signal back up the wire. These standing waves cancel out some of the incoming signal and combine with some of the signal to cause incorrect impulses to enter the TV set. The metal touching ends up as loss of fine detail, loss of color intensity and ghosts in the TV picture.

**Broken Wire:** If you can see where the lead-in is broken splice it right there. More times than not, though, the wire breaks inside the insulation and there is no visual tipoff. You conclude there might be a break in the wire when snow and flashing appears in your TV picture and the rabbit ears test says the antenna is at fault.

The best approach is replacement of the entire length of wire. Should you want the satisfaction of locating the exact trouble

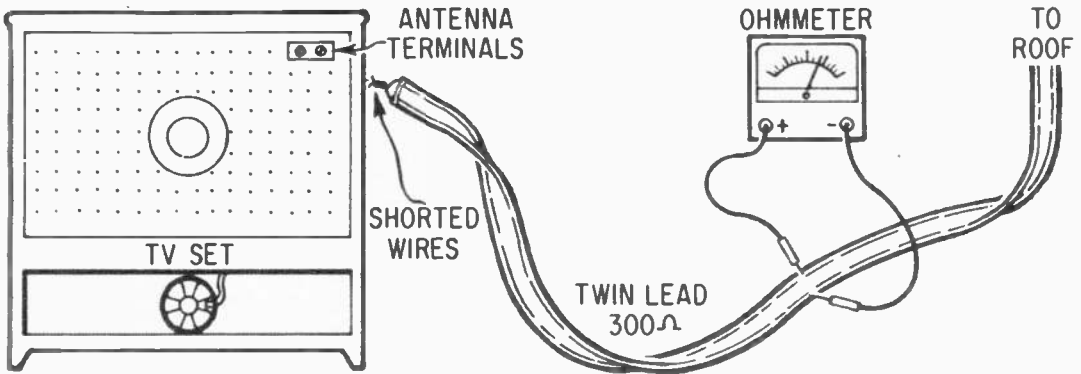

By shorting your lead-in at antenna terminals and working your way up, you can locate actual break.

When a new building is erected in the area, it can have a harmful effect on many sets' reception.

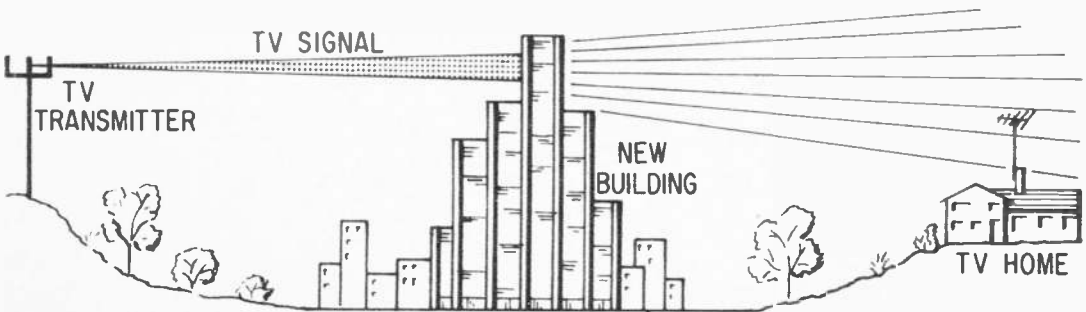

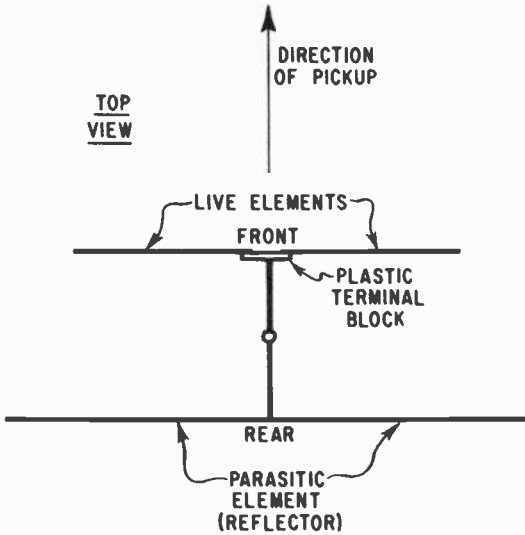

Be sure to maintain insulation on live element. Don't be concerned with shorts on other elements.

First step in any motor troubleshooting is check of the connections. Alliance rotors have this layout.

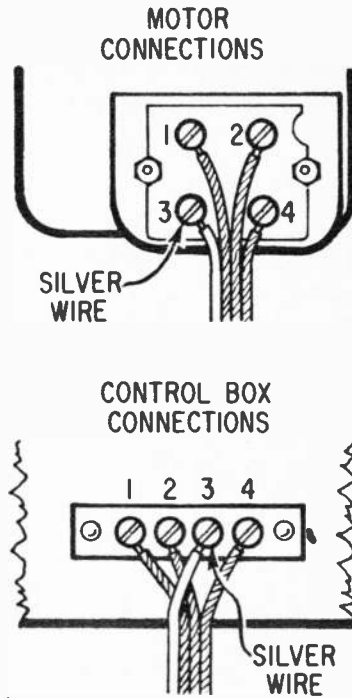

A common cause of motor failure is a defective filter capacitor in control box. Change before going on.



spot, here is how it can be done. You'll need an ohmmeter or other type of continuity device. Disconnect the wire at the set's antenna terminal and short the two ends together. Then working toward the antenna head on the roof, pierce the insulation with the meter probes and shake the wire. As long as the meter reads short you haven't reached the break. As soon as the meter reads open or the needle begins acting erratic you have just passed the break. It lies between that spot and the last one. Zero in on it from there. Then splice in a new section of wire.

**Broken or Worn Out Standoffs:** These items break, come loose or lose their insulating centers. It is usually obvious when this happens and you can find the bad one

by examining them one by one. The bad standoff can cause the lead-in to be loose, break or touch metal. This gives all the snow, flashing, loss of color, etc., symptoms. If in doubt replace the standoffs. They are inexpensive and simple to install.

**Worn Out Heads:** Antenna heads become defective because they wear out. The bolts rust, the elements deteriorate, fall off, bend, touch each other and cause the head to swing in the wrong direction.

Another more subtle defect occurs when new high buildings are built nearby or a TV transmitter moves its location. The TV picture symptoms usually occur over a long period of time, little by little, and you hardly realize what bad shape you are in.

When you decide to do work on your an-



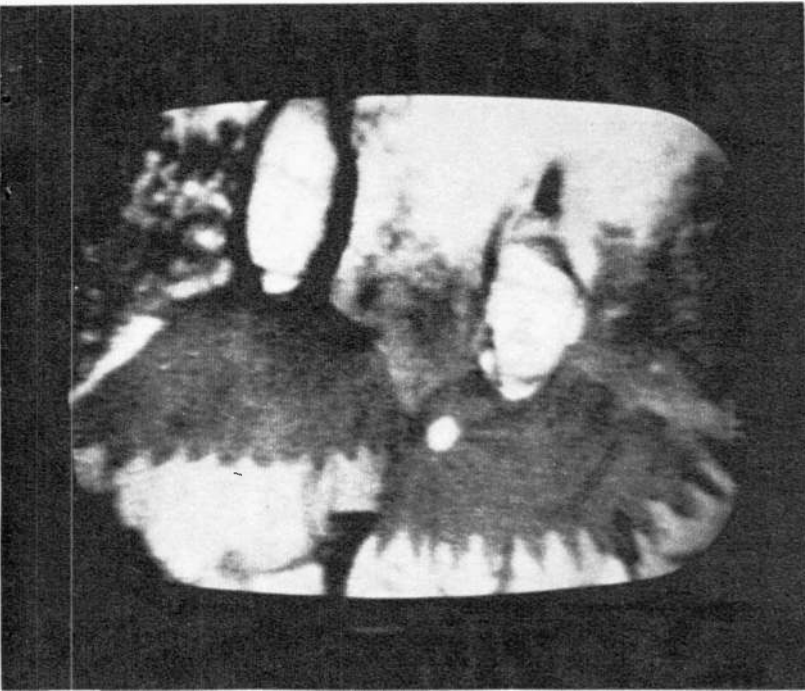

Annoying snow is one of the problems that can afflict your screen when the signal booster has failed.

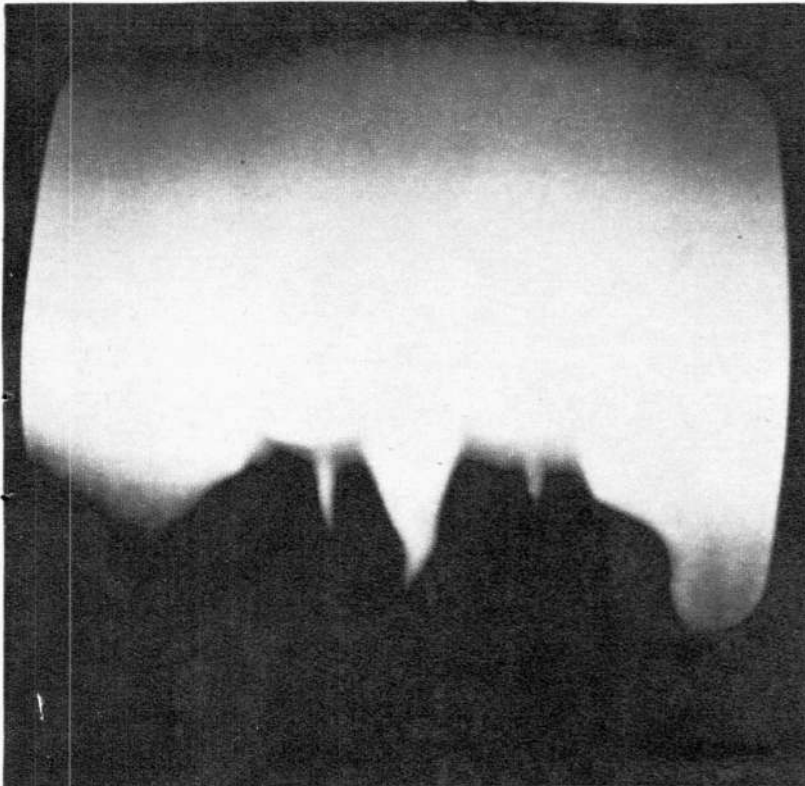

Hum bars also result from signal booster failure; also rolling and overload. Always check tubes, filter.

tenna head, should you repair or replace? If the head is more than a year old and is an inexpensive type, replace. It will probably fall apart as you take it apart. If it's a fancy rig the repair attempt might be worthwhile, especially if it's anodized.

Bent elements need only be straightened. Broken elements need replacing. Buy some 1/2-inch aluminum tubing and a hacksaw. Remove the old element and measure off a new replacement length exactly. Attach the new element.

If it's a parasitic element it's attached directly to the crossbar. You can run screws and bolts through them at will with little concern for insulation. If it's a driven element, one that has lead-in attached to it, be sure you maintain insulation between the elements. Don't short out the spacing between the elements on the insulated element holder.

After you repair the head take a can of plastic spray and put a coat on the antenna, especially around where the lead-in is installed. When you place the new antenna or repaired antenna in place check the orientation. Are you picking up best

possible all-around reception? Loosen the mount, rotate the antenna a few degrees at a time and make note of the pictures on your screen. At the heading where best reception is obtained, lock the antenna in.

If you find you need two or three spots for best reception on different channels you can cut a motor in so you can orient your antenna from setside.

**Probing the Roof:** When your TV picture is a casualty of progress and a new structure has hurt your reception you can probe the roof for a new antenna location and height. This is a two-man walkie-talkie job. One man on the roof walking around with an antenna head on a pole testing different locations on the roof, different angles, and various heights; the second man at setside reporting results. It's time-consuming and dangerous for the rooftop man but often you can get excellent results.

When this produces poor results you can try more expensive rigs and different manufacturers' products.

**Servicing Motors:** The more complex your antenna system becomes, the more

A familiar type of failure is breakage of the built-in antenna. Exact replacements are available at TV stores.



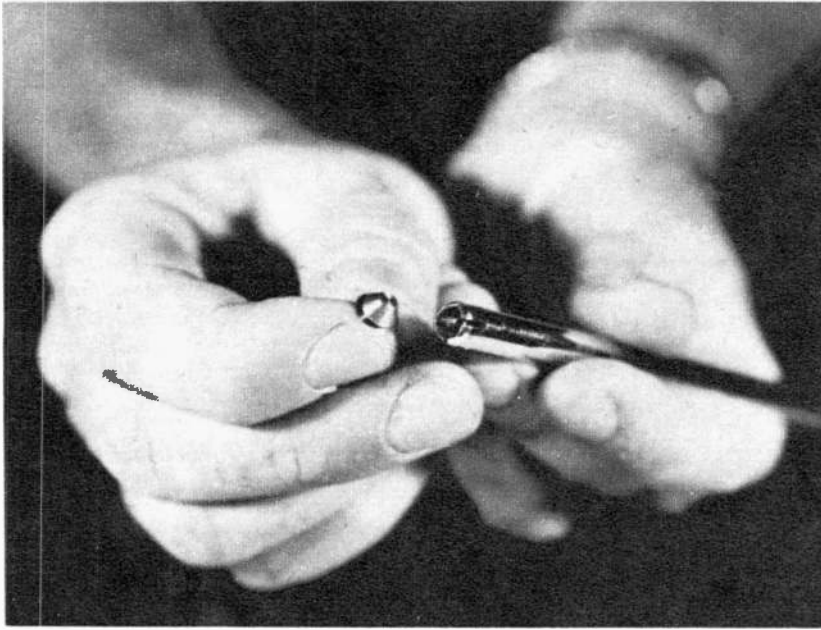

If only the rod of the built-in antenna breaks, then buy a universal easily installed cheap replacement.

likelihood you'll need service. When you get a motorized antenna in addition to all else, there is a motor, a length of four-wire cable and a control box. These three items are all subject to failure. The symptoms are simple; the motor won't turn.

First check is to make sure all connections are okay. If one of the eight connections, four in the control box and four in the motor, should come off, the motor won't turn. Next check is to look over the wire. It is subject to breakage and fraying due to wind and weather. Be sure to snug it down firmly and replace any standoffs that might have gone bad.

Once you are sure the wire is okay, check out the control box. We prove or eliminate the control box as faulty by installing a new one and see what happens. If performance is restored then we know the box is at fault. Should the trouble persist we know it's not. Perhaps you can borrow a control box from a neighbor and do the same thing.

Actual servicing of the control box means testing switches, wiring and clock mechanism type equipment. Once you establish that the wire and control box are cleared, the only thing left is the motor. There is a filter condenser in the motor. In a great percentage of motor failures it's that filter that has gone bad. If you can get the motor down, check it first. Everything else in the motor is mechanical, and if you

can work on gears and rotation equipment it's all yours. Decide in servicing the motor and control box whether it is worth your while to repair the old equipment or replace it. Unless it's the filter I'd replace the entire motor. It's rough to keep climbing up and down to service it. You can go a little further with the control box since it is convenient. However, too much servicing on it indicates replacement.

**Servicing Boosters:** Repairing boosters is just like repairing any other circuit. It's electronic work and you need circuit repair technique. There are two troubles a bad booster can cause: Snow in the picture to a more or less degree, and visible hum in the picture to a more or less degree.

The rabbit ears test will pinpoint the trouble as being either in the booster or in the TV. It's very important to use the test. Since the booster is an auxiliary RF amplifier, it causes exactly the same symptoms as the tuner.

The first approach is to replace the tube, transistor or nuvistor. In boosters ninety-five per cent of the time this will effect the cure. If it doesn't, you need a bench repair which you must use your judgment on attempting.

Should you have visible hum trouble, in addition to the tube or equivalent, try replacing the booster's filter condensers. Chances are good you might effect this repair. •





# Those Wonderful New Antennas

You need an all-channel yagi, antenna amplifier, motor and booster for job

*Photos courtesy of JFD Electronics*

Large antennas, once a rarity, are now appearing on rooftops due to the influence of color TV.

**S**INCE the strong acceptance of color TV, antenna installations have become a major factor again, just as in the beginning of commercial TV. Large antenna rigs have begun to appear on rooftops in large numbers. Antenna manufacturers have been coming out with families of antennas and antenna accessories. People are quite willing to spend between one and two hundred dollars to pull good TV reception.

The do-it-yourselfer is out in force buying and installing these fancy rigs. There is a certain amount of information from my

experience I'd like to impart to you so you can install your rig safely and get good value for money spent.

**Shopping List:** Once you decide you want to install an outdoor antenna you head for an electronic supply store. The supplies break down into the following items that come in many sizes, shapes and purposes. Heads, poles, lead-in wire, stand-off insulators and mounts. Then if you want a super installation there are motors and boosters. The following lists are the general types of these items.

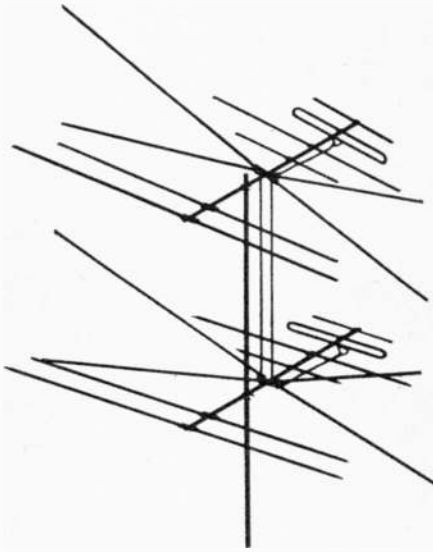

The conical and stacked conical antennas though still available, are not as popular today. They're good for distances to 50 miles.

This is a yagi type that pulls channels seven through thirteen. There are all types available. Low band picks up channels 2-6.



### Heads

- Conical
- Stack Conical
- One Channel Yagi
- All Channel Yagi
- UHF Antenna
- Electronic Yagi
- Super Electronic Yagi

### Poles/5 Ft. Section

- Aluminum
- Steel
- Steel Anodized

### Lead-In Wire/100 Ft.

- 300 ohm light wt.
- 300 ohm med wt.
- 300 ohm heavy wt.
- 300 ohm Shielded cable
- 720 ohm Coaxial cable

### Standoff Insulators

- 3" wood
- 5" wood
- 8" wood
- Mast Type
- Masonry Type

### Mounts

- Light Chimney Mount
- Heavy Chimney Mount
- Short Wall Mount
- Long Wall Mount
- Roof Mount
- Guy Wire/100 Ft.
- Guy Hooks
- U-Bolts

### Motors

- Standard
- Deluxe
- Super Deluxe

### Boosters

- Tube Type
- Transistor
- Nuvistor
- Double Nuvistor

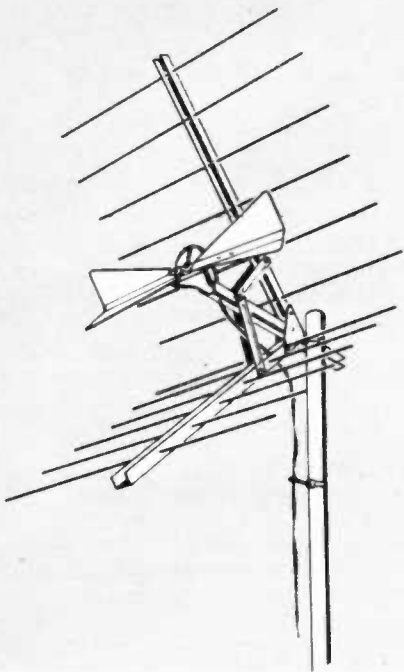

One of the typical UHF antennas is the corner reflector. It can pull reception up to 60 miles.

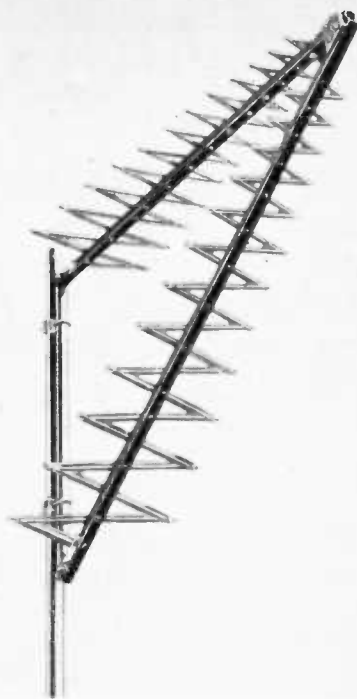

A JFD Zig-a-Log UHF antenna achieves sharp directivity, overcomes ghosts and interference.

### The Brains of the Antenna

The head of the antenna requires the most consideration during the purchase. You must decide what you want from your antenna. Do you want to pull 20 miles, 50 miles, 100 miles or further? The more distance you want the more expensive the job is going to be.

**Conical:** For short distances up to 50 miles away, unless the terrain is very hilly, a biconical or stacked biconical will do the trick. It has broad band receptive power. It pulls channels 2 through 13 satisfactorily. It is not too directional. You can aim it bulls eye at your weakest channel and the stronger ones are still picked up even if they are to one side or even to the rear. It is cheap, sturdy and snaps together all in one motion.

The conical lends itself well to stacking. Be sure to use stacking bars to separate the two heads. The bars are cut the correct distance to provide maximum pickup of all the channels. Should you stack at incorrect heights, some of the signal could cancel other signal out. Stacking has the advantage of doubling gain in the horizontal plane, which means reduced vertical pickup of interference.

**One-Channel Yagi:** To pull a single channel a yagi head is useful. It is cut for one particular channel and is extremely

directional. This gives it enormous strength on that particular channel and makes it as interference-free as possible.

Yagis also come in low band and high band types. The low band picks up channels two through six. The high band picks up channels seven through thirteen.

Therefore when your reception problem is a single channel or a single band you should choose the yagi for that channel. If that is the general reception situation in your area, suppliers will stock the yagis you want. If not, they can order it for you. For instance, if you want to pull channel two ask for a "channel two yagi."

**All-Channel Yagis:** An all-channel yagi is in essence a bunch of yagis, one for each station 2 through 83, all hooked together. That's why they get so large and complicated-looking. Four popular all-channel yagis are the Channel Master Crossfires, the Winegard Colortrons, the JFD LPV's and the Jerrold Paralogs. They come in small, medium and large according to the distance you want to pull. There are 50 milers, 75 milers, 100 milers, 125 milers, 150 milers and 175 milers. The larger they are the further they pull and the more they cost.

### How the Head Works

There are only three basic working ele-



ments in an antenna array, no matter how complex it is. Any other gadgets are there simply to match the three basics together or trap out unwanted signal. The three signal gatherers are the dipole, the reflector and the director.

**Dipole:** The dipole is two metal sticks that are physically held together by a plastic terminal block that insulates each arm from the other. The lead-in wire has two ends. Each end is attached to one of the metal sticks where the metal touches the insulator. The dipole is cut at a particular half wave length and is the live or driven element. The energy it absorbs is sent directly to the TV set.

A dipole is quite often the entire antenna without the other elements. When it is by its lonesome it can absorb energy from two directions—front and back. Its general pickup pattern is shown in the sketch.

**Reflector:** The reflector is not attached to the lead-in. It simply sits behind the dipole. It's known as a parasitic element. It's cut a bit longer than the dipole. It absorbs signal strength then reradiates the signal back to the dipole. It also blocks off any other signal that tries to come in from the rear.

In effect, the addition of the parasite makes the antenna higher in gain and more directional. If you look at the reflector pattern you can see the pattern is reduced drastically. You can think of the reflector as an element that bounces signal back to the dipole and bounces the signal off that tries to come in the rear entrance.

**Director:** The third element is the director. As the name implies, it is in front of the dipole. It, too, is a parasite. The director is cut smaller than the dipole. It absorbs the TV signal, too, and reradiates it back to the dipole. The director sharpens the directivity of the antenna even more than the reflector. The additional front gain reduces the ratio of front to back gain since the front gain is now stronger than without the director. In effect this makes rear-door pickup in ratio less.

### Lead-in Wire

The lead-in wire takes the signal the head has absorbed and funnels it down into the TV. The lead-in must have certain characteristics. One of these is called impedance. Most antennas have an impedance of about 300 ohms. Most tuners have an impedance of about 300 ohms. In order for the lead-in to match with the antenna and tuner, it should have an impedance of 300 ohms. The familiar flat twin-lead possessed

this impedance. Under most home conditions twin-lead will be used. It's satisfactory in insulation and interference-rejection qualities. It's also easy to work with and inexpensive.

However, if you have a reception situation where the lead-in must be run hundreds of feet and/or the interference around you is at extremely high levels you'll probably have to use something other than twin-lead. This something is 300 ohm shielded twin-lead or 72 ohm coaxial cable. They are more expensive but are heavy duty and almost interference-proof. Any noise flying through the air will not be picked up by coax as it will with twin-lead.

Unfortunately, in addition to cost, they are hard to work with. If your reception calls for it, you'll have to use it even if you do have a tougher installation job.

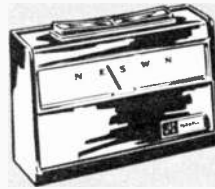

JFD MANUAL COMPASS CONSOLE  
AND ROTATOR MODEL NO. MCR110

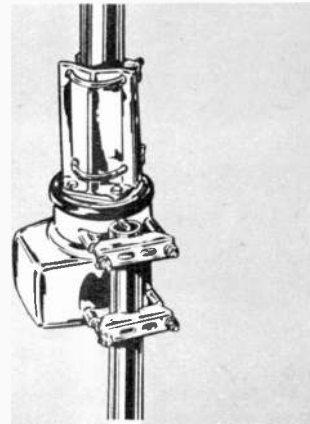

The standard-type rotator works well and is controlled manually while watching the TV picture.

To pull distance of between 50 and 75 miles, a small super antenna installs and aims nicely.

*Courtesy of Channel Master*

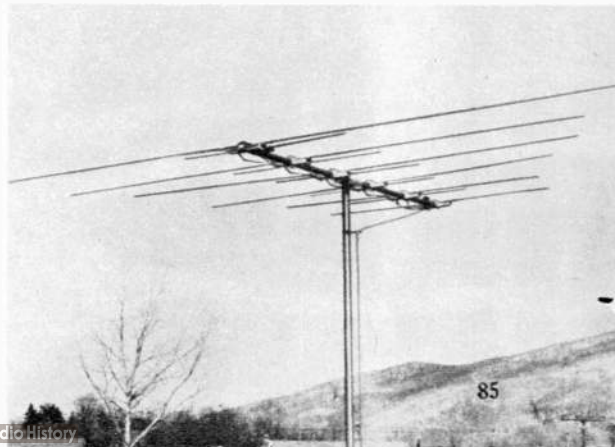

## Standoff Insulators (& Mounts)

Why use standoff insulators? Why not simply tape the lead onto the mast and tack it to the walls of the house? As a matter of fact, this is just what you do with the shielded cables. With the heavy stuff, you need only to concern yourself about impedance at the antenna and the TV connections.

With unshielded twin-lead, though, the impedance problem requires more concern. If you taped twin-lead to the metal mast, the mast becomes an integral part of the lead wire and the wire-mast combination presents an entirely different impedance to the signal. Should you tack twin-lead to the house, even though the wood and shingle are insulation, when they become wet they change the impedance of the lead.

At an impedance bump the signal waves are dissipated and bounced back up the wire where they came from. These reflections cancel out some of the signal strength and enter the TV at the wrong time causing ghost images.

Standoffs, on the other hand, hold the wire far enough away from mast and wall so no impedance bumps occur. Standoffs come in various forms. There are mast standoffs, short and long wood standoffs and masonry standoffs. Liberal use of them keeps wire snug and a constant impedance throughout the entire length of lead-in.

## Mounts

An antenna mount must hold its ward firmly and permanently in all kinds of weather, from a snowstorm to a hurricane. With a short simple installation you can use a chimney or wall mount. For a high or complex installation you must also guy the array down. Failure to mount an antenna properly will bring it crashing down.

**Chimney Mount:** The most-used mount for local installations is the chimney type. It is simply two or four steel straps that are tied around the chimney. At one corner a holder protrudes from each strap. The pole slips into and is tightened down

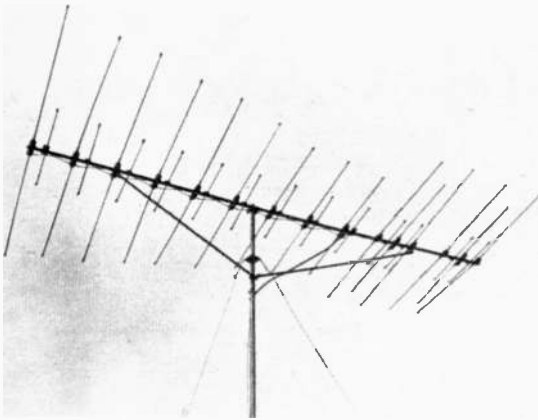

*Courtesy of Winegard*

To pull 100 miles or so you need one of these large monsters that are so complicated-looking.

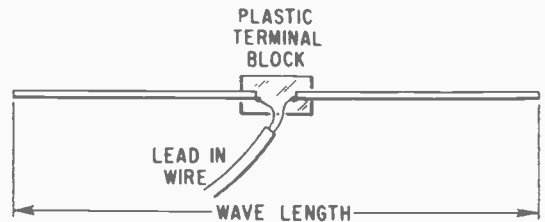
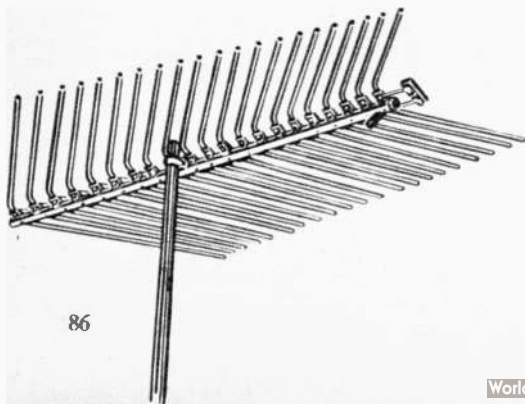

A dipole or driven element is nothing more than two equal metal sticks mounted on an insulator.

All the elements in the antenna stand broadside in a horizontal plane to the incoming TV signal.

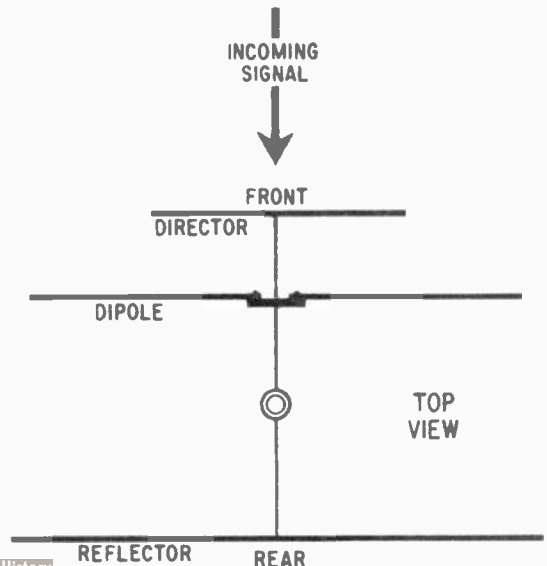

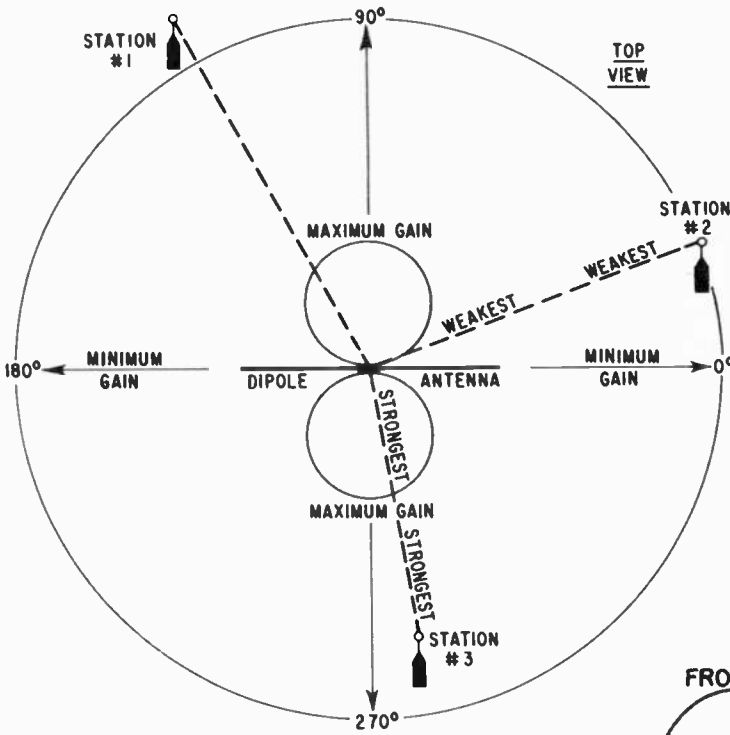

Dipole pattern. The more area in a figure 8 that a good signal path can cover, the stronger is the signal.

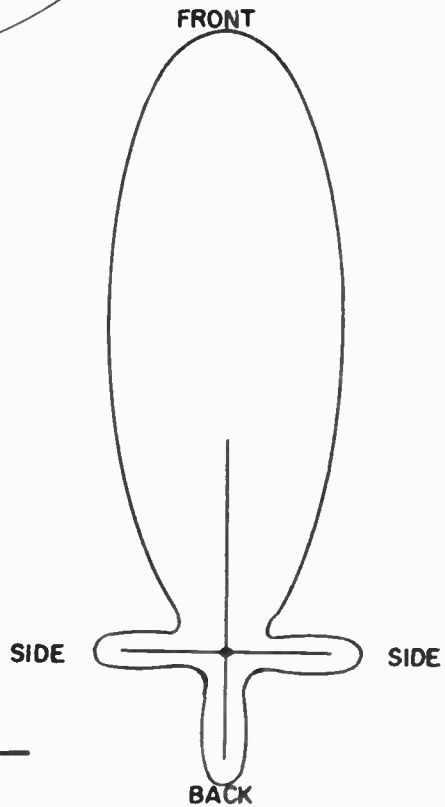
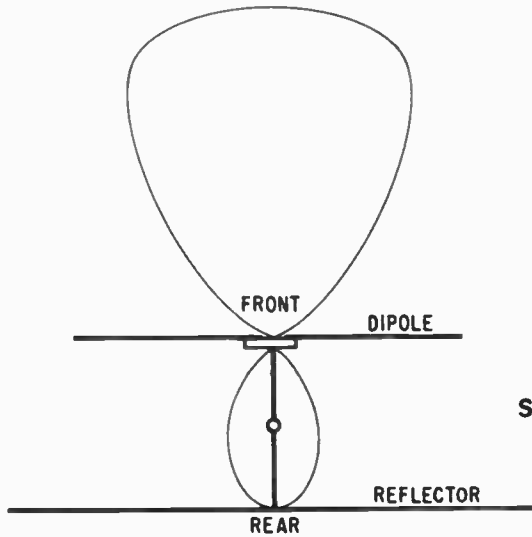

Dipole and reflector pattern. Addition of reflector reduces rear entrance pickup, narrows it.

Super antennas have extremely narrow patterns. It must be aimed directly at TV transmitter.



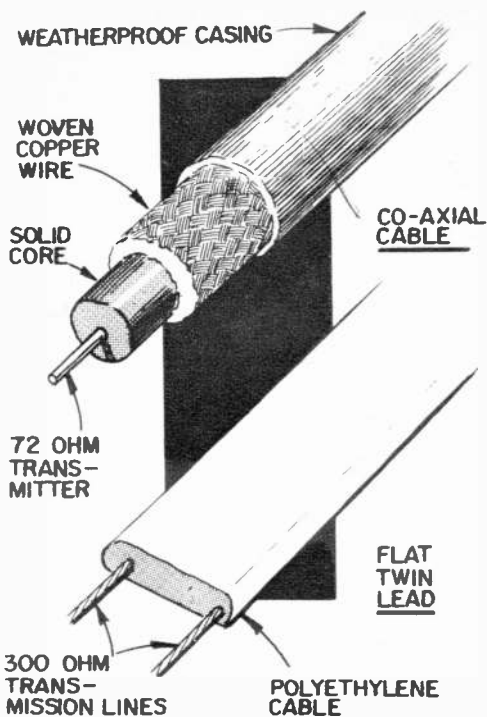

The flat twin lead is common, cheap and easy to work with. Coax is expensive but more permanent.

You must slide lead into the standoff groove and then squeeze it shut with a pair of pliers.

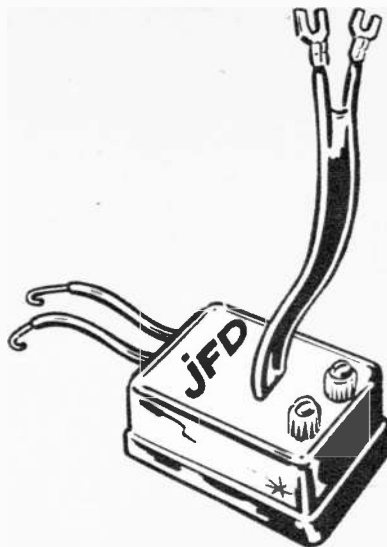
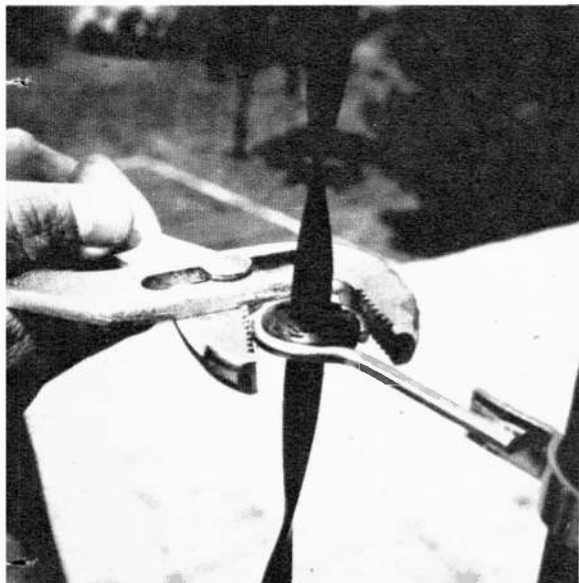

Should you use 70 ohm coax you'll need one of these matching transformers to make input 300.

permanently in the holders. This is a neat, quickly installed strong mount.

Should you install one, separate the two straps as far from one another as possible for maximum holding power. Make sure the chimney is strong enough to hold the antenna system. Do not use a pole longer than ten feet with a chimney mount. If you do, a strong wind might tear it loose.

**Wall Mount:** Second in popularity, the wall mount has the same kind of holders as the chimney type. Instead of straps the wall mount is nailed, screwed, bolted or lagged into a convenient eave or wall. They come in short or long sizes to clear roof overhangs. Here again, separate the holders as far as practical and do not use a pole longer than ten feet or your wall might be torn out.

**Guy Wires:** Whenever an antenna needs a pole higher than ten feet, and/or a heavy antenna array, and/or a motor is being used, or you simply desire a very strong installation, the answer is guy wires. Guy wires are usually many strands of powerful wire with a very high tensile strength. It comes uncoated or with a green plastic weather-proofing. You gauge the number of needed guys by the height of the antenna. You can use three or four guys with a fifteen-foot pole. You can use six guys or eight with a thirty.

If a guy ring is available mount it on the pole. If no guy ring is available take a U bolt and mount it on the pole instead. Take your three or four lengths of guy wire and tie them to the holes in the guy ring or to the pole above the U bolt. Do all this before putting the antenna into the mount.

# SOMEONE SHOULD DEVELOP AN EASY WAY TO LEARN ELECTRONICS AT HOME

## RCA INSTITUTES DID!

**RCA introduces new CAREER PROGRAMS**—beginning with the student-proved "AUTOTEXT" Programmed Instruction Method—the faster, easier way to learn. You start to learn the field of your choice immediately. No previous training or experience needed.

Pick the career of your choice—and RCA Institutes will do the rest! RCA's new, revolutionary "Career Programs" help you go directly to the career you want! You waste no time learning things you'll never use on your job! Each Career Program is designed to get you into the kind of job you want in the fastest, easiest possible way!

### SEPARATE COURSES

In addition, in order to meet specific needs, RCA Institutes offers a wide variety of separate courses which may be taken independently of the above Career Programs, on all subjects from Electronics Fundamentals to Computer Programming. Complete information about these courses will be sent with your other materials.

**CHOOSE A CAREER PROGRAM NOW** your first step to the job of your choice!

- Television Servicing
- Telecommunications
- FCC License Preparation
- Automation Electronics
- Automatic Controls
- Digital Techniques
- Industrial Electronics
- Nuclear Instrumentation
- Solid State Electronics
- Electronics Drafting

### RCA INSTITUTES BONUS EXTRAS

Only RCA Institutes offers you a Liberal Tuition Plan, one of the most economical ways to learn. Plus, you get top quality equipment in all kits furnished to you with your courses—yours to keep and use on the job. And now, RCA's NEW PROGRAMMED ELECTRONIC BREADBOARD GIVES YOU LIMITLESS EXPERIMENTATION—scientific laboratory procedures

right in your own home! You build a working signal generator, AM Receiver, Multi-meter, Oscilloscope, and other valuable equipment—ALL AS A PART OF YOUR COURSE! Get the facts today!

**Classroom Training Also Available.** Day and Evening Classes are available to you in New York City at RCA Institutes Resident School. You may be admitted without any previous technical training; prep courses are available if you haven't completed high school. Coeducational classes start four times a year.

### SEND ATTACHED CARD TODAY FOR FREE DESCRIPTIVE BOOK

All courses and programs approved for veterans under new G.I. Bill. **Canadians:** These same RCA courses are available to you in Canada. No postage. No customs. No delay. Your inquiry will be referred to our school in Canada.

RCA INSTITUTES, INC. Dep't RG-98  
320 West 31 Street,  
New York, N.Y. 10001

Accredited Member National Home Study Council

# RCA

Then mount the antenna in position. Find three or four locations on the roof or on the side of the roof to run the guy wires to. The locations, using the pole as the center of a circle, should be about 120° for three and 90° for four, apart from one another. The angle can be off a little.

Put three or four hooks into the locations chosen. Be sure to use some roof tar to seal off the holes made by the guy hooks. Tie all but one of the guy wires snugly into the hooks without bending the pole. On the last guy wire attach a small turnbuckle. Then run it into its guy hook snugly. Make sure all guy wires are taut and the pole is straight. Then tighten up with the turnbuckle. (After about two weeks you can give the turnbuckle a few more turns for a final tightening.)

You can use guy wires with a chimney mount or a roof mount.

**Roof Mount:** A roof mount is simply a holder on a swivel. It's used only with guy wires. It's used to seat the bottom of the pole on the roof.

Take a piece of 1/2" plywood about 18" square. Attach the roof mount onto the plywood. Then attach the holder of the mount onto the bottom of the pole. There is a swivel on the mount so the plywood can sit flush on any roof no matter how steep.

### Boosters

While it's not always possible or necessary to attain an ideal booster here is what one is: A booster is simply another stage of the tuner of the TV; an RF Amplifier that takes the signal before it gets to the TV and amplifies it many times. After the booster action, the processed signal is then fed to the RF Amplifier in the tuner.

The best place to amplify the signal is just after it leaves the antenna array, before it has a chance to make the journey through the lead-in wire. At this time the signal is as pure as the aerial can make it. No interference or weakening of the signal has taken place yet, as it does in the lead-in wire.

If you are able to amplify the signal at this time, the stronger signal that will force through the lead-in will actually reject and be less pregnable to interference and weakening effects.

The matching of the antenna to the booster to the lead-in is another consideration for the ideal booster. If the output of the antenna has a 300 ohm impedance then the input of the booster should be exactly 300 ohms. The same goes for the output of the booster into the 300 twin-lead. Actually this is almost impossible across the entire low and high bands, but the closer you can

come to it the better off you are. Now about amplification devices.

**Tube:** Available are tube, transistor and nuvistor. The tube is the old reliable and works well. It can absorb great amounts of signal and process them all nicely without going into oscillation, overloading or cross-modulating. It is quite strong for up to about 75 miles. If you want to use your electronic antenna for local as well as distant reception in a metropolitan area the tube booster is a good bet.

**Transistor:** The transistor type is stronger than the tube type but has the tendency to overload. In a strong signal area this will happen on the local channels. However, if your electronic antenna is primarily for use to pull distance and not to be used for strong local reception, the transistor will outpull the tube.

**Nuvistor:** The nuvistor is sort of a compromise booster. It has almost the pulling power of a transistor and the overloading freedom of the tube. It works well. In fact, there is the Colortron with two nuvistors that pulls better than a single transistor and won't overload.

**Setside Boosters:** While the right rooftop booster is ideal, it is not always the practical thing to do. You might not want to go through all the steeplejack work necessary to cut in a booster on your existing antenna or the price might be prohibitive. If so, you can get a setside booster that works well. They come in tube, transistor and nuvistor models with the same pros and cons. The only thing wrong is the boost-up of the noise the lead-in picks up, as well as the signal. This might or might not be a terrible thing according to your particular reception situation.

They are simple to install. All you do is disconnect the lead-in from the TV set and attach it to the booster. Then you attach the booster to the antenna terminals of the TV set. Then turn the booster on. You'll know quickly if you have increased the gain of your signal.

### Motors

The last major item on the list is a motor for the antenna. A popular misconception is that people think the motor itself performs some signal-pulling job. It doesn't. All it's there for is to turn the antenna around so you can aim directly at the desired transmitter. If your reception needs do not require movement of the antenna—that is, all your TV channels are arriving from a single direction—you do not need a motor.

However, to install a superhead and booster and not put a motor on is a waste.



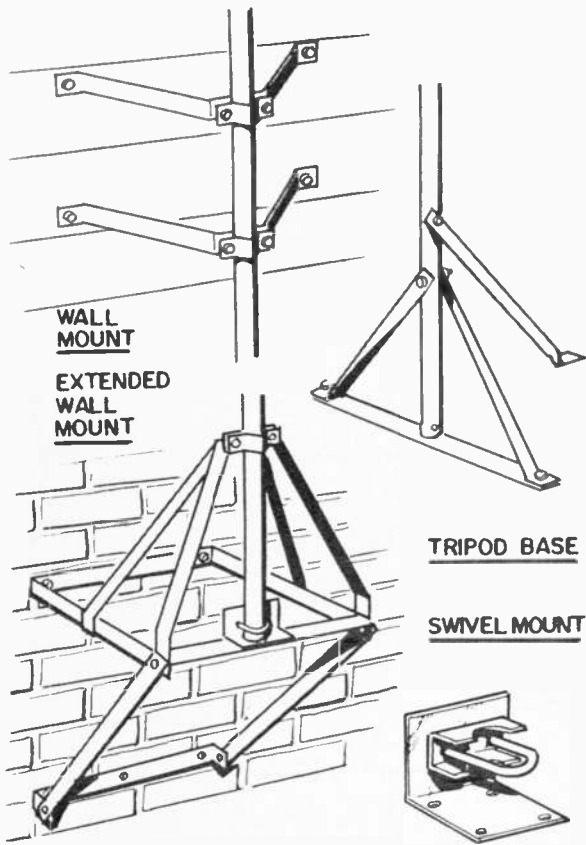

Chimney mounts are the most popular, but these wall and roof mounts might be more convenient.

Even if your primary purpose is a special channel you'll find that by rotating around you'll get all kinds of reception you didn't dream was available.

There are many antenna motors on the market—the Channel Master Rotator and the Alliance Tenna Rotor. They all come in good deluxe and super deluxe type models. Each step up gives you a heavier duty motor. Each step up gives you a fancier, easier-to-work control box. Basically, they all perform the one desired function, though. They rotate your antenna.

To sum up, you can pick up TV stations up to a couple of hundred miles away with the proper equipment. The main items you need are an all-channel yagi, an antenna amplifier and a motor.

There are many on the market; you can pick and choose and ask the advice of the sales person as to which one to purchase. Detailed instructions for each item come with the product. •

### THREE MEANS OF ATTACHING GUYS

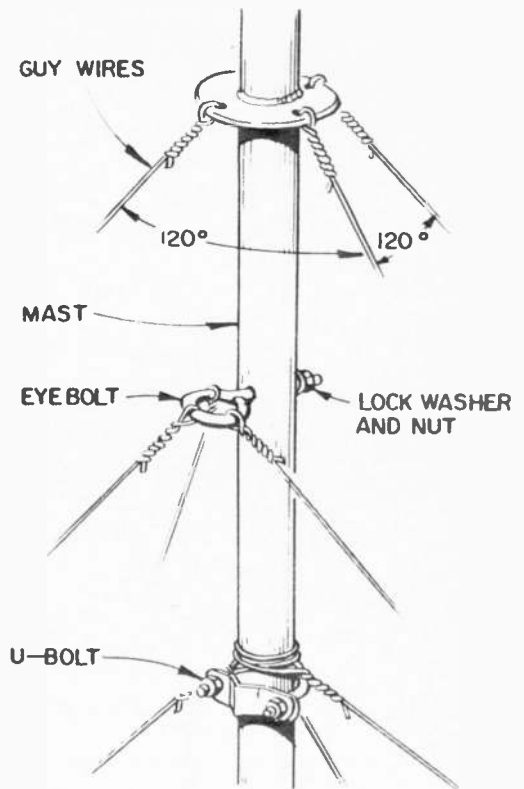

Guy wires are tied to holes in a guy ring, or to the mast above a U-bolt before mounting antenna.

There are many different styles of antenna motors—with various decorative control boxes.



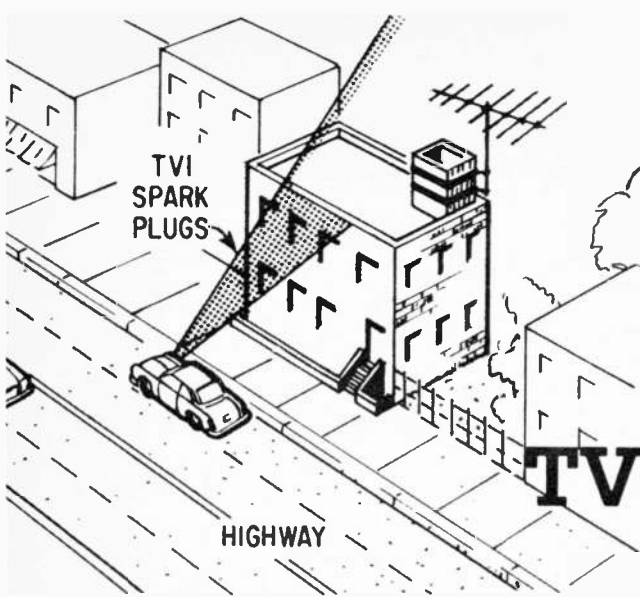

First know the difference between the erratic and the transmitted kind, then try to locate its source

# TV Interference

Ignition noise can be blocked off by the body of your house if you locate the antenna correctly.

**T**V INTERFERENCE was bad enough on black and white TV but on color TV it's maddening. There is nothing you can do about some forms of TVI and you can exterminate completely other forms of TVI. First you must analyze what kind of TVI it is and then apply some detective work to locate its source.

There are two categories of TVI. One is Erratic Interference that is coming from electrical equipment that is sparking or leaking the electricity off. The other is transmitted interference that is coming from electronic transmitters, has a legitimate other purpose and is arriving on your TV screen unwittingly.

## Erratic Interference

This is the most prevalent kind of everyday interference. It includes sparking, leaking, poor wiring, etc. Some of it is easy to get rid of and some of it is rough. Let's go through the common types.

**Light Bulbs:** Electric light bulbs, especially the three-way bulbs, are a major source of trouble. They cause black horizontal jagged lines of ripple to roll through the picture. They take place most often around the frequency of channels 2, 3 and 4.

In the three-way bulbs there are two connection points in the base of the bulb. The higher value connection tends to carbonize due to the large amount of current that flows through it. If you remove the bulb, take a nail file and scrub off the carbonization you can quite often effect a cure. It's also a good idea to file down the connections in the lamp itself.

The same type of TVI can be caused by a one-way bulb, too. Here the filament cracks but doesn't break. To the naked eye the bulb looks okay and lights normally. Tiny sparks are flying across the break in the filaments, however. They radiate TVI through the air into channels 2, 3 and 4.

By the process of elimination turn off each bulb one by one till the TVI stops in the picture. Replace the suspect.

**Auto Ignition:** The sparks in a spark plug radiate static. These unwanted impulses can be picked up by your TV antenna system, especially the long length of lead-in wire. They find their way down the wire and into the TV tuner where they ride right through your TV circuits and display themselves on the picture and issue out of the speaker.

Ignition noise is common and well known. You can tell when a driver is gunning or slowing his motor by the annoying dots in your picture and the rat-tat-tat out of the speaker. On color programs you see the dots in color. (In a color set, when the color killer is adjusted right, a black and white program shows the TVI in black and white.) There is always a certain amount of ignition noise and you are used to it. However, if the condition begins to get unbearable,

At top right, an everyday car ignition noise is caused by spark plugs. You can actually hear a car engine gunning or slowing. Middle, when a strange snowy picture pushes your local channel off the air, it's called co-channel. At bottom, this windshield wiper effect on your TV screen occurs when an adjacent TV channel spills over.

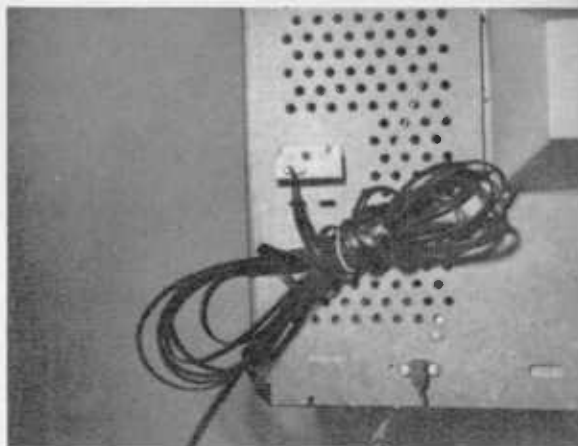

Don't wrap up extra lead-in behind TV. Besides weakening signal it becomes source of TVI pickup.

able there are a few corrective measures you can take.

One, try twisting the flat ribbon lead-in every few feet. The flat side has maximum interference pickup and turning the wire reduces flat side exposure.

Two, install some 300 ohm shielded cable or 72 ohm coaxial cable instead of the ribbon lead-in. There is practically no TVI pickup in these.

Three, isolate the antenna as much as possible from the street where the cars are driving. Do this by checking the location of your antenna. If it is not in the farthest spot from the street, placing the solid house between it and the roadway, relocate it there.

**Electric Appliances:** Vacuum cleaners, power mixers, electric shavers, dryers, dishwashers, etc., all cause erratic TVI in the picture. Most of this interference is not radiated like the last two types. It travels through the power line from the offending appliance to the TV set. The TV set has special capacitors in its line and a filtered power supply to eliminate such noise but it can't get it all out.

The remedy attempt is to install a plug-in line filter either at the appliance or the TV set. These filters are available in most hardware stores. They work well in some cases, not at all in rare instances, and just a bit in others.

### **Transmitted Interference**

The less common type of TVI comes from other transmitters. Rather than erratic, their kind is intelligible and operates on definite frequencies. This type can



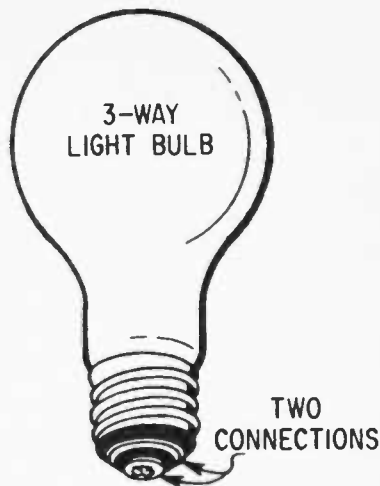
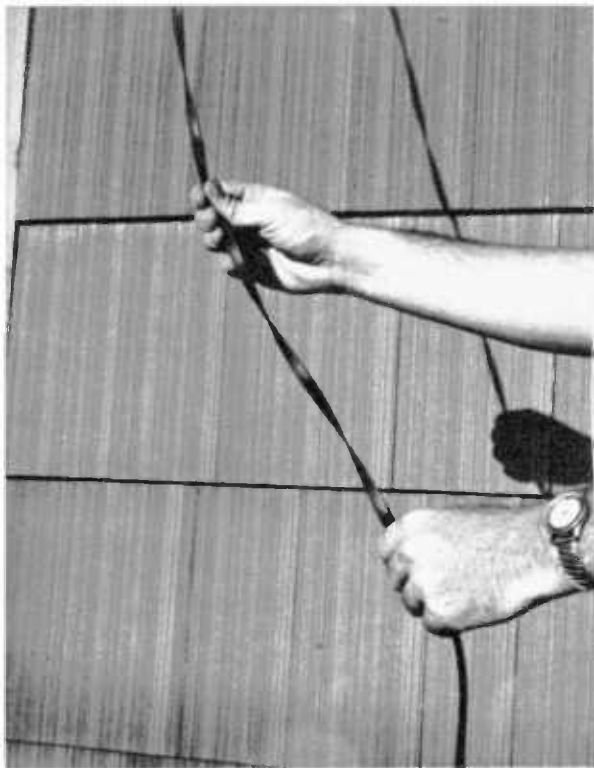

Three-way electric light bulbs can cause jagged lines in channels 2, 3 and 4. Replace bad ones.

Left, you can reduce ignition noise by reducing flat side pickup. A turn every foot is enough.

Below, in sun spot radiation periods ionosphere bounces signals hundreds of miles, causing TVI.

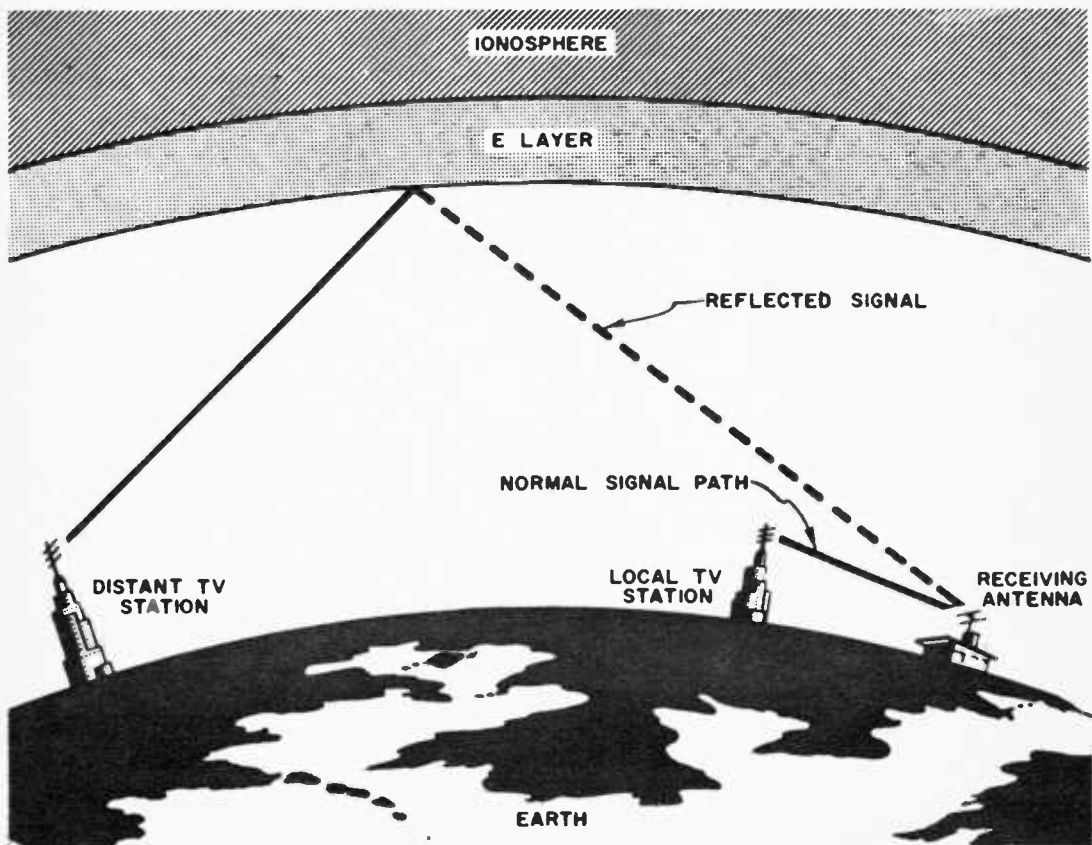

Installing a line filter either at the offending appliance or set itself will reduce interference.

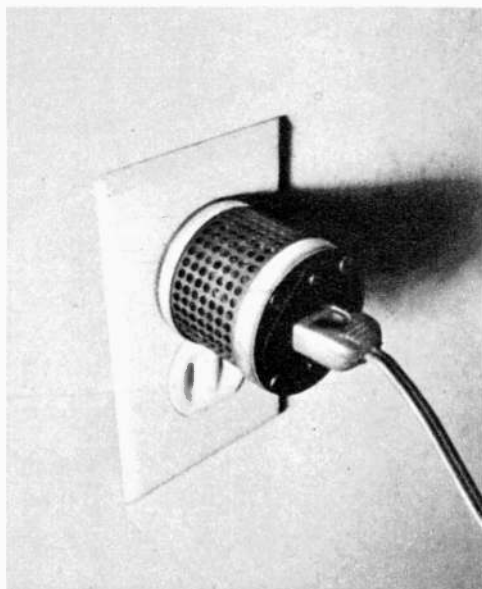

## TVI

TROUBLE	REMEDY
Bars & Rippling on Channel 3	Locate defective 3-way or conventional light bulbs and replace
Auto Ignition	Replace lead-in with shielded type—Relocate antenna away from roadway
Electric Appliances	Install plug-in filter at appliance or TV set
920 KC Beat	Increase signal strength with stronger antenna—adjust color killer
Co-Channel Interference	No cure—Wait it out
Adjacent Channel Interference	Install tuned wave trap
Industrial Interference	Locate source of TVI and notify source or FCC
Amateur Interference	Contact amateur

be trapped out to a more or less degree.

**920 KC Beat:** This is the latest kind and is a direct result of color TV. The sound carrier and the color subcarrier in the TV signal are set exactly 920 kilocycles apart. Whenever the sound is heard, its carrier mixes with the color. This 920 KC beat appears on the TV screen as a herringbone interference in the lighter parts of the picture.

The main thing you need to cure this condition is a good color antenna. Good gain increases the signal to noise ratio and simply rejects the 920 KC beat. Also, you could orient your antenna to different directions. There might be one direction that is best for 920 KC rejection.

Other than that you'll have to judiciously adjust the fine tuner to the best spot. It's somewhere between complete loss of color and loss of picture to the sound bars. It's the nature of the beast.

Should you see little bits of the 920 KC beat in the black and white picture, around small objects, you have a slightly different condition. To cure this condition adjust the Color Killer control till the condition just disappears.

### Co-Channel Interference

As the name implies, this is interference from a channel with the same frequency. For instance Channel 4 in Miami could

possibly interfere with Channel 4 in New York, if the atmospheric conditions are correct.

The interference could be merely lines or ripples (in a moderate case), or in an extreme situation your local channel can be pushed off entirely with a strange snowy picture taking its place. How is this possible?

TV carrier waves normally travel in a straight line of sight path. This gives the carrier an effective range of about 30 miles according to terrain. (Range can be increased by using principles described in the antenna section, Chapter 12.) All other transmitted energy that misses the earth travels on out to space and is dissipated. The 30-mile range was deliberate and permits many channels, with the same frequency of 2, 3, 4, etc., to function near each other without interfering with one another. However, atmospheric conditions sometimes conspire against this well-laid plan.

There is a layer of atmosphere in the sky starting at about 50 miles, on up to about 250 miles, called the ionosphere. The layer between 50 and 80 miles is called the "E" layer. In this region, the air molecules are more sparsely spaced than at low levels, yet not as sparse as at higher levels. They are just close enough together to become heavily ionized by cosmic ray

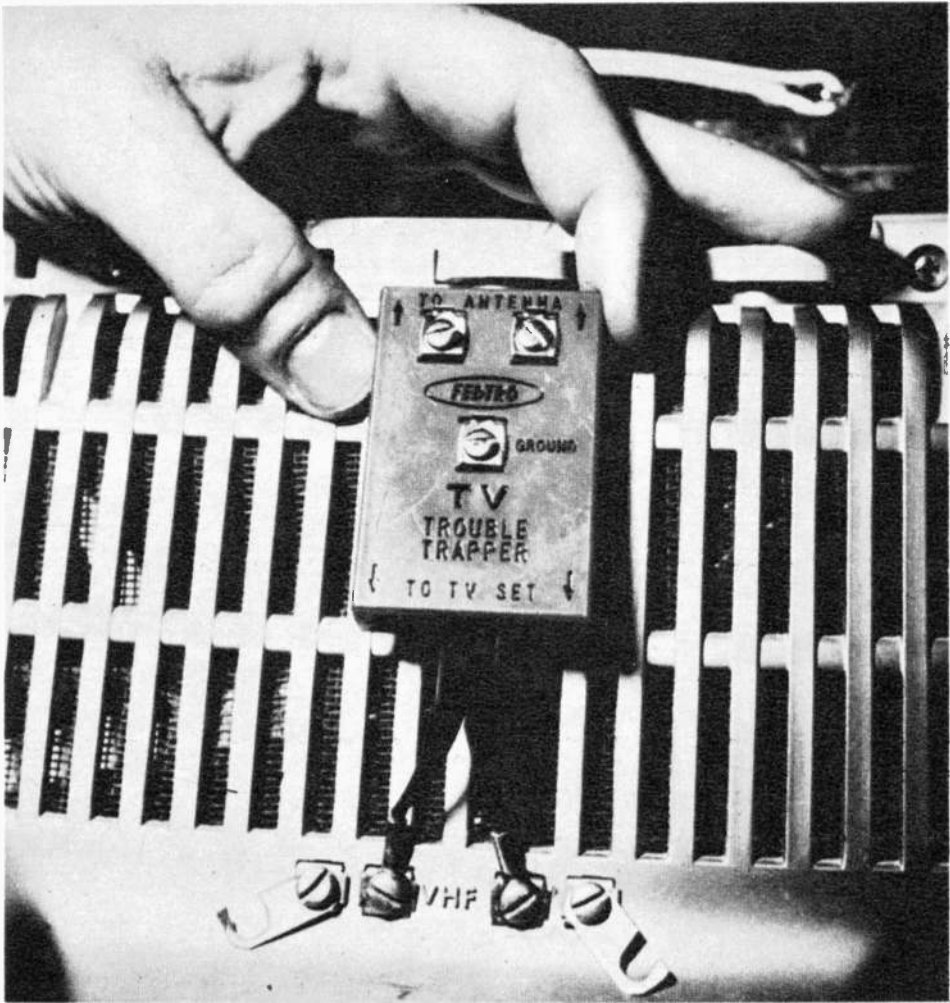

Adjacent channel can be reduced by an installed trap that will tune to the unwanted frequency.

Below, you can make your own TV trap with lead-in wire. Cut stub at the point of best reception.

bombardment, yet not close enough to collide and lose the ionization.

The E layer affects RF energy by bending the transmitted waves back toward earth. Most of the time there is not enough bending of TV waves to cause any ill effects. However, during certain atmospheric coincidences, like sun spots, the E layer becomes extra heavily ionized. Then it reflects a lot of the TV waves. The waves can bounce back and forth between the E layer and earth, traveling thousands of miles.

Co-channel can come from any distant station no matter how far, but the strongest type usually comes from a station about 400 miles away. It will shove your local

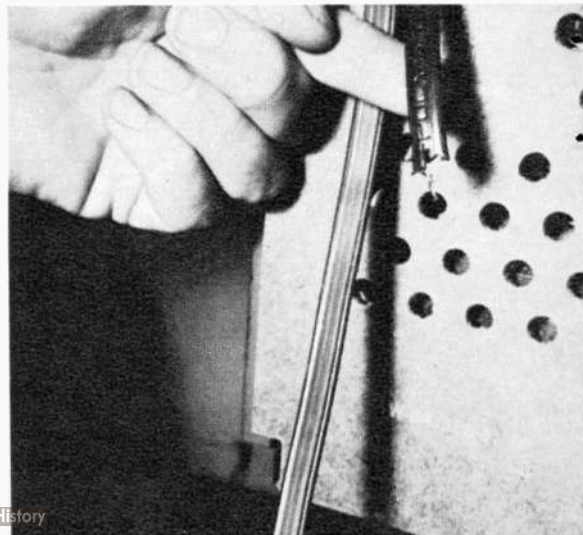



channel off your TV screen. It's known as sporadic E skip. What can you do? Sit down and wait till it disappears. Try to enjoy the novelty of the phenomenon. It usually doesn't last too many days.

### Adjacent Channel Interference

Not to be confused with co-channel, an adjacent channel is the one next to it, not the same one. The TV interference caused by it happens when your TV begins picking up the adjacent channel in addition to the one you have it tuned to.

The victimized channels in our area between Philadelphia and New York are 4 and 11 from New York. Channels 3 and 10 from Philadelphia keep interfering with them. The TVI appears as a writhing herringbone pattern on top of 4 and 11. On occasion, a weak superimposed picture appears moving quickly with the horizontal blanking bar, giving a "windshield wiper" effect.

There's a good reason why Channel 3 and 10 interfere with 4 and 11. The audio portions of 3 and 10 are only 1.5 megacycles below the lowest frequencies of 4 and 11's picture information. This is closer together than the sound and picture are on any one channel taken by itself. The sound and picture on all channels are 4.5 megacycles apart.

Most TV's are not able to tune close enough to keep the sound of 3 from the picture of 4. The sound thus appears as a herringbone overlay. If the channel is strong enough, then it also wipes the windshield. Channel 10 does the same thing to 11.

There are commercial traps on the market that can be installed. One trap is tunable from Channels 2 through 6, while another is tunable from 7 through 13. They cancel out the channel you tune them to. For example, if you want to rid 4 of 3, tune the trap to 3.

### Industrial Transmitters

There are many different electronic instruments in common use today. In the main, they are very well shielded and cause no appreciable TVI. However, you might be unlucky enough to be in a position where this is not true. Should you be constantly annoyed with some type of RF interference, it will appear on your screen as herringbone stripes or overlays. To trap it out is going to be a tedious job.

You're going to have to try a number of traps, installed between the antenna lead-in wire and the antenna terminals. The trap that rids you of the TVI is, of course, the one to install permanently.

For best results, rather than install it at the antenna terminals, install it as close to the tuner input as possible. The closer you get to the tuner, the less lead-in will pick up TVI after the trapping.

A convenient homemade RF trap can be made out of lead-in wire. Cut off a piece about three feet long. Attach one end right on top of the lead-in from the aerial. Then short out the stub every few inches, watching the picture full of TVI at the same time. The spot that is best, cut and short.

### Amateur Transmissions

A word about hams: The amateur radio operator is usually blamed for all TVI from auto ignition to sporadic E skip. Mostly he is not at fault.

True he is on the air and it's possible for you to pick up his transmission. Usually, though, any pickup is due to poor alignment or trapping in your TV. A high pass filter at his frequency, installed at your antenna input, will usually make up the deficiency in your TV.

If the signal still comes in, contact the amateur and tell him how you are receiving his signal. I've never met a ham who wouldn't be happy to help cure your TVI whether he has a hand in it or not. •

If you live between adjacent channels like 3, 4, 10 and 11, they're so close on spectrum they interfere.

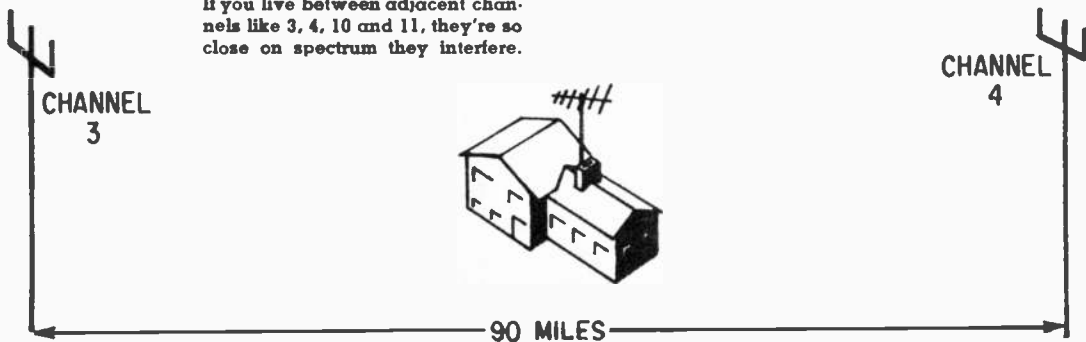

# The Latest About Picture Tube Repairs

Unlike black and white, color tube trouble usually means replacement

**W**HEN a black-and-white picture tube goes bad, odds are it can be repaired and its life extended for a period of time. When a color picture tube shows defect symptoms, odds are that it has given up the ghost and replacement is the only answer.

At any rate, the same repair measures can be tried on color tubes, but aside from the first technique we'll discuss, results will only occur in a minority percentage.

## Trouble No. 3—No Brightness, Sound OK

Yes, this is exactly the same symptom as when the high voltage quits. Only in this instance you'll be clued onto the picture tube because the high voltage is present and strong. You can take your neon test lamp and place it near the cap or the base of the horizontal output tube. When the picture tube is bad the neon lights bright.

Look at the neck of the picture tube. The

A professional repairman uses a CRT rejuvenation machine to strip poison off the cathode surface.

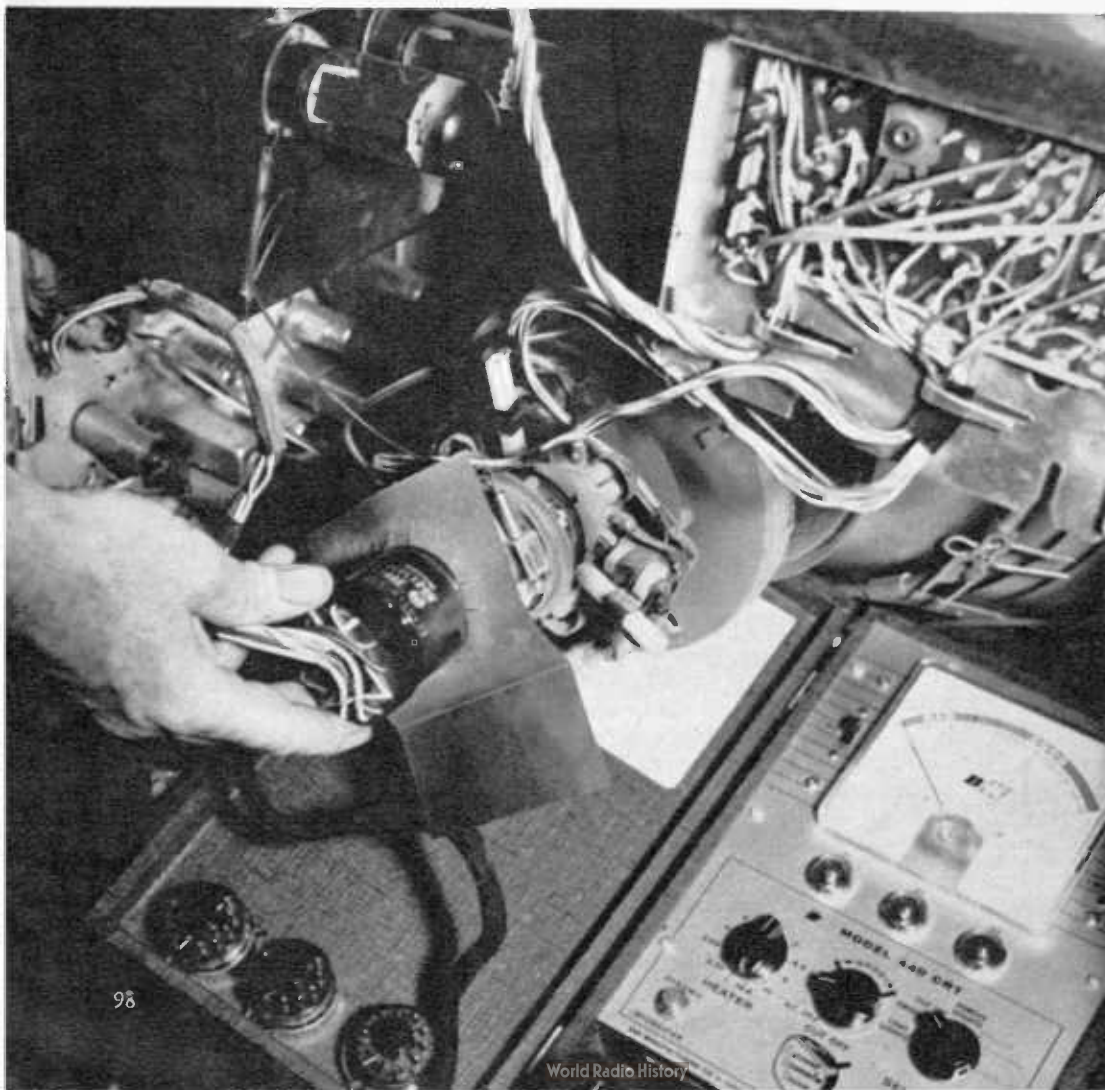

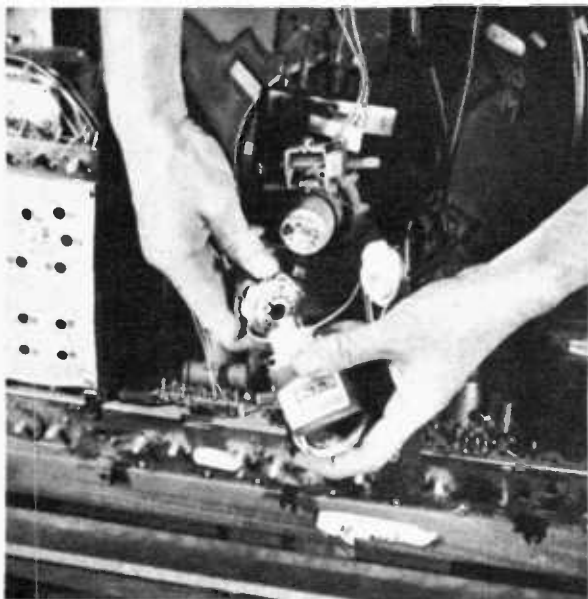

While odds are in your favor with brighteners on black-and-white TV, they're against you with color.

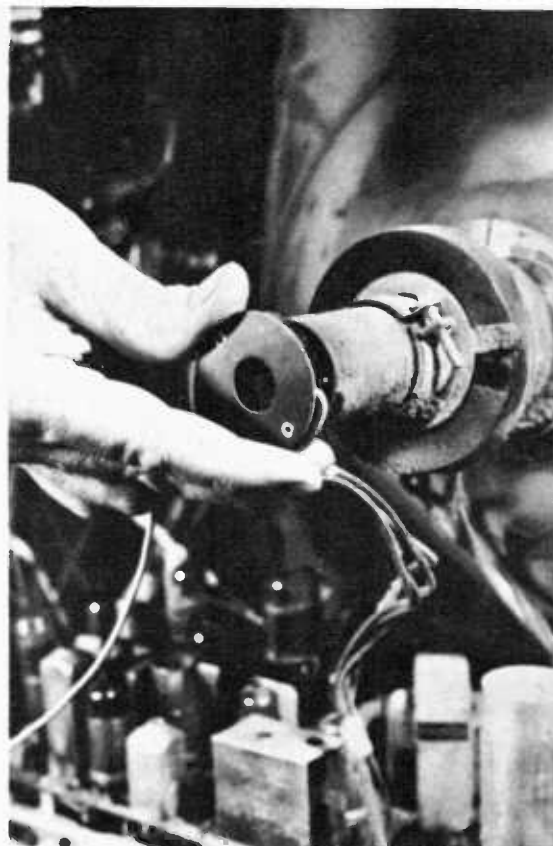

When the heaters are out, the first step is to jiggle cap and see if they will flicker back on.

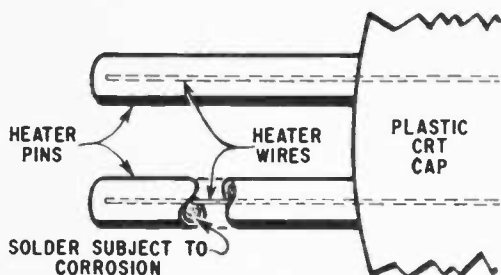

Common reason for CRT heaters going out is an easily repaired cold solder job in the cap pins.

### CRT REPAIRS

TROUBLE	REMEDY
No Light—Sound OK	Redo corrosive heater solder joints
Dim Picture (B & W) Loss of One Color (Color CRT)	Rejuvenate CRT— Install appropriate brightener
Fixed Brightness (B & W) No Video—Color OK (Color)	Install isoformer
Should Brightness Disappear After Isoformer is Installed	Short heater cathode outside of CRT neck

tube is definitely at fault if the filaments are not lit, or if the neck is lighting up with a bright blue light. When the neck is signaling bright blue you must replace. If the filaments are out you can probably repair them.

A fast check is to grasp the cap attached to the pins sticking out of the neck, and jiggle it. Should the filaments start to light you'll be able to repair for sure.

Whether it does or not, pull off the cap, get a pair of pliers and squeeze the pins sticking out of the plastic socket. (If your CRT is the type that doesn't have a plastic socket and the pins are part of the tube and not the socket you can't do this repair.) Then take your solder gun, heat each pin till the solder runs and try to add a drop of solder into each pin hole.

What you are doing is reheating a corrosive solder joint and restoring a solid connection. This repair applies to both monochrome and polychrome tubes.

**Rethreading the Socket:** On occasion as you perform the above repair, the socket will come off in your hands. Don't panic, you can reinstall it. Take your solder gun and one by one heat and tap out the solder



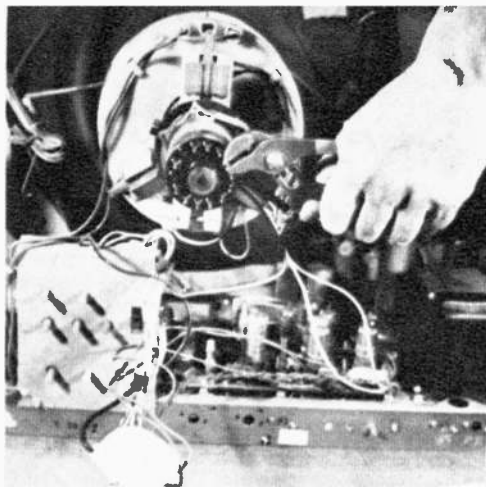

Technicians use a CRT pin crimper to squeeze out cold solder joint. You can use pair of pliers.

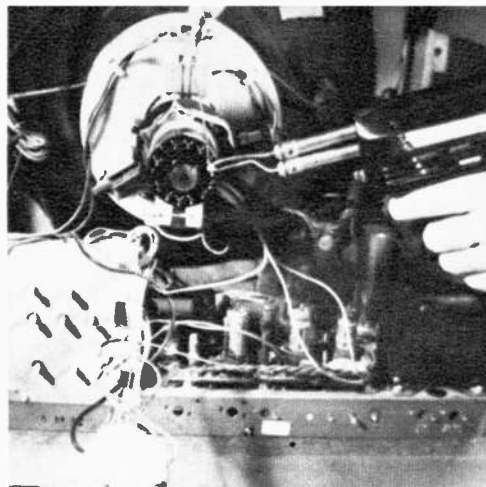

If you can heat pins with a solder gun and add solder in addition to crimping, repair is sure.

in each pin. Then take a wire brush and carefully scrub off all corrosion from the wires sticking out of the CRT.

Attach a length of fine wire or strong thread to each protruding wire. Run the extensions through the proper pins in the socket and then thread the socket back on. Run a little solder into each hollow pin. Reglue the plastic cap back onto the glass with some epoxy.

#### Trouble No. 54—Dim Picture

The pure form of this trouble happens only in a monochrome CRT and is accompanied by two other indicators. One, there is no shrinking of the picture. If there is shrinking TROUBLE No. 4 or TROUBLE No. 5 is indicated. They are power supply problems, not CRT.

Two, as you advance the brightness control with this trouble, the whites in the picture get a shiny quicksilver look and the picture might turn inside out or go negative. If the picture doesn't do this but simply gets a little brighter as you advance the control, the trouble is probably not in the picture tube but in the video section.

The corresponding trouble of DIM PICTURE in a color CRT is TROUBLE No. 51—LOSS OF ONE COLOR. That's because it's rare for all three guns in a color CRT to go at the same time. It's usually just one gun that goes while the other two perform satisfactorily. This removes one color from the screen. You can tell which gun is going by which color is missing. If the picture becomes a mixture of purples you have lost your green component. If the picture is blue and green you have lost red. Should the picture be red and green you have lost blue.

The repair attempt is easy. You must install a CRT brightener on the tube. A



The CRT cap is only a plastic cover over glass. If the cap comes off you can thread it back on.

brightener is simply a small step-up transformer that overheats the cathode by raising the filament voltage from its rated 6.3 volts to 7.8 volts. The brightener won't hurt the filaments since they are 100% over-rated and can burn safely up to 12.6 volts. In fact, if your picture tube becomes dim for the second time you can try installing a second brightener in series with the first.

The only real problem you'll have is getting the right brightener. There are between sixteen and twenty different kinds. You'll need the following two facts to get the right one. One, the number of your picture tube. And two, the wiring of your tube heaters, series or parallel.

A professional uses a rejuvenation machine in addition to installing the brightener. This gives the brightener a better and faster start. In fact, sometimes the bright-



This dim picture happens for the most part only in a black-and-white set. A pure form has no shrinking.

ener won't do the trick unless the tube is rejuvenated first.

In a color TV when you restore one low gun by installing a brightener the other two guns work stronger too. The picture will probably get the wrong tint and a gray scale tracking procedure will probably have to be employed. (See TROUBLE No. 44—TINTED PICTURE, Chapter 9.)

#### **Trouble No. 55—Fixed Brightness**

The pure form of this trouble happens only in a black-and-white CRT. There is a dull-looking picture on the screen, usually with retrace lines showing. Turning the brightness control has no effect. The picture remains the same. There is a short in the electron gun and it is probably a heater to cathode short.

The short in the gun effectively shorts

the brightness control right out of the circuit. While the brightness control won't work, the contrast control does.

The problem here is, the heater and cathode must not touch electrically because they operate at different voltage potentials. When they do touch, the cathode is dropped down to the heater potential.

A clever repair can be made by isolating the heater from its low voltage potential. This can be accomplished with a 1:1 isolation transformer.

Isolation transformers can be bought for black-and-white TV's. They look and install exactly like a brightener. Here again be sure you buy the right one. There are also available brighteners that are wound as an isolation transformer. Get one of these and you'll get the brightening action as well as the isolation.

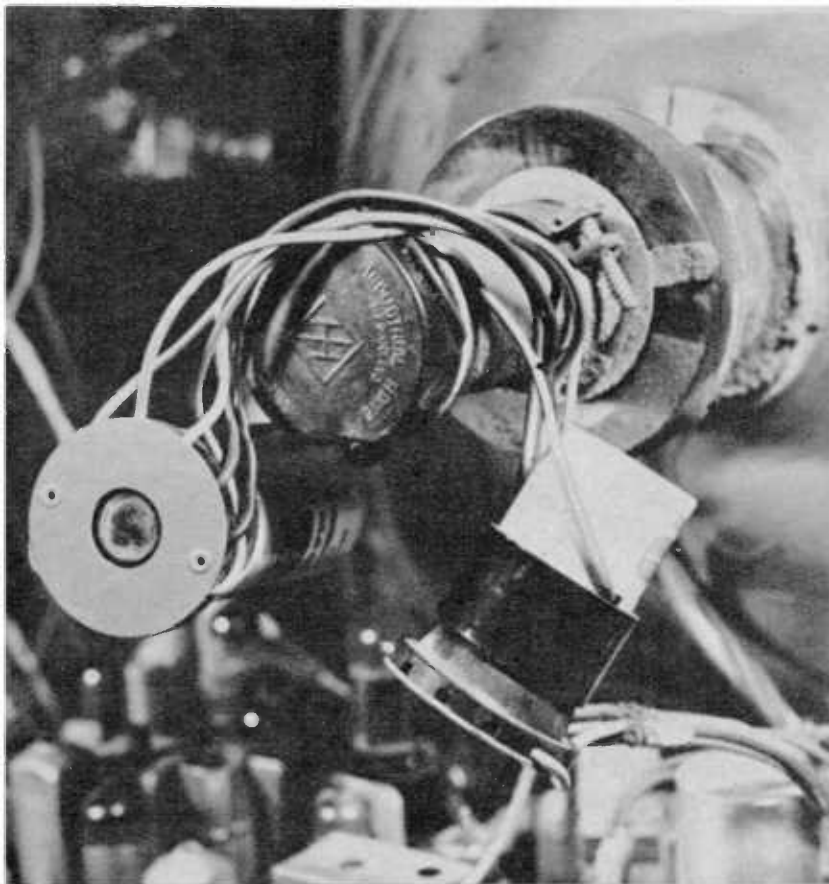

When one brightener fails to do the trick, there's no harm done by installing a 2nd one; exercise caution.



The pure form of fixed brighteners happens only in black-and-white TV's and shows retrace lines.

102



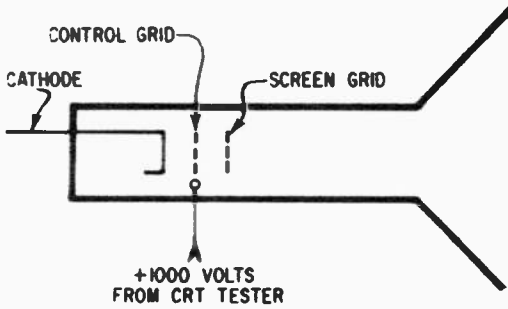

A rejuvenation machine places 1000 volts on control grid. This sucks electrons fast from cathode.

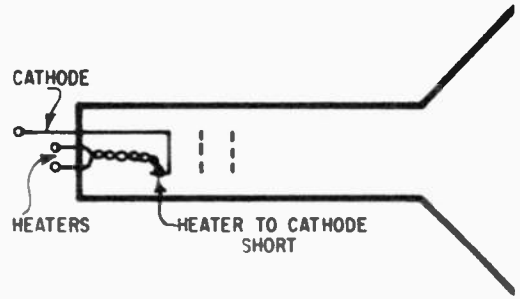

A heater to cathode short will effectively short out the brightness control—rendering it dead.

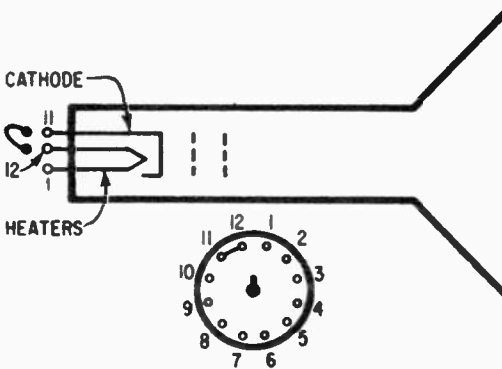

When the isoformer kills brightness, it's because the cathode is broken. Fix with exterior short.

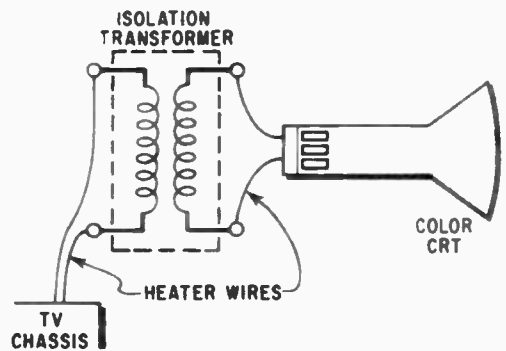

Any correctly rated 1:1 transformer can be installed directly into the heater leads of color CRT.

**In Case You Lost Brightness:** There is the occasional case, where you have fixed brightness, when you install an iso-former and then lose brightness altogether. When this happens it's because the cathode has broken. Most of the time you can restore the picture by placing a short between the heater and the cathode pins on the CRT. For instance, if the heaters are pins 12 and 1 and the cathode is pin 11, by placing a piece of wire between pin 11 and 12 you'll cure all.

The corresponding trouble of **FIXED BRIGHTNESS** in a color CRT is **TROUBLE No. 48—NO VIDEO, COLOR OK**. This means there is no Y but the R-Y, G-Y and B-Y are appearing on the screen. A smeary color picture is the result with no black and white at all. When a monochrome show is on just a raster appears. This happens because the Y is coming in through the shorted cathode while the colors are

arriving by way of the clear control grids.

Unfortunately, there is no isoformer made for color CRT's at the present time. You can buy one that will work, even though it was conceived for another purpose. One I've been using is a damper heater isolation transformer that is rated 1:1 at 2 amperes.

Find the heater leads for your color CRT. They are usually coded black and brown. Snip them midway between the chassis and the CRT cap. Attach the primary of the transformer to the chassis lead ends and the secondary of the transformer to the cap lead ends. Mount the transformer conveniently on the chassis or on the cabinet.

If the isoformer repair is going to take, it's an instant success. If it still doesn't work it indicates further shorts in the electron gun and you'll probably have to replace the CRT. •

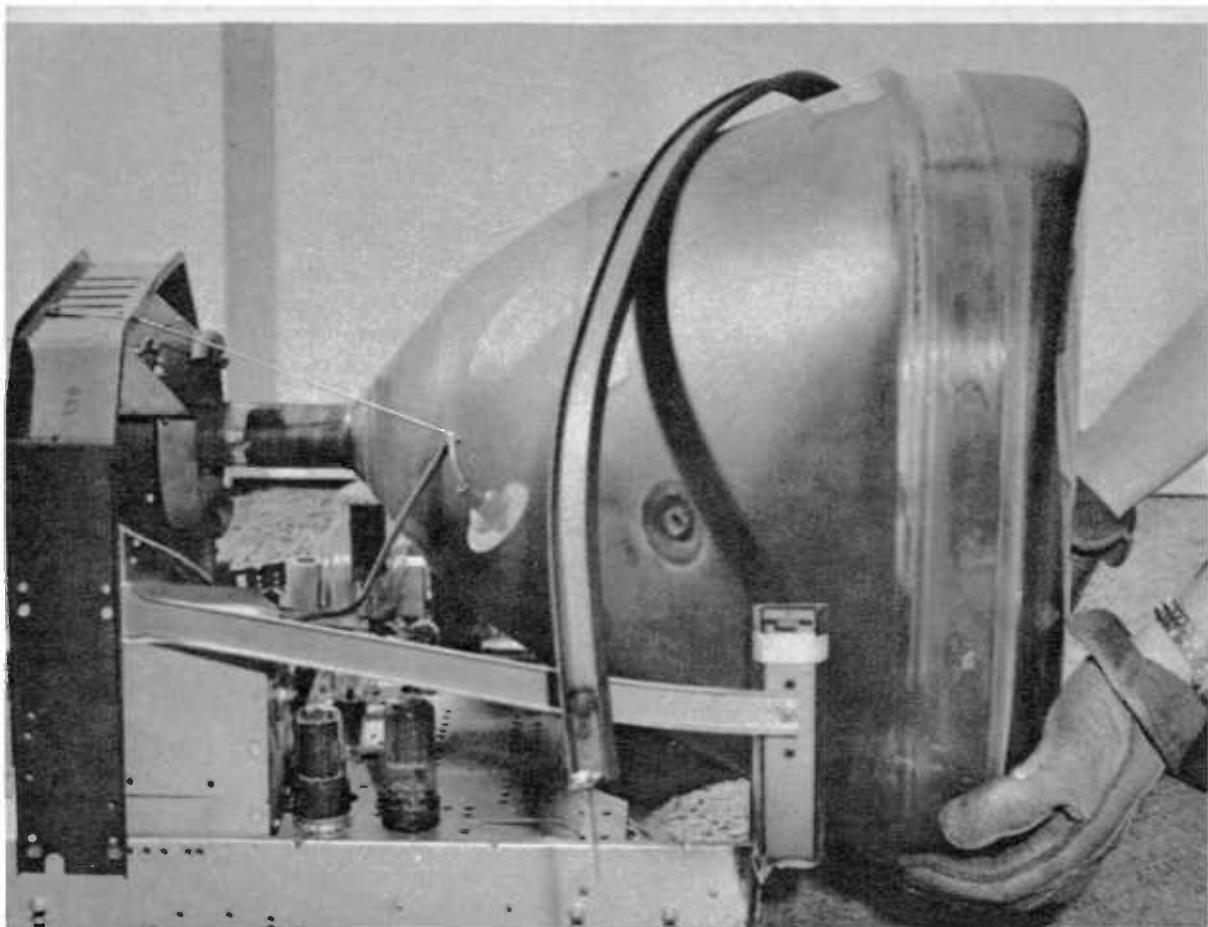

Every CRT has a limited life-span. Whether you get a new one or a rebuilt depends on the individual set.

# Actually Replacing Picture Tubes

Buying a new or rebuilt CRT—and proper installation procedure

**T**HERE comes a time in the life of every picture tube, monochrome or polychrome, when it needs replacement. What then? Let's go through the various considerations.

**The Buy:** The first question you must answer is, should I buy a new CRT or a rebuilt one? There is no pat answer. It's all according to what kind of picture tube you are replacing. There are three general types. One is the old black-and-white tube that is typified by the 21FLP4. This is a 90-degree tube with a conventional 12 pin socket. In this case a rebuilt tube is prob-

ably the best buy. The TV is an older one. These type tubes are rebuilt easily and have a good product result. The only difference between a new and rebuilt tube that is made by a name brand company is that the glass is used over again. A name brand company uses the same quality control and glass inspection procedures on new and rebuilt tubes. You can feel safe with a rebuilt.

The second type tube is the newer black-and-white tube. This is typified by a 17DQP4. These are 110-degree tubes with newer eight pin sockets. They are not quite

as easy to rebuild. Shop around and check prices on new and rebuilt versions. Be sure to get a name brand tube. If the price differential is enough you can chance a rebuilt. Should there be only a few dollars' difference take the new, for this is evidence of great difficulty and a large rejection rate on the rebuilds.

If you can, try to make a deal with the company you buy from, that if the rebuilt is not satisfactory you can trade it back

in for a credit on a new one. The 110-degree tubes do not rebuild quite as easily as the 90-degree ones.

The third general type is the color CRT. I do not recommend, at this time, the use of rebuilds. I would advise a new tube, with rare earth phosphors only. The black-and-white tube's main breakdown area is the electron gun. This is the part that is replaced during rebuilding. In a color CRT, though, only the gun is changed. There are

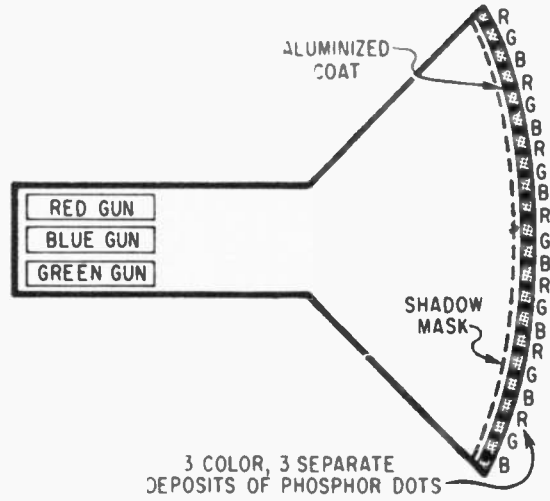
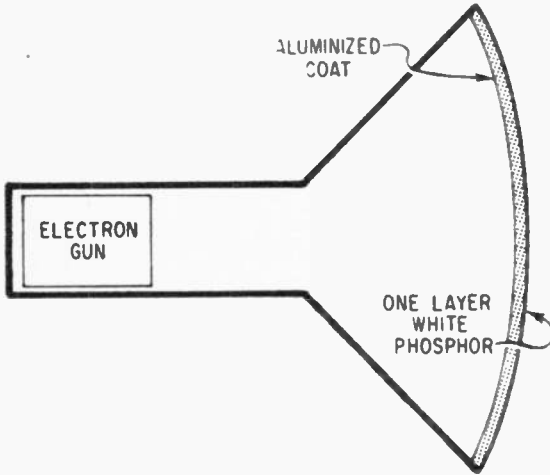

A black and white CRT is easily and reliably rebuilt since the gun is the main breakdown area.

A color CRT has reliability problems with the shadow mask and tri-color screen, plus the gun.

The big consideration to easy CRT removal is to place TV on its face, lift up and then away.

When CRT cap has been on a long time, pry it off carefully from the rust, dust and corrosion.

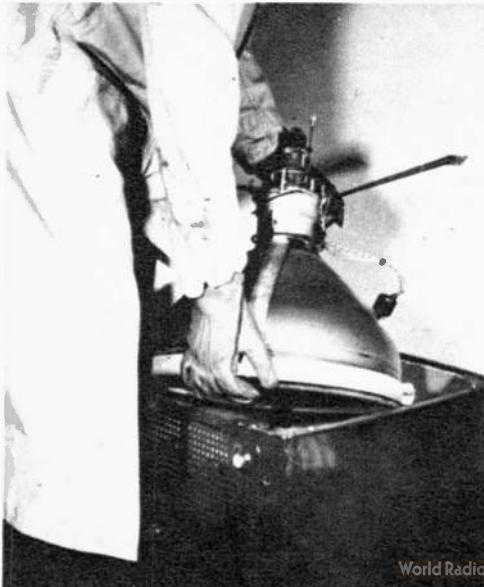



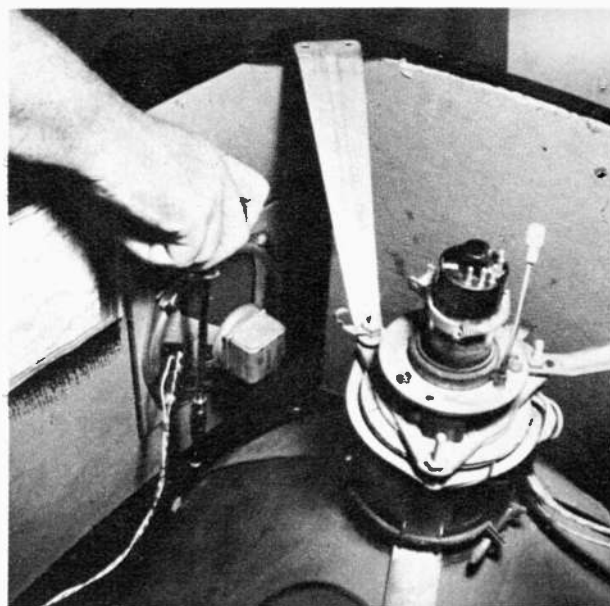
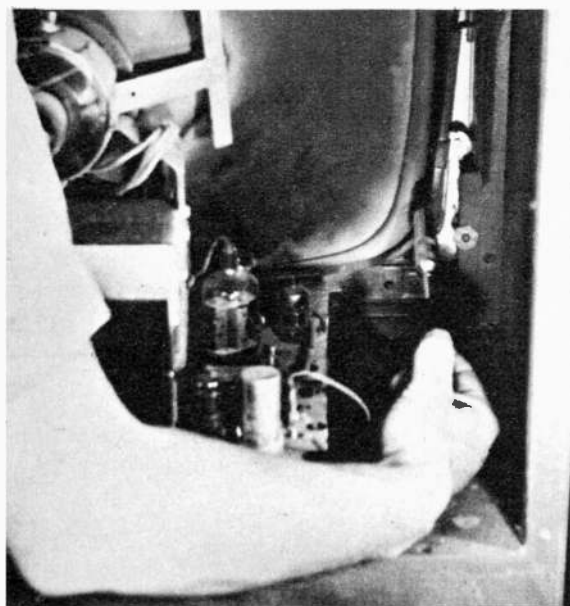

When the CRT is bolted in with its own bracket assembly, it's usually attached to the cabinet.

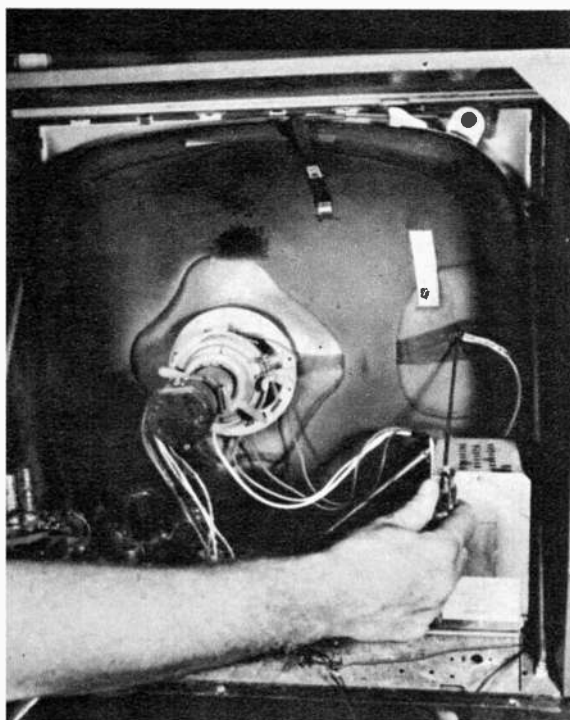

Be careful removing anode button. There are different kinds and sometimes it stores electricity.

other major defect areas such as the shadow mask and the tri-color screen. These components cannot be easily rebuilt.

Also if you get a new rare earth tube and your TV didn't have one previously the picture will be better than when the set was new.

Be sure to get an exact replacement tube. It need not be the exact same number but it must be an exact replacement. If it's not you are asking for complications due to incorrect physical size.

When you buy the tube check the labeling on the box. By law the manufacturer must state new or rebuilt. New is designated by the unmistakable NEW on the box. A rebuilt is usually disguised by a label that reads something like this: "This tube is made of all new materials except the glass envelope which might be subject to reuse."

### The Installation

The big trick in taking out a picture tube is to lay the TV on its face after the chassis and other accessories are out of the way. That way the tube will stay in place with or without its mounting. Lifting is up and down, not sideways.

Safety first is important. In factories gloves, goggles and a long shop coat are required. It would be a good idea for you to do the same if you are going to handle

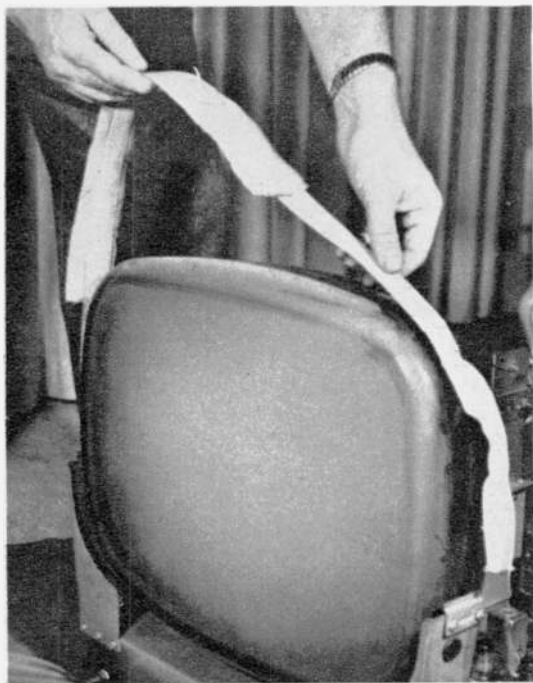

Some picture tubes are mounted with a cloth-type strap. This makes for much easier removal.



When a yoke freezes to the glass neck, it can be loosened easily with this special yoke loosener.

**ALL NEW!**  
NRI learn-by-doing training in

## ADVANCED COLOR TV



- Build your own custom color set in 5 training stages
- 50 designed-for-learning color circuit experiments
- Programmed with 18 "bite-size" lesson texts

A comprehensive training plan for the man who already has a knowledge of monochrome circuits and wants to quickly add Color TV servicing to his skills. **DEFINITELY NOT FOR BEGINNERS.** It picks up where most other courses leave off—giving you "hands on" experience as you build the only custom Color TV set engineered for training. You gain a professional understanding of all color circuits through logical demonstrations never before presented. The end product is your own quality receiver.

### TRAIN WITH THE LEADER

This NRI course—like all NRI training—is an outgrowth of more than 50 years experience training men for Electronics. NRI has simplified, organized and dramatized home-study training to make it easy, practical, entertaining. You train with your hands as well as your head, acquiring the equivalent of months of on-the-job experience. Demand for Color TV Service Technicians is great and growing. Cash in on the color boom. Train with NRI—oldest and largest school of its kind. Mail coupon. No obligation. No salesman will call. **NATIONAL RADIO INSTITUTE**, Color Div., Wash., D.C. 20016.

### MAIL FOR FREE CATALOG



**NATIONAL RADIO INSTITUTE**  
Color TV Division  
Washington, D.C. 20016 48-098

Send me complete information on NRI new Advanced Color TV Training. (No salesman will call)

Name  Age

Address

City  State  Zip

ACCREDITED MEMBER NATIONAL HOME STUDY COUNCIL



a large picture tube. It can implode with great force and throw glass in all directions.

A black-and-white CRT is removed easily. Just the CRT cap, an ion trap (if there is one—they have disappeared almost completely from the scene), sometimes a focus coil and the deflection yoke are removed from the neck. Then the high voltage anode lead is removed from the CRT well. The well and the anode lead are discharged to the chassis with your jumper cord.

The mounting bolts are removed and the CRT lifted out. That's all there is to it. The new tube is replaced by retracing your steps exactly. The only stopgap you might run into is a frozen yoke or hardware. In that case you must stop and call for help.

A color CRT can also be removed but not quite as easily. Again with the TV on its face and the chassis out of the way follow the next few steps.

Unplug the CRT cap. Remove the blue lateral magnet, noting its exact position on the neck. Remove the purity tabs, noting their position. Loosen the convergence yoke assembly and remove it, noting its exact position. Loosen the deflection yoke and remove. Disconnect the anode lead from the CRT well and discharge both well

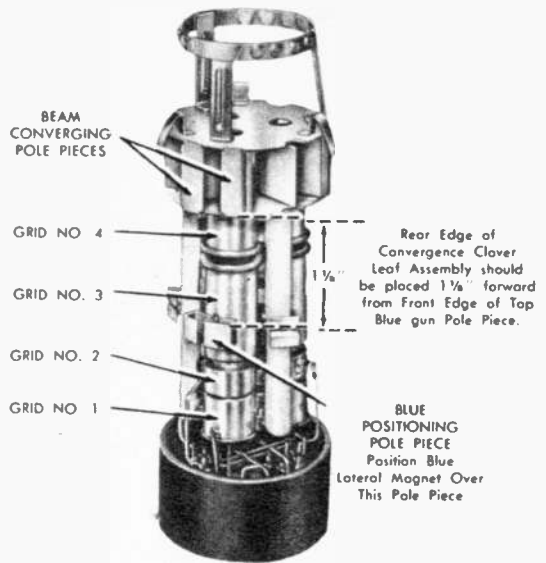

If you look closely in the neck at the electron gun assembly you can pick out the pole pieces.

The convergence assembly purity rings and blue lateral magnets must always be placed correctly.

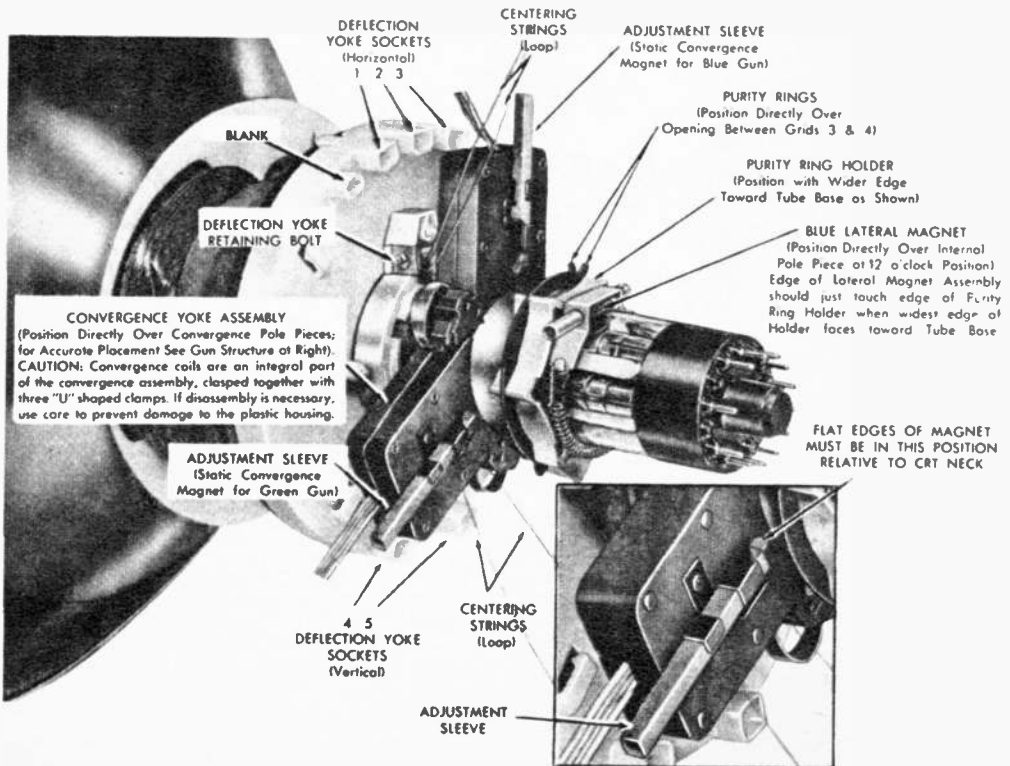





A tilted picture is easily straightened by loosening the yoke and then carefully rotating it into place.



Black shadows in corner of tube are caused by yoke being mounted too far back from the bell.



Sometimes a picture tube needs a strap between the heater and the focus anode mounted in electron gun.

and lead. Then remove mounting hardware and lift out.

The new tube is replaced by retracing your steps exactly. Be sure to place the blue gun at the top just as the old tube was mounted. There is a marking on the rim of the face plate showing the top position. Be sure you get all of the neck hardware over their proper places in the electron gun assembly. Once you get the TV back together you have to adjust the picture back into place.

### What Does What

**Tilted Picture:** Should the picture return upside down or tilted you can straighten it out by rotation of the yoke.

**Shadows in Corners:** If you develop black shadows around the perimeter of the tube the yoke is mounted too far back. Push it up closer to the bell of the tube.

**Picture Not Centered:** Centering devices

closely resemble the purity tabs. On a black-and-white tube they are centering devices, on a color tube they are not. Centering devices on a color tube could be adjustments on the rear chassis panel or strings sticking out of the yoke assembly. Check service folder for the exact type.

**Out of Focus:** Focus is obtained by adjusting till the lines of the picture stand out the sharpest. Lots of black-and-white CRT's have a focus strap that is a little piece of metal shorting out a few pins on the CRT socket. Quite often it is left on the old tube and focus is lost. If you lose focus after replacing a tube check the old tube for the strap. Check your service folder for exact positioning of focus adjustments.

**Color CRT's:** After replacing a color CRT, a complete convergence setup is needed. Turn back to Chapter 9 and follow it from start to finish. •

# Installing UHF on an Older TV

It's easy and inexpensive to convert your pre-'64 VHF-only set

**E**VERY new TV that rolls off a production line in the U.S. has tuning for channels 2 through 84. However, there were about 60 million TV sets built before April 1964, the date when UHF became law. Very few of the pre-'64 TV's had provisions for channels 13 through 84.

There are still literally millions of TV's in use that can't get the UHF programs. If you own one of these it's quite easy and relatively inexpensive to convert your VHF-only TV for UHF reception too.

One point I'd like to make first. Lots of TV sets have a UHF antenna terminal in the rear, and a hole with a cover saying UHF in the front. There is nothing in between. There might be a factory UHF tuner available but probably not. If you can get that special UHF tuner, fine, but since you probably can't, forget that terminal and hole. It is useless.

**Converters:** We buy and install UHF converters by the case. From a convenience, financial and performance stand-

point these converters are better deals than the factory jobs most of the time. They are usually easier to install, cost less and perform better. Their only drawback is they won't fit your UHF hole. Occasionally you can even use the terminal strip already on your TV back.

There are two kinds. One sits outside the TV and the other mounts inside your TV. Both are converters rather than tuners which actually gives them more signal gain. A factory UHF tuner is tied directly into the IF strip. A UHF converter is connected into the VHF tuner and the signal gets the benefit of the extra circuits it flows through.

There are about four price ranges and you get exactly what you pay for. The more expensive converters have extra amplification stages, pilot bulbs, fine tuners and AC outlets (so you can plug the TV into the converter and won't need an extra AC outlet in the wall). They vary from about twelve to forty dollars.

If you own a television that doesn't possess UHF channels 14 through 83, it's an easy thing to install.

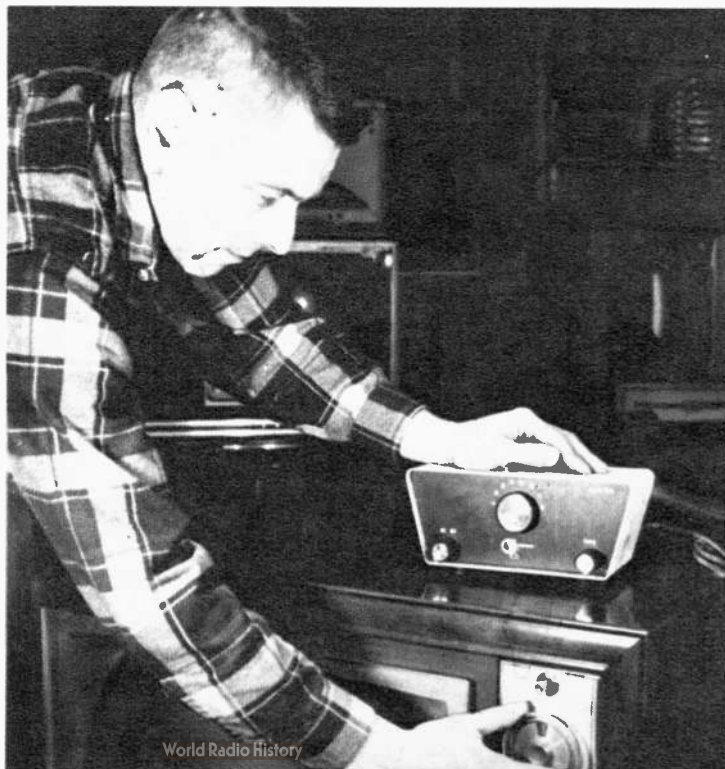

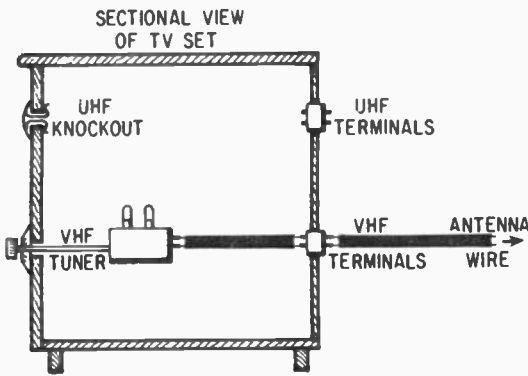

Lots of TV's own holes labeled UHF and VHF terminals on its back—but nothing in between.

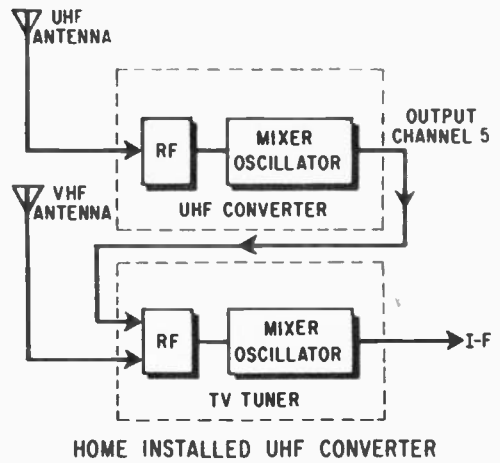

A converter works by changing all UHF stations to channel five. Tuning is done by converter dial.

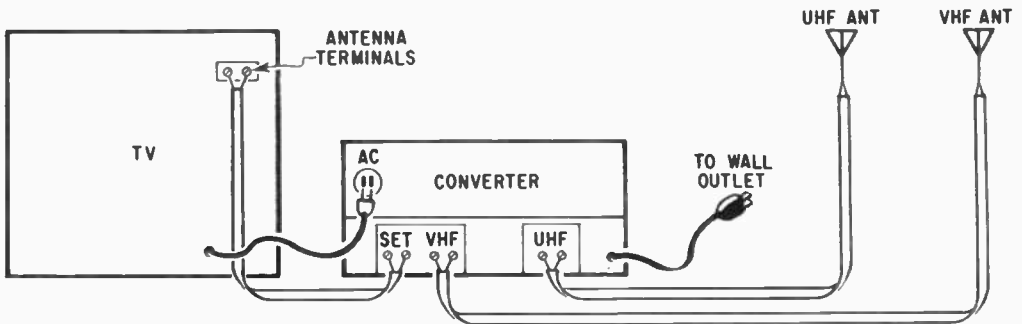

UHF CONVERTER ATTACHMENTS

Converter has three sets of terminals, one for the UHF antenna, one for VHF, and another for jumper cord.

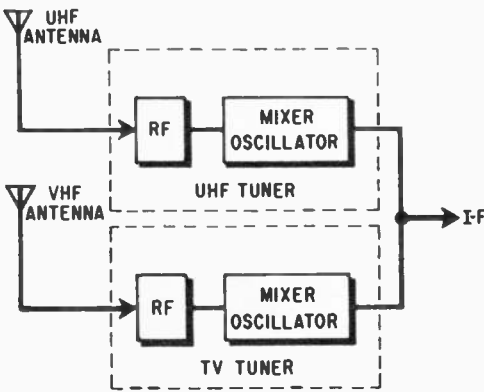

FACTORY INSTALLED UHF TUNER

A UHF tuner is separate from the VHF tuner and is wired directly into the first IF circuit.

A simple wire ring with a diameter around eight inches makes an excellent indoor UHF antenna.

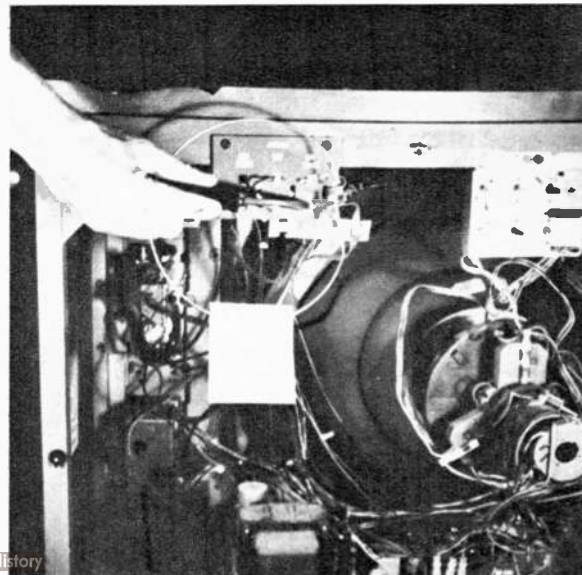



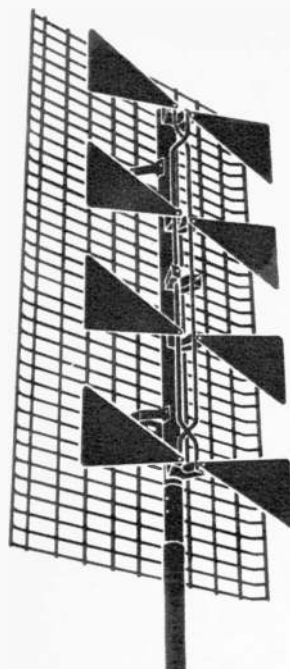

The UHF outdoor antenna, left and also below, is smaller and shaped differently than its VHF counterpart for tuning.

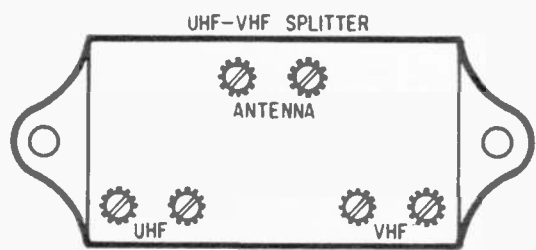
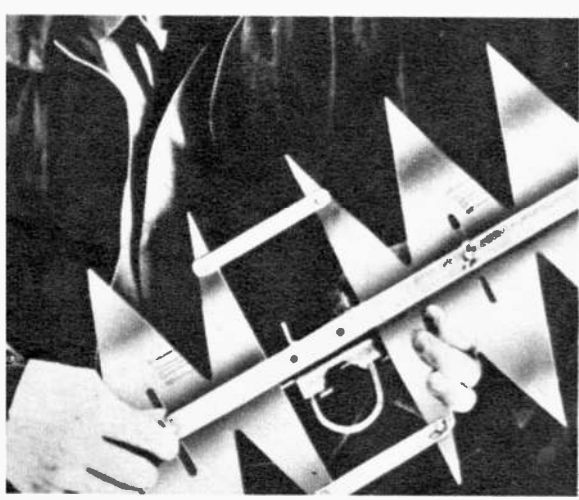

If your VHF antenna pulls in good UHF, you can install a splitter and use it for both of them.

**Outside Converters:** This looks like a little table model radio and is hooked up in four simple steps. 1) Attach your regular antenna to the terminals on the converter marked VHF ANTENNA. 2) Attach your new UHF antenna to the terminals marked UHF ANTENNA. 3) Attach provided jumper lead-in wire to the terminals on the converter marked TV SET. 4) Attach other end of jumper wire to the antenna terminals on your TV. Then plug the converter into an AC outlet.

With the converter off, your TV will operate normally. With the converter on, all the UHF channels are converted to Channel 5. Tune your TV for Channel 5 and then tune the converter dial for the desired UHF stations. It's that easy.

**Inside Converter:** With the built-in converter, you have a woodworking job on your hands. Drill a hole in the cabinet and mount the converter in the hole according to the instructions you get with the converter. Electrically the converter installs exactly like the OUTSIDE CONVERTER except for the electricity. Most of these show installation of the electricity directly to the AC input in the TV. If you get confused better call for help.

**UHF Antennas:** While many times your regular antenna will pull the UHF stations in fairly well, a separate UHF antenna pulls best. The simplest antenna is an indoor type, a metal ring eight inches in diameter. You can purchase one or make one from a coat hanger. It attaches directly to the UHF antenna terminal, either on the TV if your tuner is built-in, or on the back of the universal converter box. To orient the antenna move it up and down or rotate it.

For something more powerful than the ring, there are various indoor antennas and outdoor antennas. The outdoor antenna can be attached directly to the mast of your regular antenna. There will be no interference as long as each antenna has its separate lead-in.

**Splitters:** If you take your regular antenna and attach it to the UHF and find it pulls satisfactorily, you can dispense with a separate UHF antenna by means of a VHF-UHF splitter. This is a simple gadget that can split the signal in two.

Once you get a splitter, run the antenna into it. There is a pair of terminals for this purpose. At the other end of the splitter you'll find two other pairs of terminals, one marked UHF and the other VHF. Run a lead from each and attach them to their respective terminals on the converter or TV •

# PROGRESSIVE RADIO

Reg. U. S.  
Pat. Off.

**CIRCUITS AT HOME**  
with the New Improved  
**PROGRESSIVE RADIO "EDU-KIT"®**

only  
**\$29.95**



Training Electronics Technicians Since 1946

## A Practical Home Radio Course

### Now Includes

- ★ 12 RECEIVERS
- ★ 3 TRANSMITTERS
- ★ 5Q. WAVE GENERATOR
- ★ SIGNAL TRACER
- ★ AMPLIFIER
- ★ SIGNAL INJECTOR
- ★ CODE OSCILLATOR

### EXPANDED "EDU-KIT" NOW INCLUDES

- ★ TRANSISTOR (Solid State) CIRCUITS
- ★ VACUUM TUBE CIRCUITS
- ★ PRINTED CIRCUITS
- ★ HAND WIRED CIRCUITS

**YOU DON'T HAVE TO SPEND  
HUNDREDS OF DOLLARS FOR A RADIO COURSE**

The "Edu-Kit" offers you an outstanding PRACTICAL HOME RADIO COURSE at a rock-bottom price. Our Kit is designed to train Radio & Electronics Technicians, making use of the most modern methods of home training. You will learn radio theory, construction, practice and servicing. THIS IS A COMPLETE RADIO COURSE IN EVERY DETAIL. You will learn how to build radios, using regular schematics; how to wire and solder in a professional manner; how to service radios. You will work with the standard type of punched metal chassis as well as the latest development of Printed Circuit chassis. You will learn the basic principles of radio. You will construct, study and work with RF and AF amplifiers and oscillators, detectors, rectifiers, test equipment. You will learn and practice code, using the Progressive Code Oscillator. You will learn and practice troubleshooting, using the Progressive Signal Tracer, Progressive Signal Injector, Progressive Dynamic Range & Electronics Tester, Square Wave Generator and the accompanying instructional material.

You will receive training for the Novice, Technician and General Classes of F.C.C. Radio Amateur License. You will build Receiver, Signal Tracer, Square Wave Generator, Code Oscillator, Signal Tracer and Signal Injector circuits, and learn how to operate them. You will receive an excellent background for television, Hi-Fi and Electronics.

Absolutely no previous knowledge of radio or electronics is required. The "Edu-Kit" is the product of many years of teaching and engineering experience. The "Edu-Kit" will provide you with a basic education in Electronics and Radio, worth many times the low price you pay. The Signal Tracer alone is worth more than the price of the kit.

## THE KIT FOR EVERYONE

You do not need the slightest background in radio or science. Whether you are interested in Radio & Electronics because you want an interesting hobby, a well paying business or a job with a future, you will find the "Edu-Kit" a worth-while investment. Many thousands of individuals of all

ages and backgrounds have successfully used the "Edu-Kit" in more than 70 countries of the world. The "Edu-Kit" has been carefully designed, step by step, so that you cannot make a mistake. The "Edu-Kit" allows you to teach yourself at your own rate. No instructor is necessary.

## PROGRESSIVE TEACHING METHOD

The Progressive Radio "Edu-Kit" is the foremost educational radio kit in the world, and is universally accepted as the standard in the field of electronics training. The "Edu-Kit" uses the modern educational principle of "Learn by Doing." Therefore you construct, learn schematics, study theory, practice troubleshooting—all in a closely integrated program designed to provide an easily-learned, thorough and interesting background in radio.

You begin by examining the various radio parts of the "Edu-Kit." You then learn the function, theory and wiring of these parts. Then you build a simple radio. With this first set you will enjoy listening to regular broadcast stations. Then you learn advanced theory and troubleshooting. Then you build a more advanced radio, learn more advanced theory and techniques. Gradually, in a progressive manner, and at your own rate, you will find yourself constructing more advanced multi-tube radio circuits, and doing work like a Professional Radio Technician.

Included in the "Edu-Kit" course are Receiver, Transmitter, Code Oscillator, Signal Tracer, Square Wave Generator and Signal Injector Circuits. These are not unprofessional "breadboard" experiments, but genuine radio circuits, constructed by means of professional wiring and soldering on metal chassis, plus the new method of radio construction known as "Printed Circuitry." These circuits operate on your regular AC or DC house current.

## THE "EDU-KIT" IS COMPLETE

You will receive all parts and instructions necessary to build twenty different radio and electronics circuits, each guaranteed to operate. Our Kits contain tubes, tube sockets, variable, electrolytic, mica, ceramic and paper dielectric condensers, resistors, tie strips, hardware, tubing, punched metal chassis, Instruction Manuals, hook-up wire, solder, selenium rectifier, coils, volume controls and switches, etc.

In addition, you receive Printed Circuit materials, including Printed Circuit chassis, special tube sockets, hardware and instructions. You also receive a useful set of tools, a professional electric soldering iron, and a self-powered Dynamic Radio and Electronics Tester. The "Edu-Kit" course includes Code Instructions and the Progressive Code Oscillator, in addition to F.C.C. Radio Amateur License training. You will also receive lessons for servicing with the Progressive Signal Tracer and the Progressive Signal Injector, a High Fidelity Guide and a Quiz Book. You receive Membership in Radio-TV Clubs, Free Consultation Service, Certificate of Merit and Discount Privileges. You receive all parts, tools, instructions, etc. Everything is yours to keep.

## FREE EXTRAS

### • SET OF TOOLS

- SOLDERING IRON
- ELECTRONICS TESTER
- PLIERS-CUTTERS
- VALUABLE DISCOUNT CARD
- CERTIFICATE OF MERIT
- TESTER-INSTRUCTION MANUAL
- HIGH FIDELITY GUIDE & QUIZZES
- TELEVISION BOOK & RADIO TROUBLE-SHOOTING BOOK
- MEMBERSHIP IN RADIO-TV CLUB: CONSULTATION SERVICE & F.C.C. AMATEUR LICENSE TRAINING
- PRINTED CIRCUITRY

## SERVICING LESSONS

You will learn troubleshooting and servicing in a progressive manner. You will practice repairs on the sets that you construct. You will learn symptoms and causes of trouble in home, portable and car radios. You will learn how to use the professional Signal Tracer, the unique Signal Injector and the dynamic Radio & Electronics Tester. While you are learning in this practical way, you will be able to do many a repair job for your friends and neighbors, and charge fees which will far exceed the price of the "Edu-Kit." Our Consultation Service will help you with any technical problems you may have.

## FROM OUR MAIL BAG

J. Statatits, of 25 Poplar Pl., Waterbury, Conn., writes: "I have repaired several sets for my friends, and made money. The "Edu-Kit" paid for itself. I was ready to spend \$240 for a Course, but I found your ad and sent for your Kit."

Ben Valerio, P. O. Box 21, Magna, Utah: "The Edu-Kits are wonderful. Here I am sending you the questions and also the answers for them. I have been in Radio for the last seven years, but like to work with Radio Kits, and like to build Radio Testing Equipment. I enjoyed every minute I worked with the different kits; the Signal Tracer works fine. Also like to let you know that I feel proud of becoming a member of your Radio-TV Club."

Robert L. Shuff, 1534 Monroe Ave., Huntington, W. Va.: "Thought I would drop you a few lines to say that I received my Edu-Kit, and was really amazed that such a bargain can be had at such a low price. I have already started repairing radios and phonographs. My friends were really surprised to see me get into the swing of it so quickly. The Trouble-shooting Tester that comes with the Kit is really swell, and finds the trouble, if there is any to be found."

## PRINTED CIRCUITRY

At no increase in price, the "Edu-Kit" now includes Printed Circuitry. You build a Printed Circuit Signal Injector, a unique servicing instrument that can detect many Radio and TV troubles. This revolutionary new technique of radio construction is now becoming popular in commercial radio and TV sets.

A Printed Circuit is a special insulated chassis on which has been deposited a conducting material which takes the place of wiring. The various parts are merely plugged in and soldered to terminals.

Printed Circuitry is the basis of modern Automation Electronics. A knowledge of this subject is a necessity today for anyone interested in Electronics.

Progressive "Edu-Kits" Inc., 1186 Broadway, Dept. 512HM, Newlett, N. Y. 11557

## UNCONDITIONAL MONEY-BACK GUARANTEE

Please rush my Progressive Radio "Edu-Kit" to me, as indicated below:

Check one box to indicate choice of model

- Regular model \$26.95.
- Deluxe model \$31.95 (same as regular model, except with superior parts and tools).
- Expanded model \$36.95 (same as Deluxe model, except with 5 additional solid state circuits plus valuable Radio-TV Tube Checker).

Check one box to indicate manner of payment

- I enclose full payment. Ship "Edu-Kit" post paid.
- Ship "Edu-Kit" C.O.D. I will pay postage.
- Send me FREE additional information describing "Edu-Kit."

Name \_\_\_\_\_

Address \_\_\_\_\_

## PROGRESSIVE "EDU-KITS" INC.

1186 Broadway, Dept. 512HH, Newlett, N. Y. 11557

# Warner Programs are Your Guide to Financial Security and Success

## INSTANT MONEY...

Plastics are the wave of the future — now you can become a part of this industry. Start in your spare time to build your own future. Imagine: you can turn the worth of raw material into a finished product that sells for \$2.50. You become a Warner distributor and reap the full benefits of its 46 years experience in know-how and help. Three exciting fields for Immediate Profits... and any man, regardless of age, education or experience can learn. Warner methods guarantee your ability to *succeed!*

## BIG INDUSTRY...A.I.G.\*

One little-known fact about the electroplating industry is that there are 5,000,000 or more new customers every year! Yet this segment of the metalizing business is *only 1%* of the market potential! One small, independent operator — who started in his spare time, at home — ran his metalizing business to an annual volume of \$1,000,000.00 within four short months! Don't procrastinate... **INVESTIGATE!** Find out for yourself how you can become a part of the American Industry Growth\* picture.

## NEW PROCESS...

The Multi Million dollar a year marking industry is now within reach of the small independent operator. Warner's research has produced a revolutionary new process which allows you to enter this field. The Warner method and quality is equal to the best in the field... and your service — (the basis of any business) can assure you earnings up to \$16.50 per hour in your Spare time!

## SECRETS OF...

Are you worth \$25,000.00 a year and do you want to be your own boss?

Warner's newest shop is a unique breakthrough in the Engraving field. It is not — and we repeat, **NOT** — direct selling. It is a business that knows no season... yet it is a business that will never be taken over by the giant corporations. In fact, *they will want you as a supplier!* Now, Warner makes it possible for you, the independent businessman, to cash in on this once-in-a-lifetime opportunity... **ON THE GROUND FLOOR!**

## Many Operators Have ALL 4 Shops . . .

**INSTEAD OF BEING USED BY INDUSTRY... BECOME A PART OF INDUSTRY!**

This is *your* opportunity to own your own business — start it in your spare time — the **WARNER-WAY** will even help you finance it — earnings can be as high as \$36 per hour! **EACH ONE OF THESE SHOPS CREATES BUSINESS FOR THE OTHER.**

OUR 46TH YEAR of providing the "tools" for success of the small business for those who earnestly want to be independent and enterprising. Let us send you full information without obligation.

The Warner Electric Co., Dept. CS-173-KO  
1512 W. Jarvis Ave., Chicago, Ill. 60626

Please send me additional information on the shop I have checked below. I understand there is no obligation.

Laminating  
 Rubber Stamps

Metalizing  
 Engraving

NAME \_\_\_\_\_

ADDRESS \_\_\_\_\_

CITY &  
STATE \_\_\_\_\_

ZIP  
CODE \_\_\_\_\_

**The WARNER ELECTRIC COMPANY, Inc.**  
Dept. CS-173-KO, 1512 W. Jarvis Ave. • Chicago 60626

## WRITE TODAY!

**BUILDING PROFITS FOR PEOPLE  
SINCE 1922**

# LET YOUR MAILMAN BE YOUR BANKER!