

TELEVISION

Volume III
(1938-1941)

TELEVISION

Volume III

(1938-1941)

Edited by

ALFRED N. GOLDSMITH

ARTHUR F. VAN DYCK

ROBERT S. BURNAP

EDWARD T. DICKEY

GEORGE M. K. BAKER

DECEMBER, 1946

Published by

RCA REVIEW

RADIO CORPORATION OF AMERICA

RCA LABORATORIES DIVISION

Princeton, New Jersey

Copyright, 1947, by
Radio Corporation of America,
RCA Laboratories Division

First PrintingMay, 1947
Second PrintingJuly, 1948
Third PrintingMay, 1949

Printed in U.S.A.

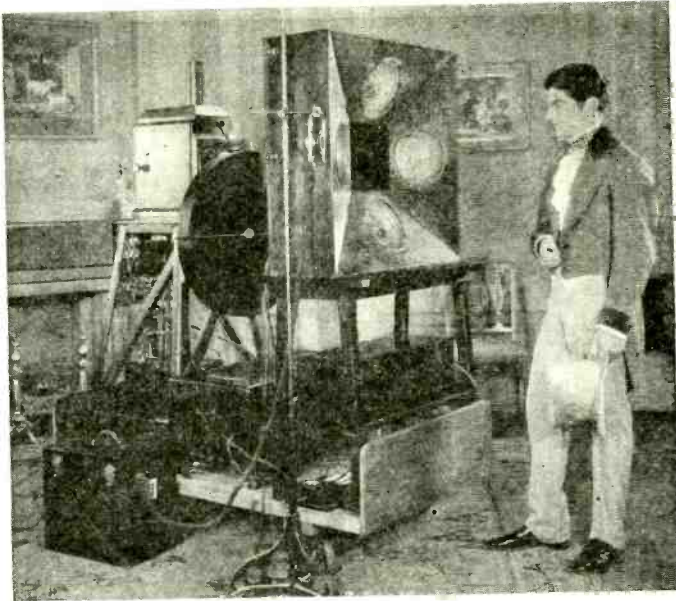

1928

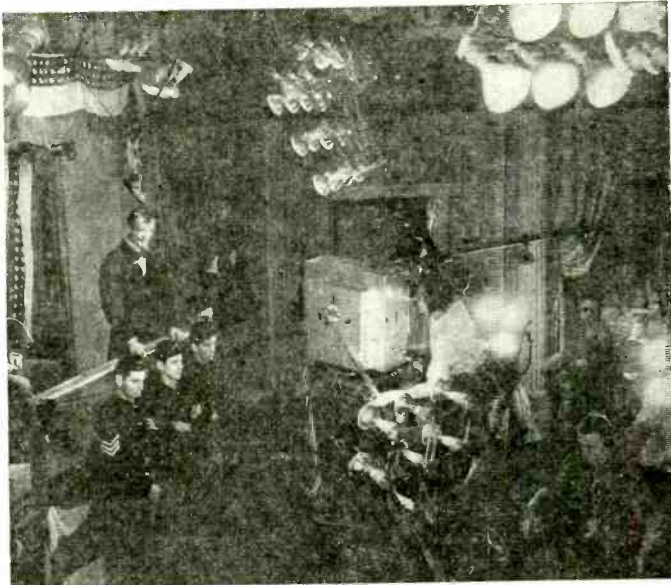

Today

Television Studios and Pickup Equipment

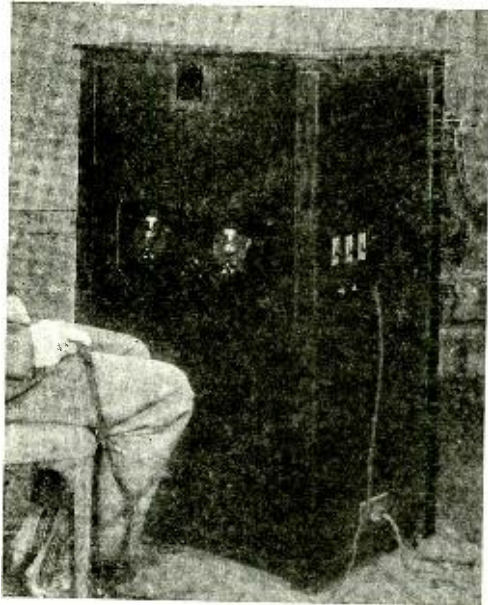

1928

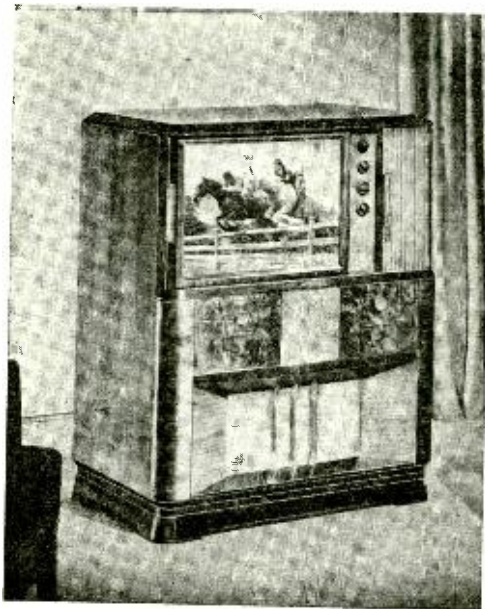

Today

Television Receivers

TELEVISION, Vol. III

PREFACE

IN 1936, the Radio Corporation of America published the first volume in its **Technical Book Series**—TELEVISION, Vol. I, which was followed a year later by TELEVISION, Vol. II. Additional books in the series were published in 1938 and 1939 on other subjects; a fifth book was ready to go to press in late 1941, but was not published because of the war. It was the intention to continue the technical series with subsequent volumes on later developments in fields already covered as well as new fields. Wartime security restrictions made it necessary, however, to postpone further publication.

During the war, RCA Institutes Technical Press, which formerly published the **Technical Book Series**, was discontinued; at the end of the war, its functions were transferred to RCA REVIEW at RCA Laboratories Division, Princeton, N. J. As soon as conditions permitted, RCA REVIEW commenced work on the compilation, selection, and editing of material for the next volume on television. It was immediately apparent that it was not possible to "bridge the gap" between 1937 and 1946 in one volume. Accordingly, two volumes on television are being published at this time.

* * *

This book, TELEVISION, Vol. III, covers the period 1938-1941. The papers are presented in four sections: Pickup; Transmission; Reception; and General.

* * *

The large number of excellent papers on the subject of television has made necessary a very stringent selection process. All the available material can not be included in full form. A number of papers are, therefore, presented herein in summary form only; it has been necessary to omit others entirely. Suitably balanced presentation of the various phases of television was the major criterion in deciding which papers to include in full and which in summary. The presentation of a paper in summary form (or the non-inclusion of any particular paper) is not intended to indicate any deficiency in technical accuracy, literary merit, or importance.

TELEVISION, Vols. I and II have been out of print for some time, and the plates were not retained during the war because of the shortage of type metal. The numerous requests being received for these two volumes, copies of which are no longer available, indicate the desirability of providing additional reference material on the earlier phases of television development. For this reason, the Appendix to this book includes **summaries** of all papers published in TELEVISION, Vols. I and II.

* * *

RCA REVIEW gratefully acknowledges the courtesy of The Institute of Radio Engineers, the McGraw-Hill Book Company, the Society of Motion Picture Engineers, the Optical Society of America, and the American Academy of Political and Social Science in granting to RCA REVIEW permission to republish material, written by RCA engineers, which has appeared in their publications.

The appreciation of RCA REVIEW is extended to all authors whose papers appear herein, and particularly to those whose papers are being printed in this book without prior publication.

* * *

TELEVISION, Vol. III, like its predecessors, is being published for scientists, engineers, and other groups interested in television, with the sincere hope that the material here assembled may help to speed developments and advance the position of television among companion arts and services.

The Manager, RCA REVIEW

RCA Laboratories
Princeton, N. J.
December 24, 1946

TELEVISION

Volume III

(1938-1941)

CONTENTS

	PAGE
FRONTISPIECE	— v —
PREFACE	<i>The Manager</i> , RCA REVIEW —vii—
INTRODUCTION	C. B. JOLLIFFE —xi—

PICKUP

Television Studio Technic	A. W. PROTZMAN 1
Application of Motion-Picture Film to Television	16
..... E. W. ENGSTROM, G. L. BEERS, AND A. V. BEDFORD	30
The Image Iconoscope .. H. IAMS, G. A. MORTON, AND V. K. ZWORYKIN	45
The Orthicon, A Television Pickup Tube	A. ROSE AND H. IAMS
A Determination of Optimum Number of Lines in a Television System	59
..... R. D. KELL, A. V. BEDFORD, AND G. L. FREDENDALL	82
Some Factors Affecting the Choice of Lenses for Television Cameras	82
..... H. B. DEVORE AND H. IAMS	95
The RCA Portable Television Pickup Equipment	95
..... G. L. BEERS, O. H. SCHADE, AND R. E. SHELBY	

TRANSMISSION

Analysis and Design of Video Amplifiers	116
..... S. W. SEELEY AND C. N. KIMBALL	135
Transient Response of Multistage Video-Frequency Amplifiers	135
..... A. V. BEDFORD AND G. L. FREDENDALL	152
A Wide-Band Inductive Output Amplifier	152
..... A. V. HAEFF AND L. S. NERGAARD	163
Mobile Field Strength Recordings of 49.5, 83.5 and 142 Mc from Empire State Building, New York—Horizontal and Vertical Polarization	163
..... G. S. WICKIZER	175
Selective Side-Band Transmission in Television	175
..... R. D. KELL AND G. L. FREDENDALL	191
A 500-Megacycle Radio-Relay Distribution System for Television	191
..... F. H. KROGER, B. TREVOR, AND J. E. SMITH	211
A Precision Television Synchronizing-Signal Generator	211
..... A. V. BEDFORD AND J. P. SMITH	229
Vertical vs. Horizontal Polarization	229
..... G. H. BROWN	241
A New Ultra-High-Frequency Tetrode and Its Use in a 1-Kilowatt Television Sound Transmitter	241
..... A. K. WING, JR. AND J. E. YOUNG	251
A Vestigial Side-Band Filter for Use With a Television Transmitter	251
..... G. H. BROWN	

RECEPTION

Direct-Viewing Type Cathode-Ray Tube for Large Television Images	277
..... I. G. MALOFF	285
Effect of the Receiving Antenna on Television Reception Fidelity	285
..... S. W. SEELEY	

CONTENTS (Continued)

	PAGE
Contrast in Kinescopes.....	R. R. LAW 294
Superheterodyne Converter System Considerations in Television Receivers.....	E. W. HEROLD 325
Optimum Efficiency Conditions for White Luminescent Screens in Kinescopes.....	H. W. LEVERENZ 330
Cathodoluminescence as Applied in Television.....	H. W. LEVERENZ 349
Video Output Systems.....	D. E. FOSTER AND J. A. RANKIN 394
A Resumé of the Technical Aspects of RCA Theatre Television.....	I. G. MALOFF AND W. A. TOLSON 424

GENERAL

Recent Developments in Television.....	E. W. ENGSTROM 431
The Progress of Television, 1938-1941.....	A. N. GOLDSMITH 441
The Outlook for Television—1941.....	A. F. VAN DYCK 448

SUMMARIES

New Television Amplifier Receiving Tubes.....	A. P. KAUZMANN 453
Simple Television Antennas.....	P. S. CARTER 453
Transatlantic Reception of London Television Signals..	D. R. GODDARD 454
Simplified Television I-F Systems.....	G. MOUNTJOY 455
Television Lighting.....	W. C. EDDY 455
Low Cost Television Receiver.....	D. E. FOSTER AND G. MOUNTJOY 456
Picture Signal Analyzer.....	H. B. DEAL 457
Field-Strength Survey, 52.75 Megacycles from Empire State Building.....	G. S. WICKIZER 457
Field Strength Measuring Equipment at 500 Megacycles..	R. W. GEORGE 457
RCA-NBC Television Presents a Political Convention as First Long-Distance Pickup.....	O. B. HANSON 458
Cascade Amplifiers with Maximal Flatness.....	V. D. LANDON 458
A Method and Equipment for Checking Television Scanning Linearity.....	V. J. DUKE 459
A Simplified Television System for Radio Amateurs and Experimenters (with <i>Bibliography</i>).....	L. C. WALLER AND P. A. RICHARDS 459

APPENDIX

TELEVISION, Volume I (1936)—Summaries	461
TELEVISION, Volume II (1937)—Summaries	473

TELEVISION, Vol. III

INTRODUCTION

AS television advances from experimentation and theory to practical reality, it becomes increasingly evident that it involves problems of extraordinarily complicated nature.

Television is many things—an art, an industry, and a service, all based upon science. To imitate, by any means whatsoever, the functions of the human eye and ear and to duplicate these functions by electronic means is certainly the function of an art based upon science at its best. To provide, in quantity, the equipment for such reproductions of human vision and hearing, so that many may share its benefits simultaneously, is certainly the activity of an industry that will stand beside the more basic industries which today form an integral part of our national life. And finally, to offer to individuals and to commercial and government organizations the broadcasting facilities, application techniques, program and other material for widespread use of this new medium is to render a public service of the highest order.

Each of the many broad facets of television has its multiple and particular technical facets. All of the research and engineering organizations of RCA and its various divisions and subsidiary companies are concerned with television. In the broad fields of physics, chemistry, radio and electronics, and within these fields—in mechanics, basic electricity, mathematics, heat, sound, light and optics, and magnetism—men and women, scientists, engineers and executives, find that sooner or later, to a greater or lesser degree, their work deals with television. To some, television is the entire daily problem; to others, television is not the actually assigned problem at all. But often research workers in other fields may come upon the answers to television problems. Again, at times, they may be asked to apply their specialized knowledge and skill to problems associated with television developments. This is true beyond the engineering laboratories, in the Radio Corporation of America as a whole, where television—the industry and the service—at some time touches almost every group.

* * *

As in the case of earlier volumes, the contents of TELEVISION, Volume III reflect the complicated nature and broad scope of television.

The variety of subjects covered shows clearly the extent to which many widely-separated efforts contribute to the solution of the overall problem. If this consolidated record of past developments by RCA engineers provides stimulus for further work, it will have served the purpose for which it is published.

RCA Laboratories
Princeton, N. J.
December 24, 1946

A handwritten signature in cursive script, appearing to read 'C. Bloembergen', written in black ink.

*Executive Vice President in Charge
RCA Laboratories Division*

TELEVISION STUDIO TECHNIC*†

BY

ALBERT W. PROTZMAN

Engineering Department, National Broadcasting Company, Inc.,
New York, N. Y.

Summary—The studio operating technic as practiced in the NBC television studios today is discussed and comparisons are made, where possible, to motion picture technic. Preliminary investigations conducted to derive a television operating technic revealed that both the theater and the motion picture could contribute certain practices.

The problems of lighting, scenic design, background projection, and make-up are discussed, with special emphasis on the difficulties and differences that make television studio practice unique.

An explanation is given of the functioning of a special circuit used in television sound pick-up to aid in the creation of the illusion of close-up and long-shot sound perspective without impracticable amount of microphone movement. The paper concludes with a typical television production routine showing the coördination and timing of personnel and equipment required in producing a television program.

IF ONE were forced to name the first requirement of television operating technic and found himself limited to a single word, that word would undoubtedly be "timing." Accurate timing of devices and split-second movements of cameras are the essentials of television operation. Personnel must function with rigid coördination. Mistakes are costly—they must not happen—there are no second chances.

Why such speed and coördination? Television catches action at the instant of its occurrence. Television does not allow us to shoot one scene today and another tomorrow, to view rushes or resort to the cutting room for editing. Everything must be done as a unit, correct and exact at the time of the "takes"—otherwise, there is no television show.

Now, to discuss some preliminary investigations conducted before production was attempted, and to describe the equipment and technic used in meeting these production requirements. Technical details are deliberately omitted. Wherever possible, we shall compare phases of television operation with their counterparts in motion picture production.

For so new a medium as television it is, of course, an impossibility to present a complete and permanently valid exposition. Television technic and apparatus constantly advance. Some technic now current may be outmoded in a day or a month. We have only to recall the early days of motion picture production, when slow-speed film and

* Decimal Classification: R583.2.

† Reprinted from the *Jour. Soc. Mot. Pic. Eng.*, July, 1939.

inferior lenses were a constant limitation. So, with television, it is already possible to envision more sensitive pick-up tubes that will permit the use of smaller lenses of much shorter focal length, thus eliminating many of today's operating difficulties.

PRODUCTION TECHNIC INVESTIGATIONS

In May, 1935, the Radio Corporation of American released television from its research laboratories for actual field and studio tests. Long before the first program was produced in the middle of 1936, plans were laid, based on extensive research into the established entertainment fields, for the purpose of determining in advance what technics might be adaptable to the new medium of television. From the stage came the formula of continuity of action, an inherent basic requirement of television. This meant memorized lines and long rehearsals. Prompting could not be considered, for, as you know, the sensitive microphone which is as much present in television as it is in sound motion picture production, does not discriminate between dialog and prompting.

From the motion picture studio came many ideas and technics. If television is a combination of pictures with sound, and it is, no matter what viewpoint is taken, the result spells in part and for many types of programs, a motion picture technic at the production end. However, enough has already been said about the peculiarities of television presentation to justify saying that the movie technics do not supply the final answer. There remained the major problem of preserving program continuity without losing too much of motion picture production's flexibility. Our present technic allows no time for adjustments or retakes. Any mistake immediately becomes the property of the audience. The result of the entire investigation led to what we think is at least a partial answer to the problem. This technic, we hope, will assist considerably in bringing television out of the experimental laboratory and into the field of home education and entertainment.

GENERAL LAYOUT OF FACILITIES

In order to present a clearer view of our problems, we shall give a brief description of our operating plant. The present television installation at the National Broadcasting Company's headquarters in the RCA Building, New York, N. Y., consists of three studios, a technical laboratory, machine and carpenter shops, and a scenic paint shop. Our transmitter is located on the 85th floor of the Empire State Building. The antenna system for both sight and sound is about 1300 feet above the street level. Both the picture and sound signals are

relayed from the Radio City Studios to the video and sound transmitters either by coaxial cable or over a special radio link transmitter.

One of the studios is devoted exclusively to televising motion picture film, another to programs involving live talent, and the third for special effects. It is the operation of the live-talent studio with which we are concerned in this paper.

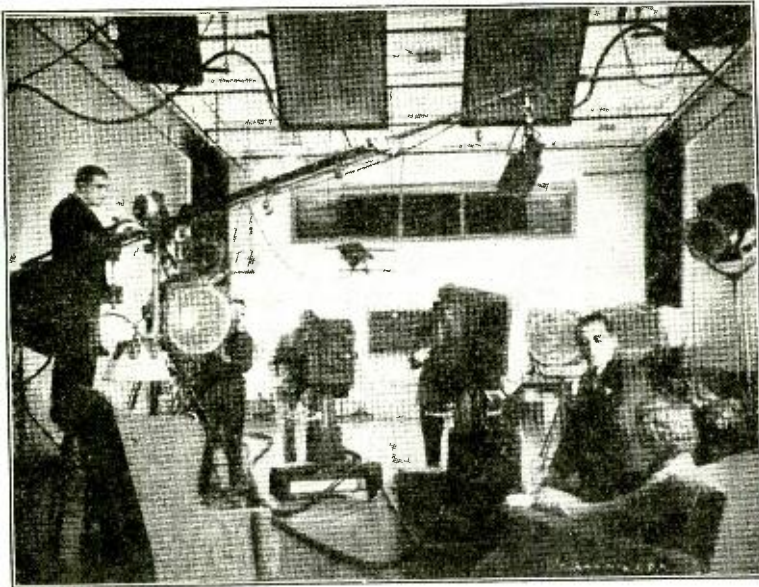

Fig. 1(a)—General layout of live-talent studio; control room at upper rear.

DESCRIPTION OF LIVE-TALENT STUDIO

Figure 1(a) shows the general layout of the live-talent studio. The studio is 30 feet wide, 50 feet long, and 18 feet high. Such a size should not be considered a recommendation as to the desired size and proportions of a television studio. The studio was formerly a regular radio broadcasting studio, not especially designed for television. To anyone familiar with the large sound stages on the motion picture lots, this size may seem small (Figure 1(b)). Yet, in spite of our limited space, some involved multi-set pick-ups have been successfully achieved by careful planning. Sets, or scenes, are usually placed at one end of the studio. Control facilities are located at the opposite end in an elevated booth, affording full view of the studio for the control room staff. Any small sets supplementing the main set are placed along the side walls as near the main set as possible, and in

such position as to minimize camera movement. At all times, we reserve as much of the floor space as possible for camera operations and such floor lights as are absolutely essential. At the base of the walls and also on the ceiling are scattered numerous light-power outlets to minimize the length of lighting cables. At the rear of the studio is a permanent projection room for background projection.

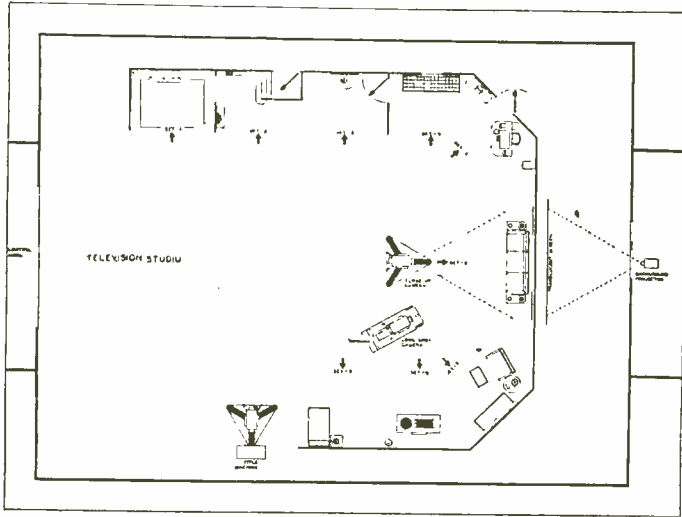

Fig. 1(b)—Television studio floor plan.

CAMERA EQUIPMENT

The studio is at present fitted for three cameras. To each camera is connected a cable. This cable is about two inches in diameter and fifty feet long, it contains 32 conductors including the well known coaxial cable over which the video signal is transmitted to the camera's associated equipment in the control room. The remainder of the conductors carry the necessary scanning voltages and current supplies for the camera amplifiers, interphone system, signal lights, etc. From this description, it is apparent that adding another camera in a television studio involves a much greater problem than that of moving an extra camera into a motion picture studio. In television, it is necessary to add an extra rack of equipment in the control room for each additional camera.

MOVEMENT OF CAMERAS

One camera, usually the long-shot camera using a short-focal length lens, is mounted on a regular motion picture type dolly to

insure stable movements. The handling of the dolly is done by a technician assisting the camera operator. It is impracticable to lay tracks for dolly shots as is often the motion picture practice, because usually each camera must be moved frequently in all directions during the televising of a studio show. Naturally, dolly tracks would limit such movement. The other television cameras utilize a specially de-

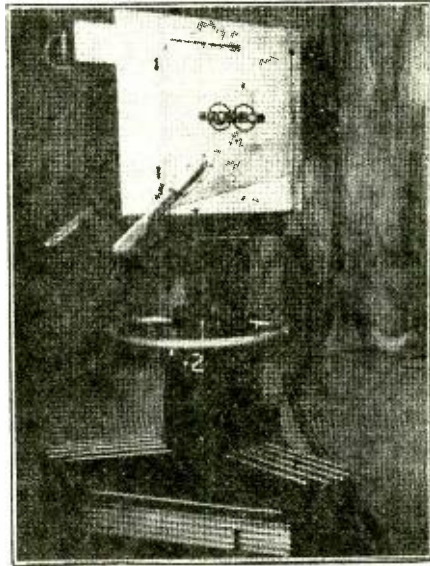

Fig. 2—Studio camera.

signed mobile pedestal (Figure 2). Cameras mounted on these pedestals are very flexible and may be moved in and out of position by the camera operators themselves. Built into the pedestals are motors which elevate or lower the camera; this action is controlled with push-buttons by the camera operators. A panning head, similar to those used for motion picture cameras, is also a part of the pedestal. It is perhaps needless to stress here that one of the strict requirements of a television camera is that it must be silent in operation. In the electronic camera proper there are no moving parts other than those used for focusing adjustments; hence, it is a negligible source of noise. When camera pedestals were first used they were the source of both mechanical noise and electrical disturbance when the camera-elevating motor was in use. Since then this problem has been overcome, and it can be stated that the entire camera unit is now free of objectionable mechanical noise or electrical surges.

LENS COMPLEMENT

Each camera is equipped with an assembly of two identical lenses displaced 6 inches vertically. The upper lens focuses the image of the scene on a ground-glass which is viewed by the camera operator. The lower lens focuses the image on the "mosaic," the Iconoscope's light-sensitive plate. This plate has for its movie counterpart the film in a motion picture camera. The lens housings are demountable and interchangeable. Lenses with focal lengths from 6½ to 18 inches are used at present. Lenses of shorter focal length or wider angle of pick-up can not be used since the distance between the mosaic and the glass envelope of the Iconoscope is approximately 6 inches. Lens changes can not be effected as fast as on a motion picture camera, since a turret arrangement for the lenses is mechanically impracticable at present. However, it is probably safe to say that future advances in camera and Iconoscope design will incorporate some type of lens turret. Ordinarily, one camera utilizes a 6½-inch focal length lens with a 36-degree angle, for long shots, while the others use lenses of longer focal lengths for close-up shots. Due to its large aperture, the optical system used at present has considerably less depth of focus than those used in motion pictures, making it essential for camera operators to follow focus continuously and with the greatest care. This limitation will probably be of short duration, since more sensitive Iconoscopes will permit the use of optical systems of far greater depths of focus.

It is desirable here to point out a difference in focusing technic between motion picture cameras and television cameras. "Follow-focus" in motion pictures occurs practically only in making dolly shots. For all fixed shots, the lens focus is set, the depth of focus being sufficient to carry the action. Also, it is the duty of the assistant cameraman to do the focusing. This relieves the cameraman of that responsibility and allows him to concentrate on composition, action, and lighting. In television, the camera operator must do the focusing for fixed shots and dolly shots alike. This added operation, at times, is quite fatiguing.

Vertical parallax between the view finder lens and the Iconoscope lens is compensated for by a specially designed framing device at the ground-glass that works automatically in conjunction with the lens-focusing control. It may be of interest to note here that at first the television camera had no framing device. This meant that images, in addition to being inverted as they are in an ordinary view-finder, were also out of frame. The camera operator had to use his judgment in correcting the parallax. With this new framing device, the operator

now knows exactly the composition of the picture being focused on the mosaic in his camera. The framing device can be quickly adjusted to accommodate any lens between 6½ and 18 inches focal length.

Because of the fact that several cameras are often trained on the same scene from various angles, and because all cameras are silent in operation, performers must be informed sometimes—such as when they are speaking directly to the television audience—which camera is active at the moment. Two large green bull's-eye signal-lamps



Fig. 3—Typical television set.

mounted below the lens assembly are lighted when the particular camera is switched "on the air."

SET LIGHTING

There are two outstanding differences between television lighting and motion picture lighting. A much greater amount of key light is required in television than in motion pictures. Also, a television set must be lighted in such a way that all the camera angles are anticipated and properly lighted at one time. Floor light is held to a minimum to conserve space in assuring maximum flexibility and speed of camera movements. Great care must also be taken to shield stray light from all camera lenses. This task is not always easy, since, during a half-hour performance, each camera may make as many as twenty

different shots. Just as excessive leak-light striking the lens will ruin motion picture film, it has a definitely injurious effect upon the photo-sensitive mosaic and upon the electrical characteristics of the Iconoscope. A direct beam of high-intensity light may temporarily paralyze a tube, thus rendering it useless for the moment.

SETS

Television sets (Figure 3) are usually painted in shades of gray. Since television reproduction is in black and white, color in sets is

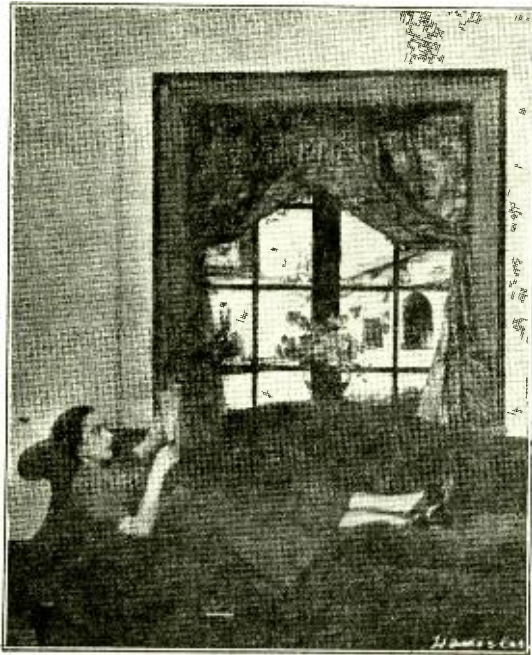

Fig. 4—Background projection window shot.

relatively unimportant. Chalky whites are generally avoided because it is not always possible to keep "hot lights" from these highly reflective surfaces which cause a "bloom" in the picture. This, in turn, limits the contrast range of the system. Due to the fact that the resolution of the all-electronic system is quite high, television sets must be rendered in considerable detail, much more, in fact, than for a corresponding stage production. As in motion picture production, general construction must be as real and genuine as possible; a marked difference, for instance, can be detected between a painted door and a real door. On the legitimate stage, a canvas door may be painted with fixed highlights; that is, a fixed perspective, because the lighting

remains practically constant, and the viewing angle is approximately the same from any point in the audience. But, in television the perspective changes from one camera shot to another. Painted perspectives would therefore be out of harmony with a realistic appearance. This is also true in motion picture work. Sets must also be designed so that they can be struck quickly with a minimum effort and noise because it is often necessary to change scenes in one part of a studio while the show is going on in another part. At present, we find it desirable to construct television sets in portable and lightweight sections without sacrificing sturdiness.

BACKGROUND PROJECTION

The problems of background projection in television differ somewhat from those encountered in motion pictures. More light is necessary because of the proportionately greater incident light used on the sets proper (Figure 4).

Considering the center of a rear-screen projection as zero angle, we must make it possible to make television shots within angles of at least 20 degrees on either side of zero without appreciable loss of picture brightness. This requirement calls for the use of a special screen having a broader viewing angle than those used in making motion picture process shots. Also, in motion pictures, the size of the picture on the screen can be varied to the proper relation to the foreground for long shots or close-ups. For television, the background picture size can not be changed once the program starts. Our background subject matter must also be sharp in detail and high in contrast for good results.

At present, only glass slides are used. A self-circulating water-cell is used to absorb some of the radiant heat from the high-intensity arc. Also both sides of the slide are air-cooled. These precautions permit the use of slides for approximately 30-minute periods without damage.

MAKE-UP

This may be a suitable time to correct some erroneous impressions concerning the type of make-up used in television. It has never been necessary to use gruesome make-up for the modern all-electronic-RCA television system. At present, No. 26 panchromatic base, similar to that used for panchromatic film, and dark red lipstick is being used satisfactorily. From the very beginning, we have made tests to determine the proper color and shades of make-up, keeping in mind that a color closely approximating the pigmentation of the human skin is most desirable from the actor's psychological standpoint.

THE CONTROL ROOM

Now, a few words about the operations in the studio control room during a televised production (Figure 5). All camera operators in the studio wear head-phones through which they receive instructions from the control room. Directions are relayed over this circuit by the video engineer or the production director. Here the televised images are observed on special Kinescope monitors and necessary electrical adjustments are made. Alongside each of these monitoring



Fig. 5—The television control room. Note the two Kinescope monitors in the upper left corner.

Kinescopes is a cathode-ray oscilloscope which shows the electrical equivalent of the actual picture. Two monitors are provided in order that one may be reserved for the picture that is actually on the air, while the other shows the succeeding shot as picked up by a second or third camera. This enables the video engineer to make any necessary electrical adjustments before a picture goes on the air.

Seated immediately to the left of the video engineer is the production director whose responsibility corresponds to that of the director of a motion picture. He selects the shots and gives necessary cues to the video engineer for switching any of the cameras into the outgoing channel. The production director has, of course, previously

rehearsed the performance and set camera routines in conjunction with the camera operators and the engineering staff. The camera operator has no control to switch his camera on the air. All camera switches, which are instantaneous, are made by electrical relays controlled by buttons in the control room. At present, the video engineer's counterpart in motion picture work is the editor and the film processing laboratory.

To the left of the production director sits the audio control engineer whose responsibility is entirely separate from that of the video engineer. He also is in a position to view the monitor, and may communicate by telephone with the engineer on the microphone boom. The audio engineer is responsible for sound effects, some of which are dubbed in from records. His job is somewhat similar to that of the head sound engineer on a motion picture production. Thus, we have the control room staff—three men who have final responsibility for the success of the completed show.

An assistant production man is also required on the studio floor. Wearing headphones on a long extension cord, he is able to move to any part of the studio while still maintaining contact with the production director in the control room during a performance on the air. Actors require starting cues, titles require proper timing, and properties and even an occasional piece of scenery must be moved. The assistant director supervises these operations and sees that the instructions of the production director are properly carried out.

Members of the studio personnel also to be mentioned include lighting technicians, the property man, and scene shifters, whose responsibilities parallel those of their motion picture counterparts. Specially trained men are also needed for operating title machines. In the future all titling will undoubtedly be done in a separate studio inasmuch as operating space in a television studio is at a premium. Today, however, title machines do operate in the studio and require the utmost care in handling. Types of titles used include dissolves and wipes similar to those used in moving pictures.

SOUND REPRODUCTION

As in motion picture work, a microphone boom is used in television production, and is operated in a similar way. Perspective in motion picture sound is accomplished by keeping the microphone, during a long shot, just out of the picture and moving it down closer to the action as the camera moves in for a close-up, thus simulating a natural change in perspective. In television this is not always possible because there are always three cameras to consider. This same condition pre-

vailed in the early days of motion pictures when it was thought desirable to take a complete scene, shooting both long-shot and close-up cameras, at one time. In the television studio at least one camera is always set for a long shot while the others are in position for closer shots. If the microphone is placed in such a position as to afford a "natural" perspective for close-ups, the succeeding switch to a long shot would reveal the microphone in the shot. You in motion pictures can order a retake; in television broadcasting we can not rectify the mistake. It is quite obvious, therefore, that the man on the boom can not lower his microphone to the "natural" position for each camera shot. We therefore place the microphone in a position just out of range of the long shot. In order to accomplish some sense of perspective between long and close-up shots, a variable equalizer that drops the high and low ends of the spectrum is automatically cut into the audio circuits when the long-shot camera is on the air. In this operation, sufficient change in quality and level is introduced to aid the illusion of long-shot sound perspective. Of course, when a close-up camera is switched in, the audio returns to the close-up perspective quality once more. This may be called remote control sound perspective.

Special sound effects, music, etc., from the studio picked up from recordings are mixed in the control room. In motion pictures, some of the effects and most of the music are dubbed in after the actual shooting of the scene.

The general acoustical problems in a television studio are similar to those in a motion picture sound-stage. Walls and ceiling should be designed for maximum absorption to permit faithful exterior speech pick-up. A stage or studio must be designed to enable presentation of an exterior or an interior scene. With the studio designed for maximum absorption, illusions of exterior sound characteristics can be created. For interiors, the hard surfaces of the sets and props offer sufficiently reflective surfaces to create the indoor effect.

TYPICAL PRODUCTION ROUTINE

After the foregoing discussion of the equipment and personnel, it may be interesting to follow an actual production from the beginning of rehearsal to its final presentation. For this example, assume that we are to produce a playlet (Figure 6). When the scenery has been erected, the first rehearsals begin without the use of cameras or lights. Besides familiarizing the actors with their lines, the rehearsals afford the production director and the head camera operator an opportunity to map out the action of the play. All action, including camera shots.

cues, and timing, is noted on a master script which thereafter becomes the "bible" of the production. Timing is very important because of the necessity of having a particular act time in with the other acts or film subject.

After several hours of rehearsing, the first equipment rehearsal is called. Cameras are checked electrically and mechanically. Focus controls and framing devices are lined up so that correct focus on the ground-glass is also correct focus on the mosaic plate. This completed, the cameras are ready for rehearsal. With the scene properly lighted, the camera operators begin working out movements to pick up the



Fig. 6—(Left) Scene on the air. (Right) setting up for next scene.

desired shots in the proper sequence. The production director instructs the staff and personnel from the control room, speaking over a public-address system. Each shot is worked out and its camera location marked on the floor. At times, the actors may unconsciously depart slightly from the rehearsed routine during an actual show; the camera operator must be prepared and alert to make the best of the situation regardless of all previous floor markings. Continuity is so planned that while one camera is taking the action, another camera is moving to a new location and composing a new shot to be switched on at the proper time. This frees the first camera, which can now move to a third location, and so on. Sometimes during a twenty-minute per-

formance each camera may take twenty different shots. Of course, besides different floor locations, the height and angle of the cameras must be varied to comply with good composition. During rehearsals, timing must frequently be revised to allow for the actual camera movements.

Finally, a dress rehearsal is scheduled. The complete program is televised, including any film subjects or slides that may be needed to complete the program. Frequently the program will begin with a short film leader, followed immediately by a newsreel or a short subject, the film portion of the program coming from the film-televising studio. While the film is running, the live-talent studio is continuously warned as to the time remaining before it must take over the program. Once the studio program goes on the air the production director is no longer able to use the public address system to communicate with the personnel in the studio. Instead, he uses a telephone circuit to his assistant in the studio, and, through the video engineer, communicates by phone with the camera operators.

Another standby warning is usually given when there is one minute to go. Then, as the cue to begin comes, the green light on the title camera is lighted. From this point, continuity must be rigidly preserved. As titles move from one to another, appropriate music is cued in and actors are sent to their opening positions.

With the completion of titles, the image is faded out electrically and cameras are switched to the opening shot. Performers begin their action on a silent cue from the assistant director, who is instructed from the control room. During this first scene, the camera previously picking up titles moves quickly into position to shoot a second view of the action. Again cameras are switched, permitting the first to move to a new position; and so the action proceeds. If the play has several scenes, the concluding shot of the first scene is taken by one camera while others line up on the new scene and wait for the switch. Frequently, there are outdoor scenes. These are filmed during the first stages of rehearsal for transmission from the film studio at the proper time during the performance. The switch to film is handled exactly as another camera switch, except that the switch is to the film studio instead of to one of the studio cameras. The projectionist must be warned in advance to have his projector up to speed and "on the air" at the proper instant to preserve the production continuity. This requires very critical timing, as you can well appreciate. When the film is completed the studio cameras again take over the next interior scene.

Upon completion of the studio portion of the program, one camera lines up on the final studio title, which usually returns the program to the film studio for a concluding film subject.

Since the first program on July 7, 1936, many television programs have been produced. Each has been a serious attempt at something new. Although much has been accomplished, there remain a vast number of unknowns to be answered before it can be said that television's potentialities have been even partially realized. Today, as this paper has indicated, television bears many points of similarity to motion pictures. As a matter of fact, it is likely that television would be somewhat handicapped if it were unable to borrow heavily from a motion picture production technic that has been built up by capable minds and at great expense over a period of many years. Infant television is indeed fortunate to have such a wealth of information at its disposal. Possibly continued experimentation will lead us toward a new technic distinctive of television. During its early years, however, television must borrow from all in creating for itself a book of rules. The first chapter of that book is scarcely written.

APPLICATION OF MOTION-PICTURE FILM TO TELEVISION*†

BY

E. W. ENGSTROM,# G. L. BEERS,‡ AND A. V. BEDFORD#

Research Department, RCA Manufacturing Company, Inc.,
Camden, N. J.

Summary—Motion-picture film will form an important source of programs for television broadcasting. Film projectors for this use are required to meet a number of conditions peculiar to television. Methods for projecting and utilizing motion-picture film are outlined. A specific film projector and associated television channel are described in some detail.

In establishing a technique for producing films most suitable for television, equipment is needed to interpret the final results. Apparatus that will be used by broadcasting stations is described. A simpler system has been designed that may be useful for the specialized service of gaging the merit of films for television. This is described and its operation indicated.

Some very preliminary observations are included on the characteristics of films that have given good results in experimental work and in field tests.

THE production and utilization of motion-picture film for television programs introduces many new problems. It is the purpose of this paper to review these problems and to describe methods and apparatus for the use of film in television.

GENERAL DISCUSSION OF UTILIZATION METHODS

It is desirable first to review the general characteristics of two electronic television pickup systems, which are known to give practical results. In both systems the scene to be transmitted is projected upon a photo-emissive area or mosaic. The resulting "electrical image" is methodically explored by electronic means, one narrow strip or line at a time, in a process called scanning. The result of this scanning process is an electrical signal which varies in accordance with the scene brightness along the scanning lines. The information residing in this signal is used at the receiver to reconstruct the image—one element at a time—in a similar synchronized scanning process.

In one pickup system, exemplified by equipment using the Farnsworth dissector tube, only the light falling upon an element of the photo-emissive area at the instant that element is being scanned is effective in producing the signal. The other pickup system, exemplified by equipment using the Iconoscope, makes use of the principle of storage, whereby, when a particular photo-emissive element is scanned the light which has fallen upon that element since it was last scanned is effective in producing the signal.

* Decimal Classification: R583 X R582.

† Reprinted from the *Jour. Soc. Mot. Pic. Eng.*, July, 1939.

Now Vice President in charge of Research and research engineer respectively with RCA Laboratories Division, Princeton, N. J.

‡ Now Asst. Director of Engineering in charge of Advanced Development with RCA Victor Division, Camden, N. J.

at 30 frames per second and 60 fields per second, interlaced. ¹The projector must flash a still picture upon the mosaic every 1/60 second with each flash lasting less than 1/600 second. Since the film must run at a mean speed of 24 frames per second for proper reproduction of sound and motion, it is evident that each frame must be projected more than once to provide the required sixty flashes per second. Since sixty divided by 24 is 2½, it would seem logical that each frame should be projected two and one-half times. This is impracticable, but a very satisfactory method is to project alternate frames of film two and three times each, respectively; for example, the even frames twice and the odd frames three times. Figure 2 shows the various steps of projection and scanning in proper relative time on a horizontal time scale. Since the light flashes are very brief, a relatively long (approximately 1/67 second) interval is available between flashes for

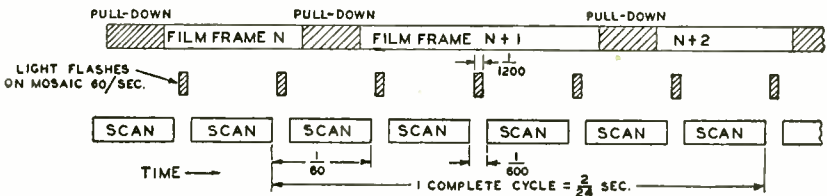

Fig. 2—Preferred sequence of events in film transmission by Iconoscope.

the film pull-down. However, if the full time available is used, the alternate pull-downs must occur at non-uniform intervals of 2/60 and 3/60 seconds, respectively. Note from this figure that the scanning or transmission times occur *between* adjacent light flashes so that the television picture signal is actually produced and transmitted during periods when no optical image is present on the mosaic. However, during these periods an electrical image is present in the form of bound electrostatic charges on the tiny photo-sensitized silver globules comprising the mosaic. It is the act of neutralizing or rather equalizing these charges by the electrons of the scanning beam which causes the useful signal current to flow from the conducting back coating of the mosaic plate.

Referring again to Figure 1, the film is drawn through an illuminated gate by an intermittent sprocket which is driven by an intermittent cam and spider-follower of the early Powers type. The

¹G. L. Beers, E. W. Engstrom, and I. G. Maloff, "Some Television Problems from the Motion Picture Standpoint", *Jour. Soc. Mot. Pic. Eng.*, Vol. XXXII, pp. 121-136, February, 1939.

3600-r.p.m. special synchronous motor drives the cam at 12 revolutions per second through a suitable gear, thus pulling the film down 24 times per second, since the cam has two "throws" instead of the customary one "throw." In order to pull the film at unequal intervals as required, the "throws" are located 144 degrees and 216 degrees apart, respectively. The film picture in the gate is projected upon the small photo-emissive mosaic of the Iconoscope by a standard projection lens. The light is chopped 60 times per second by a large rotating shutter, located near the lens. The shutter is accurately timed relative to the intermittent cam so that the film is always stationary when the light flashes occur.

The generator of synchronizing signals for the television deflecting system is synchronously controlled by the same 60-cycle power supply which drives the projector synchronous motor. The phase of this signal generator is adjustable so that the operator can make the short duration light flashes fall safely within the 1/600-second intervals between the vertical scanning periods with some tolerance on each side for slight phase displacements such as are caused by small changes in the mechanical load on the projector or by voltage variations. This adjustment is very important, as any abrupt change in the illumination of the mosaic during the picture signal transmission time produces a spurious light streak across the received picture.

An ordinary 3600-r.p.m. synchronous motor has two identical pole structures which can assume either polarity and hence such a motor can lock into synchronism in either of two phase positions, depending fortuitously upon starting conditions. Two such lock-in positions are one-half of a cycle of the power-supply frequency apart in time, which for a 60-cycle power system is 1/120 second. Inspection of the diagram of Figure 2 shows that displacing the light flashes 1/120 second with respect to the scanning periods would cause them to occur during instead of between the scanning periods. The abrupt change in mosaic lighting caused by a flash during the scanning period would produce a serious streak across the middle of the picture as mentioned above. To prevent the frequent locking-in of the motor in the wrong position, a special synchronous motor is used which includes an additional d-c winding for fixing the polarity of the poles and thus determining the lock-in position with respect to the a-c power supply.

The sound head used is standard, since the mean speed of the film is 24 frames per second. It has been found that a suitable fly-wheel associated with the intermittent cam prevents any detectable deterioration of the reproduced sound due to the dissymmetry of the intermittent cam.

DESCRIPTION OF FILM PROJECTOR

It is of interest to return now to the method for using film which is considered best at present, and review the apparatus in more detail.

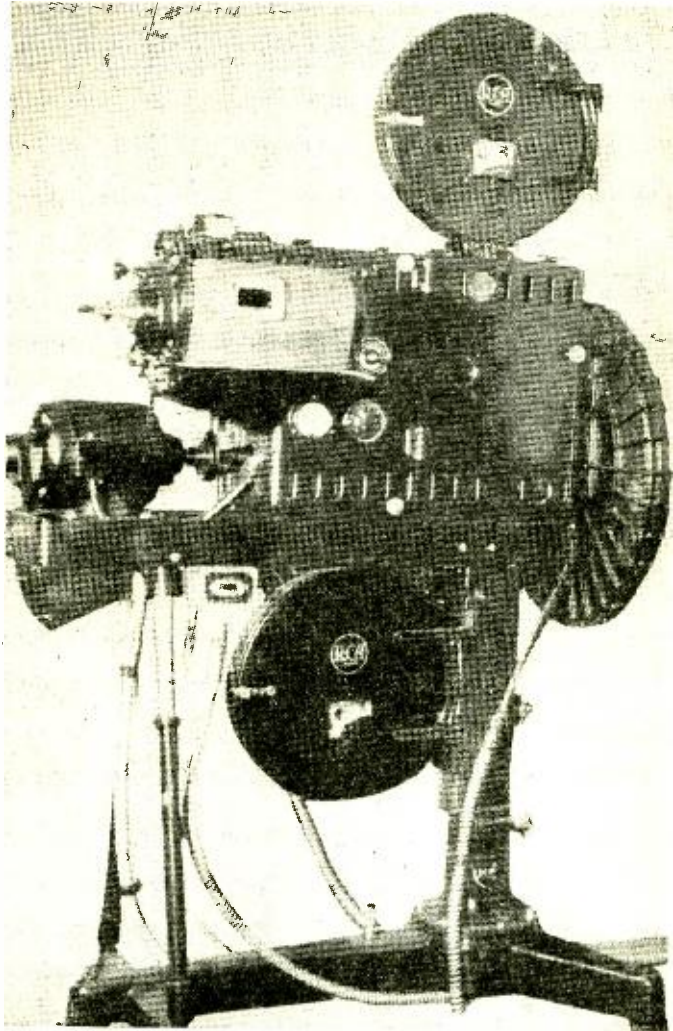

Fig. 5—RCA 35-mm sound motion-picture projector designed for 30-frame-per-second television with interlaced scanning.

Figure 5 is a general view of a 35-mm sound motion-picture projector* designed for 30-frame-per-second television with interlaced scanning.

* This projector was built to RCA specifications by International Projector Corp.

This projector differs from standard theater projectors in the following major respects:

1. A special shutter is used to provide efficient light pulses of very short time duration for projecting, 60 times per second, images of the film pictures onto the photo-emissive mosaic of the Iconoscope.

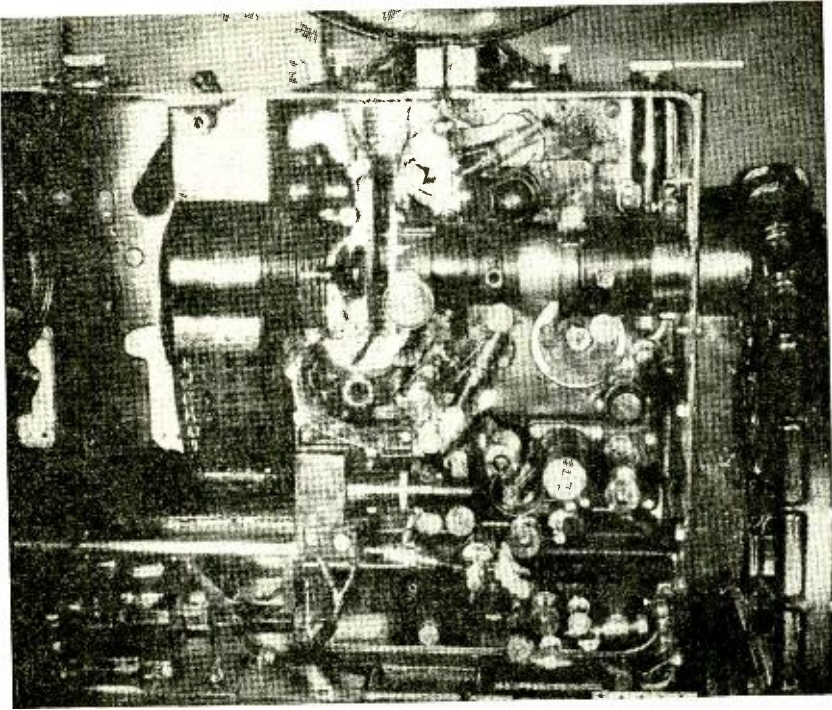

Fig. 6—Film projector for television with doors open.

2. The intermittent mechanism is designed for the three-to-two ratio of pull-down periods required in using 24-frame film for 30-frame television.
3. A special synchronous driving motor is used to assure that the projector mechanism always "locks-in" in proper time relation with the synchronizing pulses.
4. An additional film gate with light source and photo-electric cell is included near the picture gate for deriving a control potential which varies with the average density of the film.

In the projector shown in Figure 5, it was impracticable to locate the shutter between the light source and the film. The shutter was,

therefore, mounted just beyond the projection lens. Sufficient clearance between the shutter and lens was provided to permit a limited movement of the lens for focusing. The time during which the image may be projected onto the photo-emissive mosaic of the Iconoscope is limited to the vertical return time of the scanning beam. With present television standards this is not more than 10 per cent of 1/60 second or 1/600 second.

In order to make efficient use of the projection lens, it is necessary for the aperture in the shutter to be at least as wide as the diameter of the lens. A large diameter shutter (23") is necessary to meet this requirement. This shutter rotates at 3600 r.p.m. and has a peripheral speed of approximately $4\frac{1}{4}$ miles per minute. The shutter is enclosed in the circular housing which is shown at the extreme right-hand side of Figure 5. In the shutter housing opposite the projection lens is a window through which the picture is projected. The shutter disc is made of two overlapping sections of thin metal. These two sections can be rotated with respect to each other through a small angle in order to vary the width of the aperture. Figure 6 is a photograph showing the film side of the projector with the cover removed.

A second gate is located four frames of film above the picture gate. To the left of this gate, as shown in Figure 6, is a lamp housing. To the right of this gate is a photocell housing which also includes an optical system for forming an image of the lamp filament on the photocell. The output voltage from this photocell is rectified, and after being passed through a suitable filter is used to control the return-line blanking signals. The resultant variation in the blanking signals is used to control the average brightness of the reproduced picture. Figure 7 shows a view of the film side of the projector with a film threaded ready for projection.

Although the projector just described is equipped with a small 30-ampere arc, either an incandescent lamp or an arc may be used.

EQUIPMENT FOR BROADCASTING TELEVISION FILM PROGRAMS

In considering the production of motion-picture films for television, it is important to review the apparatus that will be used in the broadcasting station. The essential elements of a system for television transmission from motion-picture film are shown in Figure 8. These include: Film Projector; Iconoscope Film Camera; Camera Amplifier Equipment; Control Equipment; Monitor Equipment; Synchronizing Generator.

The Iconoscope camera used with the film projector includes deflecting circuits and a pre-amplifier for the video signals. This pre-amplifier provides a signal level suitable for transmission over a coaxial

cable to the camera amplifier equipment. The camera is usually mounted on one side of a wall, with the film projector located on the other side. The picture is projected through a window in the wall into the camera onto the photo-emissive mosaic of the Iconoscope.

The camera amplifier equipment includes apparatus for amplifying further the video signals from the camera and a line amplifier to

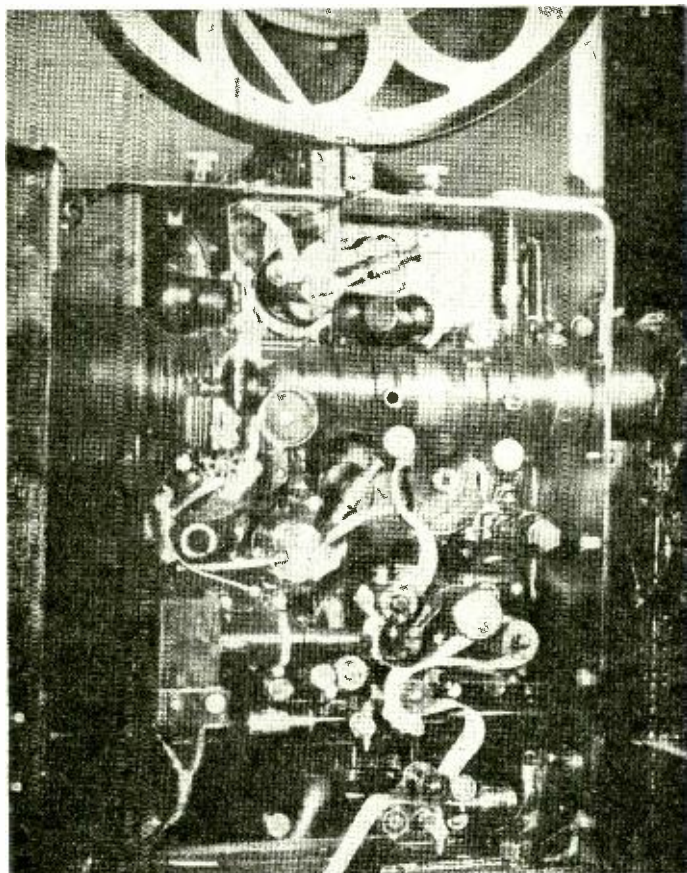

Fig. 7—View of film projector for television showing film path.

prepare these signals for transmission over coaxial cable to any desired location. Amplifiers providing suitable wave shapes for horizontal and vertical deflection of the Iconoscope beam are included as well as the power supplies for the several parts of the system. This equipment is usually rack-mounted in some convenient location.

The control equipment provides means for varying the video signal gain, the picture brightness, and the uniformity of the picture-background illumination (shading), and for starting and stopping the

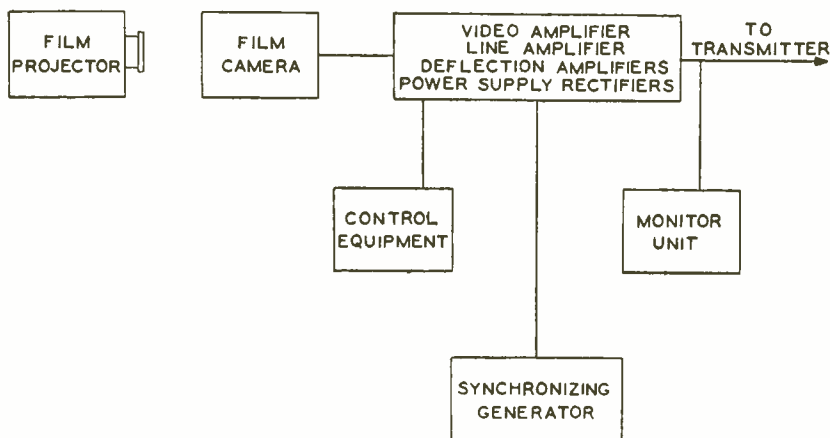

Fig. 8—System for television transmission from motion-picture film.

film projector. In an installation designed to provide a continuous program from motion picture film, where two or more film projectors and television channels are included, controls are also provided for switching from one channel to another.

The monitor equipment includes a 12" Kinescope by means of which television images obtained from the film can be viewed. It also includes a cathode-ray oscilloscope for observing the wave shapes

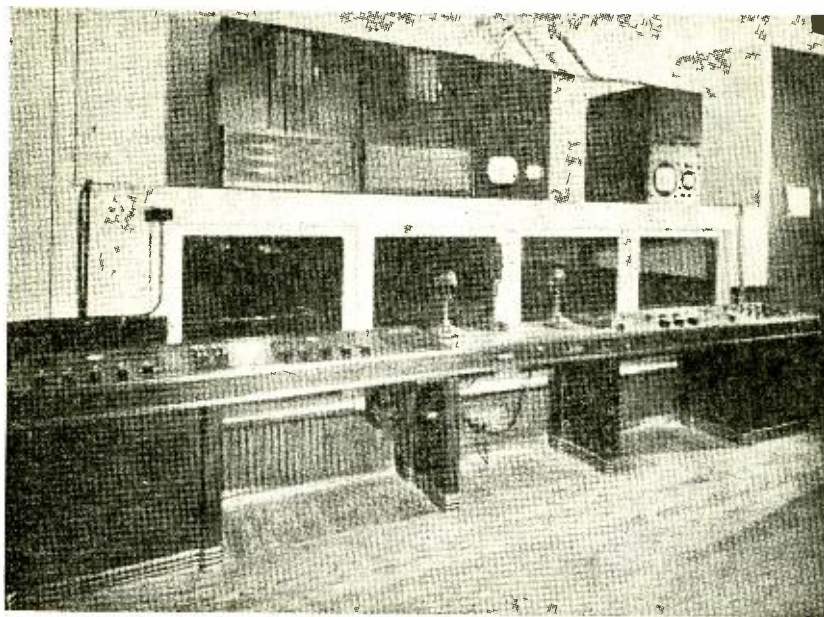

Fig. 9—Television control equipment for studio and film-type cameras.

and amplitudes of the television signals. This monitor equipment is usually located so that it may be observed conveniently by the operator manipulating the control apparatus.

The synchronizing generator supplies the several complex waveforms which are required to determine the timing of scanning processes in the transmitting equipment and to synchronize the reconstruction of the images at the receivers. The wave shapes of the synchronizing signals have been standardized by the Radio Manufacturers Association.

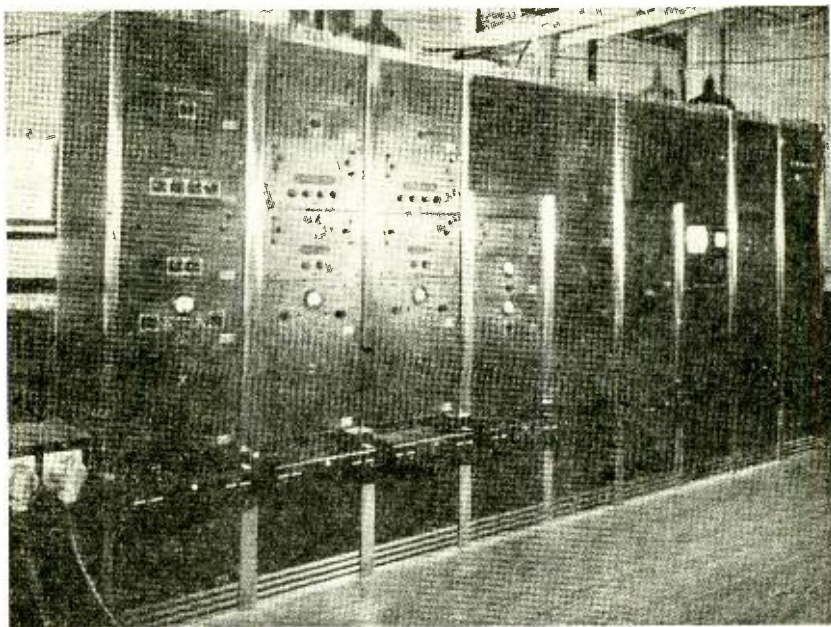

Fig. 10—Television terminal equipment suitable for television broadcasting stations.

Views of television equipment of a type suitable for television broadcasting stations are shown in Figures 9 and 10. Figure 9 shows an installation of control equipment for studio and film type cameras. This equipment is grouped on a common control console with the monitors mounted in a recess in the wall above the console. In this installation, the control engineer may look directly into the studio. Figure 10 shows a typical installation of racks of television-terminal equipment.

SIMPLIFIED TELEVISION APPARATUS

For specialized services, more simple and compact television equipment is desirable. Apparatus of this sort has been developed both for

direct studio pickup and for film applications. The simplified equipment suitable for producing television signals and television images from motion-picture film includes all of the elements previously described, but in far more compact form. The equipment less the Iconoscope camera and the projector is included in one cabinet approximately 44 inches high, 34 inches wide, and 21 inches deep. This equipment produces a television signal which is suitable for transmission to remote viewing positions or for other uses.

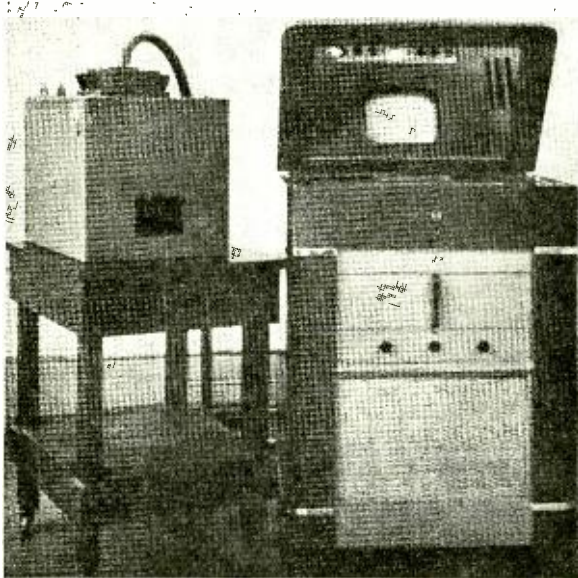

Fig. 11—Simplified television apparatus suitable for judging the merits of motion-picture film.

This simplified equipment is not as flexible in some respects as the broadcasting type of equipment, nor does it lend itself well to large complex systems. However, it does provide the facilities necessary for judging the merits of film for television use. In this simplification of apparatus and circuits, the synchronizing wave shapes do not conform entirely to the Radio Manufacturers Association standards. The synchronizing signals are, however, satisfactory for the self-contained monitor and for other receivers or reproducing devices, but the adjustments may be a little more critical than would be the case with standard synchronizing signals. Figure 11 shows a view of the equipment with the Iconoscope camera mounted on a simple wooden dolly.

APPARATUS FOR JUDGING THE MERITS OF MOTION PICTURE
FILM FOR TELEVISION

An earlier paper* reviewed some of the limitations inherent in present-day television and compared these with similar limitations in motion-picture film and apparatus. Experience has indicated that the production of television pictures from a particular film is the only practical method for judging the merits of that film as television program material. It is, therefore, suggested that this method be used for checking and studying motion-picture films produced for television programs and for determining the usefulness of film available from other sources. Apparatus of the type used at the television-broadcasting station or apparatus of the simplified type just described will be satisfactory for this service.

FILM BEST SUITED FOR TELEVISION

Laboratory work and field-test experience permits some preliminary generalizations on film that has given good results for television. Comment is here directed to the technical characteristics of film and not to the entertainment qualities. It appears that film having characteristics best suited for theater projection is also generally best for television. Studio sets having all dark backgrounds should be avoided. A goodly number of close-ups should be used, but these should be generously interspersed with long shots. Some experience may be necessary to take into account the resolution limits* of present-day television. Special processing of film does not seem to be necessary.

Film photographed in color directly from real life or nature appears satisfactory for television. Some cartoons in color have not given particularly satisfactory results. Thus, it appears that there may be no really serious technical problems in the production of motion-picture films suitable for television-program material.

THE IMAGE ICONOSCOPE*†

By

HARLEY IAMS,# G. A. MORTON# AND V. K. ZWORYKIN‡

Research Department, RCA Manufacturing Company, Inc.
Camden and Harrison, N. J.

Summary—An iconoscope having increased sensitivity is to be desired for purposes of improving studio conditions, making possible more universal outdoor work, and permitting greater depths of focus. The new tube described obtains its high sensitivity by making use of an electron image of the scene to be transmitted, projected onto a scanned mosaic. The method permits more efficient and better photocathodes, and also secondary-emission image intensification at the mosaic, resulting in a sensitivity 6 to 10 times greater than that of the standard iconoscope operated under the same conditions. The translucent photocathode is made by evaporating silver on a transparent surface, oxidizing, treating with caesium, and evaporating more silver. The electron image may be focused by either electrostatic or magnetic fields. Several types of mosaics are suitable for receiving and storing the electron picture.

THE iconoscope has been in service as a television pickup tube for some time and its capabilities under a wide variety of conditions are well known.^{1,2} Quantitative data on its performance are now sufficiently numerous to be able to state definitely what can be expected from the present standard iconoscope. The conclusion to be drawn from this information is that while the tube is sufficiently sensitive to permit the transmission of an excellent picture from both studio and outdoor scenes, a very real improvement in the quality of the transmitted picture could be had if the sensitivity were increased.

It is found that to obtain an optimum picture with an f/4.5 lens of 7-inch focal length, a surface brightness of from 100 to 200 candles per square foot is desirable. This means, when a reflection coefficient of 0.25 is assumed, that the illumination must be of the order of from

* Decimal Classification: R583.11 × R583.6.

† Presented, Thirteenth Annual Convention, New York, N. Y., June 17, 1938. Reprinted from *Proc. I.R.E.*, September, 1939.

Now with the Research Department, RCA Laboratories Division, Princeton, N. J.

‡ Now Vice President and Technical Consultant, RCA Laboratories Division, Princeton, N. J.

¹ V. K. Zworykin, "Iconoscopes and Kinescopes in Television", *RCA REVIEW*, Vol. I, No. 1, pp. 60-84; July, 1936.

² V. K. Zworykin, G. A. Morton, and L. E. Flory, "Theory and Performance of the Iconoscope", *Proc. I.R.E.*, Vol. 25, pp. 1071-1093; August, 1937.

1000 to 2000 foot-candles. Of course, a picture of high entertainment value can be obtained with less than 10 per cent of this light.

In the studio the amount of light available is at the disposal of the operator, and the required 1000 to 2000 foot-candles is always obtainable. Light of this intensity is not harmful and is far from unbearable; however, it is not comfortable and is accompanied by considerable heat. For comparison it may be stated that the illumination in direct sunlight on a summer day is about 9000 foot-candles.

The operating sensitivity of an iconoscope is directly determined by the depth of focus which is needed. In this, the television pickup tube differs from the photographic camera. For either case, only the diameter of the lens determines the distance which an object can be moved toward or away from the lens without the image being blurred a given percentage of its height. Proof of this statement is as follows.

Referring to Figure 1, the object and image distances are x and

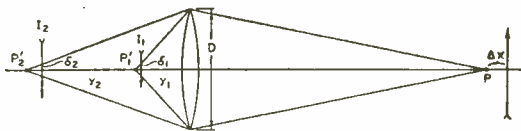

Fig. 1—Depth of focus in the object field.

$$y = \frac{fx}{x - f} \qquad m = \frac{f}{x}$$

$$\frac{dy}{dx} \cong -\frac{f^2}{x^2} \qquad \frac{\delta}{m} = D \frac{\Delta x}{x}$$

$$\delta = -\frac{D}{y} \Delta y = D \frac{f}{x} \frac{\Delta x}{x}$$

y , respectively, and the focal length of the lens f . These quantities are related by the equation

$$y = \frac{fx}{x - f}$$

By differentiation, a change in the object distance Δx is found to produce a change in image distance of

$$\Delta y \cong \frac{-f^2}{x^2} \Delta x.$$

This will produce a circle of diffusion in an image at y of

$$\delta = \frac{D}{y} \Delta y = D \frac{f}{x} \frac{\Delta x}{x}$$

where D is the diameter of the lens, and the object distance is assumed to be large compared with the focal length.

Since the magnification is given by f/x , the quantity to be determined, that is, the circle of diffusion divided by the magnification, can be expressed as follows:

$$\frac{\delta}{m} = D \frac{\Delta x}{x} .$$

indicating that the depth of focus at the object is dependent only upon the lens diameter.

Since the blackening on a photographic plate depends upon the light intensity reaching the plate, it is possible to decrease the size of the picture and the focal length of the lens, keeping the numerical aperture constant, thus increasing the depth of focus without loss of sensitivity. In the case of the iconoscope the signal output depends not only upon the intensity of the light falling upon the mosaic, but also the velocity of the scanning spot across the area. Thus, for a given scanning frequency, the picture signal is proportional to the total light flux rather than the intensity. If, then, the mosaic area and lens focal length are decreased, keeping the aperture constant, there is a resultant loss in sensitivity. The conclusion is that the depth of focus can be obtained only by decreasing the lens diameter and increasing the sensitivity of the tube, irrespective of the numerical aperture of the lens. In other words, it may be said that for a given sensitivity of iconoscope the signal output is approximately inversely proportional to the square of the depth of focus in the object field.

The increased sensitivity required for lower light levels and greater depths of focus can be approached from a number of different directions. Perhaps the first to mention is that of improving the performance of the ordinary iconoscope. Important advances have been made along this line in the past few years, by improving the photosensitivity and the operation of the mosaic.³ Improvements have also been made in the amplifier and coupling circuits which have increased the effective efficiency of the tubes. These advances will undoubtedly continue in

³ Some of the results are described in a companion paper, by R. B. Janes and W. H. Hickok, "Recent Improvements in the Design and Characteristics of the Iconoscope". Presented, Thirteenth Annual Convention, New York, N. Y., June 17, 1938. *Proc. I.R.E.*, this issue, pp. 535-540.

the future, but material improvement becomes increasingly difficult.

A second approach is through the use of the secondary-emission multiplier as a means of amplifying the signal. Work is being carried on along this line and shows definite promise.

Another method is by the use of secondary-emission image intensification, that is, an iconoscope in which an electron image of the object being televised, instead of an ordinary light image, is focused onto the mosaic.

It is interesting to note that this general method of increasing iconoscope sensitivity has been proposed by a number of television workers all over the world. To the writers' personal knowledge, by 1934 various phases of the idea had been advocated by A. V. Bedford, H. A. Iams, G. A. Morton, G. N. Ogloblinsky, A. W. Vance, and V. K. Zworykin. On February 12, 1936, British patent 442,666 was issued to H. G. Lubszynsky and S. Rodda. Various experimental results have been published by Knoll and Schröter;⁴ Iams and Rose;⁵ Zworykin, Morton and Flory;² Nagashima, Shinozaki, Udagawa, and Kizurka;⁶ and a description of the use of such a tube by British Broadcasting Company appeared in *Wireless World*.⁷ This paper is presented for the purpose of giving additional technical information on the subject.

In one practical form the image iconoscope consists of a photoelectric cathode upon which an optical image can be projected, an electron-lens system for focusing the electrons leaving the photocathode onto the mosaic, and an electron gun which scans the mosaic in the ordinary way. This is shown schematically in Figure 2. The photocathode used in this type of tube is semitransparent so that the light image can be projected on the rear surface while the electrons are emitted from the face. The electron-lens system is so arranged that there is a strong field drawing the electrons away from the photocathode, in order that the photoemission may be completely saturated. The electron-lens system, which will be described in detail later, may make use of magnetic or electrostatic lenses or a combination of the two. When an optical image is projected on the photocathode, electrons are emitted from the latter at a rate per unit area proportional to the

⁴ Knoll and Schröter, "Translation of Electron Pictures and Drawings with Insulating and Semiconducting Layers", *Phys. Zeit.*, Vol. 38, pp. 330-333; May 1, 1937.

⁵ Iams and Rose, "Television Pickup Tubes with Cathode-Ray Beam Scanning", *Proc. I.R.E.*, Vol. 25, p. 544; May, 1937; *Proc. I.R.E.*, Vol. 25, pp. 1048-1070; August, 1937.

⁶ Nagashima, Shinozaki, Udagawa, and Kizurka, "The 'Tecoscope' C-R Television Transmitter", *Rep. Rad. Res. (Japan)*, Vol. 7, pp. 12 and 13; June, 1937.

⁷ "Super-Emitron Camera", *Wireless World*, Vol. 41, pp. 497-498; November 18, 1937.

light intensity. Thus, close to the photocathode there is a charge reproduction of the light image. The electrons making up this charge image are accelerated toward the mosaic and focused on it by the electron-lens system. Therefore, there is projected on the mosaic an image made up of high-velocity electrons. The mosaic is made in such a way that for every electron which strikes it, several secondary electrons are emitted. In this way areas which are bombarded become positive with respect to the rest of the surface. The electron image striking the mosaic produces, in consequence, a charge image similar to that produced by the photoelectrons from an optical image on a light-sensitive mosaic. When scanned, this charge image gives rise to the picture signal.

The advantages gained by projecting an electron image upon the mosaic are as follows.

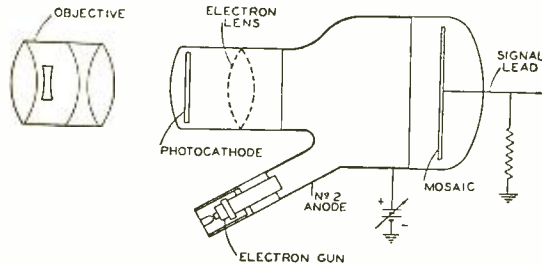

Fig. 2—Schematic diagram of image iconoscope.

First, the photocathode may be improved. By disregarding the shape of the spectral curve it is possible to make semitransparent photocathodes which have a sensitivity between 20 and 50 microamperes per lumen, and this value will probably become still greater as a result of further research on these emitters. This is to be compared with the present maximum of 15 microamperes per lumen for the standard mosaic. Even more important is the fact that a strong field exists at the photocathode, which saturates the emission. When it is remembered that the efficiency of the mosaic as a photocathode is only 20 to 30 per cent due to the unfavorable field condition in an ordinary iconoscope, the advantage of this method as far as the photoelectric emission is concerned is obvious.

Second, the photoelectrons are focused on the mosaic, which has a high secondary-emission ratio. The actual measured ratios for various types of mosaics have values from 3 to 11. However, since there exists on the mosaics of this type of tube the same unfavorable field conditions found in the case of the ordinary iconoscope, the secondary emis-

sion is not saturated. Therefore, only a fraction of the saturated secondary emission is available for producing the charge image. The value of this fraction depends upon the distribution of initial velocities of the substance in question. When there is a large percentage of high-velocity secondary electrons, the fraction of the total secondary-emission ratio available is greater, and for a given ratio both saturated signal output and the sensitivity at low lights is higher. The relation here is very complicated, however, since these same factors influence the behavior of the electrons produced by the beam and, consequently, both the electron redistribution and the potential distribution on the mosaic.

Now that the more important general aspects of the image iconoscope have been considered, there are certain details of its construction that should be more completely outlined.

The photoelectric cathode is one of the most important elements of the tube, and perhaps the most difficult to prepare. One convenient form consists of a glass disk, which may be the end of the tube, upon which is evaporated an extremely thin layer of silver. This silver is oxidized by electrically glowing in it an atmosphere of oxygen at low pressure. Caesium is then admitted and the tube is baked. The final sensitization is done by adding another minute layer of silver. The complete preparation and activation is carried out after the tube has been assembled, exhausted, and the thermionic cathode in the gun activated. This procedure requires the mounting of a source for evaporating silver in the tube in such a way that it does not interfere with the operation of the iconoscope. To meet this requirement the evaporating filament may be mounted in the apertures of the electron lens where it does not interfere with the electron-ray bundle or the field configuration, or it may be made movable so that it can be withdrawn to a position where it does not affect the operation.

The sensitivity of this type of cathode lies between 20 and 50 microamperes per lumen. The value is, in general, somewhat lower when the films are made in such a way as to reduce the ratio of infrared sensitivity to visible response. Even today the technique for making semitransparent films of this type with an emission as high as 50 microamperes per lumen suitable for use in an iconoscope is still being experimentally investigated.

Spectral-sensitivity curves which have been obtained are shown⁸ in

⁸ These spectral sensitivity curves were plotted on the automatic spectral sensitivity curve tracer developed by T. B. Perkins, Research and Engineering Department, RCA Manufacturing Company, Inc., Harrison, N. J. See T. B. Perkins, "An Automatic Spectral Sensitivity Curve Tracer", *Jour. Opt. Soc. Amer.*, June, 1939.

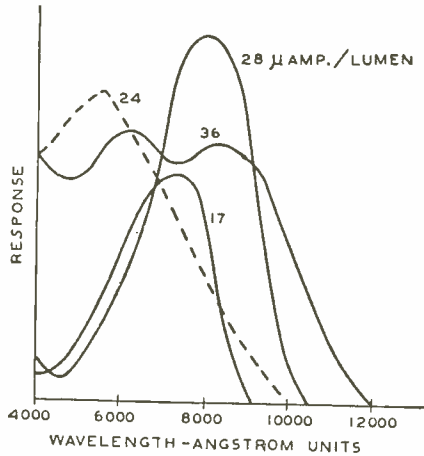

Fig. 3—Spectral response of semitransparent photocathodes.

Figure 3. To a considerable degree, it is possible to control the shape of the spectral curve by controlling the processes.

The electron-optical system for focusing the electron image from the photocathode on the mosaic may make use of either magnetic or electrostatic lenses.

The electrostatic lens system is based primarily upon the field between two coaxial cylinders.^{9,10} It is shown, in its simplest form, in Figure 4, together with the corresponding optical analogue. In the form actually employed the cathode cylinder is divided into a series of

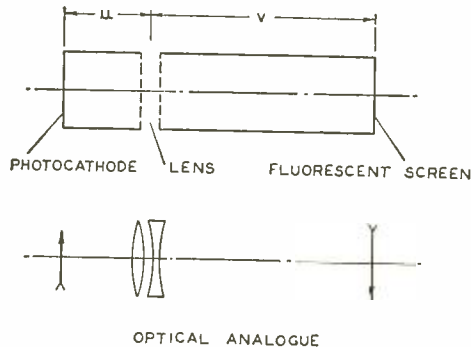

Fig. 4—Diagram of basic electrostatic-lens system.

⁹ V. K. Zworykin and G. A. Morton, "Applied Electron Optics", *Jour. Opt. Soc. Amer.*, Vol. 26, pp. 181-189; April, 1936.

¹⁰ G. A. Morton and E. G. Ramberg, "Electron Optics of an Image Tube", *Physics*, Vol. 7, pp. 451-459; December, 1936.

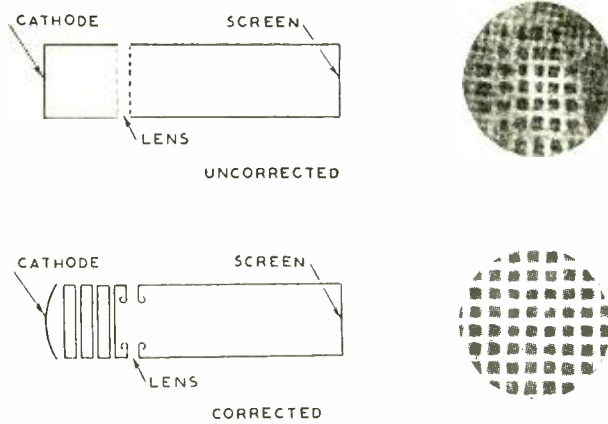

Fig. 5—Corrected and uncorrected electrostatic-lens system.

rings which are connected to successive steps of a voltage divider in order to permit electrical focusing of the image. Furthermore, the cathode is curved to reduce curvature of the image-plane distortion and astigmatism. The appearance of a corrected and an uncorrected image produced by this type of system is shown in Figure 5. The limit of the resolution of a system corrected as described is set by chromatic aberration, that is, the aberration produced by the distribution of axial initial velocities. Without resorting to very elaborate correcting systems, the only way of raising this resolution limit is to use high overall potentials, thus reducing the ratio of initial velocity to working velocity.

Experimentally, it is found that with 1000 volts the resolution corresponds to about 400 lines, while at 3000 volts it is 800 lines or better. In the case of the higher voltage, mechanical imperfections of the lens and cathode probably determine the limit. A typical lens structure is shown in Figure 6.

From a theoretical point of view, the magnetic-lens system is much

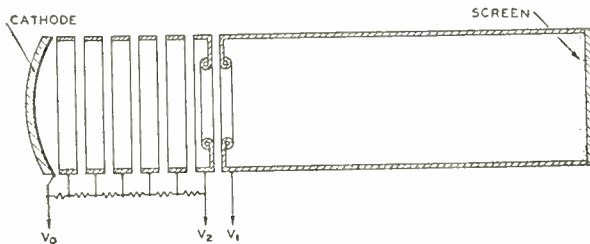

Fig. 6—Electrostatic-image tube.

more complicated than the electrostatic lens. Structurally, however, it is no more difficult.

The simplest magnetic lens is formed by a uniform magnetic field. Such a field will produce an undistorted, erect image whose principal aberration is that due to initial velocities. This form of lens does not readily lend itself to the present image iconoscope. The other extreme is the so-called short-coil lens, which produces an inverted image whose magnification is a function of object-to-coil and coil-to-image distance. Unless this coil can be made large compared with the electron bundle being focused, the aberrations are very severe. Between these two extremes there are a great many possible types of lenses. It is found that if a lens coil is made in such a way that the flux lines close to the cathode approximately coincide with the paths which would be traversed by the electrons in the absence of the magnetic field, the image defects are minimized. To accomplish this, a focusing coil with distributed

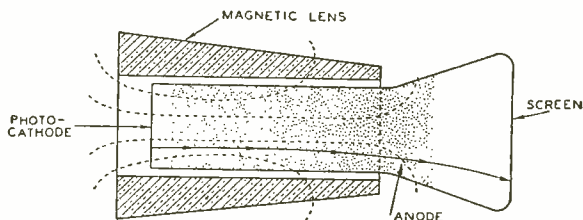

Fig. 7.—Magnetic-image tube.

windings may be used. A lens designed on this principle is diagrammed in Figure 7. This lens produces a real image which is rotated at an angle of about 30 degrees with respect to the object. The electrons do not cross the axis of the system as they do in the case of the electrostatic lens, but execute approximately helical paths about the axis in such a way that their radial distance changes only by an amount equal to the image magnification. Because of this, the variation in convergence for rays originating at different radial distances along the cathode is small, and the curvature of the image plane is much less than in the electrostatic case. The most important image defects in this type of lens are curvature of the image field, pincushion distortion, and rotational distortion.

The first two are sufficiently small so that it is found unnecessary to curve the cathode to correct for them. By properly choosing the length, position, and distribution of the magnetic coil used as lens, the rotational distortion can be minimized. Chromatic aberration, similar to that already described, exists in this lens. Its effect can be reduced

by using fairly large over-all voltages. Figure 8 shows an image produced by this type of lens. While the image defects mentioned are observable, they are relatively unimportant.

Considering next the mosaic for the image iconoscope, it is evident that it must meet the following requirements:

- (1) Capacitance between the front surface and signal plate of about 100 micromicrofarads per square centimeter. The value used is not at all critical and may be much smaller or larger than this figure, but it should be uniform over the surface of any one mosaic.
- (2) The resistance must be high, both through the dielectric and over its surface.
- (3) The secondary-emission ratio and initial velocities must be high. These must also be uniform over the surface.

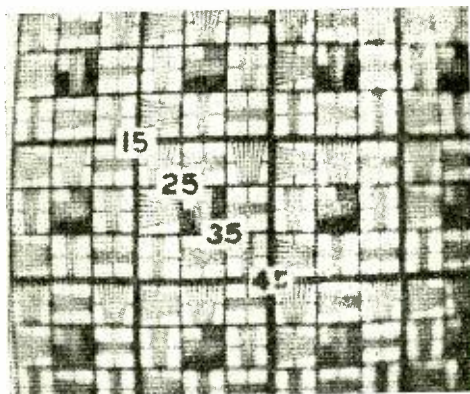

Fig. 8—Resolution pattern by magnetic-image tube.

There are many ways of preparing mosaics which are satisfactory for this type of tube. Only three will be considered here.

The first type is prepared in the same way as the mosaic used in the ordinary iconoscope. Before it is mounted in the tube a mica sheet, about 1.5 mils thick and free from flaws, is coated on one side with a conducting film to serve as signal plate, and on the other with a vast number of minute silver elements. After the tube is exhausted the silver is oxidized and caesiated. One thing that recommends this type of mosaic is that it is comparatively easy to produce a surface which is free from blemish and which is uniform.

A second "mosaic," which leads to greater sensitivity and also permits higher resolution, can be made by using mica of the same

thickness as given above and having the usual signal plate. Instead of covering the face with silver, the mica is left free. Thus, although the mica serves the purpose of a mosaic, its surface is a continuous insulator. The treatment used to activate the surface is to glow it in oxygen and then expose it to caesium vapor. Both secondary-emission ratio and sensitivity are higher in this case than for the first-described mosaic. It is, however, more difficult to obtain uniformity in the case of a mosaic of this type.

The final form of mosaic to be described differs from those previously mentioned in that it makes use of an insulator in the form of a finely divided powder covering a metallic signal plate. The response for this type of mosaic is considerably higher than for either of the others. With a proper technique excellent mosaics of this type can be obtained, not only in their sensitivity but also in uniformity. When suitably activated this type of mosaic lends itself well to the mode of

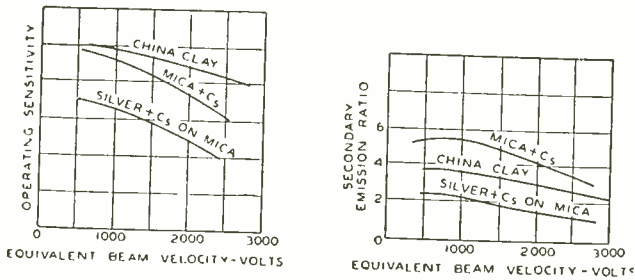

Fig. 9—Properties of various mosaics.

operation in which use is made of conductivity through the mosaic, a potential being applied between second anode and signal plate. Figure 9 shows typical secondary-emission¹¹ and response curves for these mosaics.

The final element, the electron gun, is of conventional design and has been described fully in the literature. The beam voltage used with this type of tube is in the neighborhood of 1000 volts and the current in the scanning beam between 0.1 and 0.2 microampere. In this respect it resembles the ordinary iconoscope.

Several types of image iconoscopes have been developed to a point where they are adequate for practical television transmission. Three of these developmental types are illustrated in Figures 10, 11, and 12. The first two are electrostatically focused tubes, both embodying the

¹¹ Data supplied by Herbert Nelson and R. B. Janes, Research and Engineering Department, RCA Manufacturing Company, Inc., Harrison, N. J.

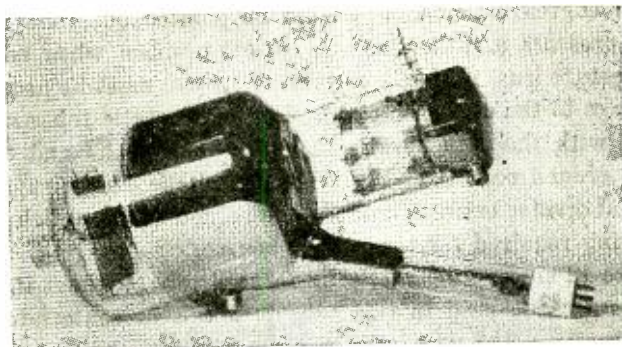

Fig. 10—Photograph of electrostatic-image iconoscope.

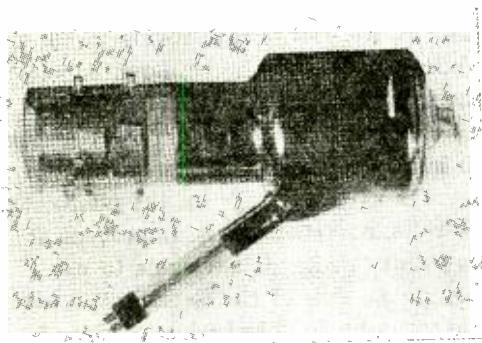

Fig. 11—Photograph of electrostatic-image iconoscope.



Fig. 12—Magnetic-image iconoscope

use of a curved cathode. It should be pointed out that the curved cathode presents a rather serious optical problem when used with a large-aperture lens, in that a correcting system must be used to fit the light image to the curved surface. The electrostatic tubes are usually operated with the cathode at -2000 to -3000 volts and the second anode at ground potential. The focusing voltage can be supplied from a potential divider between cathode and second anode, which minimizes the filtering required for the voltage source.

Figure 12 shows a magnetically focused tube, without its lens coil. Since the cathode used in this tube is flat it presents no particular optical problem. The magnetic lens has a flux density on the axis of about 50 gauss. No second focusing voltage is required as focusing is done by adjusting the magnetic field.

While the operating conditions of these tubes are in a way similar to those of the ordinary iconoscope, there are some differences which are important and should be considered.

The use of an electron image tube requires that three adjustments be made: the optical image, the electron reproduction, and the beam. In operation, the last two can be adjusted once and for all, and only the optical focus changed to meet the different scenes.

Although, as has already been indicated, the operating sensitivity of the tube decreases as the voltage on the photocathode is increased above 600 to 800 volts, nevertheless the improvement in resolution and crispness of the picture makes it advisable to use from 2000 to 3000 volts, particularly in the case of the electrostatic tube.

Another advantage of using the higher voltages is that it minimizes the interaction between the image and the deflecting field of the scanning beam. Tests indicate that at 2000 volts this interaction is negligible.

The earth's magnetic field constitutes another source of interference. Since in these latitudes the earth's magnetic vector makes an angle of about 70 degrees to the horizontal, its effect is to deflect the electron images to one side and either to shift the image up or down, or to rotate it slightly, depending upon the direction the tube is pointing. In the case of the magnetic tube this may be compensated by letting the axis of the magnetic lens make a slight angle with the axis of the tube. This angle may be adjustable to take care of different directions of the tube. The correction in the case of the electrostatic tube is accomplished by means of three mutually perpendicular sets of coils over the lens end of the tube. Without this compensation, the displacement of the picture on the mosaic may be as much as 5 per cent of its width or the rotation may be as much as 10 degrees.

As is the case with all iconoscopes, a spurious signal (which can easily be compensated) is generated by the scanning action on the mosaic as a consequence of the electron redistribution phenomenon. However, because of the high symmetry of the tube, and the small amount of exposed glass, the spurious signal is very small in these image iconoscopes. This factor is a very important point in their favor.

The sensitivity of the image iconoscopes, which have been described is, under comparable operating conditions, between six and ten times that of the usual form of iconoscope. This sensitivity is in terms of light flux in the optical image rather than in terms of image brightness for reasons explained in the first part of the paper. The lenses used with image iconoscopes are commonly of shorter focal length than those used with iconoscopes. Thus, if the iconoscope uses an $f/4.5$ lens with a 7-inch focal length, the equivalent lens for one of the magnetic image iconoscopes has an f value of 1.6 and a focal length of 2.5 inches, and

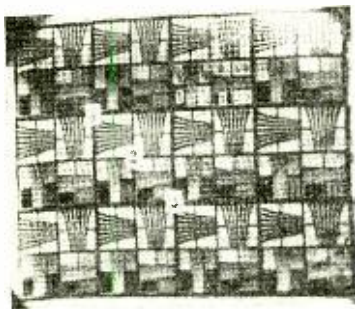

FIG. 13—Resolution pattern reproduced by electrostatic-image iconoscope.

for one of the electrostatic image iconoscopes, it has an f value of 2.1 and a focal length of 3.25 inches. Such optical systems operate to give equal angles of view, equal depths of focus, and gather the same total light flux.

While the sensitivity is important, the quality of the picture is even more important. The resolution in the case of the image iconoscope is about the same as that of the ordinary iconoscope, that is, high enough so that the definition of the picture is limited by electrical circuits rather than the tube. The high saturated signal output gives the tube a somewhat greater contrast range. In order to illustrate the quality of the reproduction by these tubes Figures 13, 14, and 15 are presented.

The first is a resolution pattern transmitted by an electrostatic tube, the second and third typical scenes by a magnetic and an electrostatic tube, respectively.



Fig. 14—Television image reproduced by magnetic-image iconoscope.

The pictures just shown clearly indicate that these image iconoscopes are practical working tools, advanced well beyond the laboratory stage. These tubes have been subjected to quite exhaustive tests, both for studio and outdoor pickup, and have been found to have high sensitivity and signal output. The color response can be made high in the visible region, or peaked for infrared radiation.

It is not safe to predict what further increase in sensitivity can be expected from this type of tube; however, work is in progress along the lines of combining secondary-emission signal multiplication with image intensification, and also of using more than one stage of image multiplication. Both of these investigations should be very fruitful.

ACKNOWLEDGMENT

In closing, the authors wish to express their debt to Mr. G. N. Ogloblinsky, deceased, and their appreciation of the able work of Drs. A. Rose and H. B. DeVore, and Messrs. L. E. Flory and E. A. Massa, which has made these results possible.



Fig. 15—Television image reproduced by an electrostatic-image iconoscope.

THE ORTHICON, A TELEVISION PICK-UP TUBE*†

By

ALBERT ROSE‡ AND HARLEY IAMST

Research and Engineering Department, RCA Manufacturing Company, Inc.,
Harrison, N. J.

Summary—Extensive laboratory and field tests have shown that the Iconoscope is capable of transmitting clear, sharp television pictures even under conditions of unfavorable illumination. An analysis of the operation of the tube suggests that improved efficiency and freedom from spurious signals should result from operating the mosaic at the potential of the thermionic cathode, rather than near anode voltage. The beam electrons then approach the target with low velocity, and the number of electrons which land is dependent upon the illumination.

Several new designs were developed to make sure that the beam of low-velocity electrons was brought to the cathode-potential target in a well-focused condition, that the scanning pattern was undistorted, and that the focus of the beam was not materially altered by the scanning process. A magnetic field perpendicular to the target was found to be useful in focusing and guiding the beam. In some of the tubes, the scanning beam was released by a flying light spot moving over a photocathode. In other tubes it was found more convenient to develop the beam in an electron gun with a thermionic cathode. Special horizontal and vertical deflection systems capable of operating in the presence of a magnetic field were evolved.

The electron gun type of pick-up tube, which has been called an Orthicon, has a maximum signal current output over 300 times the noise in a typical amplifier. The signal is proportional to light intensity. The resolution is sufficient for the transmission of a 441-line picture. Spurious signals are negligible. Within the accuracy of measurement, all the photoemission is converted into video signals. In its present developmental form, the Orthicon gives promise of becoming a useful television pick-up tube.

INTRODUCTION

WITH the beginning of scheduled television broadcasting in New York, it is natural that a great deal of attention should be given to the commercial aspects of the art. Engineers realize, however, that research and development work must continue if future improvements are to be assured. Further investigations have, therefore, been carried on to provide ways to transmit clearer images, with less illumination. This paper will discuss an improved form of pick-up tube resulting from some of these investigations.¹

* Decimal Classification: R583.11 × R583.6.

† Reprinted from *RCA REVIEW*, October, 1939.

‡ Now with the Research Department, RCA Laboratories Division, Princeton, N. J.

¹ Albert Rose and Harley Iams, "Television Pick-up Tubes Using Low-Velocity Electron-Beam Scanning," *Proc. I.R.E.*, Vol. 27, No. 9, pp. 547-555, September 1939.

At the present time, the RCA television system uses Iconoscopes to convert the optical image into a sequence of video signals for transmission to the receiver. Several previous publications have described these tubes and explained how they operate,^{2,3,4} so that a brief review of their characteristics is sufficient to serve as a basis for a discussion of new pick-up tubes.

Extensive laboratory and field tests have shown that the Iconoscope is capable of transmitting clear, sharp television images, even under conditions of unfavorable illumination⁵. The spectral response is suf-

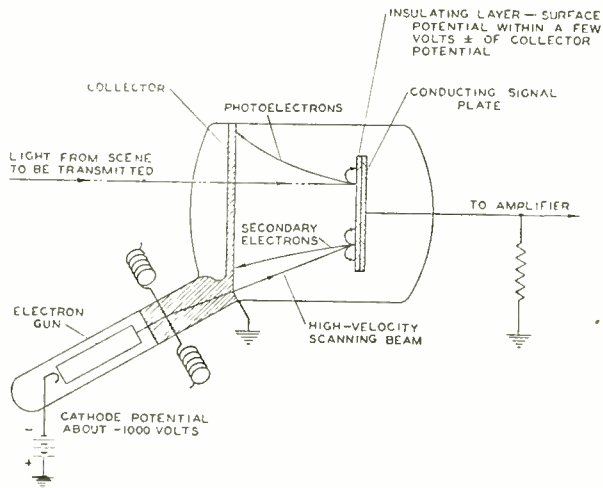

Fig. 1—Schematic diagram of an Iconoscope.

ficiently like that of the human eye to give a natural appearance to the viewed scene. In the circuits associated with the tube, provision is made to "keystone" the deflection (so as to make the scanning beam move over the mosaic in a rectangular pattern) and to introduce shading signals into the amplifier (to compensate for the "dark spot" signal).

In the course of these tests, several significant discoveries were made. One of these was that the good operating sensitivity of the tube

² V. K. Zworykin, "The Iconoscope—A Modern Version of the Electric Eye," *Proc. I.R.E.*, Vol. 22, No. 1, pp. 16-32, January (1934).

³ V. K. Zworykin, "Iconoscopes and Kinescopes in Television," *RCA REVIEW*, Vol. 1, No. 1, pp. 60-84, July 1936.

⁴ V. K. Zworykin, G. A. Morton and L. E. Flory, "Theory and Performance of the Iconoscope," *Proc. I.R.E.*, Vol. 25, No. 8, pp. 1071-1092, August (1937).

⁵ Harley Iams, R. B. James, and W. H. Hickok, "The Brightness of Outdoor Scenes and Its Relation to Television Transmission," *Proc. I.R.E.*, Vol. 25, No. 8, pp. 1034-1047, August (1937).

is obtained in spite of an operating efficiency only 5 or 10 per cent of that which is theoretically attainable⁴. In other words, during typical operation only about one-third of the photoelectrons which the mosaic emits are drawn away, and only about one-quarter of the stored charge is effective in producing the video signal. This lowered efficiency is connected with the release of secondary electrons from the mosaic by the scanning beam.

The situation is illustrated in Figure 1, which shows the essential parts of an Iconoscope. Light in the optical image focused on the mosaic causes the emission of photoelectrons, leaving a pattern of charges corresponding in intensity to the light and shade of the scene to be transmitted. This pattern of charges is scanned by a beam of electrons, which strike the mosaic at high velocity. On the average, each beam electron releases several secondary electrons. Since the mosaic is an insulated surface, the electron current leaving it must (on the average) be equal to the electron current arriving. Thus, when the tube is in darkness, only as many secondary electrons can escape from the mosaic as there are beam electrons which arrive. The rest of the secondary electrons fall back on the surface near or far from the point of emission. Nonuniformities in the escape and rain of secondary electrons cause the "dark spot" signal.

Many of the numerous secondary electrons are emitted with appreciable velocity, so that the condition of one secondary electron leaving for each beam electron arriving means that the electric field near the mosaic is such as to hinder the escape of secondary electrons. This field also reduces the escape of the photoelectrons, which have lower average emission velocity. When the mosaic is lighted, those photoelectrons which escape contribute a positive charge to the lighted parts of the surface. These charges are partly dissipated by the rain of secondary electrons, but sufficient charge is stored during a frame period to produce a strong signal in an amplifier connected to the signal plate when the beam releases the stored charge.

LOW-VELOCITY ELECTRON BEAM SCANNING

If one could ignore the immediate practical problems and choose an ideal mode of operation for a television pick-up tube, he might want to provide a field strong enough to draw away all of the photoelectrons which are emitted, and he might prefer to do the scanning without involving secondary emission in the process. These conditions can be met by operating the mosaic, in known fashion, at the potential of the cathode in the electron gun.

Cathode-voltage operation is possible, for the potential of an insulated surface exposed to an electron beam is stable at this voltage⁶. High-vacuum cathode-ray tubes are usually operated so that the beam electrons strike the screen with high velocity, and liberate many secondary electrons. The screen potential then adjusts itself (usually near anode voltage) so that the number of secondary electrons which escape is equal to the number of beam electrons which arrive. However, the other stable condition occurs when the surface is at cathode potential. The beam electrons then approach the target, but are repelled and retire without striking. If the target becomes slightly positive (by photoemission, for example), the beam electrons land without producing appreciable secondary emission and restore the original voltage.

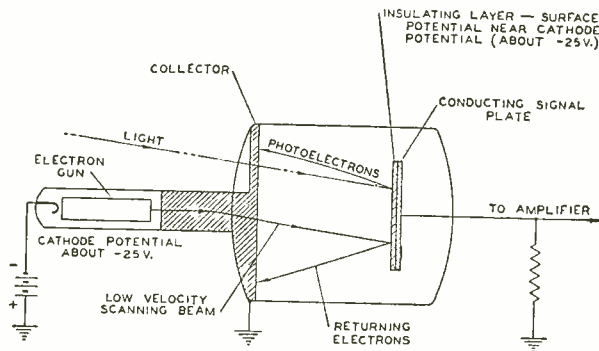

Fig. 2—Pick-up tube with cathode-potential target.

Figure 2 illustrates the operation of a television pick-up tube with its photosensitive target at cathode potential. In the absence of light the beam electrons approach the surface, are slowed to zero velocity, and then are drawn away. There is no signal in an amplifier connected to the signal plate. When light falls on the mosaic, all the photoelectrons are pulled away by the strong electrostatic field between the mosaic and the anode. The charges given the surface are not dissipated by a rain of electrons, but are stored until the scanning beam approaches. When the beam comes near a lighted area, and finds it a few volts positive, electrons land until their negative charge brings the surface to cathode potential again. The velocity with which the beam electrons reach the surface is so low that secondary emission is not involved to any appreciable extent. The signal is simply due to the impulses given the signal plate by the beam electrons, as they arrive at the lighted parts of the target.

⁶ A. W. Hull, "The Dynatron," *Proc. I.R.E.*, Vol. 6, No. 1, p. 5, February (1918).

DESIGN PROBLEMS

So far, much of the discussion has related to ideals. Some of the problems which must be solved before a pick-up tube can be made to operate in a satisfactory manner with its target at cathode potential are illustrated in Figure 3. When the electron beam is deflected, in usual fashion, at an angle to the axis of the tube, the electrons do not approach the target perpendicularly. The negative voltage needed to keep an electron from landing on the mosaic is only as great as the component of velocity perpendicular to the mosaic, and the electric field is not able to stop motion parallel to the surface. When conditions are as illustrated, the beam charges one part of the target to cathode potential, and other parts slightly more positively. Also, the point of contact of the beam may be elongated into a line. This situation may

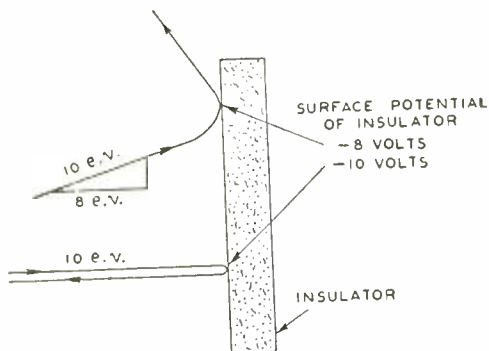

Fig. 3—Electron paths near target.

be expected to cause a loss of resolution at the edges of the picture, and unstable operation when the electrons move with considerable velocity tangent to the surface of the target. These considerations suggest that it would be preferable for the beam always to approach the mosaic nearly perpendicularly, or for the beam to be constrained.

Another important problem is that of providing sufficient beam current (about one microampere) in a beam which retains its small diameter when the electrons are slowed to almost zero velocity and are subject to strong local fields at the mosaic surface.

In the solution of these problems, a magnetic field perpendicular to the mosaic and extending to the source of the electron beam has been found useful. When the field is made sufficiently strong, the beam is focused and refocused many times between the cathode and the target. In a uniform magnetic field, the final size of the scanning spot is substantially the same as that of the source of the beam. The magnetic

field can also be used to keep the beam electrons from proceeding very far across the surface of the mosaic at grazing incidence. Electrons which tend to move in this fashion cut across the lines of flux, and move in circular paths. The diameter of these circles can be made as small as is desired by increasing the strength of the magnetic field.

Several types of pick-up tubes based upon these principles have been designed. In some, the scanning beam is developed at a photocathode illuminated by a moving spot of light, while in others the beam originates at a thermionic cathode. The name Orthiconoscope (or Orthicon, for short) has been used to denote these tubes in which the target is operated at cathode potential. (The Greek prefix "orth",

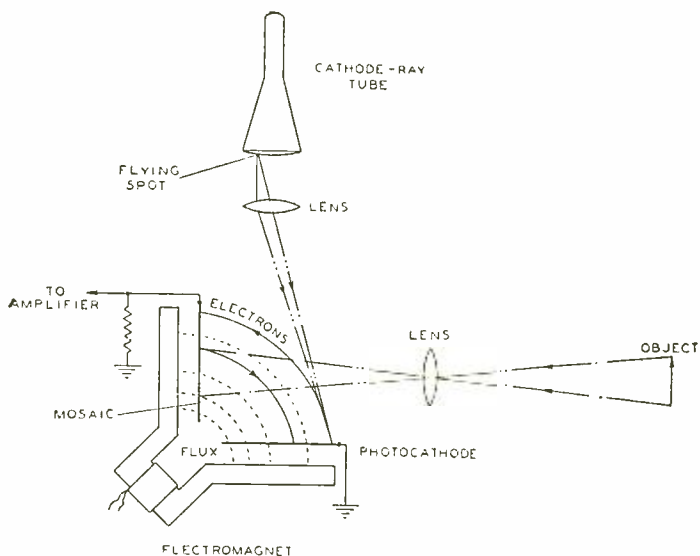

Fig. 4—Pick-up tube using photoelectrons for beam.

meaning straight, is added to the well known term "Iconoscope" to describe the linear relation between light and signal output, which has been observed.)

TUBES WITH PHOTOELECTRIC SCANNING BEAM

One of the tubes which has been built and tested is illustrated schematically in Figure 4. A charge image of the scene to be transmitted is developed by focusing the optical image upon a conventional mosaic. The electron beam which scans the mosaic is produced by photoemission from a conducting photocathode, which is illuminated by a flying light spot focused from the face of a cathode-ray tube

with a short-time-lag screen. At any instant, the light from a single spot on the cathode-ray-tube screen is focused on the photocathode. The emitted photoelectrons are guided by the curved lines of flux between the pole faces of an electromagnet, and the beam is also focused by this field. When beam electrons approach a lighted part of the mosaic, they are absorbed and produce signals in the amplifier. From the dark parts of the mosaic the beam electrons are reflected back to the photocathode. Photoemission from the mosaic is collected by the photocathode.

The picture transmitted by this tube is quite sharp, and is free from spurious shading. Streaking, which one might expect because of time lag in the luminescent material, is not apparent. Most of the discharging of charged areas takes place in the first fraction of a

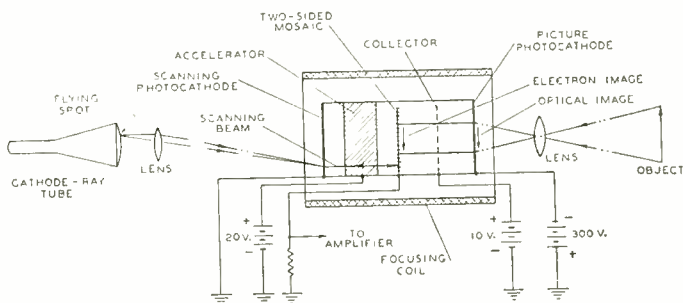

Fig. 5—Pick-up tube using secondary emission amplification.

microsecond, and after that the beam electrons fail to reach the target and their presence is not observed.

Tubes which incorporate secondary emission amplification of the image, in a fashion somewhat comparable with the method used in the Image Iconoscope⁷, have also been built and tested. Such an arrangement is shown in Figure 5. In this case, the optical image is focused upon a translucent photocathode and the resulting photoemission is focused upon a two-sided mosaic by means of an axial magnetic field. Secondary electrons released from the mosaic by the high-velocity picture electrons are drawn away to a collecting electrode, giving image amplification. The electron beam which scans the other side of the mosaic is obtained from a flying light spot moving over another translucent photocathode, and is focused by the same axial magnetic field which focuses the electron image. As in the previous tube, the scanning beam restores the mosaic to the potential of the

⁷Harley Iams, G. A. Morton, and V. K. Zworykin, "The Image Iconoscope," *Proc. I.R.E.*, Vol. 27, No. 9, pp. 541-547, Sept. (1939).

scanning cathode. When the tube is operated, the gain in sensitivity due to secondary emission amplification is readily observed.

While a number of tubes which use photoelectric scanning beams have been tested, these two examples are sufficient to indicate the methods that have been used. These methods make possible the scanning of a large mosaic with a well-focused beam of low-velocity electrons, resulting in the transmission of video signals free from spurious signals. Further, an increase in sensitivity through secondary emission amplification may be obtained. However, because the auxiliary apparatus to generate the flying light spot represented a complication, an investigation was made of tubes in which the beam is derived from a thermionic cathode, and is deflected in the presence of a magnetic field.

TUBE WITH A THERMIONIC SCANNING BEAM

The most important problem in the design of a pick-up tube, operating with its target at cathode potential, and using an electron gun to

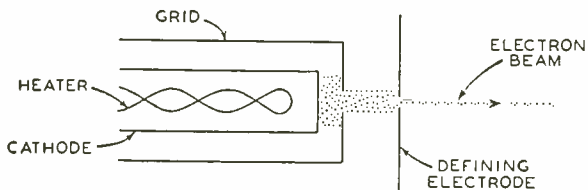

Fig. 6—Electron gun.

generate the scanning beam, is that of deflecting the beam without defocusing it. In the case of the tubes described above, each point on the target had a corresponding point on the photocathode such that the same magnetic line intersected both of them. Photoelectrons generated at one end of the line at the photocathode were focused at the target with substantially one-to-one magnification. A slight enlargement of the scanning spot occurred due to the emission velocities of the photoelectrons transverse to the magnetic field. If, in some way, larger transverse velocities were introduced into the motion of the beam electrons, they would describe helices of larger amplitude around the magnetic lines and result in a larger spot at the target. In the case of a tube using an electron gun, only the central point on the target is normally connected with the cathode by a magnetic line. If electrons from the gun are to reach other points on the target, either they must cross the magnetic lines of the axial field or they must be guided to other points by warping the axial magnetic field. Both of these devices are used in the form of Orthicon to be described. To insure, however,

that the deflected spot is not larger than the undeflected spot it is necessary that no significant amount of velocity transverse to the magnetic field, imparted to the beam electrons by the deflection system, be retained by the electrons as they approach the target.

The simple electron gun shown in Figure 6 generates a stream of electrons moving parallel to the axis with a velocity of about a hundred volts. The cross section of the beam is limited to the size of a picture element by the defining aperture in the last electrode. In this state, the beam enters the deflection system and in this state it should emerge except for a displacement from the axis.

The high-speed horizontal deflection is accomplished by a pair of electrostatic deflection plates in combination with the axial magnetic

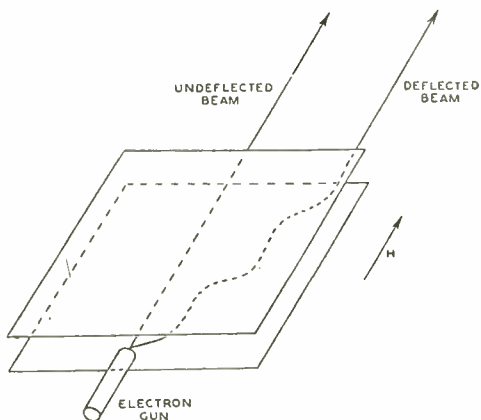

Fig. 7—Path of electron beam in electric and magnetic fields.

field. A somewhat schematic representation of the path of the beam through the plates is shown in Figure 7. The beam is seen to be deflected in a plane parallel with the plates and to diverge from the axis only while it is between the plates. After leaving the plates, the beam continues parallel to the axis. The amplitude of deflection is proportional to the electric field and the transit time of the electrons through the plates, and inversely proportional to the strength of the axial magnetic field. Since the maximum amplitude of deflection is limited to the width of plates, these must be as wide as the target to be scanned. The wiggles in the beam in Figure 7, when viewed from the end of the plates, that is along the axis, appear as a series of cycloids. This is the two dimensional path described by electrons moving in crossed electric and magnetic fields. If the electric field from the deflection plates could be sharply cut off at the entrance and exit edges, the transit time of the beam could be adjusted so that only an

integral number of cycloids would be performed by the beam in passing through the plates. In this way, none of the transverse velocity represented by the cycloidal motion would be retained by the beam after it left the plates. While this is a possible arrangement, it has been found that a less critical way of insuring that the emergent beam retains substantially none of the transverse velocity acquired in the plates is to suppress the amplitude of cycloidal motion within the plates. The amplitude of cycloidal motion may be considerably reduced by admitting the beam to the plates through a gradually increasing electric field and similarly letting it leave through a gradually decreasing field. For this reason, the deflection plates are flared out at the entrance and exit ends.

Two significant distinctions are to be noted, in the above account, between electrostatic deflection in the presence of a magnetic field, as

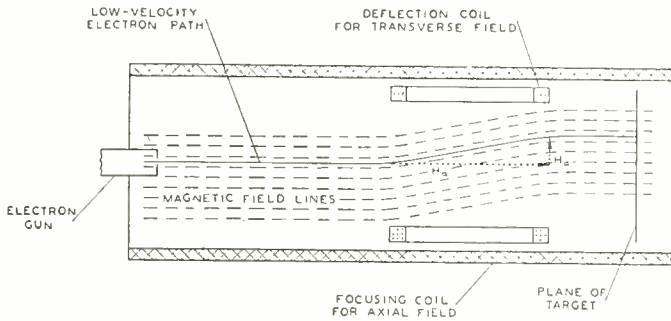

Fig. 8—Path of electron beam in warped magnetic field.

in an Orthicon, and electrostatic deflection in a magnetic field free space, as in the usual cathode-ray tube. First, the plane of deflection, which is perpendicular to the plates in the usual electrostatic deflection, has been rotated through ninety degrees into a plane parallel with the plates, in an Orthicon. Second, while the usual plates impart a transverse velocity to the beam which causes the beam to continue to diverge from the axis after leaving the plates, the plates in an Orthicon cause the beam to diverge from the axis only while the beam is between the plates. The axial magnetic field constrains the beam to motion parallel with the axis after it leaves the plates.

The low-speed vertical deflection is accomplished by a pair of magnetic coils. Here, again, while magnetic coils are used in the usual cathode-ray tube without an axial magnetic field, their action in an Orthicon is essentially different by virtue of this field. Briefly, the axial magnetic field rotates the plane of deflection through ninety degrees and causes the electrons in the beam to move parallel to the

axis after leaving the deflection coils. The average path of the beam through a pair of deflection coils immersed in an axial magnetic field is shown in Figure 8. The amplitude of deflection is proportional to the magnitude and axial length of the deflection field and inversely proportional to the magnitude of the axial magnetic field. From Figure 8, it is evident that the separation of the coils must be as large as the height of the target to be scanned. While Figure 8 shows the average path of the beam to follow the magnetic lines closely, the actual path contains a helical motion imparted to the electrons due to their passing through a curved magnetic field. For small deflections, the amplitude of this helical motion is of the order of, or less than, the helical motion of the electrons due to their emission velocities. The magnetic coils may therefore be considered as a means of displacing the beam from

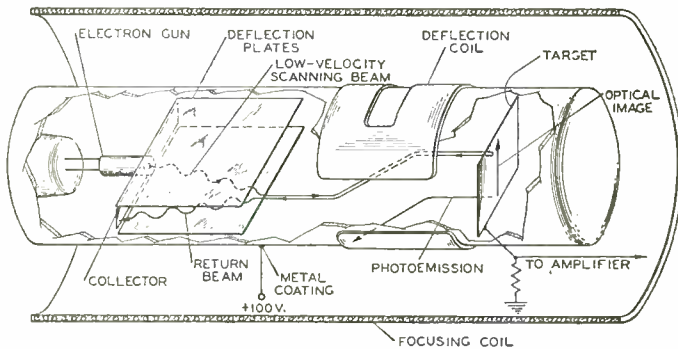

Fig. 9—Schematic diagram of an Orthicon.

the axis, without contributing any significant transverse velocity to the beam electrons.

The beam, as it leaves the deflection system and approaches the target, is in substantially the same condition as when it left the gun, except that it may be displaced from the axis. Since the target surface is at cathode potential, the beam passes through an electric retarding field sufficient to slow it to near zero velocity at the target. The target is a thin mica sheet, the side facing the beam being covered with a mosaic of photosensitive elements and the side away from the beam being coated with a translucent conducting film of metal known as the signal plate. The optical picture is focused on the photosensitive side through the translucent signal plate. The photoelectrons are drawn away from the zero-potential surface to various positive electrodes near the target (see Figure 9). As described earlier, if the element approached by the beam has been unlighted, the beam electrons will not land on the target, but will be brought to rest near it and be

accelerated back away from the target. If the element has been lighted, enough of the beam electrons will land to replace the photoelectrons that have been drawn away during the previous frame time. In this way, the beam maintains the target at cathode potential and generates the video signal. The electrons which do not land at the target retrace substantially their original path as they return toward the electrostatic plates. In passing back through the plates, the beam diverges from its going path in the direction of the original deflection, as shown in Figure 9. The beam eventually strikes an elongated collector electrode, also shown in Figure 9.

OPERATING CHARACTERISTICS

The description of the operation of an Orthicon would lead one to expect a set of simple operating characteristics. This expectation has been borne out by numerous observations on the tubes. Briefly, substantially no signal is transmitted with no light on the target. With an optical picture focused on the target, a signal proportional to the light intensity at each point is transmitted. The maximum signal is limited by the amount of beam current. In some tubes a modulated beam current of one microampere has been observed. This corresponds to a signal current about three hundred times the noise level of a typical television amplifier.

Not only is the transmitted signal proportional to the light on the target, but also the conversion of possible photoemission into signal takes place at substantially 100 per cent efficiency. This requires that the photoemission from the target be saturated throughout the frame time, that the charge be fully stored for that time, and that all of the stored charge be useful in producing a video signal when the scanning beam passes over it. Tests made on Orthicons have shown that the photoemission from the target is saturated when the collector electrodes surrounding the target are more than twenty volts positive with respect to the target. Since these electrodes are usually about plus one hundred volts, a saturated photocurrent is assured under static conditions. During a frame time, the photoemission from the target is swept over the collecting electrodes by the field from the vertical deflecting coils. To test whether the photocurrent was saturated equally throughout the frame time and equally stored, a spot of light was projected on the target once a frame time for about one-tenth of the frame time. The signals, both of the photocurrent and of the discharge process, were observed on an oscilloscope. The storage time was varied from zero to a full frame time by varying the time at which the

spot was projected on the target. No variation in either of these signals was observed throughout the full range of storage time, indicating that the photocurrent was equally saturated and the charge equally stored throughout the frame time. A final overall test, which compared the transmitted signal with a known amount of light on a target of known photosensitivity, showed that (within ability to measure) all of the stored charge (or by the above tests, all of the photoemission at the target) was utilized in producing video signal. As a result of this high operating efficiency, Orthicons with a target photosensitivity of one microampere per lumen exhibited approxi-



(Courtesy R. D. Knell)

Fig. 10—Television picture transmitted by an Orthicon.

mately the same operating sensitivity as Iconoscopes with a target photosensitivity of ten microamperes per lumen.

Observations on the resolution of the transmitted picture showed more than four-hundred-line resolution over the entire picture and as high as six-hundred-line resolution in the center. For the particular size of target used, two and one-half inches wide, this means that the scanning beam near zero velocity can resolve elements on the target less than one two-hundredth of an inch apart.

Two representative pictures transmitted by an Orthicon are shown in Figures 10 and 11. No shading-compensation signals were introduced into the television system from which these pictures were taken.

CONCLUSIONS

As a result of the tests which have been described, it may be concluded that the operation of a television pick-up tube with its target

at cathode potential makes possible (1) the efficient conversion of photoemission into video signals, (2) a large signal output, and (3)



(Courtesy R. D. Knell)

Fig. 11—Television picture transmitted by an Orthicon.

the elimination of spurious signals. While developmental Orthicons incorporating these features have been built and operated, additional work to determine optimum designs is in progress.

A DETERMINATION OF OPTIMUM NUMBER OF LINES IN A TELEVISION SYSTEM*†

BY

R. D. KELL,‡ A. V. BEDFORD‡ AND G. L. FREDENDALL‡

RCA Manufacturing Company, Inc.,
Camden, N. J.

Summary.—In a television system horizontal resolution and vertical resolution are equally costly in video-band width. That is, on the basis of a fixed-band width, the vertical resolution increases with the number of scanning lines and the horizontal resolution decreases a corresponding amount—and vice versa. Also if a given increment of resolution is available for increasing the quality of a picture which originally has equal vertical and horizontal resolution, the quality will be improved more by applying the increment equally to the vertical and horizontal resolution than by applying it to improve resolution in only one direction. This conclusion follows from the known equality of the acuity of the human eye in various directions and the random orientation of the subject matter transmitted. Hence, the optimum utilization of the transmission band requires that the number of lines be near that number which provides equal horizontal and vertical resolution.

In applying this criterion, the horizontal and vertical resolution is calculated in terms of the amount of blur with which the most elementary hypothetical test subject is reproduced on the receiving screen. The test subject is a single abrupt transition in brightness along the surface of the subject. The transition is placed nearly at right angles to the scanning lines for the analysis of vertical resolution and parallel to the lines for the analysis of horizontal resolution.

The immediate reduction of the visibility of the line structure justifies revising the number of lines slightly upward from the number determined by the criterion of "equal vertical and horizontal resolution" for the receivers of present practicable fidelity. As the fidelity of receivers is increased a corresponding improvement in shape of the scanning spot will reduce this particular need for more lines. Hence, it is possible to choose a number of lines which will provide nearly optimum picture quality for both present receivers and future improved receivers. This number of lines is between 441 and 507 (at 30 frames per second) based upon the reception of a maximum video-frequency signal of 4.5 Mc. which is available with the vestigial side-band method of transmission within the 6-Mc channel allocated for each television transmission (including sound).

(1) PREVIOUS ANALYSIS

EVEN in the early days of television experimentation it was tacitly assumed that the transmission band for the video signal should be wide enough to provide horizontal resolution equal to vertical resolution. (The expression "resolution" as used in this paper, refers to that useful characteristic of a picture which makes the picture

* Decimal Classification: R583.1.

† Reprinted from *RCA REVIEW*, July, 1940.

‡ Now with the Research Department, RCA Laboratories Division, Princeton, N. J.

sharp and clear as contrasted to blurred, "fuzzy" or smeared. It has usually been measured in terms of the distance between adjacent points or bars which can just be "resolved" or distinguished in the picture; but "resolution" as we apply the term is equally as important in pictures having no fine lines or "points," but having relatively large black, white or gray areas with sharp junctions between these areas.) The transmission band intended to meet this condition was calculated by the simple formula

$$f = N^2 r a / 2 \quad (1)$$

where

N = number of scanning lines
 f = maximum video frequency in c.p.s.
 a = picture-aspect ratio (= 4/3)
 r = frame-repetition rate.

This formula neglects the return time of the scanning spot between lines and between frames, but corrective factors may be applied readily. It may be seen by inspection that (1) gives the highest frequency required to transmit a checker board pattern in which the width of each square is equal to the line pitch when it is necessary only that each square be reproduced as a dot without retaining the square shape. It was assumed in Eq. (1) that the vertical location of the checker board pattern was always such that the scanning lines coincided with the rows of squares.

In 1934, Kell, Bedford, and Trainer¹ recognized that useful television subject matter would have details that generally did not coincide with the scanning lines and that, therefore, the vertical resolution would depend upon the relative positions of the scanning lines with respect to the picture detail. They made observations using a complete television system to transmit a test pattern. The pattern consisted of a tapered wedge of near-horizontal alternate black and white bars which converged and thus occupied all positions with respect to the scanning lines. The average of readings made by several observers indicated that 100 scanning lines were required to make 64 black and white bars distinguishable. Then, upon the assumption that in the finest checker board pattern resolvable the width of a square must be 1/0.64 times the line pitch, the frequency-band requirement was multiplied by a factor $K = 0.64$. This constant K has been widely accepted

¹ R. D. Kell, A. V. Bedford and M. A. Trainer, "An Experimental Television System", *Proc. I.R.E.*, Vol. 22, No. 11, p. 1247, November, 1934.

² Such a test pattern and its application are given in "A Figure of Merit for Television Performance", A. V. Bedford, *RCA REVIEW*, Vol. III, No. 1, July, 1938. When vertical and horizontal resolution are considered separately this test pattern may be considered equivalent to a continuous series of checker board patterns of different coarseness.

by television workers although there is not universal agreement as to its numerical value.

The determination of the band width by this method is open to criticism due to several inaccurate and incomplete hypotheses. First, the influence of the size, shape, and light distribution of the scanning aperture in both transmitter and receiver, all of which are known to affect resolution, has been omitted in the derivation of the formula. Some justification for this omission is the assumption that any reasonable variations in the spot would affect vertical and horizontal resolution equally unless the aperture attenuation is compensated. Compensation for aperture attenuation improves only the horizontal resolution and, hence, alters the relations for equal vertical and horizontal resolution.

Second, the most unsound assumption is that the transmission of a series of regularly spaced squares or bars is a measure of useful resolution. Actually, the subject matter usually transmitted will be represented by changes of light intensity along a scanning line that repeat at such intervals as to be substantially non-repeating so far as high-frequency behavior is concerned. After an abrupt change from black toward white, the next change is as likely to be toward white again instead of black which would be required to complete a single cycle. It is still less likely that the subject will contain repeating simple cycles which are identical.

Fidelity in transmission of the checker-board pattern is not a complete criterion of the capability of the system to transmit properly the most elementary "building block" with which picture detail is constructed, namely: an isolated abrupt change from black to white. This is evident from the fact that a good phase characteristic is not necessary for the transmission of a checker-board pattern. On the other hand, both theory and experiment show that reasonable linearity of phase is required for the proper transmission of isolated abrupt changes from black to white, or from white to black. Even if complete phase correction is assumed, there is still no assurance that the successful transmission of repeating dots in either a vertical or horizontal direction is an infallible indication of the ability of the system to transmit useful detail.

Wheeler and Loughren³ have used the average reproduced width of a very narrow isolated white line as a criterion of useful resolution and have reached theoretical conclusions regarding the required band width. Here again, the criticism offered is that the unit for analysis is too specialized and is not the most elementary "building block" of

³ H. A. Wheeler and A. V. Loughren, "The Fine Structure of Television Images", *Proc. I.R.E.*, Vol. 26, No. 5, May, 1938.

which picture detail is constructed. The narrow line is a more basic unit than the repeating squares of the checker board, but a line represents *two* abrupt changes, black to white and then white to black.

(2) REPRODUCTION OF AN ABRUPT CHANGE IN BRIGHTNESS AS A MEASURE OF RESOLUTION

Almost all investigators⁴ have used "equal vertical and horizontal resolution" as a criterion for adjusting the number of scanning lines to the band width. We also propose to use the criterion of equal vertical and horizontal resolution, but we prefer a different measure of resolution

In the present theoretical investigation the most elementary building unit of which picture detail may be constructed has been adopted as a test unit. The fidelity of reproduction of the unit in the received picture is a measure of the resolution of the picture. This unit is an "abrupt change or discontinuity in intensity of illumination" along the surface of the subject to be transmitted. An analogous unit used in electric-circuit theory is the "Heaviside Unit Function." It may be represented as a sharp transition from black to white, from white to black, or from any intermediate shade to any other shade. For convenience in the analysis the transition is considered to occur from black to white. This causes no loss of generality because resolution is independent of polarity and amplitude. In the reproduced picture at the receiver the change from black to white is not abrupt, but gradual. The distance along the picture screen required for the change from black to white to be effectively completed is a measure of the "blur" in the picture. The reciprocal of this distance is then a measure of useful vertical or horizontal resolution depending upon the angular position of the test transition. As will be seen the curves showing the surface illumination along the transition may have various irregular shapes depending upon the position of the transition from black to white with respect to the scanning lines, the spot size and shape, and the amplifier amplitude and phase characteristics. (The direction of the transition is considered to be at right angles to the junction or border dividing the black and white areas.) A comparison of these shapes is necessary in order to arrive at a significant relative evaluation of vertical and horizontal resolution.

⁴ J. C. Wilson, "Channel Width and Resolving Power in Television Systems", *Jour. Tele. Soc.* (London), Vol. 2, No. 2, Part II, pp. 397-420, June, 1938. An extensive bibliography is included.

* An exception occurs in the vestigial side-band systems of transmission where a slightly different shape of transient response wave occurs if the modulation is excessive. Some account of this condition will be taken later.

In useful television picture subjects the transitions to be transmitted will have many different shapes and degrees of abruptness. It is proper however to use the unit-function type of transition as a test unit for evaluating the response to all these transitions because any transition from black to white may be represented by a series of such Heaviside unit functions. If the system will respond properly to a unit function it will also respond faithfully to any wave shape. (Amplitude linearity of response is assumed)

(3) VERTICAL RESOLUTION

The determination of vertical resolution is based upon a test-picture subject in which the upper portion is black and the lower portion is

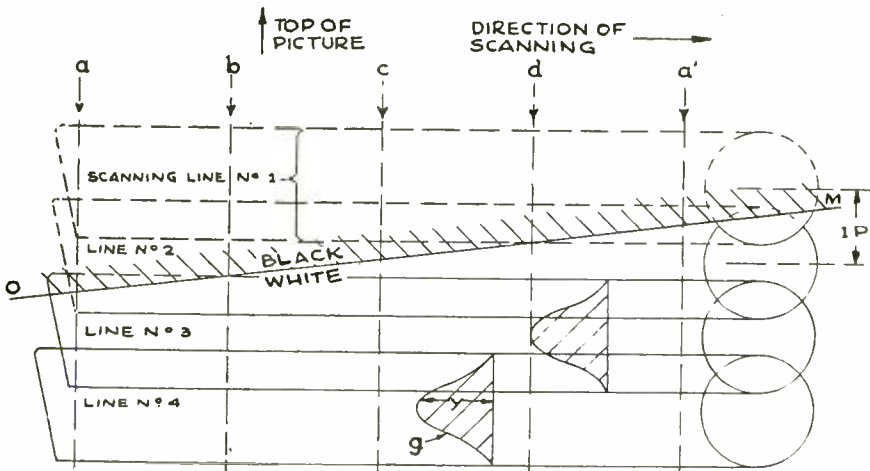

Fig. 1—A section of a scanning pattern showing the position of a black-to-white junction nearly parallel to the scanning lines. Representative transitions occur along *a*, *b*, *c* and *d*.

white with an infinitely abrupt transition between. The light intensity across the transition in the received picture will be a function of spot size in the transmitter, spot size and distribution in the receiver, distance between centers of adjacent scanning lines (that is, line pitch), and the position of the abrupt junction with respect to the scanning lines. Vertical resolution does not involve changes in intensity along the scanning lines and is, therefore, independent of the high-frequency response of the transmission system.

The distribution of intensity over the luminous spot of a simple cathode-ray tube has approximate circular symmetry, but is not of uniform intensity along its diameter. The intensity is greatest at the center of the spot and decreases toward the edge in consequence of aberrations in the focusing fields of the electron stream and the random

initial velocities of electrons emitted from the cathode. The light distribution of the spot is such that the light intensity distribution *across* a single scanning line may be approximated by the cosine-squared function as shown in Figure 1. (This does not mean that the *intensity* along a diameter regarded as a function of the *distance* along the diameter is a cosine-squared.) The ordinates y of the curve g indicate the light intensity of the scanning line at various points across the line. The overlap of adjacent scanning lines has been assumed to be 50 per cent of the scanning-line pitch as shown. (The line pitch is the distance from center to center of the lines.)

The size of the scanning spot in the best cathode-ray receiving tubes available at the present time varies considerably with modulation of light output from minimum to maximum useful values. Also the intensity distribution within the spot changes with modulation. A constant spot is assumed for the present analysis, but the results may be properly applied to a system including a variable spot by considering the assumed constant spot to be the effective mean spot of the system. In the cathode-ray pick-up devices the scanning spot is not modulated and, hence, the assumption of a constant spot at the transmitter is entirely correct.

The black-to-white junction in the test subject is indicated by the line OM in Figure 1. OM is drawn nearly, but not quite parallel to the scanning lines in order that the junction will fall at every possible position with respect to the scanning lines. The various transitions from black to white, for example along the broken lines a , b , c , and d , are substantially vertical and, hence, are essentially measures of vertical resolution. If the junction line OM had been drawn exactly parallel to the scanning lines, the resulting transition would be very critical to vertical position with respect to the scanning lines and the test would lose its significance unless a variety of vertical positions and a mean of the several transitions were used. An easier method is to use the nearly parallel test junction. This not only is permissible, but is desirable because the exactly parallel test junction would represent a very special case of the subject matter.

Curve c in Figure 2 shows the calculated light intensity at the receiving screen that corresponds to the variation along the line c of Figure 1. Identical cosine-squared spots are assumed in the pickup device and the receiver. In Figure 2 the abscissa is the vertical distance along the receiving screen. The unit of distance is the scanning-line pitch. The dotted curves c_1 , c_2 , and c_3 show the contribution of the individual scanning lines to form the sum curve c . (Incidentally, curve c shows that the cosine-squared spot with 50 per cent overlap does not produce a flat field—one in which the scanning lines are indistinguish-

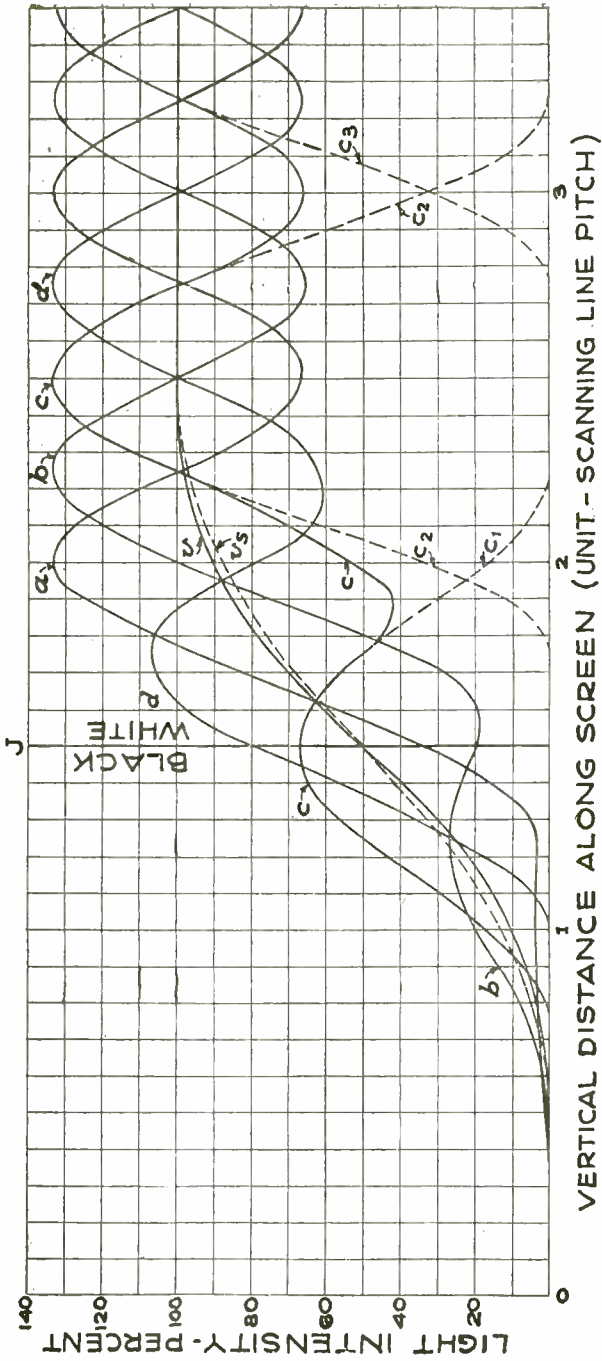

Fig. 2—Curves *a*, *b*, *c*, and *d* are plots of light intensity along *a*, *b*, *c* and *d* of Figure 1. The steepness of rise of the mean curve *v* is a measure of vertical resolution.

able—because the light intensity at the center of a line is twice as great as at the mid-points.)

Similarly, curves *a*, *b*, and *d* of Figure 2 show the light intensities in the transitions along the lines *a*, *b*, and *d*, respectively, of Figure 1. The relative position of the junction in the test subject is marked *J*.

Since the curves *a*, *b*, *c*, and *d* have different rates of rise it is evident that the resolution of a vertical transition depends upon the position of the test subject with respect to the scanning lines at the transmitter. It is natural to seek a single value of effective vertical resolution that will agree with an observer's impression of the vertical resolution of which a given television system is capable. Such a quest has promise of success in advance because common television experience shows that the observer does not separately scrutinize every vertical transition in a complex television picture. However, he does form an impression of the sharpness of an outline of a black, gray, or white area in a subject that depends upon the mean distribution of intensity along the outline.

It is reasonable to assume that the eye will tend to obtain an impression of the net sharpness of the junction *OM* that corresponds to a mean transition curve or arithmetic-average of all the transition curves which may occur across the junction. The basic assumption is that in effect the eye integrates the light intensities in elemental areas parallel to the junction *OM*. In addition the use of the "arithmetic-average" mean transition curve for this purpose is supported by the fact that in most real television subjects there is at least the minute amount of motion required to cause the scanning lines to intersect the junction at continually changing points. Thereby the well-known ability of the eye to integrate light values with respect to *time* effectively contributes to the effect which was at first assigned to the optical integration of elemental areas along a stationary junction.

All conditions at *a'* and *a* (Figure 1) are identical and the transitions between *a* and *a'* change smoothly and gradually. Then since *b*, *c*, and *d* are equally spaced between *a* and *a'* the average of curves *a*, *b*, *c*, and *d* of Figure 2 is reasonably near the average of all the transitions across the junction *OM*. The curve *v* (Figure 2) is a plot of the average values of the ordinates of curves *a*, *b*, *c*, and *d* and will be used as the mean vertical transition curve in the following study.

(4) HORIZONTAL RESOLUTION

The next step is the determination of a horizontal transition curve for comparison with the mean vertical transition curve *v* in order to arrive finally at an economic choice of the number of scanning lines for the band width available for picture transmission.

The test subject used above must be rotated substantially 90 degrees

so that the junction between the black and the white areas is at right angles to the scanning lines, and the transition from black to white is *along* the scanning lines. The sharpness of the transition at the receiver may now be limited by both the signal transmission band and by the well-known aperture attenuation occasioned by the use of finite scanning apertures.

According to well-established theory the variation of the light intensity along a scanning line due to use of a finite symmetrical scanning aperture may be derived by replacing the effect of the aperture by an imaginary one of infinitesimal length and passing the signal through a hypothetical electrical network that attenuates all of the

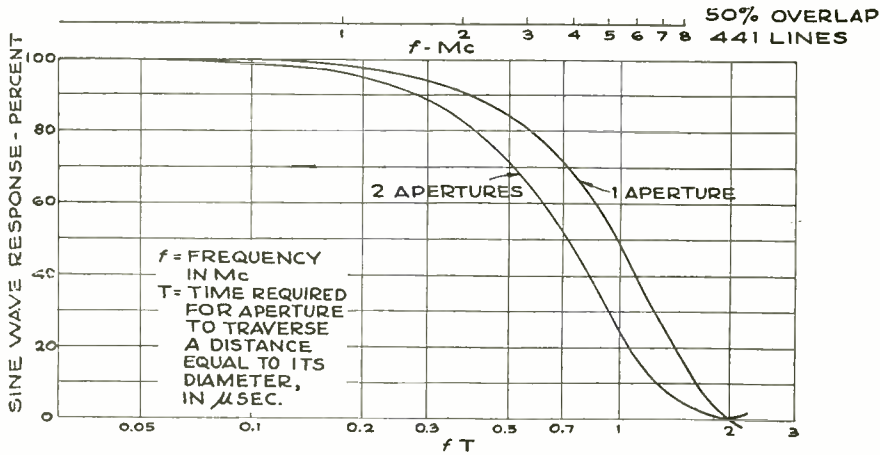

Fig. 3—Equivalent frequency response of a circular-scanning aperture having a cosine-squared transverse-light intensity.

frequencies in the picture signal by various prescribed amounts such as shown in Figure 3. This figure shows the calculated frequency characteristic of the cosine-squared aperture. The aperture introduces no phase distortion up to the frequency of zero response. The " f " abscissa scale applies only for a 441-line picture, a 50 per cent overlapped spot and a repetition rate of 30 frames per second. The " fT " scale may be applied to any system using a cosine-squared spot by inserting the proper value of T as defined in the figure. The frequency characteristic of the transmitting and receiving apertures may be compensated by correcting networks located in the transmission system, nearly up to the frequency at which the aperture response becomes zero. It will be seen after a determination of number of scanning lines has been made, that the required compensation for the aperture losses is reasonable to obtain for the video band available.

Present television-channel allocation requires that the picture transmitter and the accompanying sound transmitter operate within a 6-Mc

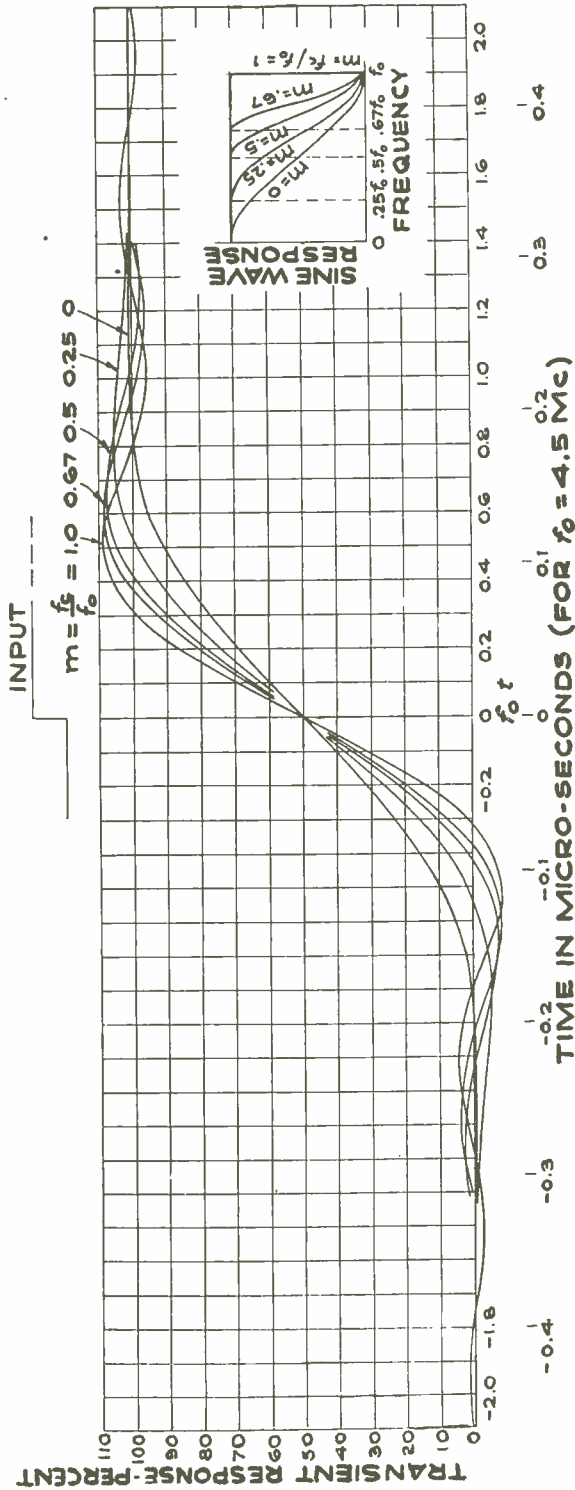

Fig. 4—Transient response of various idealized video-transmission systems having the different cut-off characteristics shown in the insert. Steepness of rise determines horizontal resolution.

band. Considerable experimental and theoretical work has determined that by the use of vestigial-side-band picture transmission the picture carrier may be located so that a maximum of 4.5 megacycles video-band width may be received. The extent to which this 4.5-megacycle video band is utilized for controlling the light intensity of the scanning spot in the receiver is determined by the receiver design. Probably most commercial receivers will fall materially short of ideal utilization due to the high cost of providing an overall frequency characteristic flat in amplitude and phase and having an abrupt cut-off. It is likely that cheaper receivers will have overall frequency characteristics which begin to fall at a relatively low frequency and very gradually approach zero response at 4.5 megacycles. (The "over-all" characteristic is the equivalent video-frequency characteristic of the system which includes the transmitter and the effects of the radio-frequency, intermediate-frequency, and video-frequency characteristics of the receiver.) It is necessary to investigate the horizontal resolution provided by representative types of receivers characterized by certain overall frequency characteristics.

Figure 4 shows the calculated⁵ transient response to a unit-function input wave for five different idealized frequency characteristics. (The input wave shown at the top of the figure is essentially the signal produced by scanning across the junction of our test subject when located in a vertical position.)

Each idealized frequency characteristic has uniform sine-wave response up to a frequency f_c beyond which the amplitude drops along a curve having a sine-wave shape to zero at f_o as shown in the insert of Figure 4. Each curve is identified by a different scale of m , the ratio f_c/f_o . The idealized characteristics have linear phase shift as evidenced by the symmetry of the transient response curves about the point of 50 per cent transient response. The origin of the abscissa scales was arbitrarily placed at the time of 50 per cent response. The generalized scale, $f_o t$, is applicable to systems having any value of f_o , expressed in megacycles when t is in microseconds. A specific time scale corresponding to $f_o = 4.5$ megacycles is included, as our present interest is limited to systems having this maximum video frequency.

(5) COMPARISON OF VERTICAL AND HORIZONTAL RESOLUTION

It is well established theoretically that vertical resolution and horizontal resolution are equally costly in video-band width. In other words, the vertical resolution can be increased a reasonable amount by increasing the number of lines, but in consequence the horizontal resolution

⁵ Several practicable methods for calculating this response are given by A. V. Bedford and G. L. Fredendall, in "Transient Response of Video-Frequency Amplifiers", *Proc. I.R.E.*, Vol. 27, No. 4, pp. 277-284, April, 1939

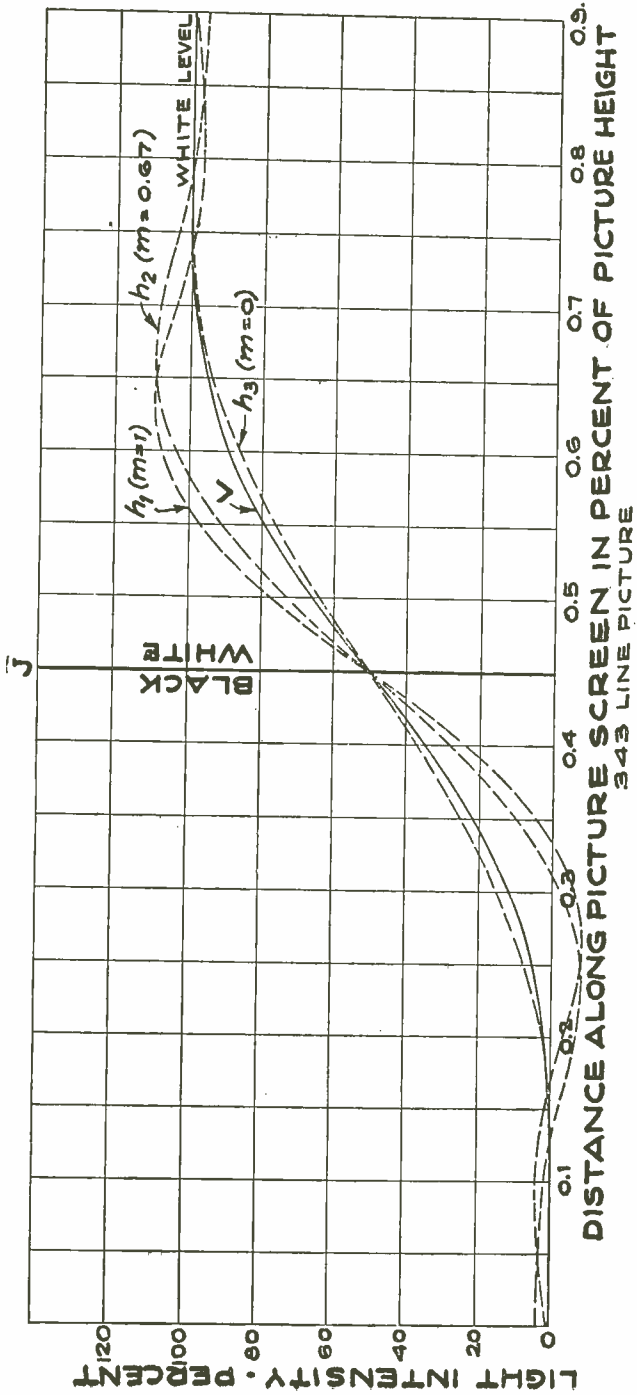

Fig. 5—Curve v of Figure 2 and several curves of Figure 4 are replotted here for comparison of the variable-light intensity vertically and horizontally along the receiving screen. 343 scanning lines and 30 frames per second.

must decrease a proportional amount if the band width and frame-repetition rate are fixed.*

Therefore, the conditions for optimum use of the facilities available for a television service must include among other factors the choice of a number of scanning lines which will provide a favorable ratio of the vertical to the horizontal resolution. Without attempting at the moment to specify the ratio, we shall proceed to compare the vertical and horizontal resolution obtainable for different numbers of scanning lines.

Figure 5 shows the mean vertical transition curve v taken from Figure 2 and several horizontal transition curves h_1 , h_2 , and h_3 , taken from Figure 4, replotted for a 343-line (30-frame-per-second) picture. The curves were made properly superimposable for comparison by using the abscissa scale which is common to both the vertical and horizontal transitions, namely, the distance along the picture screen†. The data for curves h_1 , h_2 , and h_3 in Figure 5 corresponding to receivers of different fidelity, were calculated from the transient response curves of Figure 4 where $f_o = 4.5$ megacycles and $m = 1.0$, 0.67 , and zero, respectively, the per cent response being considered directly equivalent to per cent light intensity produced by the kinescope since we have assumed the use of adequate compensation for the aperture losses‡. The abscissas of curves h_1 , h_2 , and h_3 for Figure 5 were determined by letting a unit of time in Figure 4 become the distance traveled by the beam along the screen in the same unit of time. From a comparison of the rates of rise of curves h_1 and v of Figure 5 it is evident that for a 343-line picture the horizontal resolution theoretically obtainable is much better than the vertical resolution. In fact, even the relatively poor frequency characteristic $m = 0$ as represented by h_3 , would provide only about 10 per cent less horizontal than vertical resolution.

* The two types of resolution also are related in apparatus cost since the cost of the amplifiers is a function of the video-frequency band width which is received and also because any steps taken to reduce the size of the scanning spot, such as operating at a higher anode voltage which increases the receiver cost, are apt to improve both vertical and horizontal resolution in the same order.

† The data for curve v of Figure 5 was obtained from curve v of Figure 2 by multiplying the abscissa by a factor 0.324, (because one line pitch of a 343-line picture is 100/309 per cent of the picture height) and then shifting the origin of the abscissa scale. Suitable allowance is made for loss of 10 per cent of the vertical lines due to vertical blanking and for 15 per cent loss of length of each scanning line in calculating these curves and those curves which follow involving horizontal transitions and horizontal resolution. An aspect ratio of 4/3 was used in all cases.

‡ The negative values of light intensity shown cannot exist as it means only that the kinescope is driven beyond cut-off. For transitions from gray to white the negative portions would be interpreted to mean another shade of gray.

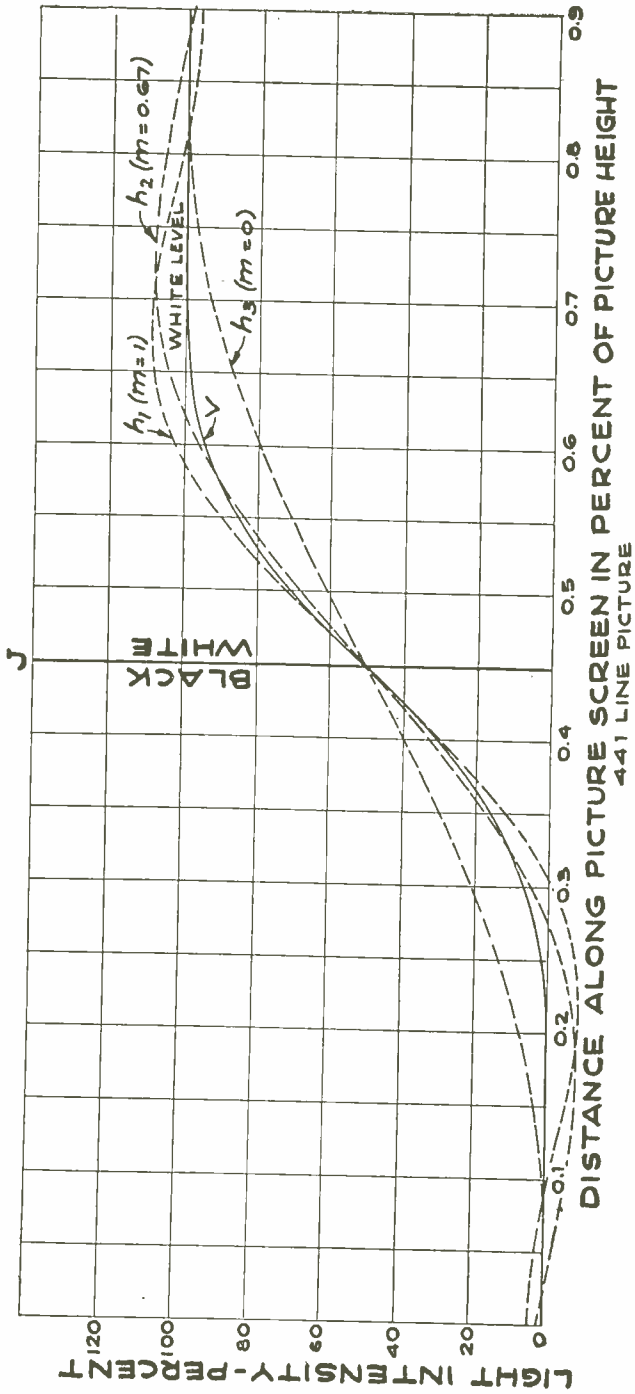

Fig. 6—Same as Figure 5 except for 441 lines.

In a similar manner Figures 6, 7, and 8 have been prepared to compare the transitions obtained in pictures having 441, 507, and 605 scanning lines, respectively. By inspection of these curves it can be seen readily that the frequency characteristic $m = 0.67$ provides about equal vertical and horizontal resolution for a 441-line picture and that the best frequency characteristic, $m = 1$, provides about equal vertical and horizontal resolution for a 507-line picture. Figure 8 shows that in a 605-line picture the vertical resolution is much better than the horizontal resolution provided by the best frequency characteristic, $m = 1$.

Before drawing conclusions as to the specific number of scanning lines for the greatest utilization of the available transmission bands, it is desirable to summarize the major observations drawn from inspection of Figures 5, 6, 7, and 8 in another set of curves.

In Figure 9, the vertical resolution V in arbitrary units has been plotted against the number of lines in the picture. Curve V is a straight line through the origin because the number of scanning lines determines the vertical resolution explicitly when the size of the scanning spot is constant in terms of the scanning-line pitch. The horizontal-resolution curve H_1 has been drawn with ordinates which vary inversely as the number of lines or such that the product of H_1 and V is constant. This relation between horizontal resolution and vertical resolution is valid for any other reasonable criterion for measuring resolution as well as the reproduction of an abrupt junction from black to white. Curve H_1 (for $m = 1$) was made to intersect curve V at that number of lines (507) for which the vertical resolution and the horizontal resolution are essentially equal as seen by inspection of Figure 7. This condition determines curve H_1 uniquely. Then we may say that the curves V and H_1 of Figure 9 are plots of vertical and horizontal resolution in the same arbitrary units when measured by the criterion of response to an abrupt junction.

The curve H_2 (for $m = 0.67$) is similar to H_1 except that the intersection with V is at 441 lines as indicated by the close agreement of curve h_2 and v in Figure 6. Curve H_3 also was drawn such that its ordinates vary inversely as the number of lines, but the value of H_3 was made about 10 per cent lower than V at 343 lines since by inspection of Figure 5, h_3 is about 10 per cent less steep than v for this number of lines.

(6) PICTURE REPETITION RATE

Since the speed of the scanning spot along the scanning lines is proportional to the picture-repetition rate, the steepness of the curves h_1 , h_2 , and h_3 of Figures 5, 6, 7, and 8 and the ordinates of H_1 , H_2 , and

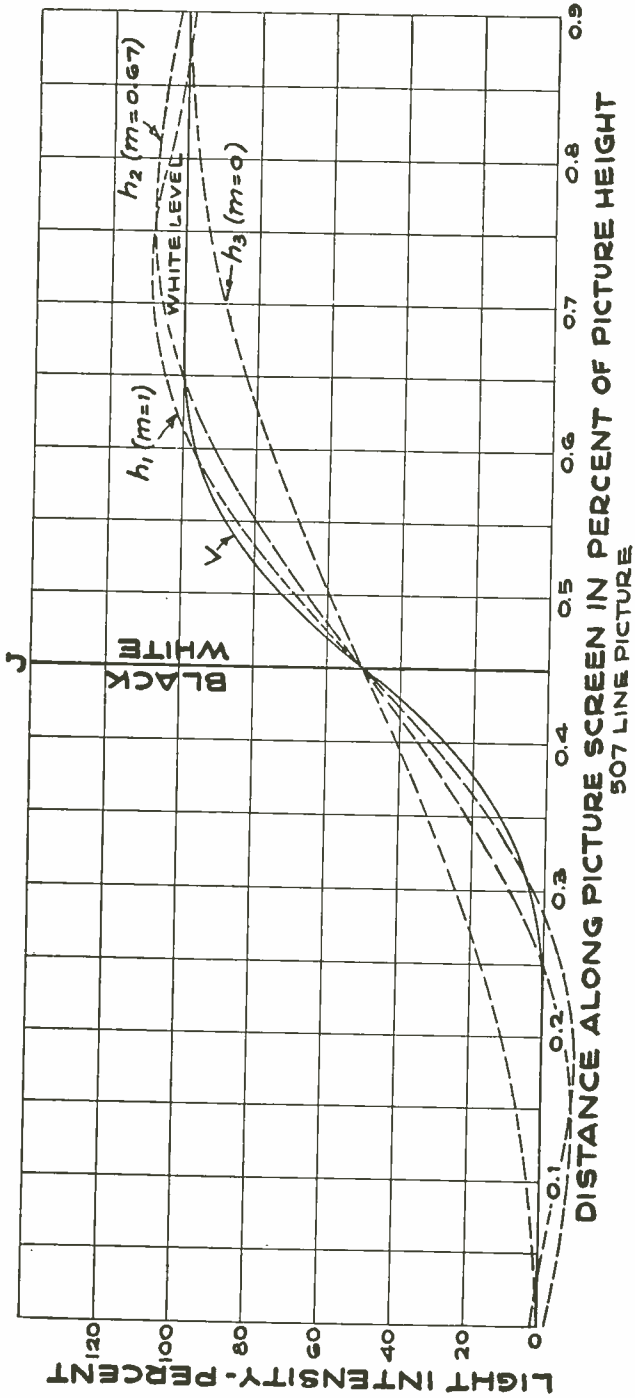

Fig. 7—Same as Figure 5 except for 507 lines.

H_3 of Figure 9 would vary inversely as the repetition rate. The net effect is that the number of lines which will provide a prescribed ratio of horizontal and vertical resolution will vary inversely as the *square root* of the picture-repetition rate.

The present study has been based upon the assumption of a frame frequency of 30 per second, interlaced. The corresponding field frequency is 60 per second, a number which has the advantage of dividing into the fundamental and harmonic frequencies of the prevalent 60-cycle power circuit a whole number of times. Let us briefly digress to review the possible advantages and disadvantages of several other frame frequencies.

A system using 24-frames and 48 interlaced fields per second appears attractive due to increased resolution or saving in frequency band. However, if the present study had been based upon 24 frames per second the suggested number of lines would be only 12 per cent higher. Unfortunately the 24-frame system is vulnerable to several serious defects. As a consequence of cross-talk in the transmitting equipment and the receiver, the kinescope beam is subject to small spurious modulation and deflection at 60- and 120-cycles. The beating with the 48-cycle field deflection causes adjacent fields to have different brightnesses and different positions on the screen. The result is 12- and 24-cycle flicker and motion in various areas of the scanning pattern as discussed in an earlier paper.⁶ In addition to the usual types of cross-talk between electric circuits, the kinescope beam is deflected by the 60-cycle stray magnetic field of the power transformer.

By the use of additional electric filtering, electric shielding, magnetic shielding and careful transformer placement the cross-talk can be reduced to tolerable values, but the residual spurious deflection (though not readily detectable) will still reduce the theoretical vertical and horizontal resolution by at least a part of the theoretical gain. The 24-frame interlaced picture will also have appreciable inter-line flicker due to the low repetition rate (particularly for the brighter pictures) that will contribute further to eye fatigue.

One source of interference tending to cause flicker at a rate of 24 cycles per second that could not be avoided by the television engineer is the 120-cycle photo-electric pick-up by the camera from the 60-cycle light source generally present at the site of outside pick-up programs. The authors are convinced that the defects of a 24-frame system enumerated above appreciably outweigh the *theoretical* gain of only 12 per cent in horizontal and vertical resolution.

⁶ R. D. Kell, A. V. Bedford and M. A. Trainer, "Scanning Sequence and Repetition Rate of Television Images", *Proc. I.R.E.*, Vol. 24, No. 4, pp. 559-576, April, 1936.

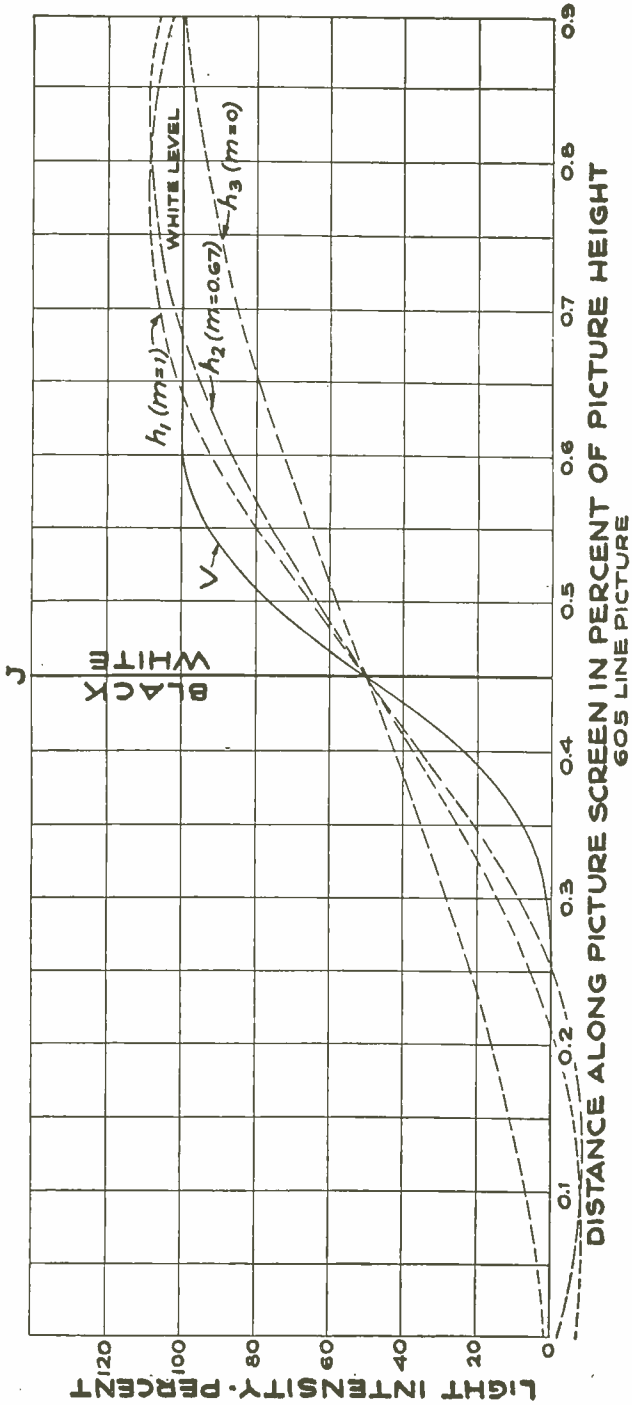

Fig. 8—Same as Figure 5 except for 605 lines.

A frame frequency of 15 per second has been seriously considered because it has the desired relation with the power frequency and because it theoretically would allow an increase of about 41 per cent in the vertical and the horizontal resolution within the available video band. Of course the low-field frequency of 30 would cause an intolerable amount of flicker unless sufficient light-storage were used in the receiver, such as conceivably might be provided by a suitable luminescent screen having long retentivity. However, if the screen material had a gradual rate of decay of light in common with the thousands of materials already reported, the picture would be badly smeared when the subject moved. On the other hand if at a future date an ideal picture-storage device should become available for providing uniform brightness for each entire frame period followed by an abrupt replacement by the next frame, flicker would be eliminated, but rapid motion in the subject would appear rather jerky. It is therefore very probable that a 30-frame-per-second interlaced system will afford a greater net service to the public.

(7) CHOICE OF NUMBER OF SCANNING LINES

It is clear that if the vertical resolution and horizontal resolution are *grossly* different, most of the excess value of the greater is lost due to the observer's tendency to choose a viewing position where his eyes, rather than the lower resolution, limit his realized resolution. At this viewing position it is evident that the observer obtains no appreciable benefit from the excess portion of the greater resolution. If the difference between the two resolutions is relatively small, say 20 per cent, the excess is not entirely lost in every case, because it is known that observers do not or can not generally adjust their viewing distance so critically that all of the excess of the higher resolution is unappreciated. Nevertheless, the various viewing distances used will tend to vary about the position where the eye limits the realized resolution. Hence, even when the excess of one resolution is small, the benefit from the excess portion of resolution will be less than from a similar-valued portion of the lesser resolution.

Generally the subjects to be transmitted by a television system for domestic service will be varied and will require substantially equal vertical and horizontal resolution for satisfactory results. Then upon the assumption that the vertical and horizontal borders and outlines of objects and areas in the picture are of equal value in defining the objects and areas, any increase of definition of either vertical or horizontal borders or outlines at the expense of the other definition must detract from the completeness with which the object is defined

as a whole.* Therefore, from the point of view of resolution only, the number of lines should be such as to provide "equal vertical and horizontal resolution." However, there are several other qualifying and limiting conditions affecting the choice of number of scanning lines which will be discussed; but for the moment we shall assume that a condition of equal vertical and horizontal resolution makes optimum use of available facilities and determines the number of lines.

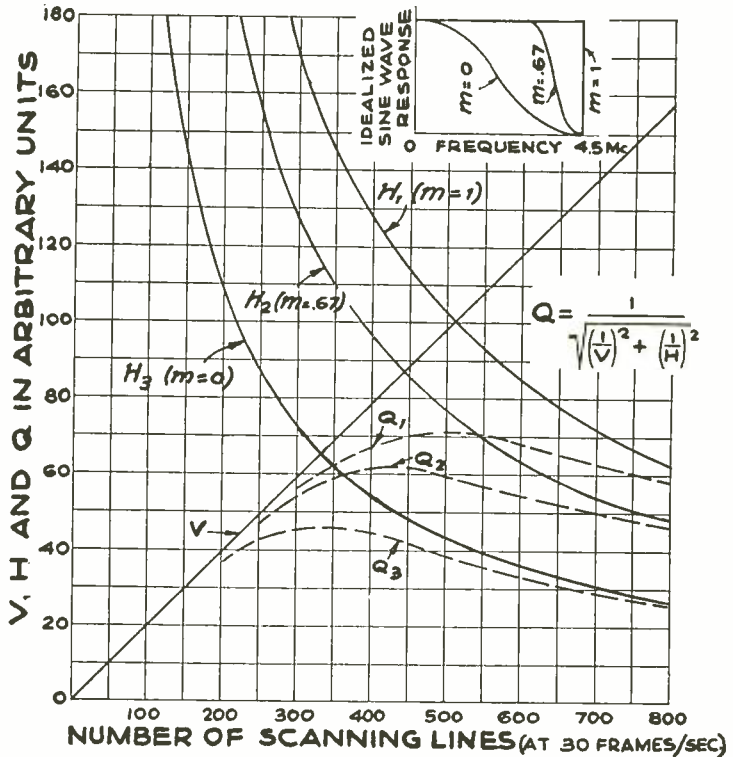

Fig. 9—The V and H -curves are vertical and horizontal resolution, respectively, provided by receivers having the idealized over-all frequency characteristics shown in the insert. The Q -curves are intended to indicate the corresponding picture quality as a function of the number of scanning lines.

By application of only the criterion of "equal resolutions" the optimum number of lines may still be 507, 441, 290, or some other value depending upon the response characteristic of the typical receiver

*Certain tests made in a recording "facsimile" system indicate that a typed page has maximum legibility when the horizontal resolution of the system is somewhat greater than the vertical resolution. This is due to the predominance of vertical strokes in the average typed page and the close spacing of the letters along the typed line compared with the line-to-line spacing. In order to accommodate many such transmissions most efficiently the vertical and horizontal resolutions are generally made unequal in facsimile systems.

assumed as seen by the points where V intersects H_1 , H_2 , and H_3 in Figure 9. It is expected that the fidelity of response of commercial receivers will vary with the price class of the receiver and with the future state of development of the art. Then since only a single number of scanning lines must be chosen to operate with all the types of receivers, it is desirable to know the relative quality of the pictures of receivers, it is desirable to know the relative quality of the pictures received by the different receivers for different numbers of lines.

Curve Q_1 (for $m = 1$) in Figure 9 is intended to express an index of picture quality as a function of the number of the lines and a fixed-video response. According to curve Q_1 , the quality is reduced as the number of lines is varied above and below that corresponding to equal values of H_1 and V_1 . Q is calculated from the formula

$$Q = \frac{1}{\sqrt{\left(\frac{1}{V}\right)^2 + \left(\frac{1}{H}\right)^2}} \quad (2)$$

The assumption is that the vertical blur, $1/V$ and the horizontal blur, $1/H_1$ may be regarded as vectors at right angles. The formula effectively adds these vectors and obtains the reciprocal of the sum, a number which appears to be related to the net resolution provided by V_1 and H_1 . Admittedly, this procedure is arbitrary, but it has some logical support and has been partially verified as an equation of practical significance by a series of specific viewing tests.

Curves Q_2 (for $m = 0.67$) and Q_3 (for $m = 0$) were calculated by using the values of H_2 and H_3 instead of H_1 in Eq. (2). Each Q -curve is a maximum at the number of lines which provide equal vertical and horizontal resolution. Due to insufficient evidence presented here concerning the reliability of Eq. 2, the curves Q_1 , Q_2 , and Q_3 will be used only as a qualitative aid in visualizing how picture quality may be impaired when H and V are appreciably unequal. None of our conclusions will depend upon numerical values taken from the Q -curves.

There are several factors which tend to reduce the horizontal resolution of a receiver operating under practical receiving conditions:

(1) Multiple-path reception of the radio wave. (This depends upon terrain, obstacles, and reflectors such as buildings. No known remedy gives complete relief in many receiving locations so that

* In these tests a calibrated test pattern consisting of converging bars (see Reference 2) was reproduced by a television receiver having a fixed-band width with the test bars placed at 45° to the scanning lines, such as to indicate resolution in a diagonal direction. The number of scanning lines was changed in small steps over a wide range. The average values of readings by five observers were plotted and found to conform quite closely to curve Q_3 of Figure 9.

multiple-path reception is probably a permanent factor of consequence.)

(2) Accumulated-phase and amplitude errors in the transmitting and receiving system⁵. (This is likely to be appreciable particularly in chain programs in which the residual imperfections of equalization for the repeaters and links have an opportunity to "add up.")

(3) Imperfect aperture compensation. (Since aperture compensation requires an increase in the high-frequency response without the introduction of non-linear phase shift, rather complex correcting circuits are required. Due to cost considerations, a compromise solution is likely. Precompensation in the transmitter may offer a partial solution of this problem.)

(4) Vestigial side-band transmission. (Kell and Fredendall⁷ and other writers have shown that inherent imperfections in the horizontal transitions occur, due to the absence of most of one of the side bands, even when only ideal filters are used. This effect is important only when high modulation is used.

It is impossible to evaluate accurately the effects enumerated above, but it is reasonably estimated that they may be on an average of such value that a receiver which is perfect for the available 4.5-Mc video band (as indicated in Figure 9 by $m = 1$) would provide actual horizontal resolution poorer than that shown by H_2 (for $m = 0.67$).

Considered only from the point of view of the overall-frequency characteristic, a receiver having the characteristic which we have indicated by $m = 0$, is very poor compared with the measured response of a certain existing commercial receiver of good quality. However, the measured transient response of the commercial receiver proved to be very comparable in rate of rise to the theoretical transient response for the $m = 0$ receiver, due to the phase distortion associated with circuits employed for rejecting adjacent channel interference. Nevertheless, this receiver demonstrated that it was capable of reproducing a satisfactory 441-line picture. It is to be expected that most commercial receivers will fall short of even the effective fidelity indicated by the curves for $m = 0.67$. In order not to penalize the receivers of this general fidelity excessively, the number of lines should not be much above 441 (see Figures 6 and 9).

It is known that as the number of scanning lines is increased the objectionableness of the line structure of the picture is reduced. Even though the limitation of resolution is generally subject to more serious criticism than the visibility of the line structure it should still be

⁷ R. D. Kell and G. L. Fredendall "Selective Side-Band Transmission in Television." *RCA REVIEW*, Vol. IV, No. 4, pp. 425-440, April, 1940.

economical to shift the choice of the number of scanning lines slightly upward from that determined solely by considerations of resolution.

The line structure of the picture can be altered by changing the size, shape, and light distribution of the scanning spot. The circular receiving spot with cosine-squared distribution of intensity was chosen for this study because such a spot permits high-average light intensity in present practicable kinescopes. A size of spot giving 50 per cent overlap was chosen as a reasonable compromise between loss of resolution for a larger spot on one hand, and a loss of light and a more apparent line structure on the other hand.

A uniform rectangular spot with height equal to the line pitch may be considered ideal since it produces an entirely flat field and provides higher resolution than other configurations, such as a cosine-squared spot with 100 per cent overlap⁸, which is also known to produce a flat field. A vertical-transition curve v_s , for the rectangular spot, is plotted in Figure 2 (v_s corresponds to v which is for the cosine-square spot with 50 per cent overlap). Since the rate of rise of v_s is essentially the same as that of curve v the subsequent curves of Figures 4 to 9 would apply substantially as well for the rectangular spot.

It is of interest to note from Figure 7 that if the full possibilities of the 4.5-megacycle video band (represented by $m = 1$) become realizable and the rectangular scanning spot becomes practicable—as results of future engineering development—the optimum number of lines would be about 507.

In view of the several considerations above, we conclude that the use of a number* of scanning lines between 441 and 507 at 30 frames per second allows optimum use of the channels available for a television-broadcast service in the United States. In reaching this conclusion we have satisfaction in the belief that adoption of the number of lines suggested will allow a nearly optimum performance of receivers of present commercial quality and at the same time will not penalize future receivers of improved quality.

⁸ Recommended by H. A. Wheeler and A. V. Loughren, Reference 3. A flat field is one in which no visible line structure is present.

* The number of lines should preferably be multiples of small odd whole numbers in order to facilitate construction of simple electronic synchronizing-signal generators. Numbers 441, 495, 507, 525, 539, 567, 605, 625, etc. satisfy this condition.

It is interesting to note that the number of scanning lines 507 results in $K = 0.85$ when inserted in equation (1) after revision as follows:

$$f = N^2 r a K (1 + t_h) (1 - t_v) / 2$$

where $t_h = 0.15$ = the fractional part of horizontal-sweep period for return time) and $t_v = 0.10$ = the fractional part of vertical-sweep period allowed for vertical-return time.

SOME FACTORS AFFECTING THE CHOICE OF LENSES FOR TELEVISION CAMERAS*†

By

H. B. DEVORE AND HARLEY IAMS‡

Research and Engineering Department, RCA Manufacturing Company, Inc.,
Harrison, N. J.

Summary—The design of a television camera for a particular use involves the selection of a lens which, under the poorest conditions of illumination which are expected, will form a sufficiently bright image to meet the requirements of the pickup tube used. When the size and sensitivity characteristics of the pickup tube and video-frequency amplifier, the required signal-to-noise ratio, and the angle of view of the camera are known, the specifications of the lens can be computed.

If a tube having a sensitive surface of width W inches and an operating sensitivity of s microamperes per lumen is to be used in picking up a scene having a surface brightness B candles per square foot, with a horizontal angle of view α , the following equations can be used to determine the lens to be used:

$$\text{focal length: } F = \frac{W}{2} \cot \frac{\alpha}{2} \text{ inches}$$

$$\text{numerical aperture: } f = \frac{0.064 W \sqrt{TBs}}{\sqrt{10^6 I_n N}}$$

in which T is the light-transmission factor of the lens, I_n is the equivalent root-mean-square noise current at the input of the amplifier used with the tube, and N is the required signal-to-noise ratio.

The paper discusses the derivation of these equations and includes charts to facilitate computations.

Comparison of predicted results with the observed performance of the apparatus have shown good correlation.

THE public would like to see television pictures of many events, sometimes of subjects that are difficult to transmit. The engineer often wishes to know beforehand whether the camera available will produce the desired results, or how to design one which will. The purpose of this discussion is to outline the factors involved in such a design, particularly matters related to the choice of a lens suitable for the pickup tube which is to be used.

* Decimal classification: R583.12.

† Reprinted from *Proc. I.R.E.*, August, 1940.

‡ Now with the Research Department, RCA Laboratories Division, Princeton, N. J.

THE RCA PORTABLE TELEVISION PICKUP EQUIPMENT*†

BY

G. L. BEERS,^a O. H. SCHADE,^b AND R. E. SHELBY^c

Summary—Spot news, athletic events, parades, etc., form an important source of television program material. In the spring of 1938, field experiments were started in New York City with mobile television pickup equipment. Two telemobile units were used each of which was about the size and shape of a 25-passenger bus and weighed 10 tons. The limitations of these telemobile units are discussed. Lightweight television pickup equipment has recently been developed. The new equipment includes a small iconoscope camera, camera auxiliary, camera-control, and synchronizing-generator units, and an ultra-high-frequency relay transmitter and receiver. Most of the units are about the size of a large suitcase and weigh between 40 and 70 pounds. Each of the units is described and some of the practical applications of the equipment are indicated.

INTRODUCTION

IN the spring of 1938 field experiments were started in New York City with mobile television pickup equipment. Two telemobile units were used, one of which contained standard rack-mounted equipment for two cameras and the other housed a 159-megacycle 300-watt transmitter. Each unit was about the size and shape of a 25-passenger bus and weighed 10 tons. The total power required to operate both units was approximately 20 kilowatts. Field tests with the mobile units have definitely proved their usefulness in providing entertaining television programs. The size, weight, and power requirements of these units, however, have imposed definite restrictions on their use. In order to minimize these restrictions light-weight portable television pickup equipment has recently been developed. It is the purpose of this paper to describe the several units of this equipment and indicate some of its possible applications.

* Decimal classification: R583.

† Presented at the New York Meeting of the I.R.E. on April 3, 1940. Reprinted from *Proc. I.R.E.*, October, 1940.

^a RCA Manufacturing Company, Inc., Victor Division, Camden, N. J. Now Asst. Director of Engineering in Charge of Advanced Development, RCA Victor Division, Camden, N. J.

^b RCA Manufacturing Company, Inc., RCA Radiotron Division, Harrison, N. J. Now the Tube Department, RCA Victor Division, Harrison, N. J.

^c National Broadcasting Company, Inc., New York, N. Y.

GENERAL CHARACTERISTICS OF THE EQUIPMENT

Past experience with all types of television pickup equipment has shown that it is desirable to locate all the control equipment at some central point if effective program supervision with a minimum of personnel is to be obtained. It is therefore essential that provision be made in portable television pickup equipment so that long lengths of camera cable can be used between the control equipment and the cameras. This requirement was responsible, to a considerable extent, for the division of the equipment into the several units shown in the block diagram in Figure 1. In this diagram the units for a complete system with a single camera are outlined by the solid lines. The

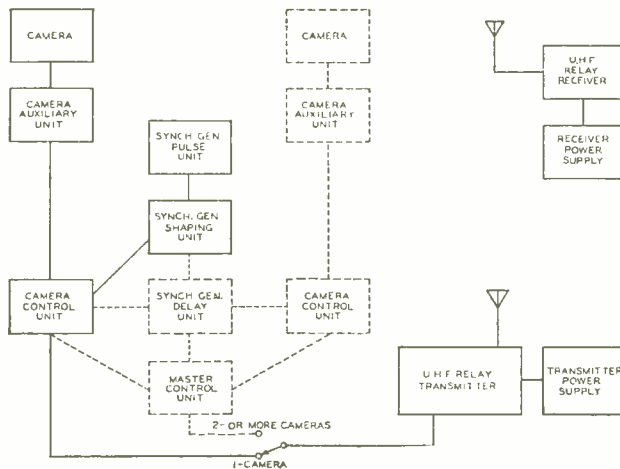

Fig. 1—Block diagram of complete portable television pickup system.

additional units required for a second camera are shown by the dotted lines. The only units which must be duplicated to add a third camera are the camera auxiliary and camera-control units. The receiver shown in the diagram is normally located at or near the main television transmitter and is therefore not a part of the equipment which must be transported to the remote pickup point.

The equipment is designed to produce synchronizing signals in accordance with the Radio Manufacturers Association standards. All the video-frequency amplifiers are adjusted to pass a frequency band from 30 cycles to 5 megacycles. Lengths of camera cable up to 500 feet can be used between the camera and camera-control equipment so that any two cameras can be separated by distances up to 1000 feet.

The specifications of the lens are determined by the size and sensitivity characteristics of the pickup tube to be used, the brightness of the scene, the noise characteristics of the pickup tube and the video-frequency amplifier, the required signal-to-noise ratio, and the angle of view of the camera. These factors determine the focal length and diameter of the lens. The lens having thus been specified, it is of interest to determine the depth of field for the system. However, as increasing depth of field and brightness of image impose contradictory requirements on the aperture of a lens, the depth of field can only be increased with a given pickup tube at the expense of signal-to-noise ratio in the transmitted picture.¹

The operating sensitivity of a pickup tube may be affected by a number of factors and a direct quantitative comparison of different tubes is, therefore, quite difficult to make. This operating sensitivity, depending on the manner in which the tube operates, may differ greatly from the photosensitivity of the sensitive surface. By the choice of somewhat simplified conditions, measurements may be made which permit a useful estimate of the operating sensitivity. The method of measurement has been described in a recent publication.²

A spot of light is made by forming on the sensitive surface of the pickup tube an image of a slit illuminated by a lamp operated at a color temperature of 2870 degrees Kelvin. This color temperature had become standard for phototube data, and so has also been adopted for pickup-tube measurements. The signal from the output of the video-frequency amplifier is observed on an oscillograph which has its horizontal sweep synchronized with the horizontal scanning of the pickup tube. The signal from the slit then appears as a narrow peak superimposed on the base line which represents the signal from the black area of the picture. The amplifier-oscillograph system is calibrated by applying a known alternating current through a small standard resistor in series with the amplifier input. By varying the intensity of illumination in the slit and observing the corresponding signal currents delivered to the amplifier, it is possible to obtain a curve showing the performance of the tube. If the spot of light is moved to any part of a uniformly sensitive surface, the signal output remains constant. Hence, the amplitude of the short pulse of current due to a small spot of light can be taken as a measure of the signal current which would flow continuously if the whole target were lighted.

¹ Harley Iams, G. A. Morton, and V. K. Zworykin, "The image iconoscope," *Proc. I.R.E.*, vol. 27, pp. 541-547; September, 1939.

² R. B. Janes and W. H. Hickok, "Recent improvements in the design and characteristics of the iconoscope," *Proc. I.R.E.*, vol. 27, pp. 535-540; September, 1939.

It has been found convenient to express the operating sensitivity of a pickup tube under given conditions as the quotient of the signal current produced at the amplifier input by scanning the slit of light, divided by the light flux required to illuminate the entire picture at the intensity of the slit image. The sensitivity (within a substantially linear part of the characteristic curve) may be expressed in units of microamperes per lumen. This form of expression for tube sensitivity has two advantages. The curves for different tubes may be compared directly; size or type of tube is immaterial. Second, computation of the signal output is simplified. Since the output impedances of nearly all pickup tubes in general use are high compared with normal amplifier input impedances, the signal, expressed in microamperes of modulated

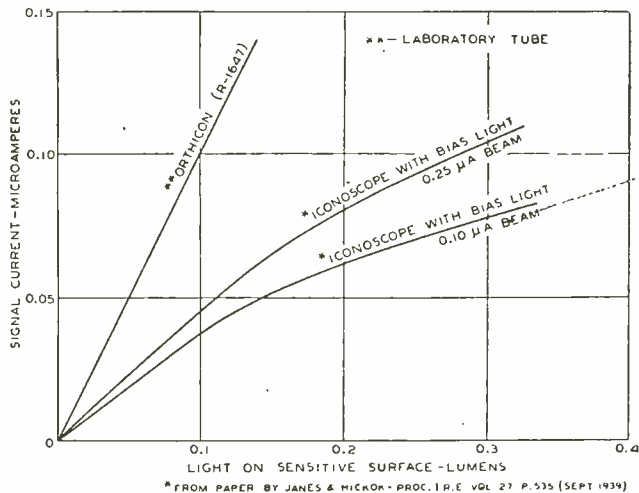

Fig. 1

current, is independent of the amplifier input resistance which is used. (The noise level in the amplifier, however, depends upon the capacitance of the pickup tube and input circuit.) The curves of Figure 1 represent the performances of some typical pickup tubes.

The tubes for which the characteristics are given in this figure are laboratory models, and the curves are not necessarily to be taken as being representative of these classes of tubes. They are, rather, presented to illustrate a convenient form for representing the sensitivity of a pickup tube.

These curves will not necessarily be accurate for subjects other than a light spot on a black background, but it is believed that the relative forms and positions of the curves will be maintained for other typical scenes.

The signal output which is required of a pickup tube is determined by the background "noise" originating in the pickup tube and amplifying system used with the tube. Since signal and noise will be amplified together, an initially unsatisfactory signal-to-noise ratio can never be improved. The noise generated in the pickup tubes which do not use electron multipliers is small compared with that originating in the amplifier. The simplest input for the amplifier is that in which the signal current of the pickup tube flowing through an input resistor produces a potential drop which is applied to the grid of the first tube, usually a high-transconductance pentode. The noise current originating in this type of amplifier consists of two significant components: thermal-agitation noise developed in the input impedance, and current fluctuations in the plate circuit of the tube. The mean-square, thermal-agitation-noise current is given by

$$d \overline{i_t^2} = \frac{4kT}{R} df \quad (1)$$

for a frequency band df , in which R is the input resistance, T the temperature in degrees Kelvin, and k the Boltzmann constant. The tube noise may be conveniently expressed in terms of the equivalent resistance which, connected between grid and cathode, would cause mean-square current fluctuations of the same magnitude in the plate circuit by reason of thermal agitation, the resistor being assumed to be at 300 degrees Kelvin. Data giving values of this equivalent resistance for a number of tubes are available in the literature. If this resistance is denoted by R_t , the equivalent mean-square fluctuation current in the input circuit resulting from the tube is

$$d \overline{i_s^2} = 4kTR_t \left[\frac{1}{R^2} + (\omega C)^2 \right] df \quad (2)$$

in which C is the total input capacitance (pickup tube, amplifying tube, and circuit).

The total equivalent input noise current caused by the tube and circuit is obtained by adding (1) and (2)

$$d \overline{i_n^2} = d \overline{i_t^2} + d \overline{i_s^2} = 4kT \left\{ \frac{1}{R} + \frac{R_t}{R^2} + R_t (\omega C)^2 \right\} df. \quad (3)$$

The second term R_t/R^2 is, for any probable values of R_t and R , entirely negligible. The total current is obtained by integrating (3) over the pass band of the amplifier and is

$$\overline{I_n^2} = \int_0^{f_m} \overline{i_n^2} df = \frac{4kT}{R} f_m \left\{ 1 + \frac{R_t R (\omega_m C)^2}{3} \right\}. \quad (4)$$

The root-mean-square noise current will then be

$$\overline{I_n} = 2 \sqrt{\frac{kT}{R} f_m \left\{ 1 + \frac{R_t R (\omega_m C)^2}{3} \right\}}. \quad (5)$$

Analyses of more complicated input circuits have indicated that these do not give any appreciable reduction in noise level as compared with this simple one.

When part of the amplification is obtained by means of an electron multiplier, as in some dissector tubes, a different expression should be used to determine the effective noise current. In this case, the noise originates predominantly at the photocathode. The expression for equivalent noise current at the cathode as given by Larson and Gardner³ has the form

$$i_{\Delta t} = \sqrt{\frac{i_0 e}{\Delta t}}$$

where $i_{\Delta t}$ = the current responsible for the noise,

i_0 = the current for one picture element,

e = the electronic charge, and

Δt = the time for the transmission of one picture element.

This expression may be converted to the following formula for root-mean-square noise current at the input of the multiplier

$$\overline{I_n} = \sqrt{2e i_0 f_m}.$$

The signal-to-noise ratio (N) which is required for a television picture has been discussed by Zworykin, Morton, and Flory.⁴ Their

³ C. C. Larson and B. C. Gardner, "The image dissector," *Electronics*, vol. 12, pp. 24-27 and 50; October, 1939.

⁴ V. K. Zworykin, G. A. Morton, and L. E. Flory, "Theory and performance of the iconoscope," *Proc. I.R.E.*, vol. 25, pp. 1071-1092; August, 1937.

conclusions are that for an average picture, the ratio of peak picture signal to root-mean-square noise of 3 to 1 is highly objectionable; 10 to 1 gives an acceptable picture, while 30 to 1 is excellent. A ratio of 10 to 1 may be assumed to be the minimum useful value. For this ratio, the signal current which the pickup tube must deliver can be computed, and from the sensitivity of the tube, the total light which must be projected on its sensitive surface can be calculated. For the case of the conventional amplifier.

$$L = \frac{10 \bar{I}_n}{s \times 10^{-6}} = 10^7 \frac{\bar{I}_n}{s} \quad (6)$$

L being the light flux in lumens and s the operating sensitivity in microamperes per lumen.

The first consideration in the selection of a lens which will deliver this amount of light to a given television pickup tube is the field that must be covered. This may be expressed as the angle of view of the transmitted picture measured in a horizontal plane. The specification of the angle of view determines the focal length of the lens, which may be computed from the formula

$$F = \frac{W}{2} \cot \frac{\alpha}{2} \quad (7)$$

in which W is the width of the sensitive area of the tube and α is the horizontal angle of view.

The choice of the angle of view determines the effective magnification of the picture. It is generally accepted that the most favorable viewing distance for a television picture is about five times the height of the picture. At this point the distance between two successive scanning lines in a 441-line picture subtends an angle of about 1.7 minutes, which is approximately the resolution limit of the eye. The width of the picture subtends an angle of about 15 degrees. If the camera uses a lens which covers this angle of view, the reproduced image will have the same appearance as the original scene viewed from the camera. With a lens which gives an angle of view of 30 degrees, the reproduced picture will have the same appearance as the original scene viewed by an observer at a distance from the scene about twice that of the camera. The perspective will, of course, be somewhat faulty, but considerable distortion of the perspective is tolerable, as photographic experience has shown.

The angle of view being given, the diameter which a lens must have to enable a scene of specified brightness to be picked up satisfactorily is determined by the amount of light which must fall on the sensitive area of the tube.

The intensity of illumination in the image formed on a plane surface by a lens has been worked out by a number of people. A useful expression has been given by Goodwin.⁵ For a uniform source having a brightness of B candles per square foot, the intensity in the image is

$$E = \frac{\pi BT}{4f^2} \cos^4 \theta \quad (8)$$

lumens per square foot, where T is the transmission factor, f is the focal number of the lens, and θ is the angle to the axis of the system made by a light ray striking the area under consideration. For large angles of view, the intensity at the edges of the image falls off rapidly compared with that at the center. While observing that such a decrease in intensity across the field is present, it is convenient for the purposes of calculation to assume that the field is uniformly illuminated at the intensity that exists at the center. This is, to some extent, justified by the fact that the center of interest in a picture is in general in the center of the field.

In a tube in which the sensitive surface has a width W and an aspect ratio 4:3, the area of this surface is $3/4 W^2$, and the light falling on it is

$$L = \frac{3\pi}{16} \frac{BTW^2}{f^2} \quad (9)$$

Solving (9) for the numerical aperture, we obtain

$$f = \frac{0.77W \sqrt{T}}{\sqrt{L/B}} \quad (10)$$

As B is given in candles per square foot and L is in lumens, then W must be expressed in feet. A more convenient expression is

$$f = \frac{0.064W \sqrt{T}}{\sqrt{L/B}} \text{ with } W \text{ given in inches.} \quad (11)$$

⁵ W. N. Goodwin, Jr., "The Phototronic photographic exposure meter," *Jour. Soc. Mot. Pic. Eng.*, vol. 20, pp. 95-118; February, 1933.

The transmission coefficient of the lens T , which represents chiefly losses by reflection at the air-glass surfaces in the lens, depends on its structure. Values given in the literature for typical lenses range from 40 to 70 per cent transmission, being generally lower as the lens aperture increases. For purposes of calculation a value of 60 per cent may be taken as a reasonable mean. For this value,

$$f = \frac{0.050W}{\sqrt{L/B}}. \quad (12)$$

This relationship is plotted in the curves of Figure 2.

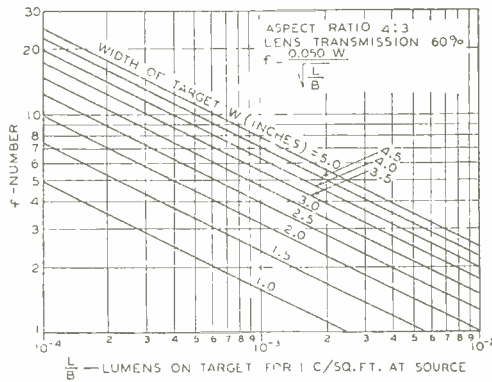

Fig. 2

The lens diameter may be found from the expression

$$A = \frac{F}{f}. \quad (13)$$

The angle of view and image brightness required by the tube determine completely the lens which must be used for a given brightness of scene. It is also desirable to be able to estimate the depth of field of the system.

If a lens of diameter A and focal length F forms on a plane surface at F_1 an accurately focused image of an object at a distance P_1 , then for any other object distance the image of a point source of light will be a circle having a diameter depending on the object distance. If the maximum tolerable diameter of this "circle of confusion" is δ , then the limiting distances from the lens between which the image will be

considered satisfactorily focused will be given by

$$P_2 = \frac{\frac{FA}{\delta}}{\frac{FA}{\delta P_1} + 1} \quad \text{and} \quad P_3 = \frac{\frac{FA}{\delta}}{\frac{FA}{\delta P_1} - 1} \quad (14)$$

In photographic technique, it has long been accepted that the limit of the tolerable circle of confusion is 0.010 inch on a picture to be viewed at 10 inches distance. That is, δ may subtend an angle of 0.001 radian or about 3.5 minutes. In a television picture the problem of choosing a suitable value for δ is complicated by the scanning process. As the angle subtended by the width of a scanning line at normal viewing distance (1.7 minutes) is about half of the size of the photographically tolerable circle of confusion, it might be expected that the effect on δ of the scanning process should be relatively small.

In an attempt to determine a suitable magnitude for the permissible circle of confusion in the case of television pickup, the following experiment was made. A photograph was made of a number of men located over a range of measured distances from a camera which was accurately focused for infinity. In the picture so obtained, the size of the circle of confusion corresponding to each man's position was calculated from the constants of the camera lens. Reference lines were drawn to take care of subsequent magnification and a lantern slide made from the photograph. This was projected on a number of pickup tubes at several magnifications. In each case judgment was rendered by a number of observers as to the man in the transmitted picture who appeared to represent a dividing point between those in acceptable focus and those definitely out of focus. From these observations the acceptable circle of confusion was calculated. Values were obtained ranging from about 1/120 to 1/180 of the height of the scanning pattern. No differences were noticed among the different types of tubes tested, all of which were capable of better than 450-line resolution, as observed from transmission of a standard test pattern.

It seems evident that the departure from perfect focus which is tolerable depends to a considerable extent on the type of subject being transmitted. Much more latitude is certainly permissible in pictures of people than in subjects having high detail contrast, such as a resolution pattern, to take an extreme case. More work along this line is needed before accurate statements can be made concerning depth of field. For the present, it is believed that a useful estimate can be made

by assuming the tolerable circle of confusion to be 1/200 of the picture height, i.e., about two scanning lines. With the standard aspect ratio 4:3,

$$\delta = \frac{3W}{4 \times 200} = \frac{W}{267}. \quad (15)$$

Substituting this in (14) for depth of field, we obtain

$$P_2 = \frac{\frac{267 FA}{W}}{\frac{267 FA}{W P_1} + 1} \quad P_3 = \frac{\frac{267 FA}{W}}{\frac{267 FA}{W P_1} - 1} \quad (16)$$

or, since from (7),

$$\frac{F}{W} = \frac{\cot \frac{\alpha}{2}}{2}$$

$$P_2 = \frac{133 A \cot \frac{\alpha}{2}}{\frac{133 A \cot \frac{\alpha}{2}}{P_1} + 1} \quad P_3 = \frac{133 A \cot \frac{\alpha}{2}}{\frac{133 A \cot \frac{\alpha}{2}}{P_1} - 1} \quad (17)$$

A convenient concept in depth-of-field calculations is that of hyperfocal distance (HD). This is the distance beyond which all objects are in good focus when the lens is focused accurately for infinity. Placing $P_1 = \infty$ in the expression for P_2 in (14), we obtain

$$HD = \frac{FA}{\delta} = 133 A \cot \frac{\alpha}{2}. \quad (18)$$

The expressions for the near and far limits of focus can be rewritten in terms of the hyperfocal distance as follows:

$$P_2 = \frac{HD}{\frac{HD}{P_1} + 1} \quad P_3 = \frac{HD}{\frac{HD}{P_1} - 1} \quad (19)$$

It is seen that when a lens is focused accurately for the distance HD , all objects from $HD/2$ to infinity are in good focus. Further, when the lens is focused for a distance $P_1 = HD/k$ in which k is any constant, the region of good focus extends from $HD/(k + 1)$ to $HD/(k - 1)$.

For a given lens aperture and angle of view, the hyperfocal distance can be read on the chart of Figure 3.

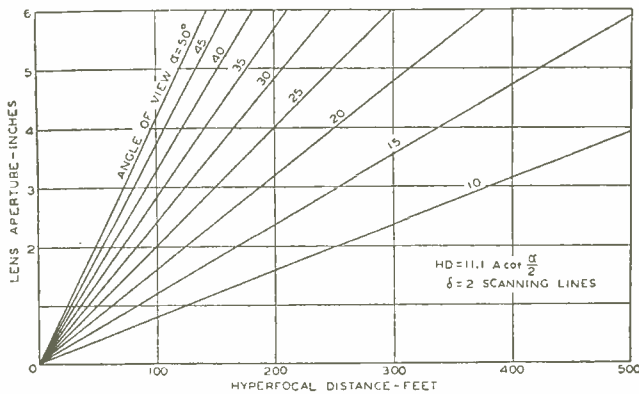

Fig. 3

By way of summary, it might be well to run through a representative series of calculations. Assume that an iconoscope which has a mosaic 4.75 inches wide and a sensitivity of 0.4 microampere per lumen is to be used. The camera is to cover a 30-degree angle of view and is to be used at a baseball park where the brightness of the players is expected to be at least 50 candles per square foot.⁶

From the angle of view and the width of the mosaic, it is found that the required lens must have a focal length of

$$F = \frac{W}{2} \cot \frac{\alpha}{2} = 2.38 \times 3.73 = 8.9 \text{ inches.} \quad (7)$$

⁶ Data relative to the brightness of some typical scenes are given by Harley Iams, R. B. Janes, and W. H. Hickok, "The brightness of outdoor scenes and its relation to television transmission," *Proc. I.R.E.*, vol. 25, pp. 1034-1047; August, 1937.

The preamplifier to be used with the iconoscope uses a type 6AC7/1852 input tube (equivalent grid resistance for noise, 500 ohms) with a 200,000-ohm input resistor. The total tube, circuit, and iconoscope capacitance may be 26 micromicrofarads.

The amplifier has a 4-megacycle pass band. Then the root-mean-square noise current will be

$$\begin{aligned} \bar{I}_n &= 2 \sqrt{\frac{kT}{R} f_m \left\{ 1 + \frac{R_t R (\omega C)^2}{3} \right\}} \\ &= 2 \sqrt{\frac{1.37 \times 10^{-23} \times 3 \times 10^2 \times 4 \times 10^6}{2 \times 10^5}} \\ &\quad \left\{ 1 + \frac{5 \times 10^2 \times 2 \times 10^5 (6.28 \times 4 \times 10^6 \times 2.6 \times 10^{-11})^2}{3} \right\} \quad (5) \end{aligned}$$

$$= 2.2 \times 10^{-9} \text{ ampere.}$$

If the entire mosaic were uniformly illuminated at the brightness of the high lights, the luminous flux required to produce a satisfactory signal-to-noise ratio of 10 to 1 would be

$$L = 10^7 \frac{\bar{I}_n}{s} = \frac{10^7 \times 2.2 \times 10^{-9}}{0.4} = 0.056 \text{ lumen} \quad (6)$$

and for a scene having a brightness of 50 candles per square foot, the ratio $L/B = 0.056/50 = 1.12 \times 10^{-3}$ lumen per candle per square foot.

From the curves of Figure 2 the f number of this lens will be

$$f = 7.1$$

and the lens will have a diameter

$$A = \frac{F}{f} = \frac{8.9}{7.1} = 1.25 \text{ inches.} \quad (13)$$

We find then that the use of an $f/7$ lens of 8.9 inches focal length will permit a picture to be transmitted under the above conditions which will have a just passable signal-to-noise ratio.

From Figure 3 we find the hyperfocal distance of this lens to be

$$HD = 52 \text{ feet.}$$

When this lens is focused at a distance of 52 feet the depth of field will include all objects from 26 feet to infinity. When the lens is focused on an object 20 feet away, the field will include objects between 14.5 feet and 32.5 feet from the camera.

Improvement in the quality of the picture with respect to noise may be obtained by increasing the aperture of the lens. For example, to obtain a signal-to-noise ratio of 30 to 1 would require an $f/4$ lens of the same focal length. This improvement, however, will be accompanied by a corresponding decrease in depth of field ($HD = 88$ feet).

Checks on the usefulness of computations such as those given above have been made in a number of cases, involving several different pickup tubes. The tests were made by observing television pictures transmitted under a variety of conditions, and comparing the picture quality with that which the formulas would lead to expect. From these tests it was found that the computations led to conclusions which were reasonably close to the observer's judgment of picture quality.

THE RCA PORTABLE TELEVISION PICKUP EQUIPMENT*†

By

G. L. BEERS,^a O. H. SCHADE,^b AND R. E. SHELBY^c

Summary—Spot news, athletic events, parades, etc., form an important source of television program material. In the spring of 1938, field experiments were started in New York City with mobile television pickup equipment. Two telemobile units were used each of which was about the size and shape of a 25-passenger bus and weighed 10 tons. The limitations of these telemobile units are discussed. Lightweight television pickup equipment has recently been developed. The new equipment includes a small iconoscope camera, camera auxiliary, camera-control, and synchronizing-generator units, and an ultra-high-frequency relay transmitter and receiver. Most of the units are about the size of a large suitcase and weigh between 40 and 70 pounds. Each of the units is described and some of the practical applications of the equipment are indicated.

INTRODUCTION

IN the spring of 1938 field experiments were started in New York City with mobile television pickup equipment. Two telemobile units were used, one of which contained standard rack-mounted equipment for two cameras and the other housed a 159-megacycle 300-watt transmitter. Each unit was about the size and shape of a 25-passenger bus and weighed 10 tons. The total power required to operate both units was approximately 20 kilowatts. Field tests with the mobile units have definitely proved their usefulness in providing entertaining television programs. The size, weight, and power requirements of these units, however, have imposed definite restrictions on their use. In order to minimize these restrictions light-weight portable television pickup equipment has recently been developed. It is the purpose of this paper to describe the several units of this equipment and indicate some of its possible applications.

* Decimal classification: R583.

† Presented at the New York Meeting of the I.R.E. on April 3, 1940. Reprinted from *Proc. I.R.E.*, October, 1940.

^a RCA Manufacturing Company, Inc., Victor Division, Camden, N. J. Now Asst. Director of Engineering in Charge of Advanced Development, RCA Victor Division, Camden, N. J.

^b RCA Manufacturing Company, Inc., RCA Radiotron Division, Harrison, N. J. Now the Tube Department, RCA Victor Division, Harrison, N. J.

^c National Broadcasting Company, Inc., New York, N. Y.

GENERAL CHARACTERISTICS OF THE EQUIPMENT

Past experience with all types of television pickup equipment has shown that it is desirable to locate all the control equipment at some central point if effective program supervision with a minimum of personnel is to be obtained. It is therefore essential that provision be made in portable television pickup equipment so that long lengths of camera cable can be used between the control equipment and the cameras. This requirement was responsible, to a considerable extent, for the division of the equipment into the several units shown in the block diagram in Figure 1. In this diagram the units for a complete system with a single camera are outlined by the solid lines. The

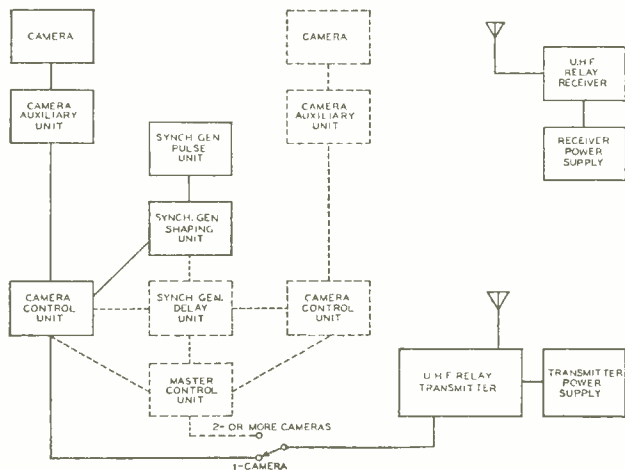

Fig. 1—Block diagram of complete portable television pickup system.

additional units required for a second camera are shown by the dotted lines. The only units which must be duplicated to add a third camera are the camera auxiliary and camera-control units. The receiver shown in the diagram is normally located at or near the main television transmitter and is therefore not a part of the equipment which must be transported to the remote pickup point.

The equipment is designed to produce synchronizing signals in accordance with the Radio Manufacturers Association standards. All the video-frequency amplifiers are adjusted to pass a frequency band from 30 cycles to 5 megacycles. Lengths of camera cable up to 500 feet can be used between the camera and camera-control equipment so that any two cameras can be separated by distances up to 1000 feet.

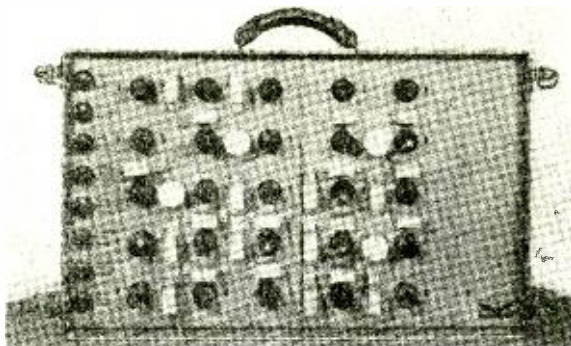

Fig. 2—Synchronizing-generator shaping unit—tube side, cover removed.

The equipment operates from any suitable 110-volt, 60-cycle, single-phase power-supply system. The power consumption for the portable equipment with one, two, and three cameras is 1400, 2000, and 2500 watts, respectively.

All the units are designed to make the tubes and circuit components as accessible as possible. The suit-case type of construction which is used for the camera auxiliary, camera-control, master-control, and three synchronizing-generator units is illustrated by Figures 2 and 3. These photographs show both sides of the synchronizing-generator shaping unit. The accessibility of the tubes on one side of the unit and the circuit components on the other is clearly illustrated. The central chassis portion of the unit is welded to the outside case to form a rigid unit. A view of the complete unit with the side covers in place

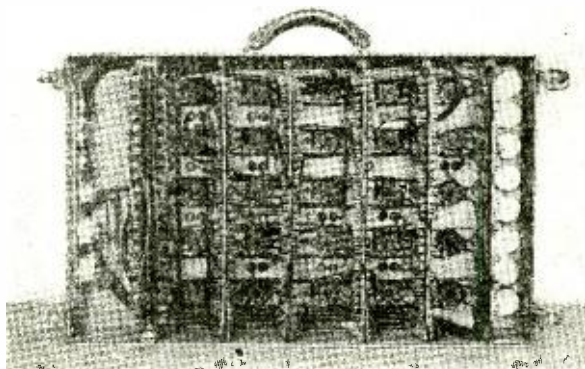

Fig. 3—Synchronizing-generator shaping unit—circuit component side, cover removed.

is shown in Figure 4. The over-all dimensions of the suit-case type units are $8 \times 15 \times 25$ inches and their weights vary between 45 and 72 pounds. The camera weighs 28 pounds and its tripod 30. The weights of the transmitter and its power-supply unit are 60 and 190 pounds. The total weights of the portable pickup equipment less inter-connecting cables for one, two, and three cameras are 550, 850, and 1050 pounds, respectively. These weights can each be reduced by 250 pounds when the equipment is used at locations from which the television signals can be sent by coaxial cable to the main transmitter. The camera cable used with the equipment weighs approximately 0.6 pounds per foot. If 500-foot cables are used with each of three cameras the total weight of these cables is approximately the same as the total



Fig. 4—Synchronizing-generator shaping unit with covers in place.

weight of the equipment units.

The functions of the individual units are discussed in the descriptions which follow.

CAMERA

In order to keep the camera dimensions as small as possible the camera was designed to use the new $4\frac{1}{2}$ -inch iconoscope.

Development work on small iconoscopes has been in progress for several years. As the dimensions of an iconoscope are made smaller with a corresponding reduction in the mosaic area a loss in resolution and sensitivity is normally expected. A new gun structure which has recently been developed has made it possible to obtain adequate resolu-

tion from the 4½-inch iconoscope. Tests on this tube have also shown that its operating sensitivity when using a lens of a given aperture is substantially the same as that of the standard iconoscope. This unexpected sensitivity is attributed to the smaller spacing between the several tube elements which results in a more-efficient collection of the secondary electrons. This increase in the electron-collecting efficiency enables the tube to be operated at a higher average beam current for a given ratio of signal to dark-spot voltage.

Figure 5 is a photograph of the camera mounted on a standard

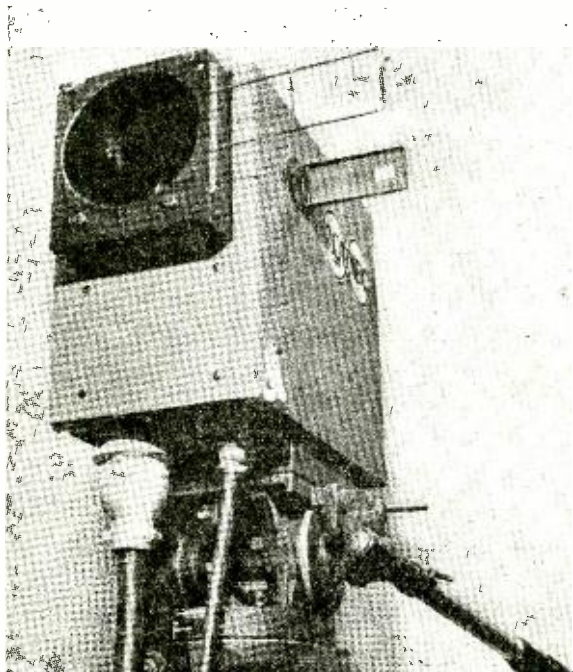

Fig. 5—Portable television camera on tripod.

motion-picture tripod and shows the wire-frame view finder which is used by the cameraman to keep the scene to be televised within the field of the camera. Focusing is done remotely by observing the picture on the kinescope in the camera-control unit. A Selsyn motor at the camera-control unit is used to operate a similar motor in the camera which in turn drives the lens carriage.

The internal construction of the camera is shown by the photographs in Figures 6 and 7. The focusing motor is housed within the

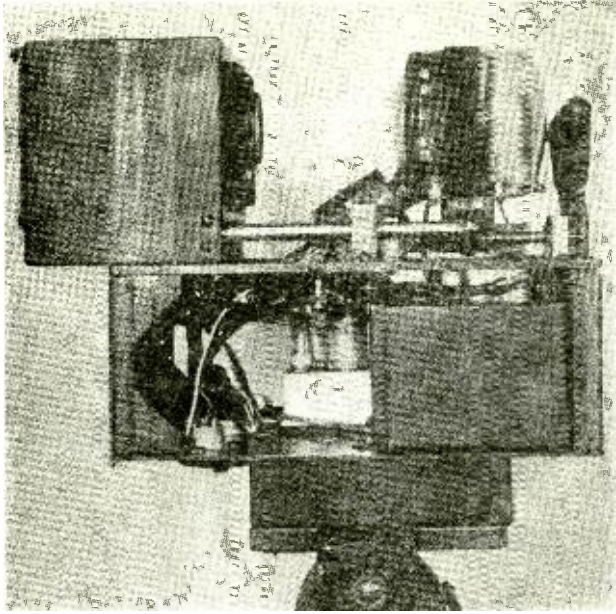

Fig. 6—Right side of portable television camera, cover removed.

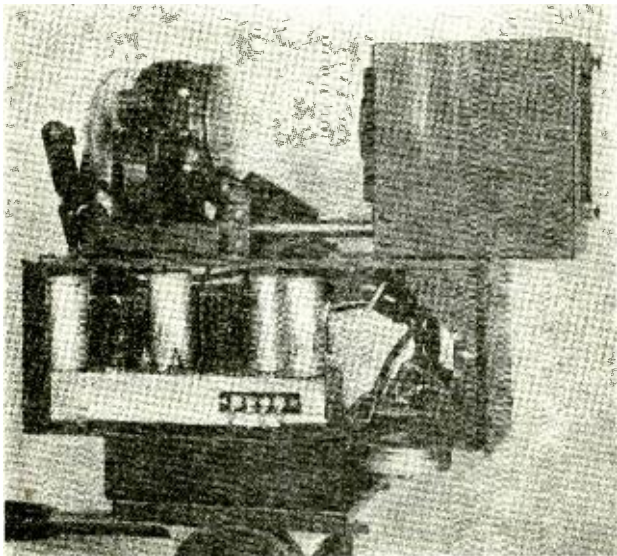

Fig. 7—Left side of portable television camera, cover removed.

rectangular shield which is visible in the lower right-hand corner of Figure 6. The two-stage pre-amplifier which can be seen in Figure 7 is used to raise the picture signals derived from the iconoscope to a satisfactory level to transmit over a short length of coaxial cable to the camera auxiliary unit. The iconoscope with its deflection yoke, the lens carriage, and the two shielded bias lights, which are mounted in back of the iconoscope, are all clearly shown in this photograph.

Figure 8 shows the lens-mounting arrangement. Lenses are interchanged by loosening the four thumbscrews shown in the photograph

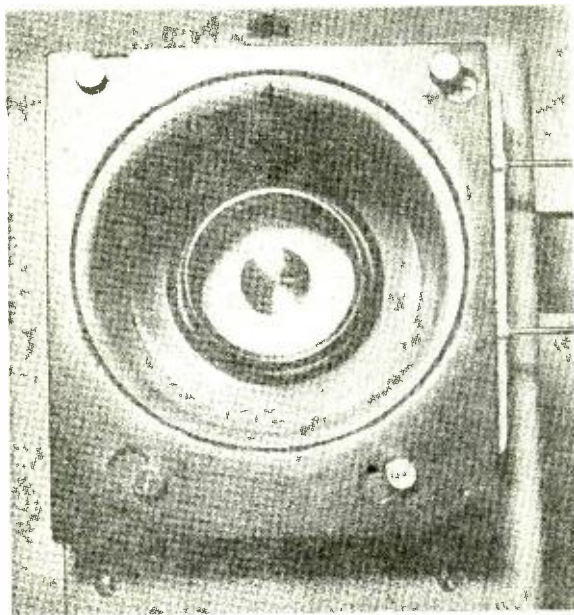

Fig. 8—Portable television camera—lens mounting.

and then rotating the lens mounting slightly in a counterclockwise direction. The complete lens-mounting assembly can then be removed by pulling it forward. Another lens is attached to the camera by reversing the procedure.

CAMERA AUXILIARY UNIT

The problem of obtaining satisfactory deflection of the iconoscope beam when a long length of camera cable is used is greatly simplified when the horizontal deflection power is developed in or near the camera. The use of a camera auxiliary unit makes it possible to meet this

requirement and at the same time keep the dimensions and weight of the camera as small as possible. In addition to the horizontal-deflection circuits the camera auxiliary unit contains a four-stage video-frequency amplifier, iconoscope blanking and protection circuits, and a power-supply rectifier. This unit is connected to the camera through an eight-foot length of camera cable and is usually located between the legs of the camera tripod.

The video-frequency amplifier which contains both a high-frequency peaking and low-frequency losing circuit is used to raise the video-frequency signal from the pre-amplifier in the camera to a sufficient level so that a satisfactory signal-to-noise ratio is obtained at the receiving end of a 500-foot length of camera cable. This amplifier is assembled as a complete unit on a small chassis which is flexibly

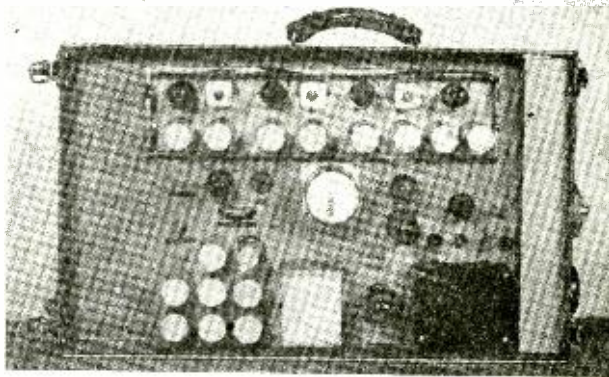

Fig. 9—Camera auxiliary unit—tube side, cover removed.

mounted in an opening in the main chassis of the camera auxiliary unit. The construction of the amplifier and the method of mounting are illustrated in Figures 9 and 10. It will be noted that this construction maintains the general arrangement of having all the tubes accessible from one side of the unit and the circuit components and wiring accessible from the other.

The voltage wave developed across the iconoscope deflection yoke is used to produce a vertical iconoscope blanking pulse. A protective circuit is provided by which the grid of the iconoscope receives a high negative bias if for any reason the deflection of the iconoscope beam is interrupted thereby preventing damage to the iconoscope mosaic. Horizontal saw-tooth waves produced in the camera-control unit are transmitted to the camera auxiliary unit over a flexible coaxial line included in the main camera cable. These waves are amplified by a

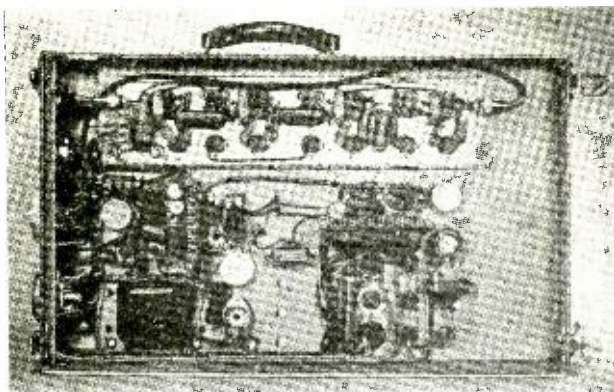

Fig. 10—Camera auxiliary unit—circuit-component side, cover removed.

two-stage amplifier in this unit and fed to the iconoscope deflecting yoke through a step-down transformer. The power-supply rectifier in the camera auxiliary unit supplies anode potentials to all the tubes in both this unit and the camera. A 15-conductor rubber-covered camera cable is used to provide the electrical connections between the camera auxiliary and camera-control units. The outside diameter of this cable is slightly under one inch. As previously stated, lengths of camera cable up to 500 feet can be used between the camera auxiliary and camera-control units.

CAMERA CONTROL UNIT

The camera-control unit is normally the central control point at which all the operating adjustments are made while the equipment is in use. The several functions of this unit are indicated by the block

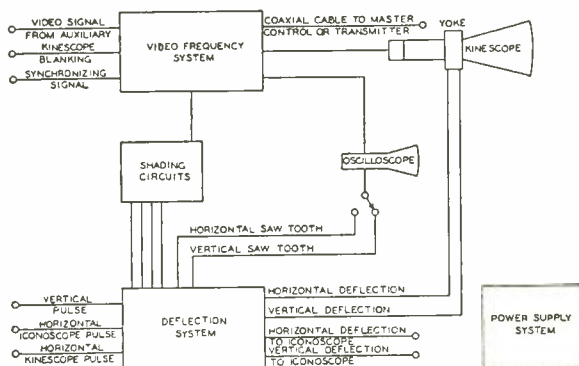

Fig. 11—Block diagram of camera-control unit.

diagram shown in Figure 11. The video-frequency system shown in this diagram amplifies the video-frequency signals received over the camera cable from the camera auxiliary unit. Blanking and shading signals are inserted in this portion of the system. The shading signals which are used are saw-tooth and parabola waves at both line and field frequencies. Controls are provided for varying both the amplitude and phase of these signals. In case only a single camera is used synchronizing signals can be inserted in the video-frequency system of the camera-control unit. Suitable signal potentials are supplied to the seven-inch kinescope which is used to monitor the picture and the two-inch oscilloscope which is used to observe the wave shapes of the picture signals. The video-frequency system is also designed to feed a two-volt peak-to-peak signal to a 75-ohm coaxial cable. Controls are provided for varying the video-frequency gain and the amplitude of the kinescope blanking signals.

In the deflection system line and field-frequency impulses received from the synchronizing generator are used to produce saw-tooth waves which are supplied to the iconoscope, kinescope, and oscilloscope. Provision is made in the synchronizing-generator delay unit for delaying the kinescope horizontal-deflection impulses with respect to the iconoscope impulses. Facilities are included in the camera-control unit for keystoneing the horizontal deflection of the iconoscope. A switch is provided so that horizontal deflection of the oscilloscope at either line or field frequency can be obtained. Kinescope and iconoscope width, height, and centering controls are included. The line and field-frequency saw-tooth waves produced in the deflection system are also used as shading signals in the video-frequency system.

The power-supply system includes a high-voltage rectifier for supplying anode potentials to the iconoscope and kinescope. A low-voltage rectifier is used to supply anode potentials to all the other tubes in the camera-control unit. Focus and bias controls for the kinescope and iconoscope are included in this portion of the system.

Figures 12 and 13 show both sides of the camera control unit with the side covers removed. The front of this unit showing the kinescope, oscilloscope, and the several control knobs is illustrated by the photograph in Figure 14. A metal cover is supplied which protects these tubes and knobs when the equipment is not in use.

MASTER-CONTROL UNIT

When more than one camera is used to televise a desired scene some means must be provided for switching from one camera to another and

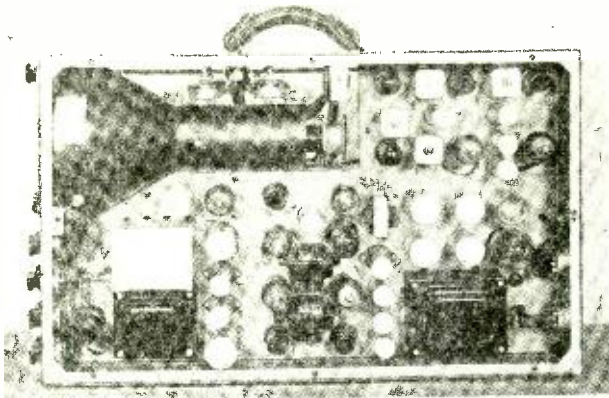

Fig. 12—Camera-control unit—tube side, cover removed.

for monitoring the "on-the-air" picture. In the portable pickup equipment these requirements are filled by the master-control unit. The block diagram in Figure 15 shows the several functions of this unit. The video-frequency system amplifies the signals received from the camera-control unit and supplies them to the kinescope and oscilloscope. Synchronizing signals are normally inserted in the video-frequency system of the master-control unit. The line amplifier in this unit is designed to provide a four-volt peak-to-peak signal across a 75-ohm line. A separate 75-ohm output circuit is included which can be used to feed an additional monitor unit. The video-frequency system is provided with an interlocked switching arrangement by which any one of four

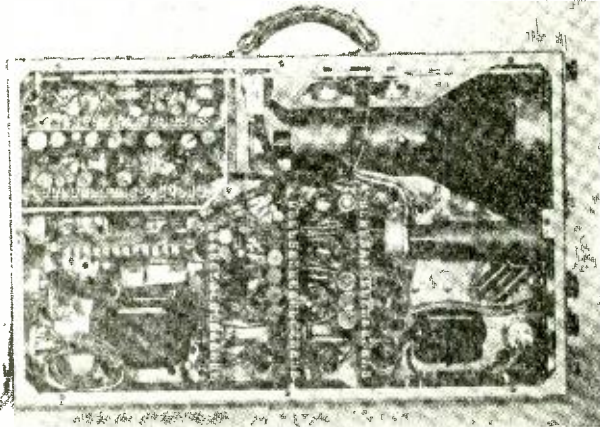

Fig. 13—Camera-control unit—circuit-component side, cover removed.

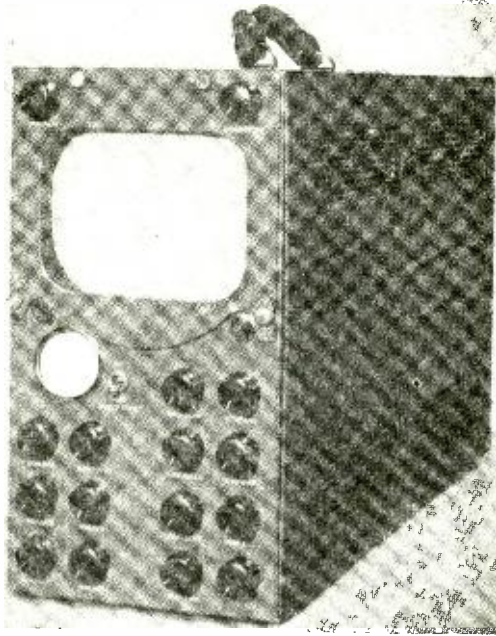

Fig. 14—Camera-control unit—front view.

input signals can be selected, amplified, monitored, and fed to the outgoing line. Indicator lights on both the master-control unit, each camera-control unit, and camera show which camera is "on the air."

The deflection system for the master-control unit employs synchronizing and deflection circuits which are essentially the same as those used in television receivers. The picture observed on the kinescope in

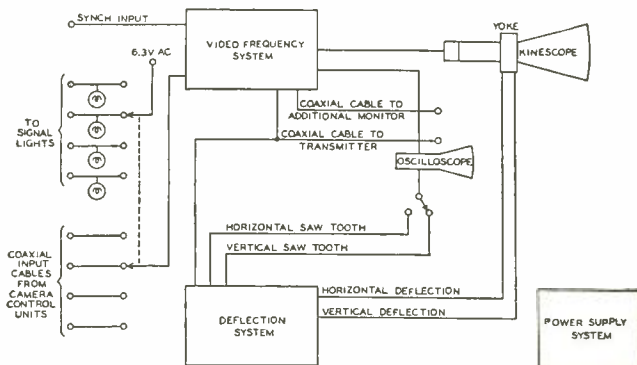

Fig. 15—Block diagram of master-control unit.

the master-control unit is therefore an indication of the performance to be expected at the receiving locations.

The low-voltage and high-voltage rectifiers used in the master-control unit are similar to those included in the camera-control unit. Figure 16 is a front view of the master-control unit and shows the switching and indicator-light arrangement.

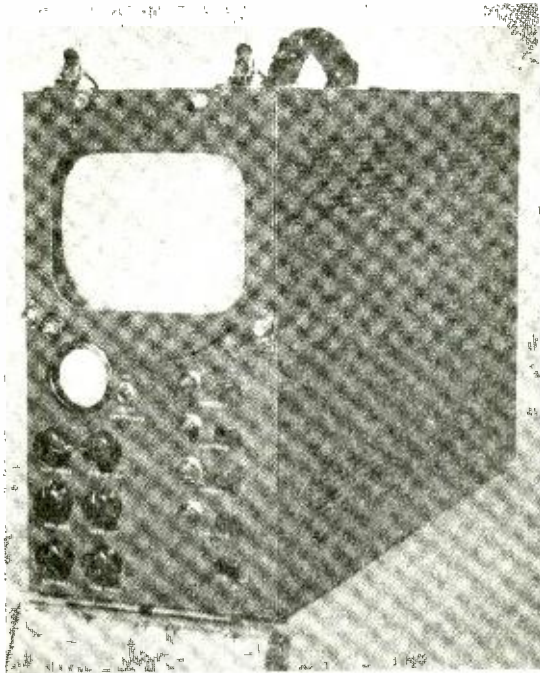

Fig. 16—Master-control unit—front view.

SYNCHRONIZING GENERATOR

The portable synchronizing generator is designed to produce pulses in accordance with the standards of the Radio Manufacturers Association. The synchronizing generator is divided into three units, the pulse unit, the shaping unit, and the delay unit.

PULSE UNIT

The pulse unit contains an electromechanical pulse generator for producing 26,460- and 60-cycle pulses. This type of pulse generator was used because it gave the desired electrical characteristics with a

minimum of equipment. This generator consists of a brass disk having 441 peripheral teeth and rotated by a 3600-revolution-per-minute synchronous motor. This disk revolves inside a stationary brass ring having 441 teeth on its inner circumference. The clearance between the teeth on the rotor and stator is approximately 0.012 inch. A single radial fin is used on the rotating disk in conjunction with a similar stationary fin to produce the 60-cycle pulses. Direct polarizing voltage is applied between the stators and rotating disk through resistors. The current variations through the resistors in accordance with the changes in capacitance produce the desired voltage pulses. The use of a large number of teeth on both the rotor and stator minimizes the effect of inaccuracies in the width of the teeth and the spacing between them since each pulse is produced by the average change in capacitance caused by each of the 441 teeth on the rotor and stator. In addition

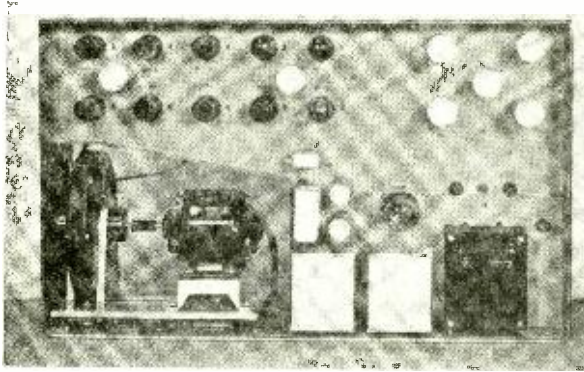

Fig. 17—Synchronizing-generator pulse unit—tube side, cover removed.

to the pulse generator the pulse unit contains tubes and associated circuits for shaping the pulses and for obtaining pulses at line frequency by selecting every other one of the 26,460 pulses. A power-supply rectifier to provide anode potentials for the complete synchronizing generator is also included in the pulse unit. Figure 17 shows the tube side of the pulse unit. The pulse generator is shown in the lower left-hand corner of the figure. The rotor and stator are completely surrounded by a bakelite housing.

SHAPING UNIT

The shaping unit receives 60-, 13,230-, and 26,460-cycle pulses from the pulse unit. Four sets of pulses are provided by the shaping unit

as follows:

- Iconoscope horizontal driving pulses
- Iconoscope vertical driving pulses
- Blanking pulses
- Synchronizing pulses

Although the synchronizing pulses are formed by combinations of several pulses the leading edge of each pulse is the leading edge of a 26,460-cycle pulse. Controls are provided for varying the width of the several pulses. Photographs of the shaping unit with the side covers removed have been previously shown in Figures 2 and 3.

DELAY UNIT

When two or more cameras are used and they are connected to the

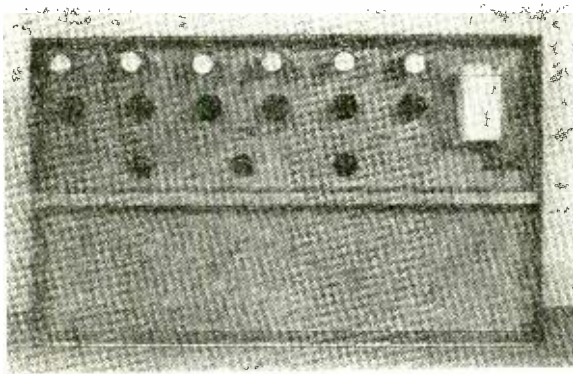

Fig. 18—Synchronizing-generator delay unit—tube side, cover removed.

control equipment through cables which differ greatly in length it is necessary to delay the driving pulses to the camera connected to the shortest cable so that the pulses returning to the control equipment from this camera correspond in time with those returning from the camera connected to the longest cable. The synchronizing-generator delay unit contains an artificial line which is used to delay the driving pulses to any one of three cameras by an amount corresponding to any normal length of camera cable up to 500 feet. Buffer tubes are used between the switches and the artificial line so that the characteristics of the line are not affected by the various lengths of camera cable. Switch positions are provided for 50-, 100-, 200-, 300-, 400-, and 500-foot lengths of cable. Figure 18 is a photograph of the tube side of the delay unit and shows the switch knobs for varying the delay for each camera. The photograph shown in Figure 19 illustrates the construction of the

artificial line and the circuit components used with the buffer tubes. The space in the bottom of both sides of this unit is used to carry spare tubes.

RELAY TRANSMITTER

One of the requirements of any portable pickup system is that some provision must be made for conveying the signal from the remote point to the location where it can be utilized. The wide frequency band used in television makes this problem especially difficult. One obvious solution is of course a portable transmitter for relaying the signal from the remote pickup point to a suitable receiving location near the main transmitter. An ideal transmitter for this type of work must be reasonably rugged, light in weight, and deliver sufficient power to

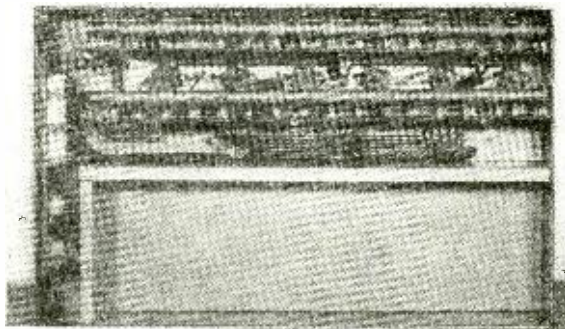

Fig. 19—Synchronizing-generator delay unit—circuit component side, cover removed.

provide a satisfactory service range. The ultra-high-frequency television relay transmitter was designed to meet these requirements. This transmitter is crystal-controlled and will deliver a peak power of 25 watts at any specified frequency between 280 and 340 megacycles. The radio-frequency portion of the transmitter consists of four stages; crystal oscillator, two multiplier stages, and the power-amplifier stage. Two neutralized 1628 triodes are used in the power amplifier. All the circuits which are resonant at carrier frequency are "transmission-line circuits." All the other radio-frequency circuits are conventional *L-C* circuits.

The video-frequency portion of the transmitter consists of three stages which are adjusted to pass the frequency band between 30 cycles and 5 megacycles. An input of 2 volts, peak to peak, is sufficient to

grid-modulate the power-amplifier stage completely. The direct-current component of the video-frequency signal is restored in the grid circuit of the modulator stage, and direct-current coupling is employed between the modulator plate and the power-amplifier grids.

The monitoring system in the transmitter consists of a diode rectifier, a video-frequency amplifier, and a two-inch oscilloscope. Provision is made so that the output of the video-frequency amplifier can be fed to a master-control unit so that the complete picture can be

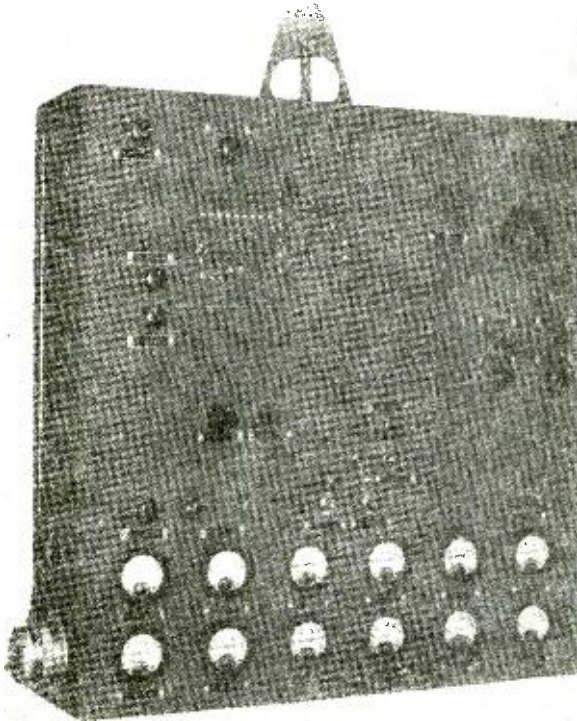

Fig. 20—Ultra-high-frequency relay transmitter—front view.

monitored.

The transmitter output system is so arranged that either a coaxial line or balanced feeder system may be used. Small antennas having high directivity are readily obtainable at the transmitter frequency. A unidirectional array using eight half-wave elements has given a measured power gain of 12 in field tests.

Figure 20 is a front view of the transmitter. The overall dimensions

of this unit are $6 \times 24 \times 26$ inches. The antenna transmission-line clamping unit is shown extending from the top of the transmitter unit. The monitoring oscilloscope is viewed through the circular opening in the upper right-hand corner of the picture. The meters at the bottom of the unit indicate the currents in the various tubes.

The rear view of the transmitter with the doors open is shown in Figure 21. The location of the various circuit components, tubes, and transmission lines can be seen in this photograph.

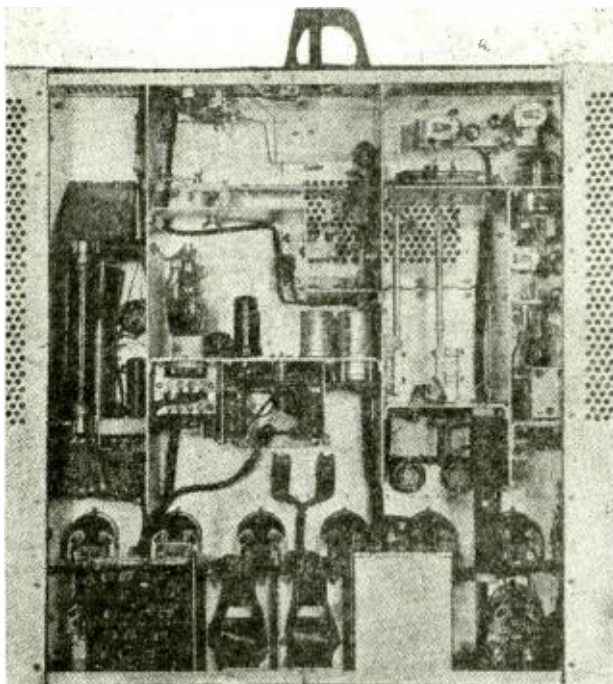

Fig. 21—Ultra-high-frequency relay transmitter—rear view, doors open.

TRANSMITTER POWER-SUPPLY UNIT .

This unit contains two rectifier systems which furnish all the direct voltages necessary for the operation of the transmitter. Figure 22 shows a view of this unit.

RELAY RECEIVER

The relay receiver is a superheterodyne designed to operate from a 150-ohm antenna transmission line. Coupled fixed-tuned "transmission-line" circuits are used in the input system of the receiver. These



Fig. 22—Ultra-high-frequency relay transmitter power-supply unit.

Circuits are adjusted to pass a frequency band of 12 megacycles in the range between 280 and 340 megacycles. The oscillator circuit is also of the "transmission-line" type. The intermediate-frequency amplifier consists of seven transformer-coupled stages. The second-detector circuit is direct-current coupled to the automatic-gain-control rectifier, so that the automatic-gain-control voltage is proportional to the peak value of the incoming video-frequency signal, i.e., synchronizing peaks. Provision is made for disconnecting the automatic gain control and using manual gain control if desired. The video-frequency amplifier supplies an output of about 2 volts, peak to peak, across a 75-ohm line. Figures 23 and 24 show the front and rear views of the receiver. The front view of the power-supply unit is given in Figure 25.

PRACTICAL APPLICATIONS OF THE EQUIPMENT

Television programs have been broadcast as a public service during

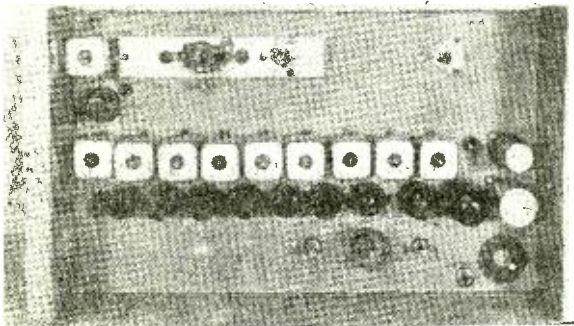

Fig. 23—Ultra-high-frequency relay receiver—front view.

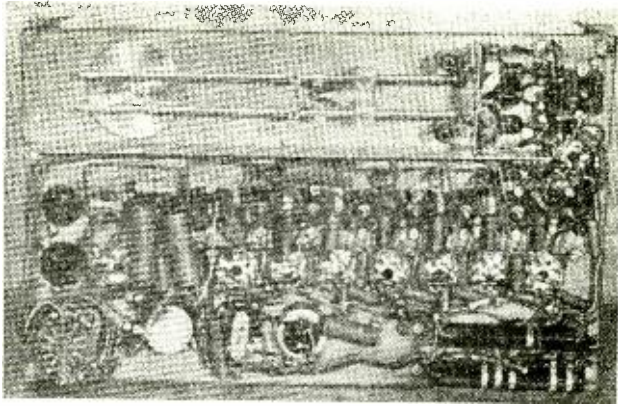

Fig. 24—Ultra-high-frequency relay receiver—rear view.

the past year. The telemobile units previously mentioned have been used in many “on-the-scene” pickups and these have almost all been very popular. The pickup of many potentially interesting programs has been impracticable because of the size, weight, and power requirements of the mobile units. Although the cameras associated with these units can be operated at distances up to 500 feet from the unit housing the control equipment, this in many instances is not sufficient because the control unit cannot be placed in an advantageous location. The alternating-current input power, especially the three-phase for the transmitter unit, frequently has been very difficult to obtain.

The new “suitcase” type of portable pickup equipment, therefore, greatly increases the program potentialities outside the studio. The size, weight, power requirements, and flexibility of the equipment are

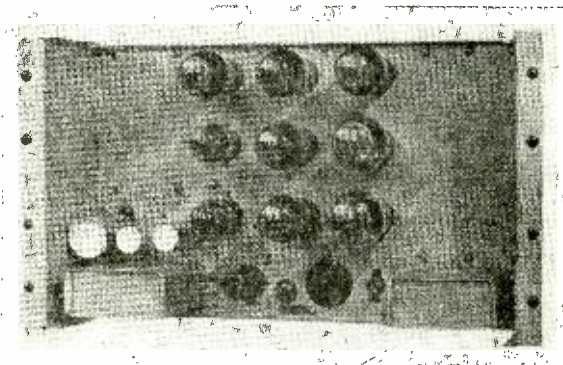

Fig. 25—Ultra-high-frequency relay receiver power-supply unit.

such that for the first time program pickups aboard airplanes, boats, and automobiles, while in motion, are possible. The program possibilities which the equipment creates are thus evident for it is obvious that the extension of the television eye to points outside the studio is an even greater boon to television than was the corresponding extension of the microphone in sound broadcasting. The new equipment has recently been used aboard an airplane to pick up scenes of New York and transmit them to Radio City for a program broadcast from the transmitter in the Empire State Building.

It is quite possible to carry the complete pickup apparatus into any building, amusement park, theater, etc., in order to televise events which are inaccessible to pickup equipment mounted permanently in a truck. The few kilowatts of single-phase alternating-current power which are required for the entire equipment can be obtained in most locations.

Another important application of the new equipment is the televising of regular sound broadcast programs in the studios in which they are normally presented. Although such use does not provide all the flexibility of a studio permanently equipped for television, it does permit a very useful extension of pickup facilities for certain types of programs.

The portability of the transmitter is a great advantage in remote pickup work. In many locations it is necessary to erect an antenna on the roof of a building or some other high structure in order to obtain line-of-sight transmission to the receiving point. In the case of a transmitter mounted permanently in a truck a rather long radio-frequency transmission line is required. The problem of adjusting such a line to carry television signals without serious reflections is a difficult one, even in a permanent installation and for portable or mobile work the difficulties are still greater. The new equipment makes it possible to locate the transmitter on the roof or upper floor of a building so that a short radio-frequency transmission line can be used to the antenna. In this case the transmitter is connected to the pickup equipment by means of a flexible coaxial cable or other video-frequency line. The transmission of the video-frequency signals over a suitable line presents a considerably less serious problem than the transmission of radio-frequency power over a line of equivalent length.

ACKNOWLEDGMENTS

The authors wish to acknowledge the individual and co-operative efforts of the many engineers who participated in the development of this equipment.

ANALYSIS AND DESIGN OF VIDEO AMPLIFIERS*†

By

S. W. SEELEY‡ AND C. N. KIMBALL‡

License Laboratory, Radio Corporation of America

PART II

INTRODUCTION

THIS paper is an extension of a previous one¹ which contained an elementary discussion of the factors influencing the performance of wide-band video amplifiers. The principal items of interest were an analysis of the effects of variable time delay and amplitude response on the reproduced picture, and a discussion of one method of high-frequency compensation. Notes on certain measurement techniques, and a discussion of low-frequency requirements were also included.

It is sufficient, in the present case, to repeat, as explained in the previous paper¹, that the ideal video amplifier should have flat frequency response and constant time delay over the band of frequencies required for adequate reproduction of the transmitted picture.

The importance of maintaining the characteristics of individual video stages as close to the ideal values as possible is accentuated in cases where numerous stages are connected in cascade. This is true because the overall gain is equal to the product of the individual stage gains, while the net time delay is equal to the sum of the time delays of the individual stages. It is interesting to note that this applies particularly to video-amplifier chains, where thirty or more stages may be used in a television transmitter.

It may be said, in general, that it is quite difficult to maintain both time delay and gain constant over a wide band. Generally a compromise is made, with neither the gain or delay exactly constant, but with both satisfactorily close to optimum values.

Furthermore, the correction expedients which are applicable at one end of the video band have no effect at the other end. Thus, the use of peaking coils for maintenance of constant gain at high frequencies does nothing whatsoever to the low-frequency performance.

Because of this segregation of the video band into two distinct regions, it is desirable to treat the high- and low-frequency characteristics as separate problems. This procedure will be followed in this

* Decimal Classification: R583.14.

† Reprinted from *RCA REVIEW*, January, 1939.

‡ Now Manager and Engineer respectively with Industry Service Laboratory, RCA Laboratories Division, New York, N. Y.

article, with the first section containing a discussion of the high-frequency aspects of the problem, and the last section dealing with the low-frequency performance of the amplifier.

SECTION I

HIGH-FREQUENCY CONSIDERATIONS

All of the video-amplifier circuits which have appeared to date consist essentially of resistance-coupled stages, each provided with some form of high-frequency gain and phase correction. The decrease in amplification and introduction of phase distortion at the higher frequencies in an uncompensated amplifier is a direct result of the existence of unavoidable shunt capacitances, which are found in any circuit containing vacuum tubes and associated components (resistors, wiring, sockets, etc.). The reactance of these shunt capacitances appears as part of the plate-circuit load, and causes its impedance to decrease as the frequency is increased, resulting in a decrease in gain at the higher frequencies. The loss in gain is accompanied by a phase delay, which, with no shunt reactance in the plate load, would normally be zero. The manner of variation with frequency of this phase delay is important in determining the constancy of time delay over the video band.

There are several ways to reduce the effect of the load-circuit capacitance. One method involves the use of a very small load resistor, whose resistance is so low compared to the reactance of the shunt capacitance at the highest video frequency that the reactance has no effect on the gain or phase characteristics. This arrangement would possess no practical advantages, because of the great loss in gain per stage entailed by the use of a small plate resistor. (The gain in a video-amplifier stage may be taken generally as the product of the tube's mutual conductance and the plate-load impedance, since pentodes are used almost universally.)

A more practical way to obtain adequate high-frequency performance is to employ a circuit containing inductance to offset the loss in gain due to shunt capacitance. In this way essentially constant gain may be obtained, without resorting to abnormal reductions in the value of plate-load resistor.

The expedients employed to extend the frequency band in which constant gain obtains are described variously as correction circuits or peaking circuits. These may take any of several forms, depending upon whether the wide-band characteristics are obtained by inserting a peaking coil in the load circuit, to maintain the load impedance at a constant value, or whether the desired effect is obtained by the use

of a coupling circuit, such as a low-pass filter, between successive stages of the amplifier.

Four types of high-frequency video load circuits will be discussed here: (1) Uncompensated load circuit. (2) Compensated circuit containing a peaking coil in series with the load resistor—known as shunt peaking. (3) Compensated load circuit in which a π -type low-pass filter is employed as the coupling element—known as series peaking. (4) Combination of shunt and series peaking.

The analysis of these various types of load circuits and the evaluation of their relative merits is somewhat simplified and made more readily adaptable to direct comparison by the use of the following list of symbols and definitions.

T_1 and T_2 = Two successive tubes of a video amplifier circuit.

R_L = Load resistor in plate circuit of T_1 .

C_T = Total capacitance shunting the load circuit. This includes tube and wiring capacitances.

C_1 = Total output capacitance of T_1 .

C_2 = Total input capacitance of T_2 .

$C_2/C_1 = m$.

L_1 = Inductance of peaking coil in series with plate-load resistor of T_1 (shunt peaking).

L_2 = Inductance of peaking coil connected between plate of T_1 and grid of T_2 (series peaking).

f_o = Top frequency in the video band.

f = Any frequency in video band above 1 kc.

Φ = Phase delay in radians (caused by reactance in plate-load circuit).

$T = \frac{\Phi}{\omega}$ = Time delay in seconds (due to reactance in plate-load circuit).

ΔT = Departure from constant time delay (seconds)

It should be noted at this point that, in general, maintenance of a flat frequency-response characteristic (at high frequencies) in a video amplifier stage usually will result in sufficiently uniform high-frequency time delay so that correction expedients which might be applied to produce an entirely uniform delay (and which might alter the response somewhat) are not usually necessary or desirable. This, of course, depends largely on the total number of stages in cascade to be employed for a given purpose, for, as pointed out previously, the

overall gain characteristic is the product of the individual stage gains, whereas the total time delay is the sum of delay characteristics of each stage.

In this connection it is important to observe that the high-frequency performance of the amplifier determines the quality of the picture along any horizontal line, i.e., the horizontal detail and resolution. If both gain and delay characteristics are flat the picture is reproduced exactly. If the gain is constant in the video band and the time delay varies with frequency, all the high-frequency components are reproduced precisely in their proper relative amplitudes, but the location of the various picture elements is not correct, because of the different amounts of time taken for passage of the different frequencies. This results in inferior reproduction of horizontal detail.

It is difficult to determine precisely the maximum permissible variation in time delay in a complete television system. Some authors² suggest limiting the total variation in time delay to 0.1 μ sec. Data calculated for a typical case shows that, for a 441-line picture (10-inch horizontal dimension on a 12-inch tube) a variation in time delay of 0.1 μ sec. up to a top frequency of 2.5 Mc would cause the 2.5 Mc component to be displaced laterally by 0.015-inch with respect to the low-frequency components. This would amount to about one picture element (at 2.5 Mc) in the horizontal direction. It should be obvious that, for a given total tolerable time-delay variation, the permissible departure from constant delay-time per stage decreases as the number of stages increases, since the total delay variation is the sum of the individual-stage delay variations. Therefore, in receivers, where at the most, only three or four video stages would be employed, the permissible variation in time delay per stage is greater than in cases where a large number of stages are used in an amplifier chain. The line amplifiers in television transmitters fall in the latter category. Furthermore, in receivers, the delay variations in the i-f circuits are generally much greater than the delay variations in the video amplifiers, consequently attention is generally directed toward minimizing departure from constant delay in the i-f circuits. The procedure in designing video amplifiers for receivers consists principally, therefore, in obtaining a flat gain characteristic over the video band, while the time delay is permitted to depart from a constant value, within reasonable limits.

The magnitude of the time-delay variations, Δ_T (departure from the desired constant value) in an amplifier stage may be written in a number of ways. One method of expressing Δ_T , which will be used in this article, evaluates the departure from constant time of transmis-

sion as a fractional part of a period at the top video frequency, i.e., $\Delta_T = K/f_o = KT_o$.

CIRCUIT 1—RESISTANCE-COUPLED VIDEO AMPLIFIER UTILIZING NO HIGH-FREQUENCY PEAKING EXPEDIENTS

The plate load Z_L comprises the load resistor R_L in parallel with the total shunt capacitance, C_T . The gain, which is equal to $Gm Z_L$, falls off as the frequency is increased according to

$$\text{gain} = Gm Z_L = \frac{Gm R_L}{\sqrt{1 + (2\pi f C_T R_L)^2}}$$

If we let R_L equal the reactance of C_T at the top frequency, f_o , we have

$$R_L = \frac{1}{2\pi f_o C_T}$$

and

$$\text{gain} = \frac{Gm R_L}{\sqrt{1 + (f/f_o)^2}}$$

At this frequency where $R_L = \frac{1}{2\pi f_o C_T}$, the gain is 70.7 per

cent of the gain at low frequencies ($f = 10$ kc, for instance). The departure from constant time delay at f_o is $0.034/f_o$, i.e., 3.4 per cent of the period T_o at the top frequency, f_o . With $f_o = 3$ Mc, Δ_T is 0.011 microseconds. This is the difference in time delay caused by the presence of shunt capacitance in the plate-load circuit.

It should be evident that the gain of this type of load circuit is not sufficiently constant to permit its use in a video amplifier, unless the load resistor is made small compared to the total shunt-load reactance at the top video frequency.

While this analysis is included primarily to demonstrate the behavior of an uncompensated circuit, and as a basis of comparison for other compensated circuits to follow, it can be put to use as a means for measuring the total load-circuit capacitance of a video stage. The method, described in detail in Part I of this article, makes use of the fact that the gain of an uncompensated stage falls to 70.7 per cent of its low (10 kc) frequency value at a frequency for which the reactance of the capacitance in question is equal to the plate-load resistance. The measurement of the point of 0.707 response may be

determined by noting the frequency at which the input to the stage under test must be increased to $\sqrt{2}$ times its low-frequency value, to maintain constant stage output.

The indicating device may include the following tube in the chain, which should have a low (100-ohm) resistor connected in its plate circuit to provide a voltage drop which can be read on a vacuum-tube voltmeter. The bias of this second tube should be maintained at its operating value, to preclude any error due to input capacitance variation with bias. A variation of this connection applies the vacuum-tube voltmeter across the load resistor R_L (with the following tube in circuit) and measures the output across R_L . The capacitance contributed by the vacuum-tube voltmeter must be known and taken into account in this measurement.

The total output-circuit capacitance can also be measured by a substitution method, in which a "Q" meter may be employed. A coil is selected to resonate with 100 $\mu\mu f$ or so on the "Q" meter at some frequency between 500 and 2000 kc. The circuit is resonated and then the capacitance terminals of the "Q" meter are connected across the output circuit of the stage under test. The plate-load resistor is removed and the plate-supply voltage of T_1 is turned off. The second tube operates normally, with its bias fixed at the operating point. The amount by which the "Q"-meter calibrated-capacitance must be changed, in order to re-establish resonance in the "Q"-meter circuit, is equal to C_T , the total shunt capacitance in the video stage.

Note that the resonant voltage which appears across the "Q"-meter tank circuit must be limited in amplitude to prevent rectification in the second tube's grid circuit, which would result in a change in bias and in second-tube input capacitance.

CIRCUIT 2—VIDEO STAGE COMPENSATED BY A COIL IN SERIES WITH THE LOAD RESISTOR (SHUNT PEAKING)

This type of video stage may be compensated (the plate load-circuit impedance made essentially constant over the required frequency band) by inserting a properly proportioned inductance in series with the load resistor. The peaking-coil inductance is determined by the values of R_L , C_T , and the top video frequency, f_o .

R_L is chosen to equal the reactance of C_T at the top frequency, f_o , (C_T is measured with L_1 not in circuit, by either of the methods previously described). Therefore,

$$R_L = \frac{1}{2\pi f_o C_T}$$

The value of L_1 is determined from $2\pi f_o L_1 = \frac{R_L}{2}$ at the top frequency, f_o . Hence,

$$L_1 = \frac{R_L}{4\pi f_o}$$

The resonant frequency of L_1 and C_T is seen to be $\sqrt{2}$ times the top video frequency, f_o .

The gain is essentially constant, up to the frequency f_o , and is equal to GmR_L .

The time delay, in terms of f and f_o is

$$T = \frac{i}{2\pi f} \tan^{-1} \left[\frac{1}{4} \left(\frac{f^3}{f_o^3} + 2f/f_o \right) \right]$$

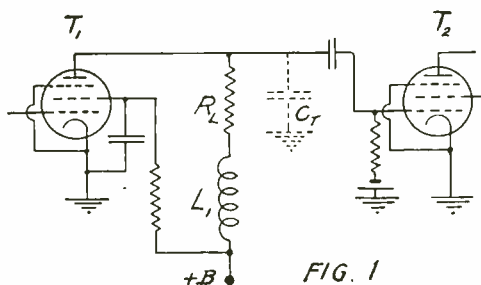

The difference in time delay over the video band (from 1 k_c to f_o) is $0.0231/f_o$ seconds. With $f_o = 3$ Mc, this time-delay departure corresponds to 0.0077 microseconds. Note that the gain over the video band, GmR_L , is equal to the gain which would be experienced in an uncompensated stage having zero shunt-load capacitance, and the same value of plate-load resistor as is used here. This improvement in gain characteristic is achieved with no increase in the departure from constant time delay; in fact an improvement of 30 per cent in the approach to constant time delay has been obtained.

The values selected for compensating the circuit

$$R_L = \frac{1}{2\pi f_o C_T} \quad \text{and} \quad L_1 = \frac{R_L}{4\pi f_o}$$

are not necessarily productive of the best phase and amplitude response. Other authors² have shown that more nearly constant time

delay and amplitude response may be obtained by using slightly different values of R_L and L_1 .

If we designate the ratio of load resistance, R_L to capacitive reactance X_c at the top frequency by p , and the ratio of inductive to capacitive reactance at f_o by s , we have

$$p = \frac{R}{X_c} = 2\pi f_o C_T R_L$$

$$s = \frac{X_L}{X_c} = (2\pi f_o)^2 L_1 C_T$$

The values chosen in the preceding case are $p = 1.0$ and $s = 0.5$. If, instead, we use $p = 0.85$ and $s = 0.3$, the time-delay curve is almost precisely flat, and the gain variation over the frequency band is slightly less than in the case previously described. However, this latter arrangement entails the use of a lower value of load resistor, so that the gain is decreased 15 per cent at all frequencies.

As a typical case, consider a video amplifier employing Type 1851 tubes. The total load-circuit capacitance ($C_{in} + C_{out}$ plus wiring and strays) is about 25 $\mu\mu f$. Let the top video frequency be 3 Mc, in which case $X_c = 2120$ ohms. If $p = 1$ the load resistor would also be 2120 ohms, and the coil inductance (for $s = 0.5$) would be

$$\frac{2120}{2 \times 2\pi f} = 56 \mu h$$

The results would be satisfactory on a basis of constant gain and time delay, with the actual gain equal to 19 per stage, for a tube having a mutual conductance of 9000 $\mu mhos$.

Use of $p = 0.85$ and $s = 0.3$ would require a resistor of 1800 ohms and a coil inductance of 33.5 microhenries, with a gain of about 16 per stage. In general, in practical cases, the value of L_1 may vary somewhat from the prescribed values, as may also the value of R_L . When several stages are used in cascade it is very important, however, to obtain as nearly uniform gain and time-delay curves as possible for each stage, since, if L_1 and R_L are not chosen according to the prescribed values, it will be difficult to make counteracting changes in alternate stages to produce an overall characteristic which does not depart too much from the theoretical values (i.e., over and under compensation in successive stages).

CIRCUIT 3— π -TYPE LOW-PASS FILTER EMPLOYED AS COUPLING
ELEMENT BETWEEN PLATE OF T_1 AND GRID OF T_2
(SERIES PEAKING)

This type of circuit possesses certain advantages over the shunt-peaking arrangement because it effectively separates C_2 from C_1 by means of L_2 . (They would normally be in parallel in the shunt peaking circuit, appearing across R_L and L_1 .) It affords a greater gain per stage with a smaller departure from constant time delay. The action of the circuit in preserving the high-frequency response of the amplifier may be described briefly as follows: A voltage $eg GmR_L$ is considered to exist across R_L , (with C_1 , L_2 and C_2 removed). C_1 is next considered to exist across R_L , which causes attenuation of the higher frequencies and produces a voltage

$$\frac{eg GmR_L}{\sqrt{1 + (2\pi f C_1 R_L)^2}}$$

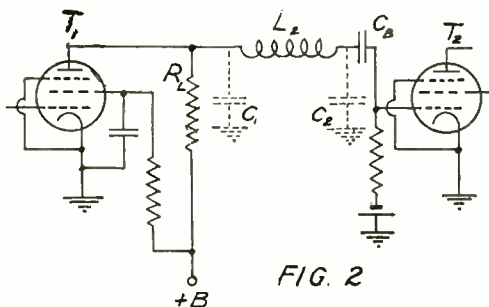

across R_L and C_1 , in parallel. This voltage is applied to the voltage divider consisting of L_2 and C_2 in series, and the resultant drop across C_2 is maintained constant by resonant rise effects in $L_2 C_2$, which counteract the attenuation produced by C_1 .

The performance of the circuit depends upon a number of factors. One of these is the ratio of the two capacitances, C_1 and C_2 , which appear at the terminals of the low-pass filter. Let this ratio of C_2/C_1 be m . C_1 includes the output and stray wiring capacitances associated with tube No. 1. C_2 includes the input and wiring capacitances of tube No. 2, as well as the stray capacitance between the blocking condenser, C_B , and ground. Note, from Figure 2, that the blocking condenser may be connected at either end of L_2 to assist in adjustment of the value of m .

The value of total capacitance ($C_1 + C_2$) may be determined experimentally by the methods described for use with the shunt-peaking circuit (L_2 is shorted in this measurement). To measure C_1 open L_2

and find the frequency at which the gain of T_1 is 70.7-per cent of its low-frequency value. A vacuum-tube voltmeter of known input capacitance may be used across R_L as an indicating device, and its contribution to C_1 must be taken into account.

An alternative method of measuring C_1 makes use of the "Q" meter, as described in connection with shunt-peaking circuits.

It has been pointed out by Albert Preisman of R.C.A. Institutes that, for best performance, C_2 should be at least twice C_1 , i.e. $m \geq 2$. This condition is fulfilled in most practical applications. If m is found to be less than 2, the ratio may be adjusted by proper disposition of the circuit components (such as the d-c blocking condenser for T_2) or by connecting small capacitances across the filter input or output terminals. It should be noted, however, that the use of additional capacitance at either end of the filter to produce the desired value of m will result in a loss in gain, for the absolute gain is inversely proportional to the total capacitance in the load circuit.

With C_2 and C_1 known from measurement, the first step in designing the coupling network is to select f_o , the top frequency in the video band for which constant gain is desired. This value of f_o , in conjunction with C_1 determines the inductance L_2 of the series-peaking coil.

To find L_2 , let f_r be the resonant frequency of L_2 and C_1 , i.e.,

$$f_r = \frac{1}{2\pi\sqrt{L_2C_1}} \quad \text{The value } f_r \text{ is chosen to be } \sqrt{2} \text{ times the top}$$

video frequency, f_o . Therefore, L_2 is determined from

$$L_2 = \frac{1}{2(2\pi f_o)^2 C_1}$$

The inductive reactance of L_2 at f_o is equal to one-half the reactance of C_1 at the same frequency.

The value of R_L , the plate-load resistor, with $m=2$ and $f_o = f_r/\sqrt{2}$, is equal to one-half the reactance of C_1 at the top video frequency, f_o . Since $m=2$, R_L also equals one and one-half times the total load-circuit, capacitive reactance at f_o .

The procedure for compensating a stage may be itemized as follows: (1) Measure C_1 and C_2 and, if necessary, adjust C_2/C_1 to be at least 2; (2) make the terminating resistor R_L equal to one and one-half times the reactance of $(C_1 + C_2)$ at the top video frequency, f_o and connect the resistor across the plate end of the filter network; (3)

obtain a coil which resonates with C_1 at $\sqrt{2}$ times the top video frequency, or use the relation $L_2 = \frac{2}{3} (C_1 + C_2) R_L^2$. The resistance of coil L_2 is immaterial as long as the coil Q is greater than 20.

Under some conditions it might be necessary to work out of a high plate-circuit capacitance into a low grid capacitance. In such a case the value of C_2/C_1 may be more nearly $\frac{1}{2}$ instead of 2. In that event, the values of L_2 and R_L are the same as those calculated for $m=2$, but the load resistor is connected across the output terminals of the network, i.e., across the smaller terminating capacitance. A reciprocal action permits interchanging the point of resistor termination in this special case, and results in operating characteristics which are the same as for the more likely case discussed previously. Specifically, the coupling network may be turned end for end without affecting its operation.

The basic design equations, to be used for any value of m , with the top video frequency chosen to be 0.707 times the resonant frequency of L_2 and C_1 , are

$$R_L = \frac{1}{\sqrt{2m} \omega_0 C_1}$$

$$L_2 = \frac{1}{2\omega_0^2 C_1}$$

where $\omega_0 = 2\pi$ times the top video frequency. If the values suggested

above $\left(R_L = \frac{3}{2} \frac{1}{(C_1 + C_2)\omega_0} \text{ and } L_2 = \frac{2}{3} (C_1 + C_2) R_L^2 \right)$ are used in

the video stage, the gain and time-delay characteristics are essentially flat out to f_o . The absolute value of gain is 50 per cent greater than the gain experienced in a shunt-peaking circuit having the same total load-circuit capacitance and the same value of f_o . The departure from constant time delay is $0.0113/f_o$ seconds. For a 3-Mc band the variation in time delay is 0.004 microseconds, which is somewhat smaller than Δ_T in the shunt-peaking case. The total time delay is greater with series peaking, but, of course, this is relatively unimportant, since, within reason, the magnitude of T is of no consequence, provided the departure from a constant value is small.

The series-peaking circuit merits serious consideration on the basis of these results. It may be expected to exceed the shunt-peaking cir-

circuit in performance in cases where the capacitance distribution is favorable, or when the ratio of capacitances can be adjusted to the desired value without causing a decrease in gain below the value experienced with shunt peaking. Note that operation with values of m less than 2 will cause the gain characteristic to peak at the high end. While this effect is not desirable generally, it may find some utility for peaking purposes in amplifiers in which the high-frequency gain in other stages of the chain is deficient. Such a condition might exist by virtue of the high-frequency attenuation experienced in a concentric transmission line, wherein a drop at the top end of the video band must be overcome by subsequent peaking stages.

CIRCUIT 4—COMBINATION OF CIRCUIT 2 AND CIRCUIT 3

This circuit provides certain advantages over either No. 2 or No. 3 used singly. As described by E. W. Herold³ it has the following char-

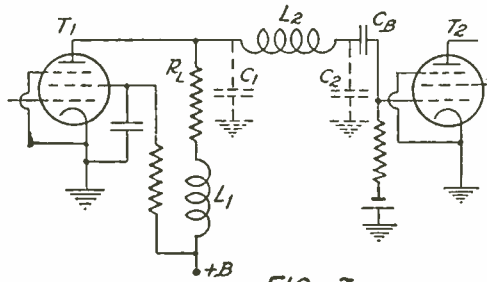

FIG. 3

acteristics: for a given total load-circuit capacitance C_T and prescribed top video frequency f_o , the load resistor which may be used (maintaining constant gain up to f_o) is approximately 80 per cent greater than in the case of simple shunt peaking. This means, of course, 80 per cent higher gain per stage, for the gain is $Gm R_L$, when the circuit is properly compensated. The departure from constant time delay is roughly equal to that experienced in a simple series-peaking circuit.

The disposition of circuit components required to produce the 80 per cent increase in over-all gain are as follows:

$$\begin{aligned}
 m &= C_2/C_1 = 2 & L_1 &= 0.12 (C_1 + C_2) R_L^2 \\
 R_L &= \frac{1.8}{\omega_o (C_1 + C_2)} & L_2 &= 0.52 (C_1 + C_2) R_L^2
 \end{aligned}$$

To design a stage similar to that shown in Figure 3 the procedure is as follows: (1) Select the top frequency f_o to be passed with uniform

gain; (2) make $m = C_2/C_1$ equal to 2; (3) determine the total load-circuit capacitive reactance at the top frequency; (4) choose a load resistor equal to 1.8 times this total load-circuit reactance at f_o ; (5) calculate L_1 and L_2 from the formulas given above.

The following table itemizes the performance characteristics of the several types of circuits described in this section.

Cir. No.	Type of H.F. Comp.	$\frac{R_L}{2\pi f_o C_T}$	$\frac{\Delta T}{\mu\text{secs.}}$	L_1	L_2	$\frac{C_2}{C_1}$
1	none	1	$\frac{.035}{f_o \text{ Mc}}$			
2	shunt	1	$\frac{.0231}{f_o \text{ Mc}}$	$.5C_T R_L^2$		
3	series	1.5	$\frac{.0113}{f_o \text{ Mc}}$		$.67C_T R_L^2$	2
4	shunt and series	1.8	$\frac{.015}{f_o \text{ Mc}}$	$.12C_T R_L^2$	$.52C_T R_L^2$	2

SECTION II

LOW-FREQUENCY CONSIDERATIONS

The presence of the unavoidable shunt capacitance in the output circuit of a video stage impairs the operation of the device only at high frequencies. Below 100 kilocycles the shunt reactances have negligible effect. Consequently, for frequencies ranging between 100 kilocycles and 200 cycles, probably all types of standard video stages perform creditably whether they are compensated or not.

In the frequency range extending below 200 cycles, the gain and time-delay characteristics of a video stage are also subjected to variations from the ideal conditions. These are caused by the inability of the d-c blocking condenser in the grid circuit, in combination with the grid leak, to pass the low video-frequency signal components with their proper amplitude and phase composition, or they may be due to inadequate by-passing of a cathode bias resistor.

It will be recalled that departure from constant gain and time delay in the high-frequency portion of the video band causes imperfect

reproduction of horizontal detail. Insofar as the horizontal detail is concerned the video amplifier could be cut off at 10 kc (passing no signals below this frequency), since the lowest frequency involved in reproducing a picture along any horizontal line is equal to the line repetition rate, 13,230 cycles per second.

The function of the very low video frequencies is to supply the background of the reproduced picture. Failure of a video stage to pass these frequencies in their original wave form will generally cause the background to vary in intensity from top to bottom of the picture. As an example of this effect, consider the situation existing when an all-white screen is to be transmitted. If the low-frequency characteristics of the amplifier are inadequate, the background of the picture will be non-uniform, i.e., there will be a gradual variation in shading in the vertical direction. This effect is least pronounced when an all-white or black screen is transmitted. Maximum departure from the desired background conditions occurs when the screen is half-black and half-white, about a horizontal center line. This matter will be discussed in greater detail later in this section.

Insofar as circuit performance at the low-frequency end of the band is concerned, it can be said that maintenance of proper phase characteristics is more important than maintenance of constant gain. However, even though the phase and gain characteristics are known, it is only with considerable difficulty that the response of the system to a low-frequency pulse may be predicted; that is, the performance of a video stage at low frequencies cannot be judged readily from measurements taken on a monotone basis. Consequently, the low-frequency performance of the amplifier may be more readily evaluated on a square-wave basis. This can be accomplished experimentally by applying a low-frequency square wave and by observing the amount of distortion of the output wave form. Or, the problem can be approached analytically, as shown below.

Let Figure 4 represent a grid-coupling circuit and Figure 5 a square wave (60 cycles base frequency) to be passed through it. We wish to establish some means of determining the effect of the grid-circuit time constant on the tilt appearing in the square wave.

The voltage drop across C , due to the application of a voltage E , may be written rigorously as $E_c = E(1 - e^{-t/CR})$, where t is the time interval following the application of E to C and R .

For relatively large time-constant circuits, in which the current through R is essentially constant for a short interval following the application of the pulse, we may write

$$E_c/E = t/CR$$

$E_c/E \times 100$ is the percentage drop in amplitude of the rectangular

wave during the duration of the pulse, t . E is measured from average value to peak value of the wave. Figure 6 shows the wave after having passed through the grid-coupling circuit. A 10 per cent drop in voltage amplitude is assumed for illustrative purposes.

Note that the amplitude of the pulse approaches the average value of the wave, that is, if the first pulse were allowed to decay indefinitely the total fall in voltage would not exceed the peak value of the wave. If the wave form of the pulse is changed, so that the positive and negative loops are of unequal time duration, the slope of the wave top becomes less pronounced for the long pulse and more pronounced for the short one. Equal positive and negative pulses in a square wave impose the most severe requirements on the grid-coupling circuits, for a given permissible wave-top tilt.

The formula given above may be used to advantage in determining the values of C and R in the grid circuit for a given percentage drop

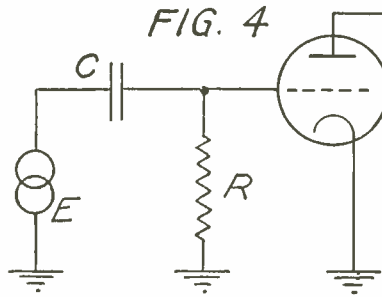

in amplitude of a square wave, by letting t equal the time duration of the pulse and by calculating C and R . Note that any values of C and R which produce a given time constant will result in the same low-frequency response. Practically however, extreme values of C and R should not be used, for large grid resistors will influence the d-c bias considerably in the event of grid current (due to gas or grid emission) in the tube. On the other hand, low values of R will require large values of C , which may cause an increase in total load-circuit capacitance (effective at the high frequencies) due to the stray capacitance from the physically larger blocking condenser to ground.

As an example of the application of the square-wave analysis to a grid-coupling stage, consider a square pulse, of 60 cycles base frequency, applied to a grid circuit containing a $0.25\text{-}\mu\text{f}$ blocking condenser and 0.5-megohm resistor. Since the duration of a single pulse is $1/120$ second, the slope in wave top may be computed from

$$\frac{E_c}{E} = t/CR = \frac{1}{120} \times 0.25 \times 0.5 = 6.7 \text{ per cent.}$$

If, on the other hand, we calculate the relative voltage response at 60 cycles (on a monotone basis), it is found that the response at 60 cycles is better than 99.9 per cent of the response with an infinite time constant. This indicates the necessity for examining the low-frequency characteristics of a video stage on a rectangular pulse basis.

There are several arrangements available for compensating for deficiencies in the grid-coupling circuits of video amplifiers. Some involve rather complicated resistor-capacitor networks, placed in the plate and grid circuits, which provide equalization of frequency response and cancellation of phase shift down to quite low frequencies. The intricacies and mathematical analysis of these circuits will not

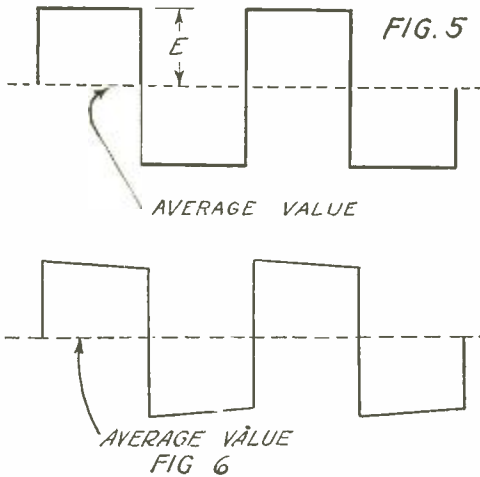

be included here, for it is felt that one simple form of correction circuit, used widely in video amplifiers, and discussed here, should be all that is required for proper operation.

The simplest arrangement includes a resistance and capacitance in parallel, connected as shown in Figure 7. It can be shown that satisfactory low-frequency response can be achieved with this type of compensation provided the time constant in the grid circuit is approximately equal to the time constant of the video load resistor, R_L , and the decoupling condenser, C_F . This is very nearly true for all frequencies at which the value of R_F , the decoupling resistor, is greater than ten times the reactance of C_F . As a practical example, let R_L be 2000 ohms (video load), $C_F = 16 \mu f$ and R_F 2500 ohms. Then the grid time constant must be equal to $R_L C_F = 0.032$ seconds. This would require a 0.25-megohm leak and only 0.125- μf grid-blocking condenser.

Note the appreciable reduction in grid-circuit time constant below the uncompensated value. The low-frequency response, in this case, is satisfactory down to 60 cycles. To extend the range to 30 cycles, the only change required is to double the size of R_F , the decoupling resistor.

This circuit has advantages over and above its low-frequency-response compensation. One of these is its filtering action against hum originating in the B supply. Another advantage, also due to filtering action, is the suppression of motor-boating tendencies at very low frequencies.

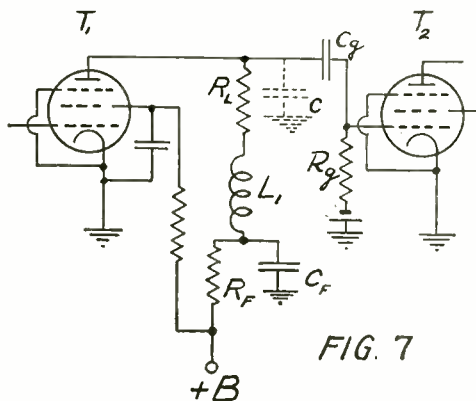

FIG. 7

The general procedure in compensating a stage at low frequencies is to select a value of C_F , say 16 μf . This, in combination with R_L , which is determined by high-frequency considerations, gives the time constant which must be obtained in the grid circuit. The decoupling resistor should be made as large as possible, consistent with obtaining the required d-c plate voltage from a normal B supply.

It should be noted that this type of plate compensation, when used to counteract deficiencies in the grid-coupling circuit, will not give perfect response down to very low frequencies (and to d.c.) except in the theoretical (and, practically, not applicable) case in which the decoupling resistor is infinite.

One of the major problems encountered in video-amplifier design is that of obtaining the required d-c grid biases. Three methods are available: (1) Battery bias; (2) bias obtained from a bleeder resistor, whose voltage is obtained from the plate power supply, generally by the insertion of a small resistor in the B -return lead; (3) cathode or self-bias. Cathode bias is, for several reasons, to be preferred. One of its advantages is that it permits the use of larger grid-leak resistors than in the case of fixed bias. A second advantage is that in

involves only one small resistor and a by-pass condenser. Principally, however, its utility lies in the fact that deficiencies in the cathode by-pass condenser may be compensated in the plate circuit by the insertion of a parallel RC network at the low-potential end of the video load. In this case, the compensation may be made exact at all frequencies down to direct current, with practical values of circuit components. This is to be contrasted with the compensating effect of the same type of plate network when used to counteract deficiencies in the low-frequency response of grid-coupling circuits. In this case compensation is exact only for frequencies at which the feeding or decoupling resistor is very large compared to the reactance of the plate-filter condenser.

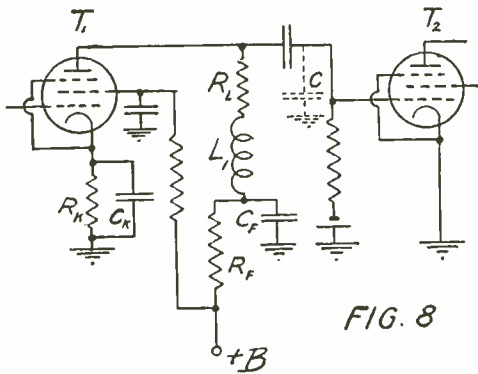

FIG. 8

The circuit for compensating for cathode-bias-network effects is that of Figure 8. In the cathode-bias case, the relation between the various resistors and condensers for compensation at all low frequencies is as follows:

$$\begin{aligned}
 C_K R_K &= C_F R_F \\
 R_F &= R_K (Gm R_L) \\
 C_F &= C_K / Gm R_L
 \end{aligned}$$

Note the presence of the $Gm R_L$ term. This product is the gain of the stage at frequencies in the mid-range of the video band. Its presence suggests a method of compensating the stage at low frequencies without a specific knowledge of Gm or the high-frequency gain. The procedure is as follows:

Connect the stage as shown in Figure 8 with both C_K and C_F sufficiently large to have negligible reactance at a frequency of 10 kc. Adjust the cathode bias resistor to produce the desired grid bias. Apply to the grid a voltage having a 10-kc frequency and of sufficient magnitude to produce a readable deflection on an oscilloscope or vacuum-tube voltmeter connected from plate to ground. With R_L , set

at its proper value to give the desired high-frequency performance note the reflection of the indicating device. This is a measure of GmR_L , the high-frequency gain. Now remove both C_K and C_F and adjust R_F (with R_K fixed at its correct bias value) to produce the same indicator deflection (constant-input volts maintained at the grid). Then shunt the cathode-load resistor with a by-pass condenser of the value to be used in circuit (say 25 μf). This being done, the only remaining step to achieve complete compensation is to shunt the decoupling-resistor R_F with a condenser which makes the time constant of the cathode circuit equal to that of the plate-filter circuit, i.e., $C_F R_F = C_K R_K$.

Values which might be employed in an 1851 video stage are:

$$R_L = 2000 \text{ ohms (depending upon video-band width)}$$

$$R_K = 150 \text{ ohms}$$

$$R_F = 2500 \text{ ohms}$$

$$C_K = 25 \mu f \text{ electrolytic}$$

$$C_F = 1.5 \mu f.$$

It will generally not be necessary to compensate in the plate circuit of one stage, for deficiencies in grid coupling and cathode-bias circuits employed in the same stage, for the cathode-bias operation permits the use of a larger grid leak than in the case of fixed bias. This will aid in preserving the low-frequency characteristics of the grid-coupling circuit.

It is difficult to prescribe exactly the minimum values of grid-circuit time constants which may be used in a video stage, for the choice of time constant will depend upon the permissible slope of the wave tops, and upon the number of stages in the chain. Generally, in video stages containing no low-frequency plate compensation (for deficiencies in grid circuits) the time constant of each grid circuit should be from 10 to 15 times the period of the lowest frequency to be transmitted.

One should not attempt to compensate for deficiencies in a number of grid or cathode-circuit time constants in one plate-compensating network, because the results will be unfavorable unless the departure from flat-top performance on a square-wave basis is small in each stage. Best results are obtained, in a multi-stage amplifier, by compensating in each successive plate circuit.

¹ S. W. Seeley, C. N. Kimball, "Analysis and Design of Video Amplifiers", *RCA REVIEW*, Vol. II, No. 2, October, 1937.

² Freeman and Schantz, "Video Amplifier Design", *Electronics*, August, 1937.

³ E. W. Herold, "High Frequency Correction in Resistance-Coupled Amplifiers", *Communications*, August, 1938.

TRANSIENT RESPONSE OF MULTISTAGE VIDEO-FREQUENCY AMPLIFIERS*†

BY

A. V. BEDFORD‡ AND G. L. FREDENDALL‡

Research Department, RCA Manufacturing Co., Inc.
Camden, N. J.

Summary—The response to a Heaviside unit voltage is set forth as the most logical and relevant criterion of the fidelity of video-frequency amplifiers.

The part of the transient response that is governed by the high-frequency amplitude and phase-delay characteristics of amplifiers may be approximated closely by the steady-state response to a square wave having a suitable period and thus may be expressed in a Fourier series. Simplicity and rapidity of numerical calculation are the outstanding advantages of the steady-state formulation.

As an illustrative example of the method the transient response of several multistage compensated resistance-coupled amplifiers are computed. Considerable data helpful in the design of amplifiers of this type are presented. It is concluded: (1) The wave-shape distortion of a Heaviside unit voltage is accumulative as the number of stages is increased. (2) The value of the damping constant $K = R\sqrt{L/C}$ should lie between 1.51 and 1.61. (3) The resonant frequency $f_0 = 1/(2\pi\sqrt{LC})$ determines the slope of the wave front of the transient response. R is load resistance; C is the total shunt capacitance; and L is the compensating inductance in series with R .

It is proposed that the oscillographic response of video-frequency amplifiers and the associated transmission apparatus to a square wave be considered as a part of performance tests of future television systems.

NATURE OF THE PROBLEM

IN TELEVISION, intelligence is conveyed by the wave shape of voltage variations that originate in the television scanner. Such a signal is the electrical equivalent of variations in the intensity of illumination of the television subject along the scanning lines; and ideally the wave shapes of the variations in intensity and the associated variations in voltage should be the same. After much amplification, modulation of a carrier wave, and demodulation and more amplification in the receiver, the signal is translated back into variations in the intensity of illumination along the scanning lines in the cathode-ray receiving tube.

* Decimal classification: 583.14.

† Reprinted from *Proc. I.R.E.*, April, 1939.

‡ Now with the Research Department RCA Laboratories Division, Princeton, N. J.

Clearly, the prime requisite of a video-frequency amplifier is the amplification of a signal, essentially transient in character, without appreciable modification of the intelligence borne by the signal; that is, the wave shape must be preserved within limits known to be tolerable. Distortionless amplification of transient voltages is obtained when the amplitude response and phase delay of the amplifier are independent of frequency from zero to infinite frequency. The essential video-frequency spectrum however is limited and extends from 60 cycles to at least 2.5 megacycles for the present 441-line interlaced scanning with a frame frequency of 30 cycles per second. Complete agreement on the upper limit of the spectrum does not exist; values ranging from 2.5 to 4.25 megacycles may be found in the literature. We know that amplifiers cannot and need not render distortionless amplification even over the video-frequency spectrum. Specific tolerances therefore are very important in design. The nature of the circuit elements in video-frequency amplifiers permits a complete division into low-frequency distortion and high-frequency distortion. We shall be concerned exclusively with the latter. Two criteria of high-frequency fidelity are in use.

The first concerns the sine-wave steady-state characteristics. (a) The amplitude response shall be substantially independent of frequency over the spectrum. (b) Differences between the phase delays at intermediate frequencies and at the upper frequency limit shall be small compared with the time required for the receiving aperture or spot to traverse a distance equal to the scanning-line pitch.

The second and less common criterion concerns the response to a Heaviside unit voltage commonly called the transient response. Three points are made in support of the unit voltage as a test signal. (1) An amplifier that responds properly to a unit voltage will amplify any video-frequency signal with acceptable fidelity. (2) If the response to a unit voltage is known, the response to any other transient signal may be calculated by the superposition theorem of operational calculus. (3) The effect of a given transient-response wave upon the picture structure can be determined by inspection.

We believe that tolerances can best be set by a direct examination of the response to transient voltages and that the second criterion is well suited for this purpose. The first criterion lacks directness and ultimately the second must be used as a check because the television video-frequency amplifier is fundamentally an amplifier of transient voltages. In this respect transmission requirements for television differ from those for sound.

A signal having the discontinuous character of a unit voltage is

generated by a dimensionless scanning spot when scanning an infinitely sharp change in picture shade. In reality the scanning spot has an appreciable diameter and changes in picture shades are never infinitely sharp. As a consequence the most abrupt unidirectional change in voltage that can be generated by a scanning spot in present television systems occurs over an interval of about 0.15 microsecond.

The existing literature treats only one or two stages and methods of calculating the transient response have not been particularly expeditious for extension to multistage amplifiers. This is at once a handicap because the transmission characteristics of the entire television system (camera amplifier, studio amplifier, transmitter, and receiver) determine the fidelity. The video-frequency signal may pass through as many as forty stages of video-frequency amplification. A satisfactory method for obtaining the overall response of a system must be readily adaptable to the data available. In most instances the circuit elements of an amplifier may be treated as lumped constants and the

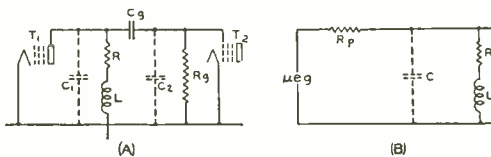

Fig. 1

- (A) Compensated resistance-coupled amplifier.
 (B) Equivalent circuit for high frequencies.

response calculated. In other instances, the circuit constants are distributed in such a way that analysis in terms of lumped elements is not feasible. In the later case it is usually practicable to measure steady-state amplitude and phase-delay characteristics of full or reduced-scale models. The application of a completely satisfactory method should not require the services of a professional mathematician. Simplicity and dependability are very desirable.

We shall discuss briefly two classical methods for the calculation of the response to a unit voltage, the operational method and the Fourier integral formulation, and then develop in detail a preferred method. The compensated resistance-coupled amplifier has been frequently used in television systems and therefore will be used here as an example. Figure 1(A) is a schematic diagram of connections. Figure 1(B) is the equivalent circuit for high frequencies. The several components of distributed capacitance have been combined in a single value

C. The inductance is added in order to maintain the response near the upper limit of the frequency spectrum at a higher level than possible in a simple resistance-coupled stage.

Using the conventional processes of operational calculus McLachlan¹ and others² have derived complete formulas for the response of a single amplifier to a unit voltage. Reference to McLachlan's paper is suggested for the details of the derivation which yields the following equation:

$$e(t) = g_m R \left[1 - \frac{e^{-\pi f_0 K t}}{K \sqrt{1 - K^2/4}} \sin (M t + \theta) \right] \quad (1)$$

in which

$$f_0 = \frac{1}{2\pi \sqrt{LC}} \qquad K = 2\pi f_0 RC$$

$$M = 2\pi f_0 \sqrt{1 - \frac{K^2}{4}}$$

$$\theta = \tan^{-1} \frac{K \sqrt{1 - K^2/4}}{K^2/2 - 1}$$

g_m = transconductance of the tube

$$R_p \gg R; \quad C_o \gg C_2; \quad R_o \gg \frac{1}{C_o \omega}$$

(Changes in the original notation have been made for convenience.)

McLachlan mentions also the steps to be taken for obtaining the response of n stages but does not give the explicit result. In any event the method of operational calculus involves the use of specialized mathematical technique and entails a great amount of labor when there are several stages all identical or different. Its application is restricted to cases in which the circuit configuration and elements are known. This excludes the practical case in which experimentally determined amplitude and phase characteristics constitute the only available data as a consequence of distributed circuit constants.

¹ N. W. McLachlan, "Reproduction of transients by a television amplifier," *Phil. Mag.*, vol. 22, pp. 481-491; September, (1936).

² O. Lurje, "Equalizing processes in wide-frequency range amplifiers," *Tech. Phys. (U.S.S.R.)*, vol. 3, pp. 229-248; March, (1936).

The Fourier integral formulation provides an expression for the response to a unit voltage involving the steady-state amplitude and phase characteristics explicitly; namely,

$$e(t) = \frac{H(0)}{2} + \frac{1}{\pi} \int_{-\infty}^{\infty} \frac{H(\omega) \sin [\omega t - \theta(\omega)]}{\omega} d\omega. \quad (2)$$

$H(\omega)$ and $\theta(\omega)$ are the amplitude and phase characteristics respectively and ω is the angular frequency.

Although (2) is outwardly simple, its usefulness is much restricted in design work as the result of difficulties in the integration of the

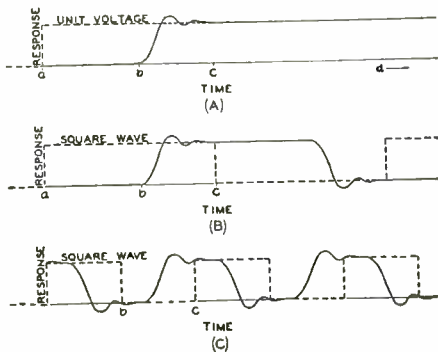

Fig. 2

- (A) Transient response of typical multistage amplifier.
- (B) Response to a square wave; period = $2t_{a-c}$.
- (C) Response to a square wave; period = $2t_{b-c}$.

infinite integral. Usually an analytical integration presents great difficulty even to a professional mathematician. Graphical solution is unavoidably tedious on account of the oscillatory character of the integrand. After checking a few points on the transient-response curves in Figure 11 by graphical integration of (2) we were convinced that the method is impracticable when a numerical answer is sought.

STEADY-STATE SQUARE-WAVE FORMULATION

Before proceeding further it is necessary to distinguish between low-frequency and high-frequency distortion. Figure 2(A) is a sketch of a typical transient response of a multistage amplifier (not necessarily a compensated resistance-coupled amplifier.) The interval $a - b$

over which the response is substantially zero is the effective time of transmission and does not represent distortion. During the interval $b - c$ the response increases from zero to a steady value after executing a damped oscillation (or an aperiodic variation). The failure of the response to rise sharply to 100 per cent, and remain there, is distortion. t_{b-c} will ordinarily be less than a half microsecond which is to say that the response during the interval $b - c$ is determined almost entirely by the amplitude and phase-delay characteristics in the upper region of the video-frequency spectrum. The capacitance of an amplifier for the reproduction of signals that correspond to the fine detail of a television subject is measured by the steepness of the wave front provided that the amplitude of the damped oscillation is low. During the interval $c - d$ there is a decline in response at a very slow rate which is governed by the low-frequency characteristics of the amplifier, that is, by coupling condensers, grid leaks, and plate-supply filters. This decline is too slow to be perceptible on the time scale in Figure 2(A). The complete response shown in Figure 2(A) may be considered as the limiting case of the response to a periodic square wave as the period becomes infinite. That is, if the square wave has the form

$$E(t) = \frac{1}{2} + \frac{2}{\pi} \left\{ \sin 2\pi f_p t + \frac{1}{3} \sin 6\pi f_p t + \frac{1}{5} \sin 10\pi f_p t + \dots \right\} \quad (3)$$

the response will be

$$e(t) = \frac{1}{2} + \lim_{f_p \rightarrow 0} \frac{2}{\pi} \left\{ A_1 \sin 2\pi f_p (t - D_1) + A_3 \sin 6\pi f_p (t - D_3) + A_5 \sin 10\pi f_p (t - D_5) + \dots \right\} \quad (4)$$

A_n and D_n are the steady-state amplitude response and phase delay for the frequency $n f_p$.

It is clear from physical considerations that a significant calculation may be carried out using a finite period. If the response during the interval $a - c$ is required, the period of the square wave is taken

only long enough to permit the response to attain a substantially constant enduring value (that is, 100 per cent) before the beginning of the following half cycle. Hence, in Figure 2(B) the period is taken equal to $2 t_{a-c}$.

Usually the effective time delay t_{a-b} is unimportant and only the response during the interval $b - c$ is required. In this instance a half period equal to t_{b-c} is sufficiently long as illustrated in Figure 2(C).

The simplicity of the steady-state formulation as a means of numerical computation may be greatly compromised if a suitable choice of the period leads to a slowly converging series. Fortunately, this is not the case in the solutions presented below or in many other practical problems that we have treated. The labor involved in a specific instance is minimized when the duration of the transitory response is known approximately. An estimate may be made usually from inspection of the steady-state amplitude and phase characteristics. The utility of the Fourier series method can be demonstrated best by applications. To this end we have calculated the responses of a single-stage amplifier and several multistage compensated amplifiers. The treatment covers the interval $a - c$; no further consideration is given to the response over the interval $c - d$.

THE TRANSIENT RESPONSE OF COMPENSATED RESISTANCE-COUPLED AMPLIFIERS

The amplitude and phase characteristics of a single stage required for the series formulation are given by the following formulas:

$$\text{amplitude response} = g_m R \sqrt{\frac{1 + B^2/K^2}{B^2K^2 + (B^2 - 1)^2}} \quad (5)$$

$$\text{phase delay} = \frac{\theta}{2\pi f} = \frac{1}{2\pi f} \tan^{-1} (B/K) (K^2 + B^2 - 1) \quad (6)$$

in which

f = frequency

θ = phase shift (θ is positive when the output voltage lags the input voltage)

$B = f/f_0$

K, f_0 , as defined for (1).

If $f(K/f_0)$ is taken as the independent variable instead of f , a

family of universal response curves and a family of universal delay curves may be drawn in which K is a parameter; and the change in variable will permit a rapid comparison of individual amplifiers having equal gains at low frequencies but different values of K . It will be shown later that K and f_0 are the essential circuit parameters. The condition for equal gains at low frequencies for different amplifiers characterized by K_1, K_2, K_3 , etc., is that the product Rg_m shall be the same in all cases. That is,

$$R_1g_{m1} = R_2g_{m2} = R_3g_{m3} \text{ etc.},$$

or

$$\frac{K_1}{f_{01}C_1} g_{m1} = \frac{K_2}{f_{02}C_2} g_{m2} = \frac{K_3}{f_{03}C_3} g_{m3}.$$

If

$$\frac{g_{m1}}{C_1} = \frac{g_{m2}}{C_2} = \frac{g_{m3}}{C_3},$$

then

$$\frac{K_1}{f_{01}} = \frac{K_2}{f_{02}} = \frac{K_3}{f_{03}}. \tag{7}$$

Hence at any given frequency the steady-state data corresponding to K_1, K_2, K_3 , etc., may be read directly from Figures 3 and 4 in which the condition of equal gain is automatically fulfilled when (7) holds.

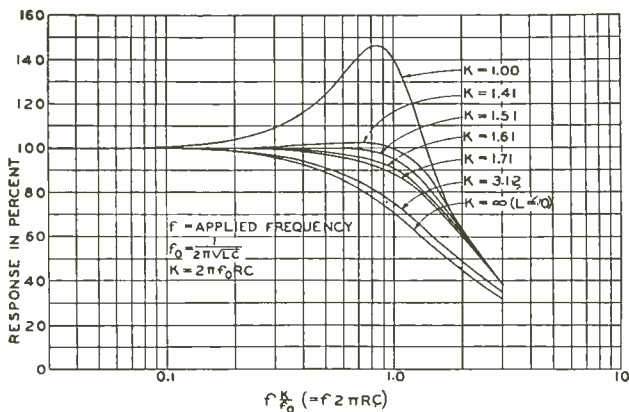

Fig. 3—Amplitude characteristic of one-stage amplifier.

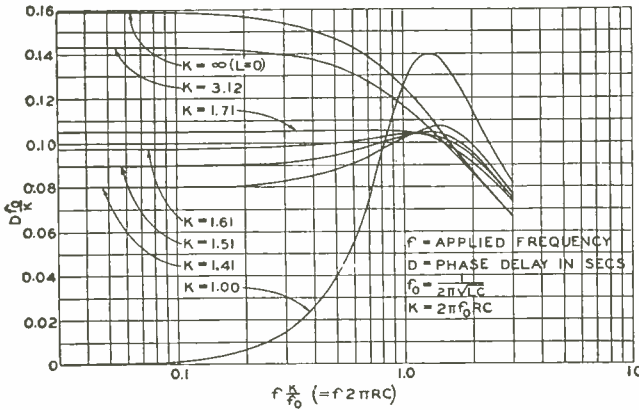

Fig. 4—Phase-delay characteristic of one-stage amplifier.

Inspection of these figures show that there is no value of K for which amplitude and phase-delay characteristics are simultaneously optimum. Among the curves in Figures 3 and 4, that for $K = 1.71$ exhibits the least dependence of phase delay on the frequency and that for $K = 1.51$ (more exactly $K = 1.55$), the least dependence of amplitude response on the frequency.

Figure 5 shows a family of curves of the response to a Heaviside unit voltage according to the rigorous equation (1). The family may be calculated easily by the Fourier series method drawing the necessary data from Figures 3 and 4. The only step in the series development requiring judgment is the choice of a fundamental period, or rather

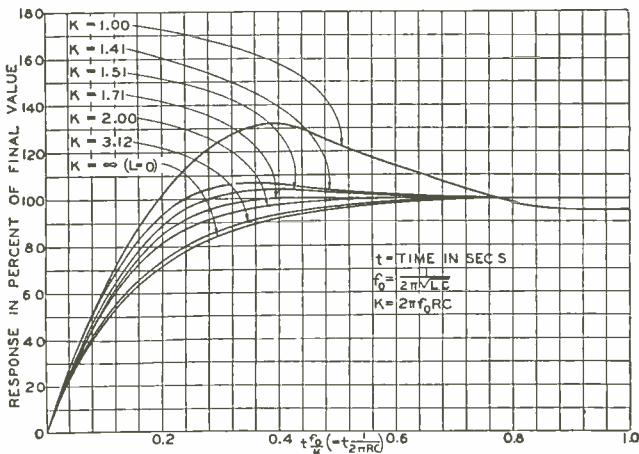

Fig. 5—Response of one-stage amplifier to a unit voltage.

half period, that just exceeds the time required for the response to attain a steady value. If a longer period is used, the convergence of the series is less rapid but the calculated response is not affected. If the period is too short, calculation reveals the misjudgment immediately by yielding a response curve that does not attain a steady value before the beginning of the next half cycle. Figure 5 is an aid in devising a guiding principle for finding a suitable period. Consider the curve of the family corresponding to $K = 1.41$. The response does not vary more than ± 1 per cent from the final value after the elapse of $0.8K/f_0$ second. Hence it is expected that the significant part of the response to a unit voltage which occurs within the interval 0 to $0.8K/f_0$ second will be approximated closely by the response to a square wave that has a fundamental period equal to $2 \times 0.8K/f_0$ or $2.26/f_0$ seconds; namely,

$$\begin{aligned}
 e(t) = \frac{1}{2} + \frac{2}{\pi} \left\{ A_1 \sin 2\pi \frac{f_0}{2.26} (t - D_1) \right. \\
 + \frac{A_3}{3} \sin 6\pi \frac{f_0}{2.26} (t - D_3) \\
 \left. + \frac{A_5}{5} \sin 10\pi \frac{f_0}{2.26} (t - D_5) + \dots \right\}. \quad (8)
 \end{aligned}$$

If terms having amplitudes less than 0.01 are neglected, the finite series expression becomes

$$\begin{aligned}
 e(t) = \frac{1}{2} + \frac{2}{\pi} \left\{ 1.02 \sin \left(2\pi \frac{f_0}{2.26} t - 0.358 \right) \right. \\
 + 0.225 \sin \left(6\pi \frac{f_0}{2.26} t - 1.20 \right) \\
 + 0.074 \sin \left(10\pi \frac{f_0}{2.26} t - 1.46 \right) \\
 \left. + 0.036 \sin \left(14\pi \frac{f_0}{2.26} t - 1.53 \right) \right\}. \quad (9)
 \end{aligned}$$

$$\begin{aligned}
 &+ 0.021 \sin \left(18\pi \frac{f_0}{2.26} t - 1.55 \right) \\
 &+ 0.014 \sin \left(22\pi \frac{f_0}{2.26} t - 1.56 \right) \\
 &+ 0.010 \sin \left(26\pi \frac{f_0}{2.26} t - 1.56 \right) \Bigg\}.
 \end{aligned}$$

The agreement between $e(t)$ computed from the series (9) and $e(t)$ computed from the rigorous equation (1) is very good as shown in Table I. Near the discontinuities in the response at $t=0$ and $t=0.8K/f_0$ the series gives the poorest approximation. This is expected according to the theory of Fourier series.

TABLE I

$\frac{tf_0}{K}$	$e(t)$ from equation	
	(1)	(9)
0	0	0.04
0.05	0.30	0.30
0.10	0.60	0.58
0.20	0.93	0.92
0.40	1.06	1.07
0.60	1.02	1.02
0.80	1.00	0.96

Slide-rule accuracy.

Advance information was available in Figure 5 for selecting a suitable fundamental period, but in useful applications of the series method such a convenient guide will be lacking. In the absence of other data, the proper fundamental frequency may usually be taken equal to the frequency at which the steady-state amplitude and delay characteristics cease to be sensibly independent of frequency. This is reasonable because distortion of the unit voltage input is caused by discrepancies in the characteristics. There are however exceptional cases in which this guide fails; one exception is the idealized amplifier. The amplitude and phase-delay characteristics of an idealized amplifier are independent of frequency in the range $0 - f_c$ and the amplitude characteristic is 0 for frequencies greater than f_c . This is one of the few instances in which the Fourier integral (2) leads to a simple expression. Thus if the amplitude response $H(\omega)$ is set equal to 1 and the phase delay $\theta(\omega)/\omega$ to D , a constant independent of frequency,

there results

$$e(t) = \frac{1}{2} + \frac{2}{\pi} \int_0^{2\pi f_c(t-D)} \frac{\sin x}{x} dx. \quad (10)$$

The definite integral is available in mathematical tables.³ Figure 6 illustrates the response of the idealized amplifier having an arbitrary value of phase delay D equal to $20/2\pi f_c$ seconds. Obviously the wave shape does not depend upon D .

A suitable period for a Fourier series development would be chosen by trial. In general a period of insufficient length is detected immediately when the calculated response fails to attain a steady value during a half cycle.

Equation (10) indicates that the idealized amplifier responds before the unit voltage is applied. This discrepancy is a consequence of the physical incompatibility of the assumptions regarding $H(\omega)$ and $\theta(\omega)$.

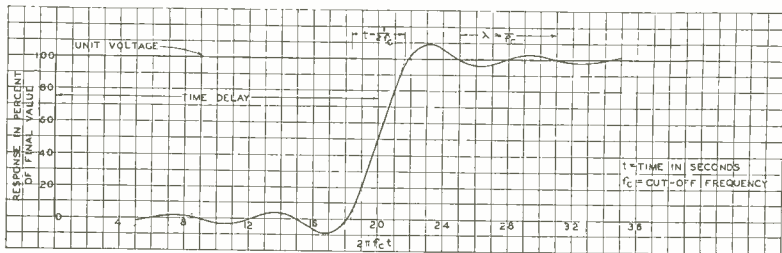

Fig. 6—Response of idealized amplifier to a unit voltage.

The idealized amplifier however is a good criterion of the optimum use of a given band width for the production of the maximum steepness of wave front.

TRANSIENT RESPONSE OF MULTISTAGE AMPLIFIERS

The simplicity and rapidity of calculation of the steady-state response to a square wave are especially valuable properties in the design of multistage amplifiers. A calculation of the stage-by-stage response of a 16-stage amplifier was laboriously made by repeated application of the superposition theorem of operational calculus before the utility of the series method was recognized. The result shown in Figure 10 illustrates the accumulative distortion of a unit voltage input, a progressive decrease in the slope of the wave front, and a progressive increase in the high-frequency damped oscillation, which is typical of cascaded stages.

³ Jahnke-Emde, TABLES OF FUNCTIONS, Second revised edition, p. 78. B. G. Teubner, Leipzig and Berlin, (1933).

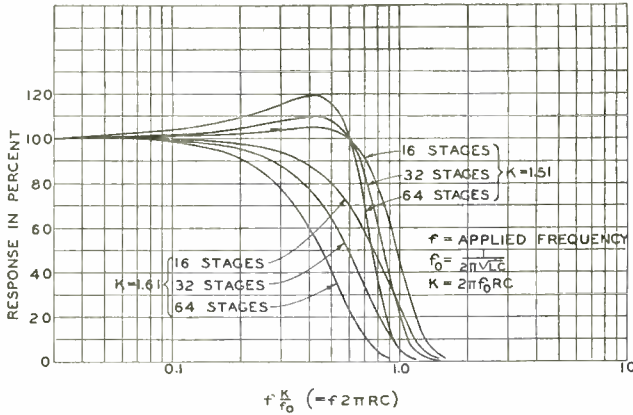

Fig. 7—Amplitude characteristics of multistage amplifiers.

Figure 11 is an extension of the Fourier series method to 16-, 32-, and 64-stage amplifiers. The required amplitude response and phase-delay characteristics shown in Figures 7, 8, and 9 were derived from Figures 3 and 4 by raising the amplitude response of one stage to the n th power and multiplying the phase delay by n . All transient-response curves are plotted with the correct effective time delay, that is, the fundamental periods of the series expansions exceeded t_{a-c} .

Fourier series formed with shorter periods may express adequately the response during the interval $a - c$ as explained above. For example the response of a 64-stage amplifier, $K = 1.61$, may have the following series expansion:

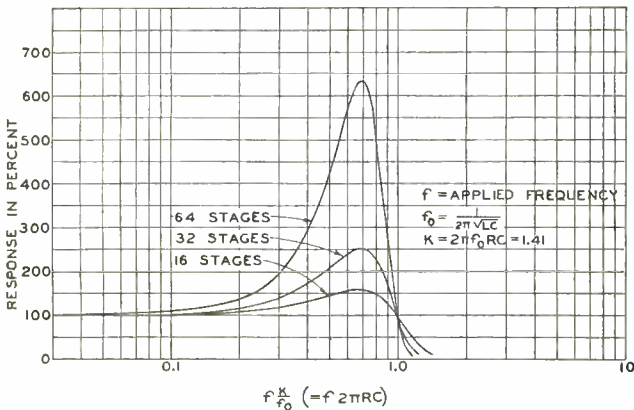

Fig. 8—Amplitude characteristics of multistage amplifiers.

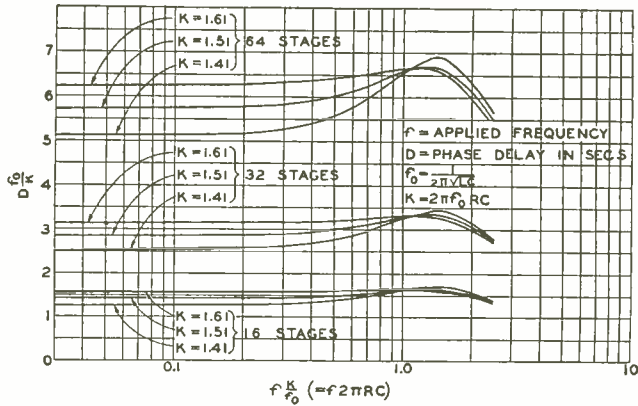

Fig. 9—Phase-delay characteristics of multistage amplifiers.

$$\begin{aligned}
 e(t) = & \frac{1}{2} + \frac{2}{\pi} \left\{ 0.98 \sin \left(2\pi \frac{f_0}{16} t - 3.95 \right) \right. \\
 & + 0.256 \sin \left(6\pi \frac{f_0}{16} t - 11.99 \right) \\
 & + 0.08 \sin \left(10\pi \frac{f_0}{16} t - 20.29 \right) \\
 & \left. + 0.016 \sin \left(14\pi \frac{f_0}{16} t - 28.88 \right) \right\} .
 \end{aligned}
 \tag{11}$$

The fundamental period $16/f_0$ is equal to two times the reciprocal of

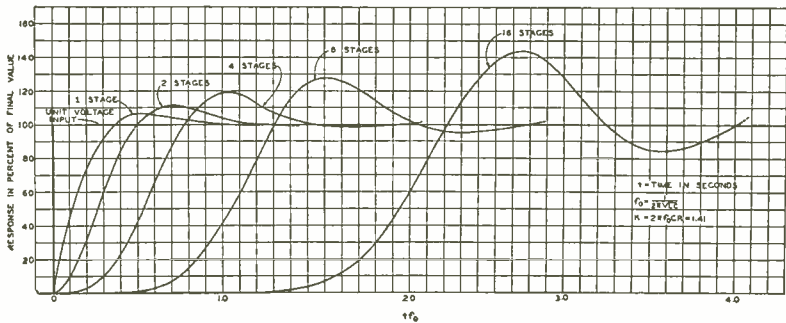

Fig. 10—Response of multistage amplifiers to a unit voltage.

frequency at which the steady-state amplitude and phase-delay curves begin to depend appreciably on the frequency as shown in Figure 11.

Equation (11) defines a response similar to that illustrated by Figure 2(C) and does not yield automatically the length of the effective time delay. If the delay is required, steps justified by the following reasoning will lead to the correct value. The square wave shown in Figure 2(C) may be considered as the superposition of a series of positive unit voltages impressed at $t = 0, -2t_{b-c}, -4t_{b-c}, -6t_{b-c},$ etc., $2t_{b-c}, 4t_{b-c}, 6t_{b-c},$ etc., and a series of negative unit voltages impressed at t equals $-t_{b-c}, -3t_{b-c}, -5t_{b-c},$ etc., $t_{b-c}, 3t_{b-c}, 5t_{b-c},$ etc. The associated transient functions will form the periodic response to the square wave. It is evident that the apparent time delay plus an integral multiple of the period of the square wave is determinable from (11). This information together with the fact that the intercept on

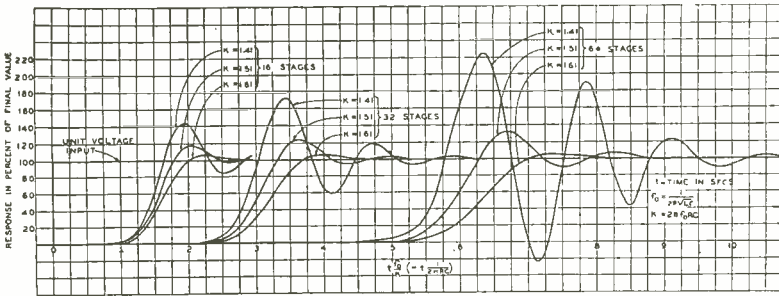

Fig. 11—Response of multistage amplifiers to a unit voltage.

the phase-delay characteristic in Figure 9 is approximately equal to the effective delay will define the delay explicitly. It is conceivable that this procedure may fail in special cases.

The character of the responses of the various 16-stage amplifiers may be compared directly on the basis of equal low-frequency gain as a result of the choice of independent variable tf_0/K ; similarly in the cases of 32- and 64-stage amplifiers. The essential character of the response is controlled by the parameters K and f_0 which may be specified independently. K determines the magnitude of the damped oscillation and f_0 determines the steepness of the wave front.

If the cathode-ray beam of a receiving tube is modulated by the response of 32 stages, $K = 1.41$, a series of alternate light and dark striations will be distinctly visible following the scanning of a vertical black-to-white junction, as a result of the damped oscillation in the

signal. A definite standard of tolerable damped oscillation in the response of video-frequency amplifiers must treat (1) amplitude, (2) frequency, and (3) rate of decay. To set up a standard is not the purpose of this paper. However, observation of television pictures transmitted by multistage video-frequency amplifiers with $K = 1.41$ has led to a general rejection of this value. Figures 10 and 11 ably support this rejection. We believe that the K factor should lie between 1.51 and 1.61.

The horizontal resolution of a television picture is substantially proportional to the slope of the wave front of the over-all response to a unit voltage. If a slope is specified, the resonant frequency f_0 may be determined by reference to the scale of abscissas in Figures 10 and 11. For example, a 32-stage amplifier $K = 1.51$ has an effective linear rise from 0 to 100 per cent response within about 0.8 unit on the axis of abscissas. Let this correspond arbitrarily to 0.16×10^{-6} second. Then

$$0.8 = t \frac{f_0}{K} = \frac{0.16 \times 10^{-6} \times f_0}{1.51}$$

$$f_0 = 7.5 \times 10^6 \text{ cycles.}$$

EXPERIMENTAL DETERMINATION OF THE TRANSIENT RESPONSE

The mathematical determination of the transient response may be obviated in the case of existing amplifiers when a generator of a square-wave form and a suitable oscillograph are available. Thus the fidelity of a video-frequency amplifier can be determined directly from an oscillographic observation of the response to a square wave of suitable period by noting the steepness of the wave front and the character of the damped oscillation. Clearly, the analytical method should give way to the experimental method whenever possible in order to avoid the labor involved in finding amplitude and phase-delay characteristics and the subsequent series solution of the transient response.

If the amplitude and phase characteristics are required for the design of correcting networks, the experimentally determined square-wave response may be analyzed graphically by the well-known methods of harmonic analysis.

CONCLUSIONS

The transient nature of the signals which television amplifiers are required to amplify suggests that the most logical and relevant criterion of the fidelity is the response of the amplifier to a Heaviside unit volt-

age. The survival of the older criterion based on the steady-state characteristics of amplitude response and phase delay is caused probably by the large accumulation of knowledge of electric filters based also on these steady-state characteristics.

We have shown that the part of the response to a unit voltage that is governed by the high-frequency amplitude and phase-delay characteristics of amplifiers may be approximated by the steady-state response to a square wave. Simplicity and rapidity of numerical calculation are the outstanding advantages of the steady-state series formulation over the method of operational calculus and the Fourier integral formulation.

The series is formed by finding the steady-state response to a square wave of voltage having a half period that is longer than the time interval required for the response to attain a steady value starting at the time of the first appreciable response. Convergence of the series is most rapid when the shortest period satisfying the above condition is used. Trial calculation will reveal the error in judgment when the period is too short.

A detailed analysis of the compensated resistance-coupled amplifier yields the following conclusions: (1) The wave-shape distortion of a unit voltage is accumulative as the number of stages is increased. (2) The value of the damping constant K should lie between 1.51 and 1.61 in most cases. (3) The resonant frequency f_0 determines the slope of the wave front of the transient response.

We propose that the oscillographic response of video-frequency amplifiers and the associated equipment to a square wave be considered as a part of performance tests of future television systems.

A WIDE-BAND INDUCTIVE-OUTPUT AMPLIFIER*†

BY

ANDREW V. HAEFF AND LEON S. NERGAARD‡

Research and Engineering Department, RCA Manufacturing Company, Inc.
Harrison, N. J.

Summary—In order to obtain amplification over a wide band of frequencies, a tube having high transconductance and low input and output capacitance is required. A grid-controlled inductive-output tube having these attributes and giving 10 watts output at 500 megacycles is described. A high ratio of transconductance to input capacitance is attained by close cathode-grid spacing and large grid-screen spacing, the latter made possible by use of a very high screen voltage. A low output capacitance is obtained by the use of an inductive-output arrangement which requires no power dissipation by the output electrodes. The design of the output circuit for low inherent capacitance is facilitated by the use of magnetic lenses to focus the electron beam. These lenses can be energized by a permanent magnet. Loading caused by secondary electron emission from the current collector is eliminated. The performance of the tube as a wide-band amplifier is described.

THE interest in the application of ultra-high frequencies for communication purposes was greatly stimulated by the publication within recent months of several papers describing successful applications of novel principles for generation and amplification of ultra-high-frequency oscillations.^{1,2,3} Power outputs of the order of hundreds of watts at frequencies of over 500 megacycles were reported.

For certain applications an ultra-high-frequency power amplifier capable of transmitting a wide band of frequencies is required. Thus, to the original requirement of high power output at high frequency a new requirement of band width is added. This additional requirement introduces certain problems which must be considered in the design of ultra-high-frequency tubes for this service. The present paper describes a power amplifier designed especially for wide-band applications

* Decimal Classification: R583.6 × R339.

† Presented at the Fourteenth Annual I.R.E. Convention in New York, N. Y. on September 23, 1939. Reprinted from *Proc. I.R.E.*, March, 1940.

‡ Now with the Research Department, RCA Laboratories Division, Princeton, N. J.

¹ A. V. Haeff, "An Ultra-High-Frequency Power Amplifier of Novel Design", *Electronics*, Vol. 12, pp. 30-32; February, 1939.

² W. C. Hahn and G. F. Metcalf, "Velocity-Modulated Tubes", *Proc. I.R.E.*, Vol. 27, pp. 106-116; February, 1939.

³ R. H. Varian and S. F. Varian, "High Frequency Oscillator and Amplifier", *Jour. Appl. Phys.*, Vol. 10, pp. 321-327; May, 1939.

at ultra-high frequencies. In order to obtain amplification over a wide band of frequencies a tube having high effective transconductance and low input and output capacitances is required. An analysis of the situation indicated that a grid-controlled inductive-output tube possesses characteristics which make it particularly well adaptable to meet these requirements. In order to make the discussion of the specific problems encountered in the design of this tube more readily understood, the principle of operation of the grid-controlled inductive-output tube will be reviewed briefly.

Figure 1 illustrates the essential elements of an inductive-output amplifier. An electron stream originates at the cathode, passes through the control grid and the output electrodes *a* and *b*, and is finally collected at the collector electrode. The control grid which is placed near the cathode varies the electron stream when the input circuit connected between the grid and cathode is excited. The output elec-

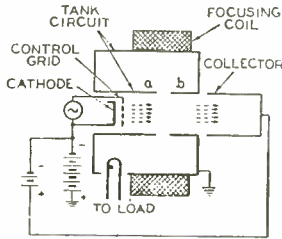

Fig. 1—Schematic diagram of a grid-controlled inductive-output amplifier.

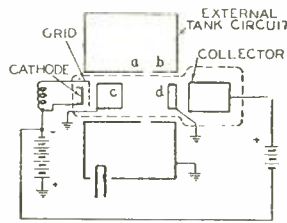

Fig. 2—Diagram of an inductive-output amplifier with an external output circuit.

trodes *a* and *b* surrounding the electron stream form an integral part of the output tank circuit which is excited by the varied electron stream passing through the output gap *a-b* at high velocity. Electrons decelerated in the gap *a-b* by the high-frequency voltage are collected at the low-voltage collector. The load is shown inductively coupled to the tank circuit.

Figure 2 represents an arrangement in which the output circuit is external to the glass envelope of the tube. In this case the excitation of the tank circuit by the varying electron stream takes place by electric induction through the glass wall of the tube. To avoid undesirable effects of electric charges on the glass the two auxiliary accelerating electrodes *c* and *d*, to which high voltage is applied, are placed within the glass envelope. These electrodes are positioned some distance away from the output gap *a-b* in order to minimize coupling to the output circuit. The screening action of the electrodes *a* and *b* makes it possible to reduce the output-input coupling to a negligible value.

With the general principles of the tube operation in mind, the particular requirements for wide-band amplification can now be considered. The figure of merit of a tube for wide-band service can be defined as the transconductance divided by the geometric mean of input and output capacitances. The first objective, then, is the attainment of high transconductance. The solution is to reduce the grid-cathode spacing to a minimum. Because of the fact that the input capacitance increases in inverse proportion to the first power of grid-cathode spacing, while the transconductance increases as the second power of the spacing, the reduction of spacing results in a net increase of the figure of merit. The use of small spacing which satisfies the high-frequency requirement of minimum transit time. The latter is important in order to avoid excessive input loading and loss in transconductance from finite electron transit time.

In order to obtain sharp cutoff characteristics and to make full use of the cathode area, the turns per inch of the grid must be increased in proportion to the reduction in the grid-cathode spacing. Because the grid-wire diameter cannot be reduced indefinitely for mechanical reasons, the μ of the control grid will be high. To obtain sufficient current at negative control-grid potential an intense accelerating field must be established at the control grid by the accelerating electrode. This can be accomplished either by placing the accelerating electrode close to the control grid or by applying a very high voltage on the accelerating electrode. The first alternative is undesirable because the proximity of the accelerating electrode results in an appreciable increase in the capacitance of the control grid. However in conventional tubes this is the only practical solution because of the limitations imposed by the dissipative ability of the screen grid and by the requirements of high plate efficiency. The use of the inductive-output principle and of electron focusing makes it possible to operate the accelerating electrode at a potential of several thousand volts. Thus, the accelerating electrode can be placed at an appreciable distance away from the control grid so that a sufficient field can be established without increase in the control-grid capacitance.

Figure 3 illustrates the potential-field distribution when an accelerating electrode of cylindrical form is used. To provide uniformity of field at the grid and to focus the beam an aperture disk is placed between the cylinder and the control grid. The control grid is mounted on this disk slightly displaced from the plane of the aperture. This arrangement produces a field uniform over the whole surface of the cathode which results in sharp cutoff characteristics and, thus, increases the effective transconductance under class B operating conditions. The

inward radial component of the electric field serves to focus the electron stream initially and, therefore, materially reduces stray current to the accelerating electrode.

With regard to output capacitance, the inductive-output tube has a considerable advantage over conventional tube design. Because the output electrodes do not dissipate energy their size is determined only from the considerations of the cross-sectional dimensions of the electron beam and the electron transit time across the output gap. By making use of a high accelerating potential the electron transit time can be reduced to a fraction of a period even when the gap length is appreciable. As a result, the end capacitance at the gap can be made

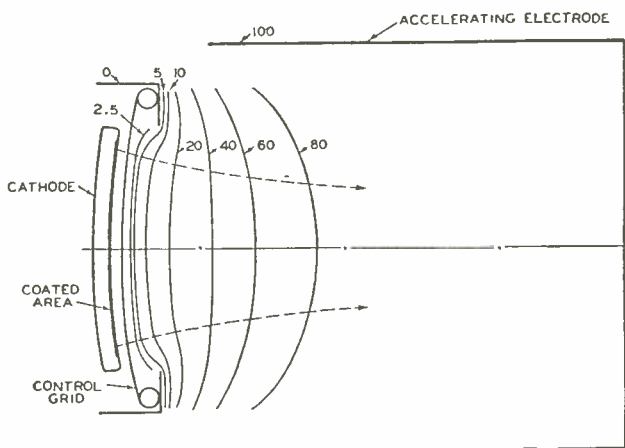

Fig. 3—Electric-field distribution between the control grid and the accelerating electrode showing beam-converging effect of the aperture disk.

very small. In some developmental tubes of the inductive-output type this capacitance has been reduced to a fraction of a micromicrofarad. However, one must consider the distributed capacitance of the output circuit. Thus, an output circuit consisting of a uniform concentric line has an effective lumped capacitance equal to one half of the total distributed capacitance. The distributed capacitance depends upon the ratio of the diameters of the inner and outer conductors and is proportional to the length of the line which in turn is proportional to the operating wavelength. The shorter the operating wavelength the smaller the capacitance of the output circuit and, therefore, the broader the circuit for the same impedance. In a properly designed circuit the total effective capacitance can be reduced to a value of the order of 1 to 2 micromicrofarads at a frequency of 500 megacycles.

Because the size of the output electrodes is determined primarily by the cross section of the electron stream, the low output-circuit capacitance is achieved by making the outer conductor of large dimensions. This requirement introduces certain problems with regard to focusing of the beam. As was described previously¹ one effective method of focusing is to produce an intense uniform magnetic field in the direction of the beam. However, in a case where a low-capacitance circuit requiring large dimensions is used the size of the focusing solenoid becomes unduly large. Focusing by electrostatic fields is not always desirable because of the necessity of introducing additional focusing electrodes.

An effective method of focusing, however, is to utilize a system of short magnetic lenses. Before describing this method we shall review

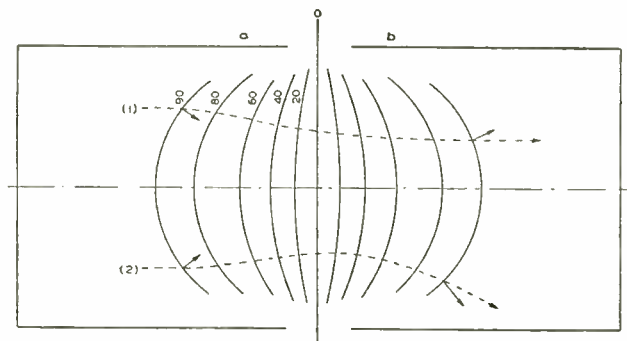

Fig. 4—Potential distribution at the output gap.

first the causes of electron-beam divergence. These are: (1) mutual repulsion of electrons, (2) the defocusing due to static electric fields, (3) the defocusing produced by high-frequency electric fields. The latter effect is quite important in an inductive-output tube since electrons are required to traverse the output gap across which there exists a high potential difference which changes appreciably during the time of electron transit. Figure 4 shows the potential distribution at the gap formed by two adjacent coaxial cylinders across which there is a difference of potential. When an electron is traveling from left to right (as indicated by path (1) in the figure) and the potential difference is such as to accelerate the electron, the electron first encounters a radial component of electric force towards the center. After crossing the center of the gap it is acted upon by a radial force tending to remove it from the beam. Under static conditions the net effect is convergence

of the beam because the electrons accelerated by the axial component of the field will traverse the diverging part of the field in a shorter time than they take to traverse the converging part of the field. However, when the field intensity increases appreciably during the electron transit, divergence may result because the electron experiences an outward force during its transit of the exit side of the gap, which is greater than the force toward the center while traversing the entrance side. This case is illustrated by an electron path (2) in Figure 4. If the field is decreasing during electron transit the net effect is to converge the beam. When the electron encounters a retarding field at the gap the effects described above are reversed. These considerations show that when the electron transit time across the output gap is appreciable, a very serious divergence or overfocusing of the electron beam may result.

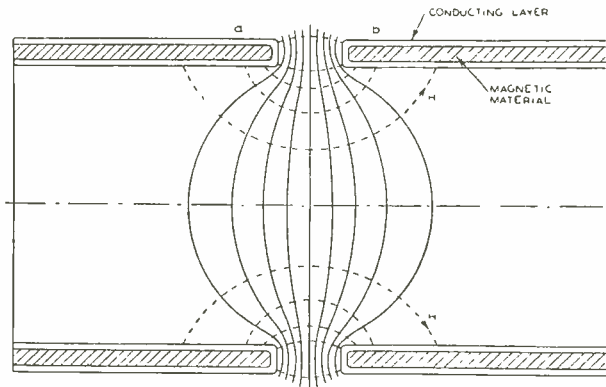

Fig. 5—Magnetic- and electric-field distribution at the lens.

The defocusing due to the variation of electric field with time is overcome most effectively when the magnetic field of the focusing lens occupies approximately the same region as the defocusing electric field. Such an arrangement is illustrated in Figure 5. A magnetic lens made from a ferromagnetic material similar in shape to the conductors producing the electric field is placed close to the output gap. Then the distribution of magnetic field is conjugate to that of the electric field. The magnetic-field intensity can be chosen sufficiently high to produce convergence in spite of the diverging effect of a rapidly changing electric field. In such a lens the force on an electron producing convergence depends on the square of the magnetic-field intensity, which is greater near the beam boundary. Therefore, the outermost electrons will receive the greatest focusing action, so that all electrons passing

through the lens will be converged. For this reason a magnetic lens of this type has a very important advantage over a uniform magnetic field. In addition, the localization of the magnetic field in the regions where it is most needed, makes the energy required to establish the requisite field considerably less than for the uniform magnetic field. This type of magnetic lens is also effective in preventing beam divergence from any cause such as space-charge or the defocusing effect of the electrostatic fields.

In order to avoid losses due to circulating currents induced by high-frequency fields in the ferromagnetic material, it is coated by a layer of material of high electrical conductivity. Because of the skin effect

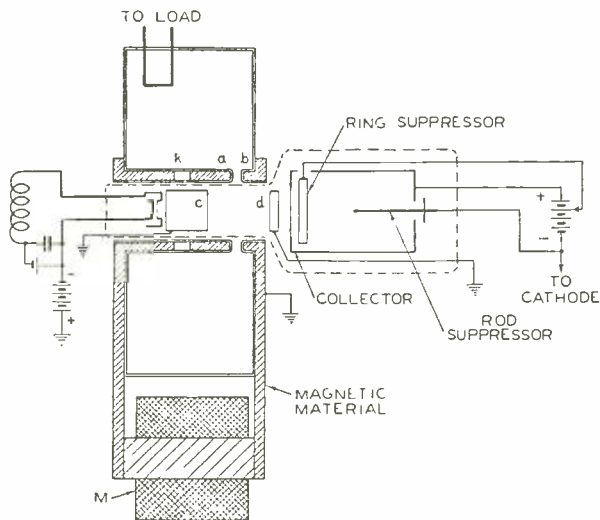

Fig. 6—Complete schematic diagram of the amplifier illustrating the magnetic-circuit arrangement and the disposition of electrodes for secondary-emission suppression.

at high frequencies the required thickness of the conducting layer is very small.

A complete arrangement for focusing the beam in the inductive-output tube is shown in Figure 6. The magnetic circuit of ferromagnetic material is energized by a coil *M*. Two lenses are formed by the gaps *a-b* and *k* in the hollow iron cylinders coaxial with the tube. One of these gaps coincides with the gap in the output circuit. The conducting material of the electrical circuit entirely encloses the iron cylinders forming the magnetic lenses so that all ferromagnetic material is completely shielded from the high-frequency fields. The first

lens k prevents the divergence of the beam caused by the accelerating electrode c . The second lens, $a-b$, compensates for the diverging effect caused by the high-frequency electric field at the output gap. By adjusting the lengths of the gaps $a-b$ and k in the magnetic circuit and by the adjustment of current in the energizing coil M it was possible to prevent electron bombardment of the accelerating electrodes and of the glass walls of the tube. The power required to do this was of the order of 1 to 2 watts, only a small fraction of that needed when a uniform focusing field is used. Because of very low magnetomotive force required to energize the lenses a permanent magnet can be conveniently used for the purpose.

An important characteristic of the inductive-output tube which is particularly advantageous at high power levels, is that high efficiency of operation can be obtained even when operating into a wide-band circuit of comparatively low impedance. This advantage is due to the fact that in an inductive-output tube the functions of output electrode and of current collector are performed by separate electrodes, the potentials of which can be chosen independently.

The wide-band requirement usually results in a tube of high current density and, consequently, of high voltage because of space-charge effects. The ultra-high-frequency requirements of short transit time also necessitate the use of high voltage. However, the wide-band operation requires the use of low-impedance circuits. Therefore the high-frequency output voltage will be comparatively low. If electrons were collected at the potential of the output electrode, a very low efficiency would result. However, in the inductive-output tube the collector potential can be adjusted independently of accelerating potential to a lower value determined primarily by the maximum amplitude of the high-frequency potential across the output gap. This operating condition establishes electric fields near the collector which tend to draw the secondary electrons from the collector towards the active spaces of the tube. The secondary electrons returning to the active spaces tend to abstract energy from the high-frequency circuit and thus reduce the useful high-frequency output power. Furthermore, these secondary electrons are finally absorbed by the high-potential accelerating electrodes thus increasing their dissipation and loading the high-voltage power supply.

In order to minimize these detrimental effects the secondary emission must be suppressed. This can be accomplished if a suppressing field is established at the surface of the collector. When a strong uniform magnetic field is used for focusing of the beam, an effective suppression of secondaries is obtained if the collector is made with a

deep recess as is illustrated in Figure 1, where a hollow cylindrical collector is shown. The electron beam held from diverging by a strong magnetic field impinges only on the back surface of the collector where the electric field due to the high-potential accelerating electrode is negligibly small because of the screening action of the long cylindrical portion of the collector. Furthermore, the space charge of the beam itself establishes a suppressing field near the surface of the collector thus effectively preventing the escape of secondaries.

However, when a system of short magnetic lenses is used for focusing, the above-described means for secondary-emission suppression are not very effective. The reason for this is that electrons may enter the collector region at an appreciable angle to the axis and strike the collector near the entrance where the intense field of the accelerating electrode will draw the secondaries away from the collector.

In order to suppress secondaries it is necessary to establish a suppressing field near the entrance to the collector. An effective arrangement is shown in Figure 6. Two suppressor electrodes are used, a ring near the entrance and a rod along the axis of the collector. The ring suppresses secondary electrons originating near the entrance and the rod produces a suppressing field over the remaining collector surface. In order to realize maximum collector efficiency, reflections of low-velocity electrons entering the collector must be prevented. Therefore, the ring suppressor is operated at a potential sufficiently low to establish a retarding field at the collector surface but not low enough to depress appreciably the space potential at the entrance to the collector. The rod suppressor electrode, however, can be operated even at cathode potential because electrons entering its suppressing field are deflected toward more positive regions so that no reflections occur. With this type of suppressor electrodes the secondary-emission current was reduced to a value less than 1.5 per cent of the beam current.

A photograph of a developmental tube incorporating principles discussed above is shown in Figure 7. The cathode, the aperture shield with the grid mounted inside, the accelerating electrodes in the form of cylinders, and the collector with the internal suppressors can be seen. The static characteristics of this tube are shown in Figure 8. At an accelerating potential of 3000 volts and a beam current of 40 milliamperes a transconductance of 6000 micromhos is obtained. The input capacitance is about 6 micromicrofarads. An output circuit properly designed for this tube for 500-megacycle operation exhibits an effective capacitance of about 2 micromicrofarads. At a frequency of 500 megacycles a power output of 10 watts has been obtained with a power gain of 10 when the tube operates into a circuit loaded to give 10-megacycle

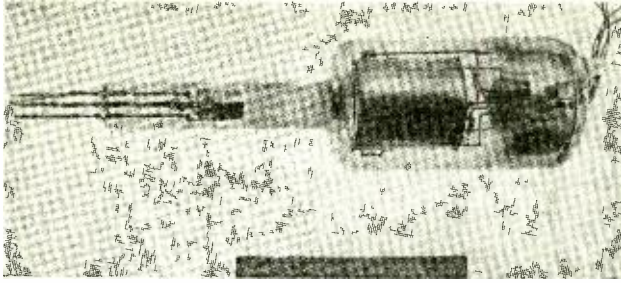

Fig. 7—Photograph of a developmental tube.

band width. The efficiency under this condition was about 25 per cent. At lower power levels, when class A operation is used, a power gain of 20 is obtained.

In conclusion, the advantages of a grid-controlled inductive-output tube for ultra-high-frequency, wide-band operation will be summarized.

- (1) High value of transconductance, and low value of input capacitance due to the use of high-voltage accelerating electrodes.
- (2) Low output capacitance due to the use of the inductive-output principle.
- (3) Good efficiency even with wide-band circuits and at ultra-high frequencies because the collector electrode potential can be adjusted to a value which is approximately equal to the peak value of high-frequency voltage appearing across the output circuit.

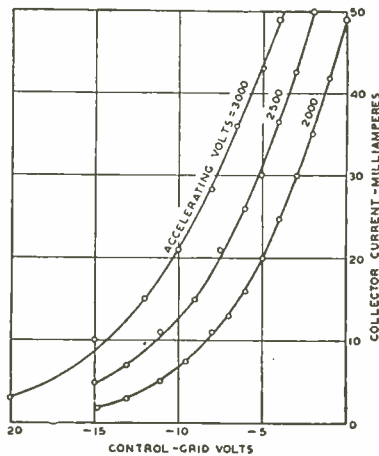

Fig. 8—Static characteristics of a developmental tube

ACKNOWLEDGMENT

The authors gratefully acknowledge the valuable contributions to this development of Professor Lloyd P. Smith, of Cornell University, during his association with the RCA Manufacturing Company.

MOBILE FIELD STRENGTH RECORDING OF 49.5, 83.5, AND 142 Mc FROM EMPIRE STATE BUILDING, NEW YORK—HORIZONTAL AND VERTICAL POLARIZATION*†

By

G. S. WICKIZER‡

Engineering Department, RCA Communications, Inc.,
Riverhead, L. I., N. Y.

Summary—The propagation characteristics of horizontally and vertically polarized waves have been studied on 49.5, 83.5, and 142 Mc, in several directions from the Empire State Building in New York City. Continuous mobile recordings of field strength were made from the transmitter location out to the limit of the receiver sensitivity.

Comparison of average field strength on horizontal and vertical polarization, over the same route, revealed that the horizontal polarization produced a stronger average field than the vertical polarization. Variation in field strength over the same route was found to be greater for horizontal polarization beyond the metropolitan area, and greater for vertical polarization in the city. Average field strength curves for three frequencies, when corrected to the same power, showed the lowest frequency (49.5 Mc) was strongest in the city, and the highest frequency (142 Mc) was strongest in the country, on horizontal polarization. On vertical polarization, the highest frequency produced the highest average field strength in both urban and suburban areas, when the curves were corrected to the same power.

INTRODUCTION

THE rapid extension of the useful limits of the ultra-high-frequency spectrum brings with it problems in applying these higher frequencies efficiently. Several factors to be considered are the choice of frequency and polarization to produce the strongest signal over a given area. In general, the most desirable frequency will be determined somewhat by the topography of the area, and the better polarization will be dictated by the electrical characteristics of the earth's surface in the area.

Although these choices might possibly be made from theoretical considerations, the problem is better adapted to an empirical solution, due to the countless irregularities existing in the transmission paths. In making a field strength survey, the system of continuous mobile recording has the advantage of producing a complete record of field strength for the entire route covered, and for this reason is much more thorough than a point-by-point method. Accordingly, mobile recordings of field strength on horizontal and vertical polarization were made on 49.5, 83.5, and 142 Mc, with the transmitters located at the Empire State Building, New York. The same path was traversed in each case, thus providing a direct comparison of field strength on the

* Decimal Classification: R583.16 × R271.

† Reprinted from *RCA REVIEW*, April, 1940.

‡ Now with the Research Department, RCA Laboratories Division, Riverhead, L. I., N. Y.

two polarizations, and also supplying additional information on propagation at these frequencies.

RECEIVING EQUIPMENT

The receiving equipment, with power supplies and antenna, was installed in a passenger two-door sedan. Suitable precautions were taken to prevent mechanical vibration of the equipment when the car was in motion.

The receiving antenna was a short doublet made of two pieces of $\frac{3}{8}$ -inch diameter, duralumin tubing, supported at a height of ten feet above the ground. The tubing was clamped in a bakelite head, which was attached to a wooden shaft about four feet long. This shaft was mounted on the roof of the car by a mechanical assembly which ex-



Fig. 1—Mobile field strength survey car.

tended through the roof, behind the rear seat. The mechanical fitting on the car was constructed to permit rotation about a vertical axis, and also to allow the antenna to be folded down against the roof when not in use. A small steering wheel and indicator were provided inside the car to assist in setting the bearing of the antenna when receiving horizontal polarization. A picture of the survey car is shown in Figure 1.

The receiver was a triple-detection superheterodyne, equipped with automatic gain control to compress the wide range of field strength to be measured. The direct-current output of the receiver was amplified and applied to a Bristol recording milliammeter. This type of recorder produces a continuous ink record on a paper chart which is drawn under the pen at a known rate.

To associate the record with geographical location, the chart was driven from the car drive shaft, through a suitable reduction gear

mechanism. With this arrangement, the recorder chart speed was either five inches per mile or twenty inches per mile, and the charts were numbered consecutively every inch.

Power for the receiver was obtained from six-volt storage batteries, which drive two 250-volt dynamotors. The batteries were connected to the car generator to reduce the battery current drain from fifteen amperes to about seven amperes.

The routes and frequencies covered in the field work are tabulated below.

Direction from New York	Frequencies
Northeast	83.5; 142 Mc.
North	83.5 Mc.
Southwest	49.5; 83.5; 142 Mc.

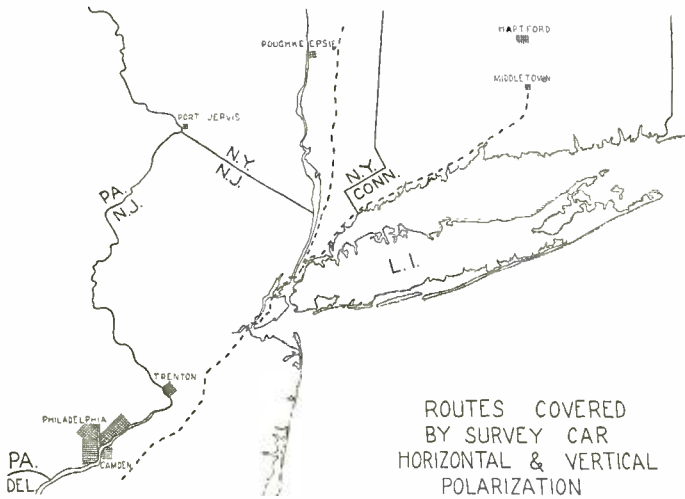

Fig. 2—Routes covered by survey car.

Additional information on the routes may be obtained from the map shown in Figure 2.

TRANSMITTING EQUIPMENT

A different transmitter was used for each of the three frequencies measured during the field work. On 49.5 Mc, the video channel of the NBC television transmitter was measured. The antenna on this transmitter was a half-wave doublet located on the south side of the building at the 85th floor. The height of this antenna was 1000 feet above the ground, and the radiated power was estimated to be 5 kw. The two higher-frequency transmitters were installed in the tower, and radiated

from half-wave doublets mounted outside the tower at the 103rd floor level, a height of 1200 feet above the ground. These doublets were changed from the north to the south side of the building, depending on the direction of the survey trip. The radiated power at 83.5 Mc was 750 watts, and at 142 Mc, the radiated power was 68 watts.

FIELD WORK

On each measuring trip, the observer kept a log correlating the numbers on the recorder chart with important locations along the route. Notations from the log were written on the charts before the analysis was begun. A chart speed of 20 inches per mile was used when re-

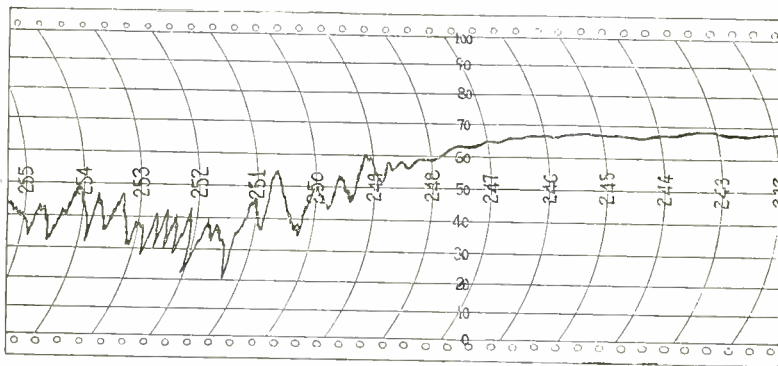

Fig. 3—Sample of mobile recording.

coding within 3 or 4 miles of the transmitter, to show greater detail on the record. At all other times the chart speed was 5 inches per mile.

On horizontal polarization, the receiving doublet was kept broadside to the transmitter, since the directivity of the doublet was appreciable. This steering operation was accomplished in several ways. At short distances, the Empire State Building was usually visible, and the local geography was well-known. Beyond the metropolitan area, the bearing was obtained from road maps, and from occasional checks of the antenna setting, by noting the position at which the signal was maximum.

RESULTS AND DISCUSSION

The recorded charts were analyzed in small sections which could be readily identified on a map. This was necessary to provide a measurement of the airline distance from the transmitter to the middle of each section. The length of these sections was chosen in proportion to the distance, and varied from about half a mile near the transmitter, to 3 or 4 miles at the the far end of the trips.

The sample chart shown in Figure 3 illustrates the two extreme types of recording obtained during the field work. The smooth portion of the trace indicates that very few indirect paths were present; a condition to be expected in clear open country, and on certain wide streets in the city where there are no intervening buildings or overhead wires. The wide irregular trace is caused by indirect rays combining with the direct ray in random phase relation. In some cases, the direct ray may be very weak, with strong indirect rays present; a condition which produces wide local variations or "standing waves".

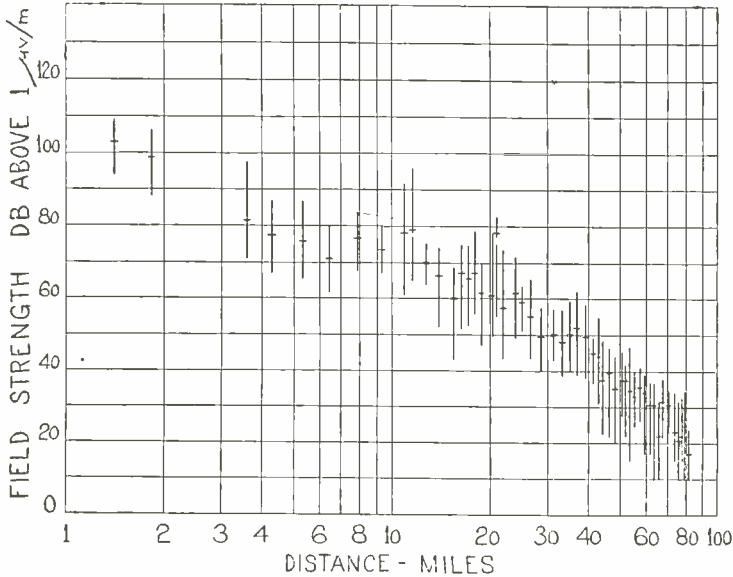

Fig. 4—Summary of field strength record taken between New York City and Camden, N. J. 49.5 Mc, horizontal polarization.

Such fields were often noticed in the city where the transmitter was shielded by high buildings, and the receiver was located near the street level. Thus both the amplitude and the shape of the field strength record contribute information of a general nature regarding the physical surroundings near the receiver location.

The field strength records were summarized by noting the maximum, minimum, and average value of field strength on each section of chart. This summary was then plotted with distance as the abscissa, and field strength as the ordinate. The range of field strength in each short section of chart is represented by a vertical line drawn at the average distance from the transmitter. The average field strength in each section is then indicated by a short horizontal mark crossing the vertical line. It will be noted that this type of graph shows the upper

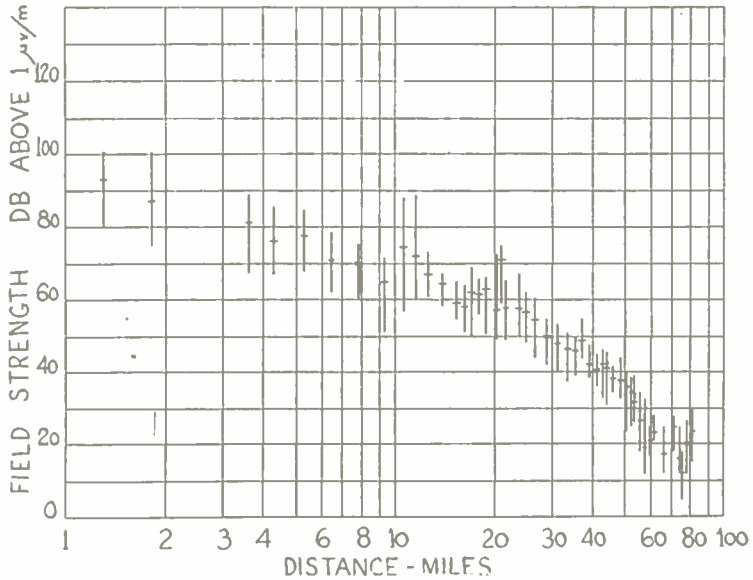

Fig. 5—Summary of field strength record taken between New York City and Camden, N. J. 49.5 Mc, vertical polarization.

and lower limits of field strength, as well as the average value. Figure 4 is the summary of a field strength record taken between New York City and Camden, New Jersey, when using horizontally polarized waves,

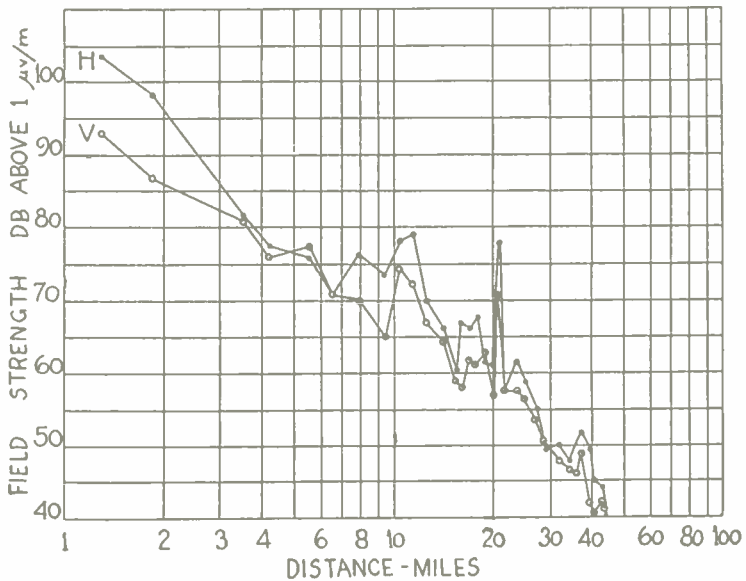

Fig. 6—Comparison of average field strength on horizontal and vertical polarization. New York City to Camden, N. J., 49.5 Mc.

on 49.5 Mc. Figure 5 is the summary of the record taken over the same route, on the same frequency, but with the transmission vertically polarized. The smaller variation in field strength in the country with vertical polarization is apparent without further study.

Comparisons of average field strength on horizontal polarization with average field strength on vertical polarization, are found in Figures 6, 7, and 8. A comparison on each of the three frequencies was chosen to illustrate the consistently stronger average field observed when horizontal polarization was used.

Near the transmitter, the indirect rays reflected from high build-

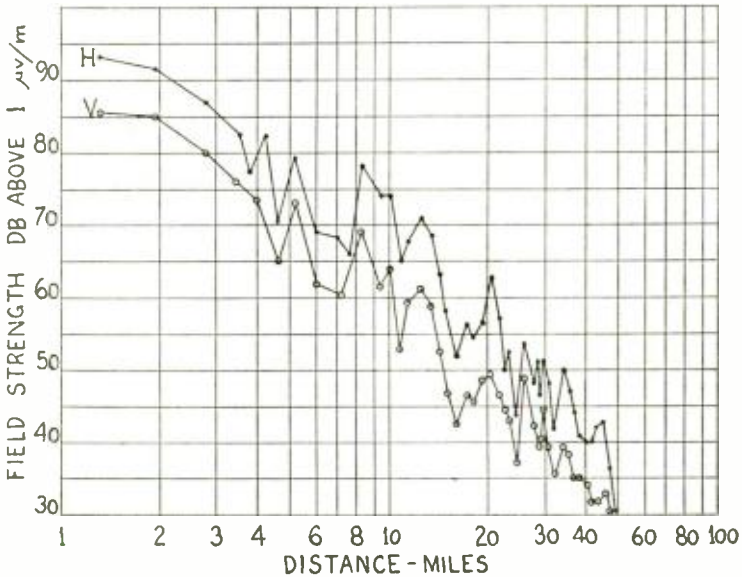

Fig. 7—Comparison of average field strength on horizontal and vertical polarization. New York City to Bridgeport, Conn., 83.5 Mc.

ings down to the street level were often stronger than the direct ray, which was shielded by other buildings. On horizontal polarization, the strength of these off-bearing rays was reduced by the directivity of the receiving doublet, since the doublet was broadside to the transmitter. On vertical polarization, the received signal was the resultant of direct and indirect rays, since the receiving doublet was non-directive. The effect of this condition is not apparent in the average signal comparisons, since only two out of six curves show the vertical polarization to be stronger than the horizontal near the transmitter.

The performance of the three different frequencies was compared by correcting the average field strength curves to an output power of 1 kw. These corrected curves, for horizontal polarization, southwest

route, are found in Figure 9. It is evident that the lowest frequency was somewhat the strongest in the city, and the highest frequency was consistently the strongest in the country.

The same kind of a comparison when using vertical polarization indicates that the highest frequency produced the highest average field strength both in the city and in the country, for the same transmitter power. This comparison is found in Figure 10.

A casual comparison of the horizontal and vertical polarization measurements revealed a difference in the maximum-to-minimum variation, over the same route. Graphs comparing the extremes of field

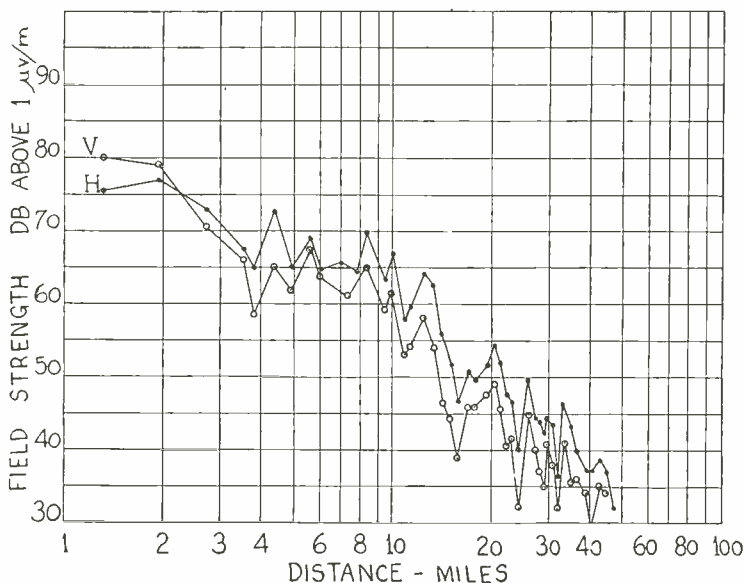

Fig. 8—Comparison of average field strength on horizontal and vertical polarization. New York City to Bridgeport, Conn., 142 Mc.

strength in each section, on horizontal and vertical polarization are shown in Figures 11, 12, and 13. It is apparent that the horizontal polarization was more variable over the greater part of the distance, although the vertical polarization was more variable near the transmitter.

The magnitude of the field strength variation on both polarizations was no doubt influenced by the low receiving antenna height. If the receiving antenna height were increased to thirty or forty feet, the number of obstructions to an optical path would be considerably reduced. Also, irregularities in the topography in the immediate vicinity of the receiving antenna would have less effect on the signal component reflected from the ground.

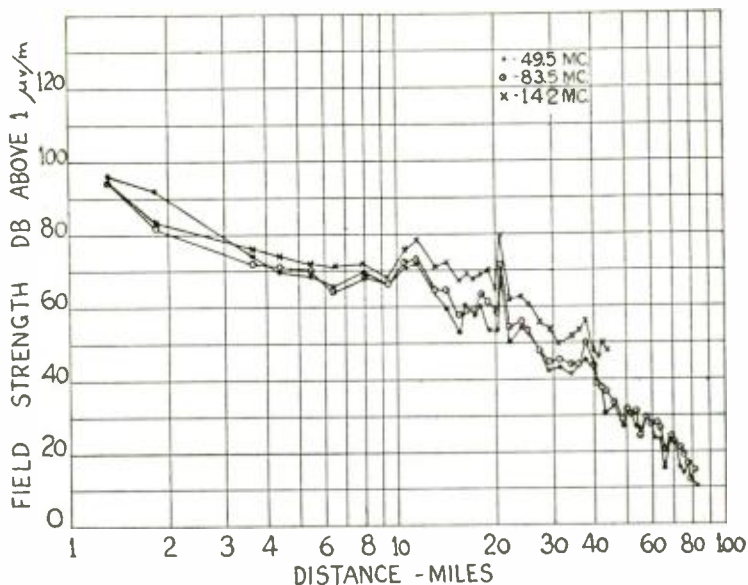

Fig. 9—Comparison of average field strength on 49.5, 83.5, and 142 Mc corrected to 1 kw antenna power. New York City to Camden, N. J., horizontal polarization.

The trend revealed in the variation curves raised the question of whether the maximum or the minimum values of field strength were

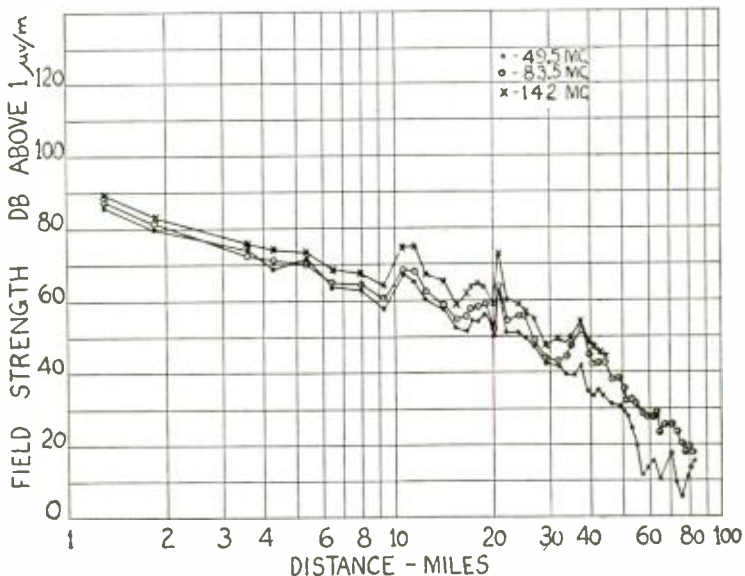

Fig. 10—Comparison of average field strength on 49.5, 83.5, and 142 Mc, corrected to 1 kw antenna power. New York City to Camden, N. J., vertical polarization.

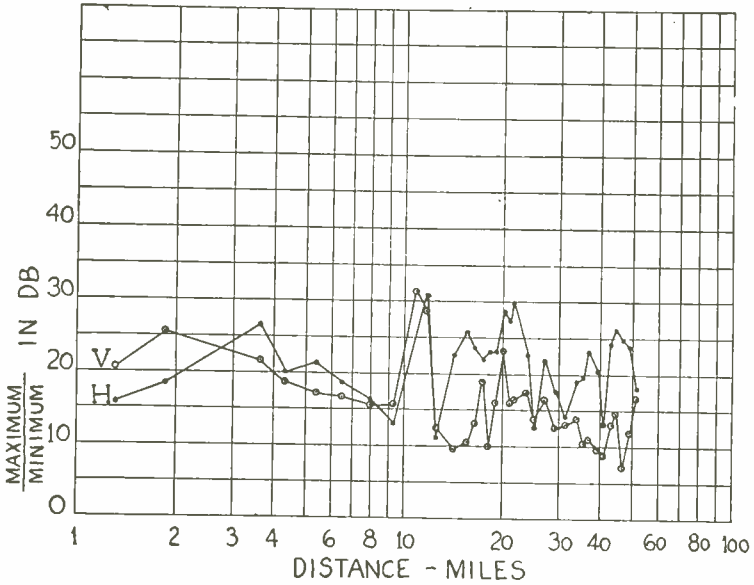

Fig. 11—Variation of field strength on horizontal and vertical polarization. New York City to Allentown, N. J., 49.5 Mc.

showing more variation. The maximums on horizontal polarization were compared with the maximums on vertical polarization for each route, and the same comparison was made between the minimums on

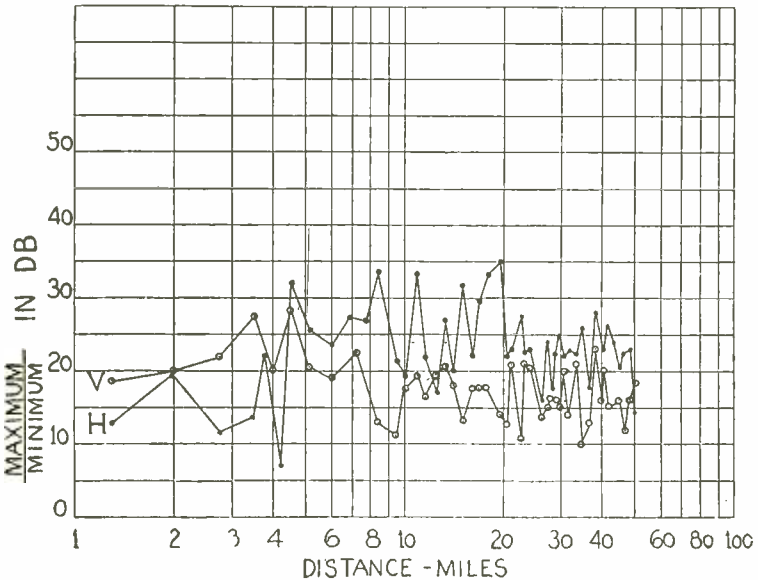

Fig. 12—Variation of field strength on horizontal and vertical polarization. New York City to Bridgeport, Conn., 83.5 Mc.

both polarizations. The averages of these individual comparisons revealed that the maximum values of field strength were greater on horizontal polarization on all recordings. The averages of the comparison of minimums were not so consistent; horizontal polarization was stronger to the north and northeast, while vertical polarization was stronger to the southwest. Most of the roads to the southwest of New York were relatively narrow, with horizontal open wires present for a considerable part of the distance. The shielding effect of horizontal wires on horizontally polarized waves is very noticeable when

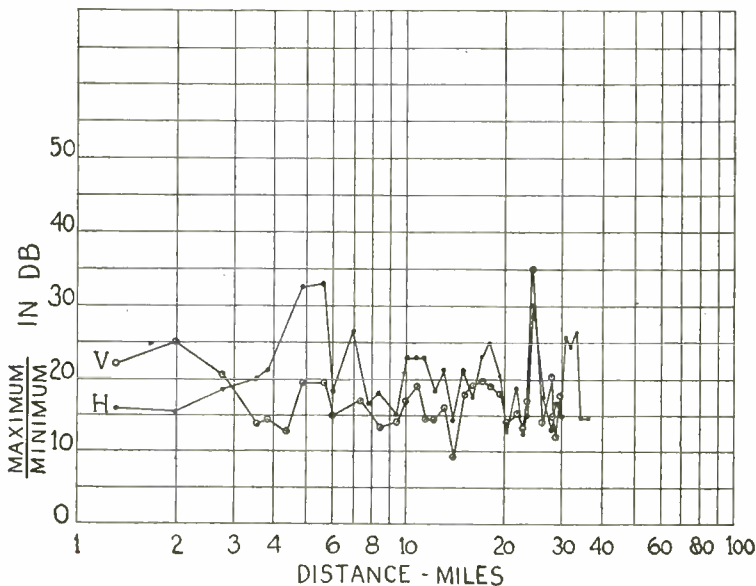

Fig. 13—Variation of field strength on horizontal and vertical polarization. New York City to Darien, Conn., 142 Mc.

recording, causing the minimums to drop to lower values on horizontal polarization.

TABLE I

Summary of field strength comparisons on horizontal and vertical polarization.

Freq. Mc	Direction	Variation	Average H/V in DB		Average Field Strength
			Maxima	Minima	
83.5	Northeast	+6.0	+9.8	+3.8	+8.1
142	Northeast	+2.7	+5.1	+2.4	+4.7
83.5	North	+2.1	+4.8	+2.7	+4.7
49.5	Southwest	+5.7	+5.7	0	+3.1
83.5	Southwest	+7.1	+4.3	-2.8	+1.9
142	Southwest	+6.9	+5.4	-1.5	+3.5

The results of all comparisons have been summarized in Table I, which indicates that, for the territory covered by the survey, horizontal polarization (1) varies over a wider range, (2) has higher maximum values, and (3) produces a higher average field strength than vertical polarization, other things being equal. The values shown in this tabulation are arithmetic averages, which correspond to a geometric average of field strength.

It should be remembered that these results and conclusions apply only to the two general directions covered by the mobile measurements. A comparison made over a salt-water path, or high-conductivity ground, might show the vertical polarization to be considerably more effective than the horizontal polarization.

CONCLUSION

On the basis of this mobile survey, the following general conclusions regarding horizontal and vertical polarization may be drawn:—

1. Horizontal polarization produced a stronger average field. Average ratio for all frequencies and routes was 4.3 db.
2. Horizontal polarization was more variable over a given distance in the country.
3. Vertical polarization was usually more variable in the city.
4. The greater variation on horizontal polarization was due to higher maximum values.
5. With horizontal polarization and equal power, the lowest frequency (49.5 Mc) produced the strongest average signal in the city, and the highest frequency (142 Mc) produced the strongest average signal in the country.
6. With vertical polarization and equal power, the highest frequency (142 Mc) was strongest both in the city and the country.

ACKNOWLEDGMENT

The field work described in this report was made possible by the cooperation of the Development Group of the National Broadcasting Company, and the Transmitter and Receiver Laboratories of R.C.A. Communications, Inc.

SELECTIVE SIDE-BAND TRANSMISSION IN TELEVISION*†

By

R. D. KELL‡ AND G. L. FREDENDALL‡

RCA Manufacturing Company, Inc.,
Camden, N. J.

Summary—*Reproduction of television detail in a selective side band system is treated as a function of the modulation factor and the ratio of vestigial side band to transmitted side band. A comparison with double side-band transmission is included.*

THE fundamental limitation placed upon the amount of detail which may be obtained ultimately in a television picture is the width of the radio-frequency spectrum allotted to a television channel. Six megacycles has been adopted as a standard width by the Radio Manufacturers' Association (R.M.A.). After provision has been made for the sound channel and guard bands and account taken of practical circuit considerations in receiver design there remains a spectrum about 5.25 megacycles wide for the transmission of picture signals.

A problem of first importance is a determination of the position of the television carrier in a spectrum of fixed width and the amplitude and phase characteristics over the spectrum that lead to the transmission of the greatest amount of detail. The following discussion is a mathematical analysis of the problem based upon certain reasonable simplifications.

The amount of picture detail refers to the fidelity of reproduction at the receiver of abrupt changes in intensity of half-tones in the picture at the transmitter. Figure 1 illustrates the typical abrupt changes which may occur in the direction of scanning (horizontal detail). The transmission of similar changes which occur at right angles to the direction of scanning (vertical detail) does not involve the transmission characteristics of the system and thus need not be considered. In (a) and (b) the single abrupt change in intensity is assumed to be isolated to the extent that the corresponding signal is not perceptibly influenced by preceding or following detail. Such detail occurs at the junctions between relatively large areas having different half-tone values.

The pulses in (c) and (d) have a width of the order of a scanning line and correspond to an isolated narrow line perpendicular to the direction of scanning.

* Decimal Classification: R583 × R148.17.

† Reprinted from *RCA REVIEW*, April, 1940.

‡ Now with the Research Department, RCA Laboratories Division, Princeton, N. J.

Two pulses not necessarily of the same height, but separated by a distance comparable to the width of the pulse are shown in (e) and (f). These correspond to two closely spaced vertical lines in the picture.

Since all types in Figure 1 are fundamental in the building of detail in a television picture, no type can be safely excluded from a study of television transmission.

PREVIOUS STUDIES OF SELECTIVE SIDE-BAND TRANSMISSION

Almost from the beginning of the transmission and reception of television images it was found that a better picture could be obtained with the receiver tuned so that the carrier was located on one side of the selectivity curve.

Poch and Epstein¹ have demonstrated by laboratory measurement the improvement in the reception of detail (e) resulting from moving

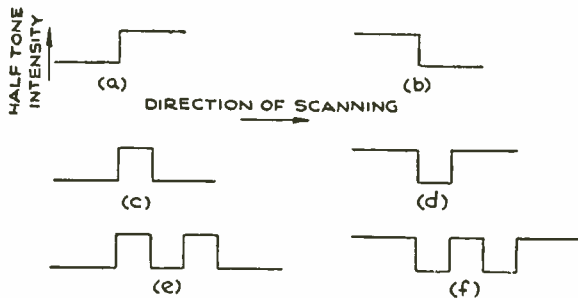

Fig. 1—Television detail.

the carrier to one side of the selectivity curve of a receiver. They gave a mathematical confirmation in the nature of a steady-state analysis of the phase and amplitude characteristics of the video signal corresponding to a low percentage of modulation of the carrier by a single video frequency. In addition to these steady-state conditions, it is important to know the response to the wave forms as shown in Figure 1.*

Goldman² has presented a mathematical analysis of the transmission of the details in Figure 1 by a selective side-band system. In his analysis the carrier was varied over a channel of one specific transmission characteristic.

PRELIMINARY CONSIDERATIONS

If the details shown in Figure 1 could be scanned by a pick-up device having an aperture of infinitesimal dimension in the direction of scanning, the video signal generated would have the same wave-

* A paper, "Effect of the Quadrature Component in Single Side-Band Transmission," by H. Nyquist and K. W. Pflieger has been published in *Bell Sys. Tech. Jour.*, January, 1940, since this manuscript was accepted by the publisher.

form as the transitions in half-tone. The effect of a finite symmetrical aperture of a practical scanning device may be obtained by imagining that the signal generated by the infinitesimal aperture is passed through an electrical filter having no phase distortion, but an amplitude distortion characteristic of the particular finite aperture. It has been found possible in practice to compensate electrically for the amplitude distortion at least up to the highest video frequency which conceivably could be accommodated in the proposed television channels. Hence, it shall be assumed in the following treatment that suitable correction has been made and that the transmitting aperture is not a controlling factor in shaping the transmitted signal.

The video amplifiers at the transmitter are regarded as distortionless up to an abrupt cut-off frequency f_0 (less than the highest fre-

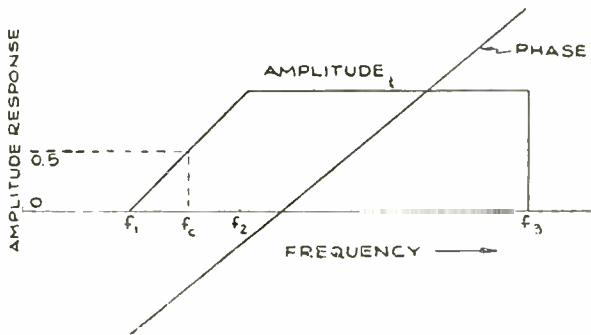

Fig. 2—Idealized transmission characteristic
 $(f_0 - f_c) < (f_1 + f_c)$.

quency of aperture compensation) and, therefore, become the controlling factor in modifying the waveform of a picture signal before modulation of the radio-frequency carrier. A linear detector responding to the envelope of the intermediate-frequency signal is commonly employed in television receivers and is assumed here.

If a receiving aperture of infinitesimal width in the direction of scanning were possible, the variation in light intensity along a scanning line would have the same wave shape as the intermediate-frequency envelope. In practice the receiving aperture is finite, but the amplitude distortion thus introduced may be compensated electrically to a degree that justifies the assumption of an infinitesimal aperture.

With the above suppositions, the envelope of the signal at the input to the detector becomes a direct criterion of the fidelity of transmission.

POSITION OF THE CARRIER ON THE TRANSMISSION CHARACTERISTIC

The overall transmission characteristic of the system properly includes the characteristics of the radio-frequency circuits at the

transmitter and the radio- and intermediate-frequency circuits of the receiver. Figure 2 shows idealized overall characteristics which (although not physically compatible) presumably could be approximated in an actual system. The amplitude characteristic shows partial suppression of one side band; the phase shift is a linear function of the frequency. The latter assumption is desirable because thereby the best transmission associated with a given amplitude characteristic will be obtained.

If the steady-state amplitude and phase characteristics are derived by determining the envelope of the system when modulated with various video frequencies, one at a time, it is found that the position of the carrier frequency exerts a large effect on the amplitude characteristic. If the carrier is near f_1 in Figure 2, the high-frequency portion is accentuated; if near f_2 , the low-frequency portion is accentuated; and if f_c is half way between f_1 and f_2 , the frequency response is flat. Harmonics of the modulation frequency are always generated when one side-band is partially suppressed; hence, the conventional frequency response of the system may be misleading unless properly qualified. If the percentage of modulation is sufficiently low, the magnitudes of harmonics are negligible.

In the analysis of selective side-band transmission the carrier f_c shall be fixed at the point of 50 per cent response which gives a flat frequency response. Frequent comparisons will be made between double and selective side-band transmissions.

REPRODUCTION OF A UNIT FUNCTION DETAIL

Figure 3 shows a carrier wave modulated by a signal which is the response of the video frequency amplifiers at the transmitter to a unit function detail. As a consequence of the finite cut-off frequency of the video amplifier, the response (Figure 3b) is not a unit function, but has the same form as that of a low-pass filter to a unit function. The solution for the envelope of the modulated carrier at the output (at the receiver) of the idealized selective side-band system of Figure 2 is derived in Appendix 1 and summarized in Equations (8) and (9).

A quantity $(f_3 - f_c)(t - \tau)$ is the independent variable in which

t is the time,

τ is the time delay of the envelope equal to the slope of the linear phase shift curve,

$(f_3 - f_c)$ is the video band width.

The envelope is found to be a function of two parameters, the ratio $(f_c - f_1)/(f_3 - f_c)$ and a modulation factor m . The modulation factor is determined by the relative amplitudes of the carrier before and after the scanning of an abrupt edge. This is illustrated in Figure 3c. Thus m is equal to unity when one of the carrier levels is zero.

The square root of the sum of the squares of the in-phase component P plus a constant and the quadrature component Q define the shape of the envelope (Equation 9). As the modulation factor approaches zero, the magnitude of the in-phase component becomes large compared with the quadrature component and the envelope approaches the case of double side-band transmission. In double side-band transmission the quadrature component is zero and the in-phase component has the same form as in Equation (8). Thus, the effect of the partial suppression of one side band is to introduce distortion in the form of the quadrature component.

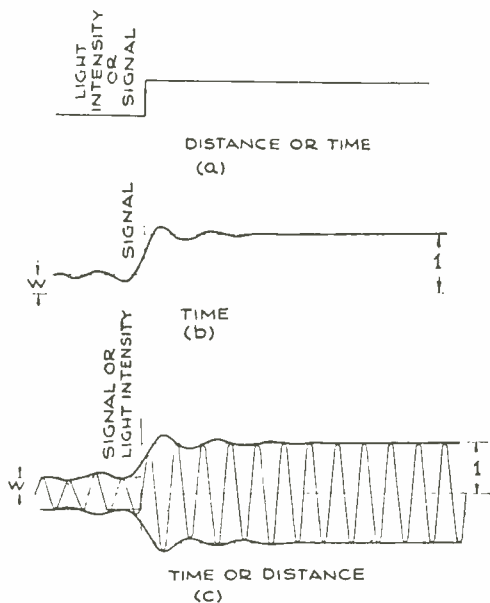

Fig. 3—(a) Unit function detail.
 (b) Response of idealized amplifier to (a).
 (c) Response of selective side-band system to (b).

$$\text{Modulation factor } m = \frac{1 - W}{1 + W}$$

In Figure 4 a family of envelopes have been plotted according to Equation (9) in which the partially suppressed side band $(f_c - f_1)$ is the parameter and m is equal to unity. A fixed band width of 5.25 megacycles is used corresponding to the standards of the R.M.A. A more explicit independent variable $(t - \tau)$ is used in place of the generalized form $(f_3 - f_c) (t - \tau)$.

Under the conditions laid down initially, the variation of intensity along the scanning line has the same wave shape as the envelope of the electrical response. Hence, the axis of ordinates may be regarded

as the intensity and the axis of abscissas as the distance along the scanning line.

A distance equal to one scanning line pitch corresponds to 0.12 microsecond (R.M.A. Standards).

Several observations may be made when $m = 1$.

(1) The steepness of rise for different values of $(f_c - f_1)$ do not differ significantly in the interval -0.15 to 0 microseconds, the range of greatest variation in the response.

(2) The amount of "transient" overshoot of each envelope increases as $(f_c - f_1)$ decreases. Under the R.M.A. standard that white correspond to zero carrier, the overshoot and damped oscillation would appear as striations of alternate light and dark bands superimposed

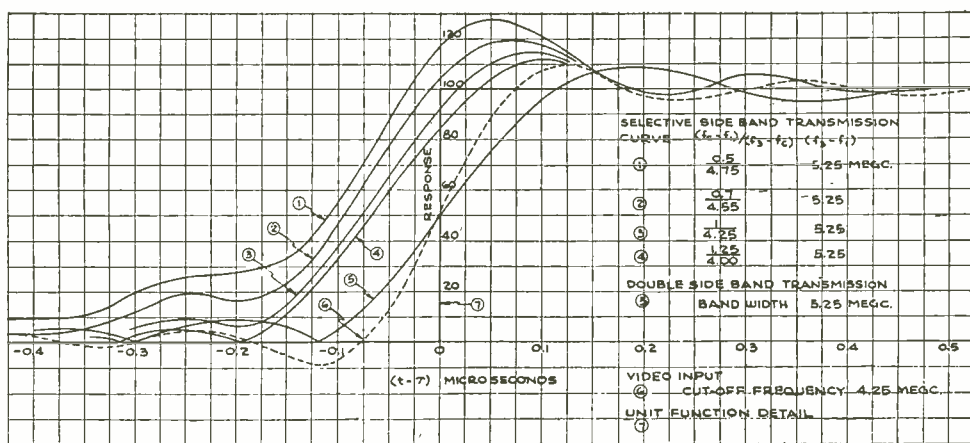

Fig. 4—Transmission of unit function detail.

in the gray region of the white to gray transition. The first striation is wider than a picture element and would, therefore, be visible at the correct viewing distance from the screen. Succeeding striations are of the order of a picture element and, therefore, may not be distinguishable.

(3) The principle rise that largely identifies the location of the transition in the received picture is preceded by an anticipatory step which is more pronounced as $(f_c - f_1)$ is decreased. This step gives the visual impression of a blurred transition. In this respect systems represented by curves (3) or (4) are definitely superior.

(4) The fidelity with which a unit function is transmitted through a system characterized by a particular value of $(f_c - f_1)$ may be judged by comparing the envelope of the response with the corresponding video signal which supplies the modulation. It is recalled that the video signal at the transmitter is the output of an idealized

amplifier having an abrupt cut-off frequency equal to $f_o = (f_3 - f_c)$. Thus, envelope (3) drawn for $(f_c - f_1) = 1$ megacycle must be compared with curve (6), the video response to a unit function detail of an idealized amplifier for which $(f_3 - f_c) = 4.25$ megacycles.

The ratio of the average slope (in the region of principal rise) of curve (3) to that of curve (6) is about 1.6. Thus, an abrupt transition between half-tones appears less abrupt when received in the selective side-band system (curve 3) than when applied as a modulating signal at the transmitter (curve 6).

(5) Curve (5), the envelope of the response of a double side-band system 5.25 megacycles wide, has an average steepness comparable with those of the envelopes (3) and (4) for selective side-band trans-

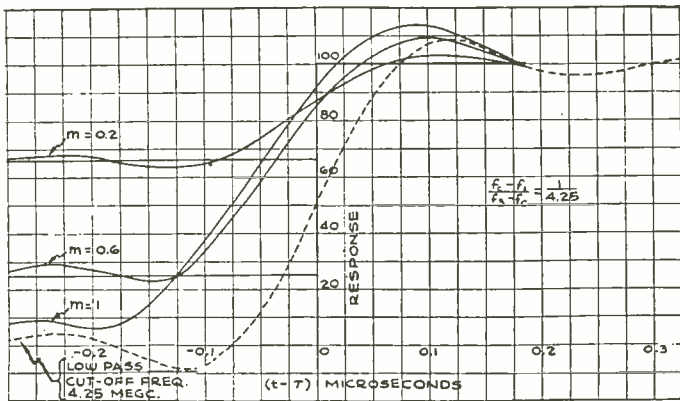

Fig. 5—Transmission of unit function detail as function of modulation factor m .

mission. This means that for a fixed band width there is no superiority of a selective side-band system over a double side-band system for the transmission of a unit function detail at percentages of modulation near 100 (m near unity).

In a video signal as in an audio signal the average percentage modulation is low. Many of the abrupt transitions in a television subject take place between two half-tones neither of which is white, that is, the value of the modulation factor m is not unity. Figure 5 is a family of envelopes drawn for $m = 0.2, 0.6,$ and 1 . $(f_c - f_1)$ is taken equal to 1 megacycle and the band width is 5.25 megacycles as in Figure 4. It is observed that the envelopes properly scaled (Figure 6) approach the video signal as m approaches zero. That is, the received signal resembles more and more the modulating video signal (cut-off frequency = $(f_3 - f_c)$ and in this sense becomes distortionless in the limit. This signifies that the fidelity of the idealized selective side-band system approaches that of a double side-band

system having a band width of 8.5 megacycles for small percentages of modulation and that of a double side-band system 5.25 megacycles wide for percentages of modulation near 100.

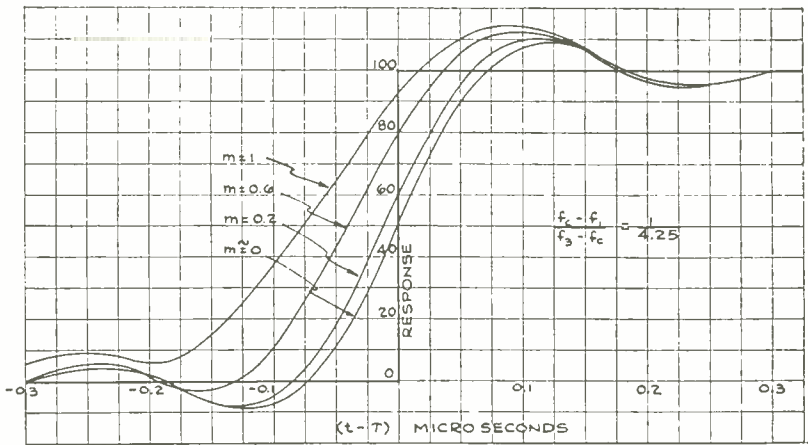

Fig. 6—Transmission of unit function detail as function of modulation factor m .

REPRODUCTION OF NARROW LINE DETAIL

A narrow line perpendicular to the direction of scanning is ideally represented by the square pulse in Figure 7(1). When the signals generated by the scanning device are limited in the amplifiers to a band width of 4.25 megacycles, the video waveforms for a pulse 0.15 microsecond long are shown in Figure 7, curve (2). This pulse corresponds to a line having a width approximately equal to a picture element in the present television system. Except for the negative loops which should be reflected in the time axis curve (2) is also the envelope of a carrier modulated by the pulse with a modulation factor equal to one and transmitted double side band with a band width of 8.5 mega-

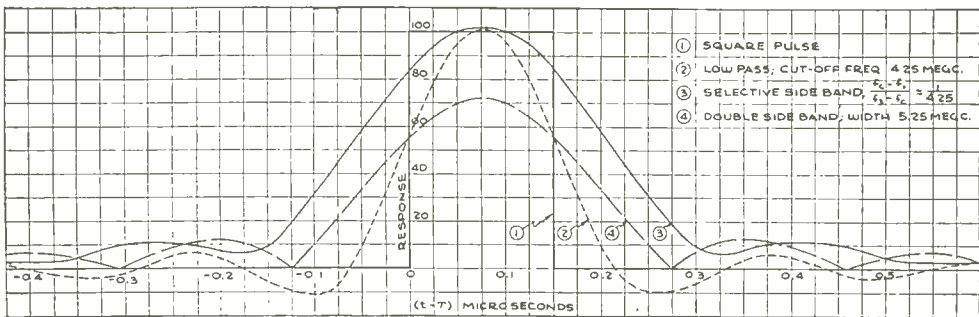

Fig. 7—Transmission of narrow line detail.

cycles. Curve (3) indicates that the maximum amplitude of the response of a selective side-band system 5.25 megacycles wide is the same as that of a double side-band system 8.5 megacycles wide. Curve (4) is the response when a band width of 5.25 megacycles is used for double side-band transmission. Comparing the two modes of transmission on the same band width it is observed that a narrow line is reproduced at only 70 per cent of its proper intensity in the double side-band case.

The apparent width is also a significant characteristic of lines of the order of a picture element wide. There is an apparent elongation of the pulse after transmission through a selective side-band system.

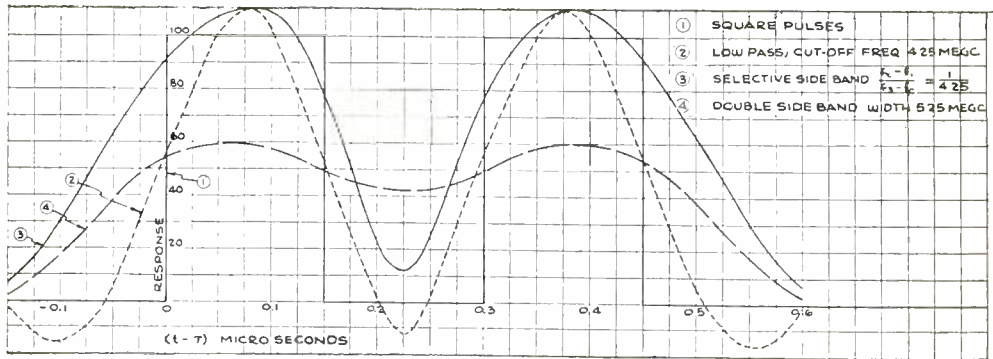

Fig. 8—Transmission of two closely spaced narrow lines.

As the modulation factor is reduced there is less and less distortion, and in the limit the transmission is the same as through a double side-band system 8.5 megacycles wide.

REPRODUCTION OF CLOSELY SPACED NARROW LINES

The term "resolution" is applied most frequently to the property of a system to distinguish between closely spaced narrow lines as represented in Figure 1e. Mathematical expressions have been developed in Appendix 3 that afford a revealing comparison of the fidelity of selective and double side-band systems for the reproduction of such fine line detail. A series of envelopes corresponding to two square pulses 0.15 microsecond long and separated by an interval of the same length are shown in Figure 8. It is observed that the video signal, curve (2), provides resolution of the two lines by sinking to a sustained low value between lines. Curve (3) represents the response of a selective side-band system and does contain an interval of low signal value, but curve (4) for double side-band transmission over a band of equal width does not indicate appreciable resolution. This

result is certainly not predicted in Curve (3), Figure 7, which illustrated the case of a single narrow line. The sloping edge of the reproduced single pulse itself exceeded the separation of pulses in Figure 8. An examination of the mathematical expression for the envelope (Equation 11) affords the explanation of the apparent contradiction. The quadrature or distorting components due to the first and second pulses partially cancel near the center of the separating interval and exactly cancel at the center.

ECONOMY IN BAND WIDTH

The economy in band width obtained by means of partial suppression of one side band depends therefore upon the range of the modulation factor. Thus, curves may be drawn for each type of television detail showing the relation between the modulation factor and the band width required for equal fidelity of reproduction of horizontal and vertical detail. This would involve a method of measuring the sharpness of transition between halftones in the unit function detail, the width of a narrow line, and the resolution of two narrow lines. The subject of the measures of vertical and horizontal resolutions in a television picture is variously treated by writers and it is not the purpose of this discussion to enter into the merits of different methods. The permissible range of the modulation factor in a television picture will represent a compromise between fidelity, band width, and intensity of the transmitted signal.

CONCLUDING REMARKS

The intent of this analysis has been to demonstrate the characteristic differences of double and selective side-band transmissions of television detail and in particular to find a favorable transmission characteristic for the latter. The analysis was developed on the hypothesis of a linear phase characteristic throughout the pass band in order to obtain the optimum envelope associated with a given amplitude characteristic. Thus, the envelopes derived here cannot be duplicated point for point in a physically possible system in which some phase distortion always resides, but the broad aspects of the idealized treatment may be realized in practice when careful phase compensation has been provided. The preceding work may be summarized as follows:

- (1) If the modulation factor is near 1, a unit function detail is transmitted most faithfully in a selective side-band system when the ratio of the partially suppressed side band to the completely transmitted side band $(f_c - f_1)/(f_3 - f_c)$ has a value lying between $1/4.25$ and $1.25/4$. Comparable fidelity is obtained in a double side-band system of equal band width that requires a video band width appreciably less than in the selective side-band example. As the modulation factor

becomes less than 1, the fidelity of the selective side-band system for the transmission of the unit function increases, whereas that for double side-band transmission (equal band width) does not increase. In the limit as the modulation factor approaches zero, the sharpness of reproduction in the selective side-band system is about 1.6 times greater.

(2) When the modulation factor is equal to 1 the width of the input video signal corresponding to a single narrow line is increased about equally after transmission through either system operated over equal band widths, but there is a reduction in amplitude of the envelope in a double side-band system. The extension in width approaches zero as the factor is made progressively smaller in the selective side-band system, but there is no change in the other system.

(3) Two narrow lines are resolved more completely by selective side-band transmission for any value of the modulation factor than by double side-band transmission over an equal band width. As the factor becomes less than 1, the remarks above also apply for the resolution of narrow lines.

APPENDIX

I. RESPONSE OF A SELECTIVE SIDE-BAND SYSTEM TO A UNIT FUNCTION DETAIL

Figure 3b may be regarded as the limit of a square wave $E(t)$ as the fundamental frequency approaches zero and the upper limit of the frequency spectrum is held constant.

$$E(t) = \frac{1}{1+m} \left[1 + \frac{4m}{\pi} \sum_1^N \frac{\sin(2n-1)\omega t}{(2n-1)} \right] \quad (1)$$

$(2N-1)\omega = \omega_o$

A sine-wave carrier modulated by $E(t)$ has the form

$$e_1(t) = \frac{1}{1+m} \left\{ \sin \omega_c t + \frac{2m}{\pi} \sum_1^N \cos [\omega_c - (2n-1)\omega] t \right. \\ \left. - \frac{2m}{\pi} \sum_1^N \cos [\omega_c + (2n-1)\omega] t \right\}$$

If $e_1(t)$ is impressed on a linear system that alters the amplitude and phase, there results

$$e(t) = \frac{1}{1+m} \left\{ A_c \sin(\omega_c t + \theta_c) + \frac{2m}{\pi} \sum_1^N \frac{A_{(2n-1)}}{2n-1} \cos \left\{ [\omega_c - (2n-1)\omega] t + \theta(2n-1) \right\} \right\} \quad (2)$$

$$\frac{-2m}{\pi} \sum_1^N \frac{B_{(2n-1)}}{2n-1} \cos \left\{ [\omega_c + (2n-1)\omega]t + \beta(2n-1) \right\}$$

If the phase shift is linear then

$$\theta_{(2n-1)} = \tau[\omega_c - (2n-1)\omega] + b$$

$$\beta_{(2n-1)} = -\tau[\omega_c + (2n-1)\omega] + b$$

$$T = (t - \tau).$$

(2) becomes

$$\begin{aligned} e(t) = & \frac{1}{1+m} A_c \sin(\omega_c T + b) \\ & + \frac{2m}{\pi} \cos(\omega_c T + b) \sum_1^N \frac{A_{(2n-1)}}{2n-1} \cos(2n-1)\omega T \\ & + \frac{2m}{\pi} \sin(\omega_c T + b) \sum_1^N \frac{A_{(2n-1)}}{2n-1} \sin(2n-1)\omega T \\ & - \frac{2m}{\pi} \cos(\omega_c T + b) \sum_1^N \frac{B_{(2n-1)}}{2n-1} \cos(2n-1)\omega T \\ & + \frac{2m}{\pi} \sin(\omega_c T + b) \sum_1^N \frac{B_{(2n-1)}}{2n-1} \sin(2n-1)\omega T. \end{aligned} \quad (3)$$

(3) has the form

$$\left(P + \frac{A_c}{1+m} \right) \sin(\omega_c T + b) + Q \cos(\omega_c T + b) = \sqrt{\left(P + \frac{A_c}{1+m} \right)^2 + Q^2} \cos[\omega_c T + b + \epsilon] \quad (4)$$

where

$$P = \frac{1}{1+m} - \frac{2m}{\pi} \sum_1^N \left\{ \frac{A_{(2n-1)}}{2n-1} + \frac{B_{(2n-1)}}{2n-1} \right\} \sin(2n-1)\omega T \quad (5)$$

$$Q = \frac{1}{1+m} - \frac{2m}{\pi} \sum_1^N \left\{ \frac{A_{(2n-1)}}{2n-1} - \frac{B_{(2n-1)}}{2n-1} \right\} \cos (2n-1) \omega T.$$

The envelope of the modulated carrier is the coefficient

$$\sqrt{\left(P + \frac{A_c}{1+m} \right)^2 + Q^2}.$$

$A_{(2n-1)}$ and $B_{(2n-1)}$ may be assigned values in accordance with the amplitude characteristic of Figure 2.

$$\frac{A_{(2n-1)}}{2n-1} + \frac{B_{(2n-1)}}{2n-1} = \frac{1}{2n-1} \text{ over the characteristic.}$$

P becomes

$$\frac{1}{1+m} - \frac{2m}{\pi} \sum_1^N \frac{\sin (2n-1) \omega T}{2n-1}$$

$$\frac{A_{(2n-1)}}{2n-1} - \frac{B_{(2n-1)}}{2n-1} = -\frac{\omega}{\omega_c - \omega_1} \text{ on the sloping part of the characteristic and}$$

$$\frac{A_{(2n-1)}}{2n-1} - \frac{B_{(2n-1)}}{2n-1} = -\frac{1}{2n-1} \text{ on the straight part of the characteristic.}$$

Q becomes

$$\frac{1}{1+m} \left[-\frac{2m}{\pi} \frac{\omega}{(\omega_c - \omega_1)} \sum_1^p \cos (2n-1) \omega T - \frac{2m}{\pi} \sum_{p+1}^N \frac{1}{2n-1} \cos (2n-1) \omega T \right] \tag{6}$$

where $(2p-1)\omega = (\omega_c - \omega_1)$; $(2N-1)\omega = \omega_o = (\omega_3 - \omega_c)$.

The first sum in (6) may be simplified by using the following proposition⁴

$$\sum_1^{\frac{K+2}{2}} \cos (2n-1) \theta = \frac{1/2 \sin (K+2) \theta}{\sin \theta}.$$

There results

$$\sum_1^p \cos (2n-1) \omega T = \frac{1/2 \sin 2p\omega T}{\sin \omega T} = \frac{1/2 \sin (\omega_c - \omega_1 + \omega) T}{\sin \omega T}.$$

If $\omega \rightarrow 0$ there results

$$\begin{aligned}
 P &= \frac{m}{1+m} \frac{1}{\pi} \int_0^{(\omega_3 - \omega_c)T} \frac{\sin x}{x} dx \\
 Q &= \frac{m}{1+m} \frac{1}{\pi} \left[-\frac{\sin(\omega_c - \omega_1)T}{(\omega_c - \omega_1)T} - \int_{(\omega_c - \omega_1)T}^{(\omega_3 - \omega_c)T} \frac{\cos x}{x} dx \right] \\
 &= \frac{m}{1+m} \frac{1}{\pi} \left[-\frac{\sin(\omega_c - \omega_1)T}{\omega_c - \omega_1} - \int_{(\omega_c - \omega_1)T}^{\infty} \frac{\cos x}{x} dx + \int_{(\omega_3 - \omega_c)T}^{\infty} \frac{\cos x}{x} dx \right].
 \end{aligned} \tag{7}$$

If a change of independent variable is made in (7)

$$(\omega_3 - \omega_c)T = \eta$$

and if

$$\frac{\omega_c - \omega_1}{\omega_3 - \omega_c} = \delta$$

more general forms for P and Q are

$$\begin{aligned}
 P &= \frac{m}{1+m} \frac{1}{\pi} \int_0^{\eta} \frac{\sin x}{x} dx \\
 Q &= \frac{m}{1+m} \frac{1}{\pi} \left[-\frac{\sin \eta \delta}{\eta \delta} - \int_{\delta \eta}^{\infty} \frac{\cos x}{x} dx + \int_{\eta}^{\infty} \frac{\cos x}{x} dx \right].
 \end{aligned} \tag{8}$$

δ and m are parameters.

These integrals have been tabulated extensively⁵.

According to (4) the envelope is the coefficient

$$\sqrt{\left\{ P + \frac{1}{2}(1+m) \right\}^2 + Q^2}. \tag{9}$$

PART 2. RESPONSE OF A SELECTIVE SIDE-BAND SYSTEM TO A SQUARE PULSE

The equation of a square pulse T_1 seconds long is obtained by adding a unit function having an amplitude $\left(\frac{2m}{1+m} \right)$ and delayed T_1 seconds to $E(t)$, Equation (1). The solution for the corresponding envelope follows in a manner similar to the development in Part 1. The result is

$$\text{envelope} = \sqrt{\rho^2 + \partial^2}$$

$$\text{where } \rho = \frac{1}{2(1+m)} - \frac{m}{2(1+m)} + P(T) - P(T - T_1) \quad (10)$$

$$\partial = Q(T) - Q(T - T_1).$$

The P and Q functions are defined by (7).

PART 3. RESPONSE OF A SELECTIVE SIDE-BAND SYSTEM
TO TWO SQUARE PULSES

Two pulses illustrated in Figure 1c are formed by adding unit functions of the following descriptions to $E(t)$:

$$\text{amplitude } \frac{-2m}{1+m}; \text{ delayed } T_1 \text{ seconds}$$

$$\text{amplitude } \frac{2m}{1+m}; \text{ delayed } T_2 \text{ seconds}$$

$$\text{amplitude } \frac{-2m}{1+m}; \text{ delayed } T_3 \text{ seconds.}$$

The envelope of the response is

$$\sqrt{\rho^2 + \partial^2}$$

where

$$\rho = \frac{1}{2(1+m)} - \frac{m}{2(1+m)} + P(T) - P(T - T_1) + P(T - T_2) - P(T - T_3) \quad (11)$$

$$\partial = Q(T) - Q(T - T_1) + Q(T - T_2) - Q(T - T_3).$$

Block-shaped signals of any description may be expressed by suitably combining functions of the unit function type. The envelopes will be given by P and Q functions defined in (7).

PART 4. RESPONSE OF LOW-PASS SYSTEMS TO TELEVISION DETAIL

a. Unit Function (Figure 1a)

$$e(t) = \frac{1}{2} + \frac{1}{\pi} \int_0^{2\pi f_c T} \frac{\sin x}{x} dx. \quad (12)$$

b. Square Pulse (Figure 1c)

$$e(t) = \frac{1}{\pi} \left[\int_0^{2\pi f_0 T} \frac{\sin x}{x} dx - \int_0^{2\pi f_0 (T - T_1)} \frac{\sin x}{x} dx \right] \quad (13)$$

c. Two Square Pulses (Figure 1c)

$$e(t) = \frac{1}{\pi} \left[\int_0^{2\pi f_0 T} \frac{\sin x}{x} dx - \int_0^{2\pi f_0 (T - T_1)} \frac{\sin x}{x} dx + \int_0^{2\pi f_0 (T - T_2)} \frac{\sin x}{x} dx - \int_0^{2\pi f_0 (T - T_3)} \frac{\sin x}{x} dx \right] \quad (14)$$

V. RESPONSE OF DOUBLE SIDE-BAND SYSTEMS TO TELEVISION DETAIL

Same as in Part 4 if $f_0 = \frac{\text{band width}}{2}$

LIST OF REFERENCES

- ¹ Poch and Epstein, "Partial Suppression of One Side Band in Television Reception," *RCA REVIEW*, Vol. I, p. 19, 1937.
- ² Goldman, "Television Detail and Selective Side-band Transmission," presented at the I.R.E. Fall Convention (1938), Rochester, New York.
- ³ Chrystal, *ALGEBRA II*, p. 273.
- ⁴ Jahnke-Emde, *TABLES OF FUNCTIONS*, second revised edition, p. 78. B. G. Teubner, Leipzig and Berlin, (1933).

A 500-MEGACYCLE RADIO-RELAY DISTRIBUTION SYSTEM FOR TELEVISION*†

By

F. H. KROGER, BERTRAM TREVOR‡ AND J. ERNEST SMITH

Engineering Department, RCA Communications, Inc.
New York, N. Y.

Summary—This paper reviews the development and operation of a radio-relay system for television-program distribution. Television programs from W2XBS located on the Empire State Building in New York City were delivered to Riverhead, Long Island, through radio repeating stations near Hauppauge and Rocky Point. The amplification in the repeaters was accomplished without demodulation and re-modulation in the repeater equipment. Radio carrier frequencies between 400 and 500 Mc were employed in the radio links. The carrier was frequency modulated directly by the video signals. The paper describes some of the problems involved in designing radio networks to interconnect television broadcasting stations and describes some of the methods applied in their solution. As a result of these developments it is now feasible to provide radio networks for television-program distribution over wide areas.

NATIONWIDE television service requires the distribution to remote areas of program material originating in any one locality as is now done by wire networks in sound broadcasting. Facilities for this service usually employ directive radio or wire networks which are capable of transmitting a modulation band ranging from 30 cycles to several million cycles per second.

Several years ago, an experimental system was set up to determine the feasibility of television relaying by radio. This work resulted in the construction and operation of a radio relay between New York City and Camden, New Jersey, in 1933.¹ At that time a 120-line picture was transmitted which required a modulation band of one megacycle.

During the last eight years the video-modulation band has increased from one megacycle to the present requirement of four megacycles. In developing a distribution system, possible future requirements should be taken into account and these may necessitate the use of even wider modulation bands.

In 1934 tubes of appreciable output at frequencies of 100 to 200 megacycles were available. To make use of these frequencies, RCA Communications, Inc. installed an experimental communication circuit between New York City and Philadelphia.² This circuit provided valu-

* Decimal Classification: R583 × R480.

† Reprinted from *RCA REVIEW*, July, 1940.

‡ Now with the Research Department, RCA Laboratories Division, Riverhead, L. I., N. Y.

¹ C. J. Young, "The Radio-Relay Link for Television Signals," *Proc. I.R.E.*, November, 1934.

² H. H. Beverage, "The New York-Philadelphia Ultra High Frequency Facsimile Relay System," *RCA REVIEW*, July, 1936; J. Ernest Smith, F. H. Kroger and R. W. George, "Practical Application of an Ultra High Frequency Radio Relay Circuit," *Proc. I.R.E.*, November, 1938.

able information on operating costs, maintenance, and signal propagation at 100 megacycles. By 1938 the progress of the art permitted the design of radio-relaying equipment for frequencies as high as 500 megacycles. Consequently, in 1939 an experimental 500-megacycle television radio relay was built and operated.

To determine the feasibility of relaying by radio it is necessary to consider the proper antenna heights, antenna aperture dimensions, spacing between relay stations, and power radiated to give the most economical result. These considerations must be based upon available data on ultra-high-frequency propagation.³ There are other factors

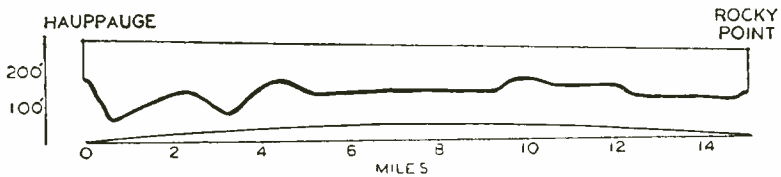

Fig. 1—Profile of terrain between Hauppauge and Rocky Point.

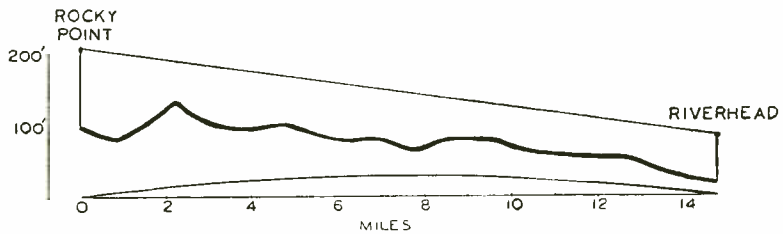

Fig. 2—Profile of terrain between Rocky Point and Riverhead.

such as signal fading, unusual interfering noise sources, and antenna efficiency which must be taken into account. Moreover, the particular terrain in question will be a factor in determining the final layout since advantageous use can often be made of elevated points thus permitting lower tower structures.

It is of interest to note that when the antennas of a fixed aperture at each end of a link are at heights sufficient to allow the direct and reflected rays to arrive at the receiving antenna with a phase angle of substantially 120 degrees, the required amplifier power gain is then inversely proportional to the square of the frequency, assuming a constant transmitter power input. This fact indicates that it would be advantageous to operate at as high a frequency as possible; especially, since the higher the frequency, the lower will be the antenna heights

³ H. O. Peterson, "Ultra High Frequency Propagation Formulas," *RCA REVIEW*, October, 1939.

necessary to bring the direct and reflected rays together with the 120-degree phase angle at the receiving antenna. It was felt that 500 megacycles for a carrier frequency would be a suitable starting point even though higher frequencies may offer additional advantages. It is expected, however, that there will be an upper limit of useful frequencies due to absorption by rain, fog, snow, and gases of the atmos-



Fig. 3—Hauppauge tower and penthouse.

phere. Also, the noise level in receiving equipment to make use of such high frequencies may be greater than is now anticipated.

Frequency modulation was employed in this work due to its advantages for circuits where multipath phenomena are absent.⁴ Furthermore, tubes were available which greatly minimize the equipment for producing a frequency-modulated carrier. In addition, frequency modulation permits the use of limiting and class C amplification thus, simplifying the problem of maintaining overall circuit linearity.

⁴ M. G. Crosby, "Freq. Modulation Propagation Characteristics," *Proc. I.R.E.*, Vol. 24, No. 6, June, 1936.

Recent measurements⁵ have shown that automobile-ignition interference is present with about the same field strength on all frequencies between 40 and 450 megacycles. This means that the interfering energy received with antennas of the same effective height and directivity will be constant with frequency. However, the antenna directivity (power gain) for a given aperture area increases in proportion to the square of the frequency; hence, a large reduction of received interference is had at the higher frequencies if the interference is not generated directly in front of the receiving antenna.

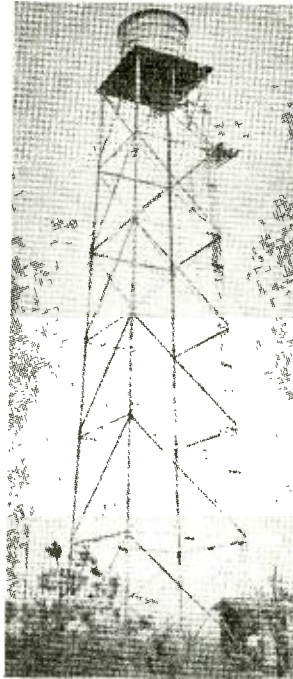

Fig. 4—Rocky Point tower and penthouse.

In Figure 1 is shown the profile of terrain between the Hauppauge terminal and the Rocky Point repeater. This profile has been plotted to show the conditions existing with an earth's radius $\frac{4}{3}$ of its actual value in order to take into account the normal refraction occurring in the earth's atmosphere. Using this profile to estimate the magnitude of the received signal by combining the direct and reflected rays in the usual manner we obtain a value of 1.6 millivolts delivered, across a 75-ohm receiver input, assuming a transmitter power of one watt and

⁵ R. W. George, "Field Strength of Motor Car Ignition Between 40 and 450 Megacycles," presented at the U.R.S.I., Washington, D. C., April, 1940.

an antenna gain of 20 decibels at each station. This calculation was based on the assumption that the indirect ray was reflected from the ground whereas, actually, underbrush and trees would cause the effective reflection point to be somewhat higher. A difference of ten feet would reduce the calculated voltage by 20 per cent giving 1.3 millivolts. The actual measured value was found to be 1.2 millivolts.

In Figure 2 a similar profile is shown between Rocky Point and Riverhead. Calculation of the expected signal compared with that actually measured shows agreement within about four decibels which is as close as the accuracy of the profile will allow in this case.



Fig. 5—Riverhead receiving antenna.

Although extensive continuous observations have not been made over such fifteen-mile paths, it is felt that signal fading would be quite small, as no appreciable fading has been observed during the tests of this television relay. A circuit of 30 miles in length operated on 500 megacycles with good optical clearance has shown fading of more than ten decibels to occur rarely and then only for short periods of less than an hour.

Assuming that fading is produced by varying amounts of refraction which results in varying the path-length difference between the direct and reflected rays, then it would be expected that minimum fading would occur when, under average conditions, the path-length difference is $\frac{1}{2}$ wavelength. This condition brings the direct and reflected rays in phase at the receiving antenna which results in the strongest possible field. Changes of refraction conditions in the atmosphere will

only alter the phase angle between the two components and will alter the resultant field strength only slightly. The opposite condition occurs when the two components are nearly in phase opposition at the receiving antenna, as in this case a small change in phase angle gives a large change in the resultant field. It is not usually economical to place the antennas at a sufficient height to bring the direct and reflected rays in phase so that a compromise with antenna heights should give a path-length difference of $1/6$ wavelength or 120 degrees. This condition results in a received field equal to that which would be obtained in free space where only the direct ray would be present.

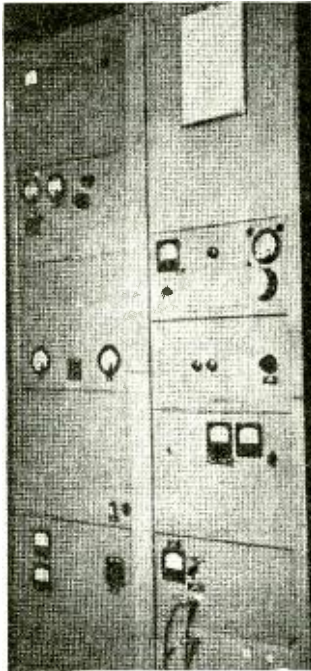

Fig 6—500-Megacycle terminal transmitter.

In order to choose the proper amplifying system it becomes necessary to know the amount of gain to be incorporated in each repeater amplifier. The term repeater as used here is considered to be the apparatus between input and output antennas. The maximum gain that can be used is determined by the ratio between the maximum repeater-output power and the noise power appearing at the repeater input. If this ratio is 120 decibels and a signal-to-noise ratio of 50 decibels is desired, then the repeater gain would be 70 decibels. It is,

of course, necessary to use the proper size of antennas, antenna heights, and station spacings to bring the signal-to-noise ratio at the repeater input to the desired value.

At the present state of development, the 500-megacycle receivers having an r-f band of eight megacycles give an equivalent noise-power input of 1.4 times 10^{-12} watts. The signal power required for a 50-decibel signal-to-noise ratio is then 1.4 times 10^{-7} watts. If the maximum power output of the repeater amplifier is 1.4 watts we will require a repeater gain of 10^7 or 70 decibels.

We have seen that our repeater amplifier should have an overall gain in the neighborhood of 70 decibels and this amplifier must have a flat bandpass of at least eight megacycles. Experience has shown that

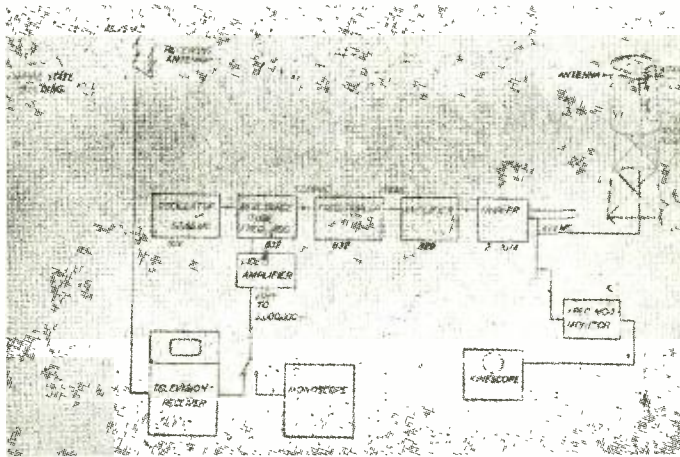

Fig. 7—474-Mc terminal transmitter at Hauppauge, N. Y

stable operation can be maintained by converting the 500-megacycle signal to a lower intermediate frequency in the neighborhood of 100 megacycles where the major portion of the gain is readily realized. An output of about 0.7 watt can be obtained on either the same 500-Mc carrier frequency or an adjacent frequency by a high, level converter. A single stage of amplification is sufficient to raise this power level to about two watts.

The system herein described used a repeater having an input frequency of 474 megacycles and an output frequency of 460 megacycles.

The relay system as demonstrated consisted of a terminal station at Hauppauge, a repeater station at Rocky Point, and a terminal at Riverhead, all located on Long Island. The tower and antenna structures at Hauppauge, Rocky Point and Riverhead are shown in Figures

3, 4, and 5. A spacing of 15 miles between stations made this circuit 30 miles long. Television signals as broadcast from the Empire State Building on 45.25 megacycles were received at Hauppauge on a receiver

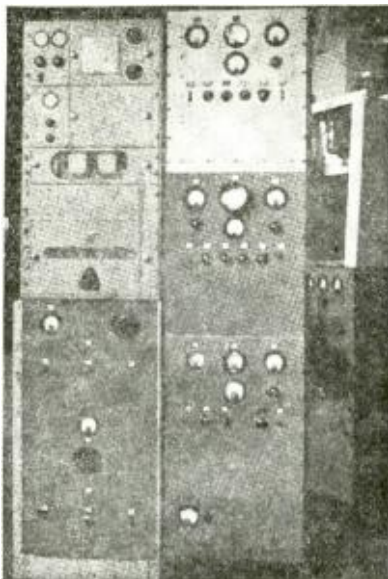

Fig. 8—500-Megacycle repeater amplifier.

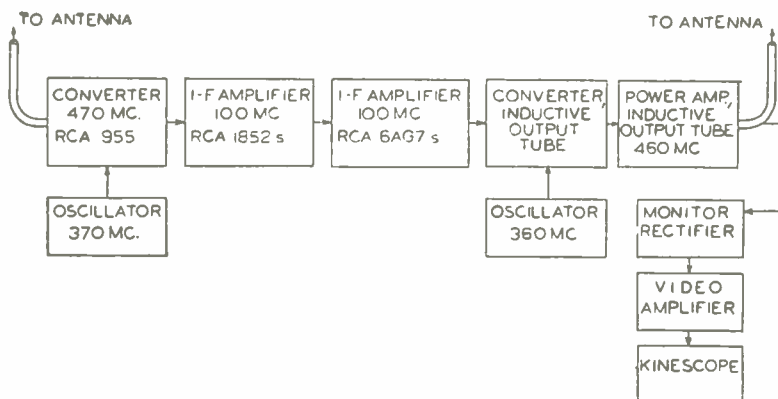

Fig. 9—Repeater-amplifier schematic diagram.

whose video output was fed to the 474-megacycle frequency-modulated terminal transmitter. These signals were relayed to Riverhead with good quality, a total distance of 70 miles from New York. Another

source of signals at Hauppauge was supplied by a monoscope described elsewhere in this paper.

The terminal transmitter is shown in Figure 6 and consisted of a 52.7-megacycle oscillator coupled with a reactance tube which was fed from a video amplifier carrying the picture signal. Following the oscillator, a wide-band tripler stage brought the carrier frequency to 158 megacycles after which a power-amplifier stage served to drive another wide-band tripler stage giving an output frequency of 474 megacycles

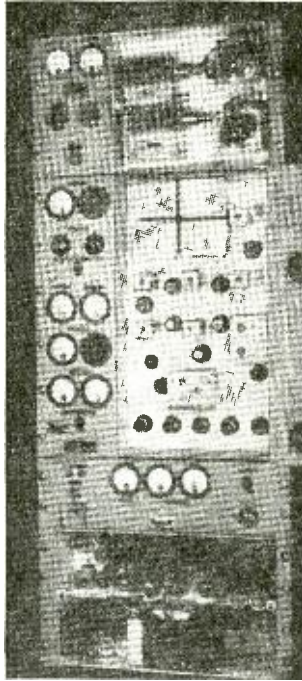

Fig. 10—Terminal receiver.

at a power level of one watt. Figure 7 shows a block diagram of the transmitter elements. A monitor rectifier at the transmitter output gave video signals to allow the output picture to be observed at all times.

The terminal transmitter was coupled to the cylindrical parabolic-reflecting antenna by means of a single 75-ohm coaxial feed line having a loss of one decibel per 100 feet. The parabolic reflector was excited by four folded doublets located along the focal axis. The antenna aperture of 110 square feet gave a measured power gain of 20 decibels over that of a half-wave dipole in free space. A 100-foot tower supported the antenna house which was fabricated from $\frac{1}{4}$ -inch waterproof plywood treated with boiled linseed oil. The repeater amplifiers and an-

tennas at Rocky Point were housed in another cylindrical plywood structure at the top of a 115-foot tower. The antennas were similar to the one used at the Hauppauge terminal.

The repeater amplifier is shown in Figure 8 and the block diagram of elements is shown in Figure 9. The input signal of 474 megacycles was fed to a triode converter, 8 stages of intermediate-frequency amplification, an inductive output tube operated as a high-level converter, followed by an inductive output tube operating as a power amplifier. The input converter made use of a 955 triode by feeding the signal to the grid and supplying a local oscillator excitation of 374 megacycles to the cathode. The 100-megacycle intermediate frequency was taken

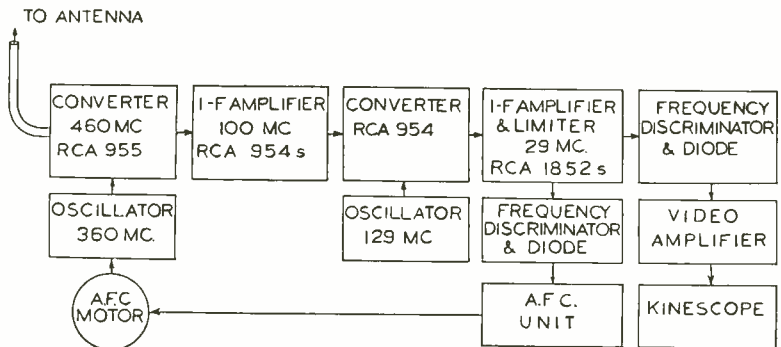

Fig. 11—Terminal-receiver schematic diagram.

from the plate circuit and amplified by six wide-band transformer-coupled stages using 1852 pentodes. Following this were two wide-band stages using 6AG7 tubes which brought the level up to 1 watt. This level was necessary to drive the inductive output tube as a converter. A local oscillator of 360 megacycles was also supplied to the input of this tube in order to obtain the final output frequency of 460 megacycles at a level of about 0.7 watts. The final inductive output-tube power amplifier provided sufficient gain to feed 2 watts to the antenna. The overall gain of the repeater amplifier was measured to be 80 decibels under actual operating conditions.

Monitor equipment was provided in order that the picture quality could be continuously observed. At the repeater station the monitor kinescope was located on the ground and was fed by a coaxial cable from the monitor rectifier at the antenna.

At the Riverhead terminal a cylindrical parabolic antenna situated 70 feet above ground fed the signal to the terminal receiver over a 75-ohm coaxial cable. The receiver used a 955 converter identical to that in the repeater amplifier. Following this, a two-stage 100-megacycle intermediate-frequency amplifier using 954 tubes gave sufficient gain and

selectivity to allow another conversion to 29 megacycles at which frequency the major portion of the gain was obtained with six wide-band transformer-coupled stages of 1852 tubes. A frequency discriminator of the Conrad type in combination with a 6H6 diode rectifier delivered push-pull video signals to an amplifier which in turn was connected to the monitor kinescope. Figure 10 shows a photograph of the terminal receiver and Figure 11 shows the block diagram.

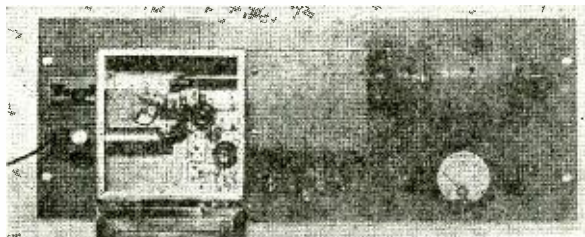

Fig. 12—100-Megacycle sweep oscillator.

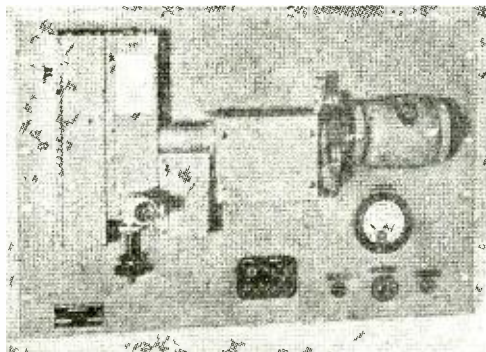

Fig. 13—500-Megacycle sweep oscillator.

In any new radio development, accurate test equipment is of the utmost importance. While such test equipment is rapidly becoming standardized for 50-megacycle television broadcasting, the state of the art was such at the time the 500-megacycle relay project was undertaken, that it was necessary to develop the required test tools during the original research. This need will be readily appreciated when it is understood that individual links of the relay must be capable of very high fidelity video transmission in order that cumulative distortion in an overall chain shall not exceed the television-broadcast requirements.

Figures 12 and 13 show two sweep-oscillator signal generators that were invaluable during the alignment and adjustment of the radio-frequency and intermediate-frequency bandpass stages. The former has a mean-carrier frequency which may be manually adjusted from

100 to 150 megacycles and the latter covers the range from 450 to 550 megacycles. Each unit is provided with a motor-driven variable capacitor which permits any amount of frequency deviation up to 16 megacycles at a 50-cycle rate. A sweep rate other than 60 cycles was chosen to avoid confusion with hum patterns. Both units have automatic volume-control circuits to eliminate any amplitude modulation in the output.

Figure 14 is a photograph of a typical television oscilloscope used throughout the relay. Its prime function is to monitor the composite

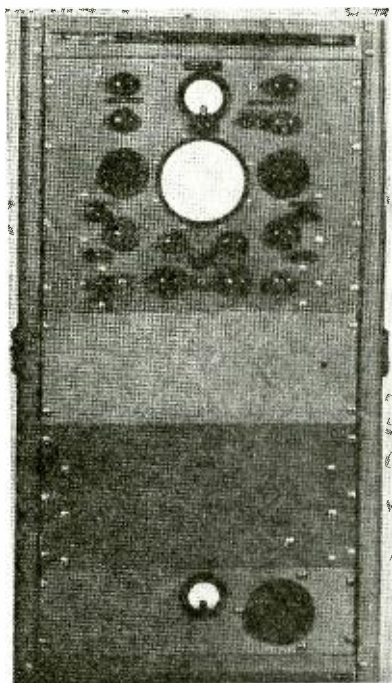

Fig. 14—High-fidelity oscilloscope.

video signal and, particularly, to show the formation of the synchronizing and blanking impulses. For this purpose, 60-cycle and 13,230-cycle horizontal sweep oscillators were provided. In addition, horizontal and vertical amplifiers having a flat response from 60 cycles to 7 megacycles with identical phase characteristics over this range were incorporated to allow precise study of the individual relay repeaters. A calibrated attenuator together with a fixed voltage source in each amplifier facilitates its use as a peak voltmeter. To simplify schedule analyses of received square waves into their Fourier series components, a 20-megacycle keying circuit was inserted to "break up" the received wave envelope into accurately spaced dots. The overall sensitivity of the unit produces a one-inch deflection on the 1802 tube with a 0.1-volt

peak-to-peak signal applied at the amplifier input. Operation of the oscilloscope is conventional and requires no description. The calibrated peak-voltmeter feature was especially helpful since it permitted direct correlation of the r-f frequency deviation with the video-signal amplitude.

For low-frequency amplitude and phase correction, 60-cycle square waves were found to be the most satisfactory test signal from the standpoint of expediency as well as accuracy. This method has the

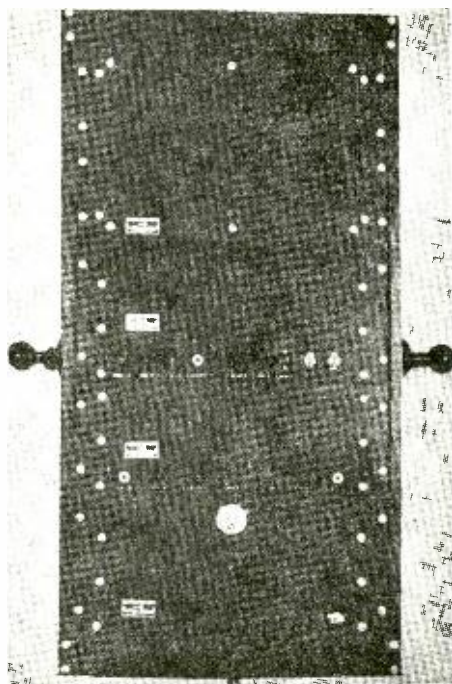

Fig. 15—Monoscope-signal generator.

advantage that any normal oscilloscope has sufficient fidelity to reproduce the received test wave. A particular variation, when used with the television oscilloscope, was to transmit the video-blanking impulses only. This test signal consists of short 60-cycle square waves (7 per cent duration) and 13,230-cycle square waves (15 per cent duration) transmitted simultaneously. When the received signal is viewed on a 60-cycle sweep in the scope, the two waves will have equal amplitudes only when the transmission medium is perfectly corrected. With slight errors in compensation, the line-frequency-pulse amplitude will be greater or less than the field-pulse amplitude due to the difference in gain or phase characteristics of the medium for the 13,230 and 60-cycle

signal frequencies. To correct the high-frequency portion of the band, 100-kilocycle square waves were used with some success. In general, however, it was more expedient to utilize ordinary signal generators with ranges up to 10 megacycles due to the wide pass bands involved.

The final and most conclusive test employed a high-fidelity monoscope—kinescope chain. Obviously, this signal checks the overall-circuit performance with respect to stability of synchronization, amplitude linearity, signal transients, picture definition, and noise effects simultaneously. The monoscope unit, containing the 1899 tube, the

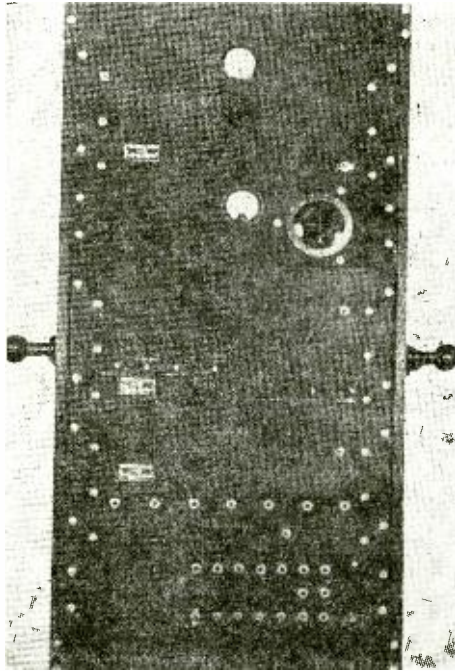

Fig. 16—Synchronizing-signal generator

deflection circuits, mixing amplifier, and power supplies, is shown in Figure 15. The synchronizing signal generator is illustrated in Figure 16. The monitor kinescope, housing the 12-inch 1803 tube, video amplifier, separators, and deflection circuits, is shown in Figure 17. All units were made portable for operation in the field. The monoscope chain transmits a standard composite video and "sync" signal of 500-line definition. Provisions were made to reverse the polarity of the video signal to obtain either a white or black background thus simulating the extreme conditions obtained with the average "movie". The 1899-tube pattern contains a wedge of half-tone steps between black and white for linearity checks. The usual horizontal and vertical

line wedges show the picture definition, the presence of transients, and at what frequencies these transients occur.

Before discussing the overall performance of the relay and the various tests conducted, it will be helpful to consider briefly the nature of a television signal and, particularly, to compare frequency modulation with amplitude modulation for this type of modulating signal. Normally, amplitude modulation is studied in one of three forms; namely, the modulation envelope, the sideband configuration or the

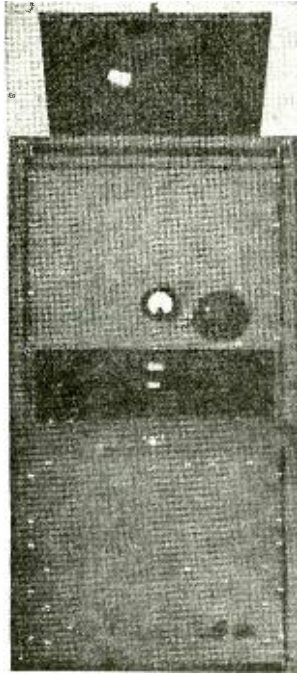

Fig. 17—Monitor Kinescope.

vector method of representation. For our purpose, the first two forms will be sufficient.

With amplitude modulation, it is well known that the sidebands are symmetrical about the carrier both as to amplitude and phase no matter how unsymmetrical the positive and negative polarities of the modulating wave may be. It is a curious fact that the first tendency of a student, during his early amplitude-modulation studies, is to associate one sideband with one polarity of the modulating wave. While this tendency is definitely incorrect when applied to amplitude modulation it is not so far wrong when the sideband distribution of a frequency modulated wave is considered. Actually, the amplitude of the sideband

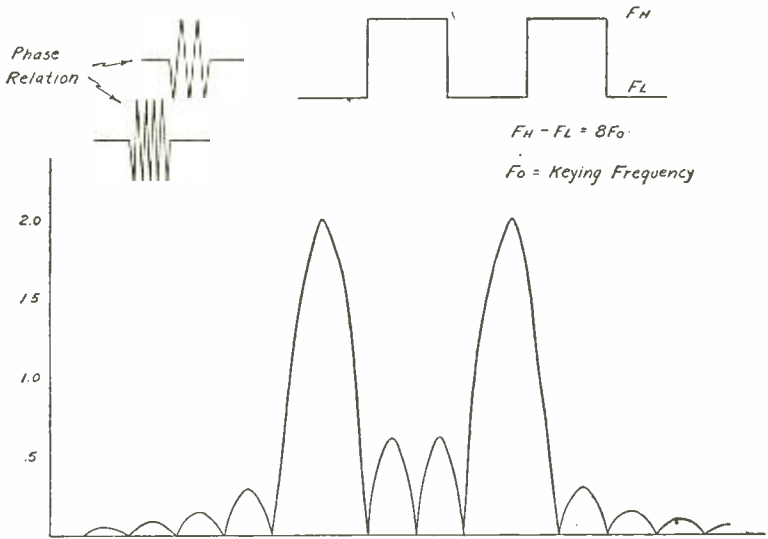

Fig. 18—F-m sidebands (symmetrical modulation).

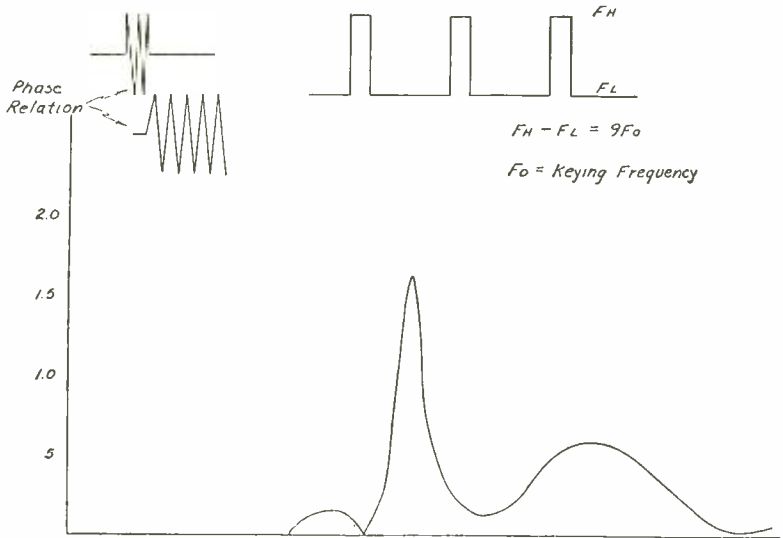

Fig. 19—F-m sidebands (unsymmetrical modulation).

components are symmetrical about the carrier in frequency modulation *only when the polarities of the modulating wave have symmetrical waveshapes*. The phases of the sidebands, on the other hand, are never symmetrical about the carrier.*

To illustrate this more clearly, consider Figure 18 which disregards the phase reversals of the even-order sideband components. It will be seen that the amplitudes of the components are symmetrical for the

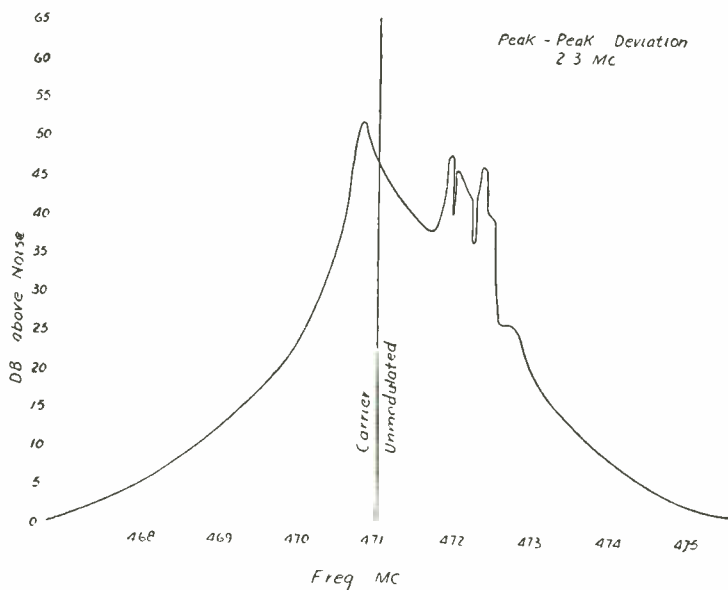

Fig. 20—F. M sidebands (monoscope composite signal).

50-50 square-wave envelope. The sidebands are calculated on the basis that the peak-to-peak frequency deviation is eight times the keying rate. A higher value of this ratio would merely move the peak sideband maxima farther apart without destroying symmetry. It will be understood that, theoretically, the sidebands extend from zero to infinity since it has been assumed that the modulating wave produces an instantaneous frequency change in the modulated wave. Now observe Figure 19 where the modulating wave is a 20-80 dot. The sideband configuration shows a very pronounced component amplitude corresponding to the frequency of longest duration of the instantaneous carrier. Further, there is no sideband symmetry about any frequency. In fact, the

* This statement is correct even if we include the very special case of sine-wave modulation with a small modulating index, since the even-order components having a 180-degree phase difference still exist although they are usually disregarded due to their small amplitudes.

sidebands are about as unsymmetrical as the polarities of the modulating envelop.

It will be understood that the present discussion is not an attempt to cover the theory of frequency modulation completely. The intention has been to show some fundamental concepts that were instrumental in determining the type of tests to be conducted. Heuristically, we may

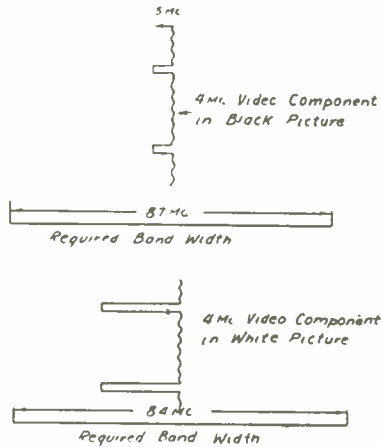

Fig 21—A-C frequency modulation (carrier at mid-band)

reason from the two examples above, that the blanking and synchronizing pulses will give sideband dissymmetry. However, the higher frequency components of the video signal considered as small amplitude sine waves, would tend to submerge this result. Figure 20 showing the measured sidebands of the 1899-monoscope composite signal indicates that no great amount of dissymmetry is obtained for a complete picture signal.

A distinction should be made between a-c transmission and d-c transmission of the video signal as applied to a frequency-modulated system. Since the standard video composite signal inherently contains all necessary information as to the picture background level (by maintaining a fixed-peak amplitude and fixed super-sync amplitude), the d-c component may be restored in the video circuits at the receiving terminal. Insofar as the relay is concerned, the signal to be transmitted may be considered as an a-c wave only. If this is done the r-f carrier

component will not be shifted when modulation is applied. On the other hand, if the d-c component is transmitted over the relay, the r-f carrier component will vary with the picture background and the frequencies corresponding to the supersync pulses will remain unchanged. Comparison of Figures 21 and 22 indicates the range of r-f or i-f frequency deviation with respect to the pass band for the two cases.

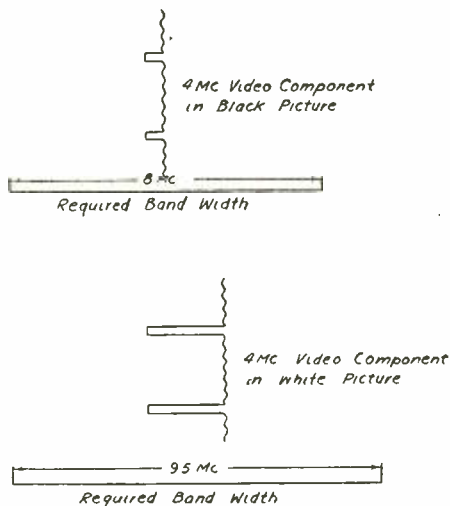

Fig. 22—D-C frequency modulation (carrier variable)

The results obtained on the overall experimental relay will now be described. With the carrier set at midband and employing a-c transmission with a peak deviation from the carrier of 2 Mc, picture definition of 375 lines was obtained with negligible transients. Synchronizing and linearity were entirely satisfactory. The r-m-s signal-to-noise ratio was 31 db.*

To determine if more effective use of the pass band could be obtained with d-c transmission, the carrier was manually adjusted in steps from the center towards the edge of the pass band. This was permissible since the d-c component of the monoscope signal is constant. At each point the video-signal polarity was reversed to compare the transmissions for two extremes of background level. In effect, this test also simulated partial sideband transmission as the carrier approached the edge of the pass band. The integrated opinion of several observers was that the fidelity of transmission remains unchanged until definite sideband clipping of the synchronizing pulses resulted in poor syn-

* Root-mean-square signal-to-noise ratio is here defined as the ratio of the root-mean-square signal-to-noise value of a sine-wave having the peak-to-peak amplitude of the received video signal as compared to the root-mean-square noise.

chronization. With the carrier shifted toward the edge opposite to the excursions of the supersync pulses, however, it was found that a somewhat larger peak-to-peak frequency deviation could be employed. Because of this and the possible theoretical advantage of maintaining the synchronizing pulses in a fixed portion of the band, automatic d-c insertion in the frequency modulators may be employed. As a matter of interest, the simultaneous transmission of video and sound on the same carrier was satisfactorily demonstrated in an additional test.

In conclusion, it can be said that radio relaying of television signals in the ultra-high-frequency spectrum above 400 Mc has been successfully accomplished and that a system consisting of radio relays would be technically adequate and feasible for television program distribution.

A PRECISION TELEVISION SYNCHRONIZING-SIGNAL GENERATOR*†

By

A. V. BEDFORD‡ AND JOHN PAUL SMITH‡

Research and Engineering Department, RCA Manufacturing Company, Inc.
Camden, N. J.

Summary—The Radio Manufacturer's Association (R.M.A.) standard television synchronizing signal consists of three types of rectangular pulses in a single wave. The timing of all pulses is such that the leading edge of each pulse is either $1/26460$ -second or $2/26460$ -second from the leading edge of its adjacent pulses. The three types of pulses differ only in the duration (or width) of the individual pulses, which is not extremely critical.

In the synchronizing-signal generator described a frequency-regulated master oscillator and multivibrator generate a master wave of uniform pulses which occur at $1/26460$ -second intervals. This master wave as produced contains only pulses which have the width specified for the narrowest type of pulses of the R.M.A. synchronizing wave, but of course, it has many extra pulses which are not required in the R.M.A. signal. Also many of the pulses should be made wider as the R.M.A. signal contains two other types of pulses of greater widths. These two other types of pulses are produced by "lap-joining" other suitable auxiliary pulses to the trailing ends of the narrow pulses of the master wave, without altering the critical leading edges of the pulses. The particular pulses of the master wave which are undesired in the final wave are "blanked" out by other auxiliary-keying pulses.

Since some of the auxiliary-keying waves are produced by 60-cycle pulse waves, it is necessary to lock the 26,460-c.p.s. and the 60-cycle pulse waves together. This is done by a chain of three pulse-counters (acting as frequency dividers) which derive the 60-cycle wave from the master 26,460-cycle wave. Stability is obtained since the tubes involved are employed substantially as lower-resistance keys.

The advantage of frequency dividing over frequency-multiplication is discussed.

The entire chain of frequency-dividers is kept in synchronism with the 60-cycle power system by comparing the 60-cycle pulse wave to the power wave to obtain a control voltage for regulating the 26,460-cycle oscillator. The circuit used is such that the derived-control voltage is made free of 60-cycle components without sacrifice of quick response.

For economic reasons involving reliability of the transmitting system, maximum attention was given to stability and inherent accuracy of performance in all critical respects.

INTRODUCTION

MANY of the standards which are necessary to specify a television system pertain directly or indirectly to the characteristics of the synchronizing-signal generator. The shapes of the synchronizing pulses, the type of interlacing, number of lines, return periods, and picture-repetition rate, all affect the design of this

* Decimal Classification: R583.13.

† Reprinted from *RCA REVIEW*, July 1940.

‡ Now with the Research Department, RCA Laboratories Division, Princeton, N. J.

generator. The Radio Manufacturers Association has adopted certain standards covering these points, but has not set tolerances on many of the standards. In order to obtain acceptable performance extremely high and stable accuracy is necessary in certain respects, as indicated in the description below. An entirely-electronic generator has been developed which employs circuits for obtaining high reliability and inherent precision of the output waves in all critical respects.

PRINCIPLES OF METHODS USED

In odd-line interlaced scanning as adopted by R.M.A. the horizontal-deflecting frequency, 13,230 cycles-per-second, is precisely a whole number plus one-half times the field frequency, 60 cycles-per-second. This results in interlacing since each field scan then contains a whole number plus one-half scanning lines. (This number is 220.5 lines for the R.M.A. standard 441-line television.) To meet these conditions it is essential that the generator of the 60 cycles-per-second synchronizing pulses be rigidly interlocked with the 13,230 cycles-per-second pulses. Since the two frequencies differ by such a large ratio and also do not have a whole number relation, a single-stage stable direct interlock is not feasible. The exact number of lines was chosen such as to permit interlocking by several stages where each step differs in frequency by a small whole-number ratio. A regulated master oscillator produces 26,460 cycles-per-second signal for driving a frequency-divider circuit producing half that frequency, i.e., 13,230 cycles-per-second. Similar frequency-divider circuits operating in cascade also divide the frequency of the 26,460 cycles-per-second oscillator in whole-number odd steps of 7, 9, and 7 producing frequencies of 3,780, 420, and 60 cycles per second, respectively.

For several reasons it is desirable (though not essential) that the nominal 60-cycle-per-second output of the synchronizing generator be accurately synchronized with the main power system of the community being served by the transmitter.¹ Due to the cost of filtering and shielding, television receivers will generally have some residual 60-cycle and 120-cycle ripple in their deflection systems and beam-modulating amplifiers. If these spurious influences are synchronous with the picture deflection they are much less annoying as the small power-frequency waves of displacement of the picture subject and the modulation shadows will not move vertically over the screen. Also when motion picture films are used as program material, the film projector should be synchronous and phased with the iconoscope-deflecting system within approximately 4 degrees. This condition is conveniently

¹R. D. Kell, A. V. Bedford, and M. A. Trainer, "Scanning Sequence and Reptition Rate of Television Images", *Proc. I.R.E.*, Vol. 24, pp. 559-576; April, 1936.

obtained by driving the projector with a synchronous motor on the 60-cycle power system. Then in order to keep the "60-cycle" signal produced synchronous with respect to the local 60-cycle power supply, the two are compared in a special improved circuit which produces a controlling voltage for regulating the frequency of the 26,460-c.p.s. master oscillator.

An inspection of the R.M.A. standard synchronizing-signal in Figure 1 shows that it consists of various time-mixtures of 26,460 and 13,230 cycle-per-second pulses. The 26,460-cycle pulses are of two kinds and occur in small groups at regular sixtieth-second intervals. Each group consists of six narrow "equalizing" pulses, six much wider pulses and six more narrow "equalizing" pulses, all occurring in the order named. (The six "wider" pulses mentioned, acting as a unit, comprise a single serrated "vertical" or field synchronizing pulse.)* Each such group occupies only about 4 per cent of the one-sixtieth second.

The remaining 96 per cent of the time is occupied by the normal 13,230-cycle-per-second horizontal or "line" synchronizing pulses. Their width is $0.08H$ (where H is $1/13230$ second) which is twice as wide as the equalizing pulses.

When used in the television receiver the leading edges of these pulses by their abrupt rise cause "firing" of the horizontal-deflecting oscillator. The duration of the pulses or shape of the trailing edge of the pulses do not appreciably affect the horizontal-deflecting circuit. According to the standard the 26,460-per-second equalizing pulses and the serrated-vertical pulses have alternate rising leading edges which are timed with the 13,230-per-second pulses such as to provide continuous uniform rising edges at intervals of $1/13,230$ second. These rising edges provide horizontal synchronization in the receivers which is uninterrupted by the vertical synchronizing pulses.

In one of the methods tested while developing the synchronizing generator, the three different kinds of pulses which comprise the entire synchronizing wave were generated continuously in separate circuits. The output of each circuit was then keyed by an amplifier which was intermittently driven to cut-off by certain "keying" waves. The final wave was obtained by adding the several keyed outputs. This simple method had a serious fault in that permanently accurate relative timing of the three types of pulses was not obtained except by frequent adjustment. The three circuits which generated the three kinds of

* Receivers can be made to operate on a synchronizing signal which is somewhat less complicated than the R.M.A. standard signal. However, to do so requires either some sacrifice in performance or the use of additional complication in the receiver. Since the number of receivers will be much greater than the number of transmitters, the generation of the R.M.A. signal is economically preferable.

RMA STANDARD T-111 TELEVISION SIGNAL

441 LINES, 30 FRAMES PER SEC., 60 FIELDS PER SEC., INTERLACED

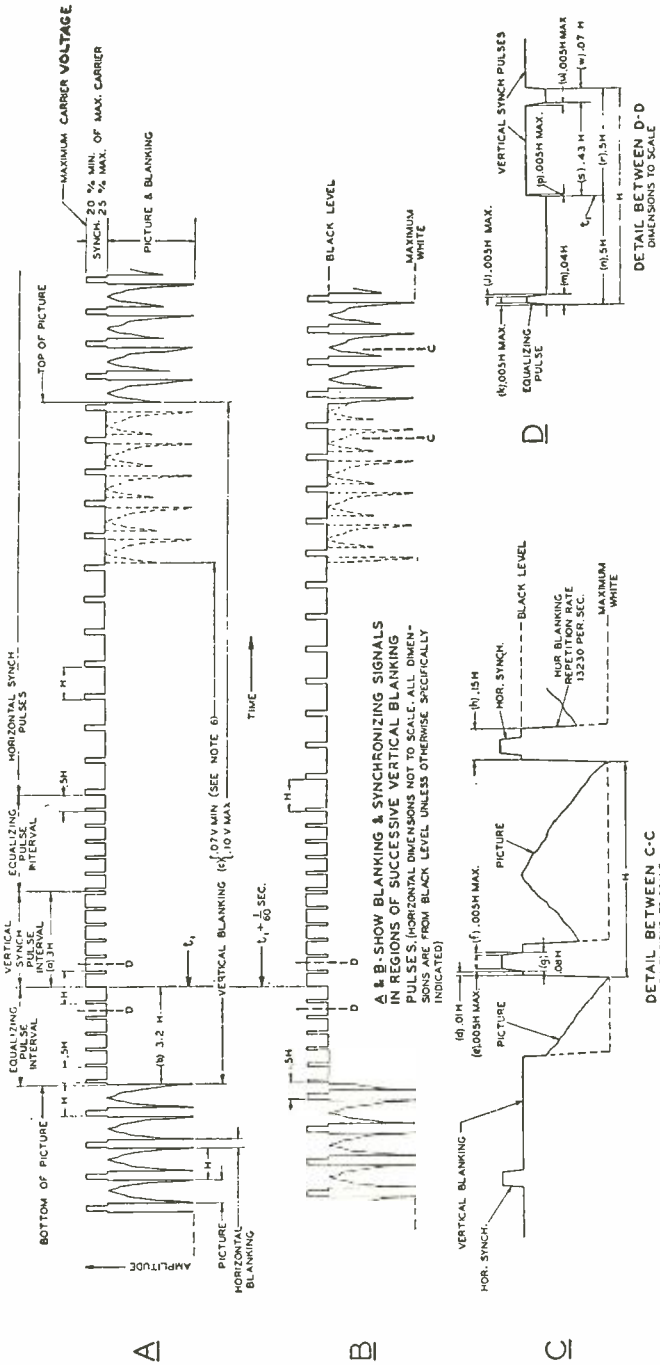

- 1- DIAGRAM C SHOWS ENLARGED DETAIL VIEW OF SIGNAL IN VIEW B BETWEEN LINES C-C
- 2- DIAGRAM D SHOWS ENLARGED DETAIL VIEW OF SYNC SIGNAL IN VIEW A BETWEEN LINES D-D
- 3- H-TIME FROM START OF ONE LINE TO START OF NEXT LINE = $1/15230$ SEC.
- 4- V-TIME FROM START OF ONE FIELD TO START OF NEXT FIELD = $1/60$ SEC. = $220\frac{1}{2}$ H DIMENSIONS TO SCALE
- 5- LEADING AND TRAILING EDGES OF BOTH HOR. AND VERT. BLANKING PULSES HAVE SLOPES (NOT INDICATED IN A & B) WHICH SHOULD BE KEPT AS STEEP AS POSSIBLE
- 6- RECEIVER VERTICAL RETRACE SHALL BE COMPLETE AT END OF .07 V DIMENSIONS TO SCALE

Fig. 1—A and B are portions of the same wave. The Synchronizing-signal Generator produces the portion (25 per cent) of the R.M.A. Standard Television Signal above the “black level”. It also produces the blanking portion of the signal shown below “black level”.

pulses were synchronized by the common 26,460-cycle pulses, but due to variable degrees of "firing resistance" and finite slope of the synchronizing pulses, timing errors, between the several kinds of pulses in the output wave, of several per cent of H frequently occurred. Further difficulty was experienced due to the three kinds of pulses having different wave shapes of their leading edges and different rates of rise due to different constants in the three generating and keying circuits. These errors sometimes resulted in loss of horizontal synchronism in the receiver at those points of non-uniformity which would require an abrupt increase in oscillation frequency and at other times caused a slight displacement of a few scanning lines at the top of the picture screen. For operation beyond reproach it seems that the error between any two adjacent horizontal-synchronizing leading edges should be considerably less than that corresponding to one picture element, which is of the order of $0.002 H$.

In the present synchronizing generator, uniformity of both timing and wave shape of all leading pulses is inherent due to a single 26,460-c.p.s. multivibrator (which is driven by rectangular waves obtained from a tuned oscillator and limiter) producing the leading edges of all pulses in the finished R.M.A. synchronizing wave. These pulses as produced have a width of $0.04 H$ and without alteration become the "equalizing pulses" in the final wave. A section of the 26,460-c.p.s. pulses are made wider by having other pulses added to their trailing ends in order to widen them to the $0.43 H$ as specified for the vertical synchronizing pulses. During the region which is to contain only the normal 13,230-per-second horizontal pulses the alternate unwanted pulses are keyed out and the remaining pulses are widened to $0.08 H$ by adding other suitable pulses to their trailing ends. In each case the leading edges of the original pulses are not altered by the additions. Since any slight change in the shape or slope of the leading edges or delay in their transmission through the circuits will be the same for all types of pulses, no relative errors will be introduced. The widths of the various composite pulses will vary somewhat with unavoidable changes in the timing of the added pulses since they are produced in separate circuits, but considerable tolerance is permissible in this respect. The widening pulses are always added to the 26,460-c.p.s. pulses with an appreciable overlap in time so that no gap in the completed pulses is ever present after a final step of limiting amplification. The principles involved will become more evident when the specific apparatus is described.

FREQUENCY DIVISION VS. FREQUENCY MULTIPLICATION

Considered casually it would seem better to begin the frequency chain with the 60-cycle power supply and use frequency multipliers

in the various steps to obtain the 26,460-c.p.s. signal, since it would avoid the indirect method of obtaining 60-cycle synchronism and the relatively complex frequency dividers as were used in the later signal generator to be described below. The objection to this simpler method resides in an inherent weakness of the frequency multipliers themselves, namely that the instantaneous-output frequency of a frequency multiplier is not necessarily correct and in close agreement with the average frequency at all times as will be explained. In this type of device the lower frequency sine-wave signal is greatly distorted by an amplifier tube to produce harmonics, and the desired harmonic is then presumably selected and isolated in the plate circuit by a tuned circuit. The operation is imperfect because the tuned circuit can not readily be made to have sufficiently low loss to be adequately selective to isolate the desired harmonic completely. Furthermore even if it were adequately selective it would not be capable of following the slight frequency changes in the 60-cycle power system. (If a flat-top band-pass filter were used the change in phase with frequency might be objectionable if sharp cut-off is obtained.)

From a physical point of view the lower-frequency input signal merely shock-excites the tuned-plate circuit once for each lower-frequency cycle and leaves the tuned circuit to generate say 7 or more cycles by free damped oscillation. Between shocks the frequency may be slightly off the ideal since it is determined only by the tuned circuit. Figuratively speaking it may be said that a 60-cycle per second wave, for example, measures or divides time into 1/60-second units. Then in attempting to produce by frequency multiplication a frequency of say 420 cycles per second we have the difficult task of measuring 1/420-second intervals by a "ruler" calibrated only in units seven times as large. The experimental efforts of others seem to support these conclusions.

FREQUENCY DIVIDERS

Two very different types of frequency-dividing circuits are available: the multivibrator* which, when driven by a higher frequency, may have its natural frequency adjusted so that firing occurs only on say every seventh pulse, and the pulse-counter circuit † which accumulates the effect of several consecutive cycles of pulses without regard to their frequency and fires producing a single pulse output when the accumulated effect is adequate.

* The blocking oscillator or other forms of self-running relaxation oscillator may be used instead of the multivibrator. The multivibrator is however, the preferred form of this general type.

† The Electric Music Industries, Limited of Great Britain is credited with developing the pulse-counter circuit for synchronizing-signal generators.

Certain advantages in stability lead to the adoption of the "counter" type of circuits for the synchronizing generator in spite of its greater complexity.

With reference to Figure 2(a) the "counter" circuit for frequency dividing may be explained as follows: Since the first frequency divider in the chain has been chosen for the explanation, V_1 is shown amplifying rectangular waves derived from the master 26,460-c.p.s.

(a) 3780 CYCLE FREQ. DIVIDER

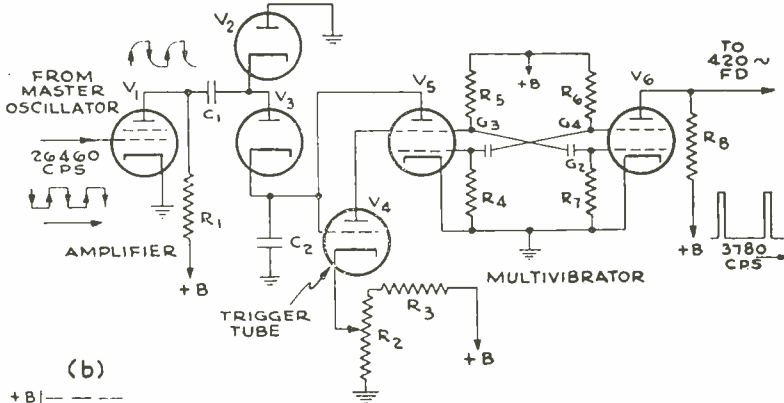

(b)

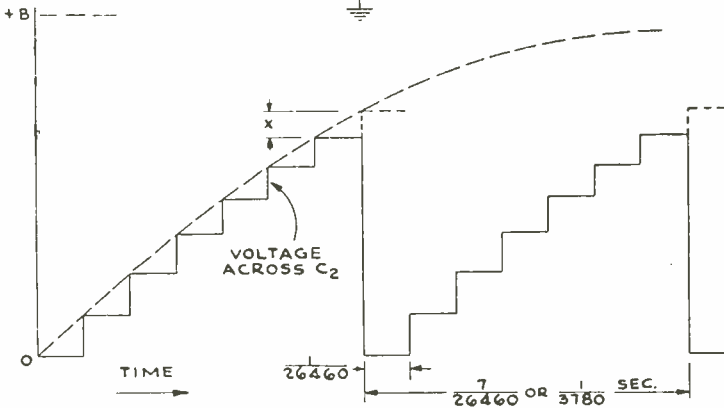

Fig. 2—(a) Frequency Divider. (b) Shows how C_2 is charged in steps through V_3 and C_1 and discharged at intervals by V_4 .

oscillator by limiting amplifiers (as shown further in Figures 3 and 4). The plate resistance R_1 is high and the grid swing of V_1 is of saturating magnitude so that the output-rectangular wave has amplitude limited by and approximately equal to the voltage of the power supply $+B$. Starting with no charges on C_1 and C_2 , the plate voltage swings to $+B$ and the capacitors C_1 and C_2 charge in series through diode V_3 to substantially the entire voltage. The $+B$ voltage of say 250 volts is divided between the two condensers inversely as their respective ca-

capacitances. C_1 is small and C_2 large so that C_2 has the lower voltage, say 1/20 of +B which is 12.5 volts.

On the negative stroke diode V_2 conducts, discharging C_1 to ground, but not altering the charge on C_2 . On the next positive stroke the conditions are repeated except that this time only approximately 225 net volts are available for adding *new* charges to the two condensers. Condenser C_2 then will obtain a second incremental charge of only about 10 volts. On the next negative stroke of the plate, diode V_2 will again discharge C_1 . The "stair-step" rise of voltage across C_2 is shown at (b) in the figure. Note that the voltage across C_2 would asymptotically approach the +B voltage as the voltage increments decrease in amplitude if not interrupted. During the "build-up" time trigger tube V_4 is biased beyond "cut-off" due to a definite portion of the positive voltage from the +B supply applied to its cathode. When the "stair-step" voltage across C_2 reaches slightly higher than the cut-off condition for the trigger tube, depending upon the setting of the potentiometer R_2 , the trigger tube conducts, driving the control grid of the multivibrator tube V_6 negatively. Tubes V_5 and V_6 are connected in a conventional multivibrator circuit using the screen grids as anodes for the multivibrator action so that the plates are available for other purposes to be explained. The multivibrator constants are such that tube V_5 would remain in the cut-off portion of the cycle for extremely long intervals if it were not for the pulses received from the trigger tube V_4 . When the trigger tube conducts, the multivibrator is triggered, tube V_5 conducts and its plate circuit quickly discharges condenser C_2 substantially to zero potential. Then the multivibrator re-sets to its initial condition where V_5 is cut-off and V_6 conducts. The "stair-step" charging cycle starts again and the charge due to the next seven cycles is metered by the trigger tube, and so on. The plate output of tube V_6 is a 3,780-c.p.s. rectangular wave of suitable amplitude to charge a similar " C_1 and C_2 " of the next "counter" circuit (or frequency divider).

This frequency-dividing circuit is entitled to be called a "pulse-counter" only on the grounds that it produces one output pulse for every certain number of input pulses over a wide-frequency range. In the present application the ability of the output to "follow" the input for a large frequency change is of no great value, except that it simplifies changes for experimental purposes. The real advantage of using the "counter" circuits instead of the multivibrators alone is their very great stability in counting accurately with changes in tube characteristics and +B voltage. The magnitude of each step in the stair-step charging of condenser C_2 tends to vary in proportion to the +B voltage. The bias voltage on the cathode of the trigger tube, which

responds to the accumulated voltage across C_2 , also varies in proportion to the +B voltage so that approximate cancellation of the effects of B-voltage changes is obtained. Some tendency to error in "counting" occurs due to the variable resistances of the diodes, which prevent complete charging of C_2 through V_3 ; and the complete alternate discharging of C_1 through V_2 . Also tube V_5 does not discharge C_2 to completion due to tube resistance. However, these effects may be made negligible

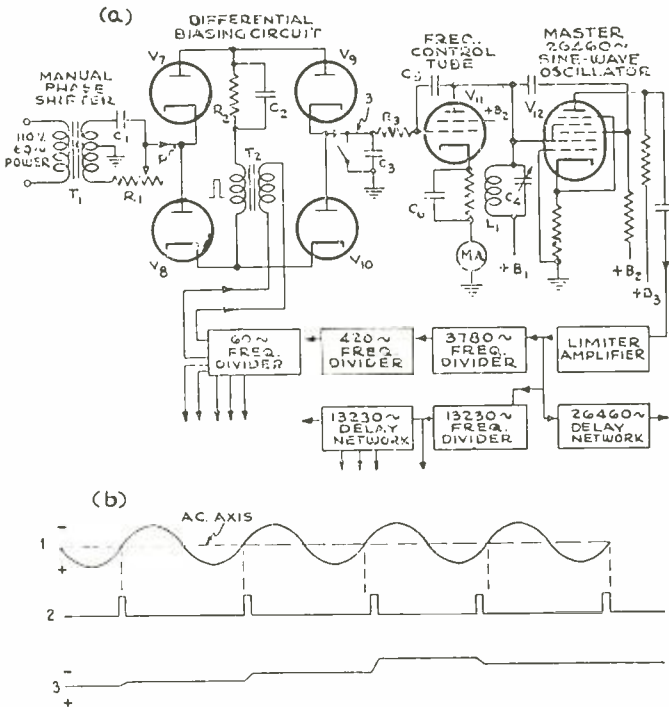

Fig. 3—(a) 60-cycle Locking Circuit. (b) Wave 1 from the Phase Shifter and wave 2 from the 60-cycle Frequency Divider produce frequency control wave 3 at 3 in the circuit. Note wave 3 is uniform except when correction is required.

by using circuit constants of relatively high impedance. Also the cut-off voltage of tube V_4 may vary incorrectly with plate voltage and from tube to tube, but this voltage is relatively small, especially in the high- μ -type tubes. Another and more-serious source of irregularity was found to be due to gas current and leakage in tubes V_4 and V_5 , when certain unfavorable types were tried for these circuit positions. The merit of this type circuit is due to the fact that to a certain extent the tubes act only as switches so that stability is largely determined by the relatively-stable condensers and resistors.

SIXTY-CYCLE LOCKING CIRCUIT

The frequency-regulating circuit for maintaining the entire synchronizing generator in synchronism with the 60-cycle power system is shown in Figure 3(a), in which each frequency-dividing circuit is represented by a block having the lower or output frequency indicated. The 26,460-c.p.s. oscillator is of the negative-transconductance type and electronic coupling to the plate circuit is used for output. The frequency is determined by the tank circuit which includes the constants L_1 and C_4 and the automatically adjustable impedance due to the plate current of the frequency-control tube V_{11} . Since the grid of this tube is excited from the tank circuit, through a small condenser C_5 , which provides phase shift, the plate current is largely in quadrature so the mutual conductance of this tube will affect the resonance frequency. The bias of tube V_{11} and, hence, its mutual conductance is controlled by the "differential biasing circuit" in accordance with the relative phases of the 60-cycle power circuit and the "60-cycle" pulse output of the last frequency-divider of the chain.

The differential-biasing circuit can best be understood by considering the entire bridge circuit comprised by the four diodes, V_7 , V_8 , V_9 and V_{10} , the condenser C_2 , the resistor R_2 and transformer T_2 , as merely a key or switch that momentarily connects the 60-cycle power supply through the manual phase shifter to the condenser C_3 . The narrow 60-cycle pulses as shown at 2 in Figure 3(b) introduced by transformer T_2 into the bridge cause the four diodes to conduct briefly for each pulse. This conduction charges condenser C_2 so as to retain the diodes entirely biased off between pulses while resistor R_2 continually discharges the condenser slightly so that the diodes will continue to conduct during the pulses. The pulses from the frequency divider as shown at 2 in Figure 3(b) occur near the time the sine-wave power-supply voltage (wave 1) impressed at P crosses the a-c axis from positive to negative and has a maximum rate of change. Hence, slight changes in the relative timing of the frequency-divider circuit and the 60-cycle power line will cause the voltage accumulated upon condenser C_3 to vary considerably as shown by wave 3. Since the sine-wave voltage at P is changing negatively during these pulses, a lagging condition of the frequency divider for example, will adjust the bias on condenser toward the negative, making the frequency-control tube less conducting. This in turn tends to cause the master oscillator to increase its frequency, thereby decreasing the lag of the entire chain of frequency-dividers. Conversely an advancement of the phase of the pulses produces a retarding influence upon the master oscillator. Hence, when the tank, L_1 , C_4 , is set manually such that its natural frequency would be approximately 26,460-cycles per second, the synchronizing generator

will be automatically adjusted to synchronism with the 60-cycle power supply. Also if the manual setting is made such that balance is obtained with the 60-cycle pulses occurring very nearly the time the sine-wave passes through zero, the locking phase relation will not vary appreciably with the amplitude of the power wave. The adjustment necessary for this condition may be determined practically by the milliammeter in the cathode circuit of the frequency-control tube.

The time required for a frequency adjustment to occur after it is needed is very short, but no appreciable 60-cycle changes in voltage occur across C_3 since C_3 can neither lose nor gain charge between the narrow 60-cycle pulses as indicated by Wave 3 being uniform between pulses of Wave 2. Note also that if no frequency correction is needed the control-voltage Wave 3 is uniform d.c.

These advantages were not present in an early form of regulating circuit used experimentally in which the 60-cycle power wave was beat with the 60-cycle pulse wave and rectified to produce variable height controlling pulses. In that circuit the pulses were filtered by R-C circuits to change the pulses to a variable d-c control voltage. Difficulty was experienced in that when the filtering was made adequate to avoid excessive 60-cycle frequency modulation, the control action was sluggish and subject to hunting or over-swing.

WAVE-SHAPING CIRCUITS FOR AUXILIARY OUTPUT WAVES

Figure 4 shows the entire synchronizing generator in block diagram. In the left-hand portion of the figure the chains of frequency dividers are indicated by blocks containing the letters FD and a number corresponding to the cycles-per-second output. The block marked "L-26,460" is the limiter amplifier shown in Figure 3 and supplies the delay network DN-26,460 with 26,460 rectangular pulses per second. Similarly the frequency divider FD-13,230 is a source of synchronized 13,230-cycle rectangular pulses which supplies another delay network DN-13,230 having several different output taps. The frequency divider FD 60 (shown in Figure 3 also) is a 60-cycle synchronous pulse source for synchronizing five separate multivibrators shown as blocks "MV". These 60, 13,230, and 26,460-cycle-per-second sources are used to produce all the synchronizing-generator output signals.

For example the output signal known as "video blanking" is a mixture of 60-cycle-per-second pulses and 13,230-cycle-per-second pulses with the 13,230-cycle pulses eliminated during the occurrence of each 60-cycle pulse. The letter "d" in Figure 4 indicates the conductors for this wave and the wave shape is shown at "d" in Figure 5. The component waves *a* and *b* are mixed in the mixer-limiter, block ML-1 of Figure 4, to provide the sum wave *c*. Wave *c* is limited in the same block at the

the first triode of V_{15} can be adjusted by the potentiometers which controls the positive bias on the second triode so that the duration of the positive pulses impressed upon tube V_{16} can be made as long as desired in the wave *b* of Figure 5. Tube V_{16} serves as a mixer since its plate is in parallel with the plate of the second triode in tube V_{18} . Tube V_{16} also limits its positive plate swing by cut-off and its negative plate swing by drawing grid current.

The multivibrator MV-10 which includes Tube V_{17} is synchronized by 13,230-cycle-per-second pulses from the frequency-divider, FD 13,230, which have been properly delayed by the delay-network DN-13,230. The multivibrator output-wave *a* is combined with wave *b* by means of the second triode of V_{18} to form voltage wave *c*. (Actually waves *a* and *b* are present as current waves in the plate leads while the voltage on the plate of either Tube V_{16} or the second triode of V_{18} is wave *c*.) The first triode of Tube V_{18} and the line-amplifier Tube V_{19} serve as limiting amplifiers to reduce wave *c* to wave *d* by saturating-off the portion of wave *c* above the broken line. The line-amplifier LA-1 is connected for output from its cathode circuit as this provides a lower impedance for operation into a 75-ohm distribution cable.

The "Iconoscope blanking" output wave and the apparatus for producing it is essentially the same as for the "video blanking" wave except that the pulses are shorter and are delayed different amounts in the synchronizing generator due to the Iconoscope blanking being subjected to additional delay by transmission through the television camera cables. The wave is shown at *e* in Figure 5 without the additional delay and the circuit apparatus involved in its generation may be determined by following backward along the lines from the letter *c* in Figure 4.

The "vertical-driving signal for the Iconoscope" is a simple 60-cycle-pulse wave as shown by wave *f* in Figure 5. Its generation involves only one multivibrator MV-3 (synchronized by the 60-cycle frequency-divider), a limiter and a line amplifier as shown in Figure 4.

The "horizontal driving signal for the Iconoscope" is a similar kind of wave involving a similar type of apparatus except that the frequency of the pulses is 13,230 per second as shown by the wave *g* in Figure 5 and the letter "*g*" in Figure 4.

CIRCUITS FOR GENERATING THE R.M.A. SYNCHRONIZING WAVE

The last signal output of the synchronizing generator is the "R.M.A. synchronizing wave" as indicated at *w* and *w'* in Figure 5 for the intervals near the even and odd vertical pulses respectively. (*W* and *w'* are views of the same voltage wave taken 1/60-second apart.) For clearness the number of equalizing pulses and the duration of each vertical

pulse shown in w' and w' has been halved as can be seen by comparing with the R.M.A. standard drawing T-111 of Figure 1. Since several unusual methods are employed to insure a very high degree of accuracy in the wave at its critical points, a brief review of the steps is of interest.

All of the waves from h to v in Figure 5 are generated and used in various combinations to produce the final wave w . In the last step, wave w is obtained from wave v alone by simply limiting or "clipping" at the positive and negative levels indicated by the broken lines on wave v . Wave v on the other hand is derived by adding the four waves

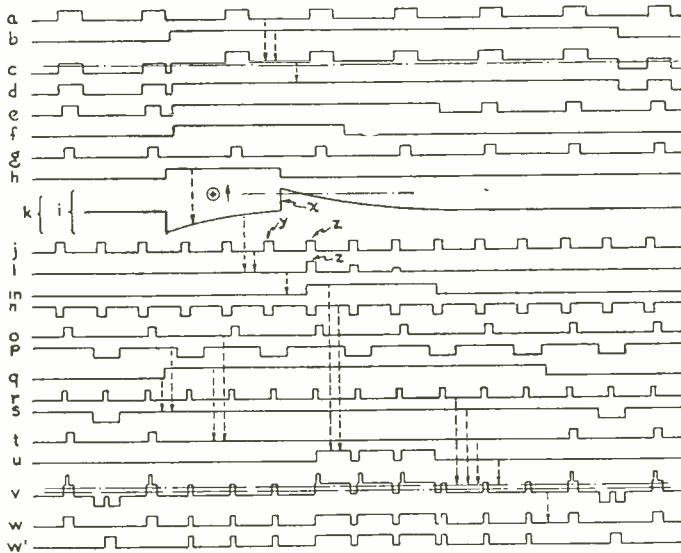

Fig. 5—Wave shapes present in circuit of Figure 4 at points indicated. Wave v , from which R.M.A. sync wave w is derived, is the sum of r , s , t , and u as shown by dotted arrows.

r , s , t , and u in mixer M-1 as indicated in Figure 5 by the vertical dotted arrows connecting the several waves. Wave r is a simple 26,460-cycle pulse wave produced by a delay-synchronized multivibrator, MV-8, and a limiter, L-5. Wave s is the 13,230-cycle pulse wave p after having a group of the pulses keyed-out by each pulse of the 60-cycle wave q . The keying is accomplished in the mixer-limiter, ML-3, of Figure 4 by applying the two waves p and q respectively to the first and third grids of a tube of the type commonly known as a pentagrid converter. When wave p allows electrons to pass the first grid, the wave q modulates their flow to the plate output circuit whereby one wave modulates the other. Wave t is produced in a similar manner by allowing wave q to key wave o in the mixer-limiter ML-4. The waves p , q , and o originate in multivibrators synchronized by suitably-delayed pulses.

Wave *u* is obtained by the 60-cycle pulse wave *m* keying the 26,460-cycle wave *n* in the mixer-limiter, ML-5, with such polarity that the high-frequency pulses are passed only *during* each 60-cycle pulse.

The pulse of wave *m* must be delayed with considerable accuracy with respect to the output of the 60-cycle frequency-divider in order to insure the leading pulse of each 60-cycle group of pulses in wave *u* being a whole pulse. The main delay is obtained indirectly by using the back or trailing edge of the pulses of wave *h* instead of a delay network as will be explained. Wave *h* is distorted to a shape such as shown at *i* by transmission through a small condenser with a resistance

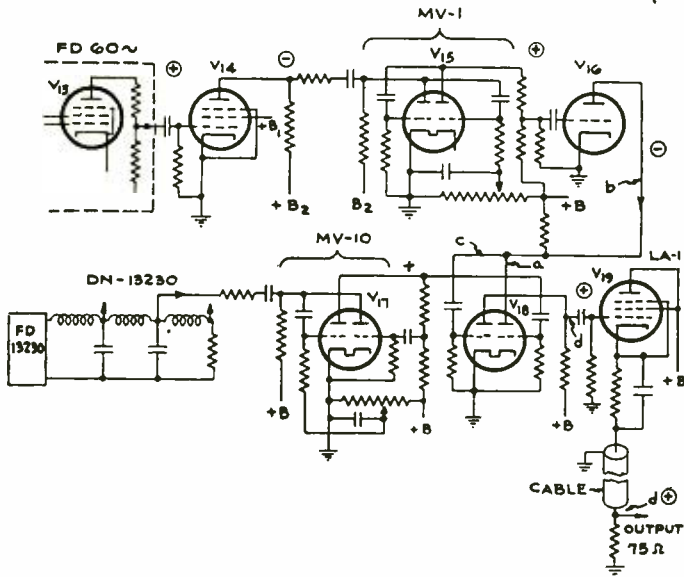

Fig. 6—Multivibrators, mixer, limiter, and line amplifier for combining waves *a* and *b* to form wave *c*, which is limited to produce *d*.

output load. It is then applied to the first grid of a pentagrid tube through a series resistor which limits wave *i* at the broken line due to grid current, producing wave *k*. Wave *j* is applied to the third grid of the tube and the limited wave *k* holds the tube cut-off except when pulse *x* of wave *i* occurs. Then the plate-output circuit contains small isolated 60-cycle groups of the 26,460-cycle pulses as shown in wave *l*. The leading pulse of each 60-cycle group of wave *l* then accurately triggers the multivibrator MV-6. This multivibrator produces the 60-cycle-pulse wave *m* which is used as described above. Wave *m* is, therefore, accurately timed with respect to the 26,460-cycle-pulses of wave *n* since waves *n* and *j* are outputs of the same multivibrator. It should be noted that the trailing end of the pulse of wave *h* could occur any time be-

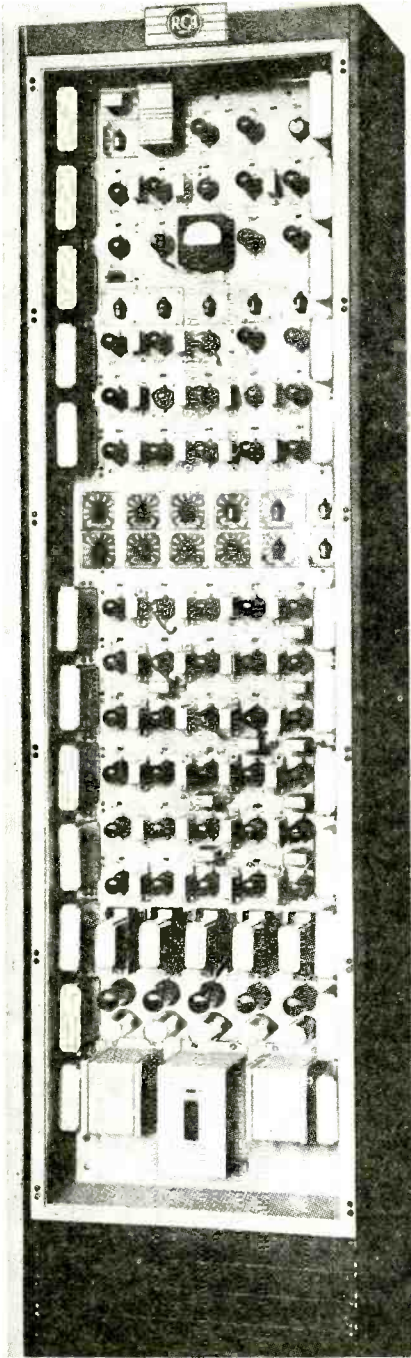

Fig. 7—Front View of Complete Synchronizing-signal Generator.

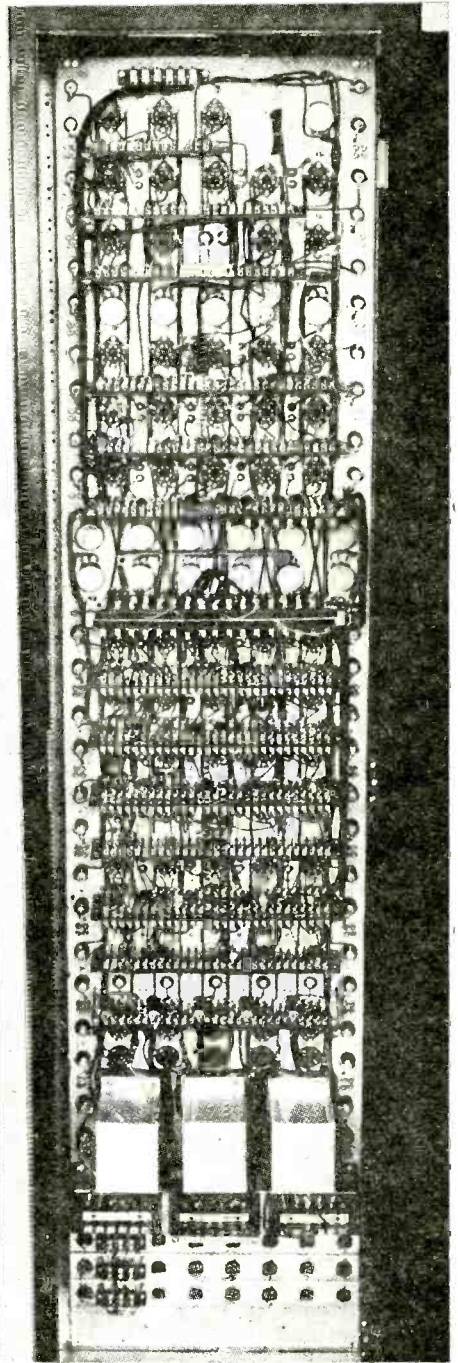

Fig. 8—Rear View of Synchronizing-signal Generator.

tween the pulses y and z of wave j and still select the same pulse z as the leading pulse in the group in wave l . Such tolerance in operation allows reliable accuracy in performance without critical adjustments.

As mentioned before, the extreme uniformity of all leading edges in the finished synchronizing wave w is due to the fact that the same oscillator produces all pulses of wave r , which provide the leading edges of all the pulses of various widths in the finished wave. The unwanted pulses of wave r are extinguished by wave s and certain other pulses are made wider by adding to their trailing end the pulses of waves t and u . If it had been attempted to add these pulses so that no over-lap was caused, i.e., as a sort of "butt point" the relative timing and wave shapes would have to be adjusted to extreme accuracy to avoid notches and gaps in the sum pulses. Study of Figure 5 shows that by using a "lap-joint" between adjoining pulses and by subsequent clipping, considerable tolerance in the timing and shape of the various component waves may be allowed.

PRACTICAL FEATURES

Figures 7 and 8 respectively show front and rear views of the synchronizing generator mounted in a cabinet rack. All of the 62 tubes (most of which are double tubes) and the controls are on the front of the single chassis, and are made accessible by opening the hinged door. Most of the smaller components are mounted on bakelite terminal boards and are readily accessible as seen in the rear view. The wiring has been greatly simplified by carefully grouping the apparatus so that leads are very short. This also avoids the need of shielded wires except in a very few connections. Adequate electric isolation of the various parts from one another is obtained by locating the parts in suitable groups on the chassis. Of course all circuits which contain pulse signals having steep wave-fronts, corresponding to several megacycles, are relatively low-impedance circuits in order to provide fidelity and prevent cross-talk.

The tube heaters are supplied by the five 60-cycle transformers near the bottom of the chassis, two in front and three in the rear. The plate supply required is 770 milliamperes at 250 volts, which is usually supplied from two external regulated power rectifiers operating on 110 volts a.c. (320 milliamperes of this current is used in the five line amplifiers for distribution about the studios.)

Since a failure of the synchronizing generator in a commercial television installation might cause a serious interruption or impairment of service, great attention was given to attain reliability and *inherent* accuracy (rather than accuracy which is dependent upon critical adjustments of controls). The use of relatively complicated circuits

in the signal generator which require the use of many tubes (with the resulting increased number of chances for tube failure) might seem to decrease the reliability. However, the circuits were chosen to permit the operation to be unaltered by very large changes in tube characteristic without readjustment of controls. Therefore, routine checking of tubes should avoid failure by the normal deterioration of tube characteristics. Furthermore, abrupt structural failure of tubes is relatively rare when, as in this case, all tubes are operated conservatively within their rating.

Similarly, a number of variable controls are provided as an aid to reliability as they allow easy periodic adjustment to optimum mean positions using an oscilloscope for an indicator. This insures that gradual changes in the circuit elements will not likely cause failure. They also permit some changes for experimental purposes.

Considerable experience with the several factory-built synchronizing generators of the type described, indicates that excellent results may be expected if reasonable care is used in routine maintenance.

ACKNOWLEDGMENT

The authors express appreciation to Messrs. K. R. Wendt and A. C. Schroeder for many valuable suggestions in connection with the development of this signal generator. Also Messrs. C. H. Vose and F. E. Cone contributed many desirable mechanical features.

VERTICAL VS HORIZONTAL POLARIZATION*†

By

GEORGE H. BROWN‡

Research Department, RCA Manufacturing Company, Inc.
Camden, N. J.

Summary—Theory and experiment are combined in this comparison of vertically and horizontally polarized ultra-high-frequency waves. Horizontal waves are shown to offer lower field strength but higher signal-to-noise ratio under broadcast reception conditions.

IN ULTRA-HIGH-FREQUENCY transmission, for aural broadcasting and for television broadcasting purposes, the transmitting antenna is usually located at a point well above the surface of the earth. This may be accomplished by placing the antenna on a tall building or on a high tower erected for the purpose. In the average receiving location this procedure is not possible. Here it is generally not practical to raise the receiving antenna to a height much greater than fifty feet. Often a height much less than this figure must be accepted. It is generally conceded that as great a height as possible is desirable at the receiving location, up to the point where the free-space wave and the wave reflected from the ground begin to cancel. At the same time, such factors as appearance, cost, and accessibility must be considered. These factors may, under certain conditions, be of such consequence that it is desirable to provide a small receiving antenna in or near the receiver cabinet. In many receiving locations in residential districts, the receiver cabinet with the receiving antenna may be only a few feet above the ground. Since it is known that the received signal strength close to the ground exhibits characteristics associated with the polarization of the transmitted signal, it seems desirable at this time to examine this phenomenon more closely than has been done in the past.

THEORETICAL AND EXPERIMENTAL INVESTIGATION

In calculating the field intensities in this paper, the formulas given by Trevor and Carter¹ have been used, particularly those given on pages

* Decimal Classification: R111.6 × R583.

† Reprinted from *Electronics*, October, 1940.

‡ Now with the Research Department, RCA Laboratories Division, Princeton, N. J.

¹ Bertram Trevor and P. S. Carter, "Notes on Propagation of Waves Below Ten Meters in Length", *Proc. I.R.E.*, March, 1933.

423 and 424 of their paper. In the calculations, it has been assumed that the earth is flat and uniform, with a known dielectric constant and conductivity. The transmitting antenna (Figure 1) is at a height h above the surface of the earth, while the receiving antenna is at height a . The horizontal distance between antennas is d . A direct wave travels from the transmitting antenna to the receiving antenna along the straight path shown as r_1 . Another wave strikes the surface of the earth at the angle ϕ and reflects at the same angle. The magnitude and phase of the wave may be altered on reflection. The amount of alteration is dependent on the frequency and the dielectric constant of the earth, as well as the conductivity and the angle of incidence of the reflected wave. The reflected wave will also arrive at the receiving antenna a little later than the direct wave because the path length r_2 of the reflected wave is greater than r_1 , the path length of the direct wave.

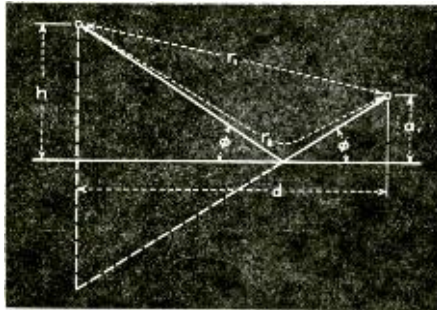

Fig. 1—A transmitting antenna at height h and receiving antenna at height a as used in these experiments. A uniform flat earth is assumed.

The total field F_V at the receiving antenna, for vertically polarized waves, is

$$F_V = F_D [1 + K_V e^{-j\theta}] \quad (1)$$

where F_D = the direct wave

K_V = reflection coefficient

$$= \frac{\epsilon_o \sin \phi - \sqrt{\epsilon_o - 1 + \sin^2 \phi}}{\epsilon_o \sin \phi + \sqrt{\epsilon_o - 1 + \sin^2 \phi}}$$

ϵ_o = a complex dielectric constant

$$= \epsilon - j \frac{18 \times 10^{20} \sigma_{emu}}{f}$$

ϵ = the dielectric constant of the earth

σ_{emu} = earth conductivity (emu)*

f = frequency (cycles per second)

For a frequency of 50 Mc, with $\epsilon = 15$ and $\sigma_{emu} = 0.5 \times 10^{-13}$, $\epsilon_0 = 15 - j 1.8$

θ = phase delay due to difference in path lengths = $\frac{2\pi}{\lambda} (r_2 - r_1)$

$$r_2 - r_1 = \frac{4ha}{r_2 + r_1}$$

$$r_2^2 = d^2 + h^2 + a^2 + 2ha$$

$$r_1^2 = d^2 + h^2 + a^2 - 2ha$$

λ = wavelength

For horizontally polarized waves,

$$F_H = F_D [1 + K_H \epsilon^{-j\theta}] \quad (2)$$

where
$$K_H = \frac{\sin \phi - \sqrt{\epsilon_0 - 1 + \sin^2 \phi}}{\sin \phi + \sqrt{\epsilon_0 - 1 + \sin^2 \phi}}$$

When the distance d is very much greater than either h or a , good approximations to (1) and (2) are as follows:²

$$F_V = \frac{F_D}{d} \left[\frac{2 \epsilon_0 (h + a)}{\sqrt{\epsilon_0 - 1}} + j \frac{4\pi ha}{\lambda} \right] \quad (3)$$

$$F_H = \frac{F_D}{d} \left[\frac{2 (h + a)}{\sqrt{\epsilon_0 - 1}} + j \frac{4\pi ha}{\lambda} \right] \quad (4)$$

To check these formulas experimentally, a transmitter was located on the roof of one of the buildings of the RCA Manufacturing Company

* σ (mho — cm) = $\sigma_{esu}/9 \times 10^{11} = 10^9 \times \sigma_{emu}$
so that

0.5×10^{-4} mho — cm = 4.5×10^7 esu = 0.5×10^{-13} emu.

² Identical results have been published by Burrows, Decino, and Hunt. (*Proc. I.R.E.*, December, 1935; page 1532). The formulas are repeated here for the sake of completeness and because we shall apply them to particular cases.

in Camden, New Jersey. A pair of concentric transmission lines fed power directly into the center of a half-wave antenna. This antenna was so arranged that it could be placed either in a vertical or a horizontal position. In both cases, the current in the antenna was held constant. The transmitter was operated at a frequency of 47.0 Mc. The height of the transmitting antenna was 197 feet above ground level. The receiving antenna was located about one mile distant. This receiving antenna was a loaded doublet, ten inches in length. When the transmitting antenna was vertical, the receiving doublet was placed in a vertical position and when the transmitting antenna was horizontal,

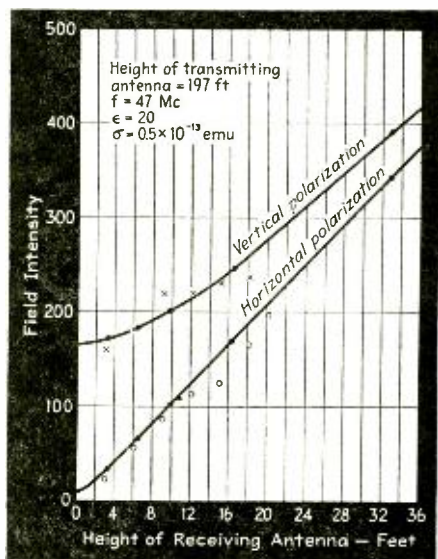

Fig. 2—Field intensity vs. receiving antenna height for both types of polarization. The solid curves were computed from formulas and the crosses and circles are experimental points.

the receiving doublet was horizontal. A scaffold was used so that the height of the receiving doublet above ground could be varied. A transmission line ran from this doublet to a calibrated receiver. Relative values of field intensity as a function of receiving antenna height were then obtained. The measured results are shown in Figure 2. The crosses on this figure show the received signal strength when the wave was vertically polarized, while the circles show the experimental results with horizontally polarized waves. The solid curves on Figure 2 were computed from Equations (3) and (4), using a dielectric constant of 20 and a conductivity of 0.5×10^{-13} emu for the earth. Figure 3 shows

the ratio of F_V/F_H as a function of receiving antenna height for these soil constants as well as for an earth with a dielectric constant of 15 and a conductivity of 0.5×10^{-13} emu. The circles are experimentally determined values taken from Figure 2.

If Equation (3) is divided by Equation (4), we obtain

$$\frac{F_V}{F_H} = \frac{\frac{2 \epsilon_0}{\sqrt{\epsilon_0 - 1}} \left[\frac{h}{\lambda} + \frac{a}{\lambda} \right] + j4\pi \frac{h a}{\lambda \lambda}}{\frac{2}{\sqrt{\epsilon_0 - 1}} \left[\frac{h}{\lambda} + \frac{a}{\lambda} \right] + j4\pi \frac{h a}{\lambda \lambda}}$$

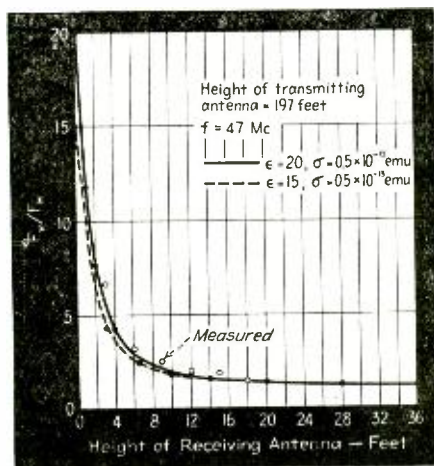

Fig. 3—Ratio of field strength compared with receiving antenna height for two values of the earth's dielectric constant.

It is seen that two antenna heights may be measured in wavelengths to form general relations for a particular value of dielectric constant. The effect of earth conductivity is slight. Figure 4 shows the ratio F_V/F_H as a function of receiving-antenna height for several values of transmitting antennas height. The receiving and transmitting antennas may be interchanged without changing the results.

To give a better picture of the effects for particular values, the curves of Figure 5 were prepared. Here a transmitting-antenna height of 60 meters with a transmitter power of 1000 watts are assumed. The dielectric constant of the earth is taken as 15 with a conductivity of 0.5×10^{-13} emu. Since a flat earth is assumed, these curves hold only within line of sight. The field strength increases directly with fre-

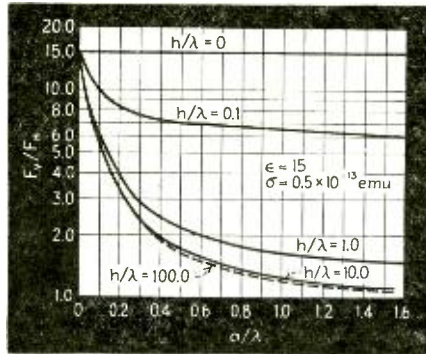

Fig. 4—Ratio of field strengths compared with receiving antenna height for several values of transmitting antenna height.

quency for large receiving-antenna heights but within a few feet of the ground the increase with frequency is small, particularly for vertically polarized waves. For a given frequency and receiving-antenna height, the signal strength of the vertically polarized waves is always equal to or greater than the signal strength of the horizontally polarized waves.

The data of Figure 5 were used to prepare Figure 6, which shows

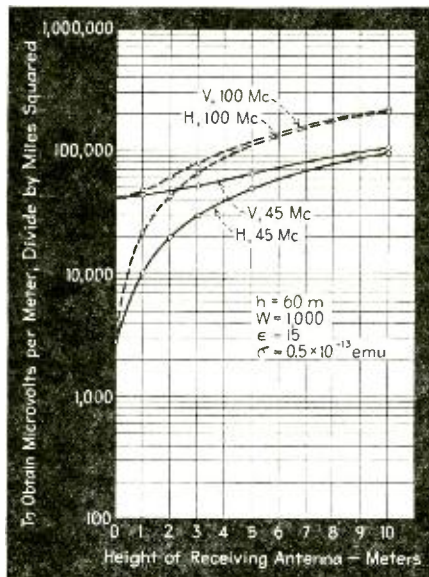

Fig. 5—Comparison of field strengths of both types of polarization at 45 Mc. and 100 Mc. These curves are valid only within line of sight.

the ratio of the vertically polarized signal to the horizontally polarized signal as a function of receiving antenna height for two frequencies. In Figure 3 of the "Summary of Statement by K. A. Norton on Ultra-High Frequency Propagation", F.C.C. Television Hearing, January 15, 1940, Norton gives values which may be used to compute field strengths at points below line of sight. He shows two curves, one for vertically polarized waves and one for horizontally polarized waves. The circles on Figure 6 show the values taken from Norton's data. His curves are based on a frequency of 50 Mc, a dielectric constant of 15, and a con-

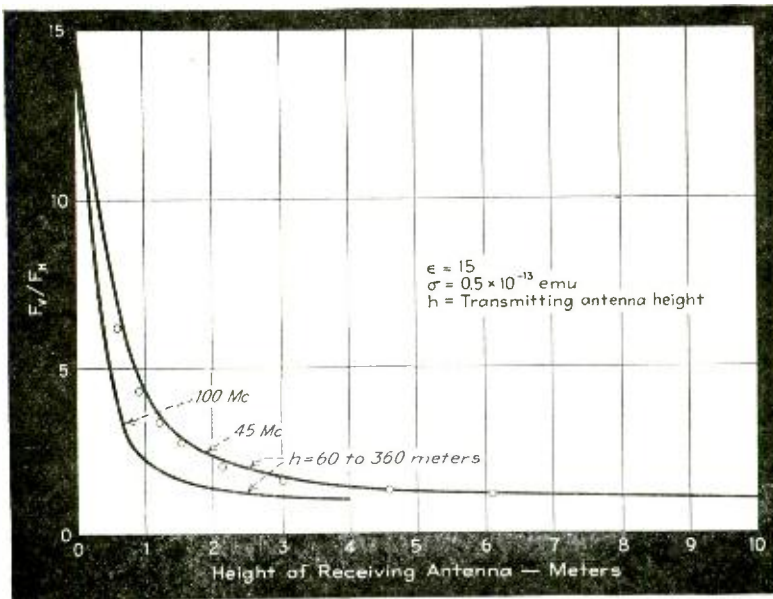

Fig. 6—Ratio of field strengths of vertical and horizontal polarization as a function of receiving antenna height at 45 Mc. and 100 Mc. Vertical polarization is superior as far as field strength is concerned.

ductivity of 0.5×10^{-13} emu.

The data considered above show that vertically polarized signals are always equal to or stronger than horizontally polarized signals. However, other factors than direct strength of signal must be considered. In the following work it has been attempted to establish a basis of comparison in which the signal-to-noise ratio is considered. Many observations have shown that there seems to be less interfering noise on horizontally polarized receiving antennas than on vertically polarized antennas. For example, C. J. Young states that horizontally polarized waves "proved to have a real advantage when it came to receiving at

Camden, as the horizontal type receiving antenna was noticeably less susceptible to pickup of interfering electric noise."³ Anderson and Lattimer⁴ found that radiation from motor boat ignition systems appeared to be largely vertically polarized. Hundreds of further observations and measurements within the R.C.A. organization have shown that a more favorable signal-to-noise ratio is obtained with horizontal polarization.

It has been found possible to use Equations (1) to (5) so that noise pickup properties may be associated directly with the type of polariza-

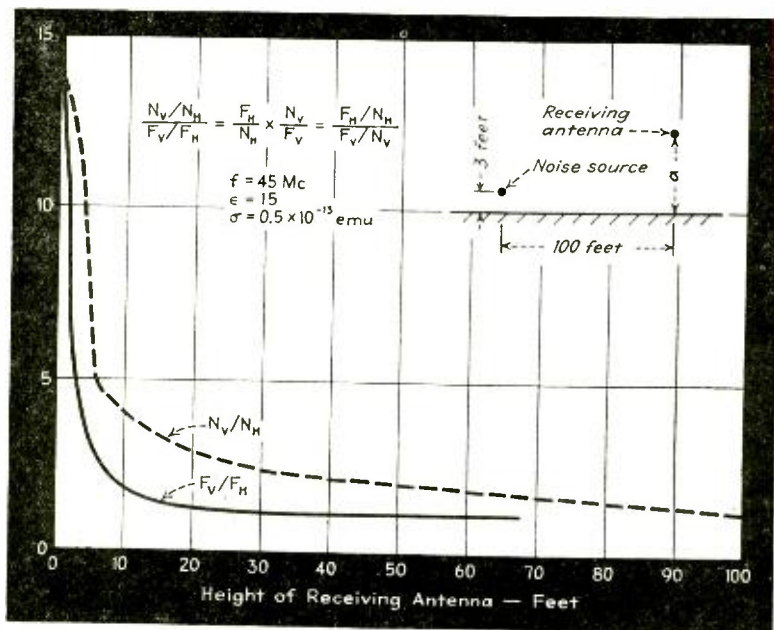

Fig. 7—The ratio of the noise of vertical polarization to that of horizontal polarization compared with the height of the receiving antenna. The transmitting antenna is assumed to be at a great height many miles away.

tion, rather than with any selective radiation properties of the noise source itself. In the first attempt along this line it is considered that the noise source is close to the ground, for example three feet above the ground. The noise source is also 100 feet distant from the receiving antenna, measured along the surface of the earth. It is assumed that the radiating system of the noise source is symmetrically distributed with equal horizontal and vertical currents. We now calculate the

³ C. J. Young, *Proc. I.R.E.*, Vol. 22, page 1290; November, 1934.

⁴ C. N. Anderson and I. E. Lattimer, *Proc. I.R.E.*, Vol. 20, p. 415; March, 1932.

vertical and horizontal field intensities at the receiving antenna as the receiving antenna is raised from the earth. We call N_V the vertical field intensity from the noise source and N_H the horizontal field intensity of the noise source. The ratio N_V/N_H is shown in Figure 7 as a function of the receiving-antenna height. If it is now assumed that the desired transmitter is located many miles away at a great elevation, we may use the 45 Mc curve of Figure 6 to show the ratio of vertical to horizontal field strength of this desired signal. This curve has been included in Figure 7 for comparison purposes. If we divide the curve, N_V/N_H , by a curve F_V/F_H , we obtain

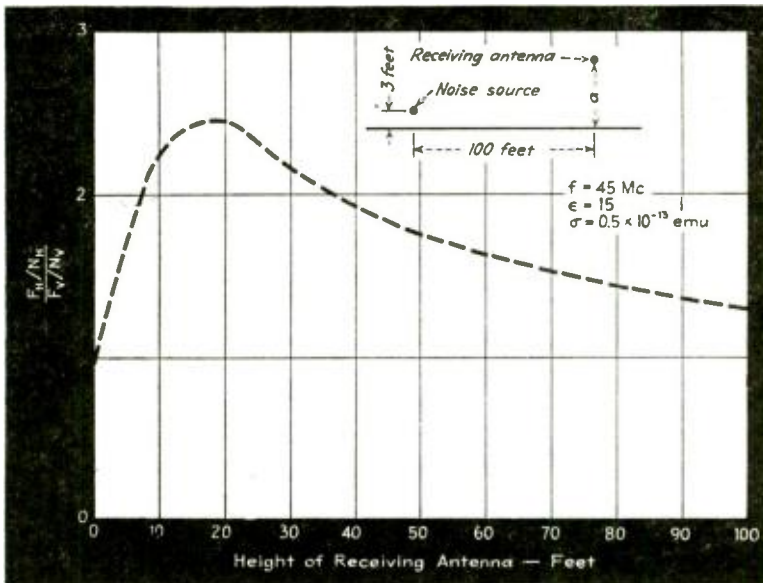

Fig. 8—Ratio of signal-to-noise ratios of the two types of polarization. The horizontal polarization is superior in this respect.

$$\frac{N_V/N_H}{F_V/F_H} = \frac{F_H}{N_H} \times \frac{N_V}{F_V} = \frac{F_H/N_H}{F_V/N_V}$$

which is the ratio of horizontal signal-to-noise ratio to vertical signal-to-noise ratio. The result of this division is shown in Figure 8. It is seen that for receiving-antenna heights of between eight and thirty-five feet, the signal-to-noise ratio of horizontally polarized signals is better than that of vertically polarized signals by a factor of two or greater. At all receiving-antenna heights, the signal-to-noise ratio is most favorable to horizontally polarized waves. The curve of Figure 8

has been repeated in Figure 9 and is shown as Curve *A*. We have made a similar calculation where the noise source is still three feet above the earth but has been removed to a great distance. The results are shown by Curve *B*, Figure 9.

Since it has been assumed that the transmitter is at a large height above the ground, a ratio of unity is obtained if the noise source is at a great distance and a great height. This is shown in Curve *C*, Figure 9. Also, since internal noise in the receiver is a constant quantity independent of signal strength and not a function of polarization, we may obtain the ratio of signal-to-noise ratios for internal noise by simply plotting F_H/F_V , which is the reciprocal of the lower curve of Figure 7. This is shown as Curve *D*, Figure 9. Because internal noise is a limiting factor only at rather large distances from the transmitter, it will very seldom be found that internal noise is the only disturbance. We must therefore weight the curve *D* together with Curves *A*, *B*, and *C*, since in almost all cases where *D* is of importance, the conditions which give *A*, *B*, and *C* will be present. The various curves might apply to interference of the following types:

A. Interference from an automobile or from diathermy equipment located 100 feet from receiver and close to the earth.

B. Automobile or diathermy equipment at a great distance from receiver and close to the earth.

C. Diathermy equipment at a great distance from receiver and located in a tall building.

D. Internal receiver noise.

If we were to take the arithmetical mean or average of the curves of Figure 9 we would not have a fair average for the average of the reciprocals of the values (ratio of vertical signal-to-noise ratio to the horizontal signal-to-noise ratio). It seems much more reasonable to use the geometric mean of the curves since then the reciprocal relation would hold. On this basis, Curve *E* is the mean of Curves *A*, *B*, and *C* obtained from

$$E = (A \times B \times C)^{1/3}$$

Here internal noise is neglected.

Curve *F* takes into account internal noise and is obtained from

$$F = (A \times B \times C \times D)^{1/4}$$

Figure 9 is based upon a frequency of 45 Mc. Figure 10 is an identical set of curves based upon a frequency of 100 Mc. Figures 9 and 10 show

that where internal noise is not a contributing factor, a more favorable signal-to-noise ratio is obtained with horizontally polarized waves than with vertically polarized waves for all receiving-antenna heights. Where internal noise is also included, horizontally polarized waves are superior for receiving-antenna heights greater than four feet.

In the above considerations it has always been assumed that the transmitting antenna is at a great elevation. In aural broadcast and television service on the ultra-high frequencies this assumption will

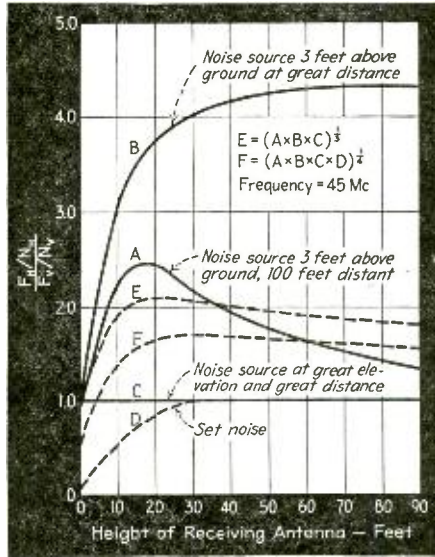

Figs. 9 and 10—Ratio of signal-to-noise ratios of both types of polarization for various locations of the noise source. Horizontal polarization has considerably higher signal-to-noise ratio for all locations of the noise source.

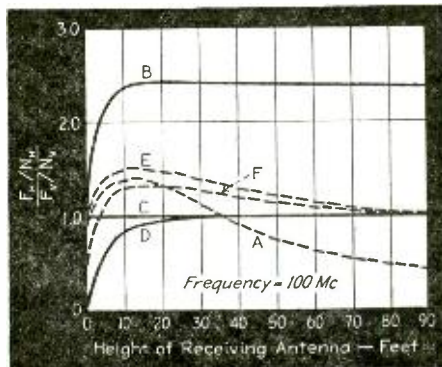

almost invariably be true. A case of importance where it is not valid is in the case of communication between two mobile units such as police cars. In this case we assume the transmitting and receiving antennas each to be three feet above ground. We also assume our noise sources to be arranged as were those considered in Figure 9. The following results are then obtained.

<i>Frequency</i>	<i>45 Mc.</i>	<i>100 Mc.</i>
F_V/F_H	7.4	4.12
<i>A</i>	1.62	0.888
<i>B</i>	1.0	1.0
<i>C</i>	0.565	0.562
<i>D</i>	0.135	0.242
<i>E</i>	0.97	0.795
<i>F</i>	0.592	0.59

From this tabulation we see that in the case of communication between mobile ground units, vertically polarized waves have a slight advantage where receiver noise is not a major item while these same vertically polarized waves have a great advantage where receiver noise is great.

CONCLUSIONS

The results of this investigation show that vertically polarized waves yield a stronger signal close to the earth than do horizontally polarized waves. As the receiving antenna is raised, the two types of polarization yield practically identical field intensities, when the transmitting antenna is at least one wavelength above ground.

In spite of the preponderance of the vertically polarized field near the surface of the earth, horizontally polarized waves yield a more favorable signal-to-noise ratio for television and aural broadcast services (between 30 and 100 Mc) where the transmitting antenna is at least a few wavelengths above ground level. Thus the desirability of horizontally polarized transmissions for broadcast services is clearly indicated.

In the case of transmission between two mobile units with both transmitting and receiving antennas near the ground, a more favorable signal-to-noise ratio is obtained with vertically polarized waves.

A NEW ULTRA-HIGH-FREQUENCY TETRODE AND ITS USE IN A 1-KILOWATT TELEVISION SOUND TRANSMITTER*†

By

A. K. WING, JR. AND J. E. YOUNG‡

RCA Manufacturing Company, Inc.,
Harrison and Camden, N. J.

Summary—A new tetrode suitable for use in the final stage of a 1-kilowatt ultra-high-frequency sound transmitter is described. Two of these tubes operated under plate-modulated conditions in such a transmitter will deliver 1 kilowatt of carrier output at 108 megacycles. Among the novel features of the design are the use of a metal header to provide a low-impedance screen-grid connection, beam-forming grids, and a forced-air-cooled anode. The new RCA type S-1 transmitter which uses these tubes is described and its performance reported.

THE design of a 1-kilowatt television sound transmitter presented problems which could not be solved by existing tube types. These problems were, first, that two tubes in push-pull connection in the output stage must be capable of delivering sufficient power to supply circuit losses in addition to the desired 1000 watts output to the antenna. Second, this power must be delivered with good efficiency at frequencies up to approximately 110 megacycles. Third, it was desired to eliminate as far as possible the need for neutralization. Finally, the tubes should preferably not require water-cooling. The design which was evolved as answering these requirements most satisfactorily is that of a beam tetrode wherein the principles of electron optics are utilized to minimize screen current and to provide characteristics approaching those of a pentode. Use is made of a novel design for the screen connection which possesses extremely low inductance and allows the screen to be maintained at radio-frequency ground potential.

Figure 1 is a photograph of the completed tube which is designated as the RCA-827R. Use is made of an external anode structure equipped with a fin assembly for forced-air-cooling. This construction minimizes plate lead inductance. Forced-air-cooling allows high unit dissipations

* Decimal classification: R583 × R355 × R331.

† Presented at the Fifteenth Annual Convention of the I.R.E. at Boston, Mass., on June 28, 1940. Reprinted from *Proc. I.R.E.*, January, 1941.

‡ Now with the Engineering Products Department, RCA Victor Division, Camden, N. J.

to be obtained as compared with conventional radiation-cooled designs. The stream of cooling air also allows the glass envelope to be made smaller than otherwise would be permissible, thus further aiding the reduction of lead length. The general arrangement of the tube terminals can be seen in this photograph.

The various features of mechanical construction by which these characteristics are obtained are best discussed with reference to Figure 2, which is a cross section of the tube and shows the construction in more detail. The basis of the construction is the use of a metal header in place of the more conventional glass stem or dish. This

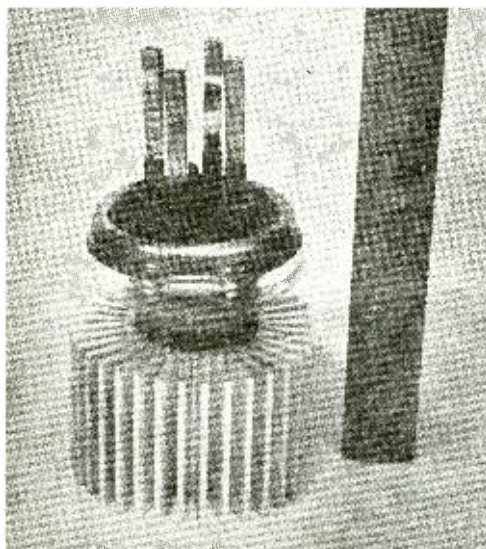

Fig. 1—The RCA-827R.

header is drawn from Kovar shaped as shown to provide suitable flexibility at the outer edge for satisfactory sealing and to prevent deformation under the atmospheric pressure when the tube was exhausted. This header serves as a low-inductance terminal for the screen which is mounted directly on it by means of a continuous conical support. External contact is made to the edge of the header, preferably continuously around its circumference; such contact resulting in minimum impedance and maximum effective shielding at the higher frequencies.

The connections to the control grid and filament are brought through the header by smaller Kovar-to-glass seals of the type shown in the cross section. It should be noted that all electrodes are supported from

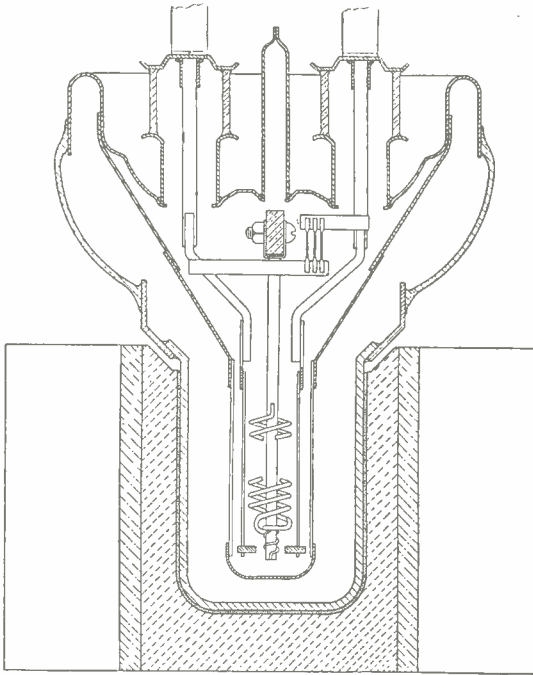

Fig. 2—Cross section of tube.

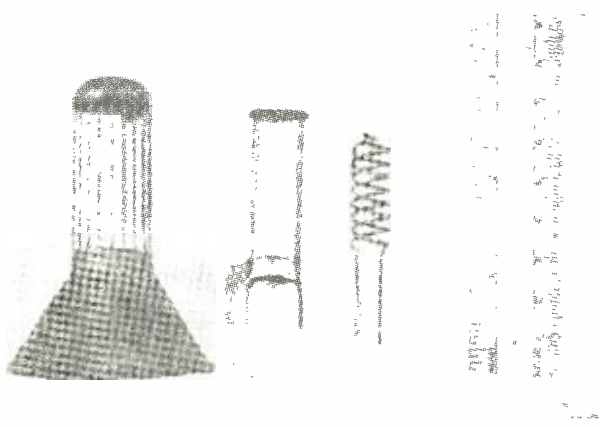

Fig. 3—Grids and filament.

the header alone, no solid insulation being used between elements within the tube. Dielectric losses which would impair the performance of the tube are thereby eliminated. Rigidity of the electrodes is assured by the short, large-diameter leads supporting them. This lead structure aids in minimizing lead inductance and losses; connecting the two control-grid leads in parallel further reduces such effects. External connection to the control grid and filament is by flexible copper ribbons.

The construction of both the control and screen grids utilizes parallel, vertical wires, as shown in Figure 3. The orientation of the two grids is such that the wires of the screen grid are located in the shadow of the wires of the control grid, thus forming electron beams between the wires which reduce considerably the current collected by the screen grid as compared with a structure having random alignment. A novel feature of the construction of the control grid is the use of a graphite spacer at the free end of the grid. This takes the form of a washer with a series of small holes around its edge to receive the grid wires. Three of the wires support the ring while the remainder are free to move longitudinally in the holes. In this way each wire can expand independently of the others so that any tendency to unequal expansion does not cause the wires to buckle and thereby cause internal short circuits or changes in characteristics. The heat of the filament is concentrated because of its compact arrangement, and since the spacing between the grid and the filament is small, special precautions were required to avoid undesirable emission from the control grid. The grid has been coated with zirconium to improve its radiating properties and to reduce the tendency toward primary emission from the surface.

The filament of the tube is of thoriated tungsten and is double helical in form. The apex of the filament is free to expand along the center support, but a small flexible connection at that end maintains the center support at the same potential as the center of the filament and therefore eliminates microphonics which might be caused by a floating contact. The spacings between filament and grid and grid and screen are approximately 50 and 120 thousandths of an inch, respectively, resulting in short electron transit time. The spacing between screen grid and anode is approximately 360 thousandths of an inch, providing a potential minimum due to space charge in this space. At a frequency of 100 megacycles and under conditions of peak positive grid swing at the carrier for class C plate-modulated telephony the transit angles in the three spaces are 14, 5, and 32 degrees, respectively.

Two other details of the construction are worthy of mention. The

exhaust tubulation is made of metal tubing to allow the completed tip-off to be kept small and out of the way of the connections to the tube, while at the same time removing the hazard of breakage. The other detail is in the means of flashing the getter in the tube. A ribbon getter is connected between the two control-grid terminals just inside the header. During the exhaust process a radio-frequency voltage is connected to the two grid leads external to the tube. The difference in impedance of the two parallel paths through the getter ribbon and through the grid allows the current to heat the getter sufficiently to flash it with very little heating of the grid. Because of its location inside the screen-grid conical support, the getter flashes onto it rather than onto the glass bulb wall. Thus, there is no getter

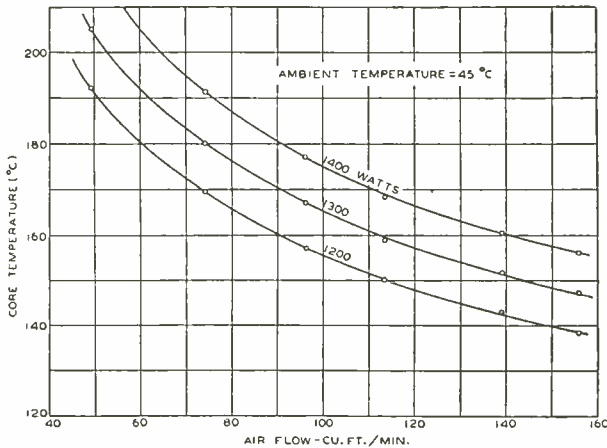

Fig. 4—Curve of radiator temperature versus air flow.

deposited upon the bulb where it can cause leakage or losses.

The construction of the radiator assembly involves several new features. A machined copper core is shrunk into a section of a hollow aluminum extrusion which forms the fins. The anode of the exhausted tube is soldered into this core. This method of construction offers savings in manufacturing cost and in weight of the finished tube. Figure 4 shows the relation between the temperature in the copper core of the radiator and the flow of cooling air for various values of total dissipation in the tube. The ambient temperature is 45 degrees centigrade. Maximum rated total dissipation is somewhat less than 1300 watts.

The essential characteristics of the tube are shown in Table I which gives the interelectrode capacitances and the maximum ratings for class C telephone and telegraph operation at frequencies up to 110

TABLE I
RATINGS AND CHARACTERISTICS
RCA-827R
TRANSMITTING BEAM POWER AMPLIFIER

Filament voltage	7.5	volts
Filament current	25	amperes
Grid-screen mu factor	16	
Direct interelectrode capacitances:		
Grid to plate (with external shielding)	0.18	maximum micromicrofarads
Input	21	micromicrofarads
Output	13	micromicrofarads

MAXIMUM RATINGS—CLASS C

	Plate-Modulated Telephony (carrier conditions)	Telegraphy (key-down conditions)	
Direct plate voltage	3000	3500	volts
Direct screen voltage	800	1000	volts
Direct grid voltage	-500	-500	volts
Direct plate current	400	500	milliamperes
Direct grid current	125	150	milliamperes
Plate input	1200	1500	watts
Screen input	100	150	watts
Plate dissipation	550	800	watts

megacycles. Calculations indicate that at low frequencies plate-circuit efficiencies of the order of 70 per cent should be obtained; measurements have shown that such efficiencies are realized. As the frequency is increased the efficiency would be expected to fall off because of transit-time effects and losses in leads and circuit. Figure 5 shows an experimental curve of efficiency against frequency for the particular carrier operating conditions of the S-1 transmitter. The curve is for a constant power output of 1000 watts into a load at the feeder terminals of the transmitter and with plate and screen voltages of 2700

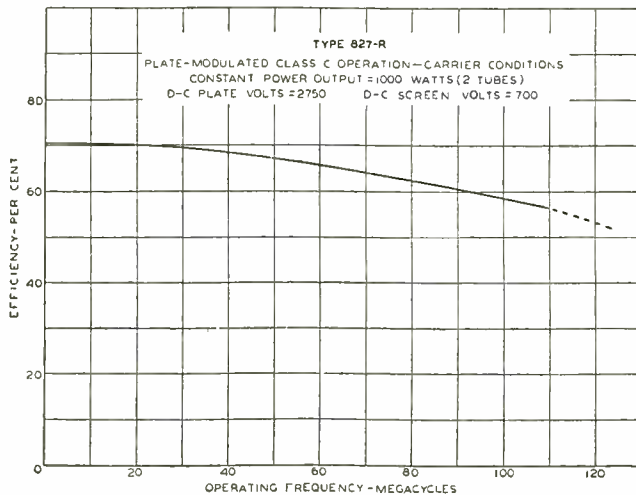

Fig. 5—Curve of plate-circuit efficiency versus operating frequency.

and 700 volts, respectively. It will be seen that the efficiency at 20 megacycles is 70 per cent as predicted from calculation and that it decreases slowly to 56 per cent at 110 megacycles. Above this frequency data have not been taken and the dashed portion of the curve is, therefore, merely an extrapolation from the trend of the curve. It is, of course, possible to use higher values of input within the tube rating and hereby obtain outputs in excess of 1 kilowatt at these frequencies.

The television sound transmitter for which the 827R was designed is designated as the type S-1. The front view of this transmitter is shown in Figure 6. A simple, pleasing appearance has been achieved by grouping all necessary meters and controls in logical and easily

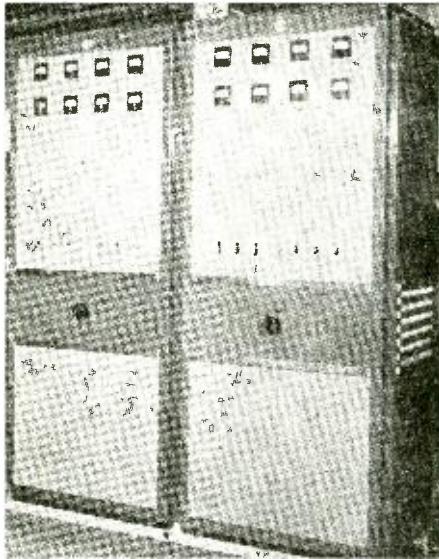

Fig. 6—Front view of type S-1 transmitter.

accessible positions. All tuning controls are terminated in flush, key-operated tuning positions. Elimination of knobs or handles on these controls prevents tampering with the adjustments by any unauthorized person, and at the same time enhances the appearance of the equipment. The adjustable elements in the circuit have been located for most efficient electrical operation and connection made to the grouped tuning controls on the front panel by bevel gear and shaft linkages. A tune-operate switch permits reduction of plate voltage for adjustment purposes, while a voltage regulator, hand-controlled, maintains all circuit voltages at the correct amplitude through considerable variation of the line voltage.

Figure 7 shows a rear view of the transmitter. The mechanical mounting of the apparatus in each cabinet utilizes two vertical-L sections. All assembly and wiring are carried out before the sections are assembled into the cabinet, and as a result a considerable saving in cost is effected. The right-hand section of the transmitter is devoted to the radio-frequency portion of the equipment. An RCA-807 crystal oscillator, employing one of two available harmonic crystals, drives an 814 doubler which excites two RCA-808's connected in push-pull as a tripler. This stage drives two RCA-8001's as a fundamental-frequency amplifier, tuned to the output frequency of the transmitter. The plate tank of this stage is inductively coupled to the grid circuit of the power



Fig. 7—Rear view of transmitter.

amplifier. Inductive coupling is likewise used between the 827R plate tank, and the transmission-line coupling coil. The connections for air-cooling the anodes of the 827R tubes may be seen below the tubes, while the horizontal duct above the tubes supplies a small quantity of air to cool the headers as well as the bulbs of the tubes in previous stages.

The left-hand unit contains the power supply, modulator, and control equipment. One single-phase rectifier, using four 872 tubes in a center-tapped bridge connection, provides two direct voltages which together supply plate and screen voltages for all tubes. Plate and filament contactors are provided, as well as time delay and overload

relays for complete tube protection. This protective system is backed up by the use of hand-operated overload breakers on the main power line and branch circuits.

Two RCA-833 tubes used in the class B modulator have sufficient power capability to modulate the plates and screens of the output radio-frequency stage to well over 100 per cent. They are driven by an amplifier chain consisting of two RCA-1603's, two RCA-807's, and two RCA-845's which are connected in a cathode-follower circuit to secure the necessary low-impedance driver circuit for the grids of the RCA-833's. The cathode-follower circuit inherently provides 100 per cent feedback over the stages so connected. Another feedback path is provided from the plate circuit of the modular tubes back through the

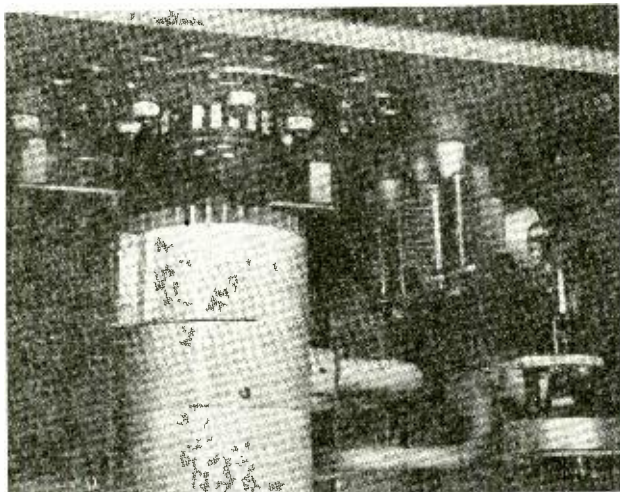

Fig. 8—The 827R tube mounting.

first audio-frequency amplifier. A high order of performance is thus obtained without requiring critical tube or circuit adjustments.

The details of the mounting for the 827R tubes are shown in Figure 8. The construction of the screen by-pass capacitors is clearly shown. Similar by-pass capacitors for the filament circuit are located on the upper side of the ground plate. They together form an assembly which slips down over the ring seal used as a screen connection; at the same time they form a part of the shield between the grid and plate circuits of the power amplifier. The spring clips which form the connection between the screen terminal and screen by-pass capacitors are clearly shown. The radiators of the 827R tubes rest on top of ceramic tubes through which the cooling air flows. They are held in position by split metal clamps. The plate tank and transmission-line coupling coil may

be seen in the lower right-hand section of the picture. The circuits are shown set up for operation at 108 megacycles. Through careful design, lead lengths and circuit capacitances have been held to a minimum so that it has been possible to use variable capacitors to tune all radio-frequency circuits. In the same way, it has also been possible to use concentrated inductors instead of transmission lines in the various tanks, thus effecting savings in space and cost without sacrifice of performance.

The plate efficiencies obtained in the output stage of the transmitter for carrier frequencies from 26 to 108 megacycles have already been mentioned in connection with the tube. Figure 9 shows a summary of

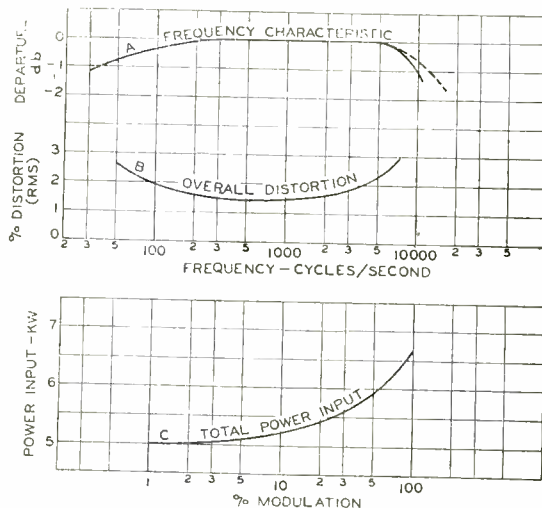

Fig. 9—Characteristics of type S-1 transmitter. In the upper part of the figure is shown the normal frequency-response characteristic with the optional response (dashed) characteristic conforming to the Radio Manufacturers Association standard for high-frequency pre-emphasis.

the performance of the transmitter in other respects. Curve A is the audio-frequency characteristic. If desired this characteristic may be altered to conform to the Radio Manufacturers Association standard which pre-emphasizes the high frequencies. Curve B shows the variation of root-mean-square distortion with modulating frequency at 95 per cent modulation. Curve C shows the total power input variation with sine-wave modulation varying in depth from 0 to 100 per cent.

By the addition of a type MI-19407 frequency-modulation exciter to this transmitter it becomes the type FM-1A 1-kilowatt frequency-modulation transmitter.

A VESTIGIAL SIDE-BAND FILTER FOR USE WITH A TELEVISION TRANSMITTER*†

BY

GEORGE H. BROWN‡

RCA Manufacturing Co., Inc., Camden, New Jersey

Summary—The television transmitter standards adopted by the Radio Manufacturers Association (R. M. A.) place the carrier of the picture transmitter at a point which is 1.25 megacycles above the lower edge of a six-megacycle channel. The television receiver characteristics permits reception of the carrier, the upper side-bands, and those lower side-bands which lie within 0.75 megacycle of the carrier. Any other lower side-bands which might be transmitted would not be accepted by the receiver, and would therefore play no part in furnishing picture information. Since these side-bands which are not accepted by the receiver lie outside of the assigned channel, they must be suppressed at the transmitter in order that there may not be any interference caused to other services operating on adjacent channels. This paper describes a filter which has been built for this purpose.

The filter is placed in the transmission line between the power amplifier and the antenna. In order to insure the absence of reflected energy on the transmission line leading to the filter at any frequency generated by the transmitter, the filter is so designed that the input impedance of the filter is practically a constant for both the pass and rejection band, while the reactance remains essentially zero.

In order to secure the constant-resistance feature throughout the rejection band, the rejected energy is dissipated in water-cooled resistors of a special type which have zero reactance and constant resistance throughout the required band.

The equivalent circuit of the filter is shown. Because of the high carrier frequency as well as the extreme selectivity required, the circuit elements are sections of concentric transmission line. The factors governing the lengths and diameters of these sections are discussed.

The vestigial side-band filter described here has been placed in a practical television installation and has been operating satisfactorily since March, 1939. The tests and observations made at the time of this installation are described.

I. INTRODUCTION

THE channels allotted to television stations in this country are limited in width to six megacycles. An early form of channel layout was as shown in the top diagram of Figure 1. The sound carrier was located one-quarter megacycle below the upper edge of the band. The picture carrier was located 2.5 megacycles above the lower edge of the band. With the picture carrier located at this point, the maximum possible modulation frequency was 2.5 megacycles. Any higher frequency modulation would cause side-bands which would lie

* Decimal Classification: R386 × R148.17 × R583.4.

† Reprinted from *RCA REVIEW*, January, 1941.

‡ Now with the Research Department, RCA Laboratories Division, Princeton, N. J.

outside the assigned channel. The receiver was operated in a semi-single-side-band fashion, having the response characteristic shown in the top diagram of Figure 1. It is to be noted that side-bands which lie more than 0.75 megacycle below the picture carrier are not accepted by the receiver and hence serve no useful purpose in forming the picture. This point is of importance in explaining the new channel arrangement.

In the new arrangement, the sound carrier remains unchanged in its position, but the picture carrier is now placed 1.25 megacycles above the lower edge of the band, thus providing an additional space of 1.25 megacycles between picture and sound carriers. The receiver characteristic is modified as shown in the lower sketch of Figure 1. If the transmitter is now modulated with frequencies up to four megacycles, all the frequencies in excess of 1.25 megacycles will cause lower side-bands to be formed which will lie below the lower edge of the assigned band. These side-bands may easily cause interference with other services which may operate in this region. Since these side-bands are not accepted by the receiver, it seems obvious that they may be filtered off at the transmitter.

It is the object of this report to describe a filter which has been built for this purpose. The filter is placed in the transmission line somewhere between the antenna and the power amplifier of the transmitter. In a conventional high-pass filter, without losses, the input impedance would become practically a pure reactance in the rejection band. If this filter were placed directly at the transmitter, this build-up of reactance in the lower side-band region would cause unsymmetrical operation of the final stage, with ensuing generation of transients. Further, if the filter were placed some distance from the transmitter, the reactance in the rejection region would cause reflected energy to be present on the transmission line leading to the filter, with consequent multiple images in the received picture. The filter discussed here has been so designed that the input resistance of the filter is practically a constant for both the pass and rejection band, while the reactance remains essentially zero.¹ Because of this fact, the transmission line between transmitter and filter is terminated in its characteristic impedance for all frequencies, pass and rejection. Then the transmitter looks into a pure resistance over both upper and lower side-bands, and the transmitter generates a double side-band signal, quite unaware of the fact that much of the lower side-band energy is not radiated.

¹ For an excellent mathematical treatment of constant resistance networks, the reader is referred to E. L. Norton, "Constant Resistance Networks with Applications to Filter Groups", *Bell. Sys. Tech. Jour.*, April, 1937, and to U. S. Patent 2,076,248 issued to E. L. Norton.

The lower side-band energy that is not radiated is absorbed in water-cooled resistors which form an integral part of the filter.

The receiver characteristic for the new arrangement is shown in the lower sketch of Figure 1. (Curve *R*.) Here also is shown the desired characteristic of the transmitter filter. (Curve *T*.) Roughly, the requirements are that the filter shall pass all frequencies above a point which is itself 0.5 megacycle above the lower edge of the band,

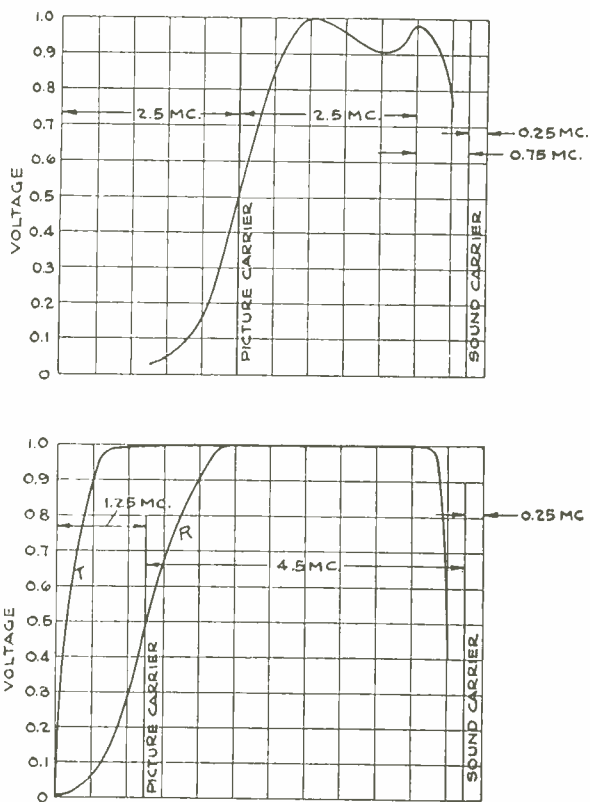

Fig. 1.

and that the attenuation of all frequencies below the lower edge of the band be as great as possible.

It was found that it was not practical at the time to secure this characteristic in a single filter stage. Actually two distinct types of filter are used, with three sections of each type.

II. TYPE A FILTER

The Type A filter is shown schematically in Figure 2. In discussing this filter, we will consider the channel to extend from 44 megacycles

to 50 megacycles, since that is the channel for which the first filter was built. Turning then to Figure 2, we may specify the values of the inductances and capacitances shown. It is assumed that the resistance of the antenna (or the input to the antenna transmission line) is 70 ohms. Then the dissipative resistor is made to be 70 ohms. The inductance L_1 is so chosen that it has a reactance of 70 ohms at 44 megacycles, while C_1 is a capacitor having a reactance of 70 ohms at 44 mc. L_2 and C_2 are so proportioned that the combination of the two in a

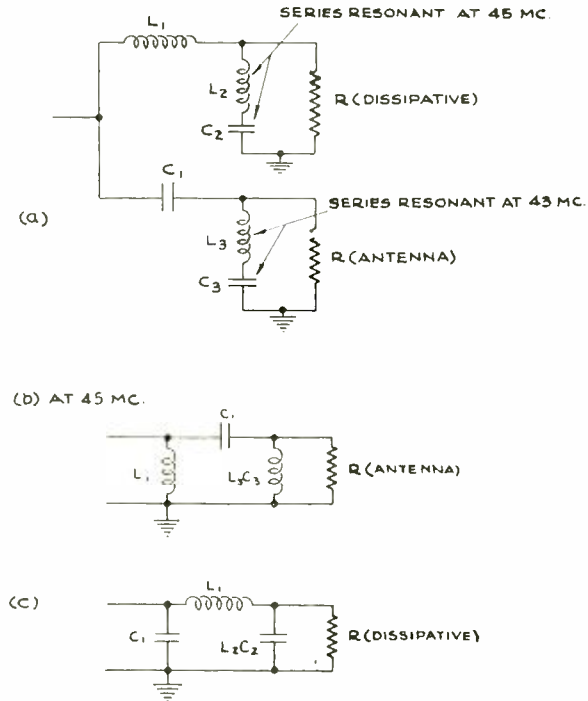

Fig. 2.

series circuit becomes resonant (zero reactance) at 45 megacycles, and at the same time, reaches a capacitive reactance of 70 ohms at 43 megacycles. L_3 and C_3 are chosen so that they yield zero reactance at 43 megacycles, and rise to an inductive reactance of 70 ohms at 45 megacycles.

Let us now examine the circuit at 45 megacycles. The dissipative resistor is short-circuited by the combination of L_2 and C_2 , so that no energy goes to the resistor. The reactances of L_1 and C_1 have changed only slightly from 70 ohms. The combination of L_3 and C_3 has placed an inductive reactance of 70 ohms in parallel with the antenna resis-

tance, yielding the equivalent circuit of Figure 2b. Since each of the arms of the Pi network has an impedance of 70 ohms, we have simply a one to one impedance transfer, with an input impedance of 70 ohms, pure resistance, and with a 90-degree phase advance between output and input voltages. All the energy put into the system comes out at the antenna terminals.

At 43 megacycles we have exactly the reverse procedure. The antenna resistance is short-circuited, and the Pi section of Figure 2c is obtained. The input impedance is still 70 ohms, pure resistance, but all of the energy is passed to the dissipative resistor.

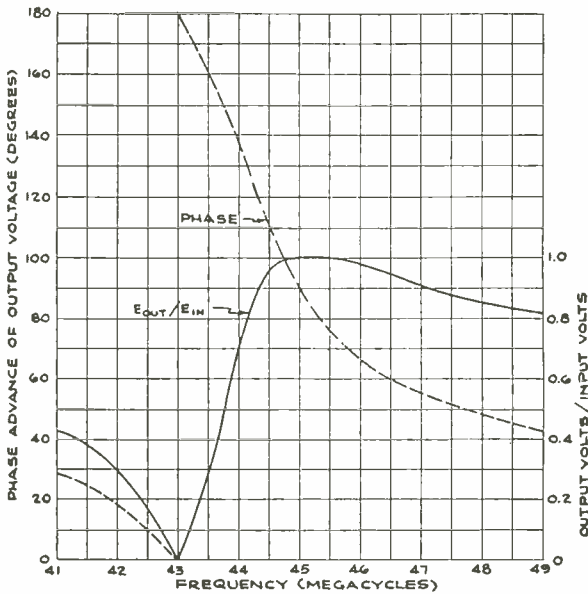

Fig. 3.

We have thus illustrated that the input impedance of the filter is a pure resistance of 70 ohms at 43 and 45 megacycles. As a matter of fact, calculations show that this condition exists for all the frequencies in question.

Figure 3 shows the phase and amplitude characteristics of the Type A filter. We see that we get very great attenuation in the region of 43 megacycles, but that the curve rises rapidly so that at 41 megacycles the attenuation is not very great. To pull down the output in the region from 41 to 43 megacycles, it becomes necessary to place three Type A filters in series. This point will be taken up later in the paper.

Let us turn now to the actual construction of the filter. If we were to use lumped inductances and capacitances, the required values of

each element would be as shown in Table I. The construction of elements of this magnitude, accurately tuned to the proper frequency, and able to stand the transmission of power of the order of 10,000 watts, becomes a serious problem, which was briefly considered before turning to the use of concentric-transmission-line elements.

TABLE I

L_1	0.253	microhenries
C_1	51.75	micromicrofarads
L_2	2.72	microhenries
C_2	4.6	micromicrofarads
L_3	2.845	microhenries
C_3	4.81	micromicrofarads

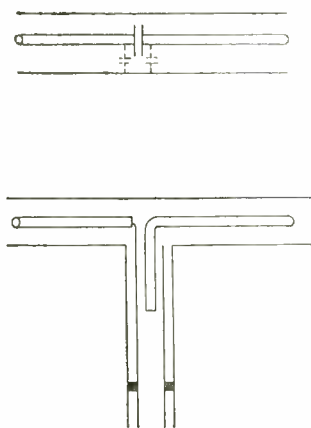

Fig. 4.

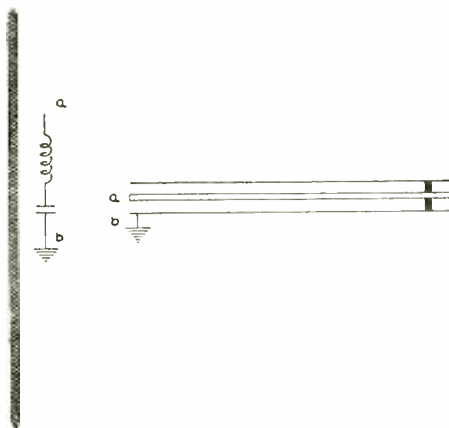

Fig. 5.

The capacitance, C_1 , is to be inserted as a series element, that is, both terminals are above ground potential. It is well known that a section of concentric transmission line, of 70 ohms characteristic impedance, open-circuited at the far end, and of length equal to one-eighth wave, has an input impedance which is capacitive and has a value of 70 ohms. However, such an element could not be placed in the hot lead because of the capacitance from the outer conductor to ground. To get around this difficulty, the outer conductor of this capacitance element is extended until its length is one-quarter wave, and the remote end is connected directly to ground. This procedure makes the impedance of this outer conductor to ground very high and effectively floats the series capacitance element. The construction is shown in Figure 4.

The inductance element, L_1 , is obtained in exactly the same manner except that a shorting plug is placed at the end of the eighth-wave rod.

The series resonant elements which shunt the antenna resistance and the dissipative resistor are formed by single sections of concentric

lines, with shorting bars at the far end, as shown in Figure 5. It is known that the input impedance of a transmission line which is shorted at the remote end becomes zero when the length of transmission line is any integral multiple of a half-wave length. As the frequency increases from this critical value, the input impedance becomes

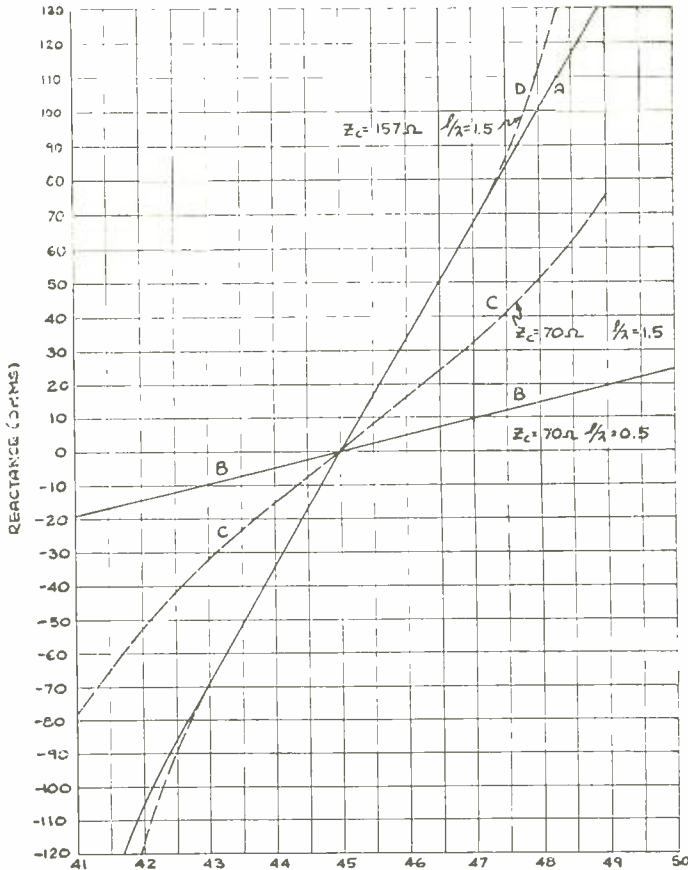

Fig. 6.

inductive, and at frequencies below the critical frequency, the input impedance becomes capacitive. We will consider the case of L_2 and C_2 , which have zero reactance at 45 megacycles and reach a capacitive reactance value of 70 ohms at 43 mc. Figure 6 shows several reactance curves, one of which (Curve A) shows the calculated curve obtained when L_2 and C_2 have the lumped constants shown in Table I. Curve B is the input reactance curve obtained when the line section has a char-

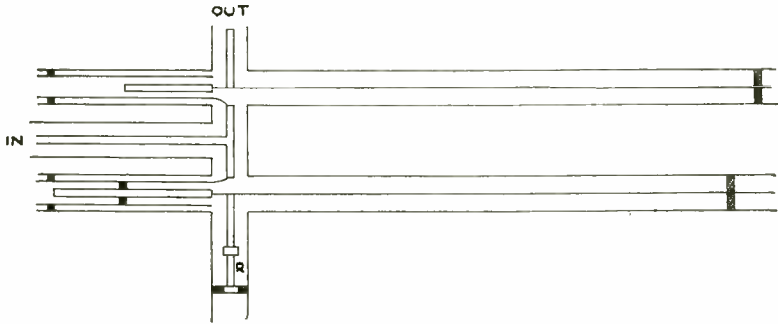

Fig. 7.

acteristic impedance of 70 ohms. and has a length equal to one-half wave. We see that the capacitive reactance at 43 megacycles is only 9.85 ohms. Curve *C* shows the input reactance when the line section has a characteristic impedance of 70 ohms, and is 1.5 waves long. The capacitive reactance at 43 megacycles is now 31.2 ohms. Curve *D* is the input reactance when the line section has a characteristic impedance of 157 ohms and is 1.5 waves long. This curve coincides almost exactly with the desired curve. Therefore, the line element chosen to simulate L_2 and C_2 consists of a shorted transmission line which is 1.5 wave lengths at 45 megacycles (32.8 feet) and which has a characteristic impedance of 157 ohms. The inner diameter of the outer pipe is 4.5 inches, while the inner rod has a diameter of 0.34 inch.

The constructional layout of a single Type A filter is shown in Figure 7. When three of these units are used in series, the point marked "out" on Figure 7 is connected to the input of the following filter.

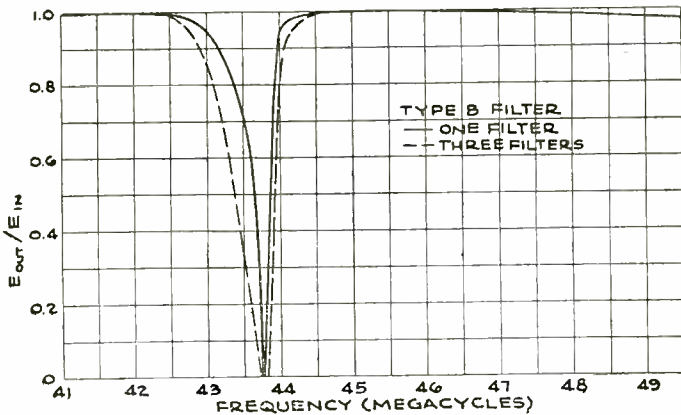

Fig. 8

III. TYPE B FILTER

When three Type A filters are connected in series, the resulting attenuation curve is satisfactory except for the small region around 43.75 megacycles, where it was felt that the attenuation was not great enough. Accordingly, it becomes desirable to use a filter which has a maximum attenuation point at 43.75 megacycles. In fact, it seemed desirable to simply cut a notch in the pass characteristic at this point.* Figure 8 shows the attenuation of such a notching filter (Type B) for the case where a single Type B filter was used and where three such filters were placed in series. These are experimentally determined curves.

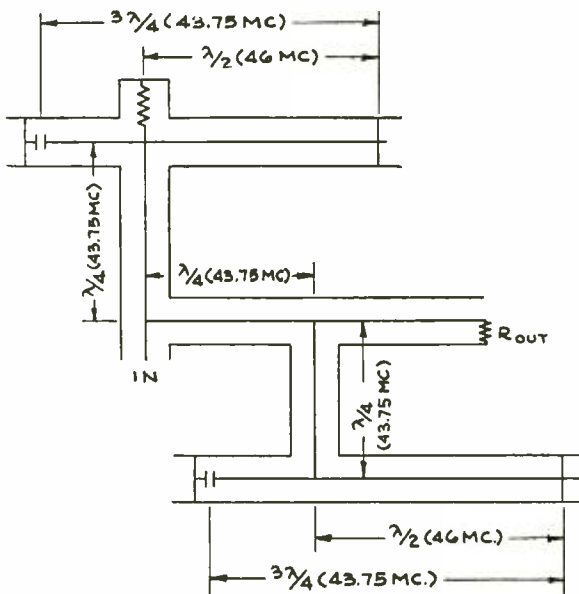

Fig. 9.

The Type B filter is likewise constructed of concentric transmission lines. The filter utilizes a water-cooled resistor in each unit, and each unit possesses the constant input resistance feature. The filter arrangement is shown in Figure 9. The element lengths are shown on this sketch.

IV. FILTER TESTS

During the early development work, a single Type A and a single Type B filter unit were built and tested in Camden. The measured

*This notching filter becomes increasingly important when used on the 50 to 56 megacycle channel, for then the maximum attenuation point would occur at 49.75 megacycles, the sound carrier of the 44 to 50 megacycle television channel.

amplitude characteristic of the Type A filter was so close to the calculated characteristic shown in Figure 3 that it seems unnecessary to repeat it here. As stated above, Figure 8 shows the measured response of the Type B filter. The input impedance of these two units in series was found to be quite satisfactory. Tests were made in which the filter

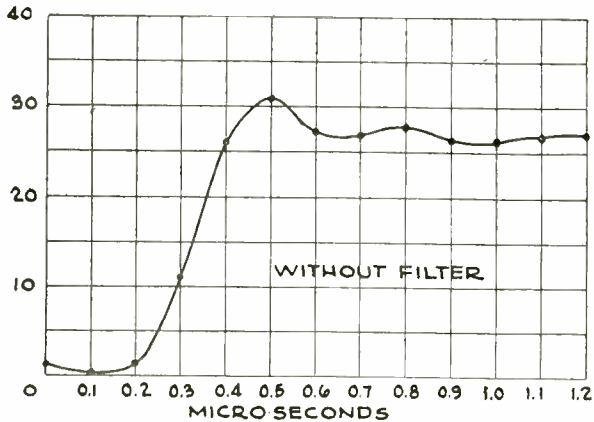
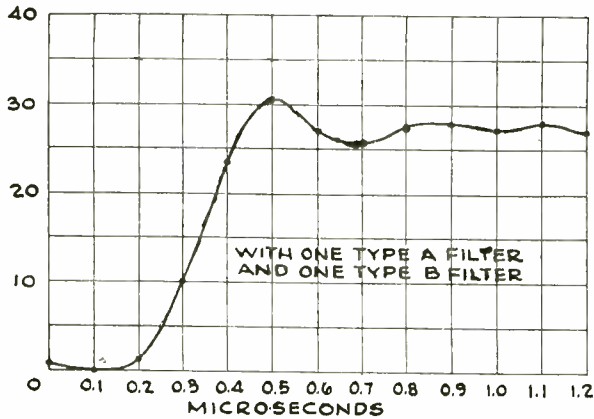

Fig. 10.

combination was fed with a signal generator which was modulated by means of a standard test pattern. A television receiver was placed at the output of the two filters. Observations were made of the received test pattern. The filter was next removed from the system, and the signal generator fed directly to the receiver. The test pattern without the filter was then observed. Most observers agreed that there was no essential difference between the two pictures.

The signal generator was modulated with a square wave, and the response at the second detector of the receiver recorded on a cathode ray oscilloscope. The filter was then placed in the circuit, and the square-wave response again observed. The results for the two cases are shown in Figure 10.

The tests on these single filter units were satisfactory in every respect. Of course, the attenuation, while in strict agreement with the calculated values, was not as great as necessary for the problem at hand. Accordingly, two more Type A filters and two more Type B filters were constructed.

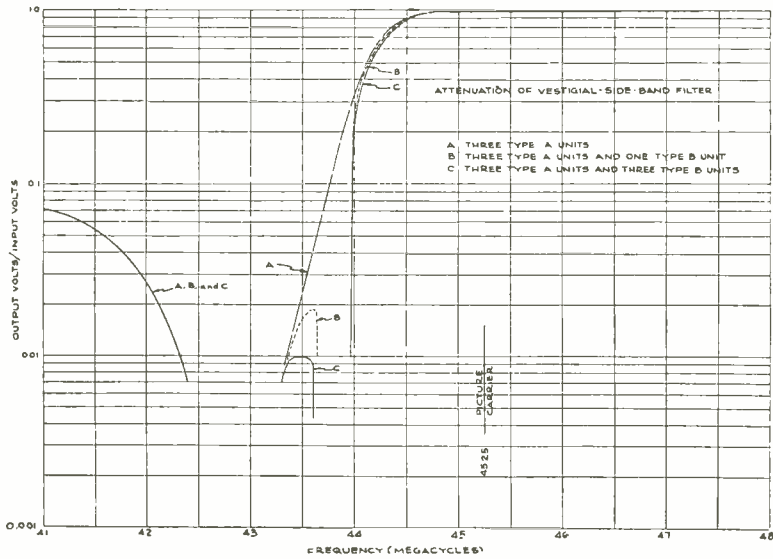

Fig. 11.

With three filters of each type, the response to a square wave was again determined and the test pattern was observed. These tests were again satisfactory. The overall attenuation characteristic as measured is shown by Figure 11. The results shown by this curve were considered to be adequate.

Observations of standing waves on the 70-ohm feed line leading from the test oscillator to the filter showed that the filter system offered a very good termination to the transmission line. The observed reflection on the feed line is shown as a function of frequency in Figure 12.

The entire set of filters as set up in Camden is shown in Figure 13. The input to the filter is at the extreme left rear and is not visible in the picture. Three Type A filters, stacked one above the other, are shown on the left, while the three Type B filters are on the right.

After a thorough series of tests in Camden, the filters were dismantled and reassembled on the eighty-fifth floor of the Empire State Building, New York City, where tests could be made using the television transmitter of the National Broadcasting Company. Many tests

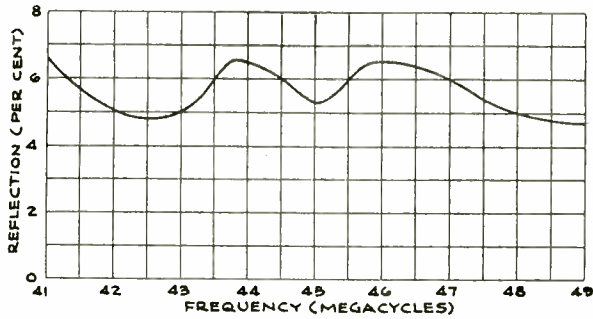

Fig. 12.

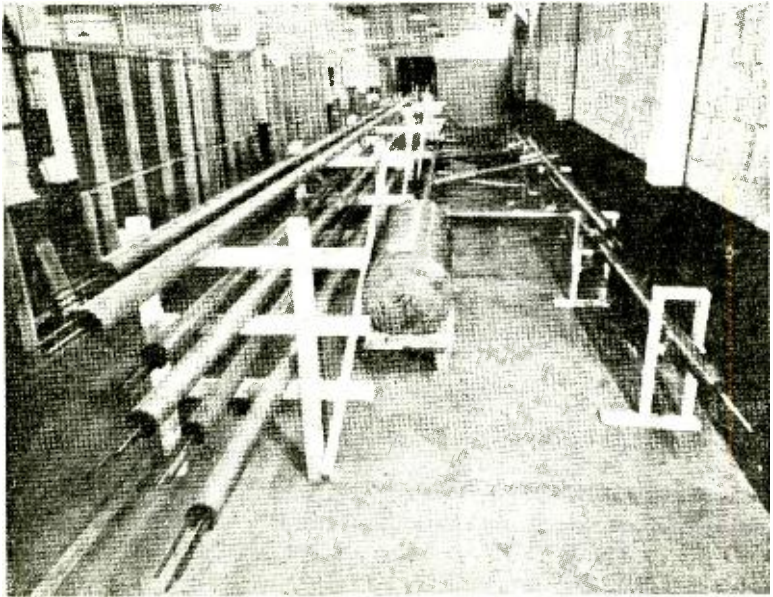

Fig. 13.

were made in 1938 and early in 1939. Field observations were made for a time using a temporary antenna located on the side of the building at the same level as the eighty-fifth floor. During March, 1939, the filter system was connected to the new antenna² which had just

² Nils E. Lindenblad, "Television Transmitting Antenna for Empire State Building," *RCA REVIEW*, Vol. III, No. 4, April, 1939.

been constructed on the top of the Empire State Building. On April 30, the new system went into regular operation.

The new top antenna is fed by two 55-ohm lines operated in push-pull. However, the output of the filter is arranged to feed into a single 70-ohm line. Accordingly, a matching drum was constructed to transfer from a single-ended 70-ohm line to the two push-pull 55-ohm lines. A sketch of this drum is shown on Figure 14. We see from the left hand (a) sketch that it would not be possible to drive the two push-pull lines with equal and opposite voltages unless means are provided to effectively isolate the end of the outer conductor of the 70-ohm

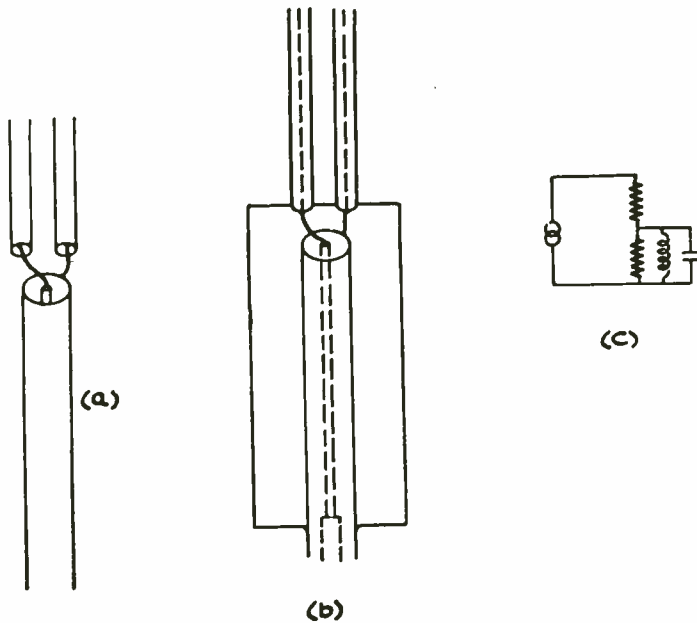

Fig. 14.

line. A quarter wave isolating section is placed around the 70-ohm line, as shown in the middle (b) sketch of Figure 14. The equivalent circuit, which determines the degree of equality of the voltages on the two 55-ohm lines, is shown on the right side (c) of Figure 14. This type of converting drum is described by Lindenblad.² In our particular case, the diameter of the outer drum was made large in order to secure high impedance for this shunting or isolating circuit over a wide band of frequencies. Figures 15 and 16 show views of the drum which is used at the Empire State Building. The drum may also be seen in

Figure 13. Our tests showed that this method of going from single-ended to push-pull was quite satisfactory, even for the wide range of frequencies required in a television system.

Reference has been made earlier in the paper to the water-cooled resistors used in the filters. These resistors were designed especially for this application. Essentially, the resistors form the inner con-

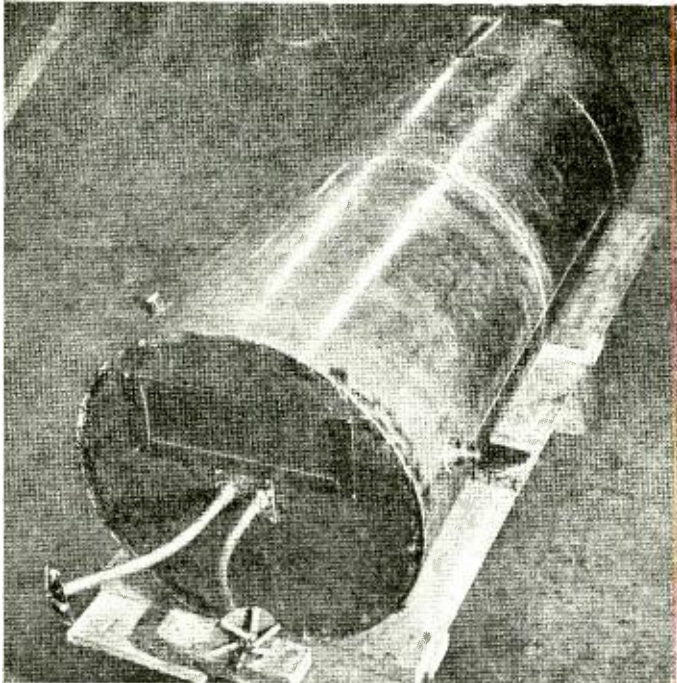

Fig. 15.

ductor of a transmission line. One end of the resistor is shorted to ground. Water is sent through this shorting plug, through the middle of a ceramic tube which supports the resistive film, and back over the surface of the resistor tube. The resistor unit, together with the shorting plug, is shown in Figure 17. As may be seen, the resistor is encased in a glass tube so that the water will return over the surface of the resistor. The theory behind the design of this type of resistance termination is given elsewhere.³ These resistors form a very good termination for the 70-ohm line. In addition, a rather large amount of power may be dissipated with a small amount of water flow. Tests

³ G. H. Brown and J. W. Conklin, "Water-Cooled Resistors for Ultra-high Frequencies," *Electronics*, April, 1941.

have shown that the resistors will safely handle a power of one kilowatt with a water flow of slightly more than one gallon per minute. Six of these resistors have been in regular use at the installation in the Empire State Building, without any failures to date.

Early in March, 1939, the transmitter was operated into the top antenna with the filters removed from the circuit. A short time later,

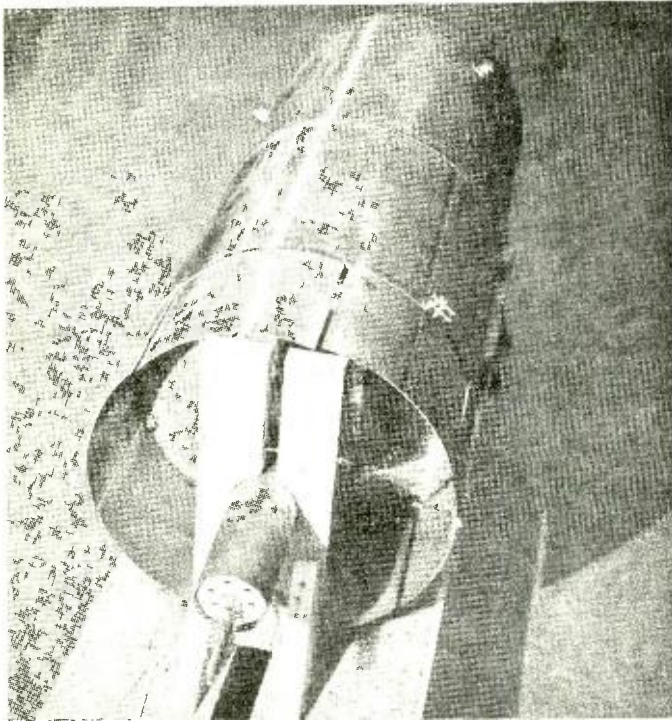

Fig. 16.

the filter was placed in the system, with a resulting transmitted picture that was unimpaired by the insertion of the filter.

V. CONCLUSION

The filter systems described in this report make possible the use of higher modulation frequencies, that is, the limited assigned band is utilized to the best advantage. The filter was built and tested in the laboratory, where almost ideal conditions existed. Later, the filter was installed in a high power television system, and is now in operation in a practical system.

APPENDIX I

A CONSIDERATION OF THE ENERGY DISTRIBUTION
IN THE SIDE-BANDS OF A TELEVISION SIGNAL

While our general experience and observations indicate that the major portion of the radiated energy of a television picture lies in the frequency spectrum very close to the carrier frequency, and that the energy dissipated in the filter resistors is small, it seems desirable to examine this distribution for a few typical cases. We will consider the case of a picture which consists of alternate vertical black and white bars of equal width. The superimposed synchronizing signals will be neglected. Then the radio frequency signal will be as shown in Figure 18. This signal consists of a sine-wave voltage which has a



Fig. 17.

frequency equal to the frequency of the carrier. This sine wave of voltage exists for a period of time T , becomes zero for an equal period, and then repeats. This signal may be analyzed by the method of Fourier. It will then be found⁴ that the signal may be represented by a carrier frequency and upper and lower side-bands equally distributed on both sides of the carrier. The amplitudes of these side-bands are represented by a simple relation.

If the voltage of the intermittent sinusoidal voltage is E , the carrier voltage, of frequency f , has a magnitude of $\frac{E}{2}$. The first upper side-band has a frequency of $f + \frac{1}{2T}$ and a magnitude of $\frac{E}{\pi}$. The next

⁴L. J. Peters, THEORY OF THERMIONIC VACUUM TUBE CIRCUITS, McGraw-Hill, 1927. Pages 124-127.

upper side-band has a frequency of $f + \frac{3}{2T}$ and a magnitude of $\frac{E}{3\pi}$

The lower side-bands follow similar relations. The pertinent relations are shown in the following table. (If T is expressed in microseconds, the frequencies will be given in megacycles.)

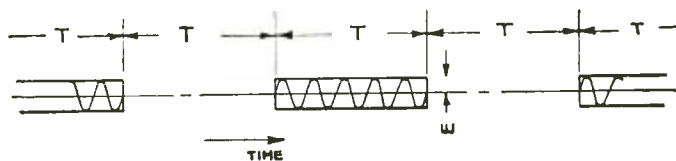

Fig. 18.

TABLE II

Frequency	Voltage Magnitude	Watts in each side-band when peak power is 10,000 watts (see note)
$f - \frac{15}{2T}$	$\frac{E}{15\pi} = -0.0212E$	4.5
$f - \frac{13}{2T}$	$\frac{E}{13\pi} = 0.0245E$	6.0
$f - \frac{11}{2T}$	$\frac{E}{11\pi} = -0.0289E$	8.35
$f - \frac{9}{2T}$	$\frac{E}{9\pi} = 0.03535E$	12.5
$f - \frac{7}{2T}$	$\frac{E}{7\pi} = -0.0455E$	20.7
$f - \frac{5}{2T}$	$\frac{E}{5\pi} = 0.0637E$	40.6
$f - \frac{3}{2T}$	$\frac{E}{3\pi} = -0.1062E$	112.8
$f - \frac{1}{2T}$	$\frac{E}{\pi} = 0.3185E$	1012.0
f (carrier)	$\frac{E}{2} = 0.5E$	2500.0

$f + \frac{1}{2T}$	$\frac{E}{\pi} = 0.3185E$	1012.0
$f + \frac{3}{2T}$	$\frac{E}{3\pi} = -0.1062E$	112.8
$f + \frac{5}{2T}$	$\frac{E}{5\pi} = 0.0637E$	40.6
$f + \frac{7}{2T}$	$\frac{E}{7\pi} = -0.0455E$	20.7
$f + \frac{9}{2T}$	$\frac{E}{9\pi} = 0.03535E$	12.5
$f + \frac{11}{2T}$	$\frac{E}{11\pi} = -0.0289E$	8.35
$f + \frac{13}{2T}$	$\frac{E}{13\pi} = 0.0245E$	6.0
$f + \frac{15}{2T}$	$\frac{E}{15\pi} = -0.0212E$	4.5

Note: By a peak power of 10,000 watts, we mean that E is of such a value that the power in the wave would be 10,000 watts if the sinusoidal wave were continuous, not interrupted for the period, T . Because the wave is cut off half of the time, the actual total power for the wave shown in Fig. 2D will be 5000 watts for a peak power of 10,000 watts. If, in Table II, we sum the power in the carrier, the first eight upper side-bands, and the first eight lower side-bands, we find a power of 4939.9 watts.

The power absorbed by the filter resistors may be readily computed from Table II. We assume that the carrier frequency is 45.25 megacycles. Then we assign a definite value for T . We then turn to Table II and see which side-bands lie between 41 and 44 megacycles and sum up the power which is assigned to these side-bands. The results of this summation are shown in Figure 19 as a function of the time interval T . We see particularly that for vertical bars which last more than 0.4 microsecond, the filter resistors must handle less than 200 watts for a peak power of 10,000 watts.

Evidently, the severest condition occurs when the transmitted picture consists of vertical bars which are between 0.36 and 0.4 microsecond wide. Then, the filter resistors must be able to handle 1125 watts. It seems reasonable to assume that average picture conditions will be closer to the 200-watt region.

It is interesting to note that 100 per cent modulation of the 2500-watt carrier, at a modulating frequency of 2.25 megacycles, causes only 625 watts to be sent into the filter resistors.

We now have sufficient data to examine the interesting case of two television transmitters operating in adjacent bands. Specifically, the No. 1 channel* lies from 44 to 50 megacycles with picture carrier at 45.25 megacycles, while No. 2 channel lies between 50 and 56 megacycles with picture carrier at 51.25 megacycles. From Table II we can

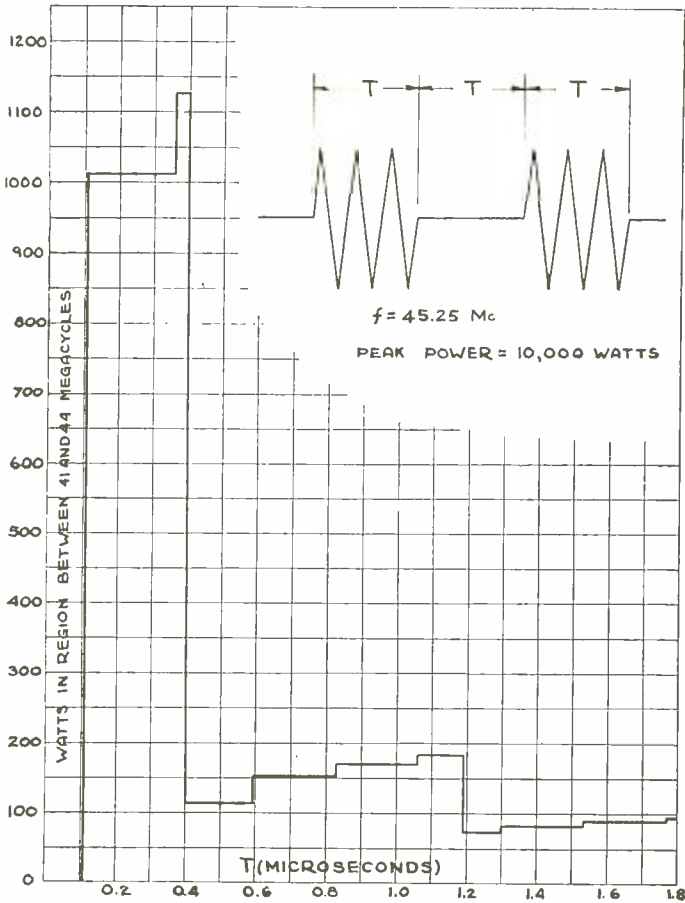

Fig. 19.

easily obtain the side-band energy distribution of either transmitter. We will consider each transmitter to have a peak power of 10,000 watts. In constructing Figure 20 we assumed each transmitter to be

* Since this paper was written, the television channel assignments have been changed. All references to channels in this paper are based on the old channel assignments that existed in 1939.

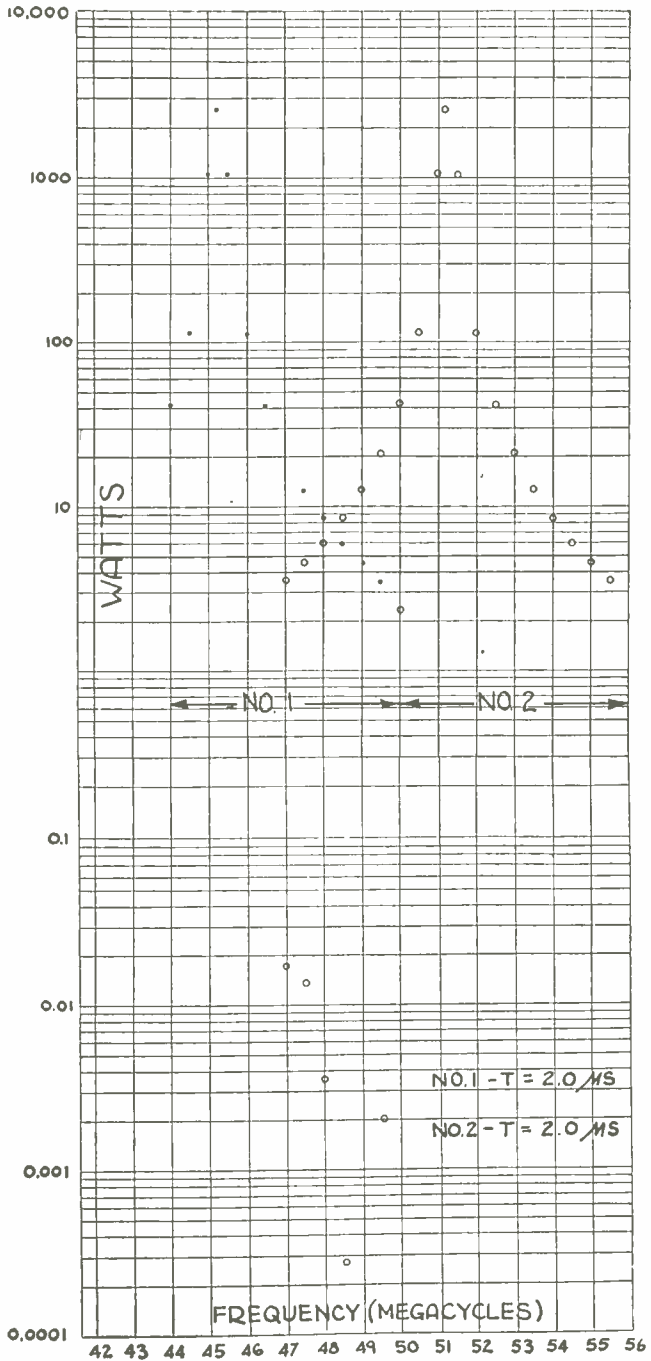

Fig. 20.

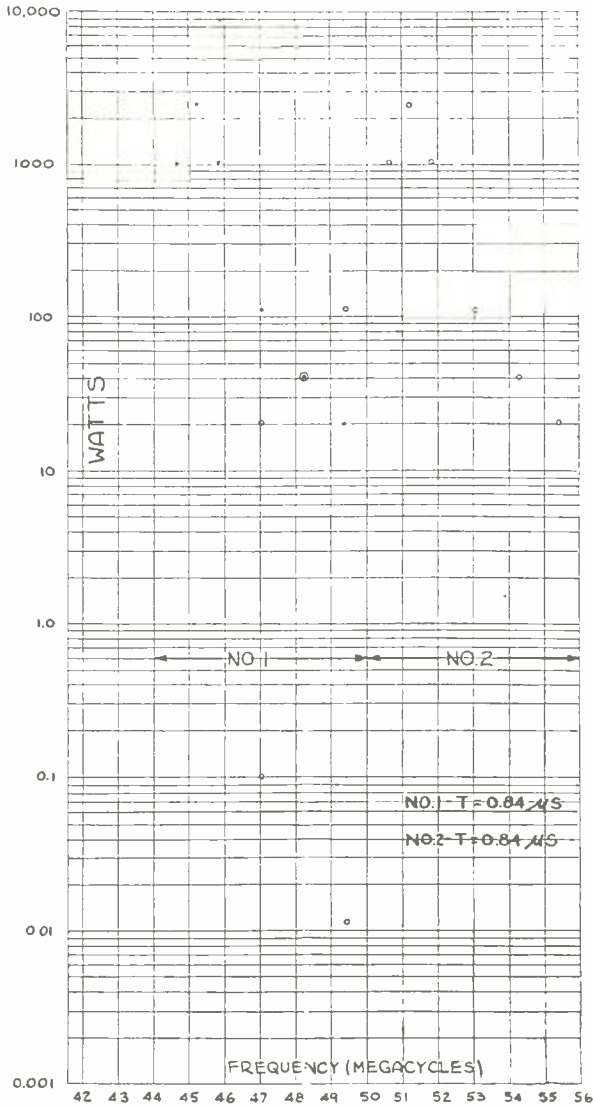

Fig. 21.

sending out a picture made up of vertical alternate black and white bars, the duration of each bar being 2.0 microseconds. The dots on Figure 20 indicate the energy distribution throughout the No. 1 channel due to the No. 1 transmitter. The circles show the energy distribution due to the No. 2 transmitter. We see that the No. 2 transmitter would radiate a strong signal in the No. 1 channel. The lower set of

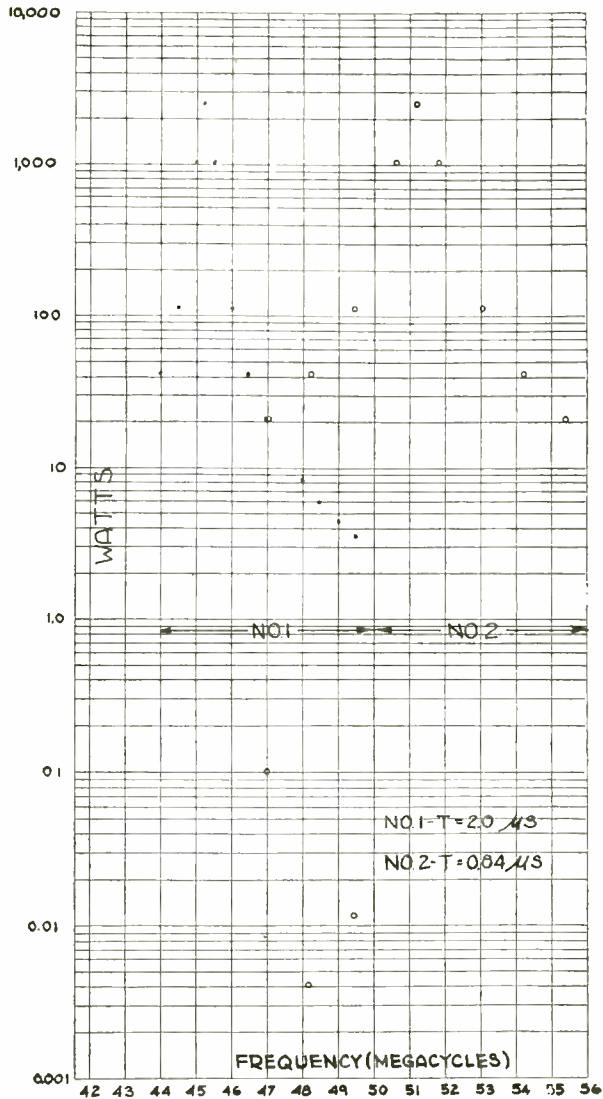

Fig. 22.

circles on Figure 20 shows the disturbing energy when the side-band filter is in operation. In this case there seems to be ample protection.

Figure 21 is similar to Figure 20 except that the width of the modulating bars is now 0.84 microsecond. In Figure 22 the width of bars for the No. 1 transmitter is 2.0 microseconds while No. 2 transmitter is modulated with 0.84 microsecond bars. The need for a side-band filter is quite evident from these figures.

APPENDIX II

INPUT IMPEDANCE OF TYPE A FILTER

For ease of reference, the Type A filter schematic diagram is repeated in Figure 23. We have already shown how transmission line elements may be used to take the place of the lumped elements shown in Figure 23. To compute the various circuit relations we use the following equations.

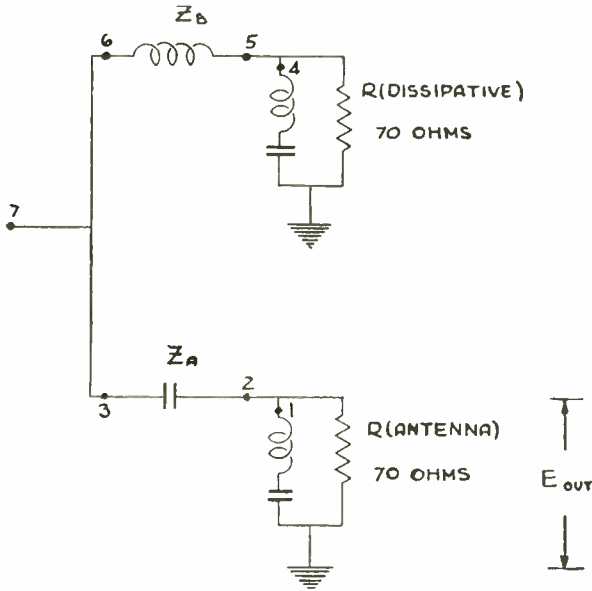

Fig. 23.

$$Z_A = -j70 \cot \left(\frac{f_{mc}}{44} \times 45^\circ \right)$$

$$Z_B = +j70 \tan \left(\frac{f_{mc}}{44} \times 45^\circ \right)$$

$$Z_1 = +j157 \tan \left(\frac{f_{mc}}{43} \times 54^\circ \right)$$

$$Z_1 = +j157 \tan \left(\frac{f_{mc}}{45} \times 54^\circ \right)$$

We may then compute the impedance at the input or at any other point. At the same time we may compute the attenuation through

TABLE III

f_{mc}	Z_A	Z_B	Z_1	Z_2	Z_3	Z_4	Z_5	Z_6	Z_7	Per Cent Reflection	E_{out}/\sqrt{P}
41	-j77.8	+j63	-j70	35-j112.8	-j174.5	60.4-j24.2	60.4+j38.8	70-j2.73	1.95	0.42	
42	-j75.2	+j65.2	-j35	14-j103.1	-j119	52.2-j30.7	52.2+j34.5	68.5-j3.5	2.7	0.30	
43	-j72.5	+j67.6	0	-j72.5	-j70	35-j35	35+j32.6	65.5+j1.9	3.65	0	
44	-j70	+j70	+j35	14+j27.9	-j35	14-j27.9	14+j42.1	70.2+j0	0	0.707	
45	-j67.6	+j72.5	+j70	35-j32.6	0	0	+j72.5	65.5-j1.9	3.65	1.0	
46	-j65.2	+j75.2	+j120.5	52.4+j30.25	+j35	14+j27.9	14+j103.1	68.5+j3.5	2.7	0.98	
47	-j63	+j77.8	+j186.5	61.8-j40	+j70	35+j35	35+j112.8	71.6+j3.6	2.8	0.91	
48	-j61	+j80.5	+j295	66.2-j45.2	+j114	50.7+j31	50.7+j111.5	73+j2.08	2.4	0.85	
49	-j59.7	+j82.2	+j588	69.5-j51.5	+j174.5	60.5+j24.2	60.5+j106.4	75+j1.2	3.5	0.815	

TABLE IV

f_{mc}	Z_1	Z_2	Z_3	Z_4	Z_5	Z_6	Z_{in}	Per Cent Reflection	E_{out}/\sqrt{P}	E_{res}/\sqrt{P}
41	0.0428 \angle +87.5°	18.55 \angle +88° 15'	+j0.0428	+j18.55 \angle +3°	1 \angle +3°	1 \angle -1°	1.0 \angle +2°	1.7	1.0	0.04
43	0.259 \angle +74° 50'	3.86 \angle -74° 50'	+j0.269	+j3.72 0.965 \angle -15°	1.035 \angle +15°	1.035 \angle +15°	1.0 \angle -5°	4.3	0.965	0.26
43.5	0.638 \angle +50.5°	1.565 \angle -50.5°	+j0.825	-j1.21 0.77 \angle -39.5°	1.298 \angle +39.5°	1.298 \angle +39.5°	1.0 \angle 0°	0	0.775	0.64
43.75	1.0 \angle 0°	1.0 \angle 0°	∞	0	0	∞	1.0 \angle 0°	0	0	1.0
44	0.717 \angle -44° 10'	1.392 \angle +44° 10'	-j1.03	+j0.97 0.697 \angle +45° 50'	1.435 \angle -45° 50'	1.435 \angle -45° 50'	1.0 \angle 0°	0	0.63	0.73
46	0	12.7 \angle -90°	0	-j12.7 0.998 \angle -4.5°	1.0 \angle 0°	1.0 \angle 0°	0.998 \angle -4.5°	3.9	1.0	0
49	0.135 \angle +82.5°	3.16 \angle -86.5°	+j0.135	-j3.14 0.952 \angle -17.5°	1.17 \angle +15° 35'	1.17 \angle +15° 35'	1.18 \angle -6°	9.65	0.99	0.14

voltage corresponds to a constant input power so we may use either equation to determine the output voltage. The results of these calculations are given in Table III. Also, we have included in this table, a column labelled "Per Cent Reflection." This is the amount of reflected voltage wave given in terms of the incident voltage wave on the concentric feed line to the filter.

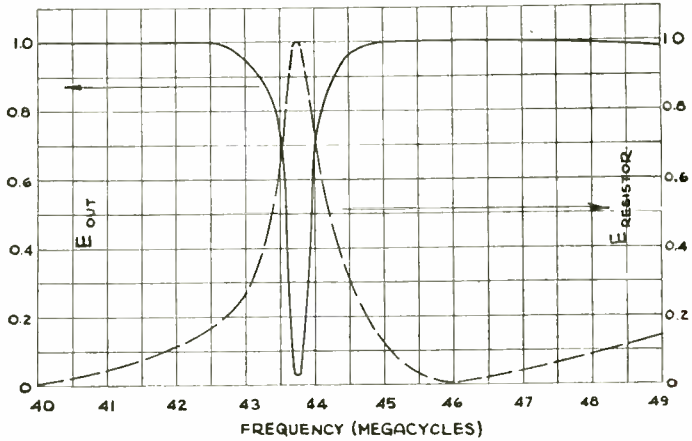

Fig. 25.

APPENDIX III INPUT IMPEDANCE OF TYPE B FILTER

The Type B filter is shown in Figure 24. In computing the impedances of this filter, we may simplify the work by remembering that the resistors have the same value as the characteristic impedance of all the line elements. Then we may take the resistor value and the characteristic impedance as unity. Table IV shows the various impedances involved, in terms of unity starting resistance. For 70 ohm lines and resistors we simply multiply the values in Table IV by 70. Figure 25 shows the calculated values of the voltage on the output and the voltage on the dissipative resistor as a function of frequency. In making these computations, we made use of the relations

$$Z_a = +j1.0 \tan \left(\frac{f_{mc}}{46} \times 180^\circ \right)$$

$$Z_b = -j1.0 \cot \left(\frac{f_{mc}}{43.75} \times 99^\circ \right)$$

DIRECT-VIEWING TYPE CATHODE-RAY TUBE FOR LARGE TELEVISION IMAGES*†

BY

I. G. MALOFF‡

Research Division, RCA Manufacturing Company, Inc.
Camden, N. J.

Summary—A new device for obtaining large bright television images of high contrast and high definition has been developed at the Camden Laboratories of the RCA Manufacturing Company. It is a direct-viewing cathode-ray tube 4½ feet long and 31 inches in diameter. It is of the continuously evacuated type and gives a picture 18 by 24 inches in size. The paper describes the design and construction of the new tube, the reasons for the development, the difficulties which were overcome, and the results obtained.

EVER since high-definition television pictures were first demonstrated, newspaper writers and laymen have commented on the small size of the picture. Seemingly it has been of little interest that the size of the picture has had little to do with the amount of information communicated. In early work on high-definition systems a 9-inch diameter cathode-ray tube was used to produce a picture approximately 6 by 8 inches. Most of the present direct-viewing cathode-ray tubes are 12 inches in diameter and produce pictures approximately 7½ by 10 inches. Even so, larger pictures are wanted. Consequently, a great amount of effort and money has been spent here and abroad in the quest for methods of producing large television images having adequate brightness, contrast, and definition.

Many solutions to the problem of obtaining large television images have been proposed and several methods have been extensively explored. Interesting demonstrations have been given here and abroad. Frequent mentions of the projection cathode-ray tube method and also of the supersonic light-valve method are made in the current technical news.

The purpose of this paper is to describe another method of obtaining large television pictures, namely, the method of large direct-viewing cathode-ray tube development. This tube was built with the primary purpose of studying television pictures of large size (18 by 24 inches) under conditions where brightness, contrast, and definition were adequate and where the method of reproduction did not limit the performance of the system.

* Decimal Classification: R583.15.

† Presented before Fall Meeting of IRE, Rochester, N. Y., November 9, 1937. Reprinted from *RCA REVIEW*, January, 1938.

‡ Now with the Home Instrument Department, RCA Victor Division, Camden, N. J.

The most important consideration in favor of the large direct-viewing cathode-ray tube is that the total amount of light obtainable from a luminescent screen is directly proportional to the area of the screen. This point will be clarified further.

At present the most widely used luminescent materials for screens in cathode-ray tubes are: the zinc orthosilicate (willemite) and the

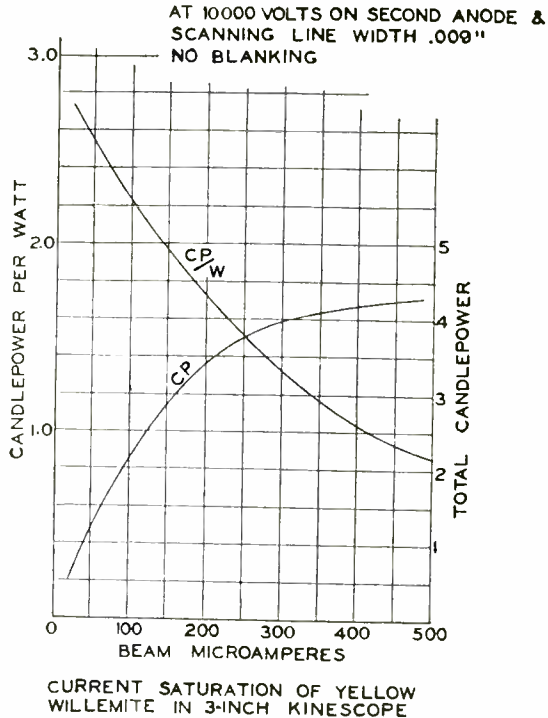

Fig. 1—Current-saturation of a willemite screen.

zinc sulphide. Both materials exhibit the property known as "current saturation." A current-saturation curve of a yellow willemite screen, bombarded by 10,000-volt electrons in a developmental projection tube, is shown in Figure 1.

Measurements show that under the conditions of normal television scanning this saturation is a function of the area of the scanning spot and not of the total scanned area. But the area of the scanning spot is necessarily a function of the total area, if the detail of the picture is to be preserved; i.e. it cannot be larger than a certain fraction of the total area scanned. In actual practice, since the luminous spot is round, a certain overlap of the scanning lines is permissible.

As a limit, after which a serious loss of detail takes place, 50 per cent overlap may be taken. The present tentative standard calls for 441 lines per frame, about 10 per cent of which are blanked out during vertical synchronizing time. The observed picture, therefore, consists of 400 horizontal lines. Allowing 50 per cent overlap this calls for the line width of one-half of one per cent of the height of the reproduced picture as the limiting maximum line width.

It may be deduced from the curves of Figure 1 that at 10,000 volts the maximum useful brightness of this particular type of luminescent screen is 0.7 candlepower per square inch or 100 candles per square foot. The maximum useful beam current (while it is on) is $58 \mu\text{a}$ per square inch, but when the average power over a period

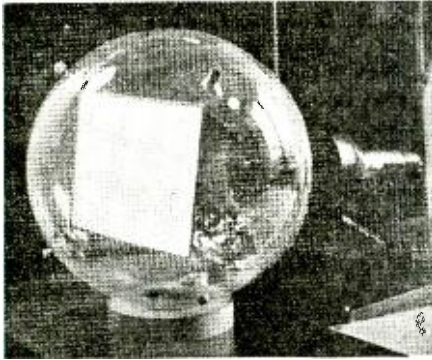

Fig. 2—12-inch direct-viewing television cathode-ray tube for large light output at high contrast.

of one complete white frame is considered, it is only 0.80 of the product of volts and amperes (max.).

The factor of 0.80 is introduced because in actual operation the electron beam scans a given picture area for only 80 per cent of the time since 20 per cent of the time it is extinguished for the line and frame returns or fly-backs.

As to the minimum required brightness of the screen, opinions vary greatly. As a yardstick, the brightness of a motion-picture screen is often used. A committee of the Society of Motion-Picture Engineers concludes that the high-lights of the picture should have at least 11-foot lamberts or 3.5 candles per square foot if eye fatigue is to be completely avoided.¹ The recommendation, however, is that 0.86 to 1.65 candles per square foot be adopted as a temporary standard.

¹ *Jour. Soc. Mot. Pic. Eng.*, May, 1936, and August, 1936.

There is very good reason to believe that a television picture should have more light than that. The author's experience indicates that at no time has he seen a television image that was too bright in a normally lighted room. With the tube shown in Figure 2, with 1.1 ma in the beam at 10,000 volts on the second anode, high-lights of 40 candles per square foot were obtained. The picture was bright and permitted demonstrations in a brightly illuminated room, but no observer pronounced the picture as being too bright. In a dark room such a picture is definitely too bright.

The reason for low screen brightness being satisfactory for motion-

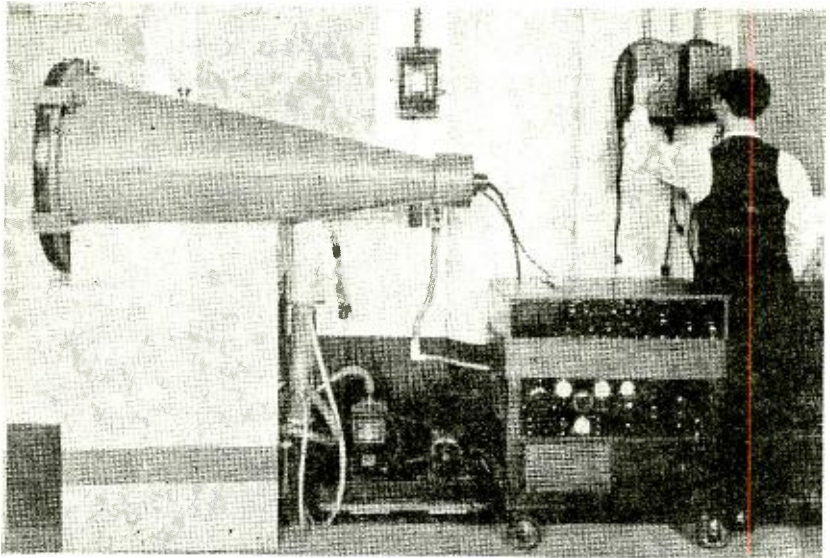

Fig. 3—Side view of 31-inch demountable TCR tube.

picture theaters is that there is practically no stray light and the size of the image is very large. The theater hall is devoted to the showing of pictures and everybody there is looking at the picture. The television receiver is placed in a room which is used for other purposes. It may be the living room of a residence, a hotel lobby, or a restaurant. To be of maximum usefulness, a television receiver should not interfere with any other functions of the room. The willemite screen by itself, at 10,000 volts, is capable of giving a surface brightness as high as 100 candles per square foot or 314 foot-lamberts or apparent foot-candles. For a screen 18 by 24 inches it would require 25 ma at 10,000 volts. For the previously mentioned figure of 40 cp per square foot, only 6 ma at 10,000 volts are required. The lower the current

density of the luminous spot, the higher is the screen efficiency. At 2 ma and 10,000 volts a directly bombarded luminescent willemite screen of the type described will have a brilliancy of 14.6 cp per square foot or 46-foot lamberts which is nine times the upper brightness limit of the tentative SMPE standard.

During the first quarter of the present year the construction of a direct-viewing TCR tube with screen 18 inches by 24 inches was completed at the Camden Laboratory of the RCA Manufacturing Company, Inc. The tube is of the demountable, continuously-evacuated type and

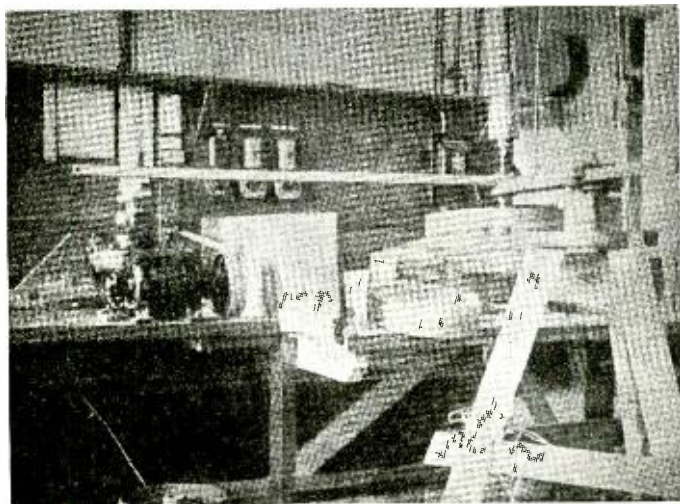

Fig. 4—Machine for grinding and polishing glass covers for 31-inch TCR tube.

has a metal envelope with a Pyrex sight glass. Figure 3 shows a side view of this tube. The envelope is made of good grade steel $\frac{1}{4}$ -inch thick with arc-welded seams and flanges.

It has the shape of a cone, and is 4.5 feet in length. The outside diameter of the larger flange is 31 inches. A three-stage oil-diffusion pump is directly connected to the tube through a special outlet. For fore-vacuum, a mechanical vacuum pump is connected to the diffusion pump by means of a length of rubber hose. The glass cover is convex outward, 31 inches in diameter and 2 inches thick. This thickness is required because the total atmospheric pressure on the glass is approximately $5\frac{1}{2}$ tons. A special machine was constructed in the laboratory for grinding and polishing both surfaces of the glass. The technique used was that of grinding telescope lenses. A layout of the grinding machine is shown in Figure 4.

For vacuum-tight joints between the glass and metal as well as between metal flanges, pure gum rubber gaskets proved very satisfactory. The performance of the tube is quite satisfactory when vacuum of the order of 10^{-6} mm Hg is reached. Normally such a vacuum is reached after 48 hours of operation. The vacuum measurements are made by means of thermocouple and ionization gauges attached to the sleeve connecting the vessel and the diffusion pump.

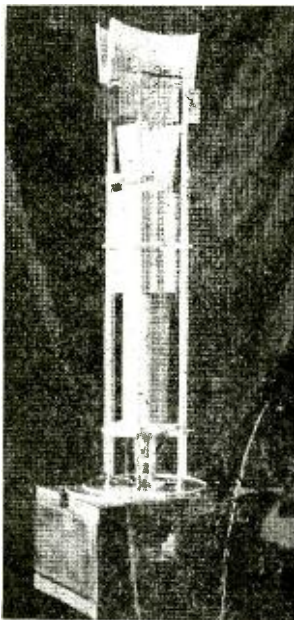

Fig. 5—Electron gun for 31-inch demountable TCR tube.

The tube was designed for 10,000 volts on the second anode. For safety reasons, instead of operating the metal envelope at 10,000 volts positive, it is grounded and the cathode is raised to the same voltage, but negative. This arrangement greatly facilitates the construction of the electron gun. The electron gun used in this tube is shown in Figure 5. It gave beam currents as high as 8 ma at 10,000 volts with corresponding brilliancy of the high-lights. However, the best overall performance was obtained with a gun giving 2 ma in a narrow beam with negligible defocusing and with -150 volts cut-off grid voltage.

The design of the power supply and video amplifier for the demountable tube offered many difficulties. The cathodes in the last stages

of the video amplifier had to be operated at minus 10,000 volts and, of course, had to be capacity-coupled somewhere along the chain to the low-voltage stages. The two coupling condensers during the operation are charged to 10,000 volts and at the same time are required to pass low video frequency currents. All the meters and controls on the last stages of the amplifier had to be insulated for 10,000 volts. A view of the portable outfit containing the video amplifier, synchronizing and deflecting circuits, and high and low-voltage supply, is shown on the right-hand side of Figure 3.

A typical received picture is shown in Figure 6. The signal was taken from an Iconoscope pickup of a regular moving picture frame,



Fig. 6—Unretouched photograph of received television picture on demountable TCR tube.

The photograph has not been retouched. It will be noted from the photograph that the sides of the image are straight and there is no apparent bulging of the image. The reason for this effect is that the 2-inch thick glass disc is used only as vacuum cover or a sight glass while the luminescent material is deposited on a flat glass sheet $\frac{3}{4}$ -mm thick, which is fastened to the walls of the tube. The flat appearance of this type of luminescent screen is not its only advantage. The fact that it is flat greatly improves the overall contrast of the reproduced picture. On a concave screen, illuminated parts throw light directly on the blacks of the image, thereby reducing the contrast. The fact that the screen glass is thin improves the contrast in details by reducing the well-known "halation" or "the spurious ring" effect.

In conclusion it may be stated that with the tube described, large, bright television images of high detail and of high contrast are obtain-

able. This tube possesses real entertainment and communication value and may be shown in normally lighted rooms in day-time and at night.

The author acknowledges the valuable help and cooperation of his associates in carrying out the developments described, especially Dr. D. W. Epstein and Mr. K. R. Wendt, both of the General Research Division of the RCA Manufacturing Company, Inc. at Camden, N. J. The 31-inch glass disc was ground and polished with the assistance of Mr. D. D. Landis of the Photophone Division of the same company.

EFFECT OF THE RECEIVING ANTENNA ON TELEVISION RECEPTION FIDELITY*†

BY

STUART WM. SEELEY‡

License Laboratory, Radio Corporation of America

Summary—Interference between direct and reflected signals from a single transmitter injects a factor into antenna design for television receivers which is not present in broadcast-receiver installations.

Means for minimizing such interference when it exists in free space and for preventing the production of multiple signals in the antenna system itself are explained.

Some data are given on the behavior of transmission lines and long wire antennas. The latter may become necessary at, or near, the boundaries of service areas to improve adverse signal to noise ratios.

I. NATURE OF THE PROBLEM

IN BROADCAST-RECEIVER practice a simple wire of from a few feet to one hundred or more in length will suffice as a receiving antenna, and its operation is completely satisfactory if the received signal is sufficiently above the local and extraneous noise level. A television receiving antenna will have to be erected with much more care and must conform to more complete specifications. This is true because of the introduction of an additional factor in visual reception not present in sound broadcasting. This factor is the necessity for preventing reflected waves, which have travelled a few hundred feet or more further than the direct wave, from entering the receiver. Fortunately this can be done in all cases, and quite easily in most cases. It is the object of this paper to point out that the problem exists in visual reception, and to describe certain methods of meeting it which have been found effective.

Space Wave Reflections

When reproducing a 441-line, 30-field per second picture, the cathode-ray spot travels across the screen of a 12-inch Kinescope at a speed of about $2\frac{1}{2}$ miles per second. This is $\frac{1}{75000}$ times the speed of light or radio waves in free space. In other words the spot will move about 0.060 inch while a radio wave is traveling 400 feet. Therefore, if both a direct and a reflected wave arrive with comparable magnitude at the input terminals of a television receiver, and one has traveled 400 feet further than the other, a double image will result. The displacement of the two images in such event will be about one-sixteenth of an inch and will cause blurring of all vertical lines in

* Decimal Classification: R583.7.

† Reprinted from *RCA REVIEW*, April, 1938.

‡ Now Manager of the Industry Service Laboratory, RCA Laboratories Division, New York, N. Y.

the picture. Actually such a condition results in even more complication than is immediately apparent from the above example. The reflected wave may have any phase with respect to the direct wave. Furthermore, each has its own side components, and those of the direct and reflected wave may be entirely different. Thus interference in the form of cancellation or reinforcement frequently causes a black line to be repeated as a white line or vice-versa. If the reflected wave travels 1000 feet or more further than the direct wave a distinct double image will result.

Thus it is readily apparent that the antenna must supply a television receiver with one signal only from a desired transmission. In metropolitan areas, reflections from large buildings may give rise to several images and the problem of proper construction, location and orientation of the receiving antenna becomes extremely important. However, at *any* location an improperly constructed antenna or antenna network and feed system may produce multiple signals of sufficient intensity and time-phase displacement to be objectionable.

Transmission Line Reflections

Under ordinary conditions, at most installations, it is necessary to use transmission lines between the antenna proper and the receiver in order to control properly the point of signal pick-up. If the maximum dimension of the antenna system (transmission line plus antenna) is of the order of 100 feet or more, and the line is not properly balanced and terminated at the receiver, reflections in the antenna network may cause a loss of detail in the reproduced picture. Thus the problem of preventing blurring or double images caused by multiple-signal reception may be divided into two parts. First, the antenna must be made non-susceptible to strong secondary waves from external reflecting media, and second, the antenna and its transmission line must be so constructed and terminated that reflections from the receiver end of the system can not bound back to the outer end of the antenna and be reflected there to re-enter the receiver as a delayed signal.

It is difficult to describe in words the appearance of images produced by multiple-signal reception, and difficult to show it clearly by illustrations produced by the photographic and printing processes necessarily involved. Figures 1 to 4 are illustrations showing a small section of a Kinescope screen reproducing a transmitted pattern, under different conditions of multiple-signal reception. The illustrations are of course not clear or representative of the general appearance of the screen when viewed by the eye, and are intended merely to show the relative effects of antenna changes. The pictures were taken on the

same receiver with different antennas, but without any changes in receiver tuning. A detailed description of the antennas and the effect of each on the received image will be given later.

II. SOURCE OF SPACE WAVE REFLECTIONS

It is to be understood that the reflecting medium need not be a metallic object. The specific inductive capacities of building stone, brick, paving material, and ordinary soil, are sufficiently greater than

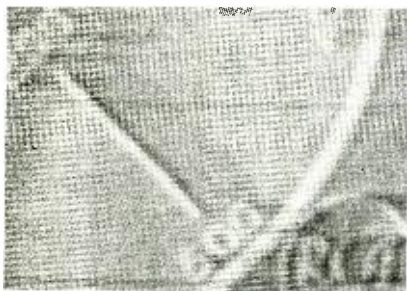

Fig. 1.

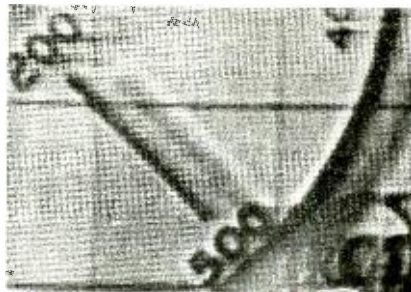

Fig. 2.

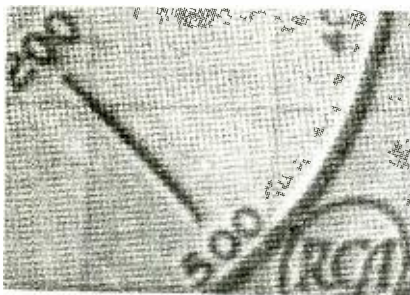

Fig. 3.

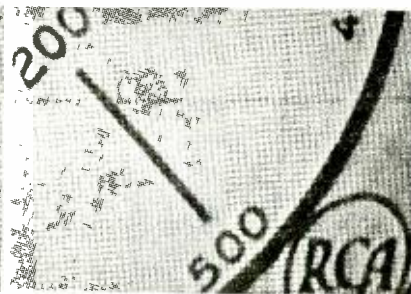

Fig. 4.

Figures 1, 2, and 3 show a small section of the Kinescope screen to illustrate the effect of various receiving antennas on reproduction. The receiver was operated with reduced contrast for best photographic results. Figure 4 is the same as 3 except that the receiver was operated with normal contrast.

that of air to have high coefficients of reflection for television frequencies at some angle of incidence. Therefore almost any surface can act as a reflector, if its dimensions are comparable to, or greater than, one-half wavelength.

If the transmitting antenna is within line of sight of the receiving antenna, and a plane surface parallel to the ground is located between the two and within sight of both, the strength and delay factor of the reflected energy will depend upon all of the dimensions of the geometrical orientation of the three objects. However, it can be shown by simple calculations that only within a radius, from the transmitter, of about six times the combined transmitting and receiving antenna heights (above such a surface) can reflections of this nature be sufficiently delayed to cause a loss of detail in the reproduced image. This, of course, is based on our present standard of 441-line, 30-frame per second transmission. Therefore, at most receiving locations, more than a mile or two from the transmitter, where reflections are troublesome, the reflecting area must lie in some plane other than that parallel to the ground.

Large buildings surrounding a receiving location offer ample opportunity for multiple-path reception even when the transmitting and receiving antennas are within line of sight. If the two are hidden from each other by tall buildings or by hills, the direct signal may be so greatly attenuated that the reflected energy exceeds that which travels the direct path. One example of this was noticed recently at a receiving location which was hidden from line-of-sight of the transmitting antenna by a nearby building. In this case, the single strong reflected wave produced an image misplaced by an amount which indicated it had travelled about nine hundred feet further than the direct wave. The receiving doublet was rotated to a position which eliminated the direct signal (which was much the weaker of the two) and good reproduction was obtained.

The most satisfactory indicator for determining the presence of undesired reflected waves and for aiding in the determination of their source, is a television receiver equipped with a portable doublet on the end of a long pole. It is necessary, of course, that the transmitter be in operation at the time of test, and that the transmitted image be stationary and of such a nature that either blurring of horizontal detail (at the edges of vertical lines) or the presence of a secondary image, is readily apparent. A single black vertical line in the middle of a white background would suffice.

The effect of orientation and rotation of the portable doublet on the relative strength of the direct and reflected signals, as reproduced by the receiver, together with a calculation of the difference in path lengths by a measurement of the displacement of the two images on the screen, will usually indicate the probable source of the reflection quite accurately. However, in many cases such information may turn out to be of only academic interest, since it will often be found that the

correct answer to the problem of proper location and construction of the fixed receiving antenna can be determined only by empirical investigation.

III. MINIMIZING SECONDARY SIGNALS

Probably the most generally useful type of television-receiving antenna will be a simple doublet, or double doublet, connected to the receiver by means of a low-impedance, twisted-pair transmission line. At the majority of receiving locations this will undoubtedly give completely satisfactory reception if normal care and thought are used in its installation. Even at many places where multiple-path reception is encountered, the same type of antenna may be made to serve satisfactorily by orientation to minimize the reflected signal, or by shielding it from the reflecting source. This might be done by placing it in proper relation to existing conductors such as metal flashings, copings, eavestroughs, etc. Usually such location can be found only by trying different positions and noting the effect on the received image. Another method of shielding a receiving doublet from reflected waves is to place a second, unloaded, dipole near it and in proper position to minimize the reflection image. Here again the cut-and-try method will probably yield the best results.

If several strong reflected signals are present at the receiving location more drastic action will probably be necessary. This was the case at the RCA License Laboratory which is located about 6000 feet north of the transmitter on the Empire State Building. Figure 1 was taken to illustrate the maximum number and relative strength of reflected signals which could be picked up at this location. The antenna was a half-wave doublet at the end of a 60-foot twisted pair which, however, was connected with the two wires in parallel to act as a "T" antenna against ground. In this case the first reflection arrived with proper phase and intensity to invert a large amount of the direct-signal detail into negative values of light intensity. This was followed by five more reflected signals varying in time of arrival and amplitude. The last of these is displaced by an amount which indicated that it had travelled 3.8 microseconds longer, and thus about 3700 feet further, than the direct wave.

It is interesting to note that in this case horizontal synchronization of the receiver was seriously impaired. The whole pattern moved to the left as though the receiver had synchronized on one of the reflected signals. This was undoubtedly the case due to partial destruction of the true horizontal pulse by the strong, short-delay, out-of-phase reflection.

Figure 2 was taken with the doublet and transmission line connected normally to the balanced-input terminals of the receiver, and with the doublet adjusted to the position which minimized secondary images. However, it can be seen that this antenna would be entirely unsatisfactory for good reception. Two principal reflections are still apparent. These are displaced by amounts which indicate additional path lengths of 800 feet and 2300 feet. A very faint trace of the 3700-foot reflection, which is strong in Figure 1, still remains.

The antenna for Figure 3 was the same as for Figure 2 except that one end of the doublet was lengthened by adding a three and one-half wavelength wire toward the transmitter. This was supported one-quarter wavelength above a wide copper coping parallel to, and about 150 feet directly above, Fifth Avenue. Resistance termination at the outer end of this antenna had little or no effect on the reproduced image, so Figure 3 was taken with the far end open. In this case the 2300-foot reflection is still faintly visible, but probably represents an acceptable minimum of direct to reflected-signal ratio.

Of a large number of antennas tested, that used for Figure 3 seems to be the only one which gives acceptable performance for reception at this location. Reflection conditions at this point are unusually severe and do not, by any means, represent the average to be expected. Although objectionable secondary images are picked up by simple half-wave doublets at various locations within the range of the transmitter, there are many more where no reflections are apparent.

IV. BEHAVIOR OF TRANSMISSION LINES AND LONG WIRE ANTENNAS

The long wire antenna at the License Laboratory is necessary only because its directional characteristics improve an adverse direct to reflected-signal ratio. At, or near, the boundaries of the service area of a television transmitter it will sometimes be necessary to use something other than a simple dipole and twisted pair for the antenna system in order to raise the signal well above the receiver hiss level.

Rubber-dielectric, twisted-pair lines dissipate a considerable amount of the received energy if they are more than a few wavelengths long. Measurement of several types of such lines indicates that the average attenuation to be expected is between 1.5 and 2.0 db per wavelength at 50 mc. Therefore, a fair increase in signal strength at the receiver can often be obtained by the use of an open-wire line, particularly if the distance from the antenna to the receiver is 50 feet or more. The attenuation of the average, close-spaced, open-wire line is about

one-tenth of that of twisted pairs. However, if an open-wire line is used, its increased impedance will cause the antenna to operate less efficiently unless the two are connected together in such a manner that the damping of the antenna is about the same as with the lower-impedance line. This can be done by the use of the well-known Y connection which is common in amateur transmitter practice.

It is also necessary for the input impedance of the receiver to be at least approximately matched to the higher-impedance line in order to realize the increased-signal level. In some recent tests it was found convenient to have a small residual-inductive component as part of the input impedance at the balanced-input terminals of the receiver. The resistive component of this impedance measured about 100 ohms; therefore, when using a 100-ohm line, two small series condensers (one in each wire) were inserted to cancel the reactance. If, however, the reactance was cancelled by shunt tuning, the input resistance became 500 ohms, which was the impedance of the open-wire line. This made it possible to analyze the behavior of the two lines without making changes in the receiver input-coupling circuit.

Under some conditions the energy picked up by the two wires of the transmission line acting in parallel may exceed that in the antenna proper. If the entire system, and the receiver input in particular, is well balanced to ground, the signals from this source cannot enter the receiver. If, however, an unbalance does exist, energy from this source may give rise to considerable trouble. This is particularly true if the entire length of line and antenna is of the order of 100 feet or more. In this case the unwanted signals may be reflected back and forth between the receiver and the outer end of the antenna producing a new image, slightly displaced from the previous one, on each round trip, and thereby obliterating much of the horizontal detail.

The energy loss in twisted-pair lines is usually sufficient so that signals cannot travel in them (back and forth) for a sufficient length of time to cause blurred reproduction before being attenuated below a disturbance level. However, energy travelling on the two wires in parallel is often subjected to much less attenuation and can make trouble, if lack of balance in the system allows some of it to enter the receiver.

A marked example of this effect was noticed recently. At a particular location, a half-wave doublet and twisted-pair line gave no indication of extraneous reflections, but the signal level (about 800 microvolts) was somewhat too low for a good signal-to-receiver-noise ratio. Therefore, it was decided to install some type of long-wire

antenna and open-wire line as an experiment to determine just how much this could be increased without resorting to means other than those which will be at the disposal of the average serviceman. Existing supports were not available for a rhombic antenna which would have had to extend from the lead-in point in a direction toward the transmitter. Therefore a single-wire, five-wavelength antenna, was placed between two tall trees which were on a line about 20 degrees from the direction of the transmitter. The 2-inch spaced transmission line was Y connected to the antenna across a point one-quarter wavelength from the end toward the transmitter. With this arrangement it was realized that the major portion of the received energy would have to travel to the far end of the antenna, be reflected there, and then travel back the entire length before entering the transmission line. Furthermore, the whole system was, of course, unbalanced with respect to ground.

A test of the operation of this antenna showed that it delivered about ten times as much signal voltage to the receiver as the doublet and twisted pair. A large portion of this was due to an increase in height above the old antenna; the rest of it was accounted for by increased antenna and transmission-line efficiency. However, the reproduced image was decidedly poor. The radical loss of horizontal detail which resulted was at first assumed to be due to a too sharply defined resonant characteristic of the antenna proper; however this proved not to be the case. The cause of the trouble was found to be end-to-end reflection of that energy which flowed down the transmission-line wires in parallel. The distance from the receiver to the outer end of the antenna was about 175 feet. The blurring of the edges of vertical lines extended for a distance which indicated that at least three complete round trips (1050 feet) were made over this path by the extraneous signal before it was sufficiently attenuated to be unnoticeable.

The difficulty was corrected by shorting and grounding the transmission line at its bottom end and tapping off a short length of low-impedance line (for a lead-in) at an empirically determined point a few feet above the ground rod. It would normally be expected that a terminating resistor between the shorting bar and the ground connection would be required to prevent reflection of unbalanced signal energy at that point; in this case it was not necessary.

In its final form the antenna delivered somewhat less signal to the receiver than when first tried with a direct connection; but it still gave a 15 db improvement over the half-wave doublet. This was sufficient to raise the signal well above an acceptable minimum.

CONCLUSIONS

Some locations within the service area of a television transmitter will require individual receiving-antenna study and design to meet conditions at those locations.

It appears at present that a standard antenna design, or any single preventative of multiple reception, can not be prescribed for all receiving locations, especially where service from two transmitters in the same area is to be obtained.

Satisfactory performance has been obtained in every case studied, by means described in the paper.

CONTRAST IN KINESCOPIES*†

BY

R. R. LAW‡

Research Department, RCA Manufacturing Company, Inc.
Camden, N. J.

Summary—One of the problems in the art of reproducing a scene by television is to obtain an image with adequate contrast. Although a relatively low contrast range may suffice for the transmission of intelligence, a much greater contrast range is essential for the reproduction of clear, life-like images.

The factors harmful to contrast in the kinescope are well known and may be studied in a variety of ways. In the belief that the reaction of the observer is the ultimate criterion for judging the perfection of the image, the author began the present investigation with a series of viewing tests designed to determine the relative psychological effects of the various factors harmful to contrast. On the basis of these tests, it was definitely concluded that halation is far more detrimental to image quality than screen curvature or bulb-wall reflections.

Experimental evaluation of the relative importance of the individual factors harmful to contrast leads to the same conclusion, and it is evident that a considerable improvement in contrast could be effected by reducing halation.

A detailed analytical study of halation shows how it depends upon various parameters. Particularly significant is the conclusion that halation may be reduced several fold by introducing a small amount of light-absorbing material in the kinescope face. According to this analysis, a 10 to 20 per cent absorption should give a three- to six-fold reduction in halation.

Developmental kinescopes made in accordance with these principles give greatly improved contrast. Not only does reduction of halation substantially double or triple the length of the scale available for the reproduction of half tones, but it has a marked effect upon the sharpness of the image.

I. INTRODUCTION

ONE of the problems in the art of reproducing a scene by television is to obtain an image with adequate contrast. This problem is more significant than it may appear on first inspection, because it involves not only the technical performance of the television system, but also the ability of the observer to see. Seeing, in turn, is an exceedingly complex physiological and psychological

* Decimal Classification: R583.15 × R583.6.

† Presented at the I.R.E. Convention, New York, N. Y., June 17, 1938. Reprinted from *Proc. I.R.E.*, August, 1939.

‡ Now with the Research Department, RCA Laboratories Division, Princeton, N. J.

process. Among the factors governing this process, contrast occupies an important position.¹

Contrast, according to the dictionary definition, expresses a state of difference or unlikeness. The differences with which we shall have to deal are differences in brightness. An objective, or brightness, contrast may be defined as the ratio of two brightnesses; or on the other hand, in terms of visual effects, a subjective contrast may be defined as the logarithm of the ratio of two brightnesses. The necessity for taking the logarithm of the ratio of the two brightnesses to obtain the subjective contrast is brought about because, as enunciated by the Weber-Fechner law,² a stimulus increasing in geometric progression is required to produce a sensation increasing in arithmetic progression. We shall, therefore, speak in terms of subjective contrast when we consider observer reactions. However, insofar as our photometric measurements are concerned, it will be more convenient to use the objective definition and define contrast as the ratio of two different brightnesses.

Although softness of outline and mildness of contrast have a very definite place in the rendition of artistic effects, a television system is also called upon to transmit lifelike, high-definition half tones. In the accomplishment of this end, contrast is significant in several respects. Thus, good half-tone reproduction requires a long scale of tone values which can only be realized with a large over-all contrast range. Then too, in a complex pattern, the apparent, or subjective contrast depends upon the gradient between two areas of different brightness. For this reason, contrast between adjacent picture elements is important. And finally, as is well known in the photographic art,³ the relative brightnesses of the intermediate tonal values has much to do with the lifelikeness of the reproduction.

In the present electronic television system,⁴ contrast is determined by many factors, both at the transmitter and at the receiver. Although the kinescope⁵ does not seriously limit contrast at the present time, a greater and greater burden is thrown on it as the character of the television signal is improved. This paper is intended to report the results of an investigation of the factors limiting contrast in the kine-

¹ M. Luckiesh and F. Moss, *THE SCIENCE OF SEEING*, D. Van Nostrand, New York, 1937.

² J. W. T. Walsh, *PHOTOMETRY*, Constable and Company, Ltd., London, 1926.

³ L. A. Jones, "Contrast of Photographic Printing Papers", *Jour. Frank. Inst.*, Vol. 202, pp. 177-207; August, 1926.

⁴ V. K. Zworykin, "Iconoscopes and Kinescopes in Television", *RCA REVIEW*, Vol. I, No. 1, pp. 60-84, July, 1936.

⁵ V. K. Zworykin, "Description of an Experimental Television System and Kinescope", *Proc. I.R.E.*, Vol. 21, pp. 1655-1673, December, 1933.

scope itself insofar as they influence the over-all contrast range and modify the contrast between adjacent picture elements.

The factors harmful to contrast in kinescopes are well known.⁶ Those familiar with the design of television cathode-ray tubes recognize that halation, curvature of the luminescent screen, bulb-wall reflections, room illumination, and stray electrons influence contrast. By way of review, let us examine these factors briefly to see how each may be detrimental.

In the conventional direct-viewing kinescope, the television picture is reproduced on a fluorescent screen which is deposited on the inner, curved surface of the bulb, as shown in Figure 1. An examination of

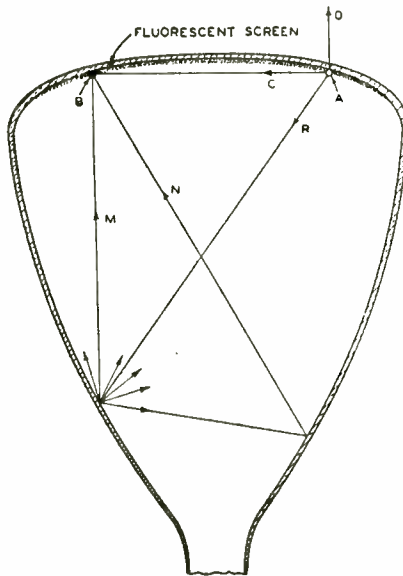

Fig. 1—Schematic diagram illustrating how screen curvature and bulb-wall reflections are detrimental to contrast.

typical light-ray paths will reveal immediately how curvature of the screen and bulb-wall reflections are harmful to contrast. Suppose that point *A* represents a bright region of the image, while point *B* represents a region that normally would be dark. Inasmuch as the fluorescent screen is substantially a perfect diffusing surface, the light flux from point *A* is scattered in all directions. A portion of this light flux, represented by the arrow *A-O*, comes out through the bulb face toward the observer. Another portion, represented by the arrow *A-C*, travels

⁶ I. G. Maloff and D. W. Epstein, *ELECTRON OPTICS IN TELEVISION*, Mc-Graw-Hill Book Company, New York, 1938.

directly across the curved screen to the dark region *B*. Still another portion of the light flux, represented by the arrow *A-R*, impinges on the bulb walls. After successive partial reflections and scatterings, a portion of this light flux, represented by the arrows *N* and *M*, finds its way to the dark region. Thus, the degree of darkness in the region *B* is dependent upon the brightness of other portions of the picture.

To understand how halation comes about, let us examine a section of the kinescope face in more detail. Figure 2 shows a cross-sectional view of the fluorescent screen and glass face of a typical kinescope. Let us see what happens to the light flux emitted by a small bright area *O*. The light ray *O-1* which strikes the glass-air interface perpendicularly will be undeflected and only a small portion, about four per cent, will be reflected. Rays such as *O-2* and *O-3* which strike the interface obliquely will be refracted away from the normal and a small

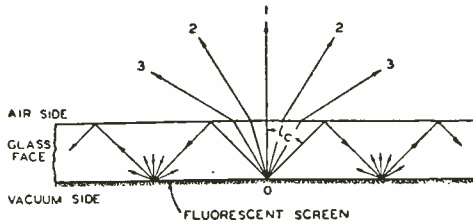

Fig. 2—Cross section of kinescope face showing how total internal reflections produce halation.

portion, still about four per cent, will be reflected. As the angle of incidence is increased, the transmitted ray is bent more and more away from the normal and somewhat more than four per cent is reflected. However, as soon as the angle of incidence is equal to or greater than the critical angle, not just a few per cent, but the entire amount of the light flux is returned to the fluorescent screen. Thus, in the case of complete optical contact between the fluorescent particles and the glass support, a bright spot would be surrounded by a dark circular area and a concentric circle of illumination whose brightness decreases with radial distance. In general, however, the inner glass surface is not entirely in optical contact with fluorescent particles; consequently, only a portion of the light flux enters the particles on its first return to the screen. The remaining portion is again totally reflected and thus gives rise to successive internal reflections. Because of this, the bright spot is usually surrounded by not one, but by a series of concentric circles of illumination of diminishing brightness, as illustrated in Figure 3. This spurious illumination around the spot is detrimental to contrast.

Room illumination is also important in determining contrast. Although we shall not discuss this problem at the present time, we may reflect that similar difficulties are encountered in the photographic and projection arts and that the corrective methods^{7,8} therein developed are applicable to the television problem also.

The effects of stray electrons are of very little importance.⁶ Electron-gun design has been so perfected that stray electrons are no longer significant in determining contrast.

So much for the review. Inasmuch as room illumination is external to the kinescope, and inasmuch as stray electrons are unimportant with electron guns of modern design, let us eliminate these two factors. We shall concern ourselves henceforth with the effects of halation, screen curvature, and bulb-wall reflections.

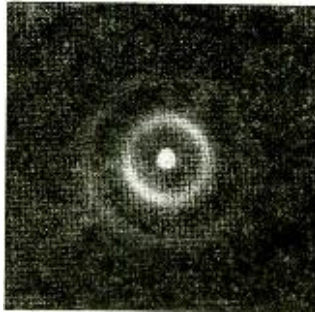

Fig. 3—Appearance of stationary spot on kinescope screen illustrating series of concentric circles of illumination occasioned by halation.

II. PSYCHOLOGICAL EFFECTS OF THE VARIOUS FACTORS DETRIMENTAL TO CONTRAST

We have seen how halation, screen curvature, and bulb-wall reflections may be detrimental to contrast, and we shall certainly wish to examine the physical aspects of these factors in more detail. However, before we do this, let us take a comprehensive look at the subject as a whole and see if we can get a perspective view of the relative importance of these factors. In the belief that the psychological reaction of the observer is the ultimate criterion for judging the perfection of the image, a logical procedure is a series of viewing tests designed to determine the relative psychological effects of these factors. Such viewing tests are facilitated by an apparatus illustrated in Figure 4 which permits two images portraying identical subject matter to be

⁷ A. Herz, U. S. Patent 1,614,672, 1927.

⁸ A. Herz, U. S. Patent 1,694,706, 1928.

compared directly. These images are derived from two substantially identical projectors arranged to project two substantially identical slides on two different viewing screens, one above the other. The only important difference between the two images is occasioned by the unlike viewing screens.

Various viewing screens have been used in these tests. The upper image in Figure 4 is reproduced on a conventional kinescope bulb face coated with willemite in much the usual manner. This screen is subject to the defects of halation and screen curvature. Semi-reflecting surfaces were introduced behind the viewing screen to simulate bulb-wall reflections. A flat glass plate, of the same thickness as the kinescope face, coated with a suitable layer of willemite, gives a viewing screen

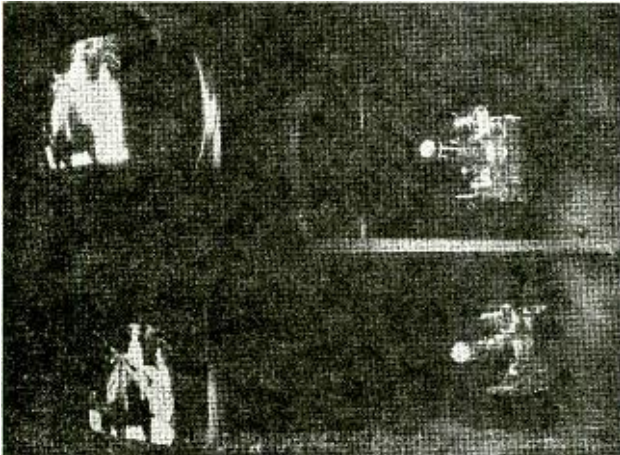

Fig. 4—Apparatus for comparing images reproduced on different screens. Upper image reproduced on conventional kinescope screen. Lower image reproduced on thin mica screen.

free from the defect of screen curvature. A thin, flat, glass plate coated with willemite makes it possible to observe the effect of reducing the spread of the halation bands. And finally, a very thin, flat, mica sheet coated with willemite gives a viewing screen substantially free from halation. The lower image in Figure 4 is reproduced on this thin, mica, viewing screen.

That the images reproduced on these viewing screens by projection may be made to have the same characteristics as they would have if they were reproduced on similar screens by electronic means is demonstrated in the following manner. Studies of the distribution of light flux emanating from a fluorescent screen when a small area is made

luminescent by impinging electrons show that the light distribution obeys Lambert's cosine law. The ratio of forward to backward light, i.e., the ratio of brightness on the viewing side to brightness on the bombarded side, depends upon the thickness and character of the fluorescent layer.

Similar studies of the distribution of light flux emanating from a willemite-coated glass plate when a small area is illuminated from the willemite side by an external light source show similar results. So long as the willemite coating is sufficiently thick and homogeneous to prevent direct transmission of the incident beam, the light distribution will be found to obey Lambert's cosine law.

Fortunately for the analogy in hand, a fluorescent screen coated with an optimum thickness of willemite for electron bombardment gives substantially the same light distribution irrespective of whether it is bombarded with electrons or illuminated by an external light source. This is not so surprising as it may seem at first sight. Examining the willemite screen in more detail, we see that it is made up of a multitude of very small, irregularly shaped, relatively transparent, crystalline particles of moderately high refractive index. Light rays entering such particles will on the average undergo many internal reflections before they escape. Similarly, light rays produced within the particle as a consequence of electron bombardment will likewise undergo many internal reflections before they escape. In either event the result is the same; each crystalline particle is filled with a substantially homogeneous radiation, the intensity of which determines the brightness of the particle.

Provided then that the willemite layer has a sufficiently good coverage to prevent the direct transmission of light from the projector, and provided also that the ratio of forward to backward light is adjusted to the proper value by using a screen of suitable thickness, an image reproduced by optical means has the same external characteristics as an image reproduced by electronic means. This is a convenient tool. Not only is one enabled to study image characteristics without the attendant electronic equipment, but one can readily obtain images of very high quality.

So much for the justification of the experimental method. As for the results, they would be best presented by a series of photographs similar to Figure 4. Unfortunately, however, the means of reproduction at our command are not adequate to illustrate the small differences occasioned by screen curvature and bulb-wall reflections. As an alternative, therefore, we must content ourselves with a description of the results.

The reactions and comments of a number of observers may be summarized as follows:

(1) A moderate amount of background illumination arising from semireflecting surfaces introduced behind the kinescope screen to simulate bulb-wall reflections is perceptible, but is not particularly detrimental to the general quality of the image.

(2) The image on the thick, flat, glass screen is somewhat better than the image on the curved kinescope screen. The difference is largely occasioned by the improved detail in the low lights.

(3) The image on the thin, flat, glass screen is somewhat better than the image on the thick, flat, glass screen. The difference in this case also appears to be occasioned by improved detail in the low lights.

(4) However, when we come to compare the image on the thin mica screen with the image on the thin, flat glass screen, the difference is striking. The image on the thin mica screen exhibits a snap and perfection that is entirely absent in the images reproduced on the other three screens.

On the basis of these observations, we may conclude that halation is far more injurious to contrast and image quality than screen curvature or bulb-wall reflections. Not only is halation very important in determining the over-all contrast range, but it has a marked effect upon the sharpness of the image. This sharpening of the image is very instrumental in determining the psychological reaction of the observer.

III. DETAILED STUDY OF THE INDIVIDUAL FACTORS INFLUENCING CONTRAST

Quite aside from the foregoing evidence, we may draw much the same conclusions by a more detailed study of the individual factors influencing contrast. Inasmuch as the regions of light and dark in a television image ordinarily will be arranged in very complicated patterns, our best approach is to analyze one representative case.

A test case readily adapted to analysis is that of a small dark spot in the center of a bright field. This is a very severe test; consequently, the results of the analysis will serve only as a yardstick for the interpretation of other patterns. For a representative image, in which the high lights constitute a relatively small part of the total picture area, the performance will certainly excel that indicated by this example. With such a test pattern in mind, let us now examine the several factors in more detail.

A. Bulb-Wall Reflections

A casual inspection of the mechanism of bulb-wall reflections will

convince one that it is impractical to compute the illumination due to bulb-wall reflections for even the most elementary pattern. Referring to Figure 1, we see that the reflections are of two kinds, direct and diffuse. The reflection coefficients for both direct and diffuse reflections are dependent upon the angle of incidence. Coupling this with the complexities of multiple reflections, the difficulties of possible ray concentrations, and the geometric shape of the bulb, we immediately see the impracticability of an analytical approach.

An experimental approach, on the other hand, is relatively simple. The apparatus illustrated on cross-section in Figure 5 is well suited to this end. In this apparatus, a projector is arranged to illuminate a rectangular area on the screen, and the light flux contributed by bulb-

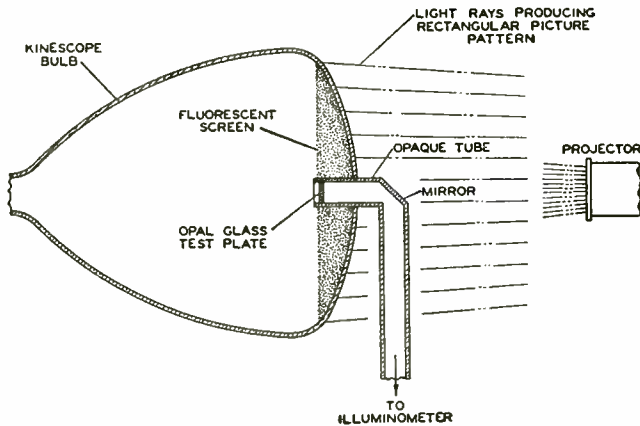

Fig. 5—Schematic representation of apparatus for measuring bulb-wall reflections.

wall reflections is received on the opal-glass test plate so situated in the opaque tube that it receives illumination only from the bulb walls. The brightness of the opal-glass test plate is measured by sighting the illuminometer on the image of the test plate in the mirror, while the brightness of the field is measured by viewing the screen through the opening at the bulb neck. The contrast ratio, i.e., the ratio of brightness of the field to the brightness of the dark area, is then readily determined if the transmission factor of the opal-glass test plate is known.

The merits of several bulb-blackening materials have been studied in this manner. The results of this study are summarized in Table I.

These results are significant in two respects. First, inasmuch as there is a very good correlation between the observed contrast ratio

TABLE I
EFFECTIVENESS OF VARIOUS TYPES OF BULB COATINGS

Type of Bulb Coating	Contrast Ratio as Determined by Bulb-Wall Reflections Alone
Uncoated bulb	4000
Acetylene black	800
E-25B-10 (RCA)	330
Aquadag	220

with a particular type of bulb coating and the diffuse-reflection coefficient for that coating, we are led to believe that the stray illumination occasioned by bulb-wall reflections is largely a consequence of diffuse reflections. This is a tribute to the effectiveness of the bulb shape in preventing direct reflections. Second, and perhaps more significant to the problem in hand, is the relatively large value of the contrast ratio. As we continue with our analysis of the other factors detrimental to contrast, we shall see that the stray illumination arriving by bulb-wall reflections is relatively unimportant. For this reason, the type of bulb coating will have relatively little effect upon contrast.

B. Screen Curvature

The effect of screen curvature on contrast is readily determined by analytical methods. In fact, if we wished, we could compute the stray illumination caused by screen curvature quite accurately for any bulb shape. However, in view of the possible wide variations in bulb shape, we shall compromise between rigor of method and adaptability of result by assuming that the image is reproduced on the interior surface of a portion of a sphere.

Let us consider a test pattern consisting of a small dark spot in the center of a uniformly bright circular field, as shown in Figure 6. Let R be the radius of the sphere, α be the angle subtended by the bright

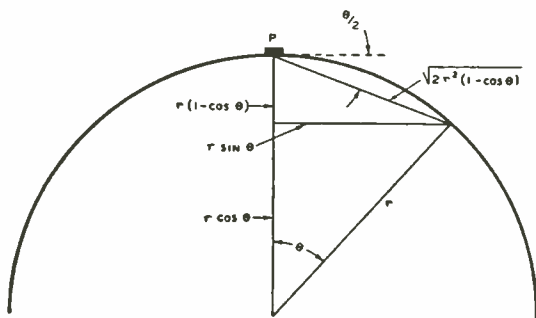

Fig. 6—Geometric considerations relative to the analysis of the effect of screen curvature.

circular field at the center of curvature, and let the bright field on the interior surface of the sphere have a brightness B . Assuming that Lambert's cosine law is obeyed at both the emitting area and the receiving area, and that the intensity of illumination varies as the inverse square of the distance, we find the light flux incident on unit area of the interior surface of the sphere in the dark spot will be

$$\phi = \frac{B}{\pi} \frac{2\pi R^2}{2R^2} \int_0^{\alpha/2} \frac{\sin \theta \sin^2 \frac{\theta}{2} d\theta}{(1 - \cos \theta)} \quad (1)$$

$$\phi = \frac{B}{2} \left[1 - \cos \frac{\alpha}{2} \right]. \quad (2)$$

This light flux will be scattered by the fluorescent particles. A portion of it, namely $T\phi$, where T is the total light-transmission factor of the fluorescent layer, will pass through the screen to the outside of the sphere. In this event, the brightness of the dark spot judged by an observer outside the sphere will be $T\phi$. The brightness of the field, on the other hand, will be $BT/(1 - T)$; whereupon, the contrast ratio, i.e., the ratio of brightness of the field to the brightness of the dark spot, will be

$$\text{Contrast Ratio} = \frac{2}{\left(1 - \cos \frac{\alpha}{2}\right)(1 - T)}. \quad (3)$$

Figure 7 shows the variation of contrast ratio with the angular size of the bright field computed in accordance with (3) for several values of the screen transmission factor. As is to be expected, we observe that the loss in contrast due to screen curvature may be made as small as desired by flattening the viewing screen. However, in view of the relatively large total pressure exerted on the external surface of a large evacuated bulb by the atmosphere, we are somewhat limited in how flat we can make the screen. In order for the envelope to withstand this pressure better, cathode-ray tubes are customarily made with a face which is quite flat near the center and more sharply curved at the edges. Our foregoing analysis is not strictly applicable to this case, but we may estimate the loss in contrast occasioned by screen curvature. By way of illustration, consider a tube envelope of the shape

illustrated in Figures 1 and 5. This is the shape of a 12-inch developmental kinescope of the type being used in the present RCA television field tests. This kinescope reproduces a rectangular image approximately 10 inches wide by 7½ inches high, and the contrast ratio as determined by screen curvature alone for the case of a dark spot in the center of the bright rectangular field should be about 70 for a conventional willemite-on-glass screen for which the transmission is about 40 per cent.

This result is checked experimentally. The effect of screen curvature on contrast may be measured in very much the same manner as we have measured the effect of bulb-wall reflections. If the opal-glass test plate of Figure 5 is moved in flush with the end of the opaque tube

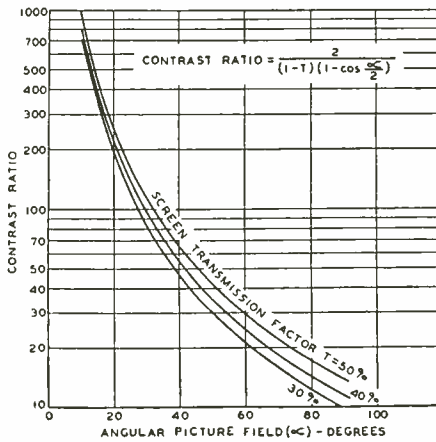

Fig. 7—Dependence of contrast ratio on screen curvature.

and the whole assembly is pushed out even with the fluorescent screen. the test plate will receive illumination by both bulb-wall reflections and screen curvature. With due correction for the relatively small amount of illumination arriving by bulb-wall reflections, the experimentally determined contrast ratio agrees very well with the theoretically derived value.

On the basis of these results, we see that screen curvature is definitely more detrimental to contrast than bulb-wall reflections. However, before we can evaluate the relative importance of either of these factors, we must examine the effects of halation.

C. Halation

The limiting value of contrast as determined by halation may be measured with the arrangement schematically illustrated in Figure 8.

In this apparatus, the field is illuminated by a lamp located sufficiently far away from the screen to give substantially uniform illumination, and the dark circular test area in the center of the field is shielded from direct illumination by a blackened conical light shield which is placed with its open end in contact with the fluorescent layer.

Neglecting diffusion through the fluorescent layer itself, we find that the only light flux reaching the dark test area arrives by halation. The contrast ratio as determined by halation is then simply the ratio of the brightness of the field to the brightness of the dark test area. Measurements of this kind for a conventional willemite-on-glass screen show that the limiting value of contrast ratio, as determined by halation, is about 5 or 6.

Comparing this result with the limiting values determined by screen

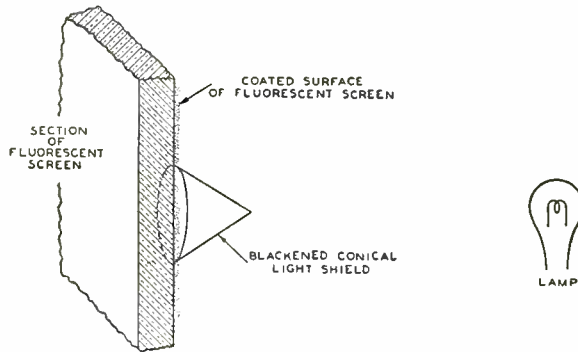

Fig. 8—Schematic representation of apparatus for measuring background illumination occasioned by halation.

curvature and bulb-wall reflections, we see why halation is so significant in determining over-all contrast. With this experimentally strengthened viewpoint as to the relative importance of halation, let us study the problem in more detail and see what can be done to minimize halation.

In beginning this study, let us first examine the way in which light flux leaves the fluorescent particles. This is very important, for it is only that portion of the light flux entering the kinescope face through regions of optical contract which is susceptible to total internal reflection.^{9,10}

⁹ M. von Ardenne, "Importance and Removal of Light Disturbances in Cathode-Ray Tubes", *Hochfrequenz. und Elektroakustik*, Vol. 42, pp. 113-115, October, 1933.

¹⁰ M. von Ardenne, "The Magnitude of the Light Disturbance in Cathode-Ray Tubes Using Different Fluorescent Screen Modifications", *Hochfrequenz. und Elektroakustik*, Vol. 66, pp. 1-4, July, 1935.

We may determine the relative portion of the light flux which enters the kinescope face through regions of optical contact. A closer examination of the fluorescent layer shows that it is made up of a multitude of very small, irregularly shaped, relatively transparent, crystalline particles of moderately high refractive index. In general, the particles will not be isotropic. However, due to their random orientation, we may suppose that they exhibit some median value of refractive index η_f . In the event that the particles are applied directly to the kinescope face without an intermediate bonding agent, any elementary area on the surface of an individual particle is bounded by one of three media: (1) another particle whose index is η_f ; (2) a vacuum whose index is unity; and (3) the kinescope face whose index we shall designate by η . Inasmuch as the light flux within the crystal will on the average undergo many internal reflections before it escapes, we may suppose that each luminous particle is filled with a substantially homogeneous radiation. If we neglect the relatively small portion of the light flux reflected at angles of incidence less than the critical angle, the light flux crossing unit elementary area between a fluorescent particle of index η_f bounded by a medium of index η_x is

$$\Delta\phi = C \int_{i=0}^{i=\gamma} \sin i \cos i \, di \tag{4}$$

where i is the angle of incidence and γ is the critical angle. But

$$\cos^2 \gamma = 1 - \frac{\eta_x^2}{\eta_f^2} \tag{5}$$

whereupon

$$\Delta\phi = C \frac{\eta_x^2}{\eta_f^2}. \tag{6}$$

Applying this to the present case, for the crystal-glass interface, we have

$$\Delta\phi_{\text{glass}} = C \frac{\eta^2}{\eta_f^2} \tag{7}$$

while for the crystal-vacuum interface,

$$\Delta\phi_{\text{vacuum}} = \frac{C}{\eta_f^2}. \tag{8}$$

Let us suppose that the kinescope face is entirely covered with fluorescent particles and D per cent of the kinescope face is in optical contact with these particles. Then, so long as $\eta_f > \eta$, the fractional part of the total light flux entering the kinescope face which will be susceptible to halation is

$$\phi_h = \frac{D\eta^2}{1 + D(\eta^2 - 1)} \quad (9)$$

while if $\eta_f \leq \eta$, the fractional part of the light flux susceptible to halation is

$$\phi_h = \frac{D\eta_f^2}{1 + D(\eta_f^2 - 1)} \quad (10)$$

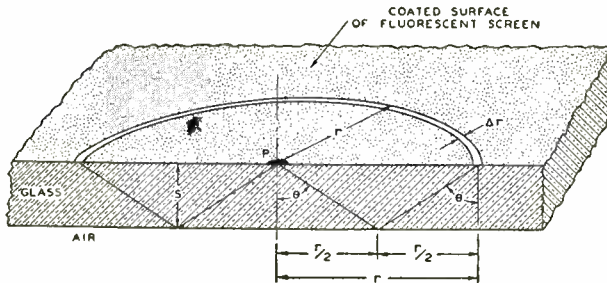

Fig. 9—Geometric considerations relative to the analysis of the effect of halation.

Because, in general, $\eta_f > \eta$, we shall be concerned with the ratio given by (9).

With this knowledge of the fractional part of the light flux that is susceptible to total internal reflections, let us return to our now familiar test case of a dark spot on a bright field. Referring to Figure 9, let p represent a dark area on a flat, uniformly bright field of infinite extent. Let the glass plate simulating the kinescope face have a refractive index η , and a thickness S . In addition, let us suppose that the glass plate exhibits a neutral light absorption such that if I_0 is the intensity of a light beam entering the material, the intensity I after passing through a thickness x of the material will be

$$I = I_0 e^{-kx} \quad (11)$$

where k is the absorption coefficient. Let the fluorescent layer have a

brightness B_0 on the side adjacent to the glass, and furthermore, let us assume that Lambert's cosine law holds, and that the intensity of illumination varies as the inverse square of the distance. If we neglect the relatively small portion of the light flux reflected at angles of incidence less than the critical angle, the light flux incident on unit area of the dark spot from first-order total internal reflections is

$$\phi_{p1} = \frac{B_0}{2S^2} \phi_h \int_{r=2S/\sqrt{\eta^2-1}}^{r=\infty} \frac{e^{-2k\sqrt{1+r^2/4S^2}}}{\left(1 + \frac{r^2}{4S^2}\right)^2} r dr. \tag{12}$$

However, of this light flux, only that portion which impinges on the interface at regions of optical contact between the glass plate and the fluorescent particles may enter the particles. The remainder will be again totally internally reflected and will not contribute to the illumination of the dark area. Neglecting the relatively small portion of the light flux reflected at areas of optical contact, we find that the fractional part of the light flux entering the particles is D , and that the remainder, namely $(1 - D)$, is again totally internally reflected. The light flux contributing to the illumination of the dark area is therefore $D\phi_{p1}$.

The light flux $D\phi_{p1}$ entering the fluorescent particles is scattered in all directions. A portion $D\phi_{p1}T$, where T is the total transmission factor of the fluorescent layer, is transmitted through the fluorescent layer, while the remainder, namely $D\phi_{p1}(1 - T)$, is returned. Insofar as first-order reflections are concerned, the resultant brightness of the dark area to an observer viewing the image from the glass side of the screen will be

$$B_{p1} = \frac{B_0 e^{-kS}}{2S^2} D(1 - T) \phi_h \int_{r=2S/\sqrt{\eta^2-1}}^{r=\infty} \frac{e^{-2k\sqrt{1+(r^2/4S^2)}}}{\left(1 + \frac{r^2}{4S^2}\right)^2} r dr. \tag{13}$$

For second-order reflections, the limits of integration and the path lengths change; furthermore, the amount of light flux will be decreased by an amount $(1 - D)$ due to the intermediate reflection. Consequently, for second-order reflections,

$$B_{p2} = \frac{B_0 e^{-kS}}{8S^2} D(1-T)(1-D)\phi_h \int_{r=4S/\sqrt{\eta^2-1}}^{r=\infty} \frac{e^{-k\sqrt{1+(r^2/16S^2)}}}{\left(1 + \frac{r^2}{16S^2}\right)^2} r dr. \quad (14)$$

Similarly, we may write the expressions for the contributions of higher-order reflections. The resultant brightness will be the summation of the individual contributions or

$$B_p = \frac{2B_0 e^{-kS}}{S^2} D(1-T)\phi_h \sum_{n=1}^{n=\infty} \frac{(1-D)^{n-1}}{(2n)^2} \int_{r=2nS/\sqrt{\eta^2-1}}^{r=\infty} \frac{e^{-2nk\sqrt{1+(r/(2nS))^2}}}{\left(1 + \frac{r^2}{(2n)^2 S^2}\right)^2} r dr. \quad (15)$$

If we make the substitution $x = 2nk \sqrt{1 + \frac{r^2}{(2n)^2 S^2}}$,

$$B_p = 2B_0 e^{-kS} D(1-T)\phi_h k^2 \sum_{n=1}^{n=\infty} (1-D)^{n-1} (2n)^2 \int_{x=2nk/\sqrt{\eta^2-1}}^{x=\infty} \frac{e^{-x}}{x^3} dx. \quad (16)$$

By successive integration by parts, we may reduce this to

$$B_p = B_0 e^{-kS} D(1-T)\phi_h \left(1 - \frac{1}{\eta^2}\right) \sum_{n=1}^{n=\infty} (1-D)^{n-1} e^{-x} \left[1 - x + x^2 e^x \int_{t=2nk/\sqrt{\eta^2-1}}^{t=\infty} \frac{e^{-t}}{t} dt\right]. \quad (17)$$

If we now introduce the value of ϕ_h from (9) and adopt the abbreviations

$$C = 2k \sqrt{\frac{\eta^2}{\eta^2 - 1}}, \quad \text{and} \quad R = (1 - D),$$

$$B_n - B_0 e^{-kS} \frac{D^2 (1 - T) (\eta^2 - 1)}{1 + D (\eta^2 - 1)}$$

$$\left[\frac{e^{-c}}{1 - Re^{-c}} - \frac{Ce^{-c}}{(1 - Re^{-c})^2} + \frac{C^2}{R} \sum_{n=1}^{\infty} R^n n^2 \int_{t=nC}^{t=\infty} \frac{e^{-t}}{t} dt \right]. \quad (18)$$

Inasmuch as an observer viewing the image from the glass side of the screen will see a field with a brightness $B_0 e^{-kS}$, the contrast ratio or ratio of brightness of field to brightness of dark area, will be

C.R. =

$$\frac{1 + D (\eta^2 - 1)}{D^2 (1 - T) (\eta^2 - 1) \left[\frac{e^{-c}}{1 - Re^{-c}} - \frac{Ce^{-c}}{(1 - Re^{-c})^2} + \frac{C^2}{R} \sum_{n=1}^{\infty} R^n n^2 \int_{t=nC}^{t=\infty} \frac{e^{-t}}{t} dt \right]}. \quad (19)$$

The value of the integral $\int_b^{\infty} \frac{e^{-t}}{t} dt$ has been tabulated,¹¹ and we may compute the contrast ratio.

This analysis recognizes four influencing factors: (1) the index of refraction of the kinescope face; (2) the light transmission of the fluorescent layer; (3) the degree of optical contact between the fluorescent particles and the kinescope face; and (4) the light absorption of the kinescope face. Of these four factors, the first is least susceptible to independent variation. If we are to use glasses commonly available, the index of refraction of the kinescope face is restricted to a value in the neighborhood of 1.5. We also observe that the light transmission of the fluorescent layer enters our result in a very simple manner. For these reasons, we shall carry out our computations in terms of optical contact and light absorption. Rather than express light absorp-

¹¹ E. Jahnke and F. Emde, "Tables of Functions", B. G. Teubner, Leipzig and Berlin, 1933.

tion in terms of the absorption coefficient k , we shall find our results more useful if we express the absorption in terms of the attenuation of the direct rays. Figure 10 shows the computed variation of contrast ratio with optical contact and attenuation for a particular example where the index of refraction is 1.5 and the light transmission of the fluorescent layer is 0.3.

The results of this computation are striking. Paradoxical as it may seem at first sight, it appears that halation may be reduced by introducing a light-absorbing layer in the kinescope face. This action of the absorbing layer is simply explained. The light rays, which enable

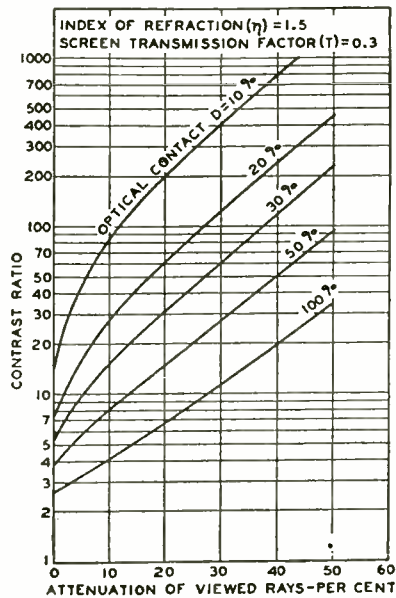

Fig. 10—Influence of various screen characteristics on contrast ratio.

us to see the image, pass through the kinescope face once in a nearly perpendicular direction and are attenuated relatively little. On the other hand, the light rays contributing to halation pass through the absorbing layer at least two extra times quite obliquely and are attenuated to a greater extent. Furthermore, with low degrees of optical contact a large part of the light flux contributing to halation arrives by multiple reflections and traverses the absorbing layer many more than three times. Such multiple reflected light rays are greatly attenuated even though the attenuation for the viewed rays is relatively small.

This theory is confirmed by experimental studies. Such experimental studies are simply made, for not only can one determine the

contrast but one can evaluate the four factors governing contrast as well. Thus, the index of refraction may be measured with a refractometer. The light absorption and the light transmission may be measured photometrically. And finally, the degree of optical contact may be determined by observing the relative illumination in the successive light bands when a light beam is multiple reflected as shown in Figure 11.

To illustrate the experimental approach, let us examine a typical kinescope and see how it fits in with the theory. The significant characteristics of a conventional willemite-on-glass screen are approximately: index of refraction, 1.5; screen transmission, 0.3; degree of optical contact, 0.3; and attenuation, zero. With a screen of these characteristics, it is to be expected that the limiting value of contrast

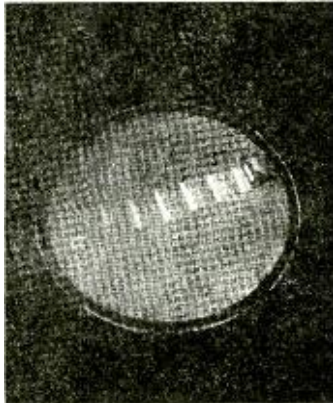

Fig. 11—Illustration showing decrease in intensity occasioned by successive internal reflections.

as determined by halation should be about 6. This agrees very well with the results of our previously described experimental observations.

We may extend the range of our experimental study in several ways. By using a special viewing screen of cellular form filled with glycerin containing different amounts of a neutral light-absorbing dye, we may vary the attenuation over a wide range. By using various screen materials and also a flashed opal-glass viewing screen which gives substantially 100 per cent optical contact we may extend the investigation over a wide range of optical contact.

In order to interpret these results accurately, we must apply two corrections. First, we must correct for the finite area of the viewing screen, and second, we must correct for the effects of normal reflec-

tions. The nature of these corrections will be discussed in more detail a little later.

In this manner, it has been possible to verify the theory in the low-contrast range. Unfortunately, however, it is difficult to correlate experiment and theory in the high-contrast range. There are several reasons for this. From an experimental standpoint, it is difficult to make sufficiently accurate measurements of contrast in this range, and from a theoretical standpoint, it is difficult to compute the corrections with sufficient accuracy. Although the contribution of partial reflections occurring at the glass-air interface for angles less than the critical angle is small, this contribution becomes very important in the high-contrast range.

A computation of the contribution of reflections of this type, which we shall designate as normal reflections, is particularly difficult when we are dealing with an absorbing medium; for, although the reflection coefficient near normal incidence is simply $(\eta - 1)^2/(\eta + 1)^2$, at angles near the critical angle, Fresnel's equations describing both the parallel and perpendicularly polarized components must be employed. Such a computation is tedious and would need to be carried out for several values of the absorption coefficient. For the purpose of this investigation, it has been considered adequate to carry out this computation for the case of zero attenuation. Obviously, the contribution of normal reflections will be less as the attenuation is increased.

For the case of zero attenuation, a point-by-point computation shows that the effect of the glass-air interface may be approximated by a partial mirror whose reflection coefficient is $0.6 (\eta - 1)^2/(\eta + 1)$. By reasoning now familiar to the reader, we find the limiting value of contrast ratio as determined by normal reflections to be

$$C.R._{\text{normal reflections}} = \frac{(\eta + 1)^2}{0.6 (1 - T) (\eta - 1)^2} \quad (20)$$

For a specific case in which the index of refraction is 1.5, the screen transmission is 0.3, and the attenuation is zero, the limiting value of contrast ratio as determined by normal reflections is approximately 60. Although this contribution becomes less at appreciable attenuations, it may still be larger than the contribution of the total internal reflections in the high-contrast range.

When we consider the consequences of a finite-area viewing screen, we encounter even greater analytical difficulties. Looking back over our preceding analysis we see that the computations were greatly simplified by the assumption of an infinite area. By way of illustration, let us

consider the case of a small dark area in the center of a uniformly bright circular field of radius R . Returning to (16), we see that although the lower limits of the summation and the integration remain unchanged, the upper limit of the summation becomes

$$n_{\max} = \frac{R}{2S} \sqrt{\eta^2 - 1}$$

and the upper limit of the integration becomes

$$x_{\max} = 2nk \sqrt{1 + \frac{R^2}{(2n)^2 S^2}}$$

These limits are seen to depend upon the ratio of screen thickness to screen size, or more properly upon the ratio of screen thickness to the radius of the circular field. The radius of the circular field may in turn be associated with the picture size when the kinescope is used to reproduce a television image. Using these limits, we might proceed to derive an expression of the same general form as (17). With such a relationship, we could undoubtedly compute families of curves of the type illustrated in Figure 10 for each of a series of ratios of screen thickness to screen size. However, this would be very laborious and does not seem to be justified in the present case. Instead, let us endeavor to get an idea of the effect of varying this ratio by considering a simple example. If we introduce the present limits in our previous equation (15) and assume no attenuation, we obtain

$$B_v = \frac{2B_0}{S^2} D (1 - T) \phi_h \sum_{n=1}^{n=R/2S\sqrt{\eta^2-1}} \frac{(1 - D)^{n-1}}{(2n)^2} \int_{r=2nS/\sqrt{\eta^2-1}}^{r=R} \frac{rdr}{\left[1 + \frac{r^2}{(2n)^2 S^2}\right]^2} \quad (21)$$

In this event the contrast ratio may be shown to be

$$C. R. = \frac{1 + D (\eta^2 - 1)}{D^2 (1 - T) (\eta^2 - 1) \sum_{n=1}^{n=R/2S\sqrt{\eta^2-1}} (1 - D)^{n-1}} \quad (22)$$

$$\left[1 - \frac{\eta^2}{\eta^2 - 1} \left(\frac{1}{1 + \frac{R^2}{(2n)^2 S^2}} \right) \right]$$

Figure 12 shows a plot of this function for several values of optical contact. For a viewing screen of given size, the contrast is observed

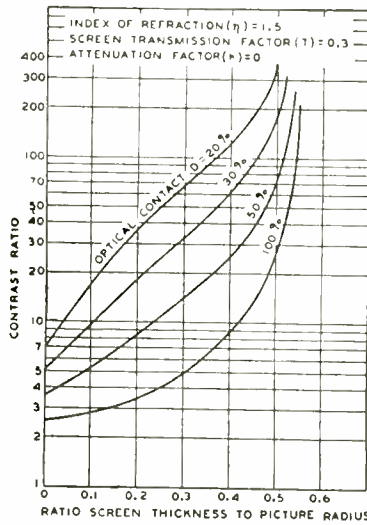

Fig. 12—Influence of picture size on contrast ratio.

to improve as the screen thickness is increased. The initial improvement is more rapid as the optical contact is decreased. As the viewing screen is made still thicker, the halation disappears irrespective of the degree of optical contact.

Although this simple example does not close this problem, it does serve to indicate the magnitude of the variation and to show that the correction to be applied for this effect is relatively small so long as the radius of the bright field is large in comparison to the screen thickness.

So much for the analysis of the individual factors contributing to loss of contrast. Let us now see how these results are to be applied to practical kinescope design.

IV. PRACTICAL DESIGN OF A KINESCOPE GIVING GOOD CONTRAST

Preparatory to an application of the results of this detailed analysis to practical kinescope design, let us summarize our findings. For a conventional willemite-on-glass kinescope reproducing a dark spot in the center of a bright field, the limiting value of contrast ratio as determined by each of the individual factors alone is approximately as follows:

Halation	6
Normal reflections	60
Curvature of screen	70
Bulb-wall reflections	200

The net contrast ratio resulting from a consideration of these factors collectively is the reciprocal of the sum of the reciprocals, or about 5.0.

We have already emphasized the importance of halation. However, before we discuss ways and means of reducing halation, let us make a few observations concerning the other factors.

The contribution of normal reflections is relatively small. This is fortunate, for unless we go to an immersion system,¹² there is very little we can do to minimize them. In this connection, it may be well to point out that the safety-glass cover customarily placed over the face of the kinescope in a television receiver has two such partially reflecting air-glass interfaces. The equivalent reflection coefficient of these two surfaces is about three times as great as the equivalent reflection coefficient of the kinescope glass-air interface and such a safety-glass cover is about three times as detrimental to contrast as our so-called normal reflections.

The detrimental effect of screen curvature on contrast may be reduced by flattening the screen. However, the contribution of this factor is also small and it is probable that the trend toward a flatter screen will be guided by the demand for a flatter image rather than by a demand for greater contrast.

As for bulb-wall reflections, their contribution to loss of contrast is even less. This is particularly true for a properly shaped uncoated bulb.

Our main avenue to improved contrast, therefore, lies in reducing halation. This may be done in several ways, for although the index of refraction of the kinescope face and the light transmission of the fluorescent layer are more or less fixed, the degree of optical contact,

¹² G. N. Ogloblinsky, "Immersion Projection Lens", U. S. Patent 2,093,288, 1937.

together with the attenuation and the thickness of the kinescope face may be varied over wide limits.

Our theory has indicated that a viewing screen of greater thickness may be advantageous. This statement requires qualification, because so far we have considered only the case of a small dark spot in the center of a uniformly bright field. Such a test object is excellent insofar as the determination of the limiting value of the contrast in the fine detail of the image is concerned, but it does not tell us much about the over-all contrast range when the image contains relatively large dark areas.

To illustrate, let us suppose that one half of the rectangular television image is uniformly bright while the other half is dark except

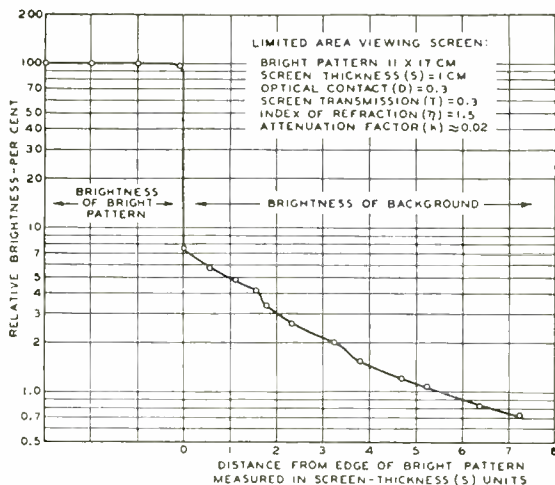

Fig. 13—Results of an experimental determination of the relative brightness of the background adjacent to a bright pattern.

for the stray illumination arriving by halation. The contrast ratio at a point on the axis of symmetry immediately adjacent to the edge of the bright pattern will be just twice as great as that for the case of a small dark spot in the center of a uniformly illuminated field of the same total size. But how does the relative brightness of the background vary as we proceed away from the edge of the bright pattern? This may be determined experimentally. Figure 13 illustrates the results of such an experimental determination for the case of 11- × 17-centimeter pattern reproduced on a 1-centimeter thick, flat, viewing screen having approximately two per cent attenuation, 30 per cent optical contact, 30 per cent light transmission, and an index of refraction of 1.5. Distance is plotted in screen thickness units (S units).

Curve A of Figure 14 is an enlarged-scale plot of the bottom portion of this curve. The breaks at approximately $1.8S$ and $3.6S$ mark the termination of the first- and second-order halation bands at the distances $2S/\sqrt{\eta^2 - 1}$ and $4S/\sqrt{\eta^2 - 1}$, respectively. The accompanying curves, B and C, are for different conditions. Thus, although we cannot make similar measurements on an infinite-area viewing screen, we can compute the background illumination immediately adjacent to the bright pattern. By analogy with the preceding case, for an infinite-area screen, we would expect the background illumination to vary in somewhat the manner indicated by curve B. Similarly, for an infinite-

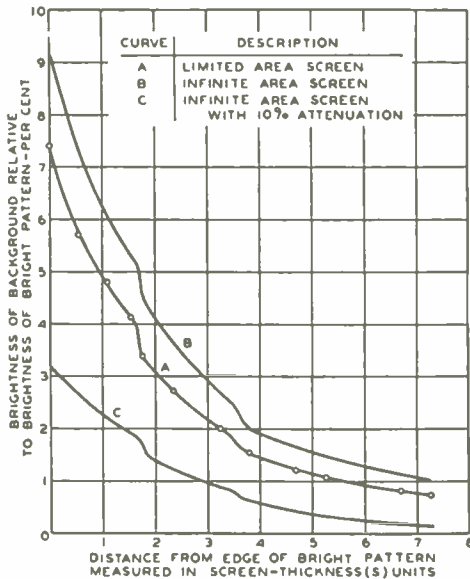

Fig. 14—Relative brightness of the background adjacent to a bright pattern for different types of viewing screens.

area screen with 10 per cent attenuation, we would expect the background illumination to vary in somewhat the manner indicated by curve C.

We now come to an interesting point. As the viewing screen is made thinner, with a given picture size, the relative size of the bright pattern in S units increases and the background illumination immediately adjacent to the bright pattern increases. These effects are illustrated in Figure 14 where we find that the background illumination goes from the condition represented by curve A to the condition represented by curve B. However, under certain conditions this shift may

not be detrimental to picture quality, for as the screen is made thinner, the halation bands move in closer to the edge of the bright pattern. This is illustrated by the curves of Figure 15 which show the variation of background brightness with distance from the edge of a bright pattern of fixed size for three different screen thicknesses. If the viewing screen is made sufficiently thin, that is, if the screen thickness is small in comparison to the size of a picture element, the halation bands move in so close to the edge of the bright pattern as to be of no importance. This condition is even more readily attained if the screen is light-absorbing, because the higher-order halation bands are more effectively suppressed. These deductions explain the apparent absence

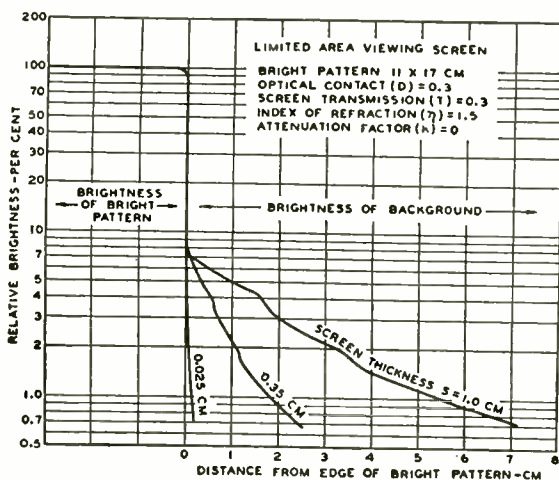

Fig. 15—Relative brightness of the background adjacent to a bright pattern for similar viewing screens of different thicknesses.

of halation in our previously described, thin, mica viewing screen.

However, in the practical kinescope the situation is quite different. If the fluorescent material is to be applied directly to the bulb face which must necessarily be several picture elements thick, the halation bands can no longer be concealed. Our efforts must, therefore, be directed toward reducing their intensity. In this respect a thicker viewing screen is advantageous. For example, referring to Figure 12, we observe that increasing the ratio of screen thickness to picture size from 0.05 to 0.15 for the case of 30 per cent optical contact increases the detail contrast by a factor of two. This is not the complete story, however, for this gain is accomplished at the expense of increased background illumination in the relatively large dark areas of the picture.

There are, therefore, two aspects to the contrast problem. First, there is detail contrast, that is, the contrast ratio for the case of a small dark spot on a bright field; and second, there is contrast range that is, the ratio of the brightness of the brightest part of the picture to the brightness of the darkest spot of the picture. A little later, when we come to examine the performance of typical kinescopes, we shall see that the second of these ratios is much larger than the first so that the loss in range occasioned by the thicker screen is more than offset by the gain in detail contrast.

So much for the qualification of our original statement that increased screen thickness gives improved contrast. This is but one of the factors governing contrast. Let us now see what improvements can be effected by combining low optical contact with a moderate amount of attenuation.

In practice, optical contact may be varied over wide limits. Conventional, sprayed screens have an optical contact of about 30 per cent. Settled screens, wherein the fluorescent particles are deposited on the kinescope face from a liquid suspension, ordinarily have an optical contact of about 20 per cent. Dusted screens, prepared by air-settling the particles on an initially tacky binder layer, may have even lower degrees of optical contact. Although the latter type of screen is ordinarily quite transparent due to the relative low coverage, this does not mean that the transmission factor T in our analysis is increased, for the transmission factor significant in this respect is the transmission of the individual particles rather than the over-all transmission. However, due to the low coverage, the optical contact in such a screen may be very low insofar as multiple reflections are concerned. Furthermore, by controlling the tackiness of the binder layer and the size of the particles, it is possible to control the depth to which the particles imbed themselves in the binder layer, thereby influencing the fractional part of the light susceptible to halation.

Although our theory has not been adapted to fit this case of partial coverage, it is immediately evident that such a screen may have very low optical contact and should, therefore, give appreciably better contrast than sprayed or settled screens. We shall see that this is so when we come to examine the performance of typical kinescopes.

Attenuation may be varied over wide limits also. Insofar as the theory is concerned, the light-absorbing medium may be dispersed in the kinescope face, or it may be disposed in a thin layer located between the fluorescent particles and the bulb face. Thus, the kinescope bulb may be made from a darkened glass, or a thin layer of light-absorbing material may be applied to the bulb face before the fluorescent mate-

rial is applied. If a binder layer is used to attach the fluorescent particles to the kinescope face, it may be advantageous to incorporate the absorbing material in the binder layer. This comes about because the binder layer ordinarily has a higher index of refraction than the kinescope face, which combination of circumstances gives rise to appreciable halation at the binder-glass interface. The extent of this disturbance is greatly reduced if the absorbing material is incorporated in the binder layer.

The amount of attenuation necessary to give a desired contrast ratio will depend upon the other characteristics of the screen. The optimum attenuation is probably between 10 and 20 per cent. Lesser attenuations would not make possible the realization of the full benefits to be derived by reduction of halation. On the other hand, greater attenuations are not to be recommended because the loss in contrast

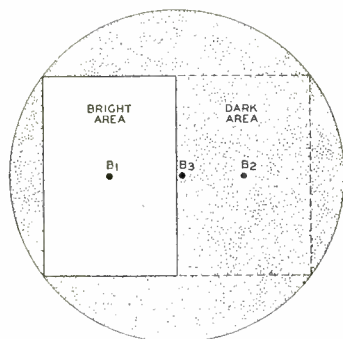

Fig. 16—Test pattern for measuring contrast performance characteristics of kinescopes.

due to halation becomes about equal to the combined losses due to the other effects and an additional sacrifice in the brightness of the image would not give a corresponding improvement in over-all contrast.

Contrast performance studies have been made on a number of developmental kinescopes of different design. In these studies, the test pattern illustrated in Figure 16 was used. A uniformly bright rectangular pattern of normal television-picture height and one-half normal television-picture width was displaced horizontally so that the inner vertical edge of the pattern coincided with the axis of symmetry of the tube. The relative brightness of the viewing screen was measured at three positions as indicated in the drawing. Thus,

B_1 = brightness at the center of the illuminated pattern

B_2 = brightness at a conjugate point on the dark background

B_3 = brightness of the dark background at a point on the axis of symmetry immediately adjacent to the bright pattern.

From these measurements, two values of contrast ratio were computed.

$$\text{Detail-contrast ratio} = B_1/2B_3$$

$$\text{Range-contrast ratio} = B_1/B_2.$$

As already mentioned, the first of these ratios, the detail contrast ratio, determines the limiting value of the contrast in the fine detail of the picture and is a measure of the sharpness or "clear-cutness" of the image. The second of these ratios, the range-contrast ratio, is an

TABLE II
CONTRAST PERFORMANCE CHARACTERISTICS OF TYPICAL DEVELOPMENTAL KINESCOPIES

Type of Screen	Optical Contact	Absorption	Ratio Screen Thickness to Half Picture Width	Contrast Ratios	
				Detail	Range
Sprayed	Approximate Per Cent 30	none*	0.04	6.2	50
		none	0.08	8.9	50
		20	0.04	19	100
Settled	20	none	0.04	10	70
		none	0.08	15	70
		20	0.04	25	100
Dusted	15	none	0.04	18	70
		20	0.04	34	100

* Clear glass.

arbitrary measure of the range-reproducing ability of the kinescope.

The general results of this study are shown in Table II.

Viewing tests with representative pictures on screens of these types show that the general appearance of the image is intimately correlated with the detail contrast ratio. Inasmuch as the detail ratio is strongly influenced by optical contact and absorption, the merits of low optical contact and moderate absorption are immediately evident.

Although improvement brought about by the use of an absorbing medium necessarily results in a small decrease in the light output efficiency, this loss does not seem to be unreasonable for a gain that contributes so much to the perfection of the image.

Although better contrast is obtained when the lowest optical contact is combined with a moderate amount of absorption we are particularly interested in sprayed screens because of the ease with which

they may be applied. Such screens would normally give poor detail contrast because of their relatively large optical contact, but the detail contrast may be appreciably improved when an absorbing medium is introduced. Thus, a 20 per cent absorption makes the contrast performance of a sprayed-screen kinescope better than that of a conventional settled- or dusted-screen kinescope.

V. CONCLUSIONS

The contrast-reproducing ability of kinescopes may be controlled by adhering to specific design principles. Sprayed-screen kinescopes using moderate absorption and a relatively thick bulb face are capable of reproducing images with more than adequate contrast for present needs. For an average picture in which the high lights constitute a relatively small part of the total picture area, the high lights may easily be 50 to 100 times as bright as the low lights; at the same time, the brightness contrast ratio for fine detail in the picture may have a value of at least twenty to one even with a sprayed screen. Such a detail-contrast-reproducing ability gives the kinescope a versatility at least as great as that of photographic printing papers. If greater detail contrast should be required, the demand can be met by combining moderate absorption with lower optical contact. As for the range-reproducing ability of the kinescope, it is probably not below that realized in motion-picture reproduction.

SUPERHETERODYNE CONVERTER SYSTEM CONSIDERATIONS IN TELEVISION RECEIVERS*†

By

E. W. HEROLD‡

Research and Engineering Department, RCA Manufacturing Company, Inc.,
Harrison, N. J.

Summary—There are three methods of operation of tubes for use in the converter stage of superheterodyne receivers. In the first, signal and oscillator voltages are impressed on the same electrode of the tube, while in the other two, signal and oscillator voltages are placed on different electrodes. The latter two methods are differentiated by whether the oscillator electrode precedes or follows the signal electrode along the direction of electron flow. By the use of four fictitious tubes, a triode and a pentode using the first method of operation, a hexode for outer-grid oscillator injection, and a hexode for inner-grid oscillator injection, the three methods are compared.

$$g_c = \frac{1}{2\pi} \int_0^{2\pi} g_m \sin \omega t \, d(\omega t)$$

$$\overline{i_{i-f}^2} = \frac{1}{2\pi} \int_0^{2\pi} \overline{i_{pn}^2} \, d(\omega t)$$

For all converters or mixers, the conversion transconductance is shown in the left-hand equation where g_m is the signal-electrode to output-electrode transconductance and ω is the angular frequency of the oscillator. The mean-squared plate noise current is shown in the right-hand equation where $\overline{i_{pn}^2}$ is the mean-squared plate noise current of the same tube under amplifier conditions. By using the formulas for $\overline{i_{pn}^2}$ developed by Thompson and North and applicable to the first three of the fictitious tubes and an empirical relation for the noise of the fourth, quantitative relations for the conversion transconductance and equivalent grid noise resistance are developed.

By assuming a similar cathode and first grid structure, the triode, pentode, and outer-grid-oscillator-injection hexode may be compared quantitatively for use in a television converter stage. It is found that the triode with oscillator and signal voltages on the control grid has greatest gain and lowest noise while the pentode is only slightly poorer in this respect. However, the triode has the disadvantage that feedback must be taken into account. The hexode with oscillator on an outer grid is at a disadvantage with respect to both gain and noise and does not appear to be suitable as a first tube in a high-sensitivity television receiver. The hexode with oscillator on an inner grid, although it can be compared only qualitatively, is judged to be not much superior in gain or noise to the other hexode. It is advantageous chiefly in the case with which a local oscillator may be combined in the same mount.

In tubes such as the triode and pentode in which oscillator and signal are applied to the same grid, the use of automatic bias such as obtained by

* Decimal Classification: R583.5 × R361.102.2.

† This paper was presented at the I.R.E. Convention in New York, N. Y., on Sept. 23, 1939 under the title, "Superheterodyne First Detector Considerations in Television receivers". Reprinted from *RCA REVIEW*, January 1940.

‡ Now with the Research Department, RCA Laboratories Division, Princeton, N. J.

a high-resistance gridleak minimizes variations of gain with oscillator voltage. Practical operating data at television frequencies are given for some commercially available tubes including two pentagrids designed for broadcast use. The latter are very poor in conversion transconductance and noise as compared with the high-transconductance type 6AC7/1852 pentode. The equivalent noise resistance of the type 6AC7/1852 used in the converter or first-detector stage is about as low as that of the other high-transconductance type, the 6AB7/1853, used as amplifier. No marked improvement in signal-to-noise ratio can be expected, therefore, by adding a type 6AB7/1853 r-f stage ahead of an 6AC7/1852 first detector in a television receiver.

INTRODUCTION

DURING recent years the communication field has seen considerable improvement in the design and performance of frequency converters for superheterodyne receivers. In many ways, however, these improvements have only followed those of amplifier tubes. The reason for this is that, basically, the principle of frequency conversion has remained unchanged: by taking an amplifier and varying its amplification periodically at the oscillator frequency we obtain the converter. Thus the better the amplifier, the better the converter, and this has been the story throughout the years. Unfortunately, the converter always appears to be behind the amplifier, because, as is indicated by simple theory, the gain of a tube used as a converter cannot exceed about one-third the gain of the same tube used as amplifier. As regards fluctuation noise, some converters are at a still greater disadvantage over amplifier tubes because they include a large number of current-drawing electrodes.

With the introduction of commercial television, many tube problems arose and, among them, not the least important was that of the converter, or first detector stage. Although an r-f stage may be used in some designs, many receivers omit this stage. It is with the latter type of receiver that the converter problem is most acute. Fluctuation noise, for example, sets a limit to the sensitivity of a receiver and, when the noise is expressed in terms of an equivalent single-frequency voltage, is very high in the wide-band picture channel. It will be seen, however, that high-transconductance amplifier tubes used in the converter stage provide a reasonably satisfactory solution to the noise problem.

The converter stage of a superheterodyne receiver comprises two parts: the modulator which produces the intermediate frequency, and the local oscillator. In a television receiver, the oscillator must operate stably and with little frequency shift up to 120 Mc. Such qualities are most readily obtained when a separate tube is used for the oscillator. This paper will be mainly concerned, therefore, with the modulator section of the converter stage, the oscillator section being treated only when it bears directly on the modulator problem.

GENERAL CHARACTERISTICS OF CONVERTER OPERATION

The process of frequency conversion is essentially one of low-percentage modulation of the local oscillator frequency by the signal frequency. One of the sidebands of the modulation process is utilized as the intermediate frequency. Such low-percentage modulation may be carried out in any one of three ways. In the first, signal and oscillator are impressed on the same electrode of the tube and modulation occurs by virtue of curvature of the tube characteristic. In the second, the signal is placed on a grid adjacent to the cathode and the oscillator is placed on a following electrode. The third way connects the oscillator to the grid adjacent the cathode and the signal to a later electrode. The conversion operation of all three is readily analyzed from the signal-electrode-to-plate transconductance, g_m , vs. oscillator-electrode voltage curve. It should be noted that this is true even when a local oscillator is included in the same tube structure.

By a Fourier analysis of the signal-grid transconductance vs. oscillator-electrode voltage curve, the conversion transconductance is found in the same way that the fundamental component of plate current in an amplifier is found by analysis of the plate-current vs. control-grid voltage curve. This has already been brought out in other papers^{1, 2}. Mathematically, letting $t = 0$ to be the time at which the fundamental component of oscillator-electrode alternating voltage crosses zero, the conversion transconductance, g_c is given by

$$g_c = \frac{1}{2\pi} \int_0^{2\pi} g_m \sin \omega t \, d(\omega t)$$

where ω is the angular frequency of the oscillator. Roughly, a close estimate of the maximum conversion transconductance of practical tubes is given by 28 per cent of the maximum signal-grid transconductance attained over the oscillator cycle. By making use of such an analysis together with the results of recent studies of tube fluctuation noise, an interesting comparison may be made among modulators of the three basic types.

Let us consider four fictitious modulators or mixers, all made with similar cathode and first grid structures, the first a triode, the second a pentode, and the third and fourth hexodes*. These are shown sche-

¹ Nesslage, Herold, and Harris, "A New Tube for Use in Superheterodyne Frequency Conversion Systems", *Proc. I.R.E.*, Vol. 24, pp. 207, Feb. 1936.

² The Operation of Frequency Converters and Modulators; E. W. Herold; to be published.

* The considerations also apply to heptodes.

matically in Figure 1. The triode and the pentode are to be operated with both oscillator and signal on the control grid, while the hexodes are operated, in the one case, with the oscillator on an outer electrode and, in the other, with the oscillator on an inner electrode. The signal-grid characteristics of each of these types is shown at the right, in every case as a function of the oscillator-electrode voltage. In the first two, the latter electrode is identical with the signal electrode so that the curves show simply the transconductance, g_m , and plate current, I_b , vs. control-grid voltage. In the other two the transconductance of one grid (the signal grid) is plotted against the voltage on another, namely the oscillator grid. In each case, the shape of the curve is typical of practicable tubes. In any event, the conclusions to be drawn are not altered by minor variations in curve shape. It should be remembered that, when the signal is placed on the same electrode as the oscillator, this electrode is not permitted to draw excessive grid current. Thus, the curves need not be extended into the positive grid region in the first two cases.

To the right of Figure 1 is given a tabular summary of conversion transconductance and noise for the four fictitious tubes. A brief discussion of the derivation of the values will be in order. If the transconductance of the triode at zero bias be called g_o and an oscillator is applied to the grid at approximately the optimum point, a Fourier analysis of the transconductance vs. bias curve gives a conversion transconductance of about $0.28 g_o$. Going to the pentode, it is assumed that the screen current is 20 per cent of the total current so that the pentode curves are lowered by this amount. The conversion transconductance is correspondingly reduced. It should be noted that g_o is the cathode transconductance not the plate transconductance (in the triode the two are the same). In the hexode first detector with signal applied to the first grid, experience indicates that the plate current is not greatly in excess of 50 per cent of the total current when the oscillator grid is at its maximum positive excursion. The curves shown on Figure 1 are plotted against No. 3 grid voltage and are typical of the shape usually obtained. In such a tube, the oscillator-electrode control is by current division so that the transconductance and plate-current curves are similarly shaped. Analysis indicates a conversion transconductance of $0.14 g_o$.

The lower hexode of Figure 1 cannot be compared directly with the other tubes because there is no direct dependence of the signal-grid (No. 3 grid) characteristics on the cathode and first grid structure. In general, the maximum No. 3 grid transconductance depends on the uniformity of the structure and on the No. 3 grid area. In most practical tubes a partial virtual cathode is formed between No. 2 and

No. 3 grids. The curve shapes drawn are typical of such tubes. It is difficult to attain a maximum transconductance (g_x in the figure) which exceeds the g_o of the other tubes without the tube being extremely critical to voltage variations. It is not likely that the hexode with signal on the outer grid offers much more possibility as regards conversion transconductance than the previous hexode. It will be observed that the conversion transconductance is approximately 28 per

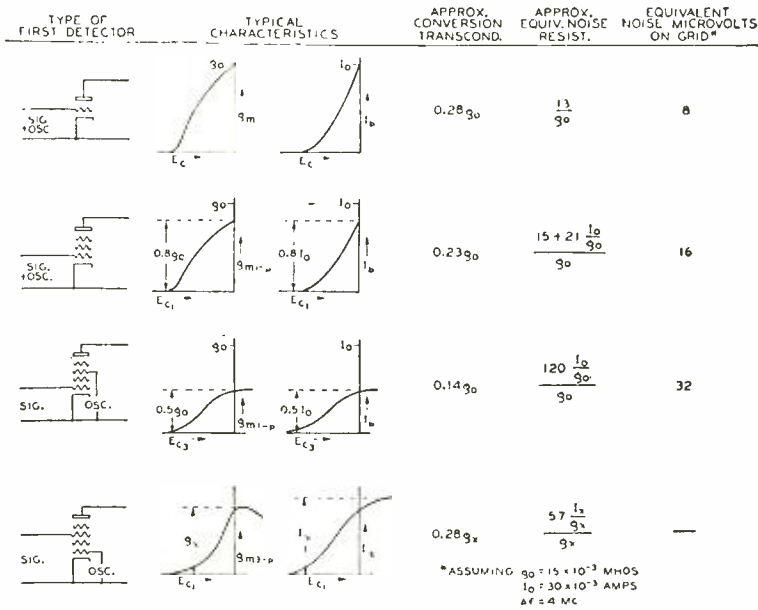

Fig. 1—Comparison of four fictitious modulators presumed to have similar cathode and first-grid structures.

cent of the maximum transconductance attained over the oscillator cycle in all the four illustrations of Figure 1, even though the curve shapes are markedly different.

The mean-squared noise of the modulator part of the converter stage may be shown to be the time-average value of the mean-squared noise over an oscillator cycle. Thus, if $\overline{i_{pn}^2}$ be the mean-squared noise current in the plate of a tube at a fixed bias, the application of an oscillator voltage will vary this noise current periodically. The resultant noise at an intermediate frequency remote from that of the oscillator will be the average over the oscillator cycle, or

$$\overline{i_{i,f}^2} = \frac{1}{2\pi} \int_0^{2\pi} \overline{i_{pn}^2} d(\omega t)$$

If an expression for $\overline{i_{pn}^2}$ is known for a tube, therefore, it becomes possible to estimate the noise such a tube will produce when used as converter or mixer. Expressions for $\overline{i_{pn}^2}$ in the triode and in the pentode have been derived³.

The noise fluctuations of a tube are conveniently expressed in terms of an equivalent noise resistance, R_{cq} , at the grid. This resistance is independent of band width and gives a direct indication of the mean-squared noise voltage per unit band-width of the grid. For these reasons it is a convenient means for comparing the noise-to-signal ratio for various tubes. The value of the resistance is obtained by equating the thermal noise of a resistor at room temperature to the equivalent grid-noise voltage of the tube. Thus, for a converter or mixer,

$$R_{cq} = \frac{1}{4kT_R} \frac{\overline{i_{i-f}^2}}{g_v^2 \Delta f}$$

where T_R is the temperature of the room, usually taken as 293°K. The values of equivalent noise resistance in Figure 1 were found in this way.

For the triode, the plate noise is approximately given by

$$\overline{i_{pn}^2} = 0.64 (4kT_R) g_m \Delta f$$

where k is Boltzman's constant, T_R is the absolute temperature of the cathode ($\approx 1000^\circ\text{K}$) and Δf is the band-width. Under converter conditions, therefore, the triode will have

$$\overline{i_{i-f}^2} = \frac{1}{2\pi} \int_0^{2\pi} \overline{i_{pn}^2} d(\omega t) = 0.64 (4kT_R) \overline{g_m} \Delta f$$

where $\overline{g_m}$ is the average transconductance over the oscillator cycle. Computation of $\overline{g_m}$ for the triode shows:

$$\overline{g_m} = 0.47 g_o$$

Using the value for g_v in terms of g_o permits the equivalent noise resistance of Figure 1 to be found; namely

$$R_{cq} = \frac{13}{g_o}$$

The equivalent noise resistance for the triode, and for the other tubes as well, as computed in this way should be considered as a lower limit

³ B. J. Thompson and D. O. North, "Shot Effect in Space-Charge Limited Tubes", presented at the Rochester Fall Convention of the I.R.E., Nov. (1936); cf. Thompson, North, and Harris, "Fluctuations in Space-Charge-Limited Currents at Moderately High Frequencies", *RCA REVIEW*, Vol. IV, No. 3, January, 1940.

rather than as a norm. Noise within the tube other than that exhibited in the plate circuit has been neglected and will, in general, increase practical equivalent noise resistances.

In the pentode, fluctuations in the current distribution between screen and plate are also present. In the usual tube with nearly uniform screen grid, an approximate expression for the noise³ is

$$\overline{i_{pn}^2} = \left[0.64 (4kT_K) g_{m1p} \frac{I_b}{(I_{c2} + I_b) \sigma} + 2e \frac{I_{c2} I_b}{I_{c2} + I_b} \right] \Delta f$$

where e is the charge on the electron, I_{c2} is the screen current, and σ is the ratio of total transconductance to the conductance of an equivalent diode. The factor $\frac{I_b}{(I_{c2} + I_b) \sigma}$ is very closely unity when the

screen current is around $\frac{1}{4}$ of the plate current as in the usual tube and will be so taken here. Since the ratio of screen to plate currents in a pentode is approximately constant, we may find the noise under converter conditions by the approximate expression,

$$\overline{i_{if}^2} = \left[0.64 (4kT_K) \overline{g_{m1p}} + 2e \frac{\overline{I_b}}{1 + \frac{I_b}{I_{c2}}} \right] \Delta f$$

where $\overline{I_b}$ is the average value of the plate current over the oscillator cycle (i.e., the actual operating plate current). Analysis of the typical curves of Figure 1 with the oscillator voltage applied at about the optimum point shows $\overline{g_m} = 0.37 g_o$ and $\overline{I_b} = 0.28 I_o$ where I_o is the maximum value of the total current. Since it has been assumed that $I_{c2}/I_b = 0.25$, the mean-squared noise can be determined in terms of I_o and g_o . The equivalent noise resistance will be found to have the value

$$R_{eq} = \frac{15 + 21 I_o/g_o}{g_o}$$

The plate noise, $\overline{i_{pn}^2}$, of a hexode or heptode is not so easily determined on theoretical grounds because of the possibility of a partial virtual cathode in the tube and the presence of secondary emission. For this analysis, however, secondary emission may be considered as negligibly small (it can be made so by a suppressor grid, for example) and virtual cathode formation may be neglected, at least for the type

of tube in which the signal is placed on an inner grid and the oscillator voltage on an outer grid. Under these assumptions, the heptode or hexode plate noise should be primarily current-distribution noise which is approximately equal to

$$\overline{i_{pn}^2} = 2e \frac{I_b I_{c2}}{I_b + I_{c2}} \Delta f$$

Under converter conditions, then,

$$\overline{i_{i,f}^2} = 2e \frac{\Delta f}{2\pi} \int_0^{2\pi} \frac{I_b I_{c2}}{I_b + I_{c2}} d(\omega t)$$

Since $I_b + I_{c2} = I_o$, which is approximately a constant, it may easily be shown that the integral becomes

$$\overline{i_{i,f}^2} = 2e \left(\overline{I_b^2} - \frac{1}{I_o} \overline{I_b^2} \right) \Delta f$$

where $\overline{I_b^2}$ the average of the square of the plate current over the oscillator cycle while $\overline{I_b}$ is, of course, the average plate current. It is found that $\overline{I_b} = 0.20 I_o$ and $\overline{I_b^2} = 0.09 I_o^2$ for the typical curve of Figure 1. Expressing the results in terms of $\overline{I_b}$ indicates $\overline{i_{i,f}^2} = 0.55 (2e) \overline{I_b}$ which approximately checks measured values.* Use of this formula gives an equivalent noise resistance for the heptode with outer-grid oscillator injection which is

$$R_{c,q} = \frac{120 I_o / g_o}{g_o}$$

The hexode or heptode with the signal on an outer grid cannot be considered as free from virtual-cathode formation and so is not amenable to similar treatment. Experimental data, however, indicate that such a tube will have a noise (with oscillator applied) of

$$\overline{i_{i,f}^2} = 2e \overline{I_b} F^2 \Delta f$$

where F^2 is often from 0.5 to 0.6 when secondary electrons from the screen are suppressed, and somewhat higher otherwise. The mean plate current for the typical curve of Figure 1 is

$$\overline{I_b} = 0.41 I_r$$

* i.e., in tubes with negligible secondary emission from the screen grid. In tubes having secondary emission, the noise-per-unit plate current is usually greater.

where I_x is the maximum plate current over the oscillator cycle. The equivalent noise resistance for this tube was computed assuming $F^2 = 0.55$ and becomes

$$R_{cq} = \frac{57 I_x / g_x}{g_x}$$

The last column of Figure 1 was computed by assuming $g_o = 15 \times 10^{-3}$ mhos, and $I_o = 30 \times 10^{-3}$ amps., values which are typical of a high-transconductance tube design. The column shows the grid voltage which is equivalent to the square root of the mean-squared noise voltage over a 4-Mc band. This voltage may be considered as limiting the useful sensitivity of the receiver.

It is now possible to compare the four fictitious tubes of Figure 1 for use in the television converter stage.* As to noise, the figure is self-explanatory and, in receivers with no r-f stage, there is little choice except between the first two. The conversion gains of the four types working into loads typical of television-receiver practice is also in favor of the first two. The triode, however, has a practical disadvantage over the pentode in that feedback must be taken into account. Since the i-f circuit is capacitive at signal frequency, an input resistance at signal frequency is obtained which is excessively low unless neutralization is used or the grid-plate capacitance is very low in comparison with the i f tuning capacitance. The feedback may also increase the noise appreciably. Thus, although it would be possible to use the triode, the pentode is probably a safer choice.

Regarding input loading at high frequencies, the first three types will have only minor differences because the cathode and signal-grid structures were assumed to be similar. It should be remembered, however, that cathode injection of the oscillator is not permissible because of the additional input loading due to the added cathode inductance. The last type with an outer grid used for the signal will be substantially free of positive input loading (the input resistance of such a tube is usually negative).

Interaction of oscillator and signal circuits is greatest when their voltages are placed on the same grid, especially since cathode injection is contra-indicated. Least interaction may be obtained in the third type, the hexode with oscillator on an outer grid, which may be made substantially free of interaction. Among the undesirable effects which may be attributed to interaction are radiation and alignment difficulties. Radiation may be reduced to some extent by selective circuits

* More detailed information on the operation of the different types of modulator will be found in Reference 2.

between antenna and grid while alignment difficulties can be minimized by coupling the signal circuit loosely to a non-critical portion of the oscillator circuit. The latter procedure is permitted in a high-transconductance tube because of the small oscillator voltage required.

It appears to be difficult to combine the function of local oscillator in the same mount with a modulator when operation is to extend to such high frequencies. There is some advantage in this respect in the last of the types, the hexode with oscillator applied to an inner grid. This statement has been borne out by the relatively larger number of types and greater popularity of such converters in the broadcast field. Because of noise and interaction due to "space-charge coupling", this last type is not too well suited for television use.

It may be concluded that, although none of the four fictitious tubes meets all of the television receiver requirements, the triode or pentode with oscillator and signal on the same grid will give highest gain and

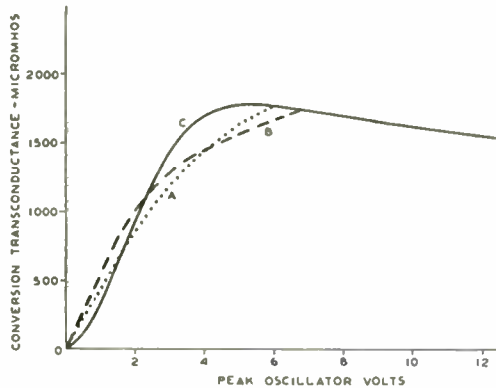

Fig. 2—Conversion transconductance of a typical variable-mu pentode. Signal and oscillator voltages applied to the control grid. Curve A, fixed-bias operation; curve B, cathode-resistor bias; curve C, grid-leak bias. Curves A and B have been drawn only up to the grid-current point.

lowest noise, and these types are, therefore, highly advantageous, particularly when no r-f stage is used.

PRACTICAL DATA ON TELEVISION CONVERTER STAGE

In a practical circuit using a pentode first detector, the methods of applying the oscillator and of obtaining bias are of considerable importance. It is highly desirable that variations of effective oscillator voltage, which are unavoidable when channels are switched, have a minimum effect on gain. It is also desirable that the oscillator voltage never swing the control grid so far positive as to draw large amounts of grid current. A means of achieving both ends consists in the use of automatic bias. This may be obtained either by a cathode self-bias

resistor or a high-resistance gridleak and condenser or both. An illustration of the improvement which may be made in this way is shown in Figure 2 which is taken from another paper*. For the curve labelled (A) a fixed bias was used at approximately an optimum point. The curve is stopped at the grid-current point. Curve (B) shows cathode-resistance bias and curve (C) a high-resistance gridleak used for bias. It is evident that least critical operation is obtained with gridleak bias. With such operation, the bias is obtained by rectification of the effective oscillator voltage. The gridleak may be made part of an avc filter, but it should be made considerably higher than the resistance common to other tubes in order to avoid biasing them excessively.

The cathode current of a high-transconductance tube used with gridleak bias reaches excessive values when the oscillator voltage is

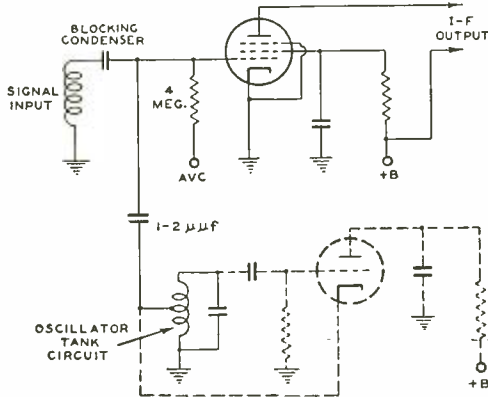

Fig. 3—Circuit of a typical converter stage using a high-transconductance pentode with a separate oscillator.

accidentally removed. This may be avoided by the use of series-screen resistor operation. Series-screen operation makes the gain even less dependent on oscillator voltage than the best of the curves of Figure 2.

Figure 3 shows a practical circuit using a pentode with gridleak bias and a series-screen resistance. The oscillator is applied across the signal circuit through a small condenser which is tapped down on the oscillator tank circuit. By this means the reaction of the signal circuit on the oscillator circuit may be kept small. The type of oscillator circuit used is not of great importance. For the sake of completeness, however, a Hartley oscillator circuit is drawn in dotted lines.

Table I shows data pertinent to television converter operation, which have been taken on a number of commercially available tube types. Two types of pentagrid tubes commonly used in broadcast receivers are included for comparison. It is evident that they are

* See Reference 2.

HEATER VOLTAGE 6.3 VOLTS
 PLATE VOLTAGE 300 VOLTS
 SUPPRESSOR VOLTAGE 0 VOLTS
 CONTROL-GRID BIAS \approx OSC. PEAK VOLTS
 BIAS OBTAINED BY GRID CURRENT THROUGH
 4-MEGOHM GRID LEAK

CURVE	SCREEN-SUPPLY VOLTAGE-VOLTS	SERIES SCREEN RESISTOR-OHMS
---	200	0
—	300	60000

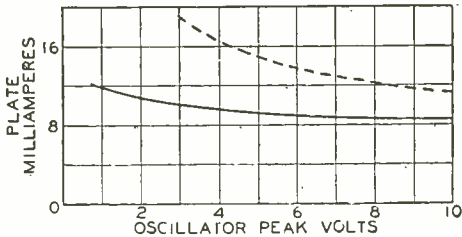
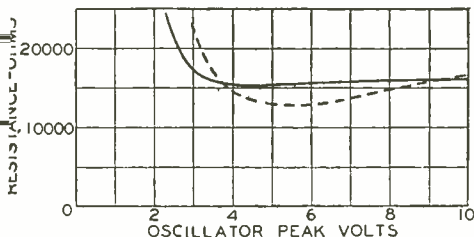
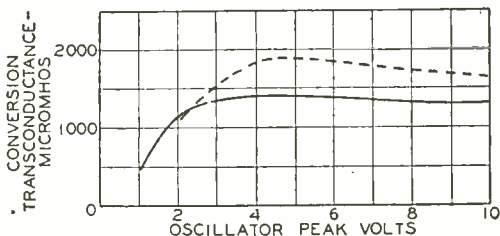

Fig. 4—Typical first-detector characteristics of the type 6AB7/1853.

It should be mentioned that the noise data of Table I were taken with a low impedance in the signal-grid circuit. The noise values must, therefore, be considered as minimum values because they neglect noise currents which are induced in the signal-grid itself by the passage of electrons,⁴ and which may be appreciable at television frequencies.

More detailed data on the conversion performance of types 6AB7/1853 and 6AC7/1852 are shown by the curves of Figures 4 and 5. The data were measured using a 4-megohm gridleak and are shown for both fixed and series-screen supply. In neither case is the

HEATER VOLTAGE 6.3 VOLTS
 PLATE VOLTAGE 300 VOLTS
 SUPPRESSOR VOLTAGE 0 VOLTS
 CONTROL-GRID BIAS \approx OSC. PEAK VOLTS
 BIAS OBTAINED BY GRID CURRENT THROUGH
 4-MEGOHM GRID LEAK

CURVE	SCREEN-SUPPLY VOLTAGE-VOLTS	SERIES SCREEN RESISTOR-OHMS
---	150	0
—	300	100000

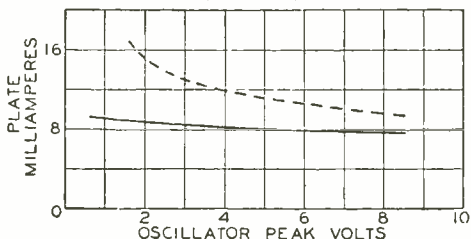
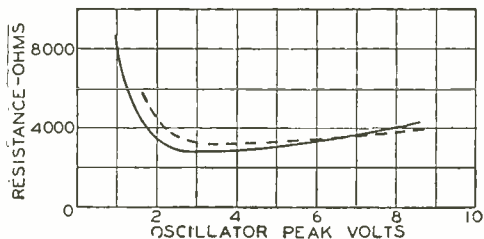
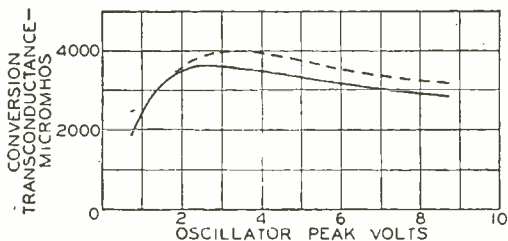

Fig. 5—Typical first-detector characteristics of the type 6AC7/1852.

⁴ S. Ballantine: "Schrot-Effect in High-Frequency Circuits"; *Jour. Frank. Inst.*, Vol. 206, pp. 159-167, Aug. (1928).

required oscillator voltage critical as to value. The conversion-transconductance curves for series-screen supply are somewhat flatter than those for fixed supply. Series-resistor-screen supply has the additional advantages that the plate current is held to reasonable values at low oscillator excitation and that variations between tubes are somewhat minimized.

The 3000-ohm equivalent-noise resistance of the 6AC7/1852 used as first detector is remarkably low and compares favorably with that of most amplifier tubes. The type 6AB7/1853, for example, when used as an amplifier, has an equivalent noise resistance of about the same magnitude. It is interesting to compare the potential signal-to-noise ratios of two receivers, each with a 6AC7, 1852 in the converter stage followed by a 6AB7/1853 i-f amplifier, but the second having a 6AB7/1853 r-f stage added. If the i-f stage gain is assumed to be sufficiently high (e.g., > 5), the noise of further i-f stages may be considered negligible. Calling the gain of the first detector stage A_D , and the gain of the r-f stage A_{RF} and assuming each tube as having an equivalent-noise resistance of R_{cq} ohms it is found that

R_1 = Noise equivalent resistance of receiver without

$$\text{r-f stage} = R_{cq} \left(1 + \frac{1}{A_D^2} \right)$$

R_2 = Noise equivalent resistance of receiver with

$$\text{r-f stage} = R_{cq} \left(1 + \frac{1}{A_{RF}^2} + \frac{1}{A_{RF}^2 A_D^2} \right)$$

It is evident that if A_{RF} is infinite, the noise resistance of the receiver with an r-f stage is at a minimum. Even with this ideal and impossible condition, the improvement in signal-to-noise ratio over the receiver

without an r-f stage will be only $\sqrt{1 + \frac{1}{A_D^2}}$ or less than 6 per cent

for $A_D > 3$. It is impractical, therefore, in a television receiver, to obtain marked improvement in signal-to-noise ratio by adding an 6AB7/1853 r-f stage to a receiver with an 6AC7/1852 first detector, no matter what the r-f stage gain may be. An improved signal-to-noise ratio can only be obtained by using a 6AC7/1852 for the r-f stage.

ACKNOWLEDGMENT

The author wishes to express his appreciation for the valuable advice of Dr. D. O. North of this laboratory.

OPTIMUM EFFICIENCY CONDITIONS FOR WHITE LUMINESCENT SCREENS IN KINESCOPES*†

By

H. W. LEVERENZ‡

Research and Engineering Department, RCA Manufacturing Company,
Harrison, N. J.

Summary—Calculations based on energy ratios and relative luminosities of complementary colors show that the efficiency of white-light production is greatest for the pair of spectral lines at 4590Å (violet blue) and 5720Å (yellow green). Spectral distribution curves of relative absorption and emission are given for the zinc-cadmium sulphide phosphor systems and for typical white kinescope screens.

IN previously published papers,^{1,2} information has been given concerning methods of producing efficient kinescope (television cathode-ray tube) screens, and data have been given indicating the wide range of colors now available in several phosphor systems.

Kinescopes used in the early stages of electronic television had green-emitting screens of manganese-activated zinc orthosilicate (willemite) or copper-activated zinc sulphide. A gradual evolution from green to yellow to cream (or sepia) to white took place as luminescence research, sponsored by television, brought forth efficient phosphors in regions of the visible spectrum other than those occupied by the original greens.

A brief summary of the color variations produced in the silicate and sulphide phosphor systems is given in Sections 3c-3d of reference 2. The more efficient phosphors are characterized by relatively narrow emission bands which produce rather saturated hues. The silicate system yielded the only homogeneous white-emitting phosphor known to the writer.³ Unfortunately, the white-emitting silicates suffered too great a loss of efficiency by being spread not only over the visible spectrum but also over part of the ultraviolet region. The problem of efficient white-light production from kinescopes, therefore, was solved

* Decimal Classification: R583.6.

† Presented before the Niagara Falls Meeting of the Optical Society of America, Oct. 27, 1938. Reprinted from *Jour. Opt. Soc. Amer.*, July, 1940.

‡ Now with the Research Department, RCA Laboratories Division, Princeton, N. J.

¹ H. W. Leverenz, *Jour. Opt. Soc. Amer.*, 27, 25-35 (1937).

² H. W. Leverenz and F. Seitz, *Jour. App. Phys.* 10, 479-493 (1939).

³ H. W. Leverenz and F. Seitz, *Jour. App. Phys.* 10, 491, and Fig. 27 (1939).

by mechanically mixing two or more phosphors to give a resultant broad emission spectrum.

Figure 1 shows the relative spectral distributions of energy for representative members of the silver-activated zinc-cadmium sulphide system.* The lower curves are for energy distribution while the upper curves are obtained by multiplying curves 1, 4, and 6 with the eye sensitivity values to obtain the relative visual stimuli represented by the

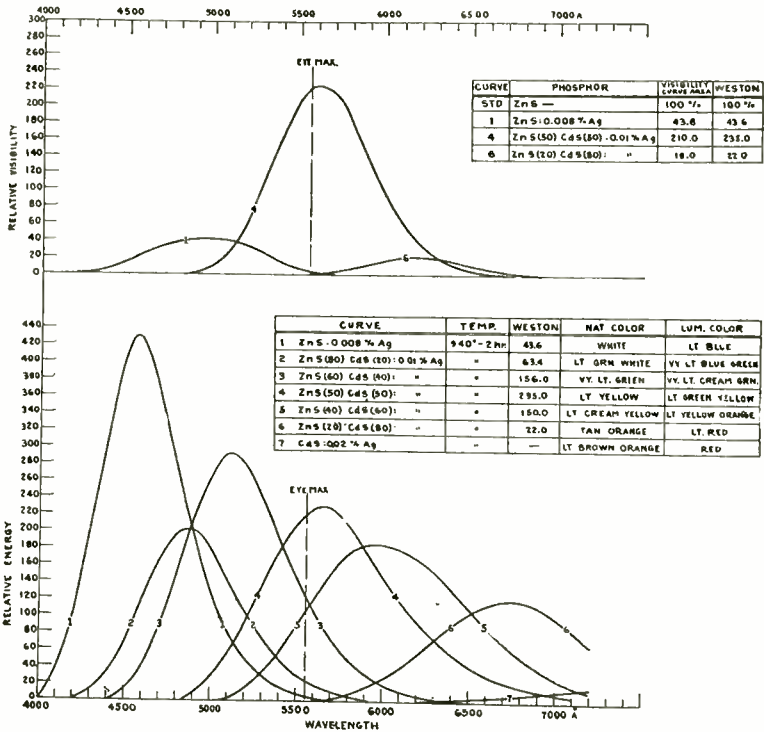

Fig. 1—Spectral distributions of energy and visibility of the zinc sulphide-zinc cadmium sulphide phosphor system.

* The marked deviation of curve 2, ZnS(80) CdS(20) : Ag, from the rest of the family of curves is evidently real. Repeated synthesis and tests give the same sub-normal result which is probably caused by a transition point in the zinc sulphide system's crystal structure. The ZnS:Ag phosphor of curve 1 shows both sphalerite and wurtzite structure while curves 3-7 of (ZnCd)S:Ag and CdS:Ag show only the wurtzite form. The ZnS(80) CdS(20):Ag phosphor therefore represents a strain point with respect to the definite crystallization which is necessary for high efficiency phosphors. The curve maximum of ZnS(90) CdS(10):Ag phosphor at 4700Å is about 60 percent of the maximum of curve 2. Further investigations, including x-ray diffraction studies, are being undertaken in this anomalous region.

area under each curve. The visual ineffectiveness of the strong blue-emitting zinc sulphide (curve 1) relative to the weaker yellow zinc-cadmium sulphide (curve 4) is occasioned by the former's greater distance from the maximum (5560A) of the eye sensitivity curve. Area-integration of the visibility-corrected curves gives good agreement with readings taken independently with an eye-corrected Weston photronic illuminometer (model 603), as is seen in the upper table of the figure.

It is obvious that the entire visible spectrum may be encompassed in infinitesimal gradations by the sulphide system alone. However, before considering the mixing of these phosphors to produce less

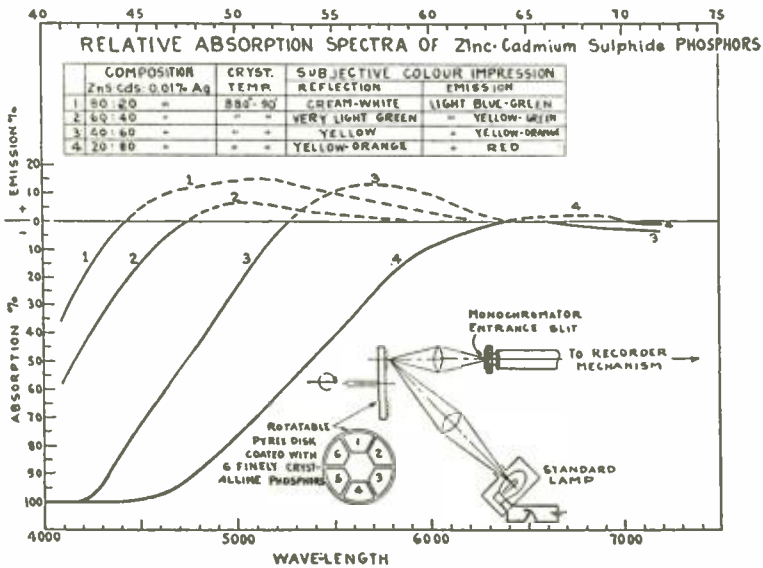

Fig. 2—Absorption spectra of zinc cadmium sulphide phosphors.

saturated colors by addition, their absorption spectra shown in Figure 2 should be considered. The method of making these absorption measurements of phosphor powders is also illustrated in the figure. The method of focusing the light into the monochromator entrance slit is shown, but details of the automatic recording spectroradiometer⁴ are omitted. The actual absorption curves are obtained as deviations from the known energy distribution of a calibrated incandescent lamp. It is seen that short wave visible radiation excites considerable luminescence in the zinc-cadmium sulphides, as evidenced by the dotted curves

⁴ V. K. Zworykin, *Jour. Opt. Soc. Amer.* 29, 84-91 (1939).

of emission above the zero axis of Figure 2. Inspection of the absorption curves of Figure 2 shows how strongly the yellow, orange, and red phosphors absorb blue and green light. A mechanical mixture of blue and yellow sulphides, calculated simply upon their known relative spectral distributions, would not yield an additive resultant emission spectrum, but would be deficient in the blue because of the yellow component's blue-absorption. The selective absorption effect may be avoided by depositing the phosphor crystals in separate layers such that the strongly-absorbing phosphors are on the side of the screen opposite the observer or projection lens.

Given a practically unlimited choice of well-saturated hues, and assuming equal efficiency of energy emission over the entire visible

TABLE I. Complementary wave-lengths and their relative luminosities.

PAIR No.	COMPLEMENTARIES				RELATIVE LUMINOSITIES		RELATIVE LUMINOSITIES OF λ_1 AND λ_2 WHICH, WHEN ADDED, PRODUCE WHITE		
	λ_1	HUE λ_1	λ_2	HUE λ_2	L_{λ_1}	L_{λ_2}	L_1	L_2	L_2/L_1
1	4430 A	Violet-Blue	5705 A		0.0275	0.9479	1.8	73.2	40.6
2	4590		5720	Yellow-Green	0.0578	0.9356	2.9	72.1	24.9
3	4665	Blue	5730		0.0802	0.9274	4.4	70.6	16.0
4	4720		5740		0.1006	0.9192	6.0	69.0	11.5
5	4745		5755		0.1126	0.9069	7.3	67.7	9.3
6	4775	Green-Blue	5765	Yellow	0.1270	0.8987	9.2	65.8	7.16
7	4805		5785		0.1425	0.8823	10.8	64.2	5.95
8	4825		5800	Orange-Yellow	0.1563	0.8700	13.0	62.0	4.77
9	4875		5860		0.1908	0.8012	19.6	55.4	2.82
10	4900	Blue-Green	5910	Orange	0.2080	0.7444	24.7	50.3	2.04
11	4935		6090	Red-Orange	0.2483	0.5158	35.7	39.3	1.10
12	4960		6500		0.2770	0.1070	43.4	31.6	0.73

spectrum, there is the question as to which pair of the many complementary colors will give optimum visible efficiency of white light.

Table I⁵ shows some complementary monochromatic wave-lengths, λ_1 and λ_2 , their individual relative luminosities (L_{λ}) interpolated from eye visibility data (see curve, Fig. 4) and the paired relative luminosities (L) of each complementary wave-length required to produce the sensation of white at 75 photons ($= L_1 + L_2$). (One photon = unit of visual stimulation = surface brightness of one candle/meter² (0.2914 foot-lambert) seen through a pupil of 1 mm² area.) The value of 75 photons expressed in foot-lamberts is: $75 \times 0.2914 = 21.9$ foot-lam-

⁵ R. H. Sinden, *Jour. Opt. Soc. Amer. and Rev. Sci. Inst.* 7, 1123-1153 (1923).

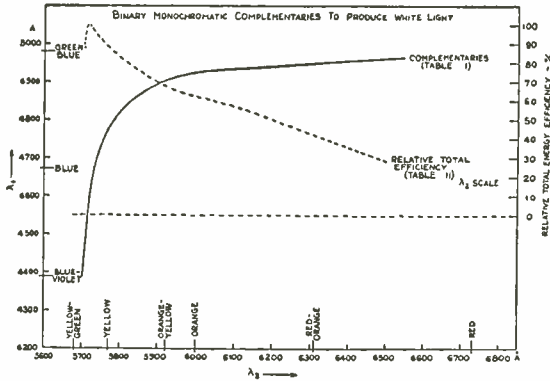

Fig. 3—Graphical representation of complementary wave-lengths and their efficiencies.

berts. This value is near enough to the 18-foot-lambert⁶ highlight brilliance of a 12-inch kinescope screen to allow direct use of the luminosity data for conclusions concerning cathode-ray television images.

The solid curve of Figure 3 shows the complementary color relationship expressed in graphical form, with the green-blue wave-length scale on the ordinate and the yellow-red wave-length scale on the abscissa to give the complementary intercepts from any point on the solid curve.

From the relative luminosity data in Table I, the relative radiant energies ($E\lambda$) required to produce white light from the listed complementaries are calculated and listed in Table II.

By forming the quotients of the paired relative luminosities L_1 and L_2 of each complementary wave-length with their corresponding individual relative luminosities, $L\lambda_1$ and $L\lambda_2$, we obtain the expressions

TABLE II. Complementary wave-lengths and their efficiencies calculated from data of Table I

PAIR NO.	COMPLEMENTARIES		RELATIVE ENERGIES REQUIRED TO PRODUCE WHITE LIGHT		TOTAL ENERGY $E_{\lambda_1} + E_{\lambda_2} = E_T$ (75 PHOTONS)	RELATIVE PERCENTAGE OF TOTAL ENERGY		RELATIVE ENERGY EFFICIENCY $E_T / \min(E_T)$
	λ_1	λ_2	E_{λ_1}	E_{λ_2}		E_1	E_2	
1	4430	5705	65.5	77.3	142.8	45.9%	54.1%	89.3%
2	4590	5720	50.2	77.1	127.3	39.5	60.5	100. (Arb. Std.)
3	4665	5730	54.8	76.3	131.1	41.8	58.2	97.1
4	4720	5740	60.0	75.2	135.2	44.4	55.6	94.2
5	4745	5755	64.9	74.7	139.6	46.5	53.5	91.3
6	4775	5765	72.5	74.4	146.9	49.4	50.6	86.8
7	4805	5785	75.8	72.8	148.6	51.0	49.0	85.8
8	4825	5800	83.2	71.3	154.5	53.9	46.1	82.5
9	4875	5860	102.8	69.2	172.0	59.8	40.2	74.0
10	4900	5910	118.8	67.6	186.4	63.8	36.2	68.4
11	4935	6090	143.7	76.2	219.9	65.5	34.5	57.9
12	4960	6500	156.6	295.0	451.6	34.7	65.3	28.2

⁶ V. K. Zworykin and W. H. Painter, *Proc. I.R.E.* 25, 937-953 (1937).

$$E\lambda_1 = L_1/L\lambda_1 \text{ and } E\lambda_2 = L_2/L\lambda_2.$$

These give the relative energies of the given complementary wave-lengths, λ_1 and λ_2 , required to produce 75 photons of white light. For example, with complementary pair 5, the relative energies required at each of the two wave-lengths, 4745A and 5755A, in order to give 75 photons of white light are

$$E_{4745} = 7.3/0.1126 = 64.9$$

and

$$E_{5755} = 67.7/0.9069 = 74.7.$$

The total energy required to produce white light from any complementary pair is

$$E_T = E\lambda_1 + E\lambda_2$$

and the relative percentage of the total energy contributed by each wave-length, λ_1 and λ_2 , comprising a white light complementary pair is given by

$$E_1 = E\lambda_1/E_T$$

and

$$E_2 = E\lambda_2/E_T.$$

For example, from a continuation of the analysis of pair 5, we obtain

$$E_T = 64.9 + 74.7 = 139.6,$$

$$E_{1(4745)} = 64.9/139.6 = 46.5\%,$$

$$E_{2(5755)} = 74.7/139.6 = 50.6\%.$$

The values E_1 and E_2 give the percentages of the total radiant energy E_T which must be produced at the given wave-lengths, λ_1 and λ_2 , to produce 75 photons of white light.

In the last column of Table II, the total energy values E_T are reduced to efficiency percentage values in terms of the most efficient complementary pair which happens to be pair 2 ($= E_T$ minimum). It is seen that pair 5, of the calculated example, has an efficiency of only 91.3 percent of pair 2, while pair 12 (4960A + 6500A) has a white-light producing efficiency of only 28.2 percent. Reciprocally expressed, pairs 5 and 12 would require, respectively, 10 percent and 350 percent more energy expenditure than pair 2 in order to produce equivalent

sensations of white light. The relative-energy efficiency data in the last column of Table II are plotted as the dotted curve corresponding to the right-hand ordinate scale in Figure 3. From the maximum of the sharply peaked curve, it is concluded that the most efficient, binary-monochromatic-white-producing source comprises violet-blue light (4590A) and green-yellow light (5720A).

Figure 4 shows the eye visibility curve, the approximate color zones and the relative energies (E_1 and E_2 from Table II) required to produce 75 photons of white light. The heights of the vertical lines of E_1 and E_2 are in direct proportion to the numerical values of E_1 and E_2 and may be read from the percentage scale on the right-side ordinate.

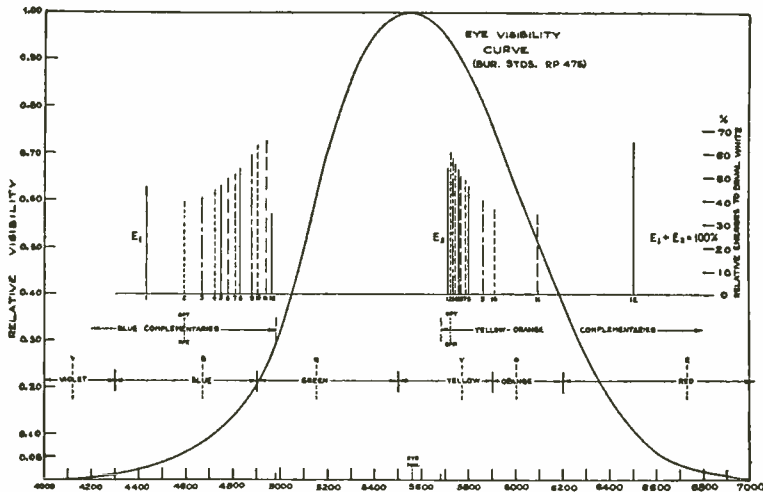

Fig. 4—Eye sensitivity curve and the energy ratios of spectral complementaries.

It is noticeable that the values of E_2 , discounting pair 12 which is very unfavorably located with respect to the visibility curve, rise to a maximum at pair 2 which is quite close (93.6 percent) to the maximum sensitivity of the human eye. The value of E_1 for optimum efficiency should naturally be kept to a minimum since none of the blue complementaries has a relative luminosity higher than 28 percent of the eye maximum. The maxima and minima of the families of E_1 and E_2 lines are in reciprocal relationship since $E_1 + E_2 = 100$ percent.

For practical purposes, the monochromatic wave-lengths given in the tables may be translated into narrow-band spectra since the fusion mechanism of color vision cannot separate the individual components of a composite color. Each wave-length thus represents any band spectrum giving substantially the same saturated color. Most of the

efficient phosphors have rather narrow emission bands which are symmetrical enough to be treated as the colors represented by the maxima of their spectral-distribution curves.

The practical conclusion from the above analysis is that a violet-blue-emitting phosphor, such as silver-activated zinc sulphide (band centered around 4590A) mixed with a substantially equivalent particle-size green-yellow-emitting phosphor such as zinc beryllium silicate or zinc-cadmium sulphide (band centered around 5720A) should be used to obtain optimum efficiency. A third, *viz.* green, component may be used to balance irregularities in band shapes.

Although this conclusion was not previously obvious, being obscured by inadequate knowledge of the energy economics of complementary color-mixing and the misleading fact that light blue (unactivated) sulphides give 2-3 times the visual efficiency of the recommended violet-blue-emitting, silver-activated zinc sulphide, it is apparent that the luminescent materials further assist this analysis, since the blue zinc sulphides, yellow zinc beryllium silicates, and yellow zinc cadmium sulphides have increasing peak energy output as their spectra are shifted to shorter wave-lengths (Figure 1 and reference 2). A further advantage is obtained in reducing the action of yellow zinc-cadmium sulphides which have strong absorptions of blue light in proportion to the extension of the yellow sulphide's emission maximum toward the red (Figure 2). By keeping the cadmium sulphide content as low as possible, the blue-light absorption is minimized. Yellow-emitting zinc-beryllium silicates have practically negligible absorption in the visible region.

Another point of practical interest is the critical nature of color mixing in the yellow-component region from 5705-5800A, corresponding to an equivalent complementary range four times as broad (4430-4825A) in the blue region as shown in Figure 4. The use of a small percentage of a third component, such as green or orange, sometimes helps to effect production of a good white light without the need of using complementary luminescent materials in exactly matched pairs.

The addition of more emitted energy in the violet and red, in order to produce equal energy over the entire visible spectrum is useful to provide a uniform, continuous source of radiant energy for many experiments in physical optics. In fact, the production of almost any band-spectrum color is much more feasible using the controllable phosphor-spectrum shifting-means already demonstrated, than is true for the "hit or miss" method of filtering white light sources with the usual absorbing media which do not allow convenient gradual spectral variation.

Figure 5 shows the emission spectra of two white-emitting mixed-phosphor kinescope screens. Screen (a) is composed of zinc sulphide plus zinc beryllium silicate and screen (b) is entirely sulphide phosphors. A comparison of the blue ends of the two curves shows the pronounced blue absorption of the yellow-emitting zinc cadmium sulphide (curve b).

The white screens shown in Figure 5 are nearly a "daylight" (i.e., bluish-) white. It may well be that television screens should not be too close an approximation to either incandescent lamp-, reddish-white or to daylight-, bluish-white, since it is desirable to operate television receivers in partially lighted rooms. Many television engineers prefer more saturated kinescope emission colors, such as yellow or green, in order to have good halftones in the television image without decreas-

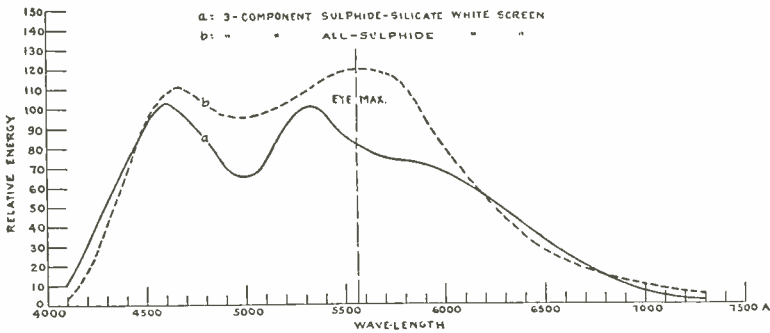

Fig. 5—Spectral distribution curves of white-emitting kinescope screens.

ing the usual illumination in the room and in order to have optimum luminescence efficiency by virtue of the phosphor's close approximation to the eye sensitivity curve.

Crystalline luminescent materials are now to be numbered among the more useful light sources, possessing good brilliancy (over 1,400,000 foot-lamberts for a short time when excited by 70,000-volt electrons⁷), high energy-conversion efficiency (up to 80 percent when some materials are excited by monochromatic ultraviolet⁸) and permitting unequaled degree of convenient control of color hue and saturation. Future uses will certainly see the extension of phosphor applications in the ultraviolet and infra-red regions of the spectrum when the important qualities of luminescent materials as unique transformers of both radiant and corpuscular energies are further exploited.

⁷ K. Scherer and R. Rübsaat, *Archiv. f. Elektrotech.* 31, 821-826 (1937).

⁸ A. Rüttenauer, *Zeits. f. tech. Physik*, 5, 148-150 (1938).

Although a quantitative theoretical treatment of phosphor luminescence is not yet developed, cross-references with associated effects such as the photoelectric effect, secondary electron emission, dielectric and semiconducting properties of crystals have indicated that the best phosphors have a bulk crystal which is of the excess cation type of semiconductor and contains a very small amount of some multivalent metallic element as an activator. Furthermore, the activator should be approximately the same size as the cation of the bulk crystal.

In closing, it is significant to note that cathodo-luminescence should probably be classified as a general property of solid matter—not just a phenomenon observed in isolated cases. Over 6000 widely different solid substances and materials, both vitreous and crystalline, having widely varied degrees of purity or impurity have been synthesized and tested in our laboratories. Every one of these materials showed discernible luminescence under electron bombardment. This was true even when the natural reflection color of the material under white light was definitely black. It is likely that *really* perfect crystals of some *really* pure substances would not luminesce in the visible spectrum, but we have not been able to obtain or synthesize such specimens despite the use of specially constructed equipment in a unique air-conditioned luminescence, research laboratory.

Acknowledgment is made of the work of Mr. E. J. Wood who accomplished most of the syntheses of the sulphide phosphors described in this paper and reference 2.

CATHODOLUMINESCENCE AS APPLIED IN TELEVISION*†

By

H. W. LEVERENZ‡

RCA Manufacturing Company, Inc., Research and Engineering Department,
Harrison, New Jersey

Summary—The cathodoluminescent art is reviewed and some new data are presented not only as general information but also to correct some current misconceptions regarding solid luminescent materials (phosphors).

Synthetic luminescent materials have been known for 327 years, but most of the polychromatic efficient phosphors were painstakingly evolved during research of the past ten years, especially in television research laboratories. Luminescence research is becoming a valuable means of supplying and interpreting new information regarding the physics and chemistry of crystalline matter.

The constitutions and syntheses of the better phosphors are outlined and a simplified theoretical mechanism of phosphor luminescence is discussed in order to provide better understanding of phosphor properties and capabilities. There are eight important qualities, each of which must be possessed in superior degree by phosphors intended for television kinescope use.

Unjustified restriction or over-emphasis of any one phosphor quality, such as phosphorescence (also known as persistence, retentivity, "after glow" or time-lag), would automatically eliminate most of the phosphors which are excellent in all eight. The choice of 30 frames/second and 60 fields/second is shown to be a minimum repetition rate, below which serious disadvantages are suffered by viewers. The speculation of using unknown phosphors having concave-downward persistence characteristics to decrease frame and field frequencies, is demonstrated to be untenable.

I. INTRODUCTION

THIS article on the subject of cathodoluminescence is offered so that those in the radio and television art may have an outline of the historical, theoretical and practical features of the "last act" in television's complicated task of seeing at a distance. The "last act" comprises converting modulated electrical impulses and electron currents into visible images which give the sense of uninterrupted continuity and motion. The performers in the "last act" are tiny crystals of specially synthesized luminescent materials which have the unique property of being able to transform electron energy into light.

Certain foibles and fallacies have persisted in the luminescent art, largely due to its alchemical birth and upbringing, and it is hoped that

* Decimal Classification: R583 X R138.313.

† A review, reprinted from *RCA REVIEW*, October, 1940, including theretofore unpublished data from the RCA Laboratories.

‡ Now with the Research Department, RCA Laboratories Division, Princeton, N. J.

the ensuing factual presentation will assist in dispelling some of the prevalent, inaccurate notions.

The generic term "luminescence" connotes the act of energy absorption with subsequent re-emission as visible and near-visible radiation while the luminescing material maintains a temperature below that required for incandescence. In this respect, the term "cold light" is concisely descriptive. In its original usage, "luminescence" applied to visible radiation only, but for convenience its use has expanded to include the near-visible regions.

Luminescence has been sub-classified according to the types of energy used for excitation. Cathodoluminescence, for example, is light emission occasioned by cathode rays, i.e., electrons, impinging on matter.¹

A further distinction is made with respect to duration of light emission after cessation of excitation. When the emission is completed within approximately 10^{-8} second, which is the normal interval for isolated excited atoms or ions to return to their ground states, the process is fluorescence. Emission continuing for a longer time than fluorescence is termed phosphorescence. Concomitance of fluorescence and phosphorescence in all but the gaseous state of matter requires the use of the more precise word "luminescence".

The first reported crystalline, inorganic luminescent materials, also called "phosphors", were accidentally prepared over 337 years ago, in 1603.² For 283 years subsequent to 1603, the alchemists synthesized phosphors by crude methods such as by heating oyster shells with sulphur to give feebly violet-phosphorescing alkaline-earth sulphide phosphors which were socially ostracised because they decomposed in moist air, evolving hydrogen sulphide. The first efficient (and, incidentally, non-odorous) synthetic phosphor was blue-green luminescing copper-activated zinc sulphide, prepared by Sidot in 1886.³ Zinc sulphide was used extensively in the first practical application of phosphors as detectors of invisible radiations such as ultraviolet, cathode ray, and X-ray as these new energy manifestations were discovered during the course of the 19th century. Radioactivity's discovery was an accidental by-product of Becquerel's work in unsuccessfully testing a theory of Poincaré who had postulated an intimate connection between X-rays and luminescence.⁴

¹ H. Pender and K. McIlwain, *ELECTRICAL ENGINEERS HANDBOOK*, Vol. V, Communications, 2-(49-53), J. Wiley, 1936.

² W. Wien and F. Harms, *HANDBUCH DER EXPERIMENTAL-PHYSIK*, XXIII, Part 1, page 1, Akademische Verlag., Leipzig, 1928.

³ T. Sidot, "Sur les propriétés de la blende hexagonale", *Comptes rendus*, 63, 188-189, 1886.

⁴ T. A. Boyd, *RESEARCH—THE PATHFINDER OF SCIENCE AND INDUSTRY*, p. 164, D. Appleton-Century Co., 1935.

Despite accelerated research on luminescence during the past half-century, phosphor applications remained chiefly of the detector variety and phosphors were usually associated with very low brilliancy values, requiring scotopic or dark-adapted vision for observation of the well-known radium watch dials, X-ray fluoroscope screens and theatrical "black magic".

With the vigorous inception of electronic television, approximately eleven years ago, an urgent need was felt for greatly increasing the capabilities of luminescent materials used in Kinescopes (television cathode-ray [TCR] tubes). The first researchers had but two phos-

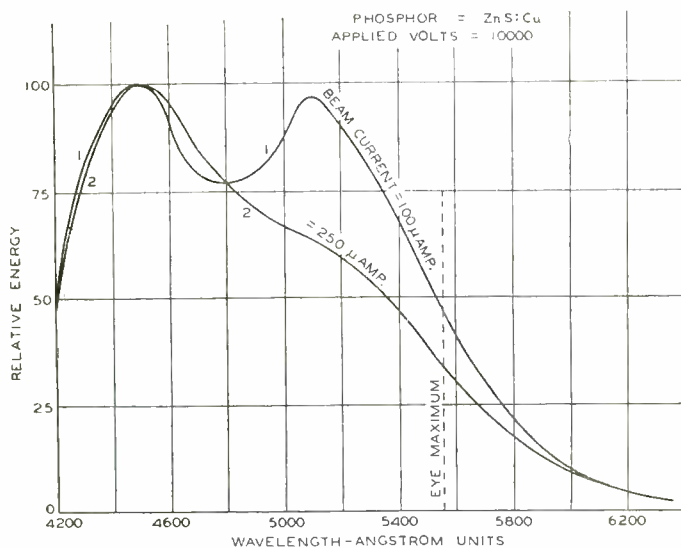

Fig. 1—Emission spectrum of a copper-activated zinc sulphide phosphor, showing the spectral variation with different excitation densities.

phors sufficiently efficient for television purposes: (1) the previously mentioned zinc sulphide, and (2) willemite, a zinc silicate mineral containing about one per cent of manganese silicate. Willemite was first discovered in 1830 and named after King Willem I of the Netherlands.⁵ Both phosphors emitted preponderantly green light, giving early television viewers considerable aesthetic dissatisfaction with the reproduced images.

Figure 1 shows the emission spectrum of a commercial luminescent zinc sulphide such as was used in early TCR tubes. The two curves are for the same material under different electron beam current densities, and show the spectral variation which caused an undesirable color

⁵ J. W. Mellor, A COMPREHENSIVE TREATISE ON INORGANIC AND THEORETICAL CHEMISTRY, Vol. VI, p. 438, Longmans, Green & Co. Ltd., London, 1930.

change from green to blue as the current density increased. Such a color change is most annoying in television pictures, since the brighter portions of the image show one color and the less brilliant portions another color.

Figure 2 shows performance results for natural vs. synthetic willemite, and indicates the low efficiency of the mineral product compared with a good present-day zinc silicate phosphor.

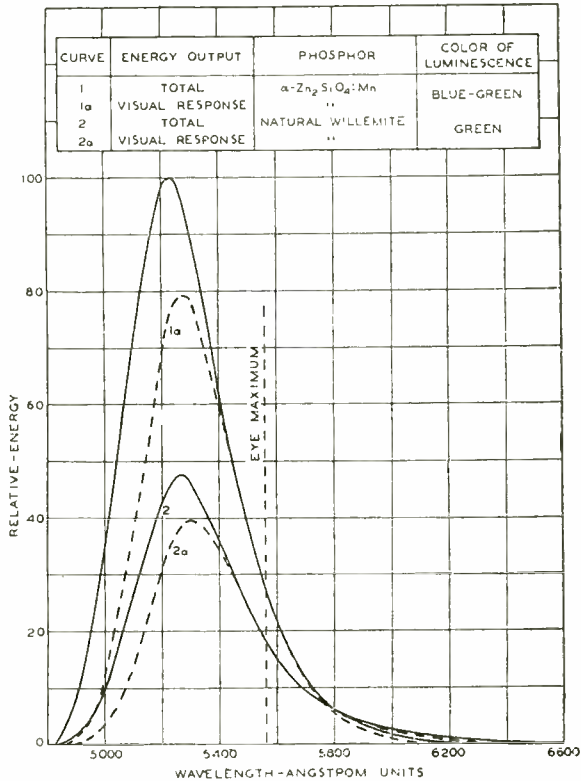

Fig. 2—Emission spectra of natural and synthetic willemite (manganese-activated α -zinc orthosilicate).

There were many more objectionable features about the phosphors known at the outset of electronic television; serious disadvantages such as poor secondary emission, further reduction of initially low efficiencies when the materials were ground and processed for Kinescope application, and a restricted choice of green colors. However, since better phosphors were vital to electronic television, which has the inherent advantage of practically inertialess picture scanning, extensive research was instigated in the RCA Manufacturing Co., Inc., under the sponsorship of Dr. V. K. Zworykin, Director of Electronics

Research, to determine the possibilities of improving phosphors for use in Kinescopes.

An intensive search of the literature on the subject of luminescence disclosed a plethora of phosphor recipes, which, as Dr. Saul Dushman said,⁶ "read just like a cook book", but unfortunately most of the recipes were like matches: they worked but once. It appeared certain that the strong green luminescence of zinc silicate phosphor (i.e., willemite) required about one per cent of manganese activator "impurity" and that of zinc sulphide required about one one-thousandth per cent of copper, but reproduction of results was an apparent impossibility unless extraordinary precautions were taken to purify all ingredients to a degree better than "spectroscopic purity".

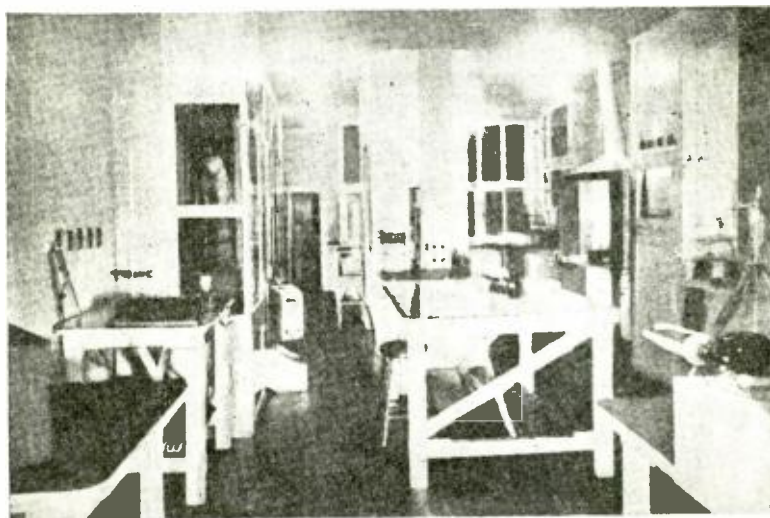

Fig. 3—View of part of the RCA chemico-physics laboratories in which luminescence research is conducted.

Accordingly, air-conditioned laboratories were designed and constructed in the engineering buildings of the RCA Manufacturing Company's Camden, New Jersey plant. Improved laboratories were constructed in the Harrison, New Jersey plant when the chemico-physics research group was transferred to Harrison in 1939. Figure 3 gives a view of one of the Camden laboratories, showing the "hospital operating room" type of simple construction which facilitated thorough cleaning of linoleum walls and floors, glass bench tops, etc.

Thus equipped, it was practical to synthesize the two principal phosphor systems, oxides (especially silicates) and sulphides in many permutations of exceptionally pure substances.

⁶ Meeting of the Optical Society of America, New York, October 1936.

Since sulphides had been originally discovered and developed abroad, European luminescence researchers concentrated mainly on sulphide phosphors. American researchers, because of their use of the naturally-occurring mineral phosphor, willemite, followed by use of the improved synthetic willemite, favored the oxygen-containing phosphors, especially since oxide phosphors are inherently more rugged than sulphides or selenides.

An important product of RCA's television-luminescence research is the zinc beryllium silicate phosphor system which is a major component of the light-emitting coatings used in the new highly-efficient, tubular, luminescent lamps (usually called "fluorescent lamps" despite the need for a considerable phosphorescence in order to minimize flicker). The luminescent art is commencing to expand into the ultraviolet and infrared regions of the spectrum and should employ the unique advantages of the high efficiencies of phosphors, and their easily controllable emission spectra in those invisible radiation ranges.

II. CONSTITUTIONS AND SYNTHESSES OF PHOSPHORS

It should be mentioned that, despite unusually favorable conditions for synthesizing luminescent materials, exact reproduction of phosphors is still difficult. Each phosphor sample tends to be individualistic, differing noticeably from identically constituted and similarly synthesized samples in one or more of its properties such as spectral emission characteristic, phosphorescent-time constant, secondary-emission qualities, etc. Attainment of practically identical phosphors is possible, but requires extreme care and extraordinary skill.

Phosphors are both impurity- and structure-sensitive materials. The addition or subtraction of as little as 0.0001 per cent (one part in a million) of a foreign substance can alter some phosphors' properties by 50-100 per cent. Maintaining identical chemical composition, but changing crystal structure by polymorphic transitions also produces equally pronounced changes in some phosphors' characteristics.

The best phosphors are well-crystallized, inorganic materials (termed "base materials" or simply "bases"), usually containing a small trace of one certain metallic salt which is called the "activator". Whereas minute concentrations of some foreign salts greatly enhance the basic crystals' luminescence, similar concentrations of other metal salts, notably those of iron, cobalt, and nickel, "poison" luminescence.

In general, the best phosphors have a relatively colorless bulk crystal which is of the excess-cation type of a high-temperature semi-conductor and contains a very small concentration of a salt of some easily polarizable multivalent element. Table 1 lists the more important phosphor constituents and a few of their pertinent properties.

The dashes in the columns titled "best activator" indicate that an efficient phosphor may be prepared from the indicated base materials without adding an activator. The vertical connecting lines, shown in the same columns, link cations which may be intersubstituted in the particular base material and yet produce a good phosphor. Galliate and selenide phosphors are not included in the table.

Synthesis of phosphors is chiefly chemical work. Obviously, the best available analytical reagent chemicals are much too impure for use in phosphors. Therefore, the chemist must further purify the substances used, add the tiny quantities of activator and perhaps a flux to assist in crystallizing the phosphor. The intimate mixture must then be skillfully heated to produce the crystal size and modification having greatest efficiency and ease of application in cathode-ray tubes.

It is especially remarkable and, from the chemist's standpoint, aggravating, that the limits of chemical purification processes coincide with the order of magnitude of activator impurity usually necessary in efficient phosphors or the magnitude of the "poisoning element" detrimental to phosphors. The coincidence occurs in the range of 10^{-3} to 10^{-8} part of activator, or impurity, to one part of bulk crystal.

The syntheses of phosphors are typified by the following two examples:

A. Synthesis of blue-emitting zinc sulphide phosphor.

Purify zinc sulphate ($ZnSO_4$) by conventional chemical methods until no spectrographically detectable impurities remain. Electrolyze the aqueous zinc sulphate solution to remove any copper, manganese, and lead which the spectrograph may not have indicated. Precipitate pure zinc sulphide with well-washed hydrogen sulphide, and wash the precipitate. $ZnSO_4 + H_2S = ZnS \downarrow + H_2SO_4$. Add sufficient solution of a silver salt to equal a silver concentration of 0.01 per cent of the weight of the zinc sulphide and further add sufficient sodium or potassium chlorides (in aqueous solution) to equal 2 per cent of the weight of the zinc sulphide. Stir well, while evaporating to dryness and heat in a quartz crucible at 800-1500° C. The time and temperature of heating may be adjusted to determine the phosphor's particle size and form. The resultant phosphor is symbolized by $ZnS:Ag$; since the alkali halide reacts with the zinc sulphide to form volatile zinc chloride and soluble alkali sulphide which are removed during heating and subsequent elutriation. Cadmium sulphide may be substituted in part for the zinc sulphide to alter the phosphor's spectral emission over the entire visible spectrum and into the infra-red.⁷

⁷ H. W. Leverenz and F. Seitz, "Luminescent Materials", *Jour. Appl. Phys.* 10, 7, pp. 479-493, 1939.

B. Synthesis of yellow-green emitting zinc beryllium silicate phosphor.

Zinc and beryllium nitrates ($Zn(NO_3)_2$ and $Be(NO_3)_2$) are purified and mixed in aqueous solution such that the ratio of zinc to beryllium is approximately nine to one on a gram-molecular-weight (mole, or molar) basis. Approximately 0.006 mole of pure manganese nitrate ($Mn(NO_3)_2$) is added per mole of zinc plus beryllium. Very pure, finely divided silica (SiO_2), such as colloidal silica or a substance such as an organic silicate is added to the nitrate solution and the carbonates of zinc, beryllium, and manganese precipitated around the silica by adding ammonium carbonate.

The amount of silica added may be exactly ortho-proportion or up to several hundred per cent over ortho-proportion. "Ortho-proportion" is two moles of (zinc + beryllium) to one mole of silica.

Stir and evaporate to dryness and heat in a clean platinum crucible at 900-1600° C depending on the degree of chemical combination, crystal type and size required. A shorthand notation for the finished phosphor is $ZnO_u:BeO_v:SiO_{2w}:Mn$. In this example, $u/v \cong 9$ and $w \cong (u + v)/2$, but u , v , w , and the Mn concentration may be varied to produce a wide variety of emission colors and other phosphor characteristics.⁸

Mechanical mixtures of certain blue-emitting and yellow-emitting phosphors, prepared as described in A and B, will give a resultant white light under cathode-ray excitation.⁹

III. THEORIES OF PHOSPHOR LUMINESCENCE

There is no theory of luminescence adequate to explain quantitatively all the properties of known phosphors or to predict the properties of new phosphors.

All efficient phosphors are definitely crystalline. See Figure 4 for examples of the regular arrays required in order to have efficient phosphors. The attainment of an ordered state is evidently necessary to provide a minimum of traffic obstruction to electrons liberated in the crystals. In view of the high efficiencies obtained, especially with corpuscular excitation, it appears that the bulk crystal, as well as the "centers" associated with the small concentration of the activators, absorbs the radiant or corpuscular exciting energy and redistributes it in smaller, more digestible packets of low-velocity free electrons or excitons (electron-hole pairs). The liberated electrons or excitons

⁸ See Figs. 24, 25, and 26 of reference 7.

⁹ H. W. Leverenz, "Optimum Efficiency Conditions for White Luminescent Screens in Kinescopes", *Jour. Opt. Soc. Amer.*, 30, 7, 309-315, 1940.

travel through the crystal for considerable distances from their origins and eventually return to their own or, more probably, to other centers which are capable of transforming the energy into luminescent emission. The actual emission act is probably performed by a neutral (non-ionized) atom or by a negatively charged ion associated with a multi-valent activator center. The centers may be visualized as loosely bound units regularly distributed throughout the crystal lattice, substituted in place of lattice units or located in places where lattice units are missing, or else associated with crystal faults.

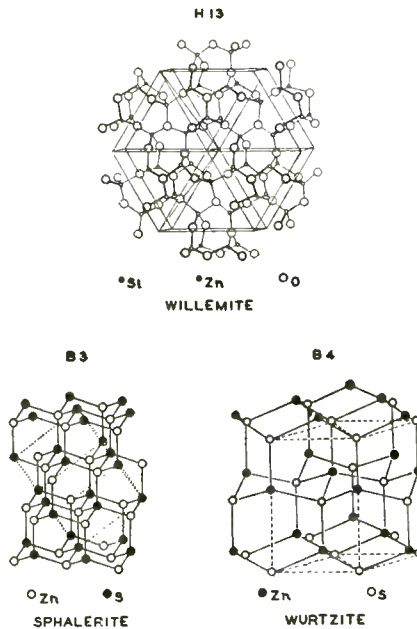

Fig. 4—Crystal structures of α -zinc silicate (willemite), α -zinc sulphide (wurtzite), and β -zinc sulphide (sphalerite).

A crude description of the *modus operandi* of a phosphor is the following: Imagine a three-dimensional lattice-work of elastic bands joining together a regular array of identical bells. This corresponds to the basic crystal of a phosphor. Dispersed at regular intervals throughout the ordered structure, in a concentration of one to a thousand, there are much smaller bells substituted for, or suspended between, bells of the main bell network. These smaller bells are the activator centers. It is apparent that considerably less force will be required to cause the smaller bells to sound than the larger bells. It is also apparent that the smaller bells may be rung by either direct application of energy or by receiving energy which has been transhipped through the elastic bands after being absorbed by some larger

unit. The reason for the greater luminescent efficiency of the crystal-line state versus the amorphous state is deducible from the model. Energy transfer through elastic bands having widely varied degrees of tension would be short-lived because the different bands would not pass the same frequencies.

In order to give a more tenable picture of the action corresponding to free electron liberation in the phosphor crystal, it would be necessary to imagine that the clappers of the bells could become detached and slide along the joining bands until they encountered a small bell which would ring, whereas the momentum of the clapper was insufficient to ring a larger bell. The absorption of energy and re-emission of sound entirely by a single small bell represents fluorescence. Absorption of energy by any unit of the lattice-work with subsequent transmittal to a small bell, possibly far removed, which emits the eventual sound represents phosphorescence. The distinction between the two luminescence acts is seen to be primarily one of localization versus decentralization and of time required for energy transport. Vigorous jangling of the entire structure would cause the main lattice bells to sound and disturb the more sensitive efficiencies of the smaller bells. The model thus portrays the effect of incandescence in phosphors.

Unfortunately, the bell model fails in several respects in simulating the operation of an actual phosphor. For example, it allows high-amplitude, low-frequency vibration to ring the small bells which emit higher frequencies than were possessed by the exciting energy. This is opposite to phosphor action as expressed in Stoke's law, "The emitted light is of a longer wavelength than the exciting radiation". Since frequency, ν , wavelength, λ , and speed of propagation, c , are related by

$$c = \lambda \nu$$

it is seen that the bell model violates Stoke's law by absorbing low-frequency long wavelength energy and emitting high-frequency, short-wavelength sound. Exceptions to Stoke's law are unimportantly rare.

The model correctly portrays the independence of a phosphor's emission spectrum with respect to means of excitation and time during or after excitation. This is true only when the phosphor's emission is a single band, since more than one band would indicate different centers (different small bells in the model) which usually vary greatly with respect to excitation-saturation and decay rate. In the latter case, the total emission color of a phosphor changes markedly during phosphorescence, while the former case has been demonstrated in Figure 1.

Refinements and ramifications of the foregoing mechanical simile provide stimulation for experiment, yet fail to depict the complex atomic dynamics of real phosphors because the actions within phosphor

crystals involve the vaguely comprehended transition zone between corpuscular and undulatory energy.

Foreign elements, such as iron, nickel, etc., previously classified as phosphor poisons are deleterious by virtue of: (1) occupying positions which might otherwise be advantageously occupied by the luminescence activator units, (2) absorbing energy and then emitting radiation in an invisible (viz. ultraviolet or infra red) region of the spectrum, and (3) decreasing phosphorescence by absorbing transhipped energy more readily than the luminescence centers and thus

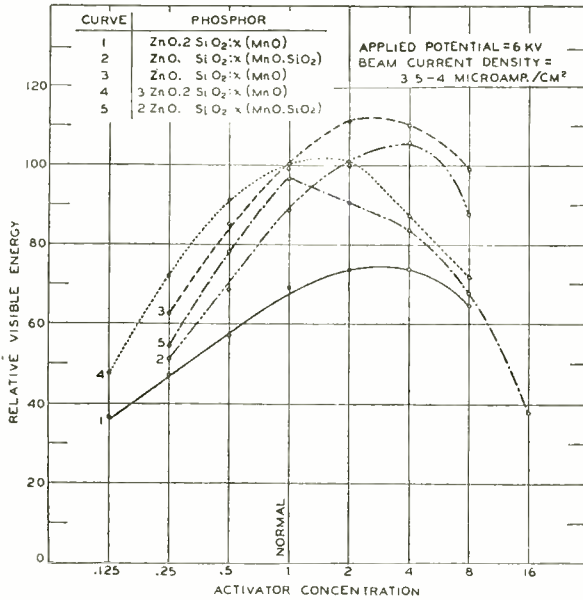

Fig. 5—Luminescence efficiency of α -zinc orthosilicate as a function of composition and manganese activator concentration.

destructively diminishing the amount of potential energy stored in the phosphor crystal. Use of more than one activator in a phosphor fails to increase efficiency since each activator is occupying positions which might be used by the other.

There is an optimum concentration of activator, but it is not critical. There is no lower limit or threshold value, except possibly as expressed in terms of the human eye's sensitivity. The completely dark-adapted eye requires a minimum of approximately 17×10^{-10} ergs/sec. visible radiation through the pupil for recognizable stimulation.¹⁰ Increasing the activator concentration above the optimum reduces efficiency by: (1) exceeding the number of suitable faults or interstitial

¹⁰ LeGrand Hardy, "Eye as Affected by Illumination", *Am. Illum. Soc., Trans.*, 29, pp. 364-384, 1934.

positions available for activator units in the basic crystal, or (2) in the case of isomorphous substitution, allowing the activator units to approach each other so closely that they produce mutual interference. The distance from center to center of manganese ions (assumed homogeneously distributed) in an α -zinc silicate phosphor with optimal activation is 9.08 Å. Using the ionic radius value $Mn^{++} = 0.91$ Å, it is found that the distance of closest approach is $9.08 - 1.82 = 7.16$ Å.

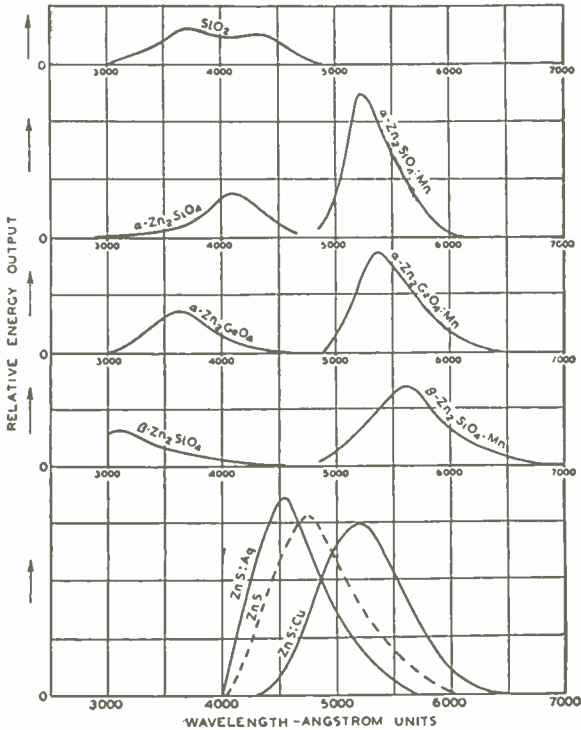

Fig. 6—Luminescence emission spectra of some activated and unactivated phosphors. The unactivated substance's emission disappears when the activator is present, and a new band having greater energy efficiency appears in the visible spectrum.

Figure 5 shows how variation of activator content affects efficiency in the α -zinc silicate system. It is noticeable that the optimum concentration of manganese increases with increasing silica concentration in the initial composition of the phosphor.

Pure, presumably unactivated, crystals also luminesce. In fact, under cathode-ray bombardment all materials luminesce. The luminescence emission spectra of several pure crystallized sulphides and silicates are shown in Figure 6 contrasted with activated phosphors of

the same substances. The ordinate scales of the various curves, including those of the same phosphor (activated and unactivated), are not drawn to relative scale.

Hitherto unpublished results, obtained in the RCA Laboratories, show the emission spectrum of pure SiO_2 (crystallized at $1300^\circ C$) to be located in approximately the same ultraviolet region as that of the pure silicates (crystallized at $1100-1300^\circ C$) of zinc, magnesium, calcium, cadmium, strontium, and barium. In the foregoing pure-substance phosphors the emission mechanism is thus determined by the $Si-O$ bond in the crystal lattice while the metal cation ($Zn, Mg, Ca, Cd, Sr, \text{ or } Ba$) has very little effect. This result is interesting, in that it is quite the opposite of the case for the same silicates activated with manganese. The manganese activator is therefore associated with the cation lattice positions whereas the pure crystal's emission centers are located in the $Si-O_x$ radicals or chains.

The emission spectrum of pure unactivated beryllium silicate phosphor appears at considerably shorter wavelengths than that characteristic of the silica and silicates listed above. The highly polarizing beryllium ion has a much smaller radius ($Be^{++} = 0.34 \text{ \AA}$) than any of the previously listed cations and is smaller than the silicon ion ($Si^{++++} = 0.39 \text{ \AA}$). In the case of beryllium silicate, it seems as logical to call the substance silicon berylliate since the beryllium-oxygen linkage is stronger than the silicon-oxygen binding.

Pure, unactivated β -zinc silicate, which is formed by quenching molten zinc silicate,¹¹ has its emission spectrum located at shorter wavelengths than that of the normal unactivated α -zinc silicate. Similarly, the emission spectrum of unactivated α -zinc germanate is at shorter wavelengths than that of pure α -zinc silicate. However, the emission spectra of manganese-activated β -zinc silicate and α -zinc germanate are located at longer wavelengths than that of α -zinc silicate. The spectrum shifts of the activated compared with the unactivated materials are seen to be in opposite directions. Evidently the binding forces of the luminescent-active optical electrons associated with the $Si-O_x$ groups are increased by expanding the lattice from α - to β -zinc silicate and similarly by expanding the lattice through substitution of germanium for silicon. The increased binding force may be due to the diminishing of the cation's polarizing influence by increasing the distance between the cations and the $Si-O_x$ groups or chains. Since the activator units are located at cation positions, the lattice expansion weakens the binding forces of the activator's valence electrons. It appears from these results that valuable information regarding strengths of crystal lattice bonds

¹¹ See page 489 of reference 7.

and their directivities may be gained by further studies of the emission spectra of cathode-ray excited substances.

There are many more interesting, though apparently anomalous, phosphor emission-spectrum shifts which have been observed in the course of our research work, but these must be withheld for future publication, since their discussion is not suited for this review.

Figure 7 shows the efficiency of manganese-activated α -zinc silicates superimposed over the phase diagram of the zinc-silica system. There is only one true compound formed, as shown by the single melting point maximum at 1512°C at the ortho-proportion of $2\text{ZnO} - 1\text{SiO}_2$. The

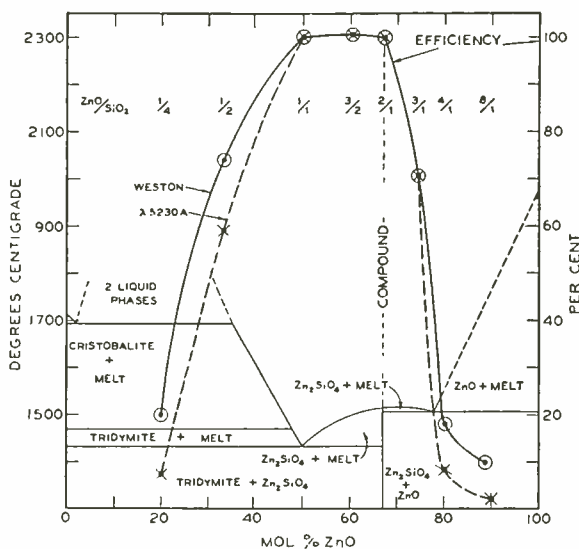

Fig. 7.—Luminescence efficiency of manganese-activated α -zinc silicate as a function of composition, with constant ratio of manganese to zinc.

sharp drop of efficiency on the excess zinc oxide side, as contrasted with the much slower decrease on the excess silica side, coupled with the pertinent information given in connection with Figure 5, has led the writer to propose a "deficiency structure"¹² explanation concerning α -zinc silicate's ability to use higher activator concentrations efficiently when the silica concentration is increased.

Figure 8 shows some X-ray powder photographs which were made by Professor B. E. Warren of the Massachusetts Institute of Technology. The photographs show no structure change in increasing the ZnO/SiO_2 ratio from that of the compound (2/1) to 100 per cent

¹² H. W. Leverenz, "Relative Emission Spectra of Zinc Silicates and Other Cathodoluminescent Materials", Paper #30, American Physical Society meeting, Washington, D. C., April 28, 1938.

excess SiO_2 (1/1). The orthosilicate (see Figure 4) phenacite-type structure persists despite the inclusion of a large excess of silica. It seems logical to propose that the silica excess continues to build a normal orthosilicate structure with the exception that some of the zinc and corresponding oxygen units are lacking. The resultant lattice, then, instead of being named an α -zinc orthosilicate with excess silica, should be called an α -zinc orthosilicate with a deficiency of zinc oxide. The distinction is important, for the absent zinc oxide positions are partially filled by manganese oxide activator units and the structure can therefore efficiently use a higher concentration of manganese activator. All the compositions, even those with several hundred per cent excess silica, are still orthosilicates despite the deviation from stoichiometric ortho-proportions. Luminescence research has valuable potentialities in

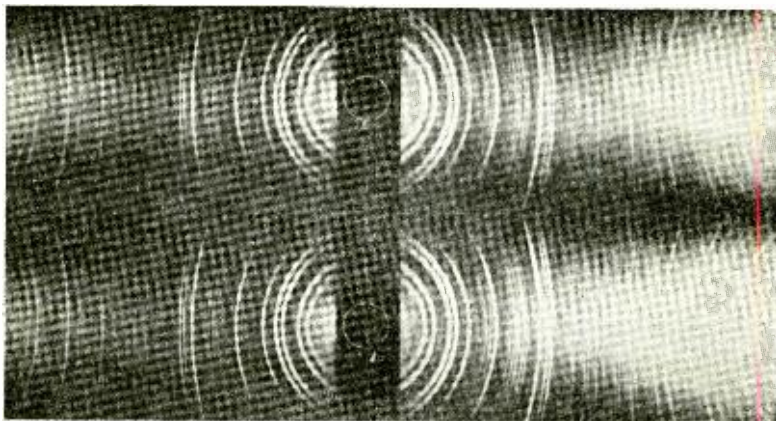

(a) $\alpha\text{-ZnO}\cdot\text{SiO}_2$. 1200 °C — 2 Hours
 (b) $\alpha\text{-ZnO}\cdot\text{SiO}_2$. 1200 °C — 1 Hour

Fig. 8—X-ray powder diffraction photographs of (a) ortho-proportion α -zinc orthosilicate, and (b) ortho-proportion α -zinc orthosilicate containing 100 per cent excess silica.

disclosing some of the newer facts of crystal chemistry, a study essentially different from that of the conventional chemistry of solutions and gases.

IV. PHOSPHOR PROPERTIES AND APPLICATION OF PHOSPHORS IN TCR TUBES

Good phosphors must meet numerous requirements for use in TCR tubes.¹³ The necessary qualifications may be divided into two groups according to whether they are: (1) objective (independent of the seeing act), or (2) subjective (directly related to the processes of seeing).

A. Objective Qualities:

(1) *Ease of applying phosphors to form TCR tube screens.*

¹³ See reference 7.

This subject has been given considerable discussion elsewhere.¹⁴ The chief objective from the phosphor standpoint is to produce a non-aggregated, smooth-flowing phosphor powder having a narrowly-limited crystal size whose average magnitude is best suited for the method of screen application, provides good screen adherence and gives sufficient screen contrast. The crystal size is best controlled by the crystallization process, since grinding of phosphors seriously reduces

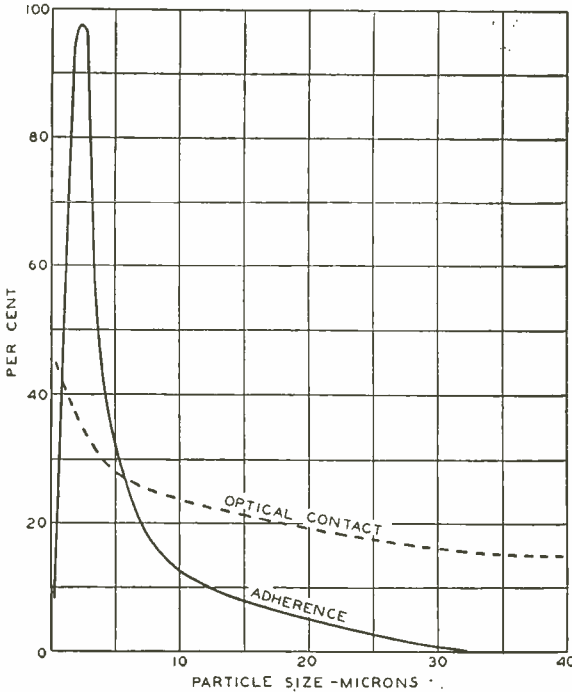

Fig. 9—The effect of phosphor particle size on optical contact and adhering power.

their efficiencies and stabilities. Table 2 shows the effect of grinding an α -zinc silicate phosphor.

Table 2

Effect of grinding upon performance of α -Zn₂SiO₄:Mn

Hours grinding	Original efficiency
0	100%
16	80
24	66
64	36

¹⁴H. W. Leverenz, "Problems Concerning the Production of Cathode-Ray Tube Screens", *Jour. Opt. Soc. Amer.*, 27, 1, 25-35, 1937.

The influence of increasing crystal size in decreasing optical contact, which in turn improves television image contrast, has also been treated in other articles.¹⁵ Figure 9 shows some recent measurements made by Dr. R. R. Law and the writer to determine the quantitative effect of varying crystal size. The relative adhering power of small quartz particles for glass walls is plotted from data by A. v. Buzagh.¹⁶ Of course, in so-called "front-surface" type TCR tubes, the matter of crystal size is relatively unimportant.¹⁷

Crystal size control is especially important in mix-phosphor screens, such as white-emitting Kinescope screens composed of the blue zinc sulphide and yellow zinc beryllium silicate phosphors described in the section on syntheses. If the particle sizes of the two phosphors are not

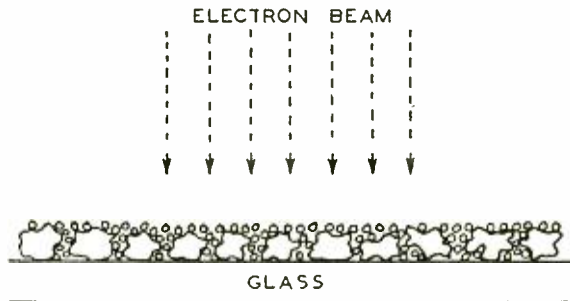

Fig. 10—Cross-section of a luminescent screen comprising large and small phosphor particles.

substantially matched, the efficiency data on the two measured separately will not allow accurate computation of the relative proportions required for a good white screen.¹⁸ Instead, the resultant screen will emit a preponderant amount of light from the phosphor having the smaller particle size. Figure 10 illustrates the effect by showing that most of the larger particles are deposited first in the settling method of screen application and that even if all the particles were deposited together, the impinging beam would encounter more small particles per unit volume on first entering the screen structure. Since the beam's energy is dissipated exponentially through the thickness of the screen, the light output per unit distance is greatest in the layers on the side of impingement. Deviations of the composition of the front surface of the screen from the average composition of the entire layer will thus change the screen's emission color.

¹⁵ R. R. Law, "Contrast in Kinescopes", *Proc. I.R.E.*, 511-524, August 1939.

¹⁶ A. v. Buzagh, "Ueber die Haftfaehigkeit mikroskopischer Teilchen an Waenden von gleicher Beschaffenheit", *Kolloid Zeits.* 51, 105-112, 1930.

¹⁷ See reference 14.

¹⁸ See reference 9.

2) Ease of outgassing phosphors.

The most efficient phosphors are materials which are also excellent catalysts in that they exhibit abnormally large adsorbing surfaces. As an example, the quantities of copper ion adsorbed by sphalerite ZnS from a dilute copper sulphate solution are equivalent to surface films many molecules thick. Since only monomolecular films have been found, the sphalerite crystals must have many crevasses or other irregularities providing inordinately large adsorption area.¹⁹

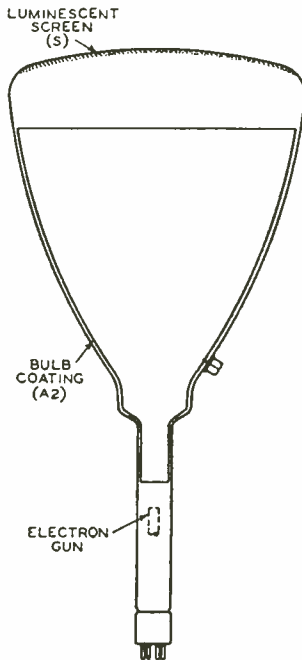

Fig. 11—Schematic section of a Kinescope.

Good phosphors, such as the sulphides and silicates, are somewhat unfortunately characterized by having very open structures with large "holes" (see Figure 4) running through their lattices and these holes may allow interstitial diffusion and retainment of small gaseous molecules.

In general, it is most advantageous to use phosphors synthesized from exceptionally pure ingredients which have been heated to very high temperatures in order to crystallize sufficiently to preclude the active, highly catalytic state prevalent at lower temperature heatings.

¹⁹ S. F. Ravitz and W. A. Wall, "The Adsorption of Copper Sulphate by Sphalerite and its Relation to Flotation", *Jour. Phys. Chem.* 38, 13-18, 1934.

3) *Secondary emission of phosphors.*

Phosphors are good insulators, usually having resistivities greater than most glasses ($10^{12} - 10^{16}$ ohm cm. at room temperature). The negative charge imparted to the screen by the exciting electron beam cannot be dissipated effectively by conduction through the crystals to the accelerating-anode coating, A_2 , in the Kinescope (Figure 11), but must be maintained at a low value by emission of secondary electrons from the phosphor, S . The secondary electrons are attracted to the anode coating as long as the collector voltage is positive with respect to the phosphor crystals, or only slightly negative, within the voltage range corresponding to the emission velocities of the secondary electrons (0 to approximately -10 V).

It is very important that a phosphor's secondary-emission ratio (ratio of emitted secondary electrons to incident primary electrons), be unity or greater for the particular voltage applied to the Kinescope. Should the ratio be less than unity, the potential on the screen will decrease with respect to the applied voltage until unity ratio is established or, failing to attain a ratio of unity or greater, the screen potential will fall to cathode potential so that no further current can reach the luminescent screen.

Figure 12 shows a secondary-emission vs. voltage curve representative of phosphors and insulators in general.

Practically, the important secondary-emission characteristics are the "limiting potential"²⁰, V_L , and "deviation angle", θ . The limiting potential is the applied voltage corresponding to the second unity-crossover (V_L) of Figure 12, and is the point beyond which further increase of applied voltage produces less than linear increase in the actual potential of the phosphor-coating. This potential determines the velocity of the impinging electrons. Figure 13 shows typical plots of some phosphor-coating potentials, relative to applied voltage, indicating the limiting potentials.

The "deviation angle", θ , represents the degree of the screen potential's non-linear conformity beyond the limiting potential. Use of applied voltages greater than the limiting potential gives a greater gain of accelerating potential the smaller the value of θ . The higher applied voltages have advantage even in the case of large values of θ ,

²⁰ W. B. Nottingham, "Electrical and Luminescent Properties of Willemite under Electron Bombardment", *Jour. Appl. Phys.* 8, 762-778, 1937.

H. Nelson, "Method of Measuring Luminescent Screen Potential", *Jour. Appl. Phys.* 9, 592-599, 1938.

W. B. Nottingham, "Electrical and Luminescent Properties of Phosphors under Electron Bombardment", *Jour. Appl. Phys.* 10, 73-83, 1939.

S. T. Martin and L. B. Headrick, "Light Output and Secondary Emission Characteristics of Luminescent Materials", *Jour. Appl. Phys.* 10, 116-127, 1939.

in that the beam current density may still be increased somewhat independently of the screen potential.

Both V_L and θ are greatly affected by extraneous influences such as Kinescope screen composition and thickness, residual gas, evaporated material from heated tube parts or getters, and deleterious effects of continued electron bombardment during tube life.

Efficient phosphors belong to the group of colorless insulators having good secondary emission. Bruining and deBoer²¹ have outlined the

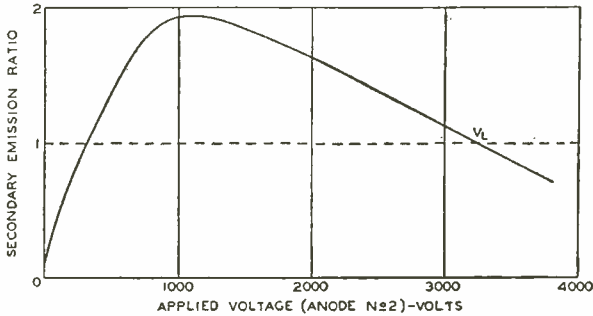

Fig. 12—Typical secondary-emission characteristic of insulators.

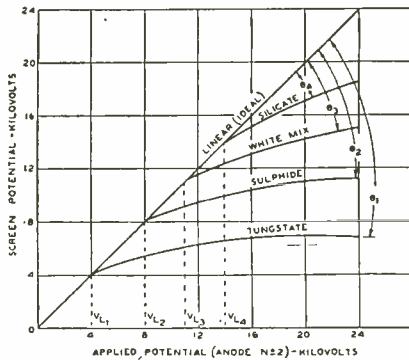

Fig. 13—Screen potential of phosphor screens as a function of applied potential.

conditions favorable for high secondary emission. They specify that the red limit of the external photoelectric effect of a material should correspond to the first absorption band on the red side of the absorption spectrum.

The quantitative influences of structure variations and changes in compositions of phosphors, as affecting V_L and θ , have yet to be

²¹ H. Bruining and J. H. deBoer, "Secondary Emission", Parts IV and V, *Physica*, VI, 3, 823-840, 1939.

investigated. With the use of higher voltages, over 20 kilovolts for projection Kinescopes, it becomes important to know more about possible means of increasing V_L and decreasing θ without resorting to extraneous devices such as supplying a conducting coating under the phosphor screen.

4) *Stability of phosphors.*

Phosphor centers are intrinsically delicate, as indicated by their sensitivity to exciting radiation of the order of 2.5 electron volts energy or more (5000 Å or less). Luminescence may be excited in phosphors with six-volt electrons, whereas television cathode-ray tubes are operated at several kilovolts. The possible destructive thermal agitation occasioned by a 10-kilovolt electron striking a phosphor center, assumed as an isolated atom, is indicated by the "temperature" which the atom would attain were the entire energy of the 10-kilovolt electron absorbed by the atom. This "temperature" would be

$$T = 1/2 m v^2 / 3/2 k = \frac{1.57 \times 10^{-7}}{2.06 \times 10^{-16}} = 7.7 \times 10^8 \text{ }^\circ\text{K}$$

where

m = mass of electron

v = velocity of electron

k = Boltzman's constant = 1.371×10^{-16} erg deg⁻¹

The absorption of energy by an atom's immediate neighbors in a crystal considerably reduces the value of T . Energy is usually subtracted in small (approximately 30 electron volts) quantities from the swiftly moving primary electron; the probability of an absorption act being inversely proportional to the electron's volt velocity. These considerations, nevertheless, do not detract from the 10-kilovolt electron's potential destructive effect.

The underlying differences between the two most important phosphor species, sulphides (including selenides) and oxides (including silicates, tungstates, borates, etc.), are the differences between sulphur and oxygen with respect to their combining affinities. Oxygen and sulphur are both members of group 6B of the periodic system²² and are, therefore, chemically equivalent. The principal difference between oxygen and sulphur (or selenium) is in the physical size of their atoms or ions. Table 3 lists the atomic and ionic radii as well as other physical data of oxygen and sulphur.

²²H. W. Leverenz, "A Convenient Periodic Chart of the Elements", *Footnote Prints*, 12, 1, 22-24, 1939.

Table 3

	Atomic Radius A	Ionic Radius A	Melting Point °K	Boiling Point °K	Deforma- tion (Polariza- tion) of the ion	First Ionization Potential el. v.	Electron ²³ Affinity
Oxygen	0.60	1.32 (O ⁻)	54	90	3.88	13.56 (O ⁺)	+3.8
Sulphur	1.04	1.74 (S ⁻)	402	717	10.2	10.3 (S ⁺)	+2.1

It is to be expected that sulphides and selenides will have less resistance than oxides have to decomposition under the so-called "burn-

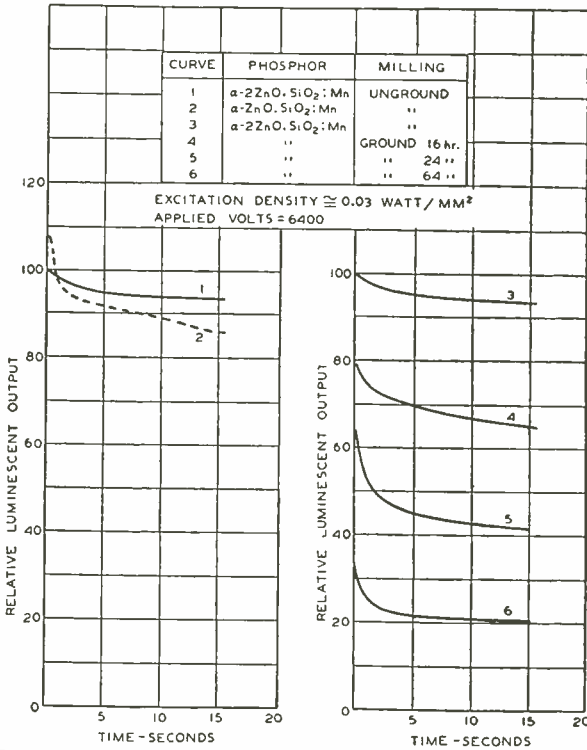

Fig. 14—"Burning" of manganese-activated α -zinc orthosilicates as affected by composition and degree of comminution.

ing" action of an electron beam. Chemically speaking, an electron is a reducing agent except when its velocity is such that it ejects two or more electrons from an atom or ion, in which case it is an oxidizing agent. The same relative stabilities of phosphors obtain with respect to other injurious actions such as comminution, exposure to moisture, light, air, tube processing (exhaust and baking), and high operating temperatures (viz. as encountered in projection Kinescopes) as well as contamination or "poisoning".

²³ G. Glockler, "Estimated Electron Affinities of the Light Elements", *Phys. Rev.* 46, 111-114, 1934.

The effect of utilizing a bulk crystal having greatest stability is illustrated by the "burning" tests shown in Figure 14. It is seen that the manganese-activated α -zinc silicate composed of ortho-proportions ($2 \text{ ZnO} \cdot \text{SiO}_2$), corresponding to the compound's melting point (1512° C) in the phase diagram of the $\text{ZnO} \cdot \text{SiO}_2$ system (see Figure 7), has less initial decrease of efficiency under intense electron bombardment and less rapid decay of efficiency on continued bombardment than is true of the hypothetical meta-proportion ($\text{ZnO} \cdot \text{SiO}_2$), corresponding to the lowest melting point (1437° C) in the phase diagram. The remainder of Figure 14 shows that decreasing the bulk crystal's stability by grinding, which increases the concentration of strains and faults as well as increasing the ratio of surface tension to lattice energy, greatly reduces a phosphor's ability to withstand "burning".

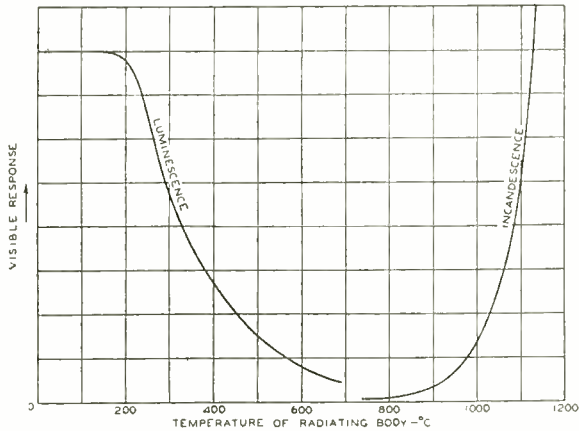

Fig. 15—Typical temperature dependence of luminescence and incandescence efficiencies of a phosphor.

5) Heat and infra-red effects on phosphors.

The general effect of temperature on a phosphor's luminescence efficiency is shown in Figure 15. When the bulk lattice elements of a phosphor become agitated to the extent that they unduly "jostle" the sensitive activator centers, luminescence ability is lost. Further increase in temperature eventually produces incandescence, which is light emission occasioned by the excitation energy mutually imparted by violent oscillation of neighboring lattice elements. The ordinate scales for the two curves of Figure 15 are not drawn to a common scale.

At very low temperatures, viz., liquid air temperature, phosphorescence may be frozen-in, or stored, for later release by applied heat or infra-red radiation. The storing process comprises trapping free electrons (detached bell clappers in our previous description of phosphor action) near activator centers and in crystal faults. A definite

quantity of thermal agitation is required to re-liberate the electron that it may wander to either another trapping location or to a suitable luminescence activator center where it may excite light emission. Electric or magnetic fields may also be used to effect dislodgement of trapped electrons.²⁴

The maintenance of phosphor efficiencies at elevated temperatures is approximately proportional to their stabilities as discussed in the preceding section. That is, oxide and silicate phosphors will generally operate efficiently at higher temperatures than sulphide and selenide phosphors. Each phosphor has an optimum operating temperature which depends not only on the phosphor, but also on the intensity of excitation.

As an example of the vital role played by the bulk lattice in phosphor stability with respect to temperature, the following description is given of a 1935 experiment with a projection tube having a screen of yellow-luminescing β -zinc silicate phosphor. Several spots on the phosphor coating were heated with a 500 microampere, 10,000 volt electron beam held stationary until some of the β -zinc silicate had been converted to the green-luminescent α -form. Starting with a 2.2 cm² pattern, these spots were scanned over a decreasing area so as to increase the power input per unit area. When the pattern area was decreased to about 1.5 cm², the green spots "burned" and appeared black. Further reduction of the pattern area to less than 0.4 cm² showed that the β -zinc silicate increased in brilliancy without discernible "burning". It was only when the beam was concentrated into such a very small area that the generated heat raised the temperatures of the tiny crystals above 900° C that the β -zinc silicate reverted to the α -form and "burned". During this experiment, the scanned area became noticeably more efficient than the unbombarded area outside the scanned pattern. This fact was determined by occasionally expanding the scanned area for momentary observations of the relative brilliancies of the scanned and the previously unscanned phosphor.

B. Subjective Qualities:

6) Emission spectra of phosphors.

The absorption spectra of phosphors are not discussed in this paper, since cathode rays are capable of providing energy in effectively any spectral region down to the wavelength of complete conversion as given by the equation

$$\lambda_{\text{min.}} = \frac{1.234 \times 10^4}{\text{electron volts}} \text{ \AA}$$

²⁴ See pages 263-279 of reference 2.

Ultraviolet sources are less versatile than electron excitation and must be chosen to produce energy within the individual absorption band of any specific phosphor. Thus, silicate, borate, and tungstate phosphors respond efficiently to low-pressure mercury discharges (predominantly 2537 Å) while sulphide phosphors respond efficiently to high-pressure mercury discharges (largely 3650 Å).

In commencing a discussion of emission spectra of phosphors, it is now necessary to introduce the subjective aspect by consideration of the process of seeing. The eye is a very selective receiver of radiation, sensitive only in the narrow band of 3800-7200 Å (approximately one octave) with a maximum of 5560 Å, as shown in Figure 16. Phosphors intended for Kinescope use must have their emissions located well

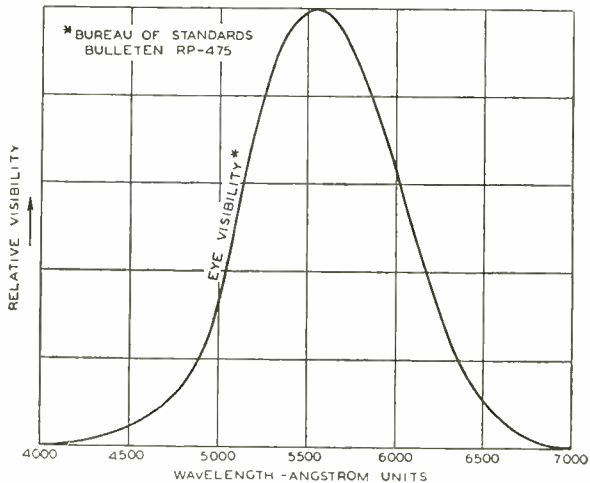

Fig. 16—Sensitivity curve of the human eye.

within the visible region and preferably near the wavelength of maximum visual response (5560 Å) if optimum efficiency is desired. Thus, many phosphors having very high energy efficiencies in the visually ineffective spectral regions are unsuitable for direct use in Kinescopes.

Seeing is a voluntary process as distinguished from hearing and breathing which are practically involuntary. The ability to interpret visual impressions is developed in each individual just as are the arts of walking and speaking. Seeing is influenced not only by objective factors such as the spectral quality, intensity and duration of light, but also by physiological factors such as fatigue, degree of abnormality of an individual's seeing mechanism, and by psychological factors such as immediate environment and the emotional state of the individual. Individuals differ greatly with respect to their visual impressions of identical objects, since each person's sight is dependent upon his own

experience in evaluating color, contrast, brightness, distance, size, aesthetic appeal, etc.²⁵ It is necessary to have well-weighted averages of a large number of persons in order to formulate a general rule concerning seeing. Similarly, the desirability or undesirability of an object or action as estimated visually must be statistically determined to have value as a representative opinion.

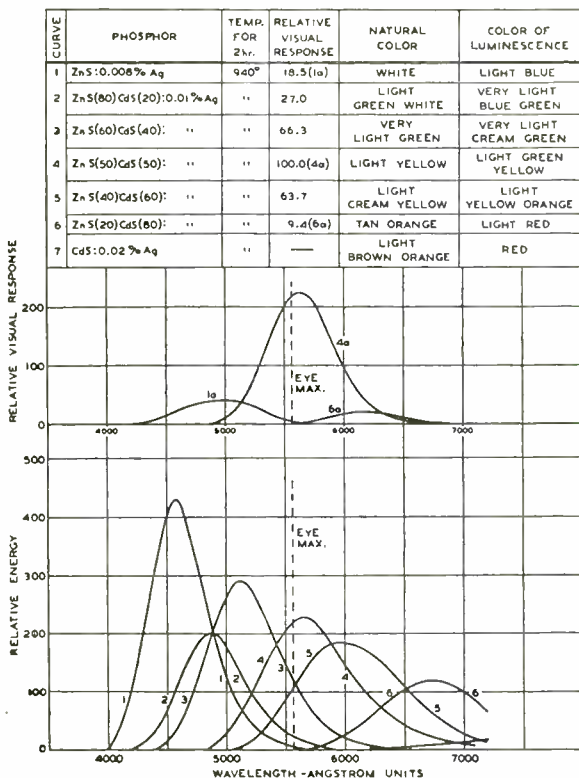

Fig. 17—Relative emission spectra and relative visible efficiencies of silver-activated zinc-cadmium sulphide phosphors.

Decades of acquaintance with printed matter, photographic reproductions and the early motion pictures have instilled a taste for black and white, or black versus some very pale color, rather than black versus a strong hue such as yellow or green. While the demand for white Kinescope screens may be largely traditional, there are some features favoring the choice of white. The contrast of white to black is greater than that of saturated colors to black and the simultaneous

²⁵ Much of the information in this paper regarding the seeing process is obtained from (a) M. Luckiesh and F. K. Moss, THE SCIENCE OF SEEING, D. van Nostrand, 1937, and (b) J. P. C. Southall, INTRODUCTION TO PHYSIOLOGICAL OPTICS, Oxford University Press, 1937.

stimulation of all the color sensations comprising white may be more desirable physiologically than the continued use of but one part of the eye's presumably tri-stimulus mechanism of color vision. Most authorities agree that light is physiologically better the nearer it approaches the spectral quality of diffuse daylight.²⁶ However, since the eye is a simple lens it cannot focus blue and red in the same plane due to chromatic aberration. Purple, therefore, can never appear distinctly in focus and white should not deviate toward lavender shades if sharp detail is to be observed. Green or yellow shades of white are usually less detectable as "off-white" than are blue or red shades of

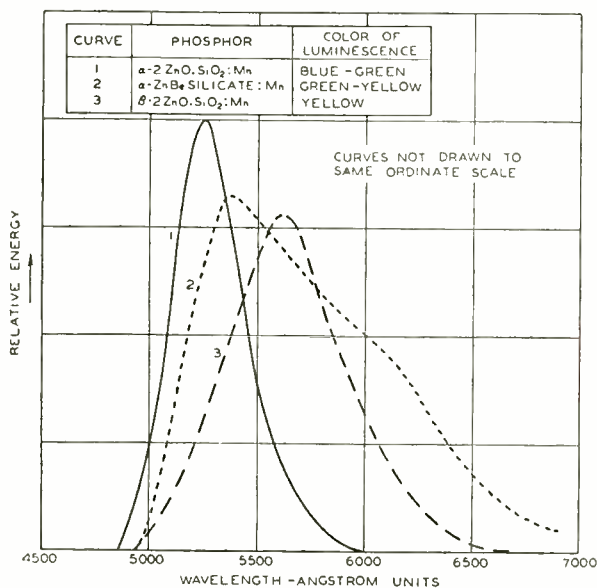

Fig. 18—Relative emission spectra of some manganese-activated silicate phosphors.

white, since the eye's sensitivity to purity (saturation discrimination) is greatest in the blue and red, and least in the green and yellow.

Through centuries of experience the human eye has associated blue-white, viz. daylight, with high illumination levels (200-5000 foot lamberts) and yellow-white, viz. candlelight or incandescent lamps, with considerably lower brightnesses (1-200 foot lamberts).²⁷ Table 4 shows some data taken from Luckiesh and Moss²⁸ with additions pertinent to this review. An ideal white light would probably comprise equal energy continuously spread over the entire visible spectrum, but the sensation of white may be produced by but two monochromatic emission

²⁶ See reference 10.

²⁷ P. J. Bouma, "Colour Reproduction in the Use of Different Sources of 'White' Light", *Philips Tech. Rev.*, 2, 1, 1-8, 1937.

²⁸ See page 325 of reference 25 (a).

lines paired in wavelength and relative energies as shown by the complementary white-stimulating pairs $E_{1_1} + E_{2_1}$, $E_{1_2} + E_{2_2}$, etc. in Figure 19.²⁹

The emission spectra of phosphors are almost all narrow bands, such as shown in Figures 17 and 18. Only one white-emitting single phosphor has been described and its efficiency is too low to be of commercial importance at present.

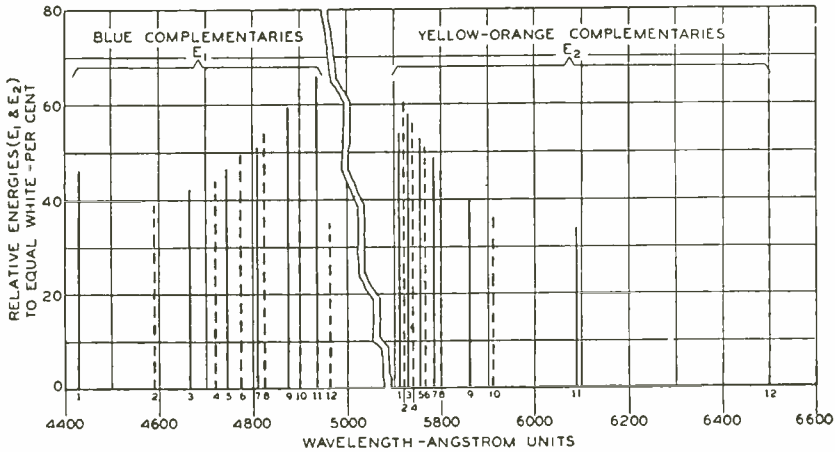

Fig. 19—Relative locations and energy ratios of binary monochromatic white-stimulating spectral complementaries.

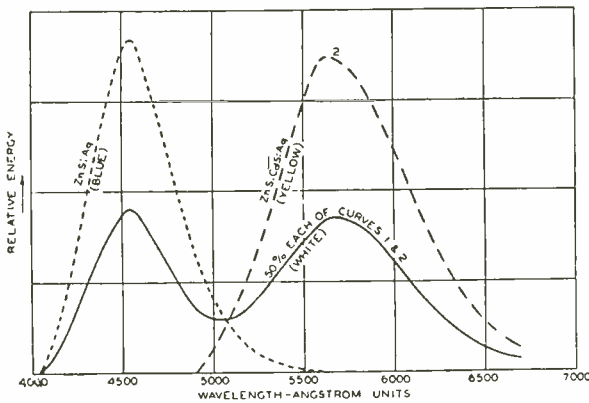

Fig. 20—White-emitting binary phosphor mixture.

Phosphor-emissions are thus usually quite saturated hues and different phosphors must be mechanically mixed to provide paler, i.e., whiter, colors.²⁹

Kinescope screens emitting white light are usually composed of mixtures of complementary blue-emitting and yellow-emitting phosphors.

²⁹ See reference 9.

Table 4

	Candles/in ²	Foot-Lamberts
<i>Outdoors, daylight (December):</i>		
Fresh snow	11.0	5000
Bare ground	0.45	200
White cloth	8.8	4000
Black cloth	0.55	250
<i>Outdoors, night:</i>		
Concrete highway, artificial lighting	0.002	1
<i>Indoors, artificial lighting:</i>		
Ceiling above office lighting unit	0.3	140
Buff wall of same room	0.018	8
Floor of same room	0.005	2
<i>Light sources:</i>		
Sun	1,000,000	450,000,000
Full moon	3.3	1,500
600-watt capillary mercury lamp	285,000	129,000,000
250-watt type H-2 mercury lamp	650	294,000
200-watt tungsten frosted lamp	144	65,000
100-watt tungsten frosted lamp	110	50,000
40-watt tungsten frosted lamp	33	15,000
Candle flame	9.5	4,300
<i>Miscellaneous sources:</i> ³⁰		
Well-lighted printed page	0.022	10
High-light brilliance on theater screen	0.006-0.012	2.7-5.2
High-light brilliance on 16 mm movie screen..	0.006	2.7
High-light brilliance of 12" Kinescope television picture (α -willemite) (6 kv).....	0.04	18.2
High-light brilliance of 2¼" x 3" projection Kinescope screen (α -willemite) (15 kv)....	1.95	880
High-light brilliance of projection Kinescope projected on a screen 1.5' x 2' (α -willemite) (15 kv)	0.0042	1.9
High-light brilliance of a projection Kinescope using β -willemite (10 kv) and high beam current	13	5,900
Front-surface, zinc sulphide screen, at 70 kv and 0.4 ma ³¹ in a 0.5 x 0.5 cm ² scanned area	3,100	1,400,000

phors as shown in Figure 20. The blue-emitting zinc sulphide phosphor is very susceptible to contamination and easily acquires a green-emission band at the expense of, and in addition to its normal blue-emission if subjected to careless handling or abuse in tube processing. The resultant screens then luminesce very green instead of white. Thus, Kinescope manufacturers sporadically rediscover and are plagued by green zinc sulphide, a phosphor first synthesized in 1886.

In order to produce and maintain a pure white emission color from a composite screen, it is necessary to have the component phosphors accurately matched and, if not entirely stable, at least unstable to the same relative degree. The complementary phosphors should have invari-

³⁰ V. K. Zworykin and W. H. Painter, "Development of the Projection Kinescope", *Proc. I.R.E.* 25, 938-954, 1937.

³¹ K. Scherer and R. Rübssaat, "Helligkeitsmessungen an Zinksulfidschirmen bei Anregung durch Kathodenstrahlen", *Archiv für Elektrotechnik*, XXXI, 12, 821-826, 1937.

ant individual and relative spectral distributions with respect to the operating range of the completed Kinescope. They must be substantially similar with respect to their secondary-emission characteristics, variations of light output with varied temperature, current density and accelerating voltage, phosphorescence characteristics and, as previously mentioned, their effective particle sizes.

The occurrence of more than one band of emission from a material is indicative of the presence of more than one type of activating center or else of more than one crystal form or chemical combining proportion.

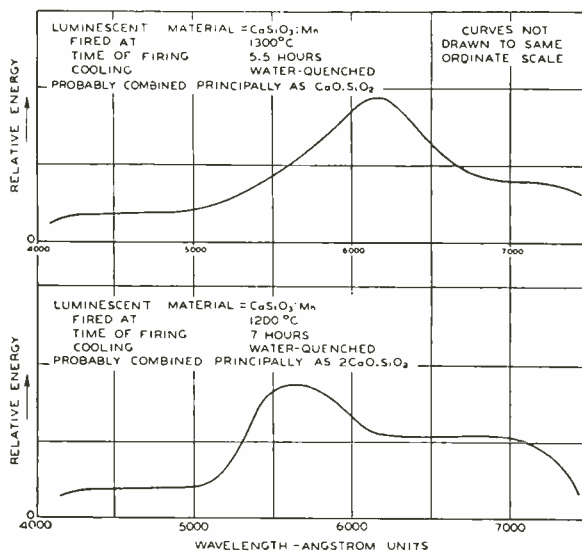

Fig. 21—Luminescence emission spectra of manganese-activated calcium silicate phosphors.

For example, the double band of $\text{ZnS}:\text{Cu}$ (Figure 1) represents the emission of (1) $\text{ZnS}:\text{Zn}^{32}$ and (2) $\text{ZnS}:\text{Cu}$ (see Figure 6), while the multiple bands of manganese-activated calcium silicate, shown in Figure 21, are indicative of the various chemical combining proportions of calcium oxide and silica. Luminescence studies are thus uniquely useful as analytical means in determining compositions and constitutions of materials.

Emission spectra of phosphors allow exceptional control and degree of variation and may, therefore, be practically "made to order". Characteristics of invariant optical media (viz. absorption filters) and spectral responses of photoelectric devices may be matched by phosphor

³² A. Schleede, "Ueber die Ursachen der Luminescenz von reinem ZnS und ZnO ", *Angew. Chemie*, 50, 908, 1937.

F. Seitz, "Interpretation of the Properties of Zinc Sulphide Phosphors", *Jour. Chem. Physics*, 6, 454-461, 1938.

spectral emission distributions for interesting applications such as in color television.

7) *Brilliance and efficiency of phosphors.*

Theoretically, enormous brilliances could be produced with present type, fine-crystal phosphor screens. The following general equation represents the maximum magnitude of luminescence energy output (E_{max}) disregarding phosphor material, but assuming unlimited rate of energy input

$$E_{max} = \frac{ZPE \text{ ergs}}{t \text{ cm}^2 \text{ sec}}$$

Z = optimum concentration of activator centers/cm³ ($\leq 10^{21}$)

P = penetration distance of the exciting radiation into the phosphor (cm)

$E = h\nu$ = the energy value of the quanta of emitted radiation (ergs)

t = the length of time required by the phosphor to convert the exciting energy into the emitted energy (seconds)

If it is assumed that every luminescent center is "loading and firing" without interruption and that the time of the fluorescent act is 10^{-8} second, and if any loss of emitted light by absorption or scattering is disregarded, the substitution of values for 10,000 volt electrons ($P \approx 0.00025$ cm)³³ exciting light at 5560 Å ($E = h\nu = 3.54 \times 10^{-12}$ erg) yields

$$\begin{aligned} E_{max} &= \frac{10^{21} (2.5 \times 10^{-5}) 3.54 \times 10^{-12}}{10^{-8}} = 9 \times 10^{12} \frac{\text{ergs}}{\text{cm}^2 \text{ sec}} \\ &= 9 \times 10^5 \text{ watts/cm}^2 \\ &= 6 \times 10^8 \text{ lumens/cm}^2 \\ &= 6 \times 10^{11} \text{ foot lamberts} \end{aligned}$$

The foregoing analysis is mainly of academic interest, but serves to give an upper limit for light output of conventional phosphor screens. Attainment of such great brilliance requires practically 100 per cent conversion of excitation energy into light in order to avoid overheating of the phosphor and requires tiny crystals in which the phosphorescence action is negligible compared with fluorescence.

Efficiencies of phosphors are higher than other conventional light sources. Tungsten lamps for home and office lighting purposes have conversion efficiencies of but 2-4 per cent while the best phosphors are approximately 5-10 per cent efficient under cathode-ray excitation and 50-80 per cent efficient under suitable ultraviolet excitation.³⁴

³³ See page 27 of reference 14.

³⁴ R. N. Thayer and B. T. Barnes, "Basis for High Efficiency in Fluorescent Lamps", *Jour. Opt. Soc. Amer.* 29, 131-135, 1939.

A. Rüttenauer, "Über die Lumineszenzausbente des Zinksilikat-Leuchtstoffes in der Gasentladung", *Zeits. f. techn. Physik*, 19, 148-151, 1938.

Overall efficiency of phosphors depends primarily upon the amount of energy which is usefully absorbed and secondarily upon the quantum deficit relationship. This latter relationship expresses the loss due to energy difference (ΔE) between the exciting ($h\nu_1$) and the emitted ($h\nu_2$) radiation.

$$\Delta E = h(\nu_1 - \nu_2)$$

E = energy

h = Planck's constant, 6.56×10^{-27} erg sec.

ν = frequency of the light (sec^{-1}) = c/λ

λ = wavelength

c = speed of light in vacuo = 3×10^{10} cm/sec

Since, by Stoke's law, $\lambda_{\text{excit.}} < \lambda_{\text{emitted}}$, then

$$E_{\text{emitted}} < E_{\text{exciting}}$$

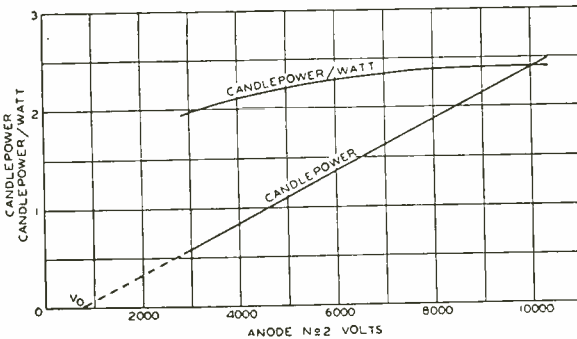

Fig. 22—Typical candlepower and efficiency curves of a phosphor as a function of the Kinescope's applied potential.

As mentioned in section IV-6, cathode rays are capable of providing energy in quantities equal to or less than that given by the equation for complete conversion

$$\lambda_{\text{excit.}} \cong \lambda_{\text{min.}} = \frac{1.234 \times 10^4}{\text{electron volts}} \text{ \AA}$$

For a 10 kilovolt electron, $\lambda_{\text{min.}} = 1.2 \text{ \AA}$. If the emitted wavelength of the excited phosphor be 5230 \AA (maximum of α -zinc silicate:Mn) then the quantum deficit allows only $1.2/5230 = 0.02$ per cent efficiency, if each electron produces but one quantum of light.

Efficiencies greater than 5 per cent are actually obtained and the light outputs of phosphors increase at a power of the electron voltage approximately between one and two, as shown in Figure 22. From a set of experimental measurements, calculations for the particular case of a zinc cadmium sulphide phosphor excited by an electron beam carrying 5 microamperes at 10,000 volts show that the phosphor was being struck by $3 \cdot 10^{13}$ electrons/second and emitting 10^{16} light quanta/second.

Each 10,000-volt primary electron was producing 330 light quanta, besides ejecting at least one secondary electron and having 90 per cent or more of its energy converted into heat. An average of 30 electron volts per quantum was expended. The particular phosphor had an activator concentration of one part of silver per million parts of sulphide, hence it was calculated that there was one silver activator center for each 2,400,000 atoms of the bulk crystal, or one activator center in each crystal segment measuring 460 Å on its cube edges and having 210 bulk crystal atoms along an edge. The probability of a primary electron scoring a direct hit on an activator center as compared with a bulk crystal unit is very small, being only: $1/2.4 \cdot 10^6 = 4 \cdot 10^{-7}$. Thus, out of the original $3 \cdot 10^{13}$ electrons/second there would be an "effective" $3 \cdot 10^{13}$

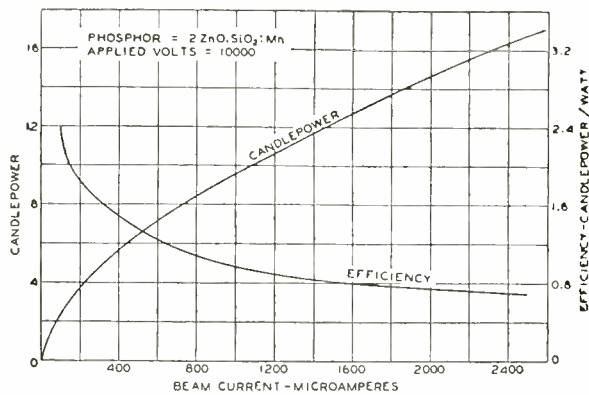

Fig. 23—Typical candlepower and efficiency curves of a phosphor as a function of the Kinescope's electron beam current.

$\times 4 \cdot 10^{-7} = 1.2 \cdot 10^7$ electrons acting solely on the silver activator centers. Assuming the entire energy of each "effective" primary electron to be converted into light, there would be $10^4 \times 1.2 \cdot 10^7 / 10^{16} = 1.2 \cdot 10^{-5}$ electron volt/quantum.

Since, even with 100 per cent efficiency, at least 2.2 electron volts are necessary to produce a quantum of light at 5560 Å, a correction factor of over 10^5 must be applied to the calculated energy conversion.

One must conclude, from the foregoing data, that a primary electron either acts over a distance of 100-200 Å in the phosphor lattice or else, as is more probable, the energy of the beam is absorbed by the bulk lattice and trans-shipped to the activator centers. The trans-shipped energy is probably in small packets corresponding in energy to radiation in the region of approximately 2000-4000 Å, thus reducing the previously mentioned quantum deficit from 99.98 per cent to 20-60 per cent.

The variation of light output with varied current density is shown

in Figure 23. A mathematical formulation³⁵ of light output in terms of independent variables in Kinescope operation is

$$L = K_1 f_1(I, a) (V_a - V_0) - K_2 f_2(V)$$

L = luminous intensity

K_1, K_2 = constants characteristic of the phosphor

I = beam current

a = beam radius

V_a = applied voltage

V_0 = extrapolated "dead" voltage (see Figure 22)

$K_2 f_2(V)$ = secondary emission function ($\propto \theta$)

Reverting again to the human eye's role in utilizing luminescence, it is found that the eye sensitivity (S) to a change (ΔJ) of brightness at a certain brightness (J) may be roughly expressed by

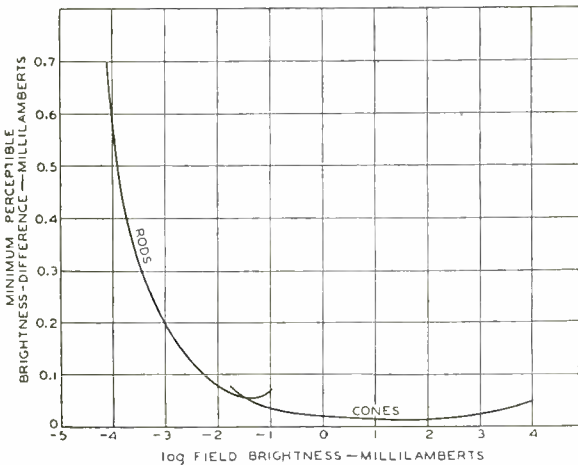

Fig. 24—Minimum perceptible brightness difference as a function of field brightness.

$$dS = K dJ/J, \text{ or } S = k \cdot \log J$$

This form of expression is generally true of all the senses, in that the detectable difference of stimulus must be varied as the total stimulus varies (Weber's Law). In general, therefore,

$$\Delta J/J = 1/k = K \text{ (constant)}$$

The ratio $\Delta J/J$ is practically constant over the comparatively narrow range of intensities from 18.6 to 1860 foot candles which is the normal range of daylight illumination.³⁶

Figure 24 shows the relationship between field brightness and minimum perceptible brightness-difference for scotopic vision (dark-

³⁵ See page 29 of reference 14.

³⁶ See pages 38-42 of reference 25 (b).

adapted or rod-vision, *R*) and photopic vision (daylight or cone-vision, *C*) as determined by Hecht.

The sense of brightness interval is demonstrated in Table 5, taken from Luckiesh and Moss.³⁷ This table shows averaged estimates of ten equal brightness intervals ranging from black to white. The white illumination was 22.8 foot candles and the reflectance of the surrounding field was 19.1 per cent.

Table 5

Estimated Brightness Value	10	20	30	40	50	60	70	80	90	100%
True Reflectance	1.12	2.90	5.95	11.05	18.0	27.3	38.9	53.6	72.8	100%

The scale given in Table 5 provides comparison factors to be applied to the thousands of subjectively determined relative brilliancies of luminescent materials reported in the literature, but the user should remember to consider color differences as well as the brightness differences.

8) Phosphorescence.

Until the 19th century and the advent of invisible forms of exciting energy, such as ultraviolet radiation, cathode-ray energy and radioactive emanation, phosphorescence was the principal demonstrable feature of luminescent materials. Quantitative measurements of phosphorescence have been made on thousands of materials since the first phosphoroscope was constructed by Becquerel in his 30 years of research on luminescence prior to 1867.³⁸ Lenard and his co-workers, starting in the 1880's, constructed many improved phosphoroscopes and experimented with all the important phosphor types under widely varied conditions including the following: temperature, means and degree of excitation, thickness of phosphor layer, size of phosphor crystals, phosphor composition and preparation, etc.³⁹

Modern investigators⁴⁰ have increased the exactness of phosphorescence measurements, but have not discovered any phosphor exhibiting

³⁷ See page 75 of reference 25(a).

³⁸ E. Becquerel, LA LUMIERE, SES CAUSES ET SES EFFETS, I, 247, Didot Freres, Fils et Cie., Paris, 1867.

³⁹ See pages 103-194 of reference 2.

⁴⁰ (a) R. B. Nelson, R. P. Johnson and W. B. Nottingham, "Luminescence during intermittent electron bombardment", *Jour. Appl. Phys.* 10, 335-342, 1939.

(b) G. R. Fonda, "Phosphorescence of zinc silicate phosphors", *Jour. Appl. Phys.* 10, 408-420, 1939.

(c) R. P. Johnson and W. L. Davis, "Luminescence during intermittent optical excitation", *Jour. Opt. Soc. Amer.* 29, 283-290, 1939.

(d) W. deGroot, "Luminescence decay and related phenomena", *Physica*, VI, 275-289, 1939.

(e) A. Schleede and B. Bartels, "Untersuchungen ueber das An- und Abklingen des Leuchtvorganges bei Phosphoren", *Zeits. f. techn. Physik*, 11, 364-396, 1938.

a decay curve contrary to the normal initially rapid decrease in light output, followed by a "tapering-off" of decay rate. According to Johnson and Davis, "It appears that the older phosphors differed chiefly in efficiency, not in any essentials of behavior, from the materials recently developed for television and fluorescent lighting." Figure 25

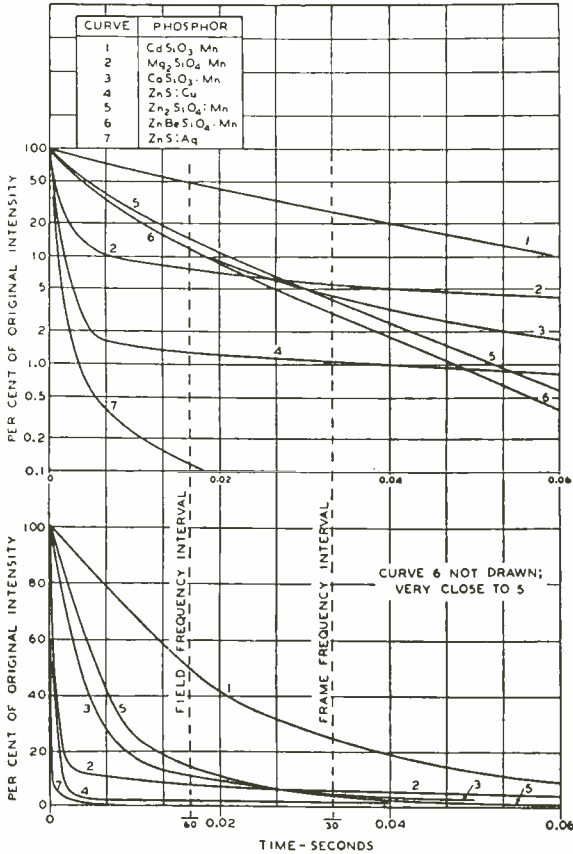

Fig. 25—Phosphor decay curves (persistences). Peak intensities arbitrarily set equal to 100.

shows typical phosphorescence curves for silicate phosphors (exponential-monomolecular) and for sulphide phosphors (hyperbolic or bimolecular).⁴¹ The persistence curves are shown plotted in normal, linear fashion as well as on a semi-logarithmic scale. The latter scale emphasizes the slower rate at the end of a phosphor's decay when the light output is very low. Pure tungstate phosphors have very short

⁴¹ The curve for Cd SiO₃:Mn is from reference 40(c) (loc. cit.) while the remainder are measurements made by T. B. Perkins, Research & Engineering Dept., RCA Mfg. Co., Inc., Harrison, N. J.

decays, lasting about 10^{-5} second. The decay curve of β -zinc silicate:Mn is practically identical with the α -form.

Equations representing the elementary types of phosphor decay curves are as follows:

1) Exponential. Characteristic of a monomolecular process

$$L = L_0 e^{-kt} \text{ typical of silicates and possibly tungstates.}$$

2) Hyperbolic, bi- or poly-molecular type

$$L = a/(b + t)^\alpha \text{ typical of sulphides}$$

where L = light output at time t

$$L_0 = \text{light output at time } t = 0$$

$$a = L_0 b^\alpha$$

and k , b , and α = constants characteristic of the phosphor.
 α has values between 0.8 and 3.

No simple equation will fit any one decay curve over its entire length. The rate of initial decay of sulphide phosphors increases rapidly with the degree of excitation, while phosphorescences of silicate phosphors are less affected by degree of excitation. The long-persistence "tail" of silicate phosphors is more concave upward than is the first nearly exponential part of the decay curve and is strongly temperature-dependent. The "tail" disappears at high temperatures ($> 100^\circ\text{C}$) and at very low temperatures ($< -100^\circ\text{C}$), while phosphor decay curves with or without the "tail" are invariably concave upward.⁴² Obviously, no combination of phosphors can yield a decay characteristic deviating from that obtained by superposition of their individual persistences and, hence, the combination's decay will follow the same trend of "upward concavity".

Phosphorescence, as previously mentioned, is light emitted as a result of freeing electrons trapped in or near activator centers and in crystal faults throughout the phosphor. It is obvious that the rate of emission of light during phosphorescence decreases with decrease of the number of electrons remaining trapped. Thus, the intensity of phosphorescence naturally decreases rapidly with time, especially during the initial decay when the concentration of trapped electrons is high. Furthermore, large concentrations of trapped electrons strain the crystal lattice, accelerating the system's rate of return to the unexcited state. The initial persistence decay rate increases with increasing degree of excitation.⁴³ In general, larger crystals phosphoresce more slowly than smaller crystals, but the decay curves of the various sizes follow the same general equations, differing only in their constants. The phosphorescence of larger crystals is slower than that

⁴² See reference 40.

⁴³ N. Riehl. "Aufbau und Wirkungsweise leuchtfähiger Zinksulfide und anderer Luminophore". *Ann. d. Physik*, 29, 7, 636-664, 1937.

of smaller crystals because free electrons have opportunity to wander farther afield in the more extended lattices. Their return to light-emitting centers is akin to the game of "musical chairs", only on a more statistically-scrambled three-dimensional scale.

During almost a century of extensive study, the non-occurrence of a single exception to the preceding statement that phosphor decay curve characteristics are concave upward is noteworthy as a statistical weight of probability precluding the attainment of speculative phosphorescent decays having concave downward characteristics; such as

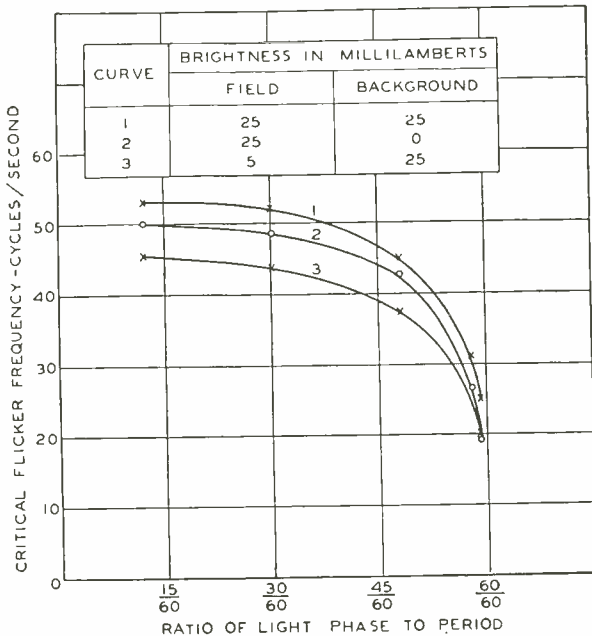

Fig. 26—Critical flicker frequency as a function of the illuminated portion of the field frequency interval.

have been suggested to permit the use of relatively few frames and fields per second for television images.

Figure 26 shows results published by P. W. Cobb⁴⁴ demonstrating the reduction of critical flicker frequency by increasing the amount of time the light was on in relation to the total time between light-dark intervals. It is seen that filling 59/60 (98.3 per cent) of the field time with light reduced the critical frequency to only 20-26 cycles/second, and that filling 45/60 (75 per cent) reduces the critical frequency to 39-47 fields per second, the exact values being dependent on illumination

⁴⁴ P. W. Cobb, "The Dependence of Filcker on the Dark-Light Ratio of the Stimulus Cycle", *Jour. Opt. Soc. Amer.* 24, 109, 1934.

levels. It follows, from Cobb's data, that the use of phosphors such as long-persistence orange-emitting calcium- or cadmium silicate would decrease the critical frequency to only about 40 fields per second at low brightness levels. At the brightness levels ordinarily demanded for television pictures, the critical frequency for these materials would be about 44 to 48 fields per second. Because it is desirable to use the most efficient light-producing phosphors, shorter persistence characteristics with still higher critical frequencies must be accepted. Thus, a mixture of blue-emitting zinc sulphide and yellow-emitting zinc beryllium silicate—which provides a brilliant white screen—fills less than 45 per cent of the field interval and has a critical frequency of 44 to 52 fields per second for a brilliancy range of 5 to 25 millilamberts.

Minor reduction in field frequency by use of long-persistence phosphors is dearly bought, in that

1) The efficiencies of the long time-lag screens, having at least approximately an exponential decay, are less than 50 per cent of the present white screens. A phosphor's excitation rate is directly proportional to its decay rate. The imposition of a longer persistence further possibly reduces the inherently low efficiencies of such phosphors by decreasing the amount of excitation obtained from the scanning electron beam which bombards each phosphor crystal for but 1.5×10^{-7} seconds in the case of a 12" Kinescope operating with 507 lines and 30 frames, interlaced.

2) The brilliancy of a long-persistence screen is naturally lower than that of a short-persistence screen because the storage process of long-lag phosphors places a two-fold limitation upon attainment of large concentrations of free electrons in the phosphor lattice:

- a. As the crystal becomes excited, there are fewer sources of further electrons which may be ejected to wander into the lattice.
- b. As the trapping positions in the crystal become filled, the later ejected electrons are summarily prevented from finding suitable positions and are thus rendered more probable prey for conversion into undesirable heat energy rather than into useful light.

3) Suitable white screens are not obtainable with the orange-emitting long-persistence phosphors by virtue of (a) the inefficiency of orange as a complementary color⁴⁵ and (b) the lack of a blue-green complementary phosphor which matches the orange component's decay curve. A mixture of cadmium silicate with copper-activated zinc sulphide produces an approximate lavender-white which, in addition to its undesirable color, is unsatisfactory because rapidly moving

⁴⁵ See reference 9.

objects are shown blue on their leading edges and orange on their trailing edges. This phenomenon is the result of incompatible phosphor excitation and decay characteristics. See decay curves shown in Figure 25.

4) Use of lower field frequencies would necessitate restricting phosphors for Kinescope use to but one or two inefficient materials out of the thousands of efficient materials which are known and in development. Such restriction is definitely poor engineering practice, since suitable persistence has been shown to be but one of the many important qualities which must be possessed by a phosphor in order that it be serviceable in Kinescopes.

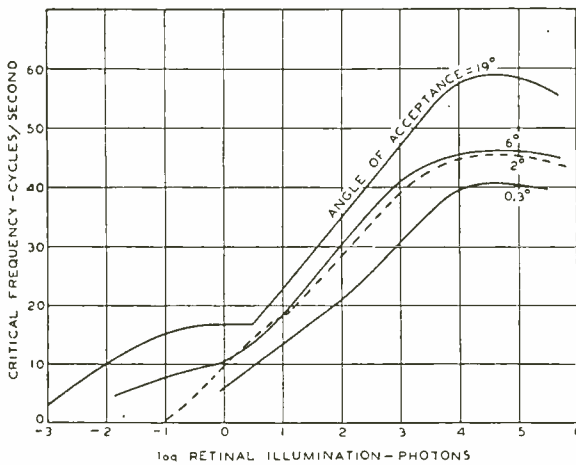

Fig. 27—Critical flicker frequency as a function of retinal illumination. (One photon = unit of visual stimulation = 0.2914 foot-lambert.)

It has been proposed to "straighten" phosphor decay curves by applying infra red or heat to accelerate their phosphorescent outputs inversely as their decay characteristics. Such proposals usually fail to take into account the refractory natures of phosphors and their non-conduction of heat. If temperatures high enough to dissipate heat effectively by radiation are used, the luminescent efficiencies of phosphors will be decreased to negligible values.

Demonstrations of reduced flicker are best carried out at low brightness levels, since the eye's sensitivity to flicker decreases rapidly with decreasing level of light intensity as shown in Figure 27.⁴⁶ However, even at low brightnesses, the tendency to approach a dim image more

⁴⁶ S. Hecht and E. L. Smith, "Intermittent Stimulation by Light", VI, "Area and the Relation Between Critical Frequency and Intensity", *Jour. Gen. Physiol.* 19, 979, 1936.

closely introduces aberrate vision and greatly increases flicker. Aberrate vision intensifies the retina's peripheral stimulation (rods) with respect to excitation in the fovea centralis (cones). This is shown in Figure 27, in that increasing the angle of acceptance from 0.3° to 19° increases the critical frequency by approximately 30 per cent. As television images increase in size and the dimensions of the home remain fixed, it will become increasingly important to take every precaution to preclude flicker, especially with respect to children who naturally tend to place themselves too close to the television screen.

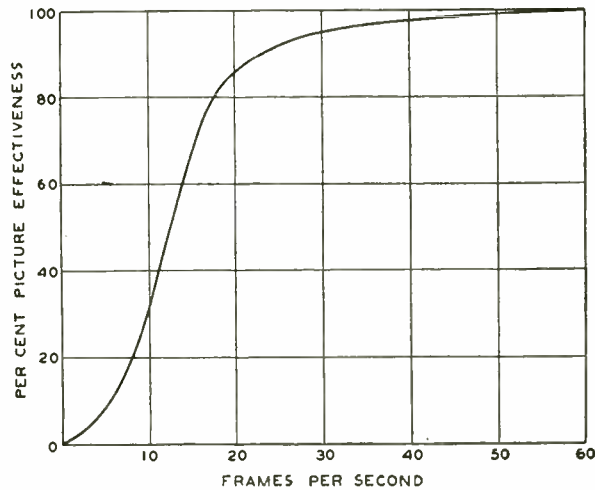

Fig. 28—Relative degree of a television picture's satisfactoriness as a function of frame frequency.

The flicker sensitivity of the human eye as a function of color is directly proportional to the eye's photopic sensitivity to that color. Thus, the critical flicker frequency for colored lights of equal intensity decreases in the order: yellow, 5800 Å; orange, 6100 Å; green, 5100 Å; red, 6500 Å; blue, 4800 Å.⁴⁷

The general average illumination level has been increasing rapidly in the past few decades. In 1896, 0.4 footcandle was deemed sufficient; in 1914, the average was 1-3 footcandles, while in 1931 the standard was 11 footcandles.⁴⁸ The brilliancies of television images will undoubtedly tend to increase with the trend of increasing illumination levels.

There is a definite increase in visual acuity up to 15-20 footcandles and increased illumination directly improves the ability of the eye to

⁴⁷ See page 374 of reference 25 (b).

⁴⁸ LeGrand Hardy, "The Measurement of Light", *Trans. Illum. Soc.* XXXV, 7, 605-624, 1940.

see quickly. There is an increase in "speed of vision" between 0.4 footcandle and 12.0 footcandles amounting to approximately 600 per cent for visual detail of size 1.15' and 331 per cent for a detail of double this size (Ferrie & Rand as quoted in Hardy).⁴⁹ Accordingly, utilization of finer detail in television images (such as by increasing the number of lines) would require increasing picture brilliancy and correspondingly increasing the eye's susceptibility to flicker.

It is well understood that a frame repetition rate of less than 30 per second is inadequate to avoid loss of continuity in rapidly moving objects since even 30 frames per second is insufficient for some television scenes of rapid motion. A thorough study by R. Thun has resulted in the graph of Figure 28 showing degree of satisfactoriness of average pictures (either motion pictures or television) as a function of frame frequency while keeping all other variables at optimum values.⁵⁰ An extensive investigation by E. W. Engstrom⁵¹ gives the essentials involved in choosing frame and field frequencies. The study showed it to be illogical to expect that the flicker problem could be solved by using phosphor screens of longer persistence.

Another important fact, which weighs against the use of longer-persistence phosphors, is the blurring or "trailing" effect which is a comet-like tail appended to moving objects reproduced on a long-persistence screen. The flattening shape of the persistence curve for very long phosphorescences intensifies the ratio of light emitted after the picture time-interval as contrasted with the maximum light intensity. Furthermore, the "carry-over" of long-persistence phosphors leaves a higher general level of illumination on the Kinescope screen, thereby seriously reducing contrast.

Summarizing: it appears most sensible to operate electronic television at 30 frames and 60 fields (or more) per second in order to assure: (1) being able to provide Kinescope screens emitting a white light comparable with the ingrained standard of daylight; (2) allowing improvement in Kinescope performance, as new phosphors are developed, without automatically discarding the more efficient materials because their decay characteristics are not slow enough; (3) affording smoothness and continuity in the ever-increasing percentage of scenes which contain rapid motions; (4) avoiding loss of contrast and blurring due to the unavoidable "carry-over" of long persistence screens; and

⁴⁹ See reference 48.

⁵⁰ R. Thun, *Die Kinotechnik*, April 5, 1935, p. 117; *ibid* Nov. 5, 1935, pp. 358-362; *ibid* Nov. 20, 1935, pp. 374-376. (Abstracted by Dr. D. W. Epstein and furnished through the courtesy of Mr. E. W. Engstrom, Director of Research, RCA Mfg. Co. Inc., Camden and Harrison, N. J.)

⁵¹ E. W. Engstrom, "A Study of Television Image Characteristics", *Proc. I.R.E.*, 21, 1631-1651, 1933; *ibid*, 23, 295-311, 1935.

(5) providing high enough levels of flicker-free picture brilliancy to be adequate, not only for the "normal eye", but also for the refractively defective eye. The latter receives greater benefit from increase in quality and quantity of illumination than does the "normal eye". Approximately two-fifths of our population, comprising millions of people, have defective visual functions⁵² which must be considered in establishing a public service such as television.

Appreciation is expressed for the stimulating interest accorded these investigations by Mr. E. W. Engstrom, Dr. G. R. Shaw and Dr. E. A. Lederer as well as other members of the Research Department.

READING LIST

(Supplemental to the cited references)

(1) General References:

- H. Rupp, *DIE LEUCHTMASSEN UND IHRE VERWENDUNG*, Borntraeger, Berlin, 1937.
 "Symposium on Luminescence", *Trans. Faraday Soc.* **35**, 1, 1939.
 V. K. Zworykin and G. A. Morton, *TELEVISION. ELECTRONICS OF IMAGE TRANSMISSION*, J. Wiley, 1940.
 F. Fritz, *LEUCHTFARBEN*, Gustav Bodenbender, Berlin, 1940. (Very extensive bibliography of over 830 papers and patents.)

(2) Recent Specific References:

- N. C. Beese, "The Response of Several Fluorescent Materials to Short Wave-Length Ultraviolet Radiations," *Jour. Opt. Soc. Amer.* **29**, 278-282, 1939.
 H. Bey, "Aufladepotentiale elektronen-bestrahlter Leuchtmassen," *Physik. Zeits.*, **39**, 605-611, 1938.
 G. G. Blake, "Infra-Red Radiations with Special Reference to their Quenching Effects upon Zinc Sulphide Phosphors," *Jour. & Proc. Roy. Soc. N. S. Wales*, **73**, 112-124, 1939.
 J. Ewels, "Resolution and Interpretation of the Luminescent Spectra of Some Solids at Low Temperatures," *Proc. Roy. Soc., Series A*, No. 928, Vol. 167, 34-52, 1938.
 G. R. Fonda, "The Fundamental Principles of Fluorescence," A.I.E.E. Technical Paper 38-57, May 1938.
 G. R. Fonda, "Characteristics of Silicate Phosphors," *Jour. Phys. Chem.*, **43**, 561-577, 1939.
 G. R. Fonda, "The Preparation of Fluorescent Calcite," *Jour. Phys. Chem.*, **44**, 435-439, 1940.
 J. Frenkel, "On the Absorption of Light and the Trapping of Electrons and Positive Holes (also Excitons) in Crystalline Dielectrics," *Sowj. Physik*, **9**, 2/3, 158-187, 1936.
 J. H. Gisolf, "The Absorption Spectrum of Luminescent Zinc-Sulfide and Zinc-Cadmium Sulfide in connection with some Optical, Electrical and Chemical Properties," *Physica*, **VI**, 84-96, 1939.
 G. Graue and N. Riehl, "Untersuchungen über die Porenweite und das innere Volumen amorpher und kristalliner Stoffe," *Zeits anorg. allgem. Chem.*, **233**, 365-375, 1938.
 W. Grotheer, "Ermüdungserscheinungen Elektronenbestrahlter Leucht-massen," *Zeits. f. Physik*, **112**, 9/10, 541-559, 1939.
 C. Hagen, "Aufladepotentiale, Sekundär-emission und Ermüdungs-erscheinungen elektronenbestrahlter Metalle und Leuchtsubstanzen," *Physik. Zeits.*, **20**, 621-640, 1939.
 S. T. Henderson, "Band Spectra of Cathodo-Luminescence," *Proc. Roy. Soc., Series A*, No. 954, Vol. 173, 323-338, 1939.

⁵² See reference 10.

- R. P. Johnson, "Luminescence of Sulphide and Silicate Phosphors," *Jour. Opt. Soc. Amer.*, 29, 387, 391, 1939.
- K. Kamm, "Über die Zinksulfid-Cadmiumsulfid-Phosphor," *Ann. d. Physik*, 30, 333-353, 1937.
- F. A. Kröger, "Some Optical Properties of Zinc Silicate Phosphors," *Physica*, VI, 764-778, 1939.
- F. A. Kröger, "Fundamental Absorption of ZnS-MnS and ZnS-CdS-MnS Mixed Crystals," *Physica*, VI, 779-784, 1939.
- J. W. Marden and G. Meister, "Effects of Impurities on Fluorescent Compounds," *Trans. Illum. Eng. Soc.* XXXIV, 503-513, 1939.
- F. Möglich, "The Mechanism of Luminescence in Phosphorescent Crystals," *Angew. Chemie*, 53, 54-56, 1940.
- J. T. Randall, "The Fluorescence of Compounds containing Manganese," *Proc. Roy. Soc. Series A*, No. 940, Vol. 170, pp. 272-293, 1939.
- N. Riehl, "Über einen neuen Effekt an lumineszierendem Zinksulfid," *Zeits. f. techn. Physik*, 5, 152-155, 1939.
- N. Riehl and M. Schön, "Der Leuchtmechanismus von Kristallphosphoren," *Zeits. f. Physik*, 114, 682-705, 1939.
- E. Streck, "Über die Zerstörung des Zinksulfids durch Licht und α -Strahlen," *Ann. d. Physik*, 34, 96-112, 1939.

VIDEO OUTPUT SYSTEMS*†

By

D. E. FOSTER AND J. A. RANKIN

Formerly with
RCA License Laboratory, New York

Summary—The output stage of the video frequency amplifier of a television receiver is required to modulate the grid of the picture tube over the range of optimum contrast. In order to accomplish this purpose a relatively large output is necessary over the entire video frequency range. In addition, the output stage must reinsert the d-c component which determines the average brightness of the scene. The advantages and disadvantages of direct coupling, grid rectification, and diode rectification as a means of accomplishing d-c reinsertion are discussed. It is pointed out that d-c reinsertion tends to restore low frequencies.

The characteristics of circuits to obtain uniform high-frequency response are discussed. The circuits dealt with are shunt peaking, series peaking, series and shunt peaking, series m-derived filter sections, shunt m-derived filter sections, and two-section constant-K filter sections.

The performance of typical video output tubes with the several circuit types as to gain and voltage output is shown.

INTRODUCTION

VIDEO frequency amplifiers have been treated in radio literature generally. However, the requirements of the video amplifier used as the output stage of the television receiver to modulate the grid of the picture tube (Kinescope) with picture signals require special consideration. This article discusses the video output stage, its particular requirements, methods of d-c reinsertion, suitable circuits for use with available tubes, and typical performance characteristics.

OUTPUT STAGE REQUIREMENTS

The video-output stage must have sufficient output to modulate the picture-tube grid over the optimum contrast range, plus additional output capability for the synchronizing pulses in order that the picture be properly reproduced. It would not be necessary to reproduce the synchronizing pulses faithfully as they occur during the blanking interval, except that the overload of the output tube is due to plate-current cut-off, so the entire video signal must be reproduced to avoid distortion of any part. Picture tubes now commonly used in this country require some 25 or 30 volts peak-to-peak for full contrast, so that with 25 per cent synchronizing pulses, the output tube must be capable of delivering at least 40 volts peak-to-peak. A higher maximum output is

* Decimal Classification: R583 X R363.4.

† Reprinted from *RCA REVIEW*, April, 1941.

desirable so that there is never any question that full contrast is achieved. It is always possible to reduce the output by means of the contrast control, so many receivers have 60 to 120 volts peak-to-peak maximum output. The situation is similar to that in radio receivers where it is desirable to have sufficient audio gain to overload the output tube even at low-modulation levels. In order to keep the number of video stages at a minimum, the gain of the output stage should be high. By careful use of the principles considered herein sufficient gain may be obtained so that the video-output stage provides all the video amplification required on practically any television receiver. The maximum output of the video stage is a function of maximum permissible plate current and the load-resistor value. The gain is a function of the effective transconductance and the load value. The load resistance for a given band width is a function of tube-output capacitance, so it may be seen that the video-output tube should have high transconductance, high plate current, and low output capacitance.

In considering circuits for video-output purposes it has been assumed in this article that the response be flat over the desired frequency range, as this is the condition generally desired. In some designs a characteristic which rises towards the high frequencies is used to compensate for loss in the high frequencies either due to picture-tube spot size or loss elsewhere in the system. This can usually be done safely to compensate to a moderate degree the effect of spot size, without introduction of undue phase distortion, but an attempt to provide more than a small amount of compensation for deficiencies elsewhere in the receiver frequently leads to phase-distortion difficulties. Therefore, for the sake of generality and because it is the most commonly used condition, it is assumed that flat response is the design criterion.

The phase shift should of course vary linearly with respect to frequency so that the time delay does not vary with frequency. However, the phase shift is not usually a serious problem in the case of a single video stage in a receiver, both because the number of reactances is relatively small, so that large phase shift does not occur, and also because the phase shift in the intermediate-frequency amplifier is ordinarily so much greater that the phase shift due to the video-output stage is of little consequence when the overall receiver-phase characteristic is considered. For these reasons the phase characteristics of the networks covered herein are not discussed. However, if the same networks are used in an application where several video stages in cascade are employed, the phase characteristics become important and must be considered in order to obtain satisfactorily uniform time delay.

The low-frequency compensation methods for video amplifiers have

been dealt with in a previous issue¹ so are not covered here except as the method of securing bias and the d-c reinsertion affect the low-frequency response.

D-C REINSERTION

In a television system where the average brightness of the scene being scanned at the transmitter is transmitted as variation of the carrier level, it is the equivalent of transmitting the d-c component of the scene. Such a system is therefore called the d-c transmission type and is in use in the United States. Since the d.c. is not carried as

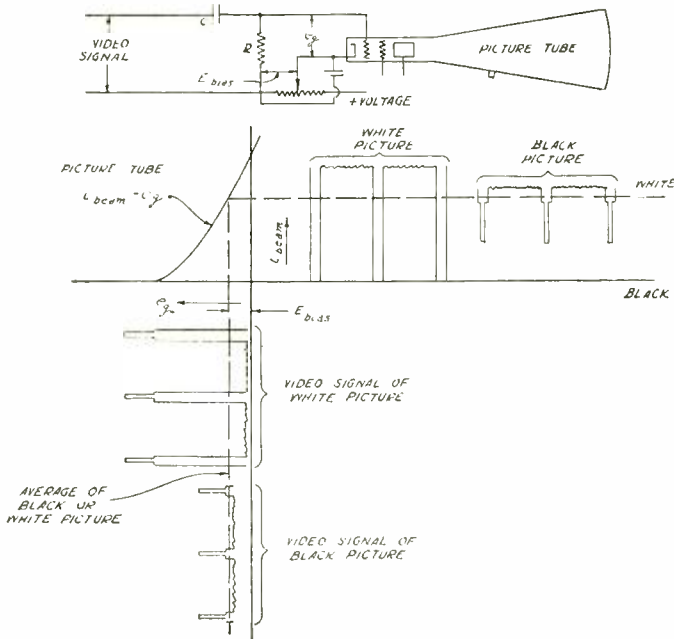

Fig. 1

such through the entire system, it is necessary to recover or to reinsert the d-c component at the receiver, this d-c reinsertion providing automatic control of the brightness of the picture tube. This restoration of the d.c. serves to fix the black level of the video signal.

The necessity for fixing the black level of the video signal appearing at the picture-tube grid is most readily appreciated by considering what conditions prevail when the black level of the video signal is not maintained at a fixed point on the operating characteristic of the picture tube.

¹ S. W. Seeley and C. N. Kimball, "Analysis and Design of Video Amplifiers", *RCA REVIEW*, Oct. 1937 and Jan. 1939.

The circuit of Figure 1 is that of the input of the picture tube. The picture tube in this circuit is operated at a constant grid bias indicated on the diagram as E_{bias} . The video signal is coupled to the picture-tube grid by the coupling condenser C , which coupling condenser permits the video signal appearing across the grid-leak k to swing around the average level of the particular video wave. The average level being such that the areas of the video wave on either side of the average level line are equal.

In Figure 1 a picture-tube $i_{beam}-e_g$ characteristic is shown with two video signals applied to that characteristic. The signals are two horizontal lines with three blanking and synchronizing pulses. Considering only the video signal of a white picture, the picture-tube bias is adjusted so that the synchronizing pulses swing the picture-tube grid beyond beam current cut-off. The average level of the video signal centers about the bias and the picture portion of the video signal is near the zero-bias end of the characteristic. With this adjustment of bias, the video signal of a white picture produces a picture-tube beam current as shown on the diagram.

It is to be noted that the picture-tube beam current is at cut-off during the blanking-pulse interval and that maximum beam current occurs during the picture portion of the wave producing a white picture.

With the same bias adjustment as that for the white-picture signal, consider the reproduction of a picture that is predominantly black. As with the white-picture signal, the average level of the black-picture signal will center on the bias. The picture-tube beam current produced by the black-picture signal is shown on Figure 1 and it is to be noted that the beam current is not at cut-off during the blanking interval. This permits the scanning retrace to be visible. The picture portion of this signal represented a black picture, nevertheless the beam current produced by this signal during the picture portion of the wave is nearly as great as that produced by the previously considered white picture. It is seen that the fixed-bias operation of the picture tube is not satisfactory due to loss in contrast and to the visible presence of retrace lines on certain types of pictures. For satisfactory operation, the black level of the various video signals must be maintained at picture-tube beam current cut-off. Several methods for fixing the black level will be discussed.

DIRECT COUPLING

The National Television System Committee recommended type of television transmission is one in which a decrease in initial light intensity causes an increase in radiated power and the black level is

represented by a definite carrier level, independent of light and shade in the picture. By using direct coupling between the second detector and the picture-tube grid, the black level is retained and is at a fixed point on the picture-tube grid characteristic.

A circuit for direct coupling between the second detector and the kinescope is shown in Figure 2. The two section $L-C$ filter between the diode detector and the load R_L is the conventional type of diode filter. This circuit is impractical in that high-output voltage would be

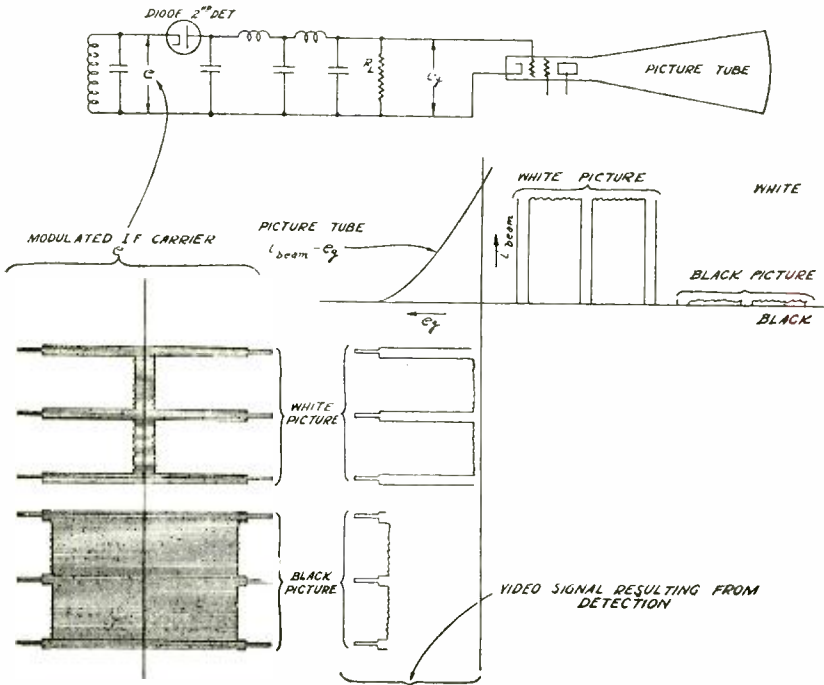

Fig. 2

required from the second detector. In a practical application of direct coupling an amplifier stage would be interposed between the second detector and the picture tube. Such an amplifier stage would require direct coupling at both input and output ends.

The modulated i-f carrier that is applied to the diode second detector is shown at "e" for two different picture signals, white and black. The video signal resulting from detection is shown applied to the picture-tube $i_{beam} - e_g$ characteristic.

The detected video signal will produce a satisfactory picture because the black level of the two video signals are at the same level and may

be adjusted to fall at picture-tube beam current cut-off. The beam current produced by these two video-signal voltages is shown, and is seen to produce beam current of approximately correct contrast if the picture-tube characteristic is reasonably linear, and to cut the beam current off during the blanking pulse interval.

One of the disadvantages of this method of operation is that when the signal is removed the picture-tube screen becomes white. This is due to the fact that with no signal the picture tube is operating at zero bias, hence at maximum beam current, which may result in damaging the picture tube.

The second major disadvantage of this system lies in the action of the contrast control. Assume, for instance, that the contrast control varies the magnitude of the modulated i-f carrier. As the carrier amplitude is increased the detector-video output will also be increased. However, the white portion of the picture is at or near zero output of the detector, so that by increasing the output of the detector the white level remains approximately fixed while the grey and black portions of the picture get blacker. This is a direct opposite to normal operation.

The addition of one or more direct-coupled amplifier stages between the second detector and the picture-tube grid does not change the mode of operation of this system as regards the zero-bias condition or action of the contrast control.

This system will perform creditably if the transmission polarity is positive with the d-c component of the video signal transmitted, as in this type of transmission the black level is at minimum-carrier amplitude while white level is at maximum-carrier amplitude so the picture tube is operated with a fixed negative grid bias. As the picture signal is applied to the picture-tube grid the fixed negative bias is decreased in accordance with the amplitude of the applied signal.

DIODE AUTOMATIC BRIGHTNESS CONTROL

The use of a diode rectifier to bias the picture-tube grid in accordance with the video-picture signal appearing at the picture-tube grid is a method of operation with several advantages.

The circuit for this arrangement is shown in Figure 3. The video signal is coupled to the picture-tube grid by means of the coupling-condenser C . The picture-tube bias is due to a fixed-bias E and the bias developed by the diode rectifier.

The picture tube $i_{bcum}-e_g$ characteristic is shown in Figure 3 along with a diode characteristic. The diode characteristic is that of a diode as connected in the circuit and is displaced from the zero axis due to the bias E_{bias} .

Consider the application of a video signal of a white picture to

this circuit. The bias E is adjusted to be greater than the bias necessary for picture-tube beam-current cut-off. The average level (dotted line) of this video signal would center on the bias E were it not for the action of the diode which creates a bias $i_d R$ nearly equal to the peak amplitude of the video signal in the negative direction. This action places the video wave as shown on the diagram with the negative peaks of the synchronizing pulses just drawing diode current. The beam current produced by this white-picture signal is shown with the picture

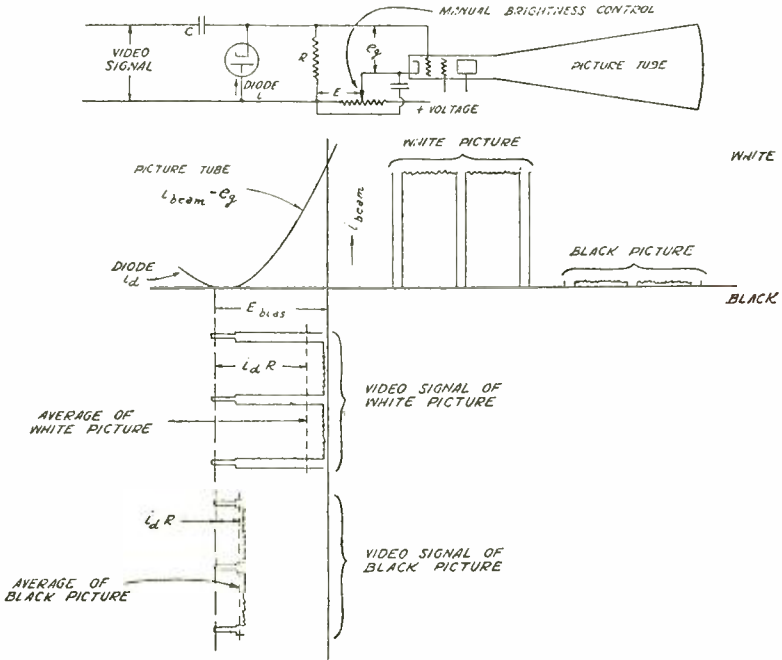

Fig. 3

portion of the wave near maximum beam current and the beam-current cut-off during the blanking-pulse interval.

With the same bias adjustment a video signal of a black picture may be applied to the circuit, again the tips of the synchronizing pulses draw diode current, but in a lesser amount than in the case of the white picture, producing a positive bias proportional to the negative-peak amplitude of the wave. The position of the black-picture wave will be as shown in Figure 3, and will produce a beam-current wave as shown, with the picture portion of the wave near black level and with the beam-current cutoff during the blanking pulse.

If the video signal is completely removed from this circuit, the bias on the kinescope will be E volts, which will cut the beam current off.

A second advantage of this circuit lies in the fact that the black level is always at a fixed point, even when the magnitude of the input-video signal is varied, so that increasing the contrast increases the brightness of the highlights.

The use of a diode as a d-c reinserter has the further advantage that with normal values of diode-leak resistance the bias developed by rectification is a linear function of the peak amplitude of the applied video signal.

BIAS DEVELOPED

It was pointed out above that the bias developed by the diode rectifier would be nearly equal to the peak amplitude of the wave in the negative direction. The exact amount of bias developed is dependent upon several circuit constants and may be most readily appreciated by reference to Figure 4. The circuit shown is that of the video-output stage producing a voltage "e" with an equivalent internal-impedance R_c , driving the conventional diode through the coupling-network R_d-C . R is the internal resistance of the diode during the time that it is conducting. For the type 6H6 diode one plate-cathode will have a resistance of approximately 4000 ohms. During the non-conducting interval the value of R will approach infinity.

The wave shown in Figure 4 is a typical video wave representing two horizontal lines with three blanking and synchronizing pulses. The tip of the synchronizing pulse is assumed to occupy 7 per cent of the time of one complete line. The percentage indicated in Figure 4 is 8 per cent. This increase is due to the addition of six vertical pulses that occur at field frequency. In a system using 441 lines at 30 frames, the line frequency is 13,230 cycles per second which is 75.5 microseconds for one complete line. If the diode is to charge the condenser C during the time of one synchronizing pulse, the time of charge will be 8 per cent of 75.5 microseconds or 6 microseconds, while the time that the condenser discharges will be the remainder or 69.5 microseconds.

On the wave shown in Figure 4 the voltages indicated e_c and e_d represent, respectively, the voltage that contributes to charging the condenser C , and the voltage that appears across C in the form of the bias developed.

If steady-state conditions are to prevail, the quantity of electricity on charging the condenser C must equal the quantity on discharge. From this, the ratio of e_c to e_d may be determined.

In a device of his kind, if the magnitude of the time constants on charge and discharge are known to a fair degree of accuracy, the evaluation of the ratio of e_c to e_d may be readily accomplished.

If $C(R_d + R_c)$ is of the order of 0.1 second it is very large compared to the time of discharge of the signal wave, which is 69.5 microseconds, the discharge current then may be assumed to be constant and equal to $\frac{e_d}{(R_d + R_c)}$

If $C(R_c + R)$ is of the order of 700 microseconds it is very large compared to the time of charge of the signal wave which is 6 micro-

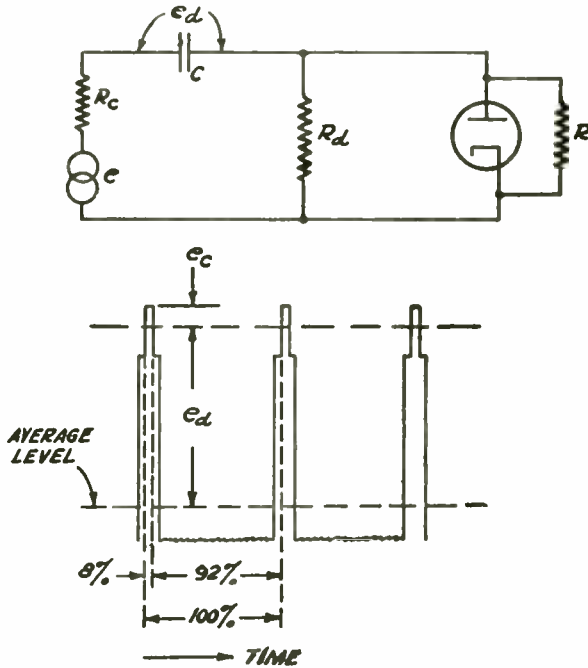

Fig. 4

seconds, and the charge current may be assumed to be constant also and equal to $\frac{e_o}{(R_c + R)}$

As stated before, for steady-state conditions to prevail the quantities of electricity on charge and discharge must be equal.

The quantity of electricity Q is equal to:

$$Q = \int i dt$$

however in the case at hand the current "i" is constant so,

$$Q = i \int dt = it$$

Therefore, since the charge occupies 8 per cent of the time, and discharge 92 per cent of the time,

$$i_d \times 0.92 = i_c \times 0.08$$

where,

$$i_d = \frac{e_d}{(R_d + R_c)} \quad \text{and} \quad i_c = \frac{e_c}{(R_c + R)}$$

$$\frac{e_d}{R_d + R_c} \times 0.92 = \frac{e_c}{R_c + R} \times 0.08$$

$$\frac{e_d}{e_c} = \frac{8}{92} \times \frac{R_d + R_c}{R_c + R}$$

Previously in this discussion time constants of charge and discharge were assumed, these time constants result if the following circuit constants are chosen:

$$\begin{aligned} R_d &= 1,000,000 \text{ ohms} \\ R_c &= 3000 \quad \text{“} \\ R &= 4000 \quad \text{“} \\ C &= 0.1 \text{ } \mu\text{f.} \end{aligned}$$

With these values of resistance the actual ratio of e_d to e_c may be calculated and equals

$$\frac{e_d}{e_c} = 12.5$$

Referring again to Figure 4 it is seen that the sum of e_d and e_c is equal to the peak amplitude of the video wave in the direction of the synchronizing pulses. From this the bias e_d may be determined in terms of the peak amplitude and is in this case 92.6 per cent of the peak amplitude.

The wave appearing in Figure 4 is that of a white picture; however, the above method of determination of bias as a function of peak amplitude applies equally well to a video signal of a black picture. A white picture might for instance have a peak amplitude of 30 volts which would produce 27.8 volts of bias, while a black picture might have a peak amplitude of 8 volts producing a bias of 7.4 volts.

GRID RECTIFICATION AS AUTOMATIC BRIGHTNESS CONTROL

Another satisfactory method of automatic brightness control is by the use of the circuit of Figure 5 wherein the last video amplifier tube “T” is biased by grid current and the picture-tube grid is directly connected to the video-amplifier-tube plate.

The video signal is coupled to the grid circuit of the amplifier tube by means of the coupling condenser C . The i_p - e_g characteristic of this tube is shown in Figure 5 along with the i_g - e_g characteristic of the kinescope.

The video signals appearing in the grid circuit of this tube produce grid current and bias in proportion to the peak amplitude of the video signal in the positive direction. The two video signals of a white-and-black picture illustrated in Figure 5 will assume their respective positions as shown due to grid rectification. It is seen that this method of bias fixes the black level of the picture signal at the

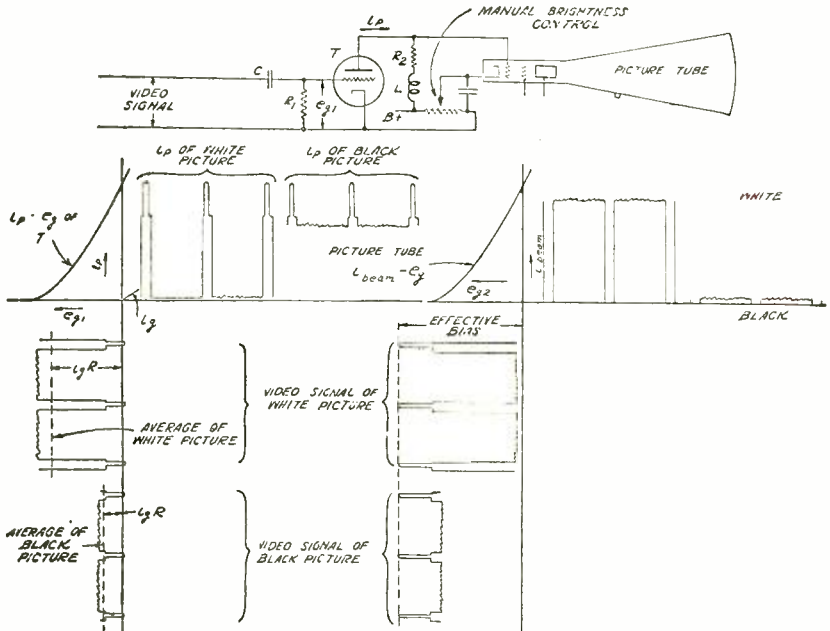

Fig. 5

amplifier-tube grid so that the tips of the synchronizing pulses just draw grid current. The actual amount of bias developed may be determined in the manner described in the previous section.

The amplifier-tube plate current produced by these two signals is as shown, which in turn produces the picture-tube grid voltage by flowing through the plate load R_2 and L .

The manual-brightness control permits adjustment of the picture-tube grid bias. The bias of the picture-tube grid is due to two voltages acting in opposition—that due to the IR drop in R_2 due to d-c plate current, and that between $B+$ and the arm of the manual-brightness control. The manual-brightness control is adjusted so that the “effective bias” as indicated on the picture-tube i_{beam} - e_g characteristic of

Figure 5 is obtained with no signal applied to the amplifier tube "T". As signal is applied to the grid of "T" the picture-tube operating bias is reduced in proportion to the peak amplitude of the video signal in the negative direction due to decreased plate current flowing through R_2 .

The beam currents resulting from the application of video-signal waves of white-and-black pictures are shown; the white-picture signal produces maximum-beam current, while the black-picture signal produces minimum-beam current and in both cases the picture-tube beam current is at cut-off during the blanking-pulse interval.

If the video signal is removed from the amplifier-input circuit the picture tube is biased beyond cut-off; further, as the signal amplitude is increased (increase of contrast) the picture highlights become brighter in the correct manner.

For the circuit of Figure 5 the video-output tube "T" will be a pentode or beam-power tube which necessitates screen voltage for that tube. A precaution is necessary in obtaining that screen voltage if normal operation of the automatic-brightness control system is to result. The screen voltage should be obtained from a bleeder that draws 3 to 4 times the current drawn by the screen.

The circuit of Figure 6 is that of the grid type of automatic brightness-control system employing a pentode-amplifier tube "T". The tube "T" obtains screen voltage by means of a screen-dropping resistor R_s . This circuit, though not practical, is useful in indicating the need for a stiff screen voltage-supply source.

In the diagram of Figure 6 is shown the i_p-e_g characteristic of the amplifier-tube "T" with three different magnitudes of video signal applied to the grid. The three signals represent, as indicated, a black, grey, and white picture respectively. These three signals produce bias-voltages B , G , and W in proportion to the peak amplitude of the respective signals.

As the bias voltage is increased from zero, the screen current decreases so that the screen-operating voltage rises, with the result that for any particular bias condition the plate current available over the cycle of grid swing will be greater than in the case of fixed screen voltage. This is shown graphically by the three dotted i_p-e_g characteristics labeled B' , G' , and W' .

Considering again the three video waves of black, grey, and white pictures, the plate-current wave of each has a different i_p-e_g characteristic. For the black-picture wave the B' characteristic obtains, for the grey-picture wave the G' characteristic obtains, and for the white-picture wave the W' characteristic obtains. The black-level plate-current wave for each of the three waves is indicated as B'' , G'' , and W'' . It is evident that even though the black levels of the various picture

signals are fixed in the grid circuit of tube "T" they are not at the same level in the plate circuit. If the screen of the amplifier-tube "T" had been operated from a fixed-voltage source the plate current corresponding to black level for the three signal waves would be the same, and at point "A". In practice it has been found satisfactory to operate the screen from a bleeder that draws three to four times the current drawn by the screen.

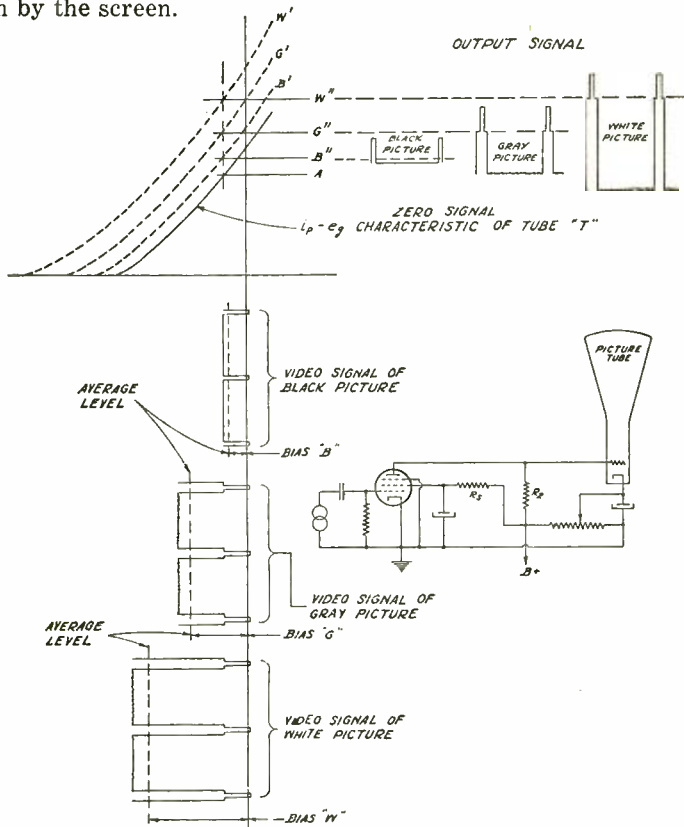

Fig. 6

Reinserting the d-c component of the video signal by grid rectification in the last video amplifier tube when a stiff screen source is used appears to perform creditably, however it has several disadvantages when compared to the diode d-c reinserter.

When operating a tube at zero bias, such as is the case with grid-type d-c reinsertion, it is necessary to lower the screen voltage to limit the plate current with no signal input to a value such that the plate dissipation of the particular tube is not exceeded. This results in reducing the maximum output to 0.4-0.5 of that obtained with normal bias operation.

Grid reinsertion of the d.c. is usually not as linear as that obtained when a diode is used. However, the non-linearity is determined by the amplifier tube used and certain tube types may be entirely satisfactory.

The major disadvantage of this type of d-c inserter lies in the fact that during the warm-up period of the receiver the picture-tube grid is positive relative to the cathode. Present types of picture tubes and high-voltage rectifiers have a short warm-up time as do many of the common filament-type low-voltage rectifiers. As was stated before, the effective picture-tube bias in the circuit of Figure 5 is due to two voltages; the IR drop in R_2 and the voltage between $B+$ and the arm of the manual-brightness control. During the warm-up period tube "T" will not start drawing plate current at the instant the $B+$ voltage is first available, which effectively returns the picture-tube grid to $B+$ with the cathode at a lower potential. The picture-tube heater and high-voltage power-supply warm-up time is approximately equal to the low-voltage power supply which results in the picture tube operating with full voltage on the electron-gun elements and a positive potential on the grid.

The condition of positive grid during warm-up may be remedied by several expedients. A heater-type low-voltage rectifier may be used which will eliminate the positive grid during warm-up, but will permit the picture tube to operate at zero bias.

A time-delay relay might be used in series with the picture-tube heater supply so that the picture-tube heater starts warm-up after the remaining tubes in the receiver are operating properly.

The warm-up time of the picture-tube heater may be delayed by the addition of a resistance in series with the heater. The picture-tube heater has a positive-temperature coefficient of resistance so that high current is drawn at the start of warm-up. The series resistance limits the initial current and, hence, prolongs the warm-up time. The heater-transformer voltage will have to be increased to compensate for the voltage drop in the series resistance. This system has the disadvantage of impairing the regulation of the heater circuit.

With the diode type of d-c inserter the grid of the picture tube is always negative even during the warm-up period so that the above precautions are not ordinarily necessary for that circuit.

REINSERTION OF LOW FREQUENCIES BY AUTOMATIC-BRIGHTNESS CONTROL ACTION

Reinsertion of the direct-current component in a video signal to secure automatic brightness control may also restore low frequencies to a certain degree.

The manner in which the low frequencies are reinserted is illus-

trated in Figure 7. The circuit is that of a d-c reinsertor by grid rectification; however the diode type of d-c reinsertor performs in much the same manner in restoration of low frequencies.

The common cause for poor low-frequency transmission in a video amplifier is due to small interstage-coupling capacitors and low values of grid leaks or insufficient cathode-resistor by-passing.

The video-signal wave represented in Figure 7 is a full frame of a picture that is half black and half white. The number of horizontal blanking and synchronizing pulses per frame have been reduced from the standard for the purpose of clarity in drawing and the vertical

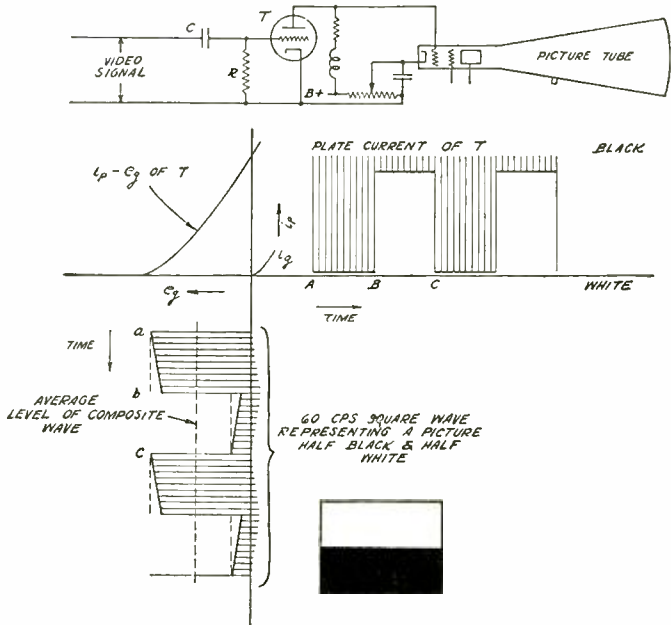

Fig. 7

synchronizing information normally present in this wave has been completely eliminated for the same reason.

The normal video wave of a picture half black and half white would be a perfect square wave of 60-cycle repetition rate. The wave shown in Figure 7 has been amplified by a video-amplifier stage that did not have perfect transmission of the low frequencies. This is evidenced by the droop of the signal wave of Figure 7. The loss in low-frequency response that this wave has suffered will be restored by the action of the automatic-brightness-control system.

Time in the diagram starts at "a". The super-sync pulse at "a" will adjust on the grid characteristic so that the tip of the pulse just draws grid current. Due to the loss in low-frequency response the

super-sync pulses that occur between "a" and "b" will progressively go further into grid current, hence produce a progressively increasing bias. The bias increases so that the tip of each super-sync pulse in the portion of the wave between "a" and "b" just draws grid current, which has the effect of restoring the low-frequency loss. The plate-current wave produced is shown and is a square wave.

The restoration of the low-frequency loss in the portion of the grid-voltage wave between "b" and "c" depends upon a factor not previously considered.

At the time when the super-sync pulse at "b" reaches the grid, the bias voltage (by the action described above) is great enough so that the super-sync pulse at *b* just draws grid current. Consider now the portion of the wave between "b" and "c". This portion of the wave slopes away from the zero-bias axis which requires that the bias progressively decrease in a discrete manner during the time interval "b" to "c" if the low frequencies are to be properly reinserted.

If the time constant RC of Figure 7 be made equal to the equivalent time constant that caused the droop in the square wave, then the bias voltage will decay at a rate equal to the slope of the signal-voltage wave. This will place the tip of each of the super-sync pulses in the "a"-*c*" interval at the point of drawing grid current. The resulting plate-current wave is shown for the entire grid-voltage wave and is a perfect square wave.

If the time constant RC is less than the equivalent time constant which caused the droop, but still large compared to $1/13230$ sec., the bias voltage could decay at a faster rate than is actually required, but it can not do so because this would cause the super-sync pulses to extend beyond zero bias so that each pulse in the "b"-*c*" portion of the signal wave draws grid current and the wave is straightened in the same manner as the "a"-*b*" portion of the wave.

If the time constant of RC is appreciably larger than that causing the drop, the d-c reinsertor will not restore the low frequencies and will result in poor reproduction of the picture.

There is one additional factor to consider in fixing the value of the time-constant RC and this is due to change in picture background. The time-constant RC should be short compared to the most rapid background change, which might be of the order of ten seconds. A value of RC of 0.1 sec. has been found satisfactory in practice.

The action of automatic brightness control should not be relied upon to reinsert large losses of low frequencies. If the losses of low frequencies are large, the droop of the square wave is no longer linear, but may vary in a number of ways depending upon the number of low-frequency loss circuits and upon the relative loss in each circuit, it is

therefore impossible to correctly compensate the low-frequency loss in this case by means of automatic-background-control action, because the RC time constant of the automatic-brightness-control circuit permits the bias to decay only in an exponential manner. However, the decay is practically linear if the RC time constant is large compared to the time duration of the lowest-frequency wave to be faithfully transmitted, as is the case having characteristics shown in Figure 7.

OUTPUT TUBES

The general requirements for video-output tubes have been outlined above. Three of the tubes currently available have characteristics suitable for such use. These are the 6AC7, the 6AG7, and the 6V6. The table below shows typical operating conditions with bias supply. The permissible load resistor for a given bandwidth varies inversely as the output capacitance, so that the gain is a function of G_m/C_{out} and the maximum output is a function of I_p/C_{out} . From this table it may be seen that the 6V6 has the greatest output, but the 6AC7 has the greatest sensitivity.

TABLE I—TYPICAL OPERATION

<i>Tube</i>	6AC7	6AG7	6V6	
<i>E</i> plate	250	250	250	volts
<i>E</i> screen	150	140	250	volts
<i>E</i> bias	2.0	2.0	12.5	volts
I_p	10	33	45	ma.
G_m	9000	10200	4100	μ mhos
C_{out}	5	12*	12	μ mf
G_m/C_{out}	1800	850	340	μ mhos/ μ mf
I_p/C_{out}	2.0	2.75	3.75	ma/ μ mf

* The output capacitance of the 6AG7 tube has now been reduced to 7.0 μ mf in place of 12 μ mf shown in the table. This reduction in output capacitance correspondingly increases the realizable output and gain and permits the use of this tube in types of circuits not previously suitable.

The input capacitance does not directly affect the operation as a video amplifier, but it does influence the permissible load on the preceding stage and thus the overall video gain. In addition the plate and screen-current requirements must be considered, the 6AC7 being most economical in that respect.

BIAS SUPPLY

The foregoing section was based on ideal bias supply. In practice the bias may be "fixed", self-bias, or grid-current bias. In the case of fixed bias, the d-c grid potential is usually obtained by the drop across

a resistance in the negative end of the power supply. Bypassing this type of bias supply is not a serious problem because a resistance-capacitance filter may be used. However, tubes operating at or near maximum rating, as do video-output tubes, are more susceptible to grid-emission difficulties and premature failure under fixed than under self-bias condition, and fixed bias is more subject to voltage-supply regulation troubles, so self-bias is to be preferred.

The use of self-bias by means of a cathode resistor results in bypass problems because of the low-resistance value necessary for securing the proper bias. The use of low-frequency compensation in the plate circuit may not be as desirable a solution in this case as is the use of a large bypass or no bypass. If degeneration at frequencies down to 60 cycles is to be avoided capacitances of the order of 200 to 1000 μf are required. With no bypass whatsoever there is no frequency discrimination, but the effective transconductance is reduced by the factor

$$G'_m = \frac{G_m}{1 + G_m R}$$

Where G'_m is effective transconductance, G_m is transconductance under d-c voltage conditions obtaining, R is cathode-resistance value. It can be seen that this degeneration may cause a loss of the order of two to one in sensitivity. Where this loss in sensitivity can be tolerated the unbypassed cathode resistor may be used for bias supply.

It has been pointed out under the section on d-c reinsertion that the operating bias for the video-output tube may be obtained by grid-current flow through a relatively high value of grid resistor. This method of securing bias may be used whether or not it is depended upon for d-c restoration. It has a satisfactory frequency characteristic, but does result in limitation of maximum output since the plate current can swing only towards cut-off and the maximum plate current at zero signal is limited by the safe plate dissipation of the tube used. The maximum plate current under no-signal input conditions may be held to a safe value by proper choice of screen potential.

The transconductance of a tube operating in this manner is not a constant, since the operating bias is a function of signal amplitude on the grid. The effective transconductance is therefore best given in the form of a curve of output versus input. A series of such curves for the three tube types considered is shown in Figure 8.

This series of curves is plotted with peak-to-peak output volts per 1000 ohms load resistance, against input in peak-to-peak volts. The operating and circuit conditions under which these curves were obtained are shown on the figure. The screen-bleeder values given provide

adequate stabilization of screen voltage so that the data may be used in evaluation of operation for d-c reinsertion by grid current.

The 6V6 is seen to have the highest output, but also requires the largest input and is not linear over any appreciable range. The 6AG7 has good transconductance and high output and is very nearly linear up to 2.5 volts input.

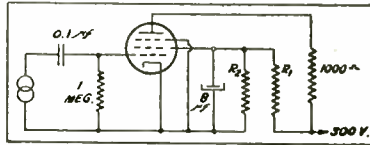

TUBE	L_{p_0}	L_{s_0}	R_1	R_2	E_{s_c}
6AC7	10ma	2.5ma	18 K Ω	7.7K Ω	77V
6AG7	30	6.4	6.4 K	5.7K	95
6V6	45	2.8	13K	10.7	120

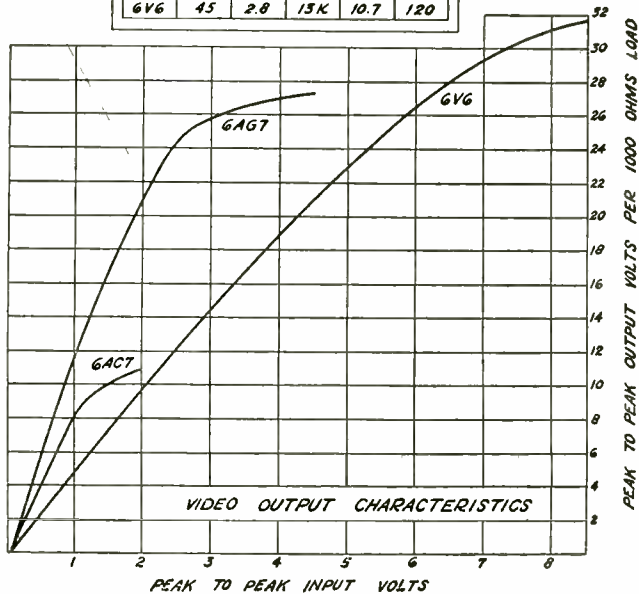

Fig. 8

The 6AC7 does not have as high transconductance, and does have materially less output voltage. It should be remembered, however, that the gain is dependent upon permissible load resistor as well as G_m , so that the performance of the 6AC7 is considerably better by comparison than would be indicated from Figure 8 because of its low-output capacitance.

In order to decide which of the three tube types considered should be employed in a given design, we must know the value of load resistor, and in order to determine the permissible-load resistor the influence

of various types of circuit must be taken into account. We shall accordingly consider circuits for these three types of tubes with both grid-current d-c reinsertion and diode d-c reinsertion.

HIGH-FREQUENCY COMPENSATION

Circuits used for high-frequency compensation in video amplifiers have as their aim the elimination of the effect of inherent shunt capacitance on the high-frequency response. The circuit should result in as high a value of load resistor as possible over a given band width, since, as has been mentioned above, the gain and output are dependent on the load-resistor value. The circuit capacitances are principally those of the output capacitance of the video tube and the input capacitance of the picture tube. While the performance of some types of circuit depends upon the ratios of these capacitances as well as their sum, the total capacitance may be taken for general consideration of a performance index. With this qualification, the criterion of a video circuit is $R\omega C$. Here R is the load resistance, ω is 2π times the bandwidth over which uniform response is obtained, and C is the total circuit capacitance. This criterion is not an exact one, because, as mentioned above, some circuits depend upon the way in which the circuit capacitances may be physically separated as well as on the total capacitance and in addition the obtainable detail depends not only upon the frequency range over which the response is flat, but also upon how rapidly the response decreases outside that range. For example, if we were to observe a picture on two different video amplifiers each of which had a loss of 2 db in response at 3.5 Mc, but one of which had a 10 db loss in response at 3.6 Mc and the other had a 10 db loss at 4.0 Mc, the observable-picture detail would be greater in the case of the second amplifier.

However, it is necessary, in the case of television receivers, to take into account the overall passband, and the i-f response usually drops off more sharply above the nominal cut-off frequency than does the video response so that the advantage of a video amplifier with a gradual cut-off is largely nullified from an overall television-receiver standpoint. Consequently the uniform-response band width has been chosen as the criterion in this paper.

The networks are considered to be driven from a constant-current source, as only high-plate-impedance tubes have been discussed herein.

Several circuits have been employed to obtain uniform response over the relatively great bandwidths required for television. One method of approach to the problem has been through consideration of network theory to determine what values of L , R , and C result in uniform response over the desired bandwidth, the other method of

approach has been through consideration of the properties of wave filters.

The consideration from the network-theory standpoint has led to evolution of circuits known as shunt peaking, series peaking, and combined series and shunt peaking. The derivation of the expressions

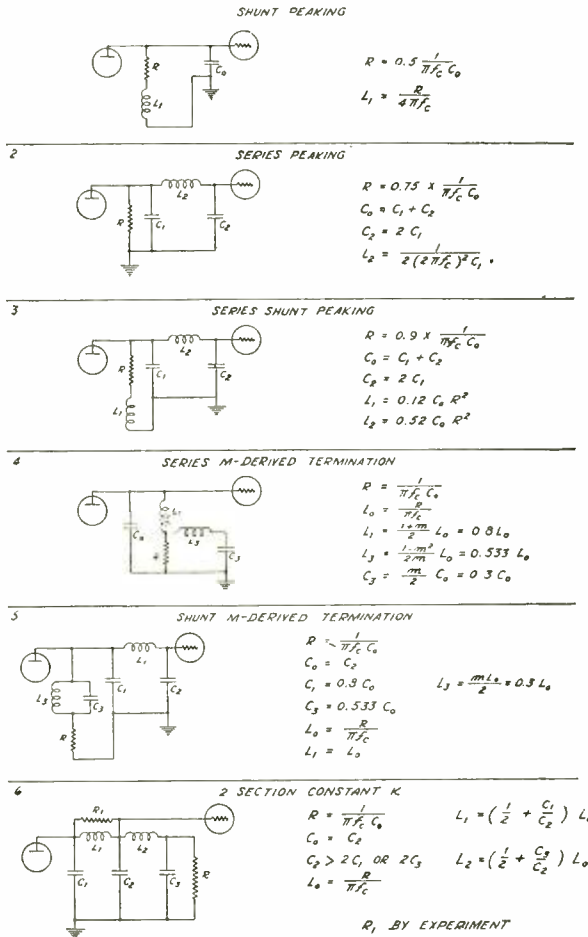

Fig. 9

applicable to these circuits has been given in detail in a previous issue¹ so will not be repeated. For the sake of completeness and for comparison with filter-type circuits the results of series and shunt-peaking circuits in the case of video-output circuits are considered here.

One requirement for all practical video circuits is that there be a capacitance across the points of application of voltage and a capacitance across the points at which the voltage is taken off. This require-

ment eliminates many circuits from consideration. There are six basic circuits which are to be considered; these six circuits and the design parameters are shown in Figure 9.

In that figure the d-c connections and any isolating condensers necessary are not shown. The capacitances shown are those of the input and output of the tubes. The load resistor is R , the maximum frequency of uniform response (cut-off frequency) f_c , and the nominal or determining value of capacitance C_o . The other circuit parameters are as designated on the respective diagrams.

1. SHUNT PEAKING

The shunt-peaking circuit is the simplest type as it uses only one inductance and does not depend upon any division of capacitance, all circuit capacitances being lumped together at one point. It has the lowest resultant load resistor of any of the circuits considered, but has the merit of permitting wide tolerances in value of circuit components with little change in performance, and has a gradual cut-off.

2. SERIES PEAKING

The series-peaking circuit divides the capacitance into two parts and hence permits the use of a 50 per cent higher load resistor for a given total capacitance and bandwidth than in the case of shunt peaking. Optimum results from this circuit, both as to load-resistance value and flatness of response, are obtained with a two-to-one ratio of capacitances. The method of treating the circuit when the ratio is other than two to one has been discussed by Seeley and Kimball.¹ The series-peaking circuit has a small number of components and permits of fairly wide tolerance of component values.

It is frequently possible to secure a higher value of load resistor than would be indicated by the design expressions for series peaking through use of a higher value of inductance. The use of this higher value of load resistance and inductance may necessitate the addition of a resistor of several thousand ohms across the inductance to secure sufficiently uniform response, but the high load-resistor value obtained is well worth while.

3. SERIES AND SHUNT PEAKING

The combination of series and shunt-peaking allows use of 80 per cent higher load resistance than shunt peaking, but is more critical as to component values and only allows use of maximum load-resistor value when the two-to-one capacitance ratio exists.

4. SERIES *m*-DERIVED TERMINATION

In approaching video circuits from filter-theory standpoint, it is necessary to review some of the pertinent factors applying to electric-

wave filters. A number of technical articles and books have been written on the subject of wave filters and the terminology generally used therein will be followed.

In order to avoid reflections it is necessary that the filter be properly terminated and in order to join one filter section to another they must have the same image impedances. In Figure 10 are shown three half sections which may be joined together to produce a filter. There are two image impedances to consider, the mid-shunt image impedance Z' which occurs in the middle of the shunt arm, and the mid-series image impedance Z , which occurs at the middle of a series arm. We are here concerned only with low-pass filters, so that the mid-series image impedance occurs in the center of the filter inductance and the

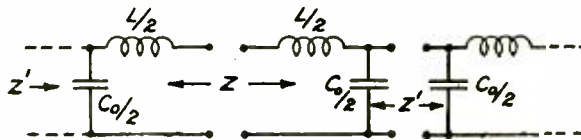

Fig. 10

mid-shunt image impedance across a filter capacitance. In video filters, experience has shown that it is readily possible to construct inductances in the form of single-layer solenoids or very narrow universal-type coils such that the Q is sufficiently high to make the dissipation effect negligible and the distributed capacitance of the coil low enough to be likewise negligible.

The mid-shunt and mid-series image impedances vary with frequency in an inverse manner. At zero frequency the image impedance of either type is R , the value of termination or effective-load resistance.

$$\text{Then } Z = R \sqrt{1 - \Delta^2}$$

$$Z' = \frac{R}{\sqrt{1 - \Delta^2}}$$

where Z is mid-series image impedance
 Z' is mid-shunt image impedance
 R is nominal or terminating resistance of the filter
 Δ is f/f_c
 f is any frequency lower than cut-off frequency
 f_c is cut-off frequency

These expressions show that the mid-series image impedance goes to zero at cut-off, whereas the mid-shunt image impedance rises to infinity.

In video amplifiers the voltage must be applied and taken off across a capacitance because of the inherent tube capacitance, which means

the voltage is taken off across a mid-shunt impedance. Now Z rises toward infinity as cut-off is approached, but to obtain uniform voltage we should have uniform impedance. If we shunt a capacitance $C_o/2$ across Z' this result is accomplished.

$$Z' = \frac{R}{\sqrt{1 - \Delta^2}}$$

$$X_c \text{ of shunt capacitance} = \frac{-j}{2\pi f C_o/2}$$

But by filter theory

$$R = \frac{1}{\pi f_c C_o}$$

$$\text{so } X_c = \frac{-jR}{\Delta}$$

Then X_c and Z' in parallel = Z''

$$Z'' = \frac{X_c Z'}{X_c + Z'} = \frac{-jR^2}{\Delta R - jR \sqrt{1 - \Delta^2}}$$

rationalizing

$$Z'' = R(\sqrt{1 - \Delta^2} - j\Delta)$$

The absolute impedance is then

$$Z'' = R(1 - \Delta^2 + \Delta^2)^{\frac{1}{2}} = R$$

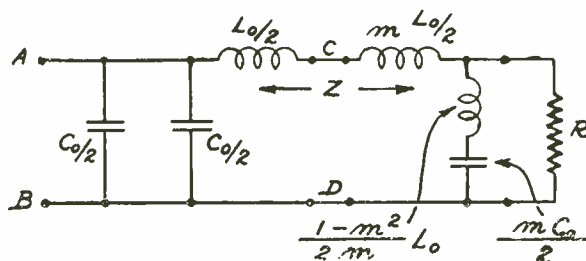

Fig. 11

so that the combination of a mid-shunt image impedance and a capacitance equal to the terminating capacitance will produce uniform impedance. It is also necessary to obtain a constant impedance equal to R in order to terminate the filter in R . This termination may be accomplished by the use of m -derived sections, specifically by terminating half-sections with an m value of 0.55 or 0.6, since such a half-section has the proper image impedance of one end to match that of a normal or constant- K filter section and on the other end has an image impedance which is a pure resistance up to 80-90 per cent of the cut-off frequency. Series m -derived sections have an image impedance the

same as the mid-series impedance of a constant- k section on one end and uniform impedance on the other end.

Such a terminating half-section is shown to the right of points $C-D$ in Figure 11. To the left of $C-D$ is a constant- k half-section with added capacitance $C_o/2$ shunted across the terminals so that the impedance across points $A-B$ is uniform with frequency.

This type of filter permits use of twice the load impedance of the shunt-peaking circuit and does not depend upon any division of capacitance. Since the series m -derived filters require very close tolerances of components, including allowance for distributed capacitance, this circuit is critical and would probably require a small adjustable trimmer to provide for production variation.

5. SHUNT m -DERIVED TERMINATION

The same general principles discussed for series m -derived termination apply in the case of the shunt m -derived type, namely an m of 0.6 to secure a half-section having uniform resistance termination on one end and mid-shunt image impedance on the other end. The shunt m -derived-type filter is quite versatile, a wide range of capacitance distribution can be handled and maximum load of twice that of the shunt-peaking circuit achieved. Experience has shown that this circuit is somewhat less critical to changes in component values than is the series m -derived type, but correct evaluation of distributed circuit capacitances is required in calculating component values and an adjustable trimmer will probably be required across C_1 , in this circuit. Both the series m -derived and shunt m -derived filters have sharper cut-off than other type circuits, because the 0.6 m section provides a frequency of infinite attenuation 25 per cent beyond the cut-off frequency. For this reason it is desirable to assume a cut-off frequency 10 to 15 per cent higher than the desired upper frequency of uniform response in making calculations on m -derived filters.

In filters with sharp cut-off, such as the m -derived type, experience has indicated that reflection transients may be introduced into the picture by misadjustment so small that the steady-state response appears uniform and the steady-state phase shift linear. It is therefore suggested that final adjustment of these types of filters be made by observation of a test pattern.

6. TWO-SECTION CONSTANT K

In addition to m -derived terminating sections, it is frequently possible to use two constant- k filter sections to secure flat response and a load resistor of twice the value obtainable with shunt peaking. Filter sections may be joined together if they have the same image impedance

although the cut-off frequency differs. If a section with higher cut-off frequency is joined to one of lower cut-off frequency, the impedance rise of the section of higher cut-off near cut-off frequency will not affect the uniformity of response materially because it is beyond the useful range of the filter as a whole.

If the capacitances can be so divided that those on the end are less than half the value of the center capacitance satisfactorily uniform response may be secured.

In Figure 12 is shown the manner in which such a filter is constituted. The load resistor depends upon the value of C_2 . The section between A and B is a full constant- K section with mid-series impedance at A and B to join to the terminating half-sections. The inductances of this section are of course each half the value of those calculated for the full section. The image impedance of the end sections must be the same as that of the center section, but the cut-off is determined by the value of C_3 or C_1 . Since C_1 and C_3 are on the ends of the filter they have half the value of a constant- K full-section capacitance. The load R prevents the impedance at that end of the filter from rising near

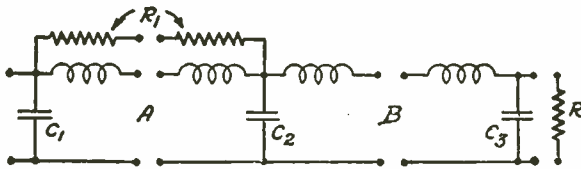

Fig. 12

cut-off of that section, but to prevent the impedance from rising near cut-off on the opposite end of the filter it is usually necessary to add dissipation by shunting a resistor R_1 across the inductance on that end of the filter. The filter is then seen to be made up of a full T section in the center joined to a half-section on each end of the same image impedance, but with cut-off determined by the existing capacitance.

This type of filter has high-load impedance and is less critical than those discussed in sections 3, 4, and 5 above, but depends upon a favorable disposition of capacitance for optimum results.

PRACTICAL OUTPUT CIRCUIT CONSIDERATIONS

The several factors that affect the design of a video-output stage have been discussed in the preceding sections. This section is devoted to a practical application of these design considerations.

From a practical point of view, the factors that lead to the choice of the output system are: picture-tube characteristics, video band width, type of d-c reinserter, gain, and output required.

TABLE 2—PERFORMANCE OF SEVERAL OUTPUT SYSTEMS

Case	Video Tube	Picture Tube	Type of DC Insertion	C_p $\mu\mu f$	C_g $\mu\mu f$	C_d $\mu\mu f$	f_c Mc	Circuit	R Ohms	Max. Peak to Peak Voltage Output	Gain
1	6AC7	1802	Grid	7	16		2.5	2	5500	55	40.7
2	6AC7	1804	Grid	7	20		3.8	6	3800	38	28.1
3	6AG7	1802	Grid	14	16		2.5	1	2120	53	20.9
4	6AG7	1804	Grid	14	20		3.8	4	2230	56	22.0
5	6AC7	1802	Diode	7	16	7	2.5	6	6650	166	60.0
6	6AC7	1804	Diode	7	20	7	3.8	5 or 6	3800	95	34.2
7	6AG7	1802	Diode	14	16	7	2.5	3	2730	180	27.9
8	6AG7	1804	Diode	14	20	7	3.8	5	2880	190	29.4

It is impossible to cover all combinations of output circuits, but eight cases are listed in Table 2 for illustrative purposes and it is believed will assist in making the choice of output tube and associated circuit in any particular design.

Two picture-tube types are considered, the 5BP4/1802-P4 and 9AP4/1804-P4. The type 9AP4/1804 has the same input capacitance as the types 1801, 12AP4/1803-P4, and 5AP4/1805-P4 so that as far as the video-output system is concerned they may be interchanged.

The three capacitances tabulated in Table 2, C_p , C_g and C_d , have the following physical significance: C_p represents the output capacitance of the video-amplifier tube in the socket plus the capacitance added by the wiring. C_g represents the input capacitance of the picture tube plus wiring and socket capacitance, the wiring capacitance being perhaps higher than will be encountered in some instances, but is believed to be an average realizable condition. C_d is the capacitance added to the circuit by the diode-type d-c reinsertor which in this case was one plate-cathode of the type 6H6 plus the capacitance-to-ground of a 0.1- μf coupling condenser and a one-megohm resistor.

The band width tabulated as f_c is the top-video frequency that is to be transmitted with no loss in fidelity. It is to be noted that only two different band widths are used namely 2.5 Mc and 3.8 Mc. The 2.5-Mc bandwidth condition is used in connection with the type 1802 picture tube because the size of the picture with this tube limits the amount of detail that may be reproduced and very little is gained by increasing the band width. The 3.8-Mc band width associated with the

larger sizes of picture tubes is felt to be a reasonable value of top frequency due to the band-width limitations of the usual i-f amplifiers.

The remaining columns have the usual significance with the exception of "circuit" which refers to the circuits of Figure 9.

CASE 1

In this case the circuit is that of series peaking, but the load resistance is approximately 40 per cent greater than with conventional series peaking. In raising the load resistance it is necessary to increase the series inductance to maintain the high-frequency response. This, results in more variation in gain in the pass band. With the capacities listed for Case 1 and with 5500 ohms load and 430 μ i peaking inductance the variation is ± 5 per cent. With these conditions the gain is good, but the maximum output is only about 40 per cent more than the minimum required.

CASE 2

This condition is not satisfactory for the reason that the maximum output is not sufficient to modulate properly the picture-tube grid. The only means of getting more output is to increase the load or plate current. The plate current is limited by plate dissipation while the circuit used results in the highest possible load for the given conditions of capacitance and bandwidth. Evidently this is not a satisfactory video-output system.

CASE 3

In this case the 6AG7 output tube is considered. The type 6AG7 and type 6V6 have the same output capacitance, so as far as the output circuit is concerned, the tubes are interchangeable, the only difference being in gain and maximum output. In this case, and those following, the gain when using the type 6V6 is 40 per cent of that obtained with the 6AG7 while the maximum output is 25 per cent greater with the type 6V6.

The use of circuit Number 1 results in a low value of load resistance, nevertheless, when using the type 6AG7 output tube is used, the gain is fair and the output is more than the minimum required.

CASE 4

The circuit (Number 4) used in this case is that of a series *m*-derived half-section terminating a half-section constant-*k* filter and results in a reasonably high value of load resistance considering the band width and total-shunt capacitance. The maximum output is adequate with fair gain. The major disadvantage in using this combination lies in the circuit. This circuit requires very close tolerances on

all of the components, particularly on the two capacitances, if uniform gain over the band is to be obtained.

CASE 5

The gain and output for this case are excellent. However, to obtain high gain and output requires the use of a diode-type d-c reinsertor which may not be justified in a receiver employing a five-inch picture tube. If the diode were eliminated and replaced by a physical capacitance the maximum output would be 67 volts with a voltage gain of 49 which would be good.

CASE 6

Two circuits are indicated in this case. They both result in the same value of load resistance and as the gain and output are good the choice lies between the two circuits. Circuit No. 5, employing a shunt m -derived termination, has the disadvantage that the tolerance on the components must be close if the transmission in the passband is to be uniform. Circuit 6 does not have this disadvantage.

CASE 7

The maximum output in this case is much more than required and the gain is reasonably good. However, the combination of tube and circuit with the addition of a diode d-c reinsertor is rather expensive to use in a receiver employing a five-inch picture tube particularly in view of the good results obtained in either Case 1 or 5. Further, the circuit, which is series and shunt peaking, requires rather close tolerances of the two end capacitances.

CASE 8

As in Case 7, the maximum output obtainable is more than ample, however the gain is lower than in Case 6 which also has sufficient output.

One point in the above discussion of the eight cases that has not been stressed is the matter of cost. Tube and component costs are always evident, but the expenditure of direct current should also be taken into account. The plate, screen, and bleeder current required by the three video-amplifier tubes considered, when operating under two conditions, are listed below.

GRID D-C REINSERTION

Tube	I_p	I_{sc}	I_{blcdcr}	Total
6AC7	10 ma.	2.5 ma.	10 ma.	22.5 ma.
6AG7	30	6.4	25.6	62.0
6V6	45	2.8	11.2	59.0

DIODE D-C REINSERTION

Tube	I_p	I_{sc}	$I_{bleeder}$	Total
6AC7	10	2.5	—	12.5
6AG7	33	8.5		41.5
6V6	47	6.5		53.5

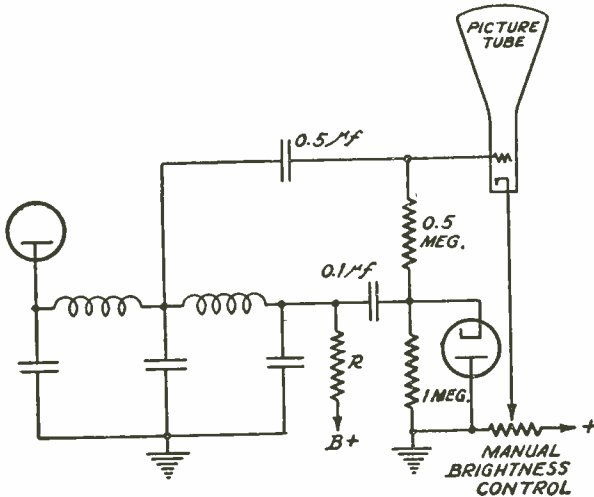

Fig. 13

On all of the circuits except Number 6 it is evident how to connect the diode to obtain d-c reinsertion. In Circuit 6 the fact that the load-resistance R is at the end opposite to the amplifier plate requires a slightly different connection as shown in Figure 13.

The eight cases considered cover the various output and picture-tube combinations, but no attempt has been made to consider each of the six filter types for each output and picture-tube combination.

The performance, as we have seen, was satisfactory in some cases and unsatisfactory in others. The principles and parameters of both output tubes and circuits have been discussed, so that the designer may calculate video-output systems other than those selected for illustration, in order to arrive at a design to meet the requirements of the particular receiver under consideration.

A RESUME OF THE TECHNICAL ASPECTS OF RCA THEATRE TELEVISION*†

BY

I. G. MALOFF# AND W. A. TOLSON‡

Research Laboratories, RCA Manufacturing Co., Inc.,
Camden, N. J.

It is obvious that in a development of this magnitude many individuals contributed to the project. It is not the purpose of this brief article to cover completely this large project but rather to present a short résumé of the most pertinent factors of the development. This is deemed to be of interest because of the formal showing on, and since, May 9, 1941. It is hoped that more detailed discussions on various phases of the project, prepared by some of those identified with the particular work, may follow.

Summary—The problems of theatre television are stated. Television projection experiences of the past are reviewed. A description of the RCA Theatre-Television System recently demonstrated in New York City is given.

STATEMENT OF THE PROBLEM

THE problem of theatre television is essentially that of providing a bright picture on a viewing screen of normal theatre size; this picture having adequate resolution, contrast, and freedom from distortions. The question of how much light is needed on a theatre projection screen has been studied in the past by the Society of Motion Picture Engineers. A committee of the S.M.P.E. charged with the study of screen-brightness requirements recommended¹ a temporary screen-highlight-brightness standard of from 7 to 14 foot-lamberts. The S.M.P.E. proposed a screen-brightness standard for the purpose of making it possible to print all the release films to the same degree of contrast (gamma) and to avoid making prints of different contrast for theatres with different screen brightnesses. So far as visual satisfaction and avoidance of eye fatigue are concerned, the range of acceptable brightnesses appears to be much wider than the recommended standard. Values of screen illumination from about 1.5 to 20 foot-candles have been regarded as satisfactory at one time or the other². With the wide-angle screens used in most of the theatres, this is nearly equivalent to 1.5 to 20 foot-lamberts in screen brightness. From information available on deluxe motion picture theatres it appears that the screen-highlight brightness varies between 5 and 22 foot-lamberts. In television, due to its flexibility in contrast and levels,³ the motion-picture standards need not be adhered to, but it is reasonable to conclude that in theatre-television pictures the limiting highlight brightness should be at least of the order of the lowest value encountered in good motion-picture houses, a value which is about 5 foot-lamberts.

* Decimal Classification: R583.

† Reprinted from *RCA REVIEW*, July, 1941.

Now with the Home Instrument Department, RCA Victor Division, Camden, N. J.

‡ Now with the Research Department, RCA Laboratories Division, Princeton, N. J.

square foot of incident illumination. Narrow-angle directional screens produce as high as 5 foot-lamberts brightness for 1 foot-candle illumination. At $3\frac{3}{4}$ per cent efficiency this calls for the staggering figure of 40,000 lumens or 12,700 candlepower on the face of the cathode-ray tube.

On the basis of the discussion just given, the problems of theatre television may be resolved into the following:

- (1) The problem of providing the most efficient optical system so as to utilize the largest possible percentage of the light generated.

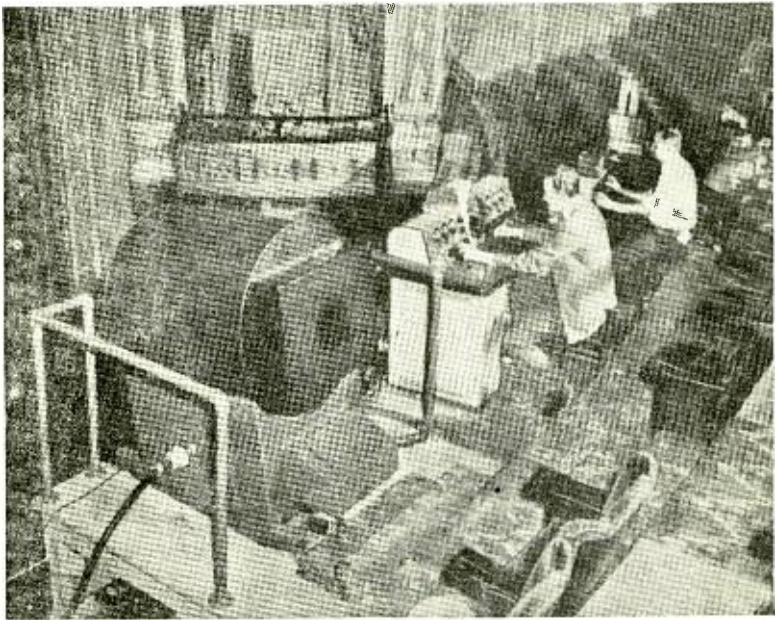

Fig. 2—Television-projection equipment installed in the balcony of the New Yorker Theatre.

- (2) The problem of obtaining sufficient candlepower per unit area of the luminescent screen, by means of increased operating currents and voltages.
- (3) The problem of providing a design of cathode-ray tube capable of operating at high currents and voltages.
- (4) The problem of providing adequate accessories, such as deflecting circuits, video and power supplies, as well as providing adequate safety for viewers and the operating personnel from the high voltage and X-rays generated.

TELEVISION PROJECTION EXPERIENCES OF THE PAST

The basic aim of the RCA television-research program from the beginning has been twofold: (1) to develop apparatus for home-television service; and (2) to develop apparatus for theatre-television service. Even in the early stages of this program it was evident that while the first item could be accomplished with the aid of either the direct viewing or the projection system, the answer to the second item could be obtained only by a projection system. Therefore, the two systems—direct viewing and projection—have been carried along side-by-side, each benefiting from the other on the way. The results of the

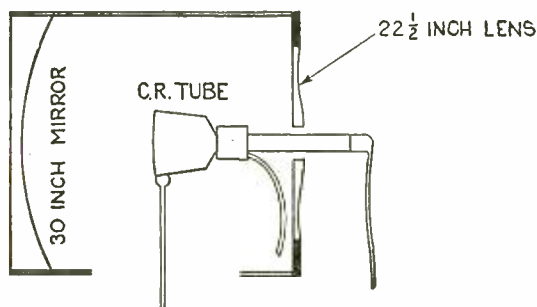

Fig. 3—Schematic diagram of reflective-projection optics showing location of cathode-ray tube.

earlier achievements in television projection have been published^{5,6}. The papers cited indicate trends as they presented themselves at the time. These trends were very much in accord with the statement of the problem as it presents itself today.

The first public showing of a theatre-television system was made by the Radio Corporation of America when it demonstrated at its annual stockholders' meeting in New York City on May 7, 1940, a projected-television picture 4½ by 6 feet in size with brightness well above the 5 foot-lambert value. The demonstration was given before some 300 stockholders and press representatives. The same system was shown informally to members of the F.C.C. on February 5, 1940 in Camden, N. J.

RCA THEATRE-TELEVISION SYSTEM

The experience with the development, construction, and operation of the system giving a projected picture 4½ by 6 feet in size with adequate brightness, definition, and freedom from distortions indicated that the answers to the problems stated earlier in this paper had

been found. The next obvious step was to build a system for a full-size theatre screen. This was done and on May 9, 1941 a demonstration of such a system, using a 441-line television signal and a projection screen 15 by 20 feet, was formally given before a large group of invited guests. The demonstration was held in the New Yorker Theatre, 254 West 54th Street, New York City. The program included dramatic sketches from the NBC Studios, Lowell Thomas, a singer, and was climaxed with a championship boxing bout. The general layout of the equipment

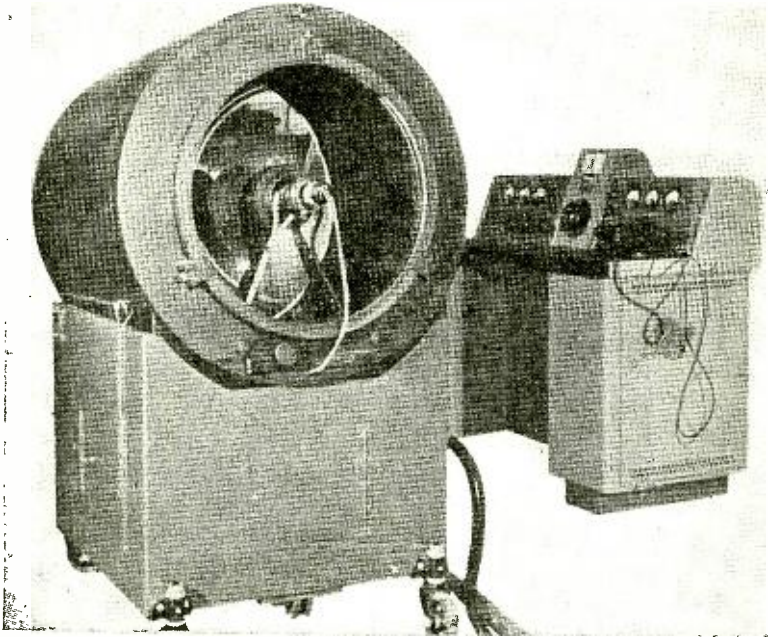

Fig. 4—Closeup of the projector and control console.

is shown in Figure 1. Previous to the formal May demonstration, one was held in the same theatre on January 24, 1941 for members of the FCC and press.

All parts of the equipment used for the demonstration in the New Yorker Theatre were scaled up from the preceding system which gave the 4½ by 6-foot picture. In addition, a few improvements and refinements resulting from experiences gained in operating the smaller equipment were provided in the new unit. A photograph of the projector, control console, and sound-control cabinet in operation at the New Yorker Theatre is shown in Figure 2.

From the beginning of the development, the problem of providing an efficient optical system appeared to be the most formidable. A few

per cent improvement was of no interest. Many-fold increase in the percentage of light delivered to the screen was sought. The answer was found in a reflective optical system consisting of a spherical mirror and an aspherical lens. The principle, that aspherical surfaces of various shapes may be combined into optical systems of high apertures and free of spherical aberration and coma, has been known for some time.^{7, 8, 9} RCA opticians applied this principle to a television-projection system. In its final form the optical system is arranged as shown in Figure 3.

This system on actual tests showed 25 per cent optical efficiency; in other words, it delivered to the viewing screen 25 per cent of the light originating on the diffusing screen of the cathode-ray tube. The gain

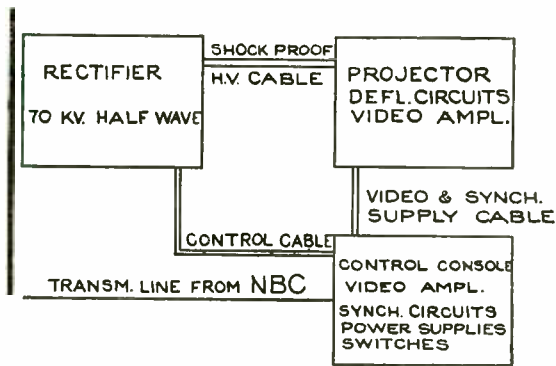

Fig. 5—Block diagram of the installation in the New Yorker Theatre.

over the conventional F:2 optical system is therefore *seven and one half to one*.

The problem of obtaining more candlepower by means of raising operating current and voltage has also been successfully solved. It was found that the thickness of the luminescent layer should increase with the operating voltages and optimum thickness was found for 60- to 70-kilovolt operation. Special provisions were worked out to avoid the so-called sticking effect.

The problem of designing a cathode-ray tube for reliable operation at 60 to 70 kilovolts was solved by introducing a new neck construction, which is now being identified as double-neck construction. The shape of electrodes had to be carefully selected and a number of refinements had to be introduced in the construction and processing of the tube. The general appearance of the tube mounted in the projector, and a closeup of the projector and control console, are shown in Figure 4.

The design of the video amplifier, deflecting and synchronizing circuits, and power supplies in a projection equipment in which the

cathode-ray tube is operated at 70,000 volts maximum offered new problems; as did also the mechanical arrangement of the equipment. Some of these problems were solved by simply increasing the capacity of the units which had been used on the lower-voltage equipment. Other problems required radical changes in design and operating technique. A block diagram of the complete installation is shown in Figure 5.

Proper thicknesses of metal were chosen in the construction of the projector to insure complete safety from the X-rays generated by the high-voltage cathode rays. The installation was thoroughly checked under operating conditions to ascertain by actual measurements that the protection was adequate. Standard rules for protection from accidental contact with high voltage were followed.

The cathode-ray tube used in this installation is capable of delivering about 400 candlepower maximum of useful light. This is equivalent to about 1200 lumens. At 25 per cent optical efficiency this means 300 lumens delivered to the screen, producing 1 foot-candle illumination on the 15 by 20-foot screen. With a five-to-one directional screen, a high-light brightness of 5 foot-lamberts results. In actual demonstrations a compromise screen having directional gain of only two-to-one was used, giving a highlight brightness of slightly more than two foot-lamberts.

REFERENCES

- ¹ Report of Projection-Screen Brightness Committee, *Jour. Soc. Mot. Pic. Eng.*, Vol. 27, p. 127, (Aug. 1936).
- ² An Analysis of Theatre and Screen Illumination Data, by S. K. Wolf. *Jour. Soc. Mot. Pic. Eng.*, Vol. 27, p. 139, (Aug. 1936).
- ³ Gamma and Range in Television, by I. G. Maloff, *RCA REVIEW*, Vol. 3, p. 416, (April 1939) and Tone Reproduction in Television (abstract), *Jour. Soc. Mot. Pic. Eng.*, Vol. 34, p. 441, (April 1940).
- ⁴ ELECTRON OPTICS IN TELEVISION, by I. G. Maloff and D. W. Epstein, *McGraw-Hill*, New York, 1938.
- ⁵ Development of the Projection Kinescope, by V. K. Zworykin and W. H. Painter, *Proc. I.R.E.*, Vol. 25, p. 937, (Aug. 1937).
- ⁶ High Current Electron Gun for Projection Kinescopes, by R. R. Law. *Proc. I.R.E.*, Vol. 25, p. 954, (Aug. 1937).
- ⁷ Theorie der Spiegelteleskope, K. Schwarzschild, II. *Gottingen Abhandlungen*, 1905.
- ⁸ G. A. H. Kellner, U. S. Patent No. 969,785, granted Sept. 13, 1910.
- ⁹ *Mitteilungen Hamburger Sternwarte in Bergedorff*, Bernard Schmidt, Vol. 7. No. 36, 1932.

RECENT DEVELOPMENTS IN TELEVISION*†

By

ELMER W. ENGSTROM‡

Director of Research, RCA Manufacturing Co., Inc.
Camden, N. J.

Summary—This paper presents a survey of the present status of television and discusses recent developments of the video art. These developments are treated in several sections: repetition rate, multiple-camera operation, television station networks, unicontrol tuning, color television, and transmission standards.

DURING the past decade television has evolved from the research laboratory to a practical reality, with promise of soon becoming a very significant factor in American life.

What television can now do will be considered first, followed by a brief consideration of what may reasonably be expected of the future. The present state of the art may be treated under several headings: the characteristics of television reproduction, the requirements of the television pickup process, and the effects of radio propagation characteristics on television broadcasting.

One important factor in analyzing the effectiveness of a television system is the amount of detail contained in the reproduced picture. To produce a system that will transmit and reproduce pictures of acceptable detail has been one of the most severe problems in television. The all-electronic system using cathode-ray tubes has proved far more satisfactory for the production and reproduction of high-definition pictures than the earlier mechanical systems which it has almost entirely replaced.

The amount of detail in the picture increases as the number of scanning lines is increased, but so also does the frequency band width for transmission. Pictures of satisfactory detail are produced with from 441 to 525 scanning lines. The exact number of lines standardized for a national television system will probably be within that range. Standardization on some definite number is necessary in order that all transmitters and receivers will operate together satisfactorily. The

* Decimal Classification: R583.17.

† Reprinted from *An. Amer. Acad. Polit. Soc. Sci.*, January, 1941.

‡ Now the Vice President in Charge of Research, RCA Laboratories Division, Princeton, N. J.

amount of detail in such a picture roughly corresponds to that obtained with 16 mm. home movies.

REPETITION RATE

The picture repetition rate for television must be great enough to give the appearance of continuous and natural motion in the reproduced picture, and must be great enough to minimize flicker. A repetition rate of 30 pictures per second, with interlaced scanning¹ providing a field (or flicker) frequency of 60 per second, has been found to be satisfactory. Special projectors for transmitting motion pictures permit the use of standard 24-frame motion picture film for television programs.

The transmission of a picture with the above detail and repetition rate requires a frequency band of about 4.5 megacycles.² There must be added to this a frequency band for the sound transmission which will undoubtedly be associated with every picture transmission. Additional frequency space is required to separate the sound and picture transmissions from each other and from other transmissions. As a result, a total band of 6 megacycles is now considered standard for a complete television service.

Television images are usually viewed directly on the face of the cathode-ray tube³ on which they are reproduced. The most common

¹ Television with scanning progressing from top to bottom of each frame 30 times per second would flicker badly. "Interlaced" scanning is a method to reduce flicker without increasing the rate of scanning (and thereby doing this without increasing the frequency band width required for transmission). The entire picture area is covered twice in each picture frame (or complete scanning cycle), each time with alternate lines only, these two scannings being interlaced to cover the entire frame forming a complete picture. The principal flicker corresponding to the entire picture area is reduced, since its frequency is doubled because of the two scannings of alternate lines. A secondary effect of interline flicker need not be considered here.

² A megacycle is one thousand kilocycles or one million cycles. A television channel of 6 megacycles is six hundred times the breadth of the frequency band now assigned to each standard sound broadcasting station.

³ In the television receiver the image may be produced on the face of a cathode-ray tube. This may be thought of as a flattened surface closing the large end of the cathode-ray tube cone or bulb shaped body. The inside surface of the flattened end, or "screen" as it is called, is covered with a white powder that becomes luminescent when bombarded by a stream of electrons. A stream of electrons is produced in the small end of the tube and directed to the screen where the stream strikes in a finely defined spot. This stream is controlled so as to scan the tube face in a regular manner from left to right in parallel lines from top to bottom. The light picture is painted by varying the intensity of the electron stream during scanning synchronously and in proportion to the scanning signal from the scene televised by the camera at the transmitter. The reproduced television picture may be viewed directly on this cathode-ray tube face.

size for the picture is approximately $7\frac{1}{2}$ by 10 inches, corresponding to a cathode-ray tube diameter of 12 inches. Tubes having faces as large as 20 inches or more in diameter have been produced. Pictures may also be reproduced by projecting the image produced on the face of the cathode-ray tube onto a screen by means of a projection lens. Pictures 18 by 24 inches have been produced with receiving equipment suitable for use in the home, and 9 by 12 feet or larger with equipment suitable for use in theaters, auditoriums, and so forth.

The smaller pictures are viewed at close distances; the optimum distance is from four to eight times the picture height from the screen. The $7\frac{1}{2}$ by 10-inch picture is thus satisfactory for a small group of people in the home, while the larger pictures will accommodate larger groups on account of the greater viewing distance.

The color of the reproduced picture is determined by the nature of the phosphor (luminescent) material which forms the screen of the cathode-ray tube. Phosphor material producing a pleasing black and white picture has been developed and is now used on practically all tubes.

The brightness of the reproduced picture is a function of the operating voltages and the electron beam intensity in the cathode-ray tube. Most receivers are designed to reproduce pictures of the same or greater brightness as that used on the screen of motion picture theaters. This brightness is sufficient to give satisfactory viewing in a living-room where others are reading, provided their reading lamps are properly shaded from the television screen and the eyes of those viewing it.

The television signal originates as very weak currents produced by the pickup tube (such as the iconoscope, "orthicon," or dissector tube) within the television camera. In a studio installation, the weak currents are amplified in the camera and conveyed by a concentric conductor within the camera cable to auxiliary equipment for controlling and monitoring. This equipment is located in a room connected by soundproof windows to the studio so that the control engineers and program director may compare the reproduced picture on the monitoring screen with the original scene in the studio. The amplified camera signal is then further amplified, combined with synchronizing signals and finally transmitted by cable or relay transmitter to the television transmitter for broadcasting.

Just as for taking motion pictures, a lens system is required to focus an image of the scene upon a sensitive surface in the camera. In television, the sensitive surface is the photoelectric mosaic within the pickup tube instead of a photographic film. An important differ-

ence obtains in that the same television mosaic may transmit an almost "infinite" number of different pictures in turn, while the making of a film record requires twenty-four frames of new film each second.

MORE THAN ONE CAMERA USED

Since it is desired to transmit different scenes and different views of the same scene in rapid succession, two or more cameras are generally used, just as in taking motion pictures. The size and mobility of the cameras in the studio are similar to that of motion picture cameras. A difference in the two arts is that "cutting" and editing is obtained by switching and fading cameras during the show while observing a monitor picture instead of by splicing different films together at "leisure" in the "cutting room." It is also evident that the time between scenes and their order of "taking" must be the same as for the presentation. Therefore, the complete presentation in the television studio of dramas comparable with the "super colossal" productions of the motion picture industry would be extremely difficult. However, television is splendidly adapted to work with "real" scenes of life and nature where timeliness is important.

The lighting required for good studio pictures is comparable to that used for taking motion pictures in natural colors. The problems of obtaining color balance and artistry by makeup and lighting effects involve the same principles in television as in black and white motion picture photography but the specific requirements and solutions differ somewhat.

Television program material may be transmitted from standard 35 mm. motion picture film with picture quality about the same as obtained in the studio. Sixteen mm. (amateur standard) films may also be used, but the quality is somewhat impaired due to the lesser detail contained in 16 mm. film. In each case, a special television projector is required, to project the film image upon the mosaic with a special time cycle that can be used by the pickup tube to produce signals efficiently.

It is expected that feature productions and other film subjects may be presented from 35 mm. film. Sixteen mm. films may be readily used to "preserve" news events occurring at inconvenient times and to "transport" news events which occur at points which cannot be reached by the television camera and relay lines or radio circuits. Sixteen mm. film records of the program actually transmitted may also be made as a record of past programs. (A similar practice for sound recording now prevails in the major sound broadcasting systems.)

Program material originating outside of the studio can be picked up by portable equipment. One type of such apparatus has been built in containers of "suitcase" size where the heaviest unit is under seventy-five pounds. The basic equipment consists of three units for one camera, or four units for two or more cameras. Radiating from this basic equipment are cables that may be up to 500 feet in length leading to each camera station. At each camera station another "suitcase" unit is needed, positioned near the camera. The television camera is usually mounted on a motion picture camera type tripod and is readily mobile. The television signals from this equipment may be transmitted to the broadcasting station by a small portable ultrahigh frequency transmitter, by a coaxial wire circuit⁴ or for up to several miles over specially selected and specially treated regular telephone circuits.

The portable apparatus is inherently capable of producing pictures as good as the studio apparatus, but imperfect light conditions frequently force acceptance of imperfect pictures. Portable equipment produced satisfactory pictures of the Republican National Convention in Philadelphia in 1940 without adding any special lights for television. This type equipment and other mobile apparatus have been widely used with success in picking up sporting events, programs of news interest, and programs depicting life in action.

Carrier frequencies high enough to sustain a transmission band several megacycles wide must be used in the broadcasting of high-definition television by radio. The short waves such as are now used for international sound broadcasting will not do, because of multipath distortion⁵ effects caused by wave reflections from the ionosphere. Television becomes thus an ultrashort wave service. The quasi-optical propagation⁶ characteristics of these waves fix the possibilities for

⁴ A coaxial cable consists of an inner conductor or wire coaxial with an outer hollow cylindrical conductor or shield. The inner conductor is supported with as little solid insulation as possible and with the shield diameter equal to several diameters of the inner conductor. An ordinary telephone cable of the same bulk would contain many pairs of wires closely packed, with only thin paper insulation between. The coaxial cable can be used for higher frequencies for which the attenuation of an ordinary cable circuit might be hopelessly great.

⁵ When a radio signal is received simultaneously over two or more propagation paths of different lengths, the several signal components combine in different phases, depending on the path differences and the signal frequency. As a result, certain frequencies in a complex signal may be reinforced and others cancelled out, thus producing serious distortion. In television, multipath propagation usually produces multiple images in the final reproduction.

⁶ Quasi-optical propagation is propagation approximately analogous to that of light, that is, in rays which are rectilinear except for the effects of refraction and diffraction.

the dispersion of television programs. As a first approximation, the range of an ultrashort wave transmitter is the range of visibility from its antenna. The importance of elevating the transmitting antenna, the receiving antenna, or both, becomes apparent.

TELEVISION STATION NETWORKS

A single transmitter can serve only an essentially local area covering a population center. A national service must be formed by connecting together in a network many such stations. This is technically possible, either by chains of short-range radio relay stations using very high radio frequency carriers, or by wire connections using coaxial cable with repeaters every few miles. Successful field tests have been demonstrated for both the radio relay and the coaxial cable interconnections. The economics of television station networks has not been demonstrated since this awaits operation of "sample" circuits under service conditions. This in turn must await the beginning of television broadcasting on a commercial basis, since such broadcasting must support the network. Much of the population of the United States is centered in about one hundred metropolitan areas, twenty-five miles in radius. A reasonable first objective would seem to be television service for these areas.

It appears desirable to use for television broadcasting the lowest available frequencies in the ultrashort wave band. In the first place, for these frequencies, diffraction carries the waves the farthest beyond the visual horizon, which has been stated as the approximate limit. For the frequencies near 50 megacycles which have been used in experimental television transmissions these effects may as much as double the service range, that is, extend it to twice the distance to the visual horizon. Diffraction is less for much higher frequencies, the propagation is more nearly like that of light, and the range is more sharply limited to the visual horizon. Furthermore, because of decreased diffraction, obstacles such as buildings, hills, bridges, etc., cast sharper shadows.⁷

In the second place, the problems of economically building higher power transmitters and more sensitive receivers become more and more difficult as the carrier frequency is raised, and as the limits of present attainment are reached. The most powerful television transmitter yet

⁷ Because of the quasi-optical propagation characteristics, buildings, hills, etc., form obstructions in the path that may be thought of as producing shadows just as in the light analogy. The higher the radio frequency, the more sharply will these shadows or signal voids be defined, and there will be a lesser tendency for the signal to fill in or heal beyond the obstruction.

built supplies about 20 kilowatts of peak power on a carrier frequency just above 50 megacycles. This power is just capable of producing a signal fairly adequate with respect to usual radio noise levels in residential districts out to the horizon of its antenna. More power, however, is reasonably needed. However, even such power is at present unavailable for carrier frequencies over 100 megacycles. As the art develops, these power limits will be extended and the higher radio frequencies will come into use.

The radio noise levels at receiving locations determine the signal field strength which is necessary to render satisfactory service. Atmospheric, frequently referred to as static, are almost entirely absent on ultrashort waves, but interference or radio "noise" from the ignition systems of automobiles is very troublesome, particularly near busy city streets or highways. Diathermy machines used for medical purposes have been another very serious source of interference. Because of the wide transmission frequency band required for high-definition television, the inherent noise or hiss level of the receiver will always be high. This means that television service requires a relatively strong signal for a high-definition picture.

The Federal Communications Commission has assigned, for experimental television service, frequency channels 6 megacycles wide, in three groups as follows: Group A, seven channels between 50 and 108 megacycles; Group B, eleven channels between 162 and 294 megacycles; and Group C, any band above 300 megacycles, except 400 to 401 megacycles.

UNICONTROL TUNING

By agreement on frequency spacing between the picture and sound carriers and their location within the channel, it follows that unicontrol tuning for picture and sound signals may be had in the receiver. Practically all receivers built so far have been unicontrol and have used either a channel selector switch or push buttons for tuning. Experience has indicated that adjustment of television receivers can be done readily by the average user. With electronic television, the important function of synchronizing has been very satisfactory. Picture sizes are determined in present receivers by the diameter of the cathode-ray-tube face and have ranged from 3 by 4 inches to 7½ by 10 inches for the larger number, and to 9 by 12 inches for some. Many television receivers have also had facilities for receiving the regular and short wave sound broadcasting programs.

Television has been subjected to many extensive field tests during the past ten years. Much of this work has been under service condi-

tions. Each step of the development has been put to a practical test before the research worker and engineer have been satisfied to proceed. The later operations have included full-scale programming. Recently, experimental television broadcasting has been widespread, including the New York, Schenectady, Philadelphia, Chicago, and Los Angeles areas. In the New York area alone, several thousand receivers have been in use.

In the foregoing outline of the present status of television, comparatively little has been said of economic factors. However, the matter of economics pervades the entire situation, and what is now possible in television cannot well be stated without some assumption as to what is wanted, and how badly. The television system described is now suitable for development into an economic and commercial national service. At present it costs much to program, but technological advances and activity on a larger scale will lower costs. As costs are lowered, the benefits may be applied to provide both better performance and greater participation by the public. Particularly, interconnection of a number of television stations in a network, as is done in sound broadcasting, will spread the program costs over a larger audience. This will effectively increase the television service and reduce the cost per unit of audience.

There will doubtless be an increase in reproduced picture sizes and an improvement in picture brightness, contrast, and effective detail. But any great increase in picture definition is likely to prove difficult in every part of the system and to cause a major extension in frequency channel width. Improvements in pickup equipment may be expected to increase the flexibility and to reduce the cost of producing television programs. Finally, normal advances in the use of higher and still higher radio frequencies will simplify the networking problem and will open up more frequency bands in the higher ranges for efficient television use.

TELEVISION IN NATURAL COLOR

Motion pictures in natural colors have already made considerable progress in replacing pictures in monochrome. Television in natural colors also is possible, and has been demonstrated in the laboratory.

Whereas the provision of color complicates the distribution and exhibition of motion pictures but little, the transmission and reproduction of a natural-color television picture requires perhaps two times the facilities (particularly of the frequency channel width) which would be required to reproduce a monochrome picture with the same

definition. While the addition of color may compensate for, but not take the place of, a loss of detail, still it appears that natural-color television will require an increase in complexity and cost. This and the lack of detail are prohibitive handicaps at the beginning, so "black and white" television will be used first. Eventually television in natural colors will appear because color adds much to picture information and viewer satisfaction. Color television will probably use higher radio frequencies and wider bands for broadcasting than the first channels to be used.

The same methods which have been used to produce stereoscopic or three-dimensional motion pictures may also be applied to television. However, stereoscopic motion pictures, although technically possible for some time, have given no real promise of reaching widespread acceptance. Stereoscopic television seems even less promising, because of the newness of the art and the practical doubling of all facilities which would be required to provide it.

Television for large audience viewing, with pictures of movie screen size, is the promise of the near future. This will make a service possible to many large groups of people so that they may see events of timely interest while such events are happening. This will bring into being another facility for which there is no present counterpart.

TRANSMISSION STANDARDS

Television transmission and reception have often been referred to in terms of a lock-and-key analogy. Standards for transmission are needed in order that receivers may be built with assurance of reception from any one or all transmitters. Beginning early in 1936, committees of the Radio Manufacturers Association actively studied, and through their members tested, systems and components basic to standards of television transmission. Conclusions were reached by these Radio Manufacturers Association groups, and standards were agreed upon and submitted to the Federal Communications Commission. The Commission set up a committee of its members to make a study of television, and a report was prepared late in 1939. Two public hearings were held before the Federal Communications Commission early in 1940. At these hearings those most responsible for the research and development that has produced television urged that it be allowed to proceed in an orderly fashion. Others, including some who participated in the Radio Manufacturers Association work, urged that all was not ready, particularly on the matter of standards. Television was not permitted

to cast off its cloak of "experimental" and begin its more full-grown steps leading to a public service.

During the second half of 1940 an industry committee was formed under the sponsorship of the Radio Manufacturers Association in co-operation with the Federal Communications Commission. This was known as the National Television System Committee and was made up of representatives of many phases of industry concerned with television. This Committee was charged with the work of a thorough review and study, and the formulation of a set of standards to be proposed to the Federal Communications Commission. As 1940 drew to a close this work was well under way.

What is needed to insure progress in television? First of all, television must be put to rendering as rapidly as possible a real service to the public. This will require much effort, material, and investment of capital, and it will be a long time before any return on that capital will be possible. Opportunity must be afforded also for the early and adequate trial of new technical proposals, so that they may be put to the acid test of economic public service. The native initiative of American scientists, engineers, and entrepreneurs will do the rest. Those who are prepared to make this investment and to take the large financial risk can do so only if eventually a fair return can be earned. The American system of private enterprise can function only if this is permitted.

Since the frequency channels in the radio spectrum which are needed for television and many other important services are so strictly limited, government allocation and regulation of these channels has long since been established. Such power to regulate, however, gives government the practical power to advance or delay progress, both technical and economic, in television as well as in other radio services. Thus, the regulatory body has the major task of reaching a technical decision as to the best television system for the American people and to foster progress on a sound economic basis. To do this, and at the same time to harmonize the varied interests and objectives of the several parties, is the course that is clearly indicated.

Television has already responded to the urge to proceed. As a result of the initial efforts to provide a regular program service, the participating public seemed anxious to see a service continue and expand. As this is written, television is ready. Government and industry must decide what to do and how to do it.

THE PROGRESS OF TELEVISION, 1938-1941*

BY

ALFRED N. GOLDSMITH

Consulting Engineer, Radio Corporation of America,
New York, N. Y.

Summary—This paper is a brief presentation restricted to the discussion of the major trends in television during the period since 1938. Technical aspects are stressed but other factors are also considered as they affect development and operations. Topics covered include studio, control and remote pickup equipment, studio-to-transmitter link, transmitters, networks, industrial and government aspects, receivers, and special factors.

WITHIN the limits of a brief presentation, it is necessary to restrict this discussion to consideration, in outline, of the more important trends in television broadcasting during the period concerned. Further, only American contributions are cited, though with no implication that major contributions have not originated elsewhere. The treatment stresses engineering aspects but certain other topics are broadly considered in their influence on the technical development and operating methods of television.

STUDIO EQUIPMENT

During the period 1938-1941, early types of studio lighting for television presentations have been carefully studied and further developed along a number of useful lines. Incandescent lamps, arc lights, and high-pressure mercury-vapor lamps have been studied. This was attempted to produce not only good general lighting (so-called "key lighting"), but also some measure of modeling lighting for dramatic or esthetic effects. The former aim was fairly well achieved, although the amount of heat poured upon the set for adequate illumination was still regarded by some as excessive. The latter aim has not been adequately approached. Modeling lighting in television remains a subject for further development.

The control of the direction of lighting started in an ingenious though rudimentary fashion through the use of rope rigging attached to each lamp mount and brought to a control panel across the ceiling and down one of the studio walls. The ropes controlled the inclination

* Decimal Classification: R583.17.

and the direction of the lights. Later, some attempts were made to use remotely-controlled motors in the lamp mounts.

The original sets, particularly the "flats" representing walls or scenery, were acoustically of undesirable characteristics. As time went on it has been learned how to construct sets which permitted good acoustical quality to be maintained in the audio pick-up.

The color sensitivity of the iconoscopes used in the cameras was such that anomalous effects of lights and shades were occasionally produced. The color of sets, costumes, and makeup have now been adjusted until the television reproductions in the home show normal appearance.

In the meantime, the development of camera tubes has proceeded apace. The iconoscope — a high-voltage scanning-beam tube — gives excellent definition but is relatively insensitive (requiring high illumination intensities for satisfactory pick-up) and is prone to shading effects in the picture which could be compensated only by skilled operation by the technicians at the control panels. A more sensitive tube—the orthicon—has been developed which is of the low-voltage electron-beam type. Initially the picture resolution or detail produced by it was appreciably lower than that for the iconoscope. It affords, however, the basis for later developments which will lead to a substantial widening of the scope of television pick-up.

The lenses used in the television cameras have been systematically studied. Faster lenses covering a wider range of focal lengths have become available. A technique of wide-angle pictures (made relatively closely to the set) and of narrow-angle "close-ups" (pictures made at a distance from the set with a long-focus lens) has been under extensive development.

The elegance of presentation of programs has been enhanced by skillful introduction of change-over techniques through fading one picture into another slowly or rapidly. Attractive titles have been produced. Various special "effects" have been used either for entertainment reasons or to fill in certain parts of the video sequences. Kaleidoscopes of one form or another, sometimes motor-driven, have been found useful in this connection.

CONTROL-ROOM (AND MASTER-CONTROL) EQUIPMENT

The earliest control rooms and their cabling presented major electrical problems. Wave reflections, frequency distortions, phase shifts, and multiple reflections were all too common. Gradually there have been

developed types of cable, cable terminations, patching cords, and the like which overcame most of these difficulties.

The control of image brightness and contrast has improved as the apparatus was further developed and its operators gained experience and skill.

Music has been frequently heard, originating on records which have been skillfully interpolated into the program. The foundation has been laid for sound dubbing operations wherein a singer, actually performing as a soloist, was accompanied by a record of the corresponding composition which "cued" and directed him in the studio. The recorded music and the soloist's rendition have both been used to control the audio channel of the television transmitter.

Lantern slides have been used increasingly, and excellent forms of projectors for still pictures on film or slides have become available. The professional quality of the television programs has increased by the introduction of such slides.

The use of film assumes more importance as time goes on. Acceptable 16-mm. and 35-mm. projectors have been developed which enable the use of standard film made at 24 frames per second, even though the frame repetition rate in television is 30 per second in America. Increasing clarity of film transmission and reception results from the use of the improved apparatus. This has encouraged the program producers to mix film sequences with live-talent performances. At times filmed scenes alternated with live-talent scenes in a drama, both showing the same group of actors. The technique in question expands the scope of television programs. It thus became increasingly significant.

REMOTE PICKUP EQUIPMENT

The original remote pickup equipment was large, heavy, cumbersome, and of necessity housed in automobiles having large bodies mounted on a truck chassis. As time went on increasingly compact equipment for remote pickups, particularly of sports events, was desired. The development of such equipment went forward and it has become evident that such equipment will ultimately be available in light and convenient form.

When a number of cameras on a remote pickup are situated at different distances from the control panel, compensation methods are necessary to ensure identical framing of the pictures delivered by each camera. Delay compensation has been developed to an adequately precise extent. Remote synchronizing-signal generators have also been produced which assisted in the ready operation of a group of cameras outside of the studio.

STUDIO-TO-TRANSMITTER LINK

During the early commercial operation of television broadcasting it became evident that considerable flexibility was required in connecting remote pickup points to the transmitter. In some instances specially quiet telephone lines, with an adequate number of repeater stations, suitably compensated against frequency and phase distortions, have been found useful. Fixed studios have been connected to their transmitters by coaxial cable. But it has been found that radio-relay links are admirably suitable in many instances for carrying the program from a remote point to a receiver which in turn controlled the television transmitters. Prior to the orderly development of such equipment it was necessary to secure wave-propagation information on frequencies up to several hundred megacycles. This early work proved that the carrying of television programs from remote points to a transmitter, or even for interconnecting cities for network purposes by radio relay, is destined to become one of the accepted methods.

TRANSMITTERS

The original synchronizing-signal generators left something to be desired as to their accuracy and dependability of operation. Their limitations have been largely overcome with increased experience. Measuring instruments of the oscilloscope type permit accurate and continuous monitoring of the station operation as indicated by the modulated video wave.

There has naturally been a continued trend toward producing tubes and transmitters of greater output and at higher carrier frequencies. It has been found that the production of considerable outputs at frequencies of 100 megacycles or more taxes the knowledge and determination of the tube engineers. Nevertheless, notable progress has been made and the foundation laid for later and further developments.

Antenna structures used for television broadcasting must meet some unusual and difficult specifications. The radiated wave occupies a wide channel. The antenna must be capable of radiating such energy over a wide band of frequencies without appreciable distortion. Further, television antennas should be (in general) non-directional in azimuth, but they should be directional in altitude so as to "spray" the major part of the radiated energy over the surrounding terrain but not into overhead space. This combination of requirements is severe but has stimulated the engineers to the development of antenna systems which increasingly meet the requirements and have become successively of superior types.

Extensive wave-propagation data on the frequencies used in television have been accumulated, including data on the normal station range as well as certain anomalous and sporadic long-distance reception effects. These data have laid the solid foundation for commercial broadcasting services.

NETWORK OPERATIONS

The desirability of network interconnection of television stations has become evident during the period covered by this discussion. Early experiments in this direction indicate the feasibility of television network operation but show that considerable study and development is required before dependable high-quality relay systems of economic nature can become available.

INDUSTRIAL AND GOVERNMENTAL ASPECTS

Before a new radio art like television broadcasting can achieve its full capabilities, it is necessary that most of those concerned in the establishment of its operating standards, and the governmental regulatory authorities, shall reach an agreement on the desired band of frequencies for the service, the assignment of channels within such bands, an allocation plan for individual stations, and somewhat detailed operating standards involving the nature of the radiating wave. In the case of television it is particularly necessary, because of the complex nature of the radiated signals, that the agreement on standards proceed even into details.

The Federal Communications Commission indicated that it would establish standards in the television field after a sufficient number of field tests and considerable equipment development had been carried out, after agreement by most of the industry had been reached on desirable standards, after public hearings had been heard at which all had an opportunity to present their viewpoints, and after other precautionary measures had been taken. Under such circumstances it appeared that the Commission would issue regulations and assign channels to individual stations.

In order to meet the apparent wishes of the government, there has been formed under general industry sponsorship a National Television System Committee which is charged with the study of the field in all its technical aspects and the preparation of concrete proposals to the government. The Committee has carried forward its work and issued elaborate and comprehensive reports and recommendations. On the basis of such studies, operating standards have been established and are now approved by the FCC.

RECEIVERS

As a result of the NTSC recommendations as well as viewpoints and data presented at public hearings, the Federal Communications Commission has called for a number of changes in television operations.

Five channels have been made available for television operation. The number of lines in the picture have been changed from 441 (with substantially equal vertical and horizontal resolution) to 525 (with increased vertical and diminished horizontal resolution). The sound channel has been changed from amplitude-modulated to frequency-modulated. The characteristics of the synchronizing signal have been improved.

The receivers which were produced during this period yield pictures of greater size than has been available previously. Picture brightness and gradation range, while leaving something to be desired, are nevertheless attractive and adequate for the initiation of a television service. The controls of television receivers are largely standardized as to type and designation.

Theater television is an interesting development which shows that it will be possible in due course to present high-quality pictures of adequate brightness and size in theaters, thus supplementing motion-picture entertainment of this type.

SPECIAL FACTORS

One of the most significant items of this period has been the systematic development of a television program structure. An amazingly varied group of program types have been tried out on the air. While some fell by the wayside, others have formed the basis of the presently evolving program structure and are pointing the way for future work. Script production, operating instructions, the art of the producer and of the director, the technique of those handling the studio facilities, and the skill of the actors all have grown rapidly during this formative period. When the history of television is written it will be found that much is owed to the work done during these days.

Concurrently studies of the economics of television have begun. These have disclosed a number of problems which are believed capable of solution in time.

The response of the public to television has been studied to some extent. It has been found that this new art has an outstanding appeal and that it will prove to be a medium of entertainment and instruction, as well as a means for carrying an advertising message, unequaled by any methods available in the home. In one small city a systematic

study was made of the commercial aspects of receiver sales. The first clear ideas were gained of the price ranges to which the American public would respond at that time when offered television receivers.

One anticipated fact was verified in relation to home television installations. This involved the need for highly skilled service men to make the initial antenna, transmission line, and receiver installation and to maintain the receiver in excellent operating condition by systematic and spaced inspections. It has been found that a television installation involves the application of greater technical knowledge and skill, and the use of superior antenna and transmission-line equipment, as compared to ordinary standard-broadcasting receivers.

* * *

In brief, the 1938-41 period of television development establishes conclusively the correctness and worth of the scientific researches and engineering developments previously carried out in this field, the adequacy and dependability of the field tests which have been conducted, the desirability and helpfulness of industry-wide agreement on television matters, the possibility of building an attractive television program structure, and the likely commercial prospects in television broadcasting. The stage has been set for a new act of major import in the great program presentation to the public of mass education and entertainment.

THE OUTLOOK FOR TELEVISION—1941*

By

ARTHUR VAN DYCK†

Manager License Laboratory, Radio Corporation of America,
New York, N. Y.

Summary—A brief review of the status of television is given, followed by a general discussion of current problems and the factors affecting the expansion of television service. The paper then deals in some detail with the future of television—including consideration of such topics as programming, networks, and applications other than broadcasting.

THE outlook for television in the immediate future is cloudy. It is as certain as ever that the ultimate development of television will be that of a public service larger than any we have now in radio. Sound broadcasting will be dwarfed by the potentialities of hearing plus sight—*ultimately*. At the moment, however, television is in the doldrums.

The first promise of realization of television in this generation occurred about 15 years ago, and since that time, all of the technical tools and methods needed for practicable television have been developed. Inasmuch as television reception in the home required instruments more complex than any devices which heretofore were put into homes for operation, those organizations which felt the responsibilities of such introduction, thought it wise to proceed cautiously with this introduction. In pursuance of this policy, several years were devoted to full scale field tests, with receivers built by production methods and tested in the homes of employees—not sold to the public. During these tests, transmissions were conducted on a “real life” basis in order to test the programming aspects of the new service as well as its technical aspects.

Simultaneously with the field testing of the system, coordination of industry aspects was accomplished. The Federal Communications Commission studied the matter, decided that the art was ready for service to the public, and authorized commercial operation. This was only a little over one year ago. That decision was withdrawn a little later and not reaffirmed until a few months ago. In the meantime, the enthusiasm for television which previously energized all parts of the

* Decimal Classification: R583.17.

† Now Staff Assistant to the Executive Vice President in Charge, RCA Laboratories Division, New York, N. Y.

industry was dissipated, and the new activities of national defense began to occupy increasingly the attention and the facilities of the industry. Commercial television is now again possible, but is unlikely on any major scale as long as the requirements of national defense continue. Only a few thousand receivers have been sold.

So far, the present war in Europe has followed exactly the general pattern of the World War. The causes are the same, and the general development is the same. This war is now 2 years old, and the clouds are daily becoming darker. It seems likely that television development will be delayed until peace has been restored.

The technical aspects of television have been proven. Transmitters have been built and operated satisfactorily. Receivers have been built in small quantities and operated satisfactorily. Program experimentation has been carried out, and various events outside the studio have been picked up successfully and this has demonstrated clearly the value of television service. Television is ready to go and only the uncertainties of the war situation stand in the way of rapid development. In England, of course, television broadcasting has been discontinued for the duration.

While the outlook for television in the immediate future is clouded and uncertain, its eventual large usefulness is certain. In fact, it is much easier at this time to estimate the eventual character of television than to estimate its progress during the next few years. Nearly all technical innovations develop to full service capabilities in a period of between 10 to 20 years. The first 10 years bring the beginnings of all or most of the associated features, and the form and direction of the development become clear. The second 10 years bring refinements where needed, so that in 20 years, the new service is very definitely established. Of course it does not stop improving then, but it is no longer a new service with rapid changes and new effects on other services or habits of life. Attempts to estimate the future of technical innovations are almost always too conservative. For example, one would not have guessed 30 years ago that by this time the number of automobiles in world service would be 50 million, that speeds of 60-70 miles per hour would be commonplace, and that good roads would completely cover the country. We would probably have guessed 30-40 miles per hour and good roads connecting some of the largest cities.

To estimate the future of television, we should remember that the basic considerations are that it has been shown to be possible, and that it satisfies a fundamental human desire. Therefore it will develop rapidly, with improvements being added until we are able to see everything we want to see, at any distance we want, and as well as we want.

More specifically, it is reasonable to expect that in 20 years the majority of homes will have television receivers with pictures 2 or 3 feet wide. Public places will have receivers with picture screens comparable with motion picture screens. Good home receivers will be available at prices around \$100. Programs are most important of course, and will have passed completely beyond the experimental stage, and into a definite final pattern. Program service will include the broadcasting, over national networks, of important events. Also, there will be entertainment features, probably not quite like those of the present day stage or screen, but with some of their characteristics, as well as new ones peculiar to the new medium. The most important type of television program is the "outside pickup", that is, actual events taking place outside the studio, picked up by portable television cameras, and sent to the transmitter by radio or coaxial cable circuits. This is the vital new public service which television renders which no other service can. When the events are important ones or interesting for any reason, there is a very great thrill in watching them on the television receiver while seated comfortably at home.

The National Broadcasting Company has already accomplished the broadcasting of many such events. Among them were the opening of the New York World's Fair, including the address by President Roosevelt, the visit of the King and Queen of England, street parades, zoo scenes, boxing, wrestling, baseball, football, swimming, bicycle racing, track meets, political conventions and ceremonies. It will not be many years before television cameras will be as familiar a sight at public events of all kinds as the microphone and motion picture cameras are now. The programming of television is as yet very young, but its future possibilities are limitless. Its technique permits drawing upon the stage, the motion picture, real life, lecture platform, and permits combining them in many ways. Only the most obvious things, such as sporting events, have been broadcast so far, but as time goes on, program managers will find many kinds of events having interest to home viewers. The home of the future will be an interesting place to be—we will want to stay home for fear that we will miss something!

Future television will see reproduction in full color, probably more faithfully than is prevalent now in color photography. As now developed, television is practicable only in "black-and-white." Color television is technically possible, even now, but the apparatus required is not practicable for general use, and there are various limitations in the kinds of programs that can be televised in color. In this respect television is like photography. ~~where~~ the basic requirements were met

first in black-and-white, and the more complex and more difficult color feature added later. It may be hoped and expected that after all the various problems connected with introduction of such a radically new service as television are solved on the more simple basis of black-and-white reproduction (including such matters as programs and who is to pay for them!), the refinement of color will be added. The problems involved are not difficult ones, but it will require some years' time to solve them. In the meantime, we can have very valuable entertainment, instruction and benefit from black-and-white television, just as we have had service from black-and-white photography while the more difficult color was being perfected.

In addition to the use of television for home broadcasting, there will be many other valuable applications. Some of its military possibilities are obvious, such as permitting ground headquarters to see what the television camera sees from a scouting aircraft over enemy fleets or ground forces. There will be many unexpected applications of seeing at a distance. It is difficult now to guess what they will be because we are not accustomed to seeing beyond what the human eye can do, and have not even thought about what we would like to see beyond that limit. Gradually, inventors will think of new applications, some of them of entertainment sort, many of utilitarian sort. For example, in police work there are interesting possibilities. For traffic control in congested areas or along important highway arteries, television cameras installed permanently at high points giving a good view of the ground would enable a central office to control traffic more efficiently. For policing of unusual crowds or expected trouble spots, television cameras would give headquarters instant and complete knowledge of what was happening, superior even to the two-way, police radio-telephone system. In factory operations, there are many cases where it is desirable to see what is going on in places where it is either inconvenient or impossible for a worker to remain.

Huge public gatherings can now be addressed by speakers with the aid of microphones and public address systems. But the view of the speaker from the distant seats is unsatisfactory to the unaided eye. The large auditorium of the future will include not only microphones to magnify the voice, but screens to magnify the view of the stage and speakers. Additionally, other auditoriums in the same and distant cities can have large screens and loudspeakers for both sight and sound, and can receive programs originating in the primary auditorium.

It may be that the art of the lecture platform will be revived by television into an importance even greater than that which it had before the days of radio. With television, the lecturer can use demon

strations with far more effectiveness than he can to an audience in a lecture hall, because the television camera permits him in effect to have each member of the audience right on the platform with him. Small objects and manipulations can be seen well. Microscopes can be peered into, maps and charts can be shown and described, models can be shown in close-ups, etc. Lectures with television will be more interesting and more effective, and many subjects can be used which now are not good lecture material because they require close-up demonstration.

Development of television to a public service of much magnitude requires the facilities for network operation. A television camera at an event in one city must be able to send its pictures to stations in other cities throughout the country, just as one microphone now transmits speech and music throughout the country. The facilities required for such interconnection of stations do not yet exist except in experimental form on a small scale. But the technical ways and means of accomplishing the television network operation are known. In fact, two ways are known—wires of special kind capable of carrying television currents, and radio circuits to transmit television signals over long distances by means of short distance relays. Both have been developed. One method or the other—or both—will eventually be commercialized so that a performance in one city can be transmitted to all other connected cities. Such commercialization will, of course, be slow because the installation of such network facilities, wire or radio, is expensive, and cannot be furnished more rapidly than the rest of the system, the transmitters and the receivers. But network operation will be possible, will be available when required, and it can be estimated reasonably that as soon as commercial development is free from the present uncertainties, television will go forward rapidly on a national basis, and that but a few years will be required to provide facilities for national hook-ups.

SUMMARIES

The following papers are presented in summary form only. The journal in which the full paper appears is indicated in each case.

NEW TELEVISION AMPLIFIER RECEIVING TUBES*†

BY

A. P. KAUZMANN‡

Summary

Television circuits require amplifying tubes of high grid-plate transconductance and low input and output capacitances to realize a voltage gain per stage sufficient to keep the amplifying stages at a reasonable number. To this end the 1851 and 1852, sharp cut-off, 9000-micromho grid-plate transconductance tubes—the 1853, semi-remote cut-off, 5000-micromho grid-plate transconductance tube were developed. The improvements are the result of decreasing the control-grid-to-cathode spacing, and at the same time decreasing the pitch and diameter of the control-grid wires.

The maximum allowable resistance in the control-grid circuit is determined from the grid-plate transconductance of the tube, the cathode-bias resistor, and the screen voltage-dropping series resistor. Also, the use of a small unby-passed resistor in the cathode circuit to neutralize the changes in input capacitance and input loading with varying plate current is presented. The 1851 and 1852 have the highest ratios of grid-plate transconductance to plate current of any commercially available tubes with the result that they have high signal-to-noise ratios. The high grid-plate transconductances also result in high-conversion transconductance when these tubes are used as mixer tubes; the 1851 and 1852 give a maximum of 3500 micromhos, and the 1853 a maximum of 1500 micromhos. With practical circuits the 1851 and 1852 have produced gains per stage of 3.5 to 7.0 at 50 megacycles, and of 20 to 45 at 11 megacycles. Similarly, the 1853 has produced gains per stage of 2 to 4 at 50 megacycles, and of 6.5 to 13 at 11 megacycles. All of these values are for a band-pass of 2.5 megacycles.

* Decimal Classification: R583.6.

† RCA REVIEW, January, 1939.

‡ Tube Department, RCA Victor Division, Harrison, N. J.

SIMPLE TELEVISION ANTENNAS*†

BY

P. S. CARTER‡

Summary

The frequency band widths demanded by high-definition television have considerable range when considered in relation to resonant circuits. The

transmitting antenna and transmission-line systems must, therefore, meet stringent requirements if multiple images or ghosts in the received picture are to be avoided.

Before discussing the characteristics of particular antenna systems, the transmitting and receiving antenna problems are considered. The input impedance of a transmission line, even when loaded with a resonant circuit having a Q as low as 2, undergoes considerable variation with frequency within the transmission band. If the television receiver is designed to prevent a pure resistance to its transmission line, equal to the characteristic impedance of the latter throughout the transmission frequency band, the receiving antenna requirements are not difficult to meet.

The measured impedance-frequency characteristic of a half-wave dipole of large diameter conductors, when compared with that obtained for a similar antenna of small diameter conductors, shows the advantages of the former.

A method of impedance matching has been devised whereby the usual narrowing of the useful frequency band caused by impedance transformation is overcome.

The "folded dipole" antenna and combinations of these units are superior to ordinary dipoles for television purposes. Measurements indicate that ground and other reflecting surfaces considerably affect the impedance-frequency characteristics of antennas.

The use of a type of antenna called the "double cone" or "hour glass" antenna results in a very flat impedance-frequency characteristic at the input terminals of a transmission line over a wide range of frequency. By properly proportioning the dimensions of this antenna its impedance can be made to match the characteristic impedance of all practical open-wire transmission lines. The current and electric field distributions along the surfaces of the conical conductor have been measured. The theory of this is briefly considered.

Curves of the characteristics of the systems discussed are included. For comparison purposes the measurements of line reflection vs. frequency for the several antenna systems considered are shown by a family of curves in a single figure.

* Decimal Classification: R326.6.

† *RCA REVIEW*, October, 1939; also printed in full in *RADIO AT ULTRA-HIGH FREQUENCIES*, Vol. I.

‡ Research Department, RCA Laboratories Division, Rocky Point, L. I., N. Y.

TRANSATLANTIC RECEPTION OF LONDON TELEVISION SIGNALS*†

By

D. R. GODDARD‡

Summary

The results of daily observations at Riverhead, L.I., N.Y., since September 1938, of the English television transmissions on 41.5 and 45.0 megacycles are summarized and discussed. A photograph of one of the television images received during this period is shown. A resumé is made

of the signal strengths observed since January 1937. During each winter of this period signal strengths of between 10 and 500 microvolts per meter were frequently received. These experiments show the existence of sporadic transoceanic reception of television signals, as well as the practicability of direct recording of television signals on film from the kinescope screen.

* Decimal Classification: R583.7.

† *Proc. I.R.E.*, November, 1939.

‡ Research Department, RCA Laboratories Division, Riverhead, L. I., N. Y.

SIMPLIFIED TELEVISION I-F SYSTEMS*†

By

G. MOUNTJOY‡

Summary

Two examples of television picture intermediate-frequency amplifiers are described in this article, one for receivers requiring a relatively narrow band, and the other for wide band receivers. These show the simplicity which results from the choice of mutual inductance coupling and capacitance tuning, and demonstrate that this simplification may be secured together with good performance. Several practical types of transformers and trap circuits are discussed, and choice among these may be made on the basis of design and performance requirements of a particular amplifier. Consideration of the principles and illustrative examples discussed will enable the engineer to design a television intermediate-frequency amplifier to meet desired requirements and to predict the performance thereof with a useful degree of accuracy.

* Decimal Classification: R583.5.

† *RCA REVIEW*, January, 1940.

‡ Formerly with Industry Service Laboratory, RCA Laboratories Division, New York, N. Y.

TELEVISION LIGHTING*†

By

W. C. EDDY‡

Summary

Lighting a television production presents many problems peculiar to this new field of public entertainment. These problems have necessitated the redesign of lighting equipment and the establishment of a simplified technic for handling the equipment that differs radically from moving picture practice. To cope properly with the lighting requirements of the continuous action sequences, characterizing television productions, a system employing inside silvered incandescent lamps in a standardized unit was developed by NBC engineers. Based on multiple standardized group of 1½

kw. each, these units are used in both the foundation light and modeling equipment of the television studios in Radio City, thus insuring quantitative as well as qualitative control of lighting by the personnel. With cameras generally in motion and an average duration of pick-up from one camera a matter of seconds, the problem of modeling in the sets becomes acute. This appears to be satisfactorily solved by the technic now in use wherein the major interest is centered around the close-up camera. Even this solution, however, required new and ingenious equipment to maintain light in the sets and still give floor precedence to the cameras and sound equipment. While NBC at the present time has appeared to have standardized on the inside silvered lamp, exhaustive tests were carried out in an attempt to utilize more orthodox equipment. Actual tests under production conditions proved, however, that certain requirements of space, weight, and flexibility could not be had without a serious sacrifice of foot-candles on the set, resulting in the present set-up of equipment and personnel that are handling the television lighting assignment in the East.

* Decimal Classification: R583.3.

† RCA REVIEW, April, 1940.

‡ Formerly with Engineering Department, National Broadcasting Company, Inc., New York, N. Y.

LOW COST TELEVISION RECEIVER*†

By

D. E. FOSTER‡ AND G. MOUNTJOY‡

Summary

The television receivers introduced on the market in the beginning year of regular service were naturally high in price. It is of course axiomatic that large public sale is vitally dependent upon lower prices. Experience in sales of radio receivers and similar household devices indicates that the "threshold price level" for sales in reasonably large quantities is about two hundred dollars.

This laboratory, believing that supply of such a receiver is the most important need now facing the television industry, has attempted to determine a design of television receiver which would have the best possible performance obtainable under 1940 development, production and cost conditions, and would have a list price not over two hundred dollars.

This bulletin describes the resulting design. It utilizes the 9" tube, but otherwise has performance features commercially equivalent to the best available in today's knowledge of the art. Several features of design, novel over previous commercial television receivers, and assisting toward lower cost, are included.

While the model built and described does not include the broadcast band or any other of the possible combinations, one or more of these undoubtedly should be included in commercial designs. A section of the report describes some of these possibilities.

* Decimal Classification: R583.5.

† RCA Licensee Bulletin LB-520, May, 1940.

‡ Formerly with Industry Service Laboratory, RCA Laboratories Division, New York, N. Y.

PICTURE SIGNAL ANALYZER*†

BY

H. B. DEAL‡

Summary

Equipment to facilitate oscilloscopic examination of picture signals and waves associated with television apparatus is described.

* Decimal Classification: R583.11 × R200.

† RCA Licensee Bulletin LB-525, June, 1940.

‡ Industry Service Laboratory, RCA Laboratories Division, Chicago, Ill.

FIELD-STRENGTH SURVEY, 52.75 MEGACYCLES
FROM EMPIRE STATE BUILDING*†

BY

G. S. WICKIZER‡

Summary

This paper outlines the results of a field-strength survey which was conducted on the audio-frequency channel of the National Broadcasting Company television transmitter, operating on a frequency of 52.75 megacycles. The test transmissions were horizontally polarized. Continuous mobile recordings were made over land in a number of directions along radials from the transmitter out to the limit of the receiver sensitivity, which was reached at a distance of 70 or 80 miles, at a field strength of about 10 microvolts per meter.

From the recorded data, coverage maps based on average field strength were drawn. The maps are supplemented by graphs showing the deviation to be expected because of irregular terrain and refraction effects at the greater distances. In general, local variations, of 20 decibels in field strength were caused by irregular terrain, buildings, and other objects.

* Decimal Classification: R270 × R583.

† *Proc. I.R.E.*, July, 1940.

‡ Research Department, RCA Laboratories Division, Riverhead, L. I., N. Y.

FIELD-STRENGTH MEASURING EQUIPMENT
AT 500 MEGACYCLES*†

BY

R. W. GEORGE‡

Summary

The problems encountered in ultra-high frequency field-strength measurement are discussed. Equipment for making measurements at frequencies on the order of 500 megacycles is described which is adapted

to the basic method involving the use of a half-wave dipole-receiving antenna having known constants, and a signal generator which can be substituted directly for the antenna to duplicate the signal voltage induced in the antenna. A method of making peak-signal or noise measurements is briefly described.

* Decimal Classification: R271 × R583.

† RCA REVIEW, July, 1940.

‡ Research Department, RCA Laboratories Division, Riverhead, L. I., N. Y.

RCA-NBC TELEVISION PRESENTS A POLITICAL CONVENTION AS FIRST LONG DISTANCE PICKUP*†

BY

O. B. HANSON‡

Summary

During the week of June 24th, 1940, the National Broadcasting Company's television field pick-up equipment was installed in Convention Hall in Philadelphia for the televising of the Republican National Convention of 1940. The signals were transmitted from the NBC's convention control room via the Bell System's Philadelphia-New York coaxial cable to NBC's main control room in the RCA Building, Radio City, New York, and thence to Station W2XBS, the NBC television transmitter atop the Empire State tower. It was estimated that approximately 40,000 people viewed by television the proceedings in the Convention Hall on some 4,000 receivers scattered throughout the vicinity of New York in homes and restaurants, etc. The signal from Station W2XBS was intercepted by the General Electric Company by means of a specially constructed receiving system on Helderberg Mountain and rebroadcast through the General Electric Company's television transmitter W2XB to the television audience in that vicinity. The following article tells the story of the televising by NBC of this national event.

* Decimal Classification: R583.

† RCA REVIEW, January, 1941.

‡ Vice President and Chief Engineer, National Broadcasting Company, Inc., New York, N. Y.

CASCADE AMPLIFIERS WITH MAXIMAL FLATNESS*†

BY

V. D. LANDON‡

Summary

The theory of the conventional constant-K filter is not very satisfactory from the engineering standpoint. The theory is developed on the basis of terminations which match the surge impedance. Unfortunately, this calls for terminating resistors which vary with frequency.

When a compromise-fixed resistor is used, it becomes difficult to calculate the performance of the filter accurately. Also, the curve is, in general, not the flattest which can be had with the available number of reactive circuit elements. In the system which is about to be described, the performance is very easy to calculate regardless of the number of circuits. Also, the curve is the flattest which may be obtained with a given number of reactive circuit elements. Conventional filter theory usually ignores the resistance of the component reactors. At any rate, the effect of resistance in the reactors is very difficult to calculate accurately. In the following system, each element is expected to have resistance of a required value and the effect is accurately known.

* Decimal Classification: R363.4.

† RCA REVIEW, January and April, 1941.

‡ Research Department, RCA Laboratories Division, Princeton, N. J.

A METHOD AND EQUIPMENT FOR CHECKING TELEVISION SCANNING LINEARITY*†

By

V. J. DUKE‡

Summary

This paper describes a method and equipment for determining scanning linearity of television picture equipment. Horizontal and vertical scanning are checked simultaneously. This is accomplished by comparing an electrically-generated time-unit pattern with a camera-generated space-unit pattern in such a way that the linearity of scanning of the monitor kinescope does not enter into the problem of adjusting camera scanning. Pictures and drawings are used to demonstrate various operating features of this method, and other uses of the equipment are discussed.

* Decimal Classification: R583.13 × R200.

† RCA REVIEW, October, 1941.

‡ Engineering Department, National Broadcasting Company, Inc., New York, N. Y.

A SIMPLIFIED TELEVISION SYSTEM FOR RADIO AMATEURS AND EXPERIMENTERS*†

By

L. C. WALLER‡ AND P. A. RICHARDS#

Summary

A new Iconoscope has made it practical for amateurs to participate in electronic television investigations. An experimental amateur television

system including camera unit, receiver and 2½-meter transmitter is briefly described. In this system the frame frequency and lines per picture are, respectively, 30 and 120.

* Decimal Classification: R583 × R545.

† *RCA REVIEW*, October, 1941.

‡ Formerly with RCA Manufacturing Company, Inc., Harrison, N. J.

Tube Department, RCA Victor Division, Lancaster, Pa.

Editor's Note: For additional information on television for the radio amateur see—

“Building Television Receivers with Standard Cathode-Ray Tubes”
J. B. Sherman, *QST*, October, 1938.

“A Practical Television Receiver for the Amateur”, C. C. Shumard,
QST, December, 1938.

“Using Electromagnetic-Deflection Cathode-Ray Tubes in the Television Receiver”, J. B. Sherman, *QST*, February, 1939.

“Electrostatic Deflection Kinescope Unit for the Television Receiver”.
J. B. Sherman, *QST*, March, 1939.

“A Receiver for the New Amateur Television System”, J. B. Sherman,
QST, June, 1940.

“An Efficient U.H.F. Unit for the Amateur Television Transmitter”,
L. C. Waller, *QST*, July, 1940.

ORIGINAL PUBLICATION DATA

for papers, published in *TELEVISION, Volumes I and II, the summaries of which appear in the Appendix (Page 461)*

TELEVISION, Volume I:

- "Television", David Sarnoff, Statement to Annual Meeting of RCA Stockholders, New York City, May 7, 1935.
- "RCA's Development of Television", David Sarnoff, Statement to Annual Meeting of RCA Stockholders, April 7, 1946.
- "The Future of Radio and Public Interest, Convenience and Necessity", David Sarnoff, Statement presented before Federal Communications Commission, Washington, D. C., June 15, 1936.
- "Television in Advertising", David Sarnoff, Excerpts from "The Message of Radio", an address delivered before the Advertising Federation of America, Boston, June 29, 1936.
- "Television", C. B. Jolliffe, Statement presented on behalf of the Radio Corporation of America before the Federal Communications Commission at the Hearing on Frequency Allocations, June 15, 1936.
- "A Study of the Propagation of Wavelengths Between Three and Eight Meters", L. F. Jones, Reprinted from *Proc. I.R.E.*, March, 1933.
- "Notes on Propagation of Waves Below Ten Meters in Length", Bertram Trevor and P. S. Carter, Reprinted from *Proc. I.R.E.*, March, 1933.
- "A Study of Television Image Characteristics", E. W. Engstrom, Reprinted from *Proc. I.R.E.*, December, 1933.
- "A Study of Television Image Characteristics", (Part II), E. W. Engstrom, Reprinted from *Proc. I.R.E.*, April, 1935.
- "An Experimental Television System", E. W. Engstrom, Reprinted from *Proc. I.R.E.*, December, 1933.
- "Description of an Experimental Television System and Kinescope", V. K. Zworykin, Reprinted from *Proc. I.R.E.*, December, 1933.
- "Description of Experimental Television Transmitting Apparatus", R. D. Kell, Reprinted from *Proc. I.R.E.*, December, 1933.
- "Description of Experimental Television Receivers", G. L. Beers, Reprinted from *Proc. I.R.E.*, December, 1933.
- "The Iconoscope—A Modern Version of the Electric Eye", V. K. Zworykin, Reprinted from *Proc. I.R.E.*, January, 1934.
- "Television", V. K. Zworykin, Reprinted from the *Jour. Frank. Inst.*, January, 1933.
- "An Experimental Television System", (Part I—Introduction), E. W. Engstrom, Reprinted from *Proc. I.R.E.*, November, 1934.
- "An Experimental Television System", (Part II—The Transmitter), R. D. Kell, A. V. Bedford, and M. A. Trainer, Reprinted from *Proc. I.R.E.*, November, 1934.
- "An Experimental Television System", (Part III—The Receivers), R. S. Holmes, W. L. Carlson, and W. A. Tolson, Reprinted from *Proc. I.R.E.*, April, 1936.
- "An Experimental Television System", (Part IV—The Radio Relay Link for Television Signals), Chas. J. Young, Reprinted from *Proc. I.R.E.*, November, 1934.
- "Theory of Electron Gun", I. G. Maloff and D. W. Epstein, Reprinted from *Proc. I.R.E.*, December, 1934.
- "The Cathode Ray Tube in Television Reception", I. G. Maloff, Presented before the Radio Club of America, September 18, 1935.
- "Scanning Sequence and Repetition Rate of Television Images", R. D. Kell, A. V. Bedford, and M. A. Trainer, Reprinted from *Proc. I.R.E.*, April, 1936.
- "An Urban Field Strength Survey at Thirty and One Hundred Megacycles", R. S. Holmes and A. H. Turner, Reprinted from *Proc. I.R.E.*, May, 1936.
- "Ultra High Frequency Transmission Between the RCA Building and the Empire State Building in New York City", P. S. Carter and G. S. Wickizer, Reprinted from *Proc. I.R.E.*, August, 1936.
- "Electron Optical System of Two Cylinders as Applied to Cathode Ray Tubes", D. W. Epstein, Reprinted from *Proc. I.R.E.*, August, 1936.

TELEVISION, VOLUME II:

- "What of Television?", David Sarnoff, Reprinted from *Short Wave and Tele.*, January, 1937.
- "RCA Developments in Television", R. R. Beal, Reprinted from *Jour. Soc. Mot. Pic. Eng.*, August, 1937.
- "RCA Television Field Tests", L. M. Clement and E. W. Engstrom, Reprinted from *RCA REVIEW*, July, 1936.
- "Equipment Used in the Current RCA Television Field Tests", R. R. Beal. Reprinted from *RCA REVIEW*, January, 1937.
- "Television Among the Visual Arts", Alfred N. Goldsmith, Original Material.
- "Television Problems—A Description for Laymen", Arthur Van Dyck, Reprinted from lecture given before the Brooklyn Institute of Arts and Sciences, February, 1937.
- "Commercial Television—and Its Needs", Alfred N. Goldsmith Original Material.
- "Field Strength Observations of Trans-Atlantic Signals, 40 to 50 Megacycles", H. O. Peterson and D. R. Goddard, Reprinted from *Proc. I.R.E.*, October, 1937.
- "Some Notes on Ultra High Frequency Propagation", H. H. Beverage, Reprinted from *RCA REVIEW*, January, 1937.
- "Television Transmitters Operating at High Powers and Ultra-High Frequencies", J. W. Conklin and H. E. Gihring, Reprinted from *RCA REVIEW*, July, 1937.
- "Televsual Use of Ultra-High Frequencies", Alfred N. Goldsmith, Original Material.
- "Frequency Assignments for Television", E. W. Engstrom and C. M. Burrill, Reprinted from *RCA REVIEW*, January, 1937.
- "Partial Suppression of One Side Band in Television Reception", W. J. Poch, and D. W. Epstein. Reprinted from *RCA REVIEW*, January, 1937.
- "Television Radio Relay", Bertram Trevor, and O. E. Dow, Reprinted from *RCA REVIEW*, October, 1936.
- "Experimental Studio Facilities for Television", O. B. Hanson, Reprinted from *RCA REVIEW*, April, 1937.
- "Television Studio Design", R. M. Morris and R. E. Shelby, Reprinted from *RCA REVIEW*, July, 1937.
- "Television and the Electron", V. K. Zworykin, Reprinted from *Short Wave and Tele.*, April, 1937.
- "An Oscillograph for Television Development", A. C. Stocker, Reprinted from *Proc. I.R.E.*, August, 1937.
- "A Circuit for Studying Kinescope Resolution", C. E. Burnett, Reprinted from *Proc. I.R.E.*, August, 1937.
- "Analysis and Design of Video Amplifiers", S. W. Seeley and C. N. Kimball, Reprinted from *RCA REVIEW*, October, 1937.
- "Theoretical Limitations of Cathode-Ray Tubes", David B. Langmuir, Reprinted from *Proc. I.R.E.*, August, 1937.
- "The Brightness of Outdoor Scenes and Its Relation to Television Transmission", Harley Iams, R. B. Janes, and W. H. Hickok, Reprinted from *Proc. I.R.E.*, August, 1937.
- "Iconoscopes and Kinescopes in Television", V. K. Zworykin, Reprinted from *RCA REVIEW*, July, 1936.
- "Development of the Projection Kinescope", V. K. Zworykin, and W. H. Painter, Reprinted from *Proc. I.R.E.*, August, 1937.
- "High Current Electron Gun for Projection Kinescopes", R. R. Law, Reprinted from *Proc. I.R.E.*, August, 1937.
- "Television Pickup Tubes with Cathode-Ray Beam Scanning", Harley Iams, and Albert Rose. Reprinted from *Proc. I.R.E.*, August, 1937.
- "Theory and Performance of the Iconoscope", V. K. Zworykin, G. A. Morton, and L. E. Flory, Reprinted from *Proc. I.R.E.*, August, 1937.
- "Problems Concerning the Production of Cathode-Ray Tube Screens", H. W. Leverenz, Reprinted from *Jour. Opt. Soc. Amer.*, January, 1937.
- "Electron Optics of an Image Tube", G. A. Morton and E. G. Ramberg. Reprinted from *Physics*, December, 1936.

APPENDIX

Summaries of papers published in previous television volumes are included below as basic reference material on earlier developments in television and related fields.

TELEVISION, Volume I *Summaries*

TELEVISION*

BY

DAVID SARNOFF

President, Radio Corporation of America

The following statement was delivered at the Annual Meeting of RCA Stockholders in New York City on May 7, 1935. After a general introduction, the paper outlines a three-point plan formulated by the management of RCA to advance the progress of television. Present accomplishments in reception, transmission and establishment of television as a public service are outlined.

* Decimal Classification: R583.17.

RCA'S DEVELOPMENT OF TELEVISION*

BY

DAVID SARNOFF

President, Radio Corporation of America

This statement was delivered at the Annual Meeting of RCA Stockholders in New York City on April 7, 1936. The paper refers to the statement made the previous year and reports on completion of the building of the Empire State television transmitter and an experimental television studio in NBC. It was stated that experimental receivers had been placed at various observation points and tests were proceeding.

* Decimal Classification: R583.17.

THE FUTURE OF RADIO AND PUBLIC INTEREST, CONVENIENCE AND NECESSITY*

By

DAVID SARNOFF

President, Radio Corporation of America

This statement was presented before the Federal Communications Commission in Washington, D. C., on June 15, 1936. The paper outlines the complexity of the problems which the Commission must solve in the public interest. There follows a general discussion of the status and future of radio, including television, and in conclusion suggestions are offered for the Commission's consideration.

* Decimal Classification: R000.

TELEVISION IN ADVERTISING*

By

DAVID SARNOFF

President, Radio Corporation of America

This paper consists of excerpts from "The Message of Radio", an address delivered before the Advertising Federation of America, in Boston, Massachusetts, June 29, 1936. It discusses the use of television for advertising and compares it with the current situation existing in sound broadcasting.

* Decimal Classification: R583.

TELEVISION*

By

C. B. JOLLIFFE‡

Engineer-in-Charge, RCA Frequency Bureau

This paper is the statement concerning television presented by the Radio Corporation of America before the Federal Communications Commission at the Hearing on Frequency Allocation in Washington, D. C., on June 15, 1936. It outlines in detail the steps which RCA and NBC have pursued in advancement of the television art. It discusses the problems attending any standardization of signal characteristics, the properties of the various frequency bands available, and makes specific recommendations for frequency allocations for television broadcasting.

* Decimal Classification: R583 × R007.1.

‡ Now Executive Vice President in Charge, RCA Laboratories Division, Princeton, N. J.

A STUDY OF THE PROPAGATION OF WAVE-LENGTHS BETWEEN THREE AND EIGHT METERS*

BY

L. F. JONES‡

RCA Manufacturing Co., Inc., Camden, New Jersey

A description is given of the equipments used in an airplane, dirigible, automobile, and indoors to measure the propagation characteristics of wavelengths between about three and eight meters. The majority of observations were of television transmissions from the Empire State building.

The absorption of ultra-short-waves traveling through or around large buildings is shown to be in terms of amplitude about 50 per cent every 500 feet for seven meters and 50 per cent every 200 feet for three meters. A number of reflection phenomena are discussed and the influence of interference patterns on receiving conditions is emphasized. It is shown that any modulation frequency is partly or completely suppressed if propagation to the receiver takes place over two paths differing in length by half of the hypothetical radio wavelength of the modulation frequency. For a good television picture this corresponds to a difference of about 500 feet.

Various types of interference are mentioned. There are maps of the interference patterns measured in a typical residential room. The manner in which traffic movements cause severe fluctuations in ultra-short-wave field strengths at certain indoor points is shown by recorded field strengths.

It is shown that the service range of the Empire State transmitters includes most of the urban and suburban areas of New York, and that the interference range is approximately 100 miles. Variations of field strength with altitude, beyond line of sight, are shown. Observations made at a distance of 280 miles are described.

An empirical ultra-short-wave propagation formula is proposed. Curves are then calculated showing the relations between wavelength, power, range, attenuation, and antenna height.

* Decimal Classification: R583 X R270.

‡ Now with the Engineering Products Department, RCA Victor Division, Camden, N. J.

NOTES ON PROPAGATION OF WAVES BELOW TEN METERS IN LENGTH*

BY

BERTRAM TREVOR‡ AND P. S. CARTER‡

RCA Communications, Inc., Riverhead, L. I., N. Y.

The results of a number of measurements of field strength variation with distance from the transmitter and height above ground for several wavelengths in the range below ten meters are shown. Observations of the two transmitters on the Empire State Building in New York City, on 44 and

61 megacycles, were made in an airplane over Long Island. These tests show the nature of the interference patterns set up by the combination of the direct and reflected rays. With low transmitting and receiving antennas, field strength measurements with distance were taken for both horizontal and vertical polarizations over Long Island sand on 41.4 and 61 megacycles. Similar tests were made over salt water with low antennas on 34.8 and 59.7 megacycles. Another airplane test was made on 34 megacycles with a higher transmitting antenna and increased power up to a distance of 200 kilometers. The intervening territory in this run was partly land and partly salt water.

The experimental data are discussed in comparison with the theoretical curves determined from optical principles. The experimental results are shown to conform in general with the predictions from theoretical considerations.

The derivation of the theoretical formulas is shown in the appendix.

* Decimal Classification: R583 × R112.

‡ Now with the Research Department, RCA Laboratories Division, Riverhead and Rocky Point (respectively), L. I., N. Y.

A STUDY OF TELEVISION IMAGE CHARACTERISTICS*

BY

E. W. ENGSTROM‡

RCA Victor Company, Inc., Camden, New Jersey

An investigation was carried out to obtain quantitative information on the several characteristics of television images, particularly those relating to image detail. The tests were conducted largely through the use of equivalents so as to provide sufficient range of measurement. Such data are of value in establishing operating standards, determining satisfactory performance, and in guiding development work. It was found possible to define satisfactory television image characteristics for those items studied. The results are given in such form as to be readily applicable to practical conditions.

* Decimal Classification: R583.11.

‡ Now Vice President in Charge of Research, RCA Laboratories Division, Princeton, N. J.

AN EXPERIMENTAL TELEVISION SYSTEM*

BY

E. W. ENGSTROM‡

RCA Victor Company, Inc., Camden, New Jersey

This forms the introduction to a group of papers describing the

apparatus used in making practical tests on an experimental television system.

* Decimal Classification: R583.

‡ See previous footnote.

DESCRIPTION OF AN EXPERIMENTAL TELEVISION SYSTEM AND THE KINESCOPE*

By

V. K. ZWORYKIN‡

RCA Victor Company, Inc., Camden, New Jersey

A general description is given of an experimental television system using a cathode ray tube (kinescope) as the image reproducing element in the receiver. The fundamental considerations underlying the design and use of the kinescope for television are outlined. A description of the circuits associated with the kinescope and an explanation of the application to an experimental receiver are included.

* Decimal Classification: R583.5 × R583.6.

‡ Now Vice President and Technical Consultant, RCA Laboratories Division, Princeton, N. J.

DESCRIPTION OF EXPERIMENTAL TELEVISION TRANSMITTING APPARATUS*

By

R. D. KELL‡

RCA Victor Company, Inc., Camden, New Jersey

A description is given of an experimental television transmitter. This equipment was installed in the Empire State Building and was used in making practical tests on an experimental system. The installation included facilities for radiating sound and picture signals from studio and from motion picture film.

The general considerations underlying the design and performance of television terminal and transmitting apparatus for this experimental system are reviewed.

* Decimal Classification: R583.4.

‡ Now with the Research Department, RCA Laboratories Division, Princeton, N. J.

DESCRIPTION OF EXPERIMENTAL TELEVISION RECEIVERS*

By

G. L. BEERS†

RCA Victor Company, Inc., Camden, New Jersey

Several television and sound receivers were constructed for use in an experimental system. The major considerations involved in the design of these receivers are outlined. Curves are shown which illustrate the receiver performance characteristics. A brief discussion of some of the observations which were made during the field tests of the receivers is included.

* Decimal Classification: R583.5.

† Now Asst. Director of Engineering in Charge of Advanced Development, RCA Victor Division, Camden, N. J.

THE ICONOSCOPE—A MODERN VERSION OF THE ELECTRIC EYE*

By

V. K. ZWORYKIN†

RCA Victor Company, Inc., Camden, New Jersey

This paper gives a preliminary outline of work with a device which is truly an electric eye, the iconoscope, as a means of viewing a scene for television transmission and similar applications. It required ten years to bring the original idea to its present state of perfection.

The iconoscope is a vacuum device with a photo-sensitive surface of a unique type. This photo-sensitive surface is scanned by a cathode-ray beam which serves as a type of inertialess commutator. A new principle of operation permits very high output from the device.

The sensitivity of the iconoscope, at present, is approximately equal to that of photographic film operating at the speed of a motion picture camera. The resolution of the iconoscope is high, fully adequate for television.

The paper describes the theory of the device, its characteristics and mode of operation.

In its application to television the iconoscope replaces mechanical scanning equipment and several stages of amplification. The whole system is entirely electrical without a single mechanically moving part.

The reception of the image is accomplished by a kinescope or cathode ray receiving tube described in an earlier paper.

The tube opens wide possibilities for applications in many fields as an electric eye, which is sensitive not only to the visible spectrum but also to the infra-red and ultra-violet region.

* Decimal Classification: R583.6.

† See previous footnote.

TELEVISION*

BY

V. K. ZWORYKIN‡

RCA Victor Company, Inc., Camden, New Jersey

This paper gives an outline of a new television system developed in the laboratories of RCA Victor Company, in Camden, N. J.

The system is truly electrical and employs only electronic devices, without a single mechanically moving part.

The translation of the visual image is accomplished by means of a vacuum tube called the iconoscope. This tube is a virtual electric eye and consists of a photo-sensitive mosaic corresponding to the retina of the human eye, and a moving electron beam representing the nerve of the eye. The image is projected optically on the mosaic and transformed within the tube into a train of electrical impulses, representing the illumination of individual points of the image.

The reproduction of the image is accomplished by means of another vacuum tube, the kinescope, which transforms the electrical impulses back into the variation of light intensity through the bombardment of a fluorescent screen by the moving electron beam.

The movement of the electron beams in both tubes, which is responsible for both transformations, is linear and divides the picture into a series of parallel lines. The movements are synchronized so that the instantaneous position of the beams with respect to a point in the picture is always identical. The synchronization is transmitted together with the picture signals, and operation of the receiver is completely automatic.

The sensitivity of the iconoscope, at the present time, is approximately equal to that of a photographic film operating at the speed of a motion picture camera, permitting the transmission of outdoor scenes. The resolution is high, much higher than necessary for television images of the highest quality.

The paper describes the theory of the system, its characteristics, mode of operation, and includes photographs of images obtained on the fluorescent screen of the receiver.

* Decimal Classification: R583.

‡ See previous footnote.

AN EXPERIMENTAL TELEVISION SYSTEM*

BY

E. W. ENGSTROM‡

RCA Victor Company, Inc., Camden, New Jersey

PART I—INTRODUCTION

During the first part of 1933 a complete experimental television system was placed in operation in Camden, New Jersey. Practical tests were made under conditions as nearly as possible in keeping with probable television broadcast service. Program material was obtained from: studio pick-up and

outdoor pick-up. The outdoor pick-up was from a point a mile from the studio and transmitter. In addition, a studio program originating in the Empire State Building in New York was relayed to Camden by radio and broadcast in Camden. The transmitter used an iconoscope as the pick-up element and the receiver a kinescope as the reproducing element.

This paper is an introduction to a group of three papers which describe the transmitter terminal equipment and the transmitter, the New York-to-Camden radio relay circuit, and the receiver apparatus.

* Decimal Classification: R583.

‡ See previous footnote.

AN EXPERIMENTAL TELEVISION SYSTEM*

BY

R. D. KELL,[#] A. V. BEDFORD,[#] AND M. A. TRAINER[‡]

RCA Victor Company, Inc., Camden, New Jersey

PART II—THE TRANSMITTER

A description is given of an experimental television pick-up and transmitting installation which used a special form of cathode ray tube, the iconoscope, as the signal generating device. The installation included facilities for remote pick-up of outdoor scenes and the relaying of programs by radio. The transmitted subject matter for the tests included motion picture film, studio scenes, and outdoor scenes. Description is given of video frequency amplifiers having uniform frequency response from about 20 cycles to 600,000 cycles per second. Discussions are given on several of the problems which arose in the use of the iconoscope.

*Decimal Classification: R583.4.

[#] Now with the Research Department, RCA Laboratories Division, Princeton, N. J.

[‡] Now with the Engineering Products Department, RCA Victor Division, Camden, N. J.

AN EXPERIMENTAL TELEVISION SYSTEM*

BY

R. S. HOLMES,[‡] W. L. CARLSON,[‡] AND W. A. TOLSON[‡]

RCA Victor Company, Inc., Camden, New Jersey

PART III—THE RECEIVERS

Several television receivers were built and operated as a part of the experimental television system set up in Camden during the early part of 1933. The receiver arrangements, including sound, picture, synchronizing, and deflecting circuits are described together with some of the factors

influencing the design. The performance of the receivers is discussed and characteristic curves are given.

* Decimal Classification: R583.5.

‡ Now with the Research Department, RCA Laboratories Division, Princeton, N. J.

AN EXPERIMENTAL TELEVISION SYSTEM*

By

CHARLES J. YOUNG‡

RCA Victor Company, Inc., Camden, New Jersey

PART IV—THE RADIO RELAY LINK FOR TELEVISION SIGNALS

A radio relay circuit is described for carrying 120-line television programs from a studio in New York to a broadcast station in Camden, New Jersey. Details of the actual relay station used are given as well as the characteristics of directive antennas especially designed for this service. The completed system satisfactorily relayed television pictures over this 86-mile distance.

The project was carried out jointly by the following companies: RCA Communications, Inc., RCA Victor Company, Inc., National Broadcasting Company, Inc., General Electric Company, Inc., and the Westinghouse Electric and Manufacturing Company.

* Decimal Classification: R583.16 × R480.

‡ Now with the Research Department, RCA Laboratories Division, Princeton, N. J.

THEORY OF ELECTRON GUN*

By

I. G. MALOFF# AND D. W. EPSTEIN‡

RCA Manufacturing Co., Inc., Camden, New Jersey

The function of the electron gun irrespective of the purpose for which the cathode-ray tube is used is to generate, to concentrate, to control, and to focus an electron beam to a spot of a desired size. This paper describes the theory of the above-mentioned functions. The point of view of electron optics is presented and the theory of thick electron lenses with variable indexes of refraction is given. A somewhat detailed analysis of the action of the various parts of the gun is given, using the concepts of electron optics whenever convenient. Then a relevant part of thermionic emission is treated, with an emphasis on the distribution of velocities of emission. The initial concentration in the proximity of the cathode, the control of the beam intensity, and the effects of space charge are presented next. In closing, the performance of the gun as a whole is given, and a

mathematical and graphical design procedure, made possible by certain assumptions and approximations, is described.

* Decimal Classification: R138.311.

Now with the Home Instrument Department, RCA Victor Division, Camden, N. J.

‡ Now with the Research Department, RCA Laboratories Division, Princeton, N. J.

THE CATHODE RAY TUBE IN TELEVISION RECEPTION*

BY

I. G. MALOFF‡

RCA Manufacturing Co., Inc., Camden, N. J.

This paper was delivered before the Radio Club of America, September 18, 1935, and describes the several component parts of a television system, dealing in particular with the kinescope. This tube is first described in detail and then its operation is discussed. Then follows a presentation of scanning requirements including accessory circuits, deflecting system requirements, defects of the scanning pattern, defocusing of the luminous spot, distortion of the scanning pattern, overall frequency response, cross talk, and irregular defects.

The paper is a general treatise on the problem of television reception with specific reference to the cathode-ray tube and its associated components and problems.

* Decimal Classification: R583.7 × R138.31.

‡ See previous footnote.

SCANNING SEQUENCE AND REPETITION RATE OF TELEVISION IMAGES*

BY

R. D. KELL,‡ A. V. BEDFORD,‡ AND M. A. TRAINER‡

RCA Manufacturing Co., Inc., Camden, N. J.

This paper considers factors which affect the apparent steadiness of television images: namely, line flicker, flicker of the image as a whole, alternating-current ripple in the deflecting circuits, alternating-current ripple in the video frequency signal, and various kinds of beating of the alternating-current ripple with the various scanning frequencies. It is

concluded that an integer ratio between alternating-current ripple frequency and frame frequency is very desirable for progressive scanning and is almost imperative for interlaced scanning. Interlaced scanning with a frame frequency of thirty per second and a field frequency of sixty per second fulfills the requirements in regard to flicker and the relations to alternating-current ripple frequency for a sixty-cycle power source, and offers considerable net gain over other scanning procedures considered. The problems of both odd- and even-line methods of interlacing are discussed and the odd-line method is found preferable.

* Decimal Classification: R583.11.

‡ See previous footnotes.

AN URBAN FIELD STRENGTH SURVEY AT THIRTY AND ONE HUNDRED MEGACYCLES*

By

R. S. HOLMES# AND A. H. TURNER‡

RCA Manufacturing Co., Inc., Camden, N. J.

A description is given of the transmitter and receiver equipment used in making field strength surveys in the Camden-Philadelphia area for a low power transmitter whose antenna is 200 feet above the ground, at frequencies of thirty and one hundred megacycles.

Field strength contour maps for the area within approximately ten miles of the transmitter are given. From these maps the average field strength obtained at various distances from the transmitter was determined, and the attenuation of the signal was found to be proportional to the 1.84 power of the distance for one hundred megacycles for the region between one and ten miles from the transmitter.

Curves showing the variation from the average field strength of the signal along three routes radiating fifteen miles from the transmitter are given, and these variations are compared with the elevation profiles of the respective routes. It is shown that the signal is usually strongest on the brows of hills facing the transmitter.

Measurements were made in three representative residences, and from these data, curves showing the power required at the transmitter to furnish one hundred microvolts input to receivers with short indoor antennas located in houses at various distances up to ten miles from the transmitter were computed for the two frequencies.

* Decimal Classification: R583 × R112.

See previous footnote.

‡ Now with Engineering Products Department, RCA Victor Division, Camden, N. J.

ULTRA HIGH FREQUENCY TRANSMISSION BETWEEN THE RCA BUILDING AND THE EMPIRE STATE BUILDING IN NEW YORK CITY*

BY

P. S. CARTER# AND G. S. WICKIZER‡

RCA Communications, Inc., Rocky Point and Riverhead, L. I., N. Y.

Propagation between these two buildings at a frequency of 177 Mc has been studied with the object of providing a radio circuit with flat response over 3 Mc. It was found that the received signal arrived over several paths, some of which were due to reflection from ground and from nearby buildings. The effects on the indirect rays of horizontal and vertical directivity, and change in angle of polarization were observed. The theoretical response curve for an assumed combination of rays was compared with the curves obtained experimentally.

* Decimal Classification: R583 X R112.006.

See previous footnote.

‡ Now with the Research Department, RCA Laboratories Division, Riverhead, L. I., N. Y.

ELECTRON OPTICAL SYSTEM OF TWO CYLINDERS AS APPLIED TO CATHODE RAY TUBES*

BY

D. W. EPSTEIN‡

RCA Manufacturing Co., Inc., Camden, N. J.

The electron beam of a cathode-ray tube is usually focused by means of an electron optical system of two coaxial cylinders. This paper presents a detailed treatment of such a focusing system and is divided into two parts.

Geometric electron optics of axially symmetric electro-static (e.s.) fields is presented in Part I. This part deals with (1) the analogy between light and electron optics, (2) motion of electrons in axially symmetric e.s. fields, (3) definition and determination of positions of cardinal points due to axially symmetric e.s. fields, (4) thick and thin lenses.

The lenses equivalent to the e.s. fields of two coaxial cylinders are discussed in Part II. This part deals with (1) positions of cardinal points due to two coaxial cylinders of various diameters and at various voltages, (2) use of such cardinal points, (3) experimental determination of positions of cardinal points, (4) spherical aberration of e.s. field due to two cylinders.

The results are applied to the cathode-ray tube, throughout the discussion.

* Decimal Classification: R183.311.

‡ See previous footnote.

TELEVISION, Volume II

Summaries

WHAT OF TELEVISION?*

BY

DAVID SARNOFF

President, Radio Corporation of America

This paper discusses the current status of television in early 1937, stating first that the basic means for providing television service are already available but that much research and technical progress is still to be made before television can reach a status comparable to sound broadcasting. It is further stated that television will supplement but not replace sound broadcasting. Some of the inherent complexities of television are discussed and aspects of radio facsimile are touched upon. The relationship of television to advertising is included.

* Decimal Classification: R583.

RCA DEVELOPMENTS IN TELEVISION*

BY

R. R. BEAL‡

Supervisor of Research, Radio Corporation of America

A brief review is given of the studies made of the several characteristics of television images and other factors that have been effective in establishing standards, in determining satisfactory performance, and in guiding the step-by-step development of the RCA electronic system of high-definition television.

The system employs the "Iconoscope", a cathode-ray tube for translating the visual image into electrical impulses, and the "Kinescope" for transforming the electrical impulses back into the variations of light-intensity to reproduce the image. The sensitivity and characteristics of the "Iconoscope" as a pick-up device are discussed.

The fundamentals of the RCA high-definition television system now under experimental field test in the New York area and the standards presently employed are reviewed. Photographs of the studios and other parts of the field-test facilities are included. A brief review is given to indicate the progress made and the results attained up to the present time in these field tests.

The technic of formulating and presenting television programs is

peculiar to the requirements of television. The development of the technic is presently related to programs employing artists in studios, outside pickups, and motion picture film. The requirements of program technic are discussed.

* Decimal Classification: R583.

‡ Late Vice President in Charge of Engineering, RCA Communications, Inc., New York, N. Y.

RCA TELEVISION FIELD TESTS*

By

L. M. CLEMENT AND E. W. ENGSTROM‡

RCA Manufacturing Co., Inc., Camden, N. J.

This paper describes a series of field tests conducted by the Radio Corporation of America on its experimental television equipment. These field tests were conducted to determine the status and to indicate the course for further development. The paper includes a description in detail of the 1931-32 field test conducted in Camden, N. J., the 1934 field test conducted on further advanced equipment in Camden, N. J., and the 1936 field test conducted in New York with the transmitter at Radio City. The equipment used in these tests is described and the results are discussed.

* Decimal Classification:

‡ Now Vice President in Charge of Research, RCA Laboratories Division, Princeton, N. J.

EQUIPMENT USED IN THE CURRENT RCA TELEVISION FIELD TESTS*

By

R. R. BEAL‡

Research Supervisor, Radio Corporation of America

This paper describes in detail the equipment used for television field testing. The television terminal equipment of the audio and video transmitters are described. The television studio equipment is described, including in detail the studio control room, film studio, and film studio control room. Other elements of the system are also described including the synchronizing generator and time amplifier equipment, interbuilding radio relay link, Empire State Building control board, Empire State Building transmitters, Empire State Building antenna, and experimental field test receivers.

* Decimal Classification: R583 × R200.

‡ See previous footnote.

TELEVISION AMONG THE VISUAL ARTS*

By

ALFRED N. GOLDSMITH‡

Consulting Industrial Engineer

This paper is a general discussion of the art of television. It compares television with direct vision and motion picture photography on the following counts: duration of the envisioned picture; color; sensitivity of the various processes; range of transmission or viewing; ultimate definition; delay between the time of original pick-up and time of final viewing; and dependence of transmission on the instant of occurrence of an event. The paper concludes with the statement that television is so flexible, convenient, and eclectic a method of visual reproduction that it will have general human appeal and wide-spread application.

* Decimal Classification: R583.

‡ Now Consulting Engineer, Radio Corporation of America, New York, N. Y.

TELEVISION PROBLEMS—A DESCRIPTION
FOR LAYMEN*

By

ARTHUR VAN DYCK‡

Manager, RCA License Laboratory

This paper describes television in language which the average non-technical person can understand. The basic concepts of television are outlined and comparisons made to other forms of radio. Then the various components of a television system are discussed together with the limitations of each component. The problems of television transmission and the propagation peculiarities of ultra-high frequencies are dealt with. The paper concludes with a discussion of the receiving problems and a statement concerning the future of television.

* Decimal Classification: R583.

‡ Now Staff Assistant to the Executive Vice President in Charge, RCA Laboratories Division, Princeton, N. J.

COMMERCIAL TELEVISION—AND ITS NEEDS*

By

ALFRED N. GOLDSMITH‡

Consulting Industrial Engineer, New York

The author discusses the various factors involved in the commercialization of television broadcasting, together with the complications attendant

thereto and the indicated solutions therefor. The paper is concerned mainly with the economic rather than the technical aspects of television; however, these aspects are dealt with from an engineer's point of view. Some of the problems considered are: the best way of reaching a multitude of homes with program material of continuing interest; the avoidance of man-made interference with radio reception; the briefness of tenure of television licenses; the legislation, regulation, and external administration of radio broadcasting; the necessity for many stations with interconnections; the question of available transmitters and studio equipment; friction between local stations and networks; and many other problems concerning these aspects of television.

* Decimal Classification: R583.

‡ See previous footnote.

FIELD STRENGTH OBSERVATIONS OF TRANSATLANTIC SIGNALS, 40 TO 45 MEGACYCLES*

By

H. O. PETERSON‡ AND D. R. GODDARD‡

Engineering Department, RCA Communications, Inc., Riverhead, N. Y.

The results of daily observations at Riverhead, N. Y., since the middle of January, 1937 are reported. Some of the schedules of London and Berlin television transmitters are reported as being heard, and measurements of field strengths are summarized. The vertical angle of arrival was measured, and by means of a reversible directive antenna it was determined that the signal at times arrives from the reverse direction over the longest way around the world.

* Decimal Classification: R583.16 × R270.

‡ Now with Research Department, RCA Laboratories Division, Riverhead, L. I., N. Y.

SOME NOTES ON ULTRA HIGH FREQUENCY PROPAGATION*

By

H. H. BEVERAGE‡

Chief Research Engineer, RCA Communications, Inc.

This paper reviews some of the available information concerning ultra high frequency propagation including some studies which have been recently made by engineers of RCA Communications, Inc., on propagation of various frequencies both within and beyond the optical distance. The study is described in the following sections: (1) Propagation Within the

Optical Distance. (2) Ground Wave Propagation Beyond the Horizon, and (3) Sky Wave Propagation. The paper concludes with a summary stating that there are apparently four mechanisms which may be involved in ultra short wave propagation. These are (1) combination of the direct ray and the ray reflected from the ground; (2) diffraction at the earth's surface; (3) refraction in the troposphere; and (4) sky wave transmission.

* Decimal Classification: R112.006.

‡ Now Director of the Radio Systems Research Laboratory, RCA Laboratories Division, New York, N. Y.

TELEVISION TRANSMITTERS OPERATING AT HIGH POWERS AND ULTRA-HIGH FREQUENCIES*

BY

J. W. CONKLIN AND H. E. GIHRING‡

RCA Manufacturing Co., Inc., Camden, N. J.

The advent of high-definition television, involving modulation frequencies up to several million cycles, has necessitated the development of high-power, ultra-high-frequency transmitters. The unique tube and circuit problems encountered and the practicability of line sections as circuit elements has resulted in radical departures from conventions in transmitter design. These new vacuum tubes and circuits are described in this paper including features of high-power ultra-high frequency television transmitters.

* Decimal Classification: R583.4.

‡ Now with the Engineering Products Department, RCA Victor Division, Camden, N. J.

TELEVISUAL USE OF ULTRA-HIGH FREQUENCIES*

BY

ALFRED N. GOLDSMITH‡

Consulting Industrial Engineer

This paper points out how the science of radio is gradually shifting toward the shorter wave lengths. Several inherent qualities of ultra-high frequency waves are described including steady and high quality medium of communication; less open to natural static; and extremely high fidelity. The author then points out that the wide bands required in television will undoubtedly mean the use of the UHF portion of the frequency spectrum.

* Decimal Classification: R583.

‡ See previous footnote.

PARTIAL SUPPRESSION OF ONE SIDE BAND IN TELEVISION RECEPTION*

By

W. J. POCH# AND D. W. EPSTEIN‡

RCA Manufacturing Co., Inc., Camden, N. J.

This paper describes early tests and outlines the verification of selective side band suppression. The apparatus used in the experimental work is described and the measurements of selective side-band fidelity and phase characteristics are discussed. The calculations of fidelity and delay characteristics are included. Other items described in this paper are second-detector distortion, location of the carrier on the selectivity curve, and transmitter considerations.

* Decimal Classification: R583.7 × R148.16.

Now with the Engineering Products Department, RCA Victor Division, Camden, N. J.

‡ Now with the Research Department, RCA Laboratories Division, Princeton, N. J.

FREQUENCY ASSIGNMENTS FOR TELEVISION*

By

E. W. ENGSTROM# AND C. M. BURRILL‡

RCA Manufacturing Co., Inc., Camden, N. J.

This article is not a report of original work, but is a correlation or synthesis of information pertinent to the subject, available to the authors within the RCA Services or through published papers. Since the results of all have been taken into account it has not seemed feasible or desirable to give credit to individual sources except to mention the article by H. H. Beverage entitled "Some Notes on Ultra Short Wave Propagation" appearing in the January 1937 issue of RCA REVIEW, and the bibliography forming a part of that article. Much credit is due collectively to the many workers in this field, who have made possible the drawing with reasonable certainty of the conclusions here stated. The basic plan of any new service must always be determined by the work of such pioneers, before commercial experience has made everything plain. Because fundamental plans for broadcast television are now in the making, it is hoped that this brief article will be found both timely and interesting.

* Decimal Classification: R583 × R007.1.

See previous footnote.

‡ Now with the Research Department, RCA Laboratories Division, Princeton, N. J.

TELEVISION RADIO RELAY*

By

BERTRAM TREVOR‡ AND O. E. DOW‡

RCA Communications, Inc., Riverhead, and Rocky Point, L. I., N. Y.

A general description of the 177-Mc television radio link between the RCA Building and the Empire State Building in New York City is given. The transmitter and receiver are described in detail along with results of tests on the circuit.

* Decimal Classification: R583 × R480.

‡ Now with the Research Department, RCA Laboratories Division, Riverhead and Rocky Point (respectively), L. I., N. Y.

EXPERIMENTAL STUDIO FACILITIES FOR
TELEVISION*

By

O. B. HANSON‡

Chief Engineer, National Broadcasting Company

The experimental studio facilities of the National Broadcasting Company are described in detail in this paper. The factors determining the selection of Radio City location are considered and the following subjects are discussed in turn: factors influencing the design of a direct pickup studio, control booth and equipment, studio lighting, acoustics, the film scanning room, and the main equipment room.

* Decimal Classification: R583.3.

‡ Now Vice President and Chief Engineer, National Broadcasting Company, Inc., New York, N. Y.

TELEVISION STUDIO DESIGN*

By

R. M. MORRIS# AND R. E. SHELBY‡

Engineering Department, Development and Research,
National Broadcasting Company

This paper discusses from the viewpoint of an operating company the engineering problems involved in the design of a plant for originating television broadcast programs. The paper describes the fundamental elements of a typical camera chain and indicates how this can be expanded into a larger plant. Coaxial-cable installation difficulties are discussed and

camera operation is described in detail. Solutions which have thus far been found most feasible are indicated.

* Decimal Classification: R583.2.

Now with the Recording Department, National Broadcasting Company, Inc., New York, N. Y.

‡ Now Director of Technical Development, National Broadcasting Company, Inc., New York, N. Y.

TELEVISION AND THE ELECTRON*

BY

VLADIMAR K. ZWORYKIN‡

Director, Electronic Research Laboratory
RCA Manufacturing Company, Inc.

This paper is a review of the television art shortly after the Radio Manufacturers Association had decided upon a set of standards. A typical television system is described including discussion of the kinescope, iconoscope, the future of projection television, and transmitter networks.

* Decimal Classification: R583.

‡ Now Vice President and Technical Consultant, RCA Laboratories Division, Princeton, N. J.

AN OSCILLOGRAPH FOR TELEVISION DEVELOPMENT*

BY

A. C. STOCKER

RCA Manufacturing Company, Inc.
RCA Victor Division, Camden, New Jersey

This paper includes a brief history of the development of the cathode-ray oscillograph and points out its usefulness in television development. It then describes in detail a new cathode-ray oscillograph and discusses circuits for the correction of transients, amplifier circuits, Oscillograph mounting and power supply. The paper includes photographs of oscillographs obtained at various points in television circuits.

* Decimal Classification: R371.5 × R583.

A CIRCUIT FOR STUDYING KINESCOPE RESOLUTION*

BY

C. E. BURNETT‡

RCA Manufacturing Company, Harrison, New Jersey

Several of the characteristics of a cathode-ray tube which determine its usefulness as a Kinescope for television reception are outlined. Various means for studying these characteristics are discussed.

A system is outlined for studying kinescope resolution by breaking the picture into alternate black-and-white picture elements arranged in checker-board fashion. A practical application of this system is described for a television system using a picture frame of approximately 340 lines repeated thirty times per second. The deflection and grid-signal frequencies that are involved are discussed. The problem of synchronizing these frequencies is covered and the circuits developed for this purpose are described. Some of the results obtained with these circuits are shown.

* Decimal Classification: R583.15.

‡ Now with the Tube Department, RCA Victor Division, Lancaster, Pa.

ANALYSIS AND DESIGN OF VIDEO AMPLIFIERS*

BY

S. W. SEELEY‡ AND C. N. KIMBALL

License Laboratory, Radio Corporation of America

The nature of the problem of the analysis and design of video amplifiers is dealt with in an introductory section of this paper. Then follows a detailed analysis, including a study of phase and time delay, number of stages, low frequency considerations, measurement of gain and phase delay. The appendix includes gain, phase and time delay of a compensated stage in a video amplifier.

* Decimal Classification: R363.4.

‡ Now Manager, Industry Service Laboratory, RCA Laboratories Division, Princeton, N. J.

THEORETICAL LIMITATIONS OF CATHODE-RAY TUBES*

BY

DAVID B. LANGMUIR

RCA Manufacturing Company, Inc.
RCA Radiotron Division, Harrison, New Jersey

The current density in a focused beam of cathode rays is shown to have

an upper limit defined by $I = I_0(Ee/kT + 1) \sin^2\Phi$, where I is the maximum current density obtainable in the focused spot, I_0 is the current density at the cathode, E is the voltage at the focus relative to the cathode, T is the absolute temperature of the cathode, e is the electronic charge, k is Boltzmann's constant, and Φ is the half angle subtended by the cone of electrons which converge on the focused spot. The cases in which the focused spot is an image of the cathode, and in which it is a pupil, or "crossover", are considered separately, and the above formula is shown to apply to both. The necessary initial assumptions are (1) that electrons leave the cathode with a Maxwellian distribution of velocities, and (2) that the focusing system is free from aberrations and obeys the law of sines. Aberrations may reduce the current density, but nothing can raise it above the value defined.

In the Appendix the focusing properties of a uniform accelerating field are calculated. The virtual image of a plane cathode formed by such a field suffers from spherical aberration. The diameter of the circle of least confusion formed by electrons from a single point is approximately equal to the distance the electrons can travel against the field by virtue of their initial velocities. This aberration may be the factor which limits the resolving power of some kinds of electron microscopes.

* Decimal Classification: R138.31.

THE BRIGHTNESS OF OUTDOOR SCENES AND ITS RELATION TO TELEVISION TRANSMISSION*

By

HARLEY IAMS,# R. B. JANES,‡ AND W. H. HICKOK

RCA Manufacturing Co., Inc., Camden, N. J.
RCA Radiotron Division, Harrison, New Jersey

The average brightness of typical outdoor scenes has been determined by computation and by measurement. The average brightness of some scenes was found to be over 1000 candles per square foot, and of other scenes nearly zero. In many cases the average brightness lay between twenty and 200 candles per square foot. The sensitivity of a present-day television system using the Iconoscope has been found to be sufficient to permit the transmission of pictures with good quality when the average brightness of an average scene was greater than about fifteen candles per square foot. This sensitivity is sufficient for the transmission of parades, races, base-ball games, and many other outdoor events. Football games, which last until near sunset cannot always be satisfactorily reproduced.

Some of the Iconoscopes used in these tests are of added sensitivity, which has been achieved by means of a silver evaporation process, as well as by careful control of the purity of the materials.

* Decimal Classification: R583.

Now with the Research Department, RCA Laboratories Division, Princeton, N. J.

‡ Now with the Tube Department, RCA Victor Division, Lancaster, Pa.

ICONOSCOPES AND KINESCOPES IN
TELEVISION*

By

V. K. ZWORYKIN‡

RCA Manufacturing Company, Inc., Camden, New Jersey

This paper includes a brief history of the development of electronic television and discusses in detail the theory, construction and use of the iconoscope as applied to television transmitting and the kinescope as applied to television receivers. Each end of the television chain—transmitters and receivers—is described together with all circuits involved.

* Decimal Classification: R583.6.

‡ See previous footnote.

DEVELOPMENT OF THE PROJECTION KINESCOPE*

By

V. K. ZWORYKIN# AND W. H. PAINTER‡

RCA Manufacturing Company, Inc.

This paper discusses the general requirements and design of Kinescope tubes for projecting television images. A picture 18 x 24 inches in size having a brightness in the high lights of 0.9 candle per square foot appears to be an acceptable minimum for home television reception. Several years of developmental work were required before the problems of designing a suitable projection system were clarified. This clarification led to a developmental kinescope which closely approaches the minimum brightness requirements. The possibilities of further improvements in electron guns, fluorescent screen materials, and optical systems are discussed.

* Decimal Classification: R583.6.

See previous footnote.

‡ Now with the Tube Department, RCA Victor Division, Lancaster, Pa.

HIGH CURRENT ELECTRON GUN FOR PROJECTION
KINESCOPES*

By

R. R. LAW‡

RCA Manufacturing Company, Inc.
RCA Radiotron Division, Harrison, New Jersey

One of the problems in the art of reproducing a scene by television is to obtain an image of adequate size. Because of this there has been considerable interest in projection systems where a small, high intensity image reproduced on the face of a projection Kinescope is thrown onto a viewing

screen of the desired size by a suitable optical system. The light output and the definition of these systems has been limited by the inability of the electron gun to provide a sufficiently large beam current in a small spot.

This paper describes an electron gun giving large beam current in a small spot. The design of this electron gun is based on the results of the present investigation which shows that the ratio of the current in the first crossover inside the radius r to the total space current is $I/I_s = 1 - ar^{2E}$ where E is the voltage applied to the first crossover forming system and a is a constant for any given cathode temperature, potential distribution, and geometry. Inasmuch as the total space current varies approximately as $E^{3/2}$, the concentration of current in the first crossover increases very rapidly with voltage.

A description is given of an electron gun based on this theory. All available voltage is used to form a small intense first crossover whose edges are sharply defined by a first crossover defining aperture. A magnetic final focusing lens re-images this first crossover on the fluorescent screen. This electron gun gives beam currents of 1.5 to 2 milliamperes at an operating potential of ten kilovolts. This beam current may be readily concentrated into a 300-micron spot on the screen when the electron gun is spaced at such a distance from the screen as to give a 2.4×1.8 -inch image. In conjunction with an f 1.4 lens having a focal length of 12 centimeters, this projection kinescope has a light output sufficient to give an 18×24 -inch picture having high lights with an apparent brightness of about 2.5 foot-lamberts when viewed on a 480 per cent directional screen.

* Decimal Classification: R138.311.

‡ Now with the Research Department, RCA Laboratories Division, Princeton, N. J.

TELEVISION PICKUP TUBES WITH CATHODE-RAY BEAM SCANNING*

BY

HARLEY IAMS‡ AND ALBERT ROSE‡

RCA Manufacturing Co., Inc., Harrison, New Jersey

Television pickup tubes which use cathode-ray beams scanning, although only one class of television pickup devices, may be made in a variety of ways, a number of which are described in this paper. In these tubes, the function of the electron beam is to release secondary electrons from the target, the number escaping being modulated by electrostatic fields, magnetic fields, orientation of electrodes or changes in the secondary emission ratio of the target. The Iconoscope is a well-known example of modulation by electrostatic fields produced by photoemission from the target. A conducting photocathode when used as a target, however, acted as if its secondary emission ratio were decreased by light. A copper plate oxidized and treated with caesium transmitted a picture with some time lag. Photoconductive materials exposed to light and scanned by an electron beam were made to develop potential variations over their surface and thereby transmit a television picture. Aluminum oxide and zirconium oxide, treated with caesium, were used in this manner. Selenium, used as a photoconductive material, also transmitted a picture. Germanium used as a target sensitive to heat radiation was able to transmit a picture, probably as a result of

some thermoelectric effect. The most sensitive tubes tested were those in which an electron picture was focused upon a scanned, secondary electron emissive target. The scanning and picture projection operations may be separated by using a two-sided target. Coupling between the two sides was obtained by conducting plugs through the target. Stray secondary electrons from the electron gun, which contributed a spurious signal, were eliminated by the use of apertures in the first anode. A demountable television pickup tube was used for the experiments with selenium.

* Decimal Classification: R583.6 × R138.31.

‡ Now with the Research Department, RCA Laboratories Division, Princeton, N. Y.

THEORY AND PERFORMANCE OF THE ICONOSCOPE*

BY

V. K. ZWORYKIN,# G. A. MORTON,‡ AND L. E. FLORY‡

RCA Victor Division, RCA Manufacturing Co., Inc., Camden, New Jersey

Field tests have shown the present standard Iconoscope to be a very satisfactory television pickup device. However, from a theoretical point of view the efficiency of the Iconoscope as a storage system is rather low. The principal factors responsible for the low efficiency are lack of collecting field for photoelectrons, and losses caused by the redistribution of secondary electrons produced by the beam.

Limits to the sensitivity of the standard Iconoscope are set by the ratio of picture signal to amplifier and coupling resistor noise. Experimental and theoretical determinations indicate that an excellent picture can be transmitted with from two and one-half to six millilumens per square centimeter on the mosaic.

Two methods are considered by which the sensitivity may be increased. The first is by the use of secondary emission signal multipliers and a low capacitance mosaic, while the second makes use of secondary emission image intensification. The sensitivity limits for the two cases are calculated.

* Decimal Classification: R583.6.

See previous footnote.

‡ Now with the Research Department, RCA Laboratories Division, Princeton, N. J.

PROBLEMS CONCERNING THE PRODUCTION OF CATHODE-RAY TUBE SCREENS*

BY

H. W. LEVERENZ‡

RCA Victor Division, RCA Manufacturing Co., Inc., Camden, New Jersey

The scope of this paper includes a description of some problems incidental to applying cathodoluminescent materials in cathode-ray tubes and

kinescopes. Much of the material is generalized; however, specific differences in theory and practice arising from the use of different materials and the use of different ways of viewing, projecting or photographing the luminescent image are described. Most of the experimental procedures outlined herein were developed for producing oxide-type luminescent screens. A large portion of the article is devoted to the screening problems of a typical cathode-ray tube or kinescope.

* Decimal Classification: R138.313.

‡ Now with the Research Department, RCA Laboratories Division, Princeton, N. J.

ELECTRON OPTICS OF AN IMAGE TUBE*

BY

G. A. MORTON‡ AND E. G. RAMBERG‡

RCA Manufacturing Company, Inc., Camden, N. J.

(I). Introduction: Description of fixed-focus and variable-focus electrostatic image tube; scope of paper. (II). Focusing properties: Measurement of the variation of image distances and magnification with object distance and ratio of applied voltages for both types of tubes; calculation of potential distributions and electron paths; comparison of experimental and theoretical results. (III). Aberrations: Classification of aberrations; measurement of tangential and sagittal image surfaces for fixed-focus tube; calculation of axial (chromatic and spherical) aberrations; calculation of field aberrations; comparison between measurements and calculation; reduction of field aberrations by curving the cathode.

* Decimal Classification: R138.3.

‡ Now with the Research Department, RCA Laboratories Division, Princeton, N. J.

