

RADIO FACSIMILE

*An Assemblage of Papers from Engineers of the
RCA Laboratories Relating to the Radio Transmis-
sion and Recorded Reception of Permanent Images*

Edited by

DR. ALFRED N. GOLDSMITH

ARTHUR F. VAN DYCK

CHARLES W. HORN

ROBERT M. MORRIS

LEE GALVIN



VOLUME I

OCTOBER, 1938

PUBLISHED BY

RCA INSTITUTES TECHNICAL PRESS

A Department of RCA Institutes, Inc.

75 Varick Street, New York, N. Y.

COPYRIGHT, 1938
RCA INSTITUTES, INC.

Printed in U.S.A.



1924



1938

Transatlantic Radio Facsimile Pictures, London to New York.

PREFACE

FACSIMILE radio communication, one of the more recently developed divisions of the radio field, seems entitled to more attention in the literature of that field than it has hitherto received. Its older brother art of telegraphic communications, whether aurally received or recorded or printed, has been the subject of an extensive literature. And its youngest relative, television, has had a widespread appeal which has focused not only public attention, but also the efforts of the engineers.

It is as well here to distinguish between printer telegraphy, facsimile, and television. In printer telegraphy, an electrically operated typewriter is remotely controlled thus producing text on paper tape or in page form. Naturally the form of the printing is restricted to the characters of the alphabet included in the typewriter. The record thus produced is permanent.

"Facsimile" is a system of communication in which images are transmitted for record reception, and in which a record is to be made. In facsimile, there is accordingly used what amounts to an electrically controlled "brush," and this is remotely operated to "paint" the stationary replica of any graphic material, whether type, script, line drawings or half-tone subjects. Again, the record thus produced is, or can be made permanent.

"Television" is a system of communication in which transient visual images of moving or fixed objects are transmitted for reception by visual observers and in which no record is to be made. In television there are thus employed what are in effect an electric moving-picture camera (the Iconoscope and its lens) and an electric moving-picture reproducer (Kinescope) or projector. The reproducer yields a picture in motion, and accordingly the picture is inherently transient in its nature.

In facsimile and television communication, a process known as "scanning" is used. This is a method of analyzing and re-assembling a picture by a method similar to that used by the human eye in reading. In other words, the eye follows each horizontal line from left to right thus gathering information, and returns to a starting point at the left side of the page and repeats the process many times to reach the bottom of the page. At present, facsimile involves a relatively slow-speed scanning process which produces a graphical record of a page in a period

of several minutes. Television, however, inherently involves an extremely high-speed scanning system in order to reproduce many complete transient images during as brief a period as one second.

From the foregoing it will be seen that printer telegraphy broadly resembles the art of typewriting; facsimile somewhat resembles the field of the printing press; and television is closely similar to the motion picture.

The purpose of the present book is to assemble in convenient form much historically valuable material, exhaustive data on the present state of the facsimile art, and some hints as to what may be in store in the further evolution of radio facsimile. Although facsimile has hitherto not received the attention which may be its due, its accomplishments have been so solid and substantial in the past, and so promising for the future, that the RCA Institutes Technical Press is believed to be well justified in assembling what may be regarded as the first book, or treatise, devoted exclusively to radio facsimile. It is divided into four parts, broadly arranged chronologically from the past to the present, and as to subject matter within each part from the general to the particular. These parts deal respectively with the historical development of facsimile, the status of facsimile in 1938, radio facsimile communication methods and equipment, and radio facsimile broadcasting.

It has been fortunate for the publishers that there have been available many important articles, some of which have been previously published and others of which have been specially written for this book, covering in their totality most of the important aspects of facsimile communication and broadcasting. The publishers express their thanks to the authors of the papers herein contained as well as to the organizations which have granted permission to publish these papers, namely: The Institute of Radio Engineers, The Photographic Society of America, Michigan State College, John Wiley and Sons, Inc., and the organizations in the Radio Corporation of America group. It is their hope that this book may in some measure stimulate the further development of the important art of radio facsimile.

CONTENTS

PART I—HISTORICAL DEVELOPMENT OF FACSIMILE		PAGE
Transmission and Reception of Photoradiograms.....	R. H. RANGER	1
Photoradio Developments.....	R. H. RANGER	21
Mechanical Developments of Facsimile Equipment.....	R. H. RANGER	40
Facsimile Picture Transmission.....	V. K. ZWORYKIN	52
Image Transmission by Radio Waves.....	ALFRED N. GOLDSMITH	66
Photoradio Apparatus and Operating Technique Improvements.....	J. L. CALLAHAN, J. N. WHITAKER and HENRY SHORE	70
PART II—STATUS OF RADIO FACSIMILE IN 1938		
A Narrative Bibliography of Radio Facsimile.....	J. L. CALLAHAN	112
Photoradio Transmission of Pictures.....	HENRY SHORE	129
Facsimile Transmission and Reception.....	MAURICE ARTZT	147
PART III—RADIO FACSIMILE COMMUNICATION METHODS AND EQUIPMENT		
Propagation Requirements for Facsimile.....	R. E. MATHES and J. E. SMITH	198
The New York-Philadelphia Ultra-High-Frequency Facsimile-Relay System	H. H. BEVERAGE	212
The Development of Facsimile Scanning Heads.....	J. N. WHITAKER and MAURICE ARTZT	229
Application of an Electron Multiplier to the Production of Facsimile Test Wave-forms.....	W. H. BLISS	248
Tape Facsimile: Historical and Descriptive Note...	CHARLES J. YOUNG	264
Tape Facsimile Synchronizing Systems.....	HENRY SHORE and J. N. WHITAKER	270
Practical Application of Tape Facsimile Systems.....	J. N. WHITAKER and F. C. COLLINGS	284
Radio Weather Map Service to Ships.....	IRVING F. BYRNES and CHARLES J. YOUNG	294
PART IV—RADIO FACSIMILE BROADCASTING		
Facsimile Broadcasting.....	DUDLEY E. FOSTER	305
Equipment and Methods Developed for Broadcast Facsimile Service..	CHARLES J. YOUNG	317
Facsimile Broadcasting.....	ALFRED N. GOLDSMITH	334

PART I

TRANSMISSION AND RECEPTION OF PHOTORADIOGRAMS*

BY

RICHARD H. RANGER

Summary—This paper carries the art of electric picture transmission from its inception, over 80 years ago, to the results of present-day development.

It is pointed out that the seemingly rapid strides that have been made in the art during the last 10 years of its 83-year existence may be attributed to the larger storehouse of electrical and mechanical contrivances from which modern photo-transmission engineers may draw.

Picture transmission is not, as many think, a modern art. It is as old as the communication art itself and this paper carries us through the work, ancient and modern, of photo-transmission engineers, commencing with that of Alexander Bain in 1842.

A Denison facsimile of telegraph tape, taken in 1901, is shown, together with examples of the work of Korn taken in 1922; that of Bart-Lane in 1922; Belin, 1924; Ferree, 1924; Jenkins, 1924; and results of the A. T. & T. system in 1925.

The basic elements of all picture transmission systems are shown to consist of synchronously covering a surface, point-by-point, at both transmitter and receiver, and electrically identifying point values at the receiver so that any integral section of the received copy will have the same relative tonal value as the identical integral section on the transmitting surface.

Economics is as important a factor in the transmission of pictures as it was in the establishment of a telegraphic system of communication, and the reason that the Morse Code still exists is because it is the most economical means of getting a given amount of words from one point to another, in the shortest time, with the least power, over the greatest distance and through the greatest amount of interference.

The necessity of a picture shorthand was visualized and developed. Whereas the usual newspaper half-tone has 65 dots to the inch and 5 tonal values are desired per dot, making a total of 325 photo-pulses per inch, the picture shorthand developed in the "photoradiogram" system reduced this to 65 photo-pulses per inch giving a reduction or shorthand ratio of 5 to 1.

The photographic angle of the problem is touched on lightly and the 11,000,000-mile-a-minute flight of the picture pulses from the transmitter to the receiver are followed through their several transformations in "slow-motion."

The development of this system of picture transmission is shown graphically by examples of photoradiograms taken from epochal stages in the course of the development.

The commercial possibilities of this system are discussed, and in closing it is pointed out that one very immediate and effective use to which photoradiograms will be put is in the transmission of words, printed, typewritten or handwritten.

* Presented before the Institute of Radio Engineers, New York, June 3, 1925. Reprinted from *Proc. I.R.E.*, April, 1926. This paper was a report from the engineering laboratories of R.C.A. Communications, Inc.

INTRODUCTION

From recent announcements it may seem to many that the art of picture transmission has suddenly been born; but it is as old as the communication art itself. The transmission of pictures electrically had its inception almost at the same time as straight telegraphy, for in 1842 Alexander Bain, an English physicist, first proposed a device to send pictures from one place to another by electric wires. His plan is so basically correct that it is only right at the start to show the simplicity of his plan and how, generally, we are all following in his footsteps. He had, as is seen in Figure 1, two pendulums which were arranged electrically

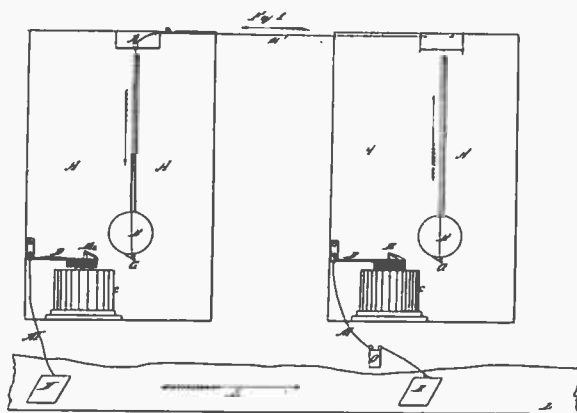

Fig. 1—Copy of Bain's original patent

in such a manner that if one preceded the other by a slight amount of the time of a stroke it was held until the other had reached the same position, when both then started a new stroke. These swinging pendulums were the basic synchronizers which are necessary in any picture work. On each swing, a tablet descended a notch at a time at the side of the pendulum. At the transmitting station the swinging arcs of the pendulum carried a small contactor which rode over type faces making the appropriate electric contacts to be transmitted to the distant receiver where a similar swinging pendulum was tracing a path across a piece of paper. By chemical action, the electricity received from the transmitter would discolor the paper at the receiver to give an impression of the original.

We have here the basic elements of all picture transmission. First, the synchronous action covering a surface point-by-point at both transmitter and receiver, and the electrical identifica-

tion of the point value to correspond between transmitter and receiver.

As it has taken more than eighty years from this initial step to anything approaching commercial reality, there must be something basically difficult in the process.

There have certainly been one thousand workers in the field, and surely it would seem that all of the fundamental conceptions of solving the problem had been realized by this time. However, it is safe to say that present successes are largely due to the wonderful strides that have been made in recent years in the production of more accurate instruments, which have given present-day workers in this field a far greater storehouse from which to draw upon in the accomplishment of the problem. Naturally many transmissions of pictures have been made and successfully, too.



Fig. 2—Denison facsimiles of telegraph tape.

The fact that ours may have gone greater distances is only because that is what we were requested to do.

THE START

Mr. Owen D. Young, Chairman of the Board of Directors of the Radio Corporation of America, stated, at a banquet, that he was tired of all the arduous effort behind a twenty-four-hour job of sending radio messages by telegraphy from a transmitting operator to a receiving operator who put down the letters one by one at a distant point. Instead of this, the new possibilities of radio should make it feasible for us to say: "ZIP, and a page of the *London Times* is in New York City." "Not being an engineer," he added, "I am not interested in the details; that is your job." If he had perhaps known, or if we had ourselves known, of all the griefs that others had gone through, perhaps we might have hesitated treading on such fearful ground. But, fortunately for us, our knowledge of the basic art developed apace with our study of the problem, and we found ourselves living through all the past lines of thought of these many investigators, in rapid succession.

Figure 2 is a Denison facsimile of telegraph tape taken in 1901. Figure 3 is an example of the Korn system taken in 1922.

of work and time and money, when it is evident that a line of attack does not have the earmarks of success. But having two lines of attack at all times, we have realized this perhaps a little more readily, and as a result have built up quite a graveyard of dead ideas, and we trust a living survivor of merit.

PICTURE SHORTHAND

Morse's wonderful contribution to communication was not alone, as most seem to think, the development of a telegraphic machinery or equipment, but largely the development of the



Fig. 7—Sample of cable picture transmission by the Bart-Lane System, 1922.

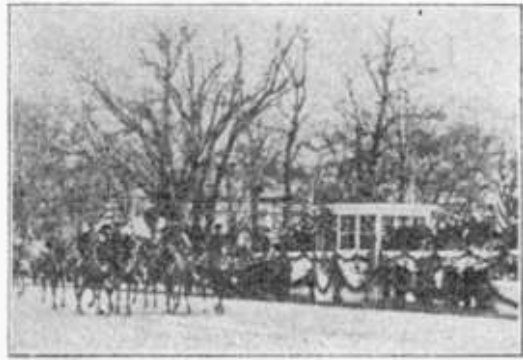

Fig. 8—One of the views of the presidential inauguration that was transmitted from Washington to New York by the A. T. & T. System in 1925.

telegraph code. Any number of telegraph devices had been constructed before Morse, but they did not have the economic practicability of an all-round system which would get words across in a short space of time.

How successful Morse was may be realized when, today, it is an established fact that the Morse code, representing letters by the dots and longer dashes, is still the most economical way of getting a given amount of words from one point to another, in the shortest time, with the least power, over the greatest distance, and through the greatest amount of interference.

Of course other means of sending words have been produced, typically, the telephone; but it requires, as you may all well realize, a higher quality of wire service and perfection in appara-

tus to accomplish the higher speeds realized in words transmitted by the voice. The same thing is true of many other systems proposed and in use wherever better facilities are available.

As soon as we realized the economic angle of our problem we began to look for a picture shorthand. It may well be mentioned at this time that our whole problem was largely one of realizing what confronted us and what our real aim was and then the answers began to come easily.

Practically every system to date has been, and still is, on the basis of dividing the picture up into small unit areas and to transmit their values one after the other. This is exactly the plan that would occur to any one knowing the success of the usual half-tone process of printing a picture as in a newspaper. Figure 9 shows this half-tone effect, and it will be seen that there is a regular grading in the proportionate size of the little squares to the surrounding area from the lightest portion to the darkest. Naturally a picture transmission system which would duplicate this would seem to be all that was necessary. But when we realize that the usual newspaper half-tone (and none too good a one at that) has at least 65 dots in a row for an inch, or more than 4,000 of them to a square inch, the size of the job becomes apparent. Let us assume that we wish five tone values to each of these dots, we may then describe this, arbitrarily, as requiring five photo units for each of these dots, or some 20,000 photo units to the square inch. In other words, it requires the ability to transmit from one point to another in identifiable shape 20,000 photo unit pulses per square inch. Naturally, this can be done on any circuit if you have time enough, and if it is a particularly good circuit it can be done in a very short time. The ratio between the speed of transmission available and this quantity of units is the limiting factor.

On high-class telephone circuits we can readily send 200 such photo units in a second; but in the usual telegraph circuits such speeds are quite difficult, the fastest usual speeds being some 75 separate pulses a second, and normally around 30 or 40 impulses a second. The telegraph circuit, wire or radio, is a slower moving but further carrying message channel.

It is thus seen that, analyzing in this way, the usual method of picture transmission has found its serious drawbacks in the number of pulses that have to be put through; and the precision with which they have to be put through; and the time that it takes to put them through.

Search for a shorthand method of accomplishing the same results was then started. Our first effort in this direction consisted in the variable dot-spacing method. Obviously, if we place a group of dots on a piece of white paper and space them widely, we will get an impression of practically white. If we place them close, we approach black. This is what we did in our first shorthand attempt, making each dot of generally the same size; although it worked out practically such that the individual dots widely spaced were a little lighter than those grouped together. These dots by their grouping constituted the shades of the picture. The dots were so chosen that in size they would occupy a space of approximately one-fourth of the 64th of an

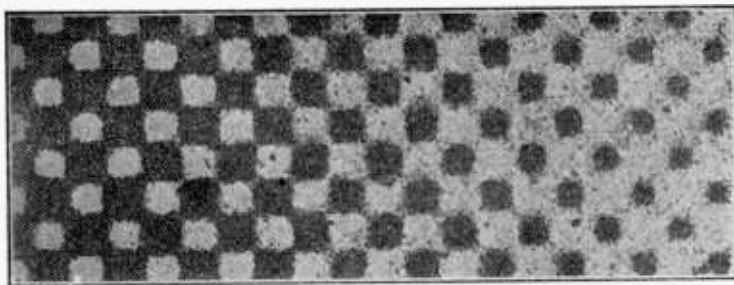

Fig. 9—A fundamental specimen of "Korn's" work in 1922.

inch as being the usual newspaper standard. One such dot per 64th of an inch would then give an impression of gray color. If they were spaced further apart, this gray color would give way to white. If they were spaced closer together, the gray would become darker up to almost black for the deepest portions. The spacing then was approximately two to each 64th of an inch. Under these conditions it is realized that we have gone from the necessary five values for each 64th of an inch of the older systems to two values for each 64th of an inch, and have therefore realized a shorthand of a ratio of approximately five to two. Naturally we had the idea of what we wanted in the way of this dot concentration before we had the actual means for accomplishing it, but we were not long in finding a circuit which would give us this photographically and automatically.

DOT-DASH PLAN

Not satisfied with the shorthand already accomplished, we carried the process a step further. Now we start from separately grouped dots in the white end of the scale, and come up to the densely concentrated dots as before. But this time the receiver drum is given twice the speed of the movement, so that the spacing which formerly gave almost a black, now gives a middle gray. Then to accomplish the further deepening to the black, we lengthen out each of the dots grouped closely together so that they become heavier and heavier, and finally for solid black we have the transmitter held constantly. Many adaptations of our first plan could be suggested, but after trying many we came to a few, one of which consists of a balanced arrangement such as many are familiar with in the usual push-pull type of amplifier. In Figure 10 one side of the outfit works in the progression from white to gray and the other side works in the light progression from gray to black, with a slight overlap at the center.

The reduction that this shorthand accomplishes over the previous method is 2 to 1, so that, over all, a 5 to 1 improvement has been made. This means that with a fixed available speed for the transmission of individual units, by this process five times the area can be covered in the same length of time. Furthermore, a wide range of tones is secured without abrupt changes from one tone to the next. The individuality of the alignment of the sharp edges can be made very precise providing the synchronizing of the motors is sufficiently accurate.

And what interested us more than anything else was that we seemed to be entering on a new form of art. No doubt many will look on this as rather a bold expression, but it is the very boldness of our pictures which carries them across. While it is true that they leave considerable to the imagination, this is inherently true of art, and it is an interesting thing that the more that one sees of this type of picture the more one sees in any given example. Naturally, when the pictures are reduced in size, the artistic effect is greatly enhanced.

PHOTOGRAPHY

In such a development it is natural that those who see only the general effects of the work may not appreciate the effort that must be expended on all the details involved. And if I may

be allowed to mention one briefly, it is the production of a good film at the transmitter. We have found in our work that a film that would be normally classed as thin, is the best for our purposes. In actual measurements we have found that a film which varies in its ability to transmit light from 25 per cent at the darkest portions, to 80 per cent at the lightest portions, gives us best results. Naturally, it would be by chance that a film produced in the usual manner would be of a value best suited for transmission.

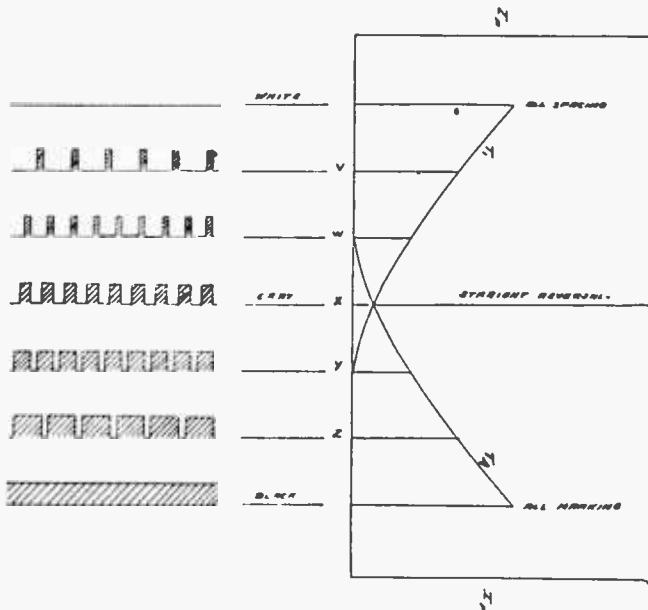

Fig. 10

To organize our operations on a practical basis we have therefore made a very extensive study of photographic copying. We have found, for example, that with a given fixed original, it is possible to get a wide variation in the transparency of the copy from this original by changing either the exposure time in our copying camera, or the development time. Also it is possible to get a still wider variation by using different types of films. These facts have, of course, been known, but mostly in a rule of thumb way. Curves have been developed which show the effect of changing the time of exposure in seconds, with a constant development; the effect of changing the time of development in minutes, with a given exposure; the effect of changing to a

different film giving a very flat contrast; also other curves, accentuating the contrast.

From these curves as a starting point it is possible to obtain a wide range of values by proper selection. These have all been classed in the five sets of curves about a particular point to show just how the variations can be obtained, (Figure 11). For example, we will suppose that the original from which we are to make a copy centers about a value of nine-tenths in density. It is then seen that if it already covers a wide range of values from this as a center, we can use a flat curve with a two-second exposure and $2\frac{3}{4}$ -minute development. If it covers a less range, we can use a different type of film with eight seconds of exposure and $1\frac{1}{2}$ -minute development. The same type of film can be modified by giving it a shorter exposure and in turn, a longer

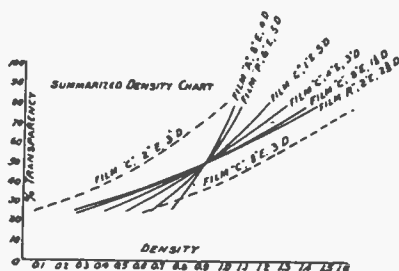

Fig. 11—Summarized density chart.

development, to make the curve take up different positions, and finally, by using a special slow-process film, we can obtain the required transparency with only a very slight density change available in the original. Naturally, it would not always be possible for the original film to center about a point such as nine-tenths, and we have therefore also shown on this curve how the whole process may be moved to the left or to the right by changing the exposure and using the same development. This information has been drawn up in a single table, so that the practical operator can obtain from any given original the copy which will have the exact range desired.

9. FIRST APPARATUS

We will now come to the concentration of the apparatus we use. Basically, we must start with a photograph. This photograph is conveniently in the form of a film such that it may be placed around a glass cylinder, as shown on the picture of the

original transmitter, Figure 12. A powerful light is on the inside of this cylinder. To give an idea how powerful this light is, a few figures are cited:

The Incandescent Gas Mantel has	85 c.p. per square inch of surface.
The Carbon Filament Lamp has	400 c.p. per square inch of surface.
The Metallic Filament Lamp has	1200 c.p. per square inch of surface.
The Nernst Lamp has	2500 c.p. per square inch of surface.
The Gas Filled Lamp has	12000 c.p. per square inch of surface.
The Gas Arc has	15000 c.p. per square inch of surface.
The Sun	900000 c.p. per square inch of surface.

Naturally it has been one of our main problems to find the very best materials available for each and every part of the system.

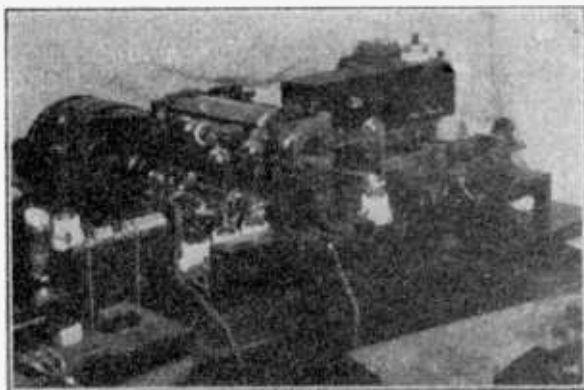

Fig. 12—The first photoradiogram transmitter, 1924. This unit is now in London.

This has been made easy by the ready reception we have received from everyone, such as lamp manufacturers, ink manufacturers, fountain pen, paper, camera suppliers, etc., and others affiliated in this work. May I state what a pleasure it has been to have had such a wealth of material offered us in this work.

10. REVOLVING CYLINDER

This strong gas arc-light is in the inside of the glass cylinder and sends its ray by lenses through the film placed on the cylinder to a motion picture lens focused on the film which throws an image of the film onto the photo-cell, point by point. As the cylinder revolves, each portion of the picture is shown progressively to the photo-cell. The photo-cell is then moved bodily down the cylinder length so that the whole picture is gradually built up line upon line.

Figure 13 is a view of the commercial type of transmitter of the present time.

11. PHOTO CELL

In the camera box (Figure 14) is the electric eye, the photo-cell, which is a device for interpreting light values in terms of electric current. I believe it was Shelford Bidwell who first suggested the use of light sensitive electric valves for photo transmission work. Many others since then have contributed to this plan, notably, Elster and Geiter in Europe. We are indebted to the General Electric Company and to the Westinghouse Company

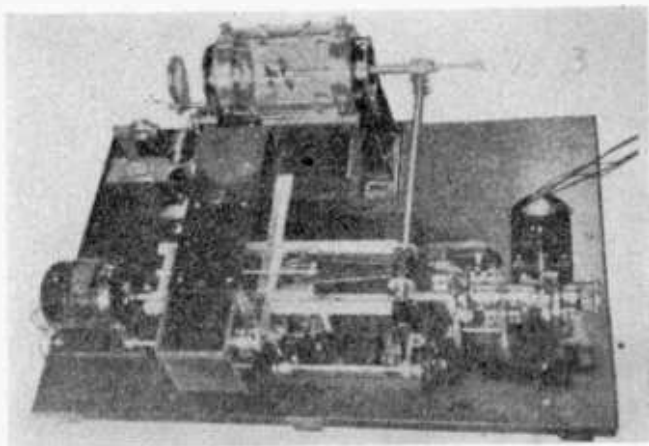

Fig. 13—The first commercial type of photoradiogram transmitter, 1925.

for the excellent photo-cells they have developed for us in this work. Basically, the idea of the photo-cell is that a high voltage is applied to the cell, almost sufficient to ionize it. Photo-electric action is realized when light strikes a photo-cell such that the potassium hydride which lines the inside surface of the cell is ionized and electrons pass from the potassium hydride to the cathode in the center of the cell. Highly attenuated argon gas fills the inside of the cell which increased the ionizing effect materially, so that an appreciable current flows through the cell with the action of the light to the extent of some two micro-amperes. This current, of course, must be greatly amplified, which is done by the use of the three-electrode vacuum tube. This is shown on the attached circuit, Figure 15, where the cur-

rent is caused to pass through a high resistance, R , which causes voltage variations to be applied to the grid of the vacuum tube. This amplification might be carried on in further steps in the usual manner. However, for our first dot concentration plan this was quite sufficient in itself to give effective results. This is arranged by having a vacuum tube with its grid thus controlled by the photo-cell, with its plate current supplied through a condenser charged at intervals. These intervals are determined by the rate at which the condenser discharges. In other words, a

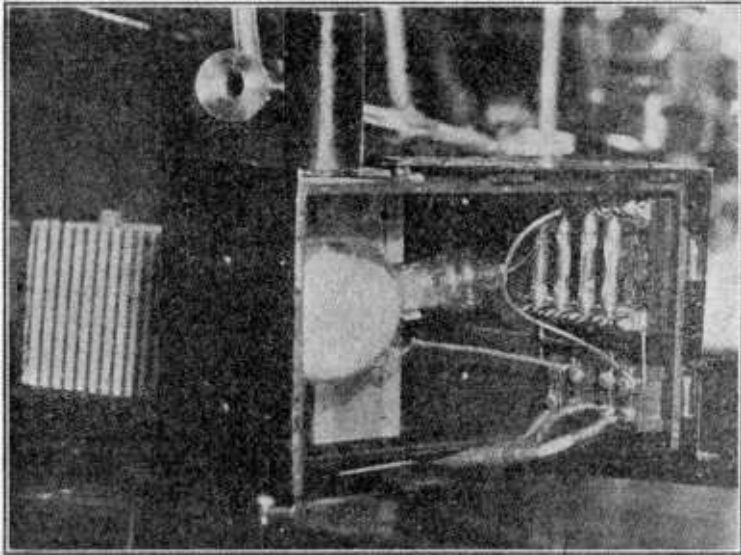

Fig. 14—This view shows the photo-cell in the photo-cell box

sort of low-pressure valve is arranged such that when the condenser discharges to a certain extent, the plate battery is again connected to the condenser to charge it up to the maximum value. This is accomplished by having a large C battery connected to the high side of the condenser so biased that the plate voltage must fall below a given value before a second three-electrode tube stops drawing plate current through its plate. This second plate current is carried through a relay; while the relay coil is energized the contacts are open, but when the relay falls back against the contacts the charging B battery pulse is sent on to the condenser.

It is thus seen that the time interval between the successive charges of the condenser is determined by the rate of the plate-current flow in the first vacuum tube, and as this is in turn determined by the photo-cell current, we have a direct interpretation of the light action in terms of the relay closing. This relay closing can be used to activate telegraph lines or a telegraph radio circuit.

12. C LIGHT

As an interesting adjunct to our photo-cell operation we may mention the use of an additional light beyond the normal illumination obtained through the film to be transmitted; this we have termed the *C* light, Figure 16, corresponding in its action very much to the *C* battery used in grid amplification. The use of

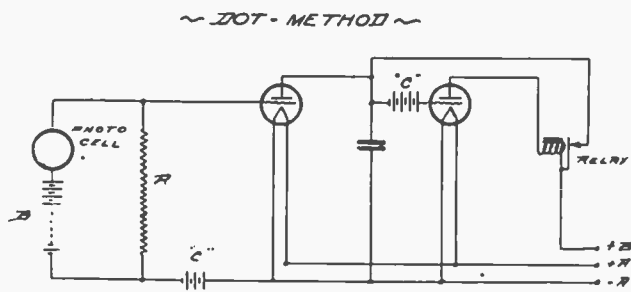

Fig. 15

the *C* light makes it possible to operate the photo-cell itself more effectively, where it, in conjunction with the amplifiers, gives a more perfect straight line characteristic to the reproduction current values.

13. SYNCHRONISM

For synchronizing, we have adopted the tuning fork as giving us the appropriate constant rate of rotation to actuate our devices both at transmitter and receiver. By the addition of clock check control we have found it possible to obtain uniform speeds at each end, where the clock controls act as a check on the tuning fork. Aside from using clock control we have also used dashes at the end of each stroke, which work very well to keep

the receiving cylinder moving correctly with respect to the transmitting cylinder.

14. THE RECEIVER

For the receiver there are many available plans, but we have concentrated on the production of a daylight operation program which involves the use of something in the order of an ink record on paper. It is seen that this dot plan fits in very readily with an ink record. It is only necessary to have the recording pen mark on the paper whenever a charging pulse starts at the transmitter. The connection between the transmitter and receiver may be either by telegraph or by the regular radio telegraph.

Figure 17 is a close-up of the original receiver with most of the auxiliary apparatus excluded. *A* is the motor which is main-

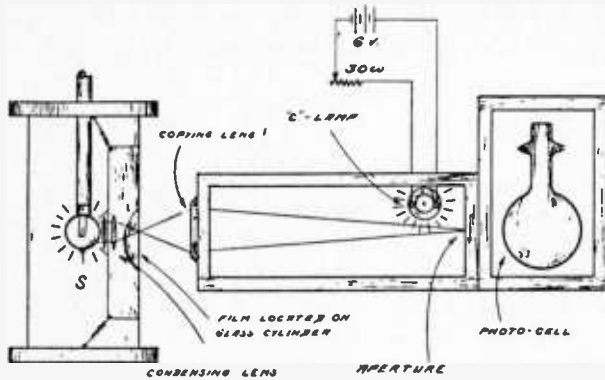

Fig. 16

tained at constant speed through the medium of the tuning fork *G* and associated apparatus. *B* is the reversing cam for changing the direction of rotation of the drum *C* upon which the recording paper is placed. *D* is the pen which is supplied with ink from the well, *E* for reproducing the picture as it is received, in the form of dots and dashes. *F* is the box for the film by means of which it is possible to obtain a photographic record at the same time the visible record is being made.

Figure 18 shows the modern type of photoradiogram receiver which is capable of making two pictures at the same time.

15. STATIC

The question of transmission to a distance is always one of obtaining sufficient desired signal strength to override the effects of disturbances. This is true of all wire lines and cables, as well

as radio. It is in this element that the telegraph wins, due to the fact that it is in a sense a trigger device, where the current is either on completely or off completely. Under these conditions

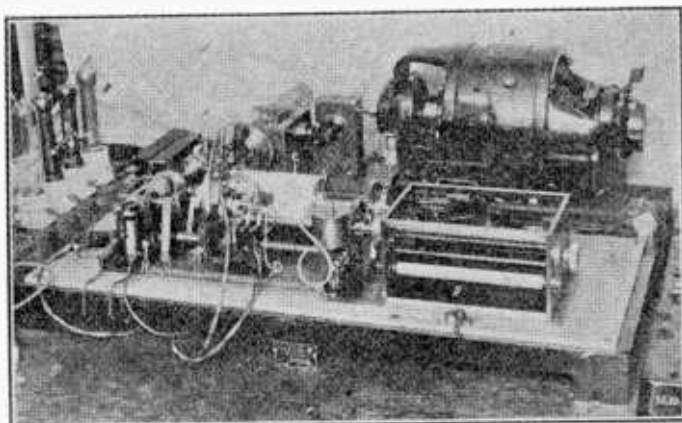

Fig. 17—The first photoradiogram receiver which is still in the design laboratory of the Radio Corporation of America in New York, 1924.

it becomes easier to identify electro-mechanically the times when the current is on and when it is off, than to attempt to

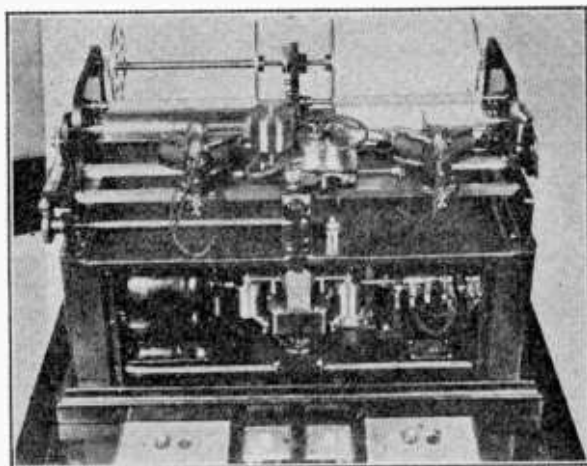

Fig. 18—First commercial type of photoradiogram receiver, 1925.

analyze the variations in current strength. That is why it is possible to get radio telegraph signals across the ocean at practically all times whereas even considering the smaller amount

of power used, I am sure it is appreciated that broadcast telephony, for example, is badly interrupted by static and fading over much shorter distances. By interpreting picture values in dots and dashes, where the full current of the radio transmitter is on even for the shortest dot, we have taken full advantage of this telegraphic supremacy to carry a picture to the greatest distance. Furthermore, it fits in most readily with the relaying operation. This we first made use of on July 6th of last year when the following picture of Secretary Hughes, Figure 19, was sent from New York by wire line to New Brunswick, N. J.,



Fig. 19—First photoradiogram, New York to London, back to New York, July 6, 1924.

thence by radio to Brentwood, England, then into London and from there by wire line back to Carnarvon, Wales, thence back by radio to Riverhead, L. I., and back into New York City. This picture is the result of this very involved journey. No picture was recorded in England, but it showed the effectiveness of our system at that time, so that when the apparatus for transmitting was sent to London the very first pictures came through successfully.

16. SOME EARLY PHOTORADIOGRAMS

The first public transatlantic demonstration of the transmission and reception of pictures by radio took place in November, 1924. The photoradiogram transmitter was located in

London. The signals from this apparatus were put on the 220-mile land line to Carnarvon, Wales, at which point they actuated the control relays of the high power radio transmitter there. These radio signals from Carnarvon were picked up at Riverhead, Long Island, amplifier, heterodyned, detected and sent in to the New York office of the Radio Corporation of America as audio frequency dots and dashes. These tone signals were again amplified at the New York office, then rectified and applied to the photoradiogram receiving equipment.

In the spring of the following year (1925) a photoradiogram transmitter was installed in the offices of the Radio Corporation of America at Honolulu. On April 29th, 1925, pictures were successfully transmitted from Honolulu and reproduced in the New York office of the Radio Corporation of America.

17. COMMERCIAL USES

Naturally, all this work has a purpose in view, and, of course the news field is the most immediate. There are two angles, however, to the newspaper situation: first, is the unusual picture, and the other is the general news picture. Naturally, a business can not be built up around earthquakes. Therefore, it must be a case of supplying regular service to groups of papers that this service will become worthwhile. However, it is interesting to see to what extent the unusual picture will force news activities. I have received the following advice as to two particular instances of the unusual picture situation:

Some examples of the need for radio pictures are to be derived from news events of the past year. The earthquake in Japan was the cause of one of the greatest races between news-gathering agencies in modern times. The representative of one agency had flown from a Chinese port over the stricken area, taken several desirable photographs, and then returned in time to mail his results on a Pacific Mail steamer sailing from Shanghai. His competitor had been forced to make the trip to Japan by both air and water and arrived some twenty-four hours after the steamer had sailed. Chartering a seaplane he made a dangerous four-hundred-mile trip to sea in order to drop his package of film on the ship. Successful in this, the race was tied until Vancouver was reached, where two speedy planes awaited the ship's arrival. From there, across the continent it was a free-for-all race, one leading and now the other. Eventually, the pictures were

delivered in New York with but a few hours' difference in time. Had a radio picture service been available, but a few hours would have transpired instead of the many days to transport the scenes of this disaster. The cost ran up into thousands of dollars and many New York papers paid as high as five hundred dollars for pictures weeks old.

One picture-gathering agency sent a representative around the world with the Army fliers. Traveling in many different ways and even stowing himself away on one of the planes, he was handicapped in keeping his service supplied with pictures from three to six weeks old. With a world-wide radio picture service it would have been but a matter of hours. With the public desire for pictorial news becoming more pronounced yearly, it is only natural that a demand for foreign pictures with foreign news items be met through radio pictures.

A very effective use to which photoradiograms will be put is distinctly in line with the original work of Alexander Bain, as emphasized in our particular development by Mr. Young, and that is, transmission of words—printed, typewritten or hand written. As an example of printed material may be mentioned a clipping taken from a Honolulu newspaper and transmitted all the way to New York by relay through California, in May, 1925. Tabulated material is particularly suited to such transmission and most difficult to accomplish by normal telegraphy. Drawings, signatures, fingerprints, and all such are a fruitful field for radio pictures.

Naturally, there remain many refinements necessary in this work, but it is largely a question of making the equipment continuously serviceable. To this end we have made both transmitter and receiver such that the operations may be continued without interruption between pictures, and with the equipment now set up and working both eastward across the Atlantic and westward to California and Honolulu, it is only a question of time when the mechanics of the operations will have been sufficiently worked out by the operators, who have to combine all that went before, in a way of radio technique with mechanical and artistic appreciation as well, to make photoradiograms of the highest service to everyone.

PHOTORADIO DEVELOPMENTS*

BY

R. H. RANGER

GENERAL PICTURE DEVELOPMENTS, 1926-1928

OUTSTANDING in this period has been the work of the American Telephone and Telegraph Company in the extension of their commercial picture network throughout the United States. A fine example of the work they are able to perform is given herewith. (Fig. 1) It is interesting to note that the telephone service has been used extensively for the transmission of printed matter—bond circulars in particular.

The other wire line method that continues to be used commercially is the Bartlane System handled between the *Daily Mirror* in London, and the Pacific and Atlantic Photo Service in this country. The method consists in reducing a picture to a perforated tape of the same sort as is used for cable messages, and then this tape is transmitted over the Western Union System across the water. The picture is then reformed from the holes punched in a duplicate tape on the other side of the Atlantic.

On December 1st, 1927, wire picture service was inaugurated between Berlin and Vienna by the Karolus-Telefunken System. Two novel features of this system must be mentioned. The first is the use of the Kerr cell. The Kerr effect has been hidden in the archives of science for forty years, and it remained for Dr. Karolus to bring it to practical use in the transmission of pictures. The Kerr cell consists of a gap between two oppositely charged electrodes with a solution of nitrobenzol covering them. Such a combination has the ability to change the speed of light passing through the cell depending upon the plane of polarization of that light. Specifically, if the light is vertically polarized with respect to the surface of the electrodes, the light train will pass through more quickly when potential is applied between the electrodes; if the light is in the same plane as the electrodes it will be retarded.

To make use of this phenomenon, a nicol prism is turned to give a beam of light at 45 deg. with the electrode surfaces on

* Dewey decimal classification: R582. Original manuscript received by the Institute of Radio Engineers, March 6, 1929. Presented before New York section of the Institute, January 10, 1928; before Los Angeles section, August 27, 1928; before San Francisco section, September 4, 1928.

Reprinted from *Proc. I.R.E.*, June, 1929. This paper was a report from the engineering laboratories of R.C.A. Communications, Inc.

entering the cell. A second nicol prism is then used on the side from which the light leaves the cell, but it is turned to allow only light at 90 deg. with respect to the first prism to pass. The effect of this optical system is to allow no light to pass when there is no electrostatic distortion produced in the cell. Now, however, when voltage is applied to the electrodes, the distortion will take place. A vector diagram shows that if the horizontal component is slowed down half a wavelength with respect to the vertical in passing through the cell, the emerging light will be plane polarized at 90 deg. from the direction in which it entered, and will therefore then be able to pass through the second or analyzing nicol prism per-



(Original)



(Received)

Fig. 1

fectly. This means that with the right amount of voltage applied to the electrodes, we will get a change from no light to full light, and the outfit therefore works as a simple light valve. It has the great advantage of being practically inertialess. The practical voltage range for operation is of the order of 500 to 1000 v. The slight disadvantages of the method are due to the fact that nitrobenzol is not a perfect dielectric and allows some current to flow, which causes some deterioration, and secondly the response is linear only over a restricted part of the curve, but its speed action is a tremendous asset.

The other outstanding development of this system is the photo-cell construction for which Dr. Schriever of the Telefunken Com-

pany is responsible. Instead of being in the more usual Christmas-tree ball form, this photocell is much like a very flat doughnut. (Fig. 2) The purpose is two-fold; first to simplify the light system, and second and most important, to increase the available light change in the pick-up at the transmitter some fifty-fold.

To accomplish this, at the picture transmitter, this doughnut cell is placed directly in front of the picture-transmitting cylinder. A very intense beam of light is then focused down to a very fine point through the hole of the doughnut at the picture. This fine little spot of light which seems to be a little glowing fire then reflects back on to the solid part of the glass photocell, and acts

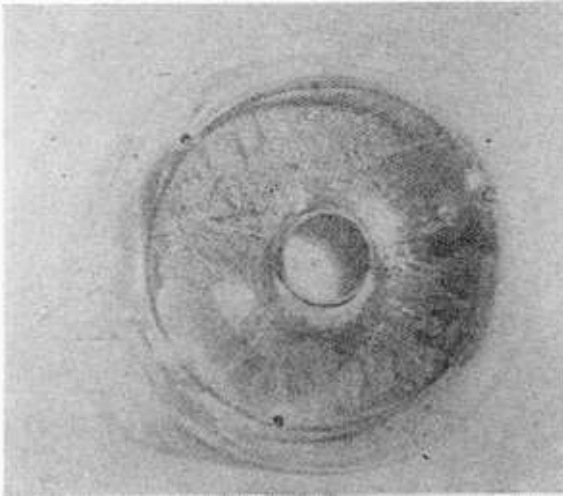

Fig. 2

on the light-sensitive chemicals placed there. Due to the fact that the active part includes such a large angle from the little spot of light, practically all the available light is used. In this sense it corresponds to having a lense aperture of $f:0.5$, and all camera enthusiasts know what that would do in the way of speed and intensity of action.

Another entrant into the picture transmission work is the Marconi Company, with Mr. Wright heading their activities in this direction. He is working on the principle of reversing the usual method of analysis at the transmitter and receiver—he uses a stationary cylinder at each end. The picture is slid forward in a curved form along the length of the cylinder. Half way around the cylinder there is a fine slit corresponding to a line of the picture, and as the picture is moved forward, a fine light spot

is rapidly revolved inside the cylinder to cross the picture from one side to the other, one line at a time through this slit, as the picture advances. He is working at quite high speeds, planning to take full advantage of the higher speed capabilities of the Marconi radio beam.

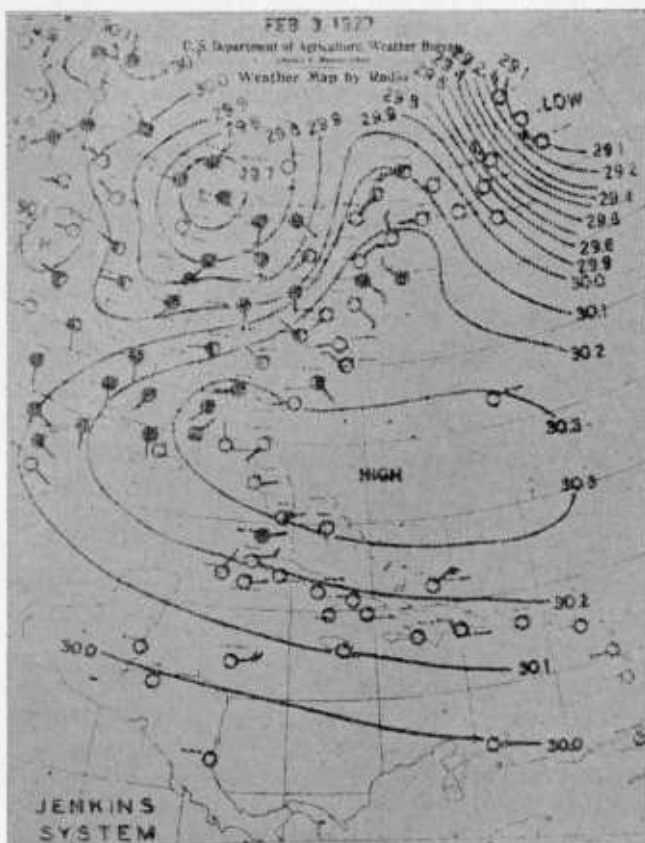

Fig. 3

MAP WORK

Two of the regular workers in picture radio, C. Francis Jenkins of Washington, and Dr. Max Dieckmann of Munich, Germany, have modified their equipment to simplify the recording of weather maps at sea. (See Figs. 3 and 4, respectively.)

AMATEUR RECEPTION

Several workers have tried to interest the amateur in picture reception. They are—T. Thorne-Baker of London, one of the

long standing workers in the field, Mr. Jenkins, and, more recently, Austin G. Cooley, in connection with *Radio Broadcast* of Garden City, Long Island. Mr. Cooley makes use of the old phonograph that may have been otherwise discarded in the amateur's home, and specializes in a "corona" discharge at the end of a fine needle point resting on photographic paper. The variations in the intensity of the incoming radio signal vary the amount of the corona, thus giving the necessary modulations for the picture.

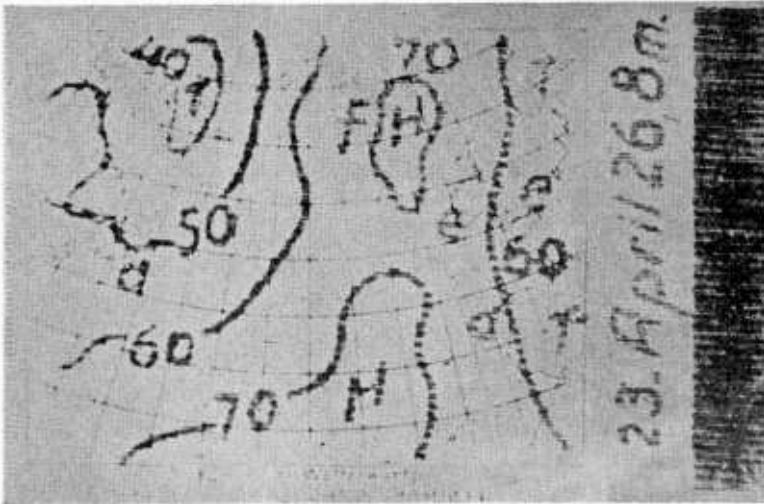

Fig. 4

Such developments are very much to the point, as surely many contributions to radio pictures will come from this stimulation; but the ease with which results will come will be with nothing like the simplicity of the broadcast reception as we know it today, where a crystal and a telephone receiver start a novice on the road to nine tube sets—later reduced to four.

TELEVISION

Great strides have been made in the even more complicated art of television—complicated by the element of vastly greater speed. In closing this all too brief summary of the outstanding workers in these fields during the past two years, acknowledgment must again be given, as was done two years ago,¹ to the continued painstaking work of Professor A. Korn of Germany. It was he who first began to get real pictures over wire lines twenty years ago.

¹ R. H. Ranger, *Proc. I. R. E.*, 14, 161; April, 1926.

PHOTORADIO AIMS

As all engineers know, no particular features of their work may ever be considered as ideal solutions—as in practical politics, it is necessary to be satisfied with compromises which conform to the general advance of the art. However, it is well to have stars on which we attempt to hang our pictures. In photoradio they have been the following:—

1. Economical operation
2. Continuous operation
3. Daylight operation
4. Visible operation
5. Finished operation

Economical operation is of course the foundation of everything worth while in the design. Naturally this economy must be in accordance with the use to which the equipment is to be put. If a larger number of sets were required, the cost of the sets themselves becomes the controlling factor as in equipment for amateurs; in photoradio to date, the prime consideration has been economy of operation—the best possible results with the least effort. Simplicity of operation is a great contributor to economy, of course, and that is where the other factors enumerated above become important. Nothing is so disastrous to production as discontinuous operation. That explains why the rotating cylinder type of equipment has been shunned in photoradio.

Daylight operation is far more satisfactory from the operator's point of view. Photography is a wonderful aid in many operations, and in much picture transmission is the obvious answer. It is certainly one of the places where compromise must be considered most carefully. The finesse of photographic recording cannot be rivalled. However, it may be said in no uncertain terms that there are many variable factors in the chemistry and physics of ordinary photography, such that its operation has become an empiric art rather than a fixed operation where definite rules will ensure a good picture in the hands of the average operator. For this reason, to add to it the further variables of a communication system increases the chances of failure tremendously. Therefore, certainly in all the original work over great radio distances, the greater certainty of visible and daylight operation has been depended upon. When the complete system so constituted has been operated sufficiently to reduce the uncertainties of the newer elements in the picture, it may well

be that it will be advantageous to return to the use of photography with greater assurance. The entire matter is of course still in a state of fluctuation, working towards the best commercial method.

Furthermore, the exact requirements of photoradio on a radio circuit have brought about a tightening of the performance of that radio circuit. The ability to key a transmitter speedily and accurately is a striking example.

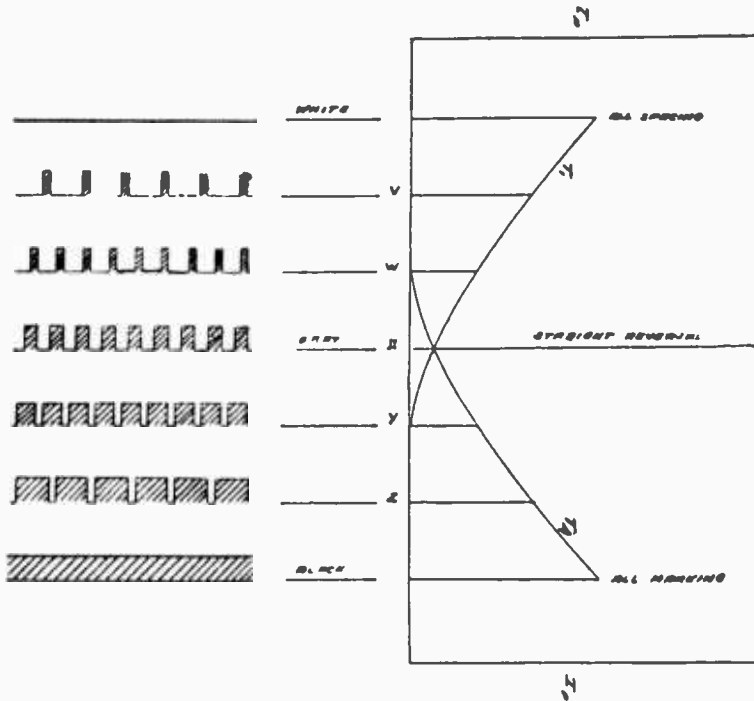

Fig. 5

It is of course advantageous that the operation be complete when the transmission has stopped. This promotes speed of delivery, which is one of the battle cries of a communications system.

DESIGN TECHNIQUE

If there is one rallying point for all of the photoradio technique, it is the use of the dot-dash method of representing picture values. This becomes at once the central feature around which all the simplification of equipment and operation is based. Variation in radio signal intensity is all too well known to require

mention here. A system which is based on signal intensity to represent the picture values is placing itself under a severe handicap at the start. The dot-dash method changes light intensity variations into time variations. An isolated dot represents a light part of the picture, close dots represent gray, and heavy dots becoming solid dashes represent black. A scale showing this relationship is given. (Fig. 5) Such solid characters may be handled over involved links of wire lines to radio without material difficulty. It is only necessary that the radio transmitter trigger-on when a character is starting and trigger-off neatly at its termination. This simplification of operation has led to our realization of another important principle of design which we have called "inherent accuracy." It means the elimination of troublesome adjustment and compensating for large variables by making their effect nil on the result.

Another example of inherent accuracy came to light in the choice of gears in the driving mechanism. In some of the early apparatus, it was found that there was an occasional tendency to have errors in sequence in synchronizing—keeping the machines in step. The trouble was found to be in the fact that the gear ratios were such that they came out unevenly, such that the teeth would mesh in a given sequence for one line, and in an entirely different sequence for the next; and would then go back to the first sequence for the third line, and so on. In consequence, if the shaft carrying one of the gears was out slightly, the regular error would show up. The answer has proved to be to make the gear ratios even.

PUSH-PULL RELAY

Everyone is familiar with the famous combination of "push-pull," but we have made use of the general principle in a unique way. Inertia is present in both mechanical and electrical devices. If the impulse to be conveyed is constant in frequency, such as a 60-cycle wave, the inertia factor is constant and therefore may be disregarded as far as obtaining correctly spaced impulses at the receiving end, but the whole idea of picture transmission is that there shall be change—change conveying thought in one form or another from the sender to the receiver.

The "reading condenser" has been a well known means for reducing the effect of electric inertia in d-c telegraphy. The time involved in producing a desired effect at a distance is determined by the time it takes to build up the current to a sufficient

intensity. Very often, however, it is possible that the final current value may be much greater than that required to produce the start of the signaling effect. Under these conditions it is possible to dispense with some of this final current strength and use it to speed up the start and finish of the signal. A simple plan for this purpose is to include a condenser with a shunting resistance in series with the main signaling circuit. This will give a large current impulse on the start and finish of the signals, and only a moderate value for the steady state.

The vacuum tube gives another simple way to reduce the inertia of inductance. By tripling the voltage on the magnetic amplifiers in connection with the long-wave stations of the RCA, and introducing twice the straight resistance of the coils, practically three times the speed of keying was obtained, with consequent improvement in the picture reproduction.

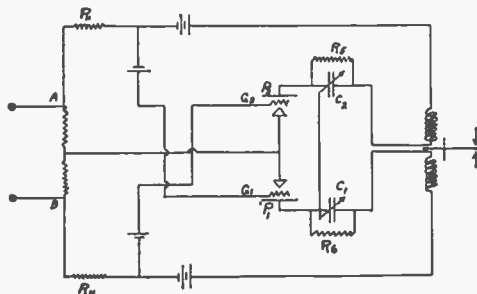

DC. PUSH-PULL RELAY
Fig. 6

As a means of improving the quality of the impulses a broad resonance has been introduced into these inertia reducers. The particular set-up is shown in Fig. 6. Double current is used in practically all of our d-c signaling work. Let it be assumed for the moment that a spacing current from the distant point is flowing in such a direction as to make point A positive with respect to point B. Under these conditions, grid G_1 will be positive and grid G_2 negative. Under these conditions, plate P_1 will be passing current in a direction through the relay to hold it to spacing. The plate current will carry through resistance R_6 and R_4 . The current through R_4 will act to make the grid G_2 even more negative. Likewise the reduction in the plate current of P_2 due to the negative value of its grid G_2 will reduce the current through R_5 and R_1 so that the grid G_1 will be even more positive. The effect of such a hook-up is that now when the current through A-B is reduced to zero, the charge on the condensers

C_1 and C_2 will be such as to cause current to flow through R_1 , R_2 , R_3 , and R_4 , which will swing the grids oppositely to their previous condition and give a marking impulse. If the current from the line should still remain at zero, the charge on the condensers would quickly dissipate itself through the resistances and the inductance of the relay coils included in the plate circuits. As soon as it did, it would swing back to the original condition, and as a result a series of dots would be produced. The frequency of these dots may be set at will by proper choice of the value of the capacities C_1 and C_2 with respect to the resistances and the inductances of the relay coils.

The net effect of the action is to be ready for any change, and immediately work with it to a maximum. It accomplishes much the same effect as the famous Gulstadt relay of cable technique, but does not depend on the less reliable contacts of mechanical relays for its reversing action. The speed of the reversals of the push-pull relay is set to correspond to the fastest dots that the complete communication setup will allow. Such a push-pull relay is included both at the transmitting station and at the receiving station where the signals are finally delivered to the recording equipment.

It is hard to estimate accurately the improvement such equipment gives, due to the fact that every improvement brings out the fact that there are weaknesses elsewhere, so that it may be better said that photoradio operation throughout the past three years has been a case of gradual improvement of all the contributing factors, always hitting the weakest spots as they develop when the other factors pass them by. D. G. Ward and J. L. Finch are particularly responsible for the increased speeds that have been accomplished at the transmitting stations during this period.

REVERSE LEAD SCREW

In order to meet the requirements of continuous operation, many plans have been proposed. Naturally the one that is most desirable is one that is continuously acting with no reversing clutches or connecting parts. On the early photoradio equipment, this was accomplished by means of a mangle rack with gear—a small ordinary gear engaging with a gear in the form of a race track. While this device has operated satisfactorily, it is not rugged and is far from inherently accurate.

In its place a reverse lead screw has been laid out. (Fig. 7) While the making of the first one was a very involved proposi-

tion, it has proved a fairly simple matter to duplicate them, as is now being regularly done in the excellent machine shop of H. O. Boehme, of New York, under the direction of Frank Kunc of our staff.

This reverse screw is cut in a solid shaft which is placed lengthwise at the base of the photoradio transmitter or receiver. A follower engages with this thread and conveys moving force to the analyzing head of the machine. The movement is uniform through 95 per cent of the travel—the remaining 5 per cent of the stroke is occupied in reversing the act. This does not mean that this entire 5 per cent is unserviceable for picture work, however; in fact the analyzing and recording is continuous up to the immediate end of the stroke when the overlapping interferes.

The curve for the reversing cut was first made in a very much enlarged form in steel as a master, and then by a panto-

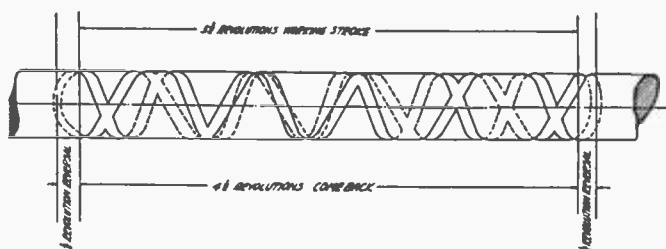

Fig. 7

graph arrangement this master was used to get the smaller cutting of the reversing section of the screw.

Very satisfactory results from the point of service and constancy have been obtained with this screw. It is to be noted that we are still using the action of making the analyzing head work in both directions. At both transmitter and receiver, the picture making goes on while the analyzing is proceeding either from left to right or from right to left. This is inherently more difficult to do from the point of view of synchronizing, but the fact that we have done it means that we have found means of synchronizing of a fairly simple sort. If it were not for the fact that the recording is visible, however, it is certain that we would never have dared to use this back-and-forth method. As it is, we are able to correct the synchronizing very easily during the actual reception of a picture. The fact that this to-and-fro analyzing requires such rigorous synchronizing and "framing" has of course strengthened our will power in the development of

synchronizing generally. Another form of speed control, which is of course the basis for synchronizing, has been developed.

AIR SPEED CONTROL

Wherever radio engineers engage with problems their first solution is naturally by the use of electricity. And there is no question but that electricity is a mighty useful agent, particularly as we gain familiarity with its uses. However, with the excessive amplifications that we indulge in, we have to be very careful not to have other electric forces present which may give interference in such amplification. Speed control is a very good instance. In central office installation, there is not much difficulty in obtaining the necessary shielding from ordinary audio amplifications, but if it is desired to place a photoradio receiver directly next to a short-wave radio receiver for example,

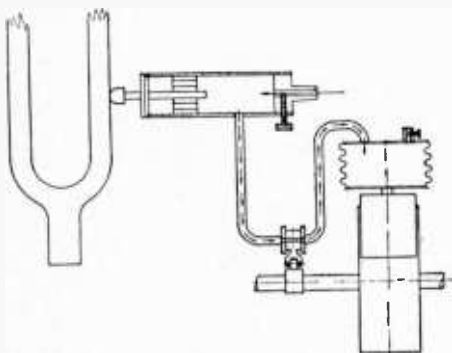

Fig. 8

the problem becomes a little more involved. Of course one answer is to take the bull by the horns and provide the proper shielding and reduce the interference as much as possible. But it is well to inquire sometimes into other possibilities which inherently eliminate such interference.

As this section and the next will show, we have recently undertaken an extensive study of the uses of air. In line with this we have developed an air speed control. One form makes use of an air driven tuning fork. (Fig. 8) It is very easy to drive an air fork; all that it is necessary to do is to have an air chamber with a slightly constrained intake. This air chamber is broadly resonant to the frequency of the fork. The fork tines then have plungers on their ends which work in and out of openings in the air chamber. The action involves the filling up of the air chamber and then giving pressure to the two plungers

which drive out the fork tines. In so doing they release the air pressure in the chamber quickly; the fork tines then return into the chamber, and this allows an even higher pressure to be built up in the chamber before the fork tines are again driven out to release the constrained pressure. The fork is self-starting. The frequency is modified by pressure, but it is not difficult to get quite constant air pressure by the use of reduction valves, and the very fact that the frequency may be varied within narrow limits provides a means of fine adjustment. Now that we have the fork vibrating, the next question is to apply this vibration to motor speed control.

To control the motor speed, the air chamber has a small valve in it which communicates to an air brake on the motor, but the valve is opened by the motor once each revolution of the motor. If the valve is opened by the motor at a time when the pressure

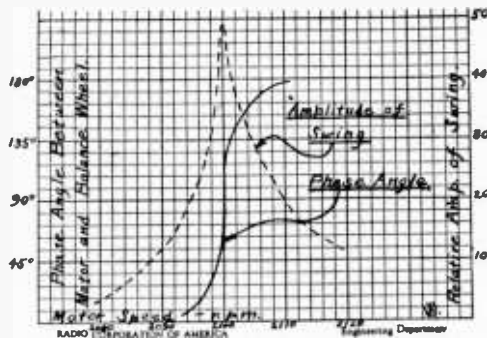

Fig. 9

is at a maximum, a good bit of air will push through the valve to enter the brake. This will of course tend to reduce the motor speed below the point where the valve will open at a high pressure time. When it does so, the motor will again speed up and will find a position between the maximum and minimum air pressure periods where its speed will hold quite truly to the fork speed. Obviously there is nothing very electric about this to cause interference, and in fact an air motor could be used if necessary, but it seems to be very easy to overcome brush trouble from motors of small size so that this has not proved necessary.

Another air drive has been worked up from this by Mr. Braman and Mr. Nelson. We are all quite familiar with the use of resonance in mechanical as well as electric arrangements to effect control of one type or another. We are also quite well aware of the fact that phase differences exist, but there are not

many instances where both phase and amplitude of resonance are used to effect the control. This is here accomplished. The setup consists of a cam on the motor shaft which gives the slight impulse necessary to set a vibrating arm in motion. The fact that this cam is reduced by levers to give an impulse of the order of one thousandth of an inch shows what good resonance it is possible to have in the arm. Plotting the displacement of the arm from a given reference point in the position of the motor as it revolves, Mr. Braman has developed this most interesting

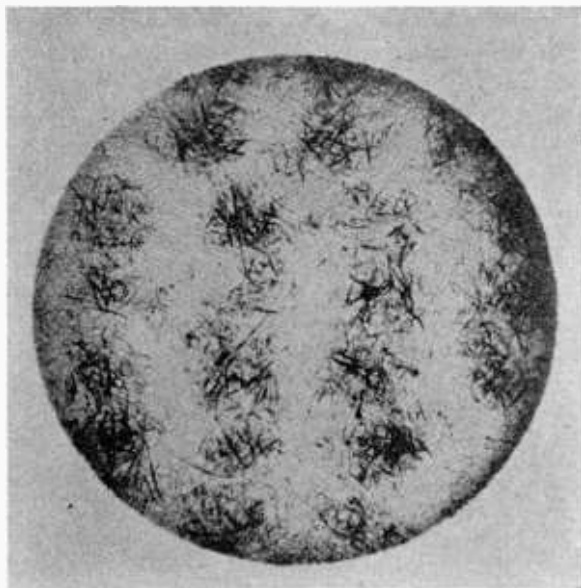

Fig. 10

curve of response of the vibrator with respect to the speed of rotation of the motor. (Fig. 9) It will be appreciated that it is a combination of phase displacement and amplitude of resonance of the vibrator. It will be noted that it has a very steep portion.

To make use of this curve, air was then driven from a nozzle through a sector carried by the vibrating arm. This air was then carried on to brake the motor. The result is a very fine setting of the speed on this frequency curve of the vibrator.

HOT-AIR RECORDING

In the search for visible, daylight, finished recording, it is believed a new departure has been realized.

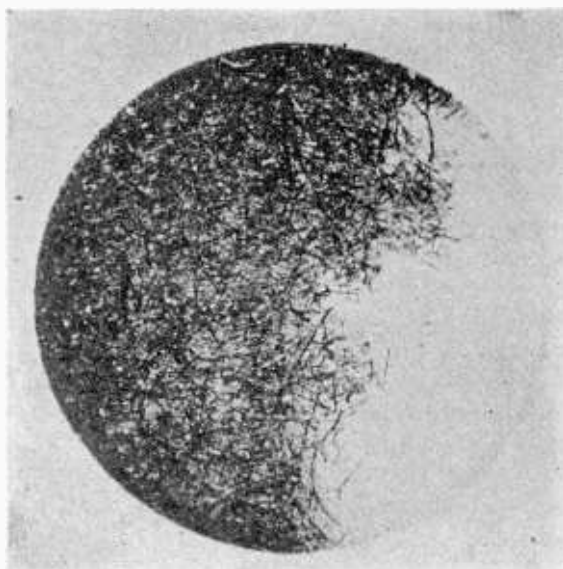

Fig. 11

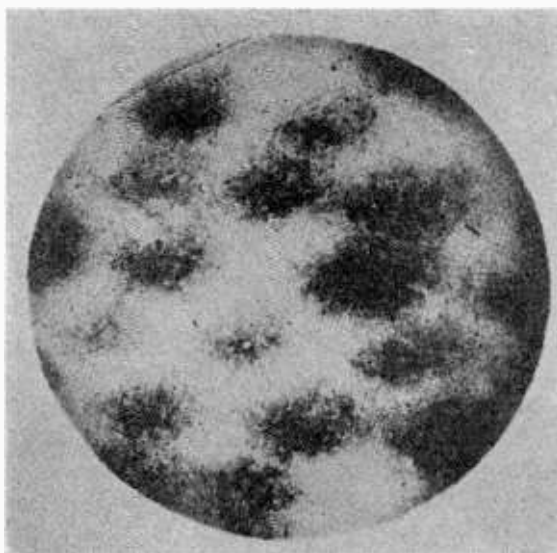

Fig. 12

We are all familiar with the sensitive gas flame of Dr. Koenig of Germany. It was this which started the development of the hot-air recording, but as a matter of fact when the obvious attempt was made to make incoming radio signals control the sensitive flame, it was found that a much too powerful agent was at hand; it was very difficult to keep the gas from eating up everything as well as the recording paper. Then it was that Mr. Hansen worked up the use of plain hot air to do the job. Likewise, an electric spark was used, but the wear and tear on the point did not prove feasible from the operating position.

By all odds the heavy part of this new development is in the sensitive paper. We are all so familiar with extreme sensitivity of photographic paper. We have tried to duplicate this where heat rather than light is the sensitizing agent. Likewise we have imposed the additional restriction that the product shall be finished without further treatment.

In beginning the chemical investigation of this we had the good fortune to be able to start with R. S. Bicknell as consulting chemist. He has been seconded by Mr. Morehouse who joined our staff for this specific investigation. Mr. Morehouse gives the following general outline of his problem.

HEAT-SENSITIVE PAPER

“Photoradiograms are recorded by means of a fine jet of heated air directed against heat-sensitive paper. When the incoming radio signal calls for a dot or a dash, the hot air stream is permitted to flow against the paper; when a space is required, the hot air stream is automatically prevented from striking the sensitized paper surface. This effect is accomplished by means of an electrically operated valve, the action of which is governed by the incoming radio signal.

“The character of the record left on the paper depends on the nature of the sensitizing agent, and also on the physical character of the paper base itself. The sensitizing agent in use at the present time consists of a practically colorless mixture of chemical salts, which are capable of undergoing what is known as an endothermic double decomposition reaction, with the formation of brownish black products. In other words, until heat is applied to these salts they remain in contact with each other on the surface of the paper in a comparatively inert condition, retaining their colorless appearance. But when heat is applied they absorb it rapidly, become mutually interactive, and

form the black products which we see as a dot or dash on the picture.

“The importance of the physical character of the paper stock is best brought out with the aid of photomicrographs. Fig. 10 shows a few dots made by the hot air stream on an ordinary uncoated book paper made sensitive to heat. It will be noticed that the dots have a very pronounced fibrous or stringy character. The same fibrous appearance is noticeable in Fig. 11

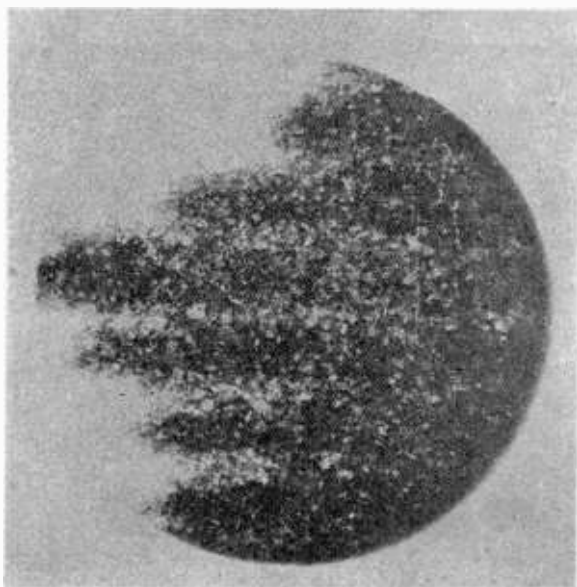

Fig. 13

which shows dashes made on this same type of paper. Fig. 12, on the other hand, shows the type of dot obtained with a clay-coated paper similarly sensitized. In this case the dots have a much softer and smoother appearance because of the fact that the paper fibres are completely covered by the thin layer of clay. Fig. 13 shows dashes made on the same clay-coated stock. In all four cases the chemical composition of the sensitizing agent is the same; the difference between the first two and the last two is entirely due to the difference in the physical character of the paper surface. In cases three and four the effect is very similar to that obtained by using photographic paper in the process of recording with the aid of light instead of heat.”

OPERATION

We now come to the question of operating the equipment. Commercial picture transmission was inaugurated on May 1st, 1926, between London and New York, and likewise it was established on the West Coast between San Francisco and Honolulu. There was considerable excitement incident to the inauguration of the service, especially from London to New York. It was finally determined that one picture only to each newspaper and commercial concern would be sent in the sequence that they were received for the inception of the service. After the novelty had worn off, the photoradio service came into extensive use on a business basis.

Besides the news service, however, there has been a gradual but general extension of the service first into the style and fashion field and then into banking and commercial operations.

A few months ago for example, a bank came to us with the request to transmit the three signatures necessary to authorize a certain commercial transaction involving one million dollars. They advised that there were but three days remaining to get these signatures into London, and as there was no Lindbergh expedition scheduled for that particular day, it would be impossible to get these signatures across by any other means. However, we were told to take our time in the three days, and get a good facsimile of the signatures across.

We advised London of the situation and asked them to work with us until a satisfactory facsimile had been transmitted. The equipment at each end was set in motion; in twenty-five minutes (it was a half-size picture) transmission was put through once. London was asked for a report on this first transmission with the idea that the reply would indicate that it should be made darker or lighter or something else on the second trial. Back came the laconic reply "O.K.," and that was all that was necessary of the three days' grace to complete the million-dollar transaction, as far as photoradio was concerned.

DEPARTMENT STORE DEMONSTRATIONS

At the request of Kauffman's of Pittsburgh we embarked on what might be termed barn-storming expeditions. It might seem at first that such excursions would be far afield from a technical development, but there is little question but that these demonstrations have speeded up the development of photoradio to commercial reality in great degree. The cost of these demon-

strations was met by the department stores. It therefore became imperative that a very worth-while and useful service be given which would be capitalized by the department store.

The basis of these demonstrations was to bring the latest styles from Paris and London directly into the department store. The transmission to New York from Europe was easy—the problem came in relaying this on to the stores. Short waves were used for the relaying. WIZ at New Brunswick and WAQ of the Westinghouse Company at Newark were used for this relaying service; they were connected with Broad Street, New York by land lines; the picture reception comes in over land lines from Riverhead, Long Island and Belfast, Maine, to Broad Street, which therefore may be termed photoradio central. The well known fading propensity of short waves became of less importance to the photoradio signals on the dot-dash plan. Added to this, limiting was used with great success. Further demonstrations were then held at Strawbridge and Clothiers in Philadelphia, Jordan Marsh in Boston, Marshall Field in Chicago, and lately at L. S. Ayres. Further barn-storming could have been developed, but it was felt that with successful termination of these demonstrations their purpose and usefulness as far as advancing the art is concerned was sufficient.

NAVY DEVELOPMENT

At the request of the Navy Department, successful transmissions were accomplished of Navy manoeuvres in Honolulu direct to New York. Subsequent to this, the Navy Department has installed photoradio equipment at the Bureau at Washington. Transmission and reception has been successfully accomplished between the photoradio station and the Radio Corporation stations. Likewise, condensed equipment has been installed on board the USS *Seattle*, later transferred to the *Texas*, when the latter became the flagship. Perhaps the most successful transmission with this equipment has been an entire page of printed matter from New York to the *Texas* when she was lying off San Diego something like three thousand miles from New York.

MECHANICAL DEVELOPMENTS OF FACSIMILE EQUIPMENT*

BY
R. H. RANGER

CONTINUED operation of the photoradio equipment has emphasized the value of certain modifications and developments for increasing efficiency and ease of operation. Where there are so many links in the complete chain from transmitter to receiver with all the necessary radio appurtenances to make the radio transmission of pictures and printed matter a success, the utmost simplicity of operation must be given the operator at both terminals to insure continued success of actual traffic handled.

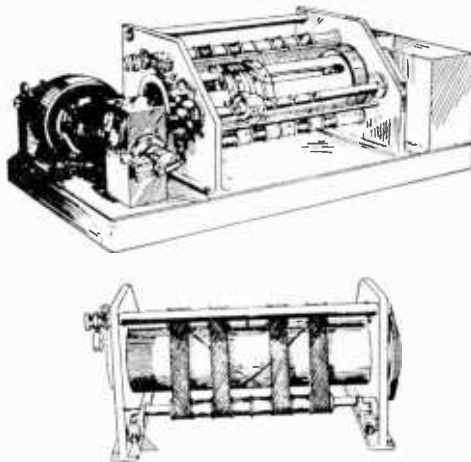

Fig. 1

In the April, 1926, issue of the *Proceedings of the Institute of Radio Engineers* is given a description of the first commercial equipment used for this purpose. This apparatus still continues to function well at the speeds for which it was designed. But its operation has shown where changes would be efficacious, and equipment has been evolved which not only does better what the

* Dewey decimal classification: R582. Original manuscript received by the Institute of Radio Engineers, April 19, 1929. Presented before Fourth Annual Convention of the Institute, Washington, D. C., May 14, 1929.

Reprinted from *Proc. I. R. E.*, September, 1929. This paper was a report from the engineering laboratories of R.C.A. Communications, Inc.

old did, but is also able to do the transmission by a new method of transmitting across the paper in diagonal directions corresponding somewhat to the halftone line pattern of engraving.

The first machine of this type is shown in Fig. 1. The paper is carried around a stationary half cylinder continuously from a roll. On the inside of this half cylinder is carried the head for the analyzing of the picture. At the transmitter it consists of a lens system. This head rotates and at the same time reciprocates from side to side of the sheet. The lens system is double ended with one lens 180 deg. opposite the other so that as the head rotates, one lens or the other is always actively analyzing inside the half cylinder. Around the lens is placed a doughnut

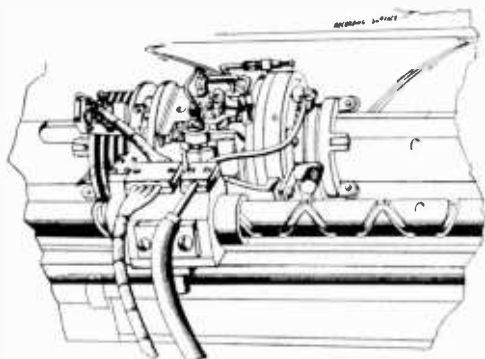

Fig. 2

light which illuminates the part of the picture being copied at each instant. Inside the head, the lens system carries back the light to the axis of the cylinder and thence axially to one end where the photocell is placed.

The transmitter may be used as a receiver merely by substituting a neon light or similar variable light source actuated by the incoming picture signals. The doughnut light would of course not be used for reception.

In place of light recording, the hot-air recording may be used by employing a double ended hot-air gun as shown in Fig. 2.

It is seen that both transmitter and receiver work down their respective sheets of paper with a series of crossing diagonal lines in the manner shown in Fig. 3.

The value of cross diagonal transmission lies chiefly in smoothing out half-tone transmission, where the crossing of the picture in two different directions at two different times gives a smoother result and likewise covers over any omissions made on

one transmission by those on the other. This is particularly useful in reducing the effect of fading when using short waves.

One of the limitations in facsimile picture transmission of printed matter is the rate at which fine lines are crossed. The speed of the entire system must be lowered to the point to which such crossing gives a definite marking where the picture

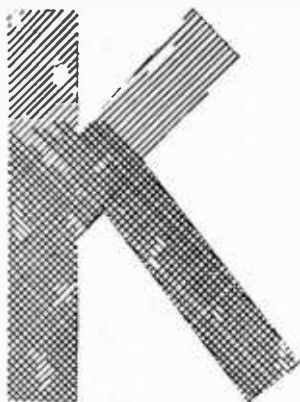

Fig. 3

is covered once only as by the usual method. But with the cross diagonal method, the speed may be measurably increased due to the fact that the chances are better that whereas on one crossing the parts of letters may present a very short cross-section, they may present a much broader stroke on the other diagonal stroke.

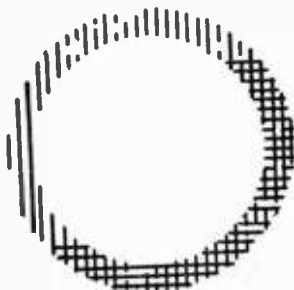

Fig. 4

A suggested result in analyzing the letter *o* is shown in Fig. 4, corresponding to these conditions.

A further extension of the diagonal principle is shown in Fig. 5. This equipment is capable of working either with horizontal strokes or with the diagonal strokes. The shift is accomplished by a clutch shown in Fig. 6.

As in some of our previous equipment the analyzing head is carried back and forth by means of a cross spiral thread. For straight horizontal analyzing, the head moves back and forth horizontally while the brass cylinder carrying the paper turns horizontally while the brass cylinder carrying the paper turns

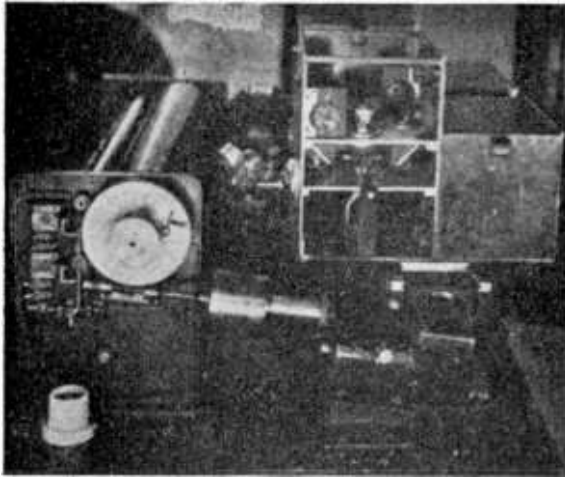

Fig. 5

slowly upward. So that for each crossing of the analyzing head, the paper is fed forward the requisite small amount to give the

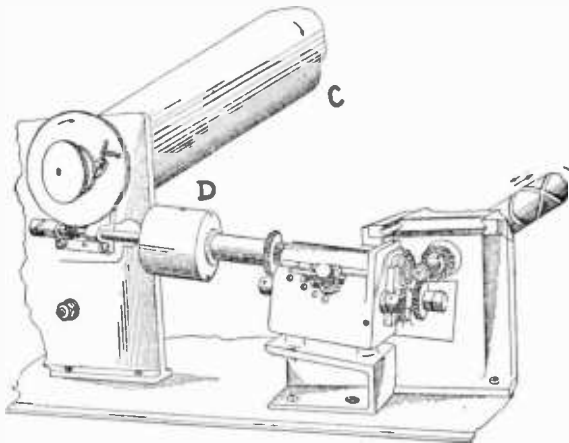

Fig. 6

next analyzing line of the picture. This of course gives a continuous paper feed.

To make diagonal pictures, the brass cylinder is rotated at a much faster speed; in fact it rotates just a little more than once

for every complete excursion of the analyzing head back and forth. It rotates a little more than once in order that the diagonal line shall be just the width of a line further down on the next stroke of the analyzing head.

To accomplish this light increase in revolution, a rather interesting arrangement is used. As seen in the illustration of Fig. 6, the motion from the double thread is carried through a bevel gear to a differential gear in the cylindrical case *D*. If the cylindrical case were held stationary, the motion transmitted in one end of the differential would be duplicated, except for a reversal in direction at the other end. This would rotate the

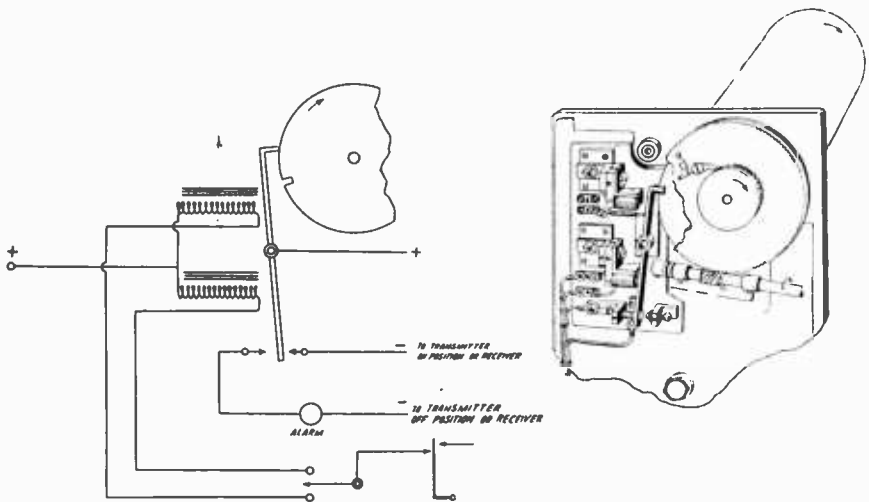

Fig. 7

brass cylinder exactly in step with the double thread screw movement. But in place of keeping the differential case rigid, it is slowly rotated by other gearing so that the brass cylinder *C* is moved forward slightly more than a complete revolution for each complete action of the double thread.

Likewise a gear shift arrangement is provided on the side of this slow differential drive such that the amount of this advance may be changed at will to give different analyzing line advances, to take care of different types of matter.

There is a further modification embodied in this machine which is used on straight horizontal analyzing. This is the fact that the cylinder is made double, such that either duplicates of the same transmission may be made on the receiver, or two entirely different pictures may be made, presuming that two different pictures are placed on the transmitter. These pictures

may be handled over a duplex circuit, or they may take turns about on a single circuit; the one on the left for example having the radio circuit when the analyzing heads at both transmitter and receiver are moving from right to left, and the one on the right having the circuit when the heads are moving from left to right. The advantage of this latter method of working is that it is then not necessary to have such accurate framing of the

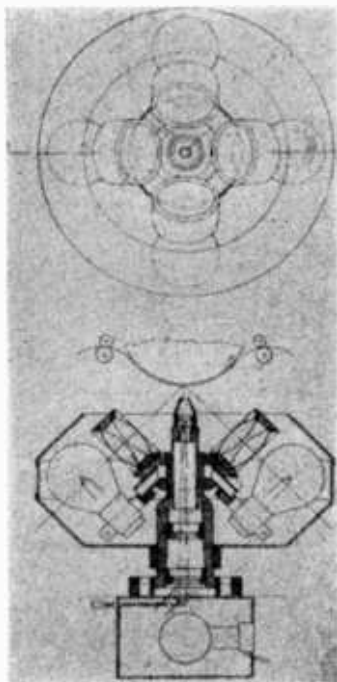

Fig. 8

analysis at the receiver as is the case when the single picture is worked on both ways. In which case there must be an absolute line-up such that the points fall directly under each other on the alternate left and right strokes.

A further detail is that of the automatic throwout which shuts off the transmission when the picture is completed. In Fig. 7 an arm at the left *L* is actuated by a contact which makes at one end of each complete movement of the analyzing head. There is one notch in the disk *K* in which this lever *L* may engage. It is started by hand from the position in which it engages. On the next stroke around, the notch will have moved forward slightly, due to the slightly faster movement of the cylinder, so

that the lever arm will no longer engage. It cannot again engage until the brass cylinder has gained enough lines to carry it completely around. When it does engage the second time, it makes

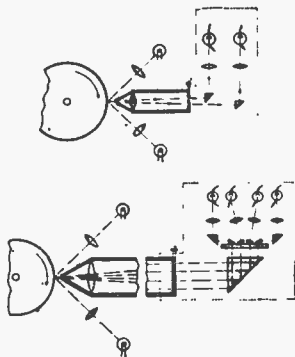

Fig. 9

a contact which shuts off the transmission and gives an indication to the operator.

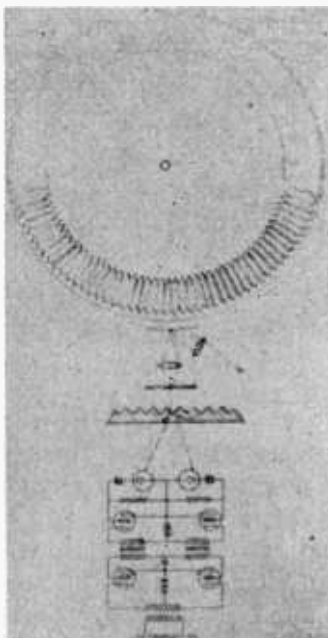

Fig. 10

The light system as shown in Fig. 8 on the transmitter is likewise unique. It consists of four lights fastened directly about the pick-up lens which is to analyze the picture. Four auto-

mobile lights are used and they give a very intense illumination of the spot being traced. The pick-up lens then carries a picture of this spot back to the slit, giving a more accurate definition of the exact spot being considered, and then the light is carried back to the photocell.

In place of analyzing a single point at a time, arrangements have been made to analyze as much as five points simultaneously. It is accomplished by means of splitting the light by the use of very small prisms which carry off the light of each of five different photocells as shown for four cells in Fig. 9. The purpose of this multiple scanning is looking forward to the time when it will

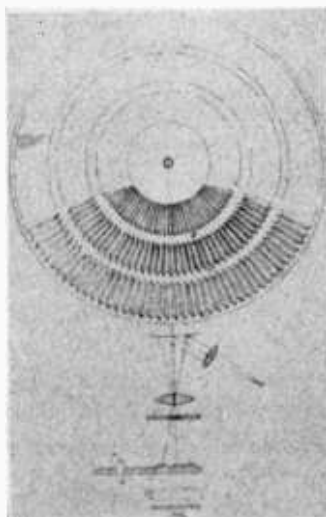

Fig. 11

be feasible economically to multiplex picture transmission. Then the analyzing may be speeded up by the number of channels that may be handled simultaneously.

PUSH-PULL PHOTOCELLS

For a long time we have been aware that it was very difficult to get linear output in the complete set-up from photocell through the associated amplifiers. The natural thought is to make use of push-pull action. After many trials, I am glad to be able to report that this has now been accomplished in the rather simple form shown in Fig. 10.

It consists of the use of a glass disk on which are grouped many small prisms. The glass prisms deflect the light first in one

direction and then in the other as the analyzing pencil of light comes on to first one and then the other side of these glass prisms. The deflected light is carried first to one photocell and then to the other.

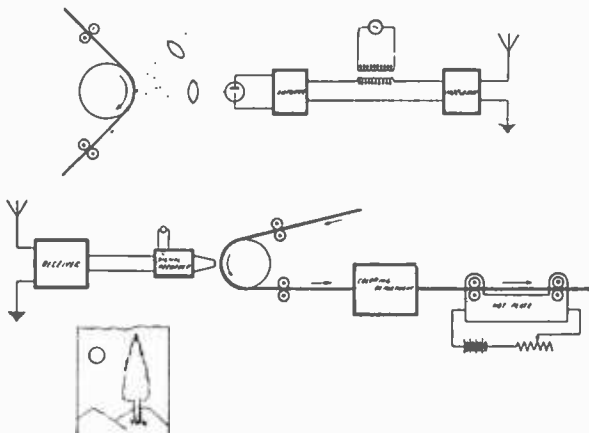

Fig. 12

In place of driving this glass disk by the usual electric motor, which would have to be shielded most carefully to prevent it



Fig. 13—Heat recording on wax. Left half shows roughened surface before inking, right half after inking. Any color may be used on roller.

acting on the sensitive photocells and amplifiers, we have broken away completely from the electric drive and use a small air turbine. A small mechanical governor keeps the speed within

the desired scope. Two pounds of air will drive the turbine at three thousand revolutions per minute with no difficulty. This makes for a very light compact arrangement with a very small amount of vibration.

Two push-pull amplifier stages are associated directly in the camera box to pick up the voltage variations from the push-pull

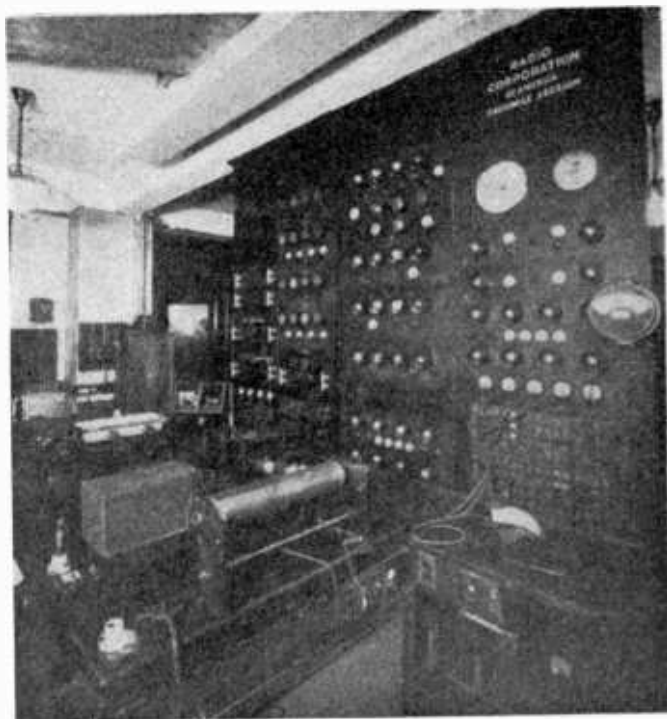

Fig. 14

photocells. The resultant audio tone is then of quite sufficient proportion to be carried away from the outfit to be further amplified and put on the line to the transmitting station. In place of a single row of such glass prisms, a multiplicity of rows of such prisms has been made as shown in Fig. 11. A different number of prisms is ground in each row, and therefore different audio notes come from each row. The result is that two or more analyzing points may be picked up from the picture and separated out by appropriate tone filters later. For short distance work, the multiple tones may be carried directly out to modulate the amplitude of the radio transmitter, and be filtered apart in

the final reception. It should be pointed out that without the push-pull photocell action, the wave form of each tone would be so bad that the filtering would be extremely difficult.



Fig. 15

TABLE OF UNITS in CODE AND FACSIMILE (Average values) 1 word = 5 letters and one space	
Code Transmission (Continental Morse)	
1 word	requires 24 cycles modulation
100 words	requires 400 cycles
1 minute	requires 400 cycle carrier
Facsimile Transmission	
6 lines typewriting to vertical inch	
12 letters or 2 words to one inch of line	
12 words per square inch	
1 letter	requires 30 cycles modulation
1 word	requires 180 cycles modulation
100 words	requires 3000 cycles
1 minute	requires 3000 cycle carrier

Fig. 16

It should be mentioned that the above job fell distinctly in the class of "it cannot be done," and Mr. J. N. Whitaker undertook the removal of this hoodoo most successfully as shown above.

WAX PAPER

At the receiving end, we are continuing the use of hot-air recording, and have now a paper developed in the hands of our chemist, Mr. F. G. Morehouse. It is much more sensitive to heat than the previous papers. A thin wax coating is placed on top of specially selected paper. This wax coating penetrates the paper as little as is possible. As such, the wax coating acts as a water repellent. However, when the hot-air, at a temperature in the vicinity of 80 deg. C strikes the paper from the fine nozzle, the wax diffuses into the paper and the repellent characteristic of the paper at that point is destroyed. After the transmission is finished, the wax paper is removed from the recorder, and it may then be quickly inked by a water ink from a roller.

This ink is much more permanent than our previous records, and gives a more pleasing finish to the work, as well as sharper definition.

PHOTO COLOR

Likewise in place of giving only a black record, any color may be used. And in fact the color may be applied selectively as directed by the transmitting operator. The result is a photoradio in color. This is shown schematically in Fig. 12. The first of such transmitted across the continent from San Francisco to New York is shown in Fig. 13. Unfortunately the colors cannot be reproduced here.

A general view of the amplifier equipment associated with the operations of both the transmitter and receiver is shown in Fig. 14. Some results of recent transmission are given in Fig. 15. A synopsis of the frequencies involved in picture transmission is tabulated in Fig. 16.

FACSIMILE PICTURE TRANSMISSION*

By

V. K. ZWORYKIN

Director, Electronic Research Laboratory, RCA Manufacturing Company, Inc.,
Camden, N. J.

Summary—A facsimile picture-transmitting system is described. The chief object of the design of this system was to produce a simple, rugged apparatus for practical usage, which would not require the attention of a skilled operator. The system does not require a special preparation of the original, and the receiver records the copy directly on the photographic paper.

The usually delicate problem of photo-cell current amplification has been simplified to such an extent that only three stages of resistance-coupled amplification suffice between the photo-cell and modulator of the broadcasting station. This was made possible through the design of a very efficient optical system, which supplies to the photo-cell quite enough light reflected from the picture even though only a small incandescent lamp for illumination is used.

The synchronizing and framing have also been simplified to such a degree that they do not require any special channels or special amplifiers.

Automatic starting devices obviate the use of any complicated scheme of signal dispatch for starting the apparatus. In spite of the simplicity of operation, it is capable of transmitting a 5 in. by 8 in. picture either in black and white or in half-tone in 48 seconds, or a message at the rate of 630 words per minute over short distances.

The resulting picture prints are of a quality quite satisfactory for newspaper reproduction and clear facsimile of messages may be made from typewritten originals.

OPTICAL SYSTEM

ALL the existing methods of electrical picture transmission can be divided into two classes: one which requires special preparation of the original before it can be transmitted, and the other which can transmit the original directly.

The first one includes the electrical contact method, now almost abandoned, which requires the preparation of the original in such a form that the dark and light parts of the picture give variable electrical resistance when explored by a traveling contact.

In another form of transmitter of the same class, as in the Belin system, which is still in commercial use in France, the picture is embossed with a special ink so that it may be reproduced by a microphone in the same way as an electrical pick-up reproduces phonograph records.

* Dewey decimal classification: R582. Original manuscript received by the Institute of Radio Engineers, November 24, 1928. Presented before New York meeting of the Institute, January 2, 1929.

Reprinted from *Proc. I. R. E.*, March, 1929. Originally published as a communication from the Research Laboratory of the Westinghouse Electric and Manufacturing Company.

The method which requires the preparation of a transparent picture either in negative or in positive form belongs also to the same class.¹ In this case the picture is explored by a sharply defined pencil of light which passes through it and activates a photo-cell placed behind it. The variation in optical density produces a corresponding variation in absorption of the light, and therefore the photo-cell delivers an electric current varying according to the picture.

The present requirement of high-speed transmission, however, rules out all these methods due to the time necessary for preparation of specially treated originals. In this case only one solution remains, and this is the scanning of the original by a pencil of light and the utilization of the light reflected from its surface. The amount of reflected light is directly dependent on

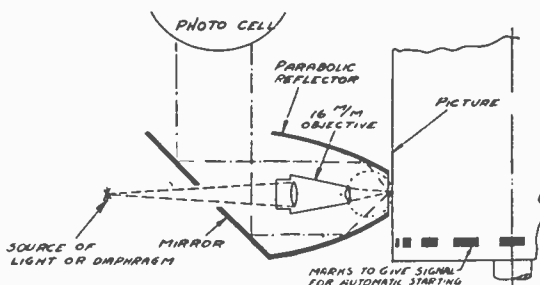

Fig. 1—Optical system of the picture machine.

the density of the picture or lettering. The specular reflection from the surface of the paper is negligible and equal at all points on the paper, and therefore does not interfere with the reflecting scanning method. However, difficulties arise in the optical part of the problem due to the small amount of light reflected. This necessitates the utmost care in the design of a very efficient optical system.

Here again are two possible solutions of the problem. One is the illumination of the original by strong diffused or concentrated light and cutting off from the illuminated area a small, sharply defined spot. The light from this spot is directed into a photo-cell. In this case the optical efficiency is determined first by the ratio of the size of the scanning spot to that of the total illuminated area, and by the light-gathering power of the optical lens. In general, in spite of all the precautions, the over-all optical efficiency of this method is quite low.

¹ This method is still in general use and, a few years ago, was the only optical method employed.

The second method, which is used in this transmitter, is inverse to the first one. In this case the size of the scanning spot is adjusted to the required dimension and the reflected light is collected. Fig. 1 gives an idea of the arrangement. The source of light is focused first on a diaphragm to make the size of the spot independent of the size of the source. The image of the

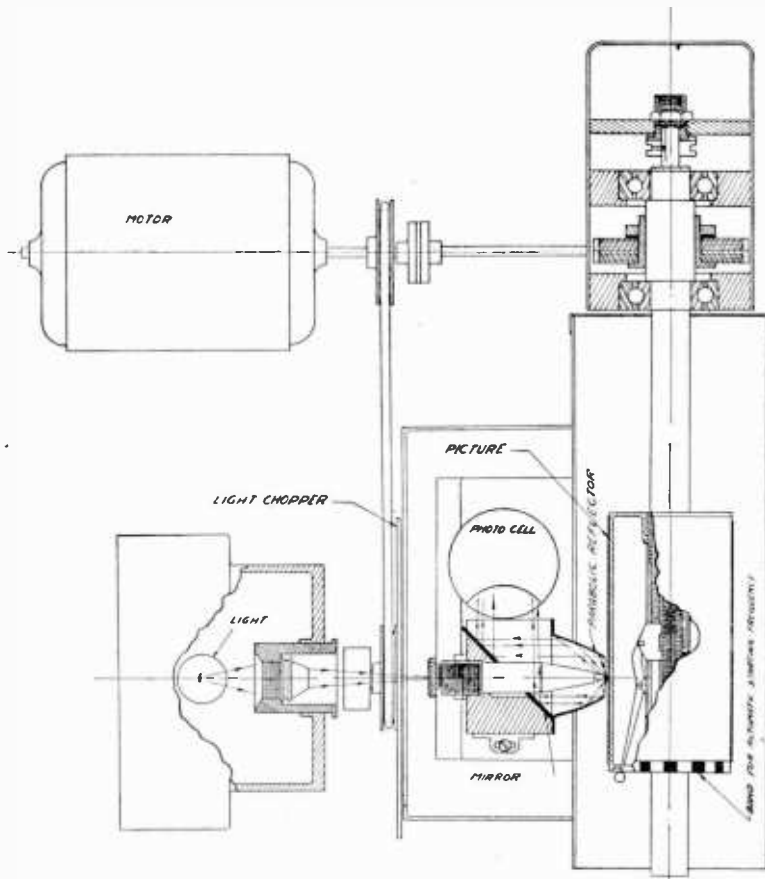

Fig. 2—Facsimile picture transmitter.

diaphragm, with necessary reduction, is focused on the surface of the picture. The reflected light is gathered by means of the parabolic reflector, the focus of which coincides with the illuminating point. Part of the reflector is cut away in order to pass the light, and the remaining part is brought into close proximity to the surface of the picture. In this case almost all the reflected light is collected and projected as a more or less parallel beam

by the reflector. A plane mirror with a small hole for passage of the illuminating spot intercepts the reflected light at 45 degrees and diverts it to the photo-cell. The optical path of the whole system is quite short and the construction is flexible for adaption to almost all kinds of scanning systems. The over-all optical efficiency is many times greater than the best possible solution by the first method. .

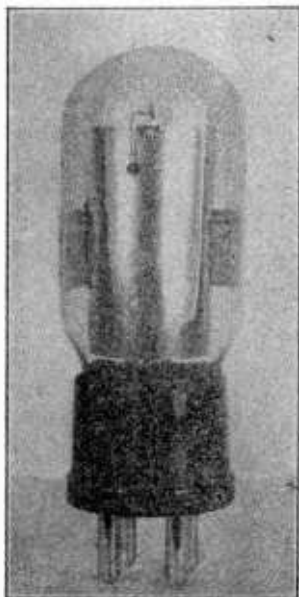

Fig. 3—Glow tube.

SCANNING ARRANGEMENT

In the present article only the intermittent type transmitter, i.e., the type in which it is necessary to stop the machine after every picture for reloading, is described. Although this type is not very suitable for commercial purposes, it has many advantages for experimental work and also for all kinds of communication where traffic requirements are not very high.

In this type, the picture to be sent is in the shape of a 5-in. by 8-in. rectangle and is wrapped around a cylinder which is placed on the shaft as shown in Fig. 2. The shaft is hollow and has a screw inside which can be locked either to the shaft or to the support. The cylinder has a locking nut, which, by means of

a lever, can be raised or lowered, locking the cylinder with the shaft and screw. While the screw is connected to the shaft, the cylinder rotates with it, but remains stationary in longitudinal direction. When the picture is ready for transmission, the screw is released from the shaft and locked to the support by means of an electromagnetic clutch. This makes the screw stationary in respect to the rotating nut and the cylinder begins to advance, exposing gradually the whole surface to the scanning spot. The speed of scanning is 56 in. per second, while that of the cylinder

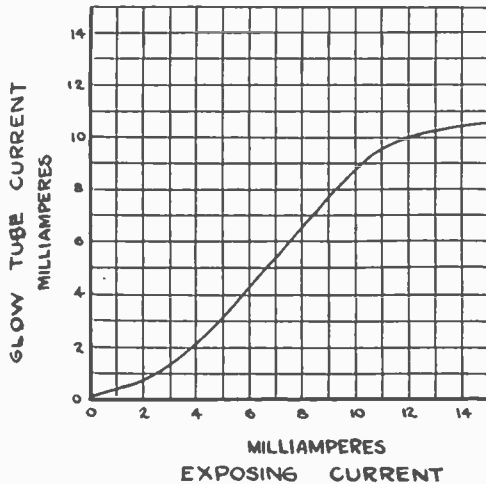

Fig. 4—Fidelity curve.

feed is $1/64$ in. per revolution, so that 52.5 sq. in. of the picture are covered per minute. Allowing, as usual, 12 words per sq. in., the rate of transmission amounts to 630 words per minute. The $1/64$ in. picture feed was found very satisfactory for typewritten messages and for most other pictures.

Care, of course, is taken to move the cylinder with uniform speed in order to avoid distortion of the picture.

Mechanically, the receiver is identical with the transmitter. A standard bromide photographic paper 5 in. by 8 in. size is wrapped around the cylinder and the recording is done by means of a glow-discharge tube. Fig. 3 shows the type of glow tube used for this purpose. It was developed by Mr. Knowles in the Westinghouse Laboratory and uses helium glow for recording. The glow is restricted to the required size by a mask built into

the tube. A discharge of approximately 15 milliamperes at 400 volts is sufficient at the present speed to produce very satisfactory blackening on the bromide paper.

Fig. 4 shows the fidelity curve for the whole transmitting process. Along the axis of abscissas is plotted the current through the glow tube. The bromide paper is exposed to this glow at working speed and is developed in the usual manner. The "density chart" prepared in this manner is put into the transmitter, and the output of the amplifier is plotted along the



Fig. 5—Photo cell.

axis of ordinates. The curve, therefore, represents the true relation between the densities of the original and of the reproduced copy.

This relation shows good proportionality from 2 to 12 milliamperes, which ratio usually is maintained for transmission of half-tone pictures. For white and black manuscripts it is preferable to sacrifice the proportionality and work further along the characteristic curve in order to produce sharper contrast.

For a highly efficient commercial transmitter, the intermittent type is not suitable, due to loss of time required for reloading. Another machine of continuous type has been developed for this purpose. Although the principle and even the optical system remains the same, the relative motion of the paper with respect to the scanning light is changed, and this in turn changes the whole appearance of the apparatus. The

reflected light is conveyed by plane mirrors along the axis into a photo-cell, which remains stationary.

PHOTO CELL

Fig. 5 shows a photo-cell used in the picture transmitter. It is of magnesium-caesium type, filled with argon. It consists of two electrodes, one on the inner surface of the glass bulb and another in the shape of a ring in the center of the bulb. A window is provided in the coating for admittance of the light. The coating is photo-sensitive; i.e., it emits electrons at a rate

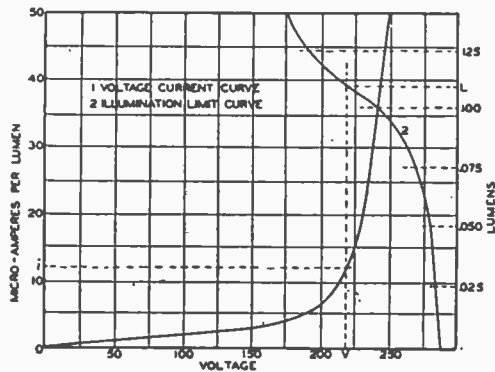

Fig. 6—Characteristics of gas-filled photo-electric cell.

proportional to the quantity of light absorbed by the coating. These electrons flow to the anode under the accelerating potential of an outside battery. During this passage they collide with the molecules of the argon, and since their velocity-voltage is higher than the ionizing potential of the argon, ionization occurs. Thus the output of the cell is increased many times without destroying the proportionality between the quantity of light absorbed by the photo-cell and the output of the cell. Fig. 6 shows the relation between the voltage applied to the cell and its output calculated in microamperes per lumen. The second curve on the same figure gives an idea of the safe operation of the cell for various voltages and degrees of illumination.

AMPLIFIER

Since the photo-cell, under operating conditions, supplies a current of the order of 1/20 of a microampere for the white

portion of the picture, a strong amplification is necessary before the output of the cell can be used for radio transmission.

The requirements for the amplifier are quite severe. It should not distort the signals and should not have a tendency to oscillate, which results in distortion of the picture.

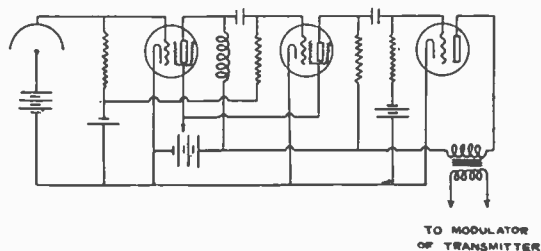

Fig. 7—Photo-cell amplifier.

In actual cases we used screen-grid tubes and the circuit as shown in Fig. 7. Voltage output of the third tube is about 40 volts, which is quite sufficient to operate the modulator of the broadcasting station through a line of considerable length. Fig. 8 shows an oscillograph actually received from the picture signals.

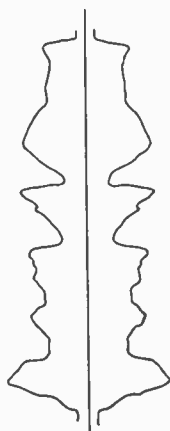

Fig. 8—Envelope of signal current.

RECEIVER AND AMPLIFIER

For the reception of the picture signals, the radio set may be a standard receiver. The amplification, in the case of weak signals, is preferably at radio frequency in so far as possible, in order to reduce distortion. Transformer-coupled audio-frequency amplification, however, gives very good results if the gain is

fairly uniform between 2000 and 4000 cycles. To date, a standard RCA short-wave receiver has been used for all work. This employs a stage of radio-frequency amplification with a screen-grid tube, detector, and two audio stages.

CONTROL OF GLOW TUBE

For the control of the glow tube which exposes the photographic paper, a vacuum tube is used. The glow tube is connected in series with the plate voltage for the vacuum tube. Fluctuations in voltage upon the grid due to the picture signal produce corresponding variations in the glow tube current. If the signal as it comes from the audio amplifier were applied

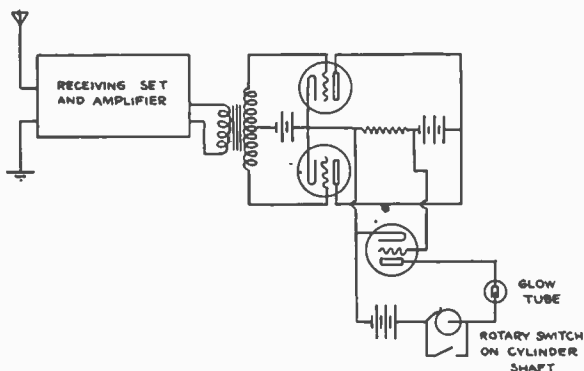

Fig. 9—Glow tube control circuit.

directly to the grid of the control tube, a negative picture would result. That this is true can be verified by following the steps in the transmission of the picture. When the light is reflected from a white area in the original picture, a relatively large amount reaches the photo-cell. The corresponding photo-cell current is amplified, producing a loud signal. At the receiving end this signal would increase the average plate current of a tube working on the lower bend of the characteristic curve. Such an increase would augment the light from the glow tube, darkening the photographic paper instead of making it lighter.

Unless the picture is to be recorded upon a film, and subsequent prints are to be made, it is necessary to reverse the process. This reversal might take place at the transmitter, but is undesirable for pictures which are largely white, as printing, for example. Bursts of static would be recorded as black spots on the white background. On the other hand, if the reversal

occurs at the receiver, these disturbances tend only to make the white whiter. Hence, reversal at the receiver is used.

The circuit employed for the control of the glow tube is shown in Fig. 9. Voltage from the receiving set is applied to the push-pull detector, using UX-112 tubes. These are so biased as to give practically zero plate current in the absence of signal. Any voltage supplied causes, on either the positive or negative half of the cycle, a voltage drop across the plate resistor. This

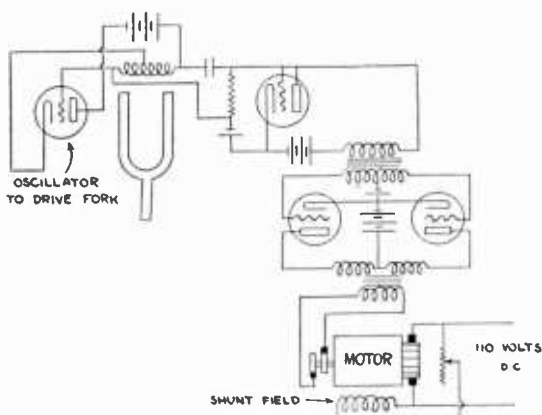

Fig. 10—Synchronizing system.

voltage drop is impressed on the grid of the control tube, decreasing the glow tube current in the case of a strong picture signal.

SYNCHRONIZING

The problem of synchronizing transmitter and receiver is of great importance, particularly for high-speed transmission. The plan of broadcasting a standard frequency by a series of stations scattered throughout the world is one of considerable merit, but has not yet been adopted. The use of voltage from interconnected power lines has been proposed, but is impractical in the general case, since the phase relations between ends of the system are too variable to permit high-speed transmission. It is necessary, then, to do one of three things: (1) provide independent, accurate sources of frequency for transmitter and receiver, or (2) send a synchronizing signal continuously to the receiver, or (3) correct periodically a less accurate source of frequency at the receiver by an impulse from the transmitter. The third method is the one used.

The source of frequency at both transmitter and receiver is a 70-cycle tuning fork in a constant temperature box. These forks are so adjusted that there is but one beat between them in 20 seconds or more; this condition is relatively easy to maintain. The fork at the receiving machine is then corrected every revolution of the picture cylinder (every seventh of a second) by an impulse of about one-half cycle duration. This impulse is transmitted over the same channel as the picture, but on the margin of the paper to avoid interference with picture signals.

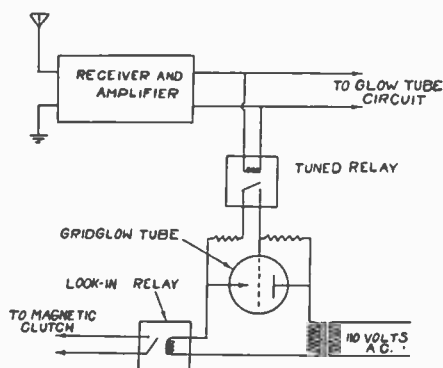

Fig. 11—Automatic starting arrangement.

Having obtained the standard frequency, the next step is to use it most advantageously in the control of the motors. To amplify a small amount of energy to such a degree that it could supply the full load of the machine would be wasteful. It is common practice at the present time to use two motors on the same shaft—one to furnish most of the torque, and one to keep the speed constant. In the present arrangement, the two machines are combined into one, similar to a rotary converter. Voltage from the tuning fork is amplified, using two UX-250 tubes in the final stage. The power from these tubes is applied to the motor slip rings, while most of the energy comes from the direct-current source. Fig. 10 shows the schematic diagram of the synchronizing circuit.

FRAMING OF PICTURE

It is not enough that the cylinders on both transmitter and receiver rotate at exactly the same speed; the picture must be framed as well. In other words, the first edge of the picture being sent should be under the spot of light at the transmitter

at the same instant that the first edge of the photographic paper is being exposed by the glow tube at the receiver.

The framing is accomplished by the following method. The picture to be transmitted is held on the cylinder by a longitudinal black band; at the end of the cylinder first transmitted is a narrow white ring. As the light spot explores this ring, a continuous signal is transmitted except for the interval when the

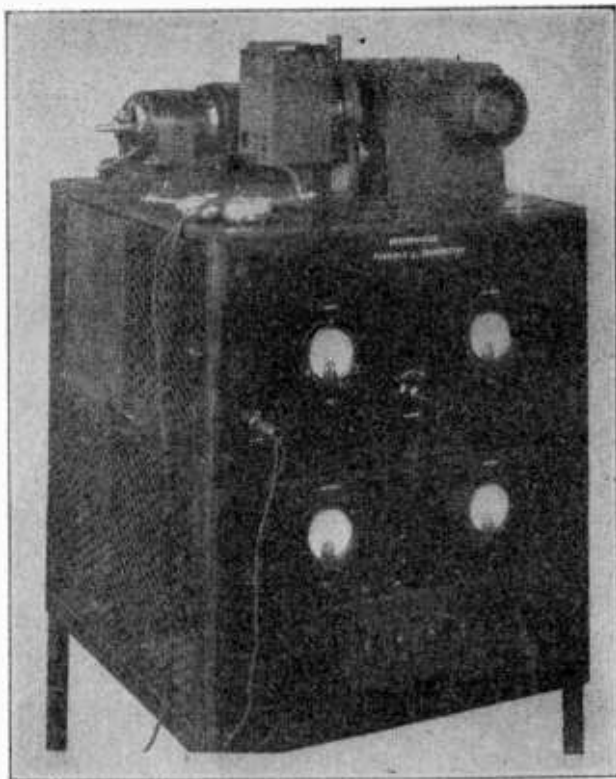

Fig. 12

black band is absorbing most of the light. The glow tube at the receiver flashes once for each time the black band occurs, or seven times per second. At the end of the shaft upon which the receiving cylinder rotates is an interrupter which breaks the glow-tube current for a time equal to that required for the transmission of the band. If the interruption takes place at the same time the flash normally occurs, the light from the glow tube appears steady, and framing is known to be correct. If the flashes are seen, however, it is necessary to correct the relative

position of the glow tube with respect to the position of the cylinder at a given instant. This is done by a process equivalent to rotating the frame of the motor.

The framing process described above is carried out for each picture transmitted by the intermittent machine, since the framing is lost when the motors are stopped. In the continuous

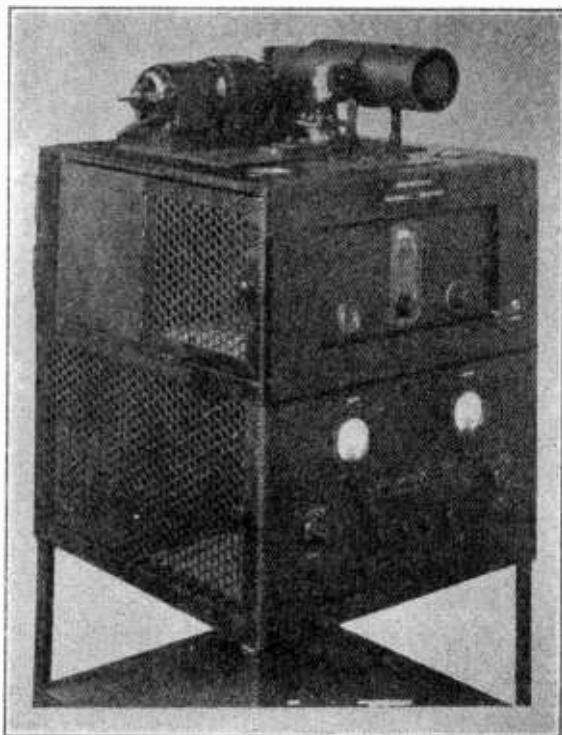

Fig. 13

machine the motors run constantly, hence framing is required only at the beginning of transmission.

STARTING OF RECEIVER

When synchronizing and framing is accomplished the picture starts to pass under the transmitter's scanning spot. The starting of the receiving cylinder is accomplished automatically. The principle of operation of this starter is as follows: On the front end of the transmitting cylinder a band of black and white spots is engraved. This can be seen on Fig. 1. When the picture is started, this band comes first under the scanning spot.

As a result, the corresponding frequency is produced by the transmitter and reproduced by the receiving amplifier. This frequency operates a small tuned relay, Fig. 11, which in turn starts a grid glow tube.² The current passing through the grid glow tube operates a lock-in relay which completes the circuit to the magnetic clutch; this starts the receiving cylinder. The starter does not require any additional equipment at the transmitter, nor at the broadcasting station.

ASSEMBLED MACHINES AND RESULTS OBTAINED

Figs. 12 and 13 show the finished appearance of the intermittent type of transmitter and receiver, respectively. Both

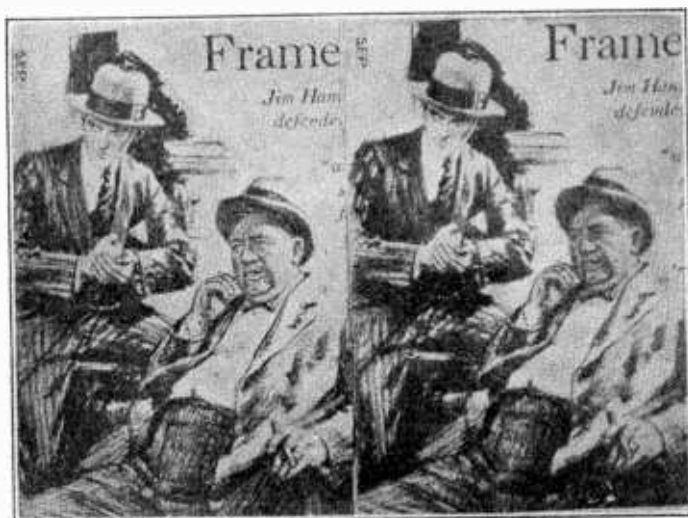

Fig. 14

machines are self-contained, including all the amplifiers, rectifiers, and tuning forks. In size, the cabinets are two ft. square by four ft. high. The transmitter could be installed at any convenient place connected with the broadcasting station by means of a telephone line. The receiver should be placed either in a dark room or adjacent to a small developing booth. With the exception of the darkening of the end of the receiving machine for handling the bromide paper, no other precautions are required in the illumination of rooms where both machines are located. In Fig. 14 are shown side by side an original picture and the facsimile transmitted over a short telephone line and a few miles of radio channel.

² See description of grid glow tube by Knowles, *Elec. Jour.*, April, 1928.

IMAGE TRANSMISSION BY RADIO WAVES*

By

ALFRED N. GOLDSMITH

Consulting Engineer, Radio Corporation of America

THE purpose of this paper is to introduce a series of papers in which are described specific methods whereby transmission by radio of stationary images or moving pictures can be effectively carried out. Accordingly it has seemed desirable to establish the position of image transmission by radio in the general engineering technique of this field rather than to discuss individual methods or specialized apparatus.

All radio engineers are well acquainted with the transmission of intelligence by modulated radio waves. The simplest mode of modulation corresponds to telegraphy and is generally carried on at slow or moderate speeds and with one hundred per cent modulation. More elaborate and difficult as to both the transmitter and receiver, and more critical in its electrical requirements on the intervening medium, is the transmission of speech or music, which involves modulation at higher frequencies than are generally required for telegraphy, and which similarly aims at complete modulation at peaks of sound amplitude, though with a comparatively small *average* modulation. Stationary image transmission at speeds now regarded as normal falls between ordinary telegraphy and telephone transmission in its general difficulty and physical characteristics. On the other hand, television, or the transmission of moving pictures, is by far the most difficult method of radio transmission seriously proposed or accomplished. The modulation frequencies are considerably higher than are required for the transmission of speech or music, the average modulation is low, but complete modulation is also desired for peaks of light or shade. Television therefore requires powerful transmitters having long and linear modulation characteristics, both as regards frequency and amplitude, receivers having similar radio and intermediate frequency characteristics indicating accurate proportionality of response, and a high quality radio circuit between transmitter and receiver. By "high quality" is meant a circuit essentially free from fading or any form of selective absorption of the radio wave.

* Dewey decimal classification: R582. Original manuscript received by the Institute of Radio Engineers, April 10, 1929. Presented at Fourth Annual Convention of the Institute of Radio Engineers, Washington, D. C., May 14, 1929.

Reprinted from *Proc. I. R. E.*, September, 1929.

1. COMPARISON OF FACSIMILE TRANSMISSION AND TELEGRAPH TRANSMISSION

Facsimile transmission is the transmission of stationary images. Its purpose in general is to avoid the human or variable element in transmission and reception and to enable the transmission of material which is not of simple alphabetic nature as, for example, drawings, writing or the like. It is not in itself the most rapid method for the transmission of intelligence. Certain of the five-element letter codes used in ordinary telegraphy are considerably the superior of facsimile transmission in this regard. They lack, however, the capability of carrying with any facility the special material which facsimile transmission can handle (such as pictures and the like). It is necessary to keep in mind the importance of the human element and the scope of subject matter which can be handled in appraising the relative values of telegraphic and facsimile methods of transmission (for the same number of words per minute). Facsimile transmission in general requires a more perfect circuit than does telegraphic transmission. While suitable facsimile terminal apparatus has been thoroughly developed and is amply capable of handling facsimile transmission and reception at any reasonable speed, yet radio circuits (while giving much promise of ultimate satisfactory performance for facsimile purposes), are not yet at a stage where extremely high speeds of transmission are consistently feasible over certain transmission distances or paths.

The practical conclusion is drawn that the improvement of the radio circuit, and the increasing importance of sending highly personal or graphic material without the necessity for skilled operators at each point of the circuit, will be the elements of most importance in any further study of the place of facsimile transmission in the communication field.

2. THE RELATION OF FACSIMILE TO TELEVISION TRANSMISSION

Television transmission is a method of communication of intelligence far transcending in its requirements any form of facsimile transmission so far developed. On the average, the transmission of an excellent facsimile picture of considerable size *at television speeds* would correspond to the transmission of a total number of dot-elements requiring but a few seconds. The actual facsimile picture sent *at facsimile speeds* may require almost as many tens of minutes for its transmission. The speed of picture element transmission is therefore in the approximate ratio of 100 to 1 or more for television as compared to facsimile transmission.

Television is therefore found to be more susceptible to disturbance by eccentricities in the transmission path than is facsimile transmission. Extremely objectionable effects in the form of blurred or multiple images, or "explosive pictures," are obtainable under conditions when telephony or telegraphy could be carried out over the corresponding circuit with little, if any, noticeable deterioration of quality.

The limitation of the service range of television stations resulting from this feature is not generally appreciated. It is, however, a factor of importance, and it is to be anticipated that the ratio of the "service range" to the "heterodyne range" of a television station will be considerably less than for telephony, facsimile, or telegraphy. This is an unpleasant feature when contemplated in the light of future Federal assignments of television frequencies to individual stations and the repetition of such frequencies at various points in the United States. Despite considerable experimentation final data on this subject are not available.

3. THE RELATION OF TELEVISION TO TELEPHONE BROADCASTING

There are certain marked differences between television and telephone broadcasting which require consideration by the radio engineer and designer. Essentially a radio telephone signal is a single modulation of the carrier wave. A television signal, in general, will necessarily include two modulations, one corresponding to the picture, and the other (directly or indirectly) to the synchronizing means. Certain general considerations indicate that the average modulation frequencies for the picture and the modulation frequency for the synchronizing signal should not be widely dissimilar if effective and accurate framing is required. The omission of synchronizing signals implies an unusually high degree of precision in the speed controls at the transmitter and receiver and, while a possibility, does not appear at present to be the most readily available method of framing the picture, (unless occasional manual adjustment is acceptable).

As previously indicated, television requires a much wider frequency band (because of the high frequencies of modulation) than does telephony. It is accordingly more open to interference, both man-made and natural, to fading, and to selective attenuation. As a secondary result of the wide frequency band occupied, the national syndication of television programs by wire lines presents a new series of problems which, so far as one can judge from the available literature, have not yet been solved.

Furthermore, the high modulation frequencies for television make transmitter and receiver design impracticable unless the shorter wavelengths (higher frequencies) are used for the transmission. This imposes further difficulties, namely, the considerable attenuation of the short wave, particularly in its passage over urban areas, and the generally diminished service area as compared to telephone broadcasting stations of equivalent power.

No doubt the considerations just mentioned have contributed substantially to the more leisurely progress of commercial television as compared to telephone broadcasting and have prompted caution on the part of responsible radio engineers interested in television service to the public.

4. FUTURE TELEVISION STANDARDIZATION

It is clear also that more definite and elaborate standardization will be required in the television broadcasting field than in the telephone broadcasting field. In order effectively and conveniently to receive a television transmission, the receiver must have certain constants and characteristics determined by the transmitter. It must be arranged to handle the same number of horizontal and vertical elements in the picture, the same number of pictures per second, must be arranged for the same scanning method (as to direction and mode), must follow the same antenna current versus picture light-and-shade correspondence relationship, must have the same synchronizing means, and presumably must be adapted to receive the transmitted arrangement of television and synchronizing signal in one or more frequency bands.

In other words, while a telephone broadcasting receiver will in general receive almost any sort of telephone transmission (excluding only such rarely used methods as single sideband transmission and "modulation by frequency variation"), a television broadcast receiver will receive satisfactorily only the highly individual transmissions emanating from a specific type of transmitter of definite design. The conclusion to be drawn from this state of affairs is an obvious one. Clearly the establishment of unusual constants in a television transmitting station by any organization not having a wide knowledge of the broadcasting and television fields and of the probable effect of such a choice of constants on the entire television service to the public, is prejudicial to the orderly and rapid development of the television broadcasting art.

PHOTORADIO APPARATUS AND OPERATING TECHNIQUE IMPROVEMENTS*

BY

J. L. CALLAHAN, J. N. WHITAKER, and HENRY SHORE

R.C.A. Communications, Inc., New York City

Summary—A brief review of photoradio inception and progress up to 1928 is included in the introductory part of the paper.

Improvements to terminal equipment which make possible greater fidelity of half-tone transmission over long-distance radio circuits are described. Radio circuit distortion is discussed and compensation methods suggested. A mathematical analysis of the photoradio keying is appended.

INTRODUCTION

THE present photoradio system of R.C.A. Communications, Inc., had its inception in 1923. R. H. Ranger has outlined in three papers^{1, 2, 3} given before the Institute, the activity of early and contemporary workers in the facsimile field as well as covering the activities of the Radio Corporation of America up to and including 1928. It is the intent of the authors of this paper to list and describe the improvements to photoradio apparatus and in operating technique which have taken place since 1928.

I. GENERAL DESCRIPTION OF THE MODERN PHOTORADIO SYSTEM

The photoradio equipment employed by R.C.A. Communications, Inc., makes use of a rotating drum and a lead screw upon which is mounted either a photocell scanner or a recording device. The subject drum and its associated lead screw are driven, through suitable reduction gears, by a thermionic brake system. The driving unit of the thermionic brake system consists of an alternator and a direct-current motor mounted on a common shaft. The alternator supplies anode voltage and current to a pair of triodes connected in push-pull. The excitation for the push-pull connected triodes is furnished by a tuning fork standard having a high order of accuracy.

The transmitting head or scanner consists of a balanced modulator circuit, the phototube portion of which is energized

* Decimal classification: R581. Original manuscript received by the Institute of Radio Engineers, May 15, 1935. Presented before New York Meeting, November 7, 1934.

¹ R. H. Ranger, "Transmission and Reception of Photoradiograms," *Proc. I. R. E.*, vol. 14, pp. 161-180; April, 1926.

² R. H. Ranger, "Photoradio Developments," *Proc. I. R. E.*, vol. 17, pp. 966-984; June, 1929.

³ R. H. Ranger, "Mechanical Developments of Facsimile Equipment," *Proc. I. R. E.*, vol. 17, pp. 1564-1575; September, 1929.

Reprinted from *Proc. I. R. E.*, December, 1935.

by light reflected from the subject drum. The scanner output is a carrier, six decibels below reference value of six milliwatts, amplitude modulated in direct proportion to the subject light densities reflected into the phototube.

Short-wave radio circuit distortion⁴ necessitates the conversion of the amplitude modulation of the scanner output into a

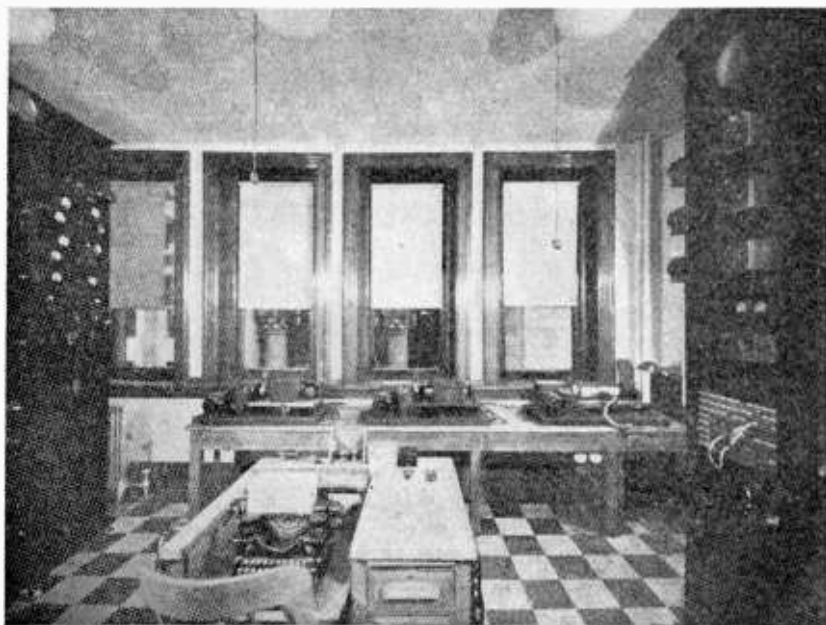

Fig. 1—Photoradio installation, 66 Broad St., New York City

series of varying length dots which can be used as control for a class C operated radio transmitter. The dot converter supplies to the radio-frequency transmitter control line an on-off keyed carrier, the keying rate and amplitude of which are held constant with weight or length of the mark intervals varying in direct proportion to the scanner output. This form of keying is called "Constant-Frequency Variable-Dot" or "CFVD" keying.

Photoradio service makes use of the standard radio transmitting and receiving station facilities normally used for radio-telegraph communication. These arrangements have been reported on by Beverage, Hansell and Peterson.⁵

⁴ T. L. Eckersley, "Multiple Signals in Short-Wave Transmission," *Proc. I. R. E.*, vol. 18, pp. 106-122; January, 1930.

⁵ Beverage, Peterson, and Hansell, "Radio Plant of R.C.A. Communications, Inc.," *Proc. A. I. E. E.*, vol. 51, no. 8, p. 586; August, 1932.

The radio receiving station delivers to the Central Office a "CFVD" keyed carrier. The carrier is then rectified and supplied to either or both visual and photographic types of recorders. In the visual recording system the rectified receiving station signal controls a shutter which regulates the flow of ink vapor directed toward the record sheet. In the case of photographic recording

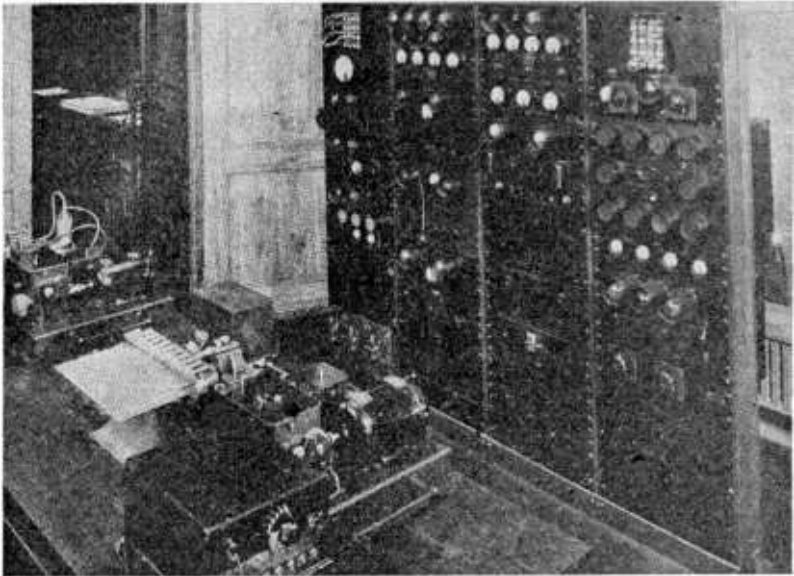

Fig. 2—Photoradio installation, 28 Geary St., San Francisco.

the rectified signal is caused to flash a glow tube, the flashes being directed by a suitable optical system, toward a record surface of either photographic film or bromide paper.

The apparatus associated with the above briefly described photoradio system is illustrated by several pictures. They are identified as Figs. 1 to 5 inclusive.

Fig. 1 is a photograph of the R.C.A. Communications, Inc., photoradio apparatus room at 66 Broad Street, New York City. The machine bench, the fork standard equipment rack on the left, and the transmitting and receiving vacuum tube equipment rack on the right can be noted.

Fig. 2 is a photograph of the R.C.A. Communications, Inc., photoradio apparatus installed at 28 Geary Street, San Francisco. The machine bench and the apparatus rack as well as the door leading into the dark room can be noted.

Fig. 3 is a photograph of the Cables and Wireless, Ltd., photoradio apparatus room at London. The machine equipment

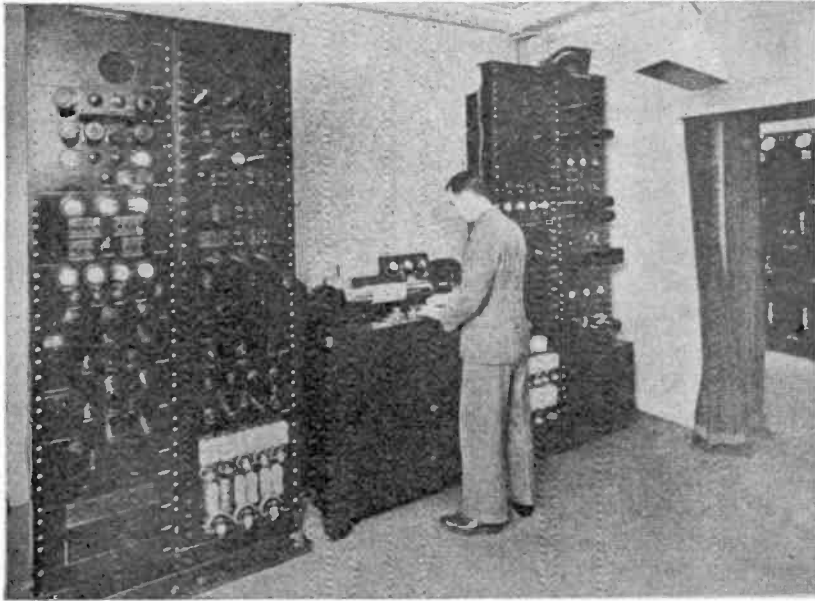

Fig. 3—Cables and Wireless, Ltd., London photoradio installation.

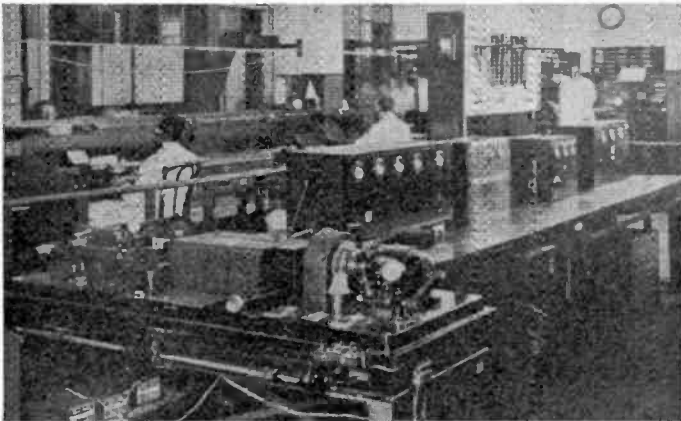

Fig. 4—Transradio Buenos Aires photoradio installation.

is shown installed between two apparatus racks, which hold the fork standard and the transmitting and receiving vacuum tube apparatus.

Fig. 4 is a photograph of the Transradio photorado installation at Buenos Aires. The machine apparatus is shown in the foreground with the vacuum tube apparatus mounted on a table just to the rear.

Fig. 5 is a photograph of the Reichspost photorado and telephoto apparatus room at Berlin. Apparatus used for continental wire-line and radio service is also shown.

A more detailed description of the component parts of the system follows.

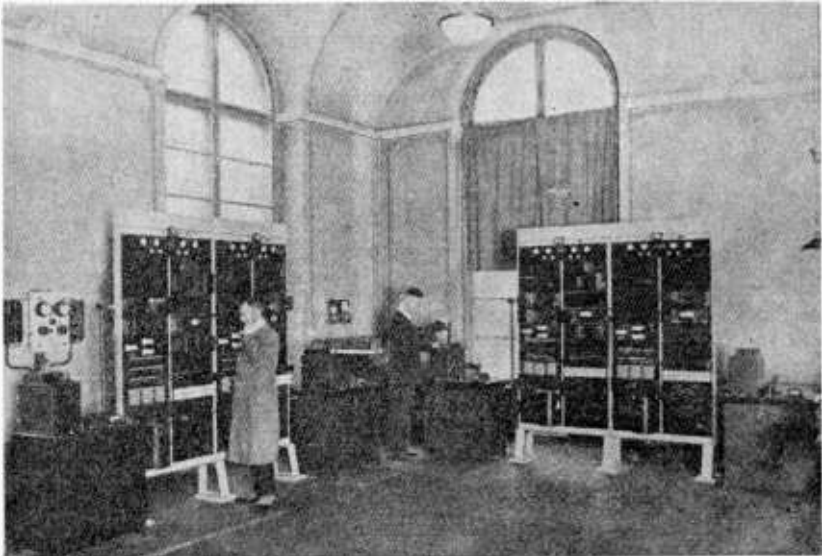

Fig. 5—Reichspost Berlin photorado installation.

II. INTERNATIONAL EQUIPMENT AND OPERATING STANDARDS

Coöperative operation of the present international photorado circuits by R.C.A. Communications, Inc., and the several foreign administrations, makes necessary equipment and operating standards. It is impossible to expect all interested administrations to agree absolutely on design and manufacturing details. Agreement on basic design points with the various equipments arranged to meet an "Index of Coöperation," will make possible commercial results.

There are four basic design points upon which agreement is necessary if successful international photorado operation is to be experienced. International agreement has been reached on these four points as indicated below:

1. A drive accuracy of at least one part in 100,000.
2. A drive source correction of seven parts in 100,000.
3. A positive means of pre-transmission phasing. This can either be automatic or manual.
4. Agreement on at least two drum speeds is provided. These speeds are 30 and 60 revolutions per minute.

In addition to agreement on the above design points, it is necessary in order to allow reasonable freedom of choice to the individual companies in the matter of drum diameter and line advance pitch, to agree on an "Index of Coöperation." A standard Index of Coöperation permits two stations having different drum diameters, for example, to work with one another without introducing distortion, since only an enlargement or reduction of the transmitted material will take place. The *basic* Index of Coöperation can be defined as the product of the stroke length or drum circumference times the line advance, the units of both being constant. The *international* Index of Coöperation is 352, which is obtained by multiplying the drum diameter by the line advance which is equivalent to the *basic* index divided by π . The Index figure must be met within one per cent in order to hold the distortion within commercial limits. Table I illustrates the importance of the Index of Coöperation principle.

TABLE I

	RCAC	LONDON	BERLIN
Diameter of cylinder	74.54 mm	88 mm	66 mm
Line advance (Lines per mm)	4.72, 5.90, 9.45	4, 5, 8	5-1/8
Index of Coöperation	352, 440, 703	352, 440, 704	352

It will be observed from this table that although three different drum diameters are used, nevertheless, because of a common Index of Coöperation of 352 between RCAC, London and Berlin, these three stations can work with one another. In addition, RCAC can work with London using two other values of line advances since again they have a common Index of Coöperation.

International coöperation on photoradio standards has been through the medium of the CCIT (International Consulting Committee on Telegraph Communications), Berne. The suggestions on standards advanced by interested parties can be found in the CCIT Committee reports.^{6,7}

⁶ CCIT Third Conference, Berne, May, 1931.

⁷ CCIT Fourth Conference, Prague, August, 1934.

III. SYNCHRONIZING SYSTEM

1. Brake Control

The arrangement employed to furnish drive power to the subject drum and line advance gear boxes consists of a special driving unit and thermionic brake.

The driving unit consists of a shunt-wound direct-current motor and an inductor alternator, the combination mounted on a common shaft. With the common shaft turning at its operating

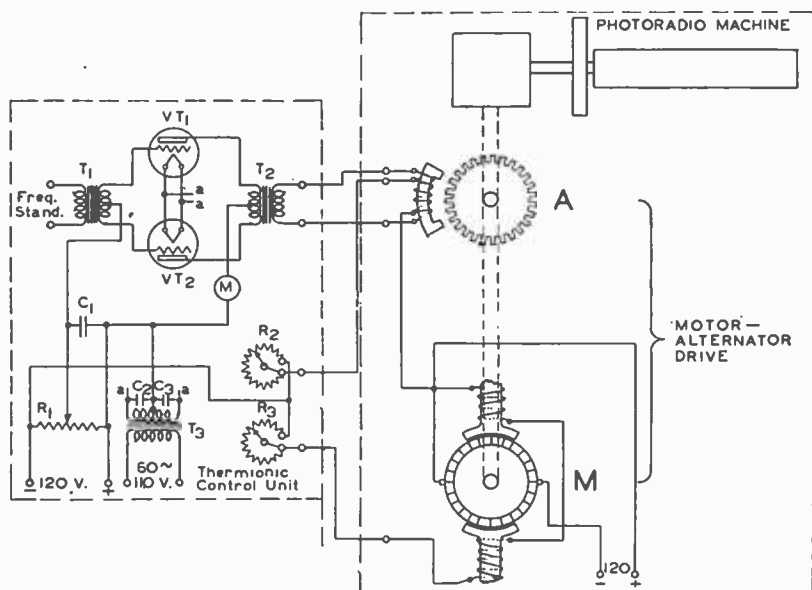

Fig. 6—Schematic layout of thermionic brake.

speed of 1800 revolutions per minute, the alternator will generate a frequency of 810 cycles per second, which is the same as that delivered by the frequency standard.

The thermionic brake consists of a pair of vacuum tubes connected in push-pull with transformer coupling between the anodes and the alternator, and between the frequency standard and the control grids.

Fig. 6 illustrates the drive arrangement schematically. The control grids of VT_1 and VT_2 are normally biased to cutoff. When tone excitation is supplied through input transformer T_1 , the control grids of VT_1 and VT_2 are alternately blocked and unblocked. The anode voltage for VT_1 and VT_2 is supplied through transformer T_2 from the armature windings of the

alternator *A*. Motor *M* of the driving unit *A-M*, is adjusted so it will run slightly faster than the synchronous speed, which is 1800 revolutions per minute. With constant 810-cycle excitation of a high order of accuracy supplied to the control grids of VT_1 and VT_2 , the action of the anode circuit on the alternator will furnish the desired braking by varying the flux through the pole pieces shown in conjunction with *M*.

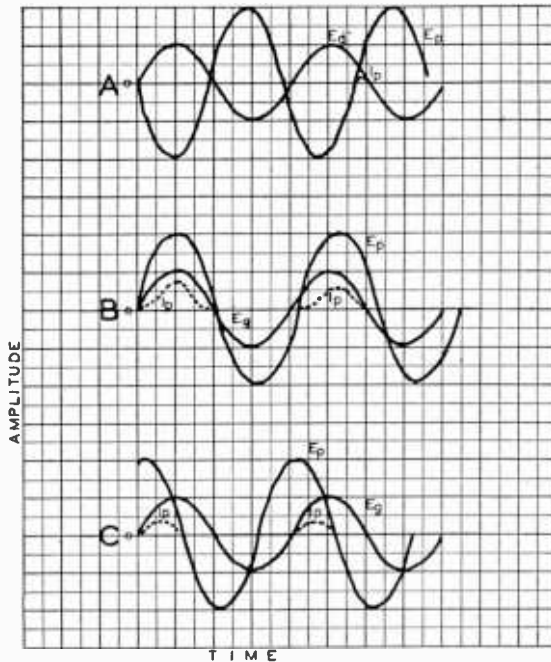

Fig. 7—Characteristic curves for thermionic brake.

Fig. 7 illustrates in graphic form the action of the brake circuit. Curve *A* is a possible condition immediately after the system has been switched on. The anode voltage E_p in this case has started exactly 180 degrees out of phase with the standard frequency grid control voltage E_g and is of course slightly higher in frequency. The anode current I_p is thus practically negligible at the start, therefore there is very little load on the alternator and the driving unit is free to run ahead of synchronous speed. As this condition continues, however, E_p draws more and more nearly into phase with E_g and I_p , and thus the alternator load increases to a value sufficient to slow the motor below synchronous speed, producing a condition illustrated by curve *B*. Since the alternator output E_p is now of lower frequency than

E_g , the two voltages will once more slip out of phase, and the driving unit, being more lightly loaded, will again speed up. This condition results in mechanical oscillation or "hunting". The constant of the system is such that the oscillations are highly damped, and the system soon reaches the condition of equilibrium

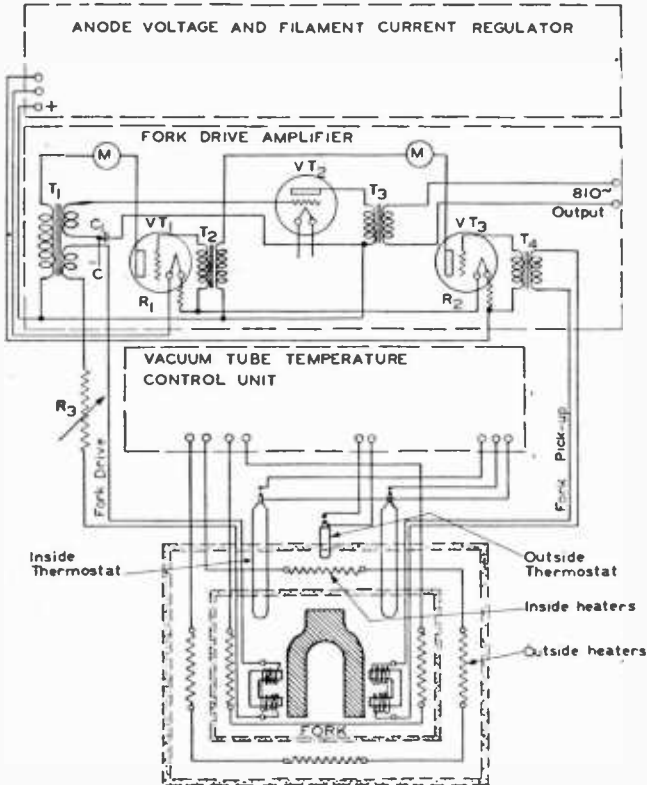

Fig. 8—Schematic layout of frequency standard.

illustrated by curve *C*. In this state the speed of the driving unit is exactly synchronous, so that a steady load I_p is supplied by the alternator, its value depending on the phase angle between E_p and E_g . It follows that at equilibrium the phase angle between the synchronizing tone and the alternator electromotive force must supply a load current of such value as to maintain the equilibrium phase angle.

2. Frequency Standard

In order to maintain the drive accuracy specified by international standards, a temperature controlled tuning fork with vacuum tube drive is used as a primary standard.

Maintenance requirements dictated the division of the stand-ard into several specific units. Fig. 8 illustrates diagrammati-cally the several units. In Fig. 1, on the left-hand rack, there are two of the standards in operation at the New York central office. The outside bays house the standards, the fork units being at the bottom with their associated units mounted above.

The fork unit proper is a double temperature controlled cabinet. The thermostats are of the sealed contact mercury type. The inner and outer compartments are held to approxi-mately 45 degrees centigrade. The fork is made from cold-rolled steel and cut to vibrate very close to 810 cycles per second. Tem-perature control and a variable resistance in the fork drive circuit are used for adjustment to the desired frequency.

The thermostat contacts in the fork unit control the excita-tion for a pair of vacuum tubes in the control unit, which, in turn, actuate relays, thereby causing voltage to be thrown on and off the fork box heater units. Control is held to 0.01 degree centigrade.

The drive amplifier is a straightforward transformer coupled arrangement. VT_1 and VT_3 are the drive and pickup tubes with VT_2 supplying the necessary power amplification for the output bus circuit. The filament, bias and anode supply for VT_1 and VT_3 , and the anode supply for VT_2 are regulated in order to minimize the effect of supply voltage variations. R_3 , in the fork drive circuit, provides the seven parts in 100,000 matching control required by international standards.

IV. UNIVERSAL MACHINES

The photoradio machine is arranged to serve either as a transmitting scanner or a recorder, the unit mounted on the lead screw carriage determining the function to be performed.

The component parts are mounted on an aluminum base casting thirty-three inches long by nineteen inches wide by two inches high. On the base are mounted the motor alternator unit, subject drum gear box, line advance gear box, subject drum assembly, and the line advance lead screw with carriage track assembly. The complete assembly is illustrated by Fig. 9. The machine shown is arranged for visual recording.

The important operating features consist of a wide range of drum speeds and line advances, service flexibility, and subject-drum loading. They will be described briefly as follows:

1. *Drum Speeds and Line Advance*

The subject drum speed can be varied by means of a simple four-step gear shift from 20 to 60 revolutions per minute. By changing the worm and worm-wheel combination inside the gear box from a "single entry" to a "double entry," two more steps are provided, namely, 80 and 120 revolutions per minute. The line advance may be varied in twelve steps between 40 and 300 lines per inch by means of a simple gear shift.

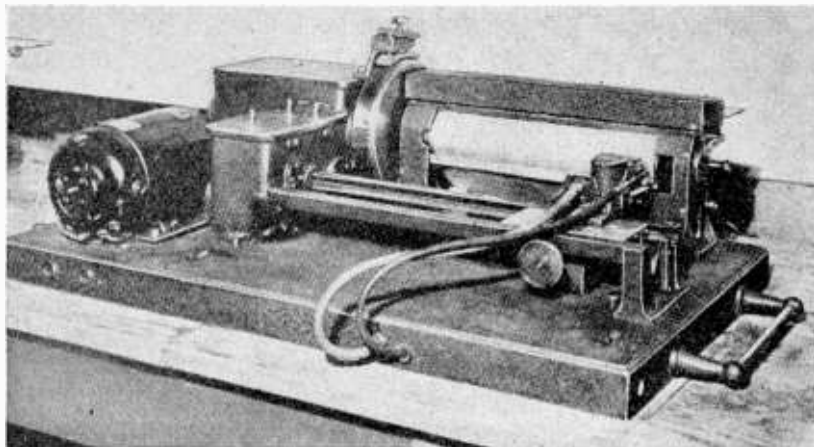

Fig. 9—Universal photoradio machine.

2. *Service Flexibility*

As mentioned above, either a transmitting scanner or recording unit can be readily fitted to the line advance carriage. This is a necessary feature judged from an initial expense and operating standpoint.

3. *Subject-Drum, Loading, etc.*

The subject drum assembly consists of the subject drum proper, loading arrangement, and gear box coupling.

The subject drum is made of aluminum alloy. It is carefully balanced and its end shafts connected to rigid supports through ball bearings. A portion of the drum periphery is cut away in order to provide space for the gripper fingers, which engage the leading and trailing edges of the subject or recording surface.

To load, the recording surface is placed on a platform positioned directly to the rear and tangent to the top of the drum. A set of feed rollers and stops are mounted directly over the drum, the point of fastening for this assembly being the drum

supports. The stops at all times just clear the drum surface, whereas the feed rollers are let down on to the drum surface during the loading operation by means of a lever. Bringing the feed rollers into play, clears the subject or record surface from the stops, forcing it against the drum surface. When the cutaway portion of the drum periphery is below the rollers, the surface in question is forced downward, thereby causing the grippers to engage first its leading edge and then when the drum revolution has been completed, its trailing edge. To lift the feed rollers after the loading operation has been completed, the control lever is thrown back.

The cam motion required for the unloading operation is started by pressing a push button which is mounted on the right-hand drum shaft support. This operation clears the grippers, thereby allowing the subject or record surface to be removed by the motion of the drum.

The connection between the drum and gear box is a combination flywheel brake and a special jaw type coupling. The flywheel brake assembly is used to minimize gear ripple and drum unbalances. The coupling is of the general jaw type but is arranged to work against rubber and springs. This arrangement absorbs the loading shock, eliminating the sudden load shift on the drive source. Table II lists detailed information on the photoradio machine used by R.C.A. Communications, Inc.

TABLE II

Diameter of cylinder	74.54 mm	2.93"
Circumference of cylinder	234.19 mm	9.22"
Gripping loss	19.05 mm	0.75"
Exposed circumference	215.15 mm	8.47"
Max. skew-index 1100*	3.36 mm	0.132"
Total gripper and skew loss	22.41 mm	0.86"
Useful subject width	211.6 mm	8.34"
Total length of cylinder	304.8 mm	12."
Useful length of cylinder	304.8 mm	12."
Scanning lines per mm or inch	mm	Inch
	1.58 4.72	40 120
	1.97 5.90	50 150
	2.36 6.30	60 160
	2.95 7.87	75 200
	3.15 9.45	80 240
	3.94 11.81	100 300

Scanning Strokes or } Drum Speeds per min. }	20, 30, 40, 60, 80, 120
Index of Cooperation	117, 146, 176, 220, 234, 293 352, 440, 469, 586, 703, 879

$$* \text{Max. skew shown} = 1100 \times \frac{1}{100,000} \times \text{total length of cylinder}$$

V. TRANSMITTING SCANNER

1. Requirements

The transmitting scanner assembly provides the means for converting variations in picture density to audio carrier modu-

lation. If the carrier modulation is a linear function of the picture density variations, and various forms of distortion are held under control, an accurate conversion of picture density changes will result.

The points which must be given attention if an efficient transmitting scanner is desired are as follows:

- (a) Scanning lamp
- (b) Optical system
- (c) Scanner output fidelity
- (d) Black-white contrast
- (e) Black output level
- (f) Setting drift
- (g) Maintenance

(a) The scanning lamp should be of the single unit type with a power requirement of not more than 75 watts.

(b) The optical system as a whole should be as simple as possible consistent with reasonable efficiency. The diaphragm should have height and width adjustments and should be calibrated. The design should be arranged for reflected light, using positive subject copy. Ordinary room lighting should offer little or no interference.

(c) The scanner output should be linear as a function of density. The wave form should be sinusoidal.

(d) The ratio between the black and white output levels should be at least three to one.

(e) Noise pickup dictates some output on black in place of the theoretical zero. A minimum of —25 decibels below zero level (1.92 volts across 600 ohms) allows for satisfactory operation.

(f) Contrast setting drift must be held to zero at least during the time required to transmit a picture.

(g) Although size suitable for mounting on the line advance carriage is essential, the layout of parts should be consistent with practical maintenance.

2. Scanner Optical System

The reflected light principle of scanning is used. That is, a light source is projected on to the positive subject copy and the result reflected into the phototube.

The optical system assembly is mounted on the subject drum side of the scanner chassis box which, in turn, is fastened to the line advance carriage. The scanner chassis box is positioned five inches from the subject drum and the side facing the drum is six and one-half by six inches. Therefore, the space available

for the optical system assembly is eight and one-half by six by five inches. Of this space the assembly makes use of approximately five by four by five inches. Fig. 10 illustrates the physical arrangement.

A standard 75-watt automobile headlight lamp is used for the scanning lamp. It is operated at approximately three-fourths of its rated value, thereby increasing the useful life. The housing provided completely encloses the lamp but louvres in the sides and bottom supply sufficient ventilation. Horizontal and vertical adjustment of the lamp base is furnished in order that the lamp may be properly centered.

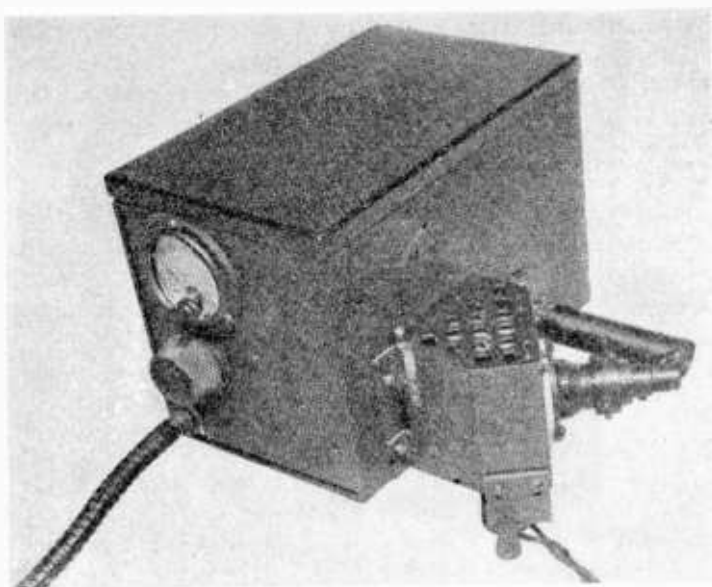

Fig. 10—Transmitting scanner.

The lens barrel between the lamp and the subject drum contains two lenses and the diaphragm assembly. The lens directly after the lamp is supplied for condensing purposes and the lens facing the subject drum is supplied to focus the diaphragm image on the subject drum. The diaphragm adjustments are such that a rectangular image will result with the height and width under control. These adjustments are calibrated, the width in lines per inch corresponding to the line advance and the height in thousandths of an inch. The width adjustment is necessary to avoid scanning line overlapping. The height adjustment is necessary to minimize aperture distortion, which has been re-

ported on in detail by Mertz and Gray of the Bell Telephone Laboratories.⁸

The lens barrel between the subject drum and the phototube contains one lens, a pickup lens, and is mounted at the subject drum end of the barrel. This lens picks up the reflection of the diaphragm image and directs it, slightly enlarged, on to the phototube. The system is only concerned with the reflection of the diaphragm image and therefore ordinary room lighting does not seriously affect the phototube.

3. Scanner Circuit Arrangement

There are possibly several circuit arrangements available which would come close to or meet the scanner specifications listed in Section V, 1. A straight audio-frequency amplifier following the phototube with mechanical interruption of the light beam, is possibly the most favored arrangement. If the modulated carrier output of the scanner could be used for direct control of a wire system or a radio transmitter, then the mechanically produced carrier would be entirely satisfactory. Where it is necessary to convert the modulated carrier output of the scanner into varying length dots, it is important to remove all chance of spurious modulation. The spurious modulation, if present, will cause serious beat interference in the recorded dot pattern. A slight misalignment of bearings, dirty mirror faces, etc., are typical causes of spurious modulation.

In order to avoid the troubles just mentioned, a circuit arrangement has been adopted which is entirely electrical in operation, employing vacuum tube technique throughout. The arrangement is in the form of a balanced grid modulator, the carrier being obtained by frequency multiplication of the 810 cycles supplied by the frequency standard, and the unbalancing effect by the phototube current changes. The output of the modulator is then amplified by a single push-pull stage in order to avoid the possibility of distorting the desired sinusoidal wave form.

Fig. 11 illustrates diagrammatically the complete transmitting scanner. *LP* is the scanning lamp, *L₁* the diaphragm condensing lens, *DF* the double diaphragm assembly, and *L₂* the lens which performs the function of focusing the diaphragm image on the subject drum. The line *S-S* is the subject drum surface. The reflected diaphragm image is picked up by lens

⁸ Mertz and Gray, "Theory of Scanning," *Bell Sys. Tech. Jour.*, vol. 13, pp. 464-515; July, 1934.

L_3 , a slight enlargement being impinged on the phototube PC . The phototube employed consists of two electrodes contained in a small gas-filled glass bulb. One electrode, the cathode, is a semicylindrical sheet of metal which has a surface sensitized with a film of caesium. The other electrode, the anode, consists of a small wire placed in the axis of the cathode surface. VT_1 and VT_2 are the modulator tubes. The carrier tone is fed to VT_1

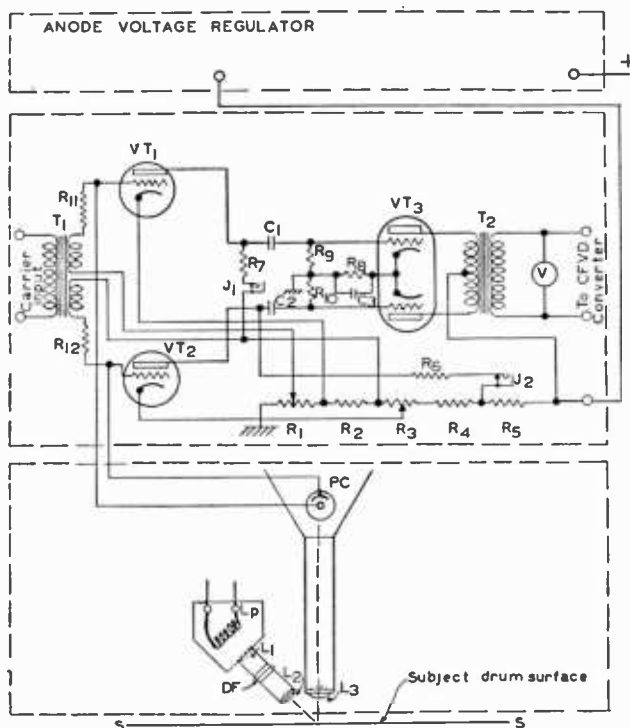

Fig. 11—Schematic layout of transmitting scanner.

and VT_2 through transformer T_1 , the connection being push-push. R_1 and R_3 are used to set the initial balance and R_3 alone for contrast change. The phototube current changes through R_{11} and R_{12} , and the voltage divider resistance assembly, furnish the modulating potential. The anode circuit unbalance between VT_1 and VT_2 caused by the modulating potential, allows VT_3 to be excited by a modulated carrier, the modulation being a linear function of the voltage appearing in the input circuit. VT_3 is a double triode. The meter V connected across the output terminals is a rectifier type voltmeter and is useful for checking contrast settings. Low voltage direct current is supplied to the heaters of the vacuum tubes from a common battery supply. The

anode requirements are furnished from the common battery supply through a glow tube regulator in order to minimize supply voltage variations.

Fig. 12 shows graphically the type of response obtained from the balanced grid modulator type of transmitting scanner. The response is essentially a linear function from 0.4 to 1.4 volts (600-ohm load). This provides a black-white ratio of at least three to one and a black level high enough to eliminate noise pickup troubles.

The arrangement illustrated by Figs. 10 and 11 is mounted in compact chassis form, the chassis being mounted inside the scanner box. As has been mentioned previously, the box is fastened to the line advance carriage. The right-hand end of

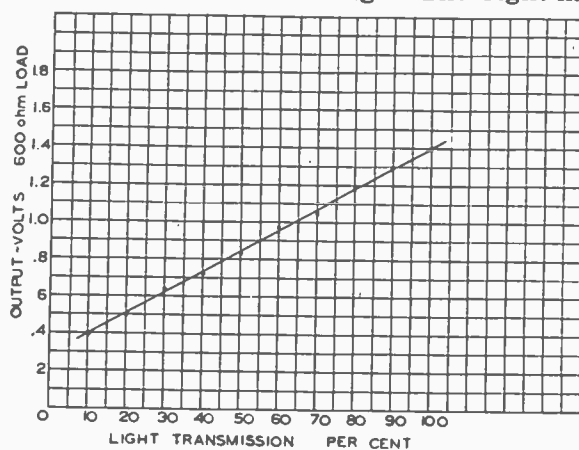

Fig. 12—Light response characteristic of RCAC BGM scanner.

the scanner box is a portion of the chassis and forms the mounting panel for the contrast control, output meter, balance checking jacks, and the supply and control cable terminations. The outside dimensions of the transmitting scanner box are eight and one-half inches long, six inches high, and five inches wide.

4. Operating Features

The optical arrangement described in Section V, 2, has made possible an improvement in efficiency of three to one over the arrangement replaced, in each case starting with approximately the same amount of illumination. A single standard low cost lamp is now used in place of two special prefocused lamps. The use of only a small area of reflected light has reduced the effect of room lighting. Definite calibrated adjustments make possible accurate duplication when required.

The balanced grid modulator type scanner circuit eliminates the lack of fidelity experienced heretofore on the black end of the density scale. It provides an output free of spurious modulation which is essential for dot conversion. The picture contrast adjustments are simple, and stable operation allows accurate holding of a given contrast setting and permits a return to a given setting if desired.

VI. TRANSMITTING CONVERTER

1. *Radio Circuit Transmission Characteristics*

The use of the band from 3000 to 30,000 kilocycles, as at present, for long-distance communication, has brought about a marked improvement in over-all efficiency, but at the same time has introduced circuit distortion which is a serious handicap to picture handling if normal technique is employed. The circuit distortion experienced takes the form of round-the-world echoes, multipath echoes, and complete or selective fading. The effect of these various forms of circuit distortion have been studied carefully by our receiving engineering group and also by other engineers, notably T. L. Eckersley.⁴ The circuit distortion phenomena are subject to wide variations from minimum to maximum, both slow and rapid. This being the case, direct control of the radio transmitter by the scanner modulation will produce a picture modulated radio-frequency carrier, which, when intercepted at the radio receiving station, is subject to distortion due to selective fading, resulting in a "streaky" picture under adverse fading conditions.

Radiotelegraph research teaches that if the radio-frequency carrier can be keyed definitely on and off, using a time basis for signaling, the troublesome circuit distortion can be compensated for, to a commercial degree, at the receiving station. This means of minimizing the circuit distortion at the radio receiving station when telegraph time basis keying is used to control the radio-frequency carrier is called "Diversity Receiving Technique." The diversity receiving system employed by R.C.A. Communications, Inc., has been reported on by H. H. Beverage and H. O. Peterson.⁹ Either this system or methods which will produce similar results are used on all successfully operated long-distance short-wave circuits.

2. *Photoradio Application of Keyed Radio-Frequency Carrier*

With stable high speed radiotelegraph circuits available,

⁹ Beverage and Peterson, "Diversity Receiving System of R.C.A. Communications, Inc.," *Proc. I. R. E.*, vol. 19, pp. 531-584; April, 1931.

means were found to convert the scanner modulation into dot keying. With the method used prior to 1930, both the dot keying rate and weight were varied in something that closely approached a linear function of the half-tone picture controlled scanner modulation. A double modulated multivibrator circuit was employed to accomplish this conversion. It has been described in papers given before the Institute by R. H. Ranger.^{1,2,3} This arrangement proved to be a marked improvement over direct modulation control of the radio transmitter, but still left much to be desired, both from a circuit handling and half-tone reproduction standpoint.



Fig. 13—Multivibrator—CFVD recording comparison.

Since 1930, improvements in the photoradio dot keying method have been made which make possible the linear response and half-tone detail desired, as well as a keying arrangement which allows for maximum radio circuit efficiency. The new method holds the dot keying rate and amplitude constant, varying only the weight as a linear function of the picture half-tone controlled scanner modulation. As mentioned in Section I, the new keying method is called "CFVD" or "Constant-Frequency Variable-Dot Keying." A comparison of a recording made by the two dot keying methods is shown in Fig. 13. The right-hand portion was recorded using the multivibrator dot converter and the left-hand portion by using the CFVD dot converter. An

improvement in the amount and smoothness of half-tone detail can be noted. The multivibrator dot keying rate used was of the order of 300 cycles per second and the CFVD dot keying of the order of 175 cycles per second, the same drum and line advance being used in each case.

A description of the CFVD system follows.

3. CFVD Converter

(a) General Theory

A broad picture of the CFVD arrangement is essential before the associated parts are examined in detail. Reference to Fig. 14, which is in block diagram form, will assist in viewing this broad picture.

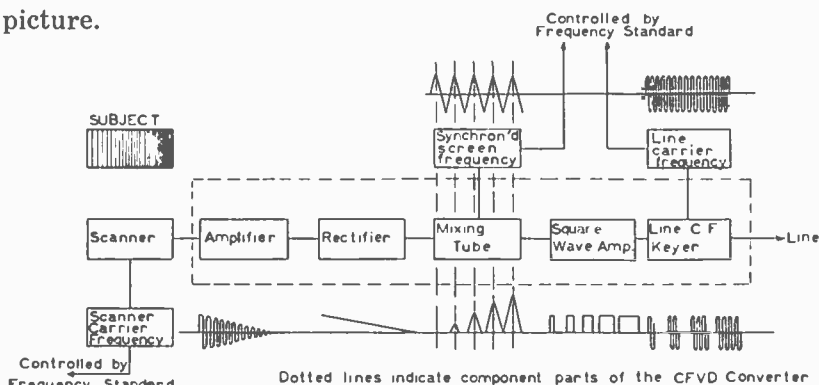

Fig. 14—Block diagram of constant-frequency variable-dot photoradio system.

The component parts directly associated within the CFVD converter, are shown within the dotted line. They are a single stage audio amplifier, a full wave rectifier, a mixing tube, a square wave amplifier, and a line carrier frequency keyer. The synchronized screen frequency and line carrier frequency units although mounted outside, are essential parts of the converter. The operating sequence and the functions performed by the various parts of the arrangement are as follows:

The transmitting scanner, which has been described under Section V, supplies the modulation which results from scanning the subject illustrated. The scanner output is then amplified and rectified. The resulting wave form is indicated below each unit. The mixing tube, in the form of a triode, has a portion of its grid bias under the control of the rectifier output. The fixed portion of the mixing tube grid bias is adjusted so the tube is at cut-off when the rectifier output is minimum. With this arrangement, saw-tooth wave form voltage from the synchro-

nized screen frequency unit is supplied in series with the mixing tube grid. The saw-tooth wave form voltage and the rectifier output voltage combine to produce the varying anode current pulses illustrated below the rectangle marked "Mixing Tube." The next step is to provide a circuit arrangement which will deliver constant amplitude varying weight dots, the weight and recurring rate governed by the mixing tube anode circuit pulses. This function is performed by the square wave amplifier. With the CFVD dots available in direct-current form, the next step is to use this direct-current form as keying bias on a tone keying stage, the output of which supplies keyed carrier to the radio

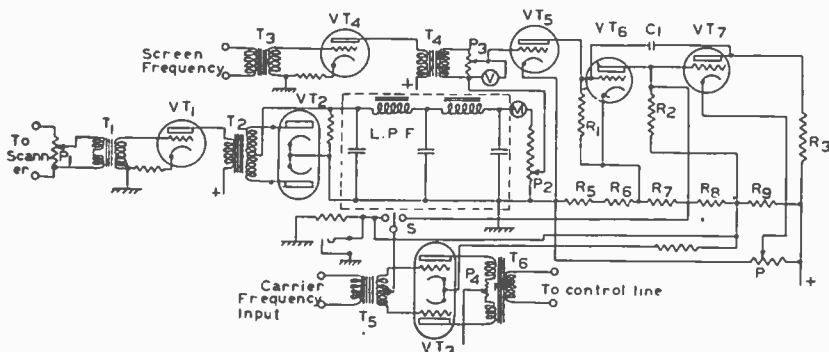

Fig. 15—Schematic layout of constant-frequency variable-dot converter.

transmitter control line. These steps will be described in more detail later. It is important to note that all audio-frequency requirements are controlled by the same source, namely, the 810-cycle frequency standard. This is necessary in order to eliminate recorded dot pattern beat interference.

(b) Circuit Arrangements

Low voltage direct current is supplied from a common bus to the heaters of all vacuum tubes. Individual unit glow tube regulation of the common source of high voltage supply is provided.

(i) Converter

Fig. 15 illustrates schematically the circuit arrangement of the component parts directly associated inside the converter unit. The scanner modulated carrier is connected to the converter through potentiometer P_1 . Its route through to the mixing tube can be traced via transformer, T_1 , vacuum tube VT_1 , transformer T_2 , full wave rectifier VT_2 , and the low-pass keying filter $L.P.F.$, with the rectified modulation voltage appearing across potentiometer P_2 .

The screen frequency is supplied to the converter through T_3 . It reaches the mixing tube through vacuum tube VT_4 , transformer T_4 , and potentiometer P_3 .

The mixing tube VT_5 , has potentiometer P_2 for adjustment of rectifier output voltage and potentiometer P_3 for screen frequency level adjustment.

The square wave amplifier is composed of vacuum tubes VT_6 and VT_7 , resistances R_2 and R_3 , potentiometer P and condenser C_1 . The voltage divider R_5 to R_9 inclusive supplies the necessary anode and bias voltages. The square wave amplifier is essentially a resistance coupled amplifier trigger circuit, the trigger regeneration being furnished by C_1 , and the duration of maximum amplitude being determined by the amplitude of the pulses in the mixing tube anode circuit.

The push-pull tone keying stage consists of the double triode vacuum tube VT_3 , and transformers T_5 and T_6 . The keying bias

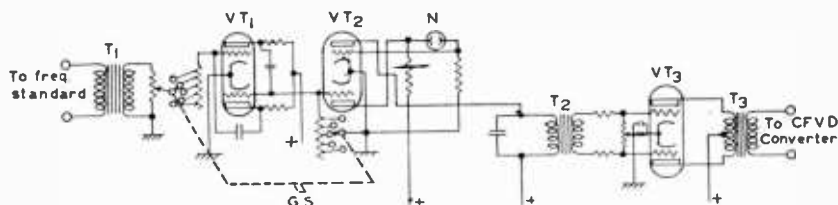

Fig. 16—Schematic diagram of synchronized screen-frequency unit.

is obtained from the anode circuit of either VT_6 or VT_7 , depending on the bias polarity desired. Switch S furnishes means for hand keying if service requirements so dictate.

(ii) Synchronizing Screen-Frequency Unit

The screen frequency unit is shown diagrammatically in Fig. 16. The arrangement is essentially a controlled multivibrator, the wave form of the frequency generated being converted to a saw-tooth envelope. The saw-tooth wave produced is then amplified by a high quality stage, the result then being suitable for the CFVD converter screen frequency requirements.

The 810-cycle standard frequency is used for control and is connected to the multivibrator vacuum tube VT_1 , which is a double triode, through transformer T_1 and its associated potentiometer. A gang switch GS varies tapped resistors connected to the input and output of the multivibrator divider, thereby producing the five desired frequencies. The double triode VT_2 serves the dual purpose of rendering symmetrical the distorted output of the multivibrator through the agency of the neon tube,

(iv) Phase Shift

The printing art has demonstrated the value of "screening" a subject in order to lay down half-tone values. The CFVD photoradio system provides an electrical screening which may be varied as the subject drum speed and screen frequency dictate. Radio circuit conditions dictate the drum speeds and screen frequencies which may be used at any given time. In order to provide the proper screen mesh when screen frequencies and drum are changed, a variation in the mesh control is required.

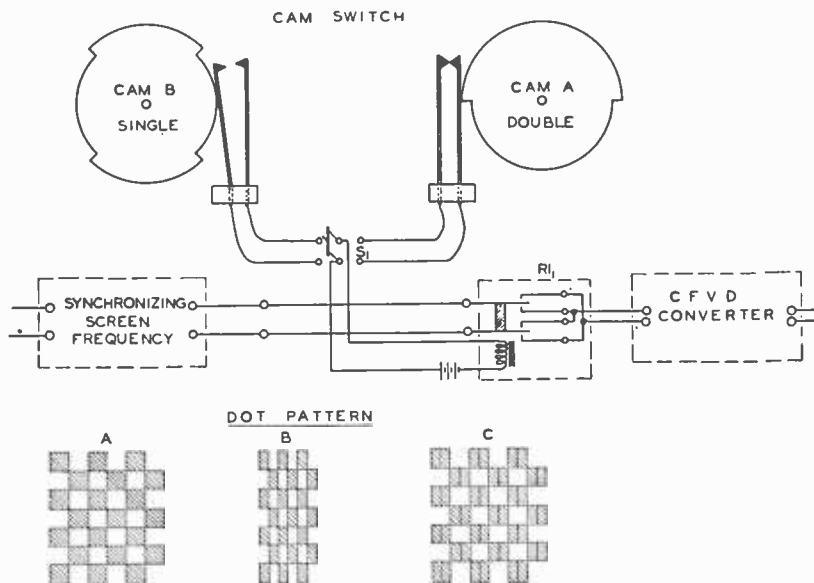

Fig. 18—Schematic layout of screen-frequency phase shift.

The electrical screening is provided by reversing the polarity of the screen frequency voltage fed to the CFVD converter at the desired rate. This is accomplished by means of a cam and contact assembly mounted on the universal photradio machine drum shaft and a relay mounted adjacent to the CFVD converter.

Fig. 18 illustrates in schematic form the reversing arrangement and the resulting recorded dot patterns. Experience indicates that a so-called double and single phase shift will satisfy the majority of cases. If a wider range of drum and screen frequencies were normally used, a somewhat different phase shift rate possibly would be required.

The dot pattern plans illustrated indicate the result of phase shift. A illustrates a recording at high drum speed and screen

frequency using a single phase shift; *B*, a single phase shift, but at lower drum speed and screen frequency; *C*, a double phase shift with the drum speed and screen frequency the same as *B*.

4. Half-Tone vs. Black-and-White Transmission

Half-tone transmission using the screen frequency converter has been described under Section VI. 3. Naturally, half-tone material represents only a part of the photoradio business handled. Therefore, means must be made available for sending black-and-white material as well as half-tone. Only a simple change is required to make possible the transmission of black-and-white material. This change is to open the synchronized screen frequency input to the CFVD converter. The rate and weight of the pulses passed on to the square wave amplifier portion of the converter will then be governed by the type of black-and-white material being scanned.

5. Keying Speed Analysis

An analysis of the CFVD keying is supplied as Appendix A. This analysis illustrates in mathematical and diagrammatic form the effect of circuit distortion when using CFVD keying and, also, suggests radio transmitting and receiving station equipment requirements if minimum distortion is desired.

VII. RECORDING ARRANGEMENTS

The ideal recording method is, of course, visual, with the ability to view the picture during the process of recording. It is also important that a visual system be linear, laying down the proper density proportion. The ability to produce multiple copies quickly is essential. If it is not possible to supply a visual system which will furnish the type of service required, the alternative is some form of photographic recording. At the present time photographic recording either on film or bromide paper is the accepted form of commercial photoradio recording.

Although accepting photographic recording for commercial work at the present time, the idea of visual recording has not been given up. Two methods of visual recording which meet at least a portion of the requirements are being used quite successfully by R.C.A. Communications, Inc., and its associated Company, RCA-Victor. RCA-Victor has carried on the development of the so-called "carbon recorder" whereas R.C.A. Communications, Inc., have been active with an arrangement called "ink vapor recording." At the present time, R.C.A. Communications, Inc., makes use of the "ink vapor recording" to monitor

all incoming and outgoing photoradio business. This provides an instantaneous check on the circuit operation.

The two recording methods used by R.C.A. Communications, Inc., will be described in the following paragraphs.

1. Visual

The arrangement used for visual recording is illustrated in schematic form by Fig. 20.

The vacuum tube assembly which delivers the signal energy to the vapor control is shown at the top of the figure. The signal furnished by the radio receiving station is amplified by the

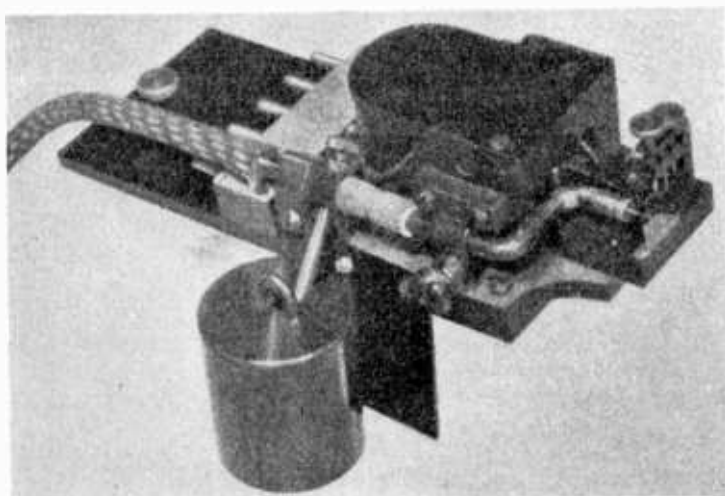

Fig. 19—Visual recording gun unit.

vacuum tube VT_1 and its associated input and output transformers T_1 and T_2 . The diode-triode vacuum tube VT_2 rectifies the signal and, also, combined with vacuum tube VT_3 , provides a degree of limiting and stage reversing required to excite properly the power tubes VT_4 and VT_5 . The output of the power tubes is connected to the signal winding of an electrodynamic unit, shown mounted on the lead screw carriage of a photoradio machine. The field FS of the gun unit can be either of the fixed magnet type or energized from available bus voltage. The armature ST of this unit is arranged to form a moving shutter or deflection plate for the ink vapor directed by pressure through nozzle NZ . Valve V and its associated waste bottle, is provided in order to furnish constant pressure without ink splatter throughout a given drum revolution. Approximately eight to

ten pounds of pressure is maintained into the atomizer container.

With the system in operation, a series of black marks will be recorded with every turn of the drum. The width of the mark, fixed by the nozzle size, is made to correspond to the line advance, and the number and length per drum revolution are dependent upon the CFVD keying being transmitted. Tests have indicated that the gun movement will follow screen frequencies as high as 1000 cycles with sufficient amplitude.

Fig. 19 is a photograph of a typical gun unit. Close examination will reveal the parts mentioned in the description of the unit.

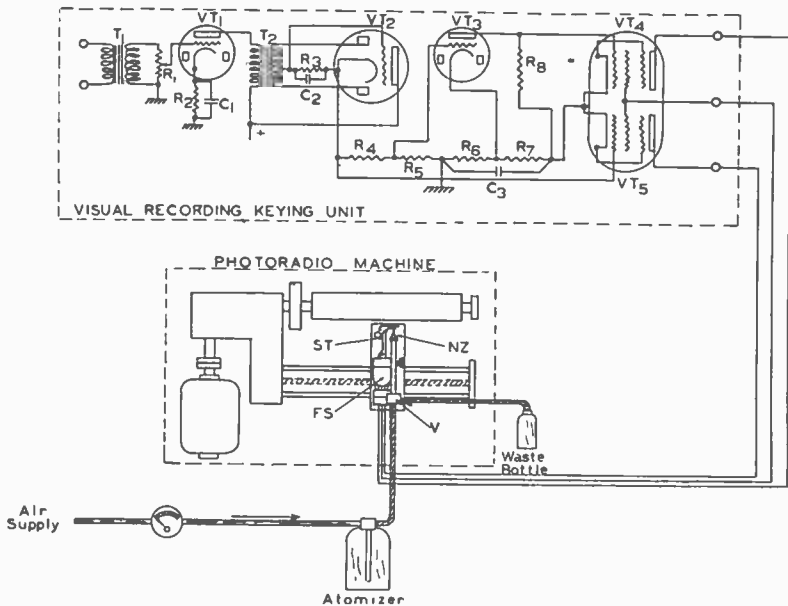

Fig. 20—Visual recording schematic layout.

The ink used is a black dye combination soluble in alcohol. The ordinary letterhead weight and quality paper is satisfactory for a recording surface, but a glossy surface enhances the appearance. With careful handling it is difficult at times to distinguish between visual and photographic recording unless a close examination is made. With ordinary handling the results obtained provide an excellent check on circuit operation.

2. Photographic

The arrangement used for photographic recording is illustrated in schematic form by Fig. 21.

The vacuum tube stage which makes possible either positive or negative recording, is shown at the top of the figure. The tone signal received from the receiving station is rectified before

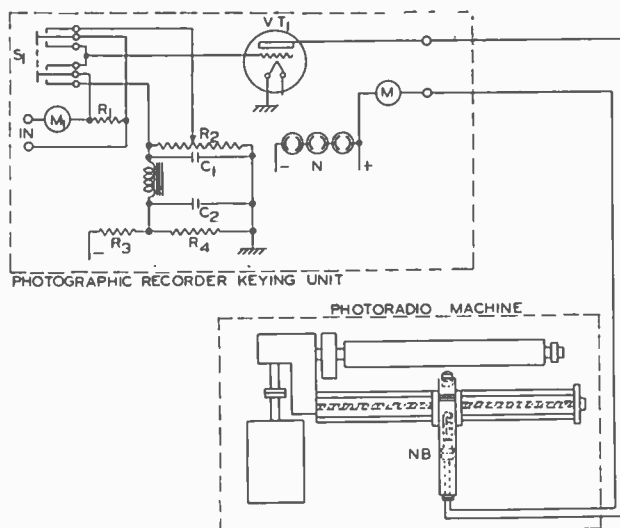

Fig. 21—Photographic recording schematic layout.

connection to this unit. Switch S_1 allows the input polarity to be changed so that the vacuum tube VT_1 is either working down to

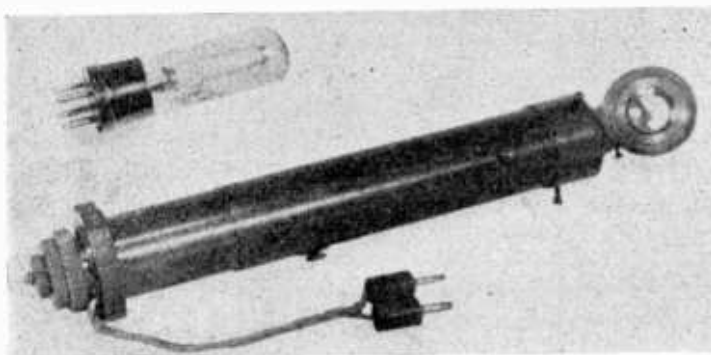

Fig. 22—Photographic recording neon and mounting barrel.

or up from cutoff. The glow tubes N provide a steady anode supply for VT_1 . The output of VT_1 is used to flash the recording glow tube NB on and off in response to the CFVD keying.

The recording glow tube has an argon-helium gas content. The light emitted is blue and contains a considerable amount of

ultra-violet. The breakdown voltage is approximately 250 volts and the operating current ten milliamperes.

The optical system is similar to that used between the scanning lamp and the subject drum. A condensing lens is used between the recording glow tube and the diaphragm which is a duplicate of that used on the transmitting scanner. The lens at the drum end of the barrel is arranged to focus the diaphragm image on the recording surface. A viewing lens is provided on



Fig. 23—Riverhead photoradio monitor equipment.

the drum end of the barrel to facilitate adjustment of the optical system. Fig. 22 is a photograph of the lens barrel assembly and the recording glow tube.

The recording surface used is either news bromide paper or Printon film. Both can be used under red or yellow light without fogging difficulties.

VIII. MONITOR

Any type of communication service where twenty-four-hour operation is required must be provided with an efficient trouble checking and monitoring arrangement. If checking and monitor-

ing methods are important for normal radiotelegraph and telephone service, they naturally assume a still greater importance when the signaling speed is several times faster, as is the case for photoradio operation. Rapidly changing radio circuit conditions require close monitoring of all outgoing and incoming pictures in order to avoid delay.

R.C.A. Communications, Inc., make use of the visual ink vapor recorder at the radio transmitting and receiving stations as well as the central office when photoradio operation is in progress. This means of monitoring is used in addition to normal meter and oscilloscope technique. Monitor arrangements of the type described assure maximum equipment efficiency, with the radio circuit the remaining variable.

If reference is made to Fig. 1 and Fig. 23, typical monitoring arrangements can be observed. In Fig. 1, which is a view of the New York office, the visual recorder is on the right end of the machine table. The apparatus rack at the right has available a volume indicator and other meter checking combinations normally used. Fig. 23 is a view of some of the monitoring arrangements in use at the Riverhead, L. I., radio receiving station. The visual ink vapor recorder and the cathode-ray oscilloscope can be observed. Similar arrangements are used at our radio transmitting stations.

IX. OPERATING TECHNIQUE

1. General

With improvements in mechanical and electrical features, it has become possible to develop an operating technique which minimizes the personal factor in setting up the CFVD converter for transmission. The method of making converter adjustments as the result of meter readings and calibration charts, enables the operator to transmit pictures with great fidelity and ease. At the same time, it becomes possible to adjust the converter accurately to take into account circuit conditions.

It is well to review the general influence of the radio circuit distortion on CFVD keying before discussing further the operating technique.

In general, assuming a perfect emitted signal from the radio transmitter, the radio circuit tends to decrease the contrast range of a picture. This is brought about by multipath transmission which adds the equivalent of a tail to the signal. This tail, then, increases the apparent weight of marking so that a transmitted twenty per cent dot, for example, would be received as a thirty

per cent dot. For the same conditions, an eighty per cent dot would be received as ninety per cent. Since contrast is defined as the ratio of the heaviest dot to the lightest, the transmitted contrast would be four while the received contrast would be three. It is apparent that the elongation is particularly disastrous when the marking is on the order of ninety per cent, because at this point filling may increase the mark time to 100 per cent at the receiving station.

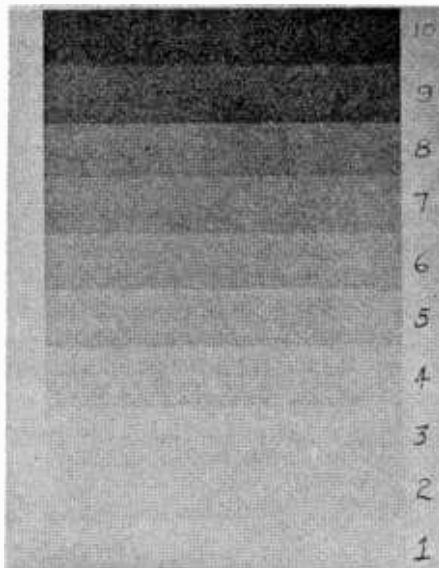

Fig. 24—Density wedge.

In order to overcome the radio circuit distortion just described, the actual marking range at the transmitter must not exceed a value such that at the receiving station the longest dot transmitted will just mark 100 per cent. Distortion control may also be increased by the proper selection of screen or keying frequency. If the actual duration in time of marking is made large, the effect of multipath tailing is not important.

With the effect of the radio circuit distortion appreciated, it can readily be understood that the operator must have means under control for expanding and contracting the contrast range transmitted.

2. *Pretransmission Requirements*

A standard test subject, calibration of essential controls, and assurance of over-all linear response is required before correction for radio circuit distortion can be applied.

The test standard requirement is met by providing a ten-step density wedge arranged as a photographic positive print with the steps ranging from white to solid black, the step spacing arranged approximately ten per cent apart. Fig. 24 illustrates the arrangement described. Care in the construction of the wedge was taken to insure a linear reflected light response when progressing through the density range. Care was also taken to provide uniform density for each step. The density wedge then provides a definite standard for calibration and test transmission.

The calibration of the photoradio transmitting equipment is dependent upon three variables; the scanner output as indicated by its output voltmeter, screen tone input to the converter mixing tube as indicated by V , Fig. 15, and the converter low-pass keying filter output as indicated by M , Fig. 15. The output value of interest for the scanner is that noted when white or wedge step 1 is being scanned. With the proper white output from the scanner, the converter standardization is accomplished by the manipulation of the screen voltage and low-pass filter output to specified standard values as indicated by meters V and M respectively and then adjusting P_2 , Fig. 15, until the converter output just "breaks white."

3. Contrast Control

With either a picture or the test wedge on the subject drum, the desired converter contrast control can be obtained by referring the M meter readings noted on black and white or the 10-1 test wedge steps, to a series of prepared charts. The charts will dictate readings which must be observed on V and M when varying the potentiometers P_3 and P_1 respectively.

4. Radio Circuit Condition Information

With the converter set for 0-100 per cent mark, the test wedge is transmitted, assigning a portion of the transmitting time to each of the several screen frequencies normally used. When the transmission has been completed, the receiving station reports on wedge step failures noted, such as 90 cycles failing steps 2 and 8, 135 cycles failing steps 2 and 8, 200 cycles failing steps 3 and 7. With this information available at the transmitting office, reference to the proper chart will supply the required readings for V and M in order to transmit 0 to 100 per cent mark. Any report indicating failures on steps 3 and 7 show lack of proper circuit contrast and therefore transmission should not be attempted.

5. Picture Acceptance Data

In order to avoid cancellation of pictures and loss of time due to poor quality of the received transmissions, it is exceedingly important that no picture be accepted in which the detail required exceeds that which it is possible to receive under average circuit conditions. The limitation of acceptance can be stated as follows.

"No picture, in which the point of interest is less than one-half by one-half inch in size should be guaranteed delivery with suitable detail."

The following Table III, of drum speeds and screen tone frequencies, gives the conditions which will provide suitable detail for the minimum area of interest of one-half by one-half inch.

TABLE III

Drum Speed	Screen Tone Frequency
20 r.p.m.	90 cycles
30 " "	102 " "
40 " "	202.5 " "
60 " "	270 " "

Under certain conditions, if a higher frequency than that indicated in the table can be used for a given drum speed, greater detail will result, but in order to protect against excessive transmission time and subsequent cancellations, the minimum area is generally adhered to.

Black-and-white acceptance is governed by the fact that type and line combinations smaller than twelve-point type formation cannot be guaranteed delivery.

CONCLUSION

The various improvements which have been reported in this paper are endeavors toward the desired goal of dependability, stability, fidelity, and ease of operation. It is felt that the CFVD principle of photoradio transmission is an important advance in the art of facsimile transmission over long-distance radio circuits. Close attention to detail is the major reason for the successful development and operation of the present-day photoradio service.

ACKNOWLEDGMENT

The authors wish to express their appreciation for the coöperation extended by their photoradio associates in Cables and Wireless, Ltd., London; Transradio Internacional Compania

Radiotelegrafica Argentine, Buenos Aires; and Deutsches Haupttelegraphenam, Berlin.

The associated subsidiary companies in the RCA organization, especially the group under the direction of Mr. C. J. Young in the RCA Victor Company, have contributed to the photoradio improvements.

Within R.C.A. Communications, Inc., Mr. W. A. Winterbottom, Vice-President and General Manager, the Engineering and Traffic Operating Groups under the direction of Messrs. C. H. Taylor and J. B. Rostron, respectively, have all furnished wholehearted support and assistance.

APPENDIX A

ANALYSIS OF FACSIMILE KEYING

In considering the CFVD facsimile system, it is of importance to know the effect of finite band width of the receiver on the quality of the reproduced signal. It is necessary also to know the effect of the ether path; i.e., fading and multipath transmission, on the signal reproduction at the receiving end.

All these factors impose distinct limitations on the maximum speed of transmission, but in spite of their combined effect commercial facsimile is entirely feasible. The individual limitations are discussed in detail below.

First, we shall consider the case of the dot envelope used to key the radio transmitter. Since the dots follow each other at a constant rate, assuming constant weight of marking, the square wave can be resolved into a Fourier series, as is well known, thus,

$$f(p) = \frac{2}{\pi} \left[\frac{\alpha}{2} + \sin \alpha \cos pt + \frac{\sin 2\alpha \cos 2pt}{2} + \frac{\sin 3\alpha \cos 3pt}{3} + \dots \right] \quad (1)$$

where α equals one half of the marking period in angular measure and ρ equals the angular velocity of the screen tone.

If a carrier of angular velocity, ω , is then modulated by such a wave as given by (1), we obtain,

$$f(\omega) = \frac{2}{\pi} \cos \omega t \left[\frac{\alpha}{2} + \sin \alpha \cos pt + \frac{\sin 2\alpha \cos 2pt}{2} + \frac{\sin 3\alpha \cos 3pt}{3} + \dots \right]. \quad (2)$$

Expanding (2) we get the well-known result,

$$f(\omega) = \frac{2}{\pi} \left[\frac{\alpha}{2} \cos \omega t + \frac{\sin \alpha}{2} \{ \cos (\omega - p)t + \cos (\omega + p)t \} \right. \\ \left. + \frac{\sin 2\alpha}{4} \{ \cos (\omega - 2p)t + \cos (\omega + 2p)t \} \right. \\ \left. + \frac{\sin 3\alpha}{6} \{ \cos (\omega - 3p)t + \cos (\omega + 3p)t \} + \dots \right]. \quad (3)$$

Equation (3) simply tells us that the transmitter emits a plurality of frequencies comprised of the carrier frequency and a number of side bands made up of the sums and differences of the carrier and harmonics of the screen frequency. It further shows that the amplitudes of the component frequencies are a function of the marking period, α .

This well-known result, may be expanded by considering the effect of the variable marking period produced in the CVFD system of transmission. Suppose we place on the record drum of the scanner a subject which varies from white to black to white sinusoidally. Then, as the drum rotates the marking period will vary from zero to 100 per cent; i.e., α will vary from 0 to $\pi/2$ and its value will be given by

$$\alpha = \frac{\pi}{2} (1 - \cos st) \quad (4)$$

where s is the angular velocity of the drum and consequently small compared to ρ and ω . Replacing in (3) by its value given in (4) and noting that

$$\left. \begin{aligned} \sin \frac{\pi}{2} (1 - \cos st) &= J_0 \left(\frac{\pi}{2} \right) - 2J_2 \left(\frac{\pi}{2} \right) \cos 2st \\ &+ 2J_4 \left(\frac{\pi}{2} \right) \cos 4st - \dots \\ \sin \frac{2\pi}{2} (1 - \cos st) &= 2J_1(\pi) \cos st - 2J_3(\pi) \cos 3st \\ &+ 2J_5(\pi) \cos 5st - \dots \\ \sin \frac{3\pi}{2} (1 - \cos st) &= -J_0 \left(\frac{3\pi}{2} \right) + 2J_2 \left(\frac{3\pi}{2} \right) \cos 2st \\ &- 2J_4 \left(\frac{3\pi}{2} \right) \cos 4st + \dots \\ \text{etc.} \end{aligned} \right\} \quad (5)$$

where J_n equals the Bessel function of the order n we obtain

$$\begin{aligned}
 f(\omega) = & \frac{2}{\pi} \left[\frac{\pi}{2} (1 - \cos st) \cos \omega t \right. \\
 & + \frac{1}{2} \left\{ J_0 \left(\frac{\pi}{2} \right) - 2J_2 \left(\frac{\pi}{2} \right) \cos 2st + \dots \right\} \{ \cos (\omega - p)t \\
 & + \cos (\omega + p)t \} + \frac{1}{2} \{ J_1(\pi) \cos st \\
 & - J_3(\pi) \cos 3st + \dots \} \{ \cos (\omega - 2p)t + \cos (\omega + 2p)t \} \\
 & + \frac{1}{6} \left\{ -J_0 \left(\frac{3\pi}{2} \right) + 2J_2 \left(\frac{3\pi}{2} \right) \cos 3st - \dots \right\} \\
 & \left. \{ \cos (\omega - 3p)t + \cos (\omega + 3p)t \} + \dots \right]. \quad (6)
 \end{aligned}$$

If (6) is expanded, we find that the angular velocities present are

ω	$\omega - p$	$\omega + p$			
$\omega - s$	$\omega - p \pm 2s$	$\omega + p \pm 2s$	$\omega - 2p \pm s$	$\omega + 2p \pm s$	
$\omega + s$	$\omega - p \pm 4s$	$\omega + p \pm 4s$	$\omega - 2p \pm 3s$	$\omega + 2p \pm 3s$	
	$\omega - p \pm 6s$	$\omega + p \pm 6s$	$\omega - 2p \pm 5s$	$\omega + 2p \pm 5s$	
\vdots	\vdots	\vdots	\vdots	\vdots	\vdots
\vdots	\vdots	\vdots	\vdots	\vdots	\vdots
	$\omega - 3p$	$\omega + 3p$			
	$\omega - 3p \pm 2s$	$\omega + 3p \pm 2s$			
	$\omega - 3p \pm 4s$	$\omega + 3p \pm 4s$			(7)
	$\omega - 3p \pm 6s$	$\omega + 3p \pm 6s$	etc.		
\vdots	\vdots	\vdots	\vdots	\vdots	\vdots

Of course, in the actual case of scanning, α does not vary sinusoidally but it does vary in a quasi-periodic fashion, so that its variation can be described by a Fourier series in terms of the angular velocity, s . The analysis is then straightforward, the series being used in (4) to derive an expression similar to that of (6). The net result would be merely to change the magnitude of the component angular velocities.

Equation (7) can be interpreted as meaning that the single discrete sum and difference frequencies, appearing as side bands, are replaced by groups of frequencies, i.e., each side band has its

own satellite of side-band frequencies whose spacing is given by $s/2\pi$. If we assume that the fiftieth harmonic of $s/2\pi$ is necessary to describe faithfully the variation of α , then the band width requirement is only increased 100 cycles over the requirement based on a fixed marking period. Consequently, in the discussion to follow on the band width requirements for facsimile keying under operating conditions, the marking period will be regarded as constant.

Present-day diversity reception with its associated limiter-keyer figuratively uses only the main body of the signal, that is, the minimum and maximum values of the signal are rejected by the threshold value and limiting action, respectively. Under these conditions, the signal exhibits an essentially linear slope from a point $12\frac{1}{2}$ per cent above its minimum value to a point $12\frac{1}{2}$ per cent below its maximum value. Accordingly, the actual signal envelope may be replaced by a trapezoidal one.

It is evident that fading will cause varying weight of marking for such an envelope since for a strong signal, the threshold value of the limiter-keyer is reached earlier than in the case of a weaker signal.

The slope of the equivalent signal at α can be determined by taking the derivative of the Fourier series, representing the square dot, and substituting α for pt .

Thus, the slope, S , is

$$S = -\frac{2}{\pi}[\sin \alpha \sin pt + \sin 2\alpha \sin 2pt + \sin 3\alpha \sin 3pt + \dots]. \quad (8)$$

Substituting in (8)

$$S = -\frac{2}{\pi}[\sin^2 \alpha + \sin^2 2\alpha + \sin^2 3\alpha + \dots]. \quad (9)$$

Note the identity

$$\sin^2 m\alpha = \frac{1}{2}(1 - \cos 2m\alpha) \quad (10)$$

and substituting (10) in (9), we get, after some algebraic manipulation,

$$S = -\frac{1}{\pi}[1 + 1 + 1 + \dots - (\cos 2\alpha + \cos 4\alpha + \cos 6\alpha + \dots)]. \quad (11)$$

Now,

$$\cos 2\alpha + \cos 4\alpha + \cos 6\alpha + \dots + \cos 2n\alpha = \frac{\cos (n+1)\alpha \sin n\alpha}{\sin \alpha}. \quad (12)$$

Substituting (12) in (11) we obtain the slope S as a function of n retained terms,

$$S = -\frac{1}{\pi} \left[n - \frac{\cos(n+1)\alpha \sin n\alpha}{\sin \alpha} \right]. \tag{13}$$

Table I gives the values of S for ten per cent dot ($\alpha = \pi/10$) and fifty per cent dot ($\alpha = \pi/2$) for the various numbers of harmonic terms retained.

TABLE I

Number of Terms Retained	Slope for 10% Mark	Slope for 50% Mark
1	0.00	0.64
2	0.28	0.64
3	0.70	1.28
4	1.28	1.28
5	1.91	1.91
6	2.50	1.91
7	2.90	2.55
8	3.12	2.55
9	3.19	3.19
10	3.19	3.19
11	3.24	3.82
12	3.46	3.82
13	3.89	4.45
14	4.45	4.45
15	5.10	5.10
16	5.68	5.10
17	6.10	5.72
18	6.32	5.72
19	6.37	6.37

DISTORTION AS A FUNCTION OF SIGNAL SLOPE

We shall now consider the effect of a sloping signal in producing distortion, by noting that with such a signal, the marking interval at half amplitude has the same weight as a perfect straight-sided signal.

Consider Fig. 25.

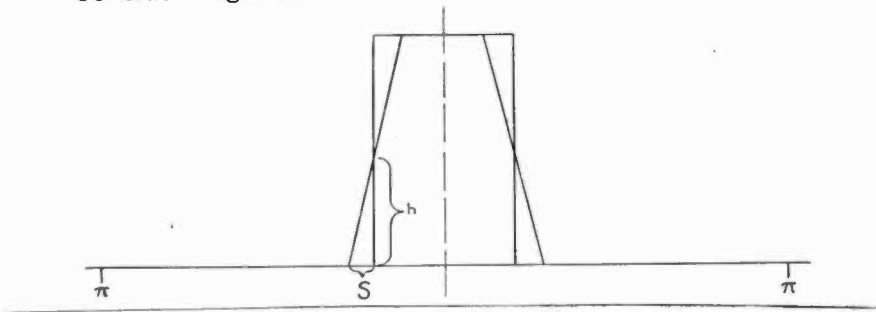

Fig. 25—Idealized signal envelopes.

Now note that

$$S = \frac{h}{\delta} \tag{14}$$

Since h is equal to half of the signal amplitude,

$$h = \frac{1}{2} \tag{15}$$

so that,

$$S = \frac{1}{2\delta} \quad (16)$$

or,

$$\delta = \frac{1}{2S} \quad (17)$$

Now the absolute distortion is defined as the elongation of the signal at the base divided by the length of the cycle. Consequently,

$$D = \frac{2\delta}{2\pi} = \frac{\delta}{\pi} \quad (18)$$

Substituting for S , we get,

$$D = \frac{1}{2\pi S} \quad (19)$$

or,

$$S = \frac{1}{2\pi D} \quad (20)$$

Thus from this equation we can determine the slope necessary to meet the permissible distortion and having the slope, we can find, from Table I, the number of terms which must be retained. The band width necessary is given by $2nf$, where f is the screen frequency; i.e., $\rho/2\pi$.

Our next step is to determine the effect of fading on distortion from which we can find the band width requirement to cope with this difficulty.

DISTORTION AS A FUNCTION OF FADING AND SIGNAL-TO-NOISE RATIO

Consider the idealized form of signal received with a finite number of harmonics as shown in Fig. 26, where the envelopes for two conditions of fading are represented.

Let,

Σ = maximum signal

σ = minimum signal

θ = threshold keying value

D = absolute distortion of signal at base

d = distortion at threshold for Σ

d' = distortion at threshold for σ

$\Delta = d - d'$, distortion at threshold due to fading

N = noise level

$\Sigma/\sigma = \phi$, fading ratio

$\Sigma/N = \mu$, signal-to-noise ratio.

From similar triangles

$$\frac{D - d}{D} = \frac{\theta}{\Sigma} \quad (21)$$

whence,

$$d = D \left(1 - \frac{\theta}{\Sigma} \right) \quad (22)$$

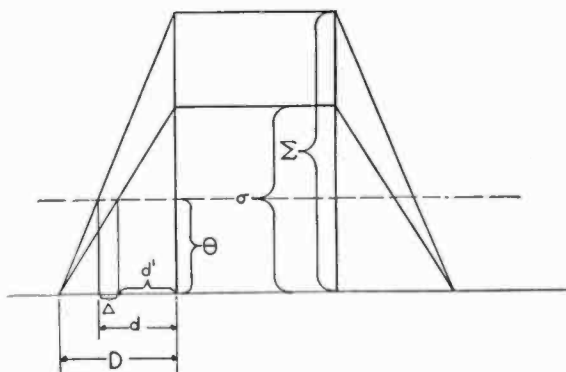

Fig. 26—Effect of fading on signal weight.

similarly,

$$d' = D \left(1 - \frac{\theta}{\sigma} \right) \quad (23)$$

$$\Delta = d - d' = D \left(1 - \frac{\theta}{\Sigma} \right) - D \left(1 - \frac{\theta}{\sigma} \right) \quad (24)$$

$$\Delta = \theta D \left(\frac{1}{\sigma} - \frac{1}{\Sigma} \right) = \frac{\theta D}{\Sigma} \left(\frac{\Sigma}{\sigma} - 1 \right) \quad (25)$$

but since,

$$\frac{\Sigma}{\sigma} = \phi \quad (26)$$

we have,

$$\Delta = \frac{\theta D}{\Sigma} (\phi - 1). \quad (27)$$

Now $\theta_{\min} = N$, so that for extreme conditions

$$\frac{\Sigma}{N} = \frac{\Sigma}{\theta_{\min}} = \mu \quad (28)$$

whence,

$$\Delta = \frac{D(\phi - 1)}{\mu} \quad (29)$$

Now Δ represents the distortion due to fading while D represents the distortion due to finite band width of the receiver. Rearranging terms in the last equation gives

$$D = \frac{\mu\Delta}{\phi - 1} \quad (30)$$

This equation gives the distortion allowable due to band width for a given distortion due to fading in terms of the signal-to-noise ratio and fading ratio.

Since,

$$D = \frac{1}{2\pi S} \quad (19)$$

we can write,

$$S = \frac{1}{2\pi D} \quad (20)$$

and substituting for D in (30) we have

$$S = \frac{\phi - 1}{2\mu\pi\Delta} \quad (31)$$

which gives the required slope for given conditions of maximum permissible distortion, fading ratio, and signal-to-noise ratio.

DISTORTION AS A FUNCTION OF MULTIPATH TRANSMISSION

The effect of multipath transmission is, in general, to add a constant amount of working time to the signal, although it is possible for cancellations also to take place. The additional signal duration so produced is dependent on the transmitter carrier frequency and the signal intensity, low frequencies producing greater time delay than high frequencies, and weak signals producing little or no delay.

Since the signal duration, due to multipath transmission, is independent of the band width transmitted, its effect is to determine the maximum keying frequency permissible to meet a given tolerance of distortion. That is, the actual duration of multipath contribution to the signal divided by the time of one cycle of the keying frequency must not exceed the permissible distortion.

Thus,

$$D_m = f_{\max} t_m \quad (32)$$

where,

D_m = distortion due to multipath transmission

f_{\max} = maximum screen frequency

t_m = time duration of signal contributed by multipath.

From this, we see that the maximum screen frequency which can be used is

$$f_{\max} = \frac{D_m}{t_m}. \quad (33)$$

The maximum distortion permissible is 0.06, a value which has been determined by inspection of large numbers of test subjects, while the time delay varies from 0.04 to 1.0 millisecond on long-distance East and West circuits from New York. On long-distance North and South circuits, experience has shown that the multipath effect is only one half to one third that of the East-West circuits. Using these figures we should expect that screen frequencies from 60 to 150 cycles would be usable.

However, since multipath transmissions occur during the time of large signal-to-noise ratio, the full effect of it is reduced by the setting of the threshold value of the limiter-keyer. As a result, it has been found possible to use screen frequencies from 90 to 175 cycles.

BAND WIDTH REQUIREMENT

Under extreme conditions of fading, the rectified output to the keyer will vary three to one, while the signal-to-noise ratio is four. With a distortion of 0.06 permissible and for a ten per cent dot we can determine the band width requirement at the receiver, by assuming that one half of the distortion may be caused by fading and that fluctuations in multipath transmission may contribute the other half. Under these conditions, $\Delta = 0.03$ and from (31) the required slope is

$$S = \frac{\phi - 1}{2\mu\pi\Delta} = \frac{3 - 1}{2 \times 4 \times 3.14 \times 0.03}$$

$$S = 2.65.$$

Consulting Table I, we see that in order for ten per cent dots to have a slope of this value n must equal seven. From this we determine the band width requirement must be $14f$. Assuming that 175 cycles per second is the highest frequency to be used, a band width of $14 \times 175 = 2450$ cycles is necessary at the receiver.

This value has been experimentally verified by using receivers of 2800 and 10,000 cycles width and observing their outputs simultaneously. No practical difference in the signals was observed except that the narrow band receiver showed less background noise, as would be expected.

PART II

A NARRATIVE BIBLIOGRAPHY OF RADIO FACSIMILE

By

J. L. CALLAHAN

Division Head, Central Office Engineering Laboratory, R.C.A. Communications, Inc.

1. INTRODUCTION

1.1—*Historical*

STARTING with Alex Bain's early work in 1842, and Faraday's suggestion of the relation between light and electricity in 1845, many workers have contributed to the art known today as facsimile and television. Caselli was possibly the first to produce a successful facsimile system, carrying on tests between Paris and other French cities in 1865. In 1900 a distinction was first made between facsimile and television⁶, and in 1908 the "Electrician"³ published an account of Knudson's system of wireless transmission of photographs. A study of the first chapter of J. C. Wilson's "Television"¹, E. D. Wilson and V. K. Zworykin's "Photocells and Their Applications"³, Ranger's first IRE facsimile article⁴, Korn's article in 1924⁵, and Schroter's Handbook⁴⁵ will provide excellent historical background material.

1.2—*Progress of Wire Facsimile*

Wire and radio facsimile are so closely related, that it is thought essential to trace the progress of wire facsimile from its origin up to the present date. The basic elements which make up a facsimile system are the same for both wire and radio service, the only difference being dictated by the propagation medium employed. A working knowledge of the contributions by the following engineers in the field of wire facsimile should prove very helpful to one interested in the radio application.

Cary ⁷	Kette and Kiel ¹⁴
Korn ⁵⁻⁸⁻⁹⁻¹³	Arendt ¹⁵
Belin ¹⁰	Reynolds ¹⁶
O'Brien ¹¹	Mills ¹⁷
Ives, Horton, Parker, Clark ¹²	Goetsch ¹⁸

It is well to remember that articles written by engineers associated with large research organizations represent the efforts of

a large group of workers whose joint efforts are responsible for the report presented by the author in question. In most instances reports from such sources cover the subject matter in complete detail, which is beyond the reach of the average individual worker.

1.3—*Start of Radio Facsimile*

1.31—*Early Work*

With radio activities increasing early in the present century, it was only natural that wire facsimile workers should turn their attention to the new transmission medium. The following references cover the period starting with Knudsen's² work in 1908 up to 1928. At that time the various applications for radio facsimile had definitely crystallized, and they will be covered in Sections 1.32, 1.33 and 1.34, respectively. Early work references are,—

Knudsen ²	Wireless World ²⁶
Gradenwitz ¹⁹	MacIlvain ²⁷
Thorne Baker ²⁰	MacDonald ²⁸
Martin ²¹	Radio News ²⁹
Dieckmann ²²	Ranger ⁴⁻³³
Sci. Am. ²³	Radio Broadcast ³¹
Belin ²⁴	Schroter ³⁰
Daily News ²⁵	Kette and Kiel ¹⁴
	Arendt ³²

1.32—*Commercial Point to Point*

The success of the long distance tests reported under Section 1.31 convinced Marconi, Cables & Wireless, Siemens, Telefunken, Reichspost and RCA that a point to point radio facsimile service was possible. Commercial service was started as follows,—

New York—London	May 1, 1926
New York—Berlin	April 18, 1932
New York—Buenos Aires	Aug. 8, 1932
New York—San Francisco	May 15, 1929
London—Australia	Oct. 16, 1934
London—Buenos Aires	Jan. 1, 1937
Berlin—Buenos Aires	June 9, 1930

The dot transmission method described by Ranger⁴ in 1926, or the improved method reported by Callahan, Shore and Whitaker³⁴ in 1935, has been employed over the circuits listed above up to the present date. A general description

of the apparatus developed by the associated companies and other interesting information pertinent to this subject is covered by the following articles.

Telephony ³⁵	QST Francais ⁴¹
Teleg. & Tel. Age ³⁶⁻⁴⁰	E.N.T. ⁴²
Elec. Rev. London ³⁷	Eastman & Hatch ⁴³
Wireless World ³⁸	Noizeux ⁴⁴
Ranger ³⁹	

1.33—Broadcast

To date broadcast facsimile has yet to prove equal to sound broadcast as a public service. Nevertheless, it has definite possibilities as a public service and may eventually approach sound broadcast as an effective means of disseminating news and entertainment. The following references start with early consideration of facsimile broadcast, and conclude with recent publications. For one interested in the subject, the references cited should prove helpful in compiling a complete story of this phase of the facsimile art.

Friedd ⁴⁶	Goldsmith ⁵⁹
Wireless World ⁴⁷⁻⁵⁴	Electrician ⁶⁰
Sci. & Inv. ⁴⁸⁻⁵³	Beard ⁶¹
Haynes ⁴⁹⁻⁵⁶⁻⁵⁸	Teleg. & Tel. Age ⁶²⁻⁶³
Henney ⁵⁰	Radiocast Reporter ⁶⁴
Radio ⁵¹	Hogan ⁶⁵
Sci. Am. ⁵²	Electronics ⁶⁶⁻⁶⁷
Elec. Rev. London ⁵⁵	IRE Proc. ⁶⁸
Sci. et la Vie ⁵⁷	Young ⁶⁹

1.34—Facsimile Tape

Here is another communication means which has great potential value especially for the mobile services. From the standpoint of general information, the following references will prove helpful.

Whitaker & Collings ⁷⁰	International Inventions ⁷²
Siemens & Halske ⁷¹	Kleinschmidt ⁷³

1.4—Comparison of Wire and Radio Propagation Medium

Engineers engaged in wire facsimile development realized during the third decade of this century that a complete understanding of their propagation medium was essential. Radio facsimile engineers have found a similar understanding of their propagation medium of even greater importance. With this thought in mind, a study of the citations listed in Sections 1.41 and 1.42 is recommended.

1.41—*Wire*

Ives⁷⁴
 Ritter⁷⁵
 Felch⁷⁶

Mertz⁷⁷
 Hinshaw⁷⁸
 Mertz & Pflieger⁷⁹

1.42—*Radio*

Rukop⁸⁰
 Ballantine⁸¹⁻⁸²
 Taylor & Young⁸³⁻⁸⁷
 Hoag & Andrew⁸⁴
 Quack & Mogel⁸⁵⁻⁸⁸
 Hafstad & Tuve⁸⁸
 Boehm⁸⁹
 Eckersley⁹⁰⁻⁹⁹
 Rickard⁹¹

Appleton⁹²
 Beverage & Peterson⁹³
 Peterson, Beverage & Moore⁹⁴
 Forsterling⁹⁵⁻⁹⁶
 Dowsett⁹⁷⁻⁹⁸
 Fuchs¹⁰⁰
 Burrows¹⁰¹
 Crosby¹⁰²
 Kenrick¹⁰³
 Moore¹⁰⁴

1.43—*Radio Facsimile Propagation Requirements*

Two companion facsimile symposium papers, prepared by Messrs. Mathes and Smith¹⁰⁵ and W. H. Bliss¹⁰⁶, treat the related subjects of propagation requirements and test apparatus employed in determining such requirements, and deserve careful reading. Radio facsimile development based on like procedure will go a long way toward eliminating much of the guesswork which was plainly evident until the latter part of the third decade of the present century.

2. RADIO FACSIMILE SYSTEMS

2.1—*Drum and Linear Feed Equipment*

Three general methods are employed to transmit radio facsimile. Up to date, time modulation has been the most successful, but amplitude, frequency, and phase modulation deserve consideration. Citations covering these methods of transmission will be listed under Sections 2.11, 2.12 and 2.13, respectively.

2.11—*Amplitude Modulation*

Brower¹⁰⁷
 Zworykin¹⁰⁸
 Horton¹⁰⁹

Finch¹¹⁰
 Fulton¹¹¹

2.12—*Time Modulation*

In view of the multipath distortion experienced on the long distance circuits, time modulation has proven the most

successful. The so-called CFVD arrangement, suggested by Callahan, Shore and Whitaker³⁴, has been adopted by the commercial organizations operating the international radio facsimile circuits. Acceptable copy can be transmitted by this keying method if slow handling and a low order of keying speed is employed. Increasing knowledge of the radio propagation medium should provide the basis for increased handling speed with acceptable quality. The work of Dr. Hudec¹¹²⁻¹¹³⁻¹¹⁴⁻¹¹⁵ in Germany is a step in this direction. The following citations are representative of the time modulation application.

Delany ¹¹⁶	Culver ¹³⁵
Amstutz ¹¹⁷	Ranger ⁴⁻²³⁻¹²⁸⁻¹²⁹⁻¹³¹⁻¹³²⁻¹³³⁻¹³⁴⁻¹³⁸⁻¹³⁹
Bartholomew ¹¹⁸	Fulton ¹³⁶
Walker ¹¹⁹	Schroter & Runge ¹³⁷
Engineering ¹²⁰	Gardner ¹⁴⁰
Television ¹²¹	McFarlane ¹⁴¹
Callahan, Shore and Whitaker ³⁴	Bailey ¹⁴²
Alexanderson and Ranger ¹²²	Finch ¹⁴³⁻¹⁴⁴
Rea ¹²³	Herrmann ¹⁴⁵
Watson ¹²⁴	Philpott ¹⁴⁶
Watson & Weaver ¹²⁵⁻¹²⁶	Eastman & Hatch ⁴³
Bartholomew & Deedes ¹²⁷	Noizeux ⁴⁴
Alexanderson ¹³⁰	Kobayashi ¹⁴⁷
Hudec ¹¹²⁻¹¹³⁻¹¹⁴⁻¹¹⁵	Wright & Smith ¹⁶⁹

2.13—*Frequency and Phase Modulation*

Both frequency and phase modulation of the r-f carrier or audio sub-carrier have received a considerable amount of thought and study. It may be that here lies the secret of successful long distance transmission of radio facsimile. The following citations are typical of the published or issued patent art covering this method of transmission.

Alexanderson ¹⁴⁸	Osawa ¹⁵²
Runge & Schroter ¹⁴⁹	Hammond, Jr. ¹⁵³
Schroter ¹⁵⁰	Wright & Smith ¹⁵⁴
Newa ¹⁵¹	Aamodt ¹⁵⁵
	R. K. Potter ¹⁵⁸

2.2—*Facsimile Tape*

Facsimile tape as a distinct method of communication was employed as early as 1901 by Denison. See Ranger reference⁴. During the latter part of the third decade and up to the present time consideration has been given to facsimile tape by quite a

number of workers. In general, this work has divided into two groups, mechanical and photo-optical scanning. The spiral helix and printer bar combination has been employed in both instances for recording purposes. A rather low ratio of intelligence handling to keying speed has handicapped facsimile tape when compared directly with the Baudot type of time code printer. Nevertheless, as stated previously, definite fields of application are available for facsimile tape. Practically all keying arrangements reported on to date are on-off keying of the r-f or audio sub-carriers. The two references listed below are typical of these methods.

Whitaker & Collings⁷⁰
Kleinschmidt⁷¹

3. RADIO FACSIMILE APPARATUS

3.1—*Scanning Equipment*

One of the best articles which can be cited to cover the subject of scanning is that published in the Bell System Technical Journal by P. Mertz and F. Gray¹⁵⁶. A careful study of this article would repay any one who is interested in the general subject of scanning. A companion facsimile symposium paper, prepared by Messrs. Whitaker and Artzt¹⁵⁷, consists of a summary of the problems involved in the design of scanner circuits. In addition to a general coverage of the subject, photo-electric scanning of facsimile tape-subject slip is touched on sufficiently well for a general understanding of the problems involved. A detailed breakdown of the scanning system follows, with a representative group of citations listed for each division.

3.11—*Light Source*

Early art required a powerful light source because of low phototube and amplifier efficiency. Developments extending back over the past ten to fifteen years have provided increased phototube-amplifier efficiency, and, as a result, a marked reduction in the amount of light required. A standard sound-motion-picture tungsten-filament exciter lamp, 50-75 watts, provides ample light for most systems employed today. See Whitaker and Artzt reference¹⁵⁷.

3.12—*Optical Arrangements*

Transparent subject copy was employed by early workers and, as a result, relatively simple optical systems were re-

quired. Present-day art employs reflected light from the subject copy to excite the phototube. The following citations cover the general trend.

Thilo ¹⁵⁹	Ranger ¹⁶⁴
Scheppmann ¹⁶⁰	Philpott ¹⁶⁵
Potter ¹⁵⁸	Zworykin ¹⁰⁸
Wright ¹⁶¹	Gardner ¹⁴⁰
Schmook ¹⁶²	Wilson & Zworykin ³
Elsey & Philpott ¹⁶³	Schroter ⁴⁵
	Whitaker & Artzt ¹⁵⁷

3.13—*Phototubes*

A vast quantity of published material is available on phototubes and dates back to Hallwachs in 1888, and those two excellent workers, Elster and Geitel, in 1889. A number of references have been chosen which it is believed cover the art sufficiently for the modern designer. If a more extensive background is required than that provided by the following citations, they will facilitate further search.

Sinding-Larsen ¹⁶⁶	Hughes & DuBridge ¹⁷³
Nakken ¹⁶⁷	Campbell & Ritchie ¹⁷⁴
Tedham ¹⁶⁸	Zworykin & Wilson ³
Wright & Smith ¹⁶⁹	Dejardin ¹⁷⁵
Metcalf ¹⁷⁰	Jamieson, Shea & Pierce ¹⁷⁶
Asao & Suzuki ¹⁷¹	Prescott & Kelly ¹⁷⁷
Iams & Salzberg ¹⁷²	Koller ¹⁷⁸
Wilson ¹	Kluge ¹⁷⁹
	Culver ¹³⁵

3.14—*Phototube Amplifiers*

In order to raise the output level of the phototube high enough for normal control purposes, many arrangements have been proposed, and operate with varying degrees of success. The following citations provide a reasonably complete coverage of this phase of the facsimile art.

Wilson & Zworykin ³	Whitaker & Shore ¹⁸³
Keen ¹⁸⁰	Ranger ¹⁸¹⁻¹⁸¹⁻¹⁸²⁻¹⁸⁸⁻¹⁸⁹
Eulenhofer ¹⁸⁴	Artzt ¹⁸⁵
Schmook ¹⁶²	Shore & Whitaker ¹⁸⁶
Nakken ¹⁶⁷	Braden ¹⁸⁷
Shore ¹⁸²	Schroter ⁴⁵
Zworykin ¹⁰⁸	Whitaker & Artzt ¹⁵⁷

3.15—*Facsimile-Tape Mechanical-Scanning Equipment*

Facsimile-tape mechanical scanning is actually a by-product of the Baudot printer art. Siemens-Halske and Teletype have been active in this field. The following references, although not numerically large, cover the art very well.

Siemens-Halske⁷¹
International Inventions⁷²
Kleinschmidt⁷³

3.2—*Recorders*

Recording arrangements divide naturally into two groups, visual and photographic. Sections 3.21 and 3.22 list references covering all phases of the respective recording methods.

3.21—*Visual*

Visual recording methods include electrolytic, carbon, hot air, ink and ink vapor, and wax. Early workers made use of visual recording methods. For example, Greenwood in 1851 suggested ink recording; Carbonelle in 1906 designed a receiver for carbon paper recording of pictures; Bain in 1843 was the first to employ electrolytic methods for recording facsimile. The following citations cover the modern version of visual recording methods fairly well.

Delany ¹¹⁶	Carlisle ¹⁹⁸
Ranger & Morehouse ¹⁶⁸	Fulton ¹⁹⁹⁻²⁰⁰
Ranger ¹⁸⁹⁻³³⁻¹⁹¹⁻¹⁹²	Siemens-Halske ⁷¹
Morehouse ¹⁹⁰⁻¹⁹⁵	Kleinschmidt ⁷³
Bicknell & Ranger ¹⁹³	Else ²⁰¹
Ludenia ¹⁹⁶	Hogan ²⁰²
Young ¹⁹⁴	Schroter ¹⁹⁷

3.22—*Photographic*

Photographic recording divides into three general groups, namely, glow tube or crater lamp; light valves as exemplified by the Kerr cell, and the galvanometer. Bromide paper or its negative film equivalent is generally employed as a record surface.

Korn in 1906 and Belin in 1908 were among the first to make practical use of the galvanometer method. Glow tubes or crater lamps have had wide application, but difficulty in maintaining consistency in manufacture and operation has generally led to their replacement with some form of light

valve or galvanometer arrangement. The following references are typical of the published and patented art.

Belin ²⁰³	Brower ¹⁰⁷
ZSF Techn. Phys. ²⁰⁴	Gray ²⁰⁷
Wright ²⁰⁵	Dimmick ²⁰⁸
Case ²⁰⁶	Williams ²⁰⁹⁻²¹⁰
Keen ¹⁸⁰	Reynolds ¹⁶
Zworykin ¹⁰⁸	Schmierer ²¹¹
	Schroter ²¹²

3.3—*Synchronizing*

Recording equipment positioned at a distance from the scanning machine requires some form of synchronizing in order to hold the skew distortion to a useable minimum. In 1869 d'Arlincourt employed a tuning fork for synchronizing control. Other early methods of synchronizing are illustrated by Amstutz¹¹⁷, and Belin²¹³⁻²¹⁴.

This bibliography has covered two types of equipment, namely, drum and linear feed, and facsimile tape. Synchronizing arrangements will be treated under Sections 3.31 and 3.32, respectively.

3.31—*Drum and Linear Feed Equipment*

International communication via facsimile, whether over wire or radio, requires a set of standards, which, if adhered to, will allow for design variation. Among other things, the standards include a working index and a specification covering drive-control accuracy. Schroter⁴⁵ reports that H. Stahl was responsible for suggesting the working index. The CCIT 3rd²¹⁵, 4th²¹⁶, and 5th²¹⁷ Conferences have set up working standards which are now recognized by all engaged in international facsimile service.

For some services where an extensive power network is available, only phase correction is required when starting. A phasing signal can be transmitted which provides the necessary phasing or framing pulse for utilization at the receiver. Other arrangements on the order of that disclosed by Rieper²¹⁸ may prove useful.

3.311—*Frequency Standards*

Widely spaced equipments require a relatively high order of drive accuracy. In practically all facsimile installations this requirement is met by a tuning fork stand-

ard. The international standard of drive accuracy, 1 part in 100,000, can easily be met over long periods of time by employing a fork standard control. Tuning fork standards are covered by the following references.

Dye²¹⁹
Wood²²⁰

Norrman²²¹
Ranger²²²
Artzt²²³

If the drive accuracy of 1 part in 100,000 is maintained at the scanner and the recorder, it is only necessary to frame when the picture is started. A lower order of drive accuracy requires the transmission of some form of control over the circuit. The following citations illustrate this method of control.

Jacobson²²⁴
Zworykin¹⁰⁸
Brower¹⁰⁷
Ranger²²⁵

Nichols²²⁶
Finch²²⁷⁻¹¹⁰
Morton²²⁸
Long²²⁹

An excellent review of modern synchronizing methods is illustrated by Schiweck²³⁰.

3.312—*Machine Drive Methods*

Some form of a motor or motor alternator is essential as a prime mover for the scanner and recorder machines. In most instances, means to provide synchronous power supply for the prime mover is required. The following references illustrate how this problem can be solved.

Ranger²³¹
Karolus²³²
Purrington²³³

Cooley²³⁴
Wolf²³⁵
Adler²³⁶
Young²³⁷

3.32—*Facsimile Tape*

If an extensive power network is not available for drive power at the scanner and recorder, three alternatives can be considered. A double helix at the recorder with scanner and recorder drive essentially at same speed. A start-stop method disclosed by Hell²³⁸ may also be employed. The ideal, of course, is complete synchronous drive. A companion facsimile symposium paper, prepared by Shore and Whitaker²³⁹, reports on a development program directed to provide a synchronous drive system satisfactory for commercial service.

3.4—*Machine Design*

Citations covering drum and facsimile-tape machine-design methods will be listed under Sections 3.41 and 3.42, respectively.

3.41—*Drum and Linear Feed Equipment*

It is interesting to compare the crude machine design proposed by Delany in 1885 with the modern arrangements. The following references illustrate the trend.

Delany ¹¹⁶	Hough ²⁴⁴
Fulton ²⁴⁰⁻²⁴¹	Philpott ²⁴⁵
Alexanderson ²⁴²	Young ⁶⁹
Ranger ²⁴³⁻¹⁹¹⁻³⁹	Electronics ⁶⁷

3.42—*Facsimile Tape*

Mechanical scanning and associated recorder machine design arrangements are illustrated fairly well by Kleinschmidt⁷³. Photo-optical scanning and associated recording design is covered briefly by the Whitaker and C. Wang's companion facsimile symposium paper⁷⁰.

4. FUTURE TRENDS

4.1—*Multi-Channel*

One method which can be employed to speed up long distance radio facsimile, if space circuit limitations prove to be a permanent handicap, is multi-channel operation. Considerable thought and study has been devoted to this method of control. So far, this work has been in the experimental stage and has not been reduced to practice on commercial circuits. The references which illustrate the trend of this work follow.

Ranger ²⁴⁶⁻³⁹⁻²⁴⁸⁻²⁵⁰⁻²⁵¹⁻²⁵²	Eldred ²⁵³
Hansell ²⁴⁷	Schriever ²⁵⁴
Schroter ²⁴⁹⁻²⁵⁵	

4.2—*Color Facsimile*

Another possibility for future application is color facsimile. The following citations very briefly illustrate this.

Freund ²⁵⁶	Hinton ²⁵⁸
Ranger & Smith ²⁵⁷	Whitaker & Artzt ¹⁵⁷

4.3—*General*

Schroter's articles²⁵⁹⁻²⁶⁰ entitled "Possibilities of Further Development in Picture Telegraphy" provide food for thought to

one interested in facsimile development. The section on phototelegraphy in the International Bureau, Berne, article entitled "Retrospect of 1936"²⁶¹, also makes interesting reading.

To one who has had a very minor part in the development of radio facsimile, it would appear that a broader knowledge of our propagation medium offers the most promising basis for high speed commercial quality radio facsimile.

5. CONCLUSION

There is such a wealth of material available from which a bibliography of facsimile may be compiled that it is quite impossible to include in one brief résumé all such material and references. The many patents and publications which have been referred to herein by the author have been selected for convenience of present and future reference and because of the belief that they represent illustrative examples of the several forms of apparatus considered. However, in view of the illustrative nature of the several citations, no inferences can or should be drawn from the inclusion of any reference as to either its possible breadth or its possible domination of the field with which it has been mentioned nor should the omission of citation be considered as indicating any lack of importance.

Acknowledgment is due all of the technical and other publications used as a source of reference material.

BIBLIOGRAPHY

- ¹ *Television* by J. C. Wilson, Pitman & Sons, Ltd., 1937.
- ² *Electrician*, Vol. 61, pp. 89-90, May 1, 1908.
- ³ *Photocells and Their Applications* by E. D. Wilson and V. Zworykin, published by John Wiley & Sons.
- ⁴ *I.R.E. Proc.*, Vol. 14, No. 2, April, 1926, R. H. Ranger.
- ⁵ *E.N.T.*, Vol. 1, No. 6, pp. 175-187, 1924, A. Korn.
- ⁶ *M. Perskyi Annexes Congres Internationale d'Electricite*, 18th-25th August, 1900, pp. 54-56.
- ⁷ *Elec. Engr.*, Vol. 19, pp. 57-58, 1895, G. R. Carey.
- ⁸ *E.T.Z.*, Vol. 33, pp. 454-455, May 22nd, 1902, A. Korn.
- ⁹ *E.T.Z.*, Vol. 36, pp. 1131-1134, Dec. 14th, 1905, A. Korn.
- ¹⁰ *Sci. & Inv.*, Vol. 8, pp. 717, 805 and 812, Nov. 1920.
- ¹¹ *Bell Tel. Quart.*, Vol. 3, pp. 186-195, July, 1924, J. B. O'Brien.
- ¹² *Bell System Tech. Jl.*, Vol. 4, pp. 187-214, April, 1925, H. E. Ives, J. W. Horton, R. D. Parker, A. B. Clark.
- ¹³ *E.T.Z.*, Vol. 47, pp. 717-719, June 24th, 1926, A. Korn.
- ¹⁴ *T.F.T.*, Vol. 16, pp. 31-40, February, 1927, G. Kette & W. Kiel.
- ¹⁵ *Zeits*, Vol. 9, pp. 135-144, March; Vol. 10, pp. 30-39, May, 1929, P. Arendt.
- ¹⁶ *Bell Sys. Tech. Jl.*, Vol. 15, pp. 549-574, October; *Elec. Eng.*, Vol. 55, pp. 996-1007, September, 1936, F. W. Reynolds.
- ¹⁷ *Bell Tel. Quart.*, Vol. 14, pp. 13-22, January, 1935, John Mills.
- ¹⁸ *E.N.T.*, Vol. 14, pp. 443-446, December, 1937, Goetsch.
- ¹⁹ *Sci. Am. Suppl.*, Vol. 67, p. 67, January, 1909, Alfred Gradenwitz.

- ²⁰ *Elec. Eng.*, Vol. 5, pp. 697-698, August 5th, 1909.
- ²¹ *Wireless World*, Vol. 3, pp. 57-60, April; pp. 102-106, May; pp. 62-165, June; pp. 228-232, July, 1915, M. J. Martin.
- ²² *Zeits f. Fernmeldetechnik*, Vol. 1, pp. 223-228, November 20, 1920, M. Dieckmann.
- ²³ *Sci. Am.*, Vol. 125, pp. 163-173, September 3rd, 1921.
- ²⁴ *Onde Elec.*, Vol. 1, pp. 271-283, May, 1922, E. Belin.
- ²⁵ December 1st, 1924 issue of *New York Daily News*.
- ²⁶ *Wireless World*, Vol. 15, pp. 353-354, December 10th, 1924.
- ²⁷ *Wireless Age*, Vol. 12, pp. 20-23, February, 1925, K. M. MacIlvain.
- ²⁸ *Wireless Age*, Vol. 12, pp. 7-9, July, 1925, K. MacDonald.
- ²⁹ *Radio News*, Vol. 7, p. 1264, March, 1926.
- ³⁰ *E.U.M.*, Vol. 44, pp. 61-66, June 27th, 1926, F. Schroter.
- ³¹ *Radio Broadcast*, Vol. 9, p. 206, July, 1926.
- ³² *E.T.Z.*, Vol. 50, pp. 744-748, May 23rd, 1929, P. Arendt.
- ³³ *I.R.E. Proc.*, Vol. 17, No. 6, June, 1929, R. H. Ranger.
- ³⁴ *I.R.E. Proc.*, Vol. 23, No. 12, December, 1935, J. L. Callahan, Henry Shore, J. N. Whitaker.
- ³⁵ *Telephony*, Vol. 90, p. 19, April 17th, 1926.
- ³⁶ *Teleg. & Tel. Age*, p. 199, May 1st, 1926.
- ³⁷ *Elec. Rev.*, London, Vol. 98, pp. 820-822, June 4, 1926.
- ³⁸ *Wireless World*, Vol. 24, pp. 192-195, February 20th, 1929.
- ³⁹ *I.R.E. Proc.*, Vol. 17, No. 9, pp. 1564-1575, September, 1929, R. H. Ranger.
- ⁴⁰ *Teleg. & Tel. Age*, No. 22, pp. 465-466, October 16th, 1929.
- ⁴¹ *QST Francais*, Vol. 11, pp. 13-20, July, 1930.
- ⁴² *E.N.T.*, Vol. 9, pp. 49-56, February, 1932, F. Schroter.
- ⁴³ *Marconi Rev.*, No. 47, pp. 1-12, March-April, 1934, J. W. Eastman and J. F. Hatch.
- ⁴⁴ *Revista Telegrafica*, Vol. 25, pp. 728-730, September, 1936, P. J. Noizeux.
- ⁴⁵ *Handbuch der Bildtelegraphie und des Fernschens* by F. Schroter, published by Julius Springer, Berlin.
- ⁴⁶ *Radio News*, Vol. 8, pp. 126, 184-185, August, 1926, W. Friedd.
- ⁴⁷ *Wireless World*, Vol. 20, p. 198, February 16th, 1927.
- ⁴⁸ *Sci. & Inv.*, Vol. 15, p. 345, August, 1927.
- ⁴⁹ *Wireless World*, Vol. 21, pp. 226-230, August, 1927, F. H. Haynes.
- ⁵⁰ *Radio Broadcast*, Vol. 11, pp. 341-343, October, 1927, K. Henney.
- ⁵¹ *Radio*, Vol. 10, p. 22, March, 1928.
- ⁵² *Sci. Am.*, Vol. 138, p. 366, April, 1928.
- ⁵³ *Sci. & Inv.*, Vol. 15, pp. 113-114, April, 1928.
- ⁵⁴ *Wireless World*, Vol. 22, pp. 542-546, May 23rd, 1928.
- ⁵⁵ *Elec. Rev.*, London, Vol. 103, p. 444, September 14th, 1928.
- ⁵⁶ *Wireless World*, Vol. 23, pp. 550-560, October, 1928, F. H. Haynes.
- ⁵⁷ *Sci. et la Vie*, Vol. 35, pp. 66-67, January, 1929.
- ⁵⁸ *Wireless World*, Vol. 24, pp. 331-334, March 27th, 1929, F. H. Haynes.
- ⁵⁹ *I.R.E. Proc.*, Vol. 17, pp. 1536-1539, September, 1929, A. N. Goldsmith.
- ⁶⁰ *Electrician*, Vol. 105, p. 527, October 31st, 1930.
- ⁶¹ *P.O.E.E. Jl.*, Vol. 24, pp. 4-5, April, 1931, A. T. J. Beard.
- ⁶² *Teleg. & Tel. Age*, No. 17, p. 386, September 1st, 1931.
- ⁶³ *Teleg. & Tel. Age*, p. 327, November 1st, 1932.
- ⁶⁴ *Radiocast Reporter*, Vol. 3, pp. 7-9, October 31st, 1932.
- ⁶⁵ *Radio Eng.*, Vol. 13, pp. 18-19, November 30th, 1933, J. V. L. Hogan.
- ⁶⁶ *Electronics*, Vol. 7, p. 141, May, 1934.

- ⁶⁷ *Electronics*, Vol. 7, pp. 336-340, November, 1934.
- ⁶⁸ *I.R.E. Proc.*, Vol. 25, No. 2, p. 199, February, 1937.
- ⁶⁹ *RCA Review*, April, 1938, C. J. Young.
- ⁷⁰ *RCA Institutes Technical Press*, "Radio Facsimile," pp. 284-293, J. N. Whitaker, F. C. Collings.
- ⁷¹ Br. Patent 427,257, Siemens, Halske.
- ⁷² Br. Patent 380,217, International Inventions.
- ⁷³ U. S. Patent 2,046,328, E. E. Kleinschmidt et al.
- ⁷⁴ *Opt. Soc. Am. Jl.*, Vol. 12, pp. 173-194, March, 1926, H. E. Ives.
- ⁷⁵ *Television Soc. Jl.*, Vol. 1, Series 2, pp. 113-123—Discussion, pp. 123-124, March, 1932, E. S. Ritter.
- ⁷⁶ *Bell Lab. Record*, Vol. 14, pp. 154-157, January, 1936, E. P. Felch.
- ⁷⁷ *Bell Lab. Record*, Vol. 14, pp. 178-181, February, 1936, P. Mertz.
- ⁷⁸ *Bell Lab. Record*, Vol. 14, pp. 193-197, February, 1936, F. A. Hinshaw.
- ⁷⁹ *Bell Sys. Tech. Jl.*, Vol. 16, pp. 541-559, October, 1937, P. Mertz and K. W. Pfleger.
- ⁸⁰ *E.N.T.*, Vol. 3, pp. 316-318, August, 1926, H. Rukop.
- ⁸¹ *I.R.E. Proc.*, Vol. 15, No. 4, April, 1927, Stuart Ballentine.
- ⁸² *I.R.E. Proc.*, Vol. 15, No. 12, December, 1927, Stuart Ballantine.
- ⁸³ *I.R.E. Proc.*, Vol. 16, No. 5, May, 1928, A. Hoyt Taylor & L. C. Young.
- ⁸⁴ *I.R.E. Proc.*, Vol. 16, No. 10, October, 1928, J. B. Hoag & Victor J. Andrew.
- ⁸⁵ *I.R.E. Proc.*, Vol. 17, No. 5, May, 1929, E. Quack & H. Mogel.
- ⁸⁶ *I.R.E. Proc.*, Vol. 17, No. 5, May, 1929, E. Quack & H. Mogel.
- ⁸⁷ *I.R.E. Proc.*, Vol. 17, No. 9, September, 1929, A. Hoyt Taylor & L. C. Young
- ⁸⁸ *I.R.E. Proc.*, Vol. 17, No. 10, October, 1929, L. R. Hafstad & M. A. Tuve.
- ⁸⁹ *Telefunken Zeitung*, No. 53, pp. 9-22, 1929, O. Boehm.
- ⁹⁰ *I.R.E. Proc.*, Vol. 18, No. 1, January, 1930, T. L. Eckersley.
- ⁹¹ *Marconi Review*, No. 27, 1930, C. E. Rickard.
- ⁹² *Wireless World*, Vol. 28, pp. 43-44, January 14th, 1931, E. V. Appleton.
- ⁹³ *I.R.E. Proc.*, Vol. 19, No. 4, April, 1931, H. H. Beverage & H. O. Peterson.
- ⁹⁴ *I.R.E. Proc.*, Vol. 19, No. 4, April, 1931, H. O. Peterson, H. H. Beverage, J. B. Moore.
- ⁹⁵ *Elektr. Nachr. Techn.*, Vol. 5, p. 53, 1928, K. Forsterling.
- ⁹⁶ *ZS fuer Techn. Phys.*, Vol. 12, p. 453, 1931, K. Forsterling.
- ⁹⁷ *Television Soc. Jl.*, Vol. 1, pp. 84-97, December, 1931, H. M. Dowsett.
- ⁹⁸ *Marconi Review*, No. 36, pp. 1-13, May-June, 1932, H. M. Dowsett.
- ⁹⁹ *Jl. Institution of Elec. Eng.*, Vol. 71, pp. 405-459, September, 1932, T. L. Eckersley.
- ¹⁰⁰ *Hochf. Tech. u. Elec. Akus*, Vol. 44, No. 5, pp. 163-166, November, 1934, J. Fuchs.
- ¹⁰¹ *I.R.E. Proc.*, Vol. 23, No. 5, pp. 470-480, May, 1935, C. R. Burrows.
- ¹⁰² *I.R.E. Proc.*, Vol. 24, No. 6, June, 1936, M. G. Crosby.
- ¹⁰³ *QST*, September, 1936, G. W. Kenrick.
- ¹⁰⁴ *RCA Review*, July, 1937, J. B. Moore.
- ¹⁰⁵ *RCA Institutes Technical Press*, "Radio Facsimile," pp. 198-211, R. E. Mathes and J. E. Smith.
- ¹⁰⁶ *RCA Institutes Technical Press*, "Radio Facsimile," pp. 248-263, W. H. Bliss.
- ¹⁰⁷ U. S. Patent 1,834,330, W. M. Brower.
- ¹⁰⁸ *I.R.E. Proc.*, Vol. 17, No. 3, March, 1929, V. Zworykin.
- ¹⁰⁹ *I.R.E. Proc.*, Vol. 17, No. 9, September, 1929, J. W. Horton.
- ¹¹⁰ U. S. Patent 1,985,654, W. G. H. Finch.
- ¹¹¹ U. S. Patent 1,985,084, Otho Fulton.
- ¹¹² *Elektrische Nachrichten Technik*, December, 1937, E. Hudec.

- 113 *Fernsprech und Funk Technick*, January, 1938, E. Hudec.
 114 *E.N.T.*, No. 10, October, 1937, E. Hudec.
 115 *Telegraphen Fernsprech und Funk Technick*, No. 7, 1937, E. Hudec.
 116 U. S. Patent 316,754, P. B. Delany.
 117 U. S. Patent 1,019,403, N. S. Amstutz.
 118 U. S. Patent 1,653,425, H. G. Bartholomew.
 119 *Wireless World*, Vol. 30, pp. 564-567, June 1st, 1932, R. C. Walker.
 120 *Engineering*, Vol. 137, No. 3553, pp. 203-204, February 16th, 1934.
 121 *Television*, Vol. 8, No. 94, pp. 702-752, December, 1935, E. Belin.
 122 U. S. Patent 1,787,851, E. F. W. Alexanderson and R. H. Ranger.
 123 U. S. Patent 2,086,679, W. T. Rea.
 124 U. S. Patent 1,579,263, E. F. Watson.
 125 U. S. Patent 1,602,469, E. F. Watson and Allen Weaver.
 126 U. S. Patent 1,664,652, E. F. Watson and Allen Weaver.
 127 U. S. Patent 1,910,586, H. G. Bartholomew and M. L. Deedes.
 128 U. S. Patent 1,790,722, R. H. Ranger.
 129 U. S. Patent 1,790,723, R. H. Ranger.
 130 U. S. Patent 1,839,456, E. F. W. Alexanderson.
 131 U. S. Patent 1,848,839, R. H. Ranger.
 132 U. S. Patent 1,848,840, R. H. Ranger.
 133 U. S. Patent 1,857,329, R. H. Ranger.
 134 U. S. Patent 1,857,330, R. H. Ranger.
 135 U. S. Patent 1,898,080, C. A. Culver.
 136 U. S. Patent 1,902,552, O. Fulton.
 137 U. S. Patent 1,914,898, F. Schroter and W. Runge.
 138 U. S. Patent 1,973,725, R. H. Ranger.
 139 U. S. Patent 1,973,726, R. H. Ranger.
 140 U. S. Patent 1,950,171, P. C. Gardner.
 141 U. S. Patent 2,002,208, M. D. McFarlane.
 142 U. S. Patent 2,047,817, A. Bailey.
 143 U. S. Patent 2,066,261, W. G. H. Finch.
 144 U. S. Patent 2,066,262, W. G. H. Finch.
 145 U. S. Patent 2,095,701, J. Herrmann.
 146 U. S. Patent 2,103,793, L. R. Philpott.
 147 *Elec. Communication*, Vol. 16, No. 2, pp. 144-152, October, 1937, Masatsugu Kobayashi.
 148 U. S. Patent 1,830,586, E. F. W. Alexanderson.
 149 U. S. Patent 1,914,898, W. Runge and F. Schroter.
 150 U. S. Patent 1,937,131, F. Schroter.
 151 *Journal I.E.E.*, Japan, Vol. 54, No. 5, p. 433, May, 1934, Y. Nawa.
 152 *Rep. of Rad. Res. in Japan*, Vol. 4, No. 3, pp. 48-49, October, 1934, Z. Osawa.
 153 U. S. Patent 1,977,438, J. H. Hammond, Jr.
 154 U. S. Patent 1,964,375, G. M. Wright and S. B. Smith.
 155 U. S. Patent 2,094,052, T. Aamodt.
 156 *Bell Sys. Tech. Jl.*, Vol. 13, pp. 464-515, July, 1934, P. Mertz & F. Gray.
 157 *RCA Institutes Technical Press*, "Radio Facsimile," pp. 229-247, J. N. Whitaker and M. Artzt.
 158 U. S. Patent 1,777,016, R. K. Potter.
 159 U. S. Patent 1,924,700, H. G. Thilo.
 160 U. S. Patent 1,763,482, W. Scheppmann.
 161 U. S. Patent 1,809,617, G. M. Wright.
 162 U. S. Patent 1,857,745, A. Schmook.

- 163 U. S. Patent 1,877,566, H. M. Elsey and L. R. Philpott.
- 164 U. S. Patent 1,828,000, R. H. Ranger.
- 165 U. S. Patent 1,927,900, L. R. Philpott.
- 166 U. S. Patent 1,473,882, A. Sinding-Larsen.
- 167 U. S. Patent 1,889,758, T. H. Nakken.
- 168 Br. Patent 356,747, W. F. Tedham.
- 169 U. S. Patent 1,995,138, G. M. Wright and S. B. Smith.
- 170 *I.R.E. Proc.*, Vol. 17, No. 11, November, 1929, G. F. Metcalf.
- 171 *I.R.E. Proc.*, Vol. 19, No. 4, April, 1931, S. Asao and M. Suzuki.
- 172 *I.R.E. Proc.*, Vol. 23, No. 1, January, 1935, H. Iams and B. Salzberg.
- 173 *Photoelectric Phenomena* by Hughes and DuBridge. Published by McGraw Hill.
- 174 *Photoelectric Cells* by Campbell and Ritchie. Published by Pitman & Sons.
- 175 *Rev. Gen. d'Elec.*, Vol. 34, pp. 515, 555, 591, 629; 1933, G. Dejardin.
- 176 *Jour. Soc. Mot. Pic. Eng.*, 27, p. 365; 1936, M. F. Jamieson, T. E. Shea, and P. H. Pierce.
- 177 *Bell Sys. Tech. Jl.*, XI, 3, 334, July, 1932, C. H. Prescott, Jr. & M. J. Kelly.
- 178 *J.O.S.A.*, p. 135, September, 1929, L. R. Koller.
- 179 *Zeits f. Physik*, 95, 11-12, pp. 734-746, July 12, 1935, W. Kluge.
- 180 U. S. Patent 1,503,590, E. Keen.
- 181 U. S. Patent 1,738,315, R. H. Ranger.
- 182 U. S. Patent 1,958,212, Henry Shore.
- 183 U. S. Patent 1,991,970, J. N. Whitaker and Henry Shore.
- 184 U. S. Patent 1,972,221, E. Eulenhofner.
- 185 U. S. Patent 1,988,472, M. Artzt.
- 186 U. S. Patent 2,095,717, Henry Shore and J. N. Whitaker.
- 187 U. S. Patent 2,084,186, R. A. Braden.
- 188 U. S. Patent 1,819,264, R. H. Ranger and F. G. Morehouse.
- 189 U. S. Patent 1,770,493, R. H. Ranger.
- 190 U. S. Patent 1,779,261, F. G. Morehouse.
- 191 U. S. Patent 1,819,197, R. H. Ranger.
- 192 U. S. Patent 1,841,452, R. H. Ranger.
- 193 U. S. Patent 1,844,199, R. S. Bicknell and R. H. Ranger.
- 194 U. S. Patent 1,848,862, C. J. Young.
- 195 U. S. Patent 1,850,600, F. G. Morehouse.
- 196 U. S. Patent 1,875,063, W. Ludenia.
- 197 U. S. Patent 1,882,043, F. Schroter.
- 198 U. S. Patent 1,958,885, R. W. Carlisle.
- 199 Br. Patent 318,120, Otho Fulton.
- 200 *Radio Craft*, Vol. 6, pp. 718-743, June, 1935, O. Fulton.
- 201 U. S. Patent 2,063,992, H. M. Elsey.
- 202 U. S. Patent 2,111,776, J. V. L. Hogan.
- 203 U. S. Patent 915,154, E. Belin.
- 204 *Z.S.f. Techn. Phys.*, Vol. 10, p. 634.
- 205 *Proc. Phy. Soc.*, Vol. 44, Part 3, May, 1932, W. D. Wright.
- 206 French Patent 748,285, T. W. Case.
- 207 U. S. Patent 1,974,067, F. Gray.
- 208 U. S. Patent 1,989,973, G. L. Dimmick.
- 209 U. S. Patent 1,991,479, R. M. Williams.
- 210 U. S. Patent 1,991,480, R. M. Williams.
- 211 U. S. Patent 2,002,551, M. Schmierer.
- 212 U. S. Patent 2,004,587, F. Schroter.

- 213 U. S. Patent 1,260,303, E. Belin.
 214 U. S. Patent 1,535,979, E. Belin.
 215 CCIT Third Conference, Berne, May, 1931.
 216 CCIT Fourth Conference, Prague, August, 1934.
 217 CCIT Fifth Conference, Warsaw, 1936.
 218 U. S. Patent 1,857,742, G. Rieper.
 219 *Proc. Roy. Soc.*, London, 103A, p. 241, May, 1923, D. W. Dye.
 220 *Jour. Sci. Inst.*, Vol. 1, p. 335, August, 1934, A. B. Wood.
 221 *I.R.E. Proc.*, Vol. 20, No. 11, November, 1932, E. Norrman.
 222 U. S. Patent 1,802,478, R. H. Ranger.
 223 U. S. Patent 2,113,365, M. Artzt.
 224 U. S. Patent 1,710,223, Moses Jacobson.
 225 U. S. Patent 1,940,016, R. H. Ranger.
 226 U. S. Patent 2,111,153, H. J. Nichols.
 227 U. S. Patent 2,069,061, W. G. H. Finch.
 228 U. S. Patent 2,050,363, E. R. Morton.
 229 U. S. Patent 1,930,246, M. B. Long.
 230 *Zeits f. Fernmeldetechnik*, Vol. 13, pp. 10-14, January 21; pp. 24-30, February 18, 1932, F. Schiweck.
 231 U. S. Patent 1,829,420, R. H. Ranger.
 232 U. S. Patent 1,856,076, A. Karolus.
 233 U. S. Patent 1,994,230, E. S. Purrington.
 234 U. S. Patent 2,015,742, A. G. Cooley.
 235 U. S. Patent 2,033,021, L. J. Wolf.
 236 U. S. Patent 2,039,869, B. Adler.
 237 U. S. Patent 2,117,587, C. J. Young.
 238 U. S. Patent 2,113,429, R. Hell.
 239 *RCA Institutes Technical Press*, "Radio Facsimile," pp. 270-283, by Henry Shore and J. N. Whitaker.
 240 Br. Patent 318,119, Otho Fulton.
 241 U. S. Patent 1,759,303, Otho Fulton.
 242 U. S. Patent 1,792,264, E. F. W. Alexanderson.
 243 U. S. Patent 1,803,133, R. H. Ranger.
 244 U. S. Patent 1,886,189, C. W. Hough.
 245 U. S. Patent 1,985,057, L. R. Philpott.
 246 U. S. Patent 1,740,834, R. H. Ranger.
 247 U. S. Patent 1,751,584, C. W. Hansell.
 248 U. S. Patent 1,789,687, R. H. Ranger.
 249 U. S. Patent 1,792,767, F. Schroter.
 250 U. S. Patent 1,800,357, R. H. Ranger.
 251 U. S. Patent 1,807,011, R. H. Ranger.
 252 U. S. Patent 1,807,012, R. H. Ranger.
 253 U. S. Patent 1,870,989, B. E. Eldred.
 254 U. S. Patent 2,089,667, O. Schriever.
 255 *Hochf. Tech. u. Eleck. Akus.*, Vol. 41, March, 1933, F. Schroter.
 256 *E.u.M.*, Vol. 44, pp. 81-84, August 22nd, 1926, B. Freund.
 257 U. S. Patent 1,817,098, R. H. Ranger, and S. B. Smith.
 258 U. S. Patent 1,957,646, F. J. Hinton.
 259 *Telefunken Zeitung*, Vol. 16, No. 70, Part I, pp. 35-43, April, 1935, F. Schroter.
 260 *Telefunken Zeitung*, Vol. 16, No. 71, Part II, pp. 17-36, May, 1935, F. Schroter.
 261 *The Telegraph Journal*, January, 1937, International Bureau, Berne.

PHOTORADIO TRANSMISSION OF PICTURES¹

BY

HENRY SHORE

Radio Corporation of America

THE transmission of pictures by means of electricity is a subject which has engaged the attention of many capable workers. Beginning in 1842, Alexander Bain, an English physicist, conceived and solved the problem in its broadest aspects so accurately that practically every system since devised, has employed principles first used by him.

Essentially, there is provided at the transmitting end means to scan each elemental area of the picture to be transmitted, to convert the light of each of the scanned areas into an electron signal proportional in intensity to the strength of the light received from the scanned element. At the receiving end the electrical impulse is reconverted into light, the value of which bears direct relation to the signalling energy. There are, however, additional considerations. Each of the reconverted elements of the picture must occupy the same relative position with respect to the reproduced picture as the scanned element occupied in relation to the original picture. At the receiver the reproducer must travel with respect to the picture surface at a speed identical with that of the transmitter; it must also start out in the same relative position as the transmitter in order that the picture received be undistorted.

The necessity of this maintenance of identical speeds and position relation, known as "synchronism" and "phasing" respectively, arises from the fact that in transmitting a picture wave three variables must be considered, namely, the two dimensions of the picture, the width and height, and the density of each elemental area. We have, however, only one dimension available in our transmitting channels, the instantaneous magnitude of the electric current. We must, therefore, rely upon some other factor to provide the two linear dimensions of the picture, which is time.

By selecting predetermined time intervals to transmit each of the elements, and knowing the position which each element is to have for

¹ Based on a paper delivered before the Photographic Society of America, at Rochester, N. Y., April 26, 1937, and published in the Journal of that Society, December, 1937.

Reprint from *RCA Review*, July, 1938.

a given instant, we can reassemble the picture by sending the proper amplitude of current at the correct instant. For example, we may describe a ludicrous system, but one which may nevertheless be effective in reducing the problem to its simplest terms of explanation. Two men are at opposite ends of a telephone circuit. The man at the transmitting position says "I will now send you picture element number one, for the upper lefthand corner. The value of this element is Four." By prearranged code, the receiving man knows that "Four" is one of say ten steps of value between white and black. Accordingly, he makes a mark upon a paper of the proper shade, *and in the proper place*, as directed. By some such cumbersome method, the receiving man may, after duly recording 12,000 separate messages of instruction, look upon one square inch of the complete picture being sent him. We return now to a consideration of more practical means of picture transmission by radio.

In practice, the task described is merely relegated to mechanical and electrical devices, which scan the picture to be transmitted in a predetermined fashion and at a predetermined speed. If we follow at the receiving point the same scanning trace with respect to the scanning pattern, in exactly similar speed, we automatically indicate for each instant of transmission the proper coordinate position of the elemental area, as well as its value in electric current.

This is the problem and its solution in its broadest aspects. Years have been spent by the many workers to perfect means of following a predetermined scanning pattern in precise time relation and in producing electrical impulses which are strictly proportional to the density of the elemental areas, and in reproducing those electrical impulses into elemental areas the density of which is strictly proportional to the electric impulses. Historically the simplest scanning means was a pendulum swinging back and forth across type faces in which a small light contactor rode over the faces to make electrical contacts. The closing of the contact transmitted a signalling impulse. At the receiving end a similar pendulum traced a similar path on paper. By electrolytic action the electrical impulse received from the transmitter would discolor that part of the paper in contact with the recording stylus in accordance with the contact of the original. After each swing of the pendulum the type face at the transmitter and the paper at the receiver would be advanced an appropriate distance. The surface of adjacent areas of the type-face contact therefore were in rough correspondence to similar areas contacted by the pendulum of the receiver. Such a system of scanning, because it depends upon back and forth action for its operation, is known as "reciprocating scanning".

Following this ingenious device other systems were subsequently proposed. The next was one in which the picture to be transmitted was mounted on a drum. The scanning element was mounted on a screw advance parallel to the axis of the drum; and suitable gearing provided between the shaft of the drum and the lead screw caused the carriage to move longitudinally with respect to the drum as the drum was rotated by a motor. The gearing and the pitch of the screw determine the rate at which the scanning device so mounted travels. For present practice this is fixed to be about 1/100th of an inch for each revolution of the drum.

It will thus be apparent that the scanning path was that of a helix and, since the pitch is small, substantially parallel line scanning results. This is a so-called "rotary scanning system". Practically all other scanning systems are derived from these two either singly or as a combination of both rotary and reciprocal scanning. Either system provides a means for scanning each elemental area of the picture to be transmitted and the final choice is generally dependent upon other considerations. In general, the rotary system is preferred, since such systems may be maintained in synchronism more easily and do not suffer from back-lash and other mechanical imperfections as much as reciprocal scanning systems.

Transmitting heads, which constitute part of the scanning system, fall into two general classes—those representative of the earliest work in the field which make use of electrical contact and resistance variations, and those which make use of electrical light translating methods.

The first type of system is represented by the class in which the message to be transmitted is written or printed in special electrically conducting ink upon the message blank. A scanning stylus rides over the message blank and, in accordance with the changing electrical resistance it encounters, a varying electrical current is produced. Such systems have the disadvantage of being operative at only relatively low speeds, and because they do not compensate for varying thicknesses of the ink, spurious variations in resistance take place. These produce distortions in the transmitted signals. In the same category belong those systems in which an embossed image of the picture on thin metal foil is used or, alternatively, a half-tone plate is used in conjunction with a fine stylus. In either of these forms, the stylus making contact with the raised portions of the metal closes the electrical circuit to transmit pulses representative of the raised areas of the picture surface.

In the second class, light-translating elements, such as selenium cells of the variable resistance or bridge type, photoelectric, photo-

voltaic and barrier layer cells, are represented. Either transparencies of the picture or the picture itself may be used in systems of this class. In the case of transparency, light is transmitted through a negative of the picture by means of a suitable optical system focused on the light translating element. In accordance with the variation of densities, corresponding variations in electrical currents are produced for actuation of the radio transmitter. Such a system has the disadvantage of requiring the preparation of a film for transmitting, and of not permitting the direct use of picture or message blank. The direct picture method employs a source of light to illuminate a small area of the picture. The reflection of this light is focused upon the light translating element to produce corresponding variations in electrical currents. In direct picture transmission systems of this class, a large source of light covering an appreciable area may be used, if a suitably apertured optical system, restricting to a small area the light falling on the light translating element, is also employed. Alternatively, the light may be focused through an aperture to the picture, the aperture being so dimensioned as to have the size of the smallest elemental area to be scanned. The reflected light is picked up and focused on the photoelectric cell. This latter method is preferred since it affords generally greater efficiency.

In the receiver, substantially the same arrangement for scanning the picture area is provided. That is to say, that if a reciprocating scanning system is used at the transmitter a similar reciprocating scanning system is used at the receiver, or if a rotary scanning system is used at the transmitter the same general type is provided at the receiver. Occasionally, however, and depending on the whim of the apparatus designer or operating conditions, a combination of a reciprocating scanning system at the transmitter and rotary scanning system at the receiver or the converse is used. Such systems, however, are inherently more difficult to synchronize and consequently, have not received much consideration from technical investigators.

Suitable means of synchronizing the receiving-driving mechanism must be provided, and here the methods and apparatus for maintaining the receiver in synchronism are as ingenious and variegated as the designers themselves. Some of the more important systems of synchronizing are the start-stop systems in which the receiver is running at a speed slightly higher than the transmitter, and is stopped at the end of each revolution. A synchronizing impulse, transmitted once during each revolution at the transmitter, actuates a clutch arrangement at the receiver. This engages the receiver mechanism with the driving means for one stroke after which the clutch is automatically disengaged, to be re-engaged by the next synchronizing impulse.

Another method makes use of synchronous motors at the receiver and a synchronous generator at the transmitter. The alternating current generated by the synchronous generator is transmitted to the receiver and drives the receiver through a synchronous motor. Variations of speed occurring at the transmitter produce variations in the frequency of the current received, since the synchronous motor at the receiver follows faithfully the speed of that at the transmitter. This, of course, requires the transmission of relatively large amounts of synchronizing energy. Of course we cannot conveniently operate motors on both sides of an ocean from a single, and therefore, automatically synchronizing, source of power. To overcome this handicap at the receiver, another system makes use of a direct current motor of poor speed regulation. Mounted on the same shaft is a synchronous motor which is supplied by synchronizing energy from the transmitter. In this case, the d-c motor supplies the bulk of the power and the synchronizing energy can be reduced, accordingly, since it is only necessary in this system to supply enough energy to take care of the variations. At the present time, and since we have perfected means for generating alternating currents the precision of which can be maintained within one part in a million, independent driving sources at the transmitter and receiver are utilized. At the receiver the frequency of the driving energy is adjusted to that of the transmitter by means of phasing or synchronizing signals transmitted prior to the transmission of the picture, and once adjusted, requires no further attention. This is because the frequency is maintained to such a high order of precision. This system has the advantage of eliminating the necessity for transmitting during the picture transmission any synchronizing signals.

We turn now to the actual recording of the signals. One is confronted with the difficulty of choosing from a large number of methods. Each method has its own peculiar advantages and disadvantages and the final choice is, therefore, governed by the factors which are peculiar to the particular installation.

In the early days, a simple ink recorder was used. This recorder, mounted upon a carriage similar to the transmitting scanning head, used a modified fountain pen with its point just clear of the paper. The incoming signal actuated an electromagnet which placed the pen point in contact with the paper. In accordance with the signals, a fine line was drawn each time the pen contacted the paper. Such a system, of course, is limited to relatively low speeds due to the inherent difficulties, due to mechanical inertia, of accurately and quickly actuating the pen. Difficulties were also encountered in the drying qualities of the ink; blurring and the like. To overcome this, a method

of wax recording was used in which an ordinary drafting pen was fed with molten wax from a receiver through a capillary wick. By properly adjusting the temperature of the reservoir containing the wax, it could be made to congeal on the surface of the paper almost instantaneously upon contact with the paper. This eliminated many of the "blurring" difficulties which were encountered with the ink pen recorders. However, the temperature adjustment was critical and merely a draft was often sufficient to cause the wax to crystallize in the pen, resulting in failure of the recording process.

Other methods have been used along these lines in which the ink, in a fine stream or in the form of vapor, is projected toward the recording surface and either electrostatic or electromagnetic means used for diverting the stream of fluid from striking the paper. Such methods are capable of being used in fairly high speeds of recording, but have the disadvantage of being rather wasteful since the stream must be projected continuously and only permitted to strike the paper during the recording intervals. These methods, however, do have a very important advantage in that they do not require a paper which is specially prepared.

Still another class of recording method makes use of specially prepared paper. That is, a paper which has a sensitized surface. Paper of this class includes material used for electrolytic and pyro-recording. In the electrolytic system, the paper is coated with some chemical which is capable of being decomposed by electric current. Decomposition is effected by a light stylus in contact with the surface of the paper. In accordance with the received current from the transmitter, this occurrence of decomposition is generally accompanied by a change in color. The method is quite simple, but has a serious drawback in requiring a specially prepared surface. The fact that moisture must be present, in order that the electrical decomposition take place, requires the surface of the paper to be moistened before placing it upon the picture-support surface which is an added disadvantage. The wear at the stylus point is quite high and this requires constant replacement of the recording point. Furthermore, strong electrical currents have a tendency to produce a widening of the recorded line, which introduces serious distortions. The pyro-recording systems are typified by the chemically prepared surface and the wax prepared surface types of papers. In the chemically treated papers, a coating of salts, generally containing nickel, is placed on the paper. A jet of air, heated to a fairly high temperature, is directed upon the surface of the paper. Under the influence of heat, the salts on the surface of the paper decompose, leaving a black residue, and produce, accordingly, a picture the intensity of which is a function of the temperature of the air. For-

tunately, this type of chemical reaction is non-linear and exhibits variations in intensity only over a very small range. Consequently, by running the temperature of the air above the saturation value of the decomposition effect, constant density recordings can be obtained.

In another variation of the same "heat" system, a layer of wax is deposited on the paper in the form of exceedingly fine crystals. Hot air similar to that described above is permitted to strike the surface, causing melting of the wax, which is absorbed by the paper. When the picture is finished, water ink is run over the surface of the picture, and because of the difference in properties of ink affinity between the areas of the crystalline and melted wax, copies in ink can be made. The ink is deposited only where the hot air has struck the prepared surface.

One rather important system of facsimile reproduction makes use of carbon paper facing a sheet of ordinary white paper. The two sheets of paper run between a straight edge and a cylinder upon which is raised a single spiral. The straight edge is actuated by transmitted currents through means of an electromagnet so as to press the carbon and white paper against the raised spiral of the drum. The point at which the pressure is exerted at any instant is between one point of the straight edge and one point of the spiral. As the drum rotates, the effect is, of course, to produce single line scanning across the width of the paper. By moving the paper in the same direction as the drum, line by line, scanning is accomplished, and the completed picture recorded.

In this same class of prepared papers (in the last instance, carbon paper was a necessary accessory) belongs the method of photographic recording. Here again there are available many ways of using the photographic properties of paper for recording. One system utilizes a fine stylus to scan the surface of the paper. The fine stylus is excited by high frequency electrical currents the intensity of which is varied in accordance with the received signals. Adjustment of the intensity of these high frequency currents to a point just below where ionization takes place, so that the transmitted signals may raise this level, results in the production of a corona discharge under the needle point of the stylus. This corona discharge is sufficient to produce the latent image, and following the recording of the picture the paper may be developed. A relatively insensitive emulsion may be used in this system, and recording may take place in a room having ordinary illumination without sensitizing the paper, thus obviating the necessity of dark-room recording.

Another method utilizes a light valve, similar to that used in the motion picture industry, for recording sound. It uses the incoming

signals to open or close the valve, faithfully to reproduce a recorded line-by-line picture, the width of each line varying proportional to the amplitude of the received signal. This is the so-called "Constant Density Variable Line" system of recording. Alternately, the light valve may be arranged to produce a recorded line of constant width, but to vary the intensity of the light impinging upon the photographic paper, producing the well known "Constant Width Variable Density" type of recording. The light valve may, of course, be either of the electromagnetic type or may use the gaseous discharge type in which the actual intensity of the light emitted from the ionized gaseous vapor is proportional to the received signal. Generally, it is desirable in commercial applications to have more than one copy of the received picture, and where this is the condition, film is usually substituted for photographic paper, and as many prints as may be desired are made from the film.

Photographic methods of facsimile reproduction, which have the disadvantage of requiring the operator to work in a dark room, and introduce delay due to developing, printing and drying, do have the very important advantage of being capable of working at exceedingly high speeds. In general, too, the photographic recordings show less day-to-day variation than most of the other facsimile methods. One important disadvantage, in such systems, however, is the fact that one does not have an instantaneous knowledge of receiving conditions, and any failures in the transmitted picture cannot be determined until the picture is developed. This is extremely undesirable, since sometimes these failures take place at the beginning of the transmission, and it is only after an interval of ten minutes or more that one discovers the picture must be retransmitted. In practice, this difficulty is effectively resolved by using as monitoring equipment apparatus which makes use of one of the other methods of instantaneous recording, such as the fluid, or carbon recorder, described above. Both types being operated simultaneously by the one radio signal, we gain the greater clarity of the photographic method in the received picture in the one, and at the same time may learn all we need to know about the progress of reception from the other. While the pictures produced by the monitoring equipment are not generally of the same high quality as those produced by the photographic recordings, they nevertheless show very clearly failures in the transmission. These the operator can at once perceive and retransmission can be effected immediately thereafter, rather than after the entire picture has been recorded, the negative developed, and a print made. This is, of course, of real importance in any commercial service.

Of course, there must be a transmission medium to connect scanning and reproducing equipment and in the instance of facsimile by radio, we make use of the spacious "ether" about us. The medium is not a perfect one. In fact, it is so imperfect that it accounts for practically all of the serious distortion which arises in the transmission and reception of pictures by radio.

Two basic processes of transmission are available. One is the so-called "Amplitude Modulation" method, in which alternating currents of radio frequencies are altered in amplitude, varying with the densities of the elemental areas of the picture to be transmitted, i.e. for bright areas, we obtain high amplitude currents, and for low densities, low amplitude. A value between maximum and minimum produces a current of proportional strength.

Applied to radio transmission, this method suffers a disadvantage which disqualifies it as a system of sufficient reliability for commercial use for short wave, transoceanic use. That is the phenomena of "fading", which affects the strength, or amplitude, with which a signal of given intensity may be received from one instant to another at a distant location. Since signal strength is synonymous with signal amplitude, it is readily seen that struggle with this natural handicap might be futile. Radio engineers are not the first men who have found that nature is much more easily outwitted than overcome by sheer force; and so we pass to other possible means of passing pictures through space for thousands of miles.

Frequency or phase modulation are suggested. But these, too, are affected by changes in the transmission medium and produce essentially the same effects as fading in amplitude modulation systems.

Up to the time this is written, only one answer to the problem has been found. We refer to the on-off type of keying. In this system, the transmitter is either turned on at full amplitude, or else, is turned completely off so as to transmit no energy at all. The duration of time in which the transmitter is turned on is determined by the average value of the density of a number of elemental areas, so that the duration of the transmitted impulse is actually proportional to the integrated value of the light reflected from a number of elemental areas. This is quite analogous to the half-tone method of printing pictures. The spacing between impulses is likewise determined by the integrated value of a number of areas so that, when the final recorded picture is viewed, the eye integrates relatively large areas and the impression which the eye receives depends on the number and length of the recorded lines, or "dots" to recreate the impression of the varying densities of the picture.

Of this system, there are two general types. The first system sends dots of constant duration, but spaces the dots in proportion to the amount of reflected light. If the portion of the picture being scanned is quite dark, the dots are spaced very closely together. Conversely, if the picture area is light, the dots are spaced quite far apart. Accordingly, when the received picture is looked at, the eye, seeing a number of dots very closely together, gives the impression of looking at a dark area, while that area in which the dots are spaced far apart appears to be a very light grey. Such a system, however, cannot provide very good detail and so the "Constant-Frequency Variable-Width" recording method has been developed to overcome this difficulty. In this latter system the number of dots sent per unit time is constant and, in present practice, may be as high as 100 dots per second. The width of the dot, however, may vary all the way from 10 per cent to 90 per cent of the interval between dots, and the variation of the width and the dot, that is, the time duration of the dot itself, is made proportional to the density of the elemental area being scanned. If, in addition to this, the alternate lines of dots are shifted with respect to one another, the resultant picture is a surprisingly light-true, half-tone picture, produced by conventional screening and printing methods. This is the system which is at present used commercially between the United States and Great Britain, Germany, and Buenos Aires. It is also used between New York and San Francisco.

It will be appreciated, of course, that at the receiver it is necessary only to record the duration of the dots faithfully to reproduce the picture. The amplitude no longer is of any consequence, and accordingly, therefore, limiting or saturating means of recording can be used. Along these lines, diversity reception is the practice.

The diversity system of receiving utilizes three separate antennas spaced from each other, generally about 1,000 feet apart, all of which receive signals from the same transmitter. Each antenna is connected to its individual receiver and the outputs of the three receivers are combined. Due to the fact that fading is not simultaneous at all geographically spaced locations, diversity reception utilizes the probability that the signals will not fade simultaneously at three separate points. Since the output of any one receiver is sufficient to actuate the recording mechanism, so long as there is not simultaneous fading at all three points, the recording is always a faithful reproduction of the transmitted signals. In practice, it has been found that, in a twenty-four hour day, such a system seldom gives more than a total of ten to fifteen seconds of fading. Suitable means are provided at the point where the signals are combined in order that the output may be independent of the actual sum of the three receiver outputs.

That is to say, no output is produced unless one receiver is feeding energy to the output circuit, whereupon that output is fixed in amplitude and unchanged whether or not one or both of the other two receivers contribute to the output. These receivers are standard equipment for practically all point-to-point radio telegraph use in the United States, and so the transmitter, being used under identical conditions of ordinary radiotelegraph conditions, needs no special provisions for transmitting pictures by radio.

Having described picture transmission by radio, in general, it is of interest to consider a complete system in detail. For this purpose

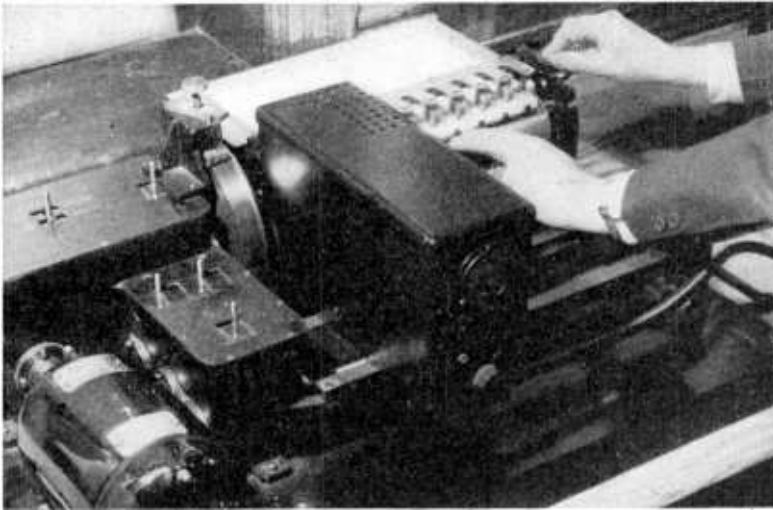

Fig. 1—Photoradio transmitter.

the present photo-radio system of RCA Communications, Inc. will be described, since it is typical of a commercial system used today.

The photo-radio machine is arranged to serve either as a transmitting scanner or a recorder and makes use of a rotating drum and a lead screw upon which is affixed, in appropriate guides, a carriage. The carriage transports the unit which determines the function to be performed. An aluminum base carries the driving mechanism, the subject drum, gear box, and the line-advance lead screw with the carriage track assembly as illustrated by Figure 1; the machine being arranged in this case for visual recording. The gear box assembly serves to furnish four speeds of 20 to 60 revolutions per minute for the subject drum. The line advance may, similarly, in twelve steps between 40 and 300 lines per inch, be provided by simple gear shift. Thus, as the driving motor turns over, the drum rotates, and the lead

screw drives the carriage longitudinally along the drum to trace out an electrical path. By making the line advance fine enough, the pitch of the helix is so small as to give substantially parallel line scanning.

To the rear of the drum, and tangential with it, is a loading platform upon which the subject is placed. A portion of the periphery of the subject drum is cut away and in the space thus provided, a series of gripper fingers similar to those used in the printing arts are provided to engage the leading and trailing edges of the subject surface. To load, the subject picture is pushed toward the drum surface along the loading platform, and a set of rollers normally held clear of the drum are let down upon it. Letting down the rollers automatically operates the grippers to place them in open position and when the gripper portion of the drum lines up with the leading edge of the paper, the grippers are tripped, seizing the paper and dragging it around the surface of the drum and off the loading platform. When the trailing edge of the paper is in line with the trailing edge grippers, these grippers are similarly triggered to seize and hold taut the paper firmly around the drum and the feed rollers are then lifted clear. Operation is then commenced with the carriage at the extreme left. For the transmitter, the scanning head shown in Figure 1 is mounted on the carriage. The indirect, that is, reflected light scanning system is used. A standard 75-watt automobile headlight lamp is used to provide the source of illumination for scanning. This is mounted at an angle with the scanner housing. Appropriate louvers in the sides and bottom are provided to afford ventilation. Horizontal and vertical adjustment of the lamp base is furnished properly to center the lamp with respect to its optical system, which comprises two lenses and an adjustable diaphragm. Positioned between the two lenses, the first of which is a condensing lens, is the variable diaphragm to provide a rectangular image. Calibrated adjustments are provided for regulating the height of the diaphragm in thousandths of an inch and the length in lines per inch, to correspond to the line advance. The second lens focuses the image of the diaphragm upon the subject drum and normal to this focused image is a pick-up lens for projecting the reflected light upon the photo-cell mounted within the scanner housing. The photo-cell current serves to modulate carrier wave energy. This is appropriately amplified and passed on to the constant-frequency variable-dot converting unit. The motor which drives the subject drum and lead screw operates at a speed of 1,800 revolutions per minute and is maintained at this speed with a maximum deviation of one part in 100,000.

This is accomplished by using a d-c motor of poor regulation, which normally runs at a speed above 1,800 r.p.m. Mounted on the motor shaft is an alternator, generating a frequency of 810 cycles. The

output of the alternator is fed to a pair of vacuum tubes, also excited by a frequency of 810 cycles from the frequency standard, which in this instance is a tuning fork, electrically driven by a special thermionic tube circuit and maintained at constant temperature. The amount of energy which the tube alternator supplies to the vacuum tubes is dependent upon the difference between the frequency of the fork and the frequency of the alternator-generated currents. The more this frequency differs, the more energy is supplied to the vacuum tubes, and as more and more energy is supplied to the vacuum tubes, the motor speed is reduced. By suitable adjustment the alternator output is fixed to be approximately 50 per cent of its rated delivery when the speed is exactly 1,800 revolutions per minute. Consequently any deviation in speed—as for example, a momentary drop—will decrease the

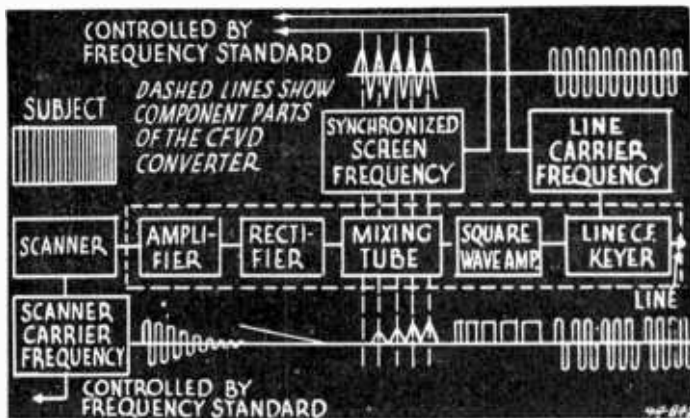

Fig. 2—Schematic block diagram of the constant-frequency variable-dot transmitting system.

load of the alternator and the motor speed will increase until the speed is again exactly 1,800 rpm.

As was pointed out above, the requirements of long distance transmission make it desirable to use constant-frequency variable-dot transmission but, as the output of the transmitting scanner is an amplitude-modulated carrier wave, it is necessary to convert these variations in amplitude to variations in dot-time duration. This is provided by an ingenious electrical circuit.

Figure 2 is a block diagram which shows the component parts of the electrical circuit and the shapes of the currents of the various steps in transforming the amplitude-modulated signal out of this scanner into constant-frequency variable-dot signals. The subject is indicated as one which shows progressively increasing densities and

as the scanner passes over each elemental area, there is provided an amplitude-modulated wave as shown in the lower left-hand corner the amplitude of which decreases with increasing density. The amplitude-modulated carrier wave is rectified by the rectifier and is fed into the mixing tube along with electrical wave energy of constant amplitude and frequency, and its wave shape is that of a symmetrical saw-tooth. The frequency of this symmetrical saw-tooth wave-shape energy, known as the screen frequency, is controlled by the same frequency standard which controls the motor speed. The screen frequency is, therefore, synchronized with the motor speed. The rectified voltage serves to bias a triode tube so that the screen energy cannot pass but, as the amplitude of the rectified voltage decreases, more and more of the screen frequency energy is permitted to pass through the tube and the width of the base of the pulses which are permitted to pass is directly proportional to the amplitude of the rectified current. These pulses are then passed through a wave-shaping circuit known as a "square-wave amplifier", which converts the triangular impulses of varying heights into rectangular-shaped impulses of constant height, with bases which are equal to the base of the triangular impulses. Accordingly, the resultant rectangular pulses have a length which is proportional to the density of the elemental areas of the subject to be transmitted. These rectangular pulses are then used to key-line carrier energy for transmitting the impulses to the transmitting station, which is generally located at considerable distance from the photo-radio equipment. The line carrier energy serves to key the transmitter on and off in the conventional "dot-dash" fashion.

At the receiving point the radio signals are detected and transmitted to the receiving photo-radio equipment. The recording arrangement employs a universal machine identical to the transmitter, except that the lead screw carriage carries either a visual recording gun or a photographic recording gun. Generally, two receiving machines are employed; one having the visual gun for monitoring purposes, and the other a photographic recording gun for producing the final recorded picture. The visual recording gun is generally mounted beside the control rack, while the photographic recording machine is in a suitable dark room. The visual recorder comprises a very fine nozzle through which ink vapor produced from an air supply and atomizer is projected toward the picture surface through a very fine nozzle. In front of the nozzle is a small shutter actuated by an electro-dynamic unit, similar to those provided in modern dynamic loud speakers for broadcast purposes. Normally, when the shutter is in register with the nozzle, the ink vapor strikes the shutter and runs off of it into a little well. The incoming signal, after being appropriately amplified, actu-

ates a keying unit which rectifies the signal and shapes the wave to provide quick acceleration to the shutter. Thus, an incoming signal pulls the shutter down clear of the nozzle and the ink vapor strikes the paper depositing a black dye, thereby building up the picture, element by element. Figure 3 is a photograph of the visual recording gun. For photographic recording the apparatus layout is essentially the same, except that a recording neon tube with an appropriate lens system is provided in the place of the visual gun unit. The tube is mounted on a base actuated by three cams, so that the tube may be rotated, as well as moved from side-to-side, and up-and-down. Longitudinal movement of the tube is provided by a sliding barrel and the

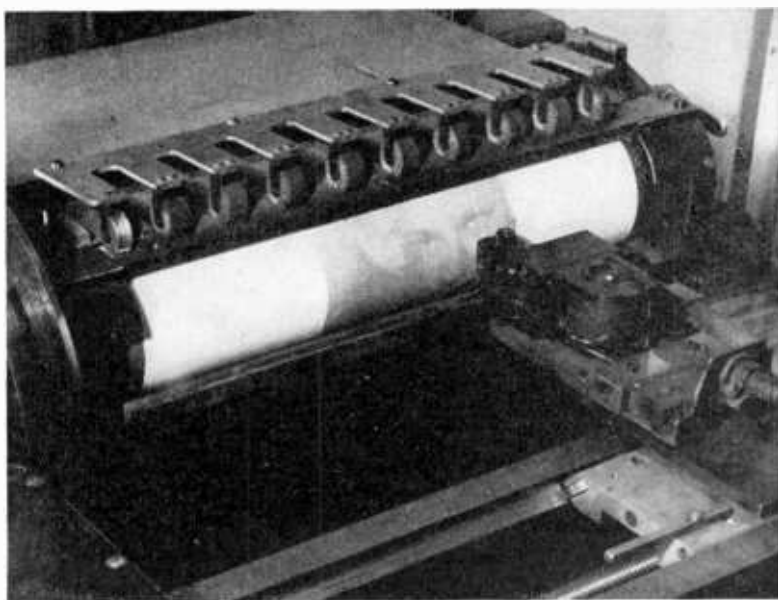

Fig. 3—Photoradio visual recorder.

optical system comprises a microscope objective lens for focusing light from the crater of the neon tube to the surface of the photographic film or paper. Mounted from the barrel of the tube on an angle of about 45 degrees is a simple magnifying glass focused upon the film at the point where light from the recording lamp is also focused. The operator can thus determine the correct adjustment of the lamp as the recording lamp is manipulated. An appropriate diaphragm is provided in this system, suitably calibrated, to insure that the resultant light will produce an image of an elemental area substantially the same as that transmitted.

The photographic recording system is shown in Figure 4. Film is

usually employed in preference to paper, to make possible multiple printing. The film used is of the Printon type and has a spectral response comparable to that of a C5 ("tri-color blue") Wratten filter. This type is used in order that the relatively high levels of illumination in the dark room may not result in unwanted film exposure. The levels of illumination used in the dark room are necessary from an operating standpoint in order that the operator may read values on various control instruments necessary to the reception of pictures. The de-



Fig. 4—Photoradio photographic recorder.

veloper used for the film is one of quick-contrast, and permits considerable over-development without creation of "fog". However, it should be borne in mind that, since the recordings are at constant illumination out of the lamp, high contrast aids in the finished picture, because the picture is really made up of alternate rectangles of white and black components of uniform density, but variable area.

In printing, a bromide paper of extra contrast is used, and a corresponding developer provided for developing. An acid hypo-bath is used for a fixer. It will be appreciated that, under the circumstances, close control of bath temperatures and developing and fixing are obviated. The service of high skilled operators is, therefore, unnecessary.

To produce the half-tone effect in the pictures, it is necessary to shift the screen frequency on alternate strokes, in order that alternate lines may have spaces lining up with dots and, conversely, dots lining up with a space. This shifting in phase is provided at the transmitter simply by reversing the terminals from the screen frequency source as it is fed into the constant-frequency variable-dot converter. It is accomplished automatically by providing a cam mounted on a shaft which rotates once for two revolutions of the drum. The cam is cut so as to affect a contactor for one-half the revolution. The cam arrangement can be seen in Figure 1 attached to the rear gear box on the left-hand side of the machine. When the contactor is closed, a double-pole, double-throw relay, cross-connected to provide terminal reversal, is actuated so that during one-half revolution of the cam, energy is fed to the constant-frequency dot through the closed position of the relay. The next half revolution feeds the energy in the open position of the relay with an attendant reversal of phase of the screen frequency. The result of this step of operation can be seen in Figure 5 showing a picture transmitted and received by radio. When the line advance is very fine, the dot pattern produced is that of elongated rectangles. It does not provide as pleasing a pattern as when the height of the dot is substantially equal to the width of the dot. To overcome this, a second cam may be used which provides reversal of phase for every two lines instead of every other line.

The actual technique in transmitting a picture requires a determination of the condition of the transmitting medium. This is done by first transmitting what is called a "density wedge". Such a "wedge" is a standardized chart of densities of ten steps, varying from white to black. The entire range provides for 10 per cent increases in the duration of the dot transmissions. The operator at the transmitting point places this "wedge" on his transmitter and adjusts the control so that 10 per cent dots will be transmitted on the first step and 100 per cent or solid black signals will be transmitted on the tenth step. The subject drum is then started, and transmits a series of dots at constant frequency with a marking weight which depends on the step of the wedge. During each revolution, dots of 10 per cent, 20 per cent and 30 per cent, etc., are transmitted for equal intervals. At the receiving station a preliminary recording is made of the wedge. Due to circuit conditions, it is sometimes found that the dots are elongated to the extent that dots which are transmitted at 80 per cent of the marking interval actually fill-in to give 100 per cent marking. Likewise 10 per cent dots may be elongated sufficiently to show 30 per cent recorded dots. This has the effect of decreasing the contrast ratio of the transmitted subject. However, the receiving operator transmits

back this information. Controls are provided at the transmitter, so that, by changing the amplification gain of the scanning head and the amplitude of the screen frequency, the weights of the dots can be changed to produce at the receiving station dots which cover uniformly the entire range from 10 to 100 per cent marking intervals. This pre-distortion of the transmitted impulses is, in effect, an electric means of changing contrast ratios in pictures and has made it possible to transmit improved pictures under adverse conditions of transmission, which formerly would have been so severe as to preclude the reception of pictures.



Fig. 5—Picture transmitted and received by radio.

With regard to the details which can be transmitted, some idea can be obtained from the fact that subject-matter is accepted where the type is no smaller than twelve-point and the area of interest is not less than $\frac{1}{2}$ inch square. The screen frequencies used in present-day practice, together with the line width, provide pictures which are about the same as 65-screen half-tones. When the conditions of radio transmission are particularly good, that is, in the absence of magnetic storms and static, the details can be increased to almost twice this value. It is apparent that, since the received picture is in the form of a half-tone, line cuts can be prepared directly from the picture without the necessity of producing half-tones, with consequent further saving in time where the pictures received are for newspaper reproduction.

FACSIMILE TRANSMISSION AND RECEPTION

BY

MAURICE ARTZT

Engineering Department, RCA Manufacturing Company, Inc.

SCANNING SYSTEMS

FACSIMILE is defined to include all systems whereby a picture is broken into separate picture elements, these elements being transmitted by some connecting means to a distant recorder where they are reassembled into their original positions to form a copy of the original. The word "picture" in the above statement includes also diagrams, typing, handwriting, photographs, and any other form of printed or written material.

Three distinct operations are performed in the transmitting and recording of facsimiles: first, the breaking up of the picture in some orderly manner into its separate elements of varying shades, this process being called scanning; second, the transmitting of these elements to the recorder by means of signals arranged to represent the electrical equivalent of these elements; third, the rebuilding of these signals by a recorder into a printed copy of the original by a reversal of the scanning process.

A fourth part of a facsimile system, supplementary but very necessary, is a method of synchronizing the recorder and scanner. The timing of the signals received must agree exactly with the timing of the recorder, in phase as well as frequency, if the copy received is to be undistorted.

1. *Picture Elements*

In processing a picture by facsimile, the picture is resolved into dots, or picture elements, similar to the small dots used in printing a picture in a newspaper or magazine. These dots are obtained by "screening" in the printing process; they are obtained by scanning in the facsimile process.

Halftones in newspaper work have from 60 to 120 dots, or picture elements, per inch, whereas fine magazine printing may use as many as 250 dots per inch. In facsimile the limits are of about the same order, almost all present facsimile systems using 100 dots (or lines) per inch, as an average. Each picture element in a facsimile is sent as a separate signal. If the num-

Reprinted from "*Electrical Engineers Handbook*" by special permission of the Editors, Harold Pender and Knox McIlwain, and publishers, John Wiley & Sons, Inc.

ber of dots is carried too high, the speed of transmission is very slow; if too few elements are used, the detail will not be good enough. To send a picture of 100 dots per inch will require as many as 10,000 separate signals per square inch of surface covered.

Figure 1 will illustrate the difference to be expected in 50 or 100 lines per inch, when the subject-matter is ordinary typing. This type would be unreadable, in certain instances, if only 50 lines per inch were used, as can be seen by the poor formation of the *a*. The 100-line-per-inch detail, though not forming perfect letters, leaves no doubt as to their identity. In commercial facsimile, letters from ordinary typewriters are often used as the original, and 100 lines per inch are necessary to insure readability.

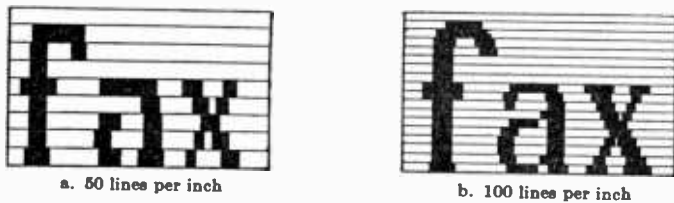

Fig. 1—Difference in detail for 50 and 100 lines per inch for typewritten letters.

Dots per inch and lines per inch are used interchangeably in the above paragraph, but this is not strictly accurate. Some facsimile systems break the subject up into dots, and send a separate signal for each dot, whether white, black, or gray. Others, however, break the sheet up into parallel lines, and send signals only for the black areas as encountered. Each line is then a continuous signal, varying in intensity with the shading of the original, and not made up of an exact number of picture elements as the dotted picture will be. The detail limits are the same in either case, and the maximum number of picture elements per square inch is the same.

These picture elements, as observed by the scanner in the process of transmission, will be of two general types, either of the simple black-and-white variety, such as typing, line drawings, etc., or of the halftone variety, in which all shades of gray from white to black may be encountered. Two separate types of scanners are not necessary, but the amplifier equipment will sometimes be different. Any system capable of transmitting and recording halftones will also operate properly on a purely black-and-white original, but the reverse is not necessarily true.

2. Applications

Facsimile is unique in communications in that it uses an integrating effect to form even simple characters. Thus in transmitting a typed message all the signals used to represent a single letter are not transmitted in sequence, but are sent out one at a time, and parts of many letters may be sent before another signal of the first letter is again sent out. For this reason fading and interference in a radio circuit that would ordinarily be severe enough to handicap a normal code or tape service seriously do not interfere to any great extent with facsimile. Letters sent by facsimile are often recognizable with nearly half of their elements missing, and readable copy may be obtained under trying conditions. Facsimile is therefore readily adapted to handling ordinary message traffic, as well as the specialized field of sending pictures.

The signals are not simple, and follow no given order even for sending the same letter. They are practically impossible to decode except by a recorder operating at the same speed as the scanner. This renders the service more secret than code transmission and limits duplicate reception.

The above advantages are bringing facsimile more and more into general use in regular traffic. The transmission of pictures and other such material for the news is of daily occurrence between New York and European capitals.

3. Scanners

The scanner of a facsimile system includes the following equipment:

1. Optical system, used to project a small spot of light on the picture, and means provided for collecting the reflected or transmitted light into a phototube.
2. Mechanical system, used to bring all parts of the picture being scanned under this spot of light in some orderly manner.
3. Amplifier system, used to change the output of the phototube into a usable electrical signal.

The electrical signals may be of the following types, each having its particular advantages and uses:

- a. Direct-current signals.
- b. Keyed audio-frequency tone.
- c. Modulated audio-frequency tone.

Each of these three types of signals may be redivided into two subheadings of "positive" or "negative," that is, signals for "black" or signals for "white." This gives a total of six types of signals normally delivered by modern scanners, the signal to be used depending on whether the transmission is by wire line or radio, and on many other factors.

Scanning methods. In the simplest form of scanning, regular lines are "ruled" across the sheet at some particular number of lines per inch, and signals are sent out representing each small area as it is encountered in ruling these lines. The sheet is thus broken into a number of scanning lines, all of the same width, and these lines are transmitted one after another until the entire paper has undergone this process.

Scanning is generally done in only one direction across the paper, and seldom back and forth. Two good reasons for this are: first, the mechanical construction of a unidirectional scanner is far simpler and requires much less precision in gearing; and second, the synchronizing system for a back-and-forth scanner must be far more accurate.

Although practically all facsimile scanners at the present time use a small point of light, and a phototube to pick up the light from the picture element being scanned, several other possible methods will be briefly described, chiefly for their historical interest.

One of the first scanning methods used was to prepare a copy on a metallic paper by drawing on it with an insulating ink. The sheet was scanned by a contact, breaking the circuit when an insulated line was crossed, sending a signal for "black." A reverse of this process has also been used, in that the ink was metallic, and closed a circuit when a line was crossed in scanning.

Directly related to the above is another system in which the copy was prepared similar to an engraving or etching, and scanned by a contact. The circuit was made and broken as this contact traversed the ridges and grooves on the plate.

Selenium cells offered the first solution to the problem of scanning an unprepared copy by light alone, although they never were satisfactory from the standpoint of speed of transmission.

The phototube and light method now in general use has none of the disadvantages of erratic contacts, or slow speeds inherent in these earlier systems. It is also capable of responding to

varying shades of light intensity, and can therefore be used to scan halftones, where varying shades of gray are needed. Its only serious drawback is in the very low voltage delivered. As the change of phototube plate current from black to white is very small, highly sensitive amplifiers are necessary.

The simplest form of the scanner, and therefore the one most generally used, consists of a drum upon which the original picture is wrapped, and an optical system arranged to project a small scanning spot of light on the surface of the paper. This spot of light is usually somewhat smaller than the width of a single scanning line. As the drum is rotated the optical system is moved relative to the drum the width of a scanning line for

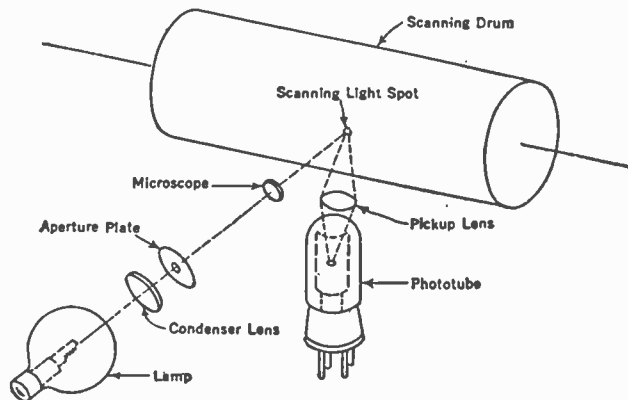

Fig. 2.—Simple facsimile scanner for reflected light.

each revolution of the drum. The entire paper is thus gradually passed under the scanning light. See Figure 2.

A phototube is arranged to pick up the light reflected from the surface of the paper, and the light reaching the phototube will be varied in intensity by the different areas of black, gray, and white that may be presented to view. A minimum light will reach the phototube for black, and a maximum for white. The output current of the phototube will then represent electrically the scanning of the copy. This current is applied to the input of the phototube amplifier, which in turn sends out the required signals. As this varying current is very small, only a fraction of a microampere, it cannot be used without a suitable amplifier.

All motions in the scanning process pictured in Figure 2 are relative. Thus the optical system may be rotated and the drum

held stationary, and the motion along the axis may be made by moving the drum or optical system relative to each other. All methods of bringing about this relative motion have been used.

Another method is to make the drum transparent, and transmit the light through a transparent copy. A photographic nega-

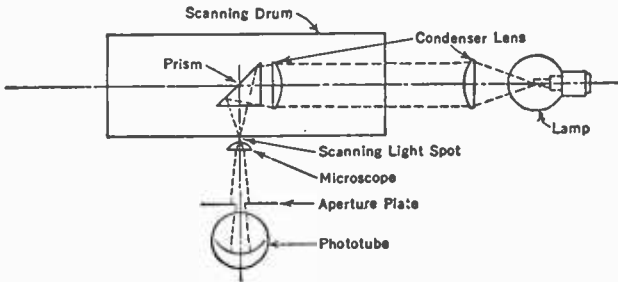

Fig. 3—Simple facsimile scanner for transmitted light.

tive may then be used as the original. This has one chief advantage over the first scanner, in that more light may be transmitted through a negative than may be reflected from a paper. A less sensitive amplifier is required. Its greatest disadvantage is that an especially prepared original must be used. Figure 3 illus-

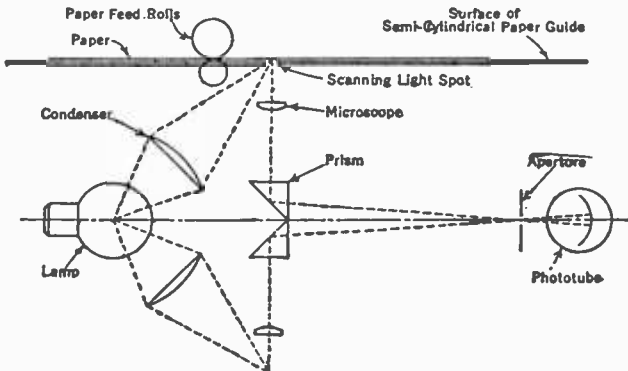

Fig. 4—Double microscope continuous-feed facsimile scanner.

trates a method of using transparent copy. Here the drum is rotated while the optical system remains stationary inside the drum. The light is picked up on the outside of the drum by the phototube.

Many scanners have been designed in an attempt to get a simple system using an unprepared copy, and not require a definite sized sheet for proper clamping on a drum. The Alexander-

son scanner in Figure 4 is an illustration of this. To avoid wrapping and clamping the picture, it is placed on the outside of a semicylinder, and scanned through a slot in the surface of the semicylindrical form. The optical system consists of two microscopes at 180 deg. rotating on the axis of this semicylindrical surface, and scanning by reflected light from the paper as seen through this slot. The paper is advanced by means of friction rolls along this surface. This scanner has two very distinct advantages: first it will scan any size of copy in which one dimension does not exceed the semicircumference of the scanning surface; and second, no stopping of the scanning process is necessary to change copy or reload. These advantages are largely overcome by the disadvantage of the extreme precision with which all mechanical parts have to be made, and the difficulty of adjusting the optical system so that each microscope receives the same amount of light and transmits identical signals.

The mechanism is so much more complicated than a simple drum type of scanner that it is seldom used at the present time.

4. Phototube Amplifiers

The first requirement of a facsimile amplifier, and the one most difficult to meet, is that the lower frequency limit is not some definite frequency as in an ordinary audio amplifier, but is zero, or a direct current. If the copy being analyzed has a large black border, this border may require a number of solid black scanning lines to represent it, and that the phototube current remain substantially constant for a number of seconds. An amplifier that did not include a direct current as a part of its frequency spectrum would not amplify such a signal properly. The upper frequency limit is much easier to meet, being generally much lower than that of the usual high-quality audio amplifier.

This maximum frequency is calculated as follows: Take the size of the smallest "dot" it is expected to be able to transmit, and make a checkerboard of these dots, separating them the width of one dot in each direction. If the scanner is set for 100 lines per inch, the smallest detail expected is a dot 0.01 in. in each direction. Therefore dots would be placed 50 to the inch in each direction, each dot being 0.01 in. square. This sort of pattern will give a maximum of "50 square cycles" per inch of scanning line transmitted. With a scanning speed of 60 strokes

per minute, and each stroke 9 in. long, this maximum frequency would be 450 "square cycles" per second. To represent properly this number of square pulses per second, at least the third harmonic of this square frequency must be amplified, and this raises the upper limit to 1350 cycles per second. The spectrum to transmit the above picture would then be from 0 to 1350 cycles per second.

Actually the spectrum can be made a little smaller than this, as another form of distortion prevents these dots from being square at the phototube. Aperture distortion, caused by the aperture being a finite size instead of infinitesimally small, will make these dots trapezoidal or even triangular, instead of square. Either form will require a somewhat smaller frequency spectrum for proper representation.

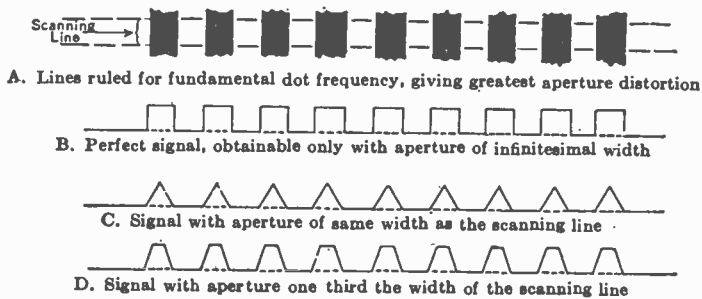

Fig. 5—Aperture distortion of signal.

These different forms of output, resulting from different apertures, may be better understood by studying Figure 5. It may be seen that, if the aperture is exactly the width of the smallest dot, the dot becomes a triangle, with a maximum value only at the one point where the aperture is exactly covered by the dot. If the aperture is narrower than this the dot becomes trapezoidal, and the proportion of time during which the value is a maximum increases. In most systems the aperture is made as narrow as is consistent with obtaining enough light to actuate the phototube amplifier properly. It cannot be made infinitesimally small, for, long before the spot of light becomes narrow enough to neglect the aperture distortion, the amount of amplification becomes so great that noises in the amplifying circuits become of the same order of magnitude as the signals to be amplified.

A Fourier analysis of the square wave in Figure 5B is:

$$e = \frac{\pi}{4} + \frac{\cos t}{1} - \frac{\cos 3t}{3} + \frac{\cos 5t}{5} - \dots$$

while that of the triangular wave in Figure 5C is:

$$e = \frac{\pi}{8} + \frac{2}{\pi} \left(\frac{\cos t}{1} + \frac{\cos 2t}{4} + \frac{\cos 3t}{9} + \frac{\cos 4t}{16} + \dots \right)$$

The harmonic content of the second wave is lower than that of the square wave given first, and a fairly complete picture of the triangular wave is given by including only up through the third harmonic. The next harmonic, the fourth, has a value of only about 7 per cent of the fundamental. However, in the square wave, by cutting off after the third harmonic, the next harmonic, the fifth, has a value of 20 per cent of the fundamental. It can readily be seen that if aperture distortion is present, as it always is, the errors introduced by cutting off all frequencies above the third harmonic will not be as serious as that caused by the aperture itself. Even in the trapezoidal wave in Figure 5D a shape more generally encountered, this error due to lack of harmonics is still low, a few per cent higher than the triangular wave. All the above waves are based on the same maximum value to reduce them to a common basis of comparison.

For purposes of discussion the frequency spectrum will be considered to include up through the third harmonic of the "square cycle" frequency, and the amplifier distortion assumed far less than the aperture distortion in every case. However, both these forms of distortion may be corrected to a large extent by other means. An "aperture distortion correction network" has been used in some systems to accomplish this, but a more general method is to pass the signals through a "threshold-limiter" amplifier to square up the wave form again.

Direct-current phototube amplifier. The simplest solution to the phototube amplifier problem is a direct-current amplifier, one form of which is shown diagrammatically in Figure 6. In this amplifier the tubes are directly connected plate to grid, and pure resistance coupling used throughout. As no capacitances or inductances are used in coupling, the frequency limit of zero is met. The upper limit of the amplifier is determined by the interelectrode capacitances of the tubes themselves, and is gen-

erally far higher than needed in facsimile. The circuit shown includes three stages of the screen-grid type of tube, and when properly designed may be made to give a voltage gain of from ten to twenty thousand. This amplifier, though extremely simple, has several serious disadvantages which limit its use to specialized services.

Drifting of the adjustment is the main source of trouble. The phototube output voltage, as developed across its output resistor, is generally about 5 to 10 mv. The battery supply to the phototube itself, and the bias battery of the first stage, must be constant to about 1 mv or serious errors will be introduced due to this change in battery voltage being superimposed on the change in phototube output voltage. All other voltages applied to the

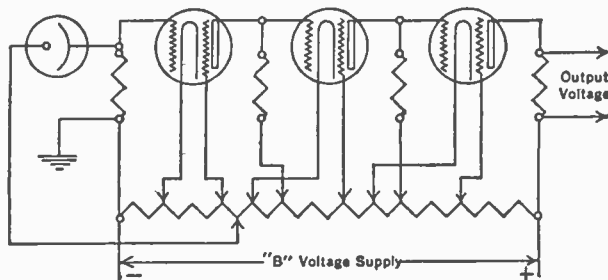

Fig. 6—Direct-current phototube amplifier.

tube elements throughout the system will have to maintain an accuracy proportional to the signal voltage developed at the particular part of the circuit where this voltage is applied. In the amplifier pictured, with a phototube output of 10 mv, and an allowable error of even 10 per cent, the entire battery voltage applied across the divider resistor would have to be maintained to within a very few millivolts. It may readily be seen that either very constant battery supplies must be used or a very elaborate system of voltage regulation introduced before this system will maintain a proper setting without frequent adjustment.

Several forms of self-regulating direct-current amplifiers have been used, but these are generally very difficult to build, or the initial adjustments are hard to make, or they do not regulate closely enough for the very low input voltages present here. For these reasons other forms of phototube amplifiers are generally used.

Chopper-type phototube amplifier. If the light reaching the phototube is made to flicker, by either modulating the light itself or by using a mechanical shutter or chopper, the output voltage developed by the phototube will not be a direct current, but a pulsating voltage which may readily be amplified by an ordinary alternating-current amplifier. As an a-c amplifier is inherently more stable than a d-c amplifier, it is comparatively easy to maintain a very constant adjustment of the system if a chopper is used.

The frequency of the chopping must be determined by the amount of detail expected in the recorded copy. This chopper frequency will in reality be a carrier, modulated by the facsimile signals. The carrier tone must be high enough to carry the third harmonic of the fundamental dot frequency as the highest modulating frequency, if the detail obtained is to be approximately the same as for a d-c amplifier. Thus, in the example given previously, scanning 100 lines to the inch and 60 lines per minute, the fundamental dot frequency, with 9-in. scanning lines, is 450 cycles per second, and the third harmonic of this therefore 1350 cycles. The carrier tone, to represent this completely, should have three carrier cycles for each cycle of the third harmonic. This will give nine carrier cycles for the smallest square dot to be sent, a larger number than is generally used, considering the amount of aperture distortion generally present. Such a carrier frequency as this, 4050 cycles, would give the equivalent detail of an aperture of from one-third to one-fifth the scanning-line width. With larger apertures more detail will not be obtained by adding more carrier cycles.

Normally, with 100 scanning lines per inch, the aperture will be from 0.005 to 0.007 in. square. With a light spot of this size, the aperture distortion will be far greater than that introduced by using a carrier tone as low as 2500 to 3000 cycles per second. Owing to the difficulties of building a chopper for high frequencies and still having it small enough to lend itself to proper placement in the optical system, the frequency of 2500 cycles would probably be used commercially in the case discussed here.

In practically all chopper systems the light is interrupted by a series of holes or slots near the outer edge of a rotating disk. The holes and spaces are equally spaced, and are placed in the path of the light, usually at the diaphragm or aperture. When the disk is turned these holes interrupt the light to the phototube. For the 4050-cycle carrier first mentioned, a disk rotating at 1800 rpm would require 135 holes. Properly spaced, so that

they could be accurately cut, such a large number of holes would require a very large disk, and to place such a large and cumbersome affair in the light path requires careful mechanical design. It must also be perfectly true and balanced, to prevent transmitting another hum frequency to the phototube by vibration. These mechanical disadvantages are causing the chopper system to be gradually replaced.

The audio amplifier, Figure 7, used with this chopper system will have to pass a band of frequencies from 1150 to 3850 cycles if the 2500-cycle chopper is used, or from 2700 to 5400 cycles with the 4050-cycle chopper. These "end" frequencies are determined by adding to and subtracting from the carrier frequency, the highest modulating frequency of 1350 cycles. In either case the band of frequencies is narrower than that used in audio

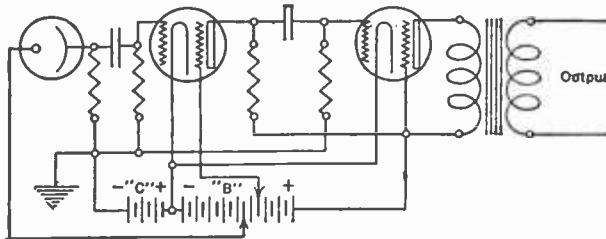

Fig. 7—Phototube amplifier for modulated or "chopped" light.
(Simple audio amplifier.)

amplifiers for sound equipment, and offers no difficulties in design.

Whether the light is modulated electrically to give this carrier tone, or chopped mechanically, one serious difficulty is usually encountered. The scanning spot of light is dark half of the time, and therefore the phototube receives only one-half the amount of light it would receive in other types of systems. The sensitivity of the phototube will be the dynamic sensitivity obtained at this carrier frequency, usually somewhat less than that for the lower modulating frequencies. Halving the amount of light, and at the same time reducing the dynamic sensitivity of the phototube, gives this amplifier system quite a handicap in phototube output voltage. A more sensitive amplifier is therefore required, and if this light reduction is carried very far, difficulties in building a quiet amplifier of the required gain will be encountered.

The disadvantage of halving the light in a chopper system was largely overcome by a balanced phototube arrangement devel-

oped by Captain Richard Ranger. The chopper disk was a mirror, in which slots were made by removing the silvering at these places. Two phototubes were used, one receiving the direct light through these slots, and the other receiving the reflected light from the silvered spaces. The output of both phototubes was combined in a "push-pull" amplifier. This system was used for many years with great success, but is now being replaced by direct modulating systems requiring less care in adjustment.

The chopper-amplifier system normally gives a tone output on "white," and zero, or nearly so, on "black." In some instances it is desirable to transmit a tone on black, and for that the action of the chopper system must be reversed. This can be accomplished by a system of rectification of the signals, filtering out

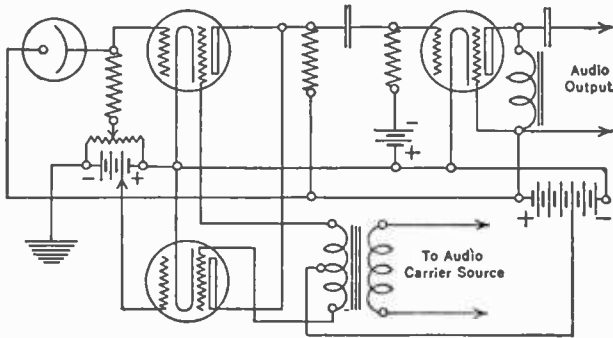

Fig. 8—Balanced modulation phototube amplifier.

the carrier, and then using these "envelopes" to remodulate another tone in the reverse direction. This is explained later under "Limited Amplifiers." Another method is by adding a second phototube that receives its light directly from the chopper without being modulated by reflecting from the picture. This phototube output is then balanced against that of the normal picture phototube to give zero signal on white. These two outputs no longer balance for black, when they are unequal, and a signal is thus sent out for black. Such a system as this has been used by Telefunken in Germany.

Balanced modulator phototube amplifier. The simple introduction of an alternating current in series with the phototube polarizing voltage would provide a carrier, and similar action to a chopper system, were it not for the fact that in most instances the tube itself has a high enough capacitance, compared

to resistance, to pass the alternating current by capacitance effect only. This is especially true where a high value resistor is used with the phototube to obtain the required sensitivity.

Figure 8 shows diagrammatically one method of obtaining an electrical carrier tone with its advantages of ease of handling, and at the same time preserving the simplicity and high sensitivity of the optical phototube system as used for a d-c amplifier.

Two screen-grid tubes are connected in a bridge circuit as shown. Their plates are connected together and have a common plate return resistor. Equal but oppositely polarized voltages of alternating current are applied to each screen by the center-tapped transformer shown. The control grids of the two tubes are entirely independent, one being operated at a fixed bias while the other depends on both a variable bias and the phototube output for control. When the two tubes are adjusted to exactly the same bias on corresponding elements, the output alternating currents of the two tubes balance to zero in the common plate resistor. By setting this zero output balance with the phototube receiving full light for white, any decrease in light to the phototube for gray or black will unbalance the bridge, and an alternating current will appear in the output resistor proportional to the unbalance in the bridge circuit.

The carrier tone applied to the screens must bear the same relationship to the modulating frequencies as explained under the chopper type of amplifier; that is, it must be high enough to carry as side bands any modulating frequency encountered in the scanning of the picture. This is much simpler to accomplish in this system, as the tone is supplied by an electrical oscillator and can therefore be made any frequency desired. The mechanical limitations of the chopper have thus been eliminated, and a simple, easily controlled circuit substituted in its place. The drifting of the d-c type of amplifier is also eliminated, for in the balanced stage, a large part of the effects of changing battery voltages is balanced out between these two tubes.

In practice the balance tubes are not operated on their characteristics at the same place ordinary amplifier tubes are used. By increasing the plate resistor to a value greater than the impedance of the tube, a secondary emission effect may be brought in to make the overall effect more of a trigger action, and far more sensitive. Curves of the tubes, in the portion used, are as in Figure 9. Here, the slope, and consequent amplification, are usually steeper in the unused portions of the

curve where the current is very low, a few microamperes. Of course, the tube could not be used here unless the input voltage is very small, as only a few tenths of a volt will shift to another section of the curve, and may even change the plate current from positive to negative. Two operating positions are found in this region, one delivering a signal on white and the other delivering a signal on black. These two positions are marked as the first and second operating positions or regions in this figure. When properly adjusted, this type of amplifier may be made to deliver as high as 100 to 1 signal ratio between black and white signals.

The normal balance position is for signal on black, but the change to a signal on white is accomplished by merely decreasing the negative bias on the first tube a little, and thus moving

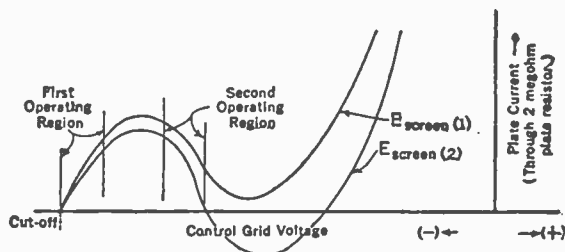

Fig. 9—Operating region of screen grid tubes in balanced modulation amplifier.

to the other operating region. A reversed keying may therefore be obtained by simply changing the balance position.

Actual design data on this circuit will depend to a large extent on the amount of input signal, the type of tubes used, and the highest keying frequency desired. It has been found, for instance, that sometimes a tube with a very low mutual conductance, and consequently poor in most usages, will show a very pronounced reversal of plate current at the low plate current region, and thus give unusually sensitive action in this circuit. With No. 57 type tubes in the balanced stage, the plate resistor should generally be about 2 or more megohms, and owing to the plate current drawn through this resistor, the actual plate polarizing voltage will be less than that on the screen grids.

The amplifier following the balanced stage is an ordinary audio amplifier such as was used with the chopper system. It should be designed to amplify only the carrier tone and its

side bands, and to filter out all direct modulating frequencies. The frequency spectrum is the same as for the chopper, 2700 to 5400 cycles with a 4050-cycle carrier, and all frequencies below this 2700-cycle minimum should be cut off. In practice it is only necessary to start the cut-off filter action at this 2700 cycles, and have the volume level down about 20 db by the time the 1350-cycle modulating frequency is reached. This is a very simple form of filtering and may be obtained by properly designing the interstage amplifier coupling units. A special filter is thus unnecessary.

Comparison of phototube amplifiers. Figure 10 shows the wave forms to be expected from these three types of amplifiers. The differences are more readily apparent in this diagram than in

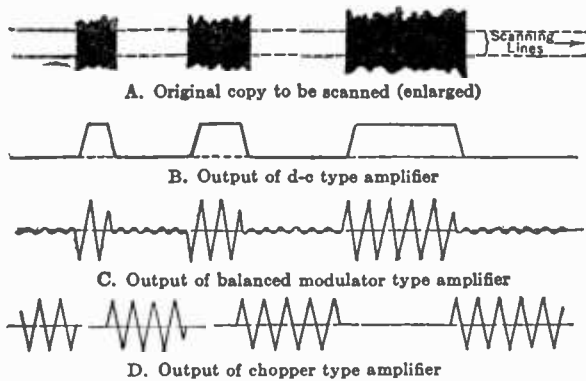

Fig. 10—Output waves of phototube amplifiers.

a general discussion of the relative merits and disadvantages of each system.

For transmission by line the last two are better, as d-c impulses are difficult to send over a long line without distortion.

For transmission by radio, if the radio transmitter is to be keyed on-off for signals, either of the last two will have to be rectified into a unidirectional impulse to key the radio transmitter, while the d-c system may be amplified up to a sufficient voltage level to perform this keying direct. The amount of d-c amplification necessary in this case is, however, usually so great that it is not very practical, and an audio tone carrier is generally used to obtain the high gains necessary.

When a d-c impulse is to be sent by a wire line, it is generally used to key an oscillator or modulator so that it may be changed into a tone transmission. Immediately on changing to tone, the

detail becomes the same as for either other type of phototube amplifier, and the one advantage of the d-c amplifier lost.

The above advantages of simplicity, reliability, and ease of maintaining adjustments explain why either the chopper or the modulator systems are commonly used in commercial installations.

5. Threshold-Limiter Amplifier

A limiter amplifier may be used after the phototube amplifier to square up all signals and give the equivalent signal of a keyed tone. In addition, a threshold control may be put on this limiter and reduce all background noises to zero.

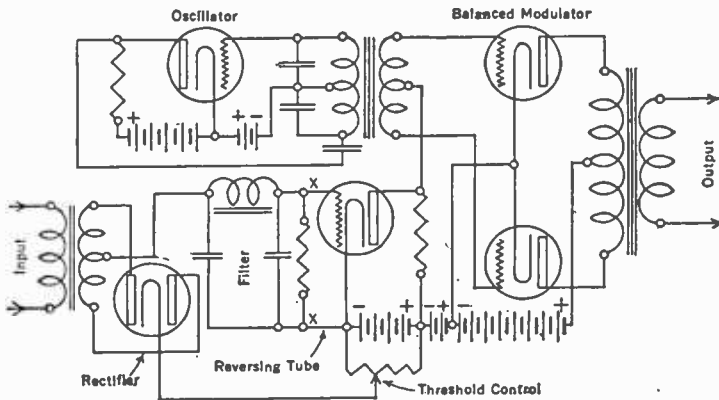
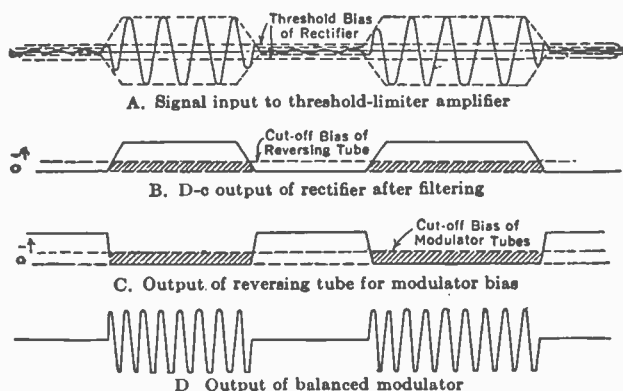

Fig. 11—Threshold-limiter amplifier.

One form of limiter amplifier that may be used to produce this on-off keyed signal, either before transmission or for correcting to some extent errors in reception, is shown in Figure 11. The amplifier described here is designed to operate on the output of an amplifier similar to that of Figure 8, but it may be altered to adapt it to any form of input. Other forms of limiter amplifiers are in use, but the principles of operation are approximately the same in all, and a description of this one will illustrate the principles involved.

In this piece of equipment it is desired to have the signals in the output absolutely square in both starting and stopping, and a background of zero for all signals not represented by a signal of full amplitude. Thus the output will be either on at full value, or off entirely, and no signals between these two values will be used.

While referring to the diagram of this amplifier in Figure 11, the wave analysis in Figure 12 will serve to explain the action more fully. An input signal, either from the phototube amplifier or received by radio, may have a wave form such as is shown in Figure 12A. Here a background of unwanted signals is obtained on white, owing either to improper balancing of the phototube amplifier or to interference on the radio channel. This signal is first rectified full wave by the rectifying tube, and then filtered in the low-pass filter to eliminate the carrier tone, leaving only the d-c envelope shown in Figure 12B. In the rectifying process the threshold control is so adjusted that all signals



• Fig. 12—Wave analysis of threshold-limiter amplifier.

between the lines drawn in Figure 12A fail to pass through the rectifier. This is accomplished by biasing the plates of the rectifier negative by this value of threshold voltage. If the background were, say 10 volts, the negative bias applied would be 10 volts, and only signals of a value greater than 10 volts would swing the plates positive and pass through. This rectified and filtered signal in 12B then represents the bias applied to the reversing tube grid, across its grid resistor.

The reversing tube is normally operated at zero bias and full plate current. It will be biased to cut-off by the signal voltage 12B. Far more signal than needed to cut this tube off is normally applied, this being shown by the shaded portion of the wave in Figure 12B. For all values of negative bias greater than this amount the reversing tube will have zero plate current, as shown by the current curve in Figure 12C.

The balanced modulator of Figure 11 is adjusted to give a normal output of tone supplied by the oscillator, when at its normal bias from the battery supply only. However, plate current in the reversing tube plate resistor furnishes additional negative bias to the modulator grids and biases it to cut off, reducing its tone output to zero. The curve in 12C therefore becomes the bias of the modulator in addition to the normal battery bias, and for all values of plate current above the shaded portion, the modulator is at cut-off. It will deliver full tone output while the reversing tube plate current is zero. It may be seen that, owing to the excess of signal applied at every transfer point, the sides of the dot are steepened at every step, and the resulting wave shape is very sharp. This output wave in Figure 12D is almost square in both starting and stopping, and a listening test with head-phones to compare the input and output of the limiter will demonstrate the increased sharpness of the signals.

The final dot, or signal, of the limiter is not quite as long as the original dot at the base line, but wider than the top portion of the original dot, and the trapezoidal wave shape is nearly gone. The lower the background noises, and consequent lower threshold setting possible, the nearer the final wave shape approaches the original black area scanned, in absolute length as well as "squareness."

If the limiter is to be used to deliver a signal on white, while the input signal is of the signal-on-black type, the reversing tube is eliminated, and the output resistor of the filter becomes the bias resistor of the balanced modulator. When used in this manner a complete reversal of the signal is obtained.

For operation with a d-c phototube amplifier, the rectifier and filter are both eliminated, and the phototube amplifier output applied directly across the grid resistor of the reversing tube at X-X.

To eliminate the "keyed" effect and obtain a direct modulating effect, with all values of signal used from full on to full off, the signals are adjusted at every point to where barely enough is obtained to operate that particular stage. Elimination of the reversing tube, and then operation with this critical value of signal, will give a reversed modulation, like that spoken of in the chopper amplifier section to obtain a reversal of signal. The threshold setting would then be zero.

The frequency of the oscillator supplying the grids of the modulator stage must be high enough to carry the dot frequency

and its third harmonic, as was required of the carrier tones of the chopper or modulator phototube amplifiers. The same oscillator might be used for this source as for the modulated phototube amplifier if this type of amplifier is used.

6. *Halftone Systems*

The transmitting and recording of a true halftone picture are rather complicated; a halftone is far more difficult than a plain black-and-white original to scan, transmit, and record.

There are essentially three methods of transmitting halftones. The first and most accurate method, but at the same time by far the most difficult to use properly, is to transmit the varying shades as varying amplitudes of signal. This is called an amplitude modulated halftone. The second method involves using several fixed values of shading, and selecting the shade nearest the value desired automatically in the phototube circuits. A third system which is highest in favor for radio use at the present time uses dots; it is similar to the method of printing a halftone picture in a magazine.

Modulated halftones. The first method will give the nearest in appearance to an actual photograph. Another factor in its favor is that it actually requires the least amount of apparatus in both transmitting and recording equipment. The serious disadvantage of this amplitude modulation system, and it is difficult to overcome, lies in the radio channel itself. If fading and interference could be overcome this method would be used exclusively. As it is an amplitude process, any change in signal level at the receiver whether caused by a change in shade or a fading of the signal, will be recorded as a different density of black. Therefore this process requires a very steady signal level to produce a usable picture in the recorder. For the above reason, the amplitude process is used in special cases of short radio circuits or for wire line transmission, and is seldom attempted on radio circuits of any great length.

The carrier tone that is modulated with the picture signals may be the audio tone of the phototube amplifier, or it may be the radio carrier wave itself. The carrier tone of the picture may be substituted for the voice frequencies in a broadcast type of transmitter, or the picture signals may be used to vary the amplitude of the radio carrier. In both cases the limitations of a very steady signal hold, but where the signal is sent as a varying audio tone, an automatic volume control, which oper-

ates on the radio carrier, may be used with success at the recorder. The allowable change in signal level will depend to a large extent on the amount of detail the recorder is capable of showing. More detail, and more accurate shading, will naturally increase the required steadiness of signal.

No processing of the phototube amplifier output is normally necessary to have this signal proportional to the amount of shading. All three types of phototube amplifiers normally vary in output directly with either the amount of white or amount of black in the copy being scanned, and such signals will therefore be amplitude modulated at the start. These signals may be sent over the line or used to modulate the radio transmitter to obtain an amplitude-modulated transmission.

In recording, limits must be set according to the maximum and minimum signals received, as these will determine the degree of intensity of the black and white between which all signals for gray will come. Best results will be obtained if these limits are not set at the absolute maximum and minimum limits of the recorder, but to, say, from 5 to 95 per cent. Practically all systems fail in holding a true linear response over the entire 100 per cent of this black-to-white signal level change, but will hold over a narrower range and give truer reproduction. For this same reason, the processing of a halftone for a magazine or newspaper usually does not include full white and full black, but stops just short of these limits.

The three types of amplifiers used with the phototube will therefore deliver the following types of signals: First the d-c amplifier delivers a d-c voltage proportional to the shade being transmitted. This can be made positive or negative by adding to or subtracting from the number of stages in the amplifier. The chopper amplifier delivers an audio tone proportional to the amount of white, but can be reversed by the process described under the limiter-amplifier section to give a signal proportional to the amount of black. The modulation amplifier will deliver an audio tone proportional to the blackness or whiteness of the picture, depending on the balance point selected.

Fixed shade halftones. The second method of using fixed shades will not be discussed here. The process is obsolete and seldom used commercially at this time. It has no advantages over systems in use today and, in fact, is generally inferior, as well as more complicated.

Dot halftones. Early successful commercial facsimile for halftones over a long radio circuit used the dot process. These

dots may be varied in quantity or size to produce a halftone effect. One system of transmission developed by Captain Ranger varied the number of dots in a given area to produce varying shades of black. This was accomplished by using the picture signals themselves to vary bias of a multivibrator. Each cycle of the multivibrator output was transmitted as a dot of full amplitude, and, as the signal input varied with shading, the frequency of this multivibrator increased or decreased to vary the number of dots

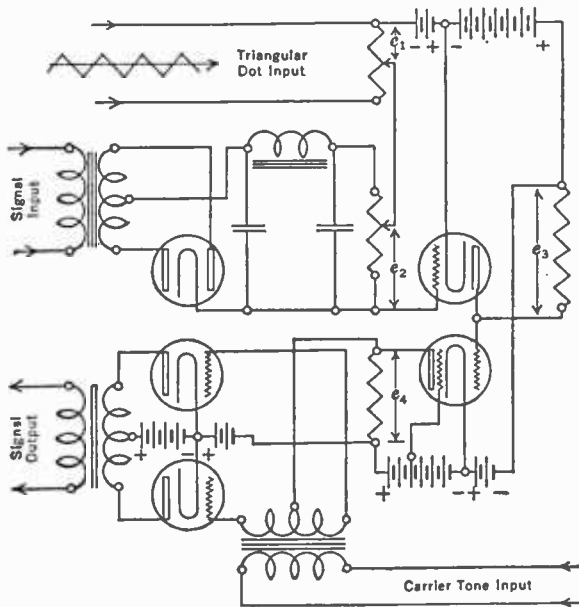

Fig. 13—Variable-width dot amplifier for screened halftones.

sent out. Thus a picture density of black would give a large number of dots in a given area, almost touching, while light grays and white would be represented by a very small number of dots in that same area.

Constant frequency-variable dot system. A second method of using dots for halftoning is called the Constant-Frequency-Variable-Dot system and generally known as the CFVD system. It has been brought to a high degree of perfection by J. L. Callahan and associates.

Referring to Figure 13, it may be seen that the CFVD combining unit is very similar to a limiter amplifier, but has, in addition to the picture and carrier tone signals, a third input which consists of a triangular wave. The theory of operation is best explained in connection with the wave analysis shown in Figure 14.

The picture signal input is an amplitude-modulated tone in which the amplitude is directly proportional to the density of the black in the scanning. Such a signal is obtained as explained under "Halftone Transmission." This signal is rectified and filtered and a unidirectional current wave obtained as in Figure 14C. This is the voltage e_2 in Figure 13, and it is added directly to the triangular wave input, voltage e_1 , of the same figure. This combination is applied to the grid of the combining tube. The combining tube is normally biased below cut-off by a voltage equal to the peak value of the triangular wave and will therefore have a plate current of zero with no picture signal. The addition of a picture signal decreases the negative bias of the combining tube and allows more and more of the peaks of the triangular wave to pass through the tube. The entire system will be so adjusted that the picture signal for black will be sufficient to allow the entire triangular wave to pass through this tube. The plate current for this combining tube will appear as in Figure 14E. For black the entire triangular wave just passes through; for gray only the peaks will pass, the width of these peaks being proportional to the density of black; and for white the output will fall to zero. Each value of shading therefore has the same number of dots to represent it, but the width of these dots varies with the shading. They become wide enough just to touch for black.

These pulses of varying width are then amplified until they are of such amplitude that only the first small fraction of the pulse is used in keying the balanced modulator, the rest of the pulse being excess signal and chopped off as in the limiter amplifier. The final dot output of the modulator is thus only slightly narrower than the width of the base line of the pulse keying that dot, and these output signals are all of full amplitude, as in the limiter. These output signals are illustrated in Figure 14F.

The waves in Figure 14DEF are shown in pairs, the reason being that in this system alternate scanning lines are staggered by the width of one-half wave of the triangular wave input. This is done to insure the final dot pattern being at 45 deg. instead of a series of vertical lines, presenting a more pleasing appearance.

The method of accomplishing this staggering is to choose a frequency for the triangular wave that is exactly odd to the drum speed. Thus, if the drum rotates 2 rps, the triangular wave frequency may be any frequency that is not divisible by 2, and a half wave will always be left over to start the second line

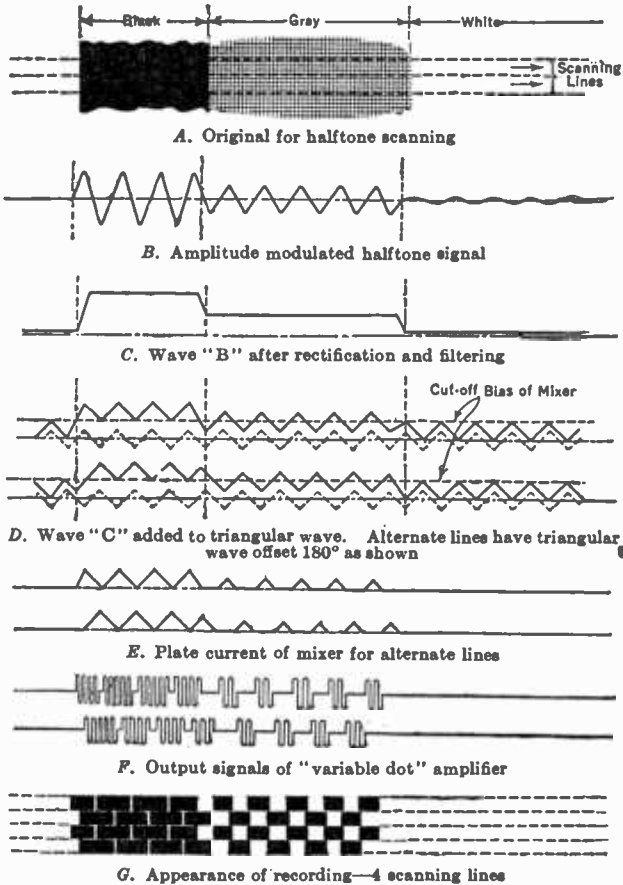

Fig. 14—Wave analysis of "CFVD" system.

180 deg. out of phase. To obtain a regular dot pattern, this dot frequency must be synchronous with the scanner itself. In practice this is usually accomplished by having a small generator on the scanner shaft to generate this tone, or by using the synchronizing frequency of the system to trigger a triangular wave generator.

The dot frequency must also bear a definite relationship with the number of scanning lines per inch, otherwise a perfect 45-deg. pattern will not be obtained. In scanning 100 lines per inch (as the number of horizontal dots should agree with the number of vertical dots, or lines), there should be 50 dots per inch in each direction. Thus the triangular dot frequency will agree with the square dot frequency at maximum keying speed. With a speed of transmission of 60 lines per minute, each line 9 in. long, and 100 lines per inch, this triangular wave frequency will be 450 cycles ± 1 cycle. This ± 1 cycle will make the frequency odd to the drum speed, and thus secure the staggered dot pattern at 45 deg. The final appearance of the received copy from such signals is shown in Figure 14G.

RECORDING SYSTEMS

A perfect facsimile recorder will build up a copy of the signals exactly as received, adding or subtracting nothing, and thus deliver a recording limited in detail only by the scanner and intervening transmitting circuit. The finished picture will be almost identical in appearance to the original copy.

Of the many recording methods, the four most generally used will be described here. These four systems are: first, photographic recorder; second, ink recorder; third, electrolytic recorder; and fourth, the carbon paper recorder. Each of these systems has advantages possessed by none of the others and, therefore, will have particular uses to which it is the best adapted.

The length of the scanning line and the number of scanning lines per inch are generally the same as for the scanner, but this is not necessary. The recorded copy may be made smaller or larger than the original by properly choosing the proportions of scanning line length to line advance. The product of the total length of the scanning line and the number of lines per inch is called the index of cooperation; and if this value is held constant, any size recording may be made with all dimensions correctly proportioned to those of the original copy. Thus, if the scanner has a total line length of 9 in. and is transmitting at 100 lines per inch, the index of cooperation would be $9 \times 100 = 900$. If it is desired to receive this picture on a recorder having a scanning line length of only 4.5 in., the line advance would be made 200 lines per inch, and the received copy would be exactly one-half size.

Other than this index of cooperation, the other factor necessary to know, to record properly, is the number of lines transmitted per minute. This is generally termed "strokes," and the "per minute," which should be added, is understood. Thus the numbers 40-900 would signify a facsimile picture with an index of cooperation of 900 and transmitted at the rate of 40 strokes per minute.

7. *Photographic Recording*

In recording photographically, the sensitized paper or film to be used is generally wrapped on the surface of a drum, and is scanned by a small spot of light. This light spot is then varied in intensity or size to record the different values of picture

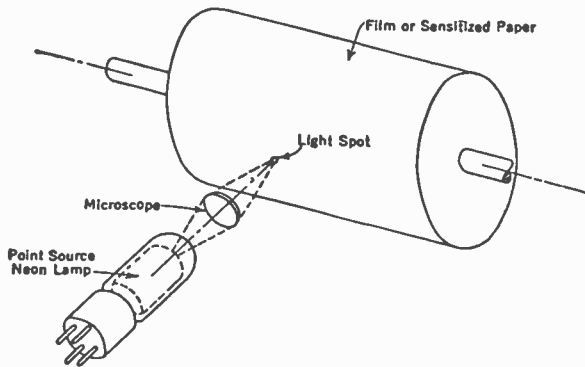

Fig. 15—Photographic recorder, using a neon lamp.

density. This light may be varied in several ways, electrically, mechanically, or by means of polarization. In the electrically varied light, a neon or other gas discharge lamp is modulated in intensity by the signals. With the mechanical system, the light is steady, and varied either in intensity or size of spot by means of a vibrating shutter or diaphragm. In the polarized system, the Kerr cell is interposed between the light source and the picture drum, and the light is polarized before reaching the cell. The angle of polarization of the cell is changed by the picture signals, allowing more or less light to reach the picture.

The first method is more generally used in this country, and a simple recorder of this type is shown in Figure 15. Here the lamp is of the "point-source" type. An intense illumination is

produced in a small aperture within the lamp itself, and an image of this aperture is projected onto the surface of the drum by a lens system. The spacings of the lamp and lens system are so arranged that the aperture image is exactly the width of a scanning line. If several values of line advance are to be used with the same optical system, a variable diaphragm is introduced to regulate the size of the image to the proper value necessary for the line width desired.

The relative motions of the optical system and drum may be any of those used in the simple drum scanner. Usually the drum is rotated while the optical system is gradually advanced along the surface.

The second method of photographic recording involves "valving" the amount of light reaching the paper from a steady light source, usually a tungsten-filament lamp. This can be done by placing an oscillograph mirror and aperture in the light path, the position of the mirror being varied electrically to change the area of the aperture exposed. As the amount of light will be directly proportional to area, a smooth variation of light with signal is obtained. Another method, more recent and more widely used, consists of placing a thin ribbon in the light path, just closing an aperture. As the ribbon is twisted by the incoming signals, light is allowed to pass through the aperture on both sides of the ribbon. This system produces a "variable width line" type of recording, similar in appearance to a zinc etching, or if the aperture is placed at 90 deg to the scanning direction, it will produce lines of constant width but variable density.

In the third method of using polarized light, a Kerr cell is utilized to change the light intensity. The optical system consists of two Nicol prisms placed between the light source and the aperture. These prisms are polarized in the same plane, and therefore pass light through the system. The Kerr cell is interposed between the prisms, and applying signals to its polarizing plates will change its light-polarizing properties. The amount of light leaving the system is therefore controlled, and a true modulation of the light may be obtained. This system has been used for a number of years in Europe.

Photographic recording, especially those methods involving modulated light by the electrical or polarizing methods, are the fastest of the recording systems. At the present time, radio circuits are much slower than either the scanner or a recorder

of this type. The photographic system is far more accurate in its ability to reproduce completely the signals received, and therefore is used in almost all commercial facsimile circuits. It has one serious disadvantage, however, in that the received picture must be developed before the results are known. The machine must be loaded and operated in the dark. In a fast service this developing is quite a handicap, and the fact that the picture cannot be seen until developed allows possible errors in the setting of the equipment to go unnoticed until the full time of transmission and developing has elapsed.

8. *Ink Recorder*

To eliminate the developing of the picture after reception, and provide a visible recording process where the change in apparatus adjustment may be seen almost at once, the ink

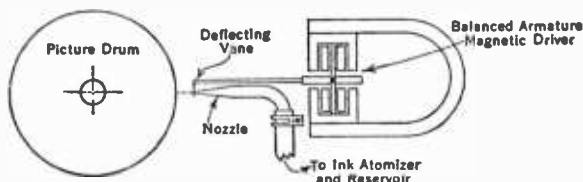

Fig. 16—Ink recorder, using atomized ink.

recording process described here was developed. A cross-section of the recorder is shown in Figure 16.

The ink is atomized into a fine mist and sprayed on the paper by a nozzle. The ink stream is very fine, and makes a spot on the paper only 0.004 or 0.005 in. in diameter. As it would be practically impossible to start and stop this spray with the speed and exactness necessary to print a facsimile, it is allowed to run continuously, and a small vane placed in the path to deflect the ink when signal for white is received. This vane is actuated by an electromagnetic driver unit. This driver is of the balanced armature, push-pull type, and is illustrated in cross-section in this diagram. One of the coils shown has current on white, no current on black; the other coil has current only on black. These two coils are poled to have an opposite magnetic effect; the armature is held with the vane down on white, and the vane is lifted for black. By properly balancing the armature and damping the mechanical action to eliminate "bouncing," the vane may be made to follow the signal very exactly and at high speeds.

This method of recording requires an ink that is completely atomized, and with no suspended matter (such as in carbon inks). The ink used is, therefore, generally a dye, methyl violet in an alcohol solution, or some similar ink of high coloring content. Some dyes in the deep green and purple region are satisfactory, and give an appearance of black on a smooth, coated paper.

There are two limitations in the speed of recording possible with this system, the amount of ink that can be atomized in a given length of time, and the speed with which the vane can be made to follow the signal. The first limitation is generally reached first. Unless the coloring matter of the ink is very intense, such a fine spray will not put on enough coloring, in a very limited time, for a clear picture of the proper contrast. Slowing down the process of course allows more time for a dot of a given size, and the ink will appear darker.

The appearance of the ink recording is very good, almost the equal of a photographic copy, and the copy is permanent. Although the ink-spray system is somewhat complicated, requiring an air compressor for the atomizer, it is still easier to use than the photographic recorder. Since the picture is visible as it is recorded, the adjustment of amplifier circuits, etc., is simpler than with a photographic recording, and less time is wasted in getting the picture properly framed.

A recorder of this type is used in regular transatlantic service at the present time.

9. *Electrolytic Recording*

Electrolytic recording is similar to photographic recording in chemical action, but has the advantage of being visible at once, or almost at once. It may or may not require some form of processing to make the recording permanent, depending on the chemicals used.

The principle of operation is that certain chemicals turn very dark in color when an electric current is passed through them. If a paper is saturated with such a chemical, and scanned by a stylus contact, it may be darkened by current at each signal for black, and thus build up the facsimile picture.

The solutions generally used are starch iodide, or certain silver or iron salts* similar to those employed in photography or blueprinting. Some of these solutions react very slowly and

* The compositions of these particular electrolytic salts are usually trade secrets.

require a high current density to bring about a dense enough black; others require much less current and are faster acting. Most of those which are the fastest are also sensitive to light in some degree and will require fixing as in photography. For others the fixing may be only washing in water, as in blueprinting.

A machine using a stylus would be a simple drum scanner with a dragging contact point on the surface of the paper. Another form of electrolytic recorder requires a continuous roll of supply paper, and prints one picture after another without reloading. This continuous type of recorder is shown in Figure 17.

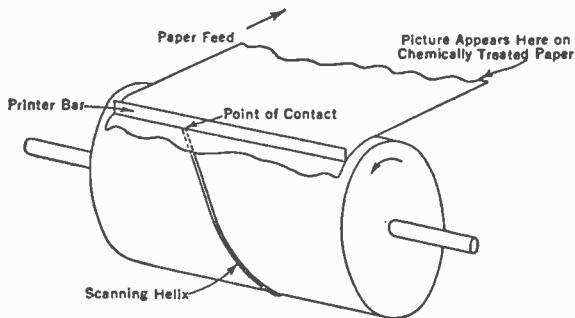

Fig. 17—Continuous feed electrolytic recorder.

Here the scanning is done by a combination of a printer bar and a helix on opposite sides of the paper. The raised helix rotates at the same speed as the scanner drum, thus making one complete turn in the length of a scanning line. The point of intersection of this helix and bar will therefore travel across the paper once for each scanning line. Current for printing is passed between the helix and bar, through the paper. The bar is weighted slightly and allowed to drag over the paper surface to secure good contact with the paper.

In this machine, as well as in almost all electrolytic recorders, the paper must be moist when operating. In the particular machine described above, the paper is coated with the chemicals and dried. A roll of this prepared paper is threaded into the machine through a trough containing water, so that the paper is dampened as used.

The advantages of this recorder are its simplicity and its visible recording feature. Its disadvantages are that it requires damp paper, possible fixing of the recording, and slow speeds. In ordinary work, the recorder is fast enough, but in some cases,

to get a depth of coloring in the short time allowed, very high current densities are necessary. This high current sometimes burns the paper, or dries it out enough so that the finished recording is quite wrinkled and does not present a very pleasing appearance. This may be overcome to some extent by having the feed rolls that pull the paper through the machine heated, thus forming a sort of ironing machine. Because of the trough for dampening the paper, the machine is not very practicable where conditions of service are severe, as on aircraft.

10. Carbon Paper Recording

The first carbon recorder consisted of a stylus dragging over carbon and white papers wrapped on a drum. The stylus was moved down to give pressure for black, and lifted for white.

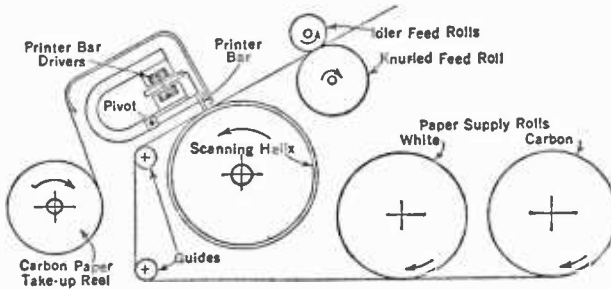

Fig. 18—Continuous feed carbon recorder.

This is a very simple form of recorder, but it has the disadvantage of the photographic recorder in that the picture is not visible until the drum is stopped and the carbon paper removed. It has the advantages of cheapness and simplicity, and that the picture requires no processing to be permanent.

A later form of carbon recorder, illustrated in cross-section in Figure 18, overcomes the disadvantage of invisible recording. Here the scanning is accomplished with a helix and printer bar, as in the continuous electrolytic recorder. Carbon and white paper are fed between the bar and the helix, and after this are separated so that the surface of the white paper is visible only a few seconds after the printing process. The bar is not allowed to drag the paper, but is normally held away from it by an electromagnetic driver unit similar to that on the "ink-gun." A signal for black depresses the bar, and a black dot is made by the pressure at the intersection of the bar and helix. The carbon paper is drawn through over guides, and wound up on a take-up

spindle. The white paper is fed over a knurled feed roll and held against it by a series of rubber idlers, similar to the paper feed of a typewriter.

Only one electromagnetic driver is shown for the printer bar. However, if wide paper is used, more than one driver may be necessary and the separate units will be equally spaced along the bar.

This method of recording is very simple, uses cheap paper, and prints a very good copy. It is quite reliable, and the complete copy, with no processing necessary, is visible only a few seconds after recording. Its disadvantages are also very pronounced. The printer bar is necessarily heavier than a stylus, or ink-deflecting vane, and therefore the speed of recording is limited. Almost any carbon paper that may be used here will be soft enough to smudge a little when rubbed in the fingers, and the finished print may, therefore, be easily smudged, the same as a carbon copy from a typewriter. More mechanical accuracy is required in building this printing bar than in the electrolytic recorder, as the bar and helix must line up parallel to within a few thousandths of an inch. The depressive motion of the bar is quite limited, and, therefore, a little discrepancy in lining up the bar and helix will result in part of the paper not being printed to a full black. Damping of the bar to eliminate "bouncing" and echo printing is somewhat of a problem, but can be overcome by over-powering the printing mechanism and absorbing the excess power in a damping arrangement on the bar itself.

One advantage mentioned separately here for emphasis is that this type of recorder may be used to print more than one copy at a time. If the printer bar action is made sufficiently powerful, several rolls of white and carbon paper may be threaded into the machine, and a number of copies of the facsimile made at the same time. As many as 8 separate copies of a message have been made in an experimental set-up. The carbon paper may be of the "hctograph" type, and extra copies of the recording may then be made by the usual duplication process of hectographing.

11. Comparison of Recording Methods

The recording method best suited for any particular service will depend to a large extent on the type of signal expected to be used. If the transmission is by line, and the signal practically perfect, the choice will be largely governed by the quality of print desired and the speed of the transmission. If the line is of the

high-quality type, capable of high-speed transmission, the best results will be obtained by using a photographic recorder. If slower transmission is satisfactory, one of the visible recorders will simplify the system. In a radio circuit, the circuit itself will probably be the limiting item in figuring the possible speed of the system, and almost any form of recorder will be fast enough. This is especially true on very long-distance transmission. In commercial systems, owing to the slow transmission over long distances, the recorder is chosen for quality of print, and therefore, either a photographic or ink recorder is used. Extra processing does not add appreciably to the total elapsed time in such a transmission.

Another factor necessary to consider is the type of signal, whether black and white only are desired, or if the signal is to be a modulated tone for true halftoning. Of the recorders discussed here, all will respond to some extent to a variable signal, but the

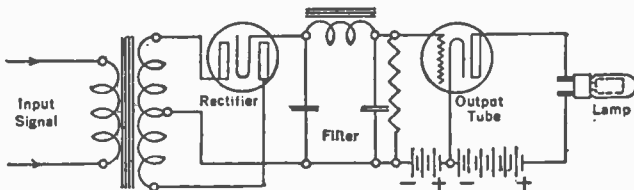

Fig. 19—Printer amplifier for photographic recorder.

photographic and electrolytic recorders will give the truest variation of coloring with signal and, therefore, are best suited to use on a modulated halftone. The carbon recorder will give a fair halftone by varying the pressure exerted on the carbon with signal, but is far better on black and white only. With the ink spray, it is very difficult to obtain variations in shading, and it is best suited for either black and white only, or "dot" halftoning.

12. Recording Amplifiers

The signals received for facsimile recording are usually in the form of tones, either modulated in amplitude or keyed on-off, and an amplifier system is necessary to change this signal into one suitable to actuate the printer mechanism. There are three general types of such amplifiers, those delivering current on black or current on white, or an arrangement for supplying a push-pull printer.

The printer amplifier in Figure 19 is one delivering current on black, and is suitable for a photographic recorder of the neon-lamp type, or an electrolytic recorder. The incoming signal is

rectified and filtered to obtain the modulation envelope, or the picture signals themselves, and this varying d-c voltage is applied as bias to an output tube normally biased to cut-off. The plate current of this tube will thus increase with signal, and either light the light of the photographic recorder or pass current through the paper of the electrolytic recorder.

To obtain current on white, the polarity of the rectifier output is reversed into the filter, and the bias of the output tube is reduced to a value giving the desired maximum plate current. Any signal impressed will then tend to increase the negative bias of this tube and decrease the plate current. A full black will give a plate current of zero, when all voltages are properly set.

Either method of using this amplifier will give a smooth variation of current with signal, and thus may be used for modulated signals, as well as for on-off keying.

For those printers requiring a push-pull action, an amplifier similar to that in Figure 20 may be used. The input system of rectification and filtering is the same as for the first amplifier, the difference being only in the output stage. In this case two output tubes are used, one of these being biased to cut-off by a battery bias in its grid circuit, while the other is set at zero bias and, therefore, full plate current. The rectified and filtered signal is so polarized that any signal tends to increase the negative bias of the tube drawing full plate current and to reduce the negative bias of the tube set at cut-off. Thus, as the signal increases in voltage, the current-on-white tube will be cut off, and the current-on-black tube will increase to full plate current. If the circuit is adjusted properly, these tubes will each draw half plate current on half signal, and operate in a true push-pull manner. The total plate current of the output tubes added together should be practically constant.

Any of the electromagnetic printer actions, such as that for the ink vane or carbon printer bar, may be operated as a single action or as push-pull, with the first or second type of amplifier. If used as single action, the mechanism will be spring biased, and deliver all its power in one direction only. Spring return, instead of an opposing current as in a push-pull system, is not generally satisfactory, and the push-pull will give a truer response with less attention necessary in design of the damping.

The two amplifiers given here are the simplest possible for the use and are not to be considered as a final design. Many refinements are necessary to insure straight line action for half-tones, and also, though batteries are shown here, the amplifier

will, in all probability, be used with a power supply of some sort to eliminate all batteries. The filters shown are of a very high impedance and should be designed to operate into at least 50,000 ohms. Such a filter is somewhat difficult to build, and it must be carefully designed. This filter is of the low-pass type, and it will pass all frequencies from zero up to the highest modulating frequency expected.

For the proper transmission of 450 square pulses per second, with a carrier tone of 4050 cycles, the filter in the recording amplifier should pass from zero to 1350 cycles at full value and eliminate all frequencies from 2700 to 5400 cycles or above. This allows from 1350 cycles to 2700 cycles to complete the cut-off of the filter and helps to simplify the design.

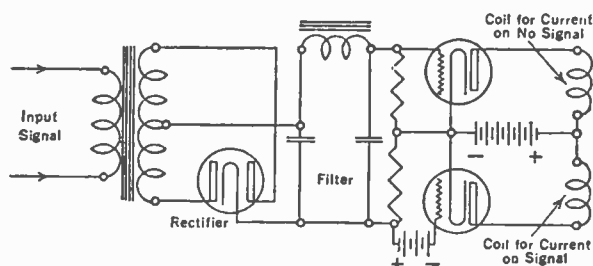

Fig. 20—Printer amplifier for “push-pull” magnetic printer actions.

In receiving by radio, it is generally desirable to include a threshold-limiter amplifier between the radio output and the recording amplifier input to square up the impulses and reduce the background. The amplifier in Figure 11, p. 163, may be used here, as in transmitting, and will operate in the same manner. In a system where transmitting and receiving are to be done with a minimum of apparatus, this limiter may be built as a separate piece of equipment and connected into either circuit as needed.

TRANSMISSION AND SYNCHRONIZATION

13. Wire Transmission

Transmission of facsimile signals by either line or radio is not as simple as in telegraphy or telephony, except at very slow scanning speeds. In very long-distance work, especially by radio, the transmission is usually for black and white only, and thus only two signals, on and off, have to be dealt with. But whether the signal is keyed on-off, or modulated for amplitude halftones,

the signals are far more difficult to transmit and receive properly, at any normal scanning speed, than a simple telegraph signal. This is due to the higher keying or modulating speeds used in facsimile, and the consequent greater danger of transients, echoes, and other forms of distortion. A facsimile signal that left the scanner a perfectly formed "square" impulse will probably be anything but square at the end of a long line, or a few thousand miles of radio, unless many precautions are taken.

In line transmission it is usually possible to correct the line so that no noticeable distortion takes place. A high-quality line, such as used for broadcast program distribution, is corrected up to 5000 cycles, and would carry a 3000-cycle tone modulated up to 500 "square cycles" with an overall distortion of less than is generally encountered in the scanner aperture, or the aperture of a photographic recorder. This line could therefore be used for transmission of pictures if this keying speed was not exceeded. A regular telephone line is corrected only to about 2800 cycles, and would carry a tone of 1600 cycles modulated up to 300 square cycles. This line would therefore require 66 per cent more time to carry a picture properly with the same detail as the first line mentioned.

Thus, the first line would carry a picture 9 in. in width, and scanning 100 lines to the inch, at one stroke per second and transmit a 10-in. length of it in about 17 minutes. The second line would require 66 per cent more time, or at least 27 minutes, to carry this same picture with the same detail.

If the number of scanning lines were cut in half, to 50 lines per inch, the transmitting time could be cut to one-fourth. The number of lines per minute could be doubled to keep the same maximum keying speed, and at the same time the total number of lines is cut in half. Of course the detail would also be cut into one-fourth by the increase in speed. A comparison of 50 lines per inch, and 100 lines per inch, scanning typewriting, is shown in Figure 1.

In the above discussion, transmission by line was considered to be by keyed or modulated audio tone. This is generally the method used, for in long lines where repeater stations are necessary it is much easier to amplify an audio tone than to attempt to amplify a d-c pulse. For this reason, the d-c signal is seldom used on long lines; its use is generally confined to short lines and controlling lines.

Care must be taken to eliminate all echoes and transients. In ordinary telephone conversation a large amount of distortion

may be present before speech becomes difficult to understand. In facsimile all these irregularities and transients in any form are printed, marring the appearance of the picture. Therefore, in general, lines for facsimile work should be more highly corrected than lines for telephone work.

As the voltage level may be set once and accurately maintained over a line transmission, the amplitude-modulated half-tone type of signal is generally used here. Thus true halftones are possible, and the results obtained are very reliable.

14. Radio Transmission

Transmission by radio is a very different matter, and more precautions are necessary to obtain the same quality of recording that a line transmission would give. Many factors enter, such as fading, echoes, interference, and other forms of distortion, that must be corrected for, or else the speed of transmission must be decreased until the particular distortion present is reduced sufficiently so that it is no longer objectionable. It is highly desirable, for these reasons, to have the scanner and recorder so arranged that many speeds of transmission are available, and the highest speed chosen consistent with the prevailing conditions at the time.

If the echoes or interference are below the signal level, a large part of the trouble can be overcome by using a limiter amplifier with threshold control at the receiver. As explained previously, this amplifier will tend to square up the pulses received and limit the background to a certain definite level. If these interfering signals or echoes are of the same order of magnitude as the desired signal, very little can be done to clear up the reception.

A certain amount of fading can be compensated for by the use of the limiter amplifier, by setting the input volume so that the signal seldom or never falls below the threshold setting. All signals higher than this will come through at the same level and print at the same density on the recorder. However, if the limiter is used to compensate for too great a change in signal strength due to fading, trouble will be encountered in the form of filling in some of the characters of type, such as the centers of *o*'s and *a*'s. Severe fading should be corrected by the use of diversity reception. This consists of using several receivers, each with its own antenna, and these separate antennas are separated as far as possible. The combined audio output of these

receivers will be a far steadier signal than the output of any one of them. Such a reception system is used in many commercial radio systems for code and tape work, as well as for facsimile.

If radio transmission is to be made by a modulated audio tone instead of the usual voice currents, an ordinary radio receiver will be used. If transmission is by cw, as in purely black and white, or "dot" pictures, the receiver will use a heterodyne beat note, and tune as for a straight code message. In normal code a beat note is generally chosen that can be heard clearly, but for facsimile work this beat note will have to be set much higher, usually 3000 to 4000 cycles. This will insure the audio tone being capable of carrying the very short dots, as the same limitations must be placed on this beat note as were placed on the audio carrier tones of the phototube amplifiers.

Selective fading will sometimes eliminate the very short dots while longer ones will come through. In this case the scanning speed can be lowered until the shortest dots are properly received. Often, on the other hand, good signals will be obtained along with heavy interference. If the speed is increased, a shorter time will be allowed for the interference to mar the picture.

In the above discussion, it will be readily seen that the radio signal is, at best, very unstable compared to a line signal, and that a straight on-off keying, such as a c-w code signal, has a far better chance of arriving with little distortion and change of value. It is, therefore, highly desirable that all signals, even for halftone work, be of this character. The "dot" halftone processes were developed to allow this type of signal to be used on all subject-matter, and much better results will be obtained over long distances by the use of the c-w signals in place of modulated waves or tones.

15. Synchronizing

In every facsimile system, it is necessary that the recorder follow the scanner over the paper in order to produce an undistorted recording. The principle of synchronizing may be better understood by referring to Figure 21. For clarity the picture elements are shown much larger in proportion than they really are. As the scanner starts the picture on element 1, the recorder also starts on its element 1. As succeeding scanning lines are drawn, the recorder must follow exactly, or the copy will be distorted by a misplacing of the elements.

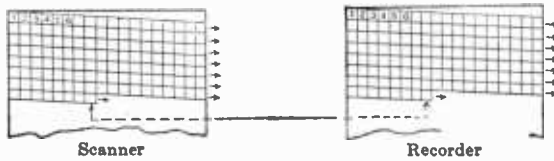
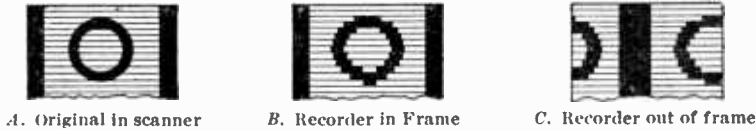

Fig. 21—Synchronism of a facsimile system.

Besides having the synchronizing correct, the recorder must be in "frame" with the scanner, as illustrated in Figure 22. Even though the two drums are rotating at exactly the same speed, if they are not in frame the border of the picture will be misplaced. The recorder drum must start each scanning line at the same time the scanner is starting that scanning line, or, as shown in Figure 22C, the border will be somewhere between the two edges



A. Original in scanner B. Recorder in Frame C. Recorder out of frame

Fig. 22—Framing of a facsimile recorder.

of the paper instead of being exactly divided. Framing and synchronizing become the same problem only if the framing line of the picture, or border, controls the speed of the recorder. Where the synchronizing frequency is independent of the "framing line," or of a much higher frequency than that of the framing line, the two problems are separate and must be treated separately. This latter is generally the case in most commercial systems in use today.

Before going into the means of synchronizing and framing, the effect of imperfect synchronizing should be shown, to illustrate the problem better. Figure 23 illustrates the effect of an



A. Original in scanner B. Recorder fast, unidirectional scanning C. Recorder fast, "back-and-forth" scanning

Fig. 23—Recorder not perfectly synchronized.

error in synchronizing on a unidirectional scanning system, and on a back-and-forth scanner. The error illustrated here is that the recorder is running faster than the scanner by a very small per-

centage. In scanning the vertical line in (A), the recorder gets farther along its scanning line each time, moving the recorded line farther and farther to the right. The result, in a unidirectional system, is shown in (B). In a back-and-forth scanning system, the result is much more pronounced, alternate lines moving apart, as in (C). The result, for the recorder being too slow, would appear the same with this method of scanning, while with the unidirectional system the line would have slanted down to the left instead of down to the right.

The accuracy of the synchronizing system may vary with the use of the particular system. In commercial work, where the recorder picture must be perfectly enough synchronized not to call forth comment from the customer, this necessary accuracy is very high. In a system scanning at 60 strokes, 100 lines per

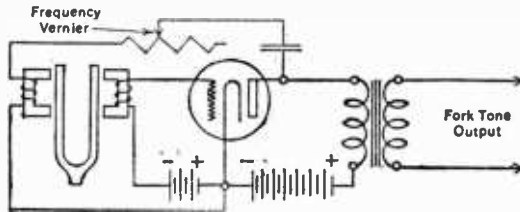

Fig. 24—Tube-driven tuning fork.

inch, and each line of 9-in. length, the total length of scanning line per vertical inch of paper is 900 in. In a picture of 10-in. length, this total scanning line length will then be 9000 in. A perfectly good copy will be made if the total drift in the border of the picture is not over $\frac{1}{4}$ in. in this 10-in. length of picture. Thus, the synchronizing system must hold an accuracy of $\frac{1}{4}$ part in 9000, or 1 part in 36,000. It must hold this rate for the whole transmitting time of nearly 17 minutes. Actually most commercial systems have synchronizing equipment accurate to 1 part in 100,000 or better.

Tuning fork frequency standard. In short-distance work, where the same a-c power supply is available to both scanner and recorder, the problem of synchronizing simplifies itself to the use of ordinary synchronous motors on the common frequency supply at both ends of the system. In longer-distance work, or across the sea, this is not possible, and the system then involves the maintenance of a separate frequency standard at either end of the circuit, these two standards to maintain the same frequency to within the prescribed limits of 1 part in 100,000 or better.

Such frequency standards usually take the form of very accurate tuning forks. Through the vibrating contacts of the fork or through the use of its electrical output, the driving motor of the scanner or recorder is then controlled. The fork is usually driven by acting as the coupling between grid and plate coils of a vacuum-tube oscillator, as in Figure 24. The oscillating tube maintains the fork in vibration.

The variable resistor in the plate coil of the fork varies the amplitude of vibration and, therefore, controls the fork frequency over a very narrow range. If the amplitude of vibration is high enough, this range of control may be extended to allow the fork to be manually set to frequency through a wide temperature change. A more accurate method, however, is to temperature-control the fork in an insulated oven by thermostat control.

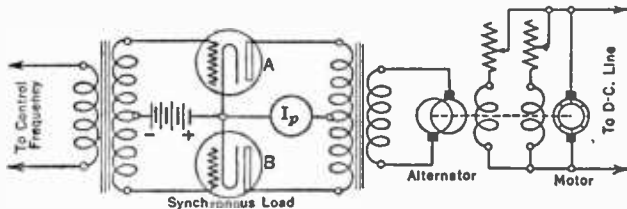

Fig. 25—Hammond synchronizing system.

In this case, the amplitude of vibration of the fork may be reduced greatly, and the vernier range of control becomes very small. A large range is not necessary, and a low amplitude of vibration will make the fork far more accurate.

Several methods of using the constant frequency supplied are described below.

Hammond synchronizing system. The Hammond system consists of a variable-speed motor and an alternator on the same shaft, and this combination is used to drive the facsimile gear. The alternator has the same frequency as the fork, or other control frequency, at the speed it is desired for the motor to run. A synchronous vacuum-tube load is connected across the alternator output as in Figure 25. These tubes receive all their plate power from the alternator, and, being connected in opposite polarity, each can draw power for only half the cycle.

The tubes are so biased by a battery that, with no input control tone, the plate current drawn is very nearly zero. When a control frequency is applied to their grids, more plate current will be drawn, if the control tone and the alternator output are

in the proper phase relationship. Figure 26 shows how this plate current varies with phase between grid and plate voltages.

Consider the alternator and control frequency exactly the same in frequency, but variable in phase. Now, if the positive half of each grid cycle occurs exactly in phase with the positive half of the plate cycle for that same tube, the tubes will draw plate current as in Figure 26A. In this phase, each tube is drawing its full load from the alternator. Now, if the motor tends to slow down, the plate voltage will lag behind the grid excitation,

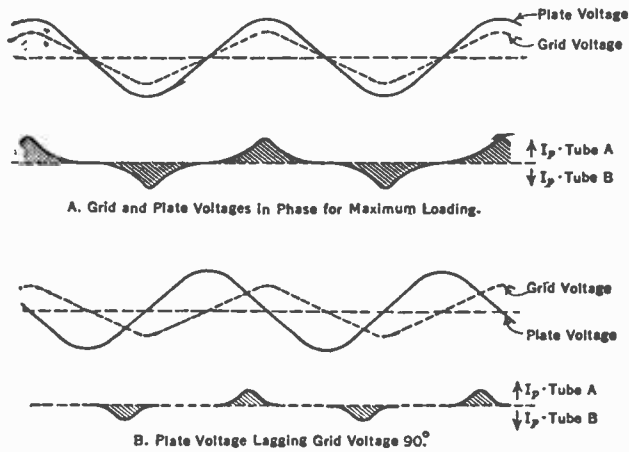

Fig. 26—Variation of load current with phase in Hammond synchronizing.

and the condition in 26B will illustrate the change. A smaller portion of the positive half of the grid cycle is used here, as the tubes can draw plate current only when their plates are positive. The total tube load is less than in A, as shown by comparing the shaded plate current curves. The load on the alternator has decreased enough to allow the motor to speed up. This load will then change constantly to compensate for any increasing or lessening of motor power due to line voltage changes, or any other cause, and maintain the motor in absolute control of the fork.

This control will hold over the load range of the tubes and alternator used, and the tubes and alternator are generally chosen to absorb over half of the motor power. The greater the percentage of motor load drawn by the alternator and tubes, the greater this lock-in range becomes.

This system provides a very positive lock-in with the tuning fork over a fairly wide range of line voltage variation. It has a very simple tube complement and associated circuits, and is generally very reliable. However, it has several disadvantages. The alternator and fork should be of fairly high frequency, to prevent the phase shifting of the alternator under varying load from shifting the picture enough to be noticeable. The alternator, therefore, becomes expensive if built with enough power to control properly over an appreciable range, and also will usually "sing" loudly at this frequency, making a very objectionable noise.

This system has generally replaced the system of using vibrating contacts on the fork itself to vary the field excitation of a d-c motor and has proved far more satisfactory.

This latter system, now obsolete, uses no tubes in the entire synchronizing system. The fork is kept in vibration by a coil-contact system as a buzzer, and extra contacts are provided in series with the motor field circuit. A commutator on the motor shaft is in this same field circuit, and the combination of fork and commutator varies the field excitation as the motor lags or leads the fork.

Controlled inverter synchronism. A newer method of synchronizing has resulted from the perfection of mercury inverter tubes. By their use high power may be generated at an absolutely controlled frequency, allowing the facsimile equipment to be driven by ordinary synchronous motors. The lock-in with the tuning fork, or other synchronizing frequency, is absolutely reliable over much wider variations in the power line voltage than in other systems.

One form of the inverter is shown in Figure 27. The two mercury tubes are connected in push-pull, forming an oscillating circuit tuned by the plate transformer and capacitor. Just enough regeneration is supplied by the grid transformer to allow the inverter to oscillate without any applied control frequency. With the load connected, the plate and grid capacitors are adjusted to values which will tune the output frequency to a value very near that desired. When the controlling frequency is applied to the grids, the inverter will then lock into synchronism with that control frequency and supply power absolutely in synchronism and in phase with the control.

The tubes shown in the diagram are of the "heater" type, and the heaters are connected directly across the line. The plate

power is applied through a reactor, limiting the plate current on its initial surge at the breakdown, and allowing the tuning circuit of the system to swing the plate load from one tube to the other for alternate half cycles. Proper tuning and setting of bias will give a very good wave shape of output, very nearly a sine wave.

The mercury inverter tube does not operate as an ordinary vacuum tube, for the grid can control only the starting of the plate current, but has no power to stop this arc. The controlling action is, therefore, merely a trigger. The wave shape of the control frequency, therefore, does not matter, and as long as it

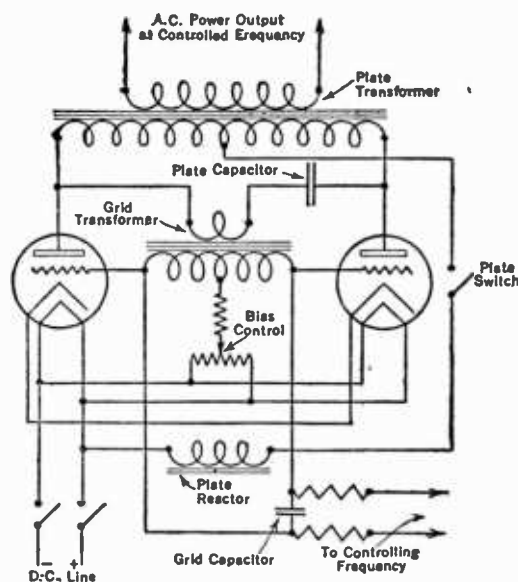

Fig. 27—Inverter (frequency controlled output).

reaches a peak value sufficient to start the plate arc, the remainder of that half cycle has no effect. The inverter plate circuit, by virtue of its tuning, will swing the other half cycle without a control pulse on the second grid, although the full control on both grids gives somewhat more reliable results.

Besides using this inverter at the recorder, a control frequency may be sent along with the picture, and the synchronism maintained by line or radio. Successful results have been obtained in this way over a fair distance, and there are no obstacles to using this method over very long lines. Radio transmission of these synchronizing frequencies presents more of a

problem, however, as a loud burst of static will sometimes cause the inverter to skip a cycle, or even abruptly stop oscillating. This will blow the plate circuit fuse or breaker, as, once the inverter stops oscillating, one or both of the tubes will draw a steady d-c arc no longer limited in current value by the reactor which limits the surge current. This disadvantage may be largely overcome by the introduction of a "flywheel" effect into the control circuit. If an ordinary audio oscillator is first locked into synchronism with the incoming control frequency, the output of this oscillator will be more reliable in controlling the inverter than the variable somewhat erratic tone as received.

Start-stop synchronization. The first methods used for facsimile synchronization were generally of the start-stop type, and although such a synchronizing system is now practically obsolete for facsimile, it is still used on some forms of automatic tape printers, such as the teletype.

In start-stop systems, the scanner is generally operated at a constant speed and has a "framing line" of a considerable time length. During this framing line interval, the recorder will have finished its scanning line and stopped automatically. The scanner sends a pulse at the start of the succeeding scanning line, and a clutch, or similar mechanical apparatus, starts the recorder on the next scanning line. A governor-controlled motor, or some other fairly accurate drive, is used to maintain the recorder at a constant speed for the duration of the scanning line proper.

The chief merit of this system is that the errors in speed of the recorder are not accumulated, but each scanning line starts afresh. The greatest possible discrepancy in synchronizing, therefore, is the error in any one scanning line itself, and this can be made quite low. The disadvantage is that the mechanics of such a system must be quite complicated, and a definite starting pulse must be received or the entire scanning line is lost. The speed of the entire system is, therefore, slowed down quite appreciably to insure that these two factors do not interfere with the picture. A complicated scanning system cannot be started instantaneously at a high scanning speed, but allowances must be made for the inertia. Fading of the signal, if received by radio, would cause such a system completely to miss whole scanning lines, if starting pulses were not received.

For use by line, such a system has advantages, as an ordinary governor will synchronize a motor accurately enough for use here, and the failure to receive a starting pulse is rare.

Other synchronizing systems. Many other systems of holding a recorder in synchronism with the scanner have been devised, and a few will be mentioned here for historical interest. Probably the first system consisted of using two pendulums, one for scanning and the other for recording. The paper was curved at a radius equal to that of the pendulum, and the motion of the pendulum scanned the sheet as the paper was gradually drawn underneath. This is a simple system and may be made highly accurate. It is, of course, cumbersome, and must be triggered at the start of the first scanning line, to frame the system. This system was used as early as 1880.

Certain recording systems require no synchronizing at all, and such methods, sometimes used for cable transmission of pictures, involve setting up a certain number of picture elements by machine, or by hand, and sending a tape of this series of elements in numerical order. The recording is then assembled by hand, usually requiring a competent artist to give the picture a life-like appearance. This method has been used for a number of years with great success over wire and cable. The Bartholomew-McFarlane system or, in shorter terms, the "Bartlane" system is a variation of this method.

The synchronizing frequency of the scanner is sometimes sent over the radio or wire line, and an amplifier used to build this signal up to a value where it is able to drive or control a synchronous motor on the recorder. Such methods are satisfactory on line transmissions, but cannot be depended upon for radio work. A fading signal or interference usually destroys synchronism.

Framing methods. Many attempts to build a satisfactory automatic framer have been made, some satisfactory on perfect signals or over wire lines, but all far more complicated than the need warrants. The usual framing method is to throw the recorder out of synchronism, allowing it to drift until the framing line no longer appears on the sheet, or is cut in two by the paper edges, as shown in Figure 22*B*. If the photographic or some other type of recorder is used in which the results cannot be readily seen, a meter in the printing circuit must be used as the indication. This can be lined up to beat time with a second meter placed on the recorder framing line by a commutator. When the two meters beat together, the framing lines of the recorder and scanner are together, and the framing position is established.

COMPLETE FACSIMILE SYSTEMS

Two complete systems for facsimile transmission by either wire line or radio are shown in block diagrams, Figures 28 and 29. The first system shown, Figure 28, is the more usual radio set-up at the present time, as much more reliable results are obtained than with the second. This system will send black and white only, and therefore, if halftones are to be transmitted, they must be in the form of dots, or similar systems using only black and white. The CFVD system could be used here, and the combining unit would replace the limiter amplifier in the transmitting end of the circuit.

If the transmission is to be by wire, the wire line is connected as shown in the dotted line, taking the audio output of the limiter or combining unit and placing this on the line. With a properly corrected line no additional squaring up of the signals will be necessary at the recorder, and so another limiter amplifier is unnecessary here. The signals are amplified and rectified by the recording amplifier, and impressed directly on the printer of the recorder.

In transmission by radio, it is absolutely necessary that the transmitter be keyed by a tube keying unit instead of the customary mechanical relays for code work, since an ordinary relay cannot respond to the high keying speeds met with in facsimile. Such a keying unit usually takes the form of an amplifier capable of biasing the transmitter power stage to cut off for no signal, and allowing this bias to return to normal for each signal thus putting the transmitter "on the air" for each separate signal. An amplifier similar to the recording amplifiers in Figures 19 and 20 (§ 12), capable of supplying high voltages into the transmitter biasing resistor, will answer this purpose nicely. Figure 30 shows such a keying unit and the method of connecting it into the transmitter biasing circuit.

The limiter amplifier used in the recording circuit is not necessary, but greatly assists in keeping the copy clear and sharp. If the circuit is two-way, the same limiter can be used for both transmitting and recording.

The second system, Figure 29, illustrates a modulated audio tone transmission for modulated halftones. The output of the phototube amplifier, in the form of an audio tone of varying amplitude, is amplified up to a point where it can be placed directly on the line (shown by the dotted lines) or to replace the microphone input of an ordinary speech transmitter. The

signal is received the same as for voice, but through the recording amplifier, and directly into the recorder printer. No processing of the audio tone is necessary in either transmission or reception.

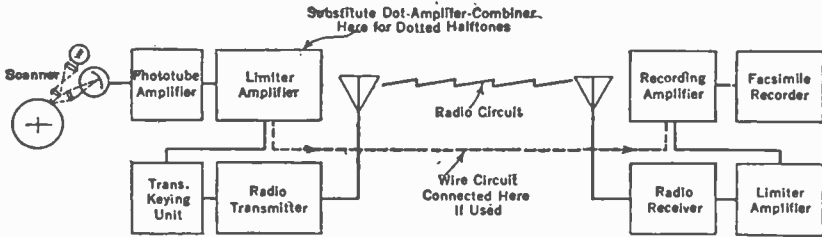

Fig. 28—Facsimile system for black and white only, or dotted halftones.

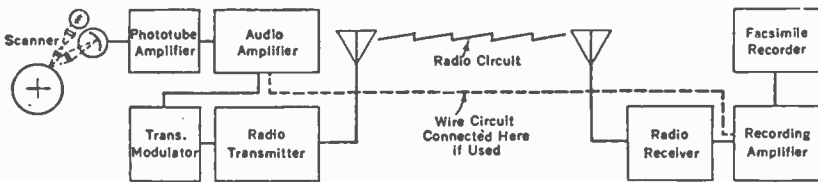

Fig. 29—Facsimile system for modulated halftones by audio carrier modulation.

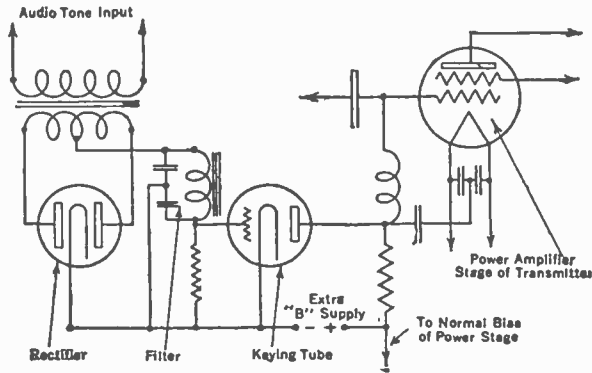

Fig. 30—Tube keying unit for c-w transmitter.

Neither of these block diagrams shows synchronizing equipment at either scanner or recorder, but of course, both ends of the circuit must be in synchronism for perfect reception.

16. *Speeds of Operation*

The speed of transmitting a facsimile depends on three things: the speed of the scanner, the recorder, and the transmitting medium. The last is generally the determining factor in the systems in use at the present time, as explained under "Transmission." Commercial systems today use practically all speeds from 20 to 120 scanning lines per minute, and from 50 to 200 lines per inch, the type of service and quality of picture determining the maximum possible speed over that particular circuit. Thus in transatlantic traffic, the speeds are usually slow, and detail required fairly high. Here the number of strokes will generally be found from 20 to 40, with 60 as a rare high. Forty strokes is the usual number, with 100 to 120 lines per inch as the required detail.

In land wire service, echoes and fading do not enter, so 60 strokes is more usual, the number of lines per inch being about the same. With lines of great length, not completely corrected, this will drop to 40 or even 20 strokes per minute.

In short radio or line circuits, 100 to 120 strokes can be used with reliable results. But here, at these speeds the possible speed of the recorder begins to show up, as some recorders will be beyond their limit at 120 strokes, if the detail is maintained at 100 lines per inch or better. The speed of the scanner will generally not begin to show until the number of strokes is increased to several hundred, provided a high enough carrier or chopper tone is used to carry the modulation of the picture.

17. *Tape Facsimile*

Recently another form of facsimile transmission and reception has been devised which promises to be of importance in the communications field. This is known as tape facsimile, for both transmission and reception are in the form of a paper tape.

The original to be transmitted is written on the tape by a typewriter, similar to a ticker tape record, and this is scanned the same as any facsimile, by a moving spot of light and a phototube. The scanning line is only as long as the tape is wide, $\frac{3}{8}$ to $\frac{1}{2}$ in., or generally a little less, and the scanning speed in strokes is very high, 60 or more of these per second. As the tape moves through the scanner it is gradually entirely scanned, and regular facsimile signals are sent out of the black and white areas on the tape. The recorder rebuilds these signals on another tape, exactly as a standard facsimile recorder.

The scanner and recorder become very simple for such short scanning lines, and therefore very cheap to build and maintain. The scanner usually takes the form of a simple optical system with a vibrating or rotating mirror to move the spot of light this short distance. A rotating prism may also be used for this scanner.

The recorder must be of the direct printing type for a completely satisfactory solution of the problem, and the carbon recorder lends itself very readily to this use. The carbon and white papers are only at the most $\frac{1}{2}$ in. wide, so the printer bar becomes very small and light, capable of much greater speeds than the longer bar of the machine in Figure 18. The helical ridge becomes very small, mounted directly on the motor shaft without intervening gearing.

The scanning and recording amplifier systems are similar to those of any other facsimile system, with about the same limits necessary in keying speeds, carrier tones, etc.

The advantage of such a system over regular coded tape is that the integrating effect spoken of under "Applications" holds here too, and a very reliable communications system is the result. Here, contrasted to the page facsimile, almost all the area scanned is filled with useful words, so that far less space is wasted. For this reason, the tape equipment will have a lower keying speed for the same number of words per minute, or a much higher words-per-minute rate for the same number of keyed cycles. A facsimile circuit that would normally carry 50 words per minute of typewriting on a page will carry nearly 100 words per minute of the tape facsimile.

18. Photo-engraving

A comparatively new use, industrially, of facsimile processes is the making of photo-engravings. The process is very much faster than the usual photographic process, and can be made to give the same detail in the plates engraved that the slower process gives, with very much less trouble.

The scanner and recorder for such an engraver are both operated together, and the scanning process will be the same as for any facsimile picture transmission. The recorder, however, does not print on paper, but actually cuts a copper or zinc plate.

In place of the usual recording mechanism, the recorder takes the form of a triangular cutting tool, and the depth of cut is determined by the signal. Cutting of the plate, which is wrapped

about a drum, is therefore very similar to the stylus method of recording. Instead of pressing the stylus harder for a heavier line, the cutter is pressed deeper for a wider cut. The triangular shape of the cutter therefore allows all shades from white to black to be represented by lines of various widths.

In building such equipment as this, which really amounts to a turning lathe in operation, the cutter and drum assemblies must be very rigidly supported to prevent chatter, and the base plate for such an equipment will therefore resemble a lathe bed in rigidity and accuracy.

The amplifier system for such an equipment generally consists of a straight d-c amplifier between the phototube and the cutter driver. In this case, as no line transmission is made, the d-c amplifier is the simplest system and the most reliable.

Practically all the features involved in the particular system described here are included in the Howie photo-engraver.

PART III

PROPAGATION REQUIREMENTS FOR FACSIMILE

By

R. E. MATHES AND J. E. SMITH

Research Engineers, Central Office Engineering Laboratory, R.C.A. Communications, Inc.

INTRODUCTION

FACSIMILE transmission inherently places rather severe demands upon its transmission medium. While the requirements themselves are identical in name to those ordinarily specified for other types of signals, the narrow tolerances permitted necessitate a more rigorous study of the major factors involved.

The type of modulation employed is of paramount importance. Present-day technique utilizes both amplitude (class A) and "on-and-off" (class C) modulation depending upon certain factors to be described in this paper. The channel band width assigned to a particular facsimile circuit is a function of the transmission speed, the fidelity of reproduction desired and the sensitivity of the recording device. The band width is most accurately described in terms of its frequency and phase characteristics. With picture modulation, increasing the band width increases both the signal and noise energy applied to the recorder. For a fixed transmission speed, however, the rate of increase of signal energy with respect to band width soon becomes less than the corresponding relation for noise energy whether the noise be of the fluctuation or impulse type. On most commercial circuits it is advantageous to restrict the band width to provide the minimum acceptable fidelity at the maximum speed of transmission to obtain as much reduction in noise as possible.

On short-wave circuits involving transmission by way of the ionosphere, multipath effects are usually present. Variations in the ionosphere produce variable frequency and phase characteristics over a band of frequencies. These effects result in over-modulation and partial or total side-band suppression as well as wave-shape distortion due to unequal transmission times of the signal components. Their magnitude for a particular type of modulation is best determined by experiment.

It is thus evident that the factors just described are interdependent and each must be coordinated with the specification for the total system. In an amplitude-modulated system the signals produced by the scanning device have an inherent aperture distortion which limits the detail that can be transmitted. The propagation characteristics need be no better than that required to transmit the pertinent facsimile signals as limited by the aperture distortion.

TYPE OF MODULATION

On long-distance radio circuits where extreme fading and low signal-to-noise levels predominate, it is advantageous to utilize a type of modulation producing maximum r-f carrier power and an effective modulation index¹ greater than unity. This is achieved by "on-and-off" keying the power amplifier adjusted for class C operation. So-called black and white copy such as a typewritten sheet may be ideally transmitted in this way. Pictures can be transmitted in a similar manner by employing the "Constant Frequency Variable Dot" or commonly called CFVD method.² The half-tone detail obtainable by this system is such that satisfactory reproduction can be made so long as the chief point of interest in the picture occupies an area not less than about one square centimeter.

For relatively local service areas or over ultra-high-frequency radio circuits where selective fading is negligible and general fading can be fully compensated by automatic gain control or other means, amplitude modulation can be employed to advantage. This method permits the transmission of greater detail and avoids the screening effect of CFVD² which will produce undesirable "beat" patterns for some types of copying processes. Three forms of amplitude modulation are described below:

1. *Sub-Carrier Modulation*

This system utilizes a sub-carrier tone modulated by the facsimile signals. The extent of the resulting side bands is ordinarily limited by a band-pass filter before application to the class A power amplifier. The sub-carrier frequency corresponds to the mid-band frequency of its channel filter for double side-band transmission and to one of the cut-off frequencies for selective side-band transmission. It has been shown in a previous paper¹ that double side-band transmission is less exacting

in its circuit requirements and at the same time gives equal fidelity to that obtainable under normal conditions with selective side-band systems. It has also been determined empirically that the sub-carrier frequency may have any value above twice the highest equivalent modulation frequency that it is desired to transmit and, with certain types of recorders, this value may be reduced to $3/2$ the modulation frequency without objectionable loss of detail.

2. *Direct Modulation*

Facsimile signals may amplitude-modulate the r-f carrier directly as is done in voice transmission. However, the very low frequencies and the d-c component are ordinarily eliminated by adverse frequency characteristics in this region. Failure to transmit the d-c component results in a relaxation or bouncing effect of the zero signal axis which appears in the received copy as a slow change in background intensity immediately following a sudden change in signal amplitude.

Non-linear phase characteristics at the low frequencies produce considerable distortion since the most important signal components then have unequal times of transmission. With this type of modulation it is essential that the linear-phase intercept pass through zero or some multiple of 2π . If, for example, the phase intercept has the value $\pi/2$ at zero frequency, the received wave form will in no way resemble the original signal. Satisfactory transmission of facsimile signals by direct modulation therefore requires more than ordinary design precautions for the overall circuit¹.

3. *Dual Channel Modulation*

This system, proposed by Mr. Artzt, of RCA Manufacturing Company, utilizes direct and sub-carrier modulation simultaneously. To avoid the deleterious effect produced by adverse phase and frequency characteristics normally obtained at the very low frequencies, this method separates the high- and low-frequency signal components into two channels by means of specially designed networks. The channel carrying the high-frequency signal components is applied as direct modulation to the radio transmitter. The low-frequency channel containing the d-c component is applied as sub-carrier modulation in the frequency spectrum above the direct-modulation channel. At the receiving terminal the sub-carrier channel is demodulated and added to the output of the direct-modulation channel before recording.

This system has the advantage that the zero- and low-frequency components are contained in the received wave so that less trouble is experienced from the transient response of the overall circuit. Also from theoretical expectations, the r-f band width requirement should be less than for the usual sub-carrier modulation system. Unfortunately, however, these advantages are not realized in practice without the design of expensive equalization networks. For example, it is essential that the two channels have equal times-of-transmission in order that their outputs may be combined in phase at the receiving end. This requires the use of delay networks in the direct-modulation channel to prevent the high-frequency signal components from arriving at the receiver ahead of the low-frequency components. Further, it has been determined that the transmission characteristics are, in general, more rigid for the dual-channel system and, therefore, it is necessary to increase the band width in excess of the sub-carrier system requirements.

BAND WIDTH

The shortest dot in a facsimile signal which is to be faithfully transmitted is recognized as the criterion of the circuit band width. If a single impulse is transmitted its components are known to be of infinite extent and of infinitesimal amplitude. Any finite band width will, therefore, pass less and less energy as the duration of the impulse is decreased. Obviously, in the absence of noise the length of the transmitted impulse is limited only by the sensitivity of the recorder. In the presence of noise, on the other hand, the received-dot energy must exceed some minimum signal-to-noise ratio for satisfactory recording.

Further, the wave shape of the received dot is also a function of the signal components transmitted, i.e., of the band width. It is known,² that in double side-band transmission the fidelity of reproduction depends upon the build-up time t_a of the received wave envelope and that t_a can be expressed in terms of band width by the relation

$$\text{B. W.} = \frac{1.1}{t_a}$$

where B. W. = Band width in cycles per second
 t_a = Build-up time in seconds.

For suddenly applied square-wave dots such as occur with CFVD keying, the build-up time may be adjusted to any value by varying the total circuit band width. Empirical investigations indicate that satisfactory recordings are obtained when the band width is such that the received wave shape is flat-topped during one-quarter of its original duration. The wave shape is then very nearly trapezoidal. With this type of keying we may threshold limit the received signal to one-half its maximum amplitude and derive the original impulse. The effect of fading² will then be identical to the effect produced by variations in threshold level, i.e., when the threshold level is above one-half the maximum signal level the duration of the recorded dot will be less than the original, and, correspondingly, for a threshold level below one-half the maximum signal amplitude the recorded dot will be elongated as compared with the original. The criterion for CFVD recording is that the reproduction of the shortest keyed dot shall not vary in duration more than sixty per cent with maximum variations in signal amplitude.

In the case of amplitude modulation the same relation holds between band width and signal build-up time. The transmitted signal itself has a build-up time due to aperture distortion and it is obvious that the band width is arbitrarily determined by this value. There would be no point in designing a circuit capable of better transmission fidelity than is available from the facsimile scanner. Similarly, it would be uneconomical to reduce the light spot to give an aperture build-up time less than the minimum detail requirement since this would increase the picture transmission time.* It may be of interest to state here that network characteristics are sometimes utilized to compensate for a portion of the distortion produced by a finite aperture in very much the same way that simple filter sections are employed to minimize the effect of loud-speaker resonances.

PHASE CHARACTERISTICS

We have the following theorem from network theory. If the attenuation and dB/dw are constant at all frequencies and the linear-phase intercept is a multiple of 2π , the received wave is a replica of the transmitted signal delayed by a time dB/dw . In this theorem B is the phase shift in radians as a function of the angular velocity w . We have previously discussed the effect

* In this paper, aperture width means the dimension in the line of scanning and aperture height is the dimension transverse to the line of scanning.



(a)



(b)

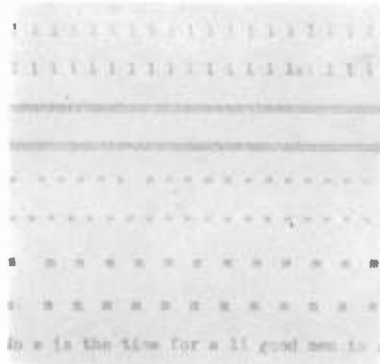

(c)

Fig. 6—Ratio of carrier to maximum signal frequencies of $5/3$.
 (a) and (b) are oscillograms of letters *l* and *m*.

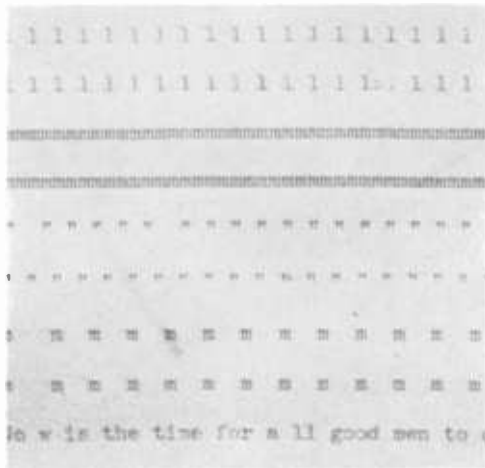

Fig. 7—Ratio of carrier to maximum signal frequencies of $5/2$.



(a)



(b)

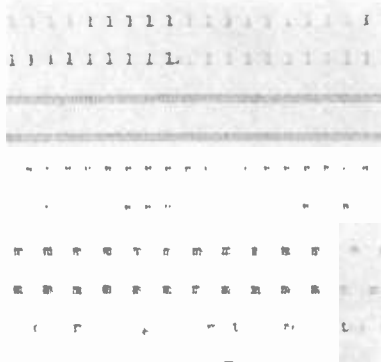

(c)

Fig. 8—Ratio of carrier to maximum signal frequencies of 5/4. (a) and (b) are oscillograms of letters *m* and *l*.



(a)



(b)

Fig. 9—Effect of aperture distortion. (a) Buildup time determined by aperture. (b) Buildup time determined by response of 600-cycle filter band.

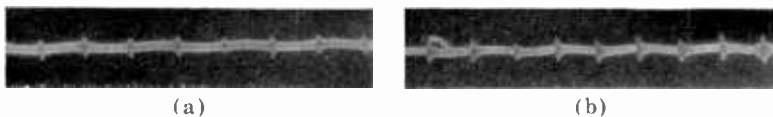

Fig. 3—Double vs. single side-band transmission through 2.5 kc filter band. Aperture distortion limiting buildup and decay of input signal. (a) $f_{mod} = 7$ kc, $f_c = 7$ kc. (b) $f_{mod} = 7$ kc, $f_c = 8.3$ kc.

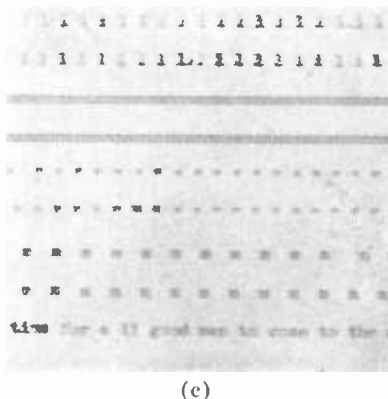
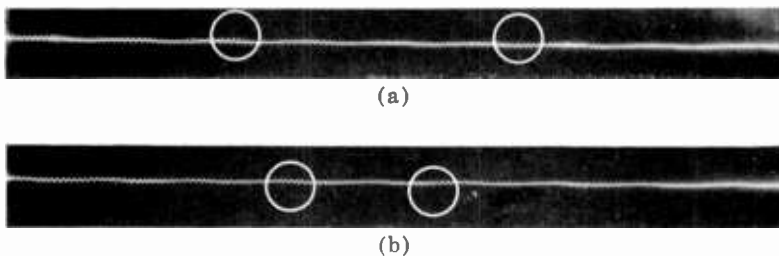

Fig. 4—Ratio of carrier to maximum signal frequencies of 5/6. (a) and (b) oscillograms of letters *m* and *l*.

we are very glad to have the opportunity
illuminated magnifier.

name implies illuminates the field of
arranged that direct rays cannot reach
light is where it is required--on the

obtained by means of a double lens sy.
uses, ground and polished to an exact

Fig. 5—Facsimile record with scanner aperture width of .006 inches.

need not suffer unduly.

1234567890
 YD JGA BEVPABOGKS
 RIECP YNMBHAIJKM
 XAFLU GITDIJELWD

practical one of making thoughts
 upon occasion, that is to say, in p
 ment". This is a sweeping statem

1234567890
 YD JGA BEVPABOGKS
 RIECP YNMBHAIJKM

(a)

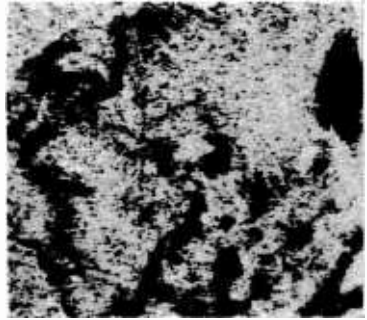

(b)

need not suffer unduly.

1234567890
 YD JGA BEVPABOGKS
 RIECP YNMBHAIJKM
 XAFLU GITDIJELWD

practical one of making thoughts
 upon occasion, that is to say, in p
 ment". This is a sweeping statem

1234567890
 YD JGA BEVPABOGKS
 RIECP YNMBHAIJKM

(c)



(d)

need not suffer unduly.

1234567890
 YD JGA BEVPABOGKS
 RIECP YNMBHAIJKM
 XAFLU GITDIJELWD

practical one of making thoughts
 upon occasion, that is to say, in p
 ment". This is a sweeping statem

1234567890
 YD JGA BEVPABOGKS
 RIECP YNMBHAIJKM

(e)



(f)

Fig. 10—Effect of random noise. (a) and (b) Signal/noise ratio of 6 db. (c) and (d) 12 db. (e) and (f) 18 db.



(a)

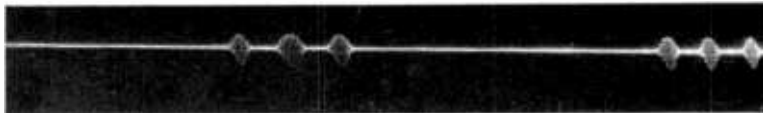

(b)

Thank you for your inquiry of the 24th on Pike "Flash-O-Lens". It is surely appreciated, and we are very glad to have the opportunity to tell you about this new illuminated magnifier.

The "Flash-O-Lens", as the name implies illuminates the field of vision, and the light is so arranged that direct rays cannot reach the eyes of the user. The light is where it is required--on the object under observation.

(c)

Fig. 1—Double side-band transmission through 600-cycle filter band. $f_{mod} = 2125$ cycles. $f_c = 2125$ cycles. (a) Midsection scanning of letter *l*. (b) Midsection scanning of letter *m*.



(a)



(b)

Thank you for your inquiry of the 24th on Pike "Flash-O-Lens". It is surely appreciated, and we are very glad to have the opportunity to tell you about this new illuminated magnifier.

The "Flash-O-Lens", as the name implies illuminates the field of vision, and the light is so arranged that direct rays cannot reach the eyes of the user. The light is where it is required--on the object under observation.

(c)

Fig. 2—Single side-band transmission through 600-cycle filter band. $f_{mod} = 2125$ cycles. $f_c = 2440$ cycles. (a) Midsection scanning of letter *l*. (b) Midsection scanning of letter *m*.

need not suffer unduly.

1234567890
 QUVWXYZ BEVPABOGKS
 CYDJGA YNMBHAUJKM
 ERIECP GTDJEJLWD

practical one of making thoughts
 upon occasion, that is to say, in pl
 ment". This is a sweeping statem

1234567890
 QUVWXYZ BEVPABOGKS
 ERIECP YNMBHAUJKM

(a)



(b)

places where the sense of the inscription
 need not suffer unduly.

1234567890
 QUVWXYZ BEVPABOGKS
 ERIECP YNMBHAUJKM
 CXAFJU GTDJEJLWD

practical one of making thoughts
 upon occasion, that is to say, in pl
 ment". This is a sweeping statem

1234567890
 QUVWXYZ BEVPABOGKS
 ERIECP YNMBHAUJKM

(c)



(d)

places where the sense of the inscription
 need not suffer unduly.

1234567890
 QUVWXYZ BEVPABOGKS
 ERIECP YNMBHAUJKM
 CXAFJU GTDJEJLWD

practical one of making thoughts
 upon occasion, that is to say, in pl
 ment". This is a sweeping statem

1234567890
 QUVWXYZ BEVPABOGKS
 ERIECP YNMBHAUJKM

(e)



(f)

Fig. 11.—Effect of periodic noise. (a) and (b) Signal/noise ratio of 6 db. (c) and (d) 12 db. (e) and (f) 18 db.

of attenuation. The slope of the phase characteristic is a measure of the circuit transmission time and must be constant if all components of the applied wave group are to arrive at the recorder with their original phase relationships. In double side-band transmission with symmetrical delay characteristics about the sub-carrier frequency this constant may be allowed a tolerance of plus or minus 3 milliseconds for the total band width. Single side-band transmission, on the other hand, permits a tolerance of plus or minus one-half millisecond for the same speed of transmission.³ The linear phase intercept is the extension to zero frequency of the tangent of $B(w)$ evaluated over the pertinent frequency band. An example is shown in Figure 13-a. The phase shift is seen to be nearly linear with frequency above 3,000 cycles. The extension of the tangent of the linear portion to zero frequency gives an intercept of π radians. The effect of the phase intercept is to add a constant phase shift to each component frequency and the resulting distortion becomes a maximum when the intercept equals plus or minus $n\pi/2$ where n is any odd integer. The significance of the phase intercept as here described pertains to d-c signals having important side-band components around zero frequency. For sub-carrier modulation, the equivalent d-c signal component corresponds to the sub-carrier frequency and, since the pass band does not ordinarily include zero frequency, the phase intercept is of no importance.

SIGNAL-TO-NOISE RATIO

There are two main types of noise; namely, fluctuation or smooth noise such as tube hiss, and impulse noise due to shock excitation. The r-m-s value of both types of noise is known to be directly proportional to the square root of the channel band width.⁴ The crest factor of smooth noise has the value 3.4 and is independent of the band width. The crest factor of impulse noise may have any value depending upon the impulse wave form and it is directly proportional to the first power of the band width.

A theoretical analysis of CFVD reception employing threshold limiting at the receiver indicates an r-m-s signal to r-m-s smooth noise ratio of 17 db is required completely to eliminate noise effects in the recording. It is assumed the threshold level may be adjusted to one-half the maximum signal amplitude within plus or minus one db.

With amplitude modulation, the signal-to-noise ratio required depends to some extent upon the signal contrast value, i.e., the ratio between maximum and minimum signal amplitudes to be transmitted. When the contrast ratio is six db or greater, satisfactory recordings can be made with an r-m-s smooth noise value of 10 db below the minimum signal amplitude. Larger contrast ratios or, what amounts to the same thing, greater effective percentage modulations will permit slightly higher values of smooth noise. While the peak amplitude of the noise will appear as specks in the picture background, their occurrence is random and the effect is not objectionable to the eye.

On the other hand, periodic noise of the impulse type such as ignition pickup or diathermy interference is particularly objectionable since it often appears as quasi-synchronized streaks in the recorded copy. The crest factor of impulse noise depends upon its wave shape and cannot be predetermined. It has the further disadvantage that the peak amplitude is directly proportional to band width. In order to suppress its effect all picture signal components comparable in amplitude and energy content to these noise peaks must be eliminated by limiting with the consequent loss of picture detail in the recording.

Fortunately, with the exception of static, impulse noise is man-made and may frequently be reduced at its source or by means of antenna and circuit design. Atmospheric interference is less objectionable due to its random occurrence and is usually of major importance only on long distance circuits.

FADING

Selective fading is due to alternate additions and subtractions at the receiver of the same signal component arriving over different radio paths. The multi-path phenomenon produced by variations in the ionosphere is generally conceded to be random over any finite frequency band. Its effect is similar to that of a network having a variable frequency and phase characteristic such that a relatively narrow band of frequencies in the spectrum fades simultaneously with other narrow band groups which are more or less equally spaced with respect to frequency. These fading spots shift in an erratic manner on long distance circuits so that at one instant the upper side bands of a signal may be fading and a moment later the carrier or a portion of the lower side band may be cancelled. General fading is similar to selective fading except the frequency band affected is much greater and

the depth of fading varies at a slower rate. The effect of general fading can be greatly reduced with automatic gain control. Likewise, space and angle diversity receiving systems are helpful in ameliorating adverse selective fading effects.

With CFVD transmission, general fading increases the necessary signal-to-noise ratio for good recording directly with the degree of fading. For example, it was stated previously that the required S/N ratio is 17 db with no fading. If the signal level varies 10 db due to general fading the maximum signal-to-noise ratio must be 27 db to prevent noise streaks during the fading intervals. Moreover, the received signal would be alternately shortened and elongated due to the threshold action. Selective fading may produce almost any type of distortion. A particularly interesting case occurs when the fundamental signal component only is cancelled thus splitting the received dot into two impulses, one at the beginning and one at the end of the original wave. This phenomenon is shown pictorially by curve *E* of Figure 16-b and described in a later section.

With amplitude modulation, level variations due to general fading or other causes in excess of one decibel cannot be tolerated. Such fading appears as streaks of variable shading in the received picture. Probably the most pronounced effects are the double-frequency components which occur during carrier fades due to beats between the upper and lower side bands producing effective over-modulation.

Empirical investigations undertaken recently have yielded interesting experimental confirmation of some of the points discussed above. A few of these are described in the subsequent sections.

DOUBLE VS. SELECTIVE SIDE BAND

Comparison of Figures 1 and 2 shows the difference in the transmission of signals through a filter with the carrier frequency centered in the band, and with it so located on the edge of the band that the carrier is attenuated by 6 db. The applied signals were of perfectly rectangular envelope and can therefore be practically considered as "unit impulses" in the mathematical sense.

It is seen that the signals of Figure 1 are symmetrical and exhibit equal build-up and decay times. The times shown in Figure 1-a, for example, measure about 1.88 milliseconds which corresponds closely to the calculated value of 1.83 milliseconds.

In contradistinction, Figure 2 shows the effect of partially suppressing the carrier and upper side band. The build-up time is less but the decay drags out into a long tail which has the general effect of shading one side and producing an artificial shadow in the space after the letter. This produces copy in which the typing is heavier than it should be and which has an indefinitely unnatural appearance.

A similar effect is shown in Figure 3 in which the signal input was shaped by the frequency-limiting effect of aperture distortion in the picture scanner. The double side band adjustment is essentially identical with the input signal, whereas the selective side band adjustment again distorted the signal shape. This would bear out the findings in other papers,¹ that the distortion of selective side bands is predominantly phase distortion of the signal components retained by the filter rather than any loss of components.

RATIO OF CARRIER-TONE FREQUENCY TO KEYING SPEED

There is a very definite relation between the duration of the shortest dot to be sent and the lowest tone frequency that will adequately convey the information contained in this dot. Figure 4 illustrates the signal formation and the picture recording obtained when the ratio between the tone and the shortest dot frequency is only 5:6. The signal is barely discernible on the trace of the tone and the recording has a severe interference pattern due to the energy of the tone itself. The energy of the signal components is low and results in a recording with very poor contrast.

Figure 8 shows the same records for a tone-to-dot frequency ratio of 5:4 and, correspondingly, Figure 6 for a ratio of 5:3. These show a progressive improvement in energy content and in smoothness of the recording. The results are still not entirely satisfactory for photographic recording but a ratio of 5:3 would be usable for other types of recording which of themselves are somewhat limited as to the definition they will clearly record.

Figure 7 shows a recording for a ratio of 2.5:1. It is entirely adequate for commercial service. Figure 12 shows traces of signals received over a u-h-f circuit consisting of five automatic relay links. The picture signals have been de-modulated by means of two-phase full-wave rectification. Considerable irregularities are noted for the cases where the frequency ratios are only 3:2. The signals are much more symmetrical and well spaced for ratios of 2:1 and 3:1.

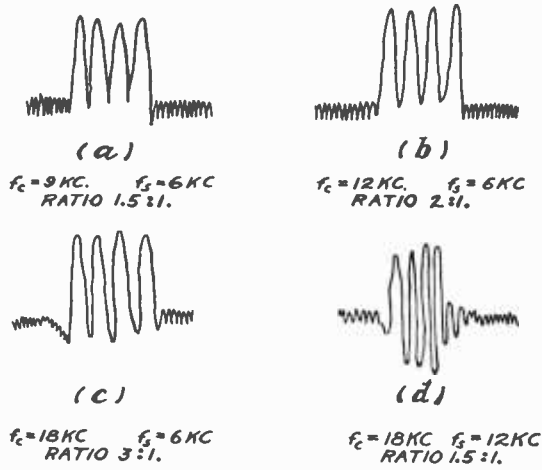

Fig. 12—Oscillograms of groups of high speed dots transmitted over 190-mile u-h-f relay chain comprising 5 automatic relays.

EFFECT OF PHASE DISTORTION

Overall phase characteristics of the above-mentioned u-h-f relay circuit were taken as shown in Figure 13. Figure 13-a is an enlargement of the low frequency end, below 3,000 cycles,

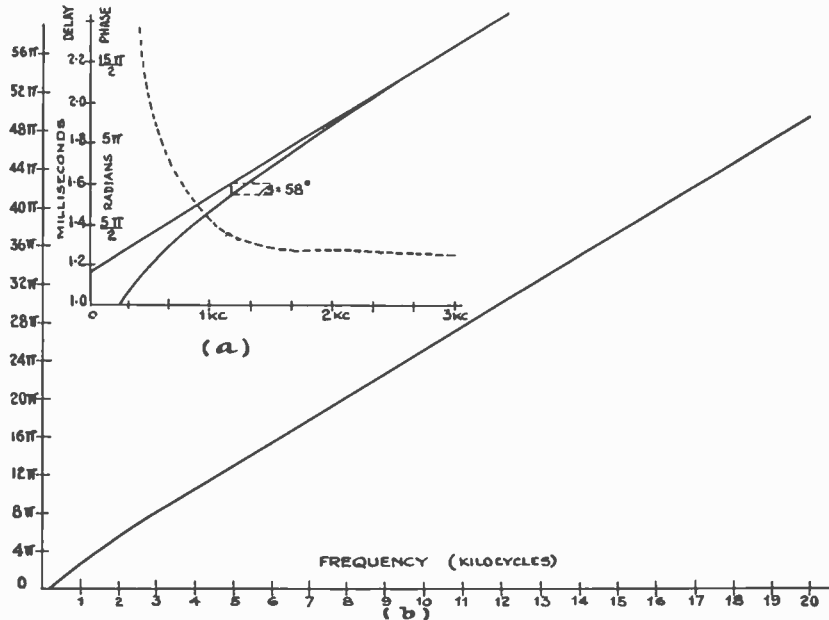

Fig. 13—Phase and delay characteristics.

and gives both the phase shift and the delay characteristics. Figures 14-a and 14-b show the effect of passing square impulses or "reversals" of about 700 cycles over the circuit. Figures 15-a and 15-b show the effect for 1,200-cycle reversals.

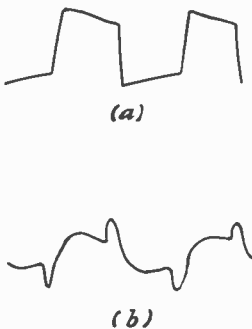

Fig. 14—Direct modulation of trapezoidal dots transmitted over 190-mile u-h-f relay circuit. $f_s = 693$ dots per sec. (a) Input. (b) Output.

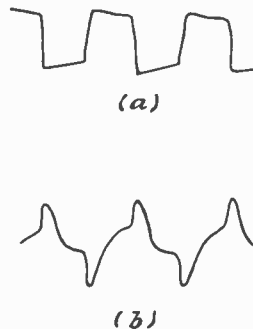

Fig. 15—Direct modulation of trapezoidal wave transmitted over 190-mile u-h-f relay circuit. $f_s = 1200$ dots per sec. (a) Input. (b) Output.

For the case of 1,200 cycles it is seen from Figure 13-a that there is a phase-delay distortion of the 1,200-cycle fundamental of some 58 degrees with respect to the undistorted phases of the harmonic components of the input wave. That distortion of the wave as indicated in Figure 13-a is almost entirely accounted for by phase distortion is shown in Figure 16. In this case the known trapezoidal input wave has had the fundamental frequency delayed by 58 degrees and then recombined with the remaining components. The resultant wave shape corresponds closely to that of Figure 15-b.

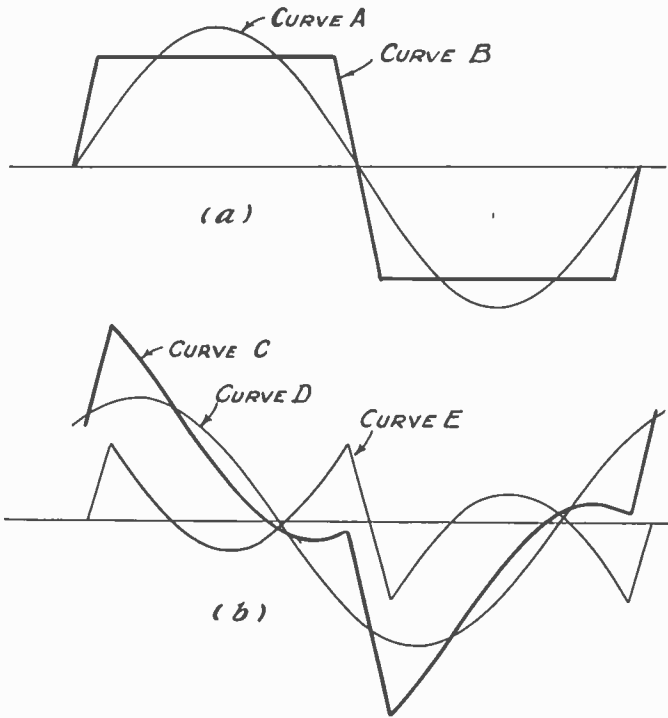

Fig. 16—Effect of shifting phase of fundamental component of trapezoidal wave by 58° with respect to other components. A = Fundamental. B = Original wave. E = other components = $B - A$. D = A delayed by 58° . C = Phase distorted wave = $D + E$.

EFFECT OF APERTURE DISTORTION

Figure 9-b shows the build-up and decay times of a rectangular envelope tone signal of full 100 per cent modulation. These times are determined by the effective pass band of the filter, which in this case is essentially 600 cycles. Figure 9-a shows the build-up and decay times of a signal produced from a sharp, black block due to finite aperture distortion of the optical system of the transmitting facsimile scanner. This aperture had an effective width of 0.006 inch.

Comparison of these two figures shows the close similarity of the signals and bears out the contention that it is uneconomic to provide a transmission circuit whose effective band width is greater than that required by the fundamental frequency indicated by the build-up and decay times of the aperture distortion.

There is, of course, a certain maximum aperture distortion (or width) which will satisfactorily handle the finest detail required. It is often assumed in commercial practice that the usual Elite office typewriter type size is the smallest which must be reproduced with full apparent fidelity. In this type the horizontal width of the vertical stems of letters such as I, t or l measure about 0.008 inch and it has been found that an aperture width of 0.006 inch is entirely satisfactory. A recording of such a condition is shown in Figure 5.

SIGNAL-TO-NOISE TESTS

Figure 10 shows the effect of random noise when the average noise frequency is comparable to the keying rate. The signal contrast ratio for black to white is 8 db. Pictures (a) and (b) were made with a maximum signal-to-noise ratio of 6 db. Similarly (c) and (d) have the ratio of 12 db. It will be noted that the duration of the noise is considerably reduced since only the sharp noise peaks are rising above the minimum signal threshold. Pictures (e) and (f) for the ratio of 18 db verify the theoretical expectations described above. Very little noise effects are visible.

Figure 11 shows the effect of periodic noise for the same signal-to-noise ratios. The noise consists of ten per cent dots having a recurrent frequency of 250 cycles per second. This low frequency does not appear at first glance to be as objectionable as the higher-frequency random noise. A close study of the small type, however, indicates the same S/N requirements. Periodic noise is generally more noticeable in large half-tone pictures particularly in the middle grey regions.

CONCLUSION

The preceding discussion and presentation of experimental evidence indicates clearly the fact that adequate transmission of facsimile signals imposes much more rigid requirements on the communication circuits than does sound transmission. These requirements are even more rigid than is necessary for television transmission at speeds requiring the same frequency band. This is because facsimile creates a permanent record which is studied at relative leisure by the recipient whereas television and sound are merely transitory reproductions.

BIBLIOGRAPHY

¹ Smith, Trevor and Carter, "Selective Side-Band versus Double Side-Band Transmission of Telegraph and Facsimile Signals," *RCA Review*, Oct. 1938.

² Callahan, Whitaker and Shore, "Photoradio Apparatus and Operating Technique Improvements," *Proc. I.R.E.* Dec. 1935.

³ C. E. Lane, "Phase Distortion in Telephone Apparatus," *B.S.T.J.* July 1930.

⁴ V. D. Landon, "A Study of Noise Characteristics," *Proc. I.R.E.* Nov. 1936.

THE NEW YORK-PHILADELPHIA ULTRA-HIGH FREQUENCY FACSIMILE-RELAY SYSTEM

By

H. H. BEVERAGE

Chief Research Engineer, R. C. A. Communications, Inc.

S F. B. MORSE demonstrated his new telegraph system just 100 years ago, thereby making available to the world its first medium for rapid communication over comparatively long distances. It is a tribute to Morse that his teachings, with relatively minor modifications in principle, were used almost exclusively in the art of record communication until comparatively recently. While Morse's telegraph is still very widely used, it is gradually being supplanted by automatic printers for record communication over radio circuits as well as over wire lines and cable circuits.

The printer, as well as the telegraph, is generally limited in its operating speed due to the fact that operators must be used somewhere in the system. A message handed in for transmission must undergo some manual operation to prepare it for transmission. This may be the perforation of tape, the operation of a printer keyboard, or the manipulation of a telegraph key. Whatever this operation may be, the human element usually limits the speed per channel to about 40 or 50 words per minute.

Many years ago, Mr. Owen D. Young called attention to the desirability of removing this limitation.¹ Facsimile methods seemed to offer a promising solution to this problem. From a purely operating standpoint there should be no limit to the speed at which words can be handled since the customer's message may be directly scanned at the transmitting end and the reproduction at the receiving end may be delivered to the addressee.

For many years, experiments have been in progress to apply facsimile methods to long distance radio circuits. It has been found that facsimile may be applied to these circuits very successfully for handling photographs, sketches, and similar material at relatively low speeds. However, since the signals on long distance radio circuits are propagated by reflections from the conducting layers of the ionosphere, the signals arrive over mul-

¹"Transmission and Reception of Photodiagrams," R. H. Ranger, *Proc. I.R.E.*, April 1926.

Reprint from *RCA Review*, July, 1936.

tiple paths differing slightly in length. The result is that the signals traveling by the different paths arrive at the receiver at slightly different times, thereby producing an echo effect that smudges the received facsimile copy if the speed of transmission is too high. For average transmission conditions on long distance radio circuits, as normally operated, the multipath echos limit the speed of message facsimile transmission to about 15 or 20 words per minute, which is considerably lower than the limiting speed set by the manual operation inherent with the telegraph and printer.

Frequencies above about 30 megacycles exhibit different characteristics than those below 30 megacycles. The very high frequencies are not turned back to earth by the ionosphere, so sky waves are absent. Propagation takes place by ground wave only, so there is fundamentally only one path for the signals to follow and there are no echo effects due to multiple path transmission. For this reason the very high frequencies may be used for such services as television and high speed facsimile. However, the ground wave is attenuated rapidly beyond the horizon and also fading sets in at distances appreciably greater than the optical path distance. The attenuation beyond the horizon increases as the frequency is increased. Consequently, for the very high frequencies, the distance for high quality service is practically limited to the optical range. It is obvious that the range can be increased by placing the transmitting and receiving antennas at the highest possible elevations. In fact, the distance of transmission is generally proportional to the square root of the respective antenna elevations, and the field intensity at a given point within the optical distance is directly proportional to the product of the transmitting and receiving antenna elevations.

Several years ago, the Radio Corporation of America set up an ultra high frequency relay station at Arney's Mount, near Mount Holly, N. J.² At Arney's Mount, 41 Mc television signals from the Empire State Building, 63 miles away, were picked up and retransmitted to the RCA Victor plant at Camden, N. J., 23 miles away, on a frequency of 79 Mc. Directive antennas were used at Arney's Mount for reception as well as for transmission. The 120-line television picture, used at that time, was clearly and reliably received at Camden during test schedules over a period of several months.

² "An Experimental Television System," C. J. Young, *Proc. I.R.E.*, November 1934.

This one way television relay demonstrated the practicability of automatically relaying wide band transmissions. R.C.A. Communications undertook to develop a two way wide band relay system to determine its possibilities for handling traffic between

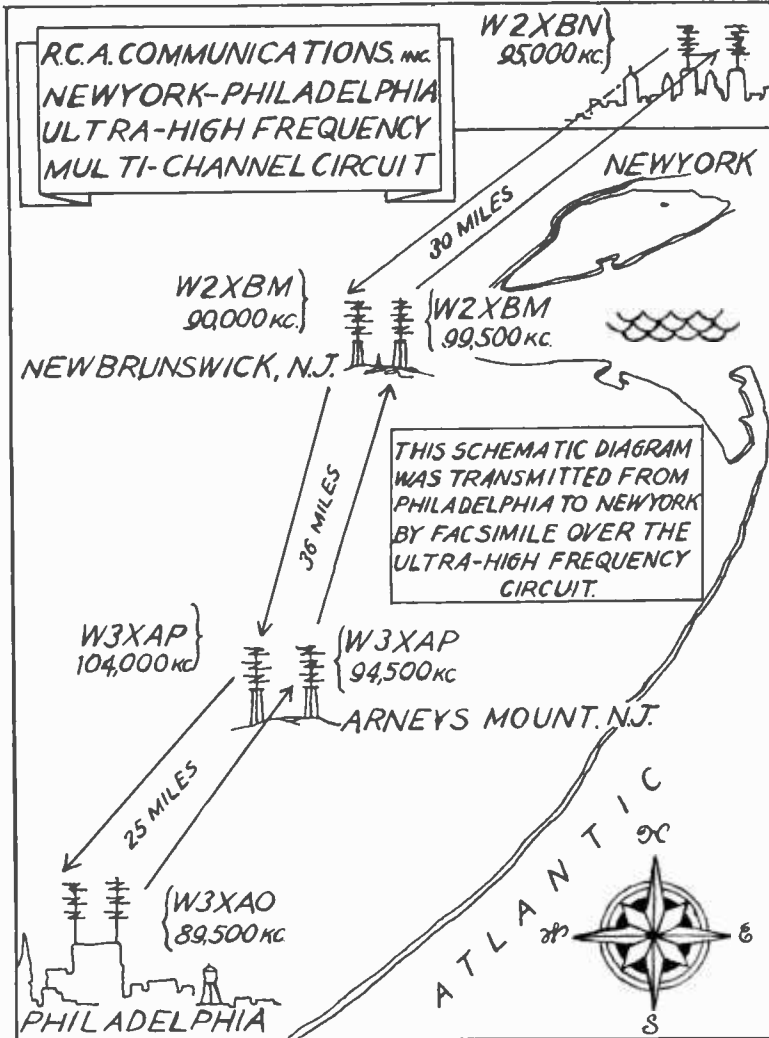

Fig. 1—Pictorial diagram of the New York-Philadelphia ultra high frequency relay system.

New York and Philadelphia, particularly for facsimile methods. This relay system is now in operation.

It was decided to use frequencies above 85 Mc to avoid conflict with probable future television assignments. Since these

high frequencies attenuate very rapidly beyond the horizon, a survey indicated the necessity for adding a second relay point at New Brunswick, N. J., in addition to a relay at Arney's Mount. A relay near the New York end was also required in order to lay down a strong enough signal in New York City to ride well above the high noise level experienced in urban areas. Fig. 1 shows the general arrangement of the relay stations.

It will be noted that at each relay point there are two receivers and two transmitters, one for the North bound relay and the other for the South bound relay. For economy, it was desirable to locate the North and South bound equipment, both transmit-

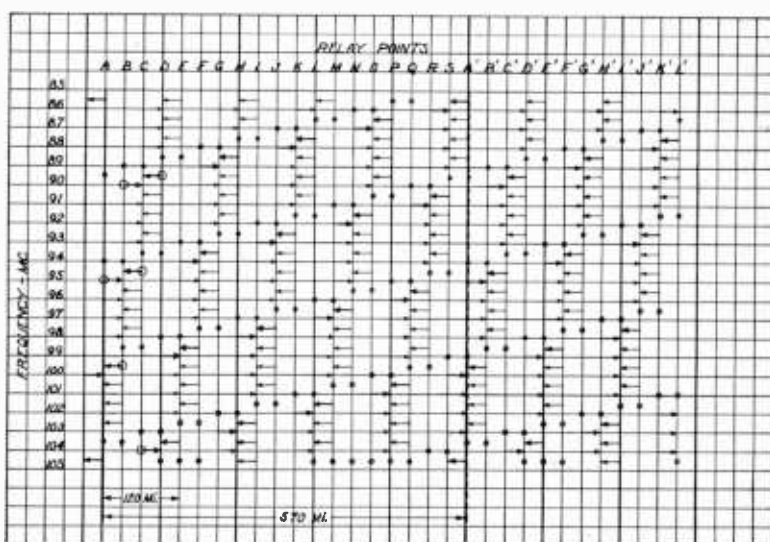

Fig. 2—Allocation plan for ultra high frequency relay system.

ters and receivers, in the same building. It was also desirable to be able to locate the receiving and transmitting antennas in close proximity. This requirement introduced some special problems to avoid cross talk between the transmitters and to keep either transmitter from interfering with either receiver. To avoid any possibility of cross talk between the transmitters, without excessive precautions, frequency differences on the order of 10% were considered necessary. To avoid interference in the receivers, it was desirable that the received frequencies be about 5% from either transmitter frequency. It was also desirable to lay out the frequency allocation plan in such a way as to provide for future extension of the relaying system in several directions from a given city.

A typical allocation plan is shown in Fig. 2. It will be noted that the received frequencies at a given relay point are separated by 0.5 Mc. One transmitter is 4.5 Mc higher in frequency than the nearest received frequency, while the second transmitter is 4.5 Mc lower than the nearest received frequency. The adjacent transmitter frequencies differ by 9.5 Mc. This meets the specification set up for avoiding cross talk and interference, and makes it possible to mount transmitting antennas and receiving antennas on the same tower. By assigning every half megacycle in a 20-megacycle band, four two-way networks may be operated from any one point, plus two to four one-way circuits (depending upon whether these same frequencies are used for one-way service at an adjacent relay point). In any given network, with relays spaced 30 miles apart, on the average, any one frequency is not duplicated until a distance of 570 miles is reached. If all four networks are used out of a single given point, the frequencies will not be duplicated closer than 120 miles, which is believed to be sufficient to avoid interference when frequencies above 85 Mc are used. The arrows with circles, shown in Fig. 2, correspond to the frequency assignments actually used on the New York-Philadelphia circuit, as may be noted by comparing Figs. 1 and 2, bearing in mind that relay point A of Fig. 2 corresponds to New York, B to New Brunswick, C to Arney's Mount, and D to Philadelphia.

The receivers were specially designed to fit this allocation plan. Triple detection receivers were used with a first intermediate frequency of 30 Mc and a second intermediate frequency of 5.5 Mc. These particular frequencies were chosen so as to avoid spurious response at the frequencies appearing in the allocation plan. These spurious response points might be expected to occur at 4.5, 5, and 10 Mc below the received frequency, and at 4.5, 5, 10, 14, and 14.5 Mc above the received frequency. Triple detection was used in order to provide high discrimination against image response while at the same time providing adequate adjacent channel selectivity with reasonable provision for frequency drift. The frequency drift of the high frequency oscillator was controlled to close limits by utilizing the stabilizing characteristics of an adjustable low power factor resonator. Low power factor resonators were also utilized in the high frequency pre-selection circuits of the receiver. The receivers are provided with flat automatic gain control so that the receiver output delivered to the transmitter modulator is held within

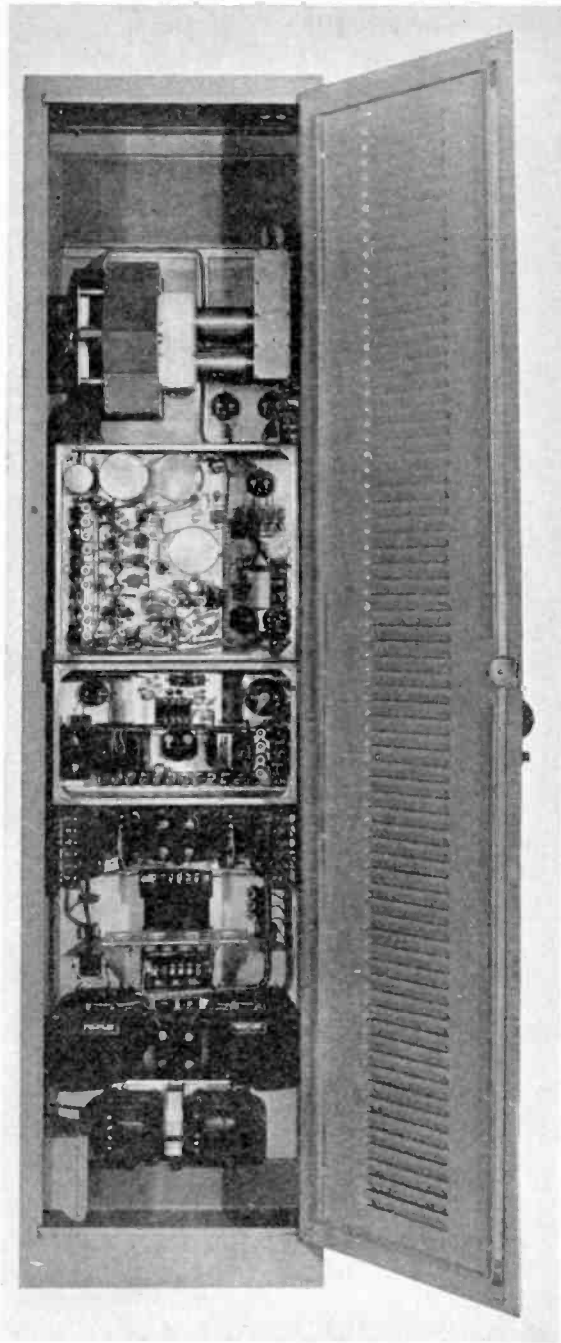

Fig. 3—Rear view of a relay receiver.

close limits in spite of possible variations of the received signal due to fading, weather conditions, or variation in the transmitter power.



Fig. 4—Front view of a relay transmitter.

Fig. 3 is a photograph of one of the receivers showing the back of the receiver with the covers removed. The transmission line comes into the right side of the top compartment. The two horizontal pipes contain the low power factor resonators for providing r-f selectivity. The massive structure at the left center

of the upper compartment is the low power factor resonator which controls the h-f oscillator. The frequency is varied by screwing a plate in and out which varies the loading capacity of the resonator.

The oscillator utilizes an RCA 955 "Acorn" triode³ which is contained in the casing of the resonator. RCA 954 tetrodes are used in the 30 Mc i-f amplifier.

The frequency of the transmitters is held to close limits by resonant line circuits of the temperature compensated type.⁴ The master oscillator consists of two RCA 834 triodes which drive four RCA 834 triodes in the power amplifier. The maximum carrier power is approximately 100 watts, but ordinarily the transmitters are operated at about half power to increase the reliability of the transmitters at unattended stations.

Fig. 4 is a photograph of one of the relay transmitters. The resonant line control, master oscillator and power amplifier are located in the circular tank-like structure at the right. The panels at the left contain power supply, controls, and modulator.

Directive transmitting and receiving antennas are used. The transmitting antennas utilize a vertical array of horizontal dipoles with a similar array a quarter-wave behind for a reflector. The transmitting antennas at New York are located on the roof of the Continental Bank Building at 30 Broad Street. Fig. 5 is a photograph of these antennas. The horizontal dipoles are approximately half a wavelength long and are spaced vertically half a wavelength. No insulators are used to support the dipoles, as they can be conductively connected to the supporting structure because the center of the dipole is at zero r-f potential. It will be noted that the transmission line is reversed at alternate dipoles to allow for the 180 degree phase reversal in a half wave section of the line, thereby forcing all of the dipoles in the antenna to oscillate in phase. The reflector is adjusted in the same manner. Three of these antennas shown in Fig. 5 are directed on New Brunswick. One is for the South bound relay, and the other two are for other purposes. All three may be received at New Brunswick without interference. The fourth antenna is for experimental purposes, and is directed on Riverhead, Long Island.

³"Vacuum Tubes of Small Dimensions for Use at Extremely High Frequencies," B. J. Thompson and G. M. Rose, Jr., *Proc. I.R.E.*, December 1933.

⁴"Frequency Control by Low Power Factor Line Circuits," C. W. Hansell and P. S. Carter, *Proc. I.R.E.*, April 1936.

The receiving antenna for picking up the North bound signals from New Brunswick may be seen in the background of Fig. 5 on the roof of the City Bank-Farmers Trust Building. This antenna is a duplicate of the transmitting antennas.

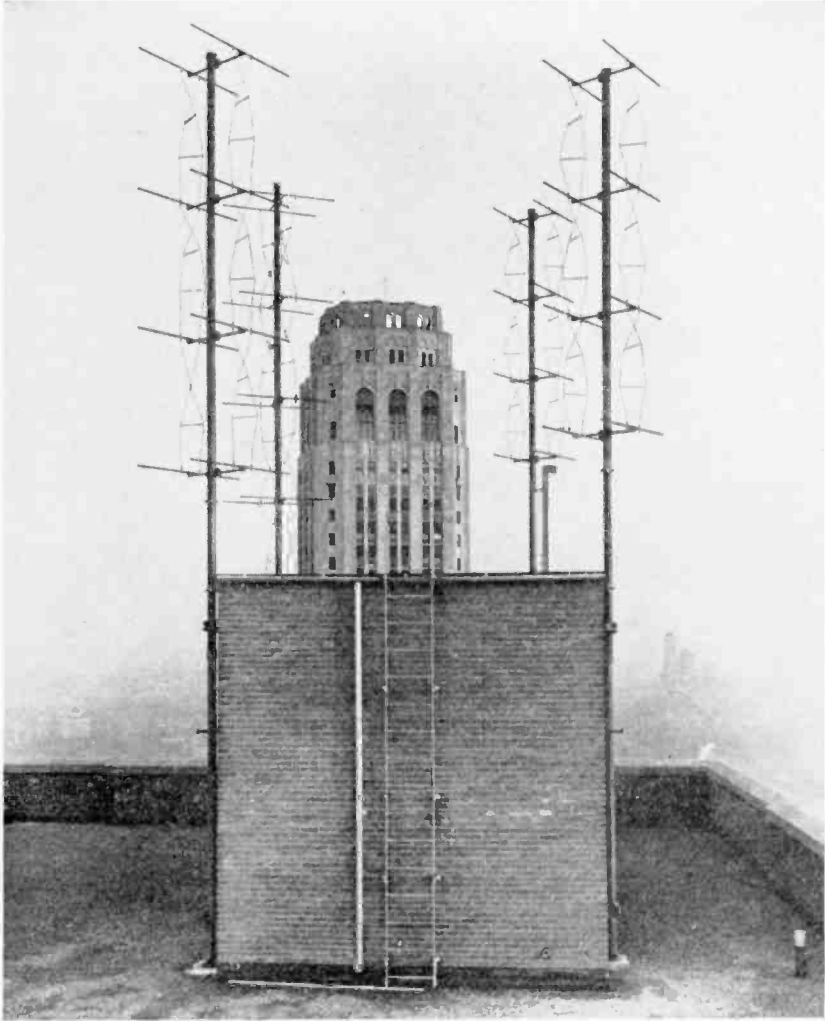

Fig. 5—The transmitting antennas at New York.

The gain of the antennas shown in Fig. 5 is about 10 db. At the relay points, the antennas are mounted on towers and seven dipoles are stacked vertically instead of four, so the gain of the antennas at the relay points is correspondingly greater. At New

Brunswick, the transmitting antennas and one of the receiving antennas are supported by a 225-foot tower on fairly level ground. At Arney's Mount, a 165-foot tower on a 220-foot hill serves the same purpose. It was necessary to use high receiving

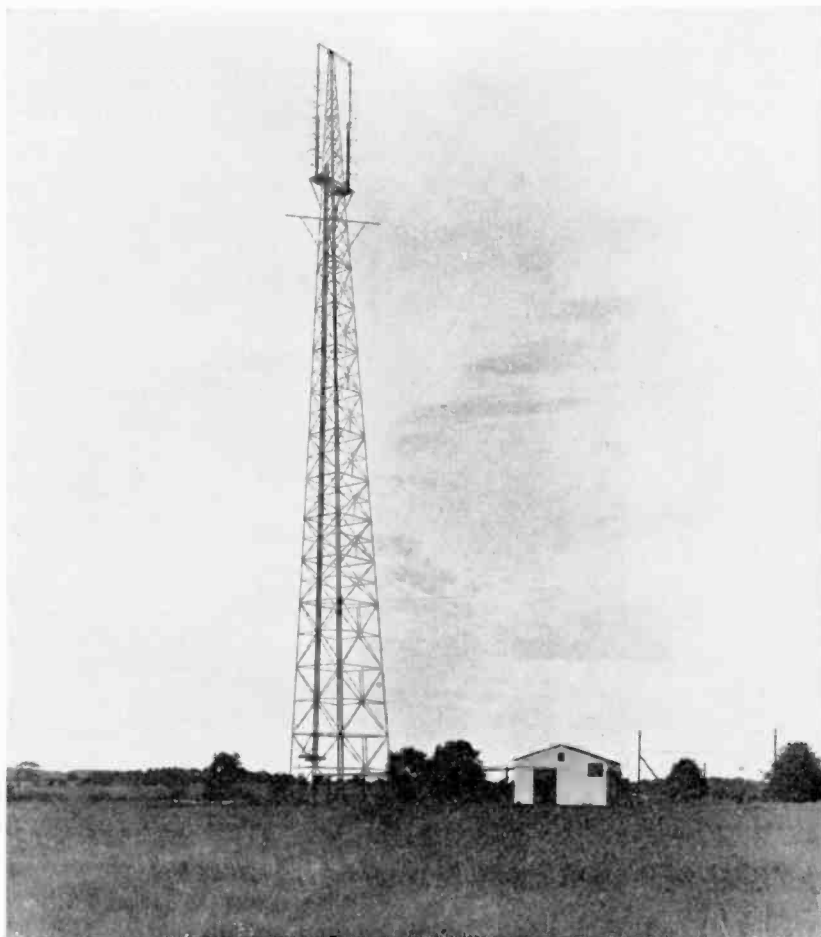

Fig. 6—Exterior view of the relay station at New Brunswick, N. J.

antennas on the New Brunswick-Arney's Mount link to obtain an approximately optical path, on account of an intervening hill.

Fig. 6 is a photograph of the relay building and 225-foot tower at New Brunswick. The two transmitting antennas are mounted at the top of the tower. The right hand antenna is directed on Arney's Mount, while the left hand one is directed on

New York. The horizontal diamond receiving antenna for receiving from Arney's Mount is supported from cross arms extending out from the tower. One of these cross arms may be seen just below the transmitting antennas. For receiving from New York, a large horizontal diamond antenna is used. This antenna is supported on wooden poles and is not visible in the photograph.

The transmitters and receivers at the relay points, and at Philadelphia, are located close together in the same building.

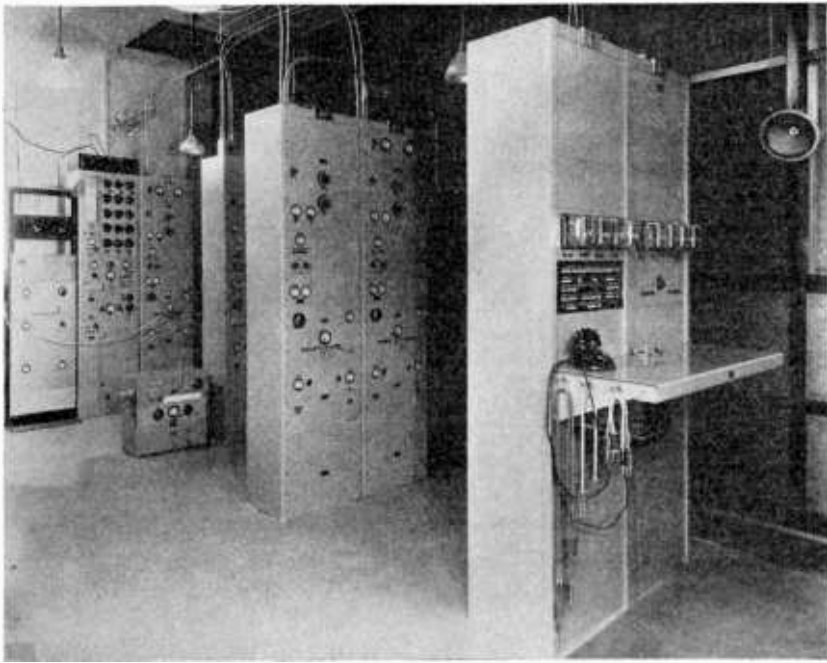

Fig. 7—Interior view of the relay station at New Brunswick, N. J.

The transmitter rooms are shielded from the receiver rooms in order to keep r-f potentials out of the control circuits and the receivers. All control lines passing from the receiver rooms to the transmitter rooms are carefully filtered against r-f potentials. Fig. 7 is a photograph of the interior of the New Brunswick relay station. The transmitters are in the shielded room at the right. The equipment in the foreground is used for monitoring and switching operations. The other racks contain the receivers for North and South bound circuits and three receivers for other purposes.

The transmission lines for the transmitters consist of two wires completely shielded the entire distance from the transmitters to the antennas. The receiver transmission lines consist of two concentric lines in parallel. Both types of lines are arranged to be balanced to ground, and all antennas are symmetrical with respect to earth. These precautions were taken in order to confine all r-f cross couplings to that existing between the antennas.

Fig. 8 is a schematic representation of the traffic office terminal equipment for one direction. Identical equipment is used for the opposite direction. The system is laid out to transmit, in

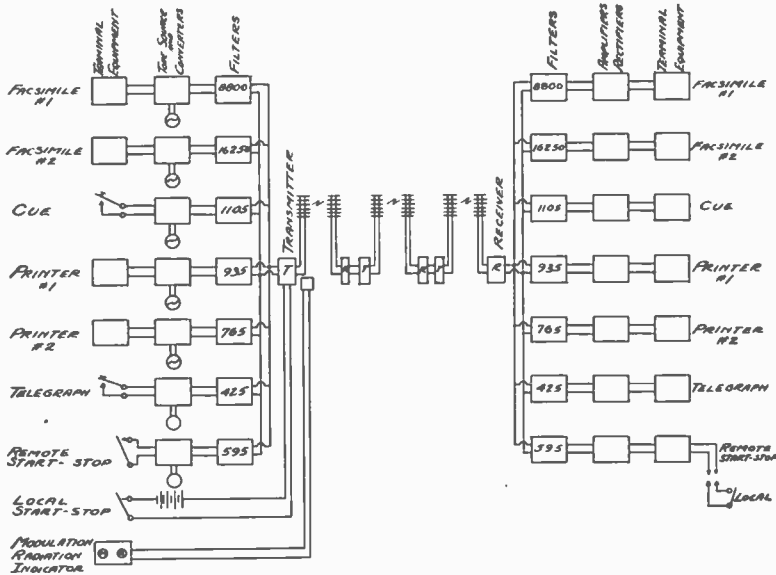

Fig. 8—Schematic diagram of terminal equipment for one direction. Duplicate equipment is used for the opposite direction.

each direction, two page facsimile channels, two printer channels, one telegraph channel, one cue channel, and a remote start-stop channel. The latter channel is for the purpose of controlling the transmitters at the remote relay points, as will be explained later. The cue channel is for the purpose of providing direct communication between the operators of the facsimile machines.

The transmitting terminal equipment at the left, in Fig. 8, controls separate sources of audio frequency by means of the converter circuits. The modulated tones pass through filters to a common line. The mid-frequency of the filter bands are indicated on the filters. The lower five filters are standard voice frequency carrier filters with an effective band width of about 80

cycles. These filters are wide enough to handle the printer, telegraph, and control channels. The two upper filters are special high pass and low pass types which are combined to pass an effective band of about 7500 cycles for each facsimile channel. The combined tones, occupying a total band width of about 20,000 cycles, are passed to the transmitter over a wire line. The transmitter is modulated about 80 percent by the combined tones. At the transmitter, a small portion of the r-f output is rectified and passed back to the central office over another wire line. Indicators are provided to show transmitter output and the percentage of modulation.

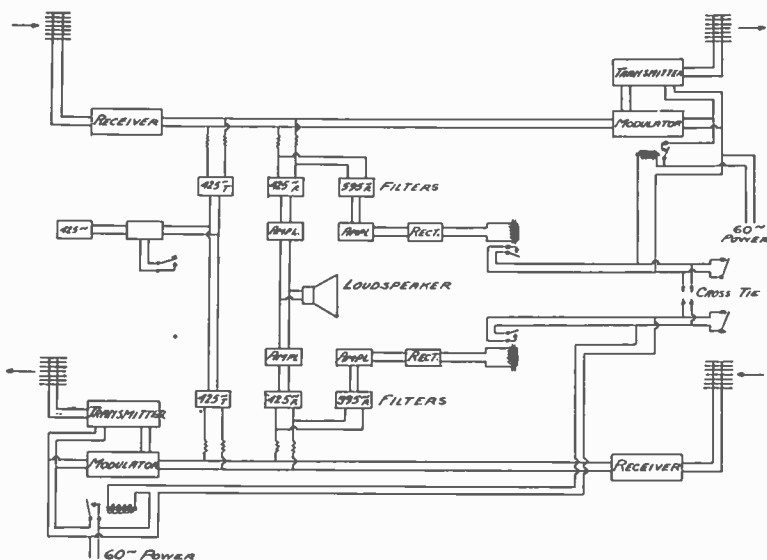

Fig. 9—Schematic diagram of a relay station.

The modulations are passed on to the distant terminal via the repeater stations. The output of the terminal receiver is passed through corresponding filters which separate the modulated tones into their respective channels. These tones are then amplified and rectified and the rectified currents operate the corresponding terminal receiving equipment.

The control equipment at the repeater stations is shown in Fig. 9. The receivers at all points operate continuously. Let us assume that New York wishes to start up the South bound relay. The New York transmitter is started by d-c control, as indicated in Fig. 8. As soon as the New York transmitter is on the air, this fact is indicated to the control point by the radiation indicator.

The remote start-stop switch is then closed, putting the 595-cycle tone on the line to the transmitter. This tone is picked up on the receiver at New Brunswick, and is passed through the 595-cycle

NEW YORK UNIVERSITY
OFFICE OF THE CHANCELLOR
WASHINGTON SQUARE, NEW YORK

11 June, 1936

My dear Mr. Wetherill:

It is eminently fitting that New York University, which cradled the theory and practice of electrical communications, and the Franklin Institute, the learned society which was the first outside of New York to appreciate their significance, should today join in recognizing this new and important centennial milestone in the translation of intelligence.

I am happy to have this opportunity to send heartiest greetings to you and to your organization over one of the channels of the new ultrahigh radio-frequency circuit for facsimile transmission.

This development is but another evidence of the great achievements which scientific effort is daily producing for the service of mankind.

Cordially yours,



Harry Woodburn Chase,
Chancellor

Mr. W. Chattin Wetherill, Vice President
The Franklin Institute
Philadelphia
Pennsylvania

Fig. 10—Facsimile specimen transmitted from New York to Philadelphia.

filter shown in Fig. 9. The tone is amplified and rectified. The rectified current operates a small relay, which, in turn, operates a large a-c relay that applies 60-cycle power to the transmitter and its modulator. Automatic time-delay relays turn on the plate

power after the filaments have warmed up sufficiently. As soon as the New Brunswick transmitter is on the air, it, in turn, transmits the 595-cycle tone on to Arney's Mount. As soon as the Arney's Mount transmitter is on the air, the tone is heard at

THE FRANKLIN INSTITUTE
OF THE CITY OF PHILADELPHIA
PHILADELPHIA

OFFICE OF THE PRESIDENT

June 11, 1936.

Dear Dr. Chase:

The Franklin Institute is particularly gratified to acknowledge the greetings of New York University on this the first public demonstration of the new Ultra-High Frequency Radio Circuit. Since 1824 The Franklin Institute has devoted itself to the promotion of science and the mechanic arts. It is, therefore, especially appropriate for us to join with New York University in appreciation of this new and important development.

A century ago, the Committee on Science and the Arts of The Franklin Institute in reporting on its examination of the Electro Magnetic Telegraph invented by Professor Samuel F. B. Morse stated in part:

"The committee beg to state their high gratification with the exhibition of Prof. Morse's telegraph, and their hope that means may be given to him to subject it to the test of an actual experiment made between stations at a considerable distance from each other."

Since that distant day, scientific research and a public appreciation of its contribution to human progress have made possible this epoch-making event in which we are participating today.

We send to you and your colleagues our kindest personal regards.

Cordially yours,

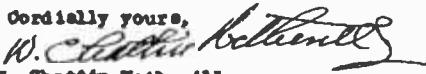
W. Chaffin Wetherill
Vice-President

To—
Dr. Harry Woodburn Chase
New York University
New York City

Fig. 11—Facsimile specimen transmitted from Philadelphia to New York.

Philadelphia. If desired, the tone can be tied back over the circuit at Philadelphia so that the North bound circuit can be automatically started in the same way. However, to save time, it is preferable to close the contacts marked "cross tie" in Fig. 9,

which causes the North and South bound transmitters at a given point to start up together. With this arrangement, either New York or Philadelphia can start the entire circuit with a minimum of delay. The circuit is shut down by removing the 595-cycle tone.

Although the circuit is unattended, it is desirable to provide communication at the relay points in order to assist the service man in checking up the circuit when he inspects the relay stations or is called out to correct some difficulty. Fig. 9 shows the communication arrangements. The general telegraph channel uses a carrier frequency of 425 cycles. Each of the relay points are provided with a 425-cycle oscillator and a keying converter. The output of the converter is connected to both the North and South bound circuits through 425-cycle band pass filters so that the 425-cycle tone passes in both directions to the other relay points as well as to both terminal offices. If any other point on the circuit wishes to communicate with the service man, they can key their local 425-cycle source, which passes over the circuit, is amplified at the relay station, and is heard on the loud speaker. Any communication in either direction is heard on the loud speaker since it is associated with amplifiers on both sides of the circuit. Telegraph sounders are used at the terminal offices rather than loud speakers.

Means are provided for observing the modulation and checking the signal-to-noise ratios at the relay points as well as at the terminals.

The communication center at New Brunswick is provided with monitoring facilities by means of which the emissions of all transmitters in the relay system are observed, and their frequencies accurately measured.

The facsimile equipment uses carbon paper recorders developed by C. J. Young of the RCA Manufacturing Company. The present operating speed is about 8 square inches per minute for each channel. Sheets up to about 8½ by 10 inches can be handled by these machines.

The relay circuit has been in operation since December, 1935. The first public demonstration was given on June 11, 1936 to commemorate the hundredth anniversary of the demonstration of the electric telegraph by Samuel F. B. Morse. In 1836, Morse gave the first demonstration of his new instrument to his colleagues at New York University. He gave the next demonstration outside New York City before the membership of The Franklin Institute in Philadelphia.

Fig. 10 is a facsimile of a letter from Chancellor Chase of New York University to Vice President Wetherill of The Franklin Institute. This facsimile was transmitted from New York and received at Philadelphia on the occasion of the public demonstration. Fig. 11 is a facsimile of the reply from Mr. Wetherill to Dr. Chase which was transmitted from Philadelphia to New York. Fig. 12 is another facsimile specimen received over the



RECEIVED AT _____ STANDARD TIME

June 11, 1936.



Souvenir of the 100th Anniversary
of Morse's Electric Telegraph and
the first demonstration of RCA's
ultra-high frequency radio circuit
connecting New York and Philadelphia.

Fig. 12—Facsimile specimen showing black and white sketch of S. F. B. Morse.

circuit which demonstrates the potentialities of this method of transmission for handling black and white sketches. Incidentally, the diagram of Fig. 1 was transmitted over the circuit from Philadelphia to New York.

At the present time, the New York-Philadelphia relay circuit is in operation 16 hours per day. Commercial traffic is regularly handled in both directions on the printer channels. The facsimile channels are operated experimentally. No definite date has been set as yet for offering the facsimile service to the public.

THE DEVELOPMENT OF FACSIMILE SCANNING HEADS

BY

J. N. WHITAKER

Research Engineer, Central Office Engineering Laboratory, R.C.A. Communications, Inc.

AND

MAURICE ARTZT

Engineering Department, RCA Manufacturing Company, Inc., Camden, N. J.

INTRODUCTION

THE first step in the transmission of images by facsimile is the conversion of light densities into corresponding values of electrical energy. This is accomplished by causing the picture subject to be scanned by a tiny light beam, and by directing the reflection of the light beam to the cathode of a phototube. The resistance of the phototube varies inversely with the intensity of the light falling upon it. If a suitable battery and load resistor is connected in series with the tube, an IR drop will appear across the resistor, in direct proportion to the intensity of the light striking its cathode.

The IR drop across the resistor in the above circuit may be amplified in the conventional manner, or may be utilized to amplitude-modulate a sub-carrier tone. The means for producing the light beam, together with a suitable optical system and the phototube with its associated electrical circuits constitute the scanning head. The output of the scanning head may be in the form of a variable direct current or a modulated carrier wave of either high or low amplitude, depending upon the application involved.

In the usual commercial radiophoto installation, the modulated sub-carrier system is preferred. In such installations the scanning equipment is located on a convenient table or bench and the bulk of the associated vacuum tube equipment is placed in nearby racks. A low impedance line ordinarily connects the scanning head with the rack equipment.

At the present time there are two facsimile services offered by RCA, namely, the commercial radiophoto service and the sale

of experimental equipment for broadcast service. Each type presents its own problems which will be treated individually in this paper.

OPTICAL SYSTEMS

In facsimile scanning only a small area of the picture is presented to the phototube view at one time. This area is moved in the process of scanning until the entire picture has been covered. The function of the optical system is to illuminate this elemental area brightly, and gather as much of the reflected light as possible into the phototube. The pick-up must be limited by apertures to receive only the illuminated area desired.

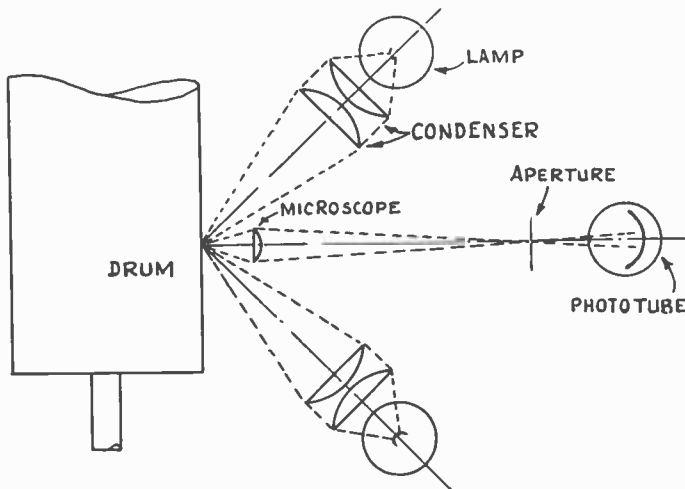

Fig. 1—Aperture in pickup of optical system.

This small scanning area is generally rectangular, having its long dimension equal to the width of one scanning line. Its short dimension is somewhat less, depending upon the allowable aperture-distortion picture-detail required, and other factors which are discussed later. If there are 125 scanning lines to the inch the effective rectangle will be $1/125$ inch or 0.008 inch long. The short dimension is 0.002 inch in the present broadcast scanner and 0.006 inch in the commercial radiophoto scanner.

There are two general types of optical systems used in facsimile. The first system (Figure 1), limits the area of scanning by an aperture at the phototube and the second (Figure 2), limits the area by the size of the spot projected on the picture. Theoretically, these two methods can be constructed to give

about equal light efficiencies, but a practical design of the second type has been found to be superior and is now utilized by RCA in both the broadcast and commercial facsimile systems.

As illustrated in the two figures, the first will project an enlarged image of the lamp filament on the drum while the second system will project the filament image at a reduced size (6 to 8 times demagnified). Thus, the intrinsic brilliance of the filament image of the second system will be about 12 to 24 times that of the first, if equal speed lenses are used. The pick-up system of the first is, however, more efficient than the second, which reduces this advantage considerably. The addition of a second lens system to the optical condenser of Figure 1 arranged to act as a projector would reduce the filament image in size and increase the efficiency. At present, the pick-up microscope of

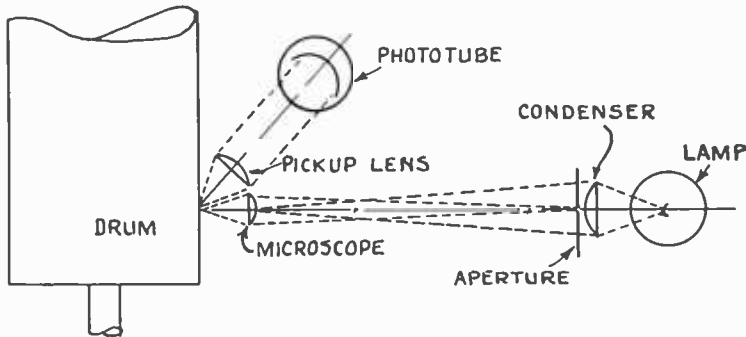

Fig. 2—Aperture in projector of optical system.

System 1 and the projector microscope of System 2 are highly corrected fast lenses. The addition of another fast lens to System 1 throws the economic balance in favor of the projector type system of Figure 2.

Even with the more efficient optical arrangement the amount of light the phototube receives is very small. The present broadcast scanner optical system uses an aperture 0.064 inch by 0.016 inch at the condenser and this is demagnified to 0.008 inch by 0.002 inch on the picture. This width is narrower than necessary for the detail required, but later processing of the signal effectively increases this to about the equivalent of a 0.008 inch by 0.004 inch area. In the commercial radiophoto system, the aperture width is increased by 0.032 inch thus providing illumination over an area 0.008 inch by 0.006 inch on the picture subject. Otherwise the optical arrangements are identical for both services.

With a 75-watt exciter lamp only 0.002 lumens of light are received by the phototube. With a sensitive tube such as the RCA-868, 0.1 microampere current will be obtained with this illumination, and if a 10 megohm load resistor is used as the phototube load about one volt of output signal will be developed.

The choice of available lamps for this service is limited. The requirements are high intensity, very low hum or flicker (if excited by a-c currents), reasonably long life and ease of replacement without disturbing the optical adjustments. These requirements are satisfied by a high-current low-voltage prefocussed-tungsten filament lamp. A heavy filament with high thermal inertia reduces hum with a-c operation to a low value. The filament location with respect to the lamp base is sufficiently accurate to allow changing lamps without readjustment. The life of this lamp at its rated power dissipation (7.5 amperes and 10 volts) is about 100 hours in normal facsimile operation.

PHOTOTUBES

A wide choice of phototubes is now available. All are of the caesium type and have a satisfactory response from the sensitivity standpoint. Those with gas amplification such as the RCA-918 and RCA-868 are most satisfactory at the present speeds. In higher speed work it is quite possible that gas amplification cannot be used due to attenuation of the higher frequencies, but that limit has not yet been reached.

The 868 and 918 phototubes are similar in physical dimensions and voltage ratings. There is an appreciable difference in their spectral responses and their sensitivity to illumination supplied by a standard Mazda lamp source. The 917 phototube is of the high vacuum type and has a sensitivity of 20 microamperes per lumen. The spectral sensitivity is, in general, comparable to that of the 918 phototube.

Where a Mazda projection lamp operated at a filament color temperature of 2870 degrees Kelvin is used as the light source, the sensitivity of the 868 phototube is 50 microamperes per lumen at 1000 cycles. The gas amplification factor is not over 7. The sensitivity of the 918 phototube under the same conditions is 102 microamperes per lumen with a gas amplification factor of not over 10. The spectral sensitivity of these two types is shown in Figure 3.

An important development now under way is the improvement of the phototube color response. This is not being done

from the viewpoint of obtaining color recordings (although this is an interesting possibility), but with the purpose that the commercial facsimile service must handle almost any type of copy presented by the customer. With the phototubes commercially available this is now impossible, for almost invariably the cus-

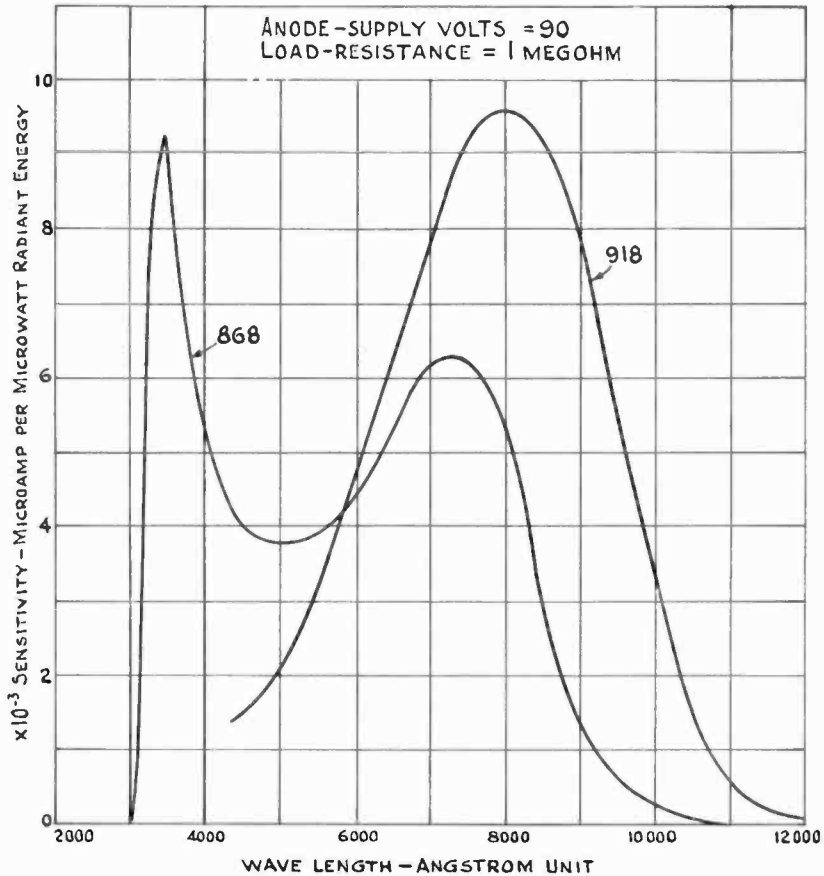

Fig. 3—Spectral sensitivity characteristics.

tomers' original will have some colors present in addition to black. This may be in the form of a written signature in green or blue ink, colored type, or red printing in the letterhead.

With the caesium tube all colors with the exception of dark blues will be transmitted as white. This is shown in Figure 4 where it may be seen that the response to colored copy is about the same as for white with the exception of the blue and violet blue colors. All colors on the copy are therefore to be avoided,

and the original should preferably be in black and white only for reliable results.

The curve with the Weston Cell and visual filter on this same figure shows the approximate eye response to the same colors, and is the phototube curve desired for colored copy to be translated into the proper eye value shade of grey. The third curve shows the response of a special rubidium phototube, which approaches the eye curve quite closely. Copy transmitted with this tube shows colors as different shades of grey, although the

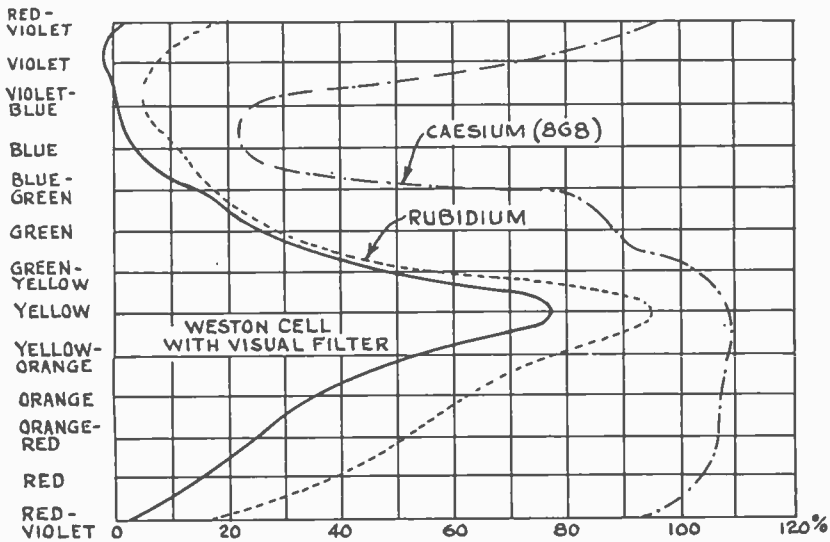

Fig. 4—Comparison of caesium and rubidium phototube with eye-color response.

response to red and orange is still about twice that desired. It will be recognized that this is very similar to the problem in photography leading to the development of panchromatic films. The curves in Figure 4 were obtained by using a set of color cards similar to paint sample cards. These gave all the data necessary for the early work and formed a much simpler test procedure than spectral analysis.

FREQUENCY SPECTRUM AND APERTURE DISTORTION

Before going into the development of the actual amplifier circuits it will be helpful to analyze the required frequency range of the amplifier. The most difficult requirement is that the amplifier characteristic includes zero frequency or d.c. This is necessary for it is quite possible to have pictures with borders, etc.,

requiring a number of scanning lines of substantially the same density. Omission of the lower frequencies and d-c component would badly distort such pictures. The upper frequency limit for a given speed of scanning is determined by the detail required which is directly related to the aperture width employed to obtain this detail.

The RCA broadcast facsimile system is based on 125 scanning lines per inch transmitted at 75 lines per minute and each line being a total of 8.75 inches long. To make the horizontal definition equal to the vertical the system should respond to vertical lines having the width of the scanning line, or 0.008 inch. A pattern of vertical lines each 0.008 inch wide and spaced 0.008 inch apart would then give the maximum number of keyed cycles

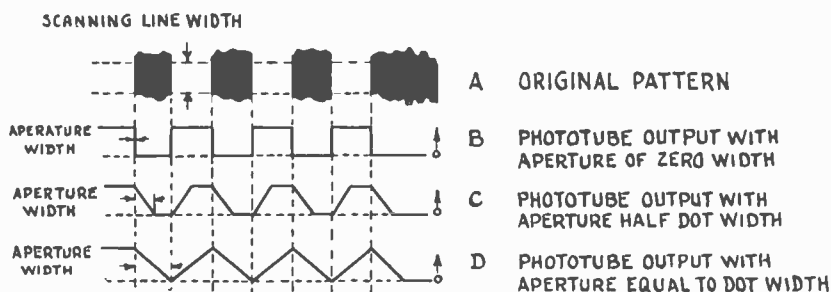

Fig. 5—Aperture distortion.

required. In this case the square cycle frequency would be $8.75/2$ (0.008) multiplied by $75/60$ or 683 square cycles per second. (See Figures 5A and 5B.)

In practice, the scanner output will be of trapezoidal rather than rectangular wave shape. The build-up and decay times of the trapezoidal envelope is determined by the aperture dimension in the direction of scanning. If the aperture is made one-half the dot width, an output wave such as shown in Figure 5C will be obtained. This particular wave shape consists primarily of a fundamental and third harmonic component. With this aperture size the highest signal frequency to be transmitted will be 683×3 or 2049 cycles. Going still further to an aperture width equal to the dot width gives the triangular wave shown in Figure 5D and it will be sufficient to transmit only the fundamental signal frequency. Even if the fifth harmonic of the fundamental is required completely to define the wave shape, the characteristic of the amplifier following the phototube need not include frequencies exceeding 3400 cycles.

Certain factors external to the scanner may also influence the choice of aperture dimensions. If black and white copy is to be transmitted, a narrow aperture may be used to sharpen the keying. It is also desirable to employ a narrow aperture in connection with special applications such as the "compensation amplifier" described in another section of this paper. When it is necessary to transmit the facsimile signal over a circuit having a limited frequency range, it is preferable to reduce the number of signal components by enlarging the aperture than to depend upon the circuit to attenuate these components.¹

AMPLIFIER CIRCUITS

It is probable that as many circuits have been devised for the facsimile phototube amplifier as for any other single application of vacuum tubes. The purpose has always been to obtain the necessary low frequency amplifier characteristic without having the "drift" and instability usually associated with a d-c amplifier. These circuits may be generally classified as follows:

- (1) Modulated light beam systems.
- (2) Modulated Oscillators.
- (3) Sensitive Modulation Systems.
- (4) Modulated Phototubes.

It will be noticed the final output of all of these systems will be an a-c carrier modulated in amplitude by the phototube current. This carrier frequency must be chosen in each case to carry the highest modulating picture frequency encountered without distortion, usually on the basis of at least two carrier cycles for each modulation cycle.

In the experimental broadcast equipment, where the picture modulation frequency may be as high as 683 cycles an audio frequency carrier of at least 1400 cycles should be employed. In the commercial radiophoto system where the picture modulation frequencies seldom exceed 300 cycles, a correspondingly lower carrier will be satisfactory.

MODULATED LIGHT BEAM SYSTEMS

In many of the earlier facsimile systems, a slotted disk was employed to interrupt the scanning light beam. These disks were driven at a constant speed usually by a synchronous motor. The phototube output was in the form of d-c pulses

¹ See the companion paper by Mathes and Smith, "Propagation Requirements for Facsimile." (Page 198).

having a frequency determined by the number of slots cut in the disk and the speed at which the disk rotated. The amplitude of the pulses depended upon the amount of light falling upon the phototube element. The tube output voltage was then amplified by means of a conventional high-gain audio-frequency amplifier. This arrangement proved quite satisfactory for relatively slow-speed facsimile systems, particularly where space requirements

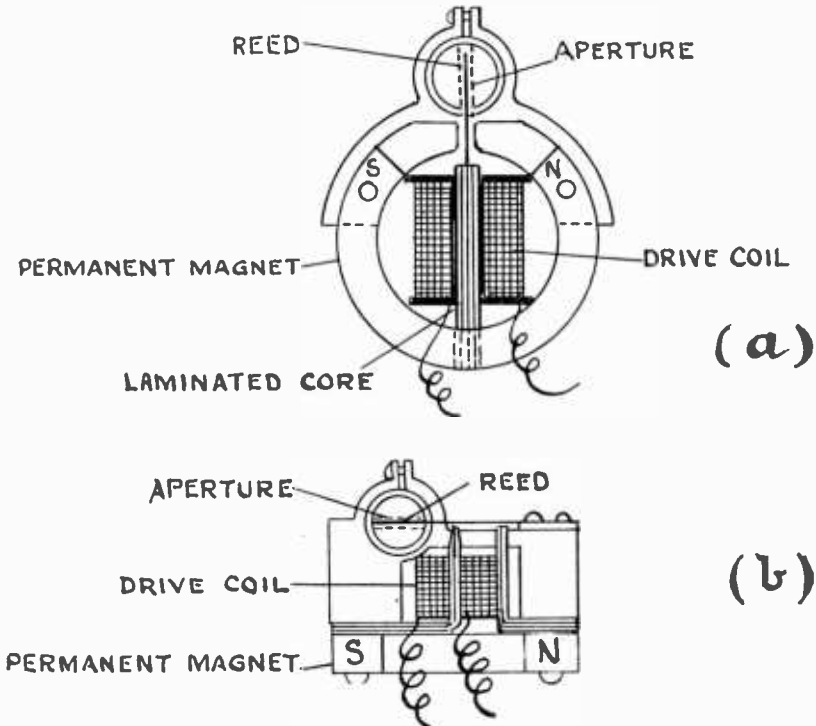

Fig. 6—Reed light valve.

were not important. It also had the advantage of linearity of output versus the phototube illumination.

As transmission speeds were increased and higher carrier frequencies were required, the physical dimensions of a suitable chopper disc grew in proportion. Moreover, mechanical inaccuracies and drive-speed variations were magnified to such a degree that the chopper disc method could no longer be considered.

One solution of this problem was the development of the reed light valve. In the course of its investigation, two types of reed-drive assemblies were found to be necessary if a frequency range above and below 1500 cycles was used. Figure 6 illustrates these

two arrangements. In this Figure, (a) and (b) are the drive assemblies for the high- and low-frequency reeds respectively. Both arrangements are designed to fit into the standard RCA optical system.

The light beam formed by the aperture is interrupted cyclically by the vibrating reed and focussed on the picture subject. The reed may be so positioned with respect to the aperture that the light beam will be interrupted either once or twice for each oscillation. With the former arrangement, the output frequency of the scanner will be the same as the vibration frequency of the reed and, with the latter, this frequency will be doubled. The major disadvantage to such an arrangement is that the

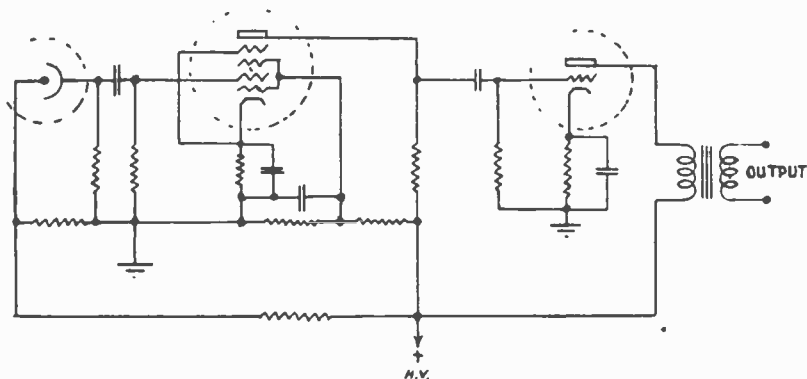

Fig. 7—A-C amplifier scanner.

output carrier frequency is fixed by the characteristic of the reed employed. Any change in this carrier frequency requires the use of a different reed. A conventional high-gain audio amplifier may be utilized with this type of scanner and merits no special comments here. A suitable amplifier circuit is shown schematically in Figure 7.

MODULATED OSCILLATORS

Many types of modulated oscillator circuits were investigated in conjunction with the facsimile scanning-head development. In general, these systems were not satisfactory. In order to obtain a usable percentage modulation with the available phototube output, it was necessary to operate the oscillator tube in an unstable condition. Amplitude modulation of the oscillator also produced some concurrent frequency modulation. This is a serious disadvantage in modern facsimile systems where frequency stability is of paramount importance.

SENSITIVE MODULATION SYSTEMS

While it was stated the present phototube output is approximately one volt across 10 megohms, the output was much less in the early facsimile tests, 0.05 volt being nearer to the value usually realized. Modulation systems which would produce a sufficient change in amplitude to be useful with this low-input voltage were necessarily rather unstable and difficult to adjust properly. Figure 8 illustrates the most sensitive of those used. Here the two screen grid tubes were connected in a bridge circuit with the carrier introduced on the two screens, and the plates connected in parallel. The control-grid bias was adjusted to a value very close to cut-off and any slight change in grid bias altered the effective screen to plate amplification. Under a con-

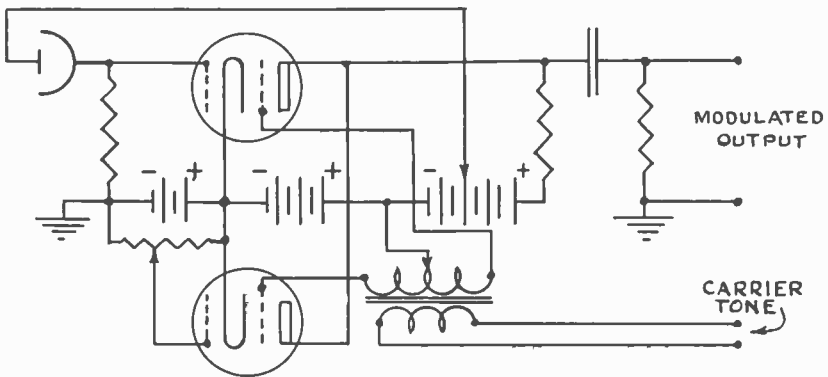

Fig. 8—Modulator bridge.

dition of no light to the phototube, the bias of the lower tube was adjusted to balance out the a.c. in the two plate circuits. A small amount of light to the phototube would then unbalance the bridge and the tone would appear in the output, varying in amplitude in accordance with the light variations. Due to the non-linear response of the tubes used, this output was not balanced as far as the d-c component or output-wave shape was concerned, and it was necessary to filter out the modulating frequencies.

The lower tube of the balanced unit was finally removed and the circuit of Figure 9 adopted. Later, to improve the contrast ratio of this single-ended modulator, the rectifier tube and an associated phase-correcting network were added. This balanced the output to zero at the low end and gave a high contrast of black to white signal. However, as with the circuit in Figure 8,

the one-sided modulator produced a distorted output carrier and the circuit still required filtering.

After the optical system had been improved to its present efficiency, sufficient phototube output was obtained to allow the

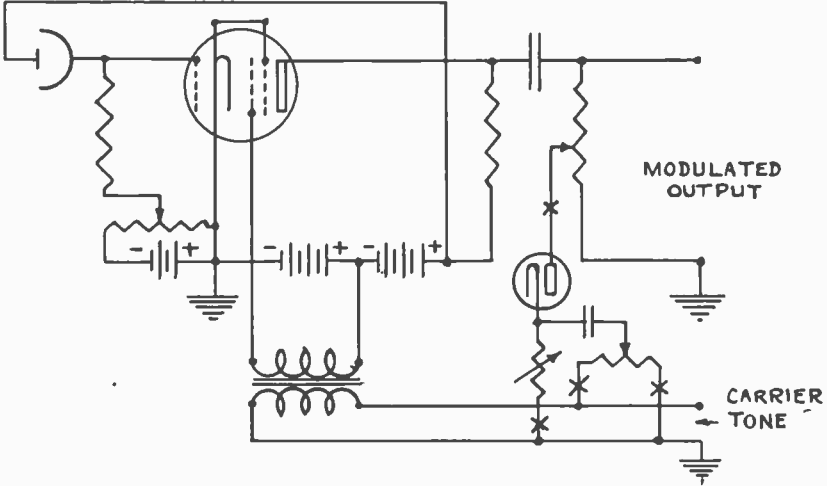

Fig. 9—Single-side modulator with rectified counter e.m.f. added.

use of a d-c amplifier before the modulator and still maintain stable operation. Figure 10 illustrates this modification. With a phototube output of one volt on white and a stable d-c amplifier with a gain of 10, a less sensitive modulator may be employed. A modulator of this type is more linear and produces less dis-

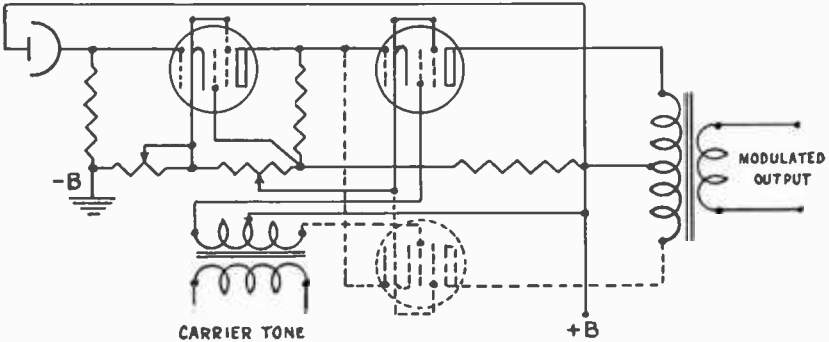

Fig. 10—D-C amplifier with single or push-pull modulator.

tortion than the more sensitive direct-modulating systems. For applications requiring a good output wave form, a balanced modulator is preferred, with the additional tube included as shown dotted in Figure 10. However, in certain cases, as in the present broadcast equipment, the second tube is unnecessary.

Subsequent processing of the signal from this modulator in a "compensating amplifier" makes the use of an extremely high-frequency carrier desirable. With this carrier (20 kc) adequate filtering of a one-sided modulator consists simply of an output transformer with very poor frequency response below 15 kc. The wave shape and linearity of the circuit is satisfactory under these conditions.

Before leaving the sensitive-modulator systems, two other types should be mentioned. One is shown in Figure 11. This arrangement amounts to an impedance commutation of the phototube output. Two commutator tubes are connected in a bridge network and are driven by a carrier tone from saturation to cut-off. Their plate impedances are therefore alternately zero

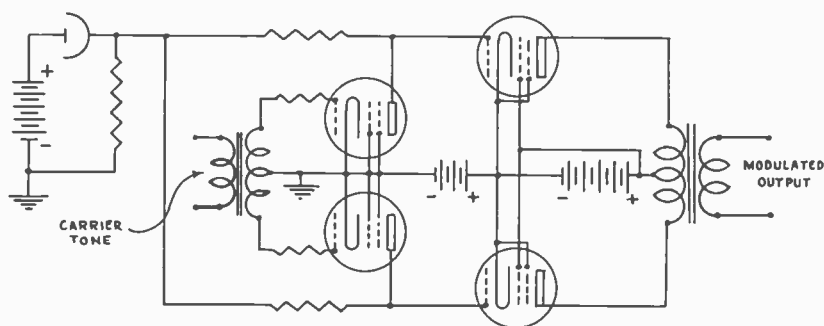

Fig. 11—Impedance commutation modulator.

and innity (relative to the series and shunt resistors) so that they alternately load the inputs of the succeeding push-pull stage. This action is equivalent to switching the phototube output between the two amplifier tubes. The output of this stage is a square wave modulated in amplitude by the amount of light to the phototube. The chief difficulty of this circuit is the high capacitance to ground offered by the large number of tubes and resistors connected across the phototube. This capacitance shunts out high modulation frequencies from the phototube output, and definitely limits the response of the system to lower transmission speeds than that required for most facsimile applications.

In another arrangement the phototube load resistor is replaced by a modulator tube as shown schematically in Figure 12 (controlled carrier scanner). With this set-up, the effective phototube load resistance is varied by the potential applied to the grid circuit of the modulator tube. The output wave form pro-

duced by this arrangement is quite sinusoidal and the modulation is linear with respect to the phototube output.

MODULATED PHOTOTUBES

Many attempts have been made to modulate the phototube plate supply at the desired carrier frequency. This may be done with fair success for carrier frequencies below 500 cycles. When higher frequencies are applied in this manner, however, the leakage due to phototube capacities becomes too great. This leakage may be neutralized, but doing so complicates the problem.

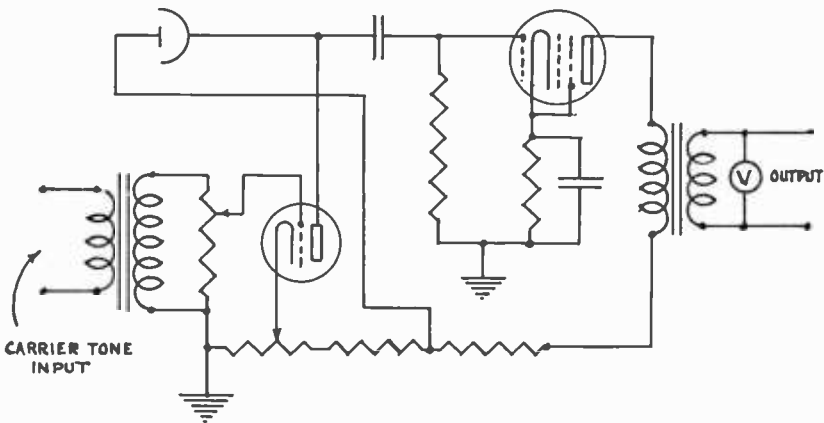

Fig. 12—Controlled carrier scanner.

SPECIAL SCANNER CIRCUITS

Some very interesting scanner circuits have been developed for special purposes. The non-linear tape-facsimile scanner and the dual channel systems for high-speed facsimile belong in this group. The non-linear system used in the tape-facsimile application is shown schematically in Figure 13. It consists of several cascaded stages of resistance-coupled amplification following the phototube. This amplifier is designed to have a flat response to frequencies between 20 and 500 cycles. The last stages of amplification act as limiters as well as amplifiers. The output of the limiter-amplifier is in the form of square pulses, which act upon the grid bias of a push-pull keyer. The resultant output is a keyed carrier tone of constant amplitude.

One feature of this system is its freedom from "drift" or variations of output due to power-supply voltage irregularities, aging of parts, etc. The steady current drawn by the phototube

may rise and fall slowly, but the output of the amplifier will be affected only by sudden changes in the phototube current such as may be caused by scanning dark lines on the tape subject.

DUAL-CHANNEL SYSTEM

The present gas phototube with a 10-megohm output resistor has adequate high-frequency response for slow-speed facsimile

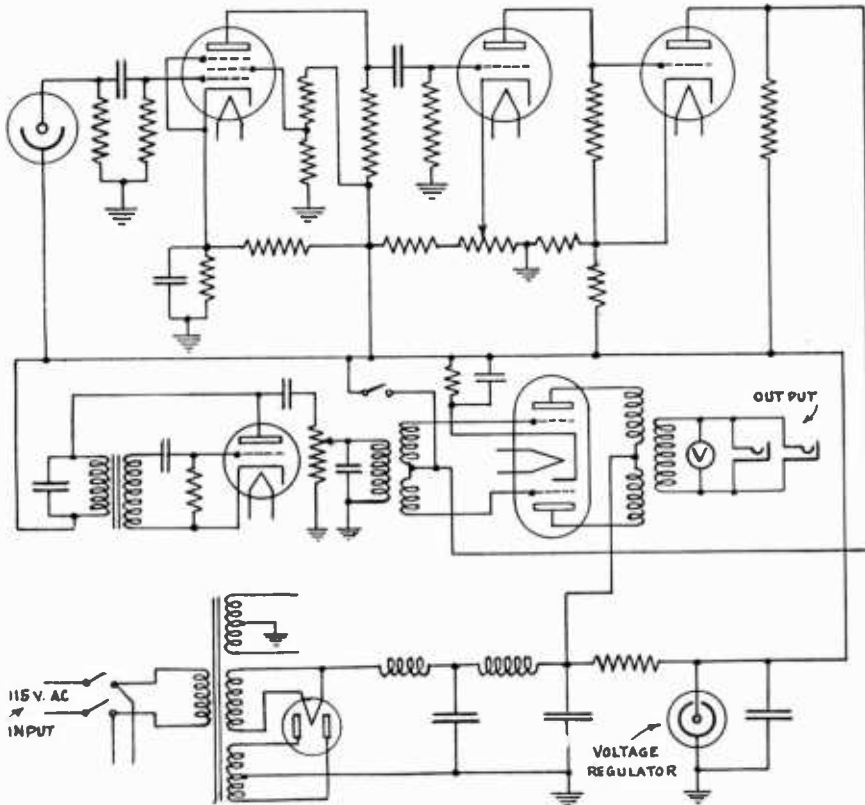

Fig. 13—Tape facsimile scanner.

uses, but sharpness of keying begins to fall off noticeably at fundamental keying frequencies above 1000 cycles. This is largely due to the shunting effect of the phototube and amplifier tube-input capacitances across the high-resistance load. It is desirable to retain the high-impedance load, for a reduction in this resistance value reduces the amplifier input in proportion. This lower input requires greater stability of the d-c amplifier than can be obtained conveniently.

The dual-channel system was devised to overcome this shunt capacitance by operating the phototube at an impedance that changes with frequency, the impedance being very high at the low frequencies and sufficiently low at the high frequencies to minimize the shunt-capacitance effect. The first circuit used is shown in Figure 14, and the characteristic curves are given in Figure 15.

The usual high value phototube resistor of 10 megohms or more is R_0 , (Figure 14), and is the impedance of the phototube load at d.c. and the very low frequencies. Two identical RC series combinations are shunted across this load, R_1C_1 and R_2C_2 , and connected in opposite phase. The low-frequency output is obtained across C_1 and the high-frequency output across R_2 . At high fre-

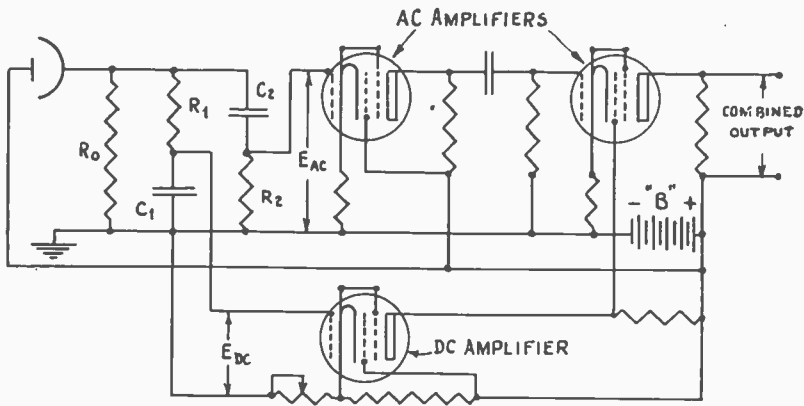

Fig. 14—Dual-channel amplifier system.

quencies, where the reactances of C_1 and C_2 are small compared to R_1 and R_2 , the effective phototube load impedance is $R_2/2$. This is usually chosen to be about 1 megohm, giving a ten-to-one reduction of capacitance shunt at high frequencies while retaining the high impedance and high output at low frequencies. These two outputs are then amplified separately, the high-frequency amplifier having 10 times the gain of the d-c amplifier, and are then recombined.

In this case the addition is not quite perfect, as shown in Figure 15, but varies from true addition without phase shift by a very small percentage at the lower frequencies. However, this phase angle never becomes greater than six degrees and the amplitude is less than 1 per cent in error in the 10-to-1 case shown here, and performance up to 10-kc keying speeds is satisfactory.

A second simplified method of accomplishing the same thing is shown in Figure 16. Here a single RC combination shunts the phototube load down at high frequencies, making the load impedance vary over a 10-to-1 ratio or even greater. The output

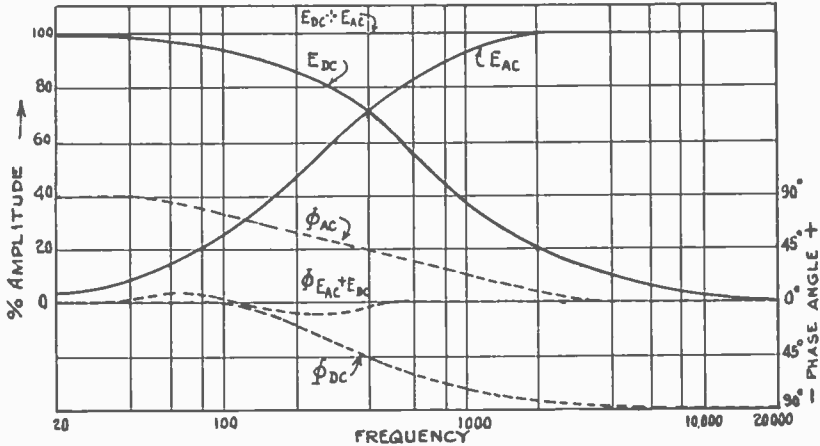

Fig. 15—Operation of dual-channel system.

circuit of this tube is arranged to have an opposite action on the effective tube gain. The plate load R_p is low enough, compared to R_3 , that variations in X_{c2} with frequency do not affect the tube load. Under these conditions the output voltage will

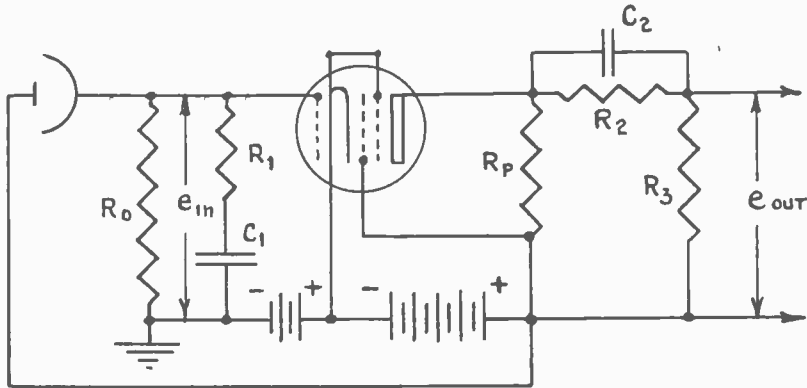

Fig. 16—Simplified dual-channel system.

be stepped down by the potentiometer effect of R_2R_3 at the d.c. and low frequencies, and becomes a greater percentage of the tube output as the frequency increases and C_2 drops in impedance. A proportionality between the ratios R_0/R_2 , R_1/R_3 and

C_2/C_1 can be found that will make the output voltage an exact multiple of the phototube current for all frequencies below that at which the shunt capacitance of the input circuit and phototube begins to have effect. If R_1 is made very small compared to R_o , this upper-frequency limit can be made much higher than any present facsimile-transmission requirement.

In use, the output of either of these circuits is applied to a push-pull modulator employing a high-carrier frequency to adequately carry the highest modulating frequencies. This modulator may be quite similar to that in Figure 10, with the dual-channel system replacing the d-c amplifier.

No attempts have been made to go beyond the frequency range of a gas phototube (about 10-kc), but by the use of a high-vacuum tube such as the RCA-917 or 919, the frequency range could be still further extended. With the lower response of the vacuum phototube, an arrangement such as the dual-channel system would be required in order to obtain the necessary low-frequency output voltage to permit the use of a stable d-c amplifier.

POWER-SUPPLY CONSIDERATIONS

The power supplied to all parts of the scanning head must be constant. Any appreciable variations will cause a corresponding variation in the scanner output, which in turn will cause streaks to appear in the recorded picture. The regulation of the power supplied to the light source and tube heaters presents the most difficult problem since this is a low-voltage high-current supply. Primary voltage regulators or floating storage-battery arrangements are generally desirable for this purpose. The plate voltage for the scanners may be satisfactorily controlled by means of glow tube regulators.

The sub-carrier tone input to the scanning head must be held at a constant amplitude and in the case of the commercial radio-photo installation, it is desirable to have this tone synchronized with the rotation of the scanning machine drum. This may be accomplished by means of a dynatron frequency-multiplier controlled by the standard 810-cycle synchronizing tone. This system has been described in a previous paper.²

² Callahan, Whitaker and Shore—"Photoradio Apparatus and Operating Technique Improvements," *Proc. I. R. E.*, Volume 23, Number 12, December, 1935.

MECHANICAL FEATURES

The space required by the scanning head inclusive of the optical system may be on the order of 0.2 cubic feet. All-metal chassis construction is used throughout to provide the necessary rigidity and convenient plug and jack connectors are employed to facilitate removal of the head for periodic inspection and servicing. Weight is also a consideration and small parts are used wherever possible.

INDICATED FUTURE DEVELOPMENTS

While the present scanning heads are adequate for facsimile keying speeds up to 1000 or 1500 cycles, anticipated future developments may exceed this limit. There are now known at least two practical methods of obtaining higher keying speeds without distortion. The first of these is the electron multiplier,³ which theoretically can be built to carry almost any frequency desired. Future development tending toward higher facsimile speeds will probably lead to the use of this very versatile tube. The second, on which some work has already been done, is a combination of the "dual-channel" system with a gas or high-vacuum phototube as discussed in a preceding section of this paper.

³ Zworykin, Morton and Malter—"The Secondary Emission Multiplier—A New Electronic Device," *Proc. I. R. E.*, Volume 24, Number 3, March, 1936.

APPLICATION OF AN ELECTRON MULTIPLIER TO THE PRODUCTION OF FACSIMILE TEST WAVE-FORMS*

BY

W. H. BLISS

Research Engineer, Central Office Engineering Laboratory, R.C.A. Communications, Inc.

INTRODUCTION

IN FACSIMILE development projects as well as in other branches of communication engineering there is the need for apparatus to produce or generate certain specialized types of voltage or current wave-forms for use in testing the various units or combinations of units that make up the equipment. Although an actual facsimile scanner operating on certain selected types of subject matter will produce these wave-forms, this method is not always practical or convenient. Furthermore, the characteristics of the scanner used may not be ideal and the output may be distorted. In studying the performance of modulators, detectors, filters, transmission circuits and recorders, a source of wave-forms simulating actual facsimile signals is highly desirable.

For any given transmission speed the two most important characteristics of the facsimile signal wave-forms are probably the maximum fundamental frequency and the aperture build-up time. Numerical examples showing how these are determined will be given in this paper. The maximum important frequency component is determined by the minimum degree of definition that is acceptable. The aperture build-up time is the length of time required for the scanning spot of light to cross any given line at right angles to the scanning direction. Since the light spot has a certain finite size and shape the aperture build-up time is a very definite quantity although it may be a small fraction of a second.

A photo-electric type, secondary emission, electron multiplier with a suitable light chopper and optical system makes a very

* This paper presents in part a thesis submitted for the degree of E.E. at Michigan State College, and is published in advance of receipt of the degree, by special permission.

good test apparatus for producing facsimile wave-forms. This system has two outstanding advantages. First, the multiplier output is great enough for most test purposes without using an amplifier, and second, the apparatus is highly flexible in regard to the production of various frequencies and aperture build-up times. These latter two quantities can be controlled independently or held in direct proportion.

A test system of this type has been set up in the Central Office Laboratory of R.C.A. Communications, Inc., and will now be described in detail. The accompanying Figure 1 illustrates a ten-stage secondary-emission multiplier of the photo-electric type. The construction, theory and operation of these vacuum tubes has been described in previous publications^{1,2}; however, a

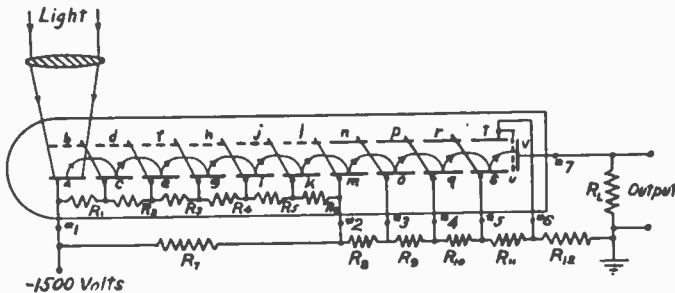

Fig. 1—A 10-stage electron multiplier circuit.

brief treatment will be given here to familiarize the reader with the magnetic type.

THEORY OF THE SECONDARY-EMISSION ELECTRON MULTIPLIER

The diagram of Figure 1 shows a typical arrangement of the external and internal circuit connections and also the relationship of the numerous tube elements. The electrodes are divided into two general groups—accelerating plates and emitters. Electrodes *b, d, f*, etc. belong to the former group and *a, c, e*, etc. to the latter. Electrode *v* is the collector and *u*, the screen. The normal operation of the tube requires the presence of a constant-intensity magnetic field whose lines of force must be mutually perpendicular to the electrostatic field lines and the axis of the tube.

The multiplying action produced is a result of the ratio of secondary-emission electrons to bombarding electrons on the emitters being greater than unity. Light, falling on the first

emitter *a*, releases electrons by photo-emission (the emitters are capable of photo-emission as well as secondary emission). These electrons are attracted by and accelerated toward electrode *b* which is at a higher potential than *a*. Except for the presence of the magnetic field the electrons would go to plate *b*; however,

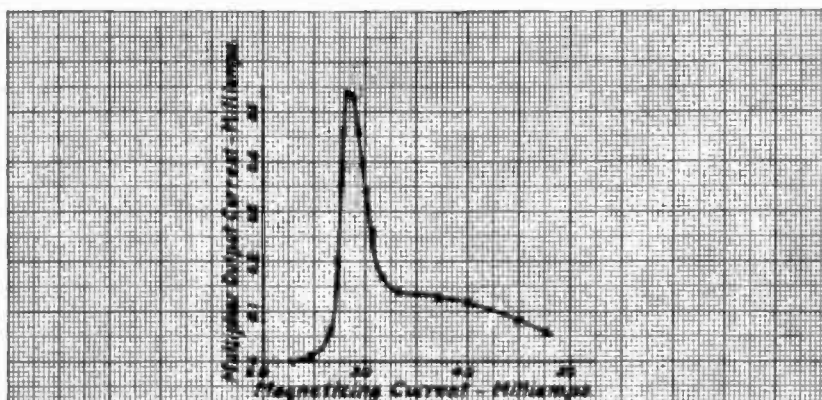

Fig. 2 Resonance Curve

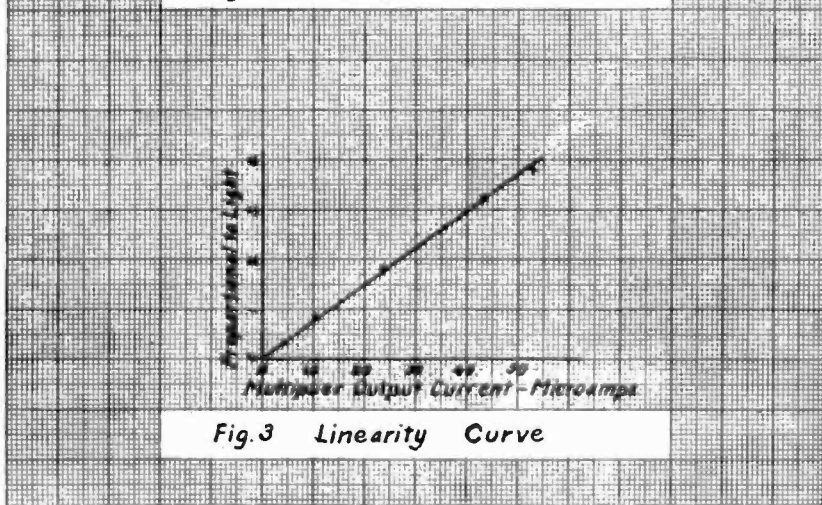

Fig. 3 Linearity Curve

the combined influence of the electrostatic and magnetic fields causes the electron path to be curved as shown in the sketch so that the electrons arrive at plate *c* which is at the same potential as *b*. The electron velocity at this bombarding point is sufficient to cause appreciable secondary emission.

A ratio of secondary electrons to primary electrons of 3 or more can readily be obtained in a 10-stage multiplier. The

increased number of electrons emitted by plate *c* is acted upon by the next accelerating electrode *d* and the magnetic field and then bombards plate *e*. In this manner the electron stream is built up or amplified as it passes down the tube to be finally collected on plate *v*.

The distribution of voltage on the numerous electrodes is accomplished by means of a tapped resistance bleeder. To avoid having too many terminals on the tube the bleeder resistors for the first few stages are mounted inside the tube envelope. The output current may be passed through a resistor R_L where an e.m.f. proportional to the light will be developed.

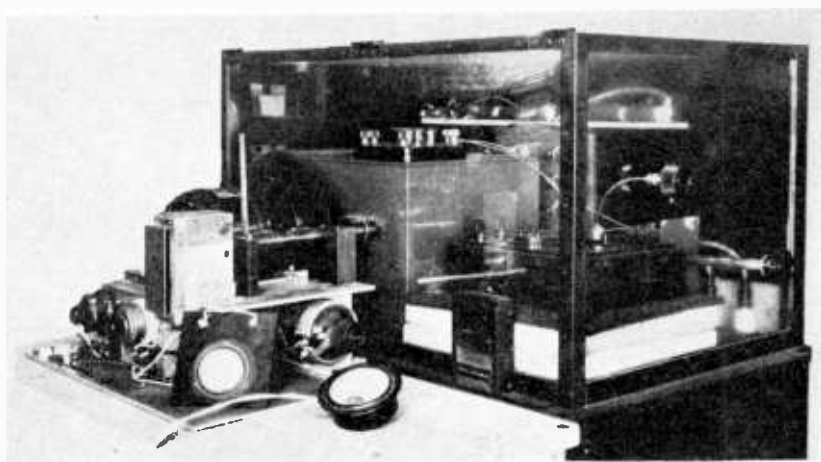

Fig. 4—General view of electron multiplier test apparatus.

Figures 2 and 3 are typical characteristic curves of the electron multiplier. Figure 2, the resonance curve, shows how the output current varies with the magnetic field strength. This was obtained with 130 volts per stage on the accelerating electrodes and 200 volts on the collector, making a total of 1500 volts. The pronounced peak of the curve indicates the necessity of the proper value of magnetic field strength for good electronic focussing. Figure 3 shows the linear relationship between the light falling on emitter *a* and the output current. This curve was made for a special purpose with very small values of light; hence the low output.

Figure 4 is a photograph of the complete apparatus exclusive of the 1500-volt d-c supply. On the left is the light chopper and optical system which is shown more in detail in Figure 5.

The multiplier tube is located within the light-proof inner chamber in the center of the picture. The output milliammeter is to the right and the bank of bleeder resistors is behind the tube

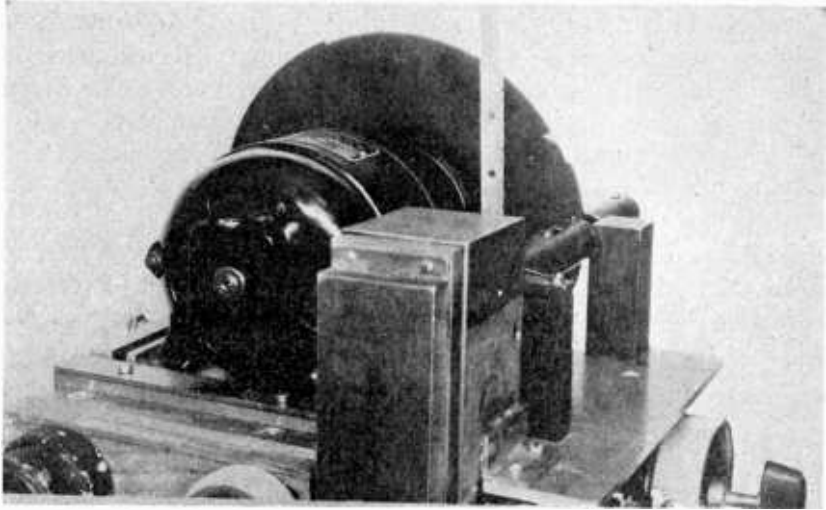

Fig. 5—Photograph of light chopper and optical system.

compartment. The latter units are all enclosed in an outer transparent walled compartment whose door is interlocked with the high-voltage supply circuit.

OPTICAL SYSTEM AND CHOPPER DISC DETAILS

Figure 6 illustrates the details of the optical system. The light source is a 10-volt, 50-watt lamp. Part (2) is a condenser

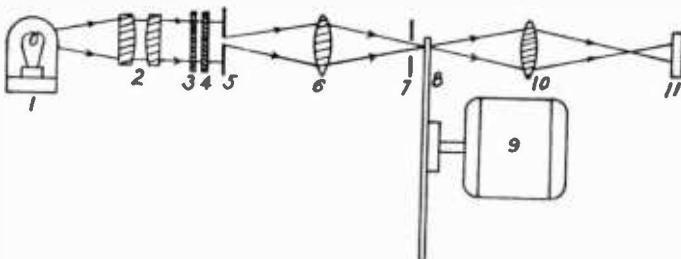

Fig. 6—Light chopper and optical system.

lens and units (3) and (4) are screens for reducing the light intensity to the desired value. Screen (4) is a stepped light-density wedge. Part (5) is the aperture whose size is deter-

mined by the aperture build-up time used. Lens (6) is for focussing the image of aperture (5) on the chopper disc (8). Unit (7) is a mask for cutting off stray light. Lens (10) focusses the chopped light on the multiplier photo-emissive surface (11). A synchronous motor (9) is used to drive the chopper disc. The lamp house, lens barrel, density wedge slide, motor and disc can all be seen in Figure 5.

The design of the disc depends upon the maximum fundamental frequency to be produced. The following illustration is a typical example:

For a 10-inch-page-per-minute scanning the

$$\text{Screw advance} = 10/60 = 0.1667 \text{ inches/sec.}$$

and for a standard line advance of 120 lines per inch the

$$\text{Screw advance} = 0.1667 \times 120 = 20 \text{ lines/sec.}$$

For a standard drum circumference of 9.22 inches the

$$\text{Linear scanning speed} = 20 \times 9.22 = 184.4 \text{ inches/sec.}$$

For this example the usual Elite office typewriter type size may be used for determining the limit of definition; that is, this will be assumed to be the finest material which is to be reproduced satisfactorily. The stems and bars of letters of this type size are 0.0082 inch wide. Taking twice this value or 0.0164 inch as the length of a cycle in scanning such letters, the following is obtained:

$$\text{Maximum fundamental scanning frequency for page-per-minute speed} = 184.4/0.0164 = 11,244 \text{ cycles per second.}$$

In this particular case the chopper disc was cut to produce 12,000 cycles per second. Since an 8-inch disc was used and the driving motor speed was 1800 rpm for 60 cycles, the teeth were made with a 1/32 inch cutter and spaced about 1/16 inch apart (center to center). This made the finished teeth and slots each practically 0.032 inch wide.

A disc for this speed which incorporates some additional features is shown in Figure 5. Two alternate 90-degree segments of the disc are solid. The other two alternate 90-degree segments are divided radially into six different bands. The outer or first band is cut away so that when this position is used, 60 cycles per second square-wave chopping is produced. The second band has 100 slots and 100 teeth, each 0.032 inch wide, in each of the two 90-degree segments. This band produces 12,000-cycle chop-

ping. The next four bands produce, respectively, 4 impulses, 3 impulses, 2 impulses and 1 impulse of 12,000 cycles. Many other designs may be made as required for various speeds and purposes.

The aperture size and build-up time for the above example are determined as follows:

In order to allow the build-up time to be as great as possible and yet not appreciably decrease the amplitude of the output for the maximum fundamental frequency, the spot of light (assumed square or rectangular) should have a width in the scanning direction equal to about 75 per cent of the width of the line of minimum definition. For the usual Elite office typewriter type size this would be about 0.006 inch. The build-up time for a 10-inch-page-per-minute speed is then

$$0.006/184.4 = 32.5 \times 10^{-6} \text{ sec.} = 32.5 \text{ microseconds}$$

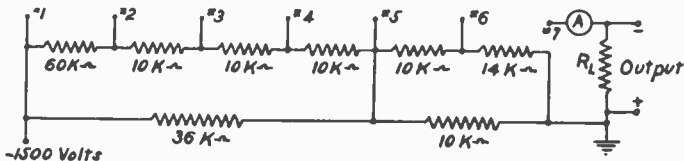

Fig. 7—Multiplier circuit for negative output.

Approximately this same value of aperture build-up time was obtained in the test apparatus by using a square aperture, 0.025 inch on a side. As in the case of the disc, the aperture may also be made to any size or shape as desired. For some of the oscillograms given in this paper a smaller aperture 0.012 inch wide was also used.

PRACTICAL MULTIPLIER CIRCUITS

For practical operation a voltage divider system different from that shown in Figure 1 is better. The arrangement shown in Figure 7 comprises a double-voltage divider which gives improved voltage regulation. This decreases the tendency for fluctuations in output due to change in applied electrode voltages. The output polarity derived from the voltage drop across R_L is negative for the connections of Figure 7; that is, the plus terminal is at ground potential as indicated. If the opposite

polarity of output is desired then the circuit of Figure 8 may be used.

For some types of facsimile testing a carrier frequency modulated by facsimile signals is used. The circuit of Figure 9 may

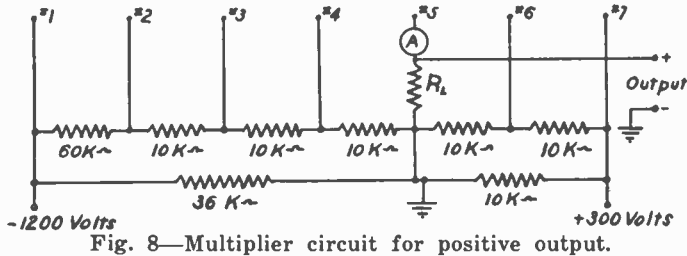

be used to derive such a modulated wave from the multiplier output. The carrier frequency is applied to the screen grids of a pair of pentodes and a modulating voltage from the multiplier

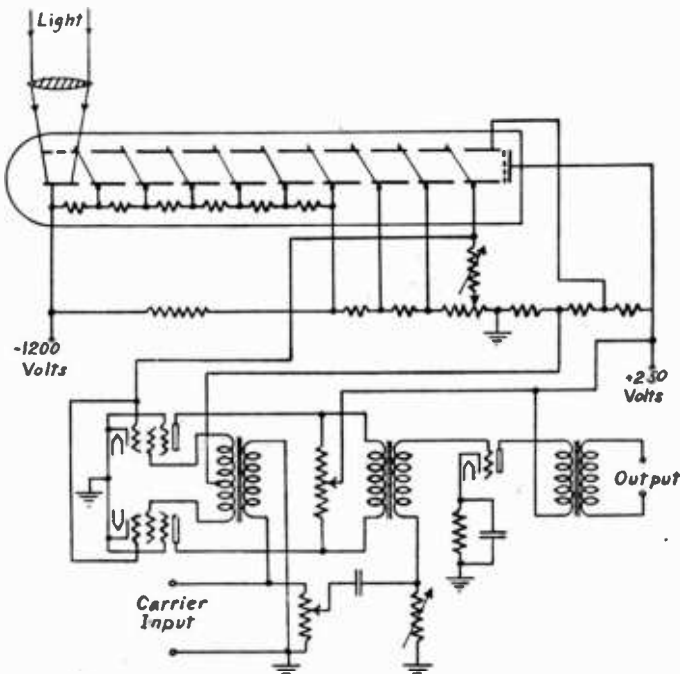

output is applied to the control grids. The circuit also shows means for improving the linearity of the modulator for low values of carrier output.

WAVEFORMS PRODUCED BY THE TEST APPARATUS

The performance of the apparatus just described is illustrated by means of the oscillograms of Figures 10-a to 10-h. The

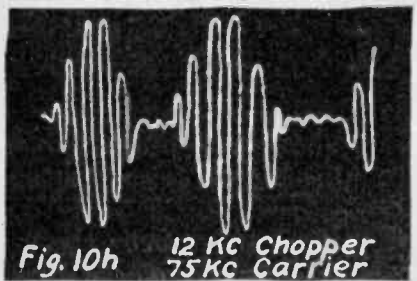
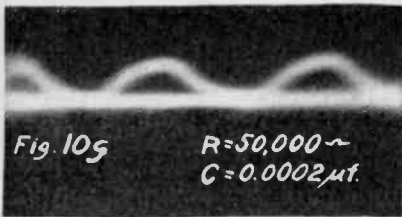
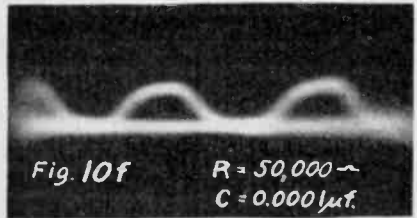
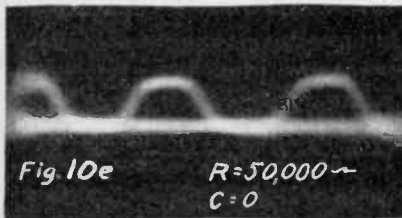
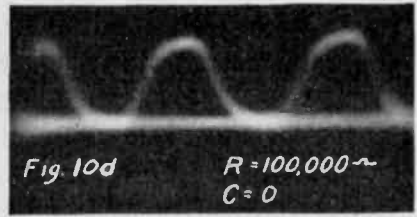
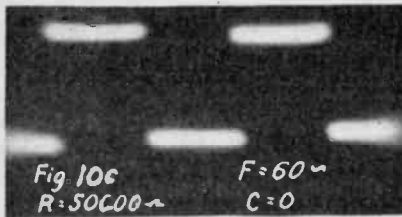
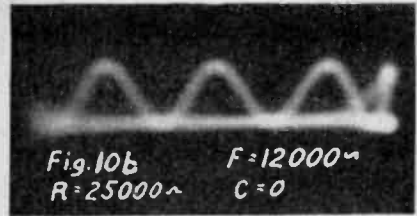
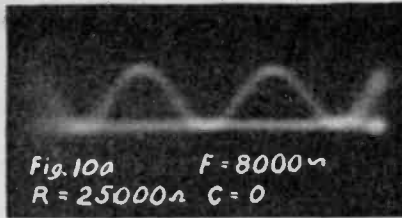

ELECTRON MULTIPLIER OUTPUT WAVEFORMS

Fig. 10

first three of these were made with the 0.025 inch aperture. Figure 10-a was obtained with the 12,000-cycle chopper teeth but with a 40-cycle supply to drive the disc motor. Hence, the actual frequency was 8000 cycles. Although this wave appears to be sinusoidal the tendency for flat top is evident. The theoretical shape is trapezoidal, but the slight amount of stray circuit capacitance which shunts the load resistor R_L , tends to round off the corners. Figure 10-b is for the full speed 12,000-cycle condition. The waveshape is very similar to the previous oscillogram. Figure 10-c shows that for 60-cycle light chopping the multiplier output is almost a pure square wave; the vertical traces were too fast to be recorded in comparison to the horizontal traces.

Since the 0.025 inch aperture gave output waves with a very short duration of flat top in the 12,000-cycle case, a series of oscillograms was taken with an 0.012 inch aperture. These are illustrated in Figures 10-d to 10-g and were taken for 12,000 cycles. Various conditions of load resistance and additional shunt capacitance were used. Figure 10-e is the best result. Figures 10-f and 10-g show the results of increasing amounts of capacitance; the increased rounding of the corners is to be noted as well as the decrease in magnitude.

The oscillograms so far discussed were obtained as photographic contact prints on the screen of a 3-inch cathode ray oscilloscope whose vertical sensitivity was approximately 90 volts per inch. The reader may readily estimate the various voltage and current values shown since the height of the wave of the original print of Figure 10-c was $\frac{3}{4}$ inch.

Figure 10-h is an example of results obtained with a circuit similar to that of Figure 9. This modulated wave was produced with a 75-kc carrier frequency and 12,000-cycle output of the multiplier as the modulating frequency.

ANALYSIS OF LOAD-CIRCUIT RESPONSE

In order to obtain a check on the effect of shunt capacity on the multiplier output waveform the following mathematical development was made:

Except for the case where the load circuit contains series inductance the output current from an electron multiplier or a photocell can be expected to follow the incident light fluctuation almost precisely. This is true only as long as these devices have sufficient anode potential to be well above the saturation point. The output current is then independent of the applied voltage.

It is the purpose of this treatment to show how much the voltage across the load resistance deviates from following the incident light variations when leakage or stray capacitance exists across this load resistance. Two cases will be considered: First, the response to a single rectangular impulse, and second, the response to a single trapezoidal impulse.

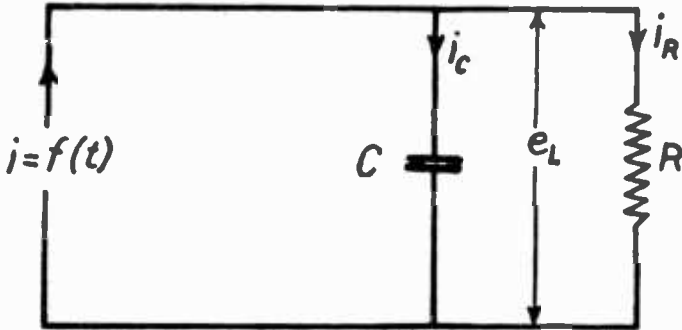

Fig. 11—Electron multiplier load circuit.

Case I

Figure 11 shows the circuit and notation that are to be used. For Case I, $i = f(t)$ will be defined by

$$\left. \begin{aligned} i = f(t) &= 0 && \text{for } t < 0, \\ i = f(t) &= I && \text{for } 0 < t < t_1, \\ \text{and } i = f(t) &= 0 && \text{for } t > t_1. \end{aligned} \right\} \quad (1)$$

Applying Kirchoff's circuit laws to the case results in the following equation:

$$i = i_c + \frac{1}{RC} \int i_c dt = I. \quad (2)$$

The solution is

$$i_c = I \epsilon^{-t/RC}. \quad (3)$$

The load voltage desired is then

$$e_L = IR(1 - \epsilon^{-t/RC}). \quad (4)$$

This is a well-recognized form. Figure 12-a shows the rectangular impulse as plotted for the theoretical case of zero shunt capacitance and also for the case of $R = 50,000$ ohms, $C = 100$

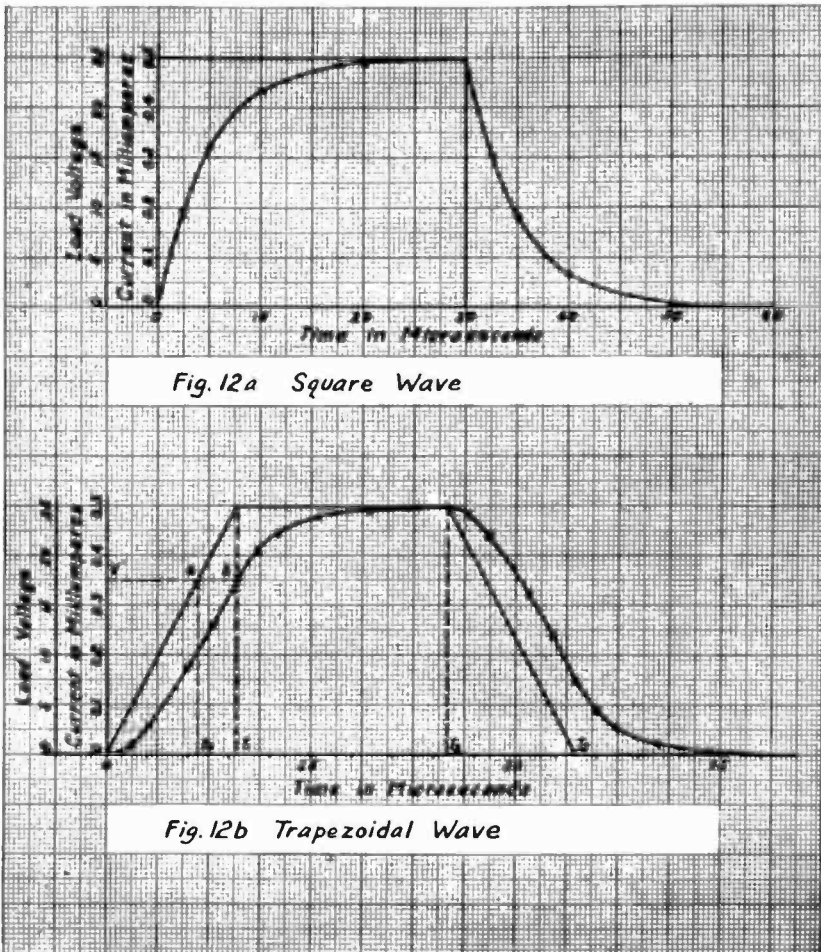

Fig. 12

mmfd. and $I = 5 \times 10^{-4}$ amp., up to the point where $t = t_1 = 30$ microseconds.

Beyond where $t = t_1$ $i = 0$ and $i_c = i_R$. If the variable t is now measured from t_1 as a new zero point, the condenser discharges through the resistor according to

$$i_c = I_R e^{-t/RC}, \quad (5)$$

where I_R is the initial value of discharge current.

The load voltage in this case which is

$$e_L = RIe^{-t/RC} \quad (6)$$

has also been plotted on the same graph.

The complete curve shows the characteristic "rounding of the corner" effect that is frequently noticed when square wave is applied to amplifiers, filters and other circuits. The smaller the value of RC (the time constant), the more nearly the response approaches the actual applied wave-form.

Case II

In facsimile scanning the light variation is never a true rectangular waveform due to aperture distortion. The theoretical variation (for a rectangular aperture) simulates a trapezoid as illustrated in Figure 12-b. For this case $i = f(t)$ may be defined by

$$\left. \begin{aligned} i = f(t) &= 0 && \text{for } t < 0, \\ i = f(t) &= Kt && \text{for } 0 < t < t_1, \\ i = f(t) &= I && \text{for } t_1 < t < t_2, \\ i = f(t) &= (Kt_2 + I) - Kt && \text{for } t_2 < t < t_3, \\ i = f(t) &= 0 && \text{for } t > t_3. \end{aligned} \right\} \quad (7)$$

There are now four periods to consider.

Period A ($0 < t < t_1$)

For this case the following equation (using operational calculus notation) may be obtained.

$$i_o = \left[\frac{P}{P + \frac{1}{RC}} \right] Kt \quad (8)$$

This may be solved by means of the superposition theorem and the result is

$$i_o = KRC(1 - e^{-t/RC}). \quad (9)$$

The load voltage will accordingly be

$$e_L = Ri_R = R(Kt - i_o) = KRCt - KR^2C(1 - e^{-t/RC}). \quad (10)$$

The curve resulting from this equation for period A is plotted in Figure 12-b for $K = 31.2$ amperes per second and the other values as previously given.

An interesting and important fact is brought out by the above development and the resulting curve. The voltage rise across the load resistance lags behind the rise in light value and this lag quickly approaches a fixed value which can be determined as follows:

Let the voltage at time t_1 as given by equation (10) be V' (represented by point b on the curve). Hence

$$V' = KRt_1 - KR^2C(1 - e^{-t_1/RC}). \quad (11)$$

In the case of zero shunt capacitance the voltage V' would be reached in t_0 seconds (point a) when

$$V' = KRt_0. \quad (12)$$

Equating the right hand members of (11) and (12) and noting that for most practical numerical examples, $e^{-t/RC}$ rapidly approaches zero as a limit, the following is obtained:

$$t_1 - t_0 \doteq RC \quad \text{for } t_1 \gg RC. \quad (13)$$

The load voltage in practical cases soon lags the ideal wave by an amount equal to the time constant of the load circuit.

Period B ($t_1 < t < t_2$)

During this interval $i = f(t) = I$ and the time may be measured from $t = t_1$ as the new zero point. In this case the fundamental equation for the current is

$$i_c = I' e^{-t/RC}, \quad (14)$$

in which
$$I' = I - \frac{E_c}{R}.$$

From this

$$e_L = RI - RI' e^{-t/RC}. \quad (15)$$

This function is also plotted on the graph between the points marked t_1 and t_2 . For the numerical values used e_L practically reaches the steady state value at the latter time, t_2 .

Period C ($t_2 < t < t_3$)

Measuring t from t_2 as a new zero our fundamental current equation is found to be

$$i_c = \left[\frac{P}{P + \frac{1}{RC}} \right] \left[\left(I - \frac{E_c}{R} \right) - Kt \right] 1. \quad (16)$$

By means of the superposition theorem the solution is

$$i_c = \left(I - \frac{E_o}{R} \right) e^{-t/RC} - KRC (1 - e^{-t/RC}), \quad (17)$$

which gives for the load voltage

$$e_L = RI + KR^2C - KRt + (E_c - RI - KR^2C) e^{-t/RC}. \quad (18)$$

The plot of this curve on the graph between t_2 and t_3 shows a lag on the voltage decay similar to that on the build-up time.

Period D ($t > t_3$)

Equation (6) will apply in this case.

$$e_L = E_o e^{-t/RC}, \quad (19)$$

t being the time measured from t_3 as a new zero and E_o is the value of e_L at t_3 from equation (18).

This completes the theoretical response curve of the load voltage for the trapezoidal wave. Not only is the waveshape altered by the presence of shunt capacitance across the load, but a delay in response with a limiting value equal to the circuit time constant occurs.

The same numerical constants used in the above example were also used in the experimentally obtained curve of Figure 10-f. The actual and calculated response check well as indicated by the similarity of the two curves—Figures 10-f and 12-b.

CONCLUSION

The electron multiplier and associated apparatus described on the previous pages have proved of value in making tests on radio and wire circuits in connection with the determination of frequency band width requirements for facsimile transmission. The application of waveforms from the apparatus to such circuits also very vividly demonstrates that for picture transmission a distortionless phase characteristic over the utilized frequency band is as important as a flat frequency response characteristic.

As a conclusion to this paper the following features and advantages of the electron multiplier test system are given:

1. A wide flexibility in frequency, aperture build-up time, aperture size and shape and output waveforms is obtainable.

2. The multiplier delivers ample output power for many testing purposes without using any additional equipment.

3. Recurring transient phenomena may be produced for test purposes and these may be readily observed by synchronizing the oscilloscope sweep circuit with the chopper disc. The disc illustrated in Figure 5 was used in this manner.

4. The apparatus may be made portable as was the case for the setup described.

5. Although the system was built up primarily for producing facsimile test signals it can be used for generating signals to be used in other kinds of testing.

6. Those experienced in facsimile engineering have found that the results obtained by using the test signals from the multiplier may be used as a criterion for accurately judging the results to be obtained in the actual transmission of facsimile material.

BIBLIOGRAPHY

- ¹ The Secondary Emission Multiplier—A New Electron Device. F. K. Zworykin, G. A. Morton, and L. Malter. March, 1936, issue of *Proc. I.R.E.*

- ² Secondary Emission Electron Multiplier. An article in the November, 1935, issue of *Electronics*.

TAPE FACSIMILE: HISTORICAL AND DESCRIPTIVE NOTE

BY

CHARLES J. YOUNG

Research and Engineering Division, RCA Manufacturing Co., Camden, N. J.

INTRODUCTION

TAPE facsimile, as a new and distinct method of communication, originated as an off-shoot of the early work on broadcast facsimile. Its possibility became apparent when experiments were being conducted with carbon paper facsimile recorders which operated continuously with a roll feed. The ordinary 8½-inch wide strip was reduced to a fraction of an inch, and the pitch of the recorder helix from 9 inches to ¼ inch. This allowed space for one line of type along the tape, and, at the same time, a corresponding increase of helix drum speed. As a result the strip was fed out rapidly, and as many words were recorded per minute as with the original page system. The scheme seemed attractive for message communication.

HISTORICAL

The first such equipment was assembled in 1931 and was put through a series of tests and demonstrations. The apparatus was in three parts, a typewriter rebuilt to print on strip instead of on a page, a scanner, and a recorder; each with the necessary amplifiers. The original scanner operated on the same principle as the early television devices, using a disc about 4 inches in diameter with a circular row of holes near its periphery. These openings were brilliantly illuminated and their image was focussed through a projection lens and prism on the tape. As the disc rotated the light spots followed one another across the ½-inch tape at a rate of 30 per second. Meanwhile the tape moved forward at a rate to give 60 scanning lines per linear inch. The reflected light from the paper was collected by a phototube, and thus facsimile impulses were obtained and

amplified in the usual way. The recorder followed closely the principles already used in the broadcast facsimile receiver, except for the reduction in scale of the helix drum. Also, a type-writer ribbon was substituted for the carbon paper. Fair results were obtained with this apparatus. By using series motors and alternators special tests were made at speeds up to 120 inches per minute, which is equal to about 200 words per minute of typewriting.

In most of this work both scanner and recorder were driven by synchronous 60-cycle motors. It was apparent at once, however, that much leeway could be allowed in the speed control if a two-turn helix were used. This would give two copies of the line of type, one above the other; and as one line drifted off at the bottom of the tape the other would come in at the top. Thus there would always be complete readable words in one line or the other. This method has been described elsewhere in detail.¹

SCANNING METHODS

The next step was the reduction of the apparatus to simpler and more compact form. One of the most interesting improvements was an optical system for the scanner which obtained the scanning action by means of a rotating hexagonal prism. This device proved to be very satisfactory and is being used in present equipment. It is outlined diagrammatically in Figure 1, both an elevation and a top view being given to show clearly the position of the cylindrical lenses. Proceeding from the exciter lamp toward the phototube, the first lens is a spherical condenser and focusses the image of the filament on the last cylindrical lens just before the tape. Next comes a vertical slit diaphragm. The first cylindrical lens tends to focus the opening of this diaphragm to a vertical line of light at the tape, but this line is collapsed to a point by the second small cylindrical lens near the tape. Interposed between the cylindrical lenses is a hexagonal prism, mounted on a vertical shaft. It is rotated by gearing from a synchronous motor, once around for every six scanning lines. As indicated by the dotted line in the top view, the light is refracted so that the spot moves across the tape as each face of the prism turns across the beam. At the corner between faces the spot jumps back to its starting position and repeats the motion. The other component of the scanning is

¹ Shore and Whitaker—"Tape Facsimile Synchronizing Systems," pp. 270-283.

obtained by moving the tape forward at a constant speed such as to give about 90 lines per inch. The size of the spot at the paper is about 0.010 inch square. Obviously spherical lenses could be used throughout, but greater light efficiency is obtained

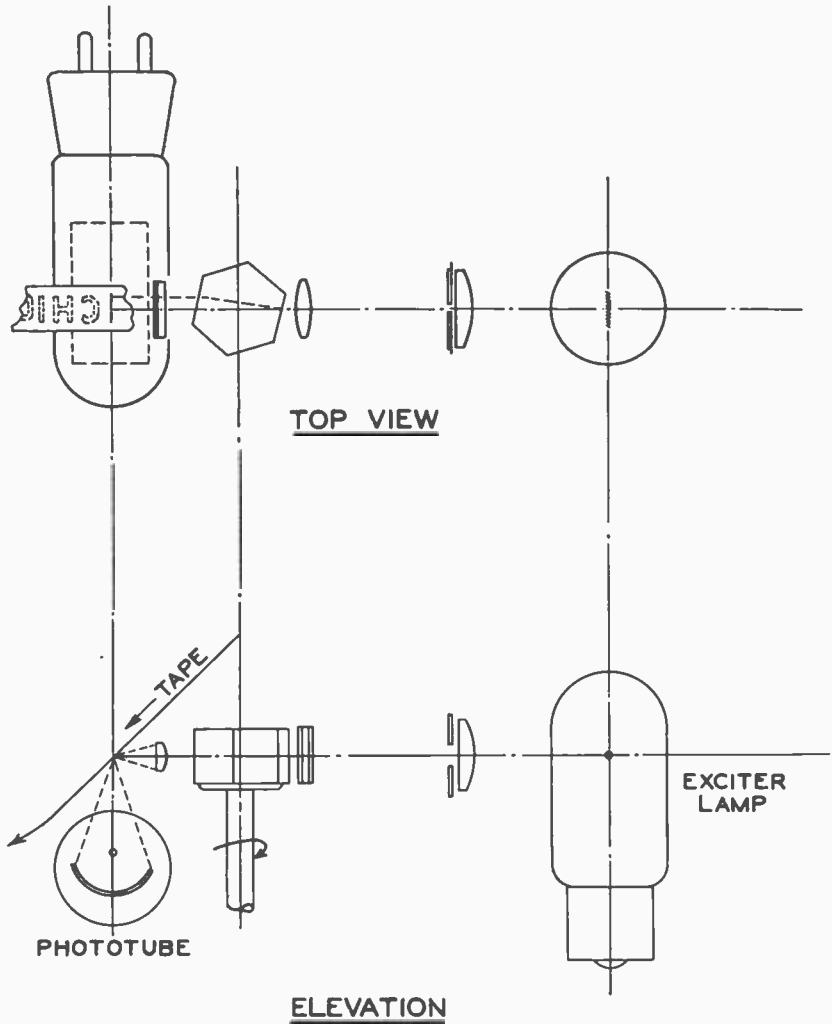

Fig. 1.

by the system here shown. The amount of light received by the phototube is also increased by placing it on the line of direct reflection from the paper. This is undesirable in page scanning, but is permissible here because the original copy is always written or typed, and the black areas are dull surfaced.

The circuits for amplifying the picture signals generated by the phototube are similar to those used for page facsimile and will not be described here. The one difference worth noting is that the frequency characteristic need not necessarily extend to zero, because the speeds are about 60 strokes per second and the copy always consists of black letters covering a small part of the total white area scanned.

The mechanical requirements on a tape scanner are basically very simple. If the scanning speed is 60 strokes per second, for example, the prism is rotated by a suitable reduction gear from a synchronous motor at 600 r.p.m. Further reduction gearing turns a tape feed roller. These parts are arranged with the optical system and amplifiers in whatever form is convenient to give the desired operating procedures.

TAPE RECORDERS

The first recorder was built with a helix about $\frac{5}{16}$ inch in diameter, a short printer bar, and means for feeding a white and a carbon paper strip between them. Present designs use the same method. The printer bar is actuated by a magnetic driver unit supplied with picture impulses from a suitable amplifier.

Many methods of printing on the tape were investigated. Carbon paper and typewriter ribbon are about equally good; the paper is run through once and either wound up or discarded into a basket, while the ribbon is provided with an automatically reversible feed. A tape of colored paper with a white wax coating, known as "Stylograph", gives good copy, but soon gums the mechanism with the scrapings from its surface. The most successful method found is to use a plain white paper tape and to ride a soft surface inking roller against the recorder helix on the side opposite the paper. This inking roller is dampened in turn from a felt roller impregnated with a quick drying ink. Thus the raised surface of the helix is constantly coated with ink, which is transferred to the paper under pressure of the printer bar.

Like the scanner, the mechanical construction of the recorder is very simple. The helix can be placed on an extension of the motor shaft and a paper feed roller is driven by additional reduction gearing. One form of portable tape recorder is shown in Figure 2. Here the box contains the motor, the printer amplifier, and the reel of white tape. The helix drum can be seen in

the center and above it the case for the inking rollers. This particular unit was designed to operate on a 12-volt d-c power supply.



Fig. 2.

TYPICAL CONSTANTS OF THE SYSTEM

One set of design constants for a tape facsimile system are tabulated below. These are typical in the sense that they give satisfactory operating speeds and can be easily realized in a practical apparatus design. They do not necessarily correspond with the values which have been used in the various programs of investigation.

Number of scanning strokes per second . . .	60
Total length of stroke	0.250 inch
Lines per inch of tape	90
Facsimile Index, $90 \times 0.250 =$	22.5
Width of tape	0.375 inch
Height of letters in type line	0.125 inch
Speed of tape	40 inches per minute
Words per minute (approx.)	60

Based on the above figures it is seen that the linear speed of the scanning spot is 15 inches per second. The maximum impulse or keying frequency required can be determined if the required number of picture elements per stroke are known. For upper-case typewritten letters as used in communication service, adequate definition is provided with 16 elements per stroke, or about 10 elements in the height of a letter. This gives 8 cycles per stroke or a keying frequency of 480 cycles per second. This makes no allowance for upper harmonics to give "square" dots, as it has been found in practical applications that sufficiently clear letter formation is obtained with impulses of sine wave shape.

In normal transmission a subcarrier is modulated by these impulses, and in turn modulates a telephone transmitter. However, direct cw keying of the radio carrier can be employed instead. The relative merits of the two systems have been discussed elsewhere.²

² Whitaker and Collings—"Practical Applications of Tape Facsimile Systems," pp. 284-293.

TAPE FACSIMILE SYNCHRONIZING SYSTEMS

By

HENRY SHORE

Patent Department, Radio Corporation of America

AND

JAMES N. WHITAKER

Research Engineer, Central Office Engineering Laboratory, R.C.A. Communications, Inc.,
New York City

THE state of the art in regard to page facsimile has crystallized to the extent of indicating that the preferred method of operation is a synchronous system. However, the field of tape facsimile being relatively new, has an equal number of proponents for non-synchronous as for synchronous systems.

The difference between a synchronous and a non-synchronous tape-facsimile system, is that at the receiving end, the synchronous recording equipment requires auxiliary equipment which is actuated under the control of a synchronizing signal transmitted together with the facsimile signal. The synchronizing signal may be interspersed with, may be transmitted concurrently with, or may be derived from the facsimile signal itself. The recorded facsimile signal will then appear on the tape as a single continuous line of type running longitudinally along the tape.

In the non-synchronous tape-facsimile system, there is generally provided means for recording a double line of type on the tape. The tape and the speed of the driving mechanism is adjusted to be approximately the same as that of the transmitting equipment. Any variation in speed between the two equipments results in the record being displaced vertically so that the recorded message runs at a slight angle with respect to the line of motion of the tape. By providing the double record, no letter or portion of the message is lost, as will be noticed by reference to Figure 1 in which 1a shows a sample of message tape received on a synchronous facsimile system, while 1b shows the record received over a non-synchronous system, in which the receiver's speed is not identical with that of the transmitter.

Before describing the various methods which may be used in synchronizing tape receivers, it would be well to describe briefly

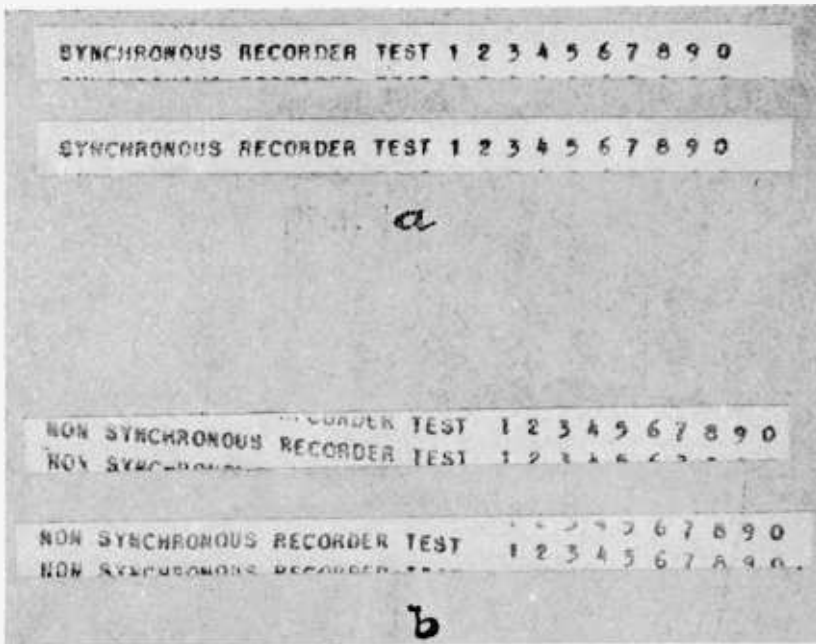

Fig. 1—Samples of synchronous and non-synchronous tape-facsimile recordings.

the component parts and the operation of the tape scanner which is shown schematically in Figure 2. The essential components

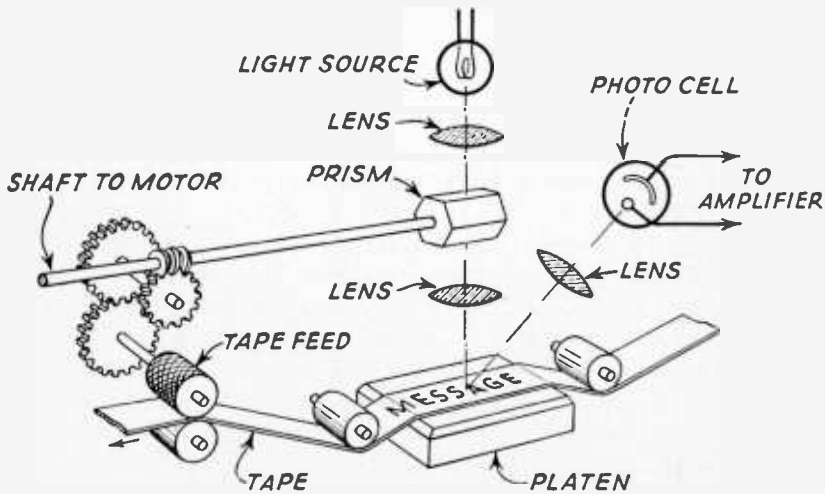

Fig. 2—Basic tape-facsimile scanning system.

consist of a motor, a tape-feed mechanism, a source of light, an optical system, means for moving the light beam across the tape, and a phototube with its associated amplifier system.

The drive motor is generally of the synchronous 60-cycle a-c operated type. The tape feed system consists of a sufficient number of rollers and guides to draw the tape past the scanning point at a constant speed. The light source is usually a pre-focused projection lamp. The optical system produces a sharply focused beam of light, and includes a light spot-deflecting arrangement such as a rotating polygonal prism to cause the beam of

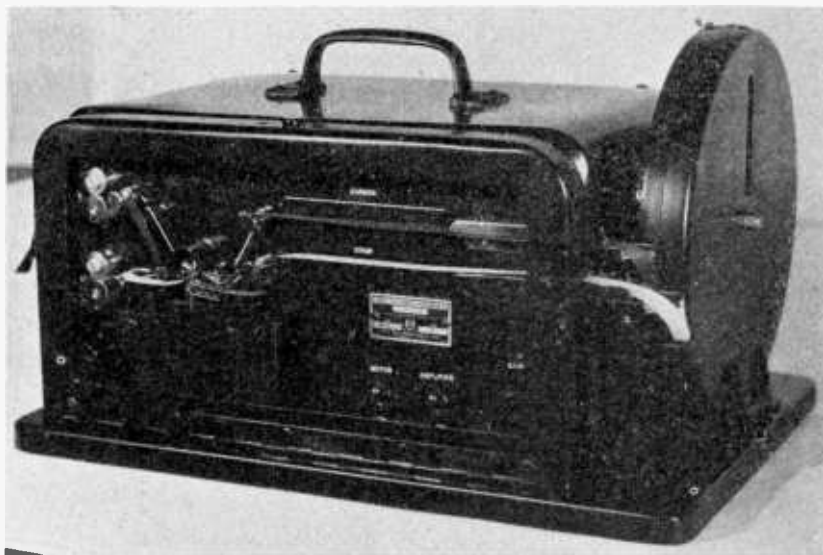

Fig. 3—Tape-facsimile recorder.

light to sweep across the tape. The phototube is arranged to receive the reflected light from the scanned tape, and the phototube amplifier converts the d-c phototube output into a keyed or amplitude-modulated sub-carrier frequency. It should be appreciated that the schematic showing of the scanner is merely representative of tape scanners in general, and although many modifications are possible and the resulting structures may appear to be totally unrelated, nevertheless the above described elements, or their equivalents, are common to all tape scanners.

The recorder shown in Figure 3 may be taken as being representative of tape facsimile recorders. Here again means are shown for feeding the tape through the recording mechanism actuated by the signals received by the radio receiver following

detection and suitable amplification. The unit pictured is of the carbon recorder type, in which a slip of carbon paper faces the record slip. Both of these pass between a rotating spiral and an electromagnetically actuated printer bar. The received signal actuates an electromagnet, causing the printer bar to press both the carbon and record tape against a very small, finite area of the spiral. The pressure thus produced transfers the carbon from the carbon slip to the record slip, producing the recorded message.

For certain applications where simplicity is the major requirement and where a common power supply is available for both the transmitter and the recorder, it is possible to use synchronous motors for driving both. Under such conditions, it is not necessary to transmit synchronizing signals since the common power supply and the synchronous motors at the transmitter and receiver guarantee synchronous performance between these two mechanisms. Where a common power supply source is not available, it is possible to provide a double spiral which produces the type of record shown in Figure 1b. Preliminary field tests have indicated, in general, that this type of recording does not meet with complete approval by the public. Since there are many applications which do not permit the use of a common power source, it is exceedingly desirable to produce the single line type of recording such as that of Figure 1a, even though auxiliary equipment for synchronizing adds to the bulk of the recorder.

All methods for synchronizing the recorder with the tape facsimile transmitter must possess certain important features. Of these, reliability of synchronization under adverse conditions is paramount. The auxiliary equipment for synchronizing must be simple in design in order to keep the additional space requirements and weight to a minimum. Freedom from maintenance requirements is likewise essential, and it is considered highly desirable that the synchronizing system should also provide automatic framing provided that such framing does not increase apparatus requirements unduly, or complicate the maintenance problem. This latter feature, however, while desirable, is not so important that it could not be dispensed with if a synchronizing method could be provided which embodied all of the other requirements.

Accordingly, the first attack on this problem did not include the feature of automatic framing. However, during the course of the development of the final synchronizing system to be described, automatic framing was provided.

The simplest solution of the synchronizing problem apparent at the beginning of the investigation, was to make use of a signal controlled thyatron drive and a synchronous recorder motor. The principle involved in the signal control thyatron drive is shown schematically in Figure 4. The received tape-facsimile signal was applied to the recording amplifier and part of the output thereof fed to the recorder. A portion of the output was fed through a 360-cycle band pass filter of fairly sharp cut-off and narrow band to the input circuit of a standard thyatron inverter. The output of the inverter was adjusted to deliver 60-cycle a.c. at 110 volts, to drive the synchronous motor of the tape-facsimile recorder. In this system, no synchronizing signal per se was necessary. It was found that when scanning the tape at 60 cycles per second, a very strong 360-cycle component was present. Since this frequency could be conveniently used to con-

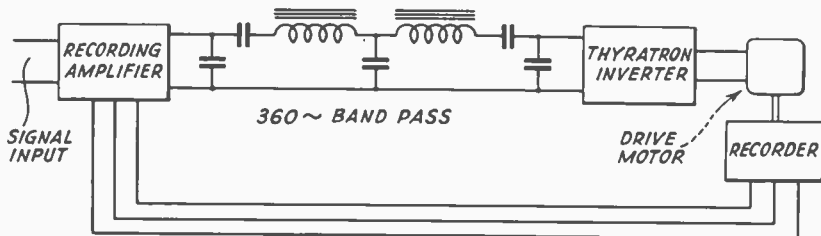

Fig. 4—Signal-controlled thyatron drive.

control a thyatron inverter in a conventional manner, this method was used in the early experiments.

The 360-cycle component owed its magnitude to the fact that the spacing of the horizontal components of the letters, together with their width, such as the letters *E* and *B*, for example, produced impulses at the rate of 6 per scanning stroke, and since the scanning was at the rate of 60 cycles per second, generated the 360-cycle per second component.

This system was operable but was not completely satisfactory in the form used, because of the varying amplitude of the 360-cycle tone derived from the signals. Large variations in amplitude arose from the fact that in between letters and words, there were intervals during which the scanning spot of light did not strike any characters, and the only impulse present was derived as the spot moved off the margin of the tape. Under such conditions, and especially between words where a number of blank scanning strokes occurred in succession, the impulses were being produced at an effective rate of 60 cycles per second.

These impulses were of very short duration, so that the 6th harmonic which was necessary to produce the 360-cycle tone, was very small. On the other hand, when scanning the horizontal bars of the letter *E*, for example, the magnitude of the 360-cycle component was at least 20 db above that produced in scanning the blank spaces. This extreme variation in amplitude had the effect of shifting the phase at which the control frequency was injected into the input circuit of the inverter, so that the inverter would slip out of control at times. While it would have been possible to use a limiter to equalize these amplitude variations, it was felt that this would not completely solve the problem in view of the fact that some shifting in phase of the 360 cycles took place during the scanning process. This system did not provide

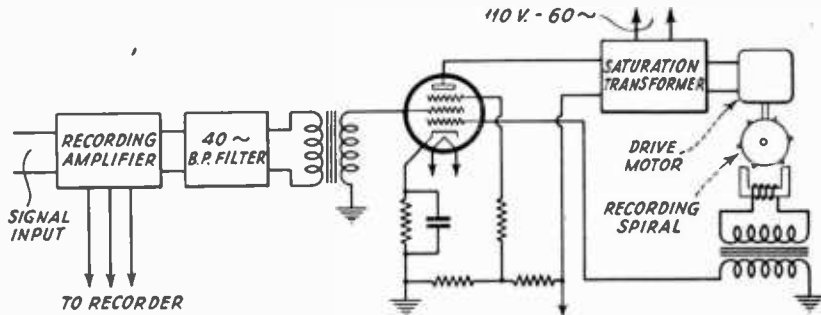

Fig. 5—Saturation transformer and tone generator arrangement.

automatic framing. In addition, even though the varying phase might have been overlooked in the event that a limiter was supplied to prevent variations in the 360-cycle control tone, the bulk of the apparatus was greater than that desired, since the inverter alone occupied considerable space and was excessively heavy. However, the system appeared to be promising for those installations where only direct current was available, since the inverter was capable of providing sufficient alternating current power to drive the synchronous motor.

In an attempt to reduce the size and weight of the auxiliary equipment necessary for synchronizing the recorder, as well as to provide more positive control, resort was made to the use of a saturation transformer scheme, and a non-synchronous a-c motor, as is shown schematically in Figure 5. In this system the incoming signal was amplified and passed on to the recorder. A portion thereof was fed through a band pass filter which was sharply peaked at the fundamental scanning rate so as to segregate this component. For example, if the scanning rate was 40

cycles, that is, 40 strokes per second, then the band pass filter would pass substantially only this frequency. The output of the filter was fed to the number 2 grid of a pentode, while the control grid was fed with 40 cycles generated by placing a pick-up unit adjacent to the recording spiral. The variation in magnetic flux across the pick-up unit generated a tone whose frequency was dependent upon the speed of the motor. In our example of 40 strokes per second, when the motor was driving at its synchronous speed, the voltage appearing across the pick-up alternated 40 times per second.

In this application the pentode functioned as a mixer tube and the average d-c plate current flowing through the d-c winding of the saturation transformer was, therefore, a function of the phase angle between the incoming 40 cycles from the band-pass filter and the generated voltage produced across the pick-up. When both of these voltages were in phase, maximum plate current was drawn, producing a maximum saturation effect, so that the winding in series with the motor and the 110-volt, 60-cycle power supply exhibited a minimum impedance. This caused the maximum voltage to appear across the motor terminals, thus driving the motor at its maximum rate of speed. When the phase angle shifted from zero degrees, the plate current was decreased through the saturation winding of the transformer with a consequential rise in impedance of the saturation transformer and drop in voltage across the motor terminals, so that the motor tended to slow down. In operation, the equilibrium point was reached automatically within two or three cycles, after which the motor ran at correct speed. This system was capable of producing synchronization under ideal conditions, although when the conditions became adverse, the response of the saturation transformer was much too slow, and accordingly, it was possible to drop a complete revolution due to the sluggishness of the system. The sluggishness arose from the fact that it was the average value of current through the winding that determined the degree of saturation of the transformer, and that for a small instantaneous shift in phase angle, the high inductance of the d-c winding prevented the saturation effect from taking place immediately.

Some difficulty was encountered when using 40-cycle control tone because of a beat with the small 60-cycle component from the power supply, and when this beat was eliminated, the control became even more sluggish than before. While the system had its simplicity to commend it, its instability of synchronization

and lack of automatic framing were disadvantages strong enough to eliminate its choice as a solution for the problem.

The next scheme tried was one in which a drive motor of inherently poor speed-load regulation was used to supply the bulk of the power and a phonic wheel mounted on the shaft of the motor was used to supply the synchronizing power. The layout is schematically shown in Figure 6. The incoming signal after being amplified was fed through a 360-cycle band-pass filter and a suitable amplifier. The output of the amplifier was supplied to the phonic wheel; the number of poles of the wheel being so chosen as to essentially provide a 360-cycle synchronous motor. This system provided excellent control but did suffer again from the same trouble as experienced with the thyatron inverter; namely, that variations in amplitude and phase of the incoming 360-cycle component were too great to hold the system locked in absolute synchronism over long periods of time.

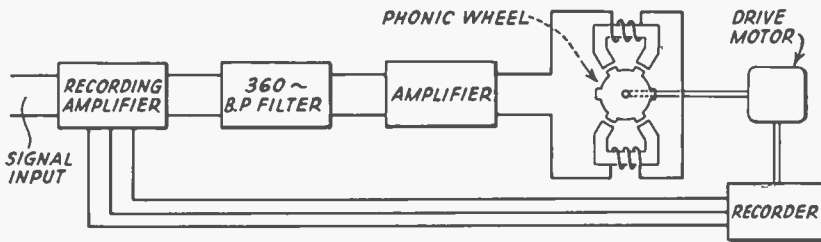

Fig. 6—Simple phonic wheel-speed control.

Instead of supplying a limiter and amplifier, it was decided in the next system to combine both of these functions by utilizing a multi-vibrator tube controlled by the 360 cycles, and to reduce the number of stages in the original amplifier which supplied power to the phonic wheel. In this system, the incoming signal also had a portion of its energy fed through the 360-cycle band-pass filter. A small amount of the filtered energy was fed into one of the grid circuits of the multi-vibrator. In order to prevent too great a shift in the multi-vibrator frequency, and to prevent locking of the multi-vibrator at some harmonic, other than the desired one, a tuned resonant circuit was included in the other grid circuit as shown in Figure 7. This had the effect of stabilizing the multi-vibrator operation and also of minimizing mis-synchronization by the phase variations of the incoming signal. The system was a decided improvement over that where the simple phonic wheel alone was used, but yet failed to provide automatic framing. It suffered also from hunting, especially during the scanning intervals between words.

The instability of the multi-vibrator was responsible for its choice in the first instance, but the experience derived in studying the characteristics of its performance in the above system indicated that since the frequency excursions encountered in synchronizing applications were of small magnitude, a more stable

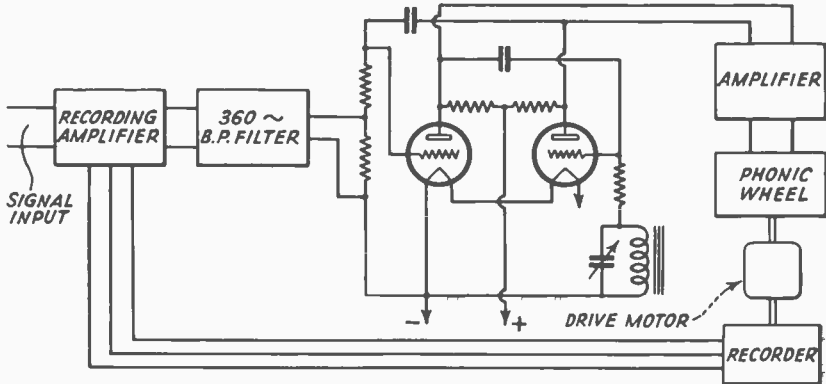

Fig. 7—Signal-controlled multivibrator system.

type of oscillator would be preferable. The oscillator should permit easy control by the injection of a relatively small amount of control voltage, and at the same time, should be relatively uninfluenced by amplitude changes of this injected control voltage.

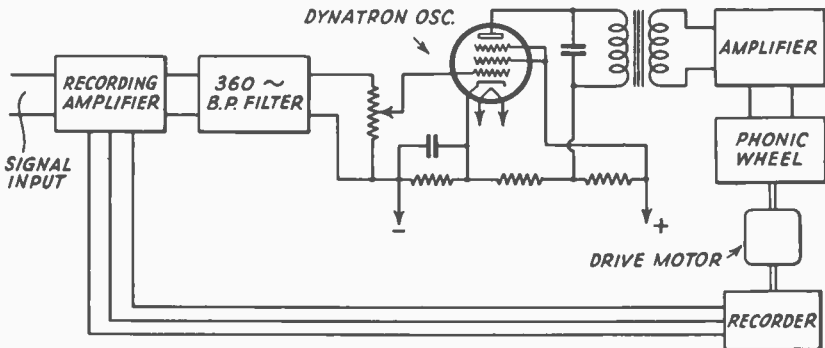

Fig. 8—Signal-controlled dynatron oscillator.

The dynatron oscillator shown in Figure 8, together with the other components of the system, met these requirements. In this system, the output of the 360-cycle band-pass filter was injected in the control grid circuit of the dynatron oscillator. The output of the oscillator was amplified and applied to the phonic wheel mounted on the drive motor shaft.

The overall operation of this system was very satisfactory and was a noticeable improvement over the multi-vibrator system. Automatic framing was not provided by the system and as experience had indicated that such a feature was extremely desirable, it was decided to modify the circuit to the form shown in Figure 9. In this arrangement, a portion of the amplified signal was fed to an open core transformer. The opening in the transformer core was arranged near the recording spiral in such a way that the teeth of the spiral would alternately open and close the gap. A second winding on the transformer supplied the synchronizing potential to the dynatron oscillator. This arrangement was effectively a magnetic commutator.

When the teeth of the recording spiral closed the gap in the transformer core, the reluctance of the magnetic circuit was

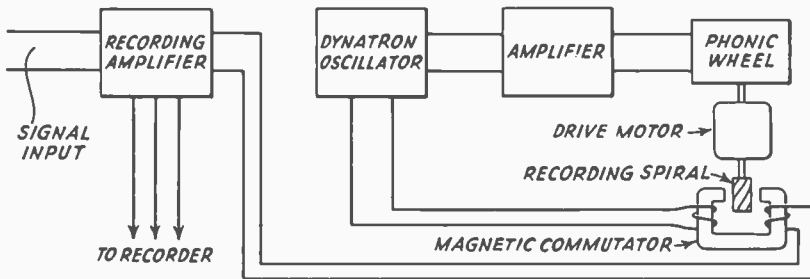

Fig. 9—Signal-controlled dynatron oscillator with magnetic commutator.

reduced, permitting a maximum transfer of energy between the windings of the transformer. If the marginal impulse (or framing line signal) was received when a spiral tooth was in a position to close the magnetic circuit of the transformer, a pulse of relatively large amplitude was applied to the dynatron oscillator. This tended to synchronize the oscillations with the controlling impulse. If the synchronizing impulse occurred when the spiral was not in position to close the transformer core, the energy delivered to the oscillator would be small, and would have little or no effect on the synchronization. Under these conditions, the oscillator frequency (and motor speed) drifted until a spiral tooth was in position to close the transformer core gap simultaneously with the reception of the framing pulse. The difference in the transfer of energy when the transformer core was open compared to when it was closed was not great enough to provide stable synchronization and framing. Accordingly, it was decided to provide a commutator mounted directly on the shaft of the

recording motor to improve this ratio. This arrangement is shown in Figure 10.

In this circuit, the incoming signal was applied to the recorder in the normal manner, and to the dynatron oscillator by way of the commutator. The brushes were so positioned as to be short circuited by a commutator segment thus closing the

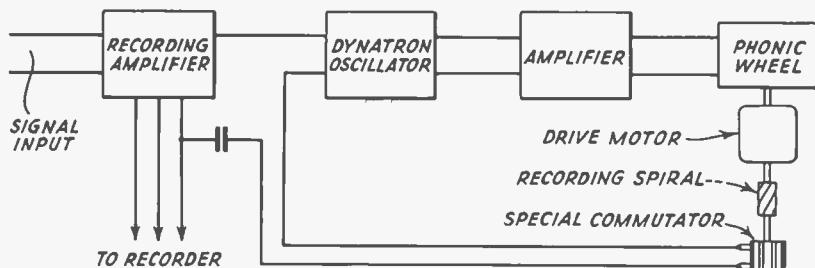

Fig. 10—Signal-controlled dynatron oscillator with special shorting-bar commutator.

circuit from the output of the recording amplifier to the input of the dynatron oscillator. Since the number of segments was equal to the number of spirals, only the marginal signal transmitted at the end of each stroke of the scanner was applied as control to the dynatron oscillator.

This system operated perfectly and provided both automatic framing and stable synchronization of the recorder with the transmitter. The mechanical obstacles encountered in commercial production of drive motors with suitable phonic wheels incorporated in the motor made it desirable to provide the next modification shown in Figure 11. In this figure, the dynatron

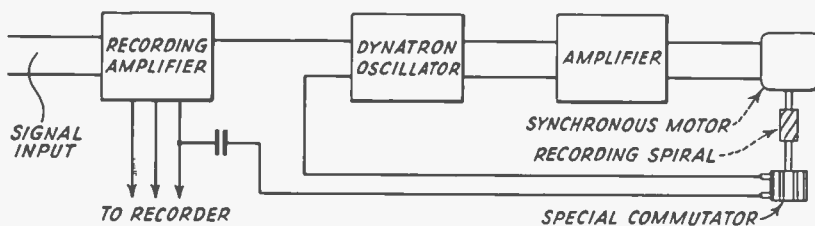

Fig. 11—Signal-controlled dynatron oscillator, special shorting-bar commutator and amplifier-driven motor.

oscillator had its frequency adjusted to 60 cycles and the output of the amplifier following the dynatron oscillator was fed directly to a synchronous motor. The oscillator circuit was adjusted so that its frequency was approximately 60 cycles. Random impulses from the recording amplifier were applied to the control

grid of the dynatron oscillator. When the signals were first received, this caused the frequency of the oscillator to vary back and forth until the continuous framing or marginal impulses were picked up by the commutator, at which time the oscillator locked in and maintained perfect synchronism and frame with the tape-facsimile transmitter. Once synchronized with the incoming signal, the recorder followed over a wide range of facsimile tape transmitter speeds.

Because this system seems to embody the desirable features of a synchronizing system, a detailed diagram of the complete circuit is shown in Figure 12. The unit comprises, generally, a

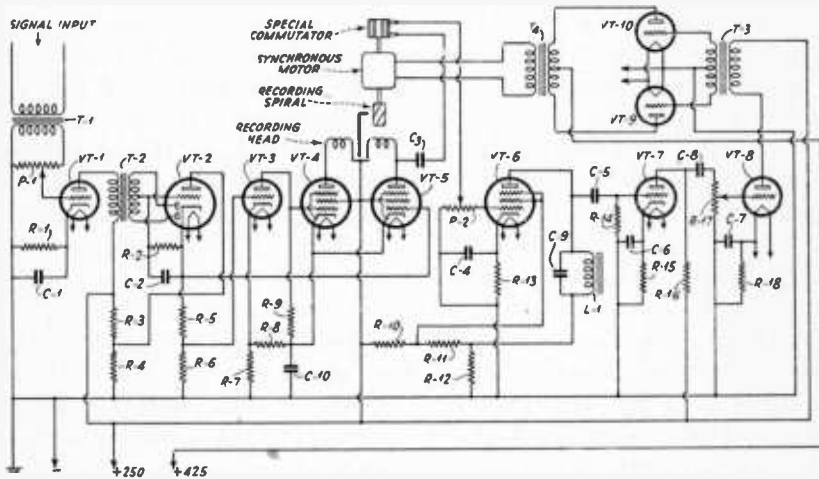

Fig. 12—Final arrangement of the tape-facsimile recording amplifier, incorporating the signal-controlled dynatron oscillator and motor-drive amplifier.

single-stage tone amplifier, a rectifier, a limiter-keyer tube, a reversing tube, and a push-pull stage whose output is connected to the recording unit. These elements are all essential and necessary for actuating the recording mechanism. In addition, there is provided a controlled dynatron oscillator, a commutator, a driver stage and a class B amplifier stage. The output of the class B amplifier supplies the power for driving the recorder motor.

In the drawing VT_1 , together with its associated components, comprises the first stage of the amplifier. The potentiometer P_1 acts as gain control for the incoming signal. VT_2 actually performs four functions. In the first place, the two diodes act as a full-wave rectifier for the amplified signal. Secondly, the

triode portion of this tube acts as a limiter. Thirdly, the output of the tube is used to operate the marking tube VT_5 , and fourth, a portion of the output is used to operate the reversing tube VT_3 . The reversing tube VT_3 operates the spacing tube VT_4 of the push-pull drive amplifier. VT_4 and VT_5 operate the tape-facsimile recording head. A portion of the output from VT_5 is passed through the blocking condenser C_3 , and the commutator, and is applied to the control grid of the dynatron oscillator VT_6 through the potentiometer P_2 to control the frequency of the oscillator in accordance with the marginal impulses transmitted at the end of each line of scanned tape at the transmitter. These impulses serve both as synchronizing and framing signals.

The commutator is made of micarta or some other suitable insulator, and has narrow copper bars imbedded in the surface. The number of these bars corresponds to the number of entries on the recorder spiral. Thus if a single-entry spiral is used the commutator would have one short-circuiting bar. If a six-entry spiral is used, six shorting bars are needed if it is desired to operate the spiral and the commutator at the same shaft speed. If it should be desirable from a standpoint of mechanical design to operate the spiral and commutator at different shaft speeds, the number of shorting bars on the commutator must be such as to maintain the relationships noted above; for example, if the commutator shaft is to be run at half of the spiral shaft speed and a six-entry spiral is used, the commutator would require twelve shorting bars in order to maintain the time relationship between the spiral entries and commutator shorting bars. The arrangement of the brushes on this commutator is such that the bars short circuit the brushes for a short interval at the end of the travel of each recording stroke. This shorting action permits any signal present to be passed on to the control grid of VT_6 .

The output of the dynatron oscillator is fed through capacity resistance coupling to an amplifier VT_7 which, in turn, supplies the driver stage VT_8 of a push-pull amplifier VT_9 and VT_{10} , the output of which is fed directly to the synchronous motor. The output of this stage is approximately 30 watts and since the motor only requires about 15 watts, it provides ample reserve power for driving the motor.

Figure 13 is a sample specimen of received tape, showing the effect of transferring the operation from non-synchronous to synchronous control, and is representative of the type of synchronizing and framing which can be expected from this system.

Such a system lends itself very readily to applications in which a common power supply is available for both the transmitter and receiver. For such applications, it is only necessary to insert a double-pole, double-throw switch between the synchronous motor input terminals and the secondary of the transformer T_4 , and



GO. FOLLOW HER TO SCHOOL ONE DAY WHICH WAS A

Fig. 13—Specimen of tape record, showing the transition from non-synchronous to synchronous recorder operation.

60-cycle supply line. Under these conditions by merely throwing the switch to the 60-cycle line position, the motor may be run synchronously with the transmitter without the use of the auxiliary equipment. It is thus evident that the dynatron oscillator and the power amplifier may be built up in the form of an auxiliary unit, which may be added readily as an adjunct to recorders built for common supply-line service, with only a few modifications to render available an automatically synchronized and framed recording system.

PRACTICAL APPLICATIONS OF TAPE FACSIMILE SYSTEMS

By

J. N. WHITAKER

Research Engineer, Central Office Engineering Laboratory, R.C.A. Communications, Inc.

AND

F. C. COLLINGS

Engineering Department, RCA Manufacturing Company, Inc.

INTRODUCTION

VARIOUS methods of recording on paper slip or tape have been popular in communication applications for a number of years. Examples of such services are the news and stock quotation tickers, teletype printers, etc. With the growing popularity of facsimile systems, attention was focused on the possibilities of applying this new communication technique to tape recording. Tape facsimile systems have many interesting possibilities.

The broadcasting of news and other vital information from a central point to fixed and mobile receiving stations is fast becoming a necessity in the modern business world. In many instances, it would be impractical to provide a skilled attendant at each receiving location. Tape facsimile systems would be ideal for such applications, as the recording equipment does not require the attention of a skilled operator at any time. The information is recorded automatically as it is received and the record is permanent.

Radio communication systems are now widely used by local and state police departments and in some localities by fire departments. The installations generally consist of conventional radio transmitters and receivers, and the orders are given verbally, often by pre-arranged code. In any case, there must be an operator in attendance to receive the instructions.

Tape facsimile could be used to good advantage in such applications as these. Not only would it be unnecessary for an attend-

ant to be present to receive orders, but a permanent record would be made which could be used for future reference should there be any misunderstanding of orders.

Tape facsimile would also be useful for stock quotation and market news service, home news broadcasting service, private point-to-point service, government and private aircraft communications, and, in fact, for any application requiring the transmission of intelligence.

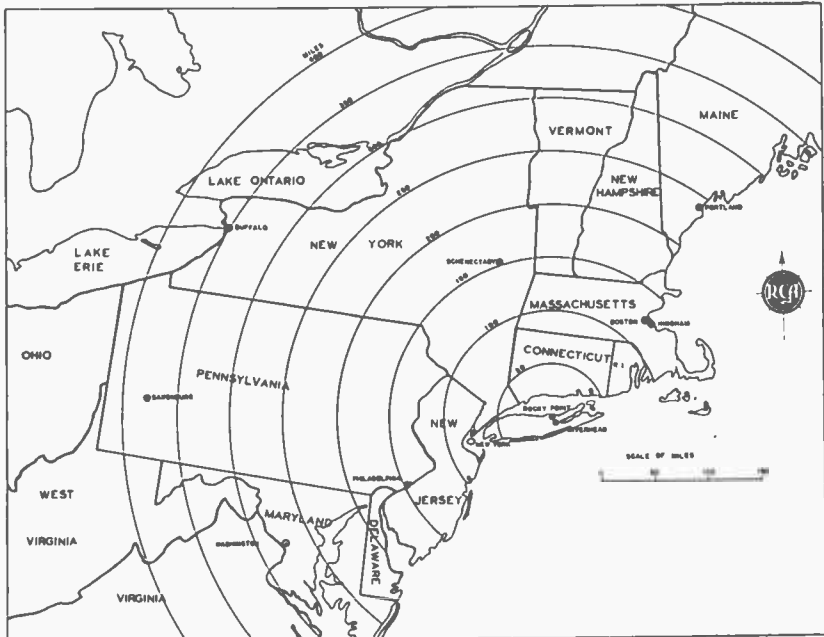

Fig. 1—Area covered by the long range survey.

TESTS AND SURVEYS

After the tape facsimile equipment had passed the laboratory stage of development a series of tests and surveys was conducted to determine the scope of its usefulness. These tests included long range surveys, local surveys, tests over point-to-point aircraft circuits and tests in connection with police and fireboat communication.

The long range survey was conducted within a radius of approximately 375 miles from Rocky Point, New York. The locations at which observations were made are shown in Figure 1.

The tape facsimile scanning equipment was operated at the Central Office Engineering Laboratory of R. C. A. Communications, Inc., at 66 Broad Street, New York City. The signals were transmitted over a wire line to the radio transmitter at Rocky Point, New York, and from there to the various receiving locations by short-wave radio.

The receiving equipment, tape facsimile recorder, field strength and noise measuring instruments and a portable radio transmitter were installed in an automobile. The tape facsimile recorder was arranged to print two lines of copy on one tape. This was to insure continuous recording at locations where synchronized power was not available.

Power was obtained from any available source at the various test locations, or from a rotary converter operating from the automobile storage battery when other power was not available. The portable radio transmitter was used for reporting to the home office and for giving instructions to the persons operating the tape facsimile transmitter.

The observations were made at more or less random points, with no particular thought of selecting the ideal locations for radio reception, as the purpose of the survey was to determine the practicability of tape facsimile under average conditions.

Results during daylight hours were satisfactory up to a distance of approximately 400 miles, assuming rural reception and satisfactory transmitter keying adjustments. Considerable difficulty was experienced during the hours of darkness, due to weak signals and multi-path phenomena. The selection of the proper radio-frequency carrier would no doubt permit satisfactory operation during both daylight and darkness.

LOCAL SURVEY

The local survey was conducted to determine the efficiency of a tape facsimile system for applications such as stock ticker and news services. Arrangements were made to install short-wave receivers and facsimile recorders in ordinary business offices. Most of these installations were made in the offices of various brokers in the Wall Street area of New York. The geographical locations are indicated in Figure 2. A set was also installed in one of the RCA offices in Rockefeller Plaza. Transmissions were made daily, using news excerpts as subject matter.

A special tape typewriter and a tape facsimile scanner were set up in the Central Office Engineering Laboratory at 66 Broad

Street. The output of the scanner was sent over an ordinary telephone line to the top of the Continental Bank Building at 30 Broad Street, where it was applied as amplitude modulation to an experimental 38.6-Mc transmitter.

The signals were picked up by means of dipole antennas at the individual receiving locations. Ordinary police type super-

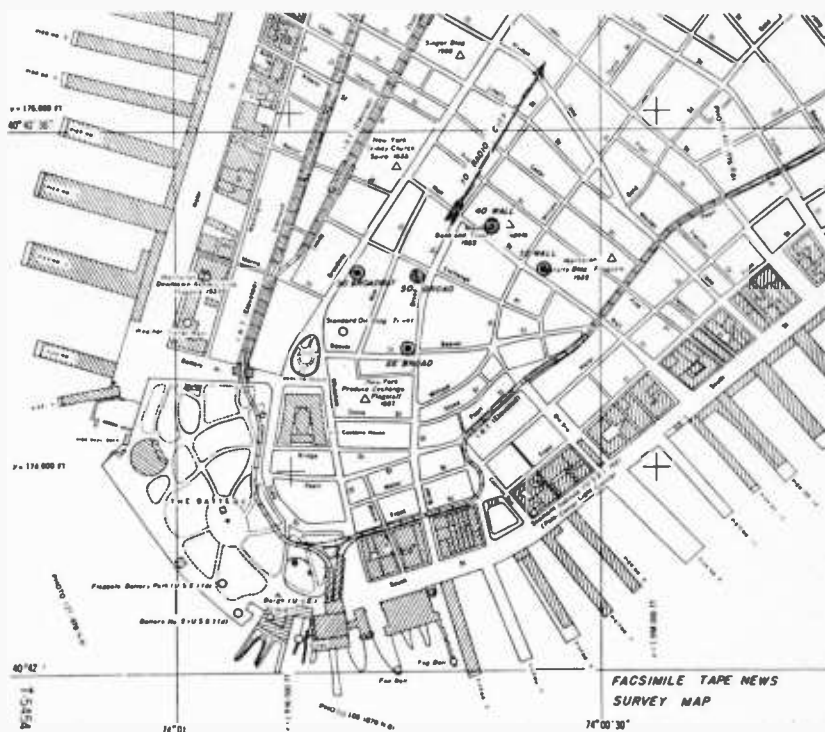

Fig. 2—Area covered by the local survey.

heterodyne receivers were used, and their outputs operated the tape facsimile recorders.

A typical example of the installation used in this test is shown in Figure 3. The equipment installed in the cabinet is shown at the left of this figure. The tape facsimile recorder is located on the top shelf. The center shelf contains the radio receiver, and the bottom shelf contains a rotary converter for use in locations not supplied with 110-volt a-c power. The complete installation with the cabinet door closed appears on the right. A photograph of the tape facsimile recorder appears in Figure 4.

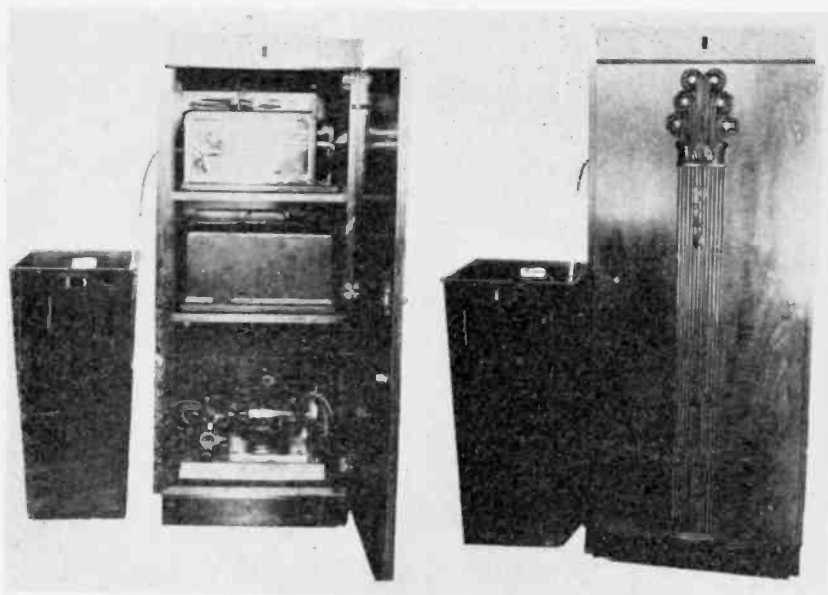

Fig. 3—Typical tape facsimile recording installation.

Figure 5 is a sample of tape recorded under ideal conditions. The irregularities introduced by radio circuit conditions are illustrated and described in the following figures and text.

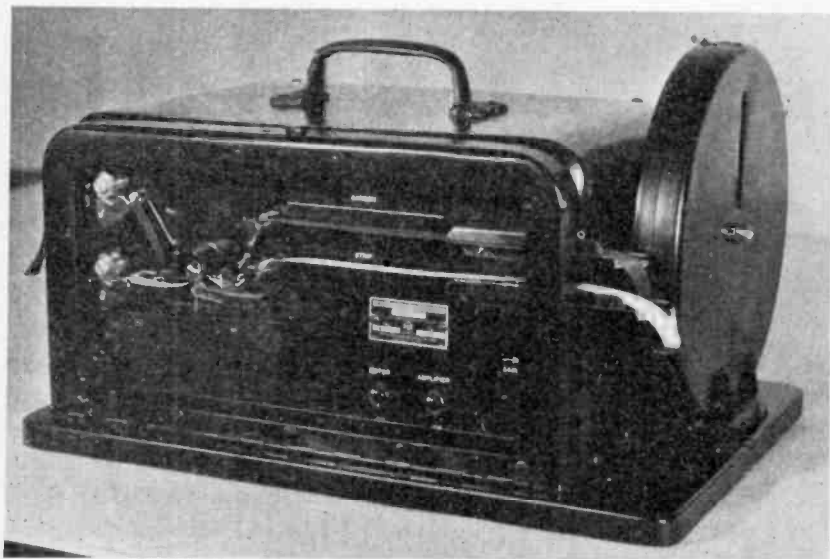

Fig. 4—RCA tape facsimile recorder.

AIRCRAFT AND POLICE SERVICE

Early in 1935 an extensive survey of the airlines and their requirements was planned. Therefore, in January, 1936, after six sets of equipment had been built, a circuit was set up between Newark and Chicago on the American Airlines. On this circuit 1 kilowatt transmitters and superheterodyne receivers were used. The facsimile signals were transmitted by keying the buffer stage of the transmitter. This test lasted only two weeks because of the interference from other stations on the same frequency (10190 kc). Three things of value were learned in this test. First, the equipment had to be made more compact before its use could be considered on the average airline; second, while a



FIG. 5



FIG. 6

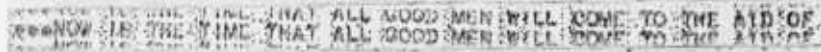

FIG. 7

Tape facsimile recordings.

signal was good enough for Morse Code transmission it was not necessarily good enough for facsimile because of short time interval fading, due to multi-path effects, and third, these echoes or multi-path transmissions are composed of a number of waves, spaced at varying time intervals from the original wave, and produce a multiple recording as shown in Figure 6. One wave is usually of much greater amplitude than the rest, so that if the recording amplifier threshold is automatically varied by the signal strength, the waves of lower amplitude may be eliminated.

The equipment was next transferred to the Transcontinental and Western Air Lines radio circuit between Chicago and Kansas City. Here, operating on frequencies of 2710, 4110, 6510 and 8015 kc on one-kilowatt transmitters and remote-controlled receivers, results were essentially the same as observed on American Air Lines tests. At the Chicago station we had an opportunity to observe the effect of ignition noise on the copy. A sample of the tape showing this ignition noise is shown in Figure 7.

It was noticed that the noise affecting the recorder always made black dots in the white spaces, but seldom made white spots in the black copy. From this it was assumed that better results



Fig. 8—Special tape facsimile typewriter and transmitter.

could be obtained by operating with carrier on for white, and off for black copy. In other words, reverse the polarity of keying. The correctness of this assumption was borne out by laboratory tests.

Early in 1936 two sets of facsimile tape equipment were set up on the Eastern Airlines Miami-to-Atlanta radio circuit. Here tests were run for short periods each day for a week. Observations indicated that bad echo effects can cause trouble even within the range of the strong ground wave. This same trouble was later observed at Camden within six miles of the station. The sky wave in this case was reduced by selecting a directive antenna with a low reception angle.

The Department of Air Commerce was interested in tape facsimile equipment as a possible means of transmitting weather reports over an ultra-high-frequency relay link connecting all airports. Two sets of equipment were installed for them between Silver Hill and Sparrows Point, Maryland. This link operated on 61 and 65 megacycles and was 300 feet below the line of sight at the Sparrows Point end. Except for a period of noisy operation caused by a loose antenna, this circuit operated with perfect satisfaction. However, the machines were not satisfactory from an operating standpoint because of the delay in conveying the message from the typewriter to the scanner.

Combining the results of the tests described above a new machine (See Figure 8) was designed and two models built. These machines were so designed as to reduce the time delay between the typewriter and the tape facsimile scanner. The recorder amplifiers were designed to include automatic input limiting. The transmitter could be keyed with signal on white or signal on black by throwing a switch at each station. When these machines were completed, they were placed on test in police service between Harrisburg and Reading, Pa., one leg operating on 1674 kc and the other on 190 kc. This circuit was operated for a few months by the state police and proved perfectly satisfactory for their point-to-point systems.

In the summer of 1937 a small portable recorder was built and tested on the RCA Manufacturing Company's experimental ultra-high-frequency transmitter. It was then mounted in a car and taken to Harrisburg for demonstration to the state police. The tests made at this time proved the practicability of a portable unit operating with a car-battery power supply.

Shortly after the above machines were built a test was made to determine the ability to operate at high noise levels. A circuit was set up between Central Airport, Camden and the RCA Laboratory in the Engineering Building, a distance of three

miles. The transmitter was arranged so that the power could be varied from 15 watts to 0.002 watts into the antenna.

The results of these tests are shown in Figure 9.

TEST No	ANTENNA INPUT POWER (WATTS)	RECEIVER OUTPUT IN VOLTS	AVERAGE NOISE IN VOLTS	PEAK NOISE IN VOLTS	TELEPHONE RECEPTION	CW TELEGRAPH RECEPTION	TAPE SAMPLE
1	15.0	.65	UNMEASURABLE	.1	GOOD	GOOD	a
2	.15	.65	.25	9.0	GOOD	GOOD	b
3	.064	.65	.30	10.0	FAIR	GOOD	c
4	.015	.65	10.25	10.25	NIL	FAIR	d

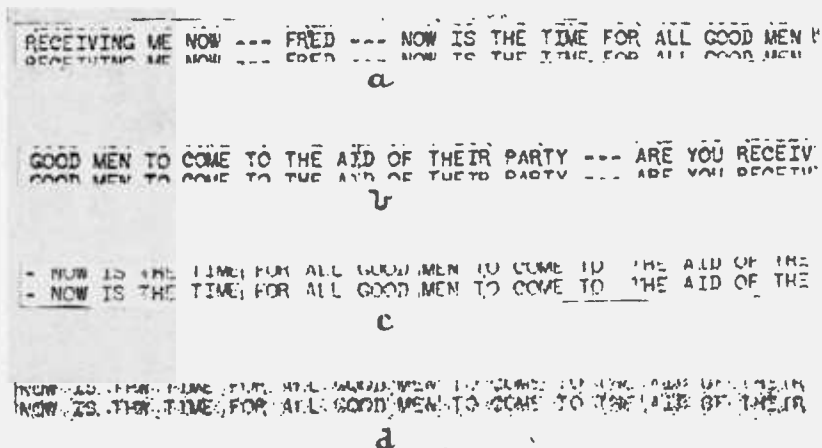

Fig. 9—Results of tape facsimile tests in areas having high noise levels.

CONCLUSIONS

The results of the tests and surveys herein described indicate that tape facsimile systems may be successfully operated over radio circuits not subject to serious multi-path phenomena. Interference such as static, ignition noise, etc. will mar the copy, without greatly reducing its intelligibility as long as the signal-to-noise ratio remains within reasonable limits. In the event that the signal-to-noise ratio is low and a letter or group of letters is obscured by the noise, it will be obvious to the observer that this portion of the message is questionable. This is a decided advantage over such systems as Teletype printers, where a distorted signal may cause misprints that are not perceptible to the observer.

This advantage is offset to some extent by the radio circuit requirements for the transmission of tape facsimile signals as compared to other printer systems. The keying speed required for the transmission of tape facsimile signals is quite high compared to that of the other tape printer systems for the same rate of transmission. The higher keying speed produces wider sidebands than can be tolerated on some radio circuits. For this reason, tape facsimile systems will probably be operated over ultra-high-frequency channels, where band width requirements are of less importance.

A tape facsimile recorder lends itself to a compact, lightweight design, ideally suited for aircraft and other mobile services. It is particularly advantageous in police work where secrecy of transmission is important.

RADIO WEATHER MAP SERVICE TO SHIPS*

BY

IRVING F. BYRNES

Chief Engineer, Radiomarine Corporation of America

AND

CHARLES J. YOUNG

Research and Engineering Division, RCA Manufacturing Company, Inc.
Camden, N. J.

Summary.—Over many months of regular operation by Radiomarine Corporation of America, the daily weather map transmission has proved to be a reliable service. Thus facsimile picture transmission, one of the latest radio developments, has been put to work as an important aid in the promotion of safe and comfortable travel at sea.

THE steady growth of scientific knowledge is constantly making possible new services to man. In the marine field the latest of these is a radio weather map service available to ships in the North Atlantic Ocean. By its means weather maps, expertly drawn in New York City by the U. S. Weather Bureau, are daily transmitted by radio facsimile and are received on board ship in exact duplicate, just as if a carbon copy had been miraculously delivered in a twenty-minute interval. The facilities which make this possible are supplied by the Radiomarine Corporation of America and have been developed over a period of several years by the coöperation of three Radio Corporation of America companies.

The pioneer work in this field was begun by R.C.A. Communications in 1930 when a number of maps and pictures were successfully transmitted from New York City to the S.S. *America* during the crossing to and from Europe. The installation was then removed from the ship and the project continued in the laboratory of the RCA Manufacturing Company. The apparatus was simplified and the method of recording changed. Then arrangements were made to continue the tests at sea.

During the next two years the equipment was operated on four different ships and made a total of 12 round trip voyages to Europe. These repeated trials under operating conditions have made it possible to work out the important technical and operating requirements for such a service. The best systems of trans-

* Prepared Jan. 12, 1934 and Revised Oct. 28, 1936.

mission, the proper wavelengths, the best design for the ship apparatus, and effective operating techniques have been established.

THE VALUE OF THE WEATHER MAP

The actual apparatus as now set up for the transmission and reception of the weather maps will be described in detail further on. Meanwhile it is worth reviewing briefly the nature and use of a weather map. The best known map is the one of the United States published daily by the U. S. Weather Bureau. It shows by means of isobars the distribution of barometric pressure, it shows the areas where rain or snow has fallen, and it gives the strength and direction of wind at each reporting station. Storm areas are readily located and their probable direction of travel seen. With this map and a little experience one may note and predict the coming weather conditions with reasonable success. In fact these maps are finding a steadily increasing demand among the many people whose business is affected in one way or another by the weather.

If a map of this sort is useful to those on shore, it is obviously much more valuable to those called upon to navigate ships at sea. But before the development of radio it was not available to them, first because the data for preparing it could not be collected over the ocean areas, and second because there was no way of delivering it if it could be drawn. Therefore navigators continued their original methods of weather prediction, observing the local conditions of barometer and sky and drawing on their experience for the probable conditions to be expected. Of course this procedure was fairly satisfactory when sailing from New York to Europe as the weather ordinarily moved along with the ship in the same direction. On the return voyage however, one was continuously meeting new weather which steadily advanced from the west bringing constantly new conditions.

With the advent of radio communication the condition was much improved because weather data could be procured. The regular facilities set up by the Radiomarine Corporation of America and the U. S. Weather Bureau provided means by which observations were obtained daily from many ships in the North Atlantic. These reports could then be coördinated and a daily forecast broadcast along with the daily news bulletins. Thus it became possible for the captain to anticipate approaching storms, fog areas and so on. And yet it should be noted that the

exact position of a storm area could not be obtained from such a weather report, and resort was often had to requesting special data from surrounding ships. Sometimes the information was available, sometimes not.

The difficulty, however, was with the written weather report, not with the Weather Bureau. They knew precisely what the conditions were from a map prepared from the radioed observations covering the whole area in question. If a hurricane was just passing out into the Atlantic from Cuba, as it did last fall, their maps showed not only its location but its extent, rate and direction of travel. The brief weather reports to the ships, however, could not tell the whole story and it was difficult for a captain to be sure just how extensive a stretch of rough going was ahead. On the other hand, with maps available he could study the desirability of holding the regular course or of detouring slightly if the disturbance was not too large. It might be possible for him to save delay in docking and consequent fuel expense, and to greatly lessen the discomfort of the passengers.

At this point the new facsimile weather service makes its value felt. An exact duplicate of the map drawn by the Weather Bureau's expert can be delivered by radio transmission every morning. It gives the captain and navigator all the information available anywhere over the ocean and puts them in as good a position to predict tomorrow's conditions over their particular course as is the Weather Bureau. It gives them the sort of data upon which the large dirigibles depend. The airship *Macon*, for example, always carries a weather expert, and his map is the basis for constant analysis of air conditions and for setting the course of the ship.

PREPARATION OF WEATHER MAP

The system by which this sort of service is made available to ships begins with the Weather Bureau office in New York City. Here Dr. J. A. Kimball, who has long specialized on the North Atlantic area, receives the observations radioed from ships every morning. They are then coördinated with similar data from North America and plotted on a large map. When the proper analysis of pressure distribution is obtained, an inked copy of the map is delivered to the office of R.C.A. Communications, Inc. at Broad Street. At 11 A.M. Eastern Standard Time transmission is begun and by 11:25 it is completed.

TRANSMISSION OF THE MAP

In making the transmission R.C.A. Communications, Inc., use their regular photoradio equipment, developed to its present



Fig. 1



Fig. 2

perfection after many years of painstaking effort, and now used in commercial picture service between New York, South America, and many countries in Europe. In other words, an actual

black and white picture of the weather map is sent out from the scanning apparatus in New York. The actual scanning machines are shown in the center and at the left in Fig. 1, the machine at the right being a monitor recorder to indicate that proper adjustments are constantly maintained. In the racks at the right are mounted the picture amplifiers used in transmission and reception. By means of the plug board connections can be made to the various control line pairs to the radio stations. Fig. 2 shows another view of the machines and also the three racks of synchronizing apparatus. Tuning fork frequency standards, operating through load amplifier, provide the extremely constant speed control which is required. Duplicate equipments are provided to insure uninterrupted service.

The method of scanning is such that the machine analyzes the picture (in this case a map) to be sent and converts it bit by bit into electrical impulses, the character and sequence of which correspond to the changes from white to black as the area of the picture is explored. The purpose of the tuning fork frequency standards is to very precisely control the speed of this scanning. The electrical impulses are obtained in the form of a control tone which is sent by wire line to the high power transmitters at Radio Central. These transmitters then relay the impulses from their special antenna systems in the form of high power radiation. During all map transmissions the outgoing signals are again monitored at the R.C.A. Communications receiving station at Riverhead, Long Island.

The proper radio frequencies on which to broadcast the signals to ships has been the subject of much special study. As a result certain bands of frequencies have been chosen for different seasons and conditions. It is anticipated that the transmissions will be made simultaneously on two frequencies, one useful for ships near America, and the other a higher frequency for ships near Europe. Six thousand kilocycles can be used for the first few days out of New York City, and approximately 14000 kilocycles for greater distances. The large number of frequencies and high powers available at Radio Central make possible the reliable transmission of the maps under practically all circumstances.

SHIP INSTALLATION FOR RECEPTION OF THE MAP

The equipment used on shipboard to record the facsimile maps has been developed over a period of several years of work in the laboratory of the RCA Manufacturing Co. Other picture

and facsimile systems have been studied, and their best features have been used. An entirely new and simplified method of recording has been devised. As a result an apparatus suitable for shipboard use has been produced.

Fig. 3 shows the front view of the equipment now installed



Fig. 3

on transatlantic liners. It is 53 inches high, 21 inches wide, 14 inches deep, and includes everything necessary except the radio receiver to be used with it. At the top is the recording machine proper which prints the received map on a sheet 8½ inches wide and 11 inches long. The printing is by a carbon paper process and long rolls of white and carbon paper are mounted in the back of the machine. Thus the recorder is always loaded and

ready to receive a map. It prints continuously as the paper is fed slowly up, and no subsequent processing of the copy is required. Each part of the map is visible a few seconds after it has been received, and the completed sheet can be delivered to the navigator immediately at the end of the transmission.

In cases where extra copies of the received map are required, the recorder may be loaded with hectograph carbon paper. The master copy thus obtained may then be duplicated in a ditto machine of the sort regularly used in offices.

Below the recorder the rack contains three panels. The upper one is the recording amplifier. This unit takes the signals from the radio receiver, amplifies and reshapes them, and actuates the printing mechanism in the recorder. The panel at the bottom of the rack is a tuning fork frequency standard which controls the power supply panel above it and thereby regulates the speed of the motor on the recorder. By this arrangement an extremely constant speed is obtained so that the impulses received will lay down black spots on the paper in exactly the sequence needed to generate a facsimile of the original map.

It is possible to receive the facsimile radio signals on the regular ship's receiver, but it has been found better to use a special receiver for this purpose with its own receiving antenna. Accordingly, one is supplied as a part of the facsimile equipment and is permanently adjusted for this service only.

Installation is made in the ship radio room by bolting the rack of apparatus to the deck and placing the receiver where it can be conveniently tuned by the ship's operator. The entire apparatus, including the receiver, is designed for the usual ship power supply of 110 volts d.c., no batteries or other power being needed.

Facsimile recording on board ship is easily handled by the radio operators. The apparatus is turned on fifteen minutes before the start of the schedule, the adjustments are checked as the first signals are received, and thereafter until the end of the recording a half hour later little attention is required.

QUALITY OF SERVICE RENDERED

The type of map which is delivered on the ship is shown in Figs. 4, 5, and 6 which are photographs from the ship recordings. They are, of course, reduced in the photographing from the original 8½ x 11-inch size and some detail is lost in the process. Fig. 4 shows two interesting maps received during the period

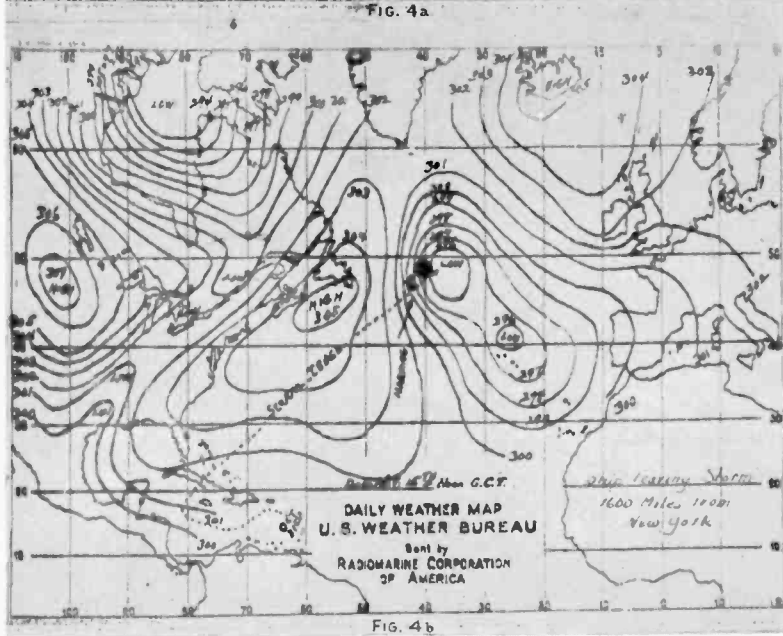
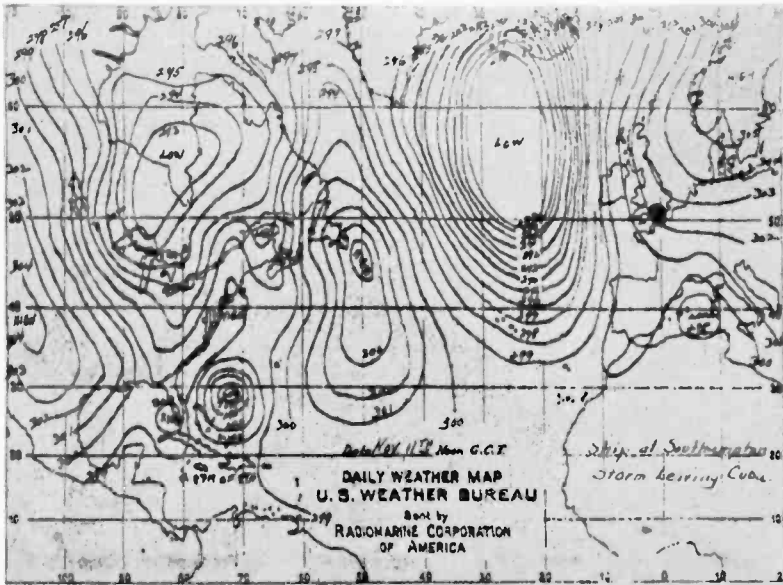

Fig. 4

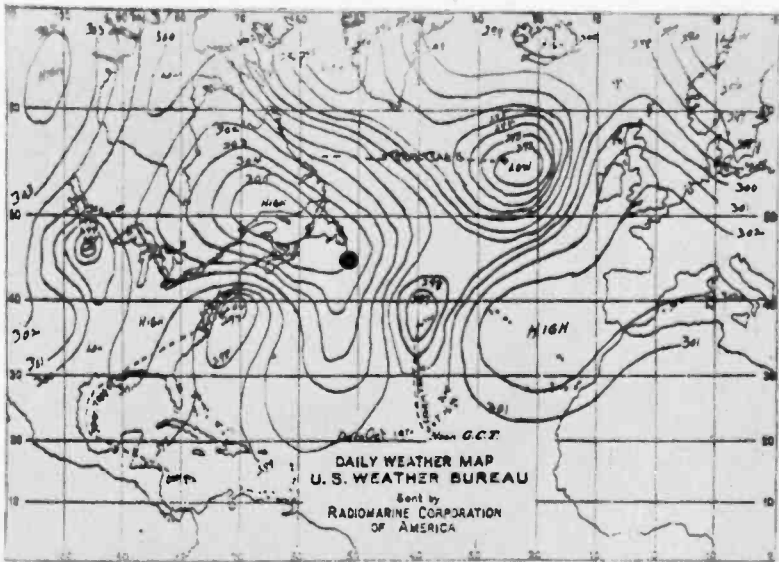

FIG. 5a

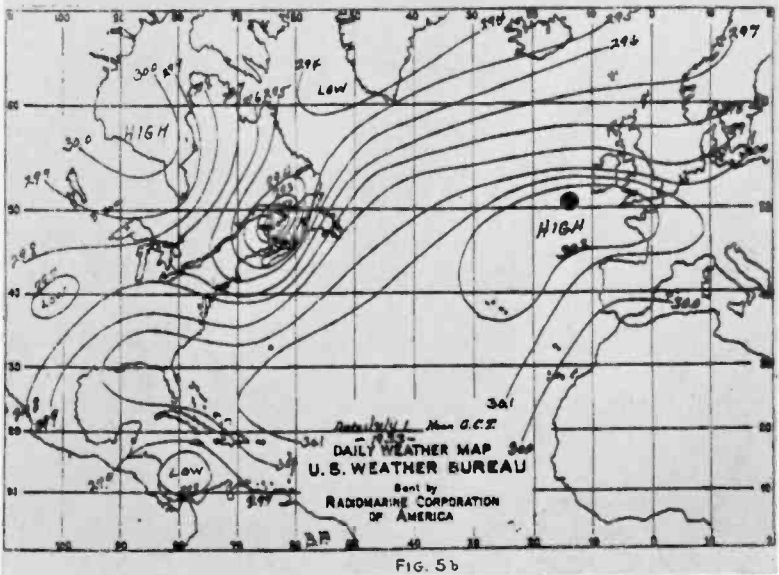

FIG. 5b

Fig. 5

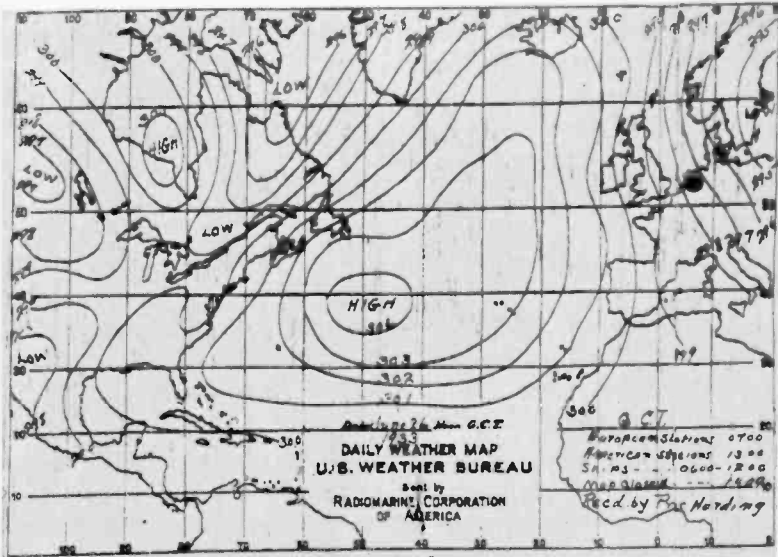

FIG. 6a

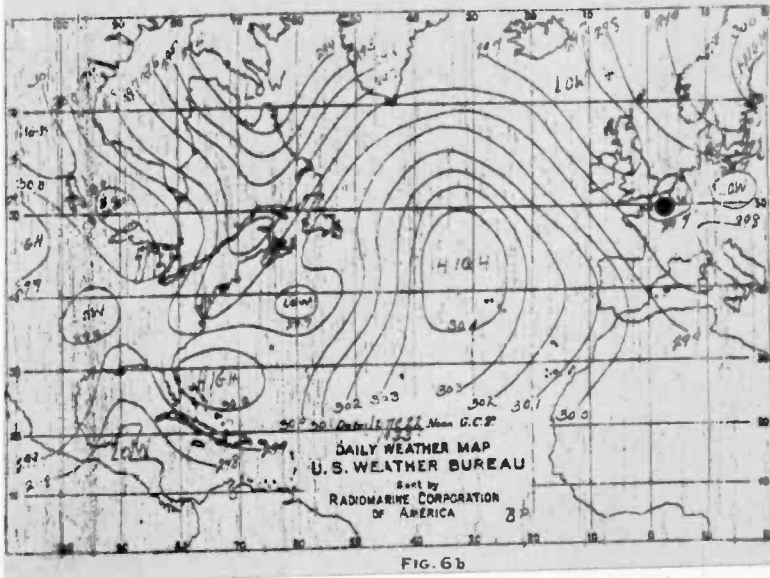

FIG. 6b

Fig. 6

of the hurricane which caused so much damage in Havana in November, 1932. On November 11th, Fig. 4a shows the ship at Southampton and the storm heading for the North Atlantic after passing over Cuba. Fig. 4b shows the conditions four days later just after the ship had passed through the storm center. Very rough weather was encountered. In the case of a localized disturbance of this sort it seems likely that time and much discomfort to the passengers could be saved by making a slight detour from the usual course.

Other samples of the maps received are shown in Fig. 5. In each case the position of the ship is indicated by a black circle. Fig. 5a, recorded 800 miles from New York, shows another stormy condition, this time including three disturbances, two moving up from the South Atlantic and one approaching the coast of Ireland. Fig. 5b, made 2700 miles east of New York shows much calmer conditions.

Occasionally, as in all other radio transmission, interference and fading tend to damage the reception. Fig. 6a, recorded at the dock in Hamburg and 6b at Havre, show the effect of interference from electrical loading machinery. The appearance of the copy is degraded, but the intelligibility of the weather data remains unaffected. Similar inductive interference from electrical motors on shipboard sometimes occurs. Fading of radio signals is encountered, but rarely affects the recorded map to any extent because of the precautions taken against it. The special radio receiver employs an automatic volume control, and further limiting of the strength of the impulses is provided in the circuits of the facsimile apparatus. In cases where the radio signal fades out entirely for a moment a few white lines will appear on the record. These gaps never cover sufficient area to make the map unusable.

PART IV

FACSIMILE BROADCASTING*

By

D. E. FOSTER

RCA License Laboratory

FACSIMILE transmission has been in commercial operation for several years in certain public point-to-point services, by both wire line and radio. It has not been introduced into broadcast services except for certain experiments in connection with broadcasting weather maps to ships at sea, but recently interest has been shown in the possibility of home broadcasting by a number of sound broadcasting stations.

Perhaps the most important fundamental consideration in connection with facsimile is the wave frequency, or wave length, upon which the service is to be conducted. The choice in this characteristic has far reaching effect not only on technical matters, but upon the kind and extent of service which can be rendered, and upon the economic aspects of the problem. It is important to understand the reasons for this. If facsimile is conducted on ultra short waves, the service is open to the same conditions and limitations which apply in the case of television on ultra short waves, namely that new transmitters are required, that the service area of any one station is very limited, that very few stations are in existence, that years would be required to build any considerable number of stations, and that the rural areas would not have service for an indefinite and lengthy time. On the other hand, if facsimile is conducted on the ordinary sound broadcast frequencies, existing transmitters can be used merely by adding a scanner to replace the microphone, service areas will be identical with those now had with sound, including rural areas, and in general a nation-wide, satisfactory service could be accomplished within merely that length of time necessary to build the scanners for the transmitting stations, and the receivers for homes and offices. It is thought that ultra short waves present more possibility for future improvements of facsimile in respect to more detail in the pictures, color pictures,

*Taken from RCA License Laboratory report issued April 25, 1938.

etc., than can be accomplished on the regular sound broadcast band with its limited 10 kc frequency channel assignments, but this ultimate perfection possibility of the ultra short waves must be balanced against its accompanying condition that years would be required to establish a service of any magnitude on these frequencies. Therefore, to many persons who have considered this situation, it appears to be best policy to initiate the service on standard frequencies and extend it later to ultra short waves, if necessary or desirable. Additionally it appears logical that both sound broadcasting and facsimile broadcasting will be permanent services, even after television has become well established, and that they (facsimile and sound) would be helpful to each other toward providing a more useful and more attractive service in competition with television, particularly for rural areas, where television will presumably be long delayed. Furthermore, it is felt by many that facsimile presents a possible and needed new service which would have the same beneficial effects on the radio industry as were experienced some years ago from the introduction of "all-wave" reception, and probably even to greater degree.

It is often felt by those who have not studied the subject thoroughly that facsimile transmission would have little public usefulness because newspapers and magazines do such a good job of printing words and pictures. This conclusion takes no account of the fact that, while we now necessarily think of facsimile program material only in terms of other printed material familiar to us, new program material suited to that new medium will be developed after a facsimile service starts, which is not suitable to and therefore not used by, existing printing media. The *fundamental* fact is that facsimile broadcasting, on sound wave frequencies at least, makes it possible to *print pictures and words instantly in every home and office throughout the country*. It seems very likely that there is material suitable for such printing which has not been used in other printing methods which require days and weeks for distribution. Similarly in the beginning of sound broadcasting, the best types of program for radio were not known, and it took several years to find programs best suited to radio. In other words, there was much doubt in the early days of sound broadcasting, just as there is now about facsimile, as to what to use for program material. This question will solve itself when the facilities are available—in fact, that is the only way in which it can be solved.

FUNDAMENTAL TECHNICAL CONSIDERATIONS

Frequency Band

Facsimile transmission at speeds of four or five 8½" x 11" pages per hour with 125 lines per inch definition, is accommodated readily in a ten kilocycle channel, so that the standard broadcast band can be used. Initially, the service is expected to be entirely satisfactory in the primary coverage area of the broadcast transmitter, but eventually there is little doubt of its being extended, through improvements in receivers and transmitters, so that any locality in the country now obtaining satisfactory broadcast sound reception will have facsimile service available. That nation-wide coverage can be accomplished in a relatively short space of time, results from the fact that facsimile modulation is no different in essential propagation characteristics from telephone or sound modulation, so that where sound works properly, facsimile will. Facsimile thus offers attractive possibilities of supplying a service of graphic or textual material in rural areas, a possibility, which in the case of television, is much more remote. If there arises a demand for considerably higher speeds of reproduction, or color pictures, greater band widths will be required. Recourse to the ultra high frequency band will provide the necessary channel width for such high speed transmission. In fact, the ultra high frequency band with its freedom from fading and its absence of atmospheric static is attractive for facsimile service. Its main disadvantage is the limitation of transmission, as in the case of television, to substantially line-of-sight, with the consequent difficulty in giving service to rural areas. Technical and service conditions indicate that the best eventual arrangement is a facsimile service of perhaps five pages per hour on the broadcast band, primarily for the rural areas, and possibly a higher speed service on the ultra high frequency bands for the urban areas.

Standards

It is obviously desirable that any facsimile receiver be capable of reception from any facsimile transmitter. In order that this be possible, adherence to a number of standards is necessary.

The Radio Manufacturers Association has adopted certain standards applying to facsimile, although not nearly all those necessary to industry interchangeability. Since the standards adopted to date are definitions, they are given here and discussed later in this bulletin.

Facsimile—

Facsimile is the electrical transmission of graphic or textual material and its reception as a recorded copy.

Scanning—

Scanning is the process, in transmitting, of analyzing successively, according to a predetermined method, the light values of elements constituting the subject area, or correspondingly synthesizing in receiving.

Scanning Line—

A scanning line is a single continuous narrow strip which is determined by the process of scanning.

Normal Scanning—

Normal scanning is that in which the scanning point moves at a constant rate from left to right in parallel equi-distant straight scanning lines, these lines being taken progressively from top to bottom of the subject area.

Scanning Line Rate—

Scanning line rate in normal scanning is the number of lines traversed per minute.

Facsimile Index—

Facsimile index in normal scanning is the product of the total length of a scanning line in inches by the number of scanning lines per inch.

Positive Transmission—

Positive transmission occurs when an increase in initial light intensity causes an increase in the transmitted power.

Negative Transmission—

Negative transmission occurs when a decrease in initial light intensity causes an increase in transmitted power.

These standard definitions cover the main items on which agreement must be reached before complete interchangeability of equipment can be realized. To achieve that end, the method of scanning must be fixed, the number of lines per unit time must be fixed, a numerical value for the index must be agreed upon, and the transmission polarity chosen. There are no industry standards fixing numerical values for these essential factors at present, but such standards should soon be adopted if progress in the field is to be orderly and efficient.

DETAILS OF CERTAIN TECHNICAL FACTORS

Scanning

The material to be transmitted is broken up electrically into individual elements corresponding to the use of a screen in photographic preparation of half-tones for printing. The scanner phototube then scans each element in turn and transmits an electrical impulse proportional to the light value of each individual element. The element being scanned is illuminated by a light source through an aperture focussed on the subject. The basic picture element is usually square, having as many elements per inch along each individual line as there are lines per inch. When 125 lines per inch are used, each element is 0.008 inch square. The basic output from the scanning phototube is therefore a square wave, but in practice becomes trapezoidal in shape due to the finite width of the scanning aperture. If the aperture is the same width as the element, the wave shape becomes triangular. An aperture of infinitesimal width will give the desired square wave, but would not admit any light to the phototube, so that a compromise must be made between low phototube output and aperture distortion of the wave shape.

If the material to be scanned is wrapped around a rotating drum, the scanning will ordinarily be progressive (RMA normal scanning is left to right), and if the material is on a flat surface the scanning is usually alternating, left and right on successive lines. The progressive, unidirectional scanning method requires less accuracy in the mechanical gearing and less accuracy in synchronizing, and therefore is to be preferred. This can be appreciated if the effect of any lack of synchronism on the two scanning methods is considered. With unidirectional scanning equivalent positions on each scanning line will be progressively shifted in one direction, so that the copy is skewed on the sheet at the recorder. With back and forth scanning, alternate lines are shifted in opposite directions in progressively increasing amounts resulting in destruction of much of the detail. Of course, if the return strokes in an oscillating system are not used, this method can become similar to normal unidirectional scanning, but only at the expense of a considerable loss of time on the circuit.

Facsimile Index

The product of the total length of scanning line and the number of lines per inch gives the facsimile index. In order for a recorder to operate correctly on a given facsimile transmitter,

it is not necessary that both have the same length of scanning line, but merely that both have the same index. For example, if the transmitter has a total length of scanning line (usually referred to as stroke length) of 8 inches and transmits 120 lines per inch the index is 960. At the recorder, the copy may be 4 inches wide, in which case it must have 240 lines per inch, or it may be 16 inches wide with 60 lines per inch or any other value for width and lines per inch provided their product is 960. This merely amounts to a reduction or magnification of the copy. It is of course likewise necessary that the number of scanning lines (strokes) per minute be the same at the transmitter and receiver.

A large index means good detail and a large amount of copy per inch of length and from that standpoint is desirable, but it likewise means greater precision in manufacturing because the combination of wide page and many lines per inch necessitates small tolerances in recorder manufacture.

Use of Sub-Carrier

Facsimile copy requires the transmission of substantially zero frequency, (i.e. direct current) when large black areas are scanned. Direct current amplification is extremely difficult and unreliable due to the stringent voltage regulation requirements. In order to avoid d-c amplification a sub-carrier tone is used. This sub-carrier is modulated by the picture frequency and is in turn used to modulate the radio carrier. At the receiver, an additional detection is required prior to the output stage to obtain the d-c picture modulation of the sub-carrier. The sub-carrier is ordinarily between 2000 and 4000 cycles, depending upon the highest picture modulating frequency.

Band Width Requirements

The band width, or highest audio frequency, depends upon the definition and speed of copy transmission, and the more picture elements there are per unit of time, the greater is the band width. The sub-carrier frequency also enters, but that is likewise influenced by the speed and detail. For example, with 125 lines per inch transmitted 75 strokes per minute with a total length of stroke of $8\frac{3}{4}$ inches, the fundamental picture element frequency is 684 cycles per second. This frequency is however not a sine wave in shape, but is trapezoidal, so that harmonics of the fundamental frequency must be transmitted if the wave shape at the recorder is to be like that at the scanner. It is

ordinarily assumed that the third harmonic should be transmitted, in this case 2052 cycles. The sub-carrier tone frequency must be higher still so that several cycles of sub-carrier are included in the highest picture element frequency. With a sub-carrier of 3200 cycles, in the example given for detail and speed, the highest audio frequency would be 5252 cycles or a band width of 10,504 cycles, slightly over one broadcast band channel. The lowest audio frequency to be passed by the receiver is 1148 cycles, so that good low frequency fidelity is not needed for facsimile reproduction. In practice the frequency band need not be as great as here calculated. This is because it is not usually necessary to carry the third harmonic of the keying frequency to produce an acceptable dot. It is also found that the upper side band above 3200 cycles can be largely eliminated without greatly damaging the recording.

The detail and speed given in the example are about maximum for this type of transmission over a broadcast band channel. If materially greater speed is desired, the communication channel width must be correspondingly increased, which means, under present frequency allocations, going to the ultra high frequency band.

Half-Tone Reproduction

For reproduction of printed matter or line drawings, only full black and full white are required, but for reproduction of pictures generally, a variety of intermediate tone values is needed. The simplest method of deriving the intermediate tone values is by ordinary amplitude modulation of the sub-carrier frequency. The transmission may be in either phase, giving negative or positive transmission, but usually negative transmission is used so that maximum intensity occurs on black. Full black then is adjusted to give 100% modulation of the sub-carrier, full white giving zero modulation, and the intermediate gradations of the picture varying the modulation proportionately.

The amplitude method of half-tone modulation is good where the signal is not subject to fading, so that it is limited to the primary coverage area of the station for reliable service. For commercial transatlantic service a different modulation system is used, which might be better for domestic broadcast facsimile where rural coverage in the secondary area of the station is desired. Fading on the broadcast band in the secondary area is seldom as severe as on transoceanic short wave signals, so that

experience may show that amplitude modulation is satisfactory. If not, resort can be had to the dot method of modulation at the transmitter without requiring any change in the receiver.

The dot method generally used now is the constant frequency variable dot system, commonly referred to as the CFVD system. In the CFVD system electrical screening is added to the picture signal, breaking the picture up into dots before modulating the transmitter. A sub-carrier can be used as with amplitude modulation to avoid the use of d-c amplifiers. The screening process, performed by the addition of a triangular wave to the picture signal, causes the transmission to be in the form of dots of varying length along the scanning line. Dense black causes a series of long dots, with substantially no space between them, to be transmitted, light gray causes narrow dots to be transmitted with considerable space between each dot. For full white no dot at all (no sub-carrier) is transmitted. The sub-carrier is held at constant full amplitude, but is keyed by the picture off and on in accordance with the gradation from black to white. This CFVD method of half-tone modulation introduces complexity at the transmitter, but not at the receiver.

Synchronizing

It is obvious that the scanner and recorder must be kept constantly in step for good reproduction. This involves two types of synchronizing, first precise speed control, and second line synchronizing or framing. The simplest system of speed regulation, and one which gives consistently reliable results when transmitter and receiver are on the same or interconnected power systems, is the use of synchronous motors at the scanner and recorder. The synchronous motors cause the recorder and scanner speeds to be the same and to keep in step.

For receiving locations where there is no network electric power, or where the power circuit frequency differs from that at the transmitter, other means of line synchronization is necessary. The synchronizing methods for use in transoceanic facsimile involve maintenance of accurate tuning-fork frequency standards which in turn control motor speeds at transmitter and recorder. For home facsimile recording such means are too complex and expensive, so that some system will probably be evolved using a control frequency transmitted along with the picture. Such systems are known, but to date have been likewise too complex for home use.

In addition to the requirement that the speed of travel of the light spot at the scanner and the printing point of the recorder be the same, some means is necessary to make sure that the recorder starts printing at the proper spot on the sheet. If this is not done the picture will be displaced on the sheet, the edges of the picture not being in the proper place. This line framing signal is usually accomplished by sending out a special framing signal at the start of transmission or at the start of each page of copy.

Recorders

Several different printing means have been developed for recording, among them being photographic, ink spray, carbon paper, and sensitized or electrolytic paper. The two seeming to offer the best possibilities for home facsimile at present, are the carbon paper and electrolytic paper methods.

In the electrolytic method, the printing point at the recorder traverses a treated paper, the flow of current through the paper causing a darkening proportional to the current, and thus building up of the image. The paper must not only be specially treated, but often must also be moist for electrolytic action to take place. The paper should be sensitive to current flow, so that high recording speeds may be employed without requiring large currents. However, it should not be sensitive to light, and should not require a photographic process after electrolytic printing. Papers have been developed which meet these requirements to a large degree. The principal objections to the electrolytic method are the relatively expensive paper, due to the treatment required, and the problem of handling a moist sheet. In some cases the paper has been caused to pass between heated rolls before leaving the recorder to iron out the wrinkles and dry the paper.

In the carbon paper process, inexpensive paper is used, a grade equivalent to news-print being quite satisfactory, a sheet of carbon paper being interposed between the printing point and the white paper. Pressure of the printing point in response to facsimile signals causes the carbon paper to mark upon the white paper and thus develop the picture.

The carbon paper process is attractive from the standpoint of low operating cost. Calculation shows that the cost of both white and carbon paper will amount to approximately one-half cent per hour of operation.

EVOLUTION OF STANDARDS

It has been pointed out that standards are needed for home broadcast facsimile service. There are certain basic considerations leading to the choice of system constants and by reviewing these basic factors, an approach to facsimile standards may be realized.

Lines per Inch

The existing standard of definition for newspaper printing forms the basis for determination of the desirable fineness for facsimile scanning. Newspaper experience seems to indicate that the average man cannot read comfortably type smaller than 6 point. Most newspapers are using a 6 or 7 point type. If a smaller type face were sufficiently legible it would probably be adopted, as the cost of paper for a given number of words of text is an important item.

The lower case letters of 6 point type measure 0.042 to 0.048 inch high depending on their design. Scanning 125 lines per inch will allow 5 to 6 lines to form the shape of the letter and it is generally conceded that a letter cannot be defined adequately with fewer strokes. Experiments with varying number of lines per inch for reproduction of typewriting showed that the letters were not well formed with less than 80 lines. With ordinary typewriting this leads to the same conclusion that 5 or 6 lines per letter are needed.

Tests made with scanning up to 200 lines per inch show that, in the present state of the facsimile recording art, the improvement in copy over that with 125 lines per inch does not seem justified. From the point of view of picture reproduction 125 lines per inch conforms well with the definitions obtained in newspapers when the customary 60 to 80 line screens are used.

Linear Speed of Scanning

This is perhaps the second fundamental constant and is tied up with the revolutions per minute of the scanning drum and the width of paper used. The maximum speed of the scanning spot along the line is usually limited by the printing speed of the system used. With the carbon paper and mechanical printer bar reproducing process, the limit comes at about 15 inches per second. Actually it has been found more practical to lower this speed, and for broadcast applications the constants chosen give a speed of 10.94 inches per second. If the definition along the line

were equal to the vertical definition of 125 lines per inch, the maximum fundamental keying speed would be 684 cycles per second. Mechanical designs of recorders now used do not actually reach this speed, resulting in somewhat less horizontal definition than vertical definition. There is thus room for improvement in recorders with the constants given.

Square Inches per Minute

This figure may be obtained directly by multiplying the width of the scanning line by the distance it travels in one minute, which, for the constants given, comes out 5.25 square inches per minute. In the actual machine this is reduced to $4\frac{1}{2}$ square inches per minute because of the allowance for framing signal and margins.

Length of Scanning Line

With a rate of 5.25 square inches per minute based on the number of lines per inch and the linear speed of the scanning spot, the length of scanning line can be chosen to give the desired width of recorded copy. This choice depends upon several factors such as the appearance of the recorded copy, the practical length of the printer bar (in systems where bar is used), reasonable size of recorder, etc. At present it is believed that experimental facsimile systems are using page widths from a minimum of 4 inches to a maximum of 11 inches. Effective picture reproduction is limited with a 4-inch width; on the other hand the recorder for an 11-inch sheet becomes bulky. The choice of $8\frac{1}{2}$ -inch wide paper is a compromise between these extremes. Based on this width paper, considerations of actual design have led to a total scanning line of 8.75 inches and a maximum type line on the page of $7\frac{1}{2}$ inches.

The four operating constants given are not basic factors for standardization because they are based on an assumed reproduced copy size. They do, however, furnish an approach to the standards of facsimile index and speed in lines per minute. These two standards in turn determine the desirable range for the frequency of the sub-carrier. The four remaining items necessary to standardization; type of motion of printing point, transmission polarity, modulation characteristic and type of synchronizing signal may likewise be approached from consideration of desirable operating constants, although here the factors to be considered are more diverse and the selection of standards correspondingly more involved.

FACSIMILE COPY

The form of program which will eventually be typical of facsimile cannot now be foretold. The facsimile program will evolve after experience with this means of broadcasting is had. The evolution of facsimile programs can be expected to follow a manner of growth similar to that of sound broadcasting, from its early experimental days, when the quantity and quality of programs appeared so limited, to the wealth of high grade broadcasting available to the listener today.

EQUIPMENT AND METHODS DEVELOPED FOR BROADCAST FACSIMILE SERVICE

BY CHARLES J. YOUNG

Research and Engineering Division, RCA Manufacturing Company, Inc.
Camden, N. J.

INTRODUCTION

SOME ten years ago, when the first extensive tests were being made of radio facsimile transmission for messages and pictures, the thought developed of using this process for actually printing a newspaper in the home by radio broadcast. It grew from a sudden realization that carbon paper offered a very simple way of making a mark on a piece of paper, and that it might be possible to design a mechanical scanning device which would spread carbon dots on the receiving sheet so as to form a facsimile reproduction. A stylus type of machine was tried first. In a short time, however, the printer bar and helix type of recorder was devised, and it then became apparent that a receiver simple enough for home use was an actual possibility.

During the years since then many machines have been built and many problems encountered and solved. In the recorder itself the printer unit is the heart of the device and this has been constantly improved with resulting better definition of copy. Various methods of synchronization have been investigated and some of them applied to actual operation. The structure of the recorder has passed through many stages from purely laboratory apparatus to finished designs for particular applications. Paper and paper-feeding systems have been studied. Some of this work was directed to commercial communication services, operating from shore to ship and from city to city; but the central and motivating idea has always been the one of making practical a facsimile broadcast service.

As work proceeded toward this objective, much assistance has naturally come from the parallel growth of facsimile or picture transmission equipment for wire-line and radio circuits.¹ In particular, many methods of printing the received image on the paper have appeared² and these have been tested and considered for the home

¹ The hearty cooperation of Mr. J. L. Callahan and his group at RCA Communications, Inc. has been helpful. Their system has been reported in "Photoradio Apparatus and Operating Technique Improvements," *Proc. I.R.E.*, Vol. 23, No. 12, Dec., 1935.

² "Photoradio Transmission of Pictures," Henry Shore, presented before the Photographic Society of America, April 26, 1937.

Reprint from *RCA Review*, April, 1938.

broadcast receiver. Each method has advantages and disadvantages, and they have been judged on the basis of the following factors:

- a) Appearance of finished copy, in terms of definition, color, etc.
- b) Sheet recorded damp or dry,
- c) Processing, if any, subsequent to recording,
- d) Possible speed of recording,
- e) Cost of paper.

After comparing in this way the various processes, it was concluded that, in the present state of the art, the carbon-paper recording was best suited to a home-use machine.

In addition to a long period of work on the sending and receiving apparatus itself, there have been a number of facsimile trials over actual radio circuits. The equipment made for receiving weather maps on shipboard had an extensive test over a span of several years, during which time evidence was accumulated on facsimile propagation in the range from 4000 to 18000 kilocycles. Early field trials of broadcast-facsimile receivers were made in Schenectady in 1929 in this same band. In New York City in 1931 broadcast operation was carried on for a short time on 2100 kilocycles. In 1932 further trials were made on 44 megacycles with the machines self-synchronized on both a-c and d-c power systems. More recently extensive studies were completed of ultra-high-frequency urban coverage with automatic recorders operating many hours per day. Naturally much information was accumulated on the effects of fading, interference, and multipath propagation. This mass of data was very helpful when it came to choosing operating standards for a broadcast system.

Having given this brief review of the background, the rest of this paper will be devoted to the actual equipment which is now available to broadcasters, in order that they may make such trials of broadcast facsimile as will demonstrate the public value of this new service. In designing the scanning equipment and the receivers this object has been kept in mind. In other words the receivers have been made as simple as is consistent with reliable performance and with clear printing of copy. All extra devices, such as paper cutters to break the recorded copy into sheets, have been eliminated. At the scanner, on the other hand, some expense has been added to provide voltage regulators and timing devices which will make it more certain that a regular and consistent program can be broadcast, even in the hands of a relatively inexperienced operator.

SCANNING EQUIPMENT

The appearance of the scanning equipment is shown in Figure 1. All parts are mounted in an attractively styled steel cabinet which is approximately 52 inches high, 32 inches wide, and 16 inches deep. The upper section of this case is a hinged cover. When thrown back it exposes a table-like surface on which is mounted the actual scanning machine. Below this level is the timer, and then come three standard panel units, the compensating amplifier, the power-supply panel, a



Fig. 1—Complete scanning equipment.

the voltage regulator. The apparatus thus forms a complete device ready for installation in a broadcast studio or newspaper office. The only connections required are a source of 60-cycle 110-volt power and a broadcast-control line to the radio transmitter.

The scanning machine proper is of the conventional rotating drum type, but with modifications to suit it to broadcast service. The subject-drum is rotated at 75 r.p.m. by a synchronous 60-cycle motor with a reducing gear having a ratio of 24 to 1. This motor and gear is very similar to those used in high-quality automatic phonographs. Between the motor spindle and the drum there is a single-position clutch, so that the drum can be stopped for change-of-subject copy and then re-engaged without losing the relative frame position with reference

to the 60-cycle power system. The motor continues to run during this loading operation and a commutator on the spindle shaft supplies an artificial frame-line signal to keep the recorders in step.

During transmission the scanning head, which is mounted behind the subject-drum, traverses slowly down the length of the copy. It is driven by a lead screw and suitable gearing from a second motor identical with the drum motor, its rate of progress being such that 125 scanning lines are drawn per inch of drum length. The parts of the head are an optical system, a phototube, and a phototube amplifier. The light source—a 75-watt exciter lamp—illuminates a small diaphragm, and the opening in this is focused through an objective lens onto the paper, making a bright rectangular spot 0.008 inch long in the direction of the drum axis and 0.003 inch wide in the direction of travel along the scanning line. The incident light beam is normal to the surface of the paper. The reflected light is taken off by a pick-up lens and passed to the phototube, this beam being in the same horizontal plane and at 45 degrees to the incident light. The solid angles formed by the objective and pick-up lenses are so arranged that no direct reflections from the paper can reach the phototube. This limitation naturally reduces the light efficiency, but it is of real assistance where various sorts of subject-copy are used. In a direct-reflection system, for example, a shiny black ink may sometimes reflect as much light as the white paper.

The phototube is a standard gas type and is connected to a special pre-amplifier. The first stage is a direct-current amplifier. It actuates a modulator to provide signal impulses in the form of an audio tone of varying amplitude. Either phase of modulation may be used, but the system is normally adjusted for maximum on black and minimum on white. The tone voltage is supplied by a tube oscillator mounted in the same case and set to produce approximately 20,000 c.p.s. This relatively high frequency is chosen because it makes possible the recovery of faithful direct-current picture signals in the compensating amplifier, without the use of filter networks following the demodulator. Distortion of the impulse shape is thus reduced.

One may well ask why such an indirect method is adopted to produce the picture impulses in the compensating amplifier. The answer is that these signals must extend down to zero frequency and that a straight d-c amplifier of sufficient gain is not easily made stable. Thus the intermediate step of tone amplification and subsequent rectification is used. Even so, all voltage supplies must be closely regulated to prevent drift of the initial d-c stage, because the maximum output of the phototube on black is only about 0.2 volt. A bias potentiometer

on the amplifier provides a static setting of this first tube, the proper conditions being chosen by observing the output-signal meter on the scanner base for black and white areas under the scanning beam.

In the compensating amplifier the modulated 20,000-cycle tone is amplified and rectified to produce signal impulses similar to those delivered by the phototube. These are operated upon by special circuits in the next two stages to produce a predetermined alteration in amplitude characteristic, the need for which will be discussed in a later section. Finally the impulses again modulate a carrier tone, this time of about 3200 c.p.s. This carrier and its side bands can be comfortably



Fig. 2—Front view of recorder with cover removed.

transmitted over a standard broadcast-wire line. The output to this line is normally set by meter at zero level.

The middle panel in Figure 1 directly below the compensating amplifier is a power-supply unit for the amplifiers and exciter lamp. The heater current in the phototube amplifier is regulated by a ballast lamp and the plate voltage by gas regulator tubes. The line-voltage regulator forms the lower panel and further improves the stability by holding constant the 110-volt supply to the whole system, thus regulating the lamp brilliance also. The need for this careful regulation lies, of course, in the fact that the shading of pictures depends directly on the amplitudes of the signal impulse, and that any fluctuations result in incorrect tone values.

No modifications are needed in a standard telephone or broadcast transmitter to handle the facsimile signals. The percentage of modulation should, of course, be set at a fixed value for "black", i.e. for maximum sub-carrier amplitude, and should not change during the schedule. It may be worth noting that this maximum modulation is a definite predetermined value and may therefore be set at 100 percent if desired without fear of overshooting.

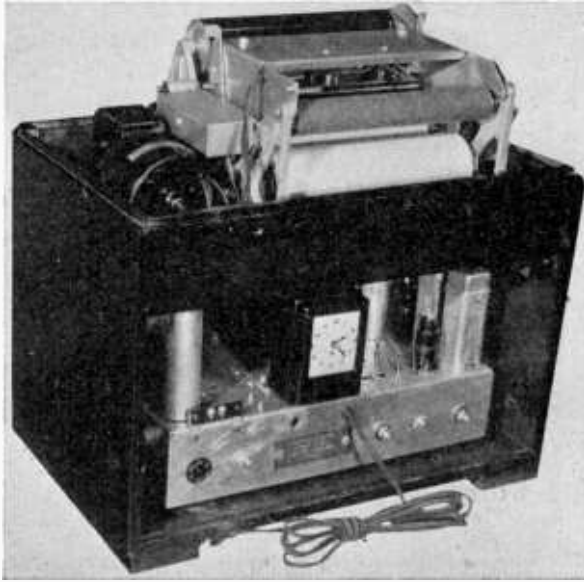

Fig. 3—Back view of recorder showing chassis and time switch.

FACSIMILE BROADCAST RECEIVER

The facsimile receiver is shown in Figure 2 with the cover removed and with the recorded copy feeding out the front. It is a complete unit, in that it includes the radio receiver chassis, and a time switch; and thus requires only an antenna and a source of 60-cycle power. It is worth emphasizing this arrangement and the reasons for it. It might have been simpler to provide only a recorder for attachment to an existing radio receiver, but the proposed conditions of operation must be considered. The schedules are to be sent out, at least according to most existing plans, over regular broadcast stations between midnight and six in the morning, a period when the channel is otherwise idle. The recorders are to be turned on and off by time switch at the proper hours. Consequently, if the recorder were made as an attachment, the

full signal. The upper or "white" tube passes plate current at no signal, but no plate current at full input. The controlling bias voltages are obtained by rectification of the 3200-cycle sub-carrier, after a stage of amplification. The coils of the magnetically operated printer unit are connected as shown in the plate circuits of the printer tubes.

The facsimile recording machine is mounted in the upper section of the cabinet and is covered by a removable lid. Its structure can be fairly well seen in Figure 5. The active parts are supported between two cast side-plates, the driving motor being on the far side out of view, and the paper-feed gearing in the right foreground. The recording drum with the raised helical ridge on its surface can be seen in the center, and above it the course of the white and carbon papers, which have been torn back to afford a clearer view. The carbon paper is wound up after use on the core at the top; the white is fed out from the front of the cabinet by a cylinder like a typewriter roll. This roller can be seen under the carbon take-up core. In taking this view the printer unit was swung back to the left into the paper-loading position. The actual operating position of the printer bar is shown by the steel rule which was placed over the papers for this photograph.

The method by which a carbon recording is produced can be easily seen by considering the helix drum as rotating at its normal speed of 75 r.p.m. Whenever a signal for black is received from the transmitter, the printer bar (represented by the rule) is sharply depressed along its whole length by the two electromagnetic drivers. See Figure 4. Obviously it pinches the carbon paper against the white at the point where its edge intersects the single turn raised helix; and because of the rotation, this intersection point repeatedly scans across the page right in step with the traverse of the light spot across the original at the scanner. If complete synchronism is maintained, the dots will organize themselves into a facsimile of the original subject.

The definition obtained at a given speed depends on the rapidity with which the magnetic drivers can move the mass of the printer bar. Consequently great care has been taken in the design of this unit. As indicated schematically in Figure 4 the bar is mounted on a frame structure with a rigid pivot at the axis of the supporting tube. It is driven at two points through connecting springs from the balanced-armature electro-magnetic drivers. These are basically similar to early forms of magnetic loudspeakers, but are much improved in constructional details. The fixed field for both units is supplied by a single permanent magnet mounted between them. The natural query as to why electromagnetic rather than moving-coil dynamic drivers are used is simply answered by pointing out that the bar must respond to

direct-current conditions; and that it is not very practical either to supply heavy direct-current components from the amplifier for an ordinary voice coil, or to provide enough turns on the coil to work with output tubes of reasonable size.

One loading of paper in the recorder includes a 345-foot roll of white paper on a large cardboard core, and a small roll of about 95 feet of carbon paper. The latter is slipped inside the white roll to make a compact shipping package. When reloading the machine the old carbon rolls are thrown out, as the coating has been thoroughly used after one passage through the recorder at about one-quarter the speed of the

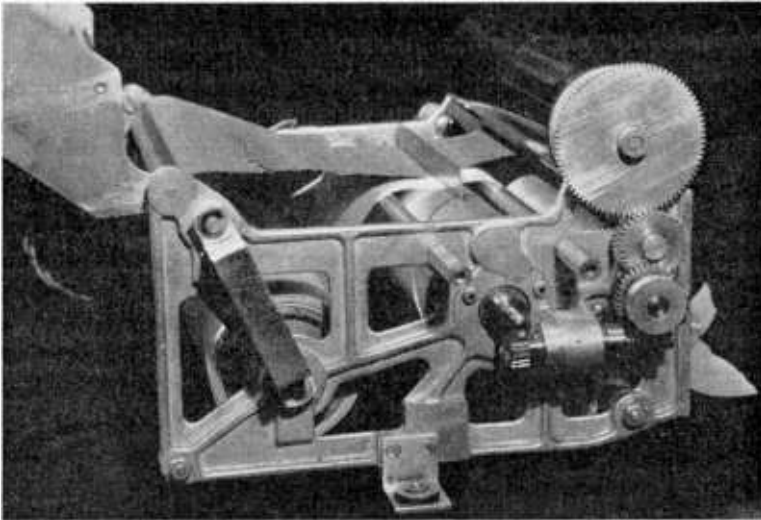

Fig. 5—Close-up photo of recorder.

white sheet. The large core from the used white roll is saved and put in position as a wind-up spindle for the succeeding loading of carbon paper. The new white roll is placed in the machine first and then the carbon roll. Each is snapped in position on centers like the film in a camera, both releases being operated by the strap handle seen on the near side plate of Figure 5. The white paper is drawn over the helix drum and passed through the feed-roller system just as a sheet is turned into a typewriter. The carbon strip is attached to the wind-up core by a gummed leader, the printer then lowered and latched in place, and the recorder is ready to function. The description of this paper-reloading process has been given in some detail to show that it can be carried out by the user of the machine without too much inconvenience. It is more difficult than loading a typewriter, but probably

simpler than most cameras. It is the only service which the owner of the machine need perform himself; and it will not come often, as one loading will last over a month on a 10-page-per-day schedule.

The recorders are assumed to be completely adjusted at the time of installation. The receiver is tuned to the chosen station and the time switch set to turn it on soon after midnight and off again some time later, according to the established facsimile schedule. The volume control is correctly adjusted and the printer position checked. A cover strip is then placed over the controls leaving only the clock face exposed, so that it may be reset if necessary after a power failure. A self-starting synchronous-clock movement is employed as being probably the most satisfactory timekeeper for the purpose.

SYNCHRONIZATION

There are two parts to the problem of synchronizing facsimile recorders and scanners; first, the one of insuring that the rate of travel of the printing point in the recorder is exactly the same as that of the light spot in the scanner; and second, that of starting the stroke in the recorder in phase with the start of the scanning line at the sending end. If the former condition is not fulfilled the recorded picture will be distorted and askew, and will soon slant off the sheet. If, however, the speed is maintained, the image will be square; but it will not necessarily fall in the center of the page. The scanner may have started its stroke half a line ahead of the recorder and the machines are said to be out of frame.

The first part of the problem, that of speed control, is easily solved in a broadcast service by operating both sending and receiving machines with synchronous 60-cycle motors driven from common or interconnected-power systems. This method is used in the equipment described here and makes for very perfect and unvarying synchronization with no additional apparatus in the receiver. It is open to the criticism that there are several places in the country where independent and unconnected-power companies operate in the primary-service area of a single broadcast station; and there are also the cases where downtown-business districts still use direct-current power. But these are the exceptions, for in most cases, the homes in the suburban and adjacent country around a city are all served by a common-power system. Thus, for an initial program of facsimile broadcasting, synchronization can be well obtained in this way for a large percentage of the market.

In areas where there are two independent 60-cycle systems, as around Cleveland or New York, for example, a possible method of working is to divide time between the two systems. The receivers

which are supplied by power from company A might be set for 12 midnight to 2:00 AM, and all on the lines of company B for 2:00 AM to 4:00 AM. The facsimile schedule would then be broadcast twice, once with the scanner synchronized on the A system, and again with it synchronized on the B system. This is easily accomplished at the scanner because the motors only require some 50 watts. The scheme is not very economical as it doubles the time on the air. It is mentioned here as an expedient which may be adopted for preliminary operation.

With further growth of broadcast-facsimile service it is to be expected that self-synchronizing recorders will become available when a simple system has been worked out and reduced to a reliable design. There is already much background on the subject and there is actual experience with facsimile installations made for commercial service. Perfect synchronization has been obtained between remote points by the use of tuning fork control; and there have also been a number of systems set up with a control transmitted over the radio circuit along with the picture.

The line framing or synchronization of the picture received at the recorder is the second part of synchronization. It is accomplished in these machines by a circuit-breaking device used in conjunction with a line-framing relay. The circuit-breaking device may be mounted on the helix-drum shaft or coupled thereto, and carries a breaking arrangement which comes under the relay armature at the instant the intersection or scanning point in the recorder goes off the edge of the paper. If the line-frame signal generated at the scanner by the clamps on the scanning drum arrives at this same instant, the circuit is such that the relay is not actuated, and the motor drives the recorder steadily in its correct line-frame position. If, however, the recorder circuit-breaking device is in another position when the line-frame signal comes in, the relay momentarily opens the motor circuit causing it to slip below synchronous speed. This will occur each revolution of the drum until the recorder reaches correct frame. The automatic framing function normally takes place only at the start of the program, and the machines thereafter run continuously in perfect synchronism. The only exceptions occur when the power at the recorder fails, or when the signal fades out completely. In such exceptional cases the machines will attempt to reframe as soon as normal conditions are restored, but may not complete the cycle until the margin space comes through at the end of the sheet. The remaining pages of the schedule will then be properly placed as before.

<p>FIRST WITH THE NEWS</p>	<h1 style="margin: 0;">News Flashes</h1>	<p style="text-align: right; font-size: small;">Official Weather Forecast Fair and Warm</p>
<p style="font-size: x-small;">SATURDAY, JULY 25, 1937</p>	<p style="font-size: x-small;">COLUMBUS, OHIO</p>	<p style="font-size: x-small;">PAGE NO. 35</p>
<h2 style="margin: 0;">SUPREME COURT UPHOLDS TVA</h2> <h3 style="margin: 0;">Vote On Important Decision 8 To 1</h3>		
<p style="text-align: center; font-weight: bold;">SENATORS READ VERDICT</p> <div style="text-align: center;">  </div> <p style="font-size: x-small; text-align: center;">In form this particular work consisted of a double column page twenty eight and one-half picas in width by about forty-two picas in depth, set in 8 point (brevier, then so called) solid.</p>	<p>Crowded Gallery Hears Hughes Read Opinion</p> <p>Considerable rivalry existed between the two principal publishers each year, as to which company should first be able to give to the legal profession that company issued quarterly, and in the fall of each year annually, a "Digest of United States Supreme Court Decisions," which ran up to 2,700 and 2,800 pages.</p> <p>The means devised by the New York state firm was for a number of years successful in attaining this object.</p> <p style="text-align: center; font-size: x-small;">Vote took 8 to 1.</p> <p>In form this particular work consisted of a double column page twenty-eight and one-half picas in width by about forty-two picas in depth, set in 8 point (brevier, then so called) solid.</p> <p>To keep the size of the book within reasonable limits it was printed on an extremely thin but opaque "bible" paper.</p> <p>With a force of about fifteen hand compositors and ten time hands the annual edition was scheduled to be set, made up and stereotyped in not to exceed fairly days, and was in some years done in twenty-seven days.</p> <p>A little figuring on the basis of hand composition production will bring one up against a decided question mark as to how this could be done with fifteen compositors; at the same time, if the methods followed in the process were not known.</p> <p>It has been stated that the job was first issued in quarterly form. And after each quarterly had been hand set, made up and printed, it was stereotyped on type high case base.</p> <p>The stereotype pages were stored on wooden galleys, two to the galley, and put, through a preliminary operation which consisted of im-</p>	
<p>MAYOR PLACES GUILT ON JONES</p> <p>Since the advent of mechanical type composition through the use of the Linotype, there has been a constant and consistent advancement in the art, with an accompanying ease of solution of problems having to do with mass production requirements and of time limitations.</p> <p>It seems evident that the revolutionary conditions produced in the printing industry by the introduction of this machine are exemplified primarily by the tremendously increased production attained, and in the quality of the product.</p>	<p>Former Editor Injured</p> <p>J. B. Smith Severely Cut in Freak Automobile Accident</p> <p>During and before the thirties there was located in a mid-western city of New York state one of the two then largest law publishing houses in the country, and among numerous other serious secondly by the rapid improvement</p>	
<p style="text-align: center;">9 A. M. - NBC RED NETWORK</p> <div style="text-align: center;">  <p style="margin: 0;">ENOCH ARDEN and His Band in the SUNSHINE HOUR</p> </div>		
<p style="font-size: x-small;">TRAVEL BY PAN AMERICAN AIRWAYS</p> <p style="font-weight: bold; font-size: x-small;">Transmitted by RCA RADIOPRESS</p>		

Fig. 6—Recorded copy reproduced by copper etched halftone plate.

SUBJECT COPY FOR TRANSMISSION

It is not within the province of this article to attempt a prophecy of the kind of copy which broadcast facsimile can most profitably publish. On the other hand, the make-up of the copy and the nature of the printing and pictures is very definitely controlled by the characteristics of the equipment. The major factors to be considered are the size of print, or the black and white detail, as limited by the resolution of the system; and the kind of original pictures needed to give the most pleasing halftone recordings.

With reference to definition, the present system, when in optimum adjustment and under favorable conditions, will transmit and record 6-point newsprint type so it is legible. The formation of the letters, however, is not very clear, and text of this size would be tiresome to read. Furthermore, it is advisable to make some allowance for production variations in recorder performance, and for some loss of signal quality in transmission due to minor maladjustments and possible interference. For these reasons it is being recommended that no type size smaller than 10-point (approximately equal to typewriting) be used until the practicability of finer definition is proven in the field. Bold or expanded type faces are desirable and lettering should be avoided which has alternate heavy and very light strokes in its design. As to margin lines and drawings, it is being suggested that lines be at least 0.020 inch wide and that the smallest space between them be at least the same width.

The halftone or picture characteristics of the system are described in the next section. In actual practice it is found that photographs with a wide range of shade values are naturally easiest to transmit, and that it is desirable to prepare the prints so that the areas of interest are delineated in terms of the middle range of grays, rather than in the very dark or very light tones. The problems are much the same as in the preparation of pictures for newspaper printing, and one is perfectly justified in using the same tricks of trimming, retouching and the like. The actual picture placed on the scanner drum should be a photograph made on thin paper so that it can be pasted in place on the page. Pictures which have been printed from a screened plate are not satisfactory unless the screen is either finer than 150 lines per inch or of the rotogravure type which gives a random-dot arrangement. Coarser screens often result in bad moiré patterns due to interference with the facsimile line structure.

In the preparation of a complete program a series of pages can be made up and printed on the standard size sheet, 8½ inches wide and 12 inches long. The text may be set by hand or linotyped, and a single

INTEGRATED OVERALL AMPLITUDE CHARACTERISTIC OF BROADCAST FACSIMILE SYSTEM

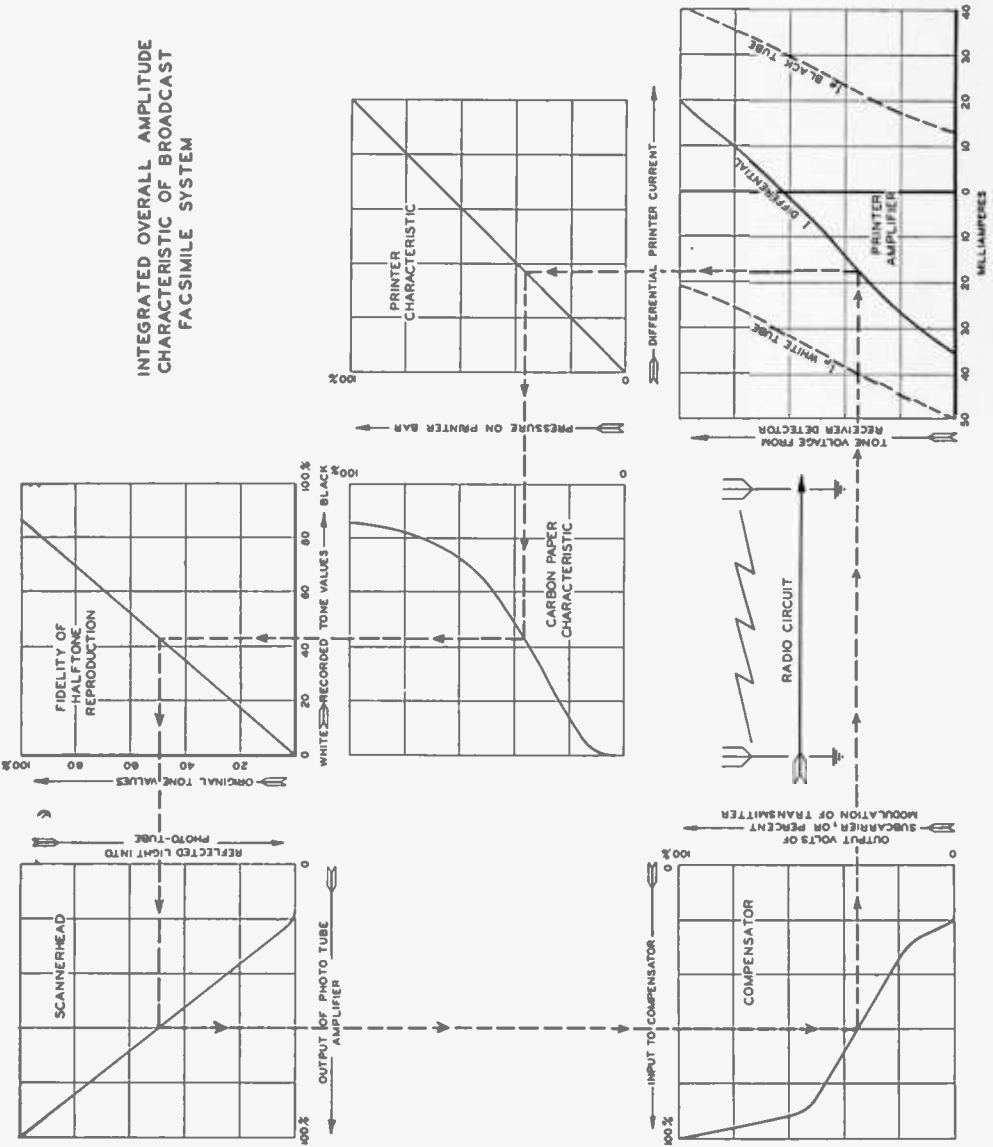

Fig. 7—Half-tone characteristic curves.

copy pulled on a proof press for each page. If finished appearance is not so important, the text may be typewritten, preferably on an electric typewriter which gives a uniform impression.

As an example of the recordings possible with the equipment which has been described, Figure 6 shows a photograph of a typical small news page. The sheet was 8½ x 12 inches as it came from the machine and the text is from 10-point type. Naturally some allowance should be made for loss of definition in the process of preparing this illustration at reduced size.

HALFTONE CHARACTERISTICS

Any facsimile system which is to send pictures must record them with shade values which correspond fairly closely with those of the original. This requirement means that close attention must be paid to the amplitude characteristic throughout the scanner and recorder. If there is unavoidable distortion at some points, compensation must be provided at others.

In carbon-paper recording the major distortion occurs in process of transferring the color to the white sheet. A certain amount of pressure is needed on the printer bar before any carbon comes off; then, as the pressure increases, more color is transferred, until saturation is reached at the darkest tone available with the particular papers used. This condition is shown in the central square on Figure 7. Grouped around are the amplitude curves of the other parts of the system, all of them so arranged that reference lines corresponding to all tone values can be carried through complete sequence. For example, suppose an original gray shade, which might be called 50 per cent black, is chosen on the scale of original tone values at the top center. Proceeding along the dotted line to the left it is found that the scanner head amplifier will deliver instead 60 per cent of its maximum signal, because of the residual output on white. After passing the compensator this will correspond to a 35 per cent tone amplitude on the line to the transmitter. The transmitter modulation curve and the receiver up through the second detector are assumed to be linear. The lower right-hand characteristic applies to the printer amplifier shown in Figure 4. The plate currents of both "white" and "black" output tubes are shown, and their algebraic sum. This differential current is really fictitious as it does not exist as such in the output circuits; but it does represent the resultant effect of the "black" and "white" currents on the printer armatures. Returning to Figure 7, measurements show that the pressure developed on the printer bar is proportional to this difference current as shown by the straight line. The non-linear characteristic

of the carbon paper has already been mentioned. Again following the dotted line, turning on the carbon-paper characteristic, one arrives finally at a recorded tone value of about 43 per cent of full black. This is seen to be the true middle-gray point for the recorder, as the maximum carbon blackness only reaches 86 per cent of the density of the original black ink. If other tone values are plotted around the chart, the final straight fidelity characteristic will be developed. Obviously this happens because the characteristic of the compensating amplifier has been worked out so as to neutralize the carbon transfer and other distortions of the system.

CONSTANTS OF THE SYSTEM

The operating speeds, paper sizes, and so on, have been referred to already, but can be more easily visualized from the following tabulation.

Number of scanning strokes per minute (r.p.m. of drums)	75
Total length of stroke.....	8¾ inches
Lines per inch	125
Width of paper on scanner.....	8½ inches
Length of paper on scanner.....	12 inches
Width of paper at recorder.....	8½ inches
Maximum width of copy.....	7½ inches
Proposed length of page.....	12 inches
Useful length of page allowing top and bottom margins..	11 inches
Number of pages per hour.....	3
Length of white paper roll.....	345 feet
Length of carbon roll (for this amount of white paper)..	95 feet

The first three figures given above are the basic operating parameters. For example, any discussion of standards should probably start here. The product of the total length of stroke by the number of lines gives the Facsimile Index, which in this case is 1093.75. Any two drum-type facsimile systems will work together which have the same drum speed and the same index, although an enlargement or reduction may take place in true proportion.

The 8½-inch wide paper was chosen for the recorder as a practical compromise between a page too narrow to give a good illusion in the reproduction of pictures, and a sheet so wide as to make the recorder bulky and expensive. The number of lines per inch is sufficient to permit definition of the smallest type size which the average man can comfortably read. Present apparatus does not reach this goal, and so this figure must be considered as an allowance for future improvement. A choice of fewer lines per inch would mean a loss of detail which may otherwise become possible; a finer-line structure

would reduce the speed of the system for the sake of an improvement in resolution of questionable advantage.

The drum speed of 75 r.p.m. was chosen as one which could be conveniently obtained from a synchronous 60-cycle motor and which would result in well-defined copy on the carbon printer. It gives a 12-inch page in 20 minutes. If allowance is made for the margins a printed area $7\frac{1}{2}$ inches wide remains, and there will be $4\frac{1}{2}$ square inches of useful recording in one minute. In terms of words this is not so slow as it seems. With a solid block of typewriting it means 45 words per minute, with 10-point type about 65, and with a typical page of newsprint about 110 words per minute.

ACKNOWLEDGMENT

In preparing this article the author has attempted to give a general view of the equipment which has been developed for broadcast-facsimile use, the way it operates, and some of the reasons for particular solutions of its problems. Much work lies behind this practical design of facsimile equipment. Credit is due especially to Mr. Maurice Artzt who has been with the project from the beginning, and whose persevering and ingenious attack has solved many of the problems. More recently Mr. H. J. Lavery has made substantial contributions to the structure of the printer; whereas the actual design of the apparatus has been brought into finished form by Messrs. R. G. Shankweiler, B. E. Lane, and A. Blain.

FACSIMILE BROADCASTING

By

ALFRED N. GOLDSMITH

Consulting Engineer, Radio Corporation of America

INTRODUCTION

IN any study which can be made at this time of the possible nature of facsimile broadcast service and the programs which it may deliver to the public, there must necessarily be numerous and justified mental reservations as to the detailed accuracy of the conclusions to be drawn as well as a recognition that these conclusions will certainly have an appreciable and permissible percentage of errors. Nevertheless such a study may be useful to the public and prospective facsimile broadcasters if it is thought-provoking and gives rise to debate and experimentation. It is in this hope that the following presentation has been drawn up. It is based in large measure on certain parts of an analysis made about four years ago, but modified slightly in the light of present-day information and experience.

It is certain that the facsimile program construction of the future cannot be predicted except in considerable generality. In the parallel case of sound broadcasting, almost all of the early predictions as to the nature of the service to be rendered by radio-telephonic mass communication were fairly wide of the mark. One notable exception was the memorable study of radio musical entertainment made by David Sarnoff in the remote days before the outlines of broadcasting were clear—a study and prediction which has recently been most satisfactorily realized in transmission and reception of such programs as those of the National Broadcasting Company's Symphony Orchestra. On the other hand, who in 1920 would have dared seriously to voice the opinion that a major nation-wide network of transmitting stations aggregating many hundreds of kilowatts of power, thousands of miles of special network wires connecting the stations, highly trained technical personnel, a great production staff and impressive expenditures would be devoted to bringing to an audience probably running into the millions the voice of a ventriloquist's dummy? And who, having issued so apparently

wild a prediction, would further have challenged plausibility by asserting that the audience would in this case be so well satisfied as to constitute the diminutive wooden imp in question a major attraction on the air waves?

There is a lesson in this and similar unpredictable triumphs of radio broadcasting to any who attempt arbitrarily either to widen or to circumscribe what may be accomplished by the newer medium of facsimile broadcasting. Our certainty in predicting the related trends must, for safety, be limited to the thought that the normal technical and service developments of facsimile broadcasting, concentration of many minds on program construction, ingenuity in selection of program material and originality in its presentation may well lead to thoroughly appealing and successful radio facsimile publications. As to the details of the future programs, we can be sure only that we *cannot* be sure of their contents or of their method of entertaining and appealing to the radio readers. The future owner of the radio broadcast facsimile receiver—shall we call it a “readio” for short—is an incalculable quantity. But, being human, we know that he *can* be satisfied, though probably in ways not evident today nor to be evolved save by the prolonged thought and trial and toil which more than usually precedes “spontaneous” success.

FACSIMILE TRANSMISSION METHODS

Facsimile broadcasting can be accomplished in at least the three following ways:

Method 1. Transmission can be carried out using existing broadcasting stations in the band from 540 to 1,600 kilocycles, but only during the hours from about 1 to 6 o'clock in the morning, local time. Transmission during other hours, when there is a large *listening* audience accustomed to the use of their receivers during such hours, would undoubtedly prove unpleasant to that audience in view of the stuttering whistling notes which would be heard in the loud speakers whenever a facsimile station was tuned in. This undesirable experience on the part of the audience might well be reflected in an adverse attitude on the part of the Federal Communications Commission toward licensing existing broadcasting stations for facsimile broadcasting outside of the restricted hours in question.

It is true that a considerable amount of material could be transmitted in the five available hours, and that the introduction of facsimile broadcasting by such “by-product” or “unused-time”

methods is an attractive possibility from an economic viewpoint. However, it must be recognized that such transmission would of necessity be only a temporary expedient as an urban service since it is certain that one of the most attractive possibilities of facsimile broadcasting is its *continual* availability as a prompt means of bringing events of "transcendent importance" into the home in recorded form. If facsimile were to be restricted to those hours when most of the potential program-readers were asleep, its appeal would be so markedly diminished that it could not be expected to develop normally and steadily in all service areas.

Method 2. Transmission under this method would be carried out in the ultra-high-frequency audio-visual band between 42 to 86 megacycles, (that is, from about 7.1 meters down to about 3.5 meters), excluding the amateur band between 56 and 60 megacycles, (5.3 to 5. meters). Care would be required in allocation of frequency bands and operating time to avoid conflict with television services, which should be possible in view of the relatively narrow frequency bands needed for facsimile transmission and the possibly limited number of hours of television transmission per day. This method has the marked advantage that high-quality and stable transmission over large urban areas is obtainable. Indeed, results paralleling in reliability and uniformity those obtainable by wire-line transmission over the corresponding limited distances, 10 to 50 miles approximately, can thus be secured. Natural static and fading are at a low minimum, and there is some hope of considerably reducing the effects of man-made static and wave reflections found in the ultra-high-frequency band at this time.

While, at first sight, it might seem to be a disadvantage of the ultra-high-frequency facsimile transmissions that they would require the readers to purchase a new form of receiving set which was sensitive and responsive to these waves, previously unused for commercial broadcasting, yet it is believed that this may really be more of an advantage than the reverse. Many existing receivers for the present broadcasting band would not be appropriate for facsimile reception nor conveniently connected to the receiving recorder. The design of a universally usable recorder would be difficult and probably uneconomic. Furthermore, the interesting possibilities disclosed under Method 3 below would be impracticable unless the facsimile recorder were provided with and permanently connected to its own ultra-high-frequency receiver.

Method 3. By this method, transmission would be carried out on the ultra-high-frequencies, much as under Method 2, but in association with ordinary or telephone broadcasting either in the present broadcasting band or on the ultra-high-frequencies. That is, the facsimile programs would be connected with, and made more attractive by simultaneous or subsequent speech or music broadcast on medium or ultra-high-frequencies. Method 3 might be used part of the time, being mixed with Method 2.

Reverting to Method 1 above, there would likely be required for each reader—(home recipient of the facsimile programs)—a time-clock-operated switch which would carry out the following functions just before 1 o'clock in the morning:

- (a) Connect the facsimile recorder to the output of the broadcast receiver.
- (b) Disconnect the loud speaker from the output of the broadcast receiver.
- (c) Turn on the receiver.

The reason for each of these functions, during the quiet hours of the night, is obvious. Conversely, the time-clock-operated switch would necessarily carry out the reverse functions just after 6 o'clock in the morning to prevent waste of paper, tubes, and power.

Considering Method 3 above in greater detail, there are several sub-methods or variants which may prove practical and attractive. These include:

Sub-Method 3 (a). Under this procedure, facsimile material, which is later to be referred to in spoken or musical programs to which it is related, is transmitted during "off-hours"—for example, in the early morning hours—and permitted to pile up unused at the time of its delivery. Each sheet of such material would carry a designation of the subject matter and the time of the ordinary telephone broadcast of speech or music to which it is related or with which it should be used, thus enabling the recipient to lay it aside until it is to be examined and studied in connection with the telephone broadcast in question.

Sub-Method 3 (b). In following out this procedure, the facsimile material is sent just sufficiently ahead of the thereto-related telephone broadcast so that each sheet of material which is to be used with that telephone broadcast is completed and available shortly before the spoken or musical material is broadcast. For example, supposing that the facsimile material accompanying a given telephone broadcast lasting 15 minutes also

takes 15 minutes to transmit and receive, the following time schedule of transmissions is illustrative of this sub-method:

<i>Type of Program</i>	<i>Time of Transmission</i>			
	9.00	9.15	9.30	9.45
Facsimile	Program 1	Program 2	Program 3
Speech or music	Program 1	Program 2	Program 3

As will be seen, facsimile Program 1 will be transmitted from 9.00 to 9.15 o'clock, and will accordingly have been completed before the telephone broadcast Program 1, to which it is related, is begun. A similar comment holds for Programs 2, and so on.

As illustrations of the types of programs to which reference is had above, the following are mentioned:

<i>Facsimile Broadcast</i>	<i>Associated Telephone Broadcast</i>
Picture of scene of action; of actors; of author.	Short dramatic presentation.
Musical score of themes or motifs; words or libretto; picture of conductor or first violinist or of concert hall or stadium.	Orchestral selections.
Summarized text; diagrams; drawings; examination quiz or questions; supplementary data.	Educational material—"radio correspondence school."
Picture of "star" actress or actor; scene from the play; coupon good for a certain payment toward admission during certain hours.	Advertisement of motion picture theater.
Scenes in a foreign country.	Travel talk.

The above sufficiently indicates the type of association of facsimile and telephone material here contemplated; and doubtless the list can be greatly expanded as experience is had in such conjoint programs.

At this point one limitation of present facsimile methods may be mentioned, namely, the fact that the text or graphic material appears on only *one* side of the sheet. Inventive effort would appropriately be devoted to overcoming this limitation. Two-side facsimile recording presents some interesting possibilities. Since the material printed on the reverse side is not visible until after the paper is well out of the recorder, the material on the reverse side of the sheets should be of the "delayed" variety such as serial stories, cartoons, other syndicated material, and general news summaries. "Flash" news should be reserved for the front side of the sheets.

COMMERCIAL FACTORS AND METHODS

In view of the fundamental differences in requirements, equipment, attendant personnel, and price ranges between facsimile equipment for broadcasting and facsimile equipment for communication purposes, the latter type and the corresponding field will not be here considered. Many of the data given below for facsimile broadcasting have been obtained through the courtesy of Mr. Charles J. Young of the RCA Manufacturing Company, Inc., Camden, N. J.

Considering first the tube requirements for facsimile broadcast receivers, these are generally similar to those needed for the standard 6-tube telephone broadcast receiver, but with three added tubes for the recorder proper. However, if the assembly of receiver and recorder is purchased at one time, a 6-tube complement for *both* the ultra-short-wave receiver and the recorder may suffice.

Such a combined receiver-recorder outfit will draw between 100 and 125 watts from the power lines. In certain cases it will be desirable and feasible to have a "monitoring receiver" turned on all the time. This receiver is tuned to the facsimile broadcasting station, but does not actuate the facsimile recorder. Instead, upon receipt of the awaited facsimile transmission signals, the monitoring receiver will actuate a sensitive electro-mechanical or gas-tube relay which will turn on the remaining tubes of the outfit and thus enable the operation of the recorder. At the conclusion of the facsimile signal transmission, a special control signal may be sent which would restore the outfit to the "monitoring" state. This sort of arrangement is advantageous from the viewpoint of reducing power consumption, since the monitoring receiver may use only about 25 watts as contrasted with the 100 to 125 watts required for full operation including recorder actuation. When facsimile broadcasts extend over any considerable portion of the twenty-four hours and are not continuous, the power economy of such a monitoring arrangement might compensate for its greater circuit and equipment complication.

FACSIMILE PROGRAM CONSTRUCTION

Facsimile broadcasting enjoys two characteristics which are of major importance to the public, and which may also serve as guides in certain phases of program construction. These two characteristics are the conservation of time between occurrence of an event and receipt of textual news concerning it, and the

assurance of accuracy in picture "spot-news" broadcasting. No other medium can quite compare with facsimile broadcasting in these two respects. For the first time in human history the moment's news can be delivered in printed form into the home without the aid of the relatively cumbersome and time-consuming utilisation of telegraph keys, printing presses, delivery wagons, and newsboys. To be sure, the facsimile recorder in the home is practically the equivalent of a local printing press, but it does not require time-taking photo engravings for illustrative material, and it does not take time to produce a multiplicity of copies of the same subject matter, comprising an edition for distribution to its readers.

To organize a service of facsimile news-picture broadcasting would require the aid of established news-gathering agencies whose services of expanded and detailed reporting may then be encouraged by the demands of the enlarged number of new readers developed by the complementary facsimile "spot-news" picture broadcasting.

A somewhat detailed study has been made of material suitable for inclusion in facsimile broadcast publications. After consideration of many items which tentatively appear available for inclusion, and which will in part be listed below, the general conclusion has been reached that

A facsimile broadcast publication is preferably a combination of a loose-leaf tabloid newspaper, a compressed topical and fictional magazine, and a summarized journal of information and opinion.

The sources of program material are in part known, and other sources will doubtless be discovered including, of course, the works of individual writers and commentators who will devote themselves primarily to this novel field of literature.

The handling of program material for facsimile broadcasting purposes differs considerably from that in the corresponding field of telephone broadcasting. Studios will not be required, nor will the usual producing and announcing staff be necessary. On the other hand, the following new facilities will be among those needed:

Editorial offices in which material for the radio publication will be assembled, edited, arranged, and issued.

Artists' offices where such retouching of photographs as is necessary will be carried out, special drawings, headlines, or sketches will be made, and the general art work of the publica-

tion will be handled. Attached to this office will be a photographic department, in which reductions or enlargements to suitable scale of the illustrations will be made on photostat machines or similar automatic cameras.

Printing offices, in which suitable typewritten or linotyped material will be prepared, for use in the transmitting scanners.

Control rooms, in which the final text will be inserted in the scanners and sent out, with due supervision of the quality of transmission in associated monitoring receivers, the monitors being connected to the transmitter control lines or to corresponding radio receivers.

The corresponding personnel will include reporters, editors, artists, photographers, printers or typists, control room operators or technicians and the like.

The facsimile publication might consist, under the present system of broadcasting in the United States, of a text portion and interspersed advertisements. A confusing abundance of material suitable for inclusion in the text can be found; in fact, there is probably far more material than could to advantage be used, at least in the early stages of the development of facsimile broadcasting. This viewpoint is in marked contrast with that which has been expressed by certain workers in the broadcasting field, but it is believed that a scrutiny of the following partial list of publication topics will indicate the wealth of available material. The topics which are used should be handled in journalistic and non-technical style in every case. This assortment of material is illustrative, but not complete, and is arranged in a generally alphabetic way for ease of reference:

Stories of adventure.

Almanac material (useful or comic in character).

Automobiling (choice of automobiles, upkeep, route maps, economical operation, repairs, turn-in allowances, and similar topics).

Aviation and air-mail information (routes, equipment, progress).

Ballots on matters of current interest, to be filled in by the readers.

Biographies of prominent historical and living personages.

Broadcast programs—that is, programs of the associated radio telephone broadcasting stations and networks, together with interesting program notes.

Budgeting—for the family, or for small businesses.

Elementary carpentry and repairs—for the town or country home.

Cartoons—general and political.

“Celebrity” items—intimate personal anecdotes relating to characters in the public eye.

Child training.

- Citizenship articles—information on the organization and conduct of local, State, and Federal governments; analysis of current political events.
- Colleges and college life—actual collegiate information; semi-fictional studies of college and high-school activities.
- Church activities—specific information, organization of social life and activities of groups of church members.
- Comedies—abbreviated text or summaries.
- Construction of various articles for use in the home, for sports, vacations, and the like.
- Political conventions—descriptions of activities, photographs, roll-calls, votes.
- Correspondence school courses—offered either by the facsimile paper as sustaining material or sponsored as “sample courses” by commercial schools.
- Problems of crime control in the community and country.
- Dramas—abbreviated text or summaries.
- Educational material—the scope of which is too considerable for inclusion herein, but which manifestly affords an unusual opportunity to the educator and the broadcaster alike.
- Elections—tabulations of successive votes as received.
- Fairy tales and fanciful stories for young children—assuming that this form of entertainment survives current changes.
- Fashion notes—facsimile offers unusual opportunities to show actual wearing apparel and the like in photographic or line-cut form.
- Fiction—including the works of popular authors facsimile-broadcast in serial form.
- Finance—current financial news and comment, consideration of business trends.
- Foods—available items, quality and price, preparation, attractive serving.
- “Funnies” for the children—and, less frankly, for the adults.
- Games—descriptions of old and new games, the organization of home entertainments, games for child and adult outdoor parties.
- Government—studies of the government and its problems and procedures prepared by officials and recognized authorities.
- Grammar—information on correct speech, letter and report writing, public speaking.
- Health articles—proper exercise, diet, care of slight injuries such as cuts and bruises, care of the teeth, periodic examinations of eyes, ears, and similar topics.
- History—popularized series of historical articles concerning unusually vivid or instructive periods of history or periods of special interest by analogy to the present time.
- Home economies—household “hints”, arranging the home table, care of furnishings, clothing, decorations.
- Horticulture—lay-out and planting of gardens, selection of flowers for formal and informal gardens, kitchen gardens, flower decorations in the home.

- Houses—plans and designs, modernization, maintenance.
- Humorous articles.
- “Inspirational” articles—character building and the like.
- Labor—its problems, activities, plans.
- Foreign language lessons.
- Letters from readers, and answers to readers’ queries.
- Live-stock quotations—and similar information of interest to farmers.
- Maps of special interest at any time—for example, maps of European states directly after events of world importance in such states.
- Medical advice to readers—for example, early detection of cancer, treatment or avoidance of colds.
- Motion pictures—information as to “stars”, stories, recent productions, studio activities.
- Music—portions of musical scores, popular musical selections, comments on current programs, libretti, simple instruction, such as “how to read music” or “how to play the ukelele” and the like.
- News items—This most important field need not be mentioned in detail, but essentially all such material of this class as now appears in newspapers may be suitable. Summarized news and news flashes will be particularly desirable. Brief mention of news can appear early in the day, to be supplemented later in the day by more full accounts.
- Household pets—choice and care.
- Poetry—short poems by popular writers.
- Politics—comments, partisan speeches, and impartial analyses (if such can be secured).
- Public Works—description of important activities in this direction.
- Puzzles—for example, cross-word puzzles and similar diversions.
- Recipes.
- Religious material—such material should, like the present broadcasts, be non-denominational in general, though current news and excerpts from delivered sermons or speeches may be denominational.
- Rotogravure section—in which would be included at intervals photographs of current happenings or unusually striking or artistic things, persons, or places.
- Science articles on such subjects as astronomy, aviation, microscopy, mineralogy, botany, zoology, and so on, but in every case in popular form.
- Short stories.
- “Short-Short” Stories—these one-page, or less, stories will be particularly convenient for facsimile publications.
- Social manners—the usual form of hints as to “behavior in company.”
- Society columns—news of the great and near-great in their social life.
- Sports—This important section may include descriptions of current sporting events, material on the sportsmen whether amateur or professional, trainers, and lessons on certain sports such as golf, even including indoor sports such as card games.

Stock market quotations.

Theater material—comments, criticism, current news, reviews, programs, stars, playwrights.

Travel articles—actual or fanciful, preferably illustrated.

Weather reports and predictions.

Wild animal stories—This popular class of material for almost all ages may be in brief form and well illustrated.

Passing to the advertising portion of the facsimile publication, it is to be noted that there are a number of new forms of advertising or modifications of old forms which lend themselves particularly to facsimile purposes. In addition to all the more usual forms now used in newspapers and magazines, some of the following may prove usable:

Broadcast programs—advertisements by the commercial sponsor of a program directing attention to its excellence and interest.

“Cartoon” advertisements—that is, advertisements built around a cartoon.

Testimonial advertisements in which the actual signatures and picture of the testimonial giver is reproduced.

Coupon advertisements, the detachable coupon being good for a rebate, a prize, or some other inducement upon presentation.

Reply-card advertisements—similar to the preceding.

“Geographical” advertisements—in which the product is associated with an interesting locality which it pictures.

“Literary” advertisements—in which a short-short story is written dramatically around the corresponding product or service.

“Star” advertisements—that is advertisements built around a pictured celebrity.

“Auction” advertisements—which are advertisements containing a mentioned price for a product to be offered that day, with the announcement that the price will be altered up or down during the day, the changes being indicated in later announcements.

“Returnable questionnaire” advertisements—the return of the questionnaire bringing some premium or advantage, and giving the advertiser information as to customer preferences and the like.

Facsimile radio advertising has a possible advantage in that an accurate idea of circulation is obtainable by consideration of facsimile-paper sales, facsimile receiver sales, and the return of coupons, questionnaires, and the like. While a guaranteed circulation may not be readily possible, a close approximation to this should be feasible.

Before proceeding to the construction of a portion of a sample facsimile publication, it seemed desirable to determine the amount or proportion of advertising included at this time in current newspapers and popular publications of various types,

on the theory that the corresponding practices had proven generally acceptable even when direct payment was made by the public for the publication in question. Accordingly a number of publications were analyzed in this respect, and the results are tabulated below:

Analysis of a Sunday edition of a prominent metropolitan newspaper:

<i>Section</i>	<i>Contents</i>	<i>Percentage Advertising</i>
1	News	71
2	News	15
3	Sports	6
4	Foreign News and Editorial Comment.....	11
5	Book Review	41
6	Magazine	23
7	Rotogravure (Picture)	36
8	Rotogravure (Picture)	32
9	Special Features	34
10	Drama, Fashion, Art	26
11, 12	Real Estate and Classified Advertisements..	89

The above tabulation, which is correct to the nearest tenth of a column, indicates that the percentage of advertising in a given section of this newspaper varies between 6 to 89 per cent. However, for the entire newspaper, the figure is 46 per cent.

The total printed area of the Sunday newspaper mentioned above was found to be 50,300 square inches. At an arbitrarily assumed speed of 10 square inches per minute for facsimile transmission, it would take about 83 hours or more than three days to transmit continuously all this material, even assuming that some of the fine, 6-point, type could be satisfactorily transmitted. Accordingly, in a 20-hour transmission day, only about one-quarter of this Sunday newspaper could be transmitted, by area though not by detailed contents. The week-day editions of the same newspaper have about 30 per cent of the area of the Sunday editions, and would therefore require somewhat more than one day to transmit, by area, according to the above assumption. Improvements in speed of transmission, multiplex transmission, and greater realisable detail hold out considerable hope that the week-day editions of most papers could be transmitted by continuously operating facsimile transmission within available time.

WEEK-DAY NEWSPAPERS

<i>Newspaper</i>	<i>Day</i>	<i>Percentage Advertising</i>
Metropolitan daily, 1.....	Monday	36
Metropolitan daily, 1.....	Tuesday	46
Metropolitan daily, 2.....	Tuesday	38
Metropolitan daily, 3.....	Tuesday	31
Daily tabloid, 1.....	Tuesday	23
Daily tabloid, 2.....	Tuesday	54

The average advertising percentage of these daily newspapers in these instances was thus found to be 38 per cent.

This percentage is markedly in excess of that found to be permissible in the telephone broadcast programs of networks and the better local stations; and it is possible that it will be found desirable, particularly in the earlier stages of the development of facsimile broadcasting, to minimise the percentage of advertising, holding it perhaps at 20 to 25 per cent maximum.

MAGAZINES

<i>Magazine</i>	<i>Price</i>	<i>Percentage Advertising</i>
Popular weekly	\$0.05	45
Monthly, 1 (a "class" magazine for men)	0.50	24
Monthly, 2 (popular fiction and topical magazine)	0.25	36
Monthly, 3 (summaries or digest of current articles)	0.25	0
This type of magazine contains considerable material of interest in the facsimile field, and also illustrates the corresponding style of condensation.		
Monthly, 4 ("class" magazine for women)	0.25	52
Monthly, 5 (popular-science magazine).	0.35	20
Monthly, 6 (specialised "health" magazine)	0.25	22
Monthly, 7 (topical magazine of opinion)	0.25	21
Monthly, 8 (magazine for children)....	0.25	38

From the above, it is found that the average is 29 per cent. The percentage of advertising in magazines is, on the average, less than in newspapers. The greater percentage of advertising in magazines tend to appear in the lower price ranges.

Passing further into the preparation of a facsimile publication, the typographical style should initially follow, in the main, established practice in the publishing and printing industries.

ABCDEFGHIJKLMNOPQRSTUVWXYZ&
 ABCDEFGHIJKLMNOPQRSTUVWXYZ&
 abcdefghijklmnopqrstuvwxyzfflffiffiffi
 abcdefghijklmnopqrstuvwxyzfflffiffiffi
 1234567890\$,,:;?!-'—|*... ()£@ ¢ † ‡ § ¶ ||-[]
 1234567890\$,,:;?!-'—|*... ()£@ ¢ † ‡ § ¶ ||-[]
 1/8 1/4 3/8 1/2 5/8 3/4 7/8
 1/8 1/4 3/8 1/2 5/8 3/4 7/8
 -A-C-D-F-H-J-L-M-P-Q-R-U-W-X-Y

Fig. 1

However, a clear type which shows much white in each letter should be selected, similar for example to that used in telephone directories and shown in Figure 1. The tentatively proposed sheet dimensions are 8½ by 11 inches, that is, standard typewriter paper size. The printed area would be approximately 7½ x 10 inches on this basis, thus leaving a ½-inch margin all around the page to facilitate handling without direct contact of the fingers with the printed material. The 7½-inch width lends itself to either two-column or three-column arrangements. Two-column arrangements may conveniently be used on the first pages, and three-column arrangements in the latter or less striking portions of the publication. Accordingly the column width may be either 3¾ inches or 2½ inches, and generally the latter.

The placing of illustrations or advertisements on such a paper is largely controlled by the rule that a free horizontal portion of the page, or at least one free column, shall be available for use at all times so that "flash" news can instantly be interpolated into the text without disturbing or destroying the appearance of the illustrations or advertisements. This is necessary because the immediate availability of "flash" news would necessarily be a widely publicised feature of facsimile publications, and this unique capability of radio facsimile might be emphasized as frequently as possible since it is a point of striking advantage and public appeal over all other existing publications.

Some of the permissible arrangements for a three-column page are shown in Figure 2. It will be seen that there is plenty

SHEET LAYOUTS FOR FACSIMILE BROADCAST PROGRAMS

("X" Indicates Advertisement or Illustration)

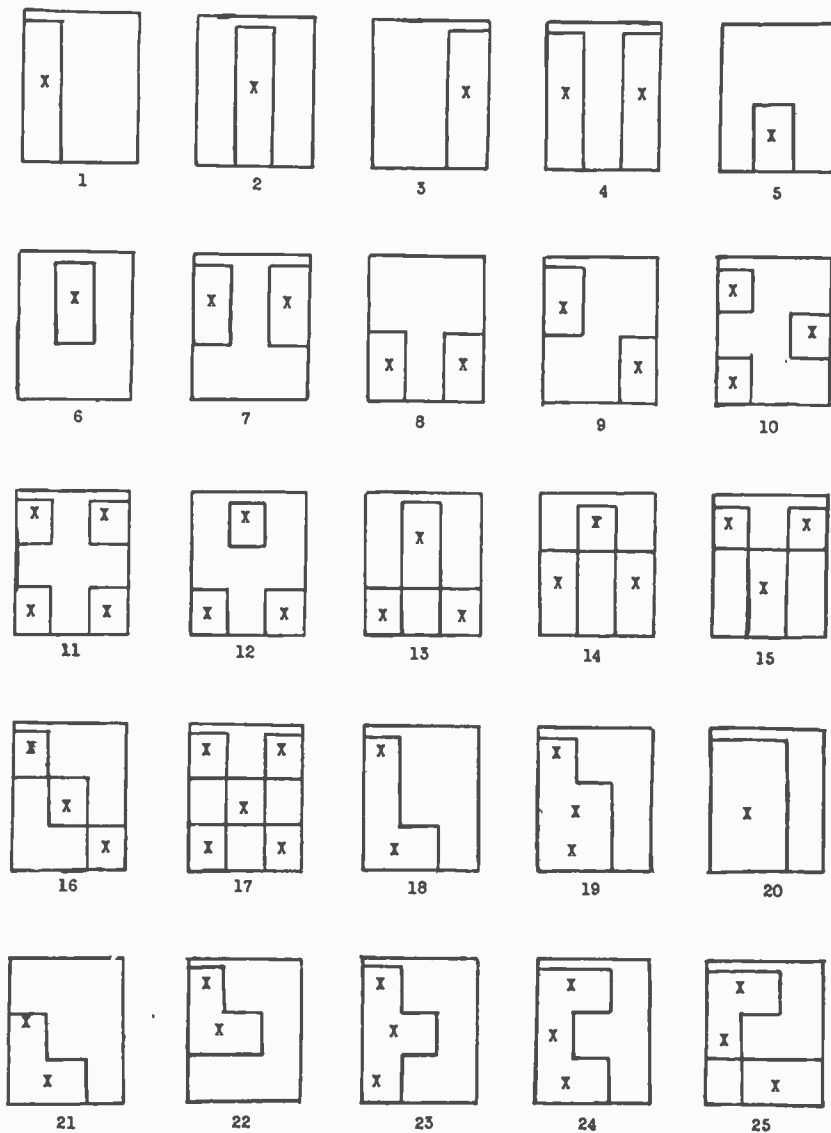

Fig. 2

of variety available, and that there is room for considerable ingenuity in getting attractive page effects. All the arrange-

ments shown meet the requirements of immediately available space for "flash" news in at least one of the vertical columns.

October 20, 1934 New York, N. Y.		THE RADIO CLARION PUBLISHED BY THE RADIOPRINT BROADCASTING CORPORATION		Page 5 1.24 A.M.
YUGOSLAVIA'S BOY KING THE small boy who was hurried back to Yugoslavia to become King Peter II already has discovered that royalty must work hard. Though only eleven, he speaks five languages well, and in the fortresslike, closely guarded palace in Belgrade he was trained rigorously for the difficult task of sitting on a throne in a stormy Balkan land. By comparison, the discipline of an English school must have seemed like wild west freedom to him, but he had only eleven days of it before the assassination of King Alexander ended his experience of British schoolboy life. The trip to England was his first journey far outside Yugoslavia. However, Peter has not found life all work. He is fond of outdoor sports and has had time to learn to ride a horse well, to swim expertly, to drive a car, and to become a skilled angler. Like all fishermen, he is apt to exaggerate the size of his catch. He is described as a bright-eyed, likable chap. Young Peter's eleventh birthday on Sept. 3 was disappointing. He had hoped to receive an airplane or a motorcycle of his own but didn't. However, those things can wait. More important, he had counted on having his father play with him the whole day at a Slovenian lake. The King was too busy with affairs of state to keep the date with his son.		STREAMLINE TRAIN SETS 57-HOUR MARK —Slashes Record 14½ Hours on Trip from Los Angeles to Grand Central—FUEL COST IS PUT AT \$80—Could Have Cut Five Hours More but 'Loafed' from Chicago—Engineer Collapses—NEW YORK, Oct. 20.—The Union Pacific streamlined train W-10001, which left Los Angeles at 10 o'clock Pacific Time, Wednesday night, pulled into Grand Central Terminal at 9.55 A.M. Eastern Standard Time yesterday, establishing a new transcontinental train record of 56 hours 55 minutes, or 14 hours and 32 minutes faster than the previous record. The stretch from California to Chicago of 2,584 miles was covered in 39 hours flat, reaching 120 miles per hour.		 <p>STREAMLINE TRAIN POWER CAR—900-Horsepower in 48 Feet—</p>
GUATEMALA PREPARES TO EXECUTE PLOTTERS —Decree Orders Death Penalty for All Possessing Explosives or Taking Part in Bombings—SAN SALVADOR, Oct. 19.—President Ubico of Guatemala has issued a decree prescribing the death penalty for anyone connected with illegal explosions. The penalty also applies to persons not delivering explosives to the authorities within 24 hours, or who manufacture, transport or use bombs. Accessories as well as principals are liable. Trial will be by military law.		REAR OF STREAMLINE TRAIN —Tail Houses Kitchen Buffet Music in the Home! Another Shipment of Wanamaker's Famous Chopper Canaries at the special price of \$4.65		 <p>Every bird purchased strong, healthy, and a sweet singer. These happy little golden musicians are especially sweet companions during the gray winter months. Get yours now and get it at Wanamaker's—we're noted for the fine breed we carry!</p>
BRITISH UNEMPLOYED DROP 54,591 in MONTH—September Total was 2,081,987 As Trade Conditions Showed Gain in Some Industries—(Continued in Next Column)		(RCA Radiogram to THE RADIO CLARION) —LONDON, Oct. 19.—According to the Ministry of Labor's monthly report issued today, the unemployed were 254,740 fewer than in September, 1935. Last month they included 1,723,820 men and boys and 358,167 women and girls. Improved trade conditions to which less unemployment is attributed are seasonal, incidental to the approach of cold weather.		

Fig. 3

Illustrations of half the page width are possible in a series of similar arrangements, and may be combined with the third-width layouts as desired. Similarly, one-sixth-width advertisements

may be placed in vertical columns at the right and left edges of the pages, thus leaving room in the center for two one-third-width columns. Numerous similar additional arrangements will suggest themselves to the future publishers.

If the facsimile material is to be typewritten rather than printed, which latter is preferable on the score of clean-cut appearance but not as regards time delay and expense, a suitable special typewriter will be required with new fonts of type. Some existing machines are particularly adapted to the purpose since their touch is automatic and therefore uniform, the spacing is changeable, and the fonts of type are readily interchangeable.¹

To gain some idea of the appearance of a facsimile broadcast, a sample facsimile publication has been prepared. Its appearance is indicated by Figure 3. It is manifestly not feasible to give any complete idea of the wide variety of material listed above as suitable for facsimile publications through a limited number of sample pages. Also, the improved equipment for rapid preparation of "copy" (referred to in the footnote to the preceding paragraph) has already extended the possibilities of "making ready" a much more "professional" appearing type page.

Mr. C. J. Young has kindly furnished the following guiding information for the preparation of material for facsimile scanners developed in his group. The sheets should be $8\frac{5}{16}$ inches wide and of any convenient length up to $11\frac{1}{2}$ inches. Prints on photostat paper are suitable for transmission. A 1-inch margin on each side is desirable. The type size may be as small as typewriting; ordinary newsprint type is somewhat too small to look well when reproduced. Pictures having half-tone screening are not desirable, but rotogravure material and original photographs are satisfactory. Line cuts are excellent for the purpose.

A horizontal line of I's may be run across the bottom of each sheet and would be intended to represent diagrammatically some sort of indication that the automatic sheet-cutter in the receivers is to be set into operation by the corresponding modulated signal. The I's were selected because the vertical lines corresponding

¹ A typewriter of new design capable of results approximating the ideal has recently been produced by a manufacturer of office equipment. The reproduced characters bear remarkable resemblance to printed alphabetical letters in their uniform blackness. In addition, the device automatically accords each character a spacing in keeping with its width, and as well "justifies" the margins. The virtues of the linotype are thus closely approximated, and "copy" suitable for facsimile scanning is made much more quickly obtainable.

thereto are of sufficient length so that, slight errors of alignment of the sheet in the scanner notwithstanding, some part of the vertical portion of each "I" will scan. Approximately 100 of these I's will thus be scanned in a horizontal line in a time of about $\frac{1}{2}$ second, thus producing approximately a 200-cycle tone, the current corresponding to which may be arranged to operate, for example, a tuned-reed or other simple form of selectively responsive relay which, in turn, actuates the paper-cutting mechanism. If possible, the paper cutter should be so placed that the printed sheet passes under it at about $\frac{1}{2}$ -inch from the carbon-printing line, which is the horizontal margin width, thus avoiding a full-sheet delay between printing and cutting off a given sheet.

GENERAL CONSIDERATIONS

Even among persons well informed on radio matters, there has been considerable confusion of thought as between facsimile and television broadcasting, combined with a tendency to regard these as similar in their methods and difficulties, and inherently likely to be competitive. The facts are otherwise. Facsimile is necessarily confined to the field of the printing arts while television functions more in the sphere of the picture in motion with accompanying sound. The following tabulation gives a more detailed comparison between certain pertinent features of facsimile and television broadcasting, and correspondingly emphasizes the differences between them.

<i>Factor</i>	<i>Facsimile</i>	<i>Television</i>
1. Program construction.	By editors, reporters, writers, photographers, graphic artists.	By scenario writers, musical composers or arrangers, scenic artists, motion-picture cameramen.
2. Availability of program material.	Considerable and immediate.	Much new material and novel methods of treatment required.
3. Studio requirements.	None.	Elaborate; rather like motion-picture studios.
4. Artist requirements.	Literary and editing ability.	Extensive literary, directing, and acting skill; on a reduced scale like motion-picture studio requirements.

5. Necessity for associated audio transmission.	Generally none; limited use in some special cases such as dramatic performances and music lessons.	Major need; analogy to <i>sound</i> motion pictures determines this point.
6. Transmitter power for large metropolitan area.	Estimated at 5-10 kilowatts.	Estimated at 10-50 kilowatts.
7. Side-band-width for low-speed low-detail transmission.	0.2-0.4 kilocycles— (though a wider band may be used for convenience).	25-50 kilocycles, (not satisfactory).
8. Side-band-width for high-speed high-detail transmission.	1-20 kilocycles.	Up to 3,000 kilocycles.
9. Network availability.	Immediate; the present networks are suitable with minor changes. ³	Remote; networks must be built using new coaxial cables, or a radio-relay system provided.
10. Annual network cost.	Somewhat as at present; that is, apparently economically feasible.	High, so far as can now be seen; perhaps many times present annual cost.

Of the above factors, Numbers 2, 3, 4, 9 and 10 weigh heavily in favor of facsimile broadcasting.

One of the troublesome problems of facsimile broadcasting and television broadcasting alike is the limited range of the ultra-high-frequency stations which will be used for both, and the consequent lack of rural coverage. This may be keenly felt, since it is the rural population which needs and desires these new services. For television, no practicable and comprehensive solution functioning within necessary economic limitations is now known. For facsimile, a sort of compromise might be effected whereby the present broadcasting station on the 540-1600 kilocycle band would send facsimile publications from 1 to 6 o'clock in the morning for the rural sections, and the ultra-high-frequency transmitters would send all day and night for

³ This statement is obviously not based upon experiments in linking radio facsimile transmitting stations by wire networks, but rather on the success of wire transmission of pictures as exemplified, for example, by the service offered by the Associated Press to its subscribing newspapers through the use of the facilities of the American Telegraph and Telephone Company.

the urban and suburban recipients. While this involves a certain duplication, it would give the rural readers at least some facsimile service. Further, the service for these rural readers will be less expensive than for the urban readers since only the recorder (which is then connected to the ordinary broadcast receiver) will be required; whereas the urban readers who want continuous, all-day-and-night, service will also purchase a new ultra-high-frequency receiver.

In conclusion, the characteristics which facsimile broadcasting equipment should possess, in order that it may enjoy public acceptance, include:

1. Moderate first cost.
2. Simplicity of operation and manipulation, with minimum required attendance and replacements.
3. Clarity of text and line cuts.
4. Satisfactory delineation of half-tones.
5. Acceptable color of picture.
6. At least a fair degree of permanency of the pictures and text.
7. Low maintenance and paper renewal charges.
8. Good recording speed.
9. Reliable synchronizing method, adaptable to any receiver location.
10. Suitability for network operation.
11. Long operating life.
12. Reasonable compactness.

Given the above characteristics, and assuming skilled program construction and consistent improvement and evolution of program material, it is likely that under suitable economic conditions there can be gradually developed a new and attractive facsimile broadcasting service to the public. It should be pointed out that the thoughts expressed in this paper are those of the writer, and that they do not necessarily reflect the viewpoint of any radio manufacturing or broadcasting organization.

