

RADIO — ELECTRONICS

Exclusive
**TELEVISION
NEWS**
Section

HUGO GERNSBACK, Editor

formerly
**RADIO
CRAFT**



LADY TELEVISION ENGINEER
SEE TELEVISION NEWS



NOV
1949

30¢

U. S. and
CANADA

LATEST IN RADIO — ELECTRONICS — TELEVISION

*If your
Pictures
look like this* →



YOUR TELEVISION WILL BE IMPROVED WITH A **WARD** OUTDOOR AERIAL

*to give you
Pictures like this* →

The modern miracle of pictures by air can be a most satisfying means of entertainment. But be satisfied only with a picture comparable to a class "A" motion picture—on every station in your area. It is unnecessary to compromise!

HERE'S WHY: Television waves are like light beams — solid objects reflect and refract them, making it impractical to pick up all stations from an indoor aerial. That is why you get double images on some stations.

In addition, indoor aerials have poor signal pickup making it difficult to get good pictures on all stations.

FURTHERMORE: Your indoor antenna may have a high noise level which increases the amount of interference as you advance the contrast control to bring up a weak picture. All of these technical difficulties are eliminated by a WARD outdoor aerial installed by a competent radio serviceman. In every case, a Ward outdoor antenna will improve reception over an indoor aerial. Also, Ward aerials are so well designed, they are attractive on a house. *It is unnecessary to compromise!*

WARD is the largest and oldest exclusive maker of television and auto radio aerials.



Does the antenna on your automobile need repair? Replace it with
WARDS'S 8-BALL — world's largest selling auto aerial.

WARD PRODUCTS CORPORATION
1523 E. 45TH STREET, CLEVELAND, OHIO
Division of the Gabriel Company



NEW



I'LL TRAIN YOU FOR YOUR FCC LICENSE

A Federal Communications Commission Commercial Operator's License puts you in line for a good job in Radio or Television Broadcasting, Police, Marine, Aviation, Two-way, Mobile or Micro-wave Relay Radio. Mail coupon below for book and catalog (both FREE) about my NEW Communications course.

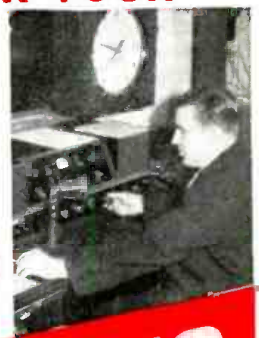

YOU BUILD THIS TRANSMITTER

with parts I send. This low-power broadcasting transmitter shows you how to put a station "on the air." You perform procedures demanded of Broadcast Station Operators, conduct many experiments, make many practical tests.

LEARN COMMUNICATIONS by PRACTICING at Home in Spare Time

with MANY KITS of MODERN EQUIPMENT I SEND



MY COURSE INCLUDES TELEVISION

Course Is New! Different!

Mail coupon now for facts about my NEW, intensely practical course in Radio-Television Communications. Let me send you FREE books. Read outlines of 78 lesson texts written for you by leading Communications experts, edited by my practical staff. See the nine big Kits of Parts I send that "bring to life" theory you learn. Read about the transmitter you build and operate, about the Electronic Multimeter you get. All equipment yours to keep. My BRAND NEW course includes BOTH Theory and Practical Experience, with result-getting kits, in Radio-Television Communications. It's backed by N. R. I.—the world's oldest and largest home study Radio school.

Mail Coupon For Book FREE

Send today! See what my NEW course is like. Find out how I get you ready for a brighter future, better earnings, more security in Radio-Television. Send coupon now in envelope or paste on penny postal. NO OBLIGATION. NO SALESMAN WILL CALL! My books, sent to you FREE, tell the full story. J. E. SMITH, President, Dept. 9MX, National Radio Institute, Washington 9, D. C.

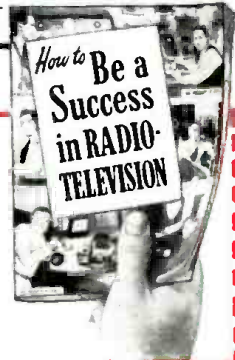

YOU BUILD

this Transmitter Power Supply used in the basic experiments in RF and AF amplifiers, frequency multipliers, buffers, etc.

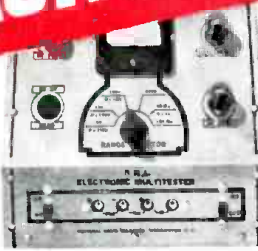

YOU MEASURE

current, voltage (AC, DC and RF), resistance and impedance in circuits with Electronic Multimeter you build. Shows how basic transmitter circuits behave; needed to maintain station operation.



YOU SET UP

code amplitude and frequency modulation circuits (put voice, music, etc., on "electrical signal" you produce). You introduce, correct defects, learn how to get best performance.



YOU BUILD

this Wavemeter and use it to determine frequency of operation, make other tests on transmitter currents.

I TRAINED THESE MEN



"I am now Chief Engineer of Radio Station WORD, in charge of four engineers. Owe all I know about Radio to N. R. I."—C. J. BURDETTE, Spartanburg, S. C.



"I have been in several kinds of Radio work. I am now specializing in Marine Radio telephone installations and service."—MURRAY DICKSON, Paducah, Ky.



"Thanks for splendid Home Study Radio Course, a large factor in my getting present position as Senior Radio Operator of Station WRGP."—C. LISTER, Pensacola, Fla.



"When I enrolled, I had no idea of entering Commercial Radio. Now Operator, Police Radio Station WASP and Highway Station WKSJ."—G. DeRAMUS, Selma, Ala.



"Hold a Radio telegraph Second Class License. Now with Civil Service as P-4 Electrical Engineer."—OTIS L. WRIGHT, Albuquerque, N. M.



"Am now Chief Engineer at Radio Station WAGC. Still using my N. R. I. texts as well references."—CHAS. W. STOKELY, Chattanooga, Tenn.

Servicing Training Also Offered by N. R. I.

If you prefer a good-pay job in Radio-Television Servicing . . . or your own money-making Radio-Television Sales and Service Shop, I'll train you at home. My famous Servicing Course also includes many Kits of Parts. You conduct experiments and tests with modern Radio and other circuits you build. I also show you how to make \$5, \$10 a week or more EXTRA MONEY fixing neighbors' Radios while training. Full information in my 64-page catalog. Mail coupon.

MAIL NOW-BOOK FREE

MR. J. E. SMITH, President, Dept. 9MX National Radio Institute, Washington 9, D. C.

Mail me FREE Catalog and Book about Radio and Television Communications opportunities and training. (No salesman will call. Please write plainly.)

Name..... Age.....
Address.....
City..... Zone..... State.....
 Check if Veteran Approved Under G. I. Bill

VETERANS GET THIS TRAINING WITHOUT COST UNDER G. I. BILL. MAIL COUPON.

RADIO — ELECTRONICS

formerly RADIO-CRAFT

Incorporating
SHORT WAVE CRAFT • TELEVISION NEWS •
RADIO & TELEVISION
*Trademark registered U. S. Patent Office

John J. Lamson
Sales Manager
Lee Robinson
General Manager
G. Aliquo
Circulation Manager

Hugo Gernsback, Editor-in-Chief
Fred Shunaman, Managing Editor
M. Harvey Gernsback, Consulting Editor
Robert F. Scott, W2PWG, Technical Editor
R. H. Dorf, W2QMI, Associate Editor
I. Queen, W2OUX, Editorial Associate
Angie Pascale, Production Manager
Wm. Lyon McLaughlin,
Technical Illustration Director

Contents — November, 1949

Editorial

To the Service Technician.....by Hugo Gernsback 19

FM (Pages 20-22)

Limit-Discriminator versus Ratio Detector
by H. K. Milword and R. W. Hollows 20

Television News (Pages 23-30)

Lady Television Engineer.....by Tex Barbarite 23
Indoor and Built-In Antennas—Their Strong and Weak Points...by Ira Kamen 25
Television Station List..... 27
Tv Custom Installations.....by David T. Armstrong 28

Theory and Engineering (Pages 31-32)

Microwaves, Part VII.....by C. W. Polmer 31

Amateur (Pages 33-34)

How to Become a Ham, Part II—Learning the Code....by George Shuart 33
Code Practice Stations..... 34

Broadcasting and Communications (Pages 35-36)

Cose of the Elusive Blip.....by James W. Essex 35
Sideband Suppression.....by I. Queen 36

Test Instruments (Page 37)

Tracer Uses Tube as Probe.....by Alva R. and Kenneth W. Wilson 37

Electronics (Pages 38-39)

Cameras Are Tested with Simple Setup.....by Fred C. Gabriel 38

Construction (Pages 40-41)

Miniature-Tube Receiver Has Permeability Tuner...by John E. Hazelrigg 40
Push-Pull Crystal Receivers.....by Rufus P. Turner 41

Audio (Pages 42-43)

Design of Class-B Drivers.....by W. H. Anderson, VE3AAZ 42

Servicing (Pages 44-60)

Service Technicians Hold Convention (see The Radio Month, page 9)
Service Data, Technicians, and Money.....by John T. Frye 44
Curing I.F. Oscillations.....by John A. Dewar 46
Home Study Courses Useful to Radiomen.....by Samuel Freedman 47
Radio Set and Service Review (Eicor Model 1000 Tape Recorder)..... 50
Fundamentals of Servicing, Part IX—The Diode Vacuum Tube...by John T. Frye 56

Foreign News (Pages 62-66)

European Report.....by Major Rolph W. Hollows 62

Departments

The Radio Month..... 8	Association News..... 84
Radio Business..... 10	Technotes..... 85
New Patents..... 68	Miscellany..... 86
New Devices..... 70	People..... 89
Radio-Electronic Circuits..... 74	Communications..... 91
The Question Box..... 80	Book Reviews..... 95
Try This One..... 83	

ON THE COVER: Tex (Mrs. Rose Ann) Barbarite, television engineer, doing maintenance work on the equipment at RCA's Exhibition Hall, Radio City, New York, N. Y. Kodachrome by Avery Slack.



You can do every kind of soldering with this new 250 watt Weller Gun. Power-packed, it handles heavy work with ease—yet the compact, lightweight design makes it equally suited for delicate soldering and getting into tight spots.

Pull the trigger switch and you solder. Release the trigger, and off goes the heat—automatically. No wasted time. No wasted current. No need to unplug the gun between jobs. 'Over and under' position of terminals provides greater visibility with built-in spotlight. Extra 5/8" length and new RIGID-TIP mean real soldering efficiency.

Chisel-shape RIGID-TIP offers more soldering area for faster heat transfer, and new design gives bracing action for heavy jobs. Here you get features not found in any other soldering tool... advantages that save hours and dollars. Your Weller Gun pays for itself in a few months. Order from your distributor or write for bulletin direct.

SOLDERING TIPS—get your copy of the new Weller guide to easier, faster soldering—20 pages fully illustrated. Price 10c at your distributor, or order direct.



WELLER
MANUFACTURING COMPANY

828 PACKER STREET • EASTON, PA.

RADIO-ELECTRONICS for

RADIO-ELECTRONICS, November, 1949, Volume XXI, No. 2. Published monthly. Publication Office: Erie Ave. E to G Streets, Philadelphia 32, Pa. Entered as second class matter September 27, 1948, at the post office at Philadelphia, Pa., under the Act of March 3, 1879. **SUBSCRIPTION RATES:** In U. S. and Canada, 10c per copy, \$1.00 per year; 15c per copy, \$1.50 per year; 20c per copy, \$2.00 per year; 25c per copy, \$2.50 per year; 30c per copy, \$3.00 per year; 35c per copy, \$3.50 per year; 40c per copy, \$4.00 per year; 45c per copy, \$4.50 per year; 50c per copy, \$5.00 per year; 55c per copy, \$5.50 per year; 60c per copy, \$6.00 per year; 65c per copy, \$6.50 per year; 70c per copy, \$7.00 per year; 75c per copy, \$7.50 per year; 80c per copy, \$8.00 per year; 85c per copy, \$8.50 per year; 90c per copy, \$9.00 per year; 95c per copy, \$9.50 per year; 1.00 per copy, \$10.00 per year. Allow one month for change of address. When ordering a change please furnish an address stencil impression from a recent wrapper. **RADIO-CRAFT PUBLICATIONS, INC.** Hugo Gernsback, Pres.; M. Harvey Gernsback, Vice-Pres.; G. Aliquo, Sec'y. Contents Copyright, 1949, by Radio-Craft Publications, Inc. Text and illustrations must not be reproduced without permission of copyright owners.

EDITORIAL and ADVERTISING OFFICES: 25 West Broadway, New York 7, N. Y. Tel. REctor 1-9690. **BRANCH ADVERTISING OFFICES:** Chicago: 308 W. Washington Street, Telephone RANDolph 6-7363. Los Angeles: Ralph W. Barker, 1127 Wilshire Blvd., Tel. MA 9-1271. San Francisco: Ralph W. Barker, 582 Market St. Tel. GARfield 1-2481. **FOREIGN AGENTS:** Great Britain: Atlas Publishing and Distributing Co., Ltd., 18 Bride Lane, Fleet St., London E.C.4. Australia: McGill's Agency, 179 Elizabeth Street, Melbourne. France: Brentano's, 37 Avenue de l'Opera, Paris 2e. Holland: Trilectron, Heemstedeche, Dreef 124 Heemstede. Greece: International Book & News Agency, 17 Amerikis Street, Athens. 88. Africa: Central News Agency, Ltd., Cor. Risik & Commissioner St., Johannesburg; 112 Long Street, Capetown; 369 Smith Street, Durban. Natal. Universal Book Agency, 70 Harrison Street, Johannesburg. Middle East: Rielmatzky Middle East Agency, Jaffa Road, Jerusalem. India: Sull Gupta (Distributors) Co., Armita Bazar Patrika Lt., 14 Ananda Chatterjee lane, Calcutta. Broadway News Centre, Post Bag #5557, Madras. Bombay #14, K. L. Kannappa Mudliar, 30 General Patters Road, Mount Road, Madras 2. Pakistan: Paradise Book Stall, Opp. Regal Cinema, Preehy St., Karachi 3.

Editorial and Executive Offices:
25 West Broadway, New York 7, N. Y.



MEMBER
AUDIT BUREAU OF CIRCULATION



Get Into

RADIO, TELEVISION and ELECTRONICS

Master ALL Phases

YOU Build This Superheterodyne

You receive complete standard equipment, including latest type High-Mu Tubes, for building various experimental and test units. You progress step by step until you build a complete Superheterodyne Receiver. It is yours to use and keep.

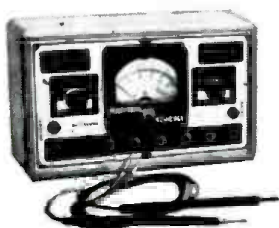

YOU RECEIVE THIS PROFESSIONAL MULTITESTER!

You will use this professional instrument to locate trouble or make delicate adjustments—at home—on service calls. You will be proud to own this valuable equipment. Complete with test leads.

SIGNAL GENERATOR

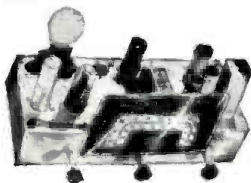

You construct the Transatron Signal Generator shown here, demonstrating Transatron principles in both R.F. and A.F. stages. You study negative type oscillators at firsthand.

AUDIO OSCILLATOR:

An electronic device, which produces audio-frequency signals for modulating R.F. (radio frequency) carrier waves, testing A.F. (audio frequency) amplifiers, speakers, etc.



T.R.F. RECEIVER

You build several T.R.F. Receivers, one of which, a 4-tube set, is shown at left, and how to conduct many tests.

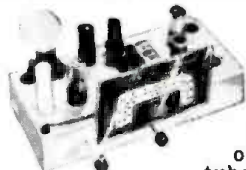

Get Complete Training. You Receive and Keep All Equipment, Parts and Lessons. No Extra Charges.

GOOD PAY and Unlimited Opportunities in JOBS LIKE THESE:

- Business of Your Own
- Radio Manufacturing, Sales, Service
- Broadcasting, Telecasting
- Television Manufacturing, Sales, Service
- Laboratories: Installation, Maintenance of Electronic Equipment, Electrolysis, Call Systems
- Garages: Auto Radio Sales, Service
- Sound Systems and Telephone Companies; Oil Well and Drilling Companies; Engineering Firms
- Theatre Sound Systems, Police Radio

And scores of other good jobs in many related fields

YOU CONDUCT MANY EXPERIMENTS LIKE THESE!

- Checking action of condensers
- Experiments with AF and RF amplifiers
- Experiments with resonance
- Producing beat frequencies
- Calibrating oscillators
- Experiments with diode, grid-bias, grid-leak and infinite impedance detectors
- Practical experience in receiver trouble shooting
- Application of visual tester in checking parts and circuits
- Experiments with audio oscillators
- Advanced trouble-shooting
- ... and many, many others

Complete Training by Practical Resident Trade School, Est. 1905

The same highly trained faculty, instruction materials and methods used here in our large, modern resident school, are adapted to your training in your own home. Shop Method Home Training has been proved by hundreds of successful graduates.

Both Resident and Home Study Courses Offered

YOU LEARN BY DOING

You receive special laboratory experiment lessons to show you how to build with your own hands various experimental units such as those shown at left, and how to conduct many tests.

You will find all lessons easy to understand because they are illustrated throughout with clear diagrams and step-by-step examples that you work out yourself. Every piece of the equipment and complete lesson material we send you is yours to keep and enjoy, including the multitester, experimental equipment, all parts of the Superheterodyne, tube manual, radio dictionary, and complete, modern Television texts. All parts are standard equipment.

Shop Method Home Training . . . Earn While You Learn

With our practical resident Shop Method Home Training, you study in your spare time. You receive Spare Time Work Lessons, which show you how to earn while you learn. Service neighbors' radios and TV receivers, appliances, etc., for extra money and experience. Many National students pay all or part of their training with spare time earnings!

DON'T DELAY! The Radio-Television Industry needs trained men NOW!

APPROVED FOR VETERANS!
Check coupon below!

For quick action, mail coupon today and we'll rush you full information.

Free!

NEW, ILLUSTRATED OPPORTUNITY BOOK AND SAMPLE LESSON SHOW YOU HOW WE TRAIN YOU . . . SEND FOR THEM TODAY! NO COST. NO OBLIGATION.

NATIONAL SCHOOLS
LOS ANGELES 37, CALIF. • EST. 1905

FIND OUT NOW . . . MAIL COUPON TODAY

National Schools, Dept. 11-RE
4000 South Figueroa Street
Los Angeles 37, California

Send me your FREE book "Your Future in Radio" and the sample lesson of your course. I understand no salesman will call on me.

NAME.....AGE.....

ADDRESS.....

CITY.....ZONE.....STATE.....

Check here if Veteran of World War II

Mail in envelope or paste on penny postal.

NATIONAL
TELEVISION

Presents
2 ALL-NEW
1950 MODELS

YOU'LL BE *Sight*
SOLD ON

Place these two new 1950 National Television receivers side by side with any other television receiver. Compare the large (12½") screen—compare the chassis—compare the picture quality—compare the cabinet styling. Because National Television is custom assembled—not mass-produced—there just *is* no comparison! Yet it costs no more.



Model TV-12W
Striking modern mahogany table model with 12½" tube and 2 six-inch oval speakers.
\$269.95

- Model TV-10W
Genuine mahogany table model with 10" screen and 2 six-inch speakers.
\$229.95



- Model TV-7W
Unbeatable TV dollar value. 7" screen with twin speakers. NC enlarging lens available, \$16.95.
\$129.95



- Model TV-7M
Metal cabinet version of TV-7W. Ideal as "second set" for playroom, den or bedroom.
\$119.95



Model TV-1225
A 12½" picture tube and a 10" speaker in a handsome mahogany console.
\$299.95

(1) Latest flyback high voltage supply gives clear, bright pictures even in fringe areas. (2) Automatic frequency control locks picture in place. (3) Exceptionally wide video band-width for beautiful clarity of detail. (4) Front-of-panel focus control. (5) Coil switching assures equivalent of separate, high-Q tuned circuits for each channel. (6) Automatic gain control. (7) 3-stage 37 mc IF minimizes picture interference caused by other radio services. (8) Double-tuned RF bandpass circuits improve selectivity and image ratio. (9) Automatic Station Selector and fine tuning control.

Prices Slightly Higher West of the Rockies

National
EST. 1914
NATIONAL COMPANY, Inc.
MALDEN, MASSACHUSETTS

RADIO-ELECTRONICS for

TV Means Jobs—Good-Paying Jobs—for Technically Trained Men



★ ENGINEERS



★ OPERATORS



★ CAMERAMEN



★ TECHNICIANS



★ INSTALLERS

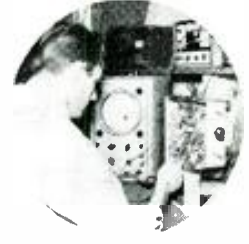

★ SERVICEMEN

Here's How CREI Home Study Training
Prepares You for a Better Job in
TELEVISION

Get in and get ahead in Television . . . the field that *Fortune Magazine* says is "the most dynamic single element in the entire American economy!" Within a few years, says the magazine, TV will be one of the first ten industries in the U.S.

New FCC frequency allocation plans call for 2,245 video stations in 1,400 communities. Since a television station requires many more technicians and engineers than the average AM station, you can readily see the great number of good jobs that are needed to be filled within the next year or two.

If you are now in radio, this is the time to prepare for your future in Television. CREI offers the very training you need to go after — and get — a good TV job. CREI courses can be studied in your spare time and can be fitted into the most crowded schedules. They are designed to give you a thorough grounding in basic principles (remember that all new electronic developments have their roots in

past techniques) and take you step-by-step through the more advanced subjects of TV and its related fields.

Don't wait another day. Television won't wait for you. In all our 22 years of association with professional radiomen we know that the man who acts promptly is the man who succeeds. The facts about CREI, our courses, and what we can do for you, are described in our 32 page booklet. It's worth reading. *Send for it today.* (Veterans: CREI training is available under the G.I. Bill. For most veterans, July 25, 1951 is the deadline—act now!)

SAMPLE LESSON FREE!

Now, see for yourself, how interesting it is to study at home and improve your ability the CREI way.

"THE ORTHICON AND IMAGE ORTHICON"—this lesson describes the development of the small, 3-inch image orthicon tube; theory and operation of the orthicon; image orthicon; specific features.

THE 3 BASIC CREI COURSES:

- ★ PRACTICAL RADIO ENGINEERING
Fundamental course in all phases of radio-electronics
- ★ TELEVISION & FM SERVICING
Streamlined course for men in "top 1/3" of field
- ★ PRACTICAL TELEVISION ENGINEERING
Specialized training for professional radiomen

CAPITOL RADIO ENGINEERING INSTITUTE

An Accredited Technical Institute Founded in 1927

Dept. 1411A, 16th and Park Rd., N.W.
Washington 10, D. C.

Branch Offices: New York (7) 170 Broadway
San Francisco (2) 760 Market St.

NOVEMBER, 1949



CAPITOL RADIO ENGINEERING INSTITUTE

Dept. 1411A, 16th & Park Rd, N.W. Washington 10, D.C.

Gentlemen: Please send me FREE SAMPLE LESSON and booklet, "Your Future in the New World of Electronics" together with full details of your home study courses as checked. I am attaching a brief resume of my experience, education and present position.

CHECK FIELD OF GREATEST INTEREST:

PRACTICAL TELEVISION ENGINEERING
 TV, FM & ADVANCED AM SERVICING
 PRACTICAL RADIO ENGINEERING
 AERONAUTICAL RADIO ENGINEERING
 BROADCAST RADIO ENGINEERING (AM, FM, TV)
 RADIO-ELECTRONICS IN INDUSTRY

NAME _____ AGE _____

ADDRESS _____

CITY _____ ZONE _____ STATE _____

I AM ENTITLED TO TRAINING UNDER G.I. BILL



FREE BOOKLET
plus
SAMPLE LESSON

...Help end
spark plug
INTERFERENCE



Spark Plugs are miniature broadcasting stations, send signals that interfere with radio reception, distort television. The New Auto-Lite "Resistor" Spark Plug reduces this interference.*



Recommend **NEW**
AUTO-LITE
Resistor
SPARK PLUG

Here's How It
Works to End
Interference

The "Resistor" acts to dampen the spark plug radio signal to an acceptable level* while still delivering the full high voltage discharge required to ignite the fuel.



Auto-Lite Ignition Engineers, working with leading automotive manufacturers, have developed the new Auto-Lite "Resistor" Spark Plug with this built-in resistor that reduces spark plug interference.* Remember, the "Resistor" also helps deliver smoother idling, improved economy, longer electrode life. Dealers are being supplied as rapidly as possible. Write for Booklet M-1186 for full information.

THE ELECTRIC AUTO-LITE COMPANY
Toronto, Ontario Toledo 1, Ohio

*Under 35mv/m from 540 k.c. to 150 m.c. at 50 ft.

Tune in "Suspense," Thursday, 9:00 P. M., E. T., CBS

COLOR TELEVISION using all-electronic methods and utilizing only the present 6-mc channel was demonstrated to the FCC last month by RCA. Resulting from new and basic technical developments, the system permits color transmissions to be sent over existing, unmodified transmitters and to be received in black and white on present receivers. Receivers built for color reception or equipped with a color converter can receive programs either in color or in monochrome so that stations need broadcast in color only shows suited for it. The system is all-electronic, with no moving parts.

Dr. E. W. Engstrom, vice-president in charge of research at RCA Laboratories, who prepared the engineering statement for the FCC, said that there is no degradation in picture quality, whether images are received in color or monochrome, on special receivers or on standard ones. No receiver adjustments are required when stations switch from color to black-and-white or *vice versa*.

The new color system is based primarily on a time multiplexing system, by which three camera signals are successively sampled at high speed. Each signal carries picture information of one of the three primary colors. The signals are combined and passed to the transmitter after filtering, containing no components of higher frequency than 4 mc.

At the receiver the r.f., pix and sound i.f., second detector, and sound circuits are standard. The video signals are separated into their color components and fed to three cathode-ray tubes, one with red phosphor, one with green, and one with blue. The three images are projected on a screen in register so that in the final picture each color shows up in its correct value.

NEW INSTRUMENT called the *cholelithophone* locates gallstones inadvertently left in a patient's body after a removal operation. Some of the stones are as small as grains of sand; they are usually transparent to X-rays.

The instrument has a thin, flexible probe which the surgeon inserts in narrow ducts. When the probe tip encounters a stone, it acts like a phonograph needle. The tiny click is relayed to an amplifier and loudspeaker, which emits a distinctive "ping."

The inventors are Dr. E. A. Walker and E. G. Thurston of Pennsylvania State College and Dr. C. K. Kirby of the University of Pennsylvania Medical School.

BONDED TELEVISION SERVICE was launched last month in Boston, Mass., by the Federal Television Co., a service contractor, as its solution to the problem of contractor reliability. The bonded warranty is backed by the American Fidelity Co., a Vermont insurance organization. The company says its guarantee is unique in that the customer is assured of his year's service. Even if the contractor went out of business, the contract would still be performed by the insurance company.

TV SERVICE CONTRACTS may be made by independent service organizations (as well as by manufacturers and dealers) in New York State and may be substantially identical to those previously in effect—including renewal provisions—provided that new parts are not furnished without additional charge. This was (effectively) the ruling laid down in an interpretive bulletin issued last month by Alfred J. Bohlinger, Deputy Superintendent of the State Insurance Department, to clarify the department's position on the opinion given earlier by State Attorney-General Nathaniel Goldstein. An additional provision forbids "insuring" the set against damage from other than normal use, such as by fire; but standard service contracts have never covered such externally caused damage in any case. Goldstein's original interpretation of the law (see September issue of **RADIO-ELECTRONICS**, page 9) appeared to indicate that independent contractors could not operate at all.

TV RELAYS owned by private corporations and those operated by the Bell System should be interconnected, said the FCC last month in a proposed decision directing Bell to drop its policy against interconnection. The policy has heretofore prevented programs relayed for some distance by Du Mont or Philco relay systems from being carried further by Bell. While stating that television relaying will eventually be a business exclusively for common carriers, the Commission called the present refusal to tie up unjust and unreasonable because of Bell's lack of adequate facilities.

"PAY-BACK" TV SERVICE was announced last month by Sylvania Television as a new plan for reducing both set owners' contract cost and the number of nuisance service calls. Under Sylvania contracts, the buyer receives a book of coupons, each good for one service call. While the number of calls is not limited by the coupons, the owner receives a refund for each coupon he holds at the end of the year. Knowing that saved service calls mean saved money, owners will not request them without good reason and technicians will not waste time unnecessarily.

CITIZENS RADIO CORP., holder of the patents on the first transceiver to be approved by the FCC for use in the citizens band, was sold last month to Stewart-Warner Corp. Al Gross, inventor of the transceiver, will continue as chief engineer. Large-scale production is scheduled to begin soon; the firm has been flooded with orders.

THEATRE TELEVISION may require 60 channels, each 50 mc wide, for a complete and competitive nationwide theatre TV system, according to a statement made last month by the Society of Motion Picture Engineers. Picture quality will eventually have to rival motion pictures, say the engineers, and the 50-mc bandwidth may be essential to provide the extra definition.

RADIO-ELECTRONICS for

The Radio Month

SERVICE TECHNICIANS HOLD CONVENTION

Radio service history was made in the three-day convention and exhibition staged in Philadelphia on September 18, 19, and 20 by the Philadelphia Radio Service Men's Association (PR SMA). Held for the purpose of publicizing and promoting Pennsylvania's Preventive Maintenance Month in October, it was the first full-scale professional combined convention and show ever held by radio service technicians. More than 1,700 persons registered for the first evening of the convention, which began at 5 p.m. on the 18th and closed at 4 p.m. on the 20th. The evening of the 19th, attendance so greatly surpassed that of the first evening that it was necessary to turn several hundred people away. About 500 technicians were in constant attendance at the daytime sessions on Monday and Tuesday.

Fifty-two booths were occupied by companies whose products are interesting to the service technician and by radio magazines which deal with service problems. Exhibits ranged through the whole gamut of radio and television test equipment and accessories from antenna towers to technical books and service data.

Booths and technical sessions received almost equal attention from the attending service technicians. The latter included talks on the technician's technical and business problems and demonstrations of television servicing and trouble shooting, backed up by ample equipment. (Both the Dynamic Demonstrator operated by John Meagher of RCA and the oscilloscope and projection equipment used to assist the talk

by Carl Quirk of Du Mont practically filled the stage.)

John Rider, Al Steinberg, and A. T. Alexander covered the general situation. Mr. Steinberg covered especially the relations among service technicians, distributors, and manufacturers. Mr. Alexander spoke on the problems of servicing and of service training from the manufacturers' viewpoint on a national scale.

Other papers covered television servicing and maintenance from the antenna to the picture tube, with special attention to front ends, alignment, electronic antennas, multiple reception, and test equipment. The papers were exceptionally well received, and the hall was crowded during every one of the lectures and demonstrations.

The convention was presided over by Dave Krantz, president of PR SMA, who lost no opportunity to drive home the importance of the Preventive Maintenance Month campaign to the service technicians of Pennsylvania. Pointing out that the example of Harrisburg last winter proved that such a campaign could increase repair business as much as 25%, he urged that every set owner in the state be given an opportunity to have his set checked over to assure continued good performance and to avoid possible major repairs which may be necessary later.

Members of PR SMA cooperated to do the organizational, executive, and menial labor needed to keep the convention running smoothly, and it is to their efforts that the great success of the undertaking is due.



Above — Dave Krantz opens a session of the convention. Below — Service technicians visit the exhibitors' booths.

NEW TELEKITS

NOW **49⁹⁵**

Jobbers: Write for Price Information

NEW
TELEKITS
10-B \$69.95
7-B \$49.95

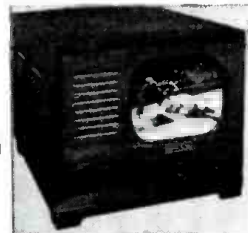

Sparkling new Telekit 10-B has 52-inch screen. Brand new compact lay-out has video tube mounted on chassis. Big illustrated easy-to-follow instruction book guides you step by step through easy assembly. No special knowledge of television is required. All you need is a soldering iron, pliers, and screw driver. 10-B Kit can be used with 1 1/2-inch tubes. Telekit 10-B, \$69.95. 10-B Telekit cabinet, \$15.95 to \$24.50. Telekit Guarantee includes free factory service.

Write for catalog listing 10-B and 7-B Telekits. New 7-B Telekit for 7-inch tube, \$49.95. 7-B cabinet \$15.95 to \$24.50.



TELEKIT BOOSTER \$12.95

If you live in a fringe area this fine Telekit booster will bring in TV signals bright and clear. There is a 20 to 30 times signal boost on all channels. NOT A KIT. Completely assembled. Works with Telekit or any other TV receiver.

13
CHANNEL
TUNER
\$12.95

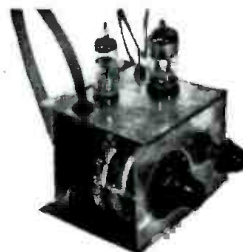

NEW 13 CHANNEL TUNER is a small compact unit with stage of R.F. Tunes all TV and ZFM channels. Made to conform with Telekit or any other TV set having video I.F. of 25.75 Mc. Complete with tubes, pre-wired pre-aligned; only three connections to make. See your jobber, or write to us for information. Your cost, \$19.95.

Write for catalog of Telekit antennas, boosters, television kits, tuners, television parts and tubes.

TELEKIT

SANDERS ELECTRONICS CO.
AVIATION BLDG., 3240 N.W. 27th AVE.
MIAMI 42, FLORIDA

THE MOST WELCOME CHRISTMAS GIFT FOR A RADIO MAN

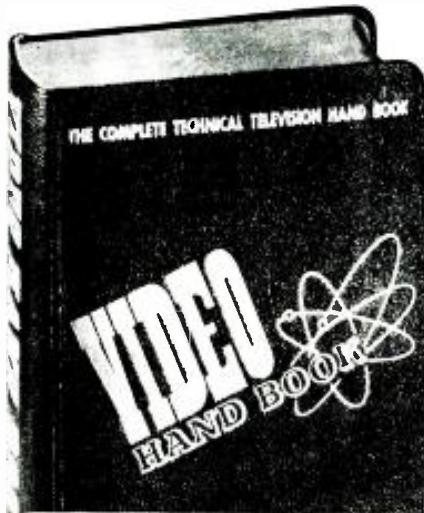

VIDEO HAND BOOK

Now in one great book—all the essential knowledge of television for laboratory technician, experimenter, serviceman . . . everyone interested in or working at television! Complete, up-to-the-minute information arranged for quick reference—easy to read . . . no mathematics. Over 900 pages . . . more than 800 photographs, diagrams and drawings. Here are some of the subjects covered: Fundamentals, the TV station, the receiver, antennas, programming, installation, service, test equipment, data, terms, etc., etc., etc.

\$5.00

RADIO DATA BOOK

The only radio handbook of its kind! Covers everything in Radio for lab technicians—experimenters—servicemen everyone and anyone! Over 900 pages, 12 big sections with hundreds of drawings and diagrams. Some of the subjects covered are . . . Testing, Measuring and Alignment . . . All about Antennas . . . Sound Systems . . . Recording . . . Complete Test Equipment Data . . . Complete Tube Manual . . . Charts, Graphs and Curves . . . 50 Tested Circuits . . . Codes, Symbols and Standards . . . 150 Basic Circuits . . . Dictionary of Radio Terms . . . etc., etc.



\$5.00

RADIO & TELEVISION LIBRARY

A complete library covering everything in Radio and Television in over 1800 pages, completely illustrated! Two handsomely bound books (contents described above) in attractive slip case . . . compact, concise, complete!



Over 1800 Pages \$9.00

And Don't forget this month's copy of

RADIO DISTRIBUTION AND MAINTENANCE

The complete trade journal devoted to sales and service of Radio, Video, Audio.
Single copies 25¢, \$3.00 per year, \$5.00 2 years.

All products of
BOLAND & BOYCE INC., Montclair 3, N.J.
are available at your
local distributor's counters. Order now!

BOLAND & BOYCE INC., PUBLISHERS

Radio Corp. of America, RCA-Victor Division, has placed on the market a new TV receiver to sell for \$199.50. The set has a 61-square-inch screen and 22 tubes. The price is \$70 lower than any previous RCA set and is the company's first below \$200.

Zenith Radio Corp. reports estimated net consolidated profits for itself and its subsidiaries for the first three months ended July 31, 1949, of its current fiscal year amounting to \$170,945 after federal income tax provision of \$218,133, depreciation, excise taxes, reserve for contingencies, and a deduction of \$251,376 representing amortization of good will incident to acquisition of a subsidiary.

Shipments for the quarter were down approximately 10% from the same quarter a year ago, due principally to the normal summertime seasonal decline and a two-week vacation shutdown.

Stewart-Warner Corp. sales for the first six months of 1949 were \$27,875,957, a decline of 26.4% from 1948, JAMES S. KNOWLSON, chairman and president, revealed in a letter sent to stockholders. Sales in the first half of 1948 were \$37,868,485.

Net profit for the six months ended June 30 was \$796,564. Profit in the first half of 1948 was \$1,874,601.

Motorola, Inc., for the six months period ended July 2, 1949, showed net earnings of \$1,908,255, equal to \$2.39 per share. This compares with earnings for the corresponding period last year of \$1,650,039, equal to \$2.06 per share.

The sales figure totaled \$33,822,368, or nearly \$7 million more than the corresponding figure for 1948, which was \$26,918,540.

Plant Mfg. Corp., Bloomfield, N. J., has been organized to manufacture capacitors, according to PHILIP GREENSPAN, president. Other corporation officers are GEORGE F. JEPSON, vice president in charge of sales, IRVING A. GREENFIELD, treasurer and JOSEF UNGER, secretary, all formerly with Solar Mfg. Corp.

Admiral Corp. has increased its production capabilities to 15,000 receivers per week, vice president, J. B. HUARISSA stated recently. Increased expansion was made possible by the development at Admiral's Cortland Street plant in Chicago of the longest straight production line in the industry, and by installing facilities for the manufacture of 500 sets per day at the Harvard, Ill., plant.

Radio Parts and Electronic Equipment Shows, Inc., Chicago, through its president, JEROME J. KAHN, announces a distributors' advisory committee, made up of 10 of the industry's leading jobbers, to consult with the directors and management of the 1950 Distributors Show on ways and means of making the show of major interest and service to jobbers.

WILLIAM O. SCHONING, of Lukko Sales, Chicago, was named chairman and AARON LIPPMAN, of Aaron Lippman Co., Newark, vice chairman. The committee will consider the greatest interests of the greatest number of distributors in advising the educational program committee and other committees on features to be incorporated in the 1950 show, to be held at the Hotel Stevens, Chicago, the week of May 22.

Misleading television ads have gone too far, industry leaders stated last month. Especially bad is the practice of advertising screen sizes in square inches; for a 12½-inch tube, for example, six different manufacturers arrived at six different "square-inch" figures. Criticism was also directed at the practice of advertising little-known receiver models as "nationally famous."

BENJAMIN ABRAMS, president of Emerson Radio & Phonograph Corp., suggests that tube-face diameters be used instead of areas to make advertising less confusing to the public. Unless this plan is adopted, he believes the FCC or the Better Business Bureau may step in.

Mr. Ahrms wrote to about 15 major producers requesting their views. Most approved of the plan, many indicating they would adopt it themselves. Large retailers, however, said they could not change unless everyone else did.

Sylvania Electric Products Corp. has entered the television receiver field with a line of sets priced between \$199 and \$450. Introducing the sets, E.E. LEWIS, president of Colonial Radio Corp., the wholly owned subsidiary of Sylvania which makes the receivers, stated that a period of television price stabilization is beginning. Further TV price reductions could be made only through elimination of important components which would create a compromise with quality and performance, Mr. Lewis believes.

The new television sets feature built-in antennas, special sensitivity, one-hand tuning, intercarrier sound, and stabilized sweep oscillators.

Radio Corp. of America has signed a contract with Fabian Theaters, Inc., for installation of instantaneous projection television equipment in Fabian's Brooklyn Fox Theater. The equipment, costing \$25,000 plus installation charges, is the first of its type to be ordered for a theater. S. H. Fabian, president of the theater chain, said the Fox would be the proving ground for theater television in this country.

John F. Rider, Publisher, Inc., announces that the forthcoming *Rider Television Manual Volume 3* will be published in a larger size than previous manuals. Page size will be approximately 12 x 15 inches, dimensions previously used only for special double-spread pages. The larger size will reduce the number of folds in giant-size pages, adding convenience and extending the life of the book.

RADIO-ELECTRONICS for

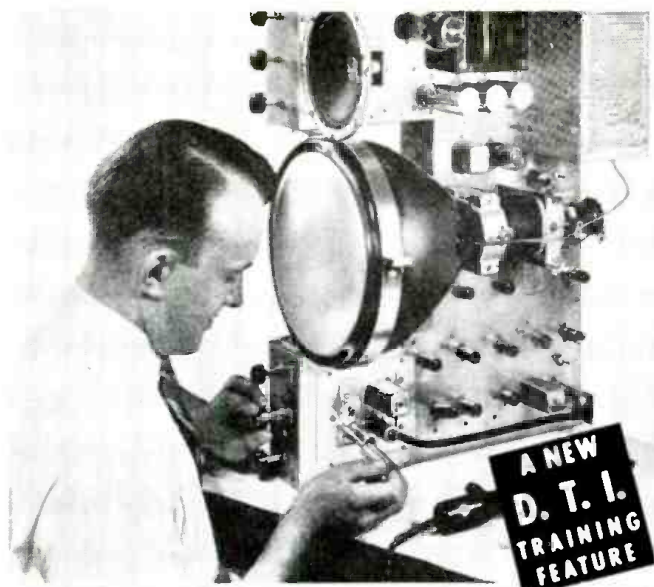

A NEW D. T. I. TRAINING FEATURE

NOW! Build and Keep Big Screen Top Quality Television Receiver at Home as You Prepare for a Profitable job in **TELEVISION RADIO-ELECTRONICS**

Choice of 10, 12½ or 16 inch picture tube

Now you can get this amazingly practical aid for learning Television at home, to help you get started toward **FASCINATING WORK . . . GOOD MONEY . . . a THRILLING FUTURE**—in a real job, or your own sales and service business. When you complete our regular home training—described below—you can build and keep a top quality commercial-type Television Re-

ceiver. Standardized chassis is adaptable for a 10, 12½ or 16 inch direct view tube that gives big, bright, sharp, steady pictures. This is an optional training advantage—designed to provide the utmost in practical "learn-by-doing" home training in Television. Mail coupon for complete details. See why you owe it to your "Television Future" to enroll for DeForest's Training, Inc.



Mail Coupon NOW for FREE Information!

See how D. T. I.'s amazingly effective methods help start you toward a **GOOD JOB** or your **OWN BUSINESS** in one of America's most promising fields—including Television, F.M. Radio, Aviation, Train, and Taxi Radio, Broadcast Radio, Industrial Electronics. Get modern lessons . . . plus 16 shipments of Radio-Electronic parts. Work over 300 experiments and projects—including building of (1) commercial-type **OSCILLOSCOPE** for practical

T-V circuit training, (2) double-range R-F **SIGNAL GENERATOR**, (3) jewel-bearing **MULTIMETER**, (4) quality 6-tube **SUPERHET RADIO**. Then build and keep that big new Television Receiver. Here's **EVERYTHING YOU NEED** for real laboratory type training . . . **AT HOME!**

You also build and keep this Professional Type Equipment

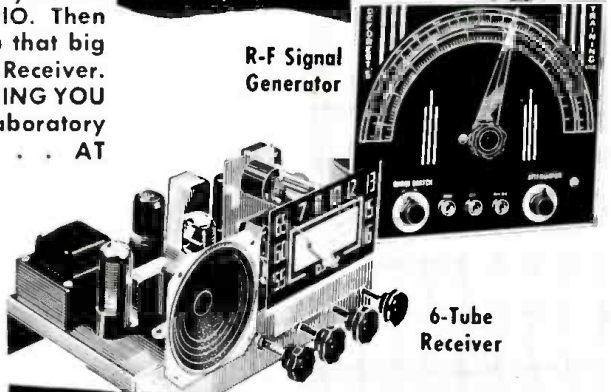

Modern Chicago Laboratories

* If you prefer, you can get **ALL** your preparation in our new, Chicago training laboratories . . . one of the finest of its kind. Ample instructors . . . modern equipment. Write for details!

Employment Service

* When you complete your training, our effective Employment Service helps you get started toward a real future in Television—Radio—Electronics.



You also use HOME MOVIES! a D. T. I. Exclusive!

D. T. I. alone includes the modern, visual training aid . . . **MOVIES** . . . to help you learn faster, easier at home. See electrons on the march and other fascinating "hidden action"—a remarkable home training advantage that speeds your progress.

De FOREST'S TRAINING, INC.
CHICAGO 14, ILLINOIS
A DE VRY Institution

MAIL THIS COUPON NOW!

DeFOREST'S TRAINING, INC.
2533 North Ashland Avenue, Dept. RC-F 11
Chicago 14, Illinois

Without obligation, give me complete facts showing how I may make my start in Television-Radio-Electronics.

Name..... Age.....
Street..... Apt.....
City..... Zone..... State.....

Simpson

INSTRUMENTS THAT STAY ACCURATE

Presents

the

New!

MODEL 303

VACUUM TUBE VOLT-OHMMETER

... A Worthy Companion
of the 260



SPECIFICATIONS

DC Voltage

Ranges—1.2, 12, 60, 300, 1200 (30,000 with
Accessory High Voltage Probe)

Input Resistance—10 megohms for all ranges

DC Probe—with one megohm isolating resistor

Polarity reversing switch

Ohms

Ranges—1000 (10 ohms center)

100,000 (1000 ohms center)

1 megohm (10,000 ohms center)

10 megohms (100,000 ohms center)

1000 megohms (10 megohms center)

AC Voltage

Ranges—1.2, 12, 60, 300, 1200

Impedance (with cable) approx. 200 mmf shunted
by 275,000 ohms

AF Voltage

Ranges—1.2, 12, 60

Frequency Response—Flat to 100,000 cycles

Decibels

Ranges—-20 to +3, -10 to +23, +4 to +37,

+18 to +51, +30 to +63

Zero Power Level—1 M. W., 600 ohms

Galvanometer

Zero center for FM discriminator alignment and
other galvanometer applications

R. F. Voltage

(Signal tracing with Accessory High Frequency
Crystal Probe)

Range—20 volts maximum

Frequency—Flat 20 KC to 100 M.C.

105-125 V., 60 cycles

Size 5 1/4" x 7" x 3 1/8" (bakelite case). Weight: 4 lbs.

Shipping Wt.: 6 1/2 lbs.

Dealer's Net Price Model 303, including DCV

Probe, ACV—Ohms probe and Ground Lead—

\$58.75; Accessory High Frequency Probe, \$7.50

Accessory High Voltage Probe, \$14.85

Also available with roll top case, Model 303RT—\$64.75

Smaller and Handier for Greater Portability

A worthy companion of the world-famous Model 260 is this brand new addition to the Simpson line—the Model 303!

Skilled Simpson engineers spent months of painstaking research in the laboratory to produce the Model 303, which is one of the most versatile instruments ever made for TV servicing. This ruggedly constructed instrument offers the maximum in portability because it is approximately 60% smaller than other vacuum tube volt-ohmmeters. However, no sacrifice has been made in readability. The 303 has a large 4 1/2" meter, despite its handy compactness.

One of the many features of the 303 is its low current consumption. The AC voltage range is wider than on any other similar instrument—from 1.2 volts minimum to 1,200 maximum. Like all other instruments bearing the Simpson name, the Model 303 is an instrument of highest quality at an amazingly low price.

SIMPSON ELECTRIC COMPANY

5200-5218 West Kinzie Street, Chicago 44, Illinois

In Canada: Bach-Simpson, Ltd., London, Ontario

NEW 1950

Heathkits

have all the Features

New 1950 Heathkit

PUSH-PULL EXTENDED RANGE 5" OSCILLOSCOPE KIT

Features

- The first truly television oscilloscope.
- Tremendous sensitivity .06 Volt RMS per inch deflection.
- Push-pull vertical and horizontal amplifiers.
- Useful frequency range to 2½ Megacycles.
- Extended sweep range 15 cycles to 70,000 cycles.
- New television type multivibrator sweep generator.
- New magnetic alloy shield included.
- Still the amazing price of \$39.50.

The new 1950 Push-Pull 5" Oscilloscope has features that seem impossible in a \$39.50 oscilloscope. Think of it—push-pull vertical and horizontal amplifiers with tremendous sensitivity only six one hundredths of a volt required for full inch of deflection. The weak impulses of television can be boosted to full size on the five inch screen. Traces you couldn't see before. Amazing frequency range clear useful response at 2½ Megacycles made possible by improved push-pull amplifiers. Only Heathkit Oscilloscopes have the frequency range required for television. New type multi-vibrator sweep generator with more than twice the frequency range. 15 cycles to 70,000 cycles will actually synchronize with 250,000 cycle signal. Dual positioning controls will move trace over any section of the screen for observation of any part. New magnetic alloy CR tube shield protects the instrument from outside fields. All the same high quality parts, cased electrostatically shielded power transformer, aluminum cabinet, all tubes and parts. New instruction manual now has complete step by step pictorials for easiest assembly. Shipping Weight 30 lbs. Order now for this winter's use.

CONVERSION FOR OTHER MODEL HEATHKIT OSCILLOSCOPES

A conversion for all 03 and 04 scopes is available changing them to the new push-pull amplifiers (does not change the sweep generator). Complete kit includes new chassis, tubes and all parts. For a small investment, add the latest improvements to your present oscilloscope (Except C.R. Tube Shield). Shipping weight 10 lbs. Order 05 Conversion Kit No. 315. **\$12.50**

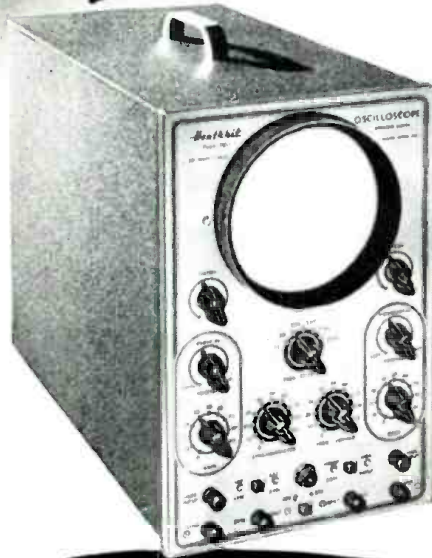

\$39.50

THE NEW Heathkit

HANDITESTER KIT

MORE Features THAN EVER BEFORE

- Beautiful streamline Bakelite case.
- AC and DC ranges to 5,000 Volts.
- 1% Precision ceramic resistors.
- Convenient thumb type adjust control.
- 400 Microampere meter movement.
- Quality Bradley AC rectifier.
- Multiplying type ohms ranges.
- All the convenient ranges 10-30-300-1,000-5,000 Volts.
- Large quality 3" built-in meter.

The instrument for all—the ranges you need—beauty you'll enjoy for years and you can assemble it in a matter of minutes—an instrument for everyone. The handiest quality voltohmmeter of all. Small enough to put in your pocket yet a full 3" meter. Easy pictorial wiring diagrams eliminate all assembly problems. Uses only 1% precision ceramic divider resistors and wire wound shunts. Twelve different ranges. AC and DC ranges of 10-30-300-1,000-5,000 Volts. Ohms ranges of 0-3,000 ohms and 0-300,000 ohms. Milliampere ranges of 10MA and 100MA. Hearing aid type ohms adjust control fits conveniently under thumb for one hand adjustment. Banana type jacks for positive low resistance connections. Quality test leads included. The high quality Bradley instrument rectifier was especially chosen for linear scales on AC. The modern case was styled by Harrah Engineering for this instrument. The 400 microampere meter movement comes already mounted in the case protected from dust during assembly. An ideal classroom assembly instrument useful for a lifetime. Perfect for radio service calls, electricians, garage mechanics, students, amateurs and beginners in radio. The only quality voltohmmeter under \$20.00. An hour of assembly saves you one-half the cost and quality parts give you a better instrument. Order today. Shipping weight 2 lbs.



\$13.50

Note
HANDY
OHMS
ADJUST.

EXPORT DEPT.
13 East 40th St.
NEW YORK CITY (16)
CABLE: ARLAB-N.Y.

The HEATH COMPANY

... BENTON HARBOR 20, MICHIGAN

Beauty · Quality · Economy



Only
\$69⁵⁰

Nothing
ELSE TO BUY

New Heathkit IMPEDANCE BRIDGE KIT

A LABORATORY INSTRUMENT NOW WITHIN THE PRICE RANGE OF ALL

Measures Inductance from 10 microhenries to 100 henries capacitance from .00001 MFD to 1000 MFD. Resistance from .01 ohms to 10 megohms. Dissipation factor from .001 to 1. "Q" from 1 to 1000.

Ideal for schools, laboratories, service shops, serious experimentors.

An impedance bridge for everyone — the most useful instrument of all, which heretofore has been out of the price range of serious experimentors and service shops. Now at the lowest price possible. All highest quality parts. General Radio main calibrated control. General Radio 1000 cycle hummer. Mallory ceramic switches with 60 degree indexing — 200 micro-amp zero center galvanometer — 1/2 of 1% ceramic non-inductive decade resistors. Professional type binding posts with standard 3/4" centers. Beautiful birch cabinet. Directly calibrated "Q" and dissipation factor scales. Ready calibrated capacity and inductance standards of *Silver Mica*, accurate to 1/2 of 1% and with dissipation factors of less than 30 parts in one million. Provisions on panel for external generator and detector. Measure all your unknowns the way laboratories do — with a bridge for accuracy and speed.

Internal 6 volt battery for resistance and hummer operation. Circuit utilizes Wheatstone, Hay and Maxwell circuits for different measurements. Supplied complete with every quality part — all calibrations completed and instruction manual for assembly and use. Deliveries are limited. Shipping weight, approximately 15 lbs.



10,000V. H.V. TEST PROBE KIT

No. 310. Extends range of any 11 megohm VTVM to 3,000 and 10,000 Volt ranges. A necessity for television. Shipping Wt., 1 pound. \$4.50

R.F. CRYSTAL TEST PROBE KIT

No. 309 Kit to assemble. R.F. probe extends VTVM range to 100 Mc. Complete with 1N34 crystal. Ship. Wt., 1 lb. \$6.50



New Heathkit TOOL KIT

Now a complete tool kit to assemble your Heathkit. Consists of Krauter diagonal cutters and pointed nose assembly pliers. Xcelite screwdriver, 60 Watt 110V. soldering iron and supply of solder. Shipping Wt., 2 lbs. Complete kit \$5.95

New Heathkit TELEVISION ALIGNMENT GENERATOR KIT



\$39⁵⁰

Nothing ELSE TO BUY

Everything you want in a television alignment generator. A wide band sweep generator covering all FM and TV frequencies 0-110 and 165 to 220 Megacycles, a marker indicator covering 19 to 43 Megacycles. AM modulation for RF alignment — variable calibrated sweep width 0-30 Mc. — mechanical driven inductive sweep. Husky 110V. 60 cycle power transformer operated — step type output attenuator with 10,000 to 1 range — high output on all ranges — band switching for each range — vernier driven main calibrated dial with over 45 inches of calibration — vernier driven calibrated indicator marker tuning. Large grey crackle cabinet 16 1/8" x 10 5/8" x 7-3/16" Phase control for single trace adjustment. Uses four high frequency triodes plus 5Y3 rectifier — split stator tuning condensers for greater efficiency and accuracy at high frequencies — this Heathkit is complete and adequate for every alignment need and is supplied with every part — cabinet — calibrated panel — all coils and condensers wound, calibrated and adjusted. Tubes, transformer, test leads — every part with instruction manual for assembly and use. Actually three instruments in one — TV sweep generator — TV AM generator and TV marker indicator. Also covers FM band.

EXPORT DEPT.
13 East 40th St.
NEW YORK CITY (16)
CABLE: ARLAB-N.Y.

The **HEATH COMPANY**

... BENTON HARBOR 20, MICHIGAN

all in HEATHKITS...

Heathkit TUBE CHECKER KIT Features

1. Measures each element individually
2. Has gear driven roller chart
3. Has lever switching for speed
4. Complete range of filament voltages
5. Checks every tube element
6. Uses latest type lever switches
7. Uses beautiful shatterproof full view meter
8. Large size 11" x 14" x 4" complete
9. Checks new 9 pin pinatures

Check the features and you will realize that this Heathkit has all the features you want. Speed — simplicity — beauty — protection against obsolescence. The most modern type of tester — measures each element — beautiful Bad-Good scale, high quality meter — the best of parts — rugged oversize 110V. 60 cycle power transformer — finest of Mallory switches — Centralab controls — quality wood cabinet — complete set of sockets for all type tubes including blank spare for future types — fast action gear driven roller chart uses brass gears to quickly locate and set up any type tube. Simplified switching cuts necessary time to minimum and saves valuable service time. Short and open element check. No matter what arrangement of tube elements, the Heathkit flexible switching arrangement easily handles it. Order your Heathkit Tube Checker today. See for yourself that Heath again saves you $\frac{2}{3}$ and yet retains all the quality — this tube checker will pay for itself in a few weeks — better build it now.

Complete with detail instructions — all parts — cabinet — roller chart — ready to wire up and operate. Shipping Wt., 15 lbs.



Only
\$29⁵⁰

Nothing
ELSE TO BUY

Heathkit SINE AND SQUARE WAVE AUDIO GENERATOR KIT



Nothing
ELSE TO
BUY

\$34⁵⁰

Experimenters and servicemen working with a square wave for the first time invariably wonder why it was not introduced before. The characteristics of an amplifier can be determined in seconds compared to several hours of tedious plotting using older methods. Stage by stage, amplifier testing is as easy as signal tracing. The low distortion (less than 1%) and linear output (\pm one db.) make this Heathkit equal or superior to factory built equipment selling for three or four times its price. The circuit is the popular RC tuning circuit using a four gang variable condenser. Three ranges 20-200, 200-2,000, 2,000-20,000 cycles are provided by selector switch. Either sine or square waves instantly available at slide switch. All components are of highest quality, cased 110V. 60 cycle power transformer. Mallory F.P. filter condensers, 5 tubes, calibrated 2 color panel, grey crackle aluminum cabinet. The detailed instructions make assembly an interesting and instructive few hours. Shipping Wt., 13 lbs.

New Heathkit BATTERY ELIMINATOR KIT

Nothing
ELSE
TO BUY



\$22⁵⁰

Now a bench 6 Volt power supply kit for all auto radio testing. Supplies 5 - 7 $\frac{1}{2}$ Volts at 10 Amperes continuous or 15 Amperes intermittent. A well filtered rugged power supply uses heavy duty selenium rectifier, choke input filter with 4,000 MFD of electrolytic filter. 0 - 15 Volt meter indicates output. Output variable in eight steps. Excellent for demonstrating auto radios. Ideal for servicing — can be lowered to find sticky vibrators or stepped up to equivalent of generator overload — easily constructed in less than two hours. Complete in every respect. Shipping Wt., 18 lbs.

NEW Heathkit SIGNAL TRACER AND UNIVERSAL TEST SPEAKER KIT

Nothing
ELSE
TO BUY

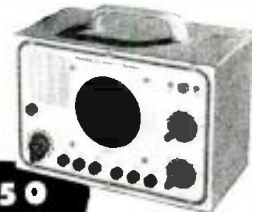

\$19⁵⁰

The popular Heathkit signal tracer has now been combined with a universal test speaker at no increase in price. The same high quality tracer follows signal from antenna to speaker — locates intermittents — defective parts quicker — saves valuable service time — gives greater income per service hour. Works equally well on broadcast — FM or TV receivers. The test speaker has assortment of switching ranges to match push pull or single output impedance. Also test microphones, pickups — PA systems — comes complete — cabinet — 110V. 60 cycle power transformer — tubes, test probe, all parts and detailed instructions for assembly and use. Shipping Wt., 8 lbs.

EXPORT DEPT.
13 East 40th St.
NEW YORK CITY 16
CABLE: ARLAB-N.Y.

The **HEATH COMPANY**
... BENTON HARBOR 20, MICHIGAN

MORE QUALITY in

1950 Heathkits

The NEW 1950 Heathkit VACUUM TUBE VOLTMETER KIT

Features

- New 200 microampere meter.
- Uses 1% precision ceramic divider resistors.
- Burn-out proof meter circuit.
- 24 complete ranges.
- Isolated probe for dynamic testing.
- Most beautiful VTVM in America.
- Accessory probes (extra) extend ranges to 10,000 Volts and 100 Megacycles.
- Modern push-pull electronic voltmeter circuit.
- Electronic AC circuit. No current drawing rectifiers.
- Shatterproof plastic meter face.



A new Model V-2 Heathkit VTVM with new 200 microampere meter, four additional ranges—full scale linear ranges on both AC and DC of 0-3 V., 10 V., 30 V., 100 V., 300 V., and 1,000 V. Accessory probe listed elsewhere in ad extends voltage range to 3,000 and 10,000 volts D.C. New model has greater sensitivity, stability and accuracy—still the highest quality features—shatterproof plastic full view meter face—automatic meter protection, push-pull electronic voltmeter circuit, linear scales—db scale—ohmmeter measures 1/10 ohm to 1 billion ohms with internal battery—isolated DC test prod for dynamic measurements—11 megohm input resistance on DC—AC uses electronic rectification with 6H6 tube. All these features and still the amazing price of only \$24.50. Comes complete with cabinet—panel—three tubes—new Mallory switches—test prods and leads, 1% ceramic divider resistors and all other parts. Complete instruction manual for assembly and use. Better start your laboratory with this precision instrument. Shipping weight 8 lbs. Model V-2

\$24.50

New 1950 VERNIER TUNING R.F. Heathkit SIGNAL GENERATOR KIT

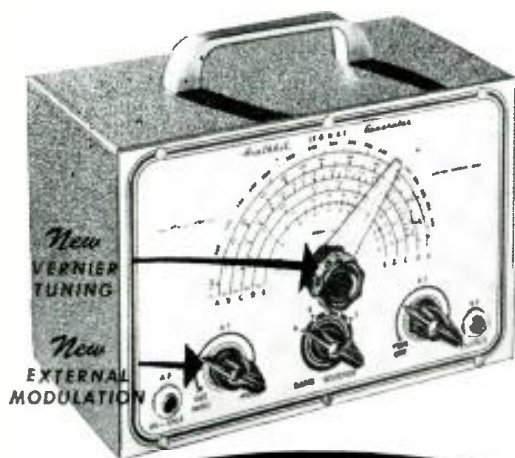

\$19.50

Features

- New 5 to 1 ratio vernier tuning for ease and accuracy.
- New external modulation switch—use it for fidelity testing.
- New precision coils for greater output.
- Cathode follower output for greatest stability.
- 400 cycle audio available for audio testing.
- Most modern type R.F. oscillator.
- Covers 150Kc. to 34Mc. on fundamentals and calibrated strong harmonics to 102 Mc.

The most popular signal generator kit has been vastly improved—the experience of thousands combined to give you the best. Check the features in this fine generator and consider the low price \$19.50. A best buy for any shop, yet inexpensive enough for hobbyists. Everyone can have an accurate controlled source of R.F. signal voltage.

The new features double the value—think of being able to make fidelity checks on receivers by inserting a variable audio signal. Internal 400 cycle saw-tooth audio oscillator modulates R.F. signal and is available externally for audio testing. The new 5 to 1 ratio vernier drive gives hairline tuning for maximum accuracy in scale settings. The coils are already precision wound and calibrated. Uses turret type coil and switch assembly for ease of construction. The generator is 110 V. 60 cycle transformer operated and comes complete in every detail—cabinet—tubes—coils—beautiful two color calibrated panel and all small parts—new step-by-step pictorial diagrams and complete instruction manual make assembly a cinch even for novices. Why try to get along without a signal generator when you can have the best for less than a twenty dollar bill. Better order it now. Shipping weight 7 lbs. **\$19.50**

CONVERSION KIT FOR G-1 GENERATORS

Conversion kit for G-1 generators for vernier tuning and external modulation includes new high band coil for greater output. Gives all the features of new G-5 listed above. Order G-5 Conversion Kit No. 316. **\$4.50**

EXPORT DEPT.
13 East 40th St.
NEW YORK CITY (16)
CABLE: ARLAB-N.Y.

The **HEATH COMPANY**

... BENTON HARBOR 20, MICHIGAN

RADIO-ELECTRONICS for



I can train you to pass your FCC License Exams in a few short weeks if you've had any practical radio experience—amateur, Army, Navy, radio servicing, or other. My time-proven plan can help put you, too, on the road to success.

Let me send you FREE the entire story

Just fill out the coupon and mail it. I will send you, free of charge, a copy of "How to Pass FCC License Exams," plus a sample FCC-type Exam, and the amazing new booklet, "Money Making FCC License Information."

EDW. H. GUILFORD,
Vice President

How to Pass FCC Commercial Radio Operator License Exams

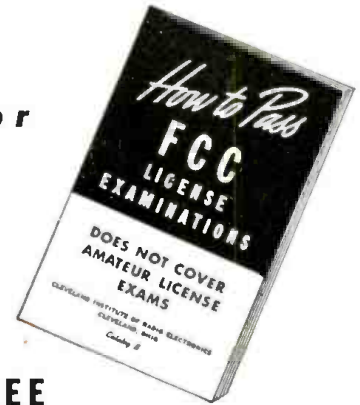

FREE

Tells where to apply for and take FCC examinations, location of examining offices, scope of knowledge required, approved way to prepare for FCC examinations, positive method of checking your knowledge before taking the examinations.

Get your FCC ticket in a FEW SHORT WEEKS

IT'S EASY IF YOU USE CIRE SIMPLIFIED TRAINING AND COACHING METHODS AT HOME IN YOUR SPARE TIME

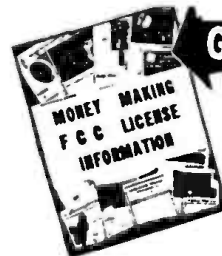

Get This Amazing New Booklet

1. Tells of Thousands of Brand-New Better Paying Radio Jobs Now Open to FCC License Holders.
2. Tells How We Guarantee to Train and Coach You Until You Get Your FCC License.
3. Tells How Our Amazing Job-Finding Service Helps You Get the Better Paying Radio Job Our Training Prepares You to Hold.

Get your license easily and quickly and be ready for the jobs open to ticket holders which lead to \$3000 to \$7500 (average pay reported by FCC nationwide survey). CIRE training is the only planned course of coaching and training that leads directly to an FCC license. Your FCC ticket is recognized in all radio fields as proof of your technical ability. Employers often give preference to license holders, even though a license is not required for the job. Hold an FCC "ticket" and the job is yours!

CIRE Job-Finding Service Brings Amazing Offers of Jobs!

"I am working at WHJM as transmitter engineer. Received this position in response to one of the employment applications sent me upon completion of my course and the receipt of my diploma. I received my 1st class Radiotelephone License on March 2, 1949."
—Student No. 2608 AT.

"Thanks for the Application for Employment you recently prepared for me. I found satisfactory employment. I submitted 57 letters, enclosing the resume you supplied. I received 17 letters indicating my application was filed for future reference, 3 telephone calls, and 1 letter requesting personal interviews. As a result, I am employed in a development engineering capacity."
—Student No. 4235 NB.

Get ALL THREE FREE

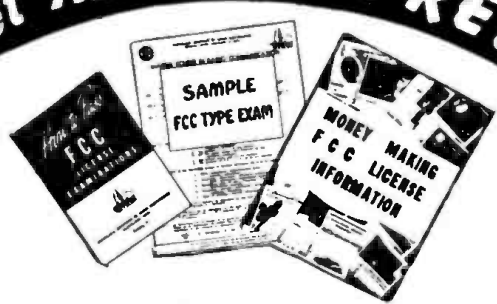

Don't Waste Valuable Time MAIL COUPON TODAY!

Don't put off getting this valuable information. Good jobs in radio need men like you. You can earn higher income, have a bank account, enjoy vacations, and have easier and better living. But you must have your FCC License. Hurry! Fill out the coupon right now and mail it. There is no obligation. You owe it to yourself to get the full story NOW.

CLEVELAND INSTITUTE OF RADIO ELECTRONICS
Desk RC-11 4900 Euclid Bldg., Cleveland 3, Ohio

Approved for Veteran Training under the "G.I. Bill of Rights"

CLEVELAND INSTITUTE OF RADIO ELECTRONICS
4900 Euclid Bldg., Cleveland 3, Ohio
Desk RC-11 Address to Desk No. to Avoid Delay

I want to know how I can get my FCC ticket in a few short weeks. Send me your FREE booklet, "How to Pass FCC License Examinations" (does not cover exams for Amateur License), as well as a sample FCC-type exam and the amazing new booklet, "Money-Making FCC License Information."

NAME.....
ADDRESS.....
CITY..... ZONE..... STATE.....

Veterans check for enrollment information under G.I. Bill.
NO OBLIGATION—NO SALESMEN.

To the Service Technician

. . . *How many service technicians are there in the U.S.A.? . . .*

By Hugo Gernsback

THIS particular article is addressed exclusively to the radio servicing trade. The reason: Ever since the inception of this magazine, in 1929, a large percentage of its reading matter has been addressed to the service technician. For over 21 years, as our old readers well remember, this policy has never changed.

From time to time we have made various surveys to ascertain the extent of service-technician readership of the magazine and have been able to draw certain conclusions from this. Yet, the editors in planning the magazine over a long-range term must have certain vital information as to its readers. *No one can give that information to us better than YOU.*

Several years ago we made a mail survey and we found that 53% of our readers were connected in one way or another with radio servicing.

With the advent of television, revolutionary changes have taken place within the servicing industry. To find out what the prevailing trends are, a new survey is urgently required.

The sensational advance of television during the past two years leaves no doubt whatsoever that the entire country will soon be blanketed completely with television stations.

Yet, speaking populationwise, 40% of the country does not have television as this is written. It is certain, however, that by 1953 nearly all of this country's inhabitants will be within range of a television transmitter.

Service technicians who have read RADIO-ELECTRONICS have no doubt observed that not all of our readers see eye to eye with us on our television policy. Those readers who are not now in an area served by television stations particularly criticize us for carrying television articles at all. The reason is that to them, for practical purposes, television articles are only of theoretical interest at present.

Yet, as we have pointed out editorially a num-

ber of times, even if you are in a locality not served by a television station, *now* is the time to learn all you can on the subject, because the moment a television transmitter begins functioning in your region *it will be too late* and time will be too short to get practical experience.

The editors keep all these points in mind in the formulation of their editorial policy, particularly from the long-range viewpoint. They also know that today there are service technicians who service only

radios, but do not touch television. Some confine themselves to television receivers, while others do both.

To give you the magazine you want at the present time, when the whole servicing industry—due to the impact of television—is in a state of flux, it is of utmost importance to the editors to have certain information on radio servicing which only you can supply.

The editor therefore, urges you to do us a great service and fill out the short blank which you will find on page 52 and mail this back to us as quickly as possible. It will give us the information necessary to bring to you in the future the articles and information which you want and need most.

This is the first time in 21 years of publishing your magazine that the editor has asked for your cooperation in this manner.

Won't you be good enough to comply with this simple request and return this short questionnaire as soon as possible?

If you know others in the servicing industry, please tell them about this too. The information is vital and most important to them and to you, as well as to us.

For our part we will, as soon as the returns are complete, publish a comprehensive resumé of this questionnaire. This will appear probably in our March issue—sooner if feasible.

Thank you for your cooperation!

*An Important Message To
All Service Technicians*

Limiter Discriminator

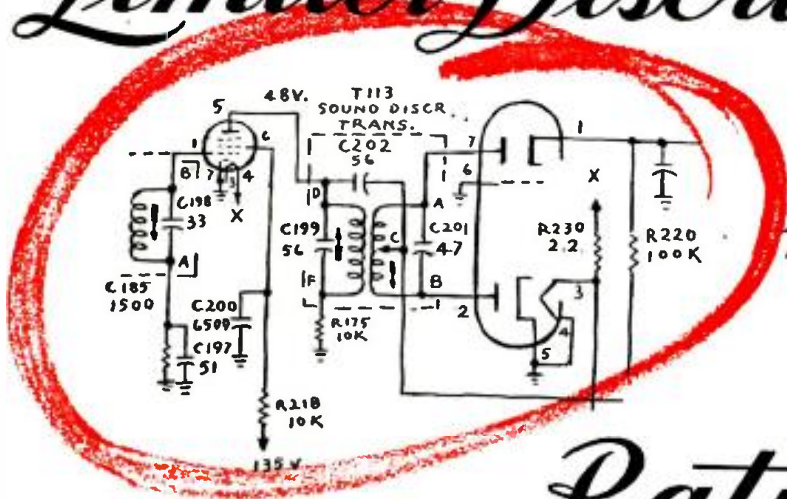

versus

Ratio Detector

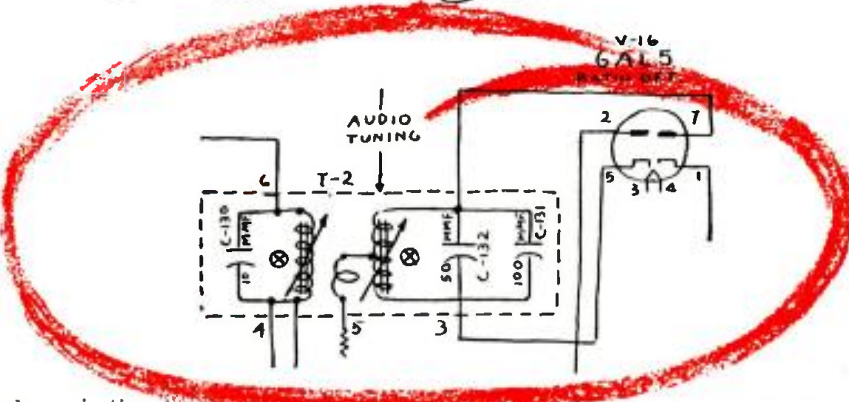

By H. K. MILWARD
and R. W. HALLOWS

IN Britain there is as yet no regular FM broadcasting, and there has been no propaganda blitz over the respective merits of the limiter-discriminator and ratio-detector systems as noise rejectors. An inquiry into this question can thus be undertaken with a completely impartial approach and with no background of "political" bias. That is why the Editor asked us some months ago to make a series of comparative tests and to report the results which we obtained. Standard components made by leading firms in the United States were sent us in England and these were used in circuits made up for the tests, which were conducted in one of the best equipped radio laboratories in the country.

The ratio detector is simpler than the discriminator with its necessary limiter or limiters; it requires fewer components, and, although a little more difficult to adjust in the first place, it is likely to be considerably cheaper to produce than the other. It is therefore important to know how its inherent noise rejection—one of the great advantages of FM over AM—compares with that of the limiter-discriminator. The conclusions we reached as the result of measurements and a series of aural tests are:

1. Though the difference in noise re-

jection is not great, the discriminator with one limiter is a slightly better performer than the ratio detector;

2. The discriminator with two limiters is decidedly superior to the ratio detector;

3. The superiority of the discriminator is most marked when the noise level is high.

In the measurements made, peak values of both signal and noise were used. Actually, the annoyance effect of impulse noise is proportional to peak values only when the recurrence of pulses is slow. As the recurrence frequency increases, the annoyance level becomes proportional to r.m.s. values¹. For com-

¹ BBC Research Department, Report G.036.

parison of the two circuits, however, it is immaterial whether peak or r.m.s. values are used so long as the same measure is used for both.

A block diagram of the complete test circuits is shown in Fig. 1. The r.f. and first i.f. stages were part of a receiver designed for FM. The i.f. and oscillator stages were modified to give an output at 10.7 mc. Two small coils of one turn each were wound on the output transformer of this i.f. stage and the output fed via two short co-axial leads to the test circuits. This insured that the test circuits were fed with similar signals so that comparative tests could be made simply by switching.

The noise generator was made up from a 6-volt vibrator, a car ignition

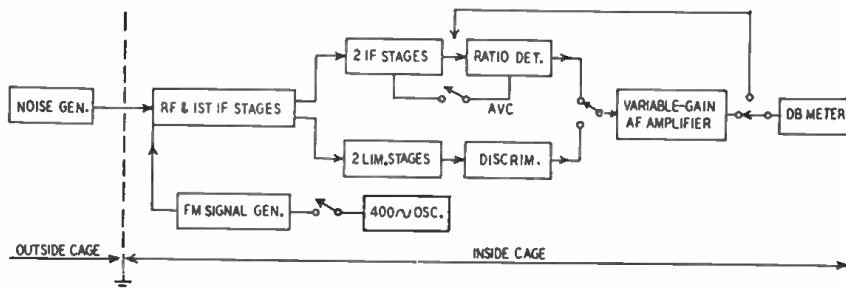

Fig. 1—Equipment used to compare ratio detector with limiter-discriminator.

coil, a spark plug, and a 6-volt storage battery. These were mounted in a double metal box as shown in Fig. 2. Originally it was intended to vary the noise signal by altering the coupling of

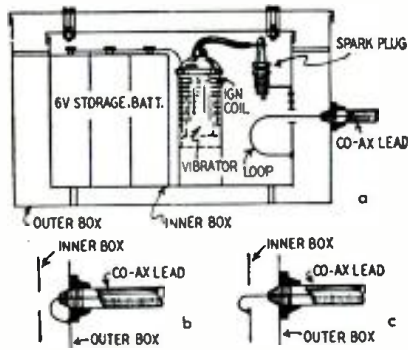

Fig. 2—Details of noise generator.

the coil feeding the receiver, but this was found unsatisfactory, for the noise signal stubbornly refused to be attenuated by more than a few db. The difficulty was overcome finally by feeding the first r.f. coil as shown in Fig. 3, and varying noise strength at its source. Three levels of noise were obtained by

1. Connecting the inner conductor of the co-axial to the outer box in a very small loop (Fig. 2-b).
2. Connecting it to the inner box in a small loop (Fig. 2-c).
3. Connecting as in Fig. 2-a with a large loop.

For the tests the noise generator was placed outside the shielded cage in which the rest of the work was done, and the co-axial led through the mesh of the cage.

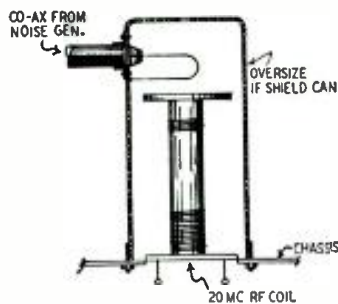

Fig. 3—Method of injecting the noise.

Some attenuation of noise level was obtained by leaving a long cable between the cage and the generator. The lowest level provided gave output signal-to-noise ratios of around 1 for signals which were just above threshold for limiter or a.v.c. action. The generator produced 50-70 noise pulses per second.

The signal generator was a simple FM oscillator which had been calibrated for the tests. The deviation it produced was not linear; but as the tests required only a signal to be compared with the noise, this was no disadvantage.

The circuits tested are shown in Figs. 4 and 5. (The schematics have been simplified by leaving out screen and suppressor connections.) They were

lined up at 10.7 mc with a 160-kc bandwidth with the aid of an oscilloscope and sweep oscillator. Response curves for the two test circuits were made as similar as possible. The curves showed a response which was level to within 3 db 70 kc each side of 10.7 mc and was 6 db down at ± 80 -kc deviation. The loss beyond these limits was about 0.4 db per kc.

When the i.f. stages were satisfactorily lined up, the demodulators were tackled. The discriminator gave the curve of Fig. 6-a without adjustment, and the ratio detector gave that in Fig. 6-b after adjustment of the tuning slugs in the transformer. The ratio detector was then adjusted for maximum AM rejection by injecting a 400-cycle signal into the suppressor grid of the

To assure complete impartiality, this comparative test of ratio and phase detectors was arranged in England, where regular FM broadcasting has not as yet been established.

first r.f. stage, which produced a signal which was amplitude-modulated. The presence of output containing a 400-cycle component was shown by the oscilloscope². The circuit values were adjusted until this component was a minimum.

The outputs of the two demodulators were connected via a changeover switch to the a.f. amplifier and meter. No deemphasis circuit was used as it would not have affected the relative merits of the circuits. The a.f. amplifier was a simple, two-stage, negative feedback combination, with an input impedance of about 20,000 ohms. The gain was

² This procedure is described in full in "The Ratio Detector," by Seeley and Avins, *RCA Review*, June, 1947.

controlled by varying the feedback path in fixed steps of 4 db.

The output meter was a v.t.v.m. with two inputs, one for r.f. and one for a.f.; and the meter itself was calibrated in decibels (reference 1 milliwatt). The meter input impedance was approximately 6,000 ohms, and the amplifier output impedance was adjusted to match. Thus readings of relative signal strengths could be made directly. The scale readings for a.f. signals were checked and found to be accurate. For both a.f. and r.f. inputs the meter measured peak volts for anything above 30 cycles or 30 pulses per second.

After this preliminary work the main test readings were taken. First the output meter (r.f. input) was connected to the output of the two i.f. stages of the ratio-detector circuit, and the a.v.c. was switched off. The noise generator was switched on, a reading taken, and the generator switched off again. This gave the level of noise with no signal. The signal generator was then switched on (with 400-cycle FM deviation ± 22.5 kc, representing about 30% of maximum deviation) and readings were taken for each of several generator output control settings. This gave a set of signal-to-noise ratios for the r.f. side.

Following this the output meter was connected to the a.f. side and a.v.c. switched on for the ratio detector. Readings were then taken with the signal generator operating the whole time, its output being varied as required. For each previously charted output level, a.f. readings for both detector circuits were taken of noise output with modulation off and modulation output with noise off. These readings gave output signal-to-noise ratios for each circuit. The actual signal-to-noise improvement, a.f. ratio r.f. ratio, depends on a number of factors including percentage modulation (in the case about 30%), and also the accuracy of the output meter at radio frequencies. Thus the improvement ratio shown by these results is not necessarily accurate, but the comparative output figures are. The results are shown in Figs. 7-a and 7-b.

The ratio detector was then altered to the form shown in Fig. 8 and a further test made. The results (Fig.

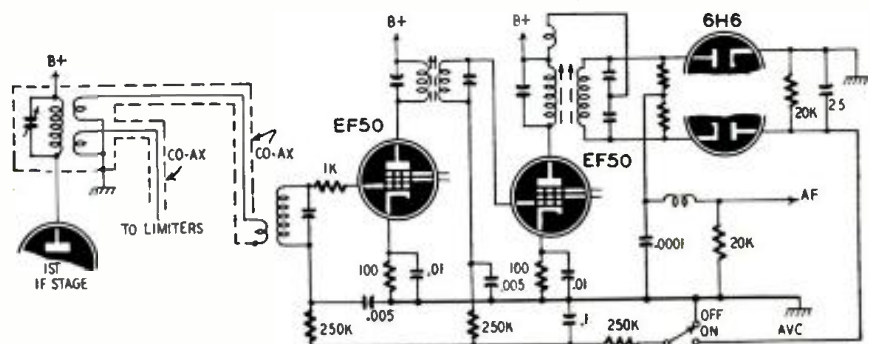

Fig. 4—Simplified circuit of the ratio detector used in the experiments.

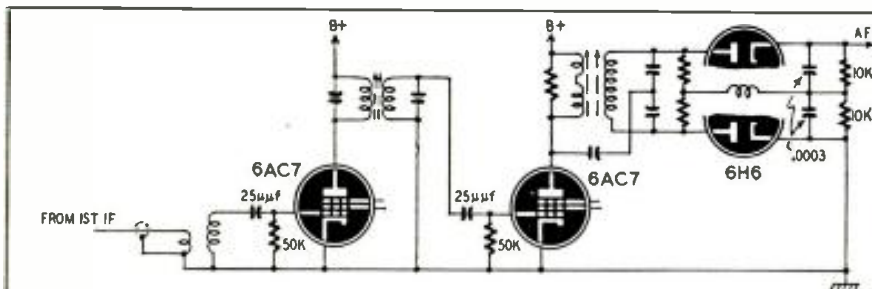

Fig. 5—The limiter-discriminator parallel of the circuit shown in Fig. 5.

7-a) are substantially the same as those for the original circuit. The results taken for two limiters with the discriminator and one limiter with the ratio detector are interesting in that they suggest a connection between noise rejection and AM rejection. This is not surprising, for a noise pulse effectively consists of two parts: that which affects only an FM system, and that which affects an AM system. There would be a certain minimum noise response from the most perfect FM system, and any practical system would be worse in proportion to its AM response.

Finally, the two circuits were tested aurally. The receiver was coupled to a short rod antenna and tuned to the BBC experimental FM transmissions. The noise generator was placed outside the building with a short length of wire protruding as an antenna. A variable attenuator was inserted in the output of the ratio-detector circuit and adjusted so that the output from a loud-speaker was the same for both circuits. Flicking the switch made it possible to compare noise levels.

In the tests four observers were asked to judge which circuit was least

noisy. The ratio detector with a.v.c. and discriminator with one limiter were tried first. When the noise level was so high that all but loud passages were masked, the judgment averaged about 3 to 1 in favor of the discriminator, each observer listening to about 10 changeovers. When noise was low enough to be noticeable only during soft passages, the results were about even for the two circuits if the switching was done during loud signal passages and about 3 to 2 for the discriminator if done during the soft passages.

When the discriminator was used with two limiters, the ratio detector remaining as it was, the results were 100% for the discriminator on the loud noise test and about 7 to 1 on the low noise. These results confirmed the measurements generally, although the difference appeared to be more noticeable aurally than was to be expected from the actual figures.

During the tests both circuits stayed in adjustment and no difficulty was experienced in lining up and adjusting either. The ratio detector was somewhat more tedious to adjust, and the component values appeared to be a little more critical.

Thought, Memory, Produce New Brain Waves

IDENTIFICATION of a hitherto unknown brain wave, which seems to be associated with thought, is reported by a research team of the Institute for Applied Experimental Psychology, Tufts College, Medford, Mass. Readers familiar with electroencephalography will remember that previously recognized brain waves not only appear best when the mind is at rest, but are actually inhibited by thought processes.



Dips show drop in "thought output" as subject finishes reading line of type.

The four researchers, John L. Kennedy, Robert M. Gottsdanker, John C. Armstrong, and Florence Gray, have named the new manifestation "kappa waves." The figure shows how the waves appear when the subject reads. The irregular waves are produced as the reader scans each line of type, and the retrace results in the drops at S. The third and longer wave was recorded

as the reader concentrated on a new paragraph. Similar graphs made while the subject was performing mental multiplications and other tasks requiring thought show a remarkable correlation of kappa bursts to periods of thought.

The kappa waves are detected by electrodes placed just back of the external canthi of the eyes (the corners of each eye where the upper and lower eyelids meet).

Later research, reported by the same workers to the recent meeting of the American Psychological Association at Denver, indicates that the kappa waves are particularly active when the brain is attempting to remember something. They reported that when a student was learning new material, kappa-wave activity was moderate. When the student was trying to recall imperfectly-learned material the kappa waves reached a maximum, and when reciting perfectly memorized matter they again sunk to a new low, the scientists reported.

Further research is being carried out on these waves, which appear to represent a new advance in brain study.

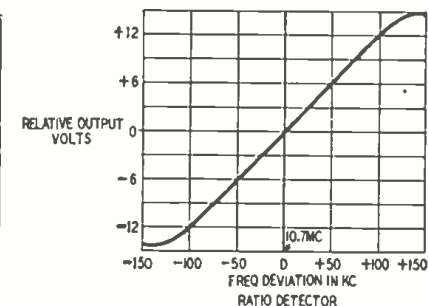
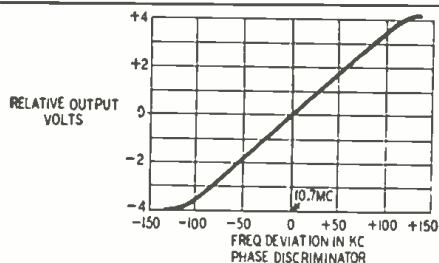

Figs. 6-a, 6-b—Curves of phase discriminator and ratio detector, no noise.

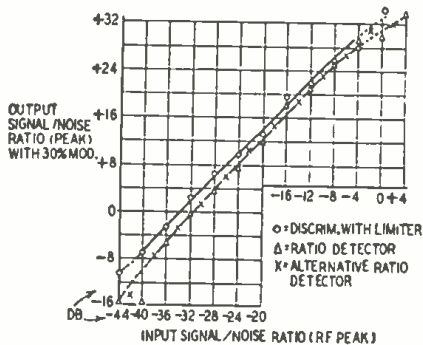

Fig. 7-a—Comparison of the two types.

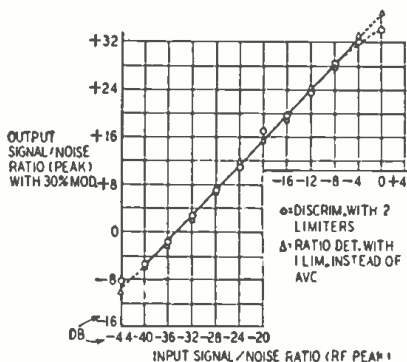

Fig. 7-b—Limiter helps ratio detector.

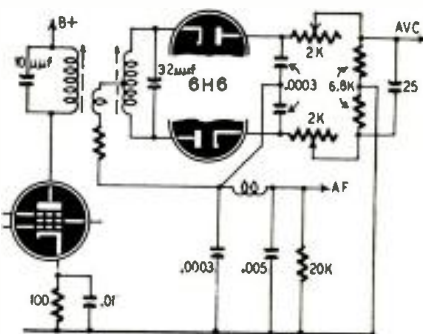

Fig. 8—An alternate ratio detector.

Lady Television Engineer

by **TEX BARBARITE**

The author
repairs a
camera



M AINTAINING an electronic exhibit like the Radio Corporation of America's Exhibition Hall in the heart of Radio City, New York, means a great deal more than replacing knobs and pilot lights removed by souvenir hunters. It includes turning a bushing on a lathe as well as answering the queries of John Q. Public on AM, FM, and television.

My engineering bent was formed in my early childhood. My hobby throughout my younger days, until I was enrolled in a girl's private school, followed radio lines. My three brothers and I constructed our own crystal sets. When crystal sets were outgrown, we graduated to vacuum-tube circuits. When I entered the girls school, I found myself very unhappy because the administration felt that science and mathematics were unnecessary subjects for a girl. Finishing secondary school, I decided to go to the Texas College of Mines in El Paso to study for a degree in mathematics. There I received a scholarship to study electrical engineering at Purdue University. At Purdue my interest was spurred by the fact that the field of engineering, hitherto dominated by men, was being opened to women by the wartime shortage of men.

From school I went to RCA in Camden, N. J., and worked in the Television Terminal Equipment Design Laboratories. This division handled design for the microwave transmitter, distribution amplifiers, video amplifiers, synchronizing generators, image orthicon and iconoscope cameras, and all associated equipment.

Having little knowledge of television, I took advantage of courses the company offered in night school. In the laboratory we operated our own experimental transmitter, W3XEP, for which I got my commercial phone license. This provided all-around experience—students served as announcers, projectionists, cameramen, station engineers, and in other essential positions. At that time I was also teaching basic theory and code to Civil Air Patrol cadets. This background was the basis for my transfer to the RCA Exhibition Hall when it opened in New York in April, 1947.

The most important exhibit here is the television field camera mounted in a "See Yourself" display. This camera (see cover), used in conjunction with the field power supply, sync generator, and camera control, utilizes an image orthicon tube. Highly sensitive, it is most useful where low light levels are available. When the camera is in use, the cover can be removed and the viewfinder attached on top of the camera. A plug receptacle provides all the connections between the two units. The viewfinder is a monitor using a 5FP4A kinescope. The sides of the camera are hinged to give access to the unit for maintenance and servicing. Selection of any one of four lenses is made possible by a rotating turret controlled by a handle at the rear of the camera.

Orthicon Ingenious

I consider the image orthicon one of the most interesting and ingenious pieces of equipment I have ever worked with. By means of the lens system, the optical image is focused on the semi-transparent photocathode, which is at a high negative potential with respect to ground.

The radial electric field produced by the accelerator grid between photocathode and target, and the axial magnetic field produced by the focus coil around the tube, assures proper focusing of the photoelectrons on the target.

If nonuniformity exists in either electric or magnetic field, the result is what is commonly known as S distortion.

As a well-focused beam of low-velocity electrons strikes the target (see drawing), enough electrons are deposited on the target to make it negative to the remaining electrons in the beam and repel them. The potential that any point on the target will reach is termed the "equilibrium potential." The beam is kept constant, and the electrons turned back are attracted to the rear end of the tube which is at the highest positive potential. The final function of the tube is to amplify the "picture information" in the returning electron beam. Several multiplier dynodes are used, each at a higher potential than the previous one. From the last dynode (there are five) the electrons are attracted toward the collector mesh (signal plate), connected to an external load resistor.

New Exhibit Projects

Projects in the making here in the Showroom include a monoscope camera and a master monitor, both to be installed in the control-room racks. The monoscope camera is a camera with the test pattern on the mosaic of the iconoscope. The pattern is composed of carbon deposited on an aluminum plate. The carbon and aluminum have different emission characteristics. Electrons

emitted by the scanning of the pattern are collected on the wall of the monoscope tube. This coating is at a positive potential with respect to the pattern, but is a.c.-coupled to ground. Therefore, the picture signal appears between plate and ground. The master monitor uses a 10-inch kinescope and a 5-inch oscilloscope and is adaptable to the supervision of composite picture signals at any stage of our transmission. A switching arrangement on the monitor allows it to be used as a con-

entertained the mayor and his wife from my home town in Texas. It's all in a day's work.

Reaction of the public to a female technician is varied and amusing. I seldom talk to visitors; but, in the two years and more that I have been at the Exhibition Hall, just about every conceivable reaction has come to me. I'm not siding with my sex, but women, by far, are easier to talk to than men. The women know nothing about radio and don't pretend to, whereas too many

set owners complain because the A-batteries of their portable receivers have gone dead before the end of the guarantee of the radio, or that the portables won't play in a steel-constructed building. Then there are our friends of the would-be-technician type who are at leisure and want to use all of ours picking up what they didn't learn in school.

Recently, I spent two weeks in Camden, N. J., at RCA's home office, learning the latest television circuits and techniques. Most important to me was the antenna information. Service and installation men will be glad to hear of the Woodward antenna which receives signals from only one direction at a time. Not an answer to any and all reception difficulties, it is most effective in cutting down co-channel interference when the receiver is located in a fringe area between two transmitters. Consisting of an array of four 8-foot dipoles in the form of a square, with the opposite members 8 feet apart, the antenna can be made to receive from one direction or the other by flipping a switch at the receiver. Interconnection of the dipoles through a diplexing network makes this one-way reception possible. Efficient reception on high bands is achieved by "shortening" the dipole with V's fastened to each leg.

Of special interest to the radio amateur is the TV interference suppressor recently developed by Captain John L. Reinartz of RCA's tube department in Harrison, N. J. This device, connected into the ham transmitter, traps harmonics before they can reach the antenna.

Hams are forever being blamed for many of the ills in television reception. I have seen at least one case where this was not true. In a small town just west of Philadelphia, there are only two amateurs in the entire area. Even though their logbooks showed they were off the air, they were blamed for a peculiar type of disturbance. The noise appeared in the form of a flash of maggots (similar to ignition noise). Just for a second it would disrupt the scene; occasionally it would travel downward in a bar effect. Service engineers from Philco, RCA, and Stromberg-Carlson traced the trouble to power lines and the power company remedied the difficulties.

My ambition—one that comes naturally to most radiomen and women—is to have my own well equipped shop. However, I am now involved in a project that has top priority; I am in the throes of building a shop in the basement of my home, not for radio, but for woodworking. It is my idea to gain some experience in the art of cabinet construction and finishing. I would like eventually to be able to design, construct, and finish custom cabinets for radios, television receivers, phonographs, and combinations. In the final analysis, I suppose that I have a different outlook on my ambition than a man would have. I prefer to make it a hobby rather than a money-making vocation.

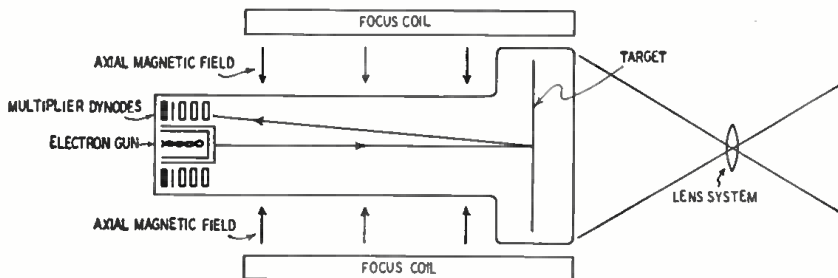

A partial cross section of the image orthicon, showing path of the electrons.

trol unit for the film camera chain. Both master monitor and monoscope must be wired for power and for our type of switching system, and adjusted for optimum operation.

Working as a maintenance engineer for the Promotion Department is not all repair work—not for a girl anyway. Once I was called on to don my best dress and attend a champagne cocktail party fashion show at the Ritz. I had to forego the champagne, however, as my job was to set up and operate a PA system for playing records. Another time I purchased and installed an inverter for Mrs. John McCormack, widow of the famous Irish tenor. I even

men are out to "stump the experts." Men also seem reluctant to talk to women about a medium that used to be exclusively theirs.

Public pours out troubles

Many people come here to complain about the operation of their radios. The majority of these cases do not require a technician, but some instruction and a little public relations. A full recitation of the circumstances usually paints an entirely new picture. But service technicians do know of instances where Junior has dropped the new radio in the brook while the 90-day guarantee was still effective. Other

CONVERTERS FOR THE ULTRA-HIGHS

Stanford Research Institute in Stanford, Calif., recently reassured the nation's present and future TV-viewers about the coming advent of u.h.f. pic-

operated by John H. Poole, sponsor of the project. Another is variable from 475-675 mc, and a third tunes from 475-890 mc.



ture transmission. The Institute's Department of Electrical Engineering has developed three new u.h.f.-to-v.h.f. converters which are both simple and inexpensive. With such a converter, a standard receiver will need no internal modifications to receive u.h.f. programs.

One of the laboratory models is fixed-tuned at 530 mc to pick up transmissions from an experimental station

The tuners used are shown in the photo. At left is a cylinder oscillator. A modified "semibutterfly" oscillator is in the center, and a 475-890-mc crystal mixer at right. With the usual TV receiver, noise figure of the converters is about 11 db, sensitivity 200 μ v. Oscillator radiation at the converter's antenna terminals is 56 mv. Image suppression is 42 db.

Indoor and Built-In Antennas Their Strong and Weak Points

The indoor TV antenna yields only a compromise performance

By IRA KAMEN

JOHN STUART MILL said, "In times of crisis we must avoid both ignorant change and ignorant opposition to change." This statement is wise counsel today both to those selling and installing television receivers and to landlords of multiple dwellings.

The urban television dealer has not been able to realize full sales possibilities because many building owners have refused to permit tenants to erect rooftop antennas. Often, to make his sale, the dealer has installed in apartments TV receivers with indoor antennas, the poor performance of which increased the tenant's resentment against his landlord.

The latter is often justified in refusing his permission, or, as shown in the photo, the roof becomes cluttered with a maze of disfiguring antenna rods, and the landlord becomes liable for public, personal, and property damage.

In addition, random installations of rooftop antennas may result in penalties for violation of local fire, building, and electrical ordinances. There are two main reasons why so many buildings have roofs like the one in the photograph: either the landlord did not want to offend tenants, or he used the permission as a way of persuading them to agree to a rent increase. Some landlords are neither cringing nor greedy, but allow the antennas so that tenants can enjoy television, feeling that the appearance of the roof—never exactly artistic in any case, with clotheslines, water towers, and so on—and the rather remote possibility of damage are subordinate to peaceful relations between landlord and tenant.

On all rooftops overloaded with antennas interference between television receivers may be so bad that on many evenings only two or three of a possible six or seven channels can be used by most tenants. All other channels show r.f. interference as pictured in

Fig. 1. The Oscillator Interference Chart shows that when a television receiver is tuned to channel 2, 3, 7, 8 or 9, its oscillator radiates interference on either channel 5, 6, 11, 12, or 13.

The final solution

The permanent solution to the multiple-dwelling problem is a vacuum-tube-type master antenna system such as approved by the engineering committee of Television Broadcasters Association and conforming to RMA specifications. To date, two systems have been tested and approved, one made by RCA and the other by the Intra-Video

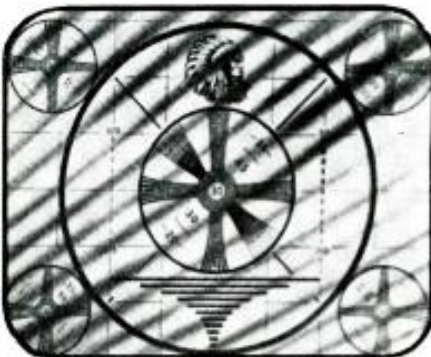

Fig. 1—Interference from another set.

Corp. of America. Both these systems suppress oscillator radiation enough to prevent its marring the pictures of other RMA standard receivers connected to the system. Any type of TV receiver may be connected to the system. Neither system is in common use.

Many a dealer is temporarily convinced (against his better judgment) that this or that indoor antenna is the answer, for he knows that a successful indoor antenna would mean greatly increased sales.

Installation companies guaranteeing in the original contract reception for stations not yet on the air should beware of the indoor antenna even

though it may operate satisfactorily for channels now in use. Nearly every indoor installation is a costly, time-consuming experiment, and the set user is almost never fully satisfied. There are call-backs and a resultant financial loss every time a new station goes on the air.

There is no such thing as a high-gain indoor antenna. Even an adjustable unit barely approaches the performance of a simple outdoor dipole on the channel to which it is adjusted. Careful comparative tests should be made on all new "sensational" indoor antennas before embarking on a wholesale indoor-antenna program.

The indoor antenna is not practical as a final solution to the problem. TV signals do not pass readily through steel structures and are attenuated by the materials of which houses are built. Such antennas are always a nuisance, whether installed under a rug, in a closet, on a table or simply on top of the receiver.

Indoor antennas usable

There are, however, many locations where indoor antennas can provide a satisfactory *compromise* signal from most stations. The set owner must, however, overlook faults. There is a reduced signal-to-noise ratio and contrast will depend not only on the control, but

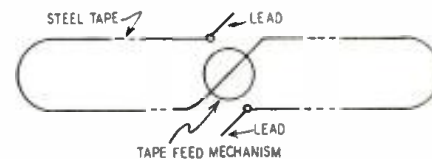

Fig. 2—Slide-Rule is a folded dipole.

on the positions of people and furniture in the room. With an "under-the-rug" antenna, every time someone walks across the room the contrast changes.

The signal quality varies, too, with the season. Window screens and foliage



The Tele-Tone has rotatable V antenna.

affect it during the summer, and during the winter, when the indoor antenna is picking up a reflected signal from a building or a mountain, ice formation on those surfaces may change picture quality and strength.

The only time, in fact, when an indoor antenna works excellently is when it is near a window from which it is possible to see the TV transmitting antenna.

Practical indoor antennas

For portable receivers, the indoor antenna is of course a must. The most practical is the rotating adjustable V which can be turned and the length of which can be adjusted. A typical one is used with the Tele-tone receiver in the photo. While the V antenna was originally a means of minimizing the space needed for a dipole, it definitely has an important advantage. Although TV transmitters send out horizontally polarized waves, reflections produce a

signal which has a different angle of polarization from the original. By setting the V at the correct angle the two (direct and reflected) signals of different polarization can be combined in phase and the signal increased.

Many receivers with only average sensitivity may be installed with an indoor antenna yielding a weak signal, if a booster amplifier with a minimum gain of 20 db is connected between antenna and receiver. The booster should not oscillate and should pass the full 6-mc bandwidth required for good reception. Many boosters have such narrow bandwidths that they do not permit the TV receiver to "track" on picture and sound simultaneously. Many oscillate on some channels, mismatch the antenna input, and are unstable.

Another practical indoor antenna is the Radio Craftsmen slide-rule. The length of a folded dipole is adjusted like a steel measuring tape. While the length of this antenna is adjustable, it cannot offer a perfect 300-ohm match except at one adjustment (if at all) for the distance between elements cannot be varied. This distance should vary from 0.54 to 0.145 inch for optimum results from channels 2 to 13. This antenna's shape is not like that of a conventional folded dipole, either, as illustrated in Fig. 2.

Fig. 3 shows a typical under-the-rug antenna with high- and low-band folded dipoles made of ribbon line. Occasionally three or four of these must be installed and a switch provided at the receiver to select the one adjusted for the desired station. In other installations pairs of dipole rods are installed in different sections of an apartment and co-axial cables circuited to a co-ax switch at the receiver. While several indoor antennas and a switch may provide satisfactory reception, it is a rare

customer who will accept and pay for such an installation.

It is conceded that a built-in TV indoor antenna (Fig. 4) would be a great stride toward full realization of customer acceptance of television. Capitalizing on this fact, several manufacturers have made judiciously worded claims to having solved this problem. However, as one of these manufacturers stated: "gold is where you find it." Indoor antennas—whether built-in or portable—will pick up television signals only if they are present in the vicinity of the indoor antenna, and the quality of the reception cannot be improved over the quality of the signals received.

Actual tests of built-in antennas indicate early enthusiastic customer reaction in some areas (Brooklyn, Queens, Kings, and Westchester County in New York) where strong TV signals from a majority of nearby TV stations have an unobstructed path to the indoor antenna from one general direction. As

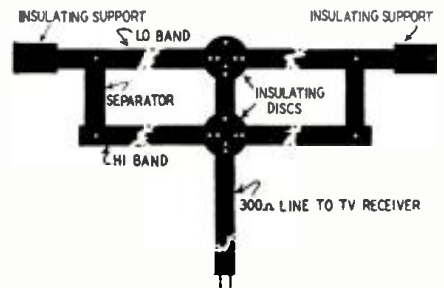

Fig. 3—Under-rug unit of ribbon line.

expected, in Manhattan, dealer and multiple-dwelling reception with built-in antennas has been generally poor. The following disadvantages have been noted by TV dealers:

On stations where signals are weak, the tuning adjustments become complex to the layman. The customer must keep his hands off the top of the cabinet as he tunes the antenna or else he affects the tuning. Metal trays or other large appurtenances cannot be placed on top of the cabinet by the customer.

In first-floor dealer establishments the built-in antenna will work on only one or two stations in one or two locations in the store, which reduces the flexibility of the dealer's sales operation. In many cases the dealer's serviceman must sell the customer on accepting the reception of the built-in antenna or rapidly install an outdoor antenna before the customer rejects the merchandise.

The service technician who has the responsibility of asking the "lady of the house" to relocate the TV receiver with built-in antenna in another section of the room or a different room where the TV receiver will pick up more channels, must have an outstanding sales personality. Many amusing situations have arisen where the receivers with built-in antennas work best in the middle of the living room, in front of a window, and in other loca-

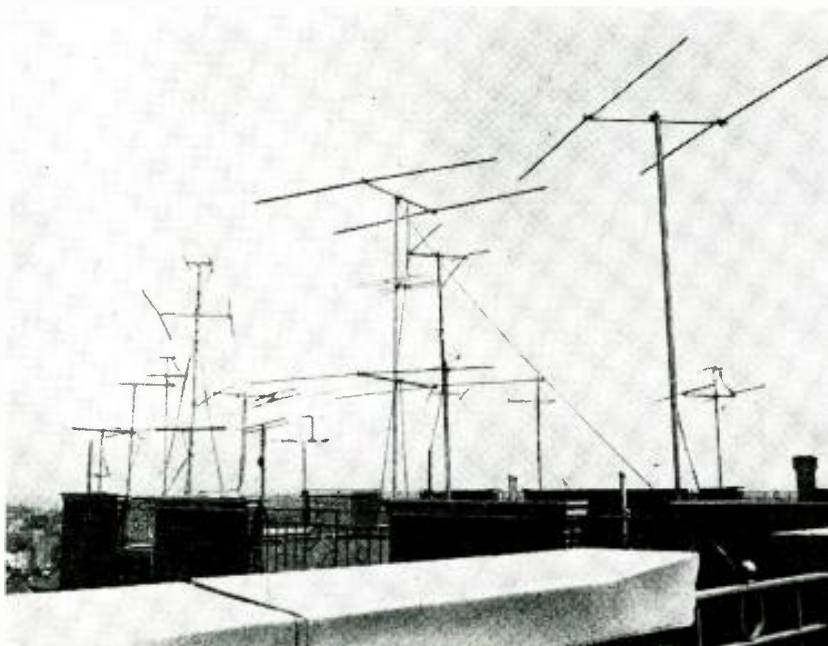

Forest of antennas on apartment roof. Close proximity can cause interference.

tions which the customer usually rejects.

The idea of installing a TV antenna on the power line cord or as a permanent unit in the rear of a console TV set as though it were a built-in radio antenna is impractical. Several manufacturers have spent considerable money and time to prove it. Certainly for apartment-house installations, it is impossible except when the TV receiver is against a favorably placed wall or in front of a window.

The increasing number of TV stations will start the indoor antenna on



Fig. 1—Plileco's built-in TV antenna.

the road out except for portable receivers and for those people willing to accept compromise reception.

OSCILLATOR INTERFERENCE CHART*

Receiver tuned to channel	Osc. freq. (mc)	Interference with channel
2 (54-60 mc)	81.25	5 (76-82 mc)
3 (60-66 mc)	87.25	6 (82-88 mc)
7 (174-180 mc)	201.25	11 (198-204 mc)
8 (180-186 mc)	207.25	12 (204-210 mc)
9 (186-192 mc)	213.25	13 (210-216 mc)

*For receivers with 21.25-27.5-mc i.f.

The plight of viewers living in multiple dwellings will be finally relieved when the landlord again faces a buyers' market and realizes that he must give his tenants television outlets just as he provides heating, plumbing, ventilation, and other fundamental services.

Many of our readers will not agree with Mr. Kamen on this controversial subject. For a different view, see Neill and Mandl in last month's issue (page 29)—Editor.

TELEGLERS GET TELESQUAT

TV fans may be getting "telesquat" and "telecrane" spinal ailments, Dr. Martin R. Stone, president of the Chicago Chiropractic Society, said in an interview with a reporter of the *Chicago Daily News*.

Persons who perch themselves precariously on the edge of their spines by sitting in a slumped position are asking for trouble. They are doing the "telesquat."

"They sit on the bottom of their spine and not on their bottom like nature intended. The 'telesquat' can cause a low backache and other physical disturbances," he said.

Sitting in a forward bent position puts a strain on the vertebrae of the neck. This is what Dr. Stone calls "telecrane." This practice can cause severe neckache, headache, and eyestrain.

TV STATION LIST

WE receive occasional reports of television stations 1,000 or more miles away being received clearly on ordinary receivers. Reports of such television dx reception are both valuable and interesting because they indicate the extent of this undesirable long-distance propagation.

Beginning with the next issue, **RADIO-ELECTRONICS** will publish reports of long-distance TV reception. Readers are invited to notify us of their TV dx experiences in detail, giving the date, time, name, location, and distance of the station, quality of reception, type of receiver and antenna in use, as well as any other pertinent data.

To aid dx'ers, the following complete list of stations gives all necessary logging information.

City	Call	Channel
ALABAMA		
Birmingham	WAFM-TV	13
Birmingham	WBRC-TV	4
CALIFORNIA		
Los Angeles	KECA-TV	7
Los Angeles	KFI-TV	9
Los Angeles	KLAC-TV	13
Los Angeles	KNBH	4
Los Angeles	KTLA	5
Los Angeles	KTSL	2
Los Angeles	KTTV	11
San Diego	KFMB-TV	8
San Francisco	KGO-TV	7
San Francisco	KPIX	5
CONNECTICUT		
New Haven	WNHC-TV	6
DELAWARE		
Wilmington	WDEL-TV	7
DISTRICT OF COLUMBIA		
Washington	WMAL-TV	7
Washington	WNBW	4
Washington	WOIC	9
Washington	WTTG	5
FLORIDA		
Miami	WTVJ	4
GEORGIA		
Atlanta	WAGA-TV	5
Atlanta	WSB-TV	8
ILLINOIS		
Chicago	WBKB	4
Chicago	WENR-TV	7
Chicago	WGN-TV	9
Chicago	WNBQ	5
INDIANA		
Indianapolis	WFBM-TV	6
KENTUCKY		
Louisville	WAVE-TV	5
LOUISIANA		
New Orleans	WDSU-TV	6
MARYLAND		
Baltimore	WAAM	13
Baltimore	WMAR-TV	2
Baltimore	WBAL-TV	11

MASSACHUSETTS		
Boston	WBZ-TV	4
Boston	WNAC-TV	7
MICHIGAN		
Detroit	WJBK-TV	2
Detroit	WWJ-TV	4
Detroit	WXYZ-TV	7
Grand Rapids	WLAV-TV	7
MINNESOTA		
Minneapolis	KSTP-TV	5
Minneapolis	WTCN-TV	4
MISSOURI		
St. Louis	KSD-TV	5
NEBRASKA		
Omaha	KMTV	3
Omaha	WOW-TV	6
NEW JERSEY		
Newark	WATV	13
NEW MEXICO		
Albuquerque	KOB-TV	4
NEW YORK		
Buffalo	WBEN-TV	4
New York City	WABD	5
New York City	WCBS-TV	2
New York City	WJZ-TV	7
New York City	WNBT	4
New York City	WOR-TV	9
New York City	WPIX	11
Rochester	WHAM-TV	6
Schenectady	WRGB	4
Syracuse	WHEN	8
NORTH CAROLINA		
Charlotte	WBTV	3
OHIO		
Cincinnati	WCPO-TV	6
Cincinnati	WKRC-TV	11
Cincinnati	WLWT	4
Cleveland	WEWS	5
Cleveland	WNBK	4
Columbus	WLWC	3
Columbus	WTVN	6
Dayton	WHIO-TV	13
Dayton	WLWD	5
Toledo	WSPD-TV	13
OKLAHOMA		
Oklahoma City	WKY-TV	4
PENNSYLVANIA		
Erie	WICU	12
Lancaster	WGAL-TV	4
Philadelphia	WCAU-TV	10
Philadelphia	WFIL-TV	6
Philadelphia	WPTZ	3
Pittsburgh	WDTV	3
RHODE ISLAND		
Providence	WJAR-TV	11
TENNESSEE		
Memphis	WMCT	4
TEXAS		
Fort Worth	WBAP-TV	5
Houston	KLEE-TV	3
UTAH		
Salt Lake City	KDYL-TV	4
Salt Lake City	KSL-TV	5
VIRGINIA		
Richmond	WTVR	6
WASHINGTON		
Seattle	KRSC-TV	5
WISCONSIN		
Milwaukee	WTMJ-TV	3

Television Channel Frequencies	
Channel Number	Frequency (mc)
2	54-60
3	60-66
4	66-72
5	76-82
6	82-88
7	174-180
8	180-186
9	186-192
10	192-198
11	198-204
12	204-210
13	210-216

The following stations, not on the air when the above list was made up, are expected to open on the dates indicated below.

City	Call	Channel	Probable starting date
Kansas City, Mo.	WDAF-TV	4	10/16/49
Greensboro, N. C.	WFMY-TV	2	9/22/49
Columbus, Ohio	WBNS-TV	10	10/1/49
Johnstown, Pa.	WJAC-TV	13	9/15/49
Dallas, Tex.	KBTU	8	9/17/49
Jacksonville, Fla.	WMBR-TV	4	10/16/49



By DAVID T. ARMSTRONG

INSTALLATIONS

The author explains techniques of successful custom-built television installations

THERE is a great deal of custom building to be done in all sections of the country, but few people know where or to whom to go to get the information they need. The service technician who wants his share of this business should go in for subtle,

suggestive selling using high-class, direct-mail techniques to reach those people who have the means to finance, and the interest in TV to desire, a custom installation.

The author's recommendation that custom building be an adjunct to a

service business is made for two reasons: first, not enough of it is likely to come your way to warrant going into it full time at the start; and, second—at the beginning anyway—you can hardly handle more than one job a month satisfactorily. The rewards are enticing enough to make one good custom installation per month sufficiently profitable to keep you going. Take it easy and build your business slowly, surely, and successfully.

Last month we had an over-all view of custom installations. In this issue we are going to follow a single installation step-by-step to give you some idea of the problems you are likely to meet.

The drawing of Fig. 1 sold this job. The room was small, 8 x 10, and was used as a den. There was a door on the extreme right and one on the extreme left. The door on the left led to the basement; the stairwell was behind the TV installation. That meant leaving that wall alone but it did solve the ventilation problem nicely.

As you can see from the sketch, the TV installation is relatively simple, but the cabinet work is extensive and expensive. During the first call on Mr. Prospect, he decided where the TV would be and what he would like done with the remainder of the blank wall. He indicated he wanted a desk with some pigeonholes for letters and some drawers on either side of the desk, plus some shelving for books.

To be a good salesman, you must swallow your own preferences. Personally, I think the pigeonholes for letters and knick-knacks a little corny, but that was one of the most appealing features of the sketch for Mr. Prospect. We gave him drawers on the left side

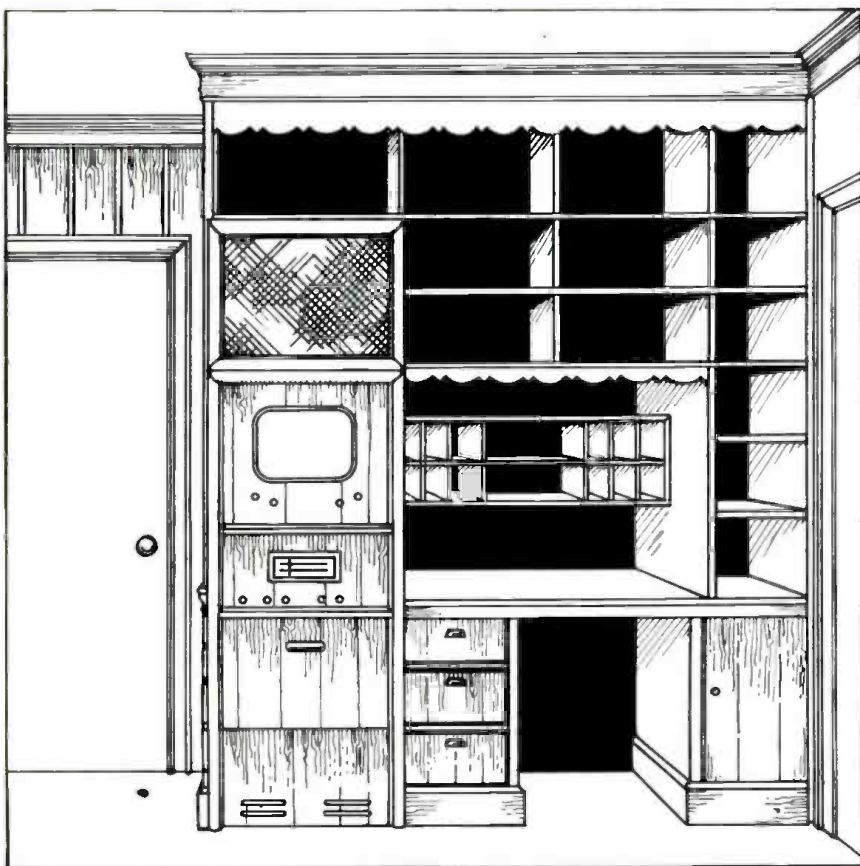

Fig. 1—Drawings like this one help to sell the installation to your prospect.

RADIO-ELECTRONICS for

and a cabinet on the right. In making the drawing we made an additional sketch of three drawers for the right side similar to the three on the left and pinned them over the storage cabinet shown. The monotony of the design at once convinced the family that it was better as we had it originally.

Here is another point. The depth of the shelves for books is 20 inches, making it possible to use the back part of the shelves for dead storage of infrequently used books and the front part for the currently consulted ones. However, the possibilities of such shelving are infinite. We asked if he had much liquor storage space, suggesting we make false partitions just behind a row of books and put in removable panels behind which liquor could be stored. But he wasn't much of a drinking man, and that was out. A little safe could be put back there and few people would suspect it. Other possibilities will occur to fertile minds; have the courage to use them.

Drawings are important

It is hard to overemphasize the selling effect of good drawings. Fig. 1 required about one hour to complete. Of course it was done by an expert draftsman. Drafting is a profitable skill for those who intend to make some money in this game. It is perhaps the chief stumbling block to many. There are so many separate and different little skills needed to sell and install TV that many little men give up. Perhaps it's just as well; the industry calls for men who can and will take the time to learn what they need to know.

The choice of a wood finish is important. This room was plaster and paint, but we sold the idea of a knotty pine finish for the entire room including the doors. Here the cabinetmaker got more work out of the job than we did; but since he was working for us, the major portion of the profit on the job was ours.

We used to hire a cabinetmaker by the job, but we have since found it profitable to have one permanently on our staff. He is paid a base sum per week whether he works or not and a higher flat rate during the time he is actually working for us. He has his own shop and makes his services, skills, and tools available to us at all times. Sometimes he is busy on a private job of his own and we have to wait a week for his services, but that is not a serious problem. People who are quality-minded and who pay quality prices realize you can't hurry a good craftsman. That is part of why it requires a month to do a job.

Construction procedure

The series of sketches in Figs. 2 and 3 break Fig. 1 down into dimensional detail. Let's consider first the front elevation and the cross-section views of the front elevation. The basic

dimensions shown are absolutely essential for installing the parts—chassis, power supply, speaker, and picture tube. The audio amplifier as the heaviest component belongs at the bottom of the assembly, resting on the floor for best support. The record player is just above the amplifier, built on a trolley arrangement so that it may be slid out for operation. This means that the cabling must be of very flexible wire that will not break.

Note the thimble through the wall at the back of the audio amplifier. This amplifier generates a large amount of heat and so does the power supply. You will recall that the wall behind the TV location was a stairwell, making it convenient to cut through for a ventilation hole. The stairwell side of the thimble is covered with a perforated metal grill.

Ventilation is necessary

Ventilation of TV custom installation is extremely important, so much so that RCA will not approve or permit an installation until the specifications show that proper venting is provided. They usually figure that a 40° C or a 72° F rise above ambient temperature is the maximum for safe receiver operation. Assuming that 70° F is the normal room temperature, an additional 72° rise would bring the temperature to 142°, the temperature of domestic hot water, which is more than most hands care to stand. Actual tests have shown that, with proper ventilation, operating temperatures are usually around 90° to 100°.

Note another thimble cut into the wall behind the picture tube and the 4-inch open spaces along the rear wall



Photo courtesy Allan Du Mont Labs., Inc. A receiver like this is easy to install and finish to the customer's specifications.

to permit hot air to flow easily out of the upper thimble. In other types of installations some provision is made

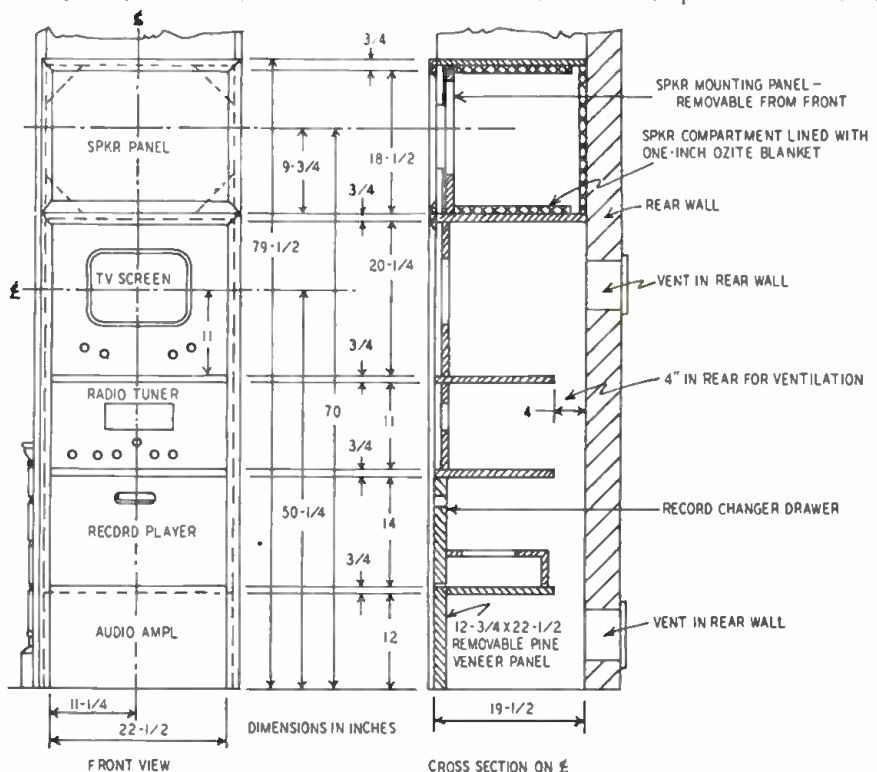

Fig. 2—A front-panel view and cross-section of the installation in Fig. 1.

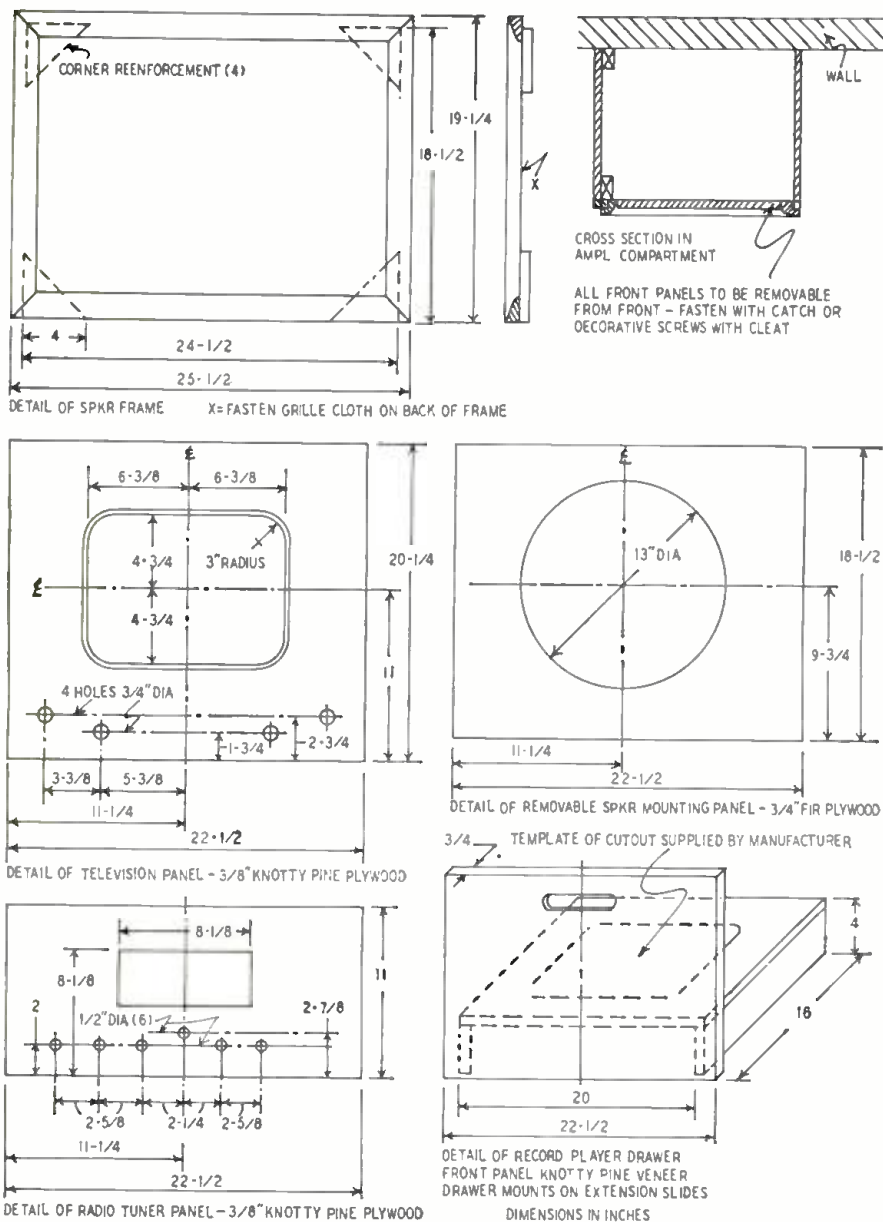

Fig. 3—Details of the panels on the individual compartments. The over-all dimensions and the positions of the holes will vary with different chassis sizes.

for openings in the paneling at the base of the unit; the grill work around the speaker provides the upper opening. So great is the chimney effect that a thin paper streamer held against the upper opening will blow out like a flag. When that happens, you are getting a good draft and you will have no trouble with overheating. The minimum opening area permissible for ventilation of the entire unit is 64 square inches.

The importance of dissipating heat from the TV installation and chassis is seldom understood. The capacitors and resistors in the front end of a tuner are heat-sensitive, and the stability of the oscillator depends to some extent on dissipating the heat generated in the oscillator and mixer sections.

Installations are flexible

Many variations are possible with the removable panels for the audio amplifier, record player, and speaker. The panels for the tuner, picture tube,

amplifier, and speaker are removed only for servicing; they may be held in place with decorative screws, or just pushed into place and held there with spring-loaded catches. The record player front panel may be a slide which fits into a niche on the right or left side or at the bottom of the reproducer; or it may be the front of a drawer in which the reproducer is located, sliding out on ball-bearing runners. What is done depends on the desires of the prospect and the skill and experience of the cabinetmaker. Spring-loaded catches are wonderful because they make a little mystery of removing the panels, but they require a degree of precision to install that not every cabinetmaker possesses.

The enlarged views of the tuner and the television screen panels indicate the hole layout for the cabinetmaker. The holes are large enough for the control knobs and shafts and permit some tolerance in case they do not line up

precisely with the shafts on the chassis.

The reinforcing corners in the speaker assembly are necessary to prevent the panel from sagging under the weight of the speaker. They are wooden pieces, and all cabinetmakers know how to install them. Cover the sides and back of the speaker compartment with a 1-inch Ozite blanket for sound deadening. Try covering the bottom and top and let the customer decide which sound he finds most pleasing.

The details of the record player in Fig. 3 will vary with the player selected. RCA will supply the installer with a template for the component used. Here the front panel is securely fixed to the record player drawer, and the handle is the slot cut into it near the top.

The installation discussed is only one of many possible types using equipment made by any of a number of manufacturers. It shows the kind of planning needed, the precision and care with which you must work, and the type of selling job involved.

Many custom installations use projection viewing systems. A typical one is made by General Electric. Fig. 4 shows how the optical system works, and, roughly, how the components must be placed. Obviously it requires a somewhat different layout from the direct-view installation.

One of the easiest installation jobs is the Du Mont unit shown in the photograph. It is shipped in the plywood case just as you see it, ready to work. All you have to do is make a place for it and finish off the front with paneling. While the installation is simplified, it takes a good bit of space and lacks the distinctiveness of an individually planned job for a specific location.

While I have no special preference for any one manufacturer, I have received much help and advice from the Consumer Custom Products Department of RCA in New York. If you make an RCA installation, you will have to have them OK your plans anyway before they will sell you the equipment.

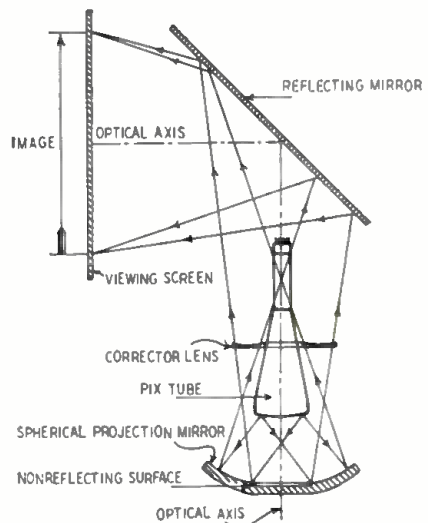
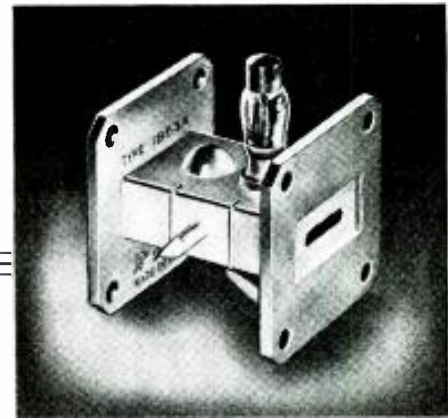

Fig. 4—A typical TV projection system.

MICROWAVES

Part VII—Action of below-cutoff attenuators, and of TR and anti-TR switches

By C. W. PALMER



Courtesy Sylvania Electric Products Inc.
A TR assembly for waveguide insertion

WE discussed waveguide attenuators in a general way in an earlier part of this series and showed how a resistance strip could be inserted into a waveguide to introduce an adjustable amount of attenuation.

Another type of attenuator used extensively in microwave work is called the "waveguide-below-cutoff" attenuator or sometimes simply the *cutoff* attenuator.

A wave propagates through a waveguide with very little loss, provided the diameter or width of the guide is greater than the cutoff point. If these dimensions are below cutoff, then there is no longer any real wave propagation; instead the magnetic and static fields of the r.f. waves are attenuated very rapidly down the length of the guide.

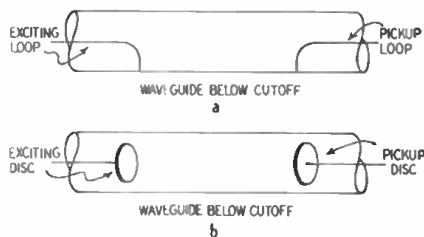

Fig. 1—Couplings are loops or discs.

If the guide diameter is made small compared to the free-space wavelength, the attenuation is independent of frequency over a very wide range. The modes generally used for such attenuators are the $TE_{1,1}$ and the $TM_{0,1}$. The methods of exciting waveguides in these two modes are shown in Fig. 1. Here a co-axial line is terminated in either a coupling loop or disc and the reduced power is picked up in another co-axial line. The distance between the exciting and pickup loops controls the amount

of attenuation. Since the relationship is linear, a scale on the movable loop or disc can be calibrated directly in decibels. Attenuators of this type usually have an insertion loss of about 10 to 20 db at the position of maximum coupling and more as the coupling is reduced.

When co-axial line is coupled into a cutoff attenuator with loops, a serious mismatch to the line results, a co-axial line terminating in a loop being practically short-circuited. Three methods of reducing the bad effects of such mismatch may be used. The most common is to pad the input and output ends of the cutoff attenuator with lengths of high-loss co-axial cable. These add about 10 db of attenuation, and their resistance damps out the effects of reflection from the mismatched co-axial line termination.

Another way is to use resistor discs, little circles of graphite or carbon, made to fit the co-axial cable, with a hole in the center to contact the inner wire. The resistance of these discs should be equal to the characteristic impedance of the line so that the line is terminated correctly.

A third method is to make the loops of a resistance material and adjust the resistance of the loop to equal the characteristic impedance of the line.

Cutoff attenuators are also made to work in waveguide at the higher frequencies where co-axial line is not desirable because of high losses. Fig. 2 shows how this is done. A rectangular or circular guide is joined to the small "below-cutoff" section with a pickup probe near the termination of the large guide. This probe ends in a fixed loop for exciting the small guide. A second (movable) loop used as the pickup point ends in a probe extending into another section of large guide to continue the waveguide circuit.

The space between exciting and pickup loops is adjusted by one of several mechanical methods, the simplest of which consists of two telescoping metal tubes, each of which contains a loop and is terminated in the co-axial lines or waveguides. A rack-and-gear drive controls the amount of telescoping and, consequently, the spacing between loops, which varies the attenuation.

TR and ATR units

In radar and microwave communication systems in which the same antenna is used for both transmitting and receiving, it is necessary to use a fast-operating transmit-receive switch to prevent transmitter power from reaching the sensitive crystals and vacuum tubes of the receiver and also to prevent the received signal from being absorbed in the transmitter.

A transmit-receive (TR) box is an electronic switch which operates in a fraction of a microsecond. It must provide an excellent short-circuit for the receiver, since even a small part of the transmitter power would burn out a silicon or germanium crystal.

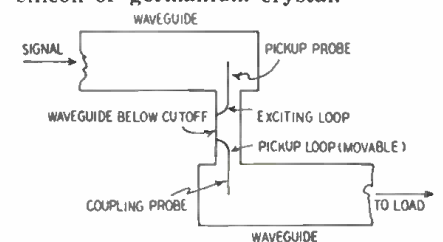

Fig. 2—Attenuator between waveguides.

Some form of gas discharge device is generally used for this purpose. Note Fig. 3. Here the transmitter power builds up a voltage across the gap, which then arcs over so that most of the transmitter power goes out to the antenna. This simple scheme could be employed in either a co-axial line or a

waveguide, but unfortunately it doesn't offer enough protection to the receiver.

The simplest way to improve it is to insert a voltage step-up transformer before the gap and a step-down transformer after it. And this is just what is done, in the form of a *resonant cavity* in which the gap is placed.

This resonant cavity may take the form of a cylindrical box with perfectly conducting walls and with two posts in the axis of the cylinder, separated by a gap, as shown in Fig. 4. In the lowest mode that will function in such a cylinder, the electrical field is parallel to the axis of the cylinder and increases toward the center. The magnetic field

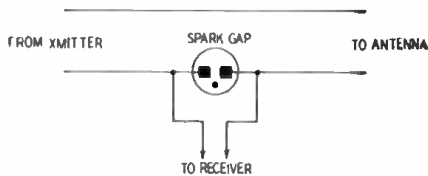

Fig. 3—The principle of the TR switch.

lines are circles perpendicular to the axis of the cylinder and currents tend to flow radially and up and down the center posts, as shown in the cross-section drawing.

Energy may be fed into and out of such a cavity either through windows in the cylinder walls or by coupling

loops inserted into the cavity. The step-up ratio of the transformer is controlled by the size of the coupling windows or loops, the ratio increasing as the window or loop size is decreased.

When weak microwave currents pass through the waveguide or co-axial cable, the TR tube permits power to pass through. But if a strong wave—such as would be set up by applying power to the magnetron transmitter of Fig. 5—passes down the guide, the tube breaks down and becomes a short circuit. The shorting of the TR gap applies a "solid wall" at the junction of the T side arm of the waveguide, and sets up a strong standing wave in the side arm which prevents the transmitted signal from reaching the receiver.

In receiving, the magnetron is not fired, and since most magnetrons have a considerable change in impedance between hot and cold conditions, it is possible to tune the waveguide to provide a matched impedance condition when the magnetron is fired, thus introducing a gross mismatch when the magnetron is not fired. This sets up a standing wave in the line between the TR tube and the magnetron so that most of the received power goes through the cold TR box to the receiver.

Some magnetrons, particularly those on 3 cm and shorter wavelengths, do

not change impedance enough to prevent an excessive loss of received signal. In these instances, an *anti-TR box* is used.

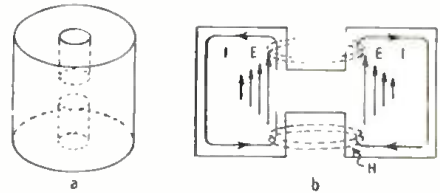

Fig. 4—Voltage is highest across gap.

The anti-TR box is very similar to the TR box except that it has only one coupling window instead of two. It is placed in a T side arm between the TR and the magnetron. On transmit, it fires just as the TR box does and reflects a solid wall at the junction of the T side arm, thus allowing maximum power to reach the antenna.

On receive, however, being situated a quarter-wavelength from the TR box and tuned in length so that when it is not fired it reflects signals coming from the direction of the antenna, it thus prevents loss of signal in the magnetron. If the distance from the anti-TR to the TR is correctly chosen, a maximum received signal will pass through the unfired TR to the receiver.

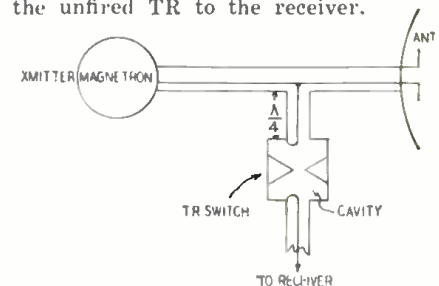

Fig. 5—TR switch in antenna circuit.

A TR switch may not fire in the first few cycles of the transmit signal and the high-voltage pulse may damage the receiver. To prevent this a "keep-alive" electrode is often built into the TR tube. An auxiliary electrode or gap near the main gap of the TR tube, it is connected to a source of voltage sufficient to keep a small arc always fired in the TR to supply the necessary ions to cause the main gap to fire on the first pulse from the transmitter. This causes a small loss of received signal, but prevents damage to the delicate receiver parts and is thus a worth-while compromise.

The use of TR and anti-TR switches in a microwave communication system permits duplex operation. Transmitter power can be applied momentarily to the antenna when it is desired to talk, but reception is possible at all times that the transmitter is not active. It also permits a single antenna and reflector system to be used for transmit and receive. This reduces cost and allows focusing on point-to-point transmissions to be simplified greatly. An even more important advantage is in radar, where the rotating antenna makes it extremely convenient to use one antenna for transmission and reception.

A DETECTOR-FILTER CIRCUIT

Heterodynes, caused by beating between adjacent-channel signals, are often annoying to users of high-fidelity receivers and tuners. A heterodyne filter is combined with an infinite-impedance detector in a circuit described in *Electronic Engineering* (London).

A parallel-resonant circuit L-C2 is inserted in series with the detector plate and B-plus in the circuit shown. The cathode bypass capacitor being small, the cathode voltage will follow the modulation envelope. Audio output is taken

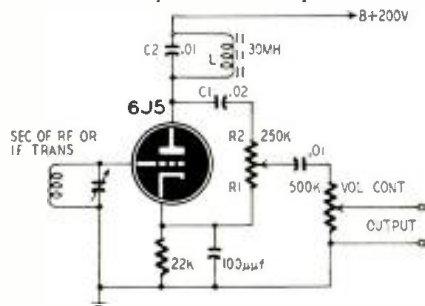

from a bridge composed of the internal resistance of the tube, C1, R1, and R2. At frequencies above and below the resonant frequency of L-C2, the plate-circuit impedance is low and most of the audio voltage is developed in the cathode circuit. If R1 and R2 are equal and the reactance of C1 is low, the output voltage will be half that developed in the cathode circuit. If the impedance

of the tuned circuit is equal to the cathode resistance at resonance, the audio voltage will be divided equally between the plate and cathode circuits. Since these voltages are 180 degrees out of phase—as in a kangaroo phase inverter—the audio voltage will be zero at the junction of R1 and R2.

R1 and R2 may be replaced by a potentiometer to permit balancing the system for best performance. The cathode capacitor is chosen to have a reactance much smaller than the cathode resistor at the lowest signal frequency—usually 550 kc—and much larger than the resistor at the resonant frequency of L-C2 (approximately 9,000 cycles). C1 is selected for a reactance equal to the resistance of R1 plus R2 at the lowest audio frequency to be passed by the audio system. If its reactance is too high, bass boost will be introduced. Feedback will occur at low frequencies if the reactance is too low. L is a 30-mh shielded r.f. choke. One with a powdered-iron core is preferable. C2 should be a high-quality mica unit. L-C2 may be replaced with a commercial heterodyne filter if it is considered desirable.

If the receiver has a separate detector, the filter may be incorporated in an a.f. amplifier stage. In such cases, the cathode bypass capacitor is omitted and the cathode resistor adjusted for normal amplifier operation.

How to Become a Ham

PART II:—

Learning the Code

By GEORGE SHUART

THE International Morse code was the first and—for a time—the only way of conveying intelligence by radio. More important to the would-be amateur, the Federal Communications Commission requires you to be able to send and receive it at a rate of 13 words per minute before you can get a license. That being the case, the thing to do is to get to work and learn it.

The code is used to transmit intelligence in exactly the same way as the spoken word. In speech, sound is varied to form words; in code, the duration and spacing of a single type of sound is varied. In either case the effect is the same. It is the complete sound that gets the idea across, not the individual variations. For example, should a person say "fishing rod," you would visualize a fishing rod, not think of the letters that make up the words, nor of the words themselves. So it is with code—one does not listen to the component parts of letters, but visualizes complete letters or words.

If I were walking down the street and heard a voice behind me say, "Shuart!" my head would turn almost instantly whether I wanted it to or not. Having been called Shuart for a number of years, I know that when somebody says "Shuart" he usually means me. I don't have to think about it. I answer to the name just as quickly and unthinkingly as my leg jumps when the doctor hits my knee with his little rubber hammer.

A good code man operates on the same basis. When he hears a long and a short sound, his hand writes "N" automatically. He doesn't think about it—he hasn't time. The long-short sound combination is directly associated in his mind with the letter N. No mental pictures of printed dots and dashes come between the sound and the letter.

There's a lesson here for you. It's so important that it is almost all you need to know:

The only good way to learn code is by ear.

Never look at any of the tables that show dots and dashes (or even dits and dahs) next to the letters they represent. From the very start of your training learn by having someone send letters to you and then tell you what each one is. That isn't practical if you can find no one to help you. But it is worth while to move heaven and earth to find someone who will sit down and send



Have a friend send the code while you copy it down.

the letters to you—even if just until you can recognize the 26 letters and 10 numerals. The rest you can do yourself.

If you can get help

You'll need a code-practice oscillator or buzzer, which can be built following instructions in any of the articles listed at the end of this story.

Don't look at any tables showing the code in print—not even at the one given in this article. Sit down at a table with a good supply of paper and pencils. Let your "instructor" send you the letter A. The first few times, he should tell you what it is. Then let him send it over and over again, perhaps 30 times. *And each time he sends it, write it down.* Then do the same with the letter B. Next, try it with alternate A's and B's until you can copy them straight in any order, identifying each correctly. *Each letter should be sent at a good clip, with long enough spaces between them for you to identify and write them down.*

Now try C. Then D. Then A, B, C, and D. And so on through the alphabet and numbers. After a while you will not have to think so long for certain letters, and you'll know you are learning. This whole procedure may take a number of sessions, each of which should be stopped when you feel your mind is getting cluttered and is no longer alert.

As soon as you have learned a few letters, have your instructor send complete words, short ones, of course, with long pauses between them so that you can write down the word immediately after it has been sent. Thus you'll avoid the pitfall of attempting to write down each letter as sent. The beginner will, of necessity, be copying slowly. Try to remain at least two letters behind the sender. Do your early copying at a very slow rate of speed . . . stop if you find that you are hurrying. Don't strain

at the pencil; that will get you nothing. Each letter should be formed carefully and slowly. It will then be more legible, and you will find it less difficult to copy *behind* the sender.

A great many code students believe that fast writing allows greater time for concentration on what is being sent. That is wrong! Write slowly and keep yourself relaxed. If a letter is missed or improperly formed, go right ahead to the next as though nothing had happened. If you stop for one letter, you will lose a dozen before you get going again.

If you have no help

If there is no one to help you, use the table printed with this article. Notice that there are no dots and dashes, only *dits* and *dahs*. A dit (short sound or dot) in print looks very much like a dah (long sound or dash) so your future progress is not so likely to be impeded by a mental picture.

Don't learn the code by eye. Put the table before you and rest your hand on the key. To learn the letter A, just let your hand follow the instructions to push once briefly (di) and once long (dah). The space between the two should be only as long as necessary to get the key up and down again. The di-dahs, remember, are just instructions for your hand, not things for your mind to learn. Make the sounds indicated with the key and oscillator and immediately pause and write each letter down. After you've made the sounds for A and B many times, mix them up—and write down each one. Then go on to C. Next, mix up A, B, and C. And so on through the list.

To send correctly, hold the key lightly, palm parallel with the operating desk, and with the elbow and the forearm muscle resting on the desk in a direct line with the key. Bounce the wrist. When the wrist is lifted, the key will go up. As the wrist is lowered,

the key will go down with it. Rapid bouncing makes the dots, while slow bouncing will make the dashes. Be proud of your "fist." Good sending is immediately recognized. You'll receive many more replies to your calls if your signals are easily understood. If your characters are slurred and your sending wobbly, the other fellow will pass you by and go to someone else who is easy to read.

Working up speed

Once you've learned the bare letters and numerals by either of the two methods above, your real training begins. It is simple; it is also tedious. Progress will be slow for a while, then suddenly speed up.

The procedure can be given in two

machines on the market. Those who have to learn alone should certainly have one. Investigate the various types to find the one most suited to your needs and pocketbook. Phonograph records—sold by most radio mail-order houses—are especially useful to the lone student. In any event a practice outfit will be needed. This can be built or purchased.

Just one final tip: don't get discouraged. You may get on beautifully for a few weeks, then be unable to improve at all. But if you keep up your practice, you will eventually forge ahead. You may hit another snag a little later. Again, don't quit, for you will eventually break the tieup. Boosting code speed is a very peculiar process, but anyone at all can do it. *Nobody gets*

TABLE OF CODE SOUNDS

A. di dah
B. dah di di dit
C. dah di dah dit
D. dah di dit
E. dit
F. di di dah dit
G. dah dah dit
H. di di di dit
I. di dit
J. di dah dah dah
K. dah di dah
L. di dah di dit
M. dah dah
N. dah dit
O. dah dah dah
P. di dah dah dit
Q. dah dah di dah
R. di dah dit
S. di di di
T. dah
U. di di dah
V. di di di dah
W. di dah dah
X. dah di di dah

Y. dah di dah dah
Z. dah dah di dit
1. di dah dah dah dah
2. di di dah dah dah
3. di di di dah dah
4. di di di di dah
5. di di di di dit
6. dah di di di dit
7. dah dah di di dit
8. dah dah dah di dit
9. dah dah dah dah dit
0. dah dah dah dah dah

SPECIAL CHARACTERS

AR. End of item.
R. Received and understood.
K. Go ahead. Transmit.
DN. Slant bar.
SK. End of contact.
IMI. Query. Repeat.
AS. Wait a minute.
String of dits. Error.
BT. Break.
AAA. Period.

Notes

"Dit" indicates a short sound (dot). "Di" is the same but omitting "t" indicates that the next sound comes immediately.

Only listening to others can give an idea of correct spacing, but the italicized sounds may be very slightly accented mentally to give each character a rhythmic individuality. Each dah should actually be the same length, as should each di or dit.

Line through zero (0) distinguishes it from letter O.

In special characters, a line over two or three letters indicates they are sent as one character without spacing.

Instructions for building code-practice oscillators were given in the following issues of this magazine, 1949: Feb., p. 86; 1948: Mar., p. 63, Apr., p. 44, May, p. 80, Sep., p. 82, Oct., p. 84. Any of these oscillators should be satisfactory.

CODE-PRACTICE STATIONS

One of the best ways to increase your code speed is to copy government and commercial radiotelegraph transmissions with the aid of your receiver. The table below lists stations of Mackay Radio, Radiomarine Corp. of America, and the U. S. Coast Guard which transmit useful material for practice at reasonably low speeds.

Stations whose calls begin with N are Coast Guard. They broadcast weather and marine information. WSL, KFS, and DZM send press, while the others transmit weather.

Other good sources of practice material are ARRL information and code-practice transmissions (write ARRL or see *QST* for schedules) and miscellaneous commercial and government code stations you may run across. Foreign countries, notably England, broadcast traffic and press in a number of languages.

Note that you will require a special receiver for frequencies below 550 kc. This can be constructed by the listener, or he can use surplus beacon receivers, some of which receive over a range extending from 200 to 500 kc.

Time (GMT)	Freq. (kc)	Call sign	Station Location
0018	408	KSE	Torrance, Calif.
0418	8,452.5		
1618	16,990		
2018			
0330	127	NMR	San Juan, P. R.
1530	4,795		
0350	425	NMF	Boston, Mass.
1550			
0400	425	NMC	San Francisco, Calif.
1600			
0418	5,555	WSL	Amagansett, N. Y.
	11,115		
0420	425	NMA	Miami, Fla.
1620			
0420	480	NMY	New York, N. Y.
1620			
0430	425	NMQ	Long Beach, Calif.
1630			
0450	410	NMN	Norfolk, Va.
1650			
0500	126	KPH	Botinas, Calif.
1700	436		
	8,440		
	11,160		
	22,325		
0500	425	NMW	Seattle, Wash.
1700			
0520	425	NMG	New Orleans, La.
1720			
0530	410	NMJ	Ketchikan, Alaska
1730			
0550	464	NMV	Jacksonville Beach, Fla.
1750			
0605	6,270	KFS	Palo Alto, Calif.
	12,550		
0900	425	NMO	Honolulu, T. H.
2100			
1700	8,670	DZM	Manila, P. I.
1748	418	WPA	Port Arthur, Tex.
	8,435		

HINTS ON COMMAND SET RIGS

A number of amateurs are using the transmitters from the SCR-274-N and ARC-5 command sets. At W2PWG, we have found a few interesting points that we have not yet seen.

If you modulate the plates of the 1625's, remove the .01- μ f plate bypass (C66) and replace it with a .002- or .005- μ f 2,500-volt mica capacitor. This prevents most of the audio from being bypassed to ground.

The PA stage must be retracted. Tune to the high end of the band and adjust the PA padder C67 for minimum plate current. It should not vary more than 6 ma as the rig is tuned to the low end. If it does, adjust the slug for minimum dip. Return to the high end and check the variation in current. Continue the adjustments at high and low ends until current is within 6 ma.

words: Copy code! Have a friend send it to you or listen to it on your receiver. Commercial stations send fast but well. Amateurs may send fast or slowly, well or badly; but whatever you listen to, you will learn code as long as you put down on paper every letter you can recognize.

Peculiarly, you will make just as fast progress (though with less sop to your ego) listening to 25-words-a-minute press as to 15-word sending from a friend. You may catch only one letter a minute at the start, but soon you'll get more.

Above all, never copy for practice anything you can get "solid" (completely). It should always be faster than you can really copy.

There are many fine code-teaching

anywhere without constant practice. Be assured that no matter how discouraging matters seem, more practice will pay off handsomely.

Many people who are interested in radio have never learned the code, simply because they believe it to be a fantastically difficult undertaking. That is not so! Learning the code is not hard, if you give yourself a chance. Just follow these four simple rules:

1. Relax! Take it easy!
2. Proceed s-l-o-w-l-y.
3. Do not set a deadline.
4. Take it in small doses.

With the help of these four rules and the simple information contained in this chapter, you may find learning the code one of your most worth-while experiences.

CASE OF THE ELUSIVE BLIP

The problem that nearly stymied a broadcast station

By JAMES W. ESSEX

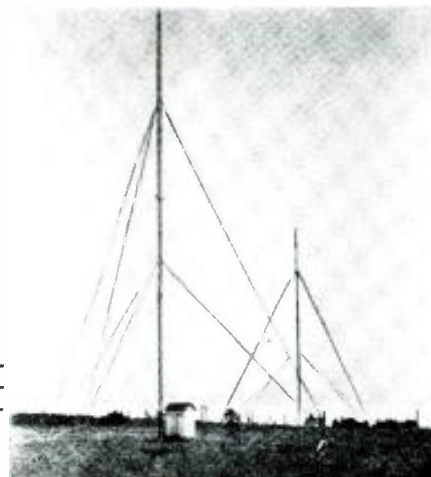

Looking east, west tower in foreground.

SETTING up a directional broadcast installation sometimes proves to be a greater problem than obtaining the necessary permission to operate a broadcast station. True, the difficulties of obtaining a license are tremendous and require a great deal of preparation and planning, but the problem of getting two towers to work as they were designed is often minimized to such a degree that a faulty pattern can hold up an anticipated opening for a long time.

Take this station as an example. CKBW is located in Bridgewater, Nova Scotia. Power was planned at 1000 watts and a license obtained to work on 1000 kc. The site was chosen, land purchased, equipment ordered, final assembly of studios and transmitter completed, and all items checked and rechecked for proper adjustment. Finally came the opening day.

Using a two-tower antenna system operating with a 90-degree phase difference between the two towers, a null area was to be had west of the line of towers—the towers running due east

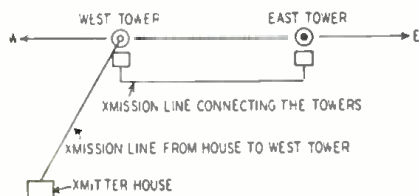

Fig. 1—Placement of towers and house.

and west. This was laid down in the brief submitted to the licensing authority, on which basis the license had been granted. This station was not to contribute any interference on the 1000-kc. channel in a westerly direction after sundown. It would operate non-directional by day and directional by night.

Because the site chosen for the in-

stallation was such that the transmitter house could not be set directly in line with the towers, it was built in the position shown in Fig. 1. This was to contribute dire complications to the system in due course.

Having set up the phasing units at the base of each tower to obtain the 90-degree displacement, we were now prepared to make our first check on the resulting radiated field.

Using a loop receiver with an output circuit driving a meter calibrated in microvolts per meter, we made a trip by automobile, completely circling the two towers, stopping at each 9 degrees where such radials intersected an accessible road at a distance greater than one mile. Points appear in Fig. 2.

Our first complete run having been made, all readings obtained in microvolts per meter were evaluated into ratios, resulting in a set of numerical values. These figures plotted on a polar graph gave us a directional pattern similar to that shown in Fig. 3.

The distortion that appeared was a clear indication of trouble, the forerunner of disappointment and delay.

Because of the strict adherence to Department of Transport (Canadian equivalent of the FCC) regulations, the distortion or "blip" clearly indicated in the null area could not be accepted. A long struggle was begun to rid the pattern of it. The date for going on the air was promptly shelved, and the battle of wits began.

Tackling the problem on the basis that incorrect phasing between towers was causing the distortion, we shifted the phase slightly above and below the mean of 90 degrees. With each shift in phase, a trip by car was taken, running through the area where the null was supposed to appear, west of the towers. At the conclusion of each run, as de-

scribed previously, the values obtained were plotted.

Soon gasoline consumption reached large proportions and the transmitter room was becoming a litter of graph paper—each run failing to bring us any closer to the desired result. The blip was determined to remain.

From the end of November to the middle of December, work carried on, though with increasing difficulty as snow began to fall. With the roads becoming difficult to negotiate by car, we abandoned the auto for a jeep. This carried us well into the null area by resorting to the farmers' fields; and with the aid of skis when any walking had to be done, our mobility was complete. It happened that the district experienced a record snowfall this particular season, and we felt that even the elements were against us. The colder it got, the warmer our tempers became.

We persevered. When phase shifting did not bring the desired result, it was suggested that some reflecting object might be adding a third signal to the array, producing the blip in the null area. This became the basis of a favorite joke. A large sign on the wall of the transmitter house stated: "All wearers of watchchains, etc., must cease wearing same forthwith. They are blamed for reradiating the signal that causes our Blip."

The reflecting-object theory was gone into thoroughly, even to the point of having the telegraph company temporarily remove copper wires which traversed the tower array directly back of the east tower. This, however, did not remove the distortion in the pattern, and the search continued.

With the approach of milder weather spirits were lightened somewhat and a final effort was made to solve the riddle.

(Continued on bottom, page 36)

Sideband Suppression

By I. QUEEN

Single-sideband systems provide a very effective method of reducing interference. Since the desired signal occupies only half the usual frequency band, there is less chance of picking up spurious radiation, heterodyne whistles, and general noise. With conventional double-sideband transmission the same improvement can still be had by chopping off one of the sidebands at the receiver.

Patent No. 2,364,863, utilizing this principle of interference elimination, was issued to James L. A. McLaughlin about four years ago. Although more complicated than systems which rely on crystal filters, Wien bridges, or highly selective circuits, the results are more effective. This is because an entire sideband is eliminated rather than just a small portion (notch or rejection slot). In addition, operation is easier because there is no need for critical retuning or

phasing for each new set of conditions.

To illustrate how single-sideband selection works, assume a conventional receiver i.f. of 455 kc and a bandwidth of 8 kc. Then the total range is 451-459 kc. Before suppressing a sideband, this i.f. is converted to a lower value by beating it with a crystal-controlled oscillator.

For maximum noise reduction it should be possible to suppress either sideband at will, to determine which gives better results. Therefore two

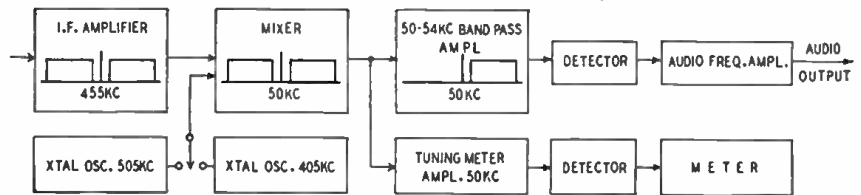

Block diagram shows how receiver selects one sideband, suppresses other.

oscillators are provided, one operating at 405 kc and the other at 505 kc. Either one may be switched into the circuit. No matter which one is used, the second i.f. (carrier) will still be 50 kc and the range will be from 46-54 kc. The second i.f. amplifier has a passband from 50-54 kc, so it transmits only the carrier and one sideband.

There is an important fact to note. When the 405-kc oscillator beats against 451-459 kc, it produces a range from 46-54 kc; therefore the lower sideband will be suppressed. When the 505-kc oscillator is used, the i.f. channel extends from 54-46 kc and the upper sideband is lost.

A portion of the mixer output is also connected to a sharply tuned 50-kc amplifier and detector. This controls a resonance meter for indicating correct receiver tuning.

CASE OF THE ELUSIVE BLIP (Continued from page 35)

A complete re-examination of all past investigations and experiments was made, and one fact made itself apparent. This was that the transmission line from the west tower to the transmitter house was running almost at right angles to the point at which the blip occurred in the null.

The angle of the transmission line to the west tower was determined with a

magnetic compass, figures being carefully recorded and compared with our previous findings as to the position of the blip. Knowing the type of transmission line in use (an open-wire system) we decided that a standing wave existed on this line, which, radiating, was causing the distortion in the null.

Armed with these facts, we investigated the tuning and phasing unit in

the west tower. The search disclosed an inductance not properly shielded, which contributed a mismatch in the line when on directional transmission and formed a standing wave.

This was remedied by having the coil shorted out by a relay when not in use (it was not used when the system was directional). The parasitic inductance effect of this coil, detuning the circuit and causing the line mismatch, was eliminated, leaving the line properly loaded and eliminating any chance of a standing wave.

Our efforts were rewarded at last. Another run through the null area proved that the troublesome blip had been eliminated.

And so we stood by and listened, huddled about the monitor speaker in the transmitter house, to the first crisp words from the speaker, "This is CKBW in Bridgewater."

Another station was on the air!

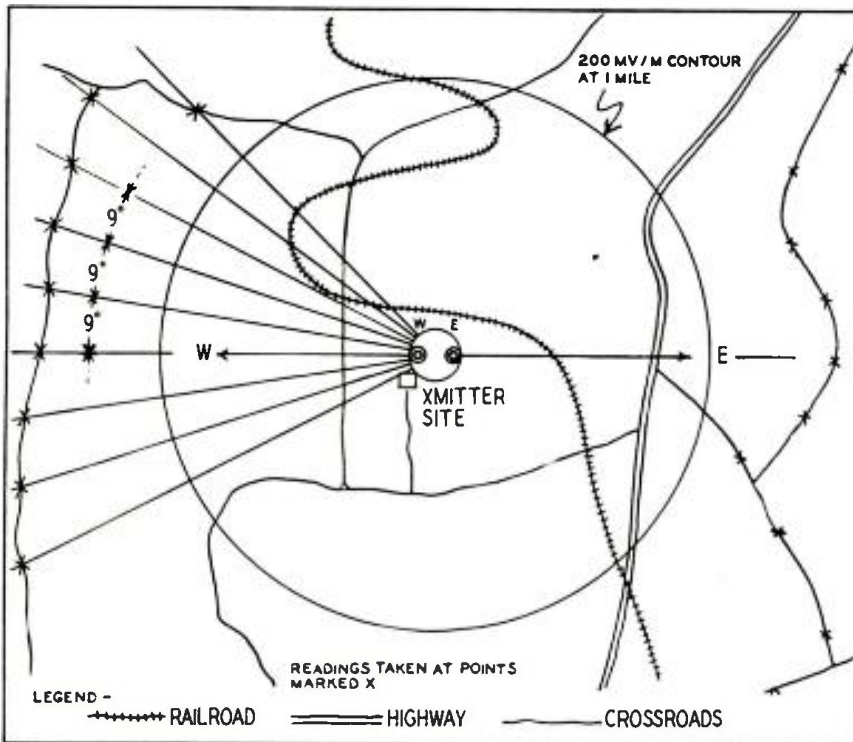

Fig. 2—Intensity readings were taken at 9-degree intervals around antenna.

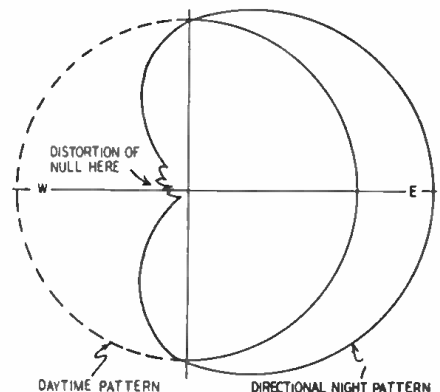

Fig. 3—The start of all the trouble.

Tracer Uses Tube As Probe

A small, convenient unit good for bench use or outside jobs

By ALVA R. WILSON and W. KENNETH WILSON



Fig. 1—Tracer is valuable shop help.

SIGNAL TRACERS are standard equipment for rapid trouble shooting. The signal tracer shown in Fig. 1 is even more useful than the average one because of its many applications. It has a 3-inch PM speaker (eliminating headphones), a volume control, and a meter which gives a relative reading of incoming signal strength. Unlike the speaker, the meter indicates signals of all frequencies, including unmodulated r.f. It enables the tracer to be used for checking a receiver's oscillator, for hunting down stray oscillations, and even for transmitter trouble shooting. When not otherwise in use, this signal tracer can be used as a local broadcast receiver.

The unique design of the probe, whose simplicity is shown in Figs. 2 and 3, gives both high input resistance and high amplification. Start with a 6K7, a 6F5, or almost any other metal tube which has a grid cap on top. Cut a piece of 1/4-inch copper tubing about 7/8 inch long. Solder it directly to the grid cap (Fig. 3). Now take a piece of No. 10 copper wire approximately 1 1/2 inches long, file one end to a point (place it in your drill chuck and hold a file against it), then wrap the other end with a 1-inch strip of waxed paper, allowing the paper to overhang the end of the wire slightly to insulate it completely from the copper tubing on the grid. When enough paper has been added for a tight fit, force the wrapped end of the wire into the copper tubing, and you have the input capacitor. The grid resistor is even more simple. Using a knife, scrape the paint from the edge of the metal tube cover where it is crimped over the piece of bakelite holding the grid connection. Now take a pencil and mark all over the bakelite, covering the entire surface between the grid and the shield. Rub the pencil lead in well with your finger, repeat the process once or twice, and you have formed the grid leak. (Note: This might work better in the authors' state of New Mexico than in higher-humidity areas.—Editor)

For convenience in changing tubes the probe tube is simply plugged into an eight-pronged female cable connector (or an S-type tube socket with a shield over the soldering lugs) to which the lead-in cable is connected.

The lead-in cable should contain a shielded plate lead, a ground wire (or the shield can be used for this since it must also be grounded), and one filament lead.

The values shown in the meter bridge circuit should be closely followed. A 1-ma meter is preferred for sensitivity. Before use, the meter is adjusted to zero (while the probe tip is grounded) with the 2,500-ohm potentiometer. Thereafter, any input signal picked up by the probe will be indicated by the meter. If the signal contains audio components, they can be heard from the speaker.

The audio stage consists of a volume control, a 6V6 (or any other good output tube), and a 3-inch PM speaker.

The box was built of hard-pressed Masonite and is held together by small finish nails driven into predrilled 1/16-inch holes. If desired, the joints may be further strengthened by applying model airplane cement to the edges before nailing.

In Fig. 1 the lower control is the meter-zero, and the upper control operates both the off-on switch and the volume. An off-on indicator light may be mounted on the front panel.

For broadcast reception a replacement-type antenna coil is used.

In receiver trouble shooting, the ground clip on the probe is fastened to the receiver chassis. An input signal (such as a local station or an oscillator

signal) can then be traced right from the antenna coil through each stage to wherever it stops.

Once you have started using this signal tracer, you will find a number of applications for it in addition to the ones already mentioned, and you will soon agree that it is a most useful piece of trouble-shooting equipment.

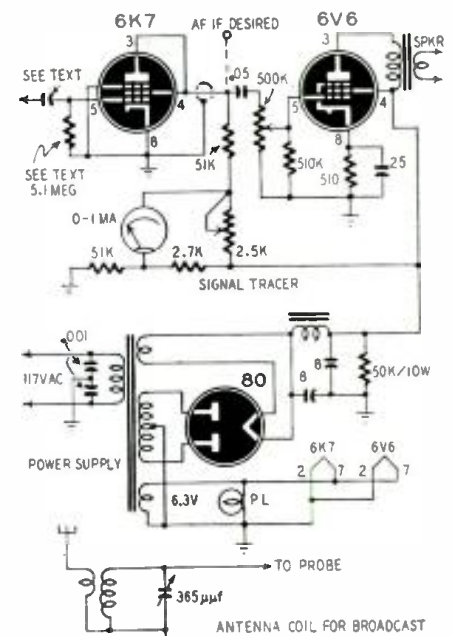

Fig. 2—Complete construction diagram.



Fig. 3—Tubing is soldered to grid cap and a wire tip is slipped into tubing.



Operator sets dividers to exact width of pulse as she clicks camera shutter.

Cameras Are Tested With Simple Setup

By FRED C. GABRIEL

A USEFUL experiment for the radio man who is also an amateur photographer is the accurate determination of a camera's shutter speeds. The method described consumes no film or other materials; hence it can be repeated as often as desired at no cost. Expensive, conventional shutter-testing apparatus

is far beyond the reach of most amateurs, and the number of professional photo laboratories supplying this service is small. An extension of the method makes it possible to check the operation of photoflash synchronizers, a boon to the indoor photo enthusiast.

The electronic equipment required includes an oscilloscope (the inexpensive

Radio test instruments check camera shutters and flash synchronizer

variety works nicely), a calibrated audio oscillator, and a photoelectric cell.

The shutter speed of a camera is the elapsed time between the opening and closing of the shutter. This time may vary considerably from the value marked on the camera and many pictures may be missed before the cause shows itself. Our method is to record the opening and closing of the shutter as marks on the oscilloscope screen. The space between the "open" and "close" markers can then be filled with sine waves of known frequency, and the time interval determined by counting them.

Here is the step-by-step procedure:

1. After allowing a warmup period for all instruments, set the audio generator to a frequency high enough to permit about five cycles to be included in the shutter interval to be measured. For example, a shutter speed of 1/100 second would include five cycles of 500-cycle audio.

2. Connect the audio generator to the scope's vertical input, and also to the external sync terminal. Be sure that the sync selector on the scope is at the EXTERNAL position, and then adjust the sweep frequency to display about 10 sine waves. Use the SYNC AMPLITUDE control to lock the pattern. Remove the signal from the scope vertical input, but leave the sync lead connected throughout the test. This will insure against sweep oscillator frequency drift. If the sweep oscillator is not synchronized to the a.f. oscillator, all subsequent measurements will be useless.

3. Hook a photoelectric cell to the vertical input terminals of the oscilloscope. Arrange a light source to shine on the photo cell (we use a 25-watt bulb in a table lamp; place the camera between light and cell. Adjust the camera to its widest aperture and click the shutter a few times. A bit of experimenting with the camera position should result in ample vertical deflection of the scope trace. The vertical gain control on the scope will probably have to be near its maximum setting. Our setup gave usable deflection from a type 921 photocell (chosen because one was at hand) with a single vertical amplifier stage in the oscilloscope. A brighter light source will increase the amplitude of the trace. Incidentally, we experienced virtually no hum from the a.c.-operated light source.

The instantaneous pattern obtained is a more or less square wave, depending on the shutter speed being meas-

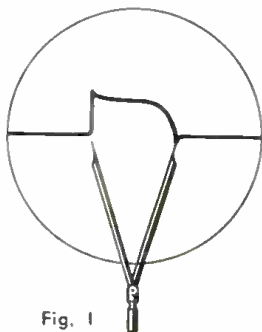

Fig. 1

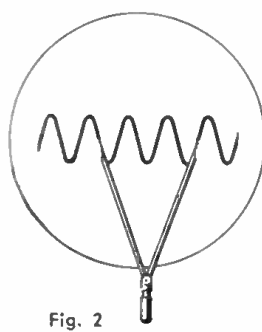

Fig. 2

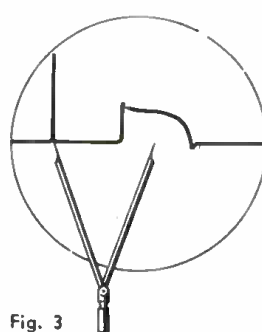

Fig. 3

ured and on the low-frequency response of the scope amplifier. In any case, the opening and closing points are clearly defined. Since the pattern is of short duration, it is necessary to click the shutter several times to be sure that all of the shutter interval is included on the scope face. Set a pair of draftsman's dividers to the width of the trace between the opening and closing markers (Fig. 1). The shutter may be operated as often as necessary to set the dividers accurately.

4. Switch the scope vertical input back to the a.f. oscillator. The stationary pattern of step 2 should be obtained immediately. Apply the dividers to the screen, and count the number of sine waves between the points, as in Fig. 2. The number of sine waves divided by the oscillator frequency gives the shutter speed in some fractional part of a second.

Checking the synchronizer

The photoflash synchronizer should close the battery circuit to the flash bulb at a predetermined interval before the shutter opening. If the synchronizer has been properly set, the open period of the shutter will coincide

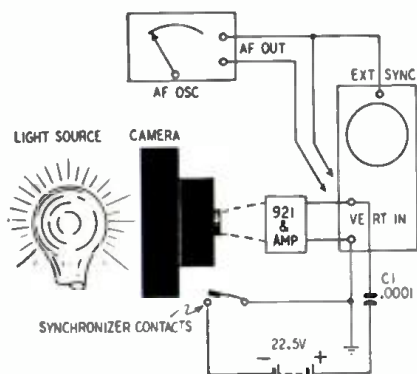

Fig. 4—A setup for synchronizer tests.

with the peak of light output from the bulb. The desired interval between closing the circuit and opening the shutter may be read from the "light output vs. time" graphs distributed by bulb manufacturers.

In our test we will display a marker from the flash synchronizer side by side with the shutter pulse described above. The audio oscillator can then be used to measure the time interval between the flash marker and the mid-point of the shutter pulse (Fig. 3). The flash marker must be readily distinguishable from the shutter markers, and it must not interfere with them. The synchronizer circuit remains closed after it has acted, but the vertical amplifiers must be allowed to recover in time to transmit the shutter pulse which follows. The synchronizer pulse is differentiated sharply by capacitor C1 (Fig. 4) and the input resistance of the 'scope. A 22½-volt battery in series with the synchronizer provides a large pip easily distinguished from the shutter markers.



Machinist's dividers are used to compare shutter opening with audio sine waves.

The required audio frequency can be determined by experiment. The time interval to measure is that between the synchronizer pip and the mid-point of the shutter pulse. The synchronizer should be adjusted until this interval corresponds to the ignition time of the flashbulb. The ignition time may be found in flashbulb data tables, or be obtained direct from the manufacturer.

Since one side of many synchronizer

circuits is grounded to the synchronizer body, this side must be connected to the ground terminal on the 'scope input to avoid 60-cycle body pickup whenever the camera and synchronizer are handled. Note that the settings of the oscillator frequency and oscilloscope sweep, sync, and horizontal gain must not be disturbed during a test. Short unshielded leads may be used for all connections.

PHOTOTUBE ANALYZER FOR LIVING CELLS

The makeup of a single living cell may be analyzed in much greater detail than ever before possible with the aid of a new electronic instrument developed after seven years of work by members of the Columbia University Zoology Department under the direction of Prof. Arthur W. Pollister. The device, known as a microspectrophotometer, uses a phototube to measure the light absorbed by the various components of the cell.

All living cells consist mainly of two ingredients, proteins and nucleic acids. There are two types of the latter, which are the principal components of the chromosomes that determine heredity.

Each type of nucleic acid absorbs light of a different wavelength, the amount of light absorbed indicating the quantity of acid present. The phototube, together with a sensitive current-measuring circuit, indicates how much light is absorbed. From this information scientists can evaluate with very good accuracy the composition of any cell they study.

The instrument has already revealed many significant facts about living cells. According to Prof. Pollister (see photo) the technique has opened an en-

tirely new field of quantitative chemistry. The device has been simplified so that anyone familiar with a microscope can use it. Research centers are being established at hospitals and laboratories in many places.

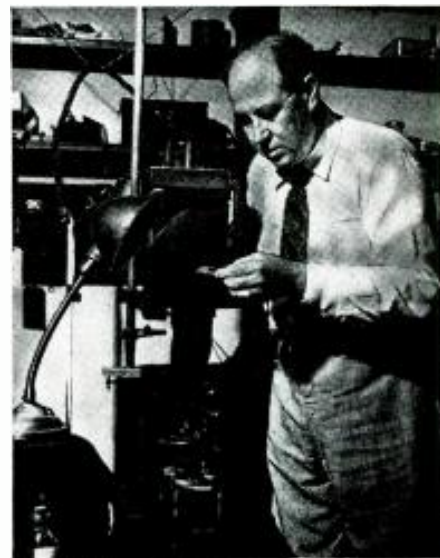

Pollister and microspectrophotometer.

Push-Pull Crystal Receiver

By RUFUS P. TURNER

BOTH the sensitivity and selectivity of a crystal radio may be improved greatly by using a two-crystal push-pull detector circuit and by tuning the antenna coil as well as both halves of the secondary. The circuit is shown in the diagram. This arrangement has pronounced advantages over a simple detector and one-coil tuning. Louder signals, longer-distance reception, and sharper tuning are obtained with the new hookup, which is only slightly more complicated than the usual simple crystal sets.

Two 1N34 germanium crystal diodes are used. The primary coil L1 is wound between the two halves L2 and L3 of the secondary coil. The main tuning capacitor is a dual 365- μf unit. The primary coil is tuned separately by means of a single-section, 365- μf variable capacitor. For all frequencies lower than 850 kc, a fixed .001- μf capacitor is connected in parallel with the primary trimmer by closing the switch.

The coil is wound in three sections with No. 32 enameled wire on a 1-inch-diameter polystyrene or bakelite tube 4 inches long, the turns of each coil being close-wound. L2 and 3 have 137 turns and L1 has 43. The inner ends of L2

and L3 are connected together and to the rotors of the main tuning capacitor. Space coils $\frac{1}{8}$ inch apart.

The components are mounted on a wooden board 8 $\frac{1}{2}$ inches long, 5 $\frac{1}{2}$ inches wide, and $\frac{3}{4}$ inch thick. All parts except the crystals are screwed to the board. The crystals are connected with their own pigtail leads directly between the stator lugs of the tuning capacitor and one of the headphone tip jacks. The crystal polarity indicated in the schematic must be observed carefully.

Operation of the receiver is very simple. Connect an antenna and a good ground to the antenna and ground terminals. The best antenna is a long wire, high in the air and out of doors. Use the nearest cold-water pipe for a ground. Tune in your station by adjusting the main tuning capacitor, then adjust the primary trimmer for maximum volume. If the frequency of your desired station is 850 kc or higher, leave the switch open. If it is lower than 850 kc, close the switch. The entire broadcast band can thus be covered.

This receiver has amazing headphone output, even when receiving low-powered broadcasters. When a long, outside antenna and a good ground are used,

high-powered local broadcast stations will operate a high-impedance magnetic loudspeaker (but not a permanent-magnet dynamic). The double tuning scheme allows separation of strong local stations. In tests using the same antenna,

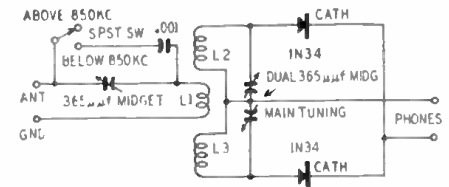

The full-wave detector uses two 1N34's.

this receiver has brought in distant stations not even heard with the best ordinary crystal set. The d.c. output of the set (taken across the headphone tip jacks with headphones disconnected) is 2.5 ma when picking up a 250-watt broadcast station 5 miles away!

The builder may consider using a 1N35 duo-diode unit in place of the two 1N34's. The 1N35 consists of a pair of mounted germanium diodes which have been matched for use in full-wave detectors and in FM detectors and discriminators.

▶ MINIATURE TUBE RECEIVER (Continued from page 40)

cuit is quite standard. The chassis is a simple U-shaped piece of 16-gauge sheet iron and is quite rugged. One-hole mounting sockets with retainer ring were used for convenience.

Two strands of No. 20 bare, tinned, hookup wire were twisted together and anchored at each end to widely separated points on the chassis near the tubes. All ground connections were soldered to this lead. This simplifies construction, but does place the a.c. line voltage on the chassis. There should be no danger, however, if the chassis is placed in an insulating cabinet and a fiber panel used to cover the back. Be sure to drill holes in the panel for ventilation.

After the set reaches full operating temperature it is exceptionally stable, due to the high capacitance-inductance ratio in the oscillator section. There is a slight drift during warm-up unless a temperature compensating capacitor is used, but this refinement is hardly worth the additional cost.

There was some difficulty in peaking the i.f. coils because of regeneration in the i.f. system, but it disappeared entirely when the 12AT6 tube was shielded.

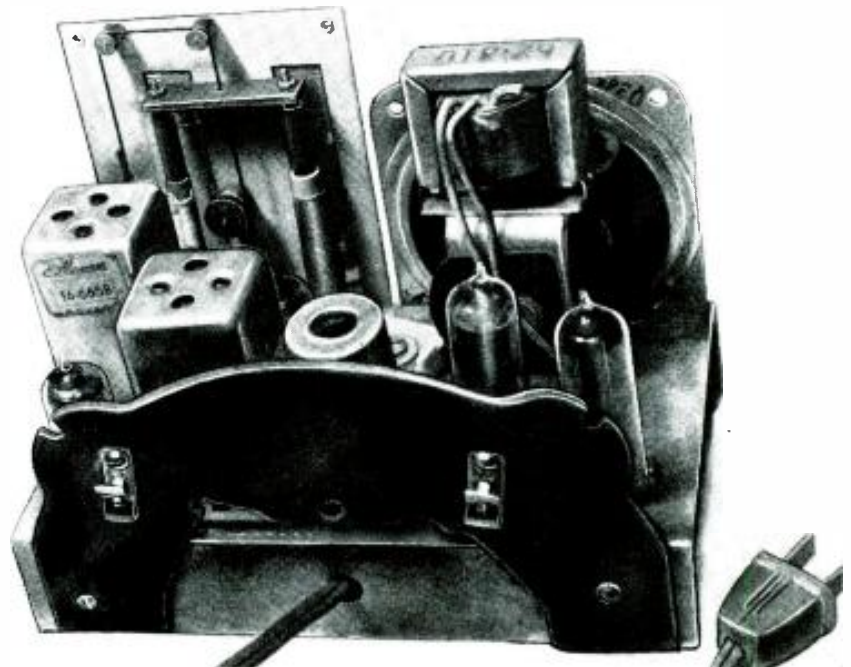

Rear view of the permeability-tuned receiver. Tuner is in upper left corner.

Design of Class-B Drivers

The design of a transformer-coupled class-B driver is simplified by this author's approach

By W. H. ANDERSON, VE3AAZ

OPERATORS of amateur phone stations are often confronted with the problem of selecting a suitable driver and driver transformer for class-B audio amplifiers or modulators. The most common solution is to select, from a catalog or manufacturer's literature, a trans-

former designed for use with the particular combination of driver and modulator tubes being used. This method is not practical when:

1. The tubes are operated under conditions other than those specified by the transformer manufacturer;
2. The driver-modulator tube combi-

nation is not listed;

3. Driver-to-line and line-to-grid transformers are to be used.

Consider a typical case where push-pull 6B4-G's are used as drivers for a class-B 75TH amplifier or modulator. Tube data shows that the 6B4-G's will deliver 15 watts of power when the effective load impedance (plate-to-plate) is 3,000 ohms, the plate voltage is 300, and 68 volts of grid bias is supplied from a fixed source. The 75TH's require 3 watts of grid drive when operated with 90 volts of grid bias and 2,000 volts on the plates. The peak grid-to-grid driving voltage is 350. Since there is a difference in the power in the primary and secondary of the driver transformer, transformer ratios cannot be calculated by comparing the primary and secondary voltages.

The grid circuit of a class-B stage presents a constantly varying load to the plate circuit of the driver stage. During one excitation cycle, the impedance of the grid circuit varies from a very low value to almost infinity and causes distortion which is intolerable in some instances. Distortion from this source is minimized by reducing the source impedance as much as possible. The driver transformer determines the impedance ratio between the driver plates and class-B grids; therefore, the greater its step-down ratio, the smaller will be the source impedance as seen by the grids.

We have found at VE3AAZ that distortion is minimized when the driver is designed to deliver just enough power to drive the class-B stage when its (the driver's) grids are fully excited—driven to zero volts by the speech amplifier. This condition is met by raising the driver plate-to-plate load impedance far above its normal value. This provides for a higher than normal step-down ratio between the driver plates and class-B grids. Increasing the driver load impedance decreases the voltage developed across the secondary load. It is important to remember that, while the voltage ratio varies directly as the turns ratio, the impedance ratio varies as the square of the turns ratio. Thus when a transformer is selected to deliver just enough voltage to drive the

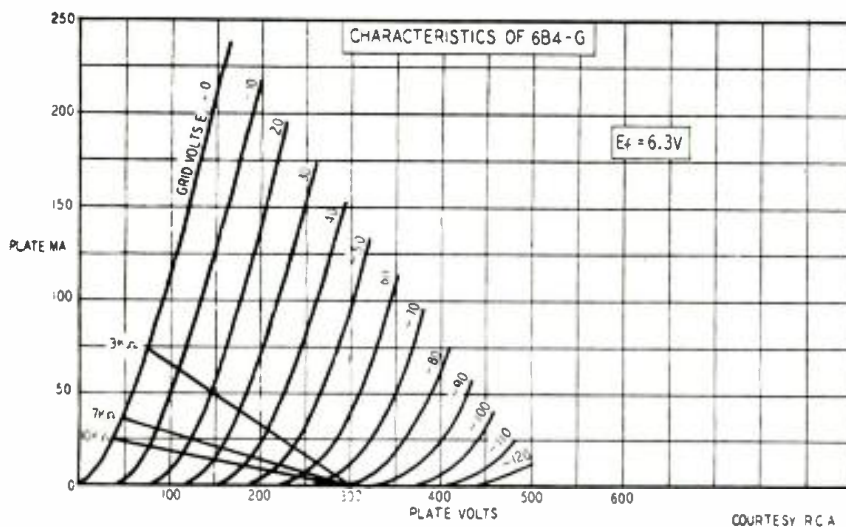

Fig. 1—Curves for this and other receiving tubes are in your tube manual.

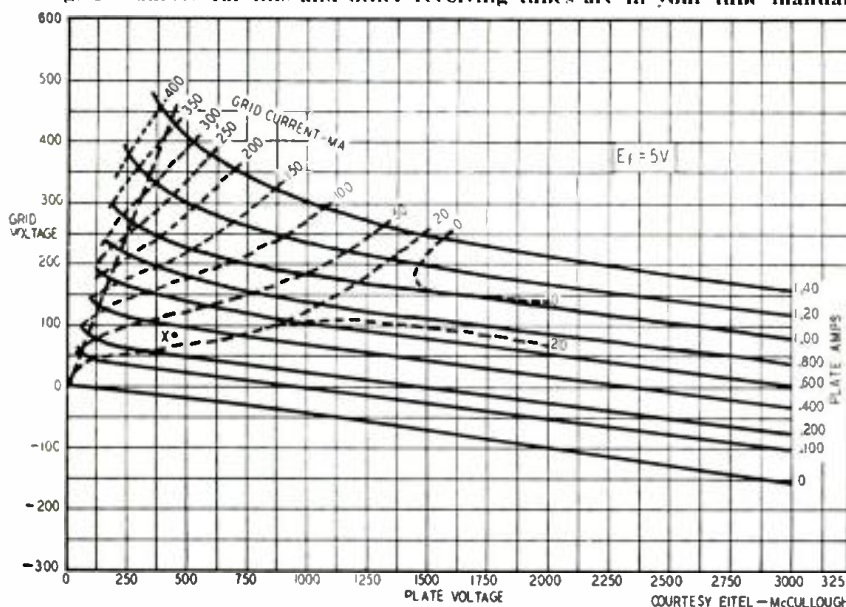

Fig. 2—Constant-current characteristics of the Eimac 75TH transmitting triode.

class-B grids, the source impedance (driver plate resistance) will be lowest—a requirement for good regulation.

The 75TH's require 3 watts of grid drive. Since in this case—as in most others—the grid driving power is stated as an r.m.s. value, peak driving power will be twice as great or 6 watts. This power is delivered to first one grid, then the other, and is provided by one-half the voltage developed across the entire secondary. Knowing the grid power and voltage, the grid impedance can be calculated by Ohm's law. Since the peak grid-to-grid voltage is 350, each half of the secondary winding will develop 175 volts and the grid impedance (E^2/W) is $175^2/6$ or 5,104 ohms.

The next step is to draw trial load lines on the characteristic curves of a 6B4-G as shown in Fig. 1. One end of each load line is the point where the plate-voltage line intersects the zero-current line and the other end is on the E_c (grid voltage) = 0 curve. The resistance of a load line is determined by subtracting the minimum plate voltage from the maximum plate voltage and dividing the result by the maximum current. Refer to the 3,000-ohm load line on Fig. 1. Note that maximum plate voltage is 300 and minimum 75. As the voltage swings from 300 to 75, the plate current changes from zero to 75 ma so the resistance of the load line is $300-75/.075 = 3,000$ ohms.

Peak power output from a given load resistance is determined from the familiar I^2R relationship, where I is the plate current at the point at which the load line intercepts the $E_c = 0$ grid bias curve. The 75TH grids require 6 watts peak power for full output. However, since the power loss in the driver transformer may run to 20%, the driver must be designed for approximately 7.5 watts peak output. Since the 7,000-ohm load line intercepts the $E_c = 0$ curve at 32 ma, the power output is $(.032)^2 \times 7,000$ or 7.18 watts.

The load resistance for a single tube being 7,000 ohms, the plate-to-plate load will be four times 7,000 or 28,000 ohms for a push-pull stage. The grid impedance is 5,104 ohms, so the transformer turns ratio (primary to one-half secondary) is

$$\frac{\sqrt{28,000}}{5,104} = 2.3 \text{ to } 1.$$

If the speech amplifier-driver combination is located at a point remote from the class-B stage, a plate-to-line and line-to-grid transformer combination will be required. Disregarding the power loss in the second transformer, the over-all turns ratio should remain the same. Assuming a 500-ohm transmission line, the plate-to-line transformer will have a turns ratio of 7 to 1 and the line-to-grid transformer will have a ratio of 2.3 to 7 between the primary and one half of the secondary.

Calculating driver requirements

Manufacturers do not always list grid-drive requirements, and this must be calculated from available data. Con-

sider the class-B operating data for the 75TH:

- D.c. plate voltage 2,000
- Max. signal d.c. plate current 225 ma
- D.c. grid voltage (negative) 90
- A.f. grid voltage 350

Each tube is carrying 112.5 ma or one-half the total plate current; however since the stage is operating class B, the peak instantaneous plate current will be three times as high or approximately 336 ma. The peak instantaneous grid voltage will be one-half the a.f. grid voltage minus the d.c. bias or $350/2-90 = 85$ volts.

The crest operating point X (Fig. 2) is the intercept of the peak grid voltage and the peak plate current values. This point shows the peak grid current to be 35 ma. Knowing that this grid current is produced by the voltage across half the driver transformer secondary, we can compute driving power as the product of 175 volts and .035 ampere (35 ma) or 6.1 watts. Similarly, we compute the grid impedance as $175/.035 = 5,000$ ohms. Note that these values agree with those used in previous calculations, but the grid-drive power does not take into account the power loss in the driver transformer.

Cathode-followers as drivers

Occasionally, a push-pull cathode-follower stage (Fig. 3) is used as a driver for a class-B amplifier. This arrangement does a good job because of the high degree of degenerative feedback due to coupling between the input and output circuits. The major disadvantage of this circuit is that the input signal must equal the sum of the bias and desired output voltages.

Load impedance calculations generally consist of finding a combination of plate voltage and a reasonably low load impedance that will provide the required output. The stability or voltage regulation of a cathode-follower is such that the load impedance has little effect on the output voltage.

The excellent voltage regulation of a cathode-follower can be seen when its performance is compared to that of a

conventional plate-loaded amplifier operating with identical loads and plate and bias voltages. If the regulation of an amplifier is perfect, the output voltage will vary in direct proportion to the input voltage.

Take two amplifiers using triode-connected 6L6's, one connected as a conventional plate-loaded amplifier and the other as a cathode-follower. Consider what happens in each when the signal voltage is halved and the reflected plate load changes from 2,000 to

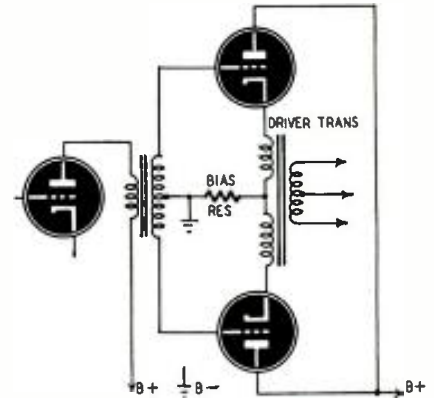

Fig. 3—A cathode-coupled driver stage.

5,000 ohms (8,000 to 20,000 ohms plate-to-plate), as it might when the class-B stage stops drawing grid current. The change in circuit performance is shown in Fig. 4 (characteristic curves for triode-connected 6L6's with 2,000- and 5,000-ohm load lines drawn in) and in the table below.

Cathode-loaded amplifier			
Drive (volts)	Reflected load (ohms)	Output (volts)	Point (Fig. 3)
20	2,000	130	A
10	5,000	115	B
Plate-loaded amplifier			
150 (20+130)	2,000	130	A
75	5,000	72	C

That the cathode-follower provides better voltage regulation is evident when we realize that the output voltage should have dropped to 65 (one-half its initial value) in both cases when the drive voltage was halved.

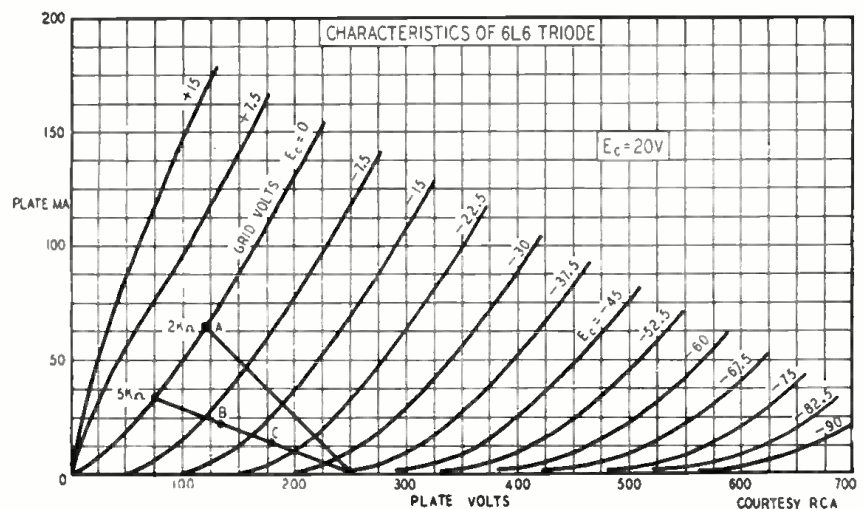
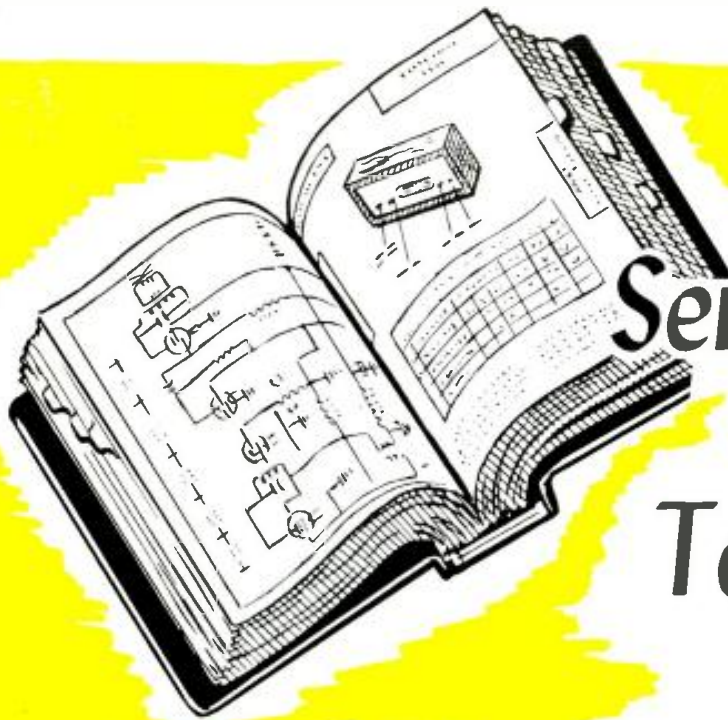

Fig. 4—Load lines compare performance of plate- and cathode-loaded amplifiers.



Service Data

Technicians

and Money

By JOHN T. FRYE

ALIE, some wag has said, is a last resort with men, but with women it is a form of first-aid.

This masculine reluctance to a mischievous expedient is commendable; but when a radio technician insists upon applying the same attitude toward the use of radio service data, he is being short-sighted, money-wasting, and just plain stupid. Nevertheless, the sad truth is that there are many who turn to their shelves of service data for help only after they have exhausted every other possibility in their attempt to repair a receiver.

This is really puzzling. Any modern shop is certain to have a complete set of service information on hand. It can be quickly demonstrated to even the most stubbornly doubtful that radios can be serviced much more quickly, pleasantly, and efficiently through the use of such data. Every radio shop owner knows that minutes shaved off the time needed to repair a set is just like money in the bank. In spite of all this, there are far too many shops in which the books do not have that well-thumbed look that radio service manuals should have.

Possibly there are a few rare cases where the technician is one of those boys who bull-headedly waste hours searching a catalog for an item before looking it up in the index, merely because he likes doing things the hard way; but these, surely, are in the minority. It seems likely that the rest do not get the maximum benefit from their

libraries simply because they have not formed the habit of using them properly.

Many, when they started servicing, felt that they could not afford to buy service manuals; the servicing procedure established necessarily excluded their use. Later, when they were able to obtain service data and did so, their servicing routine had become so firmly set that they could not—or at least did not—change it to take full advantage of the great help offered by their books.

The publishers of modern radio service data spend thousands of dollars trying to make their products of the utmost assistance in servicing *every* set that comes into the shop. The material is intended to be used all of the time, and is crammed with information calculated to be useful to the novice and the old-timer alike, but the only way in which any service technician can extract the full amount of benefit from it is to build his service procedure around its continuous use.

When to use data

The time to slide a manual from the shelf is the minute you decide which set you are going to tackle next. First, take a quick glance at the description of the receiver and at the diagram or picture in the book that shows the tube layout. You may be able to locate a similar diagram in the set, but at any rate it is much more comfortable to study the picture laid out on the bench instead of standing on your head trying

to read an upside-down sketch pasted in the darkest, most cobwebbed corner of the cabinet.

This preliminary survey can tell you a lot. It will reveal whether you are working with an a.c.-d.c. set, a transformer job, or one of those electronic mules that employ a high-voltage series-filament winding on an autotransformer. It will show whether you should expect superheterodyne selectivity or are dealing with a t.r.f. receiver—something that cannot be told with a casual glance in this day of four-tube “supers,” subchassis-mounted i.f. transformers, and padded oscillator tracking circuits. It will also reveal whether the tubes are where they should be; and if you tell an old-timer you have never wasted time working on a set in which the customer had switched a couple of tubes, you will make him question either your veracity or the amount of time you have been in the service game!

If your preliminary examination shows that surgery is indicated and that the chassis must be removed from the cabinet, take another look at your data. See if instructions for chassis removal are given. Some manuals give detailed information on this subject wherever it is needed—and believe me, it is needed often in opening up some of these ultra-modern creations with hidden chassis bolts, concealed hinges, and trick cabinet designs. Without such “open sesame” instructions, you can waste half an hour fumbling around the outside of one of these sleek-looking,

seamless armchair models like a monkey trying to get into a plastic coconut.

When the set has been extracted from the cabinet and is resting on the bench in front of you, your service data stands ready to lend a hand, no matter what method of trouble-shooting you prefer. If you use a signal-tracer, the diagram will tell you exactly where to touch your probe, and the stage gain of each section is plainly indicated. Any deviation from the normal can be detected at once, and the exact point at which this deviation begins can be pinned down.

On the other hand, if you prefer resistance measurement, the correct resistance from every tube socket connection to the common ground is given; and if voltage measurement is more to your liking, the proper operating voltage at nearly every point of the circuit is indicated.

The diagram is right there in front of you. Only a service technician who has wasted time checking and rechecking a puzzling low-resistance condition by unsoldering the leads of every capacitor that might be involved—only to find the trouble caused by a shorted bypass hidden away *inside* an i.f. shield—can appreciate the value of working with a diagram. The intelligent use of printed data removes the wasteful lost motion from radio servicing.

The service data publishers are keenly aware that time is money in servicing, and they have worked out many time-saving features. Take, for example, an all-wave set in which only one band is out of order. Obviously the fault lies in one of the components used exclusively on this band. But if you have ever watched a poor technician mumbling to himself and making circles in the air with his finger like a man trying to describe a circular staircase, while he attempts to thread his way through the maze of a multibank band-change switch, you can realize how he should appreciate a data sheet showing an entirely separate circuit diagram for every position of the switch.

The value of photos

Another set of sheets gives photographs of every set taken from different points of view and with the various parts identified by numbered or lettered "call-outs" right on the picture. Fig. 1 shows a bottom-chassis view of this nature. To show how it helps, notice Fig. 2, which is a picture of the same receiver shown in Fig. 1. If you will look closely you will notice—as did the technician—that the resistors numbered R12 and R14 in Fig. 1 are badly charred in Fig. 2. Inasmuch as the positive filter capacitor leads attach to the opposite ends of R12, and R14 connects between one side of the line and the plate of the rectifier tube, it is not hard to diagnose the trouble here: the output section of the filter

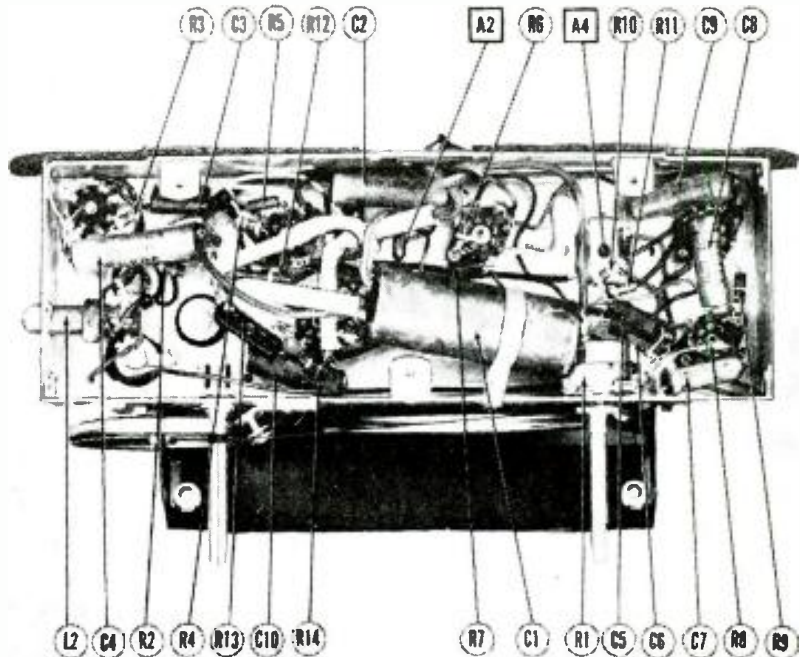
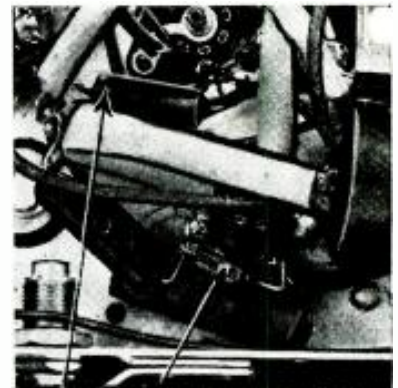

Fig. 1—Under-chassis view of receiver. Call-outs show location of all parts.

Courtesy of Howard W. Sams & Co.

capacitor has shorted, causing both the filter resistor R12 and the ballast resistor R14 to char. Cutting loose the output filter capacitor lead and checking it with an ohmmeter quickly proved this deduction correct.

A glance at the parts list was all that was needed to find the correct replacement values for C1, R12, and R14. It was not necessary to locate the parts by tracing out the circuit diagram. Only seconds were needed to determine exactly what parts were required. Had the circuit diagram been needed, it was available; but it is surprising how many times, when there are visual symptoms of trouble, you can work directly from the pictures. The beginning radio technician who has some difficulty in "seeing" a receiver in diagram form is especially grateful for this feature.



CHARRED RESISTORS

Fig 2—Charred parts are easy to spot.

Courtesy of Howard W. Sams & Co.

Data helps beginners

Speaking of beginners, it is an unhappy fact that many fellows try to start into servicing without purchasing service data. If anyone needs such help, these beginners do. The veteran technician has a wealth of practical experience to fall back on when he runs into unusual problems, but the novice feels utterly at sea. The small successes he has had in locating open filaments and shorted bypasses in AC-DC receivers stand him in poor stead when he runs into a really tough set. He simply does not know where to begin. What he needs more than anything else is the wealth of data on normal operation that a manual presents. A methodical comparison between the resistances, voltages, and stage gain of the defective receiver and the normal values of these items as presented in the service data is almost certain to uncover the trouble.

What is more, the constant use of service data is the best possible way for the newcomer to become familiar with radio circuits and manufacturing practices. As he continues to study the diagrams of the sets upon which he is working day after day, he absorbs, without any conscious effort, a knowledge of what constitutes standard circuits and normal values for components used in those circuits. Almost before he realizes it, he finds himself knowing what to expect when he makes a measurement, and is alert to any abnormality that may be encountered. The constant use of service data is about as quick a way to learn practical radio as there is.

It is paradoxical that the beginner's need for this material is indicated by the fact that successful veteran technicians invariably have them. These fellows *could* repair any receiver, using only their knowledge of radio theory

Home Study Courses Useful to Radiomen

Correspondence schools can be
beacons on the path to success

By **SAMUEL FREEDMAN**



Mr. Samuel Freedman

I AM a firm believer in home-study or "correspondence-school" training. Of the many schools and colleges at which I have trained since 1920, I don't believe any did me as much good as the home-study radio course I took in 1929-31. That was my turning point from a dull routine in an unpromising job to an opportunity eight years later in being chosen to head the Maine radio program, and head the prewar NYA radio program and become a leader in mobile radio development. That in turn led to my commissioning as a naval officer and finally to my present position in the microwave field working for DeMornay Budd.

As I discovered later, after a thorough investigation of home-study schools, my history is by no means unique. But some people still look askance at "correspondence courses," and large numbers of men are unaware of the good a course of home training can do them.

The radio, communications, and electronic fields require a tremendous amount of additional manpower with suitable qualifications. Additional qualifications are also needed by the tens of thousands of men already in these fields, who still are wholly or partially unfamiliar with microwaves, television, radio aids to aviation and navigation, nucleonics, FM, mobile radio, and other postwar developments. For national defense, the nation also requires as a reserve pool of technical manpower, over 1,000,000 persons who will qualify themselves in these fields either as a hobby or as a secondary vocational occupation.

Most people who need training cannot afford to take the time or incur the expense and loss of income required for formal schooling. (A limited exception is veterans' training under the GI Bill of Rights.) The requirements of both individuals and industry definitely in-

dicade that home-study training courses are most necessary.

Home-study schools are tried and proven. More than 1,500,000 students, mostly adults, were enrolled in them in 1948. More than \$50,000,000 was spent on tuition for courses in every sphere of employment. There is hardly a field of specialization today which would not collapse if it lost its leading figures who received some or all of their training by way of home-study methods.

The home-study field which has the greatest record of success during the past 20 years is that of radio-electronics. It has been improved tremendously, and the student gets the benefit of visual aids and extensive laboratory practice in addition to complete printed reference material for study and for his future use. The quantity and quality of instruction may even exceed that of

more formal schools carrying on classroom instruction in the old, time-honored manner.

The history of home study begins in 1891 when Thomas J. Foster, an editor in a coal-mining city, received a letter from a reader requesting information on how one of the dangers incident to coal mining might be minimized. He answered the inquiry in his newspaper. Other readers sent in similar letters, which were also answered. So the editor began to compile simply worded articles on the safety hazards of coal-mining and on self-protection against them. From this beginning was conceived a plan to furnish practical and reliable technical education by mail. Thus was born the International Correspondence Schools whose headquarters remain in the coal-mining city of Scranton, Pennsylvania. (Continued on page 48)



U.S. Army photo

One of over 20 Army laboratory plants built for electronics and nucleonics

When correspondence schools were first introduced, the new idea had to face prejudice and ridicule. Educating *via* the mails was pronounced foolish, and the classroom was declared to be the only suitable place for such a function and experience the only way to learn a trade or business. The record has proven otherwise, and today many of the nation's leading universities operate *extension* (a more refined word for correspondence) services patterned after the commercial home-study schools. It has made training possible for anyone, regardless of location and economic status. It has encouraged individuals to enter fields in which they have become outstanding, when otherwise they might have deprived themselves and the world of their talents and leadership.

Many noted educators admit the weaknesses of classroom teaching,

namely for a master course covering several subfields of employment within the over-all field of radio and electronics. For this sum, the enrollee receives the following.

1. A series of lessons ranging from about 30 to over 100, depending on the size of the lessons adopted by a particular school and the type of course selected.

2. Various additional printed features such as reference textbooks, radio dictionary, books on starting one's own radio business, texts on prerequisite material such as mathematics, questions and answers for passing FCC examinations, and so on.

3. Kits of parts with which to make experiments. With the parts much useful equipment can be constructed—test instruments, receivers, transmitters, AM or FM modulators, and various other electronic devices. It belongs to

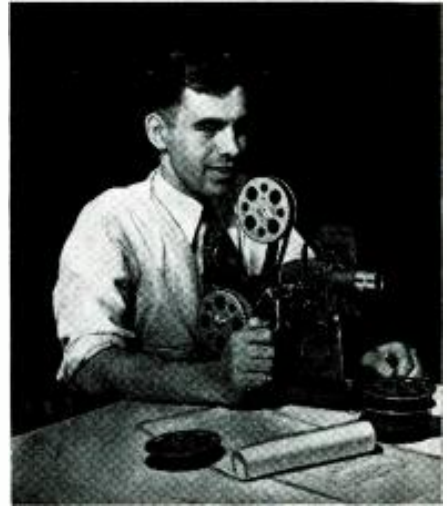

Movies showing electron action are a study aid. The projector is furnished.

NEW RADIO-ELECTRONIC OPPORTUNITIES

This list of fields developed since the end of the war shows only a few of the many opportunities for employment and advancement open to ambitious, well-trained men.

1. V.h.f. FM broadcasting.
2. Large-scale FM receiver manufacture.
3. Two-way, mobile radio for taxicabs, railroads, trucks, automobiles, etc.
4. The new citizens band.
5. Aircraft omniranges, which replace the older four-leg range stations.
6. V.h.f. aircraft communication.
7. Ground-controlled approach (GCA) systems for aircraft.
8. The expanded military radar program.
9. The tremendously expanded research carried on by the Armed Forces, government bureaus, and industry.
10. The radar fence around the U.S., which will cost about a billion dollars and require a staff of at least 25,000.
11. Placement of radar on all merchant vessels.
12. Airborne radar.
13. The tremendous expansion of the useful radio spectrum into microwaves.
14. Television broadcasting.
15. Television receiver manufacture, design, and service.
16. Food sterilization through electronics.
17. New methods of communication involving pulse transmission.
18. Supersonics.
19. R.f. heating.
20. Radioactivity detectors.
21. Upper atmosphere research and weather forecasting.
22. Radio-control and guided-missile development.
23. Radio spectroscopy.
24. Magnetic sound recording.
25. Electronics in medicine.

Oftentimes, lectures prepared by the few real authorities in a field are available only in a few scattered classrooms. Every home-study student, on the other hand, may receive instruction prepared by a master. In a classroom, if attention fails and part of a lecture is missed it remains lost. Those who learn by

the student permanently, and the retail value of the parts is appreciable with respect to course cost.

4. Consultation service, which continues for the life of the enrollee. I have personally verified and utilized this service over a number of years on a course which was started in 1929 and completed in 1931.

5. Free lifetime employment service. This has great value. The total cost of tuition is normally no more than a legitimate employment agency charges for a single placement. The service is available indefinitely, and during the lifetime of a student may repay many times the price of the course. Schools have full-time placement experts whose sole job is to discover or develop job opportunities. Many employers recognize these schools as sources of desirable employees. In view of the great technical developments now under way, only some of which are enumerated in the box on this page, no intelligent person, regardless of experience or education can help but benefit from a home-study course of some kind. The course may be for refresher purposes or it may acquaint one with new developments.

Basically, radio and electronics have never been nor are likely to be more than inductance, capacitance, resistance, and electron-tube circuits. It is

only the size, number, and manner of connection of inductors, capacitors, resistors, and tubes which result in the thousands of items falling into the category of radio and electronics. These can be definitely mastered by home-study printed material implemented by training kits of basic radio components such as are offered by reputable schools advertising in leading radio-electronics journals.

Home-study schools offer the greatest opportunity for the maximum number to get a foothold in the radio-television-electronics field. The future depends on how many of the rank and file will emerge as creators and leaders to give industry and science new impetus. Such men can emerge *via* the home-study route just as surely as they can from the classrooms of the nation's schools of higher learning.

CUT-PRICE CONTRACTORS

The Television Installation and Service Association of Chicago has warned television dealers against hooking up with cut-price service contractors who may jeopardize the dealer's future by giving unsatisfactory service (or, as past experience has proved, no service at all).

Dealers are reminded that their liability does not cease when the contract has been turned over to a service company, and that the customer will continue to associate the dealer with the service he receives on his televiser.

The wise dealer, says the Association, will check the repute, financial standing, distributor acceptance, and length of time a service company has been in business before associating himself with it. Above all, he will deal with actual service companies, not with sales-and-service outfits which may have an interest in pushing a competing brand of television receiver.

"A slight saving in the cost of a policy at the expense of losing a customer and the future business of his friends and relatives is no saving at all," the release concludes.



Courtesy DeMornay-Budd

Orders for this new microwave calorimeter now total more than \$250 million. home study can refer to their printed material as much and as often as necessary. It is always available for refresher or reference purposes since it remains the permanent property of the student.

The average home-study school may charge a tuition between \$100 and about \$400. The latter figure is nor-

ALLIED'S 1950

FREE

RADIO & TV CATALOG

196 VALUE-PACKED PAGES

Send for it now!

ALL THE LATEST RELEASES

BIG MONEY-SAVING VALUES



Get Radio's Leading Buying Guide

Here's the Buying Guide to everything in radio for everyone in radio! Preferred by expert service technicians, engineers, sound men, Amateurs, builders and experimenters—it's packed cover to cover with the world's largest selections of quality equipment at lowest money-saving prices. See the latest in TV and home radio receivers; radio-phonos with new three-speed changers; new Sound Systems, P.A. equipment and high-fidelity sound components; recorders and accessories; full selections of newest Amateur receivers and station gear; test instruments; builders' kits; huge listings of parts, tubes, tools, books, diagrams.

ALLIED gives you every buying advantage; speedy delivery, expert personal help. lowest prices, assured satisfaction—plus the most liberal Time Payment plan in radio. Get the new 1950 ALLIED Catalog. Keep it handy—it will save you time and money. Send today for your FREE copy!

LARGEST STOCKS • QUICK, EXPERT SERVICE

Send for your **FREE** copy of
Radio's Most Complete Catalog
Use the coupon below—**NOW!**

**THE WORLD'S
LARGEST
RADIO
SUPPLY
HOUSE . . .**



WORLD'S LARGEST STOCKS

Everything in radio for everyone in radio! ALLIED's huge stocks are the world's largest, including complete lines of all leading makes of parts and equipment. Get everything you need from one dependable centralized source—ALLIED RADIO!

TELEVISION & HOME RADIOS

See ALLIED's outstanding selection of new Television sets, new table model radios, FM-AM combinations with new Three-Speed Automatic Changers. Save on these radio models—the choice of experts!

AMATEUR STATION GEAR

You'll find everything you need for your shack in the new ALLIED Catalog. See all the latest releases in receivers, transmitters, parts, station equipment—the biggest and most complete listings in Ham radiol

NEW SOUND EQUIPMENT

Packaged, ready-to-use Sound Systems; amplifiers guaranteed for one full year; high-fidelity sound components; everything in speakers, mikes, P.A. accessories, intercom and recording equipment—ALLIED RADIO is headquarters for Soundmen!

Radio's Leading Buying Guide



ALLIED RADIO CORP.
833 W. Jackson Blvd., Dept. 2-L-9
Chicago 7, Illinois

Send FREE New 1950 ALLIED Catalog.

Name.....

Address.....

City.....Zone.....State.....

Radio Set and Service Review

Eicor Model 1000 Tape Recorder



EICOR'S model 1000 tape recorder (Eicor, Inc., Chicago), one of the lowest-priced sound recorders of any kind, performs at least as well and is as easy to handle as any home-type unit offered today in its price range. All of which indicates that the service technician may soon find the Eicor in the hands of many of his customers.

The appearance of the recorder is unusually neat. The black leatherette case is 14 1/4 inches wide, 8 3/4 inches high (with the lid down), and 11 1/4 inches from back to front. Three pockets are provided in the cover for the microphone and the cables. The whole unit weighs 27 pounds.

Operation is extremely simple. A reel of tape is placed on the left post; the tape is brought around the bottom of the head, over the top of the rubber-rimmed capstan, and threaded onto an empty reel on the right post. The center knob is the ON-OFF-VOLUME control. The left control sends the tape forward

or backward, or stops it. The knob at the right switches the circuit to ERASE-RECORD or LISTEN.

To rewind the tape, it is lifted off the capstan and passed across the head only. It is not always necessary to rewind, however, as the unit has a "twin-track" feature. Recordings are made on the top half of the tape. When a reel is fully recorded, the full reel can be removed from the right post, inverted, and placed on the left post; a new recording can be made on the unused half. The metal roller shown just below the capstan in the photo was apparently added in later production; it is not shown or discussed in the instruction book. If, in rewinding, the tape is passed from the right reel, directly across the bottom of the magnetic head, to the left reel, no sound will be heard. If, however, it is looped over this metal roller before reaching the head, the high-pitched "Donald Duck" sound of the recording will be heard on rewind, a valuable feature if the tape is to be rolled back only to the beginning of a certain selection. Rewind time for a full 15-minute reel is 2 minutes; a half-hour reel requires 4 minutes.

The audio quality of this recorder was judged on test to be acceptable. Jacks are provided for an external 3.2-

ohm speaker and for signal feeds from an external source such as an AM radio, FM tuner, program line, PA system, etc. The built-in speaker is 6 inches in diameter—a bit larger than usual in this type of equipment.

No tone controls are provided for the operator. A typical response curve supplied by the manufacturer shows that the output on playback, with a constant-level, varied-frequency tone

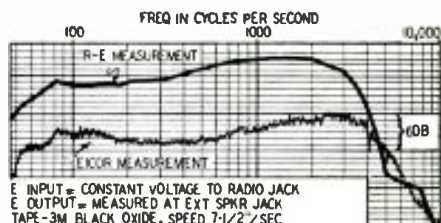

Frequency-response curves for recorder.

input while recording, stays within ± 3 db between about 50 and 5,000 cycles. Above the machine-run curve appears the result of a response check made in our own laboratory at a somewhat higher signal level. Wow and flutter in this recorder were extremely low.

The tape-pulling assembly consists

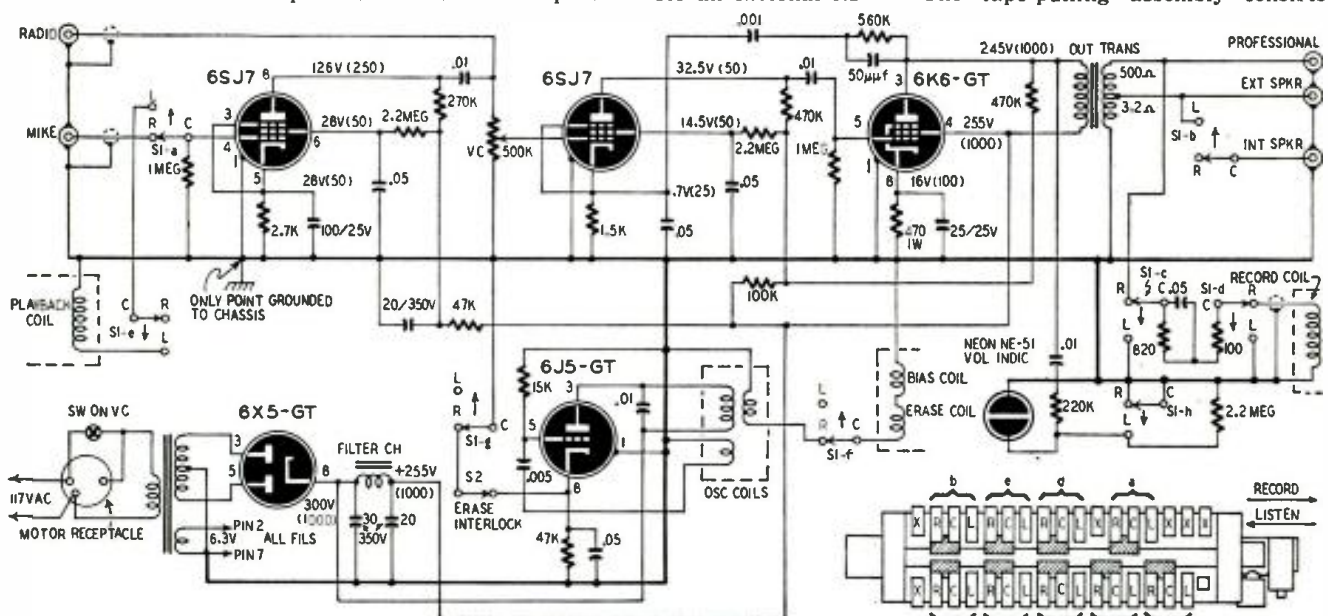

VOLTAGES MEASURED ON 20,000Ω PER VOLT METER SET TO RANGES INDICATED IN PARENTHESES THUS (1000)

SI: a-h SWITCH SECTIONS NU-NOT USED X-TIE POINTS
 R-RECORD C-COMMON L-LISTEN

Complete amplifier schematic. Apparently the single-point ground is largely responsible for the complete absence of hum.

Now, For the First Time—

GUARANTEED TEST INSTRUMENT KITS

* READ DETAILS OF UNPRECEDENTED GUARANTEE IN BOX AT BOTTOM OF THIS PAGE

THE NEW MODEL KT-40 VACUUM TUBE VOLTMETER

FEATURES

- Uses 4½%—2% accurate D'Arsonval type Meter with high torque movement and Alnico V slug.
- Meter guaranteed against burn-out on ALL electronic ranges. Meter will not be damaged even when improperly switched to higher range.
- Stabilized degenerative circuit results in linear D.C. scale.
- Isolating test-prod. for all D.C. Voltage ranges.
- Megohm input resistance on all D.C. ranges.
- Ohmmeter accurately measures from 1/10th ohm to 1 billion ohms.

SPECIFICATIONS

- D.C. VOLTS: (At 11 megohms input resistance) 0 to 3/30/-150/750/1,500 Volts.
- A.C. VOLTS: (At 1,000 ohms per Volt) 0 to 3/30/150/-750/1,500 Volts.
- RESISTANCE: 0 to 1,000/10,000/100,000 ohms. 0 to 10 megohms/1,000 megohms.
- D.B. Based on ODb equals .006 watts (6 milliwatts) into a 500 ohm line.

— 24 db to + 4 db	+ 10 db to + 38 db
— 4 db to + 24 db	+ 30 db to + 58 db

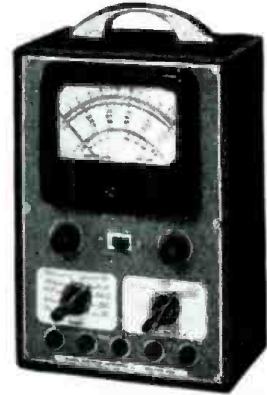

MODEL KT-40 COMPLETELY WIRED
READY TO OPERATE \$29.50

Model KT 40 Kit comes complete with all parts including test leads, V.T.V.M. prod. circuit, operating instructions, etc.

\$19⁹⁰
NET

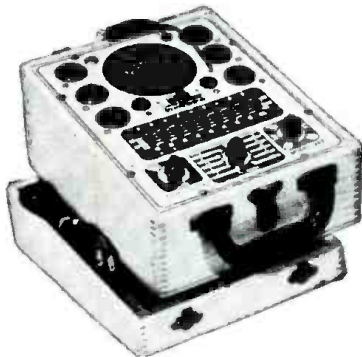

THE NEW MODEL 247

TUBE TESTER

Check octals, loctals, bantam Jr. peanuts, television miniatures, magic eye, hearing aids, thyatron, the new type H. F. miniatures, etc.

FEATURES

- Newly designed element selector switch reduces the possibility of obsolescence to an absolute minimum.
- When checking Diode, Triode and Pentode sections of multi-purpose tubes, sections can be tested individually. A special isolating circuit allows each section to be tested as if it were in a separate envelope.
- The Model 247 provides a supersensitive method of checking for shorts and leakage up to 5 Megohms between any and all of the terminals.
- One of the most important improvements, we believe, is the fact that the 4-position fast action snap switches are all numbered in exact accordance with the standard R.M.A. numbering system. Thus, if the element terminating in Pin No. 7 of a tube is under test, button No. 7 is used for that test.

Model 247 Kit comes with all parts, new speed-read chart, handsome hand-rubbed oak cabinet sloped for bench use. A slip-on hinged cover is included for outside use.

MODEL 247 COMPLETELY WIRED
READY TO OPERATE \$29.90

\$21⁹⁰
NET

THE NEW MODEL B-450

SIGNAL GENERATOR

SPECIFICATIONS

- Frequency Range: 150 Kilocycles to 50 Megacycles.
- F.M. as well as A.M. receivers can be speedily aligned with the aid of the Model B-450. Modulation in the B-450 is accomplished by Grid-blocking action which has proven to be equally effective for alignment of amplitude as well as for frequency—modulated receivers.
- R.F. is obtainable separately or modulated by Audio Frequency.
- Positive action Attenuator provides effective output control at all times.
- The R.F. Signal Frequency is kept completely constant at all output levels. This is accomplished by use of a special grid loaded circuit which provides a constant load on the oscillatory circuit. A grounded plate oscillator is used for additional frequency stability.
- Direct reading—all calibrations are etched on the front panel.

Model B-450 Kit comes complete with all parts including circuit, test leads, etc. Nothing else to buy.

MODEL B-450 COMPLETELY WIRED
READY TO OPERATE \$24.50

\$18⁵⁰
NET

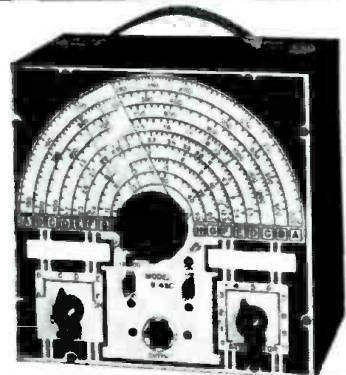

*UNPRECEDENTED GUARANTEE!!

All kits advertised on this page are offered subject to the following guarantee: If, after completion, the instrument does not operate to your fullest satisfaction, you may return it and we will ship you a brand new factory wired and tested model for only the difference between the price of the Kit and the price of the complete Instrument. Full credit will be given no matter what stage of completion has been reached in wiring the Kit.

20% DEPOSIT REQUIRED ON ALL C.O.D. ORDERS

GENERAL ELECTRONIC DISTRIBUTING CO. Dept. RC-11, 98 PARK PLACE
NEW YORK 7, N. Y.

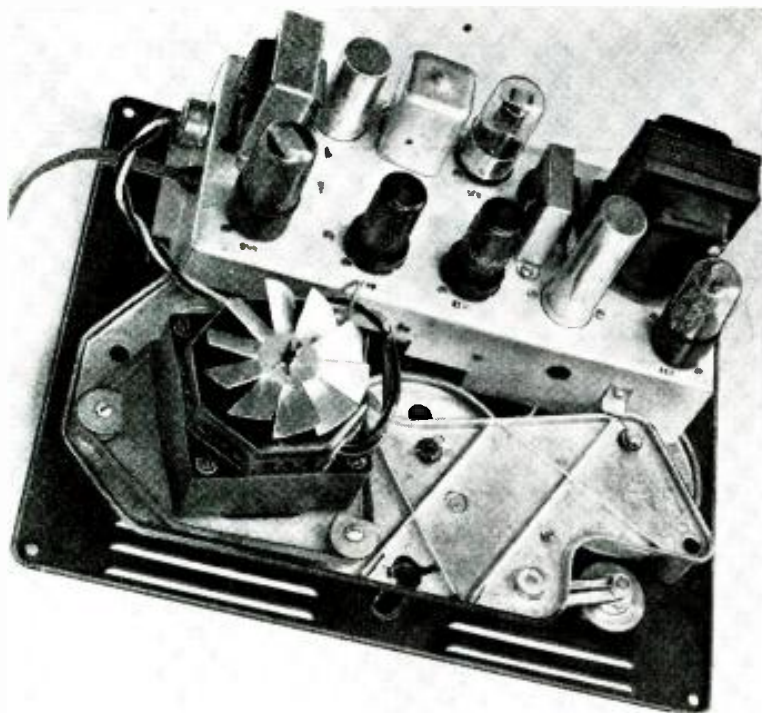

This upside-down view of the motorboard shows the amplifier chassis.

of a synchronous motor and a simple combination belt and friction drive, mounted solidly to the heavy metal motorboard. The motor runs at all times (when the switch on the volume control is turned on); the reels are started and stopped by a mechanical clutch arrangement operated by the FORWARD-OFF-REWIND knob on the left.

The chassis is screwed upside down to the motorboard. Plugs connect the internal speaker and the motor to it. The magnetic head is wired directly to the chassis and mechanically connected by a semirigid, copper bonding strip. Four screws atop the motorboard hold the chassis, but in disassembling for servicing remember to remove the two

screws holding the magnetic head to the motorboard, too.

The schematic shown was redrawn from that given in the 24-page instruction book supplied with the recorder. In the drawing in the book the components are so arranged as to duplicate their physical placement on the chassis. Since most technicians try to diagnose trouble in terms of the symptoms, the functional drawing shown here is likely to be much more useful.

The manufacturer's drawing has one very interesting feature, however. Circuit grounds are shown to be made at unexpected points and contact is made to the chassis at only one place—pin 2 of the first 6SJ7. Since there is no other

hum-reducing device apparent in the circuit, these peculiar ground connections are probably responsible for the phenomenally low hum in the loudspeaker. On both recording and playback, the volume control can be opened wide; with the ear right up against the speaker, the only hum to be heard is the slight whine of the motor.

The RECORD-LISTEN switch S1 (our numbering) is a multiple-contact slide unit attached to the chassis and actuated by a rod topped with a knob on the motorboard. It has been broken down in the drawing into separate s.p.d.t. sections for simplicity; the sections are lettered and identified on the inset drawing of the actual switch.

The four magnetic coils are all in the one head. Either playback coil or microphone is switched to the grid of the 6SJ7. The RADIO input is paralleled with the plate of this tube across the volume control. The 6K6-GT is the power amplifier, feeding either speakers or the record coil (the latter through an equalizer network). Note the provisions for attaching external 3.2- or 500-ohm speakers or lines. A 6J5-GT oscillator provides erase and bias signals.

There are four frequency-compensation networks in the amplifier. The series 560,000-ohm resistor and .001- μ f capacitor between the plate of the 6K6-GT and the cathode of the previous tube feed back (and therefore roll off) highs, beginning at about 250 cycles. The apparent effect is a bass boost from 250 down. The 50- μ f capacitor across the 560,000-ohm resistor increases the treble cut, beginning at approximately 7,000 cycles, beyond the useful range of the recorder.

The .05- μ f capacitor across the 1,500-ohm cathode resistor of the second 6SJ7 reduces degeneration of highs beginning at about 2,000 cycles. This is, of course, a high-boost circuit. The parallel 820-ohm resistor and .05- μ f capacitor in series with the record coil boost highs beginning at about 4,000 cycles. This has very little effect and is the only one of the compensators not in the circuit at all times.

The functions of the switch sections are obvious, with the exception of S2. With the cathode of the 6J5-GT grounded only through its cathode resistor and capacitor, the bias prevents oscillation. S2 is a leaf-type interlock switch, which closes only when the mechanical clutch arrangement is in the FORWARD position. This prevents erasure when the tape is being rewound, even though S1 may be on ERASE-RECORD. When S2 is closed and S1 on ERASE-RECORD, the 6J5-GT cathode is grounded directly and the oscillator operates.

S1 is, not a stock unit, but a special slide switch built for the purpose. The technician should take great care, in adjusting any of the contacts, not to misalign them. The operation has been carefully timed—certain sections break quickly, others slowly, and some are of the shorting type. The sequence of contacts is also worked out in a specific order. So beware of tampering.

Service Technician's Information Blank

See Editorial on page 19 for vital information to you.

1. Are you a full-time or part-time service technician?.....
2. Are you an "independent" service technician or employed by someone else?.....
3. Do you service radio receivers only, television receivers only, or both?.....
4. In your servicing activities are you commonly asked by customers to recommend or endorse different makes of television receivers?.....
5. Are you in favor of our publishing a greater number of television servicing articles?.....
6. What other radio magazines do you read regularly in addition to ours?.....
7. Would you like to see articles on some phase of television not now covered by the magazine, or more (or less) of any of the types now printed?

YOU need not sign your name to this blank. Please paste it on a 1¢ post card or mail by letter to Radio-Electronics, 25 West Broadway, New York 7, N. Y. Thank you.

Name

Address

City & State

choose YOUR NEEDS from one of the worlds largest selections of radio-electronics parts with a money back guarantee

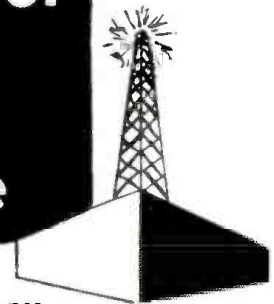

NOW ON HAND TO SERVE YOUR NEEDS IS THE LARGEST STOCK IN OUR 36-YEAR HISTORY

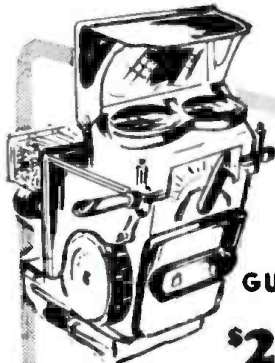

**M-K18
GUN - SIGHT**
\$2.95

Made by Eastman Kodak Co.

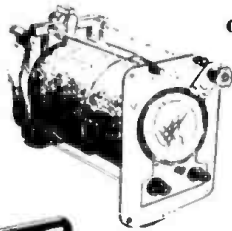

**BANK - CLIMB
GYRO - CONTROL**

For Mark 4 Automatic Pilot
\$995

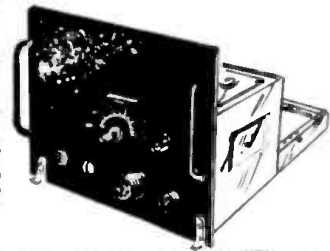

**ALL-PURPOSE
CHASSIS**
Contains 3 plugs, 2 vol. controls, 1 25 wt. resistor, 2600 ohms, 250,000 ohms 10 wt. resistors, 13-500 ohms, 10 wt. resistors, 3 1/2 mmfd., 3 bathtub condensers 600V, 3 sockets, 4 shock mounts and many other parts in a blank top chassis.
95c



TEST OSCILLATOR
Contains 12 or 24 VDC. Vibrator, Switch and many other parts used in 2-A equipment
95c

**M-1 DIRECTIONAL
GYRO**

A-5 Automatic pilot Mfd. by A. C. Spark Plug under license of Sperry Gyroscope Co., Inc.

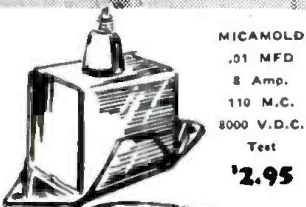
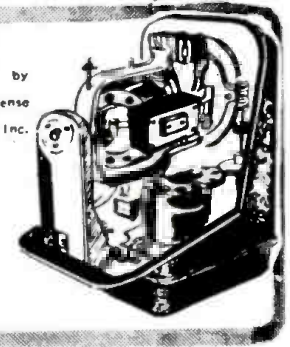

MICAMOLD
.01 MFD
8 Amp.
110 M.C.
8000 V.D.C.
Test
\$2.95

AUTO SPEAKER

Fits in the Back Seat of any car. Takes 3 minutes to install. Reg. \$9.95 Val.

\$1.95

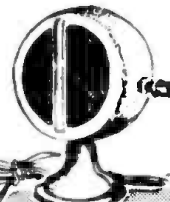

\$9.95

PLUGS AND CONNECTORS

CD 501-A CORD & PLUG SET.
Used with BC 654 between PE105 Dynamotor and Transmitter.

\$1.95

**BUILD YOUR OWN
GEIGER COUNTER**



Detects both Beta and Gamma Rays. Search probe included with 1B85 Geiger Tube. Chassis and Case comes all drilled. All parts, batteries, diagrams, and instructions included. Exact duplicate of the famous 49er Geiger Counter publicized in the September issue of Radio Electronics.

\$49.50

- 6K-C16-328
- 6K-C16-23—
- 1/2 AC-AN
- M-356-A
- AN-3100-32-8P
- 10H-528
- AN-3057-24
- AN-3102-145-1P
- PL-147
- AN-3104-32-1015
- AN-3102-18-205
- AN-3057-10-1/2-2
- U-16/U
- PL-112
- PL-118
- AN-3102-20-27P
- MC-136
- ARC-9589
- AN-3102-22-14P
- AN-3102-145-75
- AN-3106-18-125
- AN-3106-165-1P
- AN-3057-5
- AN-3102-36-8P
- AN-3102-24-3P
- PL-Q45
- AN-3104-36-18
- AN-3108-36-158
- AN-3108-28-25
- PL-Q77
- AN-3104-24-25
- AN-3104-28-2P
- AN-3057-16
- AN-3057-8
- UG-21/U
- PL-Q171—10H/614
- AN-3108-145-25
- AN-3102-145-25
- AN-3108-60-15
- PL-182 - 10H/258-B
- AN-3108-22-17P
- AN-3108-24-18P
- AN-3104-22-15
- AN-3102-16-55
- 2255-26
- PL-118
- AN-3106-18-85

45c each

DUAL 30 MV CHOKES
Hi Voltage Installation at 20 MA DC.
6x2 1/2x3 — 4 1/2 lbs. 38

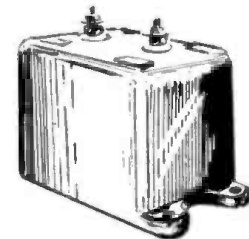

**AZEROVOX
MICA
CONDENSER**
.01 MFD
8000V.
18-20 Amps
K.C.
3000-1000
\$4.95



5249 GRAND RIVER

• DETROIT 8, MICHIGAN

HERSHEL RADIO CO.

5249 GRAND RIVER

DETROIT 8, MICHIGAN

All orders F.O.B. Detroit—Minimum Order \$2.00—Michigan customers add 3% sales tax—20% Payment must accompany all orders.



1 MEG
PREC. RES.
± 1% 89¢

JOHNSON PORCELAIN SOCKET

25W. 4 PRONG

35¢ 4 FOR \$1.00



PAPER OIL CAPACITATORS

- 1 MFD 5000 V. **'2.95**
- 1 MFD 6000 V. **'4.95**
- 2 MFD 6000 V. **'8.95**
- 2 MFD 7500 V. **'12.50**



FM RADIO AND TRANSMITTER

BC-620-A
20 MC TO 27.9 MC **\$9.95 USED**

This Xtal controlled FM set has 13 tubes and has dual Xtal controlled channels. It also contains built-in Fil. and Plate Meter. Tubes used: (4)1LN5, (1)1LC6, (1)1LM4, (2)1291, (4)1299, (1)1294 Ideal for communication between trucks, boats, etc. Used, in good condition. Less power supply. Wt. 38 lbs. Complete with carrying case and diagrams.

IRC TYPE HE **49¢**



100W. Bleeder consisting of 5 sections: 750 ohms, 23 ohms, 23 ohms, 7500 ohms, 3000 ohms, Total—11,296 ohms.

LF. TRANSFORMER **95¢**



Mounted in aluminum shield can. 5MC with air trimmer. Impedance coupled type. DISCRIMINATOR TRANSFORMER TO MATCH...95c



CORONA BALLS
Grid and plate connections for VT 127-250 TM etc. Ball Type. 10c EA. Heat dissipating silver plated. **\$1.00 Doz.**

TRANSFORMER **95¢**



Audio oscillating transformer with output and feedback winding.

VOLTAGE REGULATOR **95¢**



Carbon pile, magnetic type, coil current, 105 MA. Load max. 5 amps at 18.25V.

DON'T MISS THESE SPECIAL SAVINGS!

- Powdered iron, 3/4 slug 10c
- Jacks for PL55, or PL 68 10c
- Ass't mica condensers—per 100 \$ 1.95
- Pin straightener for miniature tubes 25c
- Ear phones, 2000 ohms, used 95c
- SCR625 Mine detector, used \$19.50
- 75,000-ohm 200 watt Bleeder Res. 95c

SILVER CERAMIC CONDENSERS

500 W.V.D.C. 10c ea. 12 for \$1.00

Available capacity (MFFD's). 2, 3, 4, 5, 7, 8, 8 1/2, 10, 11, 12, 15, 24, 25, 30, 40, 45, 50, 51, dual 60, 70, 72, 75, 80, 81, 95, 100, 120, 125, 140, 212, 350, 375, 400, 470, 500, 1000 and 5000.

With 3 RF stages. (One re-radiation suppressor R-F.) 12 tubes. Motor and manual tuning. S-meter. F-selectivity control. Crystal Filter. AVC, phasing control, ANL, etc. Also furnishes video output for scope, and panoramic output for scanning. Complete with tubes and Xtal, but without power supply. Power requirements, 270V. at 135 MA. New, in sealed cases.

ARR7 AIRBORNE VERSION OF HALLICRAFTER



SX 28A **\$129.00**

SPRAGUE CONDENSERS

.1 MFD 7000 VOLTS

'1.95



WAFFER SWITCHES

KIT OF

TEN SWITCHES **'1.85**



IGNITION COILS FOR G.E., SYLVANIA, ETC. Photo Flash Tubes

'1.29 Primary: 150V. condenser discharge. Secondary: 15,000 V. Can also be used on model airplanes.



BK 22 K RELAY



'2.95

Used in conjunction with SCR-269F. changeover contains 28V. step relay 5 deck, 6 position switch, 12V. DPST.

ANTENNA DUPLER

Originally used on BNIFF equipment to allow the use of a common antenna for receiver and transmitter. 156 to 187 MC—\$5.95.



ANTENNA

2 meter antenna: 157-187 MC. Originally used with BNIFF equipment — successfully used on 144 MC as a non-directional antenna —\$5.95.

BOTH UNITS ONLY **\$9.95**



No. MX16 Cross pointer 3/4" Meter. Two 200 microamp movements. Brand new—\$2.95

500 ohm to grid matching transformer No. 81749.. 69c

Ceramic Silver Padders Dual 3 to 12 MMFD or 5 to 20 MMFD..... 19c

Ceramic mica Padder single 5 to 20 MMFD.per dz. 50c

Choke—300MA 20HY. Insulated for 5000V. Heavy Porcelain Insulators. Very conservatively rated. Idle for KW rig \$8.95

REMOTE POSITION INDICATOR **\$4.95**



6-12V. 60 Cy. 5" Indicator with 0-360 Degree Dial.

BUTTERFLY CONDENSERS

Oscillator assembly 76 to 300 MC with acorn tube socket mounted on condenser \$3.95

Type B Frequency range 300-1000 megacycles \$2.95

BC4 Antenna condenser 105-330 MC \$3.95



MICA CAPACITOR

69¢

002. MFD.—3000 W.V.D.C.



FILAMENT TRANSFORMER

'1.95

110V., 60 Cy. Sec. 1: 4V. at 16 amps. Sec. 2: 2.5V. at 1.75 amps. insulated for 5000V. Ideal for 2X2 and 826 tubes. Hermetically sealed. Size: 6x3 1/4 x 4 1/4 L.



COAXIAL FITTINGS

- 5c HOOD
- 25c SOCKET SO-239 83-1R
- 35c PLUG PL-239 81-1SP
- 20c ANGLE-ADAPTER M-359 83-1A0

METER

Type D041. 0-1 MA. meter scale graduation 0-5 D.C. Kilo V. and 0-10 MA D.C. **\$2.95**



COLLINS FILTER CHOKE

\$1.69 6 HV, 150 MA. D.C. resistance 100 ohms. Test V. 2500.



AIRCRAFT POWER RHEOSTATS

25W. 25 ohms 1 amp maximum **69¢**
50W. 30 ohms 1.7 amps maximum **95¢**

VARIABLE CONDENSER

89¢



6 Gang silver plated. Sec. 1: 350 MMFD. Secs. 2, 3, 4, 5: 60 MMFD. Sec. 6: 80 MMFD.

FULL WAVE METER RECTIFIERS FOR USE WITH 0-1 MA. METER

95¢



AZIMUTH CONTROL

49¢ MN 32H USED

Dial calibrated 360 degree face. Ideal for antenna rationalizing indicator. 60 to 1 ratio with switch.



DETROLA RECORD CHANGER

Handles 12 10-inch records or ten 12-inch records.



Automatic Changer Only **\$9.95**

A-5 AUTOMATIC PILOT

Serve—100 foot lbs. max., to use as a steering device, or compass control on ships. **\$4.95**



PORCELAIN SOCKET (ACORN)

\$1.50 Doz. 15¢ EACH

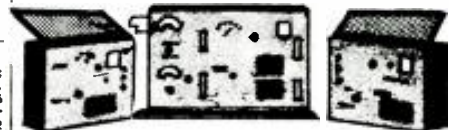
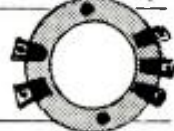

NEW BC 233 AX TRANSMITTER

801 Oscillators and 801 power amplifiers, 2-46 modulators and 1-46 speech amplifier 4 Xtal frequencies and master oscillator on selector switch. 10 to 30 Watts output. Tone voice or C.W. Mod. Ideal for 80 meter band. Comes with 3 coils TU 17A 2000-3000 Kc. TU 25 3500-5250 Kc. Black crackle case. Includes two separate cases to store extra coils. Frequencies chart and tubes included, packed in original cases, less crystals at this low price.

\$39.95

ULTRA HIGH-FREQUENCY TRANSMITTER AN/APT BRAND NEW!

1500 Megacycle Transmitter, made for U. S. Government, complete with the following tubes: 2-6AC7, 1-6L6, 2-829, 1-931A, 1-6AG7, 1-522 Ultra high freq. tube. Complete with high freq. cavity, 1 Blower to cool the many other component parts for ultra high frequency work. It has a frequency checker, complete Lecher wires, with slider and sensitive bulb for checking the wave length. The Lecher wires are so calibrated that the setting of the slider may be read directly in Centimeters. Operates on 115V. AC for filaments only. Does not include any plate supply. The tubes alone are worth many times more than what we are setting the complete transmitter for. Packed in original case—contains instruction book. Wgt. 118 lbs.



\$95.00

PORCELAIN SOCKET 829-832 ETC.

25¢ 5 For \$1



CONDENSERS

Cap MF	VOLT	Your Cost
2	1000 oil	89c
1	1000 oil	44c
8	600 oil	95c
4	600 oil	69c
2	600 oil	49c

CERAMIC INSULATORS HIGH VOLTAGE FEED THRU



SQUIRREL CAGE BLOWER

\$7.95

2" outlet 110 AC, 60 Cy. Silent Oil lite bearing motor, with mounting bracket.



HIGH-SPEED PHOTO-FLASH TUBE

\$5.95

12,000,000 lumens light output. Stops all action. Ignition coil included on back of bulb. 10,000 flashes. Diagrams furnished on request.



5-Gang Variable Condenser
5 Gang approx. 50 MMFD per section with individual air-tuned padders. 18 to 1 vernier drive. Shielded.



\$1.95

SELSYN MOTORS TWO FOR \$3.95

The ideal way of indicating the position of Rotary beams, wind indicator, etc. Line chord and instructions for 110 AC operation furnished on request.



POTTER & BRUMFIELD OVERLOAD RELAYS
Potter and Brumfield. Relay 1—5000 ohms, coil current 10 MA. Relay 2—110V, 60 Cy., AC coil. SPDT.



\$1.95

TOGGLE SWITCH

39¢

DPST. 30 amps. in Bake-a-lite case.



LIP MIKE WITH HEAD BAND and CORD

\$1.49

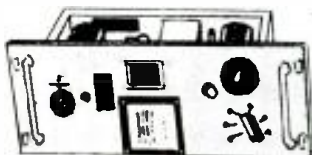

TRANSMITTER TUNING UNIT

\$2.50 FOR BC-375

Approx. 65 MMFO cond. coils, RF chokes, dials, assorted mica condensers, 2500 WVDC. OVER \$50.00 IN PARTS!

BC-AR230 TRANSMITTER

Including 4 tubes and RF Ammeter.

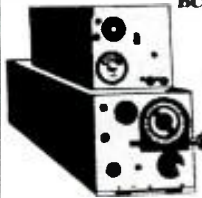

BC-AL229 RECEIVER

Including 8 tubes. Used in aircraft.

BOTH UNITS ONLY

\$9.95

30 MC-1F SILVER-SLUGGED

35¢



PLATE SENS. RELAY \$1.49 5000 ohm. coil contact D.P.S.T.

Discharge resistor Thyrite type 5F 130 V. AC or DC 95c
Resonance ind. neon bulb and alligator clip..... 19c
Paper Cond. .05., .05., .05, 300VDC—round can. 1"x1". Dozen..... \$1.00

T-17 CARBON MIKE LIKE NEW

89¢



R.F. CHOKE

6 mh. 500 ma. on porcelain form. **29¢**

MIDGET JACK VALUES!—BRAND NEW! ar

Open Circuit.....15c each
10 for\$1.44
Closed Circuit.....19c each
10 for\$1.71

Extremely small jacks that fit all standard phone plugs. Have tempered nickel steel spring contacts that retain permanent resiliency and provide positive contacts. Mount in 3/4" hole in panels up to 3/16" thick. With hardware. Shpg. wt., 4 oz.

HEINEMANN CIRCUIT BREAKER

115 V.....5 Amp.95
110 V.....15 Amp. 1.49
110 V.....20 Amp. 1.49
110V.....5 Amp.95



Adjustables — Aircraft CIRCUIT BREAKER
24 V. 20 Amp. AN 3160 SQUARE D CO.....\$1.49

PHONE PLUG REPLACEMENT FOR PL 55

29c



10 CONTACT TERMINAL STRIP

HIGH VOLTAGE INSULATION HEAVY BRASS 8 - 32 SCREWS **25¢**



4 HY 500 MA CHOKE29c
Assorted resistors 1/2 Watt fully insulated. In popular ohmages. 100 for.....\$1.49
D.P.D.T. Toggle Sw. 39c
Bakelite Pushon Ass't. Knobs.....100 for 1.85
Assorted high frequency chokes. 25 for.....1.00
Assorted waffer sockets. 100 for..... 2.95
Thordarsen T48003—2 HY—7 HY. 550 MA awinging choke—Size: 4 1/2 x 5 1/2 x 5". Black crackle case 5.95

TELEPHONE TYPE. PLATE SENSITIVE RELAY

\$1.95

7000 ohm, S.P.D.T. coil contact. S.P.S.T.



SCOPE TRANSFORMER

\$3.95

Primary 110V. 60 Cy. Sec. 4000 V. at 10 MA. Size 6x4x3 1/2"



BC 702-A HI FREQUENCY RADAR TRANSMITTER

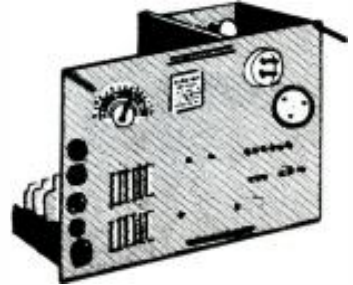

(4) 2x2 tubes, (1) Squirrel cage blower, 12-24V., .02-8000 V., 25 MA 2" meter, 2.01 at 5000 VDC. .001 at 9500V.

\$14.95

3/4" Coaxial solid copper tubing—30 foot length—beaded insulation \$2.95
50-30 MFD Electrolytic condenser, 150 V. tubular. Well-known brands; Solar, CD, etc.... 48c

THERMOSTAT. NORMALLY OPENS AT 95°.

49¢



400 CYC. BLOWER 115 Volts. Type FL. Style I 171145C R.P.M. 6700

Westinghouse Mfg. Co. **\$1.95**



AC. PLUG. DOZ. MOLDED TYPE.

35¢



PHONOGRAPH ARMS FOR CRYSTAL

25¢



D. P. D. T. 110 V. SLIDE SWITCH

19¢ EA.



D.P.S.T. JACKS FOR PL 55

39¢



PHOTO FLASH CAPACITATOR 12 MFD. 2500 V.D.C. PK. TYPE No. 777 100 WATT SEC.

\$14.95



PHOTO FLASH CAPACITATOR 20 MFD. 2500 V.D.C. PK. TYPE No. 775 65 WATT SEC.

\$9.95



TUNING DRIVE SHAFT, HOLDER AND LOCK WASHER, 10c each—\$1.00 Doz.



POWERED IRON COIL FORM

19¢



PL 68 PLUG

18c



BANANA JACK & PLUG 75c DOZ. SETS



MANUAL FLAP ACTUATOR—IDEAL FOR DOOR OPENERS, ANTENNA ROTATORS, AND HUNDRED OTHER USES

83.95

.008 BUFFER CONDENSER

29c

MODULATION TRANSFORMER AND DRIVER TRANSFORMER

RC 1206 modulation transformer. 815 Class AB2, 56W. audio. RC 1205 driver transformer, 65W to 815. Class AB2—Companion to RC 1206.

Both Units Only **\$4.95**



HERSHEL RADIO CO.

5249 GRAND RIVER

DETROIT 8, MICHIGAN

IMPORTANT NOTE

All orders F.O.B. Detroit—Minimum order \$2.00—Michigan customers add 3% sales tax—20% payment must accompany all orders.

Fundamentals of Radio Servicing

Part IX—The diode vacuum tube

By JOHN T. FRYE

HAVING spied on the busy electron while it skipped through conductors, resistors, coils, capacitors, and transformers, you may feel that you are an authority on the behavior of the little cuss; but until you have observed one doing its stuff inside a vacuum tube, you really have little idea of the power and versatility packed into one of these tiny charges of negative electricity.

Take a look at the experimental setup diagrammed in Fig. 1. The circle represents a hollow glass sphere in which are contained a couple of loops of resistance wire and a small metal plate mounted near to, but not touching, this wire. Leads are brought out from the plate and from both ends of the "filament" wire, and all the air possible has been pumped from the glass bulb before sealing it.

A low-voltage battery, an ammeter, variable resistor R1, and the filament are connected in series. Another, higher-voltage battery, with its negative terminal connected to the negative terminal of the filament battery, has

resistor R2 bridged across it so that any positive voltage from zero (at the extreme left-hand position) to the full battery voltage (at the extreme right-hand position) may be selected by the moving slider. A voltmeter is arranged to read this voltage. The slider connects through a milliammeter to the plate of our "vacuum tube."

With the slider of R2 set at zero positive voltage (extreme left), let us slowly decrease the resistance of R1, permitting more and more current to flow from the battery through the filament. The passage of this current produces heat in the filament wire; and when enough current flows, the wire becomes red hot. Our ammeter reveals how much current is flowing through the filament, but our milliammeter still stands at zero. However, if we move the slider of R2 to the positive end of the battery, the milliammeter indicates pronto that current is passing through it!

Where does this current come from? It must be flowing from the high-voltage battery, but where is the complete

circuit? Surely the current cannot pass through the space between the filament and the plate inside the glass sphere, for we have always thought of a vacuum as being a perfect insulator; yet, there is no other logical explanation of what that milliammeter pointer is saying. The current *must* be bridging the gap inside the bulb, but how?

Remember that back in Chapter I we found there are always a number of free electrons wandering aimlessly

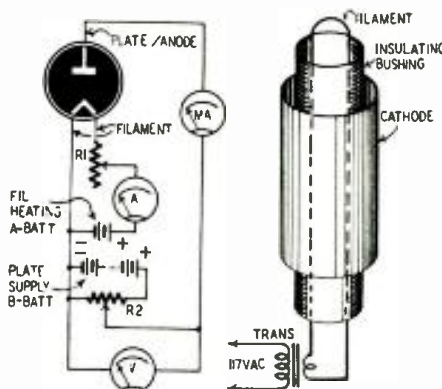

Fig. 1 (left)—Test setup illustrates diode action. Fig. 2 (right)—Cathode is cylinder surrounding the filament.

around through any conducting material? By applying voltage, we can control the direction and speed of this movement of electrons to a certain degree; but even with no e.m.f. applied, the restless little jiggers are constantly hopping around from one atom to another.

When they come to the surface of the conductor, however, they bump into a force, somewhat resembling the surface tension of water, that keeps them from passing through. While they possess some *kinetic energy* (kinetic energy is power acquired through motion; it is the reason a soft hand can slap so hard), they do not have enough to shoot through this surface barrier. They must have help if they are to escape into "the wild blue yonder."

Providing heat is the easiest way to supply this help. When the temperature of a body is raised, free electrons begin to feel freer and friskier by the second. They start to accelerate and to shoot madly about like a bunch of water bugs playing tag, and sooner or later one



These are a few of the common diodes—all sizes and ratings are manufactured.

ONLY THE NEW TYPE Q CONTROL

Gives You these Advanced Features for Modern AM, FM and TV Servicing

Here's a control for Radio Technicians that's years ahead in engineering and practical convenience. 59 standard ranges, 11 Interchangeable **FIXED** Shafts and exclusive convenience features give you more versatility with lower inventory than ever before possible.

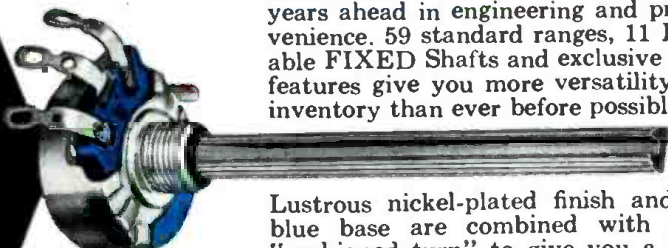

Lustrous nickel-plated finish and distinctive blue base are combined with a smoother "cushioned turn" to give you a control that looks, "feels" and performs better than any you've ever used.

KNOB MASTER FIXED SHAFT

This 3" long *fixed* shaft is standard on the Q Control. 90% of all AM, FM and TV $\frac{1}{4}$ " knobs can be accommodated without alteration, except cutting to length. It is knurled, flatted and slotted, and ends spread easily for worn or oversize knobs. Shaft inserts are no longer needed.

The Knob Master Fixed Shaft combines with compact $\frac{15}{16}$ " design and $\frac{1}{4}$ " long bushing to provide the industry's most adaptable small control.



enlarged cross-section

11 INTERCHANGEABLE FIXED SHAFTS

Now it's easy to adapt standard controls to "specials". Resilient Retainer Ring, an outstanding control design advancement, permits ready adaptability to any of 11 special **FIXED** shafts in less than a minute—using only a knife or screwdriver. Shafts are **FIXED** and permanent! They will not wobble.

Interchangeable Fixed Shafts are sealed in cellophane and individually packaged. Simple instructions are included in each carton.



REVOLUTIONARY
TYPE Q CONTROL
LEADS THE FIELD IN
CONVENIENCE FEATURES

OUTSTANDING APPEARANCE VERSATILE KNOB MASTER SHAFT INTERCHANGEABLE FIXED SHAFTS MODERN SMALL SIZE SMOOTHER ROTATION

Resilient Retainer Ring provides cushioned turn—a new sensation in operation

PRE-EMINENT ELECTRICAL FEATURES

$\frac{1}{2}$ watt rating—wider coverage

Famous IRC resistance element

Identical electrical rotation with or without switch

Wider range—500 ohms to 10 megohms

OUTSTANDING MECHANICAL FEATURES

Molded base accurately aligns parts

Salt spray materials and finishes

Two locating Jugs provided

EASILY ATTACHED IRC SWITCHES

WIDE REPLACEMENT COVERAGE

59 values

Stock list shows Radio and TV uses

Type Q IRC Volume Control Kit available

Basic stock numbers unchanged

MECHANIZED PRODUCTION

Complete mechanization of production and testing eliminates hand operations and assures maximum uniformity

ATTRACTIVE NEW PACKAGING

Controls, shafts and switches individually packaged

Complete instruction sheet with each item

For complete details, ask your IRC Distributor or use the handy-coupon to obtain your **FREE** copy of new Catalog DC-1.



**INTERNATIONAL
RESISTANCE CO.**

401 N. Broad St., Phila. 8, Pa.

In Canada: International Resistance Company, Ltd., Toronto, Licensee

Wherever the Circuit Says 

INTERNATIONAL RESISTANCE CO.

401 N. Broad St., Phila. 8, Pa.

Please send my free copy of Q Control Catalog DC-1.

Name

Address

City Zone State

Now... OHMITE Little Devils

IN 1/2-WATT OR 1-WATT ASSORTMENT



GET THIS HANDY
ALL-PLASTIC CABINET
Packed with 125 "Little Devil" Resistors
—FOR COST OF RESISTORS ALONE!

1/2-WATT ASSORTMENT
\$12.50

1-WATT ASSORTMENT
\$18.75



LITTLE DEVIL COMPOSITION RESISTORS

Guesswork's gone... when you use individually marked Ohmite "Little Devils." These tiny but rugged resistors are available in standard RMA values, 1/2, 1, and 2-watt sizes... 10 ohms to 22 megohms. Tol. $\pm 10\%$ and $\pm 5\%$. Values to 2.7 ohms available in 1-watt size, $\pm 10\%$ tol.

Each assortment, either 1/2-watt or 1-watt, is packed in its own rugged cabinet... and you pay only the regular price of the resistors, *nothing extra* for the cabinet!

Factory packed in each cabinet's 40 separate compartments are 125 carefully selected "Little Devils" (tol. $\pm 10\%$)... in the 40 values from 10 ohms to 10 megohms most frequently used by servicemen. It's no trouble to find the resistor you need... *fast!*

Molded of strong, lustrous plastic, and extremely compact—only 9" x 4 3/4" x 5 1/4"—Ohmite cabinets protect your resistors, too, and help you check inventory at a glance. You'll want to order both assortments, today.

SEE YOUR DISTRIBUTOR



BROWN DEVIL RESISTORS

A favorite with servicemen, these dependable, wire-wound, vitreous-enameled resistors are easily mounted by their tinned wire leads. Tol. $\pm 10\%$. In 5, 10, and 20-watt sizes.



MOLDED COMPOSITION POTENTIOMETER

Built to last, this Type AB Potentiometer has a heat-treated, solid-molded resistance element—not just a film—and provides unusually quiet operation. It has a 2-watt rating.

OHMITE MANUFACTURING CO., 4896 FLOURNOY ST., CHICAGO 44

Be Right with **OHMITE**

Reg. U. S. Pat. Off.

RHEOSTATS • RESISTORS • TAP SWITCHES

of them takes a long running jump and pops right through the surface of the body into the air or vacuum surrounding it. As the temperature goes still higher, more and more of these heat-propelled electrons make the grade until finally the heated object is surrounded by a veritable cloud of fugitive particles that it has emitted.

Please note that it makes no difference *how* the emitting body is heated. It could be done with a blowtorch, a gas flame, the focused rays of the sun, etc., but inasmuch as the emitting material must be heated inside a vacuum in our radio tubes, the heating effect of an electric current has proved to be the most practical.

Sometimes the filament itself is the emitting body (or cathode), as is the case in Fig. 1; but in other instances the emission is from an *indirectly heated cathode*, as is shown in Fig. 2. Here the filament is heated by current from an alternating-current transformer, and this heat passes through a bushing made of electrically insulating but heat-conducting material and raises the temperature of the sleeve-like cathode to the proper temperature for emission. Tubes are therefore loosely divided into "filament" and (indirectly heated) "cathode" types.

When an electron is emitted, its negative charge is subtracted from the total charge of the emitting body; therefore the body becomes unbalanced in a positive direction, tending to attract the negative electron back into itself if some other stronger force is not exerted on that negative particle. That is where the plate in our vacuum tube enters the picture. If the plate is positively charged with respect to the emitting filament, it tends to attract to itself the electrons that have escaped into the vacuum; and when there is a constant parade of electrons from the filament or cathode of a vacuum tube to the plate, we have a *plate current*.

These electrons pass from the plate to the positive terminal of the battery through the milliammeter, causing it to deflect. Incidentally, when only 10 ma is flowing, 6.28 times 10^{18} electrons are being emitted by the filament and attracted to the plate every second (*not* 6.28 times 10^{18} , as the printer erroneously reported in Part I of this series). However, the electrons flow from the negative terminal of the battery into the filament at the same rate at which they return to the positive terminal *via* the plate; so no electrons are really lost or gained.

Now that the mystery of how current can flow through a vacuum has been cleared up, let us do a little more experimenting with the apparatus shown in Fig. 1. Suppose R1 is adjusted until our filament just begins to glow a dull red and that R2 is then manipulated so that the voltage applied to the plate starts at zero and advances in 10-volt steps. At each step, let us carefully note the values of the plate voltage and the plate current.

The Offer Still Stands!



Only \$18.73 Down Puts the Complete Photofact Library in Your Shop Today...

NOW—the new “Pay-as-you-Profit” Plan brings the famous PHOTOFAC T Library within the reach of every Serviceman! Now you can easily own the world’s finest radio service data—seven complete volumes, plus continuous PHOTOFAC T Folder Set service—full coverage of all post-war AM, FM and TV models! Everything you’ll ever need for quicker, more profitable servicing! You pay only \$18.73 down—the remainder in small monthly payments. Absolutely no carrying charges and no interest! Make the down payment—and you get the complete Library immediately. Your Jobber has all the details of this amazing new purchase plan. See him today, or write us direct for full information.

Get the Easy-Pay Details Now!

FREE PHOTOFAC T Cumulative Index

Select your FREE PHOTOFAC T Folder (covering any AM, FM or TV model) from the PHOTOFAC T Cumulative Index. Get the FREE Index today. Covers all post-war receivers right up to the present. Helps you find the Folders you want in a jiffy—Folders that make your work quicker, easier, more profitable. Get this FREE Index at your Jobber or write direct for it now.

SERVICEMEN: We’ll Prove You’ll Save Time, and Earn More with PHOTOFAC T!

We’ll Send You Absolutely

FREE

Any PHOTOFAC T Folder Listed in the PHOTOFAC T Cumulative Index!

NOW—learn for yourself—at our expense—how PHOTOFAC T will make your service work quicker, easier, more profitable! Examine an actual PHOTOFAC T Folder. Use it. You’ll learn first-hand why this indispensable service data is used daily by over 25,000 successful service technicians. You’ll discover quickly that no other service gives you PHOTOFAC T’s outstanding advantages: *completeness, accuracy, uniformity and ease-of-use.* PHOTOFAC T alone, is the only radio service data prepared from laboratory analysis of the actual equipment. Nothing in the field equals PHOTOFAC T. Know the facts—get your FREE Folder now. Examine it—use it—compare it—and you will understand why no modern service shop can afford to be without PHOTOFAC T.



CURRENT PHOTOFAC T BEST-SELLERS

The Recording and Reproduction of SOUND, by Oliver Read. The complete, authoritative treatment of the entire subject of Sound, written by the editor of *Radio & Television News*... **\$5.00**

Photofact Television Course. The book used by thousands; gives you a clear understanding of TV principles, operation and practice... **\$3.00**

Television Antennas. Shows you how to select and install the proper antenna, and how to overcome antenna problems... **\$1.25**

1948 Record Changer Manual. Covers 45 models made in 1948, including new LP and dual-speed changers, plus leading wire recorders. Based on actual analysis of the equipment... **\$6.75**

Auto Radio Manual. Complete Photofact service data on more than 100 post-war auto radio models—a time-and-money-saver... **\$4.95**

HOWARD W. SAMS & CO., INC. INDIANAPOLIS 1, IND.

NOTE: This FREE offer is limited to Service Technicians. Attach coupon below to your letterhead and mention the name of your jobber. If you have no letterhead, send coupon to your jobber. Experimenters and others may obtain the Photofact Folder by remitting 50c.

**HOWARD W. SAMS & CO., INC.
955 N. Rural St., Indianapolis 1, Ind.**

- Send FREE Photofact Cumulative Index
- Send Full Easy-Pay Details

I am a Service Technician:

- Send FREE Photofact Folder for set model

I am an Experimenter:

- Send Photofact Folder for set model (50c enclosed)

Name

Address

City Zone State

WHERE TO BUY IT . . .

WHOLESALE RADIO

of Baltimore

New Low Price! PHILMORE'S

16" T. V. KIT

31 TUBE CHASSIS

With Voltage Doubler Pack

4 MC BAND WIDTH

\$179.95

Less Picture Tube

Complete with 16" brackets, plastic sleeves and line. The only kit with TUNER, VIDEO and SOUND IF CHANNELS completely wired and precisely pre-aligned. (Circuits similar to 630TS and 826TS. Order Model KP-30-D)

Save Money! Get Top Quality

Sheldon Custom-Made "Telegenic"

T.V. PICTURE TUBESFlat Face, Magnetic Focus and Deflection
Natural Image! Soft Glow!

10BP4—10" \$23.95
12LP4—12" \$31.00
16HP4—16" \$48.50

13 MONTH GUARANTEE

Save Money On Your

Test Equipment

QUICK . . . EASY TO ASSEMBLE

EICO KITS**5" SCOPE**Model **\$39.95**

400-K

For AM, FM & T.V. Horizontal sweep 15 to 30,000 cycles. Linear sweep with 884. Electronic Graph screen for measuring peak to peak voltage. Horizontal and vertical frequency response from 50 cycles to 50 Kc. Input impedance 1 meg. and 50 mmfd. Provision for ext. sync. test voltage and intensity modulation. Detailed instructions and picture diagrams included. NOTHING ELSE TO BUY. Operate on 105-130 volts ac, 50-60 cycles. Size 8 1/2" w. x 13" h. x 17" long.

**NEW! SIGNAL GENERATOR KIT**
EICO MODEL 320 K

A top quality signal generator for every servicing need. Can be used for FM, AM alignment and to provide TV marker frequencies. Range 150 kc. to 100 mc in 6 bands, with fundamentals to 34 mc. Pure 400 cycle audio by a composite type audio oscillator. Easy to follow schematic diagrams. Included. Complete with tubes.

\$19.95**EICO VACUUM TUBE VOLTMETER**

High precision. Tops in work bench versatility. 15 different ranges. Double triode balanced bridge circuit. Easy to follow instructions. Model 221-K.

\$23.95**NEW! EICO MULTI-SIGNAL TRACER**

High gain, hi frequency instrument. Self contained test streaker permits audible signal tracing of RF, IF and FM audio and video outputs. Complete with tubes and diode probe. In kit form.

\$18.95

Write for Free "FYI" Bulletin
Address Orders to Dept. QR-93
or Call Mulberry 2134

WHOLESALE
RADIO PARTS CO., Inc.
311 W. Baltimore St.
BALTIMORE 1, MD.

Next, let us increase the current through the filament until the filament is a bright cherry red, and then let us repeat our step-by-step increasing of the plate voltage, again carefully noting the changes in the readings of the voltmeter and the milliammeter. Finally, let us combine the results of these two observations in one graph, Fig. 3.

From this graph we can see that as the plate voltage increases, the plate current for the low-filament-current condition also increases, rapidly at first and then leveling off until a further increase in plate voltage produces practically no increase in plate current. The same thing is true after we have increased the filament current, but now the leveling-off point occurs at a higher value of plate current. For low plate voltages, the plate current is practically the same for high or low values of filament current.

The total number of electrons emitted from the filament depends upon its temperature, which in turn depends upon the current passing through it. The total number of electrons attracted to the plate depends upon, first, how many are emitted by the filament and, second, what percentage of these the attraction of the plate voltage can win over from the attraction of the filament itself. The higher the plate voltage, the higher is this percentage.

When our filament glowed a dull red, a limited amount of electrons were released. When the plate voltage was low, only a small number of these could be attracted to the plate instead of returning to the filament; but as the voltage, and consequently the attraction, of the plate went up, more and more of the available electrons succumbed to its Siren call until finally it was getting all of them. Beyond this point, an increase in plate voltage obviously could not increase the plate current.

When we increased the filament current and raised the temperature of the filament, we increased the number of electrons emitted. Under these conditions, it was necessary to raise the plate voltage still higher before it was attracting the total increased output of the filament. It is apparent that for every value of filament current there is a certain value of plate voltage which will attract all the emitted electrons and beyond which no further increase will result in more plate current. This maximum current is called the *saturation current* of the tube, and it is important that the tube be so designed that this saturation condition is never reached with the normal values of filament current and plate voltage that are applied.

Why the vacuum?

Perhaps you are wondering why there is a "vacuum" in vacuum tubes. Emission will take place in the open air, but there are two good reasons for placing our tube elements inside a vacuum. In the first place, if the filament

were heated red-hot in the open air, it would oxidize quickly and be destroyed. In the second place, if the space between the filament and the plate were not emptied, the poor little electron would have a tough time trying to shoulder its way through the bulky atoms of air and gas which have a mass some 1,800 times that of its own.

The two-element tube that we have been studying is a fundamental type, as we shall note in the next chapter, yet this *diode*, as it is called, is used in some form or other in nearly every radio and television set on the market today. Moreover, it is subject to practically all the ills suffered by its more complicated brethren.

If the filament breaks, we have no way of raising the temperature to the emitting point; and "open" filaments are one of the most common causes of tube failure. It is equally obvious that if any two elements, such as the filament and plate, actually touch each other, the tube cannot function normally. This "shorted element" route is one by which many tubes reach the junk pile.

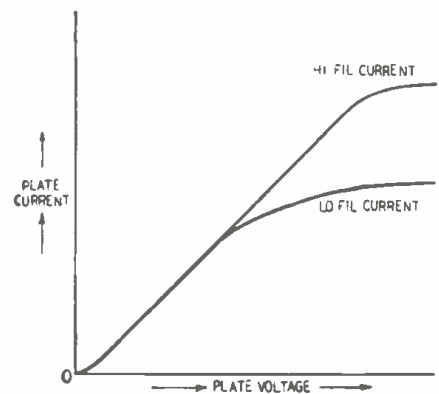

Fig. 3—Hotter cathode emits more.

As was pointed out before, the operation of the tube depends upon the elements being housed in a good vacuum, and anything that impairs this vacuum will ruin the operation of the tube. Occasionally minute amounts of gas remain in the tube or escape from some of the elements after sealing; then the tube becomes "gassy." Gassy tubes cause many headaches in the radio repair business, for they are not always as easy to detect as other defective types.

Even under normal conditions, the electron emission of a filament or cathode will fall off after a while, and this deterioration will be speeded up if the tube is subjected to overloads. Such reduced emission results in the "weak" tubes indicated by a tube tester.

Poor connections between the leads and the tube elements can result in "noisy" tubes that make a rasping, staticlike sound in the speaker; and if the various elements are not held rigidly in place, the tube will often make a ringing sound come from the speaker when the tube is touched or bumped. Such tubes, because they behave like a microphone, are called "microphonic."

COMPLETE TRAINING

**FOR BETTER JOBS
in Radio-Electronics**

Ghirardi's BIG-3

RADIO SERVICING LIBRARY

Here are three world-famous books so thoroughly covering radio theory, troubleshooting and servicing methods; so clearly explaining every phase of the work that, with a minimum of time, you'll soon be able to handle repairs and installations on any type of Radio-Electronic equipment. And that means you'll train quickly to qualify for better jobs, bigger pay checks and greater efficiency. You couldn't get a finer, more complete or easier-to-understand training course AT ANY PRICE. Remember! These are the same Ghirardi books that were more widely used for wartime training than any other books or courses of their type!

NEW LOW PRICE FOR THE COMPLETE SET

Bought singly, the books in this fact-packed library would cost you \$15. Under this special offer, you save \$1 if you buy all 3! No waiting for monthly lessons. You learn fast—and you learn right!

Let A. A. Ghirardi train you for radio-electronics—AT ABSOLUTE MINIMUM COST. Starting with the fundamentals of basic electricity, these 3 big books take you through the efficient radio testing, adjusting and repair procedures that mean time saving and more profitable work. Hundreds of working facts on tubes, color codes, transformers, resistors, capacitors, record changers, other components and more than 4,000 sets by over 200 manufacturers help you solve job snags in record time. You'll train fast and easily to repair ANY RADIO-ELECTRONIC EQUIPMENT EVER MADE better, faster and more profitably!

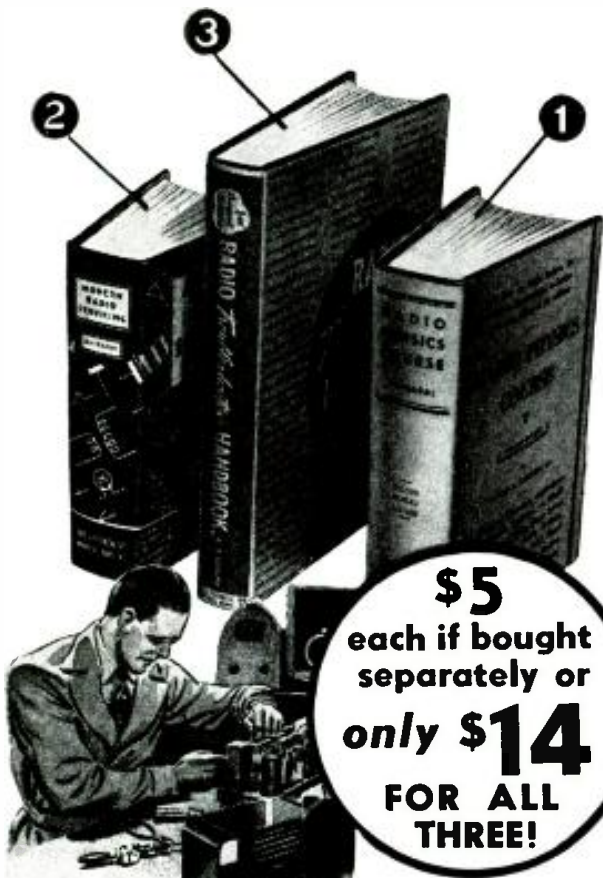

\$5
each if bought
separately or
only \$14
FOR ALL
THREE!

1—RADIO PHYSICS COURSE

Complete Basic Training for Beginners

No matter what part of Radio-Electronics-Television work you plan to enter, a knowledge of basic fundamentals is essential. Ghirardi's famous RADIO PHYSICS COURSE gives exactly the training you need—at a price you can afford to pay. Moreover, it makes even the most difficult subjects amazingly easy to understand. If broken into "course" form and sent to you as monthly lessons, you'd regard it as a bargain at \$50 or more. Instead you buy it for only \$5 and learn as fast as spare reading time permits. Many have completed this complete, basic training in a few weeks! 972 pages; 508 clear illustrations; 856 self-test review questions that make study easy. Price \$5 if bought singly.

3—RADIO TROUBLESHOOTER'S HANDBOOK

*Cuts Service Time in Half on 4
Jobs Out of 5*

This is the most recent of the 3 big Ghirardi books—and the handiest of all for the man who knows his way around in radio servicing. Just refer to RADIO TROUBLESHOOTER'S HANDBOOK for specific data on the radio you want to repair. It covers common troubles, their symptoms and complete repair methods for over 4,800 receivers by 202 leading set manufacturers. It eliminates useless testing, saves time on literally hundreds of jobs. Over 300 additional pages contain tube data, charts, etc. to help you work faster, better, more profitably on any radio ever made. Contains 744 manual-size pages. Weighs almost 4 lbs. Only \$5. Use coupon. See money-saving offer on all 3 Ghirardi books!

2—MODERN RADIO SERVICING

*Complete Professional Training in Test,
Instruments, Troubleshooting, Repair*

Ghirardi's 1300-page MODERN RADIO SERVICING is more widely used than any other book of its type—because it makes every phase of professional Radio-Electronic servicing so easy to learn. Once you've studied the basic fundamentals as outlined in Ghirardi's RADIO PHYSICS COURSE (No. 1) this big book teaches you to work by the modern, professional service methods that command the highest pay. Explains service instruments and when, where and just why to use each type. Tells how to trouble-shoot, analyze circuits, test circuits, test individual components and make all kinds of repairs, adjustments and installations. Includes complete facts and data on starting a successful service business of your own. 706 illustrations. Price \$5 if bought separately—but see special offer on all 3 Ghirardi books.

10 DAY MONEY-BACK GUARANTEE

Dept. RE-119. MURRAY HILL BOOKS, Inc.,
232 Madison Ave., New York 16, N. Y.

Enclosed find \$..... for books checked; or send C.O.D. (in U. S. A. only) and I will pay postman this amount plus a few cents postage. In either event, it is understood I may return books after 10 days and you guarantee to refund the purchase price.

- SPECIAL OFFER: All three of these big Ghirardi books only \$14 (\$15.50 outside U.S.A.)**
- Ghirardi's RADIO PHYSICS COURSE, \$5 (\$5.50 outside U.S.A.)
- Ghirardi's MODERN RADIO SERVICING, \$5 (\$5.50 outside U.S.A.)
- Ghirardi's RADIO TROUBLESHOOTER'S HANDBOOK, \$5 (\$5.50 outside U.S.A.)

Address.....

Name.....

City, Zone, State.....

European Report

By Major Ralph W. Hallows

RADIO-ELECTRONICS LONDON CORRESPONDENT

show was open I was otherwise engaged in looking after anti-aircraft guns in the wide marshes near the mouth of the River Thames. I attended my first radio show as a youngster, thrilled by the marvels of what was then called wireless. I go now as a dyed-in-the-wool old-timer. I'm pretty well stunt-proof by now, but I get as big a thrill as ever I did out of the genuine advances in radio, radar, and television techniques that one is sure of finding at every Radiolympia.

The scope of Radiolympia has been very much enlarged. This year it covered not only broadcasting, but every form of telecommunications, besides television and land, sea and air radar. A word about TV first. Two important tendencies were noticeable here. Number one is the virtual disappearance of the small-image receiver using a 5-, 6-, or 7-inch tube and designed to attract the purchaser by its low price. Time has shown that the smallest image which folks will accept is one of about 45 square inches. The 8-inch tube is therefore almost the minimum size in televisers nowadays, and even that is not overpopular. Many people prefer to put off purchasing until they can afford a set giving at least a 63-square-inch picture. And that, I rather imagine, is going to be the standard for mass-produced, popular-priced British TV receivers.

In this connection there is an interesting advance in C-R tube construction by the British General Electric Co. The maximum size of the image that a tube of given size can show depends largely upon how much of its screen is wasted because of the curvature of the glass



THE first British Radio Exhibition, in the far-away days when broadcasting was a new thing, wasn't held at Olympia. The number of receivers in use away back then in 1922 or '23 (I forget which), cannot have been much over 30,000. Nor were there many radio manufacturers. The organizers felt that a hall of modest size would answer the needs of both public and manufacturers. Actually, the show was almost overwhelmed by the flood of visitors. It was staged the following year in the great London building known as Olympia, and there it has been held ever since, except during the war years and in 1948. I can claim an unbroken attendance record from the very first pre-Olympia show to the present time, except for 1939. The exhibition was held that year, but in September, 1939, the war began for us; hence during the few days that the

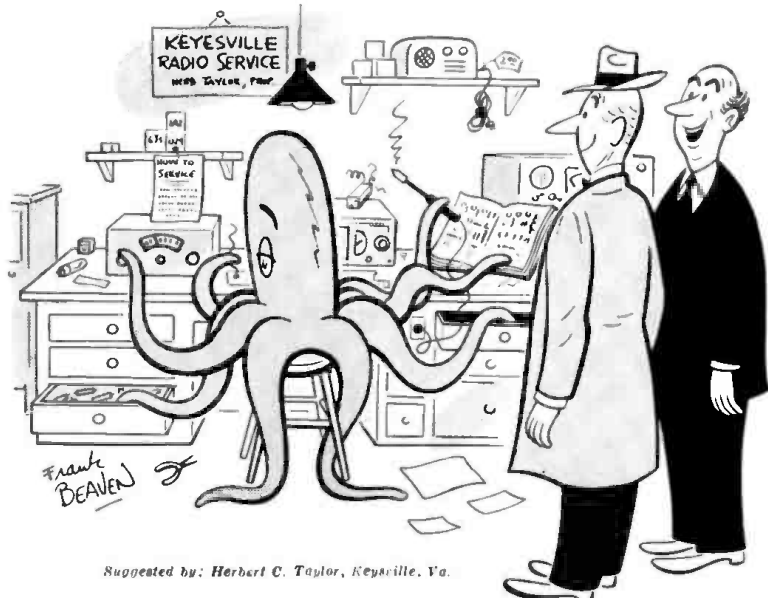

Suggested by: Herbert C. Taylor, Keyesville, Va.

"It took me quite a while to train him. He's worth three servicemen."

RADIO-ELECTRONICS for

TEICO PRESENTS

OUTSTANDING PRECISION
INSTRUMENT KITS



MODEL 221-K VTVM KIT

Build this High Precision Vacuum Tube differential meter. 15 different ranges! AC and DC ranges: 0/5/10/100/500/1000 volts. Ohm-meter range: 2 ohms to 1 megohm. Zero Center for TV discriminator alignment. Big 4 1/2" meter cannot burn out. Double triode balanced bridge circuit assures stable, guaranteed performance. 110-130 V. AC 50-60 cycle. Size 9 7/16" x 6" x 5".

\$23.95

FACTORY-WIRED VTVM Model 221. Same, but completely wired, calibrated, and tested. **\$49.95**



You Build 'Em In One Evening—
THEY LAST A LIFETIME!

NEW! Sensational TV-FM

SWEEP SIGNAL GENERATOR KIT

Model 360-K. • Crystal marker oscillator with variable amplitude. • Covers all TV and FM alignment frequencies between 500 kc and 228 mc. • Sweep-width variable from 0.30 mc. with mechanical inductive sweep. • All TV and FM Channels marked directly on panel for instantaneous reference. • Provides for injection with external signal generator marker. • Phasing control included. • Vernier driven, tuning dial for master oscillator directly calibrated in frequencies. • 3-color etched panel, and durable steel cabinet. • Complete with all tubes: 6X5GT, 12AU7, two 6C4's. Crystal not included. Size: 10" x 8" x 8 3/4".

Complete Kit, only **\$29.95**

FACTORY-BUILT AND TESTED
MODEL 360. Ready to use. **\$39.95**

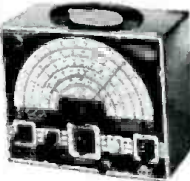

5" SCOPE KIT

Model 400-K. Laboratory precision scope, for FM, AM & TV servicing. Deflection sensitivity: .65 volts per inch full gain. Horizontal sweep circuit. 15 to 30,000 cycles. Frequency response of horizontal and vertical amps is from 50 to 50,000 cycles. Graph screen. Operates on 110 to 130 volts AC, 50-60 cycles. 3-color etched, rub-proof panel. Size: 8 1/2" x 17" x 13" high. 3-color etched panel. **\$39.95**

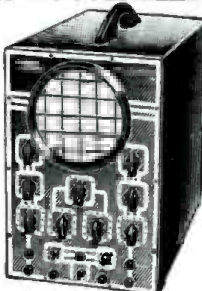

FACTORY-BUILT OSCILLOSCOPE

Model 400. Fully wired, assembled, and tested **\$69.95**

SIGNAL GENERATOR KIT

Model 320-K. For service, school use in FM-AM alignment and to provide TV marker frequencies. Ceramic insulated variable condensers. Highly stable Hartley oscillator has range of 150 kc to 100 mc with fundamentals to 34 mc. Colpitts audio oscillator supplies pure 400 cycle sine wave voltage for modulation. Large 3" dial. Easy-to-read calibrations. Easily aligned. Complete with tubes. 10" x 8" x 4 3/4". 3-color etched panel. **\$19.95**

FACTORY WIRED AND ALIGNED
Model 320. Ready to use. **\$29.95**



SEE THESE INSTRUMENTS AT
YOUR LOCAL JOBBER

Complete simplified instructions and illustrations come with every EICO Instrument Kit. Making it pure enjoyment to build your own equipment. Nothing more to buy. Anyone can build it. Write for catalog C.



ELECTRONIC INSTRUMENT CO., INC.
276 NEWPORT STREET
BROOKLYN 12, N. Y.

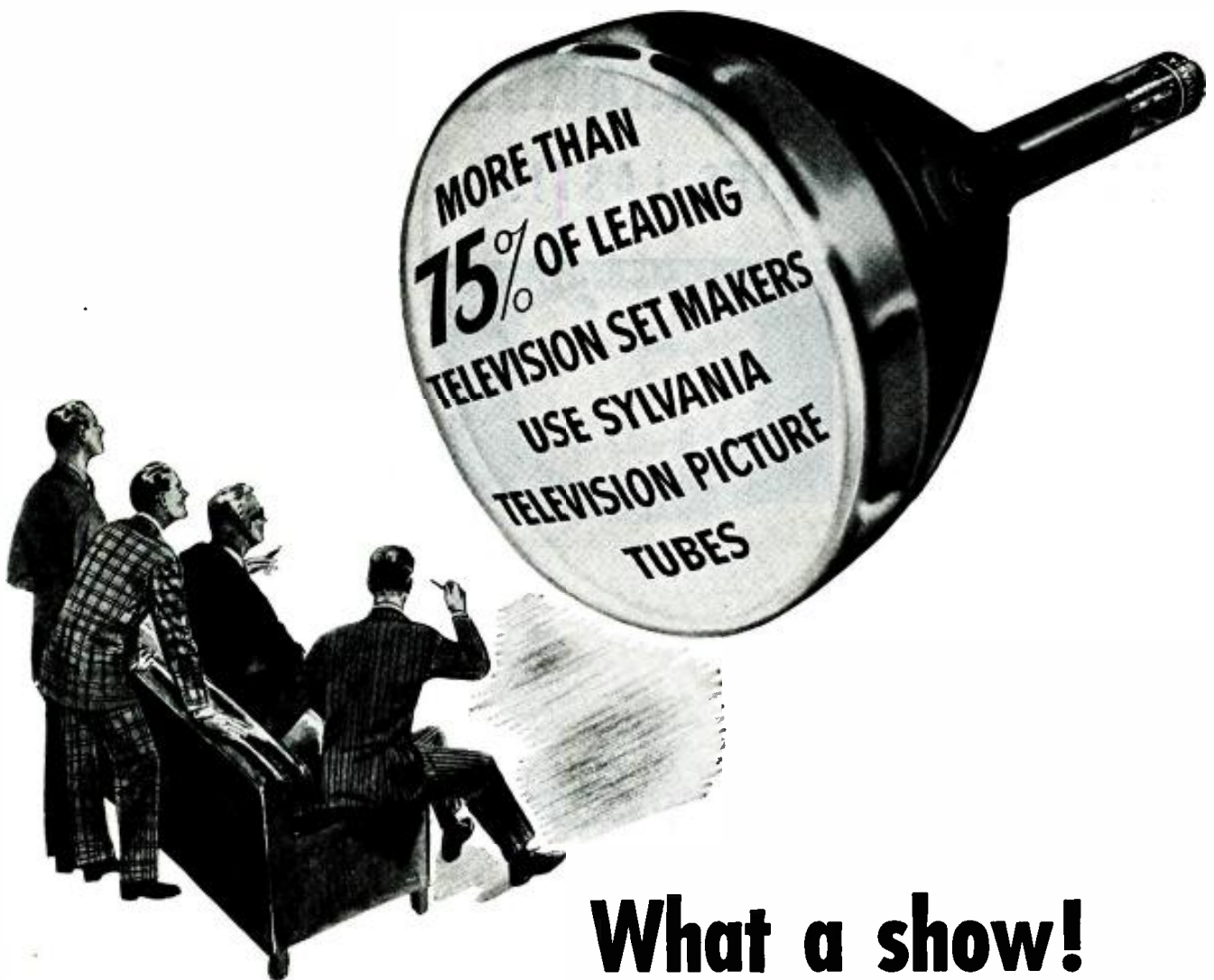

What a show!

A recent intensive survey discloses that among the major television set manufacturers, more than 75% use Sylvania cathode ray tubes!

This impressive showing is a tribute to the research and quality production techniques employed by Sylvania.

You can take advantage of this ready acceptance by having a complete stock of the various types of these television picture tubes so widely used by set makers—who in turn, of course, sell to *your* regular customers. See your Sylvania Distributor about the complete line! For complete data write *Sylvania Electric Products Inc.*, Dept R-1711, Emporium, Pa.

These leading television set manufacturers use Sylvania Television Picture Tubes

Admiral • Air King • Andrea • Ansley • Automatic
 Bendix • Crosley • DeWald • Emerson • Fada
 Farnsworth • Garod • Hollicrafters • Hoffman
 Magnavox • Midwest • Motorola • National • Olympic
 Packard-Bell • Philco • Pilot • Raytheon-Belmont
 Regal • Scott • Sentinel • Silvertone • Sparton
 Stromberg-Carlson • Tele-King • Tele-tone • Temple
 Trav-ler • Westinghouse • Zenith

SYLVANIA ELECTRIC

INVENTORY CLEARANCE

WHILE QUANTITIES LAST!!

METERS (New, or removed from new equipment)

- (A) 7½" Round. (R.S.) 0-50 Amps. D.C. Ammeter Relay. Stand-off type. Less Shunt. \$6.95
- (B) 5" Round (Weston) Zero center ± 500 Microamps. D.C. Blank Scale. Luminous Pointer. \$3.25
- (C) 3½" Fan (Weston) 0-50 V.D.C. \$3.25
- (D) 3" Round (Trip.) 2 Scale. 0-15-300 M.A. D.C. (With 15 M.A. Shunt) \$2.45
- (E) 3" Round (Trip.) 1 M.A. D.C. Spec. Scale. (With 30 V. Multiplier) \$2.85
- (F) 3" Round (Simp.) 0-2.5 Amps. R.F. (With Thermocouple) \$2.50
- (G) 3" Round Stand-off type (G.E.) 0-15 Amps. D.C. \$2.90
- (H) 3" Round Stand-off type (G.E.) 0-50 Volts D.C. \$2.75
- (J) 2" Round (Weston) ±507 Logr. Scale 0-10 Output Units (Basic F.S. 1.2 Ma. D.C.) Wood Case. \$2.35
- (K) 2" Round (Simp.) 0-8 Amps. R.F. \$1.65
- (L) 2" Round (Gruen) 0-150 Volts D.C. \$1.50
- (M) 2" Round (G.E.) 0-50 Amps. D.C. (Less Shunt) (Basic F.S. 5Ma.) \$1.50
- (O) 2" Round (Wstgln.) 2 scale. (With Multiplier) 0-3.5-140 V.D.C. Range Switch On Front. \$1.85
- (P) 2" Round (G.E. or Weston) 0-100 scale. F.S.: 1.2 Ma. D.C. \$1.65
- (R) 2" Square (Heardrite) 0-5 Ma. scale. F.S. 0-10 Volts D.C. 49c

METER ACCESSORIES

- D.C. Ammeter Shunt. Leeco-Neville 200 Amis. .005 Ohms. Mounted. New. 95c
- A.C. Ammeter Current Transformer. Weston #880. Ratio 75:1 50 to 133 Cyc. New. \$1.95

POWER TRANSFORMERS

A selection of various types of power units, some new, some used, all perfect. 10 assorted for \$9.95. Express only.

VHF ANTENNA AT-59/TRC-7

With standard Coax Male base mounting telescopic from 13¾" to 25½" high. Locks at set position. Compact. New—\$4.39

ARR-1 RECEIVER

A beautifully built T.R.F. job. In the 234 to 258 Mc. band. A "natural" for conversion to 1½ meters!! Excellent condition, with tubes and antenna relay box. Approx. SHIP. WT. 8 lbs. Only \$4.95

PE-117 C VIBROPACKS

6-12-24 Volts. Used with SCR-609 and SCR-610 transmitter and receiver. Less tubes and vibrators. Used. In good condition. SHIP. WT. 18 lbs. \$2.75. Express only.

SCR-522 POWER CABLE AND PLUG

Complete assembly in aluminum BX housing. A real time-saver!! Each \$1.00

TOROIDAL PRECISION POTENTIOMETER

For use in electrical computers, servo systems and other control circuits where 360° rotation, high precision and low noise levels are essential. 100 Ohms. New in cartons. Only \$1.19

TRANSMITTING FILTER CONDENSERS

- 4 Mfd. 600 V.D.C. Rect. Can. Oil. 65c
- 4 Mfd. 800 V.D.C. Rect. Can. Paper. 29c
- 1 Mfd. 2000 V.D.C. Round Can. Oil. 39c
- 25 Mfd. 2000 V.D.C. Rect. Can. Oil. 59c
- 25 Mfd. 3000 V.D.C. Round Can. Oil. 69c
- 4 + 4 Mfd. 1500 V.D.C. Rect. Can. Oil. \$2.95
- 2.0 Mfd. 5000 V.D.C. Rect. Can. Oil. \$4.75

HEADSETS

Used, good condition. 69c

CHEST SEYS

With one Headphone and Extended Breast mike Used. 79c

MAGNETIC RECORDING HEADS

(Shure) Low Z for use from voice coil. Slightly scratched, otherwise perfect. 79c

BC-306 ANT. LOADING COIL

As used with RC-375 Transmitter. Contains many usable parts. Variable Dial. RF Switches, etc. Only \$2.25

FENWAL THERMOSWITCHES

8-17, 115 V. 10 Amps. Set at 275 degrees. 5/8" D. X 4 1/4" L. Asbestos covered shielded leads. Variable from -100° to +100° F. at 90° per turn. New 95c



Fit in the Palm of Your Hand!

A complete Transmitter and Receiver Kit for 75-80 meter C.W., incorporating these features - 3 latest multipurpose tubes - Crystal controlled transmitter - Improved regenerative receiver - Built-in A.C./D.C. 110 V. power supply - Plug-in coil for receiver frequency change - Single control operates transmitter or receiver - Same antenna for transmitting or receiving. The "Mitey Mite" is ideal as a beginner's project or as an auxiliary for the old timer. Tests have shown remarkably gratifying results. Get on the air with the "Mitey Mite," while rebuilding the main rig! Tube line-up: 12 8A6 Det., 50B5 Xtal Osc. - Audio Amp. 35W4 Rect. Xmit. Pwr. Inpt. 4 5 W. Over-all Dimensions: 7" x 5" x 3 1/2". Shipping Weight—2 1/2 lbs.

Immediate Delivery
ORDER NOW!
25¢ DEP. BAL. C.O.D.

Complete MITEY-MITE Kit \$9.95

(See key and headset)

SELENIUM RECTIFIERS (Half-Wave) (Ratings with 500 Mfd. Filter)

- Type 1A5-Input 18 V.A.C. Output 14 V.D.C. @ 500 Ma. New. 65c
- Type 1114-Input 28 V.A.C. Output 24 V.D.C. @ 750 Ma. New. 85c

HIGH-CAP FILTER CONDENSERS (Round Metal Can Types)

- 200 Mfd. 40 Volts D.C. 45c
- 500 Mfd. 15 Volts D.C. 39c
- 500 Mfd. 200 Volts D.C. \$1.05
- 800 Mfd. 50 Volts D.C. 65c
- 1000 Mfd. 8 Volts D.C. 3 for \$1.00
- 1000 Mfd. 15 Volts D.C. 45c
- 3000 Mfd. 3 Volts D.C. 3 for \$1.00

COIL FORMS (Smoothing)

All Ceramic. Various sizes. New. 10 for 98c

SHDCK MOUNTS

Assortment of 16 mounts. 4 to a set. New. 69c

RHEDSTAT (Ohmite)

50 Ohms to 25 Amis. Baked enamel wirewound element enclosed in metal container. 1" shaft. New 59c

STAGE DIMMING RHEOSTAT

Heavy duty porcelain baked element. Commutator segment type contacts. Rating: 600 Volts; 12.5 Ohms; 10 3.0 Amis. Ward Leonard. 6 3/4" Diam. 3" deep. Panel mounting. complete. like new. Each \$2.75

POTENTIOMETER

(I.R.C. Silent Spiral) 5000 Ohms with Universal shaft. Brand new in original cartons. Each 39c. 3 for \$1.00

CIRCUIT BREAKERS (Magnetic Types)

G.E. Type AP-1. 35 Amp. 250 V. One circuit. New. \$1.85

Square D Type-M. 20 Amp. 120-210 V. Two circuits. New. \$1.75

OUNGER TRANSFORMERS

W-2262-1. AF Output. Pri. Impedance: 10,000 Ohms. Sec. Impedance: 4000 Ohms. Tapped at 250 Ohms. Metal can; 1 1/2" L. X 1 1/2" O.D. Overall. 10 1/2" at 75 Mw. 400 Cyc. 20% at 75 Mw. or 250 Cyc. Response: 250 to 2500 Cyc. ± 3 dB Glass sealed. New 49c each. 3 for \$1.00.

7-2515-2. Pri. Impedance: 5000 Ohms. Sec. Impedance: 250 Ohms. Size: 1 1/2" L. X 1 1/2" Overall. Diagram on case. Hermetically sealed. New. 39c each. 3 for \$1.00.

ELECTRONIC PACKAGE

10 Lbs. of assorted Electronic units and parts. \$1.29 quantities are limited—Order now. Minimum order—\$2.00 25% deposit required balance C.O.D. There will be a 25¢ packing charge for all orders under \$2.00. All orders shipped F.O.B. Chicago, Illinois. Any orders received without shipping instructions will be shipped Railway Express. Minimum foreign order \$25.00.

near its rim. To be acceptable to the eye, the image must be nearly flat, and this definitely limits the screen area that can be usefully employed. G-E has developed a new way of making the glass envelopes of tubes which allows the whole screen to be very nearly flat to within a short distance of the rim.

The secondary tendency is toward a brighter image. People are no longer content to have to draw blinds and curtains when they want to use the television by day, or to switch off most of the lights after dark. The aluminized screen is playing an important part here. Tubes fitted with it are not necessarily more expensive than others, and the process definitely insures a much brighter picture without the use of anything beyond normal high-voltage.

Many a housewife has told me in the past that the thing she would most like to have was a radio receiver of triangular cross section, which would fit into a corner of a room, standing on a wall bracket if a table model, or on the floor if a console. Some years ago I tried unsuccessfully to design such a set; tubes and other components of the old dimensions just didn't lend themselves to a triangular chassis. So much space had to be wasted that the resulting set was far from being a neat and compact piece of domestic furniture. I regretted this, for, if it could be realized, the corner set would have advantages far beyond its appeal to the feminine eye. The walls of the room would form an extension to its loudspeaker's baffle board and should also insure an almost ideal distribution of sound waves.

Miniature tubes and miniaturized components have made the corner set something more than a dream nowadays. Several of our firms showed models at Olympia, and I am looking forward to practical tests at home.

The corner radio doesn't stop there. The corner television has also appeared at the Exhibition and to me it seems to offer a very promising line of development. It is neat and space-saving; its loudspeaker profits in the way already mentioned from the convergence of the walls on its baffle. But there is more in it than just that. Its corner position makes it easier to arrange seats for a number of viewers. And there's another point. The corner set means that when need be, TV looking-in can be confined to just one part of the living room. There alone must lights be switched off. Those who want to read or to sew in other parts of the room can have all the illumination they require.

Phonographs and radiophonographs have always played an important part in our domestic entertainment. I believe, in fact, that Britons make more general use than Americans do of the record and the reproducer. That, possibly, is because the BBC offers a considerably smaller choice of radio programs than American stations. In the average home the more or less standard four- or five-tube superhet gives a

(Continued on page 66)

RADIO-ELECTRONICS for

UNITED SURPLUS MATERIALS

314 SOUTH HALSTED STREET

CHICAGO 6, ILL.

Sound Advice From One Serviceman To Another!

MAC'S Radio REPAIR

Choteau, Montana PHONE 71
BOX 619

John F. Rider Publisher, Inc.
480 Canal Street
New York 13, N. Y.

Rumors are running around financial circles to the effect that a good many ex G.I. radiomen who have gone into business for themselves are practically starving to death. I can well believe such rumors since I am an ex G.I., and after a year and a half I am just beginning to pull away from the deep part of that red ink pool. I think Dun & Bradstreet, Inc. still list me as a good cash-on-the-line customer. Since the above-mentioned rumors are probably true, I would like to take advantage of your advertising department to pass on some tips to ex G.I.'s who are now in or who contemplate entering the radio repair business.

A man entering radio repair must have some working capital, a good working knowledge of radio, adequate test equipment, and a GOOD REFERENCE LIBRARY. That good reference library cannot be stressed too much, because the big jobs, the mean jobs, and the tough jobs are dependent on that library.

Unfortunately there are quite a few radio wreckers operating, and the only complete key that I have found for setting those radios right is the use of Rider's manuals. If the manufacturer has made changes in the set, those changes are included in Rider's. In most cases all other changes should be discarded and the radio re-assembled according to schematic.

The SPEED with which repair work is completed has much to do with income. In the interest of speedy repair I recommend Rider's. A customer who is PLEASED with the work done on his radio doesn't mind paying a good price for it. Rider's manuals give you the information on nearly every radio made and if used will mean pleased customers. REPEAT BUSINESS and word-of-mouth advertising means extra money in your pocket. By doing conscientious work that proves satisfactory you will get both repeat business and good advertising.

There are many shops operating without Rider manuals, and that is especially true of newcomers to the business. I am sure that many of the newcomers will find that an investment in a complete set of Rider's manuals will mean the difference between success and failure in their business.

I have written this with the hope that it will help some of the boys who are busy pulling out what little hair is left in their heads, and also with the hope that it will serve to help a lot of men improve their work and thus give a better name to our business.

Yours truly,

A. E. McCorkle
A. E. McCORKLE



"HIWYNI"

This is not a code. It is simply an abbreviation of a very important condition in the operating life of a service shop. HIWYNI means **HAVE IT WHEN YOU NEED IT.** It applies to many things, but especially to RIDER MANUALS. Make sure that you have a complete library of RIDER MANUALS on hand at all times.

NOTE: Are you receiving your copy of "Successful Servicing"? It's Rider's own publication of interest to every serviceman. In it you will find all of the circuit changes in sets... as soon as they are released. It's FREE!

NOTE: The Mallory Radio Service Encyclopedia, 6th edition, makes reference to only one source of radio receiver schematics—Rider Manuals. ANOTHER NOTE: The C-D Capacitor Manual for Radio Servicing, 1948 edition No. 4, makes reference to only one source of receiver schematics—Rider Manuals.

These RIDER books are the result of twenty years of specialized publishing for the Radio Servicing Industry

- | | | |
|--|---|--|
| Television Manual, Volume 2 (Plus "How It Works" and Index) \$18.00 | Automatic Frequency Control Systems, 144 pages \$1.75 | Inside the Vacuum Tube, 424 pages, illustrated \$4.50 |
| Television Manual, Volume 1 (Plus "How It Works" and Index) \$18.00 | Servicing Superheterodynes, 288 pages, illustrated \$2.00 | Cathode-Ray Tube At Work, 338 pages, illustrated \$4.00 |
| PA Equipment Manual, Volume I \$18.00 | An-Hour-A-Day with Rider Series: "Alternating Currents in Radio Receivers" \$1.00 | Servicing by Signal Tracing, 360 pages, illustrated \$4.00 |
| Volume XIX \$19.80 | "D.C. Voltage Distribution" \$1.00 | Servicing by Signal Tracing, (Spanish Edition), 404 pages, illustrated \$4.00 |
| Volume XVIII \$19.80 | "Resonance and Alignment" \$1.00 | Understanding Vectors and Phase, 160 pages, paper binding, 99c cloth \$1.89 |
| Volume XVII \$16.50 | "Automatic Volume Control" \$1.25 | Vacuum Tube Voltmeters, 180 pages, illustrated \$2.50 |
| Volume XVI \$8.40 | Servicing Receivers By Means of Resistance Measurements, 203 pages \$2.00 | Understanding Microwaves, 385 pages, illustrated \$6.00 |
| Volume XV \$19.80 | Aligning Philco Receivers, Two Volumes, Vol. I, 1929 to 1936, 176 pages, Vol. II, 1937 to 1941, 200 pages, Each Volume \$2.00 | A. C. Calculation Charts, 160 pages, 9 1/2" x 12" \$7.50 |
| Volumes XIV to VII (each volume) \$16.50 | Radar—What It Is, 72 pages \$1.00 | High Frequency Measuring Techniques Using Transmission Lines, 64 pages, illustrated \$1.50 |
| Volume VI \$12.50 | FM Transmission and Reception, by John F. Rider and Seymour D. Usilan, 416 pages, illustrated \$3.60 | The Meter at Work, 152 pages, illustrated \$2.00 |
| Abridged Manuals I to V (one volume) \$19.80 | Broadcast Operator's Handbook, by Harold E. Ennes, 288 pages, illustrated \$3.30 | The Radio Amateur's Beam Pointer Guide, 32 pages \$1.00 |
| Record Changers and Recorders, \$9.00 | | |
| Master Index, Covering Manuals, Vols. I to XV \$1.50 | | |
| TV, How It Works, 203 pages \$2.70 | | |
| TV Picture Projection and Enlargement \$3.30 | | |
| Installation and Servicing of Low-Power PA Systems, 208 pages \$1.89 | | |
| The Oscillator At Work, 256 pages, illustrated \$2.50 | | |

JOHN F. RIDER PUBLISHER, INC. • 480 Canal Street, New York 13, N. Y.
Export Agent: Rocks International Corp., 13 East 40th Street, New York City • Cables: ARLAB

RIDER MANUALS mean Successful Servicing!

BEFORE YOU
ATTEMPT REMOTE
INSTALLATIONS -

check with

telrex

because

TELREX CONICAL "V" BEAM ANTENNAS

are performance-proved

Up to 200 miles over land and up to
300 miles over all-water TV paths



For both remote or high signal areas, Telrex Conical Window Mounts, Stacked Bi-Directionals and Stacked Arrays are the antennas dealers and service men can depend upon for consistently good results. Each type is thoroughly engineered in the laboratory, service-tested in the field and built for long service life. Using Telrex Conical Antennas on every installation is one sure way to better, brighter pictures and a minimum of service call backs. Ask your distributor for catalog or write direct outlining your antenna problems.

**TELREX ANTENNAS COVER CHANNELS 2 TO 13
AND FM—NO HIGH FREQUENCY HEAD NEEDED**

**TELREX
MODEL 1X-BD**

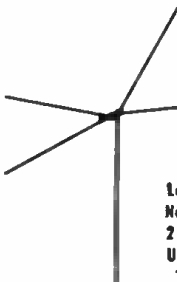

Bi-Directional Hi-Gain
Conical "V" Beam
Broad Band Full Audio
and Video Band Pass
Low Vertical Angle
Non-Varying Center Impedance
2 to 1 Front to Back Ratio
Uses 72, 150 or 300 Ohm
Transmission Lines
Universal Mounting Clamp

TELREX MODEL 2X-BD

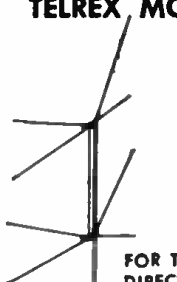

Bi-Directional Stacked
Conical "V" Beam
Low Vertical Angle
Extremely High Signal to
Noise Ratio
Constant Center Impedance
Uses 72, 150 or 300 Ohm
Transmission Lines
Universal Mounting Clamp

FOR THE ULTIMATE IN BI-
DIRECTIONAL GAIN, USE
TELREX MODEL 4X BD.

PATENT PENDING

TELREX MODEL 4X-TV

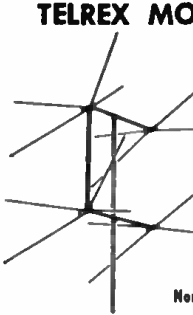

2 Bay Uni-Directional
Conical "V" Beam
Broad Band—Full
Audio and Video
Band Pass
Low Vertical Angle,
Minimum Reflections
Maximum Signal
to Noise Ratio
4 to 1 Front to Back
Ratio All Frequencies
Non-Varying Center Impedance
Universal Mounting Clamp

**TELREX
SUPEREX**

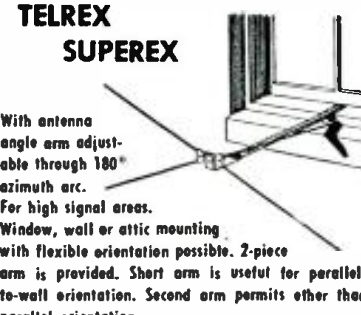

With antenna
angle arm adjust-
able through 180°
azimuth arc.
For high signal areas.
Window, wall or attic mounting
with flexible orientation possible. 2-piece
arm is provided. Short arm is useful for parallel-
to-wall orientation. Second arm permits other than
parallel orientation.

ALL TELREX ELEMENTS ARE MADE OF LASTING DURAL

COPYRIGHTED 1949

telrex·INC

ASBURY PARK 10, NEW JERSEY

AMERICA'S
OUTSTANDING
TELEVISION
BEAM

choice of three local programs, the Home Program (middle-brow), the Light (low-brow), and the Third (definitely high-brow). There are scores of possible alternatives from the continent of Europe, but fading, static (man-made or natural), heterodyne whistles, and other forms of interference severely narrow the choice. The number of worthwhile alternatives available to the discriminating listener is thus comparatively small. For these reasons the radiophonograph is very popular and there is great encouragement to manufacturers to develop its possibilities in the fullest way.

Phonograph record nowadays are appearing in an almost bewildering diversity of types. Diameters range from 10 to 18 inches; playing speeds from 33 $\frac{1}{3}$ to 78 revolutions per minute; maximum audio frequencies from 8,000 to 20,000 cycles; recording systems from the standard to the microgroove; playing times from 2 $\frac{1}{2}$ minutes upward. The demand here is for instruments that can deal faithfully with records of a wide variety of different types. This year's Radiolympia showed that the demand is being well met. There was, in fact, at least one instrument whose makers claim that it can play any type of record now on the market.

The discriminating listener, by the way, was well looked after at Radiolympia, for he could try out the radios, the phonographs, or the radiophonographs in sound-proof rooms specially provided for such purposes. And while he was thinking over his choice he could find diversion by flattening his nose against the glass walls of BBC's television studio or by gazing at the pictures of London "printed" on the PPI tubes of radar sets with the aid of a scanner revolving above the roof of Olympia.

SUB-MINIATURE

PRINTED ELECTRONIC CIRCUITS

Components and assemblies available from stock! Circuits printed on ceramic, plastic and paper bases • Designed for miniature radio and electronic applications.

SAMPLES

- Single Stage Circuits
- Voltage Amplifier
- Power Amplifier
- .85 x 1.90 x .285 in.

High temperature resistors, silver leads and capacitors fired on special vitreous base. Complete amplifier less popular brand subminiature tube \$2.99 each. State amplifier desired. C.O.D. orders.

PLASTICS & ELECTRONICS COMPANY
272 Northland Ave. Buffalo 8, New York

**"ALL-SEE"
TRANSPARENT
BOXES!**

- Safe and Loss-Proof
Containers for
- Screws
 - Nuts
 - Small Parts

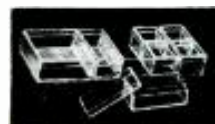

Guard those small parts—so easy to lose and very hard to replace—with a set of these "All-See" Plastic transparent containers and covers. Assure easy and safe storage. Pay for themselves!

Each set contains: one box, 1 $\frac{1}{2}$ " sq.; five boxes, 1 $\frac{1}{2}$ " x 1 $\frac{1}{2}$ " sq.; four boxes, 1 $\frac{1}{2}$ " x 1 $\frac{1}{2}$ " sq. 10 boxes in all. Transparent case. Order a set for yourself and a set for that tinkering pal of yours. An inexpensive and unusual gift. No C.O.D.'s, please. Remit \$1 for each order complete set (6 for \$5). Or send for FREE leaflet RC.

**CARGILLE, Dept. RC, 116 Liberty St.
New York, N. Y.**

NEW SUBSCRIPTION ORDER

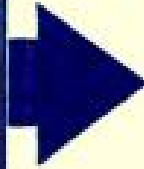

RADIO - ELECTRONICS

formerly RADIO-CRAFT

Please enter my subscription for 3 years \$8.00

1 year \$3.50 2 years \$6.00

Remittance enclosed I'll pay when billed

(Please print clearly)

Name

State

Street

Zone

City

Company

Position

Canada, Mexico, South and Central
America, same as U. S. A. All other
foreign \$1.00 extra for each year.

RADIO-ELECTRONICS, 25 West B'way, New York 7, N. Y.

BUSINESS REPLY CARD
NO POSTAGE NECESSARY IF MAILED IN U. S. A.

2c Postage will be paid by

**RADIO -
ELECTRONICS**

formerly **RADIO-CRAFT**

**25 WEST BROADWAY
NEW YORK 7, N. Y.**

FIRST CLASS
PERMIT NO. 3062
SEC. 510, P. L. & R.
NEW YORK, N. Y.



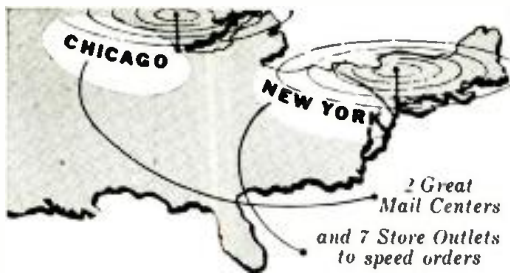

Lafayette

RADIO ELECTRO NEWS

★ ★ ★ ★ 29 YEARS SERVING & SAVING MONEY AND TIME FOR 500,000 HAPPY CUSTOMERS ★ ★ ★ ★

NEW CATALOG SO HOT IT NEEDS ASBESTOS COVERS!

5 SPEAKER BARGAINS — Big Values Speak Volumes!



15" PM SPEAKER
Here's Mr. Big among speakers. 25-watt rating guarantees power to spare with a minimum of distortion. Massive 1½ lb. permanent magnet; 6 to 8 ohm voice coil; extended bass and treble range. Dollars less than anything in its class!

No. 99N7034R **\$12.95**
(weight: 9 lbs.)



12" RCA SPEAKER
Where else can you buy a genuine, brand new RCA 12" speaker at this price? 15 watt capacity. 6.8 oz. Alnico V magnet. Voice coil impedance of 3.2 ohms. A terrific value. Don't pass it up.

No. 99N7023R (weight: 6 lbs.) **\$4.75**

10" ALNICO PM SPEAKER
Fine performance at a new low in price. 10 watt cap. 6.8 oz. Alnico V magnet. Voice coil impedance of 3.4 ohms.

No. 99N7019R (weight: 5 lbs.) **\$3.15**

12" ALNICO PM SPEAKER
Handles 14 to 18 watts with excellent sound quality. 6.8 oz. Alnico V magnet. 6-8 ohm voice coil. Ideal for use with FM receiver or P.A. system.

No. 99H7010R (weight: 6 lbs.) **\$5.95**

4" x 6" OVAL SPEAKER
Alnico V 1.47 oz. 3½" x 4¾" mounting centers. Dustproof cap. 3-4 ohms V.C. impedance. Rated 3 watts. 4½ peak. Less transformer.

No. 99N7012R (weight: 3 lbs.) **\$1.29**

IT'S FREE!



BUMPER CROP OF VALUES
PROVE U-PAY LESS AT LAFAYETTE!

SAVE ON THESE 2 MOTORS

EVEN SPEED



PHONO MOTOR

Rim-driven. 9" turntable. Constant speed (78 rpm). self-starting. 110 V., 60 cycles only.

No. 99N8003R (weight: 6 lbs.) **\$2.25**



POWER TRANSFORMER

A real bargain! Single shell mtk. electrostatically shielded. Extruded shell for 2-hole mounting. Primary 117 V. 50/60 cycles. Secondary output: 600 V. CT at 50 mil. 6.3 V. at 2A. 5V. CT at 2A. Color-coded leads.

No. 99N5156R (weight: 3 lbs.) **\$1.39**



1/20 HP MOTOR

Many uses for this fine 1/20 hp motor. 2900 rpm. 115 v., 50-60 cycles. AC. 3¼" x 2¾" x 3½" high. Shaft ¼" dia., ¾" long.

No. 99N7079R (weight: 3 lbs.) **\$3.89**

Here's Value!

Special Buy!



FILTER CHOKE

Excellent quality 25 Henry Filter Choke. 60 M.A., 200 ohms DC resistance. Unshielded, strap type mounting. Overall dimensions 2¾" x 2" x 1½". Mtg. center 2¾".

No. 99N5155R (weight: 8 oz.) **\$4.95**

CONDENSER KIT Buy!

Pick up 25 top quality tubular condensers for a song. Wax impregnated, non-inductively wound. From .002 mfd. to .5 mfd. Long, flexible pigtail leads. Meets RMA standards.



No. 99N278R (weight: 1½ lbs.) **\$9.75**

Whether you're a service man, ham, advanced amateur or beginner, you'll find this practical encyclopedia of Electronic Equipment the most useful "tool" in your kit! All the latest on Television, High Fidelity Radio and Phonograph Systems, P. A., Test Equipment, Parts, Tools, Electrical Appliances, etc., etc.

It's the most complete catalog in our 29 years of saving money for men like yourself. Return coupon now for free copy — and also to order popular items shown here (a few of thousands that always cost less at Lafayette.)

SHOP IN PERSON AT ANY OF LAFAYETTE'S OUTLETS —

NEW YORK: 100 Sixth Ave. & 542 E. Fordham Rd.

CHICAGO: 901 W. Jackson Blvd.

ATLANTA: 265 Peachtree Street

BOSTON: 110 Federal St.

NEWARK: 24 Central Ave.

DELCO VOLUME CONTROLS



STOCK NO.	OHMS	PRICE EACH
99N2155R	50,000	24¢
99N2157R	100,000	24¢
99N2160R*	300,000	22¢
99N2161R	500,000	27¢
99N2162R	600,000	27¢
99N2165R	1 Megohm	27¢
99N2167R	2 Megohm	27¢
99N2168R	3 Megohm	27¢
99N2172R	500,000 tapped at 100,000	29¢
99N2174R*	500,000 tapped at 200,000	27¢
99N2176R	1 Megohm tapped at 100,000	29¢
99N2177R*	1 Megohm tapped at 200,000	27¢
99N2181R	SPST Snap-on Switch	8¢

*Will not take switch

NAME BRAND 6-VOLT VIBRATOR

Popular universal 4-prong vibrator—replaces the great majority of vibrators, including Mallory 294, 4-4, Radiart 5300, SO-1, Utah NP-42, Delco 5,040,006, 5,052,378 and Meissner EO1. Stock up and save!

No. 99N3950R (weight: 8 oz.) **\$9.85**



SOLAR TYPE DY ELECTROLYTIC CONDENSERS

STOCK NO.	CAP. MFD.	VOLTAGE
99N3486R	30+30+15/30	300/50
99N3445R	50+50/40	150/25
99N3475R	30+15+15+15	300
99N3452R	10+15/20	350/25
99N3492R	40+40/5/20	350/250/25

SNIP NOW—MAIL FOR

FREE CATALOG

LAFAYETTE RADIO, Dept. JK-9
901 W. Jackson Blvd., Chicago 7
100 Sixth Avenue, New York 13

Check here for FREE Catalog (Please don't check if you have already gotten your catalog.)
 Please fill attached order. I enclose \$..... in postal note, money order or check. I am including shipping charges based on weight and zone.

NAME.....

ADDRESS.....

CITY..... ZONE..... STATE.....

TRANSVISION TELEVISION KITS AND INSTRUMENTS

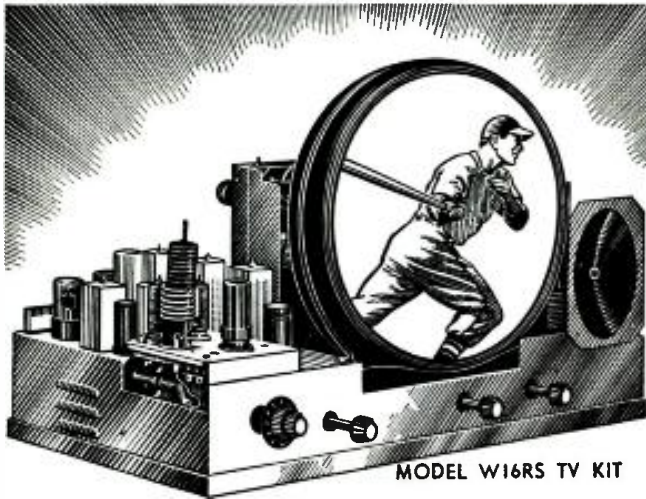

<16" Build it in 1 Day!

GIANT 160 Sq. In. PICTURE; Has 16" PICTURE TUBE

MODEL W16RS TV KIT

- (All-Glass Picture Tube, giving bright, clear, steady picture.)
- KIT COMES SEMI-WIRED and ALIGNED.** Can be completed in one day!
- SAVE** by installing the set yourself.

• LESS THAN \$200! SAVE UP TO 1/2 on the cost of equivalent picture-size sets. For **NEW LOW PRICES**, see your Transvision Outlet listed below.

The Transvision FIELD STRENGTH METER Improves Installations! ! Saves 1/2 the Work! !

- Has numerous features and advantages, including—
- (1) Measures actual picture signal strength . . . (2) Permits actual picture signal measurements without the use of a complete television set.
 - (3) Antenna orientation can be done exactly . . . (4) Measures losses or gain of various antenna and lead-in combinations . . . (5) Useful for checking receiver re-radiation (local oscillator) . . . (6) 12 CHANNEL SELECTOR . . . (7) Amplitudes of interfering signals can be checked . . . (8) Weighs only 5 lbs. . . (9) Individually calibrated . . . (10) Housed in attractive metal carrying case . . . (11) Initial cost of this unit is covered after only 3 or 4 installations . . . (12) Operates on 110V, 60 Cycles, AC.



NEW LOW PRICE
Model FSM-1, complete with tubes Net \$79.50

NEW: TRANSVISION 5" OSCILLOSCOPE

- WIDE BAND, HIGH GAIN
- IDEAL FOR TV
- MODEL 450A NET



\$99

SERVICE-DEALERS . . . Be the TV Sales Center and Service Center in your community!

- Beat competition at a profit.
- Stop being undersold—by anybody!

Here's a real opportunity to MAKE MONEY in Television. If you can qualify, you can become the Transvision Television Center in your community—and BUY TV and RADIO PARTS AT JOBBER PRICES. Practically no investment required. This offer is open only to service-dealers in territories where we do not have an authorized distributor. Contact Transvision Outlets listed below, or write to New Rochelle, for details on Transvision's "TV Center Plan." DO IT TODAY!

TRANSVISION, INC., Dept. RE, NEW ROCHELLE, N. Y. All Transvision Prices are fair traded; subject to change without notice. Prices 5% higher west of the Mississippi.

For FREE 20-page TV BOOKLET and CATALOG SHEETS, SEE YOUR TRANSVISION OUTLET!

CALIF: 8572 Santa Monica Blvd., Hollywood 3471 California St., San Francisco	167-01 Hillside Ave., Jamaica 75 Church St., New York City
DEL: 4 East 15th St., Wilmington	606 Central Park Ave., Yonkers
FLA: 42 Southeast Eighth St., Miami	622 No. Salina St., Syracuse
ILL: 1002 So. Michigan Ave., Chicago	901 Race St., Cincinnati
MD: 1912 No. Charles St., Baltimore	2001 Euclid Ave., Cleveland
MASS: 1306 Boylston St., Boston	53 W. Norwich Ave., Columbus
MICH: 23216 Wilson Ave., Dearborn	235 N. Broad St., Philadelphia
N. J.: 601 Broad St., Newark	620 Grant St., Pittsburgh
N. Y.: 1425 Boscobel Ave., The Bronx 485 Coney Island Ave., Brooklyn	700 Commerce St., Dallas
	CANADA: Hamilton, Ont.

MODULATION SYSTEM

Patent No. 2,463,275
Roy A. Henderson, W. Collingswood, N. J.
(Assigned to Radio Corp. of America)

A high percentage of modulation with little distortion is produced by this circuit. The transmitter has a grounded-grid final amplifier and a screen-grid exciter. Since the final does not reverse the polarity of a signal applied to it, the r.f. at the final plate is in phase with the r.f. at the exciter plate, making it possible to modulate three elements simultaneously: the exciter screen, the exciter plate, and the final plate.

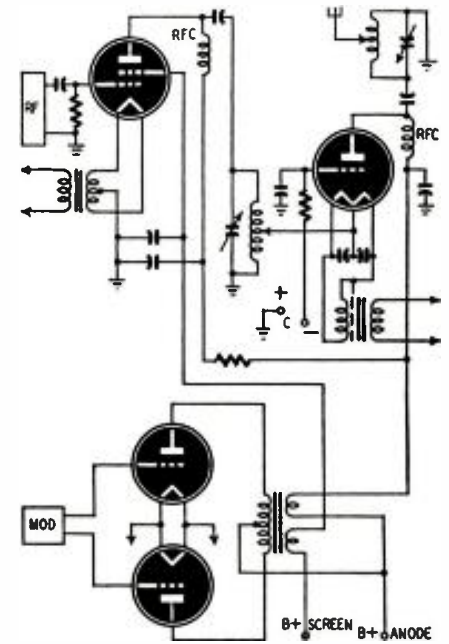

The modulation transformer has two secondaries. One modulates the exciter screen; the other modulates the plates. The audio voltages applied to the exciter elements should be proportional to their d.c. potentials for lowest distortion. The final filament transformer should have adequate shielding for low capacitance to ground, since the filaments are at an r.f. potential above ground.

SAWTOOTH GENERATOR

Patent No. 2,458,367
George W. Fyler, Lombard, and
Garth J. Heisig, Chicago, Ill.
(Assigned to Motorola, Inc.)

A multivibrator instead of a blocking oscillator is used in this vertical deflection circuit. It provides push-pull output to the electrostatic plates of a kinescope. Relatively small coupling capacitors to the deflecting plates of the kinescope are possible.

Tubes V1 and V2 form a free-running multivibrator at approximately the frequency of the vertical sync signals which trigger V1. Therefore it is possible to maintain sync in the presence of a certain amount of noise or with weak sync pulses. Capacitor C1 charges while V1 is

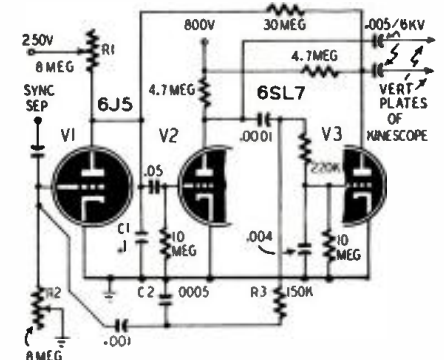

blocked and discharges abruptly when the tube conducts. The sawtooth voltage is amplified by V2 and applied to one of the kinescope deflection plates.

V2 and V3 are coupled by a differentiating network (to sharpen the pulses) and a voltage divider to reduce the input to V3, which feeds the deflecting plate. The voltage outputs from V2 and V3 must be equal and opposite.

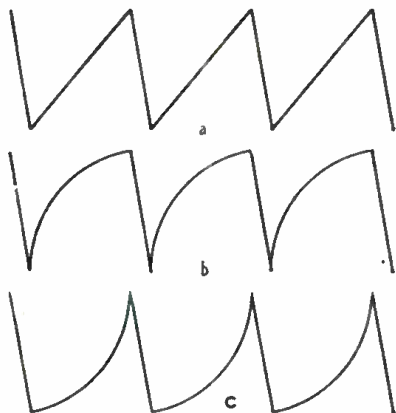

Ordinarily, large coupling capacitors are needed to pass the 60-cycle sync pulses to the kinescope. Small capacitors distort the wave so that it looks like b instead of a. A feedback circuit compensates for the attenuation of the low frequencies due to small capacitors. A large resistor (30 megohms) feeds back voltages from V2 to C1. As C1 approaches the end of its periodic charge, the V3 anode is at maximum positive potential and therefore feedback is greatest. At the beginning of the charge feedback is minimum. The feedback voltage is shown at c. When curves b and c are combined, a good sawtooth a is produced.

C2-R3 is a low-pass network to attenuate the horizontal line pulses. R1 adjusts vertical picture size. R2 controls the frequency of the multi-vibrator.

POLYPHASE GENERATOR

Patent No. 2,460,790

Charles W. Jarvis, Washington, D.C.

(Assigned to the United States of America as represented by the Sec'y of the Navy)

This polyphase generator is electronic rather than mechanical. Its output is weak, but amplifying stages may be added to bring it up to 117 volts if desired. The circuit shown here generates three phases, each of the tubes contributing one of them.

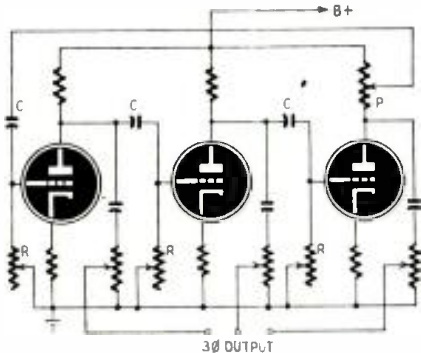

Each stage has an RC phase shifting network. If each stage is designed to shift the voltage by 120 degrees, the total is 360 degrees. Since the output of the last stage is in phase with the input to the first, and is fed back to it, oscillation takes place.

As in any phase-shift oscillator the frequency may be varied by changing the grid leaks R. For convenience all three may be ganged.

Individual phases are taken from potentiometers in the plate circuits. Each should be adjusted to give the same amplitude. P controls the over-all amplitude by governing feedback to the first stage.

SAVE WITH SOVEREIGN!

\$89.50
LESS TUBES



THE "ALL PURPOSE" TELEVISION KIT
10" — 12½" — 16"

MONEY BACK GUARANTEE

FEATURING

- Latest Type of Circuits
- AGC—Automatic Gain Control
- Picture and Sound Automatically Locked
- Sound Cannot Drift
- Non-Microphonic
- Stagger Tuned I F, for Max. Gain and Ease of Alignment
- 12 Channel Tuner
- Electromagnetic Focus and Deflection
- Automatic Stabilized Synchro-Lock Circuit Holds Picture Steady
- Voltage Regulated Circuit for Stability

Large clarified stage-by-stage pictures and schematics to insure ease of construction. Guaranteed to work. Money-Back Guarantee—Buy it, inspect it, if you don't think it's the best buy on the market—return unused within 5 days and your money will be refunded. All prices F.O.B. New York, 20% deposit with order. IMMEDIATE DELIVERY

COMPLETE WITH ALL TUBES

10" KIT	\$134.50
12½" KIT	\$149.50
16" KIT	\$169.50

SOVEREIGN TELEVISION CO. 5508C New Utrecht Ave. Bklyn 19, N. Y.

"Did over \$5,000 additional business installing ESPEY chassis"
De Young, Ithaca, N. Y.

THERE ARE THOUSANDS OF OUT-MODED RADIOS IN YOUR "BACK YARD" JUST WAITING TO BE REPLACED—AT YOUR SUGGESTION

Here is the custom-built AM-FM chassis that means BIGGER PROFITS for you!

The NEW ESPEY model 511



FEATURES

1. AC Superheterodyne AM-FM Receiver.
2. Improved Frequency Modulation Circuit. Drift Compensated.
3. 12 tubes plus rectifier and electronic Tuning Indicator.
4. 3 dual purpose tubes.
5. Treble Tone control.
6. 6-gang tuning condenser.
7. Full-range bass tone control.
8. High Fidelity AM-FM Reception.
9. Automatic volume control.
10. 13 watt (max.) Push-Pull Audio Output.
11. 12 inch FM speaker with Alnico V Magnet. 25 watts rating.
12. Indirectly illuminated Slide Rule Dial.
13. Smooth. flywheel tuning.
14. Antenna for AM and folded dipole antenna for FM Reception.
15. Provision for external antennas.
16. Wired for phonograph operation.
17. Multi-tap output trans. 4-8-500 ohms.
18. Licensed by RCA.
19. Subject to RMA warranty, registered code symbol =174.

SPECIFICATIONS

Supplied ready to operate, complete with tubes, antennas, speaker and all necessary hardware for mounting in a table cabinet or console, including escutcheon. Power requirements 105-125 volts AC, 50-60 cycles. Power consumption—85 watts. Chassis Dimensions: 13½" wide x 8½" high x 10" deep. Carton Dimensions: (2 units) 20 x 14½ x 10½ inches. Net Weight 16½ pounds each. Sold through your favorite parts distributor.

Write for Catalogue K-11 Containing Complete Specifications on This and Other Models

Makers of fine radios since 1928.



EASY TO LEARN CODE

It is easy to learn or increase speed with an Instructograph Code Teacher. Affords the quickest and most practical method yet developed. For beginners or advanced students. Available tapes from beginner's alphabet to typical messages on all subjects. Speed range 5 to 40 WPM. Always ready to QRM.



ENDORSED BY THOUSANDS!

The Instructograph Code Teacher literally takes the place of an operator-instructor and enables anyone to learn and master code without further assistance. Thousands of successful operators have "acquired the code" with the Instructograph System. Write today for convenient rental and purchase plans.

INSTRUCTOGRAPH COMPANY

4701 Sheridan Rd., Dept. RC, Chicago 40, Ill.

Your name on our Mailing List & **9LP7 Cathode Ray TUBE \$1.00**
Magnetic focus-deflection; 7700 V. anode. War Surplus; JAN; New, guaranteed, wt., 7 lbs.
POLYSTYRENE & LUCITE
cut, machined & engraved to your specs.
GOULD GREEN, 254 Greenwich St., N.Y.C. - 7

SURPLUS EQUIPMENT TROUBLE SHOOTING MANUALS (Includes Schematics)

- BC-34B Receiver
- BC-779 (Super-Pro) Receiver
- SCR-522 Transmitter-receiver
- BC-610 Transmitter

ANY BOOK \$1.00 EACH

(Add 10¢ for postage) Quantity Discounts

FL-8A Filter—\$1.37

Write for catalog

ELECTRONIC RESEARCH LABS.
1021-E Callowhill St. Philadelphia 23, Pa.

PEN-OSCIL-LITE

Extremely convenient test oscillator for all radio servicing, alignment • Small as a pen • Self powered. Range from 700 cycles audio to over 600 megacycles u.h.f. • Output from zero to 125 v. • Low in cost • Used by Signal Corps • Write for information.

GENERAL TEST EQUIPMENT
38 Argyle Ave. Buffalo 9, N. Y.

FOR TELEVISION TESTING AND SERVICING

Advanced practical engineering gives you

TEE VEE SCOPE Model TV-90

NET PRICE \$127.50

Combines the two essential instruments needed in television testing—alignment—service. A complete oscilloscope and a complete sweep generator that can be used independently. Tee Vee 90 combines two units for compactness and portability—meticulously engineered in advanced design and construction. Oscilloscope also has its own variable linear sweep. Sinusoidal sweep with phasing control for use with internal RF sweep generator when testing band pass characteristics. Synchronization provision for either internal positive, external or line frequency. External jack provided for trace blanking. Requires 10 volts of negative pulse to blank a normal intensity level trace. Independent sweep generator has a center frequency range of 1.5 to 45 megacycles giving a choice of any IF frequency desired. The band width can be varied continuously from 0.5 KC to 7 MC. Attenuation of RF is continuously variable from 0 to 500 millivolts and the output is applied through low loss coaxial cable. Traveling detector probe is included for observing signal at any point of the RF circuit under test. 105-130 volts 50-60 cycles. Weight 25 lbs. Size 14 x 18 x 12½ inches. Finished in attractive hammer-tone grey. Supplied complete with tubes, probe, coaxial output cable and operating instructions ready to operate.

Buy it at Your Local Jobber.

RADIO CITY PRODUCTS CO., INC.

152 WEST 25th ST



NEW YORK 1, N. Y.

More leading engineers and technicians have built Tech-Master for their own use than any other Television Kit

they know the best ... you want the best!

TECH-MASTER

deluxe 630-TK TELEVISION KIT with the original RCA 630TS Circuit

Supplied complete with genuine RCA parts 98% assembled. Ultra-simple wiring diagrams make it a simple matter to finish the final wiring in a week-end. For all picture tubes from 10 to 20 inches.

There is only one Tech-Master ... accept no substitute!

At all leading distributors. Write for name of your nearest distributor. Few choice jobber territories still available.

TECH-MASTER PRODUCTS CO.

443 Broadway, Dept. RC-11 New York 13, N. Y.

THREE-SPEED PHONO MOTOR

Alliance Mfg. Co.,
Alliance, Ohio

Model J is suitable for playing records at 33-1/3, 78, or 45 r.p.m. The shift lever has two positions and a reversible disc allows for the third

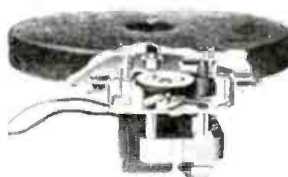

speed. The motor is said to be free of vibration and wow. Either a 9- or 10-inch turntable is furnished.

SIGNAL TRACER KIT

Electronic Instrument Co., Inc.,
Brooklyn, N. Y.

The Eico model 145 permits audible signal tracing of r.f., i.f., FM, audio, and video circuits up to 200 mc. A test speaker is built into the case. A high-

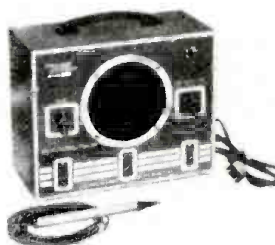

frequency probe is provided. The instrument is isolated from the power line by a transformer.

TELEVISION TRANSFORMERS

Merit Coil & Transformer Corp.,
Chicago 40, Ill.

A complete line of replacement horizontal and vertical blocking oscillator transformers for television receivers is now available. Units may be had for any receiver.

RADIO HYPODERMIC

Walter L. Schott Co.,
Beverly Hills, Calif.

The Walsco Contactless Injector is a hybrid tool with the hollow needle of a hypodermic and the rubber bulb of an eye dropper. It is useful for getting cleaning fluid or lubricant into tight places in a radio receiver. The cover of a volume control need not be opened.

SOLDERING GUN

Weller Mfg. Co.,
Easton, Pa.

The WD-250, a new version of the Weller soldering gun, is rated at 250



watts as against the 135 watts of the first model. Especially suited to radio and television work, it heats in five seconds, and has a chisel head. The bulk has not been increased, and little weight has been added.

VIBRATOR TRANSFORMERS

Chicago Transformer Division,
Essex Wire Corp.,
Chicago 18, Ill.

A new line of replacement vibrator transformers for automobile radios has just been introduced through jobbers. The units are exact duplicates of the originals, allowing installation without extra holes or components. All transformers are sealed in drawn steel cases for shielding and moisture protection.

HIGH-GAIN BOOSTER

Astatic Corp.,
Conneaut, Ohio

The Channel Chief model AT-1 is a four-tube television booster with much higher gain than ordinary boosters. Gain of all twelve channels is uniform.



Dual tuning controls are provided for separate adjustment of sound and picture signals. The dual tuning is said to improve the over-all selectivity so that much interference is minimized or eliminated. Another control varies the booster's gain so that the receiver is not overloaded by strong signals. The on-off switch controls the internal power supply and also removes the booster from the antenna circuit.

TELEVISION TOWERS

Penn Boiler & Burner Mfg. Corp.,
Lancaster, Pa.

The teletower is triangular, each section being formed of three pieces of ¾-inch, 18-gauge steel tubing braced by ¼-inch-thick straps. Standard sections are 10 feet high, from which a tower of any reasonable height may be constructed. Bases are available for flat mounting or for placing on a sloped roof.

3-SPEED CHANGER

Comet Corp.,
Chicago, Ill.

This fully automatic changer plays all records available today, 7-, 10- and 12-inch and 33 1/3, 45-, and 78-



r.p.m. All records are changed by the edge-push-off method. Two spindles are furnished, one with the standard diameter for ordinary records and the other with a diameter of 1½ inches for RCA 45-r.p.m. discs. A two-stylus crystal cartridge with tilt adjustment plays all records with a stylus force of 6 to 8 grams. A velocity trip is used.

LOW-COST TRANSFORMERS

Audio Development Co.,
South Minneapolis, Minn.

The Yeoman line of transformers is designed to afford economy along with high performance. All have open-frame construction and 10-inch leads. Impedance-matching, input, output, and power transformers are included.

Amazing SUPREME Values in New TELEVISION Manuals

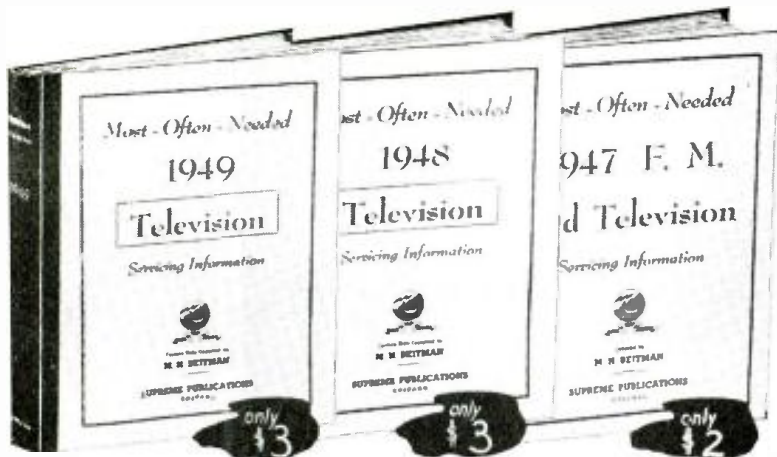

All three giant Television Manuals shown at the left are available to you for only \$8, total cost, nothing else for you to pay, nothing else to buy, and we will even prepay the shipping charges. (Or you can buy these manuals separately at only \$3, \$3, and \$2.) Take advantage of this amazing Supreme offering to step into Television at a tremendous saving. For over 16 years, radio servicemen expected and received remarkable values in Supreme Publications service manuals. And now, the three-volume Television and F.M. series beats all previous bargains. Only a publisher who sold over one million of various radio manuals can offer such bargain prices based on stupendous volume-sales.

New 1949 TELEVISION

Use this new giant hand-book of television servicing as your guide to quick fault finding and repair of any modern T-V set. Easy-to-understand description of circuits, pages of test patterns, r e s p o n s e curves, alignment facts, waveforms, voltage charts, service hints, hundreds of diagrams many in the form of giant double-spread blueprints. Here you have approved factory data on every popular T-V set. Large size: 8½x11", 192 pages + 9 blueprints 11x15", manual style. Amazing Supreme value for only \$3.

1948 T-V MANUAL

In this mammoth volume you have practical factory service data on all popular 1948 T-V sets of all makes. Let this manual show you how to make needed tests, guide you in carrying out adjustments, point to probable trouble spots, indicate location of all parts, trimmers, and controls. Includes hundreds of charts, waveforms, photographs, and many large 11x16" blueprints. Use coupon below to order, your special price only \$3.

1947 T-V & F.M.

Here is your manual of instructions for troubleshooting, repairing, and alignment of all popular 1947 F.M. and TELEVISION sets. The F.M. data covers tuners, AM-FM combinations, and all other types of F.M. circuits. Most complete information on various methods of F.M. alignment. A great deal of material on popular T-V sets including RCA 630-TS. Data on 192 large pages, 8½x11 inches. Sturdy manual-style binding. Price only \$2.

FIND—FIX ALL TELEVISION FAULTS

Use these timely television manuals as your guide to quick fault finding and repair of any television set. Eliminates guesswork—tells you just where to look and what to do. Cuts hour-wasting jobs to pleasant moments. Use test patterns for quick adjustment, or look up probable cause of trouble in the pages of hints after simply observing fault in video picture. No equipment needed with these tests. Or use your voltmeter and compare values with many voltage charts included. With an oscilloscope you can get waveforms similar to hundreds illustrated using test points suggested and in a flash locate what used-to-be a hard-to-find fault. These manuals will give you the know-how of a television expert and will repay for themselves with time saved on the first TV job. Order at our risk for a 10-day trial. Use coupon below.



NEW 1949 DIAGRAM MANUAL

Use this newest SUPREME radio manual to repair quickly all modern 1949 radio receivers. In this big single volume, you have clearly-printed, large schematic diagrams, needed alignment data, replacement parts lists, voltage values, and information on stage gain, location of trimmers, and dial stringing for almost all recently released sets. A worthy companion to the 8 previous volumes used by over 128,000 shrewd radio servicemen. Like the previous volumes illustrated above, it sells at a give-away price and gives you a whole year of radio diagrams for a couple of dollars total cost—nothing else to buy the rest of the year, nothing else to pay. Giant size: 8½x11 inches. Includes index. Manual style binding. Available at your jobber, or send coupon, price only \$2.50.

SENSATIONAL LOW PRICE

Be money ahead with SUPREME Manuals. For the remarkable bargain price (only \$2 for most volumes) you are assured of having in your shop and on the job, needed diagrams and other essential repair data on 4 out of 5 sets you will ever service. These manuals pay for themselves with time saved on a couple of jobs, after that you use them FREE. Don't spend large sums for bulky, space-wasting manuals of other publishers, don't buy additional drawings every few weeks, be wise, use SUPREME Manuals to get the most in diagrams for smallest cost.



Compiled by N. Beltman, radio engineer, teacher, author & serviceman

AMAZING SUPREME BARGAIN IN DIAGRAMS AND SERVICE DATA

Here is your low-priced, money-saving source of radio diagrams and service data for all popular sets. Above is a photograph of these giant-size manuals—available to radio servicemen at only \$2 for most volumes. Let these easy-to-use manuals guide you to quick fault finding and simplified repair of any radio. Eliminate guesswork, cut hour-wasting jobs to pleasant moments. These manuals cover every popular radio of all makes, from old timers to new 1949 sets. Clearly printed circuits, parts lists, alignment data, and helpful service hints are the facts you need to be more expert in radio servicing. There are nine volumes in all as illustrated above. Each manual is 8½x11 inches, sturdy manual style binding, average manual has 194 pages of diagrams and practical service data. Use coupon below to order on 10-day no-risk trial or see these manuals at your jobber.

Record Changers

Post-War Manual
Service expertly all modern (1945-1948) record changers. Includes every popular make. Just follow simplified factory instructions to make needed adjustments and all repairs. Hundreds of photographs and exploded views. Large size: 8½x11 inches. 144 fact-filled pages. Available at your radio jobber, or sent post—\$1.50 paid, price only

Radio Servicing Course-Book

Here is your practical radio course of 22 easy-to-follow lessons. Review fundamentals, learn new servicing tricks, all about signal tracing, oscilloscopes, recording, P.A., test equipment, and T-V. Just like a \$100.00 correspondence course. Everything in radio servicing. With self-testing questions and index. Large size: 8½x11" \$2.50 Price postpaid, only



New 1949 Edition

NO RISK TRIAL ORDER COUPON

SUPREME PUBLICATIONS, 3727 W. 13th St. Chicago 23, ILL.

Ship the following manuals on 10-day trial under your guarantee of satisfaction.

- New 1949 Television Manual \$3.00
- 1948 Television Manual 3.00
- 1947 F.M. and Television 2.00
- Post-War Record Changers 1.50
- Radio Servicing Course-Book 2.50

Most-Often-Needed Radio Diagram Manuals

- New 1949 Manual \$2.50
 - 1948
 - 1947
 - 1946
 - 1942
 - 1941
 - 1940
 - 1939
 - 1926-1938—\$2.50
- PRICED AT ONLY \$2 EACH**

- I am enclosing \$. send postpaid.
- Send C.O.D. I am enclosing \$ deposit.

Name

Address:

Supreme Publications

Sold by all Leading Radio Jobbers

NOVEMBER, 1949



Single Bay
MODEL 114-005
Complete with mast, swivel mounting plate, guy clamp, stand-off insulators and 75 ft. Amphenol 300 ohm Twin-Lead.

MODEL 114-009
Standard 114-005 TV antenna without Twin-Lead

AMPHENOL

→ INLINE → TV ANTENNAS



Two-Bay
MODEL 114-302
Two-Bay Antenna with top and bottom bay, connecting rods and two 5-foot lengths of 1/4" mast without lead-in. Supplies added high forward directive gain on all twelve TV channels.

Amphenol Inline Antennas are manufactured under Patent No. 2,474,480.

The best reception of picture and sound on ALL TV CHANNELS is directly dependent upon the mechanical and electrical construction of the antenna.

Amphenol has designed the Model 114-005 IN-LINE TV ANTENNA after years of study and research to meet the strict demands for optimum antenna performance . . . this antenna provides the best in high, uniform gain with clear, brilliant reception on all channels. The Model 114-302 TWO-BAY IN-LINE TV ANTENNA provides added high forward gain for TV sets in fringe areas.

Costly service calls due to antenna maintenance problems are eliminated with an Amphenol installation. The faithful, steady performance of Amphenol antennas is the solution for excellent picture reception through many years.

AMERICAN PHENOLIC CORPORATION
AMPHENOL 1830 SO. 54TH AVENUE
CHICAGO 50, ILLINOIS

PORTABLE ANTENNA

American Phenolic Corp.,
Chicago, Ill.

Amphenol Telear antennas are a new version of the familiar table-top V. In this one the lengths of the elements are not adjustable; but there are two dipoles, one for the low and another for the high band. The weighted base is equipped with rubber feet.

VOLTOHMMETER KIT

Heath Co.,
Benton Harbor, Mich.

The new Heathkit Handitester kit has a 3-inch, 400-ohm meter. A.c. and d.c. voltage ranges of 0-10-30-300-1,000-



5,000 volts are available as well as resistance ranges of 0-3,000-300,000 ohms. Two milliampere ranges are included, 0-10-100.

TV MASTER SYSTEM

Transvision, Inc.,
New Rochelle, N. Y.

A master antenna system which amplifies the signals is being offered for apartment houses. One antenna is erected for each occupied channel. The amplified signals are mixed and piped throughout the house. Each set is plugged into an outlet, getting maximum reception on all channels.

METAL VIEWING TUBE

Sylvania Electric Products, Inc.,
New York, N. Y.

Sixteen-inch metal tubes are now available to distributors. The 16AP4 has a 6.3-volt, 600-ma filament and



requires magnetic deflection, focusing, and ion trap. High voltage required is 12,000, focusing anode voltage 300, and control grid bias -33 to -77 volts.

METALLIZED CAPACITORS

Aerovox Corp.,
New Bedford, Mass.

Aerolite metallized paper capacitors do not contain metal foil as do conventional units but substitute high-purity paper tissue coated with a film of metal one millionth of an inch thick or less.

Less space is occupied by the electrodes, allowing more insulation and better protection against voltage surges. R.F. impedance is lower than in standard units. The capacitor is essentially self-healing after high surges or momentary overloads.

The new type P82 is available in values from .01 to 2 uf and in voltage ratings of 200, 400, and 600. Size of the capacitors is small, the 2-uf unit measuring only 23/32 inch diameter and 1 1/8 inches long.

MARKER GENERATOR

Radio City Products Co., Inc.,
152 West 25th Street
New York 1, N. Y.

Model TV 50 is a variable-frequency signal generator with four ranges covering 5 to 250 mc. It is used as a marker in conjunction with standard



television and FM sweep generators. Calibration accuracy is within 1%. A self-contained crystal oscillator may be used simultaneously with the v.f.o. or by itself. A phasing control is included. An internal mixing circuit is arranged so that the output of a sweep generator may be fed to the TV-50 and the marker's output leads carry both signals.

TELEVISION LAZY H

Technical Appliance Corp.,
Sherburne, N. Y.

The Taco Lazy H television antenna, first introduced in 1940, has been improved. Formerly made only for the low-frequency channels, the unit now has changed spacing and high-frequency whiskers to give good performance over all 12 channels. An additional reflector has been added especially for the high channels. Construction is all-aluminum except at insulation points.

ANTENNA ROTATOR

Crown Controls Co.,
New Bremen, Ohio

Designed principally for rotating television antennas but useful also for ham and other work, this rotator will support 175 pounds. It may be mounted



near the ground or roof with the antenna and mast supported by the rotator. The control unit has a meter indicating directions. A three-way momentary push switch rotates the antenna in two directions or lights the indicator dial. Castings are aluminum and the drive unit is weatherproof.

POCKET VOLTOHMMETER

Electronic Measurements Corp.,
New York, N. Y.

Model 102 is a pocket tester with a 3-inch square meter. Sensitivity is 1,000 ohms per volt. Ranges are: 12, 120, 600, and 1,200 volts a.c.; 6, 60, 300, 600, and 6,000 volts d.c.; 6, 30, and 120 ma, and 1.2 amperes d.c.; 30, 150, and 600 ma a.c. Two ohms ranges are also included.

RADIO-ELECTRONICS for

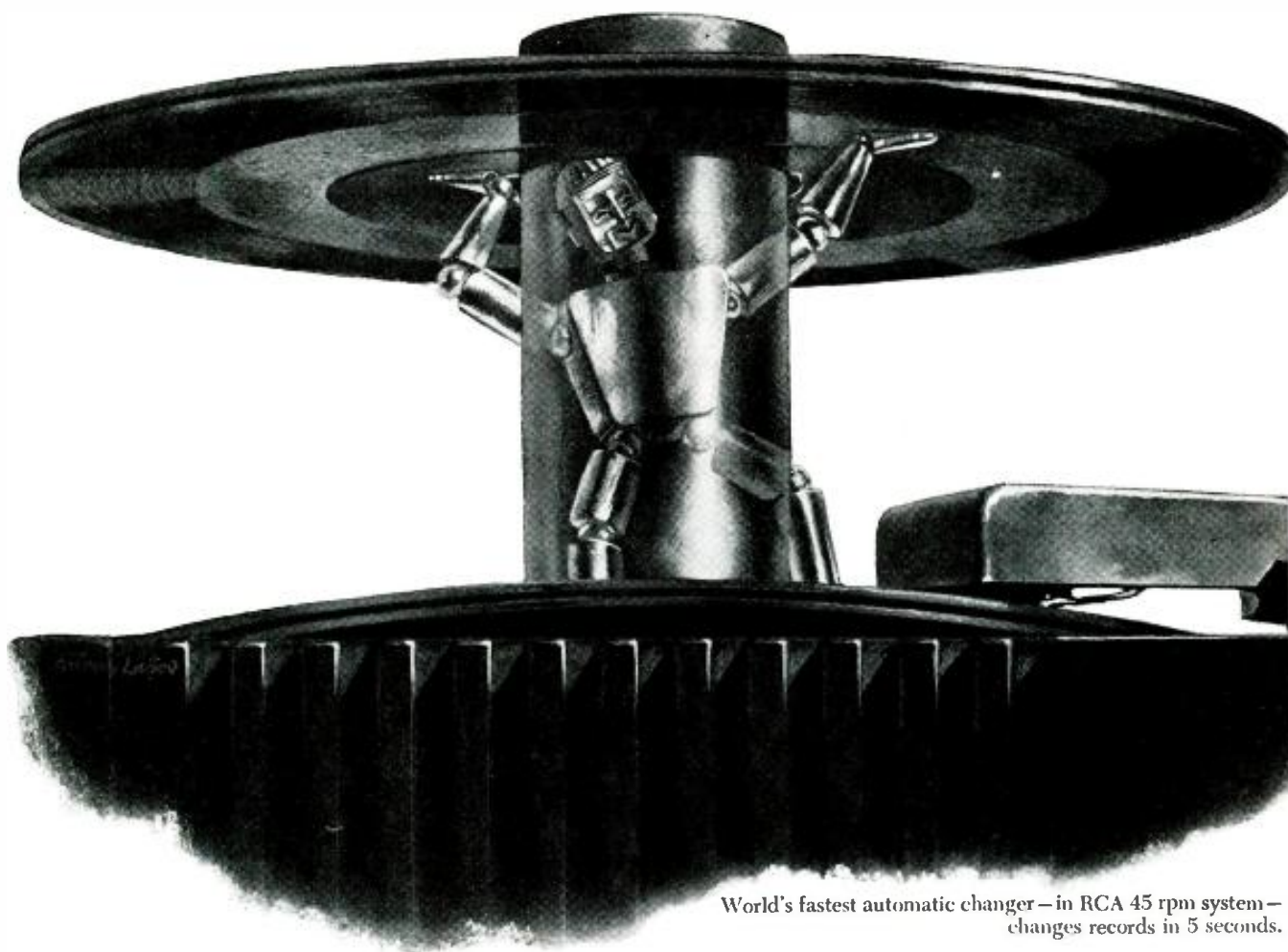

World's fastest automatic changer—in RCA 45 rpm system—changes records in 5 seconds.

Quick change artist

Hundreds of thousands are now enjoying RCA's thrilling new way of playing records . . . they marvel at its wonderful tone . . . and the speed with which it changes records.

Prolonged research is behind this achievement, research which sought—for the first time in 70 years of phonograph history—a record and automatic player designed for each other.

Revolutionary is its record-changing principle, with mechanism *inside* the

central spindle post on which records are so easily stacked. Result: a *simplified* machine, that changes records in 5 seconds.

Remarkable, too, are the new records—only 6 $\frac{1}{8}$ inches in diameter—yet giving as much playing time as conventional 12-inch records. Unbreakable, these compact vinyl plastic discs use only the distortion-free “quality zone” . . . for unbelievable beauty of tone.

Value of the *research* behind RCA's

45 rpm system—which was started 11 years ago at RCA Laboratories—is seen in the instant acceptance, by the public, of this better way of playing records. Music lovers may now have *both* the 45 rpm system, and the conventional “78.”

Development of an entirely new record-playing principle is just one of hundreds of ways in which RCA research works for you. Leadership in science and engineering adds value beyond price to any product of RCA, or RCA Victor.



RADIO CORPORATION of AMERICA
World Leader in Radio — First in Television

FREE! With Each 100 Tubes. \$20.00 List Value Filter Condensers. Cornell-Du-bilier, Mollary, Aerovox, Sprague, Solar. Ten Fast Moving Filters.

RADIO TUBES

39^c EA.

1C5	6AL5	6K6	12BA7	35
1C6	6AQ5	6K7G	12BE6	35B5
1L4	6AT6	6K8G	12F5	35C5
1R5	6AU6	6P5G	12H6	35W4
1S4	6B6	6S7	12J5	35Z4
1S5	6BA6	6SG7	12K7	35Z5
1U5	6BD6	6SH7	12L7	36
2A5	6BE6	6SJ7	12M8	37
2A7	VT-52	6SL7	12S8	38
3S4	6BJ6	6SK7	12SA7	39
5U4G	6C5	6SN7	12SF5	46
5W4	6C8	6SQ7	12S7	50B5
5X4G	6D6	6SR7	12SG7	50Y6
5Y3	6F5	6U6	12SH7	51
5Y4	6F6	6U7	12SJ7	56
5Z3	6G6	6V6	12SK7	57
6AC4	6H6	6X4	12SN7	58
6AC5	6J5	6X5	12SQ7	75
6AG5	6J6	6Z4	24A	77
6AK5	6J7	12A8	25L6	78
		12AT6	30	80
		12AU6	31	85
		12AU7	32	89
		12AX7	33	
		12BA6	34	

49^c EA.

0Z4	1T5	6E4	7A7	12C8
1A5	1Y	6E7	7B6	12J5
1A7	1LH4	6E8	7E5	12Q7
1C5	1LN5	6BG6G	7E6	12SL7
1C7	2A3	6C6	7E7	12Z3
1H5	2B7	6D8	7F7	14N7
1LA4	3LF4	6F5	7G7	19T8
1LE3	5V4	6F8	7H7	20
1LN5	5Z4	6Q7	7J7	32L7
1N5	6A8	6R7	7L7	15L6
1P5	6AC7	6SF5	7N7	16
1Q5	6AV6	6T7	7Q7	40
		6T8	7S7	43
		6U7	7T7	50L6
		6W7	7W7	53
		6Y6	10Y	11723
		6Z7	12A7	VR150
		7A4	12AT7	XXL-7A4

50L6 35Z5 12SQ7 12SK7 12SA7 5 Tubes **\$1.95**
 354 - 1R5 - 55 - 1T4 - 4 Tubes **\$1.29**

Less Than 50 Tubes 5c Per Tube Extra Individually Boxed. Standard Factory Guarantee. P. M. Speakers—5" **\$1.05**, 4" **\$1.05**, 6" **\$1.59**. Output Transformers for 50L6 39c, for 6V6 .45c.

FILTER CONDENSERS

Very best brands. Fresh stock. 450 Working Volts

8-450 V	ea.	21c
10-450 V	ea.	24c
10-450 V with 20-20-25 V	ea.	29c
15-450 V	ea.	29c
20-450 V	ea.	39c
30-450 V	ea.	49c
30-450 V with 20-20-25 V	ea.	29c
8-8-450 V	ea.	39c
10-10-450 V	ea.	43c
20-20-450 V	ea.	49c

150 Working Volts

15-15-150 V	ea.	29c
20-20-150 V	ea.	29c
20-20-20-150 V	ea.	39c
30-30-150 V	ea.	39c
40-20-150 V	ea.	39c
40-30-10 V-30-20-25 V	ea.	39c
40-40-150 V	ea.	39c
40-40-150 V-25-25 V	ea.	39c
50-30-150 V	ea.	39c
50-50-150 V	ea.	39c
60-40-150 V	ea.	39c

25 Working Volts

10-25 V	ea.	16c
20-25 V	ea.	16c
25-25 V	ea.	16c
10-25 V	ea.	16c
20-16-16-350 V Sprague type	ea.	39c
25-25-150 V-200-10 V	ea.	39c

Rated Accounts 10 Days; All Others 20% Deposit with Order. Balance C.O.D. Minimum Order \$5.00.

PREMIER RADIO TUBE CO.
 1808 WINNEMAC AVE., CHICAGO 40, ILL.
 Your tube source since 1926

REVERSIBLE TV BEAM ANTENNA

A novel 12-channel TV receiving antenna system, described in a recent issue of *RCA Review*, is a combination of two-element broadside and end-fire arrays producing a unidirectional pattern which can be reversed at will. Its elements are cut to one-half wavelength near channel 2 to keep the efficiency from falling off at low frequencies. Since the high-band channels bear a 3 to 1 frequency ratio to those in the low band, a half-wave, low-band dipole will constitute three half-waves on the high band and the radiation pattern will take the form of a four-leaf clover rather than the figure-eight of the dipole. "Vees," added to each dipole as shown in Fig. 1, have no effect on the low band, but change the high-band clover-leaf into a figure-eight, thus making each dipole bidirectional on all channels.

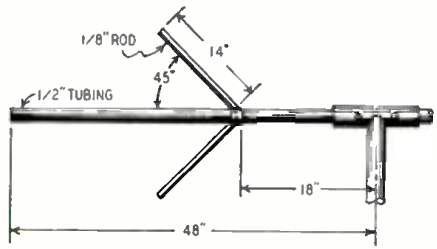

Fig. 1—"Vees" alter antenna pattern.

A diagram of the array is shown in Fig. 2. The dipoles of the broadside array—mounted above one another—are fed in phase at the center of a balanced transmission line. The end-fire elements—in a horizontal plane—are fed in the same manner; however, one half of the line is transposed to provide out-of-phase feed.

A and B are feed points for the broadside and end-fire arrays, respectively. These points are connected to opposite corners of a bridge consisting of four one-quarter wavelength lines, one of which is transposed as shown. A 150-ohm resistor and 300-ohm trans-

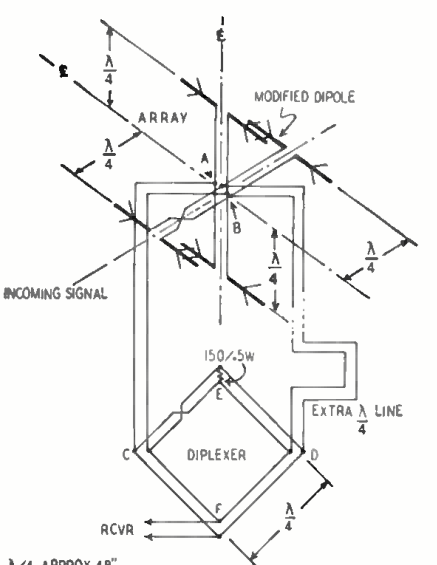

Fig. 2—Antenna array with diplexer.

HARD-TO-GET PARTS

POWERFUL ALL-PURPOSE INDUCTION MOTOR

IDEAL FOR EXPERIMENTERS—101 USES
 Sturdily constructed to precision standards, this self-starting shaded pole A.C. induction motor is powerful enough for a number of uses. Some of these are: Automatic Timing Devices, Current Interrupters, Electric Fans, Electric Chimes, Window Displays, Photocell Control Devices, Electric Vibrators, Small Grinders, Buffers and Polishes, Miniature Pumps, Mechanical Models, Sirens, and other applications.
 Consumes about 15 watts of power and has a speed of 3,100 r.p.m. When geared down, this sturdy unit will constantly operate an 18-inch untunable loaded with 200 lbs. dead weight—THAT'S POWER!
 Dimensions 3" high by 2" wide by 1 3/4" deep; has 4 convenient mounting studs; shaft is 3/16" diameter, and runs in self-aligning oil-retaining bearings. Designed for 110-220 volts, 50-60 cycles, A.C. only. Shp. Wt. 2 lbs.
ITEM NO. 147
YOUR PRICE..... \$1.95

ULTRA MAGNET
LIFTS MORE THAN 20 TIMES ITS OWN WEIGHT
LITTLE GIANT MAGNET
 Lifts 5 lbs. easily. Weighs 4 oz. Made of ALNICO new high-magnetic steel. Complete with Kellogg's World's most powerful magnet ever made. The experimenter and hobbyist will find hundreds of excellent uses for this high quality permanent magnet. Measures 1 3/4 x 1 1/2". Shp. Wt. 3 1/2 lbs.
ITEM NO. 159
YOUR PRICE..... \$1.25

GENUINE MICROPHONE TRANSMITTERS
 Regular telephone transmitters taken from a large telephone supply company's overstock. Work perfectly on 2 dry cells. Can be used on P.A. systems, call systems, inter-communications sets, short-line telephone circuits, house-to-house or farm-to-farm phone lines, also to talk through your own radio or as concealed dictaphone pick-up. Useful replacements on battery-operated rural telephone lines. THESE ARE GENUINE TRANSMITTERS, MADE BY KELLOGG, WESTERN ELECTRIC AND STROMBERG-CARLSON, excellent in appearance and operation. A remarkable value and one seldom offered in these times. Shp. Wt. 1 lb.
ITEM NO. 160
YOUR PRICE..... \$1.95

WATT HOUR METER
 Completely overhauled and ready for immediate service. Designed for regular 100-110 volt, 60 cycle 2-wire A.C. circuit. Simple to install. 2 wires from the line and 2 wires to the load. Sturdily constructed in heavy metal case. 8 1/2" high, 6 1/4" wide, 5" deep. Westinghouse, G. E., General Electric, Sylvania or other available make. Shp. Wt. 14 lbs.
ITEM NO. 33
YOUR PRICE... \$4.95

AMAZING BLACK LIGHT!!
 Powerful 250-Watt Ultra-Violet Source
 The best and most practical source of ultra-violet light for general experimental and entertainment use. Makes all fluorescent substances brilliantly luminous. No transformers of any kind needed. Fits any standard lamp socket. Brings out beautiful opalescent hues in various types of ornate Swarovski for amateur parties, plays, etc.; to obtain unique lighting effects. Built on a 2 1/2" x 2 1/2" x 2 1/2" base.
ITEM NO. 87
YOUR PRICE..... \$1.95

WESTERN ELECTRIC BREAST MIKE
 This is a fine light-weight aircraft carbon microphone. It weighs only 1 lb. Mike comes with breastplate mounting and has 2-way swiveling adjustment so that it can be adjusted to any desired position. There are 2 woven straps; one goes around neck, the other around chest. Straps can be snapped on and off quickly by an ingenious arrangement.
 This excellent mike can be adapted for home broadcasting or private communication systems. By dismantling breastplate, it can be used as desk mike.
 Comes complete with 6-foot cord and hard rubber plug. Finished in spherulized plate, non-rustable. Shipping weight, 2 lbs.
ITEM NO. 152
YOUR PRICE..... \$1.00

HUDSON SPECIALTIES CO.
 40 West Broadway, Dept. RE-11-49, New York 7, N.Y.
 I have circled below the number of the items I'm ordering. My full remittance of \$... (include shipping charges) is enclosed (NO C.O.D. ORDERS UNLESS ACCOMPANIED WITH A DEPOSIT.) OR my deposit of \$... is enclosed (no C.O.D. required). Ship order C.O.D. for balance. NO C.O.D. ORDERS FOR LESS THAN \$5.00. BE SURE TO INCLUDE SHIPPING CHARGES.
 Circle item No. wanted:
 147 159 160 87 152 33
 Name.....
 Address.....
 Please Print Clearly
 City..... State.....

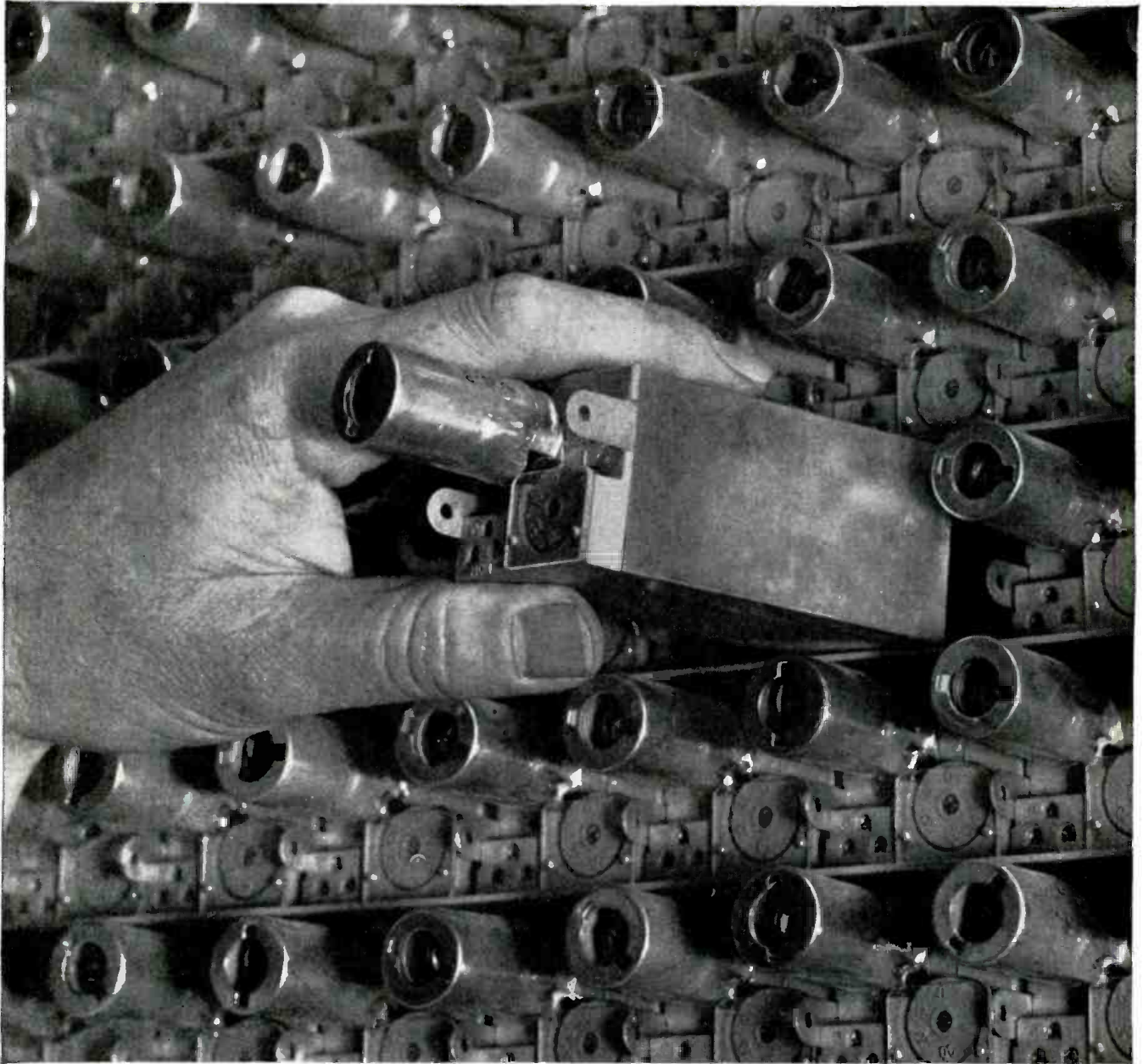

ANOTHER SCORE IN THE

battle of the inches

It takes many costly buildings to house your telephone system. Every inch saved helps keep down the cost of telephone service. So at Bell Telephone Laboratories engineers work constantly to squeeze the *size* out of telephone equipment.

In the picture a new voice frequency amplifier is being slipped into position. Featuring a Western Electric miniature vacuum tube,

tiny permalloy transformers, and special assembly techniques, it is scarcely larger than a single vacuum tube used to be. Yet it is able to boost a voice by 35 decibels. Mounted in a bay only two feet wide and 11½ feet high, 600 of the new amplifiers do work which once required a *room* full of equipment.

This kind of size reduction throughout the System means that

more parts can be housed in a given space. Telephone buildings and other installations keep on giving more service for their size — and keep down costs.

The new amplifiers, which will soon be used by the thousands throughout the Bell System to keep telephone voices up to strength, are but one example of this important phase of Laboratories' work.

BELL TELEPHONE LABORATORIES EXPLORING AND INVENTING, DEvisING AND PERFECTING, FOR CONTINUED IMPROVEMENTS AND ECONOMIES IN TELEPHONE SERVICE



NOVEMBER, 1949

Your **BEST BUY** is TV TEST EQUIPMENT by



Originally designed by McMurdo Silver . . . developed and constantly being improved by McMurdo Silver's staff of engineers. Manufactured of the highest quality, tested components by the trained electronic technicians in McMurdo Silver's modern factory. Compact! Low-priced! You can't beat the value that is built into every McMurdo Silver Laboratory Caliber Test Instrument!



Model 900-A "Vomax"

The new VOMAX makes TV, FM, and AM measurements accurately, at highest meter resistance. Giant meter, non breakable glass; 45 ranges, new single probe for a.c., d.c., o.f., r.f., volts, ohms, db, and current measurements. "VOMAX" measures TV power supply potentials up to 30 Kilovolts when used with the High Voltage Adaptor Probe. A world-beater at only \$68.50 net.

Model 918 Multiplier Probe

Built for long life and hard usage, each probe has been thoroughly tested: assuring safety of operation on voltages up to 30,000 volts d.c. Plug in tips make it readily attached to your VOMAX VTVM, Model 900 or 900A, on which direct meter readings can now be made from 1.10 volt to 30,000 volts d.c. Only \$9.95 net.

Model 915 Tubeless Grid Dip Adapter

Checks oscillators, antenna systems, transmitters, trap circuits, without mechanical coupling. Determines value of all coils and condensers. Requires no power supply or tubes; connects to any signal generator. Three calibrated plug-in coils cover 100 kc. to 300 mc. Equipped with phone jack for easy identification of oscillator frequencies. Model 915 is only \$34.95 net, including coils.

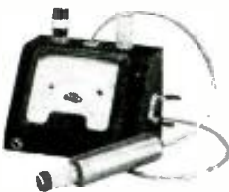

Model 906 FM-AM Signal Generator

Choice of the big engineering laboratories plus thousands of service technicians, 906 stands out as maximum value. 90 kc thru 210 mc. in 8 ranges, 1% accuracy, less than 1/2 microvolt, including strays to over 1 volt v.t.v.s. metered output, multiple shielding, adjustable 0 to 100 amplitude modulation, adjustable 0 to 1000 kc. FM sweep. Price only \$116.50 net.



Model 905-A "SPARX"

Combining signal-tracer and universal test speaker, 905-A is amazingly sensitive yet free of usual tracer hum. Vacuum-tube prod with r.f. - a.f. switching; high-gain high-fidelity amplifier, 6" PM speaker; 18-watt output transformer gives wide choice of impedances. Two essential instruments in one, 905-A is a value for exceeding \$44.50 net.



Model 911 TV FM Sweep Generator

Here is an all-in-one TV service center. Continuous range of 2 thru 226 mc. Output from 0.12 volt 1 and 5 mc. precision crystal markers insure pinpoint setting of TV if, band width, and trap circuits. Phased 60 cycle sine and 120 cycle saw-tooth voltages for direct scope control. Sweep from 0-10 mc. An outstanding buy at only \$78.50 net.



SEND COUPON TODAY

McMURDO SILVER CO., Inc.
1249 Main Street Hartford 3, Conn.

Date.....1949

Please send me — and bill through my jobber — the instruments I have checked below:

- | | |
|--|---|
| <input type="checkbox"/> 900-A "VOMAX" @ \$68.50 | <input type="checkbox"/> 906 FM-AM Signal Generator @ \$116.50 |
| <input type="checkbox"/> 918 Multiplier Probe @ \$9.95 | <input type="checkbox"/> 905-A "SPARX" @ \$44.50 |
| <input type="checkbox"/> 915 Tubeless Grid Dip Adapter @ \$34.95 | <input type="checkbox"/> 911 TV FM Sweep Generator @ \$78.50 |
| | <input type="checkbox"/> Send Free catalog of Laboratory Caliber Test Instruments |

MY JOBBER IS:

Name.....

City.....

Address.....

mission line are connected to the remaining corners of the network. This network is called a *diplexer*.

Assuming that an incoming signal approaches the array from the front (see Fig. 2), two main signals will arrive at A and B 90 degrees out of phase because of the spacing between elements and the transposition in one of the feed lines. Since transmission line B-D is one-quarter wavelength longer than A-C, the signals will arrive at the diplexer in phase. The in-phase voltages at C and D will buck each other at E because of the transposition in one leg of the bridge. Therefore, E is at zero potential, and the resistor will not absorb power. The main waves arrive at F in phase and pass through to the receiver.

When a signal arrives from behind the array, main waves arrive at C and D out of phase. This out-of-phase relationship is maintained at F, and no signal goes to the receiver; instead, it is absorbed by the resistor, the signals being in phase at this point.

If there is a mismatch between the receiver and the transmission line, the signal will be reflected back toward the antenna where some of its energy is radiated and the remainder reflected back down the line toward the receiver. In this case, reflected signals are cancelled in the same manner as signals from the back of the antenna.

The directivity of the beam can be reversed by connecting a d.p.d.t. transposition switch in one of the transmission lines. The diplexer can be mounted on spreaders for positioning behind the TV receiver.

HI-FI CRYSTAL TUNER

Designed for high-quality local broadcast reception, the new Miller bandpass t.r.f. tuner kit should make a hit with crystal receiver fans and high-fidelity audio enthusiasts. The double-tuned bandpass circuit uses negative mutual coupling to provide adequate selectivity for separating most local stations. Bandwidth is approximately 25 kc at 2-db points when measured at 900 kc.

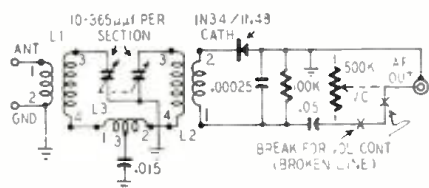

The 1N34 or 1N48 crystal diode detector develops between .05 and 0.5 volt on stations within a 20-25-mile radius when used with a good outside antenna 75 to 100 feet long. L1 and L2 are Miller 242-A antenna coils, and L3 is a type EL-55 negative mutual coupling coil.

Available in kit form, this tuner is the basis of a high-fidelity AM receiver when coupled to a hi-fi audio system.

A volume control can be connected as shown by the broken lines. If this control is included, the connection between points X must be removed.

(Continued on page 79)

McMurdo Silver Co., Inc.

FM-AM HALLICRAFTER'S CHASSIS MODEL S-59 \$32.95

HALLICRAFTER'S S-56 \$59.95

\$110.00 VALUE 11-TUBE FM-AM CHASSIS ★AUTOMATIC FREQUENCY CONTROL ON F.M.



11-TUBE FM/AM MODEL S-56, \$59.95

Model S-56 Hallicrafters, high fidelity, 11 tube AM/FM radio receiver chassis for the broadcast band and FM 88 to 108 megacycles. Automatic frequency control on FM holds the station in tune. Phone connection on rear of chassis. Full range tone control with base boost. Push pull 6K6 tubes in audio system. Frequency response essentially flat from 50 to 14000 cps. Wide vision accurately calibrated slide rule dial, with pre-selection on broadcast band. Output transformer matches 500 ohm line, 4 Antenna terminals; two for AM and two for FM. This is the finest type home radio that we know of today. Better get your order in early. Designed to be used in commercial radio setting in the \$400.00 to \$600.00 class. The regular dealer's net on this chassis is \$100.00. However, a lucky purchase enables us to offer these brand new, factory conditioned S-56 Hallicrafters chassis complete with tubes and operation instructions, at only \$59.95 less speaker. Speaker matching transformer, 500 ohms to voice coil \$2.50 extra. Chassis size 12 1/2" x 10" x 7 1/4". Weight 25 lbs. Combination offer—S-56 Hallicrafters chassis, speaker matching transformer and our model CR-13X 12 inch coaxial P.M. speaker, all for only \$71.95.



8-TUBE FM/AM MODEL S-59, \$32.95

HALLICRAFTER'S S-59 \$32.95

8-TUBE FM-AM CHASSIS PUSH-PULL AUDIO—AC CONSTRUCTION

Model S-59 Hallicrafters, high fidelity, 8 tube custom receiver chassis, for FM/AM reception. Size 12 1/2" x 9" x 7 1/4" x 9". An excellently engineered chassis, equal to those used in \$300.00 commercial sets. Wide range audio, 60 to 14,000 cps., tone control, phono input tubes, but less speaker. Weight 16 lbs. S-59 chassis and tubes. Net Price \$32.95. 6 x 6" 4.64 oz. PM speaker (O.K. for console cabinet below) \$2.95, extra. S-59 custom chassis and tubes, with our regular \$12.95, CR-13X Coaxial 12" PM speaker, all for \$42.95.

DETROLA-COILS, GANG-CHASSIS AND DIAL \$2.95



Genuine Detrola Chassis pan with 6 octal sockets, heavy duty 2000 p.f. 3 Gang Tuning condenser. All RF and IF coils and band switch for standard broadcast and foreign short wave. In this set are the parts that make the value alone. These parts all fit the chassis properly. Only material pictured and listed above is offered. It is not a complete kit. You supply your own tubes, speaker, resistors, condensers, etc. Stock No. DET-1. Shipping Weight 9 lbs. Net \$2.95.

Newly designed by one of America's finest speaker builders. Made for FM and AM high fidelity radio and amplifier. It is not a complete kit. You supply your own tubes, speaker, resistors, condensers, etc. Stock No. DET-1. Shipping Weight 9 lbs. Net \$2.95.



6 TUBE AC DC KIT \$9.95

6 Tube Superhet. Broadcast AC-DC Kit, using full size tubes. Housed in a Farnsworth plastic cabinet, with slide rule dial, 1 1/2" stage, 2 gang condenser, loop antenna and 5" speaker. This makes a factory like radio. The cadmium chassis is ready punched and sockets are installed. This type of kit usually sells for at least \$15.00. All parts furnished, including tubes: 12K8, 2-12SK7, 12SR7, 6X16 and 6X25. Complete with diagrams and photos. Kit Model FS-6. Wt. 8 lbs. \$9.95

12 INCH "COAXIAL" P. M. SPEAKER \$12.95

- REGULAR \$32.50 LIST
- RESPONSE 40-17000 C.P.S.
- MOLDED ONE PIECE CONE
- AVAILABLE IN 12 AND 15" SIZES

CONSOLE CABINET FOR S-59 \$19.95

Beautiful blond console cabinet. Size 17 x 21 x 33" high. This cabinet was intended for use on the S-59 radio-phonograph combination. The lower half of the cabinet is divided for albums. The upper half has a hinged lid, which covers the radio and changer. Radio panel is 8 x 15" and may be ordered with the S-59 or with a blank panel for installing your own chassis. Changer panel in blank will hold a changer up to 12 x 15". Cabinet will hold a 6" or a 6x6 1/2 mixer and 6x6 1/2 amplifier. This unit is worth twice our price. All wired, output is to be fed into your video channel. It can be painted and used with the Farnsworth GVZ-60 chassis, advertised below. Weight 2 lbs. Stock No. SK-T3. Net price, Sarks-Tarzan, 15 channel tuner with 3 tubes \$19.95

3-WAY—PICK ME UP PORTABLE RADIO ONLY \$12.95

Sensational New 3-Way Portable Radio Kit, 4 tubes plus rectifier. Housed in an all aluminum, leatherette covered case made by Farnsworth, non-slip feet, loop antenna built-in. Size 5 x 9 x 6". Build yourself a professional looking radio with this kit. Every piece furnished includes tubes: 1B5, 1T4, 1S5, and 3V4, as well as easy to follow diagram and photo. Receives broadcast 540 to 1450 kc. This set will make a full two gang superhet, that looks like a \$40.00 radio. We should ask \$17.00 for this kit. However, limited quantities, at \$12.95, the price possible. Stock No. PP-4X, complete kit less batteries. Shipping weight 9 lbs. Net price \$12.95. Kit of photo, 67 1/2 volt "B" and "A". \$2.25 extra.

Why pay \$20.00 or \$30.00 for an output? Supreme quality and high fidelity output transformer designed to match push-pull plates (2-6L6, 2-6V6, or 2-6AQ5) class AB, to 4-8-15-250 and 500 ohms; with 10% feedback winding. Housed in a compound filled case: 3 1/2x4 1/2x3". Actual net weight, 6 lbs. If you want the best quality from your audio system, order this transformer in our lab and find this to be the best value. Even though your amplifier only puts out 10 or 15 watts, this is what you should have. Connecting instructions furnished. Stock No. A-403, shipping weight 8 lbs. Net price \$6.95

12" COAXIAL MODEL CR-13X \$12.95

15" COAXIAL MODEL 5-15X \$24.95

15 INCH "KING COAXIAL" SPEAKER \$24.95

WORLD'S BEST 15" COAXIAL VALUE

The King Coax. A 21.5 oz. 15 inch Alnico V PM speaker with a built-in high frequency tweeter. Will respond to from 40 to 17,000 cycles. This is a ruggedly built speaker with a curvilinear one piece molded cone. Built-in high pass filter. Just hook to any 8 Ohm output transformer. Will handle 18 Watts peak. Wide range response 40 to 17,000 Cycles. This speaker should sell for \$35.00. Why buy any ordinary speaker when we offer a 12" Coaxial PM for only \$12.95. Shipping weight 8 lbs. Model CR-13X, \$12.95. Two for \$24.95

Olympic FM-AM Chassis and 12" Speaker \$47.95

Olympic Model 9-025, 10 Tube FM-AM Chassis. Latest 1040 Model with 10 tube push pull 6K6 audio base boost tone control, 12 inch Dynamic Speaker, finest heavy construction superhet with 115, 1T4, 1S5, and 3V4, as well as easy to follow diagram and photo. Receives broadcast 540 to 1700 KC and FM 88 to 108 MC. This set was designed for fringe area reception. Chassis size 12 1/2" long, 6 1/2" high, 12" front to back. Priced complete with tubes, 3-6X6, 6V6, 6AL5, and 2-6807, 20K6, 5Y3, and 12 inch speaker. This Chassis is the same as used in Olympic's highest priced radio-phonograph sets, and worth twice our price. Shipping weight 30 lbs. Olympic Model 9-025 custom chassis ready to play. net \$47.95

HIGH FIDELITY OUTPUT TRANSFORMER \$6.95

We furnish you with a diagram to Build a Hi-Fi 6L6 Amplifier

MINIATURE BROADCAST STATION KIT \$6.95

Kit Model DE-IX. Build your own miniature 110 Volt AC-DC 4 Tube Broadcast Radio Station (80 to 1600 K.C.). Broadcast from Crystal Mike or phono record. (Warning: this transmitter must be used with only a short aerial, otherwise you will broadcast two or three miles). Complete kit with tubes, diagram and operating instructions. Weight 4 lbs. Model DE-IX. Net \$6.95

REGULAR \$35.00 LIST "JUKE BOX" 15 INCH \$9.95

P.M. SPEAKER SALE PRICE HAS NEW MOLDED CONE

JEFFERSON T.V. PWR. TRAN \$2.95

T.V. Power Transformer, similar to R.C.A. 200 ma. 110 volts, 6C cycle, 760 volts D.C. filaments 5 volts at 3 amps, 5 volts at 3 amps and 6.3 volts at 8 amps. Trans. size 3 3/4 x 3 1/2 x 5 1/4". Shipping weight, 12 lbs. Stock No. MB-4F. Net price . . . \$6.95

12 WATT KIT \$10.95 20 WATT KIT \$15.95

Kit Model TM-12, 12 Watt Amplifier kit. Ideal for a high quality record player as a P.A. System or recording machine. Matched component parts ready punched chassis. One control fades from phono to mike. Input compensation for G.E. Variable Reluctance pick up. Output matches 8 ohm Voice Coil, 100 Mill Power Transformer. Complete with tubes, diagram and photos. Net \$10.95. Crystal utility mike and desk stand \$2.95 extra. Model TM-12Wt amplifier is TM-12 kit wired ready to operate net \$14.95

KINGJUKE 50-WATT 15-INCH P.M. SPEAKER SCOOP PRICE \$16.95

Model 15-L5. The KING of all low frequency response speakers. Will take 50 watts peak audio and 35 watts average, with ease. The most efficiently designed built today, 5 watts input to this speaker will give twice the air movement of an ordinary speaker. Has 8 ohm voice coil and molded one piece 8" curved cone. Designed to retail for \$50.00. Include postage for 18 lbs. Stock No. 15-L5. Net price \$16.95, 2 for \$32.95.

JEFFERSON T.V. PWR. TRAN \$2.95

T.V. Power Transformer, similar to R.C.A. 200 ma. 110 volts, 6C cycle, 760 volts D.C. filaments 5 volts at 3 amps, 5 volts at 3 amps and 6.3 volts at 8 amps. Trans. size 3 3/4 x 3 1/2 x 5 1/4". Shipping weight, 12 lbs. Stock No. MB-4F. Net price . . . \$6.95

McGEE RADIO COMPANY

NOVEMBER, 1949

CAPEHART TWO POST RECORD CHANGER \$6.95

Require Adjustment

MINIATURE BROADCAST STATION KIT \$6.95

Kit Model DE-IX. Build your own miniature 110 Volt AC-DC 4 Tube Broadcast Radio Station (80 to 1600 K.C.). Broadcast from Crystal Mike or phono record. (Warning: this transmitter must be used with only a short aerial, otherwise you will broadcast two or three miles). Complete kit with tubes, diagram and operating instructions. Weight 4 lbs. Model DE-IX. Net \$6.95

Caphart Changer Scoop. Use on famous high priced combinations. These changers have been removed from sets; to be replaced with twin speed changers. Require Minor Adjustments. These have Caphart true-timbre variable resistance cartridges. Requires same gain as the G.E. VR cartridge. Connecting instructions furnished. Base size 1 1/4x1 1/4". Weight 23 lbs. Stock No. Net \$6.95

Model DE-6XWt Miniature Radio Transmitter wired ready to operate. Net. \$8.95. Extra tone arm, with G.E. R-100 variable reluctance cartridge. \$2.95, extra.

Prices F.O.B. K.C. Send 25% deposit with order. Bal. sent C.O.D. With Parcel Post Orders include Postage. WRITE FOR BARGAIN FLYER. 1424 Grand Ave., Kansas City, Missouri



NIAGARA'S ONLY ONE NIAGARA FOR GREAT RADIO VALUES

Model 221K VTVM KIT

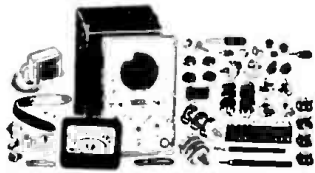

Complete—Nothing Else To Buy A Must For TV Servicing

- AC/DC Ranges 0.5, 10, 10,000 volts
 - Ohms 2 to 100 megohms in 5 ranges
 - R x 1, R x 100, R x 1000, R x 10,000, R x 1 megohm
 - 100 from minus 20 to plus 10
 - 10⁶ input resistance 25 megohms, constant on all ranges
 - AV input impedance over 15 megohms on all ranges
 - Large 4 1/2" linear movement within 2% accuracy with minimum friction
 - Size 9 1/2" x 6" x 3", wgt. 10 lbs.
- EICO model 221K VTVM kit
Cat. # N-259 **\$23⁹⁵**
Your cost
- EICO model 221 VTVM, wired and tested
Cat. # N-260 **\$49⁹⁵**
Your cost

SUPER SURPLUS SPECIALS

NIAGARA'S GOLD-PLATED SPECIAL!

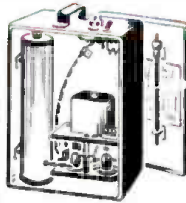

An ultra-high freq. Gold Plated Cavity Resonator with a range of 231—258 Mcs! Fully wired, including two 955 acorn tubes. Designed by the navy for use as a portable modulated test oscillator. CAN BE USED AS A MODULATED SIGNAL GENERATOR. Battery compartment is large enough to house speech equipment and power supply, making it a desirable portable UHF Transmitter for Ham use. Complete with tuning wrench, tubes, whip antenna, and circuit diagram on inside cover. Black wrinkle finished cabinet measures 3 1/2 x 6 1/2 x 6 1/2". *The Boy of a Lifetime!*

Cat. No. N-257. **\$3⁹⁵**
SPECIAL

REINER New Super TYPE "Z" HIGH VOLTAGE MULTIPLIER LEADS



Reiner H.V.M. Leads utilize the lowest range on your meter scale. Absolutely safe for 110 volt measurements. Available for all VTVM & Multiplier. Measure high voltage in TV, FM, X Ray, etc. Specify make and model VTVM when ordering. Cat. No. N-261. **\$12⁹⁵**
YOUR COST



T-17 MIKE

Lowest Price Ever! Slightly used guaranteed perfect and clean. Single button carbon lamphole. Light, efficient 200 cycle Press-to-talk switch. 5-ft. rubber cord with PL-38 plug attached.

Cat. No. N-249. **69^c**
SPECIAL

WAVE TRAPS

Traps consist of two slug-tuned silverized coils and two ceramic condensers. All mounted on a cadmium plated bracket, conveniently drilled and ready for mounting. May be used to eliminate FM sound bars in TV sets, eliminate amateur interference (shock excitation) in TV receivers. Match Hi-Fi TV antennas, and dozens of other uses too numerous to mention. They're going fast, so order yours today!

Cat. No. N-128. **39^c** each
SPECIAL



\$1,000,000 STOCK BRAND NEW TUBES

FAMOUS BRANDS. ALL BRANDED AND BOXED

REDUCED MORE THAN **50%**

TRANSMITTING		RECEIVING	
E1148	\$.34	1H5GT	\$.55
2C26	.28	3A4	.27
5B1P1	1.70	3B7	.29
10Y	.28	3D6	.29
211	.28	6C4	.28
803	3.63	6AR5	.54
805	3.63	6D6	.55
813	6.90	6K7GT	.54
815	1.37	6SH7	.27
843	.38	6SS7	.53
953	.18	7C4	.28
955	.18	12A6	.28
957	.18	12H6	.29
958A	.18	12K7GT	.53
1619	.18	12SH7	.29
1625	.18	12SR7	.29
1626	.18	28D7	.29
7193	.47	35L6GT	.53
9004	.18	50B5	.55
9006	.18	50L6GT	.54

ALL QUANTITIES LIMITED

Famous UTAH 15 and 25 Watt Potentiometers

Body: 2 11/16" dia., 27/32" depth behind panel. Bushing: 7/16" dia., 3/8" long. Shaft: 1/16" dia., 7/16" long from bushing. Effective rotation 300 degrees. Mounts in 7/16" hole. 15 W. "PW" type wirewound on bakelite strip. 25 W. "SW" type wirewound on asbestos-covered steel strip, for greater heat dissipation. PW type has 3 terminals, no off position. SW type has 2 terminals with off position.



15W		25W	
Stock No.	Resistance in Ohms	Stock No.	Resistance in Ohms
PW-100	100	SW-1	1
PW-150	150	SW-2	2
PW-200	200	SW-3	3
PW-250	250	SW-6	6
PW-300	300	SW-10	10
PW-400	400	SW-15	15
PW-500	500	SW-20	20
PW-600	600	SW-30	30
PW-800	800	SW-40	40
PW-1M	1000	SW-50	50
PW-2M	2000	SW-60	60
PW-3M	3000	SW-75	75
PW-5M	5000	SW-100	100
PW-7500	7500	SW-150	150
PW-10M	10,000	SW-200	200
PW-20M	20,000	SW-250	250
PW-50M	50,000	SW-300	300
		SW-400	400
		SW-500	500

Stock No. PW-15 watt. ALL SIZES **39c**
List \$1.50. SPECIAL

Stock No. SW-25 watt. ALL SIZES **49c**
List \$1.75. SPECIAL

TINIEST V. O. M. IN THE WORLD!



NIAGARA exclusively presents the "Universal Baby Tester," measuring 3 1/2" x 2 1/2" x 1 1/2". Contains a sensitive 0-240 microammeter with the following ranges:

- 0-15 V AC or DC
- 0-150V AC or DC
- 0-750V AC or DC
- 0-150V DC MA.
- 0-100,000 ohms

Ohms adjust and DC-AC ohms switch. Includes 1 pair test leads. Will fit into your watch pocket. Fully guaranteed.

Cat. No. N-258. **\$8⁹⁵**
Special

Niagara Radio Supply Corp. Dept. C119
160 Greenwich St., New York 6, N. Y.

- Send Free Booklet "The World At Your Fingert Tips."
- Rush items on attached list.
- Place my name on mailing list to receive special bulletins of limited-quantity bargains.

Name.....
Address.....
City..... State.....

Niagara Radio Supply Corp. Phone Dlgby 9. 1132-3-4
Dept. C119 160 Greenwich Street, New York 6, N. Y.

BATTERY INTERCOM

Operated from a battery power supply, this intercom provides for one master and a single remote station. The remote may call the master by sounding a buzzer even when the power is off. The master calls the remote by connecting the input of the amplifier to the output and creating a feedback whistle with the switch set at TALK.

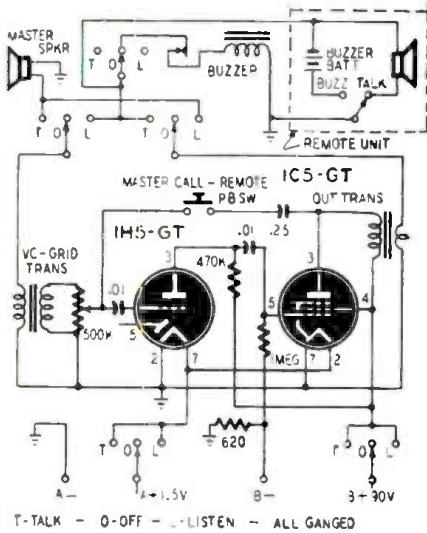

The circuit is given in the diagram. The TALK-LISTEN switch is a five-circuit three-position rotary. The center OFF position disconnects the batteries to save power. Note that if the remote buzzes the master when the three-position switch is not at OFF, the battery current will go through either the input or output transformer. It may burn up the transformer and will certainly discharge the buzzer battery. Between calls, therefore, the switch should always be set at OFF.—F. D. Crisp

BIGGEST REFLECTOR

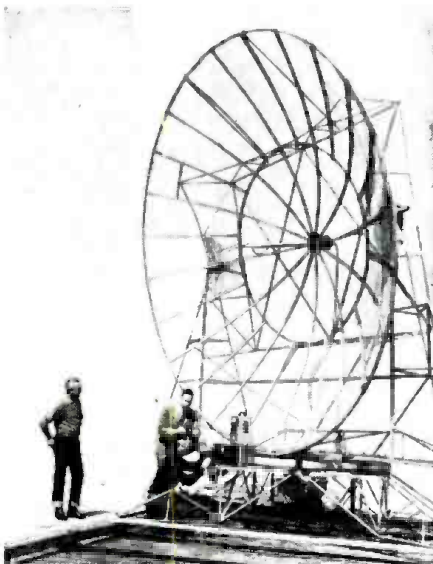

Used for reception of television signals from field pickup units, this parabolic receiving-antenna reflector is the largest in the U.S. It operates on a 100-foot track atop Mt. Lee in Hollywood, Calif. Constructed for the Don Lee Broadcasting System, the reflector stands 16 feet high. It can be pointed at any location in the surrounding area to pick up r.f.

4 OUTSTANDING VALUES
for immediate delivery!

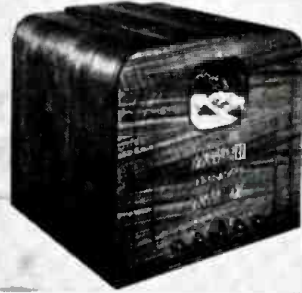

ONLY \$82.99 IS THE COST

for the sensational-new-improved
TELEKIT TELEVISION KIT

Operates the 10", 12", 12½", 15" and 16" picture tube. Complete with new built-in-pretuned and aligned 13 channel tuner, all parts and easy step-by-step instructions and schematics. \$82.99 less tubes, complete set of tubes, including 10 BP4 picture tube \$49.50, special designed 10" cabinet \$21.50.

An amazing value, even a beginner can assemble one of these fine, new, improved television kits. Uses the new 13 channel tuner, brewed and factory aligned for the entire television spectrum. Highest quality parts and excellent circuit assure perfect performance. Circuit designed by outstanding TV engineers. Contains RF stage, oscillator and mixer. Uses new IF coils, providing maximum gain and picture definition. Sound reception is high quality FM for years of listening pleasure.

Same quality and features for 7" kit, complete, less tubes **\$59.50**
Complete with tubes, \$99.50, special designed cabinet **\$19.50**

THE MODEL 999—A COMBINATION

SIGNAL GENERATOR AND SIGNAL TRACER

Signal Generator Specifications:

Frequency Range: 150 Kilocycles to 50 Megacycles. *The R.F. Signal Frequency is kept completely constant at all output levels. *Modulation is accomplished by Grid-blocking action which is equally effective for alignment of amplitude and frequency modulation as well as for television receivers. *R.F. obtainable separately or modulated by the Audio Frequency.

Signal Tracer Specifications:

Uses the new Sylvania IN34 Germanium crystal Diode which combined with a resistance-capacity network provides a frequency range of 300 cycles to 50 Megacycles. The Model 999 comes complete with all test leads and operating instructions. **ONLY**

\$28.85
NET

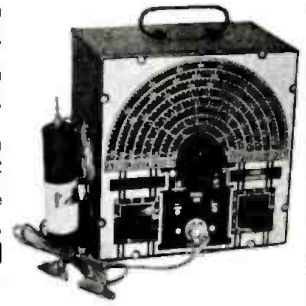

THE NEW MODEL TC-75 TEST CRAFT

A COMBINATION TEST SPEAKER and SIGNAL TRACER

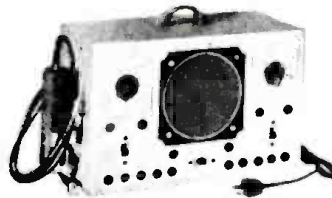

\$29.50
NET

- plus speaker substitution
- plus resistor tester
- plus condenser tester
- plus resistor substitutor
- plus condenser substitutor
- plus output indicator
- plus substitute 100 V. D.C. power supply
- plus field substitutor
- plus voice coil substitution
- plus signal tracer
- plus an experimental one stage audio amplifier
- plus universal output transformer

Complete including signal tracer probe and full instructions. A must for every radio serviceman and engineer.

THE NEW MODEL TC-50 TEST CRAFT

TUBE & SET TESTER

A complete laboratory, all purpose test-instrument, this versatile combination tube and set tester will accurately test all up-to-date designed tubes. The multi-meter section affords many necessary measurements for everyday's service work.

The New Model TC-50 Tube and Set Tester combines seven instruments, D.C.V., A.C.V., D.C.M.A., Ohms, Output Meter, Decibel Meter and Tube Tester. Full scale accuracy to 2%. English Reading GOOD and BAD scale for testing tubes. Obscureness reduced to absolute minimum. Simple and quick reading charts for tube testing. Multimeter section affords most popular everyday's measurements.

Complete with test leads, tube charts and all detailed, operating instructions. **\$39.50**
NET

Size 8" x 10½" x 5"

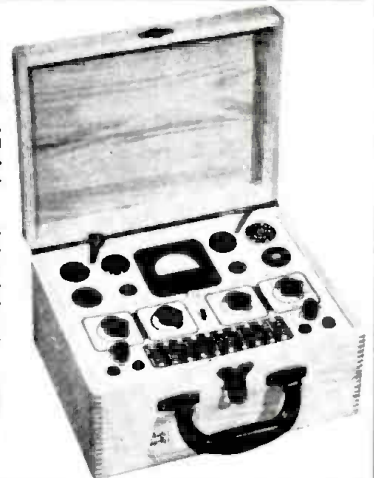

Immediate delivery from stock. 20% deposit required on C.O.D. orders.

METROPOLITAN ELECTRONICS & INSTRUMENTS COMPANY

106 FIFTH AVE.

DEPT. RC-11

NEW YORK 11, N. Y.

MID-AMERICA'S UNBEATABLE LOW PRICES

FAMOUS-MAKE RECORD CHANGER



ONLY \$9.95

ROCK BOTTOM PRICE

Takes twelve 10-inch or ten 12-inch records. Smooth, gentle change cycle. Removable metal base measures 13 1/2" x 13"; overall height 7". Complete with high-quality crystal cartridge and interconnecting wires. A real steal at our low price!

STANCOR TELEMATCH

Regular List \$9.50 NOW ONLY \$1.95

Used by TV set owners everywhere! Increases antenna efficiency, minimizes ghost images, rejects adjacent channel interference. Attaches to antenna terminals of set with 300-ohm twin lead provided; that's all there is to installation! Brand new, original display cartons; complete with instructions.

POWER TRANSFORMER SCOOP!

Fully shielded; tapped primary for adjustment over 105 to 250 volt AC range. Provides 250 VDC at 100 MA and 6.3 V at 2.5 amps. Ideal for critical TV set replacement. experimental power supplies, etc.

MA-2500 \$2.49

29c GENUINE DELCO RADIO TUBES 29c

Every Tube in Original Carton!

1G6GT	1G6GT	2E5	12XN7
1J6G	1V	782	36

Terrific Savings!

CERAMICON CONDENSERS

Made to close tolerance; rated 500 VDC. Small size with pigtail leads. 7c each. 10 of one type for 59c. 100 of one type for \$5.00

mmf	mmf	mmf	mmf	mmf	mmf
2	15	40	68	140	232
5	20	47	78	150	237
8	25	50	108	170	250
10	30	56	125	175	350
					6800

Write For BIG BARGAIN BULLETINS

EXTRA SAVING! WARD TV ANTENNA

MA-3131 TV-88. 44 to 88 MC. Complete with 60 feet of 300-ohm lead-in, insulators, mfg hardware and instructions. Regular \$12.50 list, only \$2.95
 MA-3132 TVA-88. Same as TV-88 but less 300-ohm lead-in and insulators. only \$2.49
 MA-3133 TVA-94. 44 to 88 MC; provides broad band, high gain. Complete with hardware and instructions. Regular list price \$10.60 \$2.49

Write for quantity prices on all Ward TV antennas above.

Famous-Make Model 50 ANTENNA CHIMNEY MOUNT

Sturdy all-metal mount fits any average size chimney. No guy wires required. Complete with hardware and instructions. Save over 50% on this item! MA-3135 \$1.75

300-OHM TWIN LEAD-IN

Don't miss this great buy! Standard 300-ohm lead-in for TV and FM. Buy in quantity and save!

MA-3136	per 1000 ft.	\$13.25
	per 100 ft.	1.40
	per foot	.02

ORDER FROM THIS AD!

All prices f.o.b. Chicago. 25% deposit required on C.O.D. orders; pay balance plus postage on delivery. Send orders to Desk RC-119. Minimum order \$2.50.

MID-AMERICA CO. Inc.

STORE WAREHOUSE
 2412 S. Michigan Ave. 2307 S. Archer Ave.
 Chicago 16, Ill. Chicago 16, Ill.

ALL-WAVE 1-TUBER

? Please print a circuit of an all-wave one-tube receiver using a 117L7/M7-GT. I want to wind my own coils, so please supply coil data.—A.C.B., Charlotte, N.C.

A. This circuit will give good results when used with an efficient antenna. The coils are to be wound on 1 1/2-inch plug-in forms.

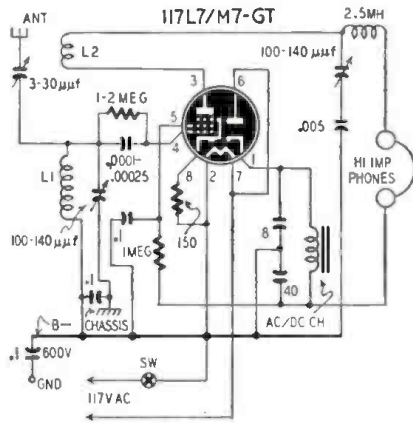

Band (Meters)	Turns (L1)	Wire size	Turns (L2)	Wire size	Spacing (L1)
200-500	126	28	28	34	close wound
135-270	82	28	16	30	1 7/8 inches
66-150	38	26	11	30	1 3/8 inches
33-75	18	24	6	30	1 1/2 inches
17-41	9	16	5	30	1 1/4 inches
9-20	3 1/2	14	3	30	1 inch

L2 should be wound at the lower end of L1. The spacing between windings

should be adjusted for smooth regeneration control. The average spacing will be about 1/4 inch. The chassis connects to one side of the a.c. line, so place the set in an insulated cabinet and use insulated knobs on the tuning and regeneration control capacitors. Dead spots are eliminated with the antenna trimmer.

ANTENNA MATCHING

? I have an antenna array consisting of a folded dipole mounted one-half wave above a simple dipole. How do I match this combination to a 300-ohm transmission line? Please show how these can be connected and give me the data on which your design is based.—H.L.M.F., US Navy

A. The antennas can be connected by transforming the impedance of each to 600 ohms and paralleling them across the 300-ohm transmission line.

Quarter-wave transmission lines are the impedance-transforming devices. The impedance (Z₁) of the matching section is

$$Z_1 = \sqrt{Z_0 Z_2}$$

where Z₂ is the impedance of the transmission line and Z₀ is the impedance of the antenna.

When the matching section is constructed from two air-insulated parallel conductors, its characteristic impedance Z₁ is equal to 276 log b/a, where b is the center-to-center distance between conductors and a is the radius of the conductor. Note that a and b must be in the same unit of measurement.

HOW TO GET THE MOST from only BASIC TEST EQUIPMENT

Servicing by Signal Substitution

The Simple, Modern, Dynamic Speed approach to receiver alignment and adjustment problems, FM-AM-TV.

- Nothing complex to learn
- No extra equipment to purchase
- Universal — non-obsolete
- Employs only Basic Test Equipment

S-S-S tells HOW — in simple, direct language.

New 9th edition now off the press. 100 pages of valuable information.

Available from all leading radio parts and equipment distributors or directly from factory at only 40c per copy.

PRECISION APPARATUS COMPANY, Inc. • 92-27 Horace Harding Blvd., Elmhurst 4, N. Y.

CONICAL TV RECORD BREAKER

Matches any ohm wire. All channels 1 to 13. No booster required. Lightweight—approx. 7 lbs. Immediate delivery.

Users report up to 300 miles reception!

\$10.95 DOUBLE STACK

8V-TV LIST \$37.95

8V-TV

NO JOBBERS. ORDER DIRECT
 20% DEPOSIT ON ALL C.O.D. ORDERS

RAYTRON—441 Summit—Toledo, Ohio

RADIOMEN'S HEADQUARTERS WORLD WIDE MAIL ORDER SERVICE ! !

\$12.95 FOR BIG BARGAIN "V".
(All 3 items listed below)

1. SENSATIONAL, FASCINATING, MYSTERIOUS SELSYNS. Brand new Selsyns made by G. E. Company. Two or more connected together work perfectly on 110V AC. Any rotation of the shaft of one Selsyn and all others connected to it will rotate exactly as many degrees in the same direction, following unerringly as if the units were connected together by shafting instead of wire. This is true whether you twist the shaft of the master unit a fraction of a revolution or many revolutions. Useful for indicating direction of weather vanes, rotating directional antennas, or controlling innumerable operations from a distance. Complete with diagram and instructions. Per Matched pair \$4.95.



2. ALUMINUM GEAR BOX 18X8X7 that contains two powerful electric motors and two matched gear trains, 62 gears in all varying in size from 1/2 to 4 inches in diameter. This unit is readily converted to rotate a beam antenna or any other similar use. \$5.00

3. HOME WORKSHOP AT BARGAIN PRICE. Accurate and precise 2 speed guaranteed hobby lathe, the essential machine for the home workshop. Sturdy enough for light production work or factory standby service. Supplied with 58" of belt for connecting to any available electric motor or power take-off. Also included in this unbelievable offer are such accessories as a 3" drill chuck with specially hardened tool inserts, a 4" electric turnace high speed grinding wheel, a cotton huffing wheel and a large supply of buffing compound, and a 3" steel wire scratch brush. Your cost \$6.00. Sole export agent. Distributor inquiries invited.

SENSATIONAL VALUE IN AC-DC POCKET TESTER

This analyzer, featuring a sensitive reduction type meter housed in a bakelite case, represents the culmination of 15 years achievement in the instrument field by a large company specializing in electronic test equipment.

Specifications of the AC-DC Model:
Volt-Ohm-Milliammeter:
AC Volts—0-25, 50, 125, 250
DC Volts—0-25, 50, 125, 250
Milliamperes AC—0 to 50
DC Milliamperes—0 to 50

Ohms Full Scale—100,000
Ohms Center Scale—2400
(Capacity)
0.5 to 15 Mfd.
Total Price, prepaid anywhere in the USA—\$7.00. Similar DC Meter, lacking the AC operated ranges of above, \$5.50 prepaid.



SCR 274N Command Set (Made by Western Electric) THE GREATEST RADIO EQUIPMENT VALUE IN HISTORY

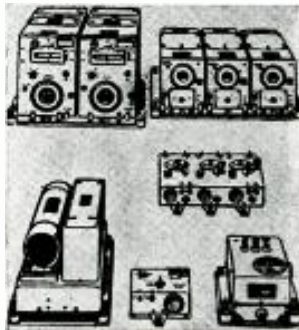

A mountain of valuable equipment that includes 3 separate Communications Receivers, covering up to 9.1 Mc, 2 separate 40 watt Transmitters including crystals, 4-28v Dynamos (easily converted to 110v AC operation), Pre-Amplifier and Modulator, 2 Tuning Control Boxes, and 1 Antenna Coupling Box complete with R.F. Ammeter. 29 tubes supplied in all. Receivers and Transmitters instantly detached from mounting racks for use in separate locations. Removed from unused aircraft and in guaranteed electrical condition. A super value at \$59.95 complete.

Bayonet type radio pilot light sockets for model railroad enthusiasts, etc. \$5.00 a hundred. Mazda licensed bulbs, per 10, 50c.

GENERAL ELECTRIC 150 WATT TRANSMITTER

COST THE GOVERNMENT \$1800.00 •

COST TO YOU—BRAND NEW—EXPORT PACKED \$100.00

This is the famous transmitter used in U.S. Army bombers and ground stations, during the war. Its design and construction have been proved in service, under all kinds of conditions, all over the world. The entire frequency range of 100 to 1000 kc of nine-tuning units which are included. Each tuning unit has its own oscillator and power amplifier, coils and condensers, and antenna tuning circuits—all designed to operate at top efficiency within its narrow frequency range. Transmitter and accessories are finished in black crackle, and the milliammeter, voltmeter, and RF ammeter are mounted on the front panel. Here are the specifications: FREQUENCY RANGE: 200 to 700 KC and 1500 to 12,500 KC. Will operate on 10 and 20 meter bands with slight modification for which diagrams are furnished. OSCILLATOR: Self-excited, thermally compensated, and hand calibrated. POWER AMPLIFIER: Neutralized class "C" stage, using 211 tube and equipped with antenna coupling circuit which matches practically any length antenna. MODULATOR: Class "B" tubes two 211 tubes. POWER SUPPLY: Supplied complete with dynamotor which furnishes 1000V at 320 MA. from either 12 or 24 volts. Complete instructions are furnished by operator set from 110V AC. SIZE: 21 1/2 x 23 x 11 1/2". Total shipping weight, 300 lbs., complete with all tubes including a full set of spares. Besides those necessary for operation, dynamotor power supply, seven tuning units, antenna tuning unit and the essential plugs.



FCC AUTHORIZES RADIO FOR PRIVATE SERVICE!!!

(The FCC announced that effective June 1, any American over 18 years of age is eligible for a 5 year station permit. In the "Citizens" band, neither code test nor technical knowledge is necessary.)

GENERAL ELECTRIC 15 TUBE TRANSMITTER-RECEIVER SET. This brand new 15 tube transmitter-receiver was designed for mobile storage battery powered service. It will operate in the "Citizens" band where no amateur license to transmit is necessary. It's a cinch for any experimenter to connect this unit for 110 V AC operation by following the instructions and diagrams supplied, which cover numerous applications, including television. For those intending to use on car or boat, a new dynamotor, exactly as originally supplied, costs only \$15.00. Don't fail to write for FREE descriptive bulletin. Order our RT-1248 for only \$29.95, or two for \$53.90.

HEAT GUN

Streamlined pistol grip heat gun. Vivid red heat. 20 cubic feet per minute blast of hot air at 160° Fahrenheit. Ordinary blowers have small fan motors, but this has a lifetime-lubricated AC-DC motor of the rugged vacuum clear type that produces a hurricane of either hot or cold air. Blow out dirt or dust from radio chassis. Dry out ignition systems. Heat carburetors. Quick-dry paint. Thaw out radiators or water pipes, etc. Warning—Keep this away from your wife. She will use it to dry her hair because it will do it in half the time of her ordinary hair dryer, to say nothing of her using it to dry stockings or clothing, or defrost the refrigerator instantly. Only \$12.95. Satisfaction guaranteed or money refunded if returned prepaid within 5 days.



Our PE-109 Power Plant Direct Current

A gasoline engine coupled to a 2000 watt 32 Volt DC generator. Can be adjusted to give 12 to 40 V. output. Ideal for use in locations not serviced by commercial power or to run any of the surplus items that require 24-32v DC for operation. The price of this power plant tested and in good condition is only \$79.95. We can also supply a converter that will supply 110v AC from the above unit or from any 32v DC source for \$12.95.



SUPER SPECIAL

New 1950 Model 500 Super Special Generator Kit. Modulation On-Off switch, internal modulation and external modulation jack provided. Internal 400 cycle sawtooth audio available for external testing and Adeltiv checks on re-receivers. Precision coils for greater accuracy and maximum stability on all 5 bands. Dial calibrations from 150 K.C. to 104 Mc. This signal generator is 115 V.A.C., 60 cycle operated and comes with everything, including complete detailed instructions. Assembly is an easy job, even for the least experienced. The lowest price and the best signal generator on the market for only \$148.75. Also available factory-assembled for \$28.75.

LINE FILTERS

Each unit contains two 4 mfd oil filled condensers and a high inductance 50 amp choke in fully shielded case. Suitable heavy current connectors are provided to attach to the input and output connectors at each end of the filter from your input and output wires. A filter with innumerable uses on oil burners, refrigerators, boats, automobiles and wherever noise is to be suppressed or interference abolished. A \$17.00 value for \$1.95.

MICROPHONES

Super Shield-High quality all chrome bullet shaped CRYSTAL MIKE of top flight nationally known brand \$5.95. Bullet DYNAMIC MIKE—\$7.95. MIKE JR—60c. PUSH-TO-TALK MIKE with switch on handle \$8.00. LABEL MIKES (Specify whether carbon or magnetic \$3c).

T-32 Microphone with desk or table stand \$2.95

AUDIO AMPLIFIER—brand new dual stage triode amplifier having 2 of the valuable and scarce output type audio transformers that sell for over \$10.00 a piece. Neat aluminum case, fully enclosed (large-size dimension 6 inches). Perfect for intercom system, phone amplifier, mike amplifier or signal tracer amplifier for testing radio sets. A sensational bargain at only \$3.40 each

SIGNAL GENERATOR

Genuine Laboratory-type precision signal generator. Manufactured and sold for \$68.00 each in large quantities during the war by Northeastern Engineering Corp., one of the top manufacturers of electronic equipment for the U.S. Govt. Five fundamental bands starting at 150 K.C. Strong harmonics up to 120 Mc. Five step ladder type attenuator as well as potentiometer output control. Regular 1000 cycle audio oscillator using vacuum tube, not a cheap neon sawtooth audio oscillator. Audio output separately available externally. Weight without packing material 18 lbs. which should show what a world of difference exists between this signal generator and the ordinary cheap oscillator used by the average serviceman. Complete with fused lead, and coaxial output lead. Super Special \$38.75.



POWER RHEOSTAT

Exceptionally rugged. Trouble-free design. Withstands severe overloading to many times the nominal 25 watt rating without burning or smoking. Perfect for motor speed control or line voltage adjustment. 3 sizes available: 50, 60 and 200 ohms. Regular price \$3.20. Special—\$1.00.



RT655

Only \$14.95

11 tube-crystal controlled super-heterodyne receiver that covers the FM band. The ultra modern circuit uses the latest type of tubes including 7 miniature 6A25's. Beautiful chrome and aluminum cabinet. Tubes and diagram included.

1950 MODEL MUTUAL CONDUCTANCE TUBE TESTER \$56.95



Attractive panel and case... Large 11 1/2" meter... Calibrated microhilo scale as well as Rad Good scale... Front panel fuse... Individual sockets for all tube base types... Proper filament voltage supplied to test any tube ever made... Unequaled switching flexibility allows all present and future tubes to be tested regardless of location of elements on tube base... Indicates gas content... Detects shorts or opens on any element of any tube... Tests cold cathode, miazle eye and voltage regula for tubes as well as all ballast, amplifier and rectifier types.
Model "C"—Sliding front counter case \$56.95
Model "P"—Handsome hand-rubbed portable case \$9.95
Built-in roll chart with either of above \$5.00 extra.

VACUUM TUBE VOLT-OHM-CAPACITY METER

There are more features engineered into this all-purpose instrument than in any other instrument on the market, regardless of price. Here are a few of the many features of this outstanding meter:

- 5 inch easy to read meter.
- 6 DC voltage ranges from 0 to 1000 V (input resistance as high as 1 megohm per volt).
- 5 AC voltage ranges from 0 to 1000 V (No dry disc rectifier to age and destroy the accuracy of this VACUUM TUBE BOLT METER).
- 6 Resistance ranges from 2 1/2 ohm to 1000 megohms.
- 4 Capacity ranges from .00025 to 20 MFD.
- A zero center range for balancing FM discriminators.
- Isolating resistor built into probe.
- Sturdy natural finish hard wood case.



This outstanding development of one of the leading manufacturers of test equipment costs only \$39.50 complete with all leads, as illustrated.

20,000 ohm per volt SUPERTESTER. Similar in appearance and made by same manufacturer as Vacuum Tube V-O-C Capacity Meter pictured above. Specifications as follows:
DC volts at 20,000 ohms per volt: 0-3v, 15v, 60v, 300v, 1500v, 6000v
AC volts at 10,000 ohms per volt: 0-6v, 30v, 120v, 600v, 3000v, 6000v
Current: 0-60 Microamps, 0-6MA, 60 MA, 600MA, 6 Amperes
Resistance: 0-3000, 300,000, 3 Mega, 300 Mega
Decibels: Minus 4 to plus 77 DB divided into 6 ranges

All special 1% accurate multipliers used. No external source of power required for AC measurements although there is no frequency error in the range from 30 cycles to 1 megacycle. This SUPERTESTER has valuable features found in no other tester on the market, such as WIDEST resistance range coverage, HIGHEST AC voltage sensitivity, WIDEST power level (10% coverage, and the lowest price—only \$29.95. We urge comparison with this instrument before buying any other tester.

"DRILLMASTER" ELECTRIC DRILL

Low-priced electric drill. Ideal for hobbyists. Complete with sander, buffers, grinding wheels, etc. This is bankrupt stock and only a few are available. A sensational bargain at \$9.95. Satisfaction guaranteed or money refunded if returned prepaid within 5 days.



ALL PURPOSE NEON TESTER. 60 to 850 volt. Indicates all kinds of current, AC, DC or RF, and comes complete with instruction booklet outlining various tests on radio sets, including the location of failing, dead stages, shorts, and making screen-grid and plate circuit tests. 35c ea. Per doz. on attractive display card—\$3.50.

Universal 4 lead broadcast band oscillator coil (can be converted to 3 lead type by addition of jumper). Ten for \$1.00



HUM DETECTOR

It is often important to know whether or not a potentiometer on an amplifier chassis is free of magnetic fields. To determine this, wind a small choke of about 100 turns on a core made of a thin iron nail. Connect the two leads from the choke to the amplifier input, or connect one to the grid of the first a.f. amplifier tube and the other to ground (in a receiver). Hold the choke on the spot being tested. If any hum is present, it will be heard in the loud speaker.

This method can also be applied to oscilloscope construction when it is necessary to locate and eliminate electro-magnetic fields which may distort the pattern on the cathode-ray tube.

A. A. BOSCHAART,
Amsterdam, Holland

RELAY CHECKER

In electronic circuits where relay contacts carry currents in the order of a few microamperes, it is essential that the contact resistance be less than 0.1 ohm. Ohmmeters and resistance bridges being unsatisfactory measuring devices for production work, this system was devised.

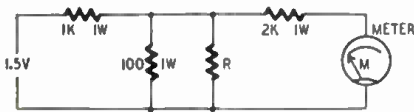

The meter M is a laboratory-type galvanometer having a deflection of .004 μ a per millimeter, and R is the contact resistance. Deflections of 10 to 12 millimeters are obtained with good contacts. Heavy low-resistance conductors should be used between the contacts and the test circuit. The loop resistance effect can be observed by shorting the conductors and taking a reading.

WILLARD MOODY,
Washington, D. C.

SAFE HOME-MADE TV SETS

It is a good idea to use separate a.c.-line cords on the high- and low-voltage power supplies in home-made TV receivers, oscilloscopes, and other similar equipment. This makes it possible to remove all unnecessary voltage from the equipment when it is being serviced or adjusted.

CHARLES ERWIN COHN,
Chicago, Ill.

BE YOUR OWN BOSS!



MAKE MORE MONEY
\$1.00 VALUE
25c
40,000 WORDS IN TEXT
NO ADS ALL "MEAT!"
In "CASH IN" you now get THE real money-makers — dozens of profitable tested mail order plans, confidential business secrets, dozens of practical tested formulas, successful tested schemes — actual experiences of men who have started on a shoestring—with less than \$10 capital. 25c a copy postpaid. Send U. S. stamps, money order, or coin.
Money Back Guarantee

NATIONAL PLANS COMPANY
1966 R Broadway New York 23, N. Y.

HICKOK Dynamic Mutual Conductance **TUBE TESTERS**
Are Dependable Income Builders



First Choice
of the Experts for Accuracy and Speed

MODEL 600

1. New, smaller, portable, lower cost tester.
2. Tests for gas content.
3. Reads directly in micromhos.
4. Separate voltage applied to each element.
5. Detects more weak tubes.

• Never in the history of radio servicing have HICKOK Tube Testers ever been excelled. Their Dynamic Mutual Conductance Circuit has long been an exclusive HICKOK development. Available in a complete line of portable, counter, and display models. Specially designed professional features. The choice of leading radio service technicians throughout the world.

See them at your jobber's now, or write for latest free literature.



ELECTRICAL INSTRUMENT COMPANY
10531 DUPONT AVENUE CLEVELAND 8, OHIO

Please send me latest literature on your line of Hickok Tube Testers:

NAME _____
ADDRESS _____
CITY _____ STATE _____

BA in KANSAS CITY, MO. the exact Center of America



DAYS CLOSER TO EVERYWHERE
A FAST . . . RELIABLE . . . ONE STOP SOURCE for EVERYTHING IN RADIO—TELEVISION—ELECTRONICS

Catalog No. 501, 144 big pages now being mailed to Dealers, Servicemen, Broadcast Stations, Schools, Factories, Public Utilities, Laboratories, Engineers, Amateurs, Experimenters
Its FREE . . . Write us if you haven't received it.

BURSTEIN-APPLEBEE CO.
1012 McGee St., Kansas City 6, Mo.
Send me your FREE catalog.
BA
NAME _____
ADDRESS _____
TOWN _____ STATE _____

Announcing the NEW RADIO-ELECTRONICS MAGAZINE LIBRARY

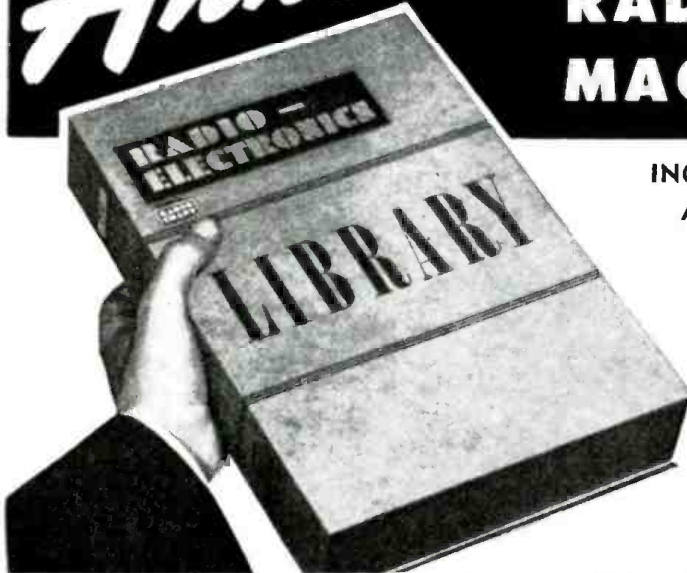

INGENIOUS, CUSTOM-BUILT STORAGE FILE
Another WALTER ASHE Value Scoop!

Only **25¢**

each plus 6¢ each to cover packing and postage (anywhere in U. S.)

Holds 12 complete issues of magazine in its present 80 to 90 page size. Measures 12" x 8 1/2" x 2 3/8"

Here's the brand new, grand new way to preserve each issue of RADIO-ELECTRONICS Magazine! Made of high quality Kraft fibre board, printed and constructed to look like a Buckram-bound book. Affords neat, orderly, flick-of-the-finger convenience. Handy Reference Index, printed on back, records the location of selected articles, wiring diagrams, etc. A "must" for every bargain-conscious reader of Radio Electronics Magazine. At the low price you'll want several of these serviceable, attractive Magazine Libraries.

Walter Ashe Radio Co. RE-11-49
1125 Pine St., St. Louis 1, Mo.
Rush my order for:

_____ Radio-Electronics Magazine Library at _____
(quantity)
25¢ each (plus 6¢ each to cover postage and packing)

Remittance for \$ _____ is enclosed
(amount)

Mail my Free Copy of new 1950 Walter Ashe Catalog _____

Name _____
Address _____
City _____ Zone _____ State _____

FREE!
NEW 1950 Catalog
of Radio, Electronics and Television. 160 pages. The Treasure Chest of Values! Order your copy today.

Order now for immediate delivery.
Use the handy coupon.

Walter Ashe
RADIO CO.
1125 PINE ST. • ST. LOUIS 1, MO.

AID FOR ORGANIZERS

One of the important stumbling blocks in the path of new association organizers is the formation of a set of rules, bylaws, and procedures. Howard W. Sams & Co., Inc., publisher of the Photofact Service, has reprinted the *Manual of Procedure*, the application blank, and the technical examination set up by the Radio Electronic Technicians Association of Ontario, Canada, an

outstandingly well organized group.

The reprints are offered without charge to any service organization for use as a guide.

ESFETA LECTURES

The Empire State Federation of Electronic Technicians opened its 1949-1950 lecture season September 7. The initial lecture was given in New York City by John F. Rider, who spoke on "The Nature of TV." The lecture in-

cluded such points as general transmission and reception problems, modulated waveforms and high-frequency propagation and reception.

The opening meeting was attended by several hundred radio-television technicians, including a number from points outside New York City. These were largely from the Long Island Television and Radio Technicians Guild and the Independent Radio-Television Technicians of Westchester County.

The meeting is the first of 16 lecture-sessions, each of which will be held in four areas in New York State—New York City, Poughkeepsie, Binghamton-Endicott, and Rochester. The complete program will extend to May, ending with a final examination-meeting.



Association Officials at September 7th meeting. Left to right: Joseph D. McNamara and John A. Wheaton, Long Island Television and Radio Technicians Guild; Arthur Silverberg, ARSNY; John Rider; Sam Marshall and Max Leibowitz.

ARSNY; Karl Nelson, Karl Richter, and C. E. Cypher, Independent Radio-television Technicians of Westchester; Noel Payne, ARSNY; Pat Avery and Paul Prochnau of the Westchester technicians association. Attendance figures ran high.

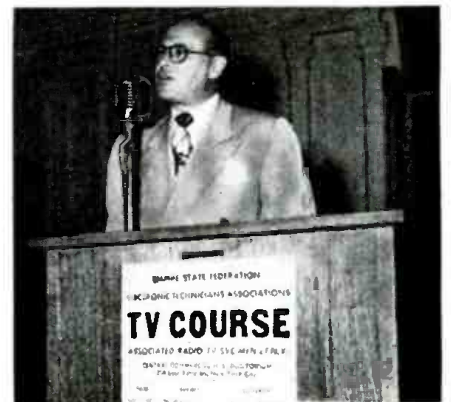

John F. Rider gives first ESFETA talk.

RADIO-ELECTRONICS for

PHILCO 48-700, 48-1000 AND OTHERS

These and several other Philco TV sets have a center-tapped primary on the antenna transformer. The input impedance is 300 ohms across the ends of the primary and 75 ohms between the grounded center tap and either outside terminal. Co-axial lead-ins are connected between one terminal and ground. Signal strength and picture

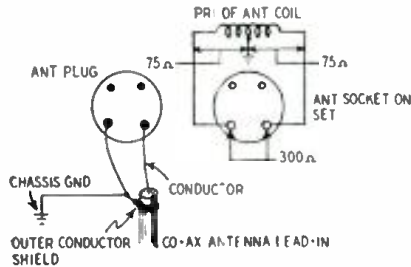

quality will be improved if the unused part of the coil is shorted out by grounding the remaining terminal. This connection can be made on the antenna plug by connecting the co-ax across the 300-ohm terminals and grounding the outer conductor to the chassis as shown in the drawings.

CLARENCE J. JONES,
Cleveland 9, Ohio

BIRDIES IN A.C.-D.C. SETS

Squeals and birdies may be eliminated from compact a.c.-d.c. sets by replacing the i.f. tube. The old tube may test perfect and can be used in another set.

ALAN MCFARLANE,
Aberdeen, S. Dak.

BRUSH B.K.-401 SOUNDMIRROR

Intermittent noise on playback and recording has, on several occasions, been traced to a bad plate resistor (220,000 ohms) in the first 6SJ7 amplifier. A 1/2-watt resistor was used in the original circuit. Replace it with a 1-watt unit.

ALBERT HOWE,
Vancouver, B.C.

TELEVISION INTERFERENCE

Look around for old-fashioned clear tungsten lamps when unable to identify or localize the source of television interference. One such lamp caused two entirely different interference patterns on two receivers in one installation. The offending lamp was removed to the service shop where it produced a third interference pattern on a set there.

R. L. CONHAIM,
Dayton, Ohio

STABILIZING THE MODEL 900 VOMAX

Early models are unstable on the 3-, 12-, and 30-volt a.c. ranges. This instability can be cured by inserting a 1-ohm resistor in series with one of the 6.3-volt heater leads. This reduces the voltage and increases the life of the tubes.

WILBUR HANTZ,
Columbus, Ohio

(The McMurdo Silver Co. has installed a 0.9-ohm, 1/2-watt resistor in the filament lead of the latest models of the Vomax.—Editor)

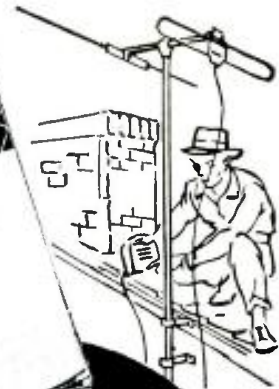

BUILD BETTER SERVICE BUSINESS

with this new booklet!



- Give customers a new appreciation of your service facilities
- Get the better, more profitable service calls

Every radio service magazine raved about this latest business builder from the makers and distributors of:

SPRAGUE CAPACITORS

Here is just the kind of advertising for your service business that you've been looking for!

"Your Money's Worth in Good Radio and Television Service" is a handsomely 2-color lithographed 16-page booklet that tells customers a lot about service they probably never realized before. It shows why good service is worth good money. It explains the large amount of

costly equipment needed to repair complicated modern receivers properly. And it demonstrates to set owners exactly why and how the best service is cheapest in the long run. Each copy can be prominently imprinted with your name and address. Fill in and mail the coupon for sample copies and details—or see your Sprague distributor.

Write for FREE SAMPLE

Dept. RE-118, Sprague Products Company
North Adams, Mass.

Please rush me a free copy of your new booklet "Your Money's Worth in Good Radio and Television Service" and explain how I can obtain additional copies for distribution to my customers.

Name _____
Address _____
City, Zone _____ State _____

For Greater Earnings ...  **LEARN RADIO-ELECTRONICS**

This fast-growing science of RADIO, TELEVISION, RADAR and ELECTRONICS, offers tremendous opportunities, and in no industry is RADIO-ELECTRONICS more important than in aviation. A skilled technician who *knows* the modern application of electronic devices, as used in the aircraft industry, is always in demand . . . not only in aviation, but in many other industries. Many large organizations call on Spartan regularly for graduates. Often, students are hired months before graduation.

Don't confuse the RADIO-ELECTRONICS course offered by SPARTAN with other courses, offered anywhere! As a graduate from this famous school you will know the application to industrial control devices; to the search for petroleum; and the important uses of radar, television and other electronic equipment.

SPARTAN offers two complete and thorough courses. You will work on the most modern and complete equipment. You will build equipment. You may join the SPARTAN "Ham" Club. Either course prepares you for Federal Communication Commission license tests — first class radio telephone, second class radio telegraph, or class "B" radio amateur.



SPARTAN'S 21 years of teaching civilian and army personnel is your assurance of receiving the best possible training in the least possible time. *You'll not need MORE than Spartan training — you cannot afford to take LESS.*

BIG CATALOG—Free

NAME _____ AGE _____
 ADDRESS _____
 CITY _____ STATE _____
 Dept. RE-119

G. I. APPROVED—Write TODAY for Complete Information

SPARTAN
 SCHOOL OF RADIO AND ELECTRONICS



SCHOOL of AERONAUTICS
 MAXWELL W. SALTHOUSE, DIRECTOR

COLLEGE of ENGINEERING
 ADDRESS DEPT. RE-119

TULSA, OKLAHOMA

CARTRIDGE WITH THE EASILY REPLACEABLE SYLUS

A SYLUS FOR EVERY PURPOSE

Here's the wide range variable reluctance pickup you have been waiting for. It features a removable and replaceable stylus to permit use of the cartridge with all types of recordings, LP microgroove records and commercial pressings. Change the size of the ball point as desired without altering the fine quality performance of this pickup. A high fidelity pickup offering flat response (meets FM specifications), low distortion and featherweight needle force. Response is velocity responsive to above 12000 cps. Needles available with .0010" ball point radius for microgroove records, or .0015", .0022", .0025", .0030" for conventional recordings and pressings. The cartridge has standard holes for mounting on tone arm. See it at your jobber or write for Bulletin No. 141M.



THE ARM WITH THE SLIDE-IN CARTRIDGE HOLDER

Ballbearing Record Arms with the new Slide-in Cartridge holder requires no soldering and fits all types cartridges. Quick acting weight adjustment for all type records, standard and LP. Made in two sizes for records up to 12" and 17". See your jobber or write for Bulletin 172M.

CLARKSTAN
 CORP.

11927 W. Pico Blvd.
 Los Angeles 34, Cal.

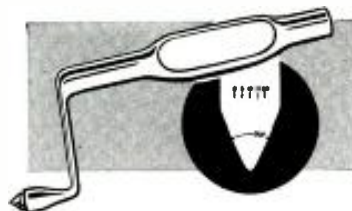

CLARKSTAN "INDIVIDUALLY SHADOWGRAPHED" SYLUS

Clarkstan finer quality styli are the result of expert craftsmanship and repeated checking for close tolerances after each cutting and polishing operation. Only highest quality sapphire rod is used. Entire cone is polished and tip is super-polished. Only Clarkstan offers a wide selection of tip radii accurate to .0001". Our diamond points are made from only the finest entire small diamonds available. See your jobber or write for Bulletin No. 170M.

ELECTRONIC LITERATURE

Any or all of these catalogs, bulletins, and periodicals are available to you if you write to us on your letterhead (do not use postcards) and request them by number. It is necessary to send only the number of item you want. We will forward the request to the manufacturers, who in turn will send the literature directly to you. This offer void after six months.

NV-1—VIBRATOR GUIDE

The Mallory Vibrator Guide is a 40-page book listing receivers using vibrators, with the correct type of vibrator for each. Notes are included on installation, building a vibrator tester, and servicing auto radios.—15¢

B10/120

NV-2—ROTATOR FOLDER

This 4-page folder—published by the E. F. Johnson Co. describes their *Rotomatic* beam rotator and amateur antenna.—*Gratis*

NV-3—PARTS CATALOG

This is a 128-page catalog of standard radio parts of many manufacturers sold by Bill Sutton's Wholesale Electronics in Fort Worth, Tex., at standard "net" prices.—*Gratis*

NV-4—SPEECH CLIPPER BULLETIN

The Electro-Voice Bulletin No. 145 describes the advantages in limiting audio modulation peaks in amateur and emergency communication services. It describes the uses of the Model 1,000 Speech Clipper.—*Gratis*

RADIO-ELECTRONICS for

NV-5—RESEARCH WORKER

Aerovox Corporation has resumed publication of *The Aerovox Research Worker*, a monthly technical publication dealing with various aspects of radio and electronics.—Available to manufacturers upon request. *Gratis* to interested parties with indorsement of a radio parts dealer.

NV-6—FOR TV TECHNICIANS

The Care of Television Customers, a handbook on courtesy and proper handling of television customers, has been prepared by the RCA Service Company for use by TV technicians.

NV-7—CLAROSTAT CATALOG

Catalog No. 49 has 15 pages describing and illustrating the various types of fixed, adjustable, variable, and flexible resistors made by Clarostat Manufacturing Company, Inc. Also included is a description of the Clarostat beam bender designed for use with 10-inch C-R tubes.—*Gratis*

NV-8—WORKSHOP TV ANTENNAS

An eight-page illustrated catalog describes the TV antennas and accessories made by The Workshop Associates, Inc. A short section on television receiving problems illustrates some of the antennas that may be required for good reception in certain localities. Graphs illustrate the radiation pattern and standing-wave characteristics of the antenna systems.—*Gratis*



ACORN
HEADQUARTERS FOR TOP VALUES



CE MIDGET CONDENSER
Double Bearing
Min. cap 8 mmfd. Max. 75 mmfd. 89c ea; 3 for \$2.40

TRANSFORMERS

—as used in Dumont TV. These are NOT Government surplus but brand new transformers used by Dumont in their TV sets. These are now being sold at a fraction of their original cost.

POWER TRANSFORMERS

Stock #20-11
Pri. 110-50/60 Cy.
4500 V. Ins.
Sec. 1000-0-1000 @ 10 ma.
5 V. @ 3 amp. **\$4.95**
4-2.5 V. Windings

Stock #20-304
Pri. 110-50/60 Cy.
Sec. 900 V. ct. @ 175 ma.
5 V. ct. @ 3 amp.
6.3 V. ct. @ 3 amp. **\$3.79**

Stock #200-4716
Pri. 110-50/60 Cy.
Sec. 850 V. ct. @ 325 ma.
2500 V. Test **\$5.95**

Stock #200-4921
Pri. 110-50/60 Cy.
Sec. 800 V. ct. @ 325 ma.
5.0 V. ct. @ 6 amp.
6.3 V. @ 8 amp.
2500 V. Test **\$8.49**

Stock #200-11325
Pri. 110-50/60 Cy.
Sec. 850 V. ct. @ 325 ma.
(Winding tapped at 750 V. ct. @ 1.5 ma.)
6.3 V. @ 1.5 amp.
5 V. @ 6 amp.
5 V. @ 3 amp. **\$8.95**

HIGH VOLTAGE TRANSFORMER
Stock #200-11086
Electrostatically Shielded
Pri. 110-50/60 Cy.
Sec. 4300 V @ 5 ma.
2.5 V. @ 1.75 amp.—12 KV Test
2.5 V. @ 1.75 amp.—12 KV Test
Perfect for Hkch Voltage Power Supply for projection. **\$18.95**

B.T.O. TRANSFORMERS
Stock #20-58
Horiz. pulse trans.
Electricoil #1629. **\$1.47**

FILTER CHOKES

Stock #21-100. 20 Hy @ 150 ma—400 ohms DC. **\$2.49**
Stock #21-135. 10 Hy @ 150 ma—200 ohms DC. **1.97**
Stock #21-329. 10 Hy @ 175 ma—70 ohms DC. **1.97**
Stock #21-330. 12 Hy @ 110 ma—100 ohms DC. **1.39**
Stock #21-331. 6 Hy @ 325 ma—105 ohms DC. **2.95**
Stock #20-401. 12 Hy @ 300 ma—100 ohms DC. **3.29**
Stock #21C-12976. 6 Hy @ 400 ma—60 ohms DC. **2.95**
Stock #21-129. 40 Hy @ 30 ma—2200 ohms DC. **1.59**

Stock #21-390. 135 Hy @ 5 ma
10 oh maximum—6500 ohms DC. **.98**

NATIONAL RF CHOKE
R-174 U for the 20, 40 and 80 meter band. 1 millihenry @ 600 mls. **49c ea; 3 for \$1.35**

FILAMENT TRANSFORMERS
Stock #20C-4933
Pri. 110-50/60 Cy.
Secs. 6.3 V. @ 7 amp.
2 windings. **\$2.95**

Stock #20C-11058
Pri. 110-50/60 Cy.
Sec. 6.3 V. ct. @ 10 amp.
cased. **\$3.19**

Stock #20-307
Pri. 110-50/60 Cy.
Sec. 15 V. @ 7 amp.
Tapped as follows from C.T.
6.3 V. @ 7 amp. each side of ct.
1.2 V. @ 7 amp. from 6.3 V.
Section to end of Secondary. **\$4.45**

A.F. VERTICAL OUTPUT TRANS.
Stock #20-374
Used with Deflection Yoke RCA 201 D1. **\$2.95**

HORIZONTAL BLOCKING OSCILLATOR TRANS.
Stock #20-17
3 winding. 321 Turns @ 28.
Enamel wire. Chicago Trans. **\$7.99**
Cr. #5227

AUDIO TRANSFORMERS
Stancor output transformer. 6L6 p.p. parallel 30 watts output. Voice coil tapped @ 4-8-15-500 ohms Imp. Upr. mount. **\$2.69**
6L6 p.p. output transformer. 20 watts output. V.C. tapped @ 4-8-15-250-500 ohms Imp. Upr. mt. **\$2.19**
Stancor Inter-stage transformer, p.p. plate to p.p. grids. Upr. mt. **\$1.39**

6.2 SPEAKER
Quam-Nichols. Alnico 5 Magnet 8 ohm ct. **\$2.39**

RCA DEFLECTION YOKE
201-D2 used for 5TP4 projection tubes. Very Special. **\$3.89**

200-4707
Pri. 110-50/60 Cy.
Sec. 6.3 V. @ 6 amp.—1000 V. Test
6.3 V. @ 3 amp.—1000 V. Test
5.0 V. ct. @ 6 amp.—1500 V. Test **\$2.95**

Stock #20-120
Pri. 110-50/60 Cy.
Sec. 6.3 V. ct. @ 10 amp.
1600 V. Ins.
Thor-Jarson #T-10F09 **\$2.95**

HORIZONTAL SWEEP OUTPUT TRANS.
Stock #200-4706
For use with Deflection Yoke RCA 201 D1. **\$4.45**

STEP-UP, STEP-DOWN TRANSFORMERS
110/220-220/110
100 W. **\$2.59**
150 W. **3.39**
250 W. **3.95**
400 W. **4.59**

ACORN ELECTRONICS CORP.
76 VESEY ST., DEPT. RE-11 NEW YORK 7, N. Y.

TERMS: 20% cash with order. Balance C.O.D. All prices F.O.B. our warehouse in New York City. No orders under \$2.50.

PHONE: WORTH 4-3270

NEW 6 VOLT RELAY
69c Postpaid

All merchandise subject to prior sale, minimum order \$2.00. No C.O.D. orders accepted. Michigan residents must add 3 Percent State Sales Tax.

IMPORTANT!!!

CATHODE RAY TUBE BARGAINS

ALL NEW GUARANTEED

3 CP 1 (Indicator Screen)	\$.75
3 FP 7-A	1.00
3 HP 7	1.25
5 BP 1	2.45
5 CP 1	1.95
5 FP 7	1.00
5 HP 1	2.45
7 BP 7	2.50
7 CP 1	3.25
908	2.45
9 GP 7	3.50

Add 25c each to cover postage and handling on all 3" tubes, 35c each on all 5" tubes, 50c each on 7" tubes. 9GP7 shipped Express, charges collect.

BRAND NEW FLAMEPROOF TELEGRAPH KEY 95c POSTPAID

ARC-5 CONTROL BOX **\$129**

Brand New in original cartons C-307
ARC-5 Push Button control box with 7 push buttons and selector switch.

POST PAID

NEW WIRE BARGAIN
\$2.00

525 feet Brand New Telephone Wire. 3 conductor braided insulated copper and steel telephone wire. It is of copper for conductivity and steel for strength. Worth at least 3c per foot, yet due to an exceptional buy we can now offer it at less than 1c per foot. (Shipped Express, Charges Collect).

NEW 2 VOLT BATTERY

Brand new, compact, spill-proof with built in hydrometer, dry charged (just add acid) \$1.25 each. Add 35c each to cover Postage and Handling.

TRIPLE TUNING HEADS

BC 450 triple remote control box for Command Receivers (SCR 274 N Series). Equipped with 3 tuning dials, 3 volume controls, and 6 selector switches. Used, but in excellent condition, a steal at only \$1.50 Each. (Add 25c each to cover postage and handling).

NEW ANTENNAS

New AN-131-A Collapsible 10 feet. 8 inches steel antennas 97c each plus 35c each to cover Postage and Handling.

NEW TUNERS

New Broadcast Band Push Button Tuner (used in 1947 Studebaker Radios) \$1.26. Add 35c each to cover Postage and Handling.

N. SilverStine Company **6532 E. McNichols Detroit-12-Mich**

Dr. Oliver D. Sledge has been appointed to the staff of the NATIONAL BUREAU OF STANDARDS, where he will do research in the Microwave Standards Section of the Bureau's Central Radio Propagation Laboratories.

Formerly a professor of electrical engineering at the Georgia School of Technology, Dr. Sledge will engage in research on microwave attenuation standards for frequencies above 300 mc and on radio measurement methods.

He has done extensive work in electronic and radio engineering, including electronic digital computer circuits and radar equipment. Before he joined the Bureau, Dr. Sledge was Associate Professor of Electrical Engineering at the Georgia Institute of Technology, where he also conducted radar research.

Octave Blake, president of CORNELL-DUBILIER ELECTRIC CORP., South Plainfield, N. J., was elected chairman of the board of RADIART CORP. of Cleveland, Ohio, a wholly owned subsidiary of Cornell-Dubilier. L. K. Wildberg, formerly vice president and general manager, has been advanced to the post of Radiart president.

The parent company bought all the stock of Radiart from Maguire Industries in 1948, and continued its operation as a manufacturer of television and automobile antennas and automobile radio vibrators, with Mr. Wildberg as vice president.



John V. L. Hogan, president of Station WQXR, New York, has withdrawn from the management of the Interstate Broadcasting Company, operator of the station. He will concentrate his efforts on facsimile and other fields.



William Warren Davis has been appointed to the Electronics Division of the NATIONAL BUREAU OF STANDARDS, where he will do research on the high-speed electrostatic memory of the electronic digital computing machines. His work will include tube characteristics and general applications.

Before he came to the Bureau, he was engaged in research on components for electric fuzes and has designed and developed equipment for vacuum-tube measurements. Davis was on the staff of the Naval Ordnance Laboratory at White Oak, Md., from 1947 to 1949. He was an electronics engineer with the Naval Research Laboratory from 1942 to 1947.



The Book that takes Drudgery out of Mathematics

Only **\$1.** postpaid

SOLVES EVERYDAY PROBLEMS HELPS YOU GET AHEAD IN LIFE

How many times have you lost money because of a mistake in figuring? Do you know how to figure quickly and correctly? Can you figure discounts, interest rates, taxes and all the other calculations you meet up with in your daily life?

Are you having trouble qualifying for Civil Service Exams or Armed Services Promotions, because you're not up on mathematics?

Here is the book that gives you a good background in mathematics; that takes all the irritation and drudgery out of it. You don't need to be scared of mathematics, because here's the subject explained without frills, without useless computations. Here's the book for men in radio jobs; for business men; technicians and craftsmen, explaining and answering everyday mathematic problems in easy-to-understand words and illustrations.

Yes, it's the key to a simple understanding of mathematics. It's a real home-study course in mathematics for the man who's alert to its importance in the world today.

ELEMENTARY MATHEMATICS
EASY — SIMPLIFIED — PRACTICAL
CONTENTS OF BOOK

- CHAPTER I. Arithmetic—Addition—Subtraction—Multiplication—Division.
- CHAPTER II. Factoring and Cancellation—Fractions—Decimals—Percentage—Ratio—and Proportion.
- CHAPTER III. The Metric System.
- CHAPTER IV. How to Measure Surfaces and Capacity (Geometry).
- CHAPTER V. Powers and Involutions—Roots and Evolution.
- CHAPTER VI. Mathematics for the Manual and Technical Craftsman—Thermometer conversion—Graphs or Curve Plotting—Logarithms—Use of the Slide Rule.
- CHAPTER VII. Special Mathematics for the Radio Technician.
- CHAPTER VIII. Commercial Calculations—Interests—Discounts—Short Cut Arithmetic.
- CHAPTER IX. Weights and Measures—Useful Tables.

ONLY **\$1.** POSTPAID

Send Stamps, Cash or Money Order.
TECHNIFAX
 110 N. Franklin St., Chicago 6, Ill.

FREE

HOW TO GET THE MOST FROM YOUR RADIO "KNOW-HOW"

Learn all about a new, simplified way of fixing radios. Nothing complex to learn, no calculating. Used by beginners and experts. Send for FREE manual: "THE INSIDE STORY," today. 28 pages—illustrated—easy to read! Shows how obsolete methods prevent full use of your real ability. Explains use of NEW techniques. You owe it to yourself and your future to "get out in front" in your work.

FEILER SEND COUPON OR PENNY POSTCARD FOR FREE MANUAL TODAY!

FEILER ENGINEERING CO., Dept. HRC9
 945 George St., Chicago 14, Illinois

Please HUSH my FREE copy of "The Inside Story"

Name.....
 Address.....
 City..... Zone..... State.....

George R. Sommers, formerly director of Pacific Coast sales for SYLVANIA ELECTRIC PRODUCTS, INC., has been appointed assistant to C. W. Shaw, general sales manager of the radio tube division, according to an announcement by R. H. Bishop, vice-president in charge of sales.

AMPERITE
 Studio Microphones at P.A. Prices

Ideal for BROADCASTING RECORDING PUBLIC ADDRESS

"The ultimate in microphone quality," says Evan Rushing, sound engineer of the Hotel New Yorker.

- Shout right into the new Amperite Microphone—stand 2 feet away—reproduction is always perfect.
- Not affected by any climatic conditions.
- Guaranteed to withstand severe "knocking around."

Models
 RBLG—200 ohms
 RBHG—Hi-imp.
 List \$42.00

"Kontak" Mikes
 Model SKH, list \$12.00
 Model KKH, list \$18.00

Special Offer: Write for Special Introductory Offer and 4-page illustrated folder.

AMPERITE Company, Inc.
 561 BROADWAY • NEW YORK 12, N. Y.
 Canada: Atlas Radio Corp., Ltd., 560 King St. W., Toronto

LEARN

Electricity OR Radio-Television

IN THE GREAT SHOPS OF **COYNE**

COYNE 50th ANNIVERSARY

TRAIN QUICKLY! OLDEST, BEST EQUIPPED SCHOOL of ITS KIND in U.S. 2 Opportunity Fields

Come to the Great Shops of COYNE in Chicago during our 50th Anniversary Year! Get quick, practical training in RADIO-TELEVISION or ELECTRICITY. G. I. Approved. Finance plan for non-veterans. Mail Coupon Today for complete details.

NOT "HOME-STUDY" COURSES!
 You learn on real, full-size equipment, not by mail. Finest staff of trained instructors to help you get ready quickly for a better job, a fine future.

FREE BOOKS Clip coupon for big illustrated Coyne book on either ELECTRICITY or RADIO-TELEVISION. Both books sent FREE if you wish. No obligation; no salesman will call. Act NOW!

B. W. COOKE, Pres.
COYNE Electrical & Radio School, Dept. 89-81H
 500 S. Paulina Street, Chicago 12, Illinois

Send FREE BOOK and full details on:

ELECTRICITY RADIO-TELEVISION

NAME.....
 ADDRESS.....
 CITY..... STATE.....

FLASH THAT VOLTAGE

Turn that knob. Extinguish the neon glow. Instantly read voltage right off dial. MINI-VOLT measures 65 to 660 v. AC. Also DC. Tells whether AC or DC. Virtually burnout-proof. Guaranteed for 25,000 hours' operation. Plastic case. 12" test leads and test probe. A "must" in electrical and radio work. Only \$2.75 postpaid!

INDUSTRIAL DEVICES INC. EDGEWATER 3 N. J.

SUPPLIES 1 to 20 AMPS
6 Volts DC, Continuous Duty

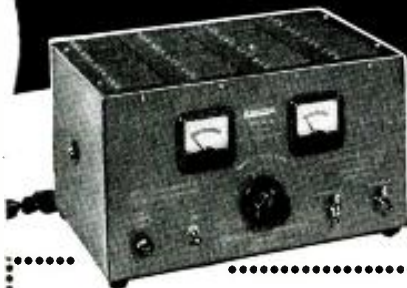

Patent Pending

**Conduction Cooling
Increases Rectifier
Power Rating 1½ Times**

New Electro Model "B" costs no more than the conventional type. Completely different application of selenium rectifiers aided by conduction cooling, dissipates over 3 times the heat. The Electro Model "B" has proved itself the most efficient direct current source of power known. Gives instant readings, and offers ample power to operate any receiver. Peak instantaneous current rating of 35 amperes (from 50 to 60 cycle 115 volt power source), permits operation of two receivers with push button solenoids.

APPLICATIONS

Test or operate auto radios, relays, telephone circuits, laboratory instruments and many other low voltage requirements.

**ONLY ELECTRO HAS
ALL THESE FEATURES**

- ★ 1 to 20 amperes at 6 volts continuous duty
 - ★ Damped volt and amperes (no wiggling) voltmeter 3% accuracy
 - ★ Less than 3% A. C. ripple or hum
 - ★ Heavy duty selenium rectifiers
 - ★ 8 heavy duty power tap adjustments
 - ★ Heavy duty transformer and choke
 - ★ 6000 mfd. filter condenser
- UNMATCHED NET PRICE \$43.50**
See Your Distributor or Write To



Pioneer Manufacturers of Battery Eliminators

ELECTRO PRODUCTS LABORATORIES
4507 N. RAVENSWOOD AVENUE, CHICAGO 40, ILL.

George K. Konz has been appointed assistant manager of advertising and sales promotion of NATIONAL UNION CORP., Orange, N. J., according to an announcement by Emil J. Maginot, sales manager of the company.

Konz, formerly with National Union's advertising department, has since served as assistant director of public relations for the American Insurance Co. of Newark.



Lloyd M. Hershey has been appointed director of research for GENERAL INSTRUMENT CORP., Elizabeth, N. J. It was announced today by Richard E. Laux, president.



Hershey previously was assistant to the chief engineer at the Hallcrafters Co. in Chicago, and prior to that was in charge of development research operations for the Hazeltine Corp.

C. G. Roberts has been appointed product manager for broadcast and television equipment for GENERAL ELECTRIC's transmitter division, Syracuse, N. Y.

Edward Maged has been appointed sales manager of RACON ELECTRIC CO., INC., New York City, where he will coordinate sales advertising and sales promotion, according to the announcement by Mr. A. I. Abrahams, president. Maged was formerly sales manager of the distributor division of University Loudspeakers, Inc.

Frank A. Hinners has joined the staff of JEWEL RADIO and TELEVISION CORP., Long Island City, N. Y., it was announced by Don J. Ferraro, president of the company.

Walter L. Stiekel has been appointed national sales manager for the receiver sales division of ALLEN B. DU MONT LABORATORIES, INC. He was formerly manager in charge of the RCA-Victor Division of the Leo Mayberg Company, located in Los Angeles.

William R. Kennaugh, who has been associated with the radio and television production field for more than 19 years, has been appointed chief process engineer at JOHN MECK INDUSTRIES, INC., Plymouth, Indiana, manufacturers of television and radio receivers.



Jensen Industries, Inc., 329 S. Wood St., Chicago 12, Ill.

**ISOLATION
BENCH TRANSFORMER**

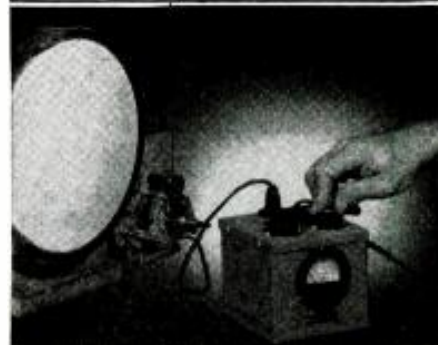

**REGULATE YOUR LINE VOLTAGE
TO FIT YOUR REQUIREMENTS**

**N-303 VARI-VOLT JUNIOR
\$15.00 DEALER NET**

A voltage regulating isolation transformer to make your bench test voltage exactly what you want...on 117V line, variable from 95 to 145 volts... if line drops to 90, variable from 75 to 115V....output adjustable in 1½ volt steps...metered output voltage...capacity up to 250 Watts intermittent, 50-60 cycles...for radio and television receiver testing at under or over voltage...to isolate "hash" and live ground from AC-DC equipment...controlled voltage for meter calibration...speed up or retard heating of light soldering iron...and for many other similar uses.

See your local Halldorson distributor for complete line of replacement transformers...exact duplicates television and auto Vibrator transformer replacements, or write direct to us for complete information. THE HALLDORSON COMPANY, 4500 Ravenswood Avenue, Chicago 40, Ill.

Halldorson
Vacuum Sealed Transformers

BUILD IT Yourself!



**OSSCO
TX-9
GEIGER
COUNTER
KIT!**

Here it is! A regular production model TX-9 Geiger counter construction kit. No jumble of tricky parts—all sub-assemblies completed. Just fit it together. One hour's work for an experienced man. This portable Geiger counter is the type preferred by professional prospectors. Send for complete details now!

Omaha Scientific Supply Co.
3601 N. 24th, OMAHA 10, NEBR.

RADIO-ELECTRONICS for

A BETTER CONE-BUY... LEOTONE

- 12" DE LUXE SPEAKER BAFFLES Walnut veneer, Shpg. wt. 8 lbs. \$2.95
- P-23 HEADSETS 5' cord & PL-55 1.29
- HS-30 HEADBANDS 15 1.15
- PL-54 PLUG with 13" tipped duple cord—15' for 1.00
- DYNAMIC HEADSET & HAND MIKE 12" MK II Shipping weight 3 lbs. 1.95
- NE-48 NEON BULBS 115V 19c 10 for 1.69
- NE-20 NEONS Min. bag 115V 8c 15 for 1.00
- 4 TUBE AMPLIFIER FOUNDATION Black crackle cabinet & slide-in chassis. Contains power trims, condensers, resistors, etc. 95¢
- 50W-25 OHM "DIVIDOMM" ADJ. RESISTOR (White) ea. 29c 1 for 1.00
- 50W-15 OHM RHEOSTAT (IRC) 1/4" shaft .89
- JACK BOX BG (300-600) Less knobs. .29
- HIGH FIDELITY CRYSTAL MICROPHONES Sensitive diaphragm, high imped. type. (1 1/2" O.D. x 1/2" deep). Rubber shock-mtd. Less housing. ONLY 98¢
- ALUMINUM HOUSING for crystal tube. .15
- 1/2" PILOT ASSEMBLY Faceted Red Jewel. Blasted brass. With 1000 1/4" for 1.00
- 30 P.E. MAGNET WIRE 400 FT. ROLL 1.19
- 6V. D.C. COOK RELAY Makes 6. breaks 1. 12 ohm coil .96
- 110V. AC RELAY (W-L) SPST. Norm. open 20A. contacts .98
- 4" PRECISION ETCHED DIAL 0-100 over 150° 1.49
- 4WV 7500V ELECTROLYTIC can. 2 1/2" x 1 1/2" .49
- NM-4 RECORDING MOTOR (G.I.) Adaptable to either 33-1/3 or 78 RPM. Silent operation on WIRE, TAPE or DISC RECORDING PLAYBACK. 110V. AC 3-3/4" x 2 1/2". Less turntable, drive wheel & nut. Plate. Shpg. wt. 6 lbs. 4.95
- TRIPLE-COIL WIRE RECORD-PLAYBACK HEAD Precision built standard 1 bit plug in type (St. George, Vitward, etc.). Moulded bakelite housing. 1 1/2" x 1 1/2" SPECIAL 6.95
- MTL. SOCKET FOR WIRE HEAD .35
- ANTENNA MAST SECTIONS MS-19, 50, 81, 51 or 51 Shpg. wt. 2 lbs. ea. 39c 3 for 1.00
- MOST POPULAR KIT IN OUR 22 YEAR HISTORY!!! LEOTONE'S "JUNIOR RADIO PARTS KIT" YOU CAN'T GO WRONG—IT FULL POINTS OF selected new & dismantled Radio & Electronic parts for every Service, Amateur, Builder, etc. TRANSFORMERS, SPEAKER ACCESSORIES, WIRE, RESISTORS, HARI, WARE, CONDENSERS, ETC., ETC. ALL THESE (shpg. wt. 21 lbs.) AND MUCH MORE FOR ONLY 2.95
- RADIO HARDWARE TREASURE FULL 4.95
- POINT OF Screws, Nuts, Washers, Lugs, etc. in a HANDY SELF-SEALING HINGED LID METAL CAN. Shpg. wt. 2 lbs. 1.98
- GT TUBE SHIELDS universal slip-on ea. 5c 21 for 1.00
- 1 MEG-1% PRECISION RESISTOR (IRC). Wire-wound .69
- 65-400WV OIL CONDENSERS 10c 12 for 1.00
- RADIO NOISE FILTER 6-30V. DC. 10 amps. Exc. for Alouette. 59c
- RADIO-AMPLIFIER STEEL CABINETS (from RCA coin radios). Glistening CHROME GRILLE & SIDE TRIM. Marine grey finish. Will BEAUTIFY any ELECTRONIC TEST, INDUSTRIAL or MEDICAL EQUIP. 16 1/2" x 9 3/4" x 10 1/2" Shpg. wt. 12 lbs. HANDY NEW 1.98
- DC-AC ROTARY CONVERTER (G.E.) 170 watts cont. duty. 115V. DC to 70V. AC. 3 1/2" x 2 1/2" x 1 1/2" High. Shpg. wt. 16 lbs. 7.95
- 110V. AC INDUCTION MOTORS Self-starting 1750 RPM. Frac. HP. 2 1/2" O.D. x 2 1/2" Shpg. wt. 1 1/2 lbs. 1.25
- SPIRIT LEVELS Red etched graduations. 8" Long .39
- NEEDLE CONTACT BINDING POSTS Plated brass. Knurled. non-removable head 9c 15 for 1.00
- SERVICERS' BARGAIN KITS
- #1—R.F. ANT. & OSC. COILS Kit of 10. .98
- #2—SPEAKER CONES 12 asstd. 4" to 12" moulded & free-edge (max. 1/2") 1.98
- #3—SPEAKER REPAIR KIT A PROFESSIONAL KIT THAT WILL SAVE YOU \$\$\$ Contains: 25 asstd. mtg. rings, 10 spiders, 25 voice coil forms, 3 yds. felt strip, 20 ebonite leather segments, kit of 16 shims & tube cement. With INSTRUCTIONS. ALL FOR SPECIAL OFFER! BOTH KITS #2 & #3 FOR ONLY 3.95
- #4—MOULDED BAKELITE CONDENSERS (Mica-mold) 50 asstd. 1000pF to 2 mtd 200 60WV. 2.49
- #5—KNOBS 25 asstd. wood & bakelite (push-on & set screw types). Kit of 25 .98
- #6—WAFER SOCKETS 1 to 8 prong. 12 for .25
- #7—VOLTAGE DIVIDERS 10 asstd. 1.75
- #8—MICA PADDERS & TRIMMERS 15 asstd. Multiple & Ceramic incl. Kit of 15 .69
- #9—VOLUME & TONE CONTROLS Wire-wound & Carbon Loss Settings. Kit of 10 1.39
- #10—WIRE-BOUND RESISTORS 5 to 29 watts. Kit of 15 .98
- #11—BAKELITE COIL FORMS to 3" diam. Kit of 18 asstd. .98
- #12—RADIO CEMENT & SOLVENT KIT 2 oz. ea. all-purpose cement & thinner with brush .69
- #13—WIRE & CABLE CLAMP KIT 1" to 1 1/2" asstd. .59
- *FACTORY REPAIR SERVICE ON ALL SPEAKERS!

Min. Order \$2.00 20% Deposit on all COO's
Please add sufficient postage—excess refunded



LEOTONE RADIO CO.
MAKERS OF CONES AND FIELD COILS
65-67 DEY STREET, NEW YORK 7, N.Y.
WORTH 2-0284-5
12,000 SQ. FT. OF RADIO PARTS

DON'T STOP TV DOPE!

Dear Editor:

William Krider (July issue, page 97) had better find himself a hole and crawl into it, because he's going to get jumped on!

He says there is no possibility of TV in his town for at least ten years as he is over 90 miles from any city of 50,000. My Rand-McNally map shows that he is less than 90 miles from Tulsa, Okla. And if he can't get the station Tulsa will have pretty soon, he really does need TV articles.

We are over 90 miles from one station and more than 130 miles from another. We get them every night, and television is pretty popular in our town. I have repaired several TV receivers, installed antennas, and checked sets.

CHARLES F. JOHNSON

Denison, Tex.

LIKES READING ABOUT TV

Dear Editor:

I disagree with William Krider. I don't think you publish enough about television!

On a set which I installed myself after reading TV articles I get good reception from all Detroit stations, 53 miles away. Even if certain articles don't help me personally, I get a kick out of them, as do at least 100 out of the 1,200 in my high school—many of whom borrow my copy of R-E just to read about TV. Anyone who tells you there is too much about TV in the magazine when it is the coming thing must want to live in the old era of silent movies.

LARRY SHAW

Port Huron, Mich.

SOME DO ADVERTISE

Dear Editor:

I would like to express my views on your article, "Manufacturers Versus Service Technicians."

I notice that Stevens, Jensen, Brooks, Meissner, Browning, and others of the same caliber do advertise directly to those who know. As regards schematic diagrams, I must give Philco due credit for getting out diagrams for their new models. Yes, I have seen some of those before the radios. I also appreciate their stand for the technician in regard to TV.

C. E. RICE

Newport, Vt.

LOOKS AHEAD TO TV

Dear Editor:

The last two issues of your magazine were especially good. I particularly like the way articles are headed under different classifications such as FM, TV, Test Equipment, etc. Let us have more articles on transmission lines, wire recorders, and FM.

Television has not yet come to this city, but I am trying to keep up with it through your magazine. I hope you will keep up the good work.

RICHARD COOVERT

Portland, Oregon

SURPLUS PRICES SLASHED!



Dynamotor D-2
D-2 Converts to 110 V AC in ten minutes, diagram included, contains integral gear box having four 1/2" drive shafts turning simultaneously at the following speeds:
4000 RPM—Grinders, buffers, flexible shaft tools, etc.
1500 RPM—Wrapping finishing rods, slow speed tools.
250 RPM—Dev. tray rocker for photo darkroom.
50 RPM—Turning barbecue spits.
Adv. 13400 Beams Thousand Other Uses Around the Work Shop
Converted to 110 volts A.C. \$7.45

DYNAMOTOR D-1
D-1 Converts to 110 V AC in ten minutes, diagram included, has shaft with squirrel cage blower, also gear reducer with 2 shafts and pulleys at the other end. 1001 uses. \$4.95 NEW

RM-29 PORTABLE FIELD TELEPHONE

An ideal portable field telephone. Complete in a rugged steel case for years of wear. Ringer circuit and 78 1/2 handset. No leather gage to deteriorate. Compact 5 7/8" x 3 1/2" also used as remote control on SCR-284. Simple two wire operation. 15 miles distance and up-wards. Can be used for television installation. Intercom system, construction companies outside and inside work, etc. Light weight. 13 lbs. Excellent condition. SPECIAL LOW PRICE EACH \$9.95
2 for \$18.95

PLUGS and CONNECTORS 49c each
YOUR CHOICE for only

- For the SCR-522 PLQ-167, PL-172
- For the BU-348 PLQ-103
- For the BC-733 PLQ-251
- For 269-F Radio Compass Inverter, PL-3108-22-48
- For the SCR-271-N PL-147, 148, 151, 152, 153, 154A, 156, 258
- For the BC-735 PL-59, PL-61, PL-61
- For the ART-13 U-107, U-161
- For the ARC-1 U-15U, U-16U
- MC-203A coupling Coax Fittings PL-259A (83-18P)-UG-21U-UG-22U
- PL-164 M-359 U-11/U
- AN-3108-28-19P
- AN-3108-128 } Combination Male and
- AN-3108-128 33 } Female
- PL-63 SQ-44 L-62
- PL-56 SQ-86

BC-733 D
A 10-tube superhet receiver for lateral blind landing guidance (CAA type certificate) TC-1045. Excellent condition 108-110 MC. Tube complement: 1-128K7; 2-128K7; 1-12A6; 1-12A17GT; 2-128K7; 3-717A—tubes alone worth more than this set low price. SCHEMATIC FURNISHED. Each \$3.95

AN/CRW-2 V.H.F. RECEIVER
6 tubes: 5-68L7, 1-68N7, 1-68G7, 1-613 Dynamotor, plug-in coils and sensitive relays. This was one of the Army's "Secret" V.H.F. remote control receivers, operating at about 110 MC. A thousand and one uses. Like new in metal case. \$4.95 Each

COMPLETE BEAM ROTATOR ASSEMBLY LP-21A and 1-82A
A large 5" indicator 1-82A, brand new and an LP-21 loop (removed from aircraft). A complete perfect beam rotator system with indicator. Loop is low impedance—contains selenium transmitter, etc. Loop alone \$5.95 Indicator alone \$4.25

FILAMENT TRANSFORMERS
Fully shielded Pri. 100 V. Sec. (#1 winding 10.2 V @ 5 A. C. T.; #2 winding 10.2 V @ 10 A. C. T.) Secondary winding can be connected in series to supply 25 V. with a line Voltage of 115 Volts— 60 Crc. New. Each. \$2.95

6 VOLT MOTOR
A real beauty, removed from aircraft. Type used for auto fan. Each. \$1.29

BC-433G
15-tube superhet radio compass receiver 200 to 1750 Kc; (W-tone-voice. Like new. Similar to R5/ARN7. Only \$19.95

TUBES
1625... 3 for \$1.10 5BP1 Scope tubes @ \$1.95
6114... @ .35 6114 Scope tubes @ 2.50
3116... @ .35 3525... @ .49

6" PM SPEAKER \$1.95
Beautiful new stock. Alnico magnet. Each

T-17 D MIKE \$2.49
The desirable single button carbon mike. With press the button to talk switch, P cord and PL-68 plug. mike cover. Features non-echo effect. New

DM-53A DYNAMOTOR \$1.39
24V., in., 220V-80M.A. out., used, good condition.

WRITE FOR NEW CATALOG
Minimum order \$2.00, F.O.B. Chicago
20% deposit required on all C.O.D. orders

NECORP ELECTRONICS, Dept. A
2635 W. Grand Ave., Chicago 12, Ill.

SENSATIONAL TELEVISION OFFER

\$85.10 worth of components ALL for the famous #630 chassis FOR **\$39.50**

Similar to RCA No.	Description	List price
201T6	POWER TRANSFORMER	\$26.50
211T1	TRANSFORMER, horizontal output.	9.00
201D1	DEFLECTION YOKE	7.50
202D2	FOCUS COIL	6.00
204T2	TRANSFORMER, vertical output.	4.75
208T2	TRANSFORMER, vertical blocking	2.25
203D1	ION TRAP BEAM BENDER	1.90
201X1	YOKE MOUNTING HOOD	1.10
T5630	PUNCHED CHASSIS PAN	10.00
204X2	VIDEO & I.F. KIT, consisting of 6 peaking coils, 5 filament chokes, 2 sound IF transformers, and 1 of each of the cathode trap, discriminator and the 1st, 2nd, 3rd and 4th IF coils	16.10

TOTAL LIST PRICE.....\$85.10

All parts listed including #630 circuit diagram— For **\$39.50**



VOLT-OHM MILLIAMETER

SENSITIVITY—1000 ohms PER VOLT
 SIX—A.C. VOLTAGE RANGES
 0-15/30/150/300/1500/3000 volts
 SIX—D.C. VOLTAGE RANGES
 0-7.5/15/75/150/750/1500 volts
 FOUR—D.C. CURRENT RANGES
 0-1.5/15/150 MA 0-1.5 Amps
 TWO—RESISTANCE RANGES
 0-500 Ohms 0-1 Megohm
 PLASTIC CASE—3 1/2" x 5 7/8" x 2 1/4"

Complete with batteries, test leads, instructions and factory warranty. **\$13.90**

QUALITY TUBULAR CONDENSERS

PER HUNDRED	PRICE
.001 — 600V	\$ 3.95
.002 — 600V	3.95
.003 — 600V	4.40
.005 — 600V	4.40
.01 — 600V	4.40
.02 — 600V	4.95
.03 — 600V	4.95
.05 — 600V	4.95
.1 — 600V	7.20

EACH	PRICE
.25 — 600V	.12
.5 — 600V	.17
.10 — 50V	.12
.16 — 150V	.18
.20 — 150V	.24
.20/20 — 150V	.26
.30 — 150V	.28
.40/20/20 — 150V-25V	.44
.40/40/20 — 150V-25V	.44
.50/30 — 150V	.44
.8 — 450V	.27
.16 — 450V	.36
.16/16 — 450V	.49
.20 — 450V	.39
.30 — 450V	.39
.40 — 450V	.59
.80 — 450V	.97
.005 — 1700V	.13
.008 — 1700V	.15
.01 — 1700V	.17
.02 — 1700V	.19

NEW LOW PRICES ON TELEVISION CONDENSERS

.05 — 2500V	.52
.1 — 2500V	.57
.25 — 2500V	.72
.05 — 3000V	.54
.003 — 6000V	.49
.005 — 6000V	.52
.01 — 6000V	.58
.0005 — 7500V	.48
.003 — 7500V	.52
.0005 — 10000V	.54

WHITE TUBE CARTONS

100—SMALL PEANUT, 1"x1"x2 1/8"	\$.75
100—LARGE PEANUT, 1"x1"x2 3/4"	.85
100—GT TYPE, 1/4"x1/4"x3 3/8"	.95
100—SMALL G, 1/2"x1/2"x4 1/2"	1.25
100—LARGE G, 2"x2"x5"	1.45
ONE POUND ROSIN SOLDER	\$.49
TWIN LEAD-IN, 300 ohms, 100 feet.	1.39
CO-AX CABLE, RG59U, 100 feet.	3.95

BROOKS RADIO DIST. CORP.
 80 VESEY ST., DEPT. A, NEW YORK 7, N. Y.

RADIO WILL CLEAN HOUSE

Dear Editor:

I thoroughly agree with your editorial in your June issue. I believe, with you, that TV will compel radio to clean house. No other means or arguments have been able to achieve that.

It will be another crowning achievement of television if, by its competition, radio is impelled to give us more of the high-class, worth-while music, and less of the drip and gutter stuff which has befouled our loudspeakers for the past 15 years.

Of course, the soap operas for Maggie and Maisie and housewives generally must endure as long as such can endure to listen. There TV cannot compete—at least if we want to have housework carried on with any appreciable degree of efficiency!

LEE DE FOREST

Chicago, Ill.

VALIANT DEFENDER

Dear Editor:

You have published many good letters and articles defending the radio technician's reputation for integrity, but I think the best was "Why Pick on Radio Technicians?" which appeared in the August issue.

Why indeed? Just call in a plumber, carpenter, or electrician to have a repair job done, and see what the charge is. And some of these repairs aren't exactly perfect either.

It doesn't seem probable that licensing is the answer. The "better mousetrap" theory ought to work so that the technician who does good work will be patronized and the ones who don't or who charge too much will go out of business.

GRANT R. BERKEBILE

Johnstown, Pa.

(But does it?—and do they?—Editor)

PHILCO HELPS TECHNICIANS

Dear Editor:

I just finished reading "Manufacturers Versus Service Technicians" in your August issue, and I want to thank you for going to bat for the men who make their livings in service work.

My own experience is that I never fail to speak well of and have confidence in the products of the company that treats me as a businessman rather than a necessary evil.

Radio manufacturers could benefit by the example of Philco Corp., which supplies full technical data to all members of its service organization—of which I am extremely proud to be a member.

During my wartime service in the RCAF I serviced sets for people where I was stationed. Running into a problem with a Philco set, I wrote to Philco Corp. of Canada. By return mail I received a circuit diagram plus complete alignment and service instructions. I have been a Philco booster ever since that experience.

CHARLES E. BEAN

Toronto, Ontario

UNIVERSAL SAVES U 50%

2

STATION INTERCOM KIT

A must item for offices, schools, churches, etc. A wonderful bargain at the price. **COMPLETE KIT—ALL PARTS, TUBES AND 2 SPEAKERS \$9.95**

25 WATT P.P. 6L6 AMPLIFIER KIT
 Hi Gain
 A wonderful buy! Make up an amplifier worth \$50 to you. Powerful enough for auditoriums seating 1500 people. Separately controlled Mike & Phono inputs. All parts, incl. drilled chassis, hardware, solder, circuit diagram, etc. **1/95 ea.**

Universal/general corp
 365 J CANAL ST. N. Y. 13,
 WALKER 5-9647

\$10,000 REWARD

Earn the government bonus by locating Radio-Active Orns with a

P.R.I. GEIGER COUNTER

Weight only 2 lbs. Priced from \$49.50 complete. The most sensitive portable Geiger Counters made.

PRECISION RADIATION INSTRUMENTS, INC.

1101-L N. Paulina St. Chicago 22, Ill.
 Dealer Inquiries Invited

Assembled for your convenience

Facts, standards practices, data

for the whole field of radio engineering

Radio Engineering Library

RADIO specialists of the McGraw-Hill publications selected the books for this library as those giving the most complete, dependable coverage of facts needed by engineers whose special fields are grounded on radio fundamentals. They cover circuit phenomena, tube theory, networks, measurements, and other subjects... give specialized treatment of all fields of practical design and application.

Library includes:

1. Fundamentals of Vacuum Tubes—Eastman
 2. Radio Engineering—Termon
 3. Communication Engineering—Everitt
 4. High-Frequency Measurements—Hund
 5. Radio Engineering Handbook—Henney
- 3559 pages!
 2558 illustrations!

- ★ Special Low Price
- ★ Bought singly, the five volumes would cost \$30.50. Under this offer you save \$3.00.
- ★ Pay in easy installments

FREE 10 Day Trial

McGraw-Hill Book Co., 330 W. 42nd St., N.Y.C. 18
 Send me Radio Engineering Library, 5 vols., for 10 days' examination on approval. In 10 days I will send \$2.50, plus few cents postage, and \$5.00 monthly till \$27.50 is paid, or return books postpaid.

Name

Address

City Zone State

Company

Position

OPPORTUNITY AD-LETS

Advertisements in this section cost 25¢ a word for each insertion. Name, address and initials must be included at the above rate. Cash should accompany all classified advertisements unless placed by an accredited advertising agency. No advertisement for less than ten words accepted. Ten percent discount six issues, twenty percent for twelve issues. Objections or misleadings a void. Advertisements not accepted for December, 1949. Issue, must reach us not later than October 24, 1949.
Radio-Electronics, 25 W. Broadway, New York 7. N. Y.

AMATEUR RADIO LICENSES, COMPLETE THEORY preparation for passing amateur radio examination. Home study and resident courses American Radio Institute, 101 West 63rd St., New York City. See our ad in Page 94.

MAGAZINES (BACK DATES)—FOREIGN, DOMESTIC, arts, books, booklets, subscriptions, pin-ups, etc. Catalog, 10¢ (refunded). Cicerone's, 863 First Ave., New York 17, N. Y.

RECORD CHANGER PARTS for leading makes. We ship everywhere. Friends Wholesale Distributors, 108 North Sixth Street, Philadelphia 6, Pa.

HERMAN LEWIS GORDON, REGISTERED PATENT Attorney. Patent Investigations and Opinions. Warner Building, Washington, D. C.

WE REPAIR ALL TYPES OF ELECTRICAL INSTRUMENTS, tube checkers and analyzers. Hazelton Instrument Co. (Electric Meter Laboratory), 140 Liberty Street, New York, N. Y. Telephone—Barclay 7-4239.

BARGAINS: NEW AND RECONDITIONED HALLI-crafters, National, Collins, Hammarlund, Meissner, RME, other receivers, tuners, television receivers, transmitters, etc. Wholesale prices. Terms. Shipped on trial. Liberal trade-in allowance. Write, Henry Radio, Butler, Missouri and 11240 West Olympic, Los Angeles, California.

BARGAIN HUNTING? RADIO SERVICEMEN WRITE, sensational catalog. Henshaw Radio Supply, 3619 Troost, Kansas City 3, Missouri.

RADIO PARTS FOR SALE. Details, Knight, Radio, 9418 Ave. A., Brooklyn 12, N. Y.

LANCASTER, ALLWINE & ROMMEL, 436 BOWEN Building, Washington, D. C. Registered Patent Attorneys. Practice before United States Patent Office. Validity and infringement investigations and opinions. Booklet and form "Evidence of Conception" forwarded upon request.

15 TESTED ONE-TUBE CIRCUITS, including "Radio-builder," Catalog—25¢. Laboratories, 578-B, San Carlos, California.

SCRIPPLI'S TUBES: 30% off List F.O.B. Pittsburgh, Pa. obtained from army signal corps in original cartons, all guaranteed perfect. Following types available: 6E5, 6L5, 6K6GT, 77, 78, 6A07, 6A6S, 6N17, 6L6, 38L, 1N5, 13641, 418721A, CT1954, 1299. Minimum quantity \$5.00 net. Send all orders to Monarch Electric Company, 411 Wood Street, Pittsburgh 22, Pa.

Aluminum tubing, etc. Beams for Amateurs, TV, FM. Lists free. Willard Radcliff, Fostoria, Ohio.

27 years experience radio repairing. Simplified system. No calculations. No formulas. Total price \$2.00 postpaid or C.O.D. Moneyback guarantee. Russ Radio, 14615 Grandriver, Detroit 27, Mich.

"TAB" Sensational 6V CARTER Dynamotors 400V/150ma, \$8.98, 250V/100ma \$4.98, ROTH \$12.49. Guaranteed Tube Bargains! 6A6, 6AK5, 6A05, ea. 37¢—6C4, 21c—388A, 40c—954, 14c—955, 18c. 1N34 Crystal, 81c. GE-2J1G1 SELSYNS used Tested PAIR \$1.49 Tuning Meter 5ma. 98c. 304m 12" UHF Mobile HAMBAND Antenna AT5/ARRI 35c. 4/81. Hi-Gain Dynamic Mike Transformer PLUS Excellent Filament Dynamic Mike. BOTH \$1.49. Write for Bargain "TABOGRAM" "TAB," Dept. 11RE, 6 Church St., NYC.

Wire Recorder, table top, Silvertone, with radio & record player. \$100.00. Unger, Box 188, Salamanca, N. Y.

Build your own Geiger Counter. Save money! Write for free parts list and diagram. Woodwind Industries, 5217-G Hollywood Blvd., Hollywood 27, Calif.

RADIO-ELECTRONICS will print—without charge—small classified advertisements for radiomen who live in exchange-restricted countries and who wish to swap something available in their countries for American radio parts or books. American radio men may then correspond with the advertisers direct. RADIO-ELECTRONICS cannot, of course, act as intermediary in or be responsible for any deals that may be made. Ads must be under 40 words in length. State your needs exactly and give full name and address. Note that most countries (including the U.S.A.) have import and export regulations and duties. Both correspondents should check with their customs authorities before arranging that any goods be shipped to them.

RADIO DATA BOOK. New, 8 x 12 inches, with more than 500 diagrams of European receivers. Will exchange for Essentials of Radio, or American Radio Data book. Jaro Kober, Jifm 56, Czechoslovakia.

WANT: Genuine E. H. Scott spares. G.E. pickup with arm. Will swap custom-built audios to your specs. frr recordings, etc. Austen Graham, 33 Warriston Crescent, Edinburgh 4, Scotland.

WHERE RADIOMEN MEET, EAT and SLEEP

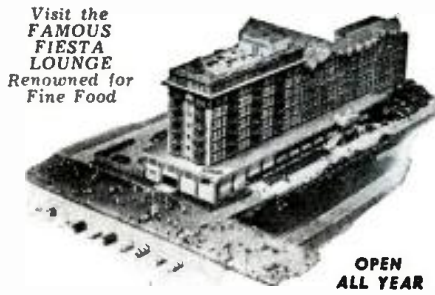

Visit the FAMOUS FIESTA LOUNGE Renowned for Fine Food

HOTEL STRAND

Atlantic City's Hotel of Distinction

The Ideal Hotel for Rest and Relaxation • Beautiful Rooms • Salt Water Baths • Glass enclosed Sun Porches • Open Sun Decks atop • Delightful Cuisine • Garage on premises. • Moderate Rate Schedule.

OPEN ALL YEAR Exclusive Pennsylvania Ave. and Boardwalk

AMAZING "SNOOPERSCOPE" TUBE
LISTED AND DESCRIBED IN OCTOBER RADIO-ELECTRONICS



An Infra-Red Image Converter Tube (British) that enabled combat men to see in the dark and through camouflage. No scanning or amplifiers necessary! Uses only infra-red light source and simple high-voltage supply. Shows image in greenish-white color on 1 1/2" screen. Has wonderful possibilities for darkroom work, fog penetration devices, night photography, etc. With technical data and diagrams. All NEW tubes.

PRICE, EACH **\$8.00**
TWO FOR \$15.00, QUANTITIES OF SIX OR MORE **\$6.00 EACH**
"Snooperscope" lens unit front. Bausch & Lomb F/2.1, 3.5 in. E. F. each **\$12.00**
Mounted lens unit. Results as good as B & L unit. Speed F 1.9, F.L. 91.44 MM. Outside dia. at one end 60 MM. Length of mount 64 MM. PRICED, EACH **\$9.00**
25% Deposit with All C.O.D.'s. All prices F.O.B. N. Y. C.
All Materials Offered Subject to Prior Sale.

Phone — **TELEMARINE COMMUNICATIONS CO.** 280 Ninth Ave. LOngcare 4-4490-1 N. Y. 1, N. Y.

\$1,000 A MONTH

That's what JUST ONE of the many plans in this book brought in—over \$1,000 a month, steadily, from radio service alone. HOW TO MAKE MORE MONEY IN RADIO SERVICE is so full of money-making plans and ideas it will amaze you. Why work for wages? Why not become your own boss and make more money? EVEN BEGINNERS who used some of the easier plans in this book averaged WAY OVER \$100 A WEEK just working from home. This book is making money for servicemen and beginners, everywhere—U.S.A., Canada Puerto Rico, Mexico, So. America, Hawaii, Philippines, and other countries. Letters of thanks are continually coming in.

AT LAST!
The real money-making secrets of radio service are given out in this book.

- Book very helpful—following advice in the book earned high as \$100 a week radio repairing, in my apartment. **C. C. Seidler, Brooklyn, N. Y.**
- In business 10 years—received many valuable pointers—read it 3 times. Would not take twice the price for it. . . . **W. J. Phillips, Bellington, W. Va.**
- In radio 3 years—Book contains far more information than expected.—Every radioman should have this book. **W. J. Fraser, Elmont, N. Y.**
- Best of its kind that have ever been printed. **E. Bradford, Chicago, Indiana**
- Have book—only a week—couldn't stop reading it. Already made money and many new customers. **A. T. Waters, Jr., Garbage, N. Y.**
- In business 17 years. Book contains many things which took me many years to learn the hard way. Book worth many times its small cost. **P. V. Fubner, Elmwood, Illinois**

25 years experience are packed in this 83 page book, 8 1/2 x 10 1/2, by V. Gale, for servicemen, beginners, students. Among MANY OTHER THINGS it shows you where the money is and how to get it FAST; How to get plenty of customers; How to test sets without taking them out of cabinets and give estimates QUICKLY; How to operate spare time and build to full time; How much to charge; How to connect with certain BIG MONEY concerns; How to increase business and expand. Send for this book today and start making more money almost as soon as you get it. The full price is only \$3 (any convenient form) postpaid; or C.O.D. at \$3 plus a few cents postal charges. You have nothing to lose. Examine it for 5 days. If you aren't positively delighted return it and we will refund your \$3 promptly. If you want more information about the book send for literature #2-RE. It's free.

MERIT PRODUCTS, DEPT. RE,
216-32 132 Avenue. Springfield Gardens 13, N. Y.

NEED FOR G-E 260 PORTABLE: The 2-volt vibrator, 2-volt storage battery, 2 rectifier cells and 3 push buttons (non-off-charge). Will return genuine Edam cheese, or what do you want from Holland? Radio Peeters, van Woustraat, Amsterdam Z, Holland.

ENGLISH READER wishes to exchange British radio and other goods for wanted American parts and books. Thomas G. Sutcliffe, 20 Granville Rd. Frizinghall, Bradford, Yorkshire, England.

BIG MONEY IN RADIO & TELEVISION
New 7-Volume Set
FREE for 7 days trial

APPLIED PRACTICAL RADIO-TELEVISION
With Television Servicing
See the Radio-Television Expert of your locality who handled the toughest service jobs. This new 7 volume set gives you solid working knowledge of Radio and Television. Very latest on Television Servicing. Covers everything from fundamentals to newest in FM, Television Electronics, etc. Clear, practical. Tells you how to construct, install, service, short-cut trouble shooting methods. Handy "on the job" Radiomans Handbook included. More than 2500 pages, 1200 illustrations, charts, diagrams.

FREE TRIAL OFFER Examine these great, pay raising books for 7 days at our expense. Just mail coupon below.

FREE RADIO-TELEVISION DIAGRAM BOOK
Act at once and get with APPLIED RADIO-TELEVISION book of "150 Radio-Television Diagrams Explained" FREE. Keep it even if you send the set back at our expense within 7 days. If you keep the set, send either \$22 cash, or \$3 in 7 days and \$3 a month until \$23.50 is paid. Either way, Diagrams book is yours! Send coupon TODAY! It's not an order—just a request to see the Set and get the Diagrams book free. Act now!

GOOD FOR FREE TRIAL and FREE BOOK!

Educational Book Publishing Division
COVENE ELECTRICAL & RADIO SCHOOL
800 S. Paulina St., Dept. 89-71, Chicago 12, Ill.
Rush 7-Volume "Applied Practical Radio-Television," postpaid, for 7 days FREE Examination per your offer. Include FREE Book of 150 Radio-Television Diagrams.
Name.....AK.....
Address.....
Town.....Zone.....State.....

RADIO MADE EASY!

A JRI Home Trainer
A NEW APPROACH to radio repairing. Here is a SIMPLIFIED METHOD of repairing radios that can be LEARNED QUICKLY—Begin repairing immediately! A COMPLETE KIT OF ALIGNMENT TOOLS INCLUDED! Balance ANY RADIO with these tools. Prepare for a GOOD INCOME NOW! Send for the JRI Home Trainer TODAY and get Alignment Tool Kit—BOTH FOR ONLY \$9.75 postpaid, or plus c.o.d. charge. Pay for itself almost immediately! SATISFACTION GUARANTEED.
THE JRI TRAINERS
P. O. Box 2091, Dept. 15-11, Chicago 9, Ill.

OUTSTANDING TELEVISION VALUES

Factory wired and tested type 630 television chassis, complete with 29 tubes, ready for installation in cabinet. Will operate 16" picture tube or smaller. Price (Less picture tube).....**\$157.50**

SPECIAL G. E. 9" TELEVISION TUBE

White screen electromagnetic deflection and focus. Brand new, type MW 22-2. Price **\$13.95**

TELEVISION TRANSFORMER

115V/60 cycles, secondary 2500 volts at 2 MA., 6.3V at .6A, 2.5 volts at 1.75A. Price **\$3.85**

HIGH GAIN CONICAL-X TELEVISION ANTENNAS

Covers channels 2 to 13 without separate section. Constant non-varying center impedance. Better than 12Db front to back ratio. Can be used with 72, 150 or 300 ohm line. Works well in weak areas and gives a sharp conical beam. Price **\$5.95** each less mast. Extra for 6 ft. mast **\$1.35**

FRINGE AREA ANTENNA

Stacked X Antennas for extra gain in fringe areas including heavy 10 ft. mast. Price **\$14.95**

PORTABLE RECORD PLAYERS

Dual Speed, AC/DC. U. S. government surplus. Used but reconditioned. 33 1/3 & 78 R.P.M. adjustable speed control, embodies a 3 tube phono amplifier with electrodynamic speaker, housed in portable, black leatherette case. Price **\$16.95**

PHONO MOTORS AC/DC DUAL SPEED

Green Flyer type reconditioned and guaranteed. Complete with 12" turntable. **\$8.95**

AC PHONO MOTOR 33 1/3 RPM

Price **\$2.45**

MODEL NFRD—RADIO NOISE FILTER

made to U.S. government specifications will eliminate all line noises when properly connected to radio television, motors, and electric appliances. Will carry up to 12 amps. Price **\$1.95**

SPECIAL

Mammoth assortment of radio & electronic parts of such items as transformers chokes, condensers resistors wire, coils, hardware etc. of not less than 10 pounds. Price **\$1.25**

Satisfaction guaranteed on all merchandise
All prices F. O. B. New York City

WRITE FOR FREE CATALOGUE T11

RADIO DEALERS SUPPLY CO.
154 Greenwich St. New York 6, N. Y.

ADVERTISING INDEX

Acorn Electronics	87
Allied Radio Corporation	49
American Phenolic Corporation	72
Amperite Company	89
Amplifier Corporation of America	97
Walter Ashe Radio Company	84
Bell Telephone Labs., Inc.	75
Baland & Boyce, Inc.	10
Brooks Radio Dist. Company	92
Buffalo Radio Supply	82
Burstein-Applebee Company	83
Jack Cantor	97
Cargille	66
Capitol Radio Engineering Institute	7
Certified Television Laboratories	97
Cinex, Inc.	97
Clarkston Corporation	86
Cleveland Institute of Radio Electronics	18
Communications Equipment Company	88
Coyne Electrical School	89, 93
DeForest's Training, Inc.	11
Electric Auto-Lite Company	8
Electro Products Laboratories	90
Electronic Instrument Company	62
Electronic Wholesalers	96
Espey Radio	69
Feiler Engineering Company	189
General Electronic Dist. Co.	51
General Test Equipment Company	69
Greenwich Sales Company	95
Greylock Electronic Supply Co.	95
Gould Green	69
Haldorson Company	90
Heath Company	13, 14, 15, 16, 17
Hershel Radio	53, 54, 55
Hickok Electrical Inst. Co.	83
Hudson Specialties	74
Industrial Devices, Inc.	189
Instructograph Company	69
International Resistance Company	57
Jersey Specialty Company	96
Jensen Industries Inc.	90
The JRI Trainers	93
Kronenberg	97
Lafayette-Concord	67
Lelectron Research Laboratories	69
Leotone Radio Corporation	91
Liberty Electronics	96
McGee Radio Company	77
McGraw-Hill Book Company, Inc.	92
McMurdo Silver Company	76
Merit Products	93
Metropolitan Electric & Inst. Co.	79
Mid-America Company	80
Midwest Radio Corporation	Back Cover
Murray Hill Books, Inc.	61
National Company	6
National Radio Institute	3
National Schools	5
Nescorp Corporation	91
Niagara Radio Supply	78
Ohmite Manufacturing Company	58
Omaha Scientific Supply Company	90
Opportunity Adlets	93
Plastics & Electronics Company	66
Precision Apparatus Company	80
Precision Radiation Inst., Inc.	92
Premier Tube	74
Progressive Electronics Company	97

RADIO SCHOOL DIRECTORY	
(Pages 94-95)	
American Radio Inst.	Hollywood Sound Inst.
Baltimore Technical Inst.	Milwaukee School
Candler System Co.	of Engineering
Commercial Radio Inst.	RCA Inst.
Commercial Trades Inst.	Radio Inst.
Don Martin School	Tri-State College
of Radio Arts	Valparaiso Tech. Inst.
Western Radio-Television Institute	
YMCA Trade & Technical Schools	

Radio City Products Company, Inc.	70
Radio Corporation of America	73
Radio Dealers Supply Company	96
Radio Supply & Engineering Company	81
Radionic Equipment Company	88
Raytron	80
John F. Rider, Inc. Publishing	65
Howard W. Sams & Co., Inc.	59
Sanders Electronics	9
Senco Radio, Inc.	81
N. Silverstein	87
Simpson Electric Company	12
Soverign Television Company	69
Spartan School of Radio Electronics	86
Sprague Products Company	85
Sprayberry Academy of Radio	Inside Back Cover
Hotel Strand	93
Supreme Publications	71
Bill Sutton's Wholesale Electronics	96
Sylvania Electric Products	63
Tech-Master Products Company	70
Technifax	189
Telemarine Communications Company	93
Telrex, Inc.	66
Transvision	68
United Surplus Materials	64
Universal General Corporation	92
Ward Products	Inside Front Cover
Weller Manufacturing Company	4
Wells Sales, Inc.	98
Wholesale Radio Parts Company, Inc.	60
John Wiley & Sons	88

SIX TUBE SUPER

Three Gang Condenser

\$33.30
NET
Crowe Panel
Kit Included



Panel kit to fit most all makes (Please specify make of car and year model). New up-to-date latest prices. Catalog available.

Bill Sutton's

Wholesale Electronics

5th at Commerce Fort Worth, Tex.

FREE!

MONTHLY BULLETIN

No strings attached. Just send us your name and you'll receive our bulletin free of charge each month. It's crammed with red-hot specials at spectacular prices!

Electronic/wholesalers, inc.

2010 14th STREET, N.W.
WASHINGTON 9, D. C.

TELEVISION

- MFGS.—DISTRIBUTORS INSTALLERS!!!

We Manufacture
300 OHM TV TWIN
LEAD TRANSMISSION WIRE

- AT THE WORLD'S LOWEST PRICES!!!

- We supply over 50% of all Twin Lead used in the Metropolitan Area

WRITE FOR QUANTITY
PRICES TODAY!!!

JERSEY SPECIALTY CO.

Little Falls, N. Y.

Phones: L.F. 4-0784-1258

HEADQUARTERS FOR ELECTRONIC TUBES IN ALL QUANTITIES



5000 Magnetrons, 1000 Kylstrons
500,000 other tubes. Write for our Bulletin and Prices.

LIBERTY ELECTRONICS, INC.

135 LIBERTY STREET NEW YORK 6, N. Y.
PHONE WQNT 4-8282

RADIO-ELECTRONICS for

NEVER BEFORE

SUCH A PHENOMENAL VARIETY OF FINE TAPE RECORDERS

within these pages: the tape recorder you want, at a popular price. Complete data on 2-speed recorders, 24 hour recorders, conference recorders, and many others. Accessories included. Write today for your free copy!



AMPLIFIER CORP. OF AMERICA
398-10 Broadway New York 13, N. Y.

CABINETS—CONSOLES
FOR
RADIO — TELEVISION
JACK CANTOR
171 A. Washington St., N. Y. 7

TELEVISION RECEIVER—\$1.00

Complete instructions for building your own television receiver. 16 pages—11"x17" of pictures, pictorial diagrams, clarified schematics, 17"x22" complete schematic diagram & chassis layout. Also booklet of alignment instructions, voltage & resistance tables and trouble-shooting hints.—All for \$1.00.

CERTIFIED TELEVISION LABORATORIES
Dept. C. 5507-13th Ave., Brooklyn 19, N. Y.

DYNAMOTORS

- for DY 12-Power supply
- for Art-13

Special \$9.95

20% deposit with order. Bal. C.O.D.
Box #11RE c/o Radio-Electronics
25 West Broadway, New York, N. Y.

GOVERNMENT SURPLUS!
WORLD'S LOWEST PRICE

PHOTO FLASH EQUIPMENT



COMES COMPLETE WITH
4 EDGERTON FLASH TUBES & REFLECTORS



EASY TO CONVERT INTO A 2-WAY PHOTO FLASH UNIT OPERATES ON 110V. AC & 12V. BATTERY

Brand new at a fraction of original cost. Contains finest component parts available. All necessary parts and complete instructions included. After conversion, works on 110V AC or 12V battery by a flick of a switch.

Immediate delivery on all mail orders

\$68. COMPLETE

CINEX, INC., 165 W. 46th St., N. Y. 19, N. Y., Dept. RE-11

TELEVISION TODAY!

Learn all the interesting facts about TV, how it works, installation aids, buyers needs, etc., written in language anyone will understand.

ORDER YOUR COPY TODAY! \$1.00



MARVIN KRONENBERG
82-27 217th Street, Queens Village, New York

Enclosed is \$1.00 Check for my copy of TV TODAY

Name _____
Address _____
City _____
State _____

RADIO AND TELEVISION MATHEMATICS. by Bernhard Fischer. Published by the Macmillan Co., New York. 5 1/2 x 8 1/4 inches, 484 pages. Price \$6.

This book is not a text but a tool—and one of the most useful this reviewer has ever seen. The woods are full of volumes explaining mathematics; there are even plenty which carry right through with radio-electronic examples for each explanation. But there are very few, if any, to which the designer may turn in his moment of need and be reasonably certain that full instructions for whatever calculation he needs to make will be spread before him like a blueprint. This is such a book.

The first 348 pages are taken up with actual problems, about three to the page, such as, "What is the secondary voltage of a transformer which has a primary voltage of 100, primary turns 200, and secondary turns 40?" Then the formula is given and the answer worked out in the necessary number of stages—so that all the reader need do is substitute the values of his own problem for those of the illustrative one and follow the author's footsteps. The problem quoted is one of the simplest; the remainder run the gamut from the lowest level to the highest and cover almost every common case the radioman is likely to run into.

Only a few mathematical points are actually explained. A chapter each is given to powers of 10, the principle of the slide rule, the j-operator, and polar vectors. Each of these is short and informative. There are 27 pages of numbered formulas (which are referred to in the problems) and 18 pages of tables. Both index and contents table are unusually complete, the latter listing each problem to save time in using the book.

The cut-and-try experimenter will probably find little use for this book, but it is recommended to the more serious radioman and the engineer as a candidate for the place of honor beside its natural partner the slide rule.—R.H.D.

ELEMENTS OF SOUND RECORDING. by John G. Frayne and Halley Wolfe. Published by John Wiley & Sons, Inc., New York. 6 x 9 1/4 inches, 686 pages. Price \$8.50.

This book is remarkable for—among other things—its exhaustive treatment of film recording. Of the 32 chapters, 14 are devoted to the techniques of sound-on-film.

Disc recording is analyzed in detail, and several chapters are devoted to the techniques and equipment which are associated with recording—the nature of sound, amplifiers, filters, tubes, speakers, acoustics, and so on. The method of analysis is not entirely mathematical so that the book may be read for general information. Vast quantities of formulas, graphs, and quantitative data are given, however, making this a thoroughly informative text and handbook. A single chapter on magnetic recording is included, but the treatment is rather superficial in comparison to the attention accorded the other systems mentioned.—R.H.D.

PROGRESSIVE KITS

The best quality—
the largest variety ...
For Beginner, Technician or Engineer
FREE Gift with Each Kit
plus **FREE MEMBERSHIP**
in **PROGRESSIVE Radio & Television Club:**
Provides **FREE Consultation Service.**

NOW! BUILD 15 RADIOS \$14.75
COMPLETE KIT ONLY...

Absolutely No Knowledge of Radio Necessary. You Need No Additional Parts.

EXCELLENT FOR BACKGROUND IN TELEVISION

Contains everything you need. Instruction book, metal chassis, tubes, condensers, resistors and all other necessary radio parts. The instruction book written by expert radio instructors and engineers teaches you to build radios in a professional manner. The circuits are designed to provide excellent performance.

Each of the 15 radios you will build operates on 110-120 volts AC or DC. The **PROGRESSIVE Radio Kit** is excellent for learning the Principles of Receiver, Transmitter and Amplifier design. It is used in many Radio Schools and colleges in U.S.A. and abroad. It is used by the Veterans Administration for veteran training.

FREE: ELECTRICAL AND RADIO TESTER, plus **FREE Membership** in the Progressive Radio & Television Club. You will be entitled to **FREE expert advice and consultation service** with licensed radio technicians. **ORDER YOUR KIT NOW!**

7"-10" TELEVISION KITS

Factory-built and aligned 13 channel Tuner—18 Tube Kit—
7" Kit..... **\$59.50**

Complete set of tubes, including Cathode Ray Tube **\$41.58**

Factory-built and aligned 13 channel Tuner. 10" Kit, less tubes..... **\$82.99**

Complete set of tubes, including Cathode Ray Tube **\$55.80**

Cabinet for 7" or 10" **\$24.50**

FREE: Television Servicing Notes

5" OSCILLOSCOPE KIT AM-FM TELEVISION

An absolute "must" for today's radio-man. Input Impedance: 1 MΩ. and 50 MΩ. Tubes—2-6X7, 2-5Y3, 1-884, 1-5BP1. **FREE: Book on Cathode Ray Oscilloscope.**..... **\$39.95**



VACUUM TUBE VOLTMETER KIT

A professional piece of test equipment you need for FM and TV. Attractive steel case. **FREE: Book on Advanced Servicing Techniques.**..... **\$23.95**



SIGNAL TRACER KIT

An invaluable aid in trouble-shooting **FREE: Book on Radio Test Instruments.**..... **\$21.95**



SWEEP GENERATOR KIT

A necessity for television work. 5-Tube circuit. 2MC to 226 MC. Sweep width 0 to 10 MC. Variable phasing control 110V 60c. operation **FREE: Television & FM Servicing Notes**..... **\$22.95**



SIGNAL GENERATOR KIT

AM & FM alignment and trouble-shooting marker for sweep generator. 150kc to 34 MC on fundamentals. Over 100 MC on strom harmonics. 400 cycle audio. 110V 60c. operation **FREE: Books on radio test Instruments**..... **\$18.95**



TOOL KIT

Consists of Diagonal cutters, combination long-nose pliers and cutters, amber-handle screwdriver, 75 Watt soldering iron, and supply of solder **FREE: 35 Watt, Midget soldering iron and supply of hook-up wire.**

\$5.75



OTHER KITS

2-Tube FM Receiver, Battery portable receiver, 3-way Portable Receiver, 3-Tube Broadcast Band Superhit Receiver, 6 tube 2-band superhit receiver, multi-tester, amplifier, signal tracer probe.

FURTHER INFORMATION ON REQUEST.
Deduct 2% if full payment accompanies order. C.O.D. orders accepted in U.S.A.

PROGRESSIVE ELECTRONICS CO.
497 Union Ave., Brooklyn 11, New York
Dept. RE-31 Phone: Evergreen 8-0054

WELLS RADIO-ELECTRONIC Components by the Thousands!

TOGGLE AND PUSH SWITCHES



STOCK NUMBER	FIG.	CONTACT	CONTACT ARRANGEMENT	MANUFACTURER & NUMBER	TYPE LEVER	MENTING DATA	UNIT PRICE
370-1	A	5a	125V SPST MOMENTARY	CH AN-3022-1R	RAT S	1-12/16 WTC/C	\$0.25
370-4	A	5a	125V SPST CENTER OFF	CH B-9A	RAT S	1-12/16 WTC/C	.30
370-14	A	5a	125V SPST CENTER OFF 1 SIDE MOM.	CH R-1R	RAT S	1-12/16 WTC/C	.30
370-20	A	5a	125V SPST MOMENTARY	CH R-1R	RAT S	1-12/16 WTC/C	.25
17-100	A	5a	125V SPST CENTER OFF	CH AN-3022-1R	RAT S	1-12/16 WTC/C	.30
17-102	A	5a	125V SPST MOMENTARY	CH B-9A	RAT S	1-12/16 WTC/C	.30
17-103	A	5a	125V SPST	CH B-9A	RAT S	1-12/16 WTC/C	.30
17-104	A	20a	125V SPST 1 SIDE MOMENTARY	CH R-1R	RAT S	1-12/16 WTC/C	.30
17-105	A	5a	125V SPST MOMENTARY	CH AN-3022-2	RAT S	1-12/16 WTC/C	.45
300-85	C	5a	125V SPST CENTER OFF	CH AN-3022-2	RAT S	1-12/16 WTC/C	.45
300-102	C	30a	125V DPST	CH C-1	RAT S	1-12/16 WTC/C	.40
300-104	C	20a	125V DPST MOMENTARY	CH B-9A	RAT S	1-12/16 WTC/C	.40
300-112	D	5a	125V 1 SPST DPST MOM 1 SIDE SPST	CH AN-3022-2	RAT S	1-12/16 WTC/C	.55
300-83	F	5a	125V SPST MOMENTARY	CH B-9A	RAT S	1-12/16 WTC/C	.40
17-100	F	3a	250V SPST	CH AN-3022-1R	RAT S	1-12/16 WTC/C	.22
17-101	F	5a	125V SPST MOMENTARY	CH AN-3022-1R	RAT S	1-12/16 WTC/C	.22
300-140	H	3a	125V SPST CENTER OFF	AMH W/LEADS	RAIL	7/16-32 BUSHING	.20
300-101	H	50a	125V SPST	CH B-9A	RAT S	1-12/16 WTC/C	.25
301-12	L	20a	125V DPST	CH B-9A	RAT S	1-12/16 WTC/C	.15
300-70	L	20a	125V DPST	AMH OPEN FRAME	RAIL	3/4 WTC/C	.75
301-12	M	5a	125V DPST	AMH OPEN FRAME	RAIL	3/4 WTC/C	.75
17-107	A	3a	250V DPST	AMH OPEN FRAME	RAIL	3/4 WTC/C	.75

S INDICATES A LUMINESCENT TIP



STOCK NUMBER	FIG.	CONTACTS	MENTING DATA	MOVING LENGTH	KEY	ADDITIONAL INFORMATION	UNIT PRICE
3001-39	A	N.O.	3/8-32 THD.	3/16	BLACK BARRELITE	1/200 ON HER-300	\$0.18
3001-60	A	SPST	3/8-32 THD.	3/8	BLACK BARRELITE		.25
3001-70	A	3/4 WTC	3/8-32 THD.	3/8	RED ON GREEN PLASTIC		.25
3001-77	A	N.O.	3/8-32 THD.	5/8	BLACK BARRELITE		.25
3001-80	A	DPST	3/8-32 THD.	3/8	BLACK BARRELITE		.25
3001-70	C	DPST N.O.	7/16-32 THD.	1/2	METAL / PLASTIC TIP	GENERAL ELECTRIC	.25
370-13	C	N.O.	7/16-32 THD.	3/8	METAL	CUTLER HAMMER	.30
17-101	C	N.O.	7/16-32 THD.	1/2	METAL	HAROLD BA-200	.40
17-102	C	DPST N.O.	7/16-32 THD.	1/2	METAL	SIGNAL CORP 30-100	.30
300-103	C	20a	125V DPST	1/2	METAL	30-100 FOR 17 WTC	.30
370-35	E	N.O.	1-7/16 WTC/C		BLACK BARRELITE	CH 6011500	.80
370-36	E	2 WAKE	5/8 WTC/C		BLACK BARRELITE	SIGNAL CORP 30-101-C	.30
311-77	F	N.O.	END OF CORD		BLACK BARRELITE		.25
370-26	H	N.O.	1-1/8 WTC/C		BLACK BARRELITE		.25
300-90	H	N.O.	3/8 PRESS FIT		BLACK BARRELITE		.25
370-21	H	N.O.	3/8 PRESS FIT		WHITE PLASTIC	3 BREAK TERMINALS	.30
301-40	L	N.O.	7/16-32 THD.	7/16	BLACK BARRELITE		.25
301-90	L	N.O.	7/16-32 THD.	3/8	BLACK BARRELITE		.25
370-37	M	N.O.	3/8-28 THD.	1/4	WHITE BARRELITE		.30
300-35	M	N.O.	3/8-28 THD.	1/4	BLACK BARRELITE		.18
370-20	M	SPST N.O.	END OF CORD	1/2	BLACK BARRELITE	ASSEMBLY OF 3 SWITCHES	.80
300-139	N	3 N.O. & 3 C.	1-3/32-32 THD.	1/2	BLACK BARRELITE	WITH 3 CONTACT CARDS	.80
370-3	N	N.O.	1-7/16 WTC/C		GREEN BARRELITE	SIMILAR TO MICRO SWITCH	.80
370-40	N	N.O.	1-1/2 WTC/C		METAL		.80

Micro Switches

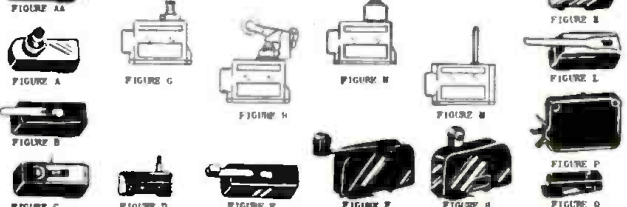

STOCK #	MANUFACTURER	SPR. TYPE	FIG.	CONTACTS	ILLUSTRATION	TERMINALS	OTHER CASE	UNIT PRICE
3001-10	Micro-switch	SPST	FIG. AA	N.O.	FIG. AA	SOLDER	Bayonette	\$0.40
3001-21a	"	SPST	FIG. AF	N.O.	FIG. AF	SOLDER	"	.50
3001-21b	"	SPST	FIG. AG	N.O.	FIG. AG	SOLDER	"	.50
3001-21c	"	SPST	FIG. AH	N.O.	FIG. AH	SOLDER	"	.75
3001-21d	"	SPST	FIG. AI	N.O.	FIG. AI	SOLDER	"	.75
3001-21e	"	SPST	FIG. AJ	N.O.	FIG. AJ	SOLDER	"	.75
3001-21f	"	SPST	FIG. AK	N.O.	FIG. AK	SOLDER	"	.75
3001-21g	"	SPST	FIG. AL	N.O.	FIG. AL	SOLDER	"	.75
3001-21h	"	SPST	FIG. AM	N.O.	FIG. AM	SOLDER	"	.75
3001-21i	"	SPST	FIG. AN	N.O.	FIG. AN	SOLDER	"	.75
3001-21j	"	SPST	FIG. AO	N.O.	FIG. AO	SOLDER	"	.75
3001-21k	"	SPST	FIG. AP	N.O.	FIG. AP	SOLDER	"	.75
3001-21l	"	SPST	FIG. AQ	N.O.	FIG. AQ	SOLDER	"	.75
3001-21m	"	SPST	FIG. AR	N.O.	FIG. AR	SOLDER	"	.75
3001-21n	"	SPST	FIG. AS	N.O.	FIG. AS	SOLDER	"	.75
3001-21o	"	SPST	FIG. AT	N.O.	FIG. AT	SOLDER	"	.75
3001-21p	"	SPST	FIG. AU	N.O.	FIG. AU	SOLDER	"	.75
3001-21q	"	SPST	FIG. AV	N.O.	FIG. AV	SOLDER	"	.75
3001-21r	"	SPST	FIG. AW	N.O.	FIG. AW	SOLDER	"	.75
3001-21s	"	SPST	FIG. AX	N.O.	FIG. AX	SOLDER	"	.75
3001-21t	"	SPST	FIG. AY	N.O.	FIG. AY	SOLDER	"	.75
3001-21u	"	SPST	FIG. AZ	N.O.	FIG. AZ	SOLDER	"	.75
3001-21v	"	SPST	FIG. BA	N.O.	FIG. BA	SOLDER	"	.75
3001-21w	"	SPST	FIG. BB	N.O.	FIG. BB	SOLDER	"	.75
3001-21x	"	SPST	FIG. BC	N.O.	FIG. BC	SOLDER	"	.75
3001-21y	"	SPST	FIG. BD	N.O.	FIG. BD	SOLDER	"	.75
3001-21z	"	SPST	FIG. BE	N.O.	FIG. BE	SOLDER	"	.75
3001-22a	"	SPST	FIG. BF	N.O.	FIG. BF	SOLDER	"	.75
3001-22b	"	SPST	FIG. BG	N.O.	FIG. BG	SOLDER	"	.75
3001-22c	"	SPST	FIG. BH	N.O.	FIG. BH	SOLDER	"	.75
3001-22d	"	SPST	FIG. BI	N.O.	FIG. BI	SOLDER	"	.75
3001-22e	"	SPST	FIG. BJ	N.O.	FIG. BJ	SOLDER	"	.75
3001-22f	"	SPST	FIG. BK	N.O.	FIG. BK	SOLDER	"	.75
3001-22g	"	SPST	FIG. BL	N.O.	FIG. BL	SOLDER	"	.75
3001-22h	"	SPST	FIG. BM	N.O.	FIG. BM	SOLDER	"	.75
3001-22i	"	SPST	FIG. BN	N.O.	FIG. BN	SOLDER	"	.75
3001-22j	"	SPST	FIG. BO	N.O.	FIG. BO	SOLDER	"	.75
3001-22k	"	SPST	FIG. BP	N.O.	FIG. BP	SOLDER	"	.75
3001-22l	"	SPST	FIG. BQ	N.O.	FIG. BQ	SOLDER	"	.75
3001-22m	"	SPST	FIG. BR	N.O.	FIG. BR	SOLDER	"	.75
3001-22n	"	SPST	FIG. BS	N.O.	FIG. BS	SOLDER	"	.75
3001-22o	"	SPST	FIG. BT	N.O.	FIG. BT	SOLDER	"	.75
3001-22p	"	SPST	FIG. BU	N.O.	FIG. BU	SOLDER	"	.75
3001-22q	"	SPST	FIG. BV	N.O.	FIG. BV	SOLDER	"	.75
3001-22r	"	SPST	FIG. BW	N.O.	FIG. BW	SOLDER	"	.75
3001-22s	"	SPST	FIG. BX	N.O.	FIG. BX	SOLDER	"	.75
3001-22t	"	SPST	FIG. BY	N.O.	FIG. BY	SOLDER	"	.75
3001-22u	"	SPST	FIG. BZ	N.O.	FIG. BZ	SOLDER	"	.75
3001-22v	"	SPST	FIG. CA	N.O.	FIG. CA	SOLDER	"	.75
3001-22w	"	SPST	FIG. CB	N.O.	FIG. CB	SOLDER	"	.75
3001-22x	"	SPST	FIG. CC	N.O.	FIG. CC	SOLDER	"	.75
3001-22y	"	SPST	FIG. CD	N.O.	FIG. CD	SOLDER	"	.75
3001-22z	"	SPST	FIG. CE	N.O.	FIG. CE	SOLDER	"	.75
3001-23a	"	SPST	FIG. CF	N.O.	FIG. CF	SOLDER	"	.75
3001-23b	"	SPST	FIG. CG	N.O.	FIG. CG	SOLDER	"	.75
3001-23c	"	SPST	FIG. CH	N.O.	FIG. CH	SOLDER	"	.75
3001-23d	"	SPST	FIG. CI	N.O.	FIG. CI	SOLDER	"	.75
3001-23e	"	SPST	FIG. CJ	N.O.	FIG. CJ	SOLDER	"	.75
3001-23f	"	SPST	FIG. CK	N.O.	FIG. CK	SOLDER	"	.75
3001-23g	"	SPST	FIG. CL	N.O.	FIG. CL	SOLDER	"	.75
3001-23h	"	SPST	FIG. CM	N.O.	FIG. CM	SOLDER	"	.75
3001-23i	"	SPST	FIG. CN	N.O.	FIG. CN	SOLDER	"	.75
3001-23j	"	SPST	FIG. CO	N.O.	FIG. CO	SOLDER	"	.75
3001-23k	"	SPST	FIG. CP	N.O.	FIG. CP	SOLDER	"	.75
3001-23l	"	SPST	FIG. CQ	N.O.	FIG. CQ	SOLDER	"	.75
3001-23m	"	SPST	FIG. CR	N.O.	FIG. CR	SOLDER	"	.75
3001-23n	"	SPST	FIG. CS	N.O.	FIG. CS	SOLDER	"	.75
3001-23o	"	SPST	FIG. CT	N.O.	FIG. CT	SOLDER	"	.75
3001-23p	"	SPST	FIG. CU	N.O.	FIG. CU	SOLDER	"	.75
3001-23q	"	SPST	FIG. CV	N.O.	FIG. CV	SOLDER	"	.75
3001-23r	"	SPST	FIG. CW	N.O.	FIG. CW	SOLDER	"	.75
3001-23s	"	SPST	FIG. CX	N.O.	FIG. CX	SOLDER	"	.75
3001-23t	"	SPST	FIG. CY	N.O.	FIG. CY	SOLDER	"	.75
3001-23u	"	SPST	FIG. CZ	N.O.	FIG. CZ	SOLDER	"	.75
3001-23v	"	SPST	FIG. DA	N.O.	FIG. DA	SOLDER	"	.75
3001-23w	"	SPST	FIG. DB	N.O.	FIG. DB	SOLDER	"	.75
3001-23x	"	SPST	FIG. DC	N.O.	FIG. DC	SOLDER	"	.75
3001-23y	"	SPST	FIG. DD	N.O.	FIG. DD	SOLDER	"	.75
3001-23z	"	SPST	FIG. DE	N.O.	FIG. DE	SOLDER	"	.75
3001-24a	"	SPST	FIG. DF	N.O.	FIG. DF	SOLDER	"	.75
3001-24b	"	SPST	FIG. DG	N.O.	FIG. DG	SOLDER	"	.75
3001-24c	"	SPST	FIG. DH	N.O.	FIG. DH	SOLDER	"	.75
3001-24d	"	SPST	FIG. DI	N.O.	FIG. DI	SOLDER	"	.75
3001-24e	"	SPST	FIG. DJ	N.O.	FIG. DJ	SOLDER	"	.75
3001-24f	"	SPST	FIG. DK	N.O.	FIG. DK	SOLDER	"	.75
3001-24g	"	SPST	FIG. DL	N.O.	FIG. DL	SOLDER	"	.75
3001-24h	"	SPST	FIG. DM	N.O.	FIG. DM	SOLDER	"	.75
3001-24i	"	SPST	FIG. DN	N.O.	FIG. DN	SOLDER	"	.75
3001-24j	"	SPST	FIG. DO	N.O.	FIG. DO	SOLDER	"	.75
3001-24k	"	SPST	FIG. DP	N.O.	FIG. DP	SOLDER	"	.75
3001-24l	"	SPST	FIG. DQ	N.O.	FIG. DQ	SOLDER	"	.75
3001-24m	"	SPST	FIG. DR	N.O.	FIG. DR	SOLDER	"	.75
3001-24n	"	SPST	FIG. DS	N.O.	FIG. DS	SOLDER	"	.75
3001-24o	"	SPST	FIG. DT	N.O.	FIG. DT	SOLDER	"	.75
3001-24p	"							

YOU Need My PRACTICAL Training to Make Money in

TELEVISION

RADIO and ELECTRONICS!



I'll Send You
8 BIG KITS of
Radio Parts and Equipment

Learn at
HOME
IN YOUR
SPARE TIME

NOW IS THE TIME To Get Into This Fast Growing Industry—Prepare For A Fine Paying Job Or Your Own Business!

If you want to get into Radio-Television and Electronics . . . you owe it to yourself to get the facts about my training. I have trained hundreds of men to become outstanding service technicians—and I'm ready to do the same for you. Whether your goal is a fine paying job in one of Radio's many branches—or a successful Radio and Television business of your own—you need the kind of training I offer! My training is practical and down to earth. **YOU NEED NO PREVIOUS EXPERIENCE.** You'll be astonished at your rapid progress. I start you with basic fundamentals and give you plenty of practical shop-bench training with many kits of parts I send you. This is the training that sticks with you and makes money for you on the job!

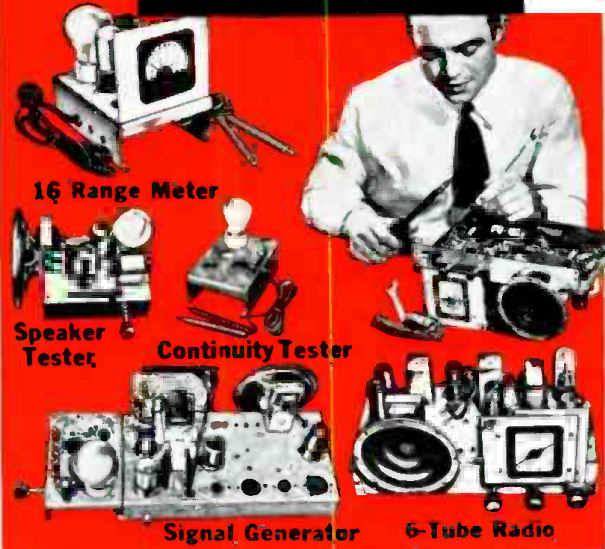

16 Range Meter

Speaker Tester

Continuity Tester

Signal Generator

6-Tube Radio

Get Paid For Spare Time While Learning

Soon after you start training I send you my famous **BUSINESS BUILDERS** that show you how to make money in spare time doing interesting Radio jobs. Look at the useful and valuable equipment you get while training with me (illustrated at left)—I send you these 8 big kits of Radio parts and equipment and help you build step-by-step a powerful 6-tube superhet radio, a 16-range test meter, plus other mighty useful equipment for Radio and Television servicing. You will perform over 175 fascinating experiments while training. You will learn about Television—so that you will be qualified to step into this fast growing, profitable field. I also send you many valuable service manuals, diagrams and my book telling exactly how to set up your own Television and Radio shop. I want you to learn all about my training—and that is why I urge you to clip and mail the coupon below for my two big **FREE** Radio books. I employ no salesmen—and nobody will call on you. The important thing is to act now and get the facts.



HAVE A BUSINESS OF YOUR OWN

A profitable Radio and Television Service Shop may be started with little capital. I will show you how to get started and how to build your small business. At left is pictured one of my graduates, Mr. Merrit C. Sperry of Fairmont, Minnesota in his own shop. The way is also open for you to build a good **SERVICE BUSINESS FOR YOURSELF.**

ALL KITS ARE YOURS TO KEEP

Each of the hundreds of Radio parts and other items I send my students is theirs "for keeps." You may use this equipment in your Radio and Television service work and save many dollars by not having to buy expensive "ready-made" test equipment. Each of my 8 kits will help you advance and learn important steps in Radio and Television servicing.



CALVIN SKINNER of New Orleans, La. tells us he makes \$5 to \$10 in spare time repairing radios. He is now also working with his own Television set.



LOREN D. SAUCIER of Coloma, Mich. reports that my training has made it possible for him to repair large numbers of Radio and Television receivers.

RADIO AND TELEVISION INDUSTRY BOOMING

You couldn't pick a better time to get into Radio-Television and Electronics. New Television stations are going on the air to serve every major city—hundreds of new AM and FM Radio broadcasting stations are also on the air to serve practically every community in America. All this creates new and bigger opportunities for the trained man who knows Radio-Television and Electronics. Good Radio and Television service men are needed **NOW!**

VETERANS

THIS TRAINING AVAILABLE TO YOU UNDER THE G. I. BILL

My Training Includes:

- Radio Servicing**
- Television**
- FM Frequency Modulation**
- Public Address and High Frequency Applications**

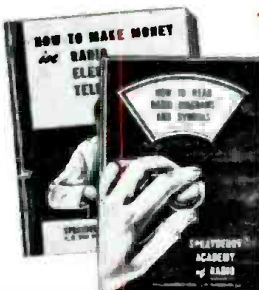

These Two Big **FREE!** Radio Books

Just mail coupon for a **FREE** sample Sprayberry Lesson and my big **FREE** book, "How to Make Money in Radio-Television and Electronics." Learn why my really practical training is best of all for you. Discover what's ahead for you in the fast moving Radio-Television and Electronics industry. No obligation. Don't delay—the future is too important to you. Mail the coupon now—and count on me for fast action.

RUSH COUPON Today!

SPRAYBERRY ACADEMY of RADIO, Dept. 20-C 111 North Canal St., Chicago 6, Ill.

Please rush my **FREE** copies of "How To Make Money In Radio-Television and Electronics" and "How To Read Radio Diagrams and Symbols."

Name..... Age.....

Address.....

City..... State.....

SPRAYBERRY ACADEMY OF RADIO
111 N. CANAL, DEPT. 20-C, CHICAGO 6, ILL.

() Check here if you are a Veteran.

NEW for 1950

MIDWEST

Celebrates its 30th YEAR of FACTORY-TO-YOU Selling with a Sensationally NEW 1950 LINE of

TELEVISION

CONSOLES and Complete CHASSIS

New GIANT 16" PICTURE

Here is Television at its finest! . . . brought to you by Midwest, for 30 years a leader in the field of radio and electronics. Immense 151-square-inch screen on new 16" metal-glass tube . . . clear, steady, bright pictures . . . Synchronized sound and picture that a child can tune in perfectly . . . Highest quality FM sound . . . Big 12" Electro-Dynamic Panasonic Speaker. Available in beautiful Television-Radio-Phonograph Consoles, as illustrated, or in complete chassis (not a kit) ready for custom installation in your own cabinet. And you can buy Midwest Television at Low Factory Prices, with Low Down Payment and Long Easy Terms — and on 30 Days Trial! Send for Catalog TODAY!



NEW LOW
Down Payment
Long EASY TERMS



LOW FACTORY TO-YOU PRICE

30 DAYS TRIAL

... also a Magnificent Line of NEW 1950
MIDWEST RADIOS
featuring the latest Improved FM Circuit
and the New 3-SPEED RECORD PLAYER



Powerful new 1950 Series 16 and Series 12 AM-FM Radio in complete chassis. Also beautiful new Console models including the magnificent Symphony Grand Radio-Phonograph with latest FM circuit and new 3-Speed Automatic Record Player. New portable and Table Models also available.

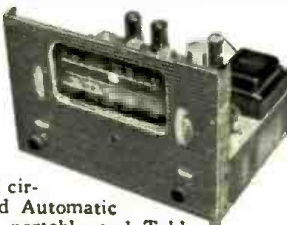

SEND FOR
FREE
32-Page
Full Color
CATALOG



Write in Name and Address (Please Print) on Coupon or 1c Postcard.

MIDWEST RADIO & TELEVISION CORP.
Dept. X384, 909 Broadway, Cincinnati 2, Ohio

Please send me your new FREE 1950 Catalog.

NAME _____

ADDRESS _____

CITY _____ ZONE _____ STATE _____

BUY DIRECT FROM THE MIDWEST FACTORY and **SAVE!**

MIDWEST RADIO & TELEVISION CORP.

Dept. X384, 909 Broadway, Cincinnati 2, Ohio