

Indiana Historical Radio Society  
**BULLETIN**

VOLUME 16

DECEMBER 1987

NUMBER 4



**Special  
Holiday  
Number**

**W**ishing You a  
Merry Christmas

***Radio's Livest Bulletin***



**Preservation For Posterity**

245 N. Oakland Ave., Indianapolis, IN 46201

## 1987 OFFICERS

**PRESIDENT** **IHRS Business, Activities, Publicity**  
 Paul S. Gregg ..... 725 College Way  
 (317) 846-3094 Carmel, IN 46032

**VICE PRESIDENT** **Legal Matters**  
 Eric von Grimmenstein ..... 9318 Seascape Dr.  
 (317) 849-0563 Indianapolis, IN 46256

**SECRETARY** **Correspondence, Applications**  
 Charles Saxton ..... 5532 W. 25th St.  
 (317) 291-5664 Indianapolis, IN 46224

**TREASURER** **Dues, Financial, Address Change**  
 Marilyn B. Johnston ..... R 1, Box 218-A  
 (317) 945-7735 Windfall, IN 46076

**HISTORIAN** **Donations, Scrapbook Material**  
 Dr. Ed Taylor ..... 245 N. Oakland Ave.  
 (317) 638-1641 Indianapolis, IN 46201

**EDITORS** **News, Articles, RADIOADS**  
 George and Edna Clemans ..... 851 W. Wooster St.  
 (419) 352-7198 Bowling Green, OH 43402

IHRS is a NON-PROFIT organization which was founded in 1971. Annual membership dues are \$8.00 which includes first class quarterly IHRS Bulletin. RADIOADS are free to all members.

**\*\*PLEASE\*\***

**Send a stamped, self-addressed envelope  
 when requesting information.**

## **\*\*\*NOTICE\*\*\***

1988 IHRS dues are now due. Send your \$8.00 check to Marilyn B. Johnston, Treasurer, Route 1, Box 218-A, Windfall, IN 46076. Membership includes four issues of the IHRS BULLETIN by First Class Mail. "For Sale" and "Wanted" RADIOADS are free. Please verify your mailing address.

## **NOTES FROM THE PRESIDENT**

I would like to say hello and welcome to all as we enter the Indiana Historical Radio Society's seventeenth year.

Seventeen years ago, thirteen men decided that they could derive more pleasure from their hobby by sharing it with others, and thus the IHRS was formed. We now have over 240 members and always want member support in expanding this number.

For those of you who don't know me, I have been collecting old radios for about eight years now. My collecting started when I was living in Lafayette, Indiana, and I came across a black-dial Zenith floor model at a local antique shop. It did not work, so I asked around if anyone locally messed with old radios. I was given the name of an individual that many of you IHRS members know—Glen Rogers.

Glen took me into his basement to help me out with some tubes I thought I needed. There I saw several wooden boxes with black Bakelite panels and knobs of all sorts. I asked what they were, and he said they were old battery radios. I kept asking questions, and he told me about the club.

I am sure when I left that he thought that he would never see me again. Over the next several years, Glen and I became good friends, and I owe much appreciation for his time and patience in helping me with a hobby that I have been crazy about. I don't have any type of electronic background, which proves that it is not necessary to totally enjoy this hobby.

I look forward to working with the club over the next two years. Please feel free to call me or drop me a note with any new ideas which will help the club grow and prosper.

Best wishes for the remainder of 1986 and a happy holiday as we approach the new year. I look forward to seeing many of you at the Indianapolis Meet in February.

Happy Holidays!  
Eric von Grimmenstein, President

***"This is a Radio Christmas"***

## IHRS BY-LAWS

Copies of the By-Laws of the Indiana Historical Radio Society are available to members upon request to Dr. Ed Taylor, 245 North Oakland Avenue, Indianapolis, Indiana 46201. Include a large, stamped, self-addressed envelope please.

## FROM THE CO-EDS

As many of you know, this is the last issue of the **Bulletin** that we will be editing. Before we sign off, however, we would like to thank the many people who have made our tenure as "Co-Eds" enjoyable. So many members have contributed material for the **Bulletin** that we have not been able to include it all. So we will pass it on to the new editor for a future issue. There have been several members, however, who have always been ready to help, and we want to mention them specifically. Ed Taylor has contributed many of our illustrations and has kept us up-to-date with his "Have You Read" feature. Del Barrett has been particularly helpful in supplying information about Indiana radio history. And, finally, Life Member Marshall Howenstein was always there with an account of his own experiences in the early days of radio. So, many thanks to you all, and let's all continue the good work in helping our new Editor, Jim Fred.

George and Edna Clemans



★  
Lego Wonder Fixed Detector

## 1988 OFFICERS

Next year the Indiana Historical Radio Society will be led by the following officers, elected at the Valpo Meeting:

President ..... Eric von Grimmenstein  
Vice President ..... John Foell  
Secretary ..... Charles Saxton  
Treasurer ..... Marilyn B. Johnston  
Historian ..... Ed Taylor  
Editor ..... Jim Fred

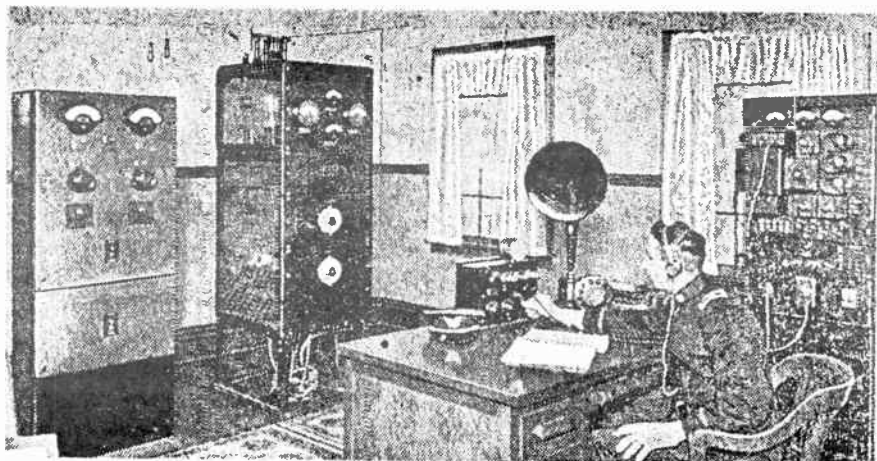

## *A Matter of History*

In 1924 WCBD broadcasting station in Zion, Illinois, was owned and operated by the Christian Catholic Apostolic Church. The station location in Zion is about midway between Chicago and Milwaukee. The station broadcast with five kilowatts of power under its evangelist pastor, Wilbur Glenn Voliva. It is thought to have been among the first broadcasting stations in the nation devoted entirely to religious programming.

Each Sunday a five-hundred voice choir sang, accompanied by a great pipe organ. The station boasted of a band of fifty and an orchestra of forty players. Services were held in Shiloh Tabernacle. In connection with the Tabernacle there was also a soundproof studio from which musical programs were broadcast.

The author and his mother broadcast a violin solo from the station one Sunday afternoon as "Guest Artists" from Goshen, Indiana.  
Marshall Howenstein



# THE KODEL P-11 - A MYSTERY SET

George B. Clemans

## KODEL



and

# Christmas

## Tune in Christmas with a KODEL

Model C-11 One-tube Receiver. The best radio set today.



**\$1000**

KODEL Model C-14 Four-tube Receiver. Illustrated here, a period at \$22.50 (without battery cabinet, loud speaker or accessories). Battery cabinet can be purchased with any KODEL set at slight additional cost.

**\$3250**

With battery compartment, \$37.00

Model S-1 Kodel Crystal Set. Sensitive, selective, low-priced.



**\$500**

Model C-12 Two-tube Receiver. A great distance getter; puts local stations on the horn; single dial tuning.



**\$1800**

Model P-12 Two-tube Portable. (Model P-11 with amplifying tube added, which increases distance and volume many times.)

**\$2250**



Model C-13 Three-tube Receiver. Gives five-tube volume with only three tubes, due to reflex amplification.



**\$2800**

Model P-11 One-tube Portable—the Camera Radio — Price \$16.00 without accessories. Tube, batteries, headphones, antenna and ground wire all self-contained. Weight 1 1/2 lbs. complete.

**\$1600**



THIS Christmas anyone can give the best that radio offers, for KODEL radio receivers are priced so low that anybody can afford them. And they are so simple to use! Just one dial to turn, and in the stations come, near and far. Only two dials in the 3 and 4 tube sets. Santa can even bring radio to the apartment house where antennas are prohibited. For KODEL will work on ground alone —hook it to the nearest radiator!

All KODEL sets contain a unique circuit, discovered by an independent experimenter. When radio conditions are right, 1000 miles on one tube! Add tubes until the four-tube set gives you the possibility of trans-continental reception.

See the KODEL line at your dealer's. If he does not carry these marvelous sets, send us his name and address and we will send you the interesting KODEL catalog, from which you can order direct. Money returned if any KODEL set does not more than satisfy you.

DEALERS: The KODEL is a sensation wherever introduced. Write for terms.

KODEL MANUFACTURING CO.

Under the same management that made the HOMERIDGE famous.

128 West Third Street, Cincinnati, Ohio



The Kodel Manufacturing Company was an early radio concern operating out of Cincinnati, Ohio. The accompanying advertisement shows their complete radio line for the year 1924. One of the most in-

resting of the sets is the Model P-11, a one-tube (UV-199) portable receiver, available for only \$16.00. Although I have found two of these radios, I have yet to be able to figure out HOW or WHY they work.

As noted in the ad, the set uses a "...unique circuit, discovered by an independent experimenter," but I have not found a published copy of a circuit diagram for it anywhere. I did, however, come across an article in a 1924 issue of **Radio Digest** that describes the P-11 as a non-regenerative radio receiver - surprising for a single-tube set of that time. Further information has been hard to come by.

To get more insight into the operation of the P-11, I tried to trace the circuit from the sets I have, which are identical. This was complicated by the fact that standard parts were not used. The tube socket, for instance, also serves as a fixed condenser and a coil mount, while the tuning condenser is a crude compression affair, part of which doubles as a by-pass condenser. Most confusing, however, is the fact that the aerial binding post on the front panel connects directly to the filament minus connection on the tube socket. How it ever gets to the antenna coil or to the tube grid is indeed a mystery. But somehow it must. Because in spite of all, the set actually works, although it oscillates wildly most of the time.

Since the Kodak Model P-11 was advertised as "The Camera of Radio" maybe I ought to take mine to a photographer and let him tell me how they work!

Write for catalogue

**CROSLEY**  
BETTER • COST LESS  
**RADIO**

Department RB-12

**CROSLEY MANUFACTURING CO.**  
Cincinnati, Ohio

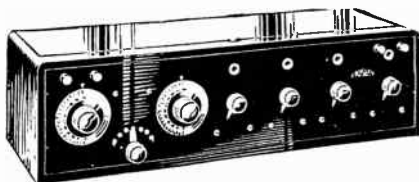

CROSLEY RECEIVER MODEL N. A four tube outfit the same as shown in the above scene. It consists of Tuner, one stage of Tuned Radio Frequency Amplification (the feature that has made it instruments so popular) Detector and Two Stages of Audio Frequency Amplification in a beautiful mahogany finished cabinet. It will bring in distant stations loud and clear. Price without phones, batteries or tubes.....\$55.00

## Congratulations ...

Ed Taylor, IHRS Historian, has won the prestigious Taylor Award from the AWA. This annual award is given at the AWA Conference to a member who has done outstanding research in the field of either television documentation or television preservation. The award is given in the memory of AWA member John P. Taylor, Vice President of RCA's commercial equipment division.

The award was given for Ed's monograph on Taylorvision and for helping others in the field of television documentation. The first winner of the Taylor Award (1985) was Kenneth McIntosh, followed by the 1986 winner, Dick Brewster. Jack Davis founded the award, and IHRS member, Ross Smith, is on the selection committee.

# MERRY

Suggestions for useful gifts to "radio bugs"

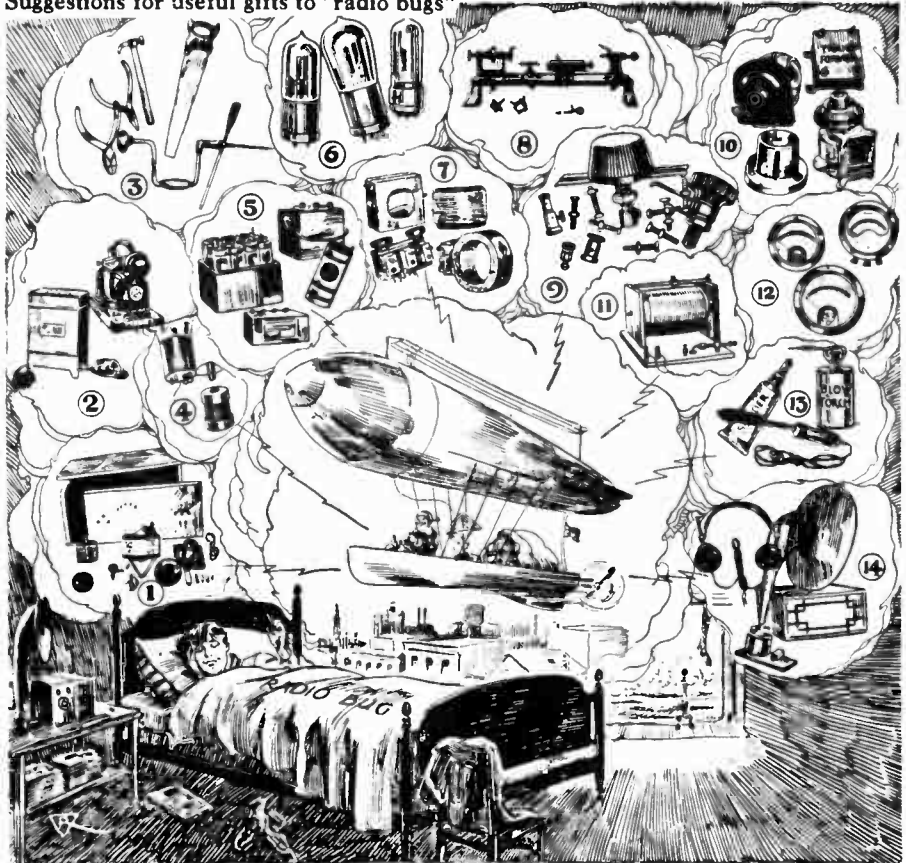

## A RADIO CHRISTMAS

**T**HE S. P. U. G. (Society for the Prevention of Useless Giving), is with us again. This time it is dealing with the matter of radio, something which is in the minds of everyone at the present time. Above, in the Radio Bug's Dream, will be seen a few suggestions for gifts.

His apparatus on hand at present must be taken into consideration so that duplicates will not be given, and in order that the recipient shall find himself in possession of material which will be of use to him in expanding his present set. If the radio enthusiast has only a crystal set, do not present him with a loud speaker (Fig. 14), or some other useless instrument. Rather, present him with a vacuum tube (Fig. 6), so that his range can be extended and in this way bring joy and happiness to his home.

To the man or boy, or for that matter, his woman, who likes to build radio sets, there are many tools (1, 2, 3), which will be greatly appreciated. A lot (Fig. 8) is something desirable but usually unattainable to the average amateur. Batteries and chargers (Figs. 5 and 2) can always be used, the latter, however, only when A.C. is available. Parts (Figs. 1, 7, 9, 10 and 12) can be used for additions to present sets. The beginner would appreciate a crystal set (Fig. 11). Soldering materials (Fig. 13) are useful. A simple but welcome present is a set of vacuum tube fuses (Fig. 4). An extra pair of phones (Fig. 14) will always find favor. To our mind radio apparatus makes the best present that anyone can give to those interested in the most fascinating of all hobbies.



# CHRISTMAS

MICHIGAN RADIO CORPORATION  
GRAND RAPIDS, MICH.



Make it a  
**RADIO**  
**X'mas!**  
with a  
**MICHIGAN**  
**FOUR**  
**\$150**

Michigan "de Luxe" 4 tube receiver. 1stage R.F. amplification. Built-in adjustable loudspeaker. Solid mahogany case. "America's most beautiful set." MRC4, \$150

**R**IGHT now, settle the question of Christmas presents. Buy a Michigan Radio receiving set.

You get more real value and satisfaction from these receivers than any others, regardless of what you pay.

Distance—with greater selectivity and simplicity of operation.

Reliability—with logging and unusual tone qualities.

And each model enclosed in a cabinet designed and made by the world's best furniture craftsmen.

Models in two, three and four tubes. Styles from \$32.50 up.

*Send for illustrated folder. Ask your dealer for a demonstration.*

Licensed under U. S. Patent, 1,113,149-letters pending 807,388



3 tube Regenerative Detector and 2 stages of amplification. The set we never could catch up on orders for last year. MRC12, \$37.00



3 tubes in handsome case with inside panel doors and compartments for batteries, headphones, etc. MRC3, \$87.50



Michigan "Midget" 2 tube regenerative long distance wonder. MRC2, \$32.50

**MICHIGAN RADIO CORPORATION**

32 Pearl Street

Grand Rapids, Mich.

# Cunningham RADIO TUBES

PATENT NOTICE: Cunningham Tubes are covered by patent, dated 2-15-08, 2-16-08, 12-29-08, 10-23-11, and others issued and pending. Licenses only for amateur experimental use. No other use will be an infringement. Cunningham 8-19-32 data book fully explaining care and operation of Radio Tubes now available by sending ten cent stamp to San Francisco office.



Price the same on all five types—  
C-301A, C-299, C-300, C-11, C-12

*R. J. Cunningham Inc.*

182 S  
Home Office, SAN FRANCISCO CHICAGO NEW YORK

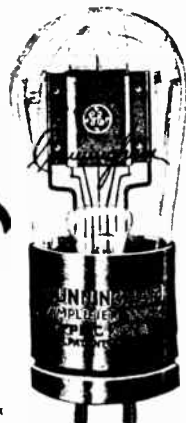

## A New Radio Sub-Collection

In the early days radio repairmen, radiotricians, and radio salesmen pasted personalized paper labels on tubes they had tested or sold. These can, therefore, be a new angle on radio history in your locality. Pictured below are three such tubes from the twenties, that I have found in my town, Bowling Green, Ohio. One radio shop was actually located on the street where we live. I have also managed to come up with a selection of tubes from many of the other small towns in the area. Tube labels can be a colorful and interesting way of exploring the impact of radio where you live.

George B. Clemans

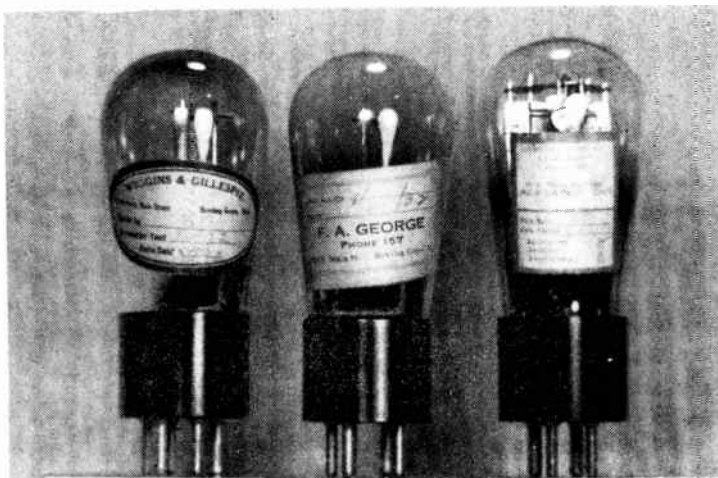

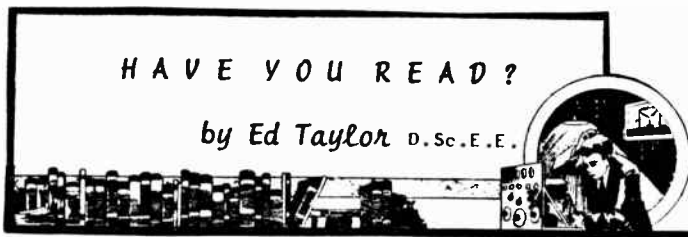

## THE MIGHTY MUSIC BOX

by

Thomas A. DeLong 1980

**The Mighty Music Box** is an in-depth history of the golden age of musical radio. All kinds of music have dominated the air-waves for over 65 years. Unlimited entertainment at the twist of a dial brought the nation crooners, country/western stars, romantic balladeers, dance bands, symphony orchestras and grand opera productions. Musical shows i.e., "Your Hit Parade," "Stop The Music," "Grand Ole Opry," and many more had a positive impact on live concerts and phonograph record sales of the day.

Over 60 photographs of the stars themselves, posters, advertisements, and other ephemeral radio memorabilia are included in this 355 page hard-bound edition.

Distributed by Hastings House Publishers at \$14.95.



# Our Newest Member . . .

The newest member of the IHRS is none other than Durward Kirby. Many of us will always remember his appearances on the Garry Moore TV show in the fifties and the many skits he appeared in with Carol Burnett. Kirby began his broadcasting career at WFBM in Indianapolis and got his first "big break" when he moved to WLW in Cincinnati, where he came to national attention. He is now semi-retired, doing occasional radio and television spots.

## DONATIONS TO THE IHRS

Ross Smith writes that approximately seventy tubes which had been donated to the IHRS Museum Fund by Mary Dorman, Elkhart, Indiana, have been sold at a total figure of \$200. Tubes were sold at IHRS meetings in Auburn, Logansport, and Valparaiso, and at the AWA Meet in Canandaigua. The tubes originally came from the Estate of Jay Winer, W9AEB. Six transmitting tubes and six receiving tubes from the collection were placed on a mounted display in the CTS-Turner Museum located on the second floor of the CTS Corporate Building, 905 North West Blvd., in Elkhart.

John Foell informed the editors that Lynn and Jack Bickhard, Antwerp, Ohio, have donated to the radio display at the Auburn Cord Duesenberg Museum a 1936 Scott Imperial All-Wave (23 tubes). The set is in extremely good condition and should be easily restored. It was donated in the memory of Amos L. Bickhard by his sons.

## A LETTER TO THE CO-EDS

October 7, 1987

Dear George and Edna,

You sure called the shot with that earthquake story in the **IHRS Bulletin** (September 1987). Culver City got a pretty good shaking in our recent quake.

Let's see if you can predict the next killer storm, explosion, or whatever. I'll be watching the **Bulletin**, so I'll know where not to go!

Seriously, I think the **Bulletin's** striking a good balance for the newer generation of historical radio bugs. We old "hardware guys" have to make room for the more "total" historians.

Morgan E. McMahon  
26356 Eastview Ct.  
San Juan Capistrano, CA 92675

*EDITOR'S NOTE: Morgan, we could say something about swallows, but we believe we'll get out of the prediction business, as well as the editing business, for a little bit. Thanks for your kind words.*

## FROM THE MAILBAG

In response to last issue's list of "Tube Equivalents from the Military," James W. Grant has made available to your editors a "Cross Index of Army VT Numbers and Commercial Numbers." Send a self-addressed STAMPED envelope (legal size) to the editors at 851 W. Wooster Street, Bowling Green, Ohio 43402, and we will send you a copy.

Bart Bartuszevige has for sale a World War II Japanese field radio. Both a receiver and transmitter, it is in working condition with some spare parts. Contact him at (517) 288-3237 or write him at 9510 South Durand Road, Durand, MI 48429.



### OBITUARY

Word was received that Sarkes Tarzian, 87, of Bloomington, Indiana, founder and chairman of the board of Sarkes Tarzian, Inc., died recently. His corporation manufactured television tuners and selenium rectifiers. He had come to the United States in 1907 at the age of seven. He graduated from the University of Pennsylvania in 1923 and immediately went to work for Atwater Kent. He soon became chief product design engineer and stayed with the Kent company until 1936 when Kent closed his doors forever. Tarzian then joined RCA, working first in Argentina. In 1940 RCA brought him to Bloomington. He became chief engineer and product manager in the manufacture of a proximity fuse.

Sarkes Tarzian, Inc., was begun in 1944 with only four employees, but it grew to more than 2,000 in Bloomington, where it operated until the late 1970's. Tarzian's first television station was WTTV Channel 4 with studios in Bloomington and Indianapolis. It was sold in 1977 for \$28 million. From 1964 to 1984 Tarzian owned and operated WATI-AM. The following stations are owned and operated by Sarkes Tarzian, Inc., of which Mr. Tarzian was chairman of the board: WTTS-FM and WGTC-AM, Bloomington; WAJI-FM, Fort Wayne; KTVN-TV, Reno, Nevada; and WRCB-TV, Chattanooga, Tennessee.

## RADIOADS

**FOR SALE:** Very nice Tuska Superdyne Jr., \$250; Stromberg Carlson Model 635 Treasure Chest, also nice, \$60. Must be picked up or I can deliver to next meet. George Hauske, 1922 East Indiana Street, Wheaton, IL 60187. (312) 668-3845.

**TRANSFORMER REWINDING SERVICE:** Send a SASE for information to Peter Yanczer, 835 Bricken, St. Louis, MO 63122.

**WANTED:** Plug-in coils for National SW3 and manual, operational manual for Heathkit Impedance Bridge Model 18-2A, new Crosley Pup, 4-tube superhet in metal cabinet 7x12x7 made in 1931-32, Philco ABC Battery Eliminator, has storage battery (A) glass with trickler charger, electrolytic rectifier for B, and C battery for C bias, Radio Receptor Company Battery Eliminator, known as "Powerizer" used as a conversion from 201A to 220 and 227 tubes (has 210 power amplifier and 80 rectifier, was used on receivers such as the AK35 and Radiola 20, etc.), copy of manual for a "Sky Buddy," and a source of black crackle or wrinkle paint. Tad Drogoski, 507 Coal Valley Road, Clairton, PA 15025.

*The Greater*  
NEUTRODYNE  
**EAGLE**  
★ *Balanced Receiver*

*"My Choice this Christmas"*

## Model Magnaformer 9-8

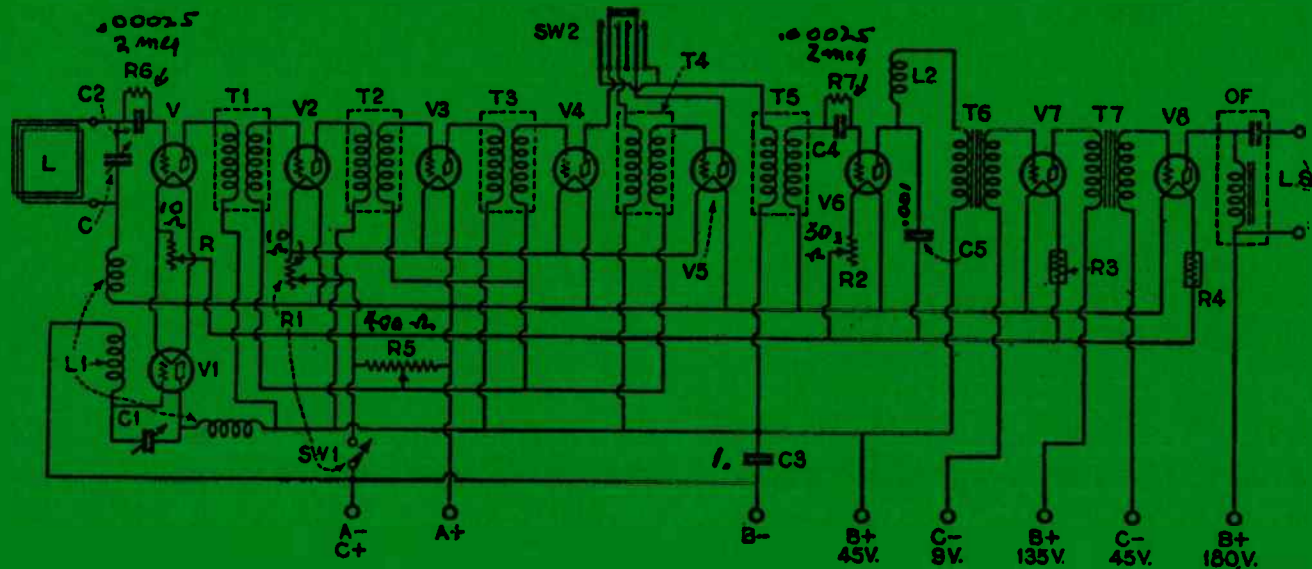

Schematic diagram of the Magnaformer 9-8 Receiver. By means of the cam switch SW2 one stage of i.f. amplification can be cut out. This switch is mounted on the front panel of the receiver, below the drum dial.

# THE LOG OF THE IHRS

*Indiana is on Eastern Standard Time.*

SUNDAY, February 21, 1988: The next meeting of the Indiana Historical Radio Society will be held in Indianapolis at the Sherwood, 6500 South Emerson Avenue. The mid-winter swap meet and flea market open at 9:30 A.M. EST. A roast beef Manhattan lunch (with salad and beverage) will be served at noon. There will be a registration fee of \$1.00 per person collected when you arrive. Your meal, of course, will be extra. At 1:00 P.M. there will be a short business meeting. Please bring suggestions and comments for location of summer meet.

We have plenty of space for set-up. Bring your good, bad, new and old radios to keep those goods moving through our Society.

Contest categories will be the following:

- I Crystal sets
- II One tube battery sets
- III Horn or unusual speakers
- IV Cathedral or mantle radios

Let's all make an effort...blow off the dust and bring in those prize radios for the contest! If you have questions concerning Indianapolis weather or road conditions, phone Eric von Grimmenstein (317) 849-0563.

*NOTE SUNDAY, NOT SATURDAY, MEETING DATE!*

FRIDAY AND SATURDAY, April 22 and 23, 1988: Annual AWA-IHRS Spring Meet. American Plaza, I-69 and Indiana 14 in Fort Wayne. Exit 105 on I-69, on the west side of the city. There are two restaurants, guest rooms, and meeting room all in the same building. There is a parking lot for flea market activities not more than 200 feet from the main building. Weekend special room rates with up to four people - \$34.50. The toll free number to call is 1-800-645-7363. Additional meeting information will be in the next **Bulletin**.

*NOTE NEW FORT WAYNE LOCATION FOR SPRING MEET!*

## MAN-MADE S-T-A-T-I-C

