

Indiana Historical Radio Society
BULLETIN

Vol. 5

August, 1976

No. 3

Toll of the Sea



AUBURN MUSEUM

IHRS Museum Project Director Del Barrett reports excellent progress. The Indiana Historical Radio Society Display is now ready for public viewing in the Auburn-Cord-Duesenberg Museum. This display will be a part of the Museum until 1979.

New Catalog of **Radio Apparatus**

RADIO APPARATUS
Our apparatus must please you all your money returned if it does not.

RADIO APPARATUS

Mailed Postpaid on Request
Quality Apparatus
Low Prices



**Navy Type Key
Marble Base
Silver Contacts** **\$4.25**

Ask for Catalog No. 7046W.

Sears, Roebuck and Co. Chicago

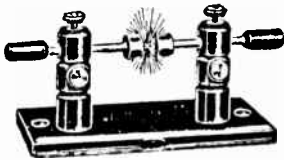

Spark Gaps,
75c, 90c, \$2.00.

American Electro Technical Appliance Company

235R Fulton Street New York City

FRESH STOCK "B" BATTERIES
25 Volt, 14 Amp., \$2.25

FULL STOCK OF DE FOREST,
GREBE, MURDOCK, AND OTHER
BEST MANUFACTURERS



The kind with
threaded
shank; with
nut, 3c ea.

AUDION CONTROL PANELS, \$6.00, \$10.50, \$12.00, \$19.00, \$22.00, \$24.00, without
bulb. 2 STEP AMPLIFIER PANELS, \$50.00, \$69.00. JEWELRY TIME SET, \$27.00.
DE FOREST HONEYCOMB COILS, price as per list. All mountings in stock. WESTERN
ELECTRIC HEAD SETS, \$12.00. Brandes SUPERIOR HEAD SETS, \$7.00. DE FOREST
DUST PROOF CRYSTAL DETECTOR, \$2.60. MARCONI TYPE, \$1.75. PARAGON RHEO-
STAT, \$1.75. PARKIN RHEOSTAT, \$1.00. DE FOREST TYPE, \$1.00. Loose couplers,
800 meters, \$5.00; 4000 meters, \$10.00; Arnold type, \$19.00. Loads of other apparatus
and parts on hand.



IHRS OCTOBER MEET

IHRS will hold its fall meet Saturday Oct. 30 in Greenfield Indiana. (25 miles east of Indpls. on US 40) from 10 AM to 3 PM. Meeting will be held in the Shelter-House at Riley Park. (At the east edge of Greenfield $\frac{1}{2}$ block north of US 40 on "A" St.) Follow the signs. Resturants are within walking distance.

BRING YOUR CRYSTAL SETS

We would like to have 100 crystal sets on display. Each member is asked to bring as many sets as possible. Also bring your Swap Material

ANNUAL ELECTION OF OFFICERS will be held at this meeting.

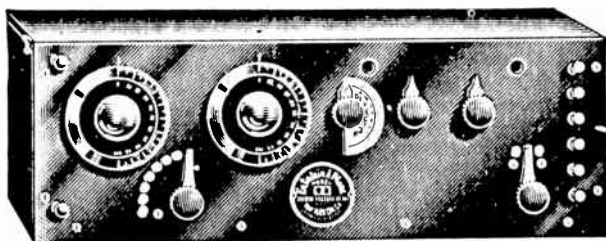

NEW YORK ENTERTAIN-A-PHONE RECEIVING SET No. 2—Complete with detector and two stages of amplification, all in one cabinet. Contains a non-regenerative two circuit hook-up with two stages audio amplification. Results are simply a revelation. It must be operated and heard to be appreciated. Workmanship and design and material of exceptional character throughout. Of unusual interest to the jobber. Price \$50.00, fully guaranteed. DW-11 $1\frac{1}{2}$ volt battery lamps may be used if desired.

NEW YORK COIL COMPANY, Inc.

338 Pearl Street

New York City, N. Y.

IHRS DISPLAY AT PURDUE UNIVERSITY JULY '76

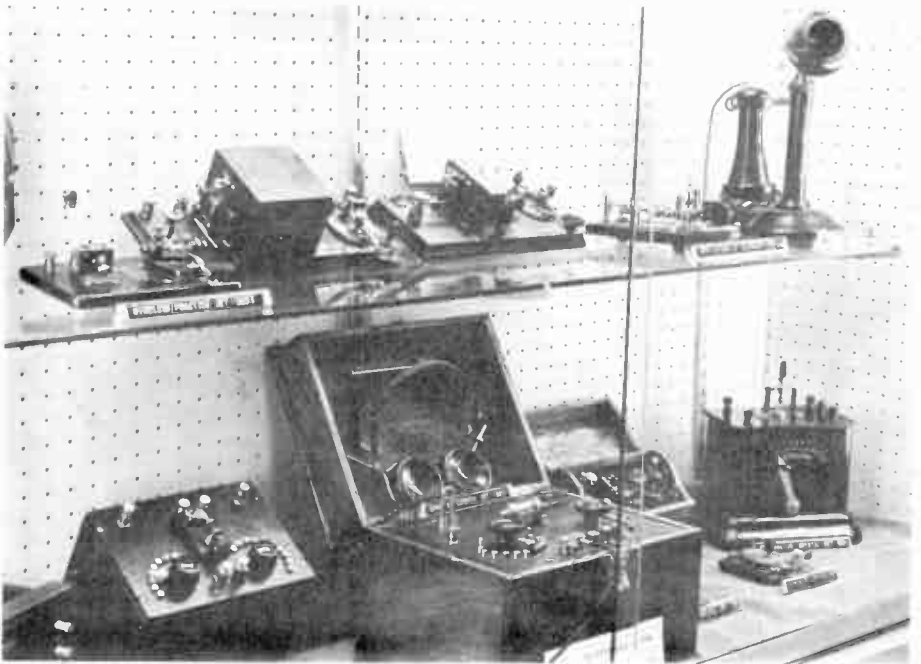
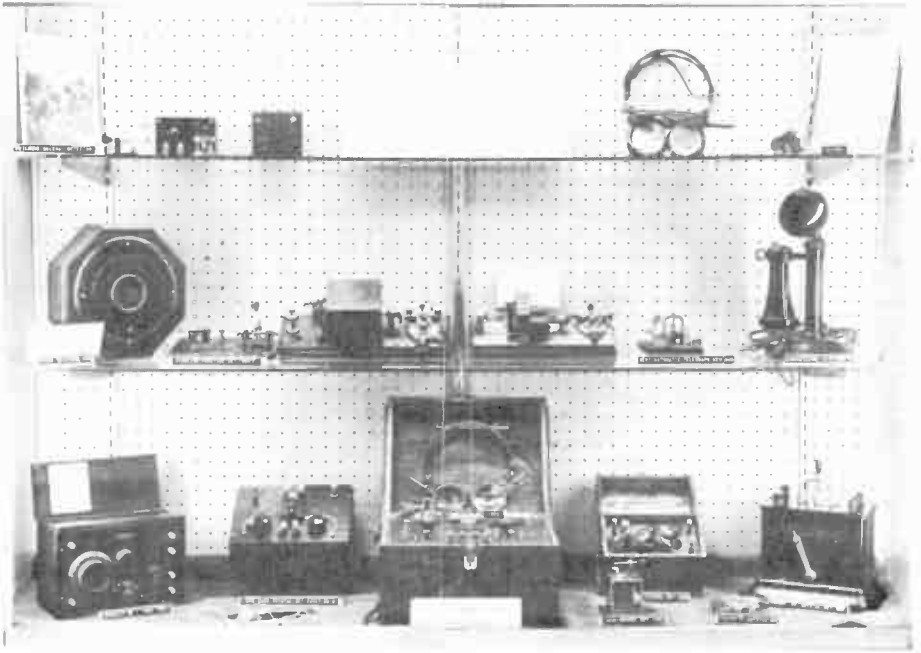

Rally for Old Tippecanoe

BATTLEGROUND MEET A BIG SUCCESS

Although the theme of the Battleground meet was built around Atwater Kent radios on July 17 at Lafayette, about 150 various types and makes of radios, half of them for sale or trade, were brought in by the over fifty in attendance. A Crosley 51 went for \$30, and a Triodyne, in mint condition, brought \$40. Seven states were represented, some from as far away as Maryland and New York.

More than enough food was provided through a carry-in style picnic dinner. This appealed to the long line of people that gathered to fill up their plates with a variety of good things to eat. Many of them took to the outdoors to enjoy eating under the trees and on benches provided by the Battleground Historical Society. These grounds are beautiful and it was a perfect day weatherwise to have such an outing. A business meeting was held following the dinner.



FIFTY YEARS AGO

In this year a comedy team known as Sam and Henry appear on WGN in Chicago. Two years later this team will change their names to Amos and Andy and for several decades, including the TV era, will reach unprecedented fame as airwave entertainers. A singing team, signed the previous year by a local radio station WIBO, will duplicate the Amos and Andy Story. The songteam, Marian and Jim, will later become known as Fibber McGee and Molly and their nation wide fame will also extend into the TV era. The "Silver Masked Tenor", Joseph M. White, with the Goodrich Silvertown Orchestra can be heard on WEA. The National Barn Dance with Chubby Parker, The Four Legionnaires, The Maple City Four and many future country music stars are on the air every Saturday Night from the Worlds Largest Store radio station in the Windy City. KDKA uses 40 or more remote pickups from locations in Pittsburgh and a model T Ford sedan equipped with crew and mobile remote pickup apparatus covers any special event broadcast. Most of the Broadcasting Stations are self orientated but a few join in some form of network programming. The big change comes on November 15th when Chief Eng. O. B. Hanson gives the signal that joins 24 stations, over 3500 circuit miles of telephone lines, to N. B. C.'s first network extravaganza. NBC Pres. M. Aylesworth announces the network opening. The program begins at 8 PM from the Grand Ballroom of the Waldorf Astoria and will continue until midnight. Will Rogers, Mary Garden, Eddie Cantor, Weber and Fields, Walter Damrosch, George Olsen, Ben Bernie, Vincent Lopez, B. A. Rolfe, Titta Ruffo of the Met., The Goldman Orchestra and Band and The Gilbert and Sullivan Light Opera Co. will all be a part of the NBC Programming. Hundreds of thousands of listeners with crystal, earphone, and loudspeaker sets will hear the program as far west as St. Paul and Minneapolis. Radio Broadcasting enters the "Golden Years" AND THAT'S THE WAY IT WAS--FIFTY YEARS AGO IN 1926

"Midget" Radio Sets



*Atchison
Radio Mfg. Co.*



Republic Radio Co.



*Woodstock
Elec. Corp.*



*Colonial
Radio Mfg. Co.*



Crosley Radio Corp.



Colin B. Kennedy



Acratone



*Simplex
Radio Co.*

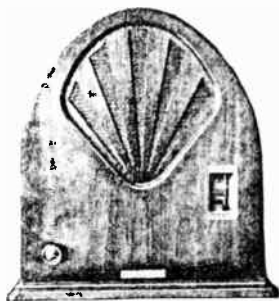

Powel Mfg. Co.

★ ★ RADIOADS ★ ★

SELL: Still a few copies left of Powel Crosley's Blue Book "Simplicity of Radio" pocket size 80 pages \$3.50, profits to AWA Museum Fund--6518 Gunpowder Lane, Prospect Ky 40059--Gordon Eklund

SWAP: First Edition of 1926 ARRL Handbook (5000 printed) for Partrick/Carter or Partrick/Bunnel, key and sounder telegraphic unit. Key base and sounder pedestals were cast integrally with cast-iron base unit.--494 Hirsch Ave Calumet City Ill 60409--Joseph P Benne Sr.

WANTED: 3KP4 Kinescope and photos or drawings of Pilot "3 TV model TV37. Will trade or buy for misc. tubes and parts.--3412 Brantford Rd. Toledo Ohio 43606--John Hoffmann

WANTED: R.A. Fesseden's biography "Builders of Tomorrows" Will pay \$10- \$15 or swap most anything--Box 225 Pocasset MA 02559-Alan Douglas

WANTED: Spark gear, coils, loose couplers; early shortwave transmitting equipment; 1 & 2 tube recvrs; old mikes & stands--pse call after 4PM any day but Monday TX 312-967-9161 --8520 Fernald, Morton Grove Ill 60053--E Pequod

WANTED: Radio and Radio-Phono made under the name of "Farnsworth" Need not be complete or in working order. (for Museum display)--1517 Pacific Drv. Ft Wayne In46819-Del Barrett

WANTED: Good 4FLA reflex HF xfmr #1, Acme R2 RF xfmr, Federal 65 audio xfmr and Pre'26 magazines. Have '28 Crosley Blue Book, Far-rand speaker, Federal 32 & 35 RF xfms & 864 tubes for trade--1922 E. Indiana Wheaton Ill 60187--G Hauske

WANTED Any model A-K Breadboard--3115 N. 61st Lincoln Neb. 68507--Irv Peterson

★ ★ RADIOADS ★ ★

WANTED: Old Radios Pre-1925--2706 Cub Hill Road Baltimore Md 21234--Emmett SmithW3BNO

WANTED: Desperate! Need two Paragon type 80 AF xfmrs any condx, any interior prts for Paragon DA-2; Carter (Carco) one-tuber see Vintage bk, parts for 1921 RCA CW Xmtr or any Wireless. Crosley small knob(concave center) tuning dial from 1922-23 set. Send SASE for for sale list.--P.O. Box 104 Mt. Carmel Ill 62863--The Ammons

WANTED Case for Radiola IIIA and three flat head screws for mounting rheostat in Radiola 5--517 E Mitchell St Kendallville Ind 46755--Philip Pepple

WANTED: Following Minneapolis made Radio Sets:Magnadyne, Crescentdyne, Interstate, Wright, Wright de Coster, H olmes-Jordan, Dotson, Northome, Northland, Cutting & Washington, Continental, Etterodyne, All Radio Boys books, Radio News prior to 1927-& WE 518W Horn--2840 Alabams Ave So. St Louis Park, Minn 55416--Jack M Bacon

SELL Or Trade, Majestic 70B console, good condx, minor repairs, Homemade 1 tube set very good condx; WANTED Radiola 28, Freshman G2 Equaphase, Tubes-UX 210, UX 874, UP 591--413 S Jefferson, Hartford City Ind 47348- K.L. Pontius

WANTED: Ant. for Radiola 26, AK Var. Condx with name tag and RF Xfmr with binding posts on top, will buy or trade, have WD11's or AK BB parts.--118 Countryview Drive Naperville Ill 60540--Mike White

WANTED: Carbon mike with stand, Crosley Pup for Rural Radio Network Museum display.--Box 415 New Palestine Ind 46163 (TX 317-861-4394) -Harry Martin

WIRELESS AMATEURS

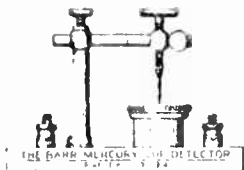

Send 2-cent stamp for free description of THE BARR MERCURY-CUP DETECTOR, the most efficient detector on the market. Tested by The Marconi Wireless Telegraph Co. and the United States Government.

Increases the efficiency of every wireless receiving set by making the signals clear, sharp and distinct.

Instantly adjustable at a constant pressure.

The Barr Mercury-Cup Detector Dept. D, The Wyoming, Washington, D. C.

Recognized as the largest and best.



Send ten cents for descriptive catalogue to Dept. B, 900-902 Penna. Ave., N. W. Washington, D. C.

WIRELESS TELEGRAPHY

Make your own "Wireless" also Dynamos, Batteries, Motors, Telegraph, Telephone, Lights, Bells, Alarms, Coils, Current Reverser, Electric Engines, etc. Book with 75 Illustrations; by experts so anyone can understand it. With Catalog. All 10c, 3 for 28c pp

J. C. DORN

705 S. Dearborn St. Dept. 21, Chicago, Ill.

The Traffic Cop of the Air



Add a Ferbend Wave Trap to your set and "Police" your reception. Regulate the Traffic. Guaranteed to tune out any interfering station. Sent postpaid on receipt of \$8.50, or \$1.25 if pre-ordered. Ferbend Electric Co. 11 E. South Water St., Chicago



NEW VIBRATONE Jr. RADIO TRANSMITTING SET



This Set Illustrated Above Operates on 110 VOLTS, D.C. or A.C.

It is absolutely complete as shown. Needs no helix, spark gap, condensers, etc., etc. Simply connect to aerial, ground and electric circuit, and send.

NO BATTERY EXPENSE

Runs all day for 2 cents.

Sends three to five miles.

PRICE \$18.00 COMPLETE

With Key, Plug and 8-foot Cord

Send for descriptive circular 146D—To-day

WIRELESS EQUIPMENT CO., Inc.

19 Park Place

New York, N. Y.

DE FOREST RADIO CO., PASSAIC, N. J.

TURNABOUT PEDESTALS FOR

Radiola Super-Heterodyne

and other directional receiving sets. Permits your set to revolve freely upon a mahogany-finished base.

Send postpaid upon receipt of \$1

Special quantity prices to dealers.

Levison Radio Laboratories

58 Collins Street, San Francisco, California



Send 10c for new and complete catalog Dealers and Jobbers write for our discounts
EMPIRE RADIO CORPORATION
271 W. 125th Street, New York City

NEWS INFORMATION

Commission Considers Refusal of 120 Licenses, Preceding General Reallocation

From July 9 to 20, the Federal Radio Commission held public hearings at Washington, taking testimony on the subject of re-licensing some 120 broadcasting stations which had been previously notified that without a showing of additional evidence that their operation was in "public interest, convenience or necessity" their licenses would be denied after August first. Of the total number of 162 broadcasting stations originally served with such notice, forty-two did not appear or make any opposition to cancellation of license, and so lost their licenses by default.

Decision was reserved in the cases of the stations heard, it being understood that after review of the testimony by the full Commission, the findings of the Commission would be announced about August first, together with the promulgation of a general reallocation order affecting the entire broadcasting spectrum. This reallocation was made necessary in order to bring the number of wavelengths, licenses and powers into proportional relation to the population of the various states, as required by the Congressional amendment to the radio law, passed in March, 1928.

Following is the list of stations cited to appear before the Commission who lost their licenses by default by not putting in an appearance or tendering testimony opposing the general order:

WLBM, Cambridge, Mass.; WRAH, Providence, R. I.; WBES, Takoma Park, Md.; WRES, Quincy, Mass.; WAIT, Taunton, Mass.; WGOP, Flushing, N. Y.; WCON, Danbury, Conn.; WOKT, Binghamton, N. Y.; WLB1, Wenona, Ill.; WLBY, Iron Mountain, Mich.; WABW, Wooster, Ohio; WGM, Jeannette, Pa.; WBBP, Petoskey, Mich.; WFBZ, Galesburg, Ill.; WLBT, Crown Point, Ind.; WJBA, Joliet, Ill.; WLBQ, Atwood, Ill.; WPEP, Waukegan, Ill.; WRAM, Galesburg, Ill.; WFKB, Chicago, Ill.; WLTS, Chicago, Ill.; WSAX, Chicago, Ill.; WJBZ, Chicago Heights, Ill.; KGFB, Iowa City, Iowa; KPFL, Osk-

loosa, Iowa; KPNP, Muscatine, Iowa; KFBG, Independence, Kans.; WMBE, White Bear Lake, Minn.; KFDZ, Minneapolis, Minn.; KGHC, Slayton, Minn.; KFMR, Sioux City, Iowa; KGEQ, Minneapolis, Minn.; WFAM, St. Cloud, Minn.; KFOJ, Omaha, Nebr.; KGFV, Ravenna, Nebr.; KGDY, Oldham, S. D.; WKLR, S. Kenosha, Wis.; KGFN, Aneta, N. D.; KFPR, Los Angeles, Calif.; KFUS, Oakland, Calif.; KOOS, Marshfield, Ore.; KFUT, Salt Lake City, Utah.

Federal-Brandes Changes Name

At a recent meeting of the stockholders of Federal-Brandes, Inc., Newark, N. J., it was voted to reclassify the stock, increase the capitalization to 1,000,000 shares of common stock, and change the company's name to the Kolster Radio Corporation.

The Kolster Radio Corporation is a combination of the Federal Telegraph Company of California and the Brandes Products Corporation of Newark, N. J., and has taken the name Kolster in honor of Dr. F. A. Kolster, the company's chief engineer, who designs the Kolster products.

Philco Buys Murdock Corp.

Following closely on the announcement that the Philadelphia Storage Battery Company, Philadelphia, has purchased the Timmons Radio Products Corporation, also of Philadelphia, comes word that Philco has absorbed the Murdock Radio Corporation of Chelsea, Mass., one of the pioneer radio companies and maker of receivers, reproducers and head-sets.

As a result of these mergers, Philco will manufacture and market a complete line of sets and reproducers, under R. C. A., General Electric, Westinghouse, and Hazeltine patents.

August, 1928

Effective August 1, 1928, the rule went into effect that assigned "K" as the first letter of the call letters of all new stations to go on the air thereafter west of the Mississippi River and "W" to those located east of the river. Existing call letters would not be changed such as KDKA, Pittsburgh and WOAI, San Antonio.

ekko's

by ROD PHILLIPS

It's the last week of June, 1924. With only five days of warm, sunny weather so far this month, that superheterodyne radio article in QST has really made the rainy afternoons go by quickly. The set is almost ready for testing...and that new loop antenna should bring in the Coast! Have you seen the EKKO Stamp Albums that are at Wile's Radio Shop?

In 1924, an enterprising company in Chicago started a hobby among radio listeners which lasted for over ten years. The EKKO Company began selling "Reception Verification Stamps" to radio stations and stamp albums to radio stores across the country. The colorful stamps were engraved by American Bank Note Company in New York. After the call-letters were printed on the stamps, they were sent in sheets to the stations, eventually to be sent individually to each listener who wrote in with a reception report. With each album purchased, a packet of EKKO Cards was supplied. The album was priced at \$1.75. The listener filled out a card for each station heard, enclosed a dime, mailed the card to the radio station's address listed in the back of the album, and waited for the EKKO Stamp to arrive. The stamp was then pasted in its proper space arranged by states.

Until the mid-1930's, collecting EKKO's was a challenging hobby among hundreds of "DX'ers." The fun was halted by the sky-rocketing number of new stations and overpowering locals on the air. Today, only a handful of people still remember the EKKO Stamp hobby. Even fewer have their well-earned collection. All the others have vanished without an echo.

© Rod Phillips 1976

ekko's

by ROD PHILLIPS

Proof of Reception Card

This card is supplied for your convenience in communicating with the broadcasting station to procure an **ekko** stamp supplied by that station.

It is necessary that definite information, other than that appearing in public print, be given to determine the authenticity of your claim.



My Name _____

State _____

On _____ at _____ I heard your station _____
Date (Day and Month) Time (A. M. or P. M.) Call letters

broadcasting the following: _____

Please send me one **ekko** stamp of your station.

Enclosed find ten cents to cover cost of mailing and verifying.

Be sure your name and address are **PLAINLY** marked above.

© Rod Phillips 1976

Restoring Antique Radio Receivers

REPAIRING RADIOLA 25s

By J. J. Stancil

SINCE there are a number of the old R.C.A. "Model 25" supers scattered around, and since it has not been deemed practical for the average Service Man to open up the catacomb when any part of its interior goes wrong, I feel that some of my experiences with these might be worth noting.

I have found, quite often, that one of the A.F. transformers gives way—especially the primary of the last transformer. Some of the people who have lived with and enjoyed these old sets do not care to part with them; so I have replaced the audio transformers. The following applies, in this instance, to the last A.F. transformer but works equally well with the interstage one.

I took an R.C.A. audio transformer (ratio $3\frac{1}{2}-1$) and, after cutting a hole through the front side of the catacomb can, directly in front of the last A.F. tube, I could readily solder the grid wire of the transformer to the grid terminal of this tube. I then connected the other secondary wire of the transformer to terminal No. 6 on the catswhisker back of the catacomb.

I then took a .002-mf. condenser; soldered one terminal of it to the catacomb can and connected the other terminal to the grid end of the secondary of the transformer, in place of the condenser connected in this circuit inside of the catacomb. I connected one of the primary wires of the transformer to terminal No. 14 of the terminal strip, back of the catacomb, and the other primary to No. 16 terminal. After making the above connections, I bolted the transformer in an external position on the oval metal frame holding the catacomb, in a position as near to the original one in the catacomb as I could. The set worked fine and there was no drop-off from volume or general efficiency that I could discern.

The points marked X are the ones to which I made connections as indicated. I have replaced both the A.F. transformers in like manner in different receivers. The first transformer would, of course, be connected to different terminals on the catacomb; but these are readily found by checking up on the terminal strip.

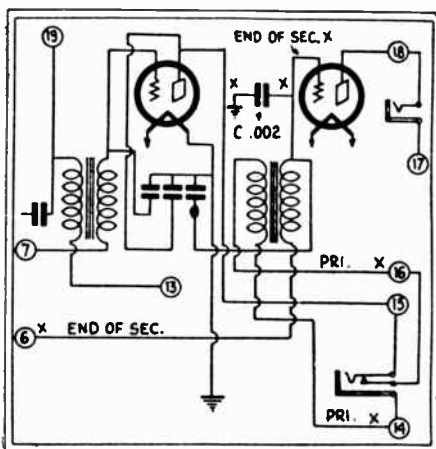

The Radiola "Model 25" is still popular with many users; transformer replacements may be made externally. The connections of the "cat" are shown in Data Sheet 16 (April, 1930, RADIO-CRAFT).

Solder All Connections

Loose connections have been the cause of many of the troubles experienced in receiving sets. When wires are connected to nuts, binding posts, etc., or with each other, care should be taken to see that these joints are tight and if possible soldered. No joints should be left unsoldered except those which have to be changed from time to time, such as the batteries and the headphones. It is advisable sometimes to solder the B batteries, as these usually last about six months. A good joint is, first of all, one that is strong enough to hold up under the strains of handling. When two wires are connected they should be soldered at the center. The solder part makes the connection perfect, and the rest of the splice takes up the strain.

Utilizing Flashlight Battery

For one-tube receiving set designed for a minimum size and weight, it is possible to use a flashlight battery to light the filament. Such a battery may supply service of one hour per day for a month.

Magnetism Increases Reception

Magnetism plays an important part in Radio reception; the sensitivity of an audio tube sometimes may be increased by placing a large magneto magnet in a certain position so that the poles of the magnet are on each side of the tube. This probably is due to the magnetic effect upon the moving electrons that flow across from the filament to the plate.

Atwater Kent

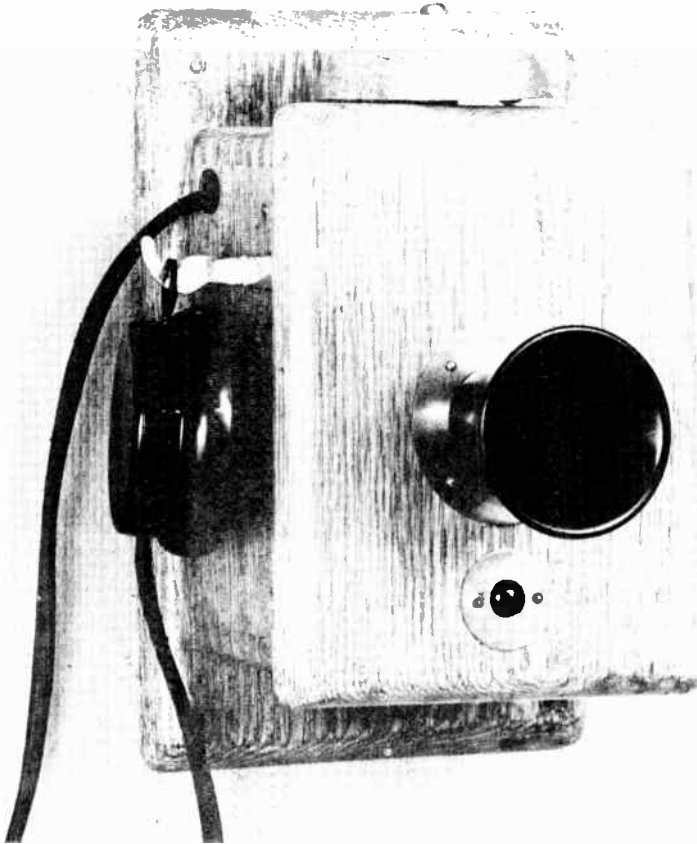

IHRS Bulletin (Mar.1975) carried an ad for a 1902 AK Telephone, taken from an issue of Electrical World. Never thought I'd see one of these "in the flesh" but this one appeared in a local antique shop and I snapped it up. The AK name does not appear on it anywhere, only the trade name "Monoplex" on the instruction sheet glued to the back. In spite of the ad's glowing description of its quality, this unit is very cheaply made but it probably worked well in its day. I should say that the watch-case receiver is not original, but is something I made up to look like the one in the ad. How many other Monoplex telephones are waiting to be discovered by Atwater Kent fans?

Alan Douglas

What is Auction ?

The word auction, pronounced ok'shun, derives from the Latin work "auctio" which literally means an increase. Auctio comes from another Latin term or terms "augere" or "auctum" which means to increase (Webster's Collegiate Dictionary). Webster further states that the word means a public sale of property to the highest bidder. In the United States, the expression is to sell, or put up, at auction. In England the term is to sell by, or put up to auction.

In early history we find the expression, "Sell at the spear." This was a form of auction used by the victorious soldiers in selling the spoils of war. The place for the sale was where the spear was placed by some soldier eager to start the sale.

Auction was brought to the United States by the early colonists. As in Europe, here too restrictions were written to limit fraud and abuse. It is through an application to hold a sale that the earliest recorded auction in the colonies is known. (New Amsterdam--1662). The earliest auction catalog extant was the sale of books of Ebenezer Pemberton. This sale took place at the Brown Coffee House in Boston on July 2, 1717. Thus, during most of that century, Boston became the "Auction Capitol of America."

The long history of disposal of property by the public competitive procedure known as auction clearly indicates the advantages of realizing a fair price. History records the such method of selling has been appreciated from early times. The subjects of auction range from the spoils of war to the glittering prize of the Roman principate itself. In America today, more livestock is sold at auction than at terminal markets (World Book Encyclopedia). In most every city we find one or two weekly auctions, not only livestock, but general merchandise, automobiles, equipment, machinery and most any item one can imagine. This is the free way of selling; little wonder then that many say auctioneering is the "white heat of salesmanship."

Another type of auction is known as the Dutch Auction. In this method, the auctioneer starts the price of an article high and goes down until someone accepts the bid. Here the usual procedure is to call for the price the auctioneer thinks the item is worth then drop down, obtain a starting bid and continue to call the increases until the highest one is obtained.

At one time in England, auctioneers sold by the inch of candle. The person making the last bid before the candle went out, was the purchaser. Other means of selling were by the hourglass or by a running boy. When the sand ran out or the boy reached his goal, the person making the bid at that time was the successful buyers.

In 1845 an act was passed requiring an auction to display, during sale, a board showing his name and address. To this day we find that such a practice continues although not required in all localities.

The first recorded professional organization dates back to the 18th century. At that time the Select Society of Auctioneers, which still exists, was formed at the Piazza Coffee House on May 20, 1799.

Auctioneering is an old and honorable profession requiring honesty, hard work and a thorough knowledge of values. An auctioneer must be able to work with people, for in people lies his business.

There is no asset that contributes as much to the success of an Auctioneer as his public relations and good will with others.

If an Auctioneer wants the good will of others, and if there is an Auctioneer who does not want it, he had better find some other means of making his living, he should try to learn what other people like about him and try to do more of it, and do far less of what you find they do not like.

There is no business or profession where good will and public relations is of more importance than the auctioneering profession. Some of the things that contribute largely to good will toward an Auctioneer can be summed up in the well known quotation "Do unto others as you would have others do unto you." This covers many rules of conduct. Be honest at all times in your dealings with others; a friendly feeling toward everyone including your competitors and soon your competitor will be one of cooperation; when asked for advice be sincere but don't give it unless asked as unsolicited advice is seldom appreciated; if you have criticism make it constructive and above all give help an encouragement to the young auctioneer who is unfamiliar with the business.

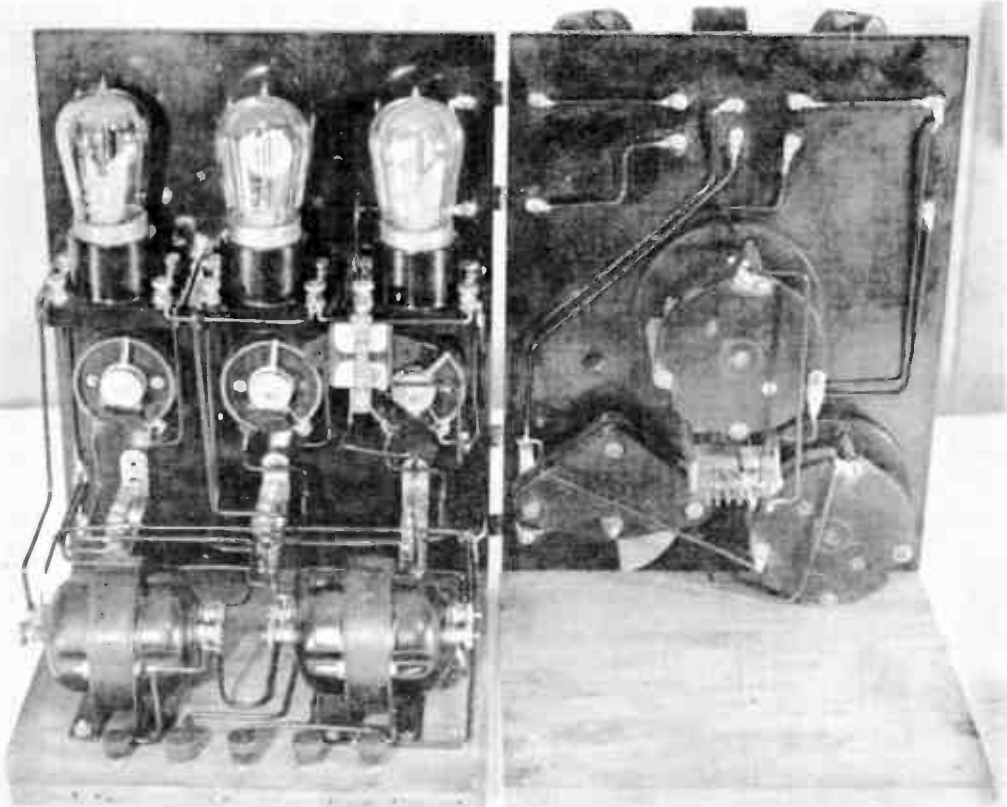
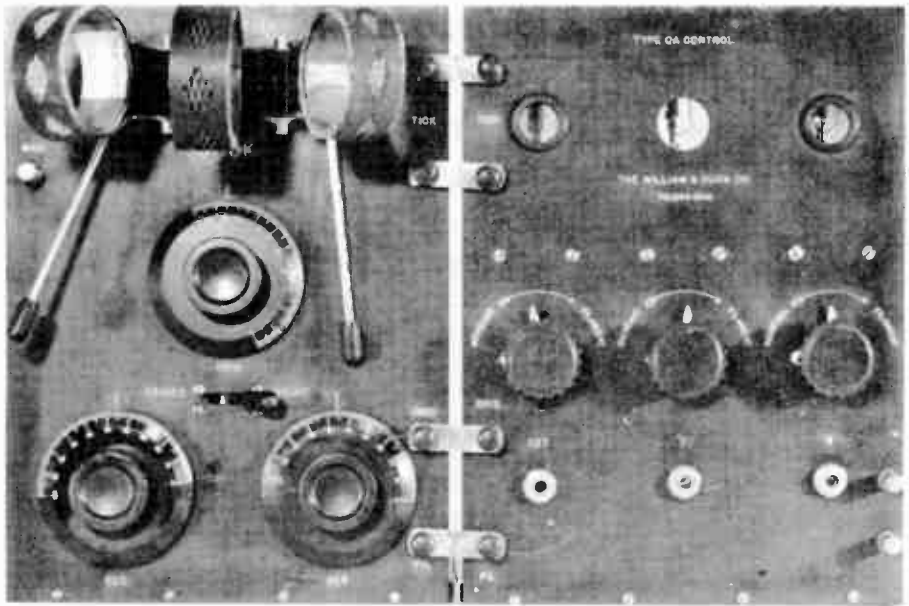

WM DUCK MODEL Q RECEIVER (TUNER) & MODEL QA
AMP. (DET. & AUDIO STAGES)

BASING OF EARLY VACUUM TUBES

by

Robert G. Middleton

Various types of bases were provided for early vacuum tubes. As an example, Fig. 1. shows the Ediswan valve base, utilized by Fleming. On the other hand, DeForest adopted the candelabra screw base, shown in Fig. 2. One of the later versions of the Fleming valve, TB-1, featured a three-pin Shaw type base, as shown in Fig. 3. The four-pin Shaw base is seen in Fig. 4.



Fig. 1

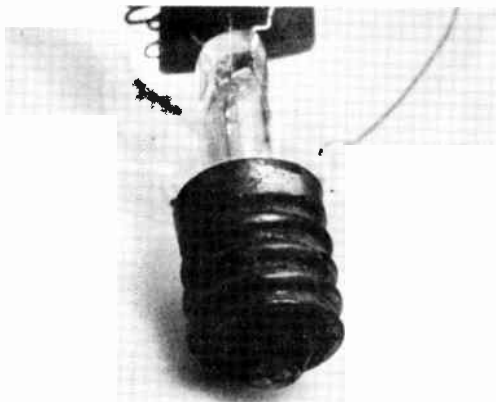

Fig. 2



Fig. 3

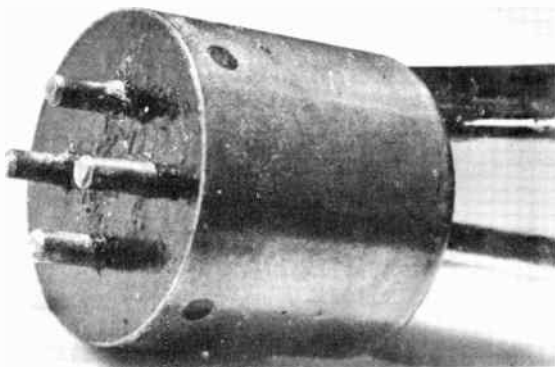

Fig. 4.

1 HRS MEMBER



BROADCASTER



REProductions™

ROD PHILLIPS

-  **On-Air Announcing**
-  **Film Narration**
-  **Commercials**

-  **Recording Studios**
-  **Creative Writing**
-  **Engineering**

Bryn Mawr, PA

**American Federation of
Television and Radio Artists
Member**

THE BIGGEST NIPPER?

This picture was taken at the Indiana State Museum in Indianapolis where the Indiana Historical Radio Society has a fine display of early wireless and radio gear.

Nipper was given to the state museum by RCA several years ago and when the radio display was set up it was decided that the dog would add much to the exhibit. Mr. Howenstein is over six feet tall, so this picture gives an idea of the size of the dog. It is possible that this is the largest Nipper ever cast.



typical big-city aerials

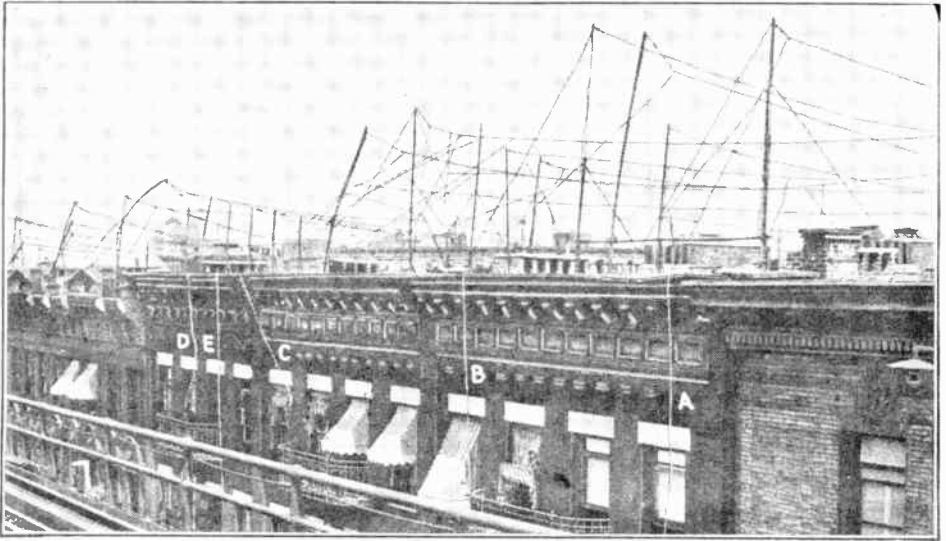

Fig. A

A typical sky-line of New York. Lead-ins A, B, C, and D run directly in front of the windows, not only marring the appearance of the buildings but actually causing a fire hazard where they run in front of fire escapes.

Fig. A shows a typical roof-line in New York City. Note the lead-in wires hanging in front of the windows at A, B, C, and D. At E, an effort was made to keep clear of the window. A clean lead job would be simply to fasten the wire to the wall outside the edge of the fire escape, with rawl plugs and knobs.

At first glance, there seems little connection between the manner of installing an aerial on a roof, and the plaster ceilings of the rooms in the apartments below. Or between a "hurry-up" job on any aerial, and a set bought on the installment plan being returned to the dealer. Here is a case, however, in which the facts can be personally vouched for by the writers.

A Shower of Plaster

Four years ago, one of the writers was called in to locate a short circuit in an apartment house which was owned by a real estate firm for whom he did maintenance and contract electrical work. While upon a stepladder opening a fixture splice, he saw a crack suddenly develop in the ceiling plaster and spread across the room, the sections of plaster on either side of the crack sagging down toward the floor.

On the roof immediately above, twelve aerials were found fastened to a vent pipe coming up through the roof. This had originally been braced with galvanized guy-

wires, but these guy-wires had been painstakingly cut by someone installing an aerial, to prevent contact with his lead-in wire.

The pull of these twelve wires against the pipe had caused the latter to shift, where it came through the roof, and a leak resulted, permitting the rain to enter and weaken the ceilings.

March, 1932

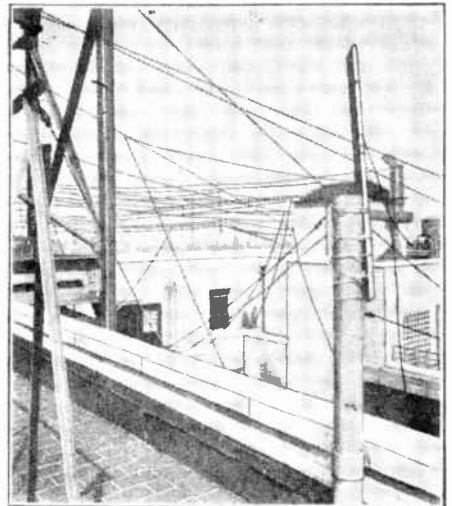

Fig. B

The pipe which caused a "shower of plaster."

Old radios on display

A rare 1913 "Marconi" radio will be one of many exhibits displayed by the Indiana Historical Radio Society today at the Tippecanoe Battlefield Museum in Battle Ground.

Also featured will be a large collection of Atwater Kent radios owned by members of the society who will be on hand to answer questions about the display.

The event is free and open to the public. It is being hosted by the Battle Ground Historical Corporation in cooperation with the Tippecanoe County Park and Recreation Board.

The Battlefield is located seven miles north of Lafayette, just off the Ind. 43 exit on I-65.



SUMMER MEET

BATTLEGROUND



OFFICERS

President Fred C. Prohl, 7257 Murphy Drv.
Indianapolis, IN 46256

V. President Gary A. Vierk, 2505 Kickapoo Dr
Lafayette, IN 47905

Secretary Walt Sanders, 15 Todd Place
Terre Haute, IN 47803

Treasurer Ed. E. Taylor, 245 N. Oakland
Indianapolis, IN 46201

Historian Delbert Barrett, 1517 Pacific Dr
Ft. Wayne, IN 46819

Membership Don K. Johnston, Box 218A RR1
Committee Windfall, IN 46076
Keith Hanselman, RR3 Box 71
Angola, IN 46073

Editorial Gary A. Vierk, 2505 Kickapoo Dr
Staff Lafayette, IN 47905
Marshall Howenstein, 807 Elm Dr
W. Lafayette, IN 47906
Glen E. Rogers, 1005 S. 18th St.
Lafayette, IN 47905

Applications for membership are available from the Treasurer, Ed Taylor. Dues are \$6.

Please use SASE when corresponding.

ADVERTISING IS FREE TO ALL MEMBERS. SEND ADS TO THE SOCIETY EDITOR. ADVERTISEMENTS FOR THE NEXT ISSUE MUST BE RECEIVED NOT LATER THAN NOVEMBER 25.

If you have an unusual radio please send a black and white photo and a description so we can add it to our bulletin.

SELL: Two 204A-good-one new, one 849 good fil. two 228A xmtr tubes. Make an offer--129 Ivy Hill Dr. W. Lafayette, K8LIH--Dave Bunte

REPRODUCTION OF THIS BULLETIN OR ITS CONTENTS IS PROHIBITED UNLESS AUTHORIZED BY THE EDITOR

The Soup-or-Nuts Antenna-Ground

Easiest to Install and Operate
Greatest Capacity and Distance

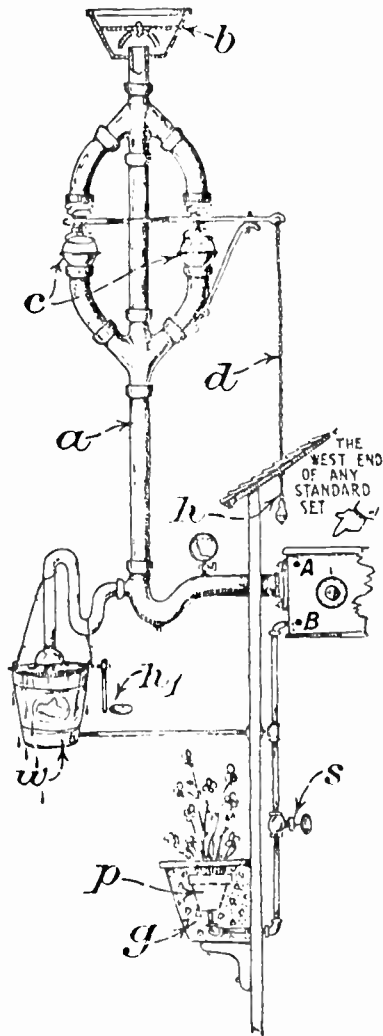

PRICE ONLY \$49.49 F. O. B.

This marvelous energy collector is unconditionally guaranteed by every plumbing shop, mail order house and gyp by whom it is sold. All that is necessary to make it work is to stretch a 50 ft. length of wire from binding-post *A* and a short length of wire from *B* to the nearest water-pipe.

b Extra heavy copper lined high wave catch basin which no wave can escape.

c Brilliantly polished high frequency, low-wave collector. Thousands of kilocycles surging about this spherical surface keep it brightly polished and unsurpassed in beauty.

d Unusual heavy wave inputs that clog the receiver may be relieved by a sudden downward pull upon the grasping unit *h*. This is an exclusive feature of this super-excellent antenna.

a Cast iron cylindrical lead-in, closely filled and compacted under three tons hydraulic pressure with magnetic iron filings and gold dental fillings. The molecular action of the filings combined with the capillary attraction of the fillings has been completely utilized in this extraordinary invention.

w Wave trap. Readily adjusted by the regulator *h*. This par excellent appliance (which even a child can attach in a few hours) will freeze out those unwanted, unappreciated local stations.

s Static amplifier and distance eliminator, a necessary adjunct to every antenna.

g Supersaturated radio-active soil composed of guanous loam, table salt, cold tea leaves and coffee grounds—a perfect and cool contact for the buried energy diffuser, *p*.

p Interred ground connection. A far-famed method of hiding the unsightly ground return. A joy to the eye.