

JANUARY 1963 • 50 CENTS

# HiFi/Stereo

review

SPECIAL:  
LAB TESTS OF STEREO FM TUNERS

MUSIC, ACOUSTICS,  
AND CONCERT HALLS

READERS' CHOICE  
OF THE YEAR'S  
BEST RECORDS



HDRI111061 15 6  
G PETERSON  
464 LAKEVIEW AVE  
ROCKVILLE CENTRE  
L I N Y

**The Fisher KM-60 StrataKit** is the most sensitive FM-Stereo-Multiplex tuner ever offered in kit form. Its ultrasophisticated Fisher wide-band circuitry incorporates the famous GOLDEN CASCADE front end, *four* IF stages and two limiters, resulting in a sensitivity of 1.8 microvolts (IHFM standard), a capture ratio of 2.5 db and a signal-to-noise ratio of 70 db. The front-end and Multiplex stages of the kit come completely assembled and pre-aligned. The other stages are also aligned and require only a touch-up adjustment by means of the tuner's laboratory-type d'Arsonval signal-strength meter. An outstanding feature of the Multiplex section is the exclusive STEREO BEAM, an ingenious Fisher invention that shows instantly whether or not an FM station is broadcasting in stereo. It is in operation at all times and is independent of the tuning meter. Price, \$169.50\*.

**The Fisher KX-200 StrataKit** is the most advanced single-chassis stereo control-amplifier available in kit form. Its music power output of 80 watts (IHFM Standard, both channels) is sufficient to drive even extremely low-efficiency speaker systems to their maximum performance level. Harmonic distortion at rated output is only 0.4%. The built-in laboratory-type d'Arsonval calibration meter assures optimum bias and balance adjustment and permits 'touching up' for continued peak performance throughout the years, regardless of tube aging. A third-channel power output with separate volume control makes it possible to feed a blend of both stereo channels into a center-channel fill-in speaker or a mono extension speaker at *any* desired volume level. Other features include DC heating of *all* voltage amplifier tubes and control facilities of almost unlimited flexibility. Price, \$169.50\*.

**The Fisher KX-100 StrataKit** is today's most spectacular value in stereo control-amplifier kits. With a music power output of 50 watts (IHFM standard, both channels), it assures superior dynamic range regardless of speaker efficiency. Harmonic distortion at rated output is 0.5%. A special power output is provided for driving a third speaker (center channel or mono extension) without the use of an additional amplifier. The exclusive Fisher duplex tape monitor permits the use of all controls and switches during tape monitoring without any change in cable connections. The convenient front-panel headphone jack is equipped with a switch for silencing the main loudspeakers, if desired. All other control and switching facilities are equally professional in their flexibility. Comparable kits are available only at much higher cost. Price, \$129.50\*.

**The Fisher KS-1 StrataKit** is the only slim-line (5¾" deep) loudspeaker system obtainable in kit form. A three-way system of this caliber in an ultra-thin enclosure would be a remarkable engineering development even as a factory-assembled unit, but as a kit it is a technological *tour de force*. It is designed around the most advanced components: 10-inch free-piston woofer with 30 cps free-air resonance and 4½-lb. magnet structure; 5-inch AcoustiGlas-packed midrange driver; 3-inch supertweeter; three-way LC-type dividing network with 1400 cps and 5000 cps crossovers; 18" x 24" x 5¾" cabinet packed with AcoustiGlas padding; matching grille cloth. The KS-1 can be mounted on the wall, placed anywhere on the floor or used in a bookshelf. Its unstrained, transparent sound quality, with precise transients and full, rich texture, is nothing short of astonishing for its size and cost. Price, \$59.50\*\*.

**There are two makers of stereo components  
who give you the most sophisticated engineering  
at the fairest possible price.**

---

**One is Fisher.**

# The other is you.

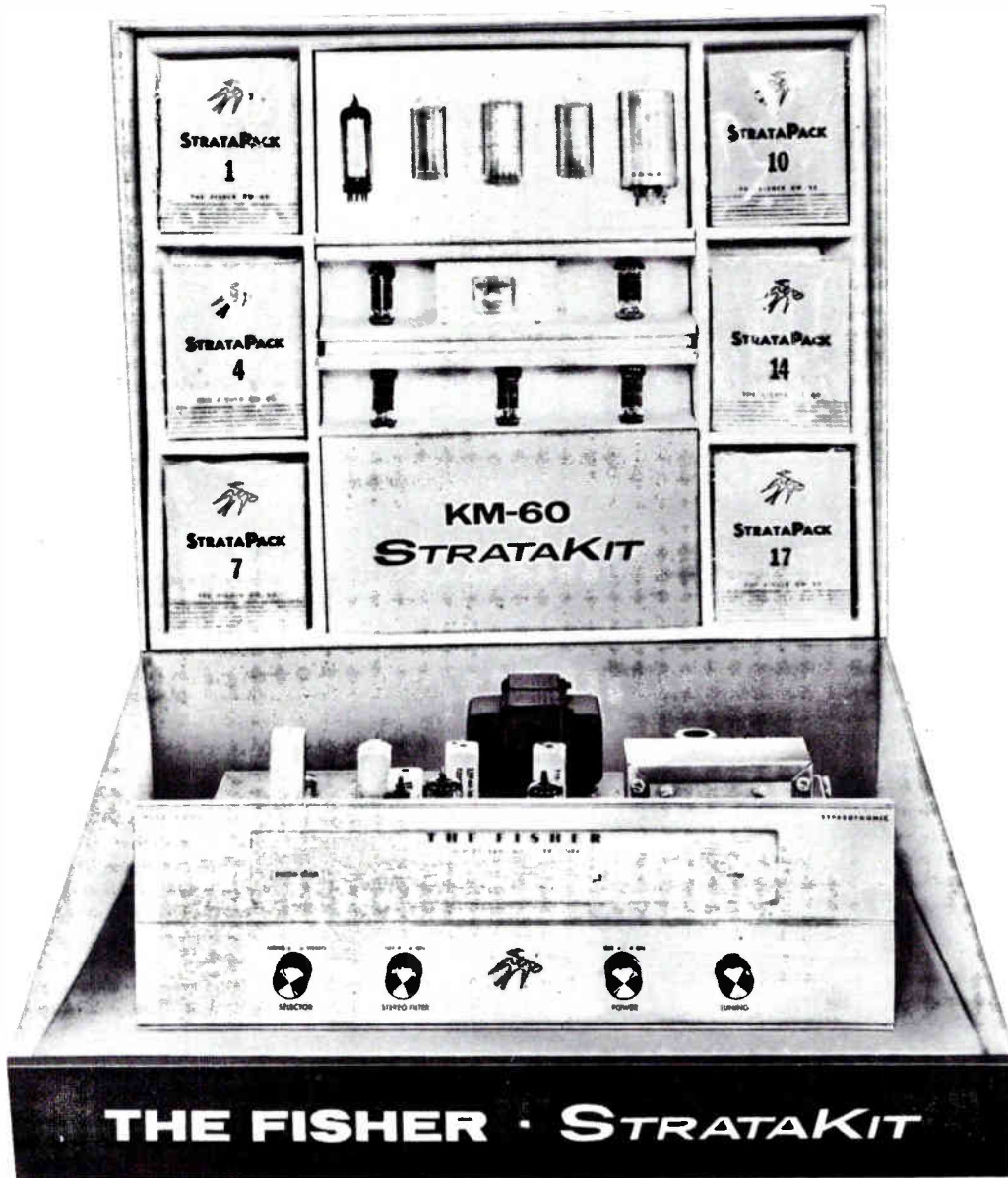

**(You can make just as fine stereo components as Fisher—with Fisher StrataKits!)**

A Fisher is a Fisher, no matter who builds it—Fisher or you. It will have a comfortable margin of engineering superiority over any other equipment anywhere *near* its price. Otherwise it would not have been allowed to go into production. That's Fisher policy.

The question is whether you want to buy your Fisher stereo components ready-made or build them with Fisher StrataKits. And the answer is that it does not make the slightest difference. The end result will be the same. It *must* be. That's Fisher policy, too.

The success of this policy is assured by the StrataKit method of kit construction, a unique Fisher development. It makes kit building so easy that there is no longer a difference between the work of an experienced technician and that of a novice.

Assembly of a StrataKit takes place by simple, error-proof stages (Strata). Each stage corresponds to a *separate* fold-out page in the instruction manual. Each stage is built from a *separate* transparent packet of parts (StrataPack). Major components come already mounted on the extra-heavy-gauge steel chassis. Wires are *pre-cut* for every stage—which means every page. All work can be checked stage-by-stage and page-by-page, before proceeding to the *next* stage. There can be no last-minute 'surprises'—you can't *help* ending up with a faultless Fisher stereo component when you build a StrataKit.

The four Fisher StrataKits shown on the right have elicited comments of almost unprecedented enthusiasm on the part of constructors ranging from housewives to professional audio reviewers. Read the

summary of engineering features and specifications and you'll begin to understand why. Build one of the kits—or build them all—and you will understand completely.

FREE! \$1.00 VALUE! Write for The Kit Builder's Manual, a new, illustrated guide to high fidelity kit construction.

FISHER RADIO CORPORATION  
21-37 44th Drive  
Long Island City 1, N. Y.

Please send me without charge The Kit Builder's Manual, complete with detailed specifications on all Fisher StrataKits.

Name \_\_\_\_\_  
Address \_\_\_\_\_  
City \_\_\_\_\_ Zone \_\_\_\_\_ State \_\_\_\_\_



# THE FISHER



looks  
like this

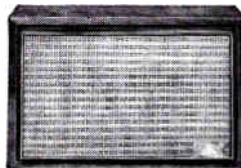

sounds  
like this!

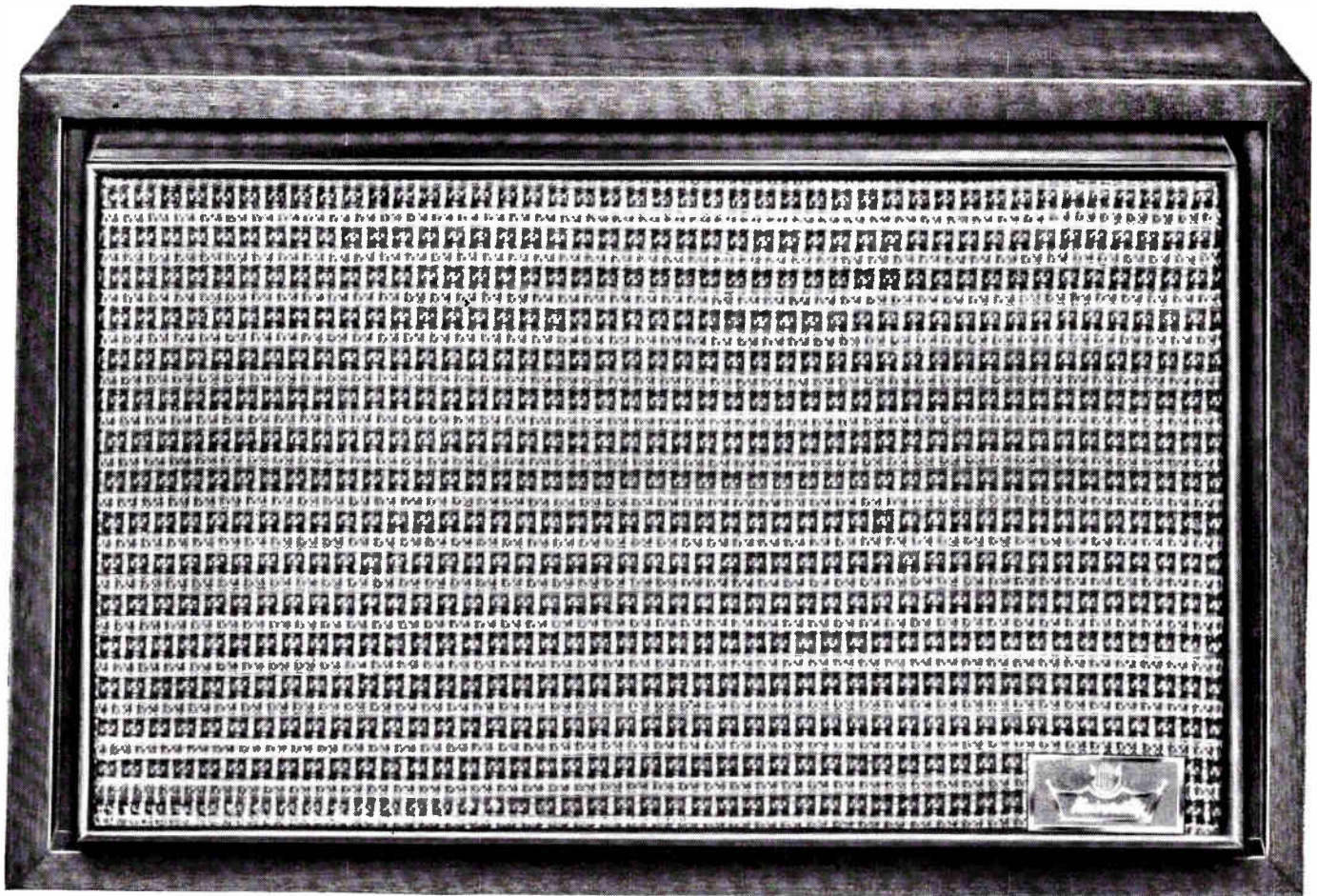

## Sensational University Mini-Flex with Optimum Q breaks through the small speaker quality barrier!

The Mini-Flex, another acoustic breakthrough from University, is the first speaker system of its type designed to fulfill its optimum performance potential—as stated in its printed specifications—without the use of “trick” amplifiers. It is a true 3-way speaker system, providing exciting bass response down to 40 cycles, exceptionally smooth mid-range and crisp, peak-free highs to 20,000 cps! Less than 0.4 of a cubic foot (15”x9”x5”)! A size hitherto considered impossible to produce performance to such specifications!

The reason—Optimum Q, the principle that eliminates the acoustic problems which, up to now, have prevented high fidelity bass performance in an ultra-compact enclosure. Optimum Q—in essence, the most ideal “marriage” of woofer and miniaturized enclosure yet devised, to assure

the lowest resonant frequency possible in a system of Mini-Flex dimensions. Other factors behind its superb performance include: special mass-loading; unusual viscous-treated “moving seal” suspension; new mid-range speaker and tweeter, each with exclusive “diffractor barriers” for ideal stereo sound dispersion. And, it looks as good as it sounds! Its crafted “cabinet-within-a-cabinet” styling will enhance any room, any home. It may be used on a wall, floor, shelf—on a table (or even under it)! Oiled walnut. Only \$69.95—at your audio dealer. For free 20-page Guide to Stereo High Fidelity, write: Desk D-1



**UNIVERSITY  
LOUDSPEAKERS**

80 SOUTH KENSICO AVE., WHITE PLAINS, N.Y.  
A Division of Ling-Temco-Vought, Inc.

U-31

# HiFi / Stereo

REVIEW

## THE MUSIC

- 31** THE BASIC REPERTOIRE  
*Mozart's Clarinet Quintet*.....MARTIN BOOKSPAN
- 39** THE SOUND OF "A"  
*Dissension and accord around the standard pitch*..KLAUS GEORGE ROY
- 51** READERS' CHOICE: 1962  
*A poll of the year's most popular records*
- 56** THE ART OF THE ALBUM  
*A gallery of the year's best record covers*
- 58** MUSIC, ACOUSTICS, AND ARCHITECTURE  
*Reflections on concert-hall design*.....EDGAR VILLCHUR
- 63** BEST OF THE MONTH  
*Reviews of the outstanding new releases*

## THE EQUIPMENT

- 22** BEGINNERS ONLY  
*A basic approach to audio*.....HANS H. FANTEL
- 35** TECHNICAL TALK  
*Lab reports on the Shure M222 tone arm and cartridge and the Concord 880 tape recorder*.....JULIAN D. HIRSCH
- 45** INSTALLATION OF THE MONTH  
*Between two poles*
- 46** LABORATORY TESTS OF STEREO FM TUNERS  
*Full performance details on the Knight KN-250A, the Lafayette LT-700, the Grommes 101BM, the Eico ST-97, and the Sherwood S-3000-IV*.....JULIAN D. HIRSCH AND  
GLADDEN HOUCK JR.
- 62** SOUND AND THE QUERY  
*Prerequisites for hi-fi sound*.....J. GORDON HOLT

## THE REVIEWS

- 69** HIFI/STEREO CLASSICS
- 87** HIFI/STEREO JAZZ
- 99** HIFI/STEREO REEL AND CARTRIDGE
- 103** HIFI/STEREO ENTERTAINMENT

## THE REGULARS

- 4** EDITORIALY SPEAKING
- 12** LETTERS
- 14** JUST LOOKING
- 112** INDEX OF ADVERTISERS

COVER PHOTOGRAPH BY SAM KIMURA

# HiFi/Stereo review

**PUBLISHER**  
PHILLIP T. HEFFERNAN

**EDITOR**  
FURMAN HEBB

**MUSIC EDITOR**  
ROBERT OFFERGELD

**MANAGING EDITOR**  
ROBERT CAMPBELL

**ART EDITOR**  
BORYS PATCHOWSKY

**ASSOCIATE EDITORS**  
ROBERT S. CLARK  
HANS H. FANTEL

**PRODUCTION EDITOR**  
MEL SCHINASI

**ASSISTANT EDITOR**  
MARCIE LAITMAN

**CONTRIBUTING EDITORS**  
CHRISTIE BARTER  
MARTIN BOOKSPAN  
WILLIAM FLANAGAN  
STANLEY GREEN  
JOE GOLDBERG  
DAVID HALL  
NAT HENTOFF  
JULIAN D. HIRSCH  
GEORGE JELLINEK  
IGOR KIPNIS

**EDITORIAL CONSULTANT**  
OLIVER READ

**ADVERTISING  
SALES MANAGER**  
LAWRENCE SPORN

**ADVERTISING  
SERVICE MANAGER**  
ARDYS C. MORAN

**ZIFF-DAVIS PUBLISHING COMPANY**

Editorial and Executive Offices (ORegon 9-7200)  
One Park Avenue, New York 16, New York  
William B. Ziff, Chairman of the Board (1946-1953)  
William Ziff, President  
W. Bradford Briggs, Executive Vice President  
Herschel E. Sarbin, Vice President and General Manager  
M. T. Birmingham, Jr., Vice President and Treasurer  
Robert P. Breeding, Circulation Director  
Charles Housman, Financial Vice President  
Stanley R. Greenfield, Vice President  
Midwestern and Circulation Office (WAbash 2-4911)  
434 South Wabash Avenue, Chicago 5, Illinois  
Advertising: Jerry Sweeney  
Western Office (CRestview 4-0265)  
9025 Wilshire Boulevard, Beverly Hills, California  
Western Advertising Manager: Bud Dean  
Foreign Advertising Representative  
D. A. Goodall Ltd., London, England

**SUBSCRIPTION SERVICE:** All subscription correspondence should be addressed to HiFi/Stereo Review, Circulation Department, 434 South Wabash Avenue, Chicago 5, Illinois. Please allow at least six weeks for change of address. Include your old address, as well as new—enclosing if possible an address label from a recent issue.

**EDITORIAL CONTRIBUTIONS** must be accompanied by return postage and will be handled with reasonable care; however, publisher assumes no responsibility for return or safety of art work, photographs, or manuscripts.

Member Audit Bureau of Circulations



## EDITORIALLY SPEAKING

by FURMAN HEBB

**A**LIVELY topic of conversation around New York this season has been Lincoln Center's Philharmonic Hall. The initial reports about the new hall were generally in agreement that it was something of a disappointment. Warmth and, more specifically, bass response were said to be lacking. After a week of tuning (by adjusting acoustical cavities behind the stage and sound-reflecting panels hung from the ceiling), most critics reported an improvement in the hall's acoustical characteristics. Even now, however, some knowledgeable and responsible observers continue to express doubts that the hall will ever sound good unless major structural revisions are made.

A fascinating sidelight of the Philharmonic Hall discussion is the way it shows how terminology that had formerly been used only to describe high-fidelity phenomena has gained common currency in the musical world. This is also noted by Edgar Villchur in his review, in this issue, of *Music, Acoustics, and Architecture*, an important new book by Dr. Leo Beranek, the acoustical consultant for Philharmonic Hall. In detailing the faults of the hall, several critics pointed to inadequate bass response, and more than one said he wished a bass control had been handy so he could have turned it up. Another complained of the hall's peaky mid-frequency response, over-brightness, and lack of tonal integration. Perhaps most interesting of all, Harold Schonberg, the critic of the *New York Times*, chose to describe the sound of the hall by comparing it to the characteristic sound quality of a particular type of loudspeaker.

In fairness to Philharmonic Hall and its designer, I must mention that Dr. Beranek has repeatedly stated that at least a year's time will be required to tune the hall properly, so perhaps we must just be patient. Also, by no means have all the reactions to the hall been negative, which suggests that the hall has at least some seats from which the sound is agreeably balanced.

But the aspect of the discussion that interests me most is the way it brings into question the validity of what we hi-fi listeners have always accepted as the ultimate criterion for a hi-fi system: that is, "Does it sound like live music?" In the past, we have always accepted the term "live music" as an absolute. Now, however, with all the controversy about the way live music sounds in Philharmonic Hall, it is obvious that this measuring stick is far from being an absolute. The same piece of music can sound quite different, tonally, depending on whether it is played in Carnegie Hall, Philharmonic Hall, or Royal Albert Hall in London. What this leaves us as a standard of comparison I'm not quite sure, but I suspect that common sense will prevail.

\*\*\*\*\*

Coming Next Month in HiFi/STEREO REVIEW

### JAZZ AND RACE

by Leonard Feather

### APPROACHING CONTEMPORARY MUSIC

by William Flanagan

### REPORT ON STEREO FM TUNERS: PART TWO

by Julian D. Hirsch and Gladden Houck Jr.

\*\*\*\*\*





1. THE YALE EDITIONS OF THE PRIVATE PAPERS OF JAMES BOSWELL; 6 celebrated volumes, handsomely boxed (publisher's price \$45.00) plus one-year subscription to the Collector's Quarterly Report (priced at \$6.00).  
A \$51.00 value for \$15.95.

2. COUNCIL OF EUROPE SERIES; the first three lavish volumes in the series—*The Rococo Age, Romantic Art, and Gateway to the Twentieth Century* (total publisher's price \$73.50) plus a one-year subscription to the Collector's Quarterly Report (priced at \$6.00).  
A \$79.50 value for \$24.95.

3. THE BEGGAR'S OPERA; a reproduction of the 1729 edition of John Gay's masterpiece with modern commentary, and a new 2-record version of the original score (combined price \$21.95) plus a one-year subscription to the Collector's Quarterly Report (priced at \$6.00).  
A \$27.95 value for \$13.95.

4. THE ART OF RUTH DRAPER; 11 monodramas on five Spoken Arts recordings, and a biography containing the texts of the records and numerous photographs (combined price \$34.70) plus a one-year subscription to the Collector's Quarterly Report (priced at \$6.00).  
A \$40.70 value for \$17.95.

5. THE COMPLETE LETTERS OF VINCENT VAN GOGH; 3 volumes, boxed, with 194 tipped-in facsimiles of drawings, sketches, and water colors (publisher's price \$50.00) plus a one-year subscription to the Collector's Quarterly Report (priced at \$6.00).  
A \$56.00 value for \$24.95.

6. THE CHARIOTEER OF DELPHI; A life-size reproduction of the classic head, and *Greek Sculpture* by R. Lullies and M. Hirmer (combined price \$35.00) plus a one-year subscription to the Collector's Quarterly Report (priced at \$6.00).  
A \$61.00 value for \$24.95.

## To those people who take uncommon pleasure in good books, music, and other works of art... six uncommon offers

YOU ARE INVITED to become a Charter Member of the Collector's Book Society by accepting any one of the Society's introductory offers illustrated on this page. Each of these offers includes a one-year trial subscription to a new periodical, the Collector's Quarterly Report, priced at \$6.00. Each of them represents an enormous total saving—as much as \$54.55. Collectively, they demonstrate the service the Society can provide for you in connection with today's most impressive cultural products.

The Collector's Quarterly Report, a unique cultural information service covering all the arts, is sent to members four times a year. In it, the Society provides a careful and critical compilation of recent projects and products that merit special attention. Books and series of books, original print editions, records, and sculpture—all of these come within its compass. And all are available for purchase through the Society, often at substantial savings.

In format, the Report is a handsome, 32-page magazine with a wealth of color illustration. Its editorial range is considerable. Forthcoming issues will contain articles on collectors and collecting and the shifting attitude toward fakes, and reports on a superb new group of demountable picture frames, a little-known

collection of baroque recordings, and a series of children's books printed today from woodblocks cut in 1870. Major fine arts publications of the preceding three months will be described and often illustrated.

**The Quarterly Choice.** Each issue of the Quarterly Report will highlight one product which is felt to be of special interest to members of the Society. Most often, this Quarterly Choice will be a book or a series of books relating to art. Members have the option of receiving the Quarterly Choice for examination without any obligation. They may return it within ten days if it fails to meet with their approval.

**No Minimum Purchase Requirements.** At no time are members obliged to make any purchases. They may order what they want—and when—often at sizeable savings, and almost always with bonus credit which may be applied to additional acquisitions.

Initial supplies of books and other merchandise illustrated here are limited. To take advantage of one of these six Charter Membership offers, simply fill out the membership coupon at the right and indicate which offer you wish to receive. You may elect to pay now and receive the special gift book or, if you wish, the Society will bill you.

HF-13

**COLLECTOR'S BOOK SOCIETY**  
327 West 41st Street, New York 36, New York

YOU MAY ENROLL ME as a Charter Member of the Collector's Book Society; enter my one-year subscription to the Collector's Quarterly Report (Value \$6.00) beginning with the Winter 1962 issue; and send me the offer I have selected at the price specified. In accepting the Charter Membership offer, I understand that I am under no obligation to purchase anything more from the Society during my membership. Purchases I do make will earn special bonus credit which can be applied to selected books, records, prints, etc. Each quarter, I will receive the Quarterly Choice for examination and approval unless I decline in advance by means of a convenient reply card. If I decide not to keep the Quarterly Choice I may return it within ten days with no obligation. If I am not satisfied with my first copy of the Collector's Quarterly Report or my selection, I may return them within ten days for a full refund, and my membership will be cancelled automatically.

Please circle the number corresponding to your Charter Membership selection.

1 2 3 4 5 6  
Note: Enclose payment now . . . and receive a copy of "Portrait of Atelier" (Value \$4.95) as a gift!

I enclose \$\_\_\_\_\_ in payment for my Charter Membership. (N.Y. City residents please add 3% sales tax. We pay postage and handling.)

Please bill me \$\_\_\_\_\_ plus postage and handling.

Name \_\_\_\_\_  
Address \_\_\_\_\_  
City \_\_\_\_\_ Zone \_\_\_\_\_ State \_\_\_\_\_

You can subscribe to the COLLECTOR'S QUARTERLY REPORT at \$6.00 annually without reference to these special Charter Membership offers. To enter subscription, fill in name and address above, mark coupon "Subscription only," and enclose check or money order for \$6.00.

HHS-2A



**THE INSIDE STORY OF THE EMPIRE TROUBADOR'S** widely acclaimed reputation as the "world's most perfect record playback system" is, in a word, **PRECISION**. Precision not only in its production, but also in its design. It's what the Troubador **DOESN'T** have that counts. Things like wow, flutter, rumble, hum, needle talk, tracking error, and so forth. None of the commonly found shortcomings that stand in the way of clean, pure response. ■ The response of the country's hi fi critics to the Empire Troubador has been uniformly uncritical, to say the least. **HIGH FIDELITY** said: "a precision-engineered product of the highest quality . . . wow, flutter and rumble completely inaudible . . . clean response." **AUDIO** stated: "Precise performance . . . we tried to induce acoustic feedback by placing the turntable on top of our large speaker system and turning up the gain — we were unsuccessful." **AMERICAN RECORD GUIDE** reported: "speed variations — that is, flutter and wow — inaudible . . . vibration extremely low . . . total rumble figures have not been bettered by any turntable I have tested." ■ The sought-after sound of the Troubador is the result of its precision components. The massive turntable is driven by a heavy duty hysteresis-synchronous motor that provides a constant speed independent of current fluctuations. Precise bearing tolerances throughout, every single Troubador is individually adjusted to perfect dynamic balance. The 980 Arm combines rock-steady stability with an incredible responsiveness. ■ Individually, the Empire 980 Arm or the new 880P Cartridge will give you superior sound. The maximum achievement from Empire components, however, is in the complete Troubador system, because these components were designed for each other. Only Empire makes a complete, integrated record playback system. What to do next? Write for free color brochure. Better still, stop in at your local authorized Empire dealer for the ultimate proof of performance — the Troubador itself. It's the world's most perfect record playback system. ■ **NOW INCLUDES THE NEW EMPIRE 880P CARTRIDGE.**

#### **TROUBADOR TABLE OF CONTENTS**

Empire 208 3-speed "silent" turntable . . . Empire 980 dynamically balanced playback arm with the sensational Dyna-Lift\* . . . and the new Empire 880p mono-stereo cartridge featuring the virtually indestructible Dyna-Life\* stylus . . . Complete with handsome walnut base: \$222.



# *new* **EMPIRE TROUBADOR**

**“WORLD'S MOST  
PERFECT RECORD PLAYBACK  
SYSTEM”**

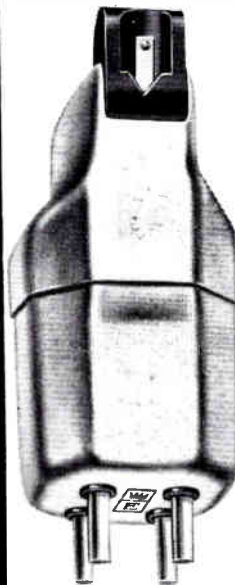

*now includes*  
**the EMPIRE 880<sup>P</sup>  
CARTRIDGE**  
**“THE LAST CARTRIDGE  
YOU'LL EVER BUY”**

**DYNAMIC MASS LESS THAN  $.5 \times 10^{-3}$  GMS.** • **COMPLIANCE:**  $30 \times 10^{-6}$  CM/DYNE. Lower dynamic mass and higher compliance than any other cartridge made... eliminates distortion and makes possible a lighter stylus, better frequency response, greater channel separation, and the remarkable new standard for:

- **TRACKING FORCE — AS LOW AS  $\frac{1}{4}$  GRAM.** At such low tracking force, the Empire 880p not only eliminates record wear, but also eliminates distortion.
- **PERFORMANCE RANGE: 6 TO 30,000 CPS.** This is well beyond the range of human hearing.
- **CHANNEL SEPARATION: MORE THAN 30 DB.** Greater separation for greater enjoyment of stereo.
- **A RESEARCH TRIUMPH — THE AMAZING DYNA-LIFE\* STYLUS.** This ultra-sophisticated hand-polished diamond stylus is the world's lightest. Coupled with a new cartridge magnetic element of lowest dynamic mass, this assures the longest possible life of the Empire 880p... the last cartridge you'll ever buy.

\*Patent pending

**“WORLD'S MOST PERFECT  
RECORD PLAYBACK SYSTEM”**

 **EMPIRE**  
SCIENTIFIC CORP. • 845 STEWART AVE. • GARDEN CITY, L.I., N.Y.

EXPORT: CANADA. Empire Scientific Corp., Ltd., Toronto, Canada • EXPORT EXCEPT CANADA. EMEC, Plainview, L. I., N. Y.

COLUMBIA RECORD CLUB now offers new members a choice of  
**92 BEST-SELLING RECORDS**  
**FROM EVERY FIELD OF MUSIC**

...featuring a truly outstanding selection of  
*classical recordings by the world's greatest artists*



465. "Generates tremendous excitement..."—N. Y. Times



274. This is "an excellent album."—Musical America



246. "Bold splashes of color, tremendous warmth."—Hi Fi Rev.



230. "Boisterous... exciting... overpowering!"—Wash. Star



456. Dazzling performances of these marvelous works



24. Also: Malaguena, Sabre Dance, Perfidia, Mam'selle, etc.

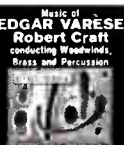

264. "A fascinating experiment to listeners."—Phila. Inq.



120. Also: Love For Sale, Candy Kisses, Merry Young, etc.



Tony Bennett



232. Most exciting and thrilling of all Beethoven concertos



90. "The most adventurous musical ever made."—Life



20. Greenfields, My Tan, Green Leaves of Summer, 9 more



Leonard Bernstein



265. "Fierce impact and momentum."—N.Y. World Telegram



33. Everybody Loves A Lover, Be My Love, Volare, 12 in all



34. Stars & Stripes Forever, Washington Post March, etc.



294. "Exciting... compelling."—New York Herald Tribune



40. Just Walking in the Rain, Bewitched, "most dazzling moments."—N. Y. Times



97. Ethel Merman's performance... overwhelming!"—Hi Fi Rev.



291-292. Two-Record Set (Counts As Two Selections.) "Intensely expressive... imbued with controlled fervor."—High Fid.



95. Complete score of the Rodgers and Hammerstein hit



151. Also: Billy the Kid, In the Valley, Strawberry Roan, etc.



38. White Cliffs of Dover, Lisbon Antigua, Tico-Tico, etc.



236-237. Two-Record Set (Counts As Two Selections.) "Bernstein caught its grandeur as well as its delicacy."—N.Y. Times



254. "Brilliant performance... lush... rich."—Musical Amer.

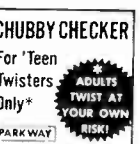

70. The Peppermint Twist, Love is Like A Twist, 12 in all



454. "Extraordinary depth and perception."—N. Y. Times

As a new member you may take

# ANY 6

of the best-selling records shown here  
 —in your choice of

## REGULAR or STEREO

# \$1.99

FOR ONLY RETAIL VALUE up to \$36.88

if you join the Club now and agree to purchase as few as 6 selections from the more than 400 to be made available in the coming 12 months

**FREE IF YOU JOIN NOW**

**A Handsome Adjustable RECORD RACK**

Here's a compact, brass-finished rack whose capacity grows as your collection grows. It's adjustable — holds from 1 to 60 records securely. Folds flat when not in use.

...will hold one record...  
 ...or as many as sixty!

<p>LEONARD BERNSTEIN N. Y. PHILHARMONIC</p>	<p>MARY MARTIN • PINZA</p> <p>ORIGINAL BROADWAY CAST</p>	<p>MARTY ROBBINS</p> <p>El Paso Big Iron Cool Water 9 More</p>	<p>RAY CONNIFF</p> <p>Symphony</p>	<p>PHILADELPHIA ORCHESTRA MORNING TROMBONE CHOIR</p>	<p>SZELL conducts WAGNER</p> <p>Tristan and Isolde Die Meistersinger Tannhauser</p>	<p>Bobby Vinton sings ROSES are RED and other songs for the young and sentimental</p>	<p>HEROIC MUSIC for Organ, Brass and Percussion</p> <p>E. POWER BIGGS</p>
<p>LEONARD BERNSTEIN New York Philharmonic Westminster Choir</p>	<p>STRAVINSKY conducts The "FIREBIRD" COMPLETE BALLET</p>	<p>For 'Teen Twisters Only" ADULTS TWIST AT YOUR OWN RISK!</p>	<p>MAHLER Symphony No. 4 BERNSTEIN New York Philharmonic</p>	<p>Foggy Mountain Banjo FLATT &amp; SCRUGGS and the FOGGY MOUNTAIN BOYS</p>	<p>AHMAD JAMAL HAPPY MOODS</p>	<p>GRIEG: SCHUMANN: Piano Concertos LEON FLEISHER STEEL CLEVELAND ORCH.</p>	<p>HOLLYWOOD'S GREAT THEMES Moon River Ben Hur El Cid 9 MORE</p> <p>PERCY FAITH</p>

<b>SHOW BOAT</b> starring JOHN RAITT COLUMBIA	<b>TCHAIKOVSKY</b> Symphony No. 7 World Premiere Recording ORMANDY PHILADELPHIA ORCH.	<b>REX HARRISON</b> JULIE ANDREWS MY FAIR LADY ORIGINAL CAST RECORDING COLUMBIA	<b>FERRANTE &amp; TEICHER</b> TONIGHT MOON RIVER SHALOM 9 More COLUMBIA	<b>WALL TO WALL SOUND</b> LOVE THEMES Ferrante & Teicher I'm in the Mood for Love My Funny Valentine Dream of Love 9 More COLUMBIA	<b>JULIE IS HER NAME</b> Cry Me a River I Should Care Say It Isn't So 9 More LIBERTY	<b>THE BLUE OANUBE</b> A Johann Strauss Festival PHILADELPHIA ORCH. • ORMANDY COLUMBIA	<b>THE SOUND OF JOHNNY CASH</b> COLUMBIA	<b>Stravinsky conducts LE SACRE DU PRINTEMPS</b> "THE RITE OF SPRING" COLUMBIA
---	---	---	--	---	---	---	---	--



**Mr. Piano ROGER WILLIAMS**  
KAPP

**Bach Organ Favorites**  
E. Power Biggs  
COLUMBIA

**BILLIE HOLIDAY**  
The Golden Years  
COLUMBIA



**LORD'S PRAYER**  
MORMON TABERNACLE CHOIR  
COLUMBIA

**NOW HEAR THIS... THE DUKES OF DIXIELAND**  
ST. LOUIS BLUES  
HONEYSUCKLE ROSE  
SWEET SUE • 8 MORE  
COLUMBIA

85. Starring William Warfield, Anita Darian, Barbara Cook

242. "Appealing tunes and lush romanticism."—Life

93. The best-selling Original Cast recording of all time

44. Also: Lili Marlene, King of Kings, La Strada, etc.

42. Also: I've Got A Crush On You, Imagination, etc.

62. Also: I'm in the Mood for Love, Easy Street, Laura, etc.

14. Sing It Pretty, Sue; You Remembered Me; 12 in all

255. "The orchestra plays with beautiful clarity."—N.Y. Times

103. It's "Hooray for Jose Jimenez!"  
—N.Y. Journal-American

17. Themes from Ben Casey, Dr. Kildare, Intermezzo, etc.

281. Five of Bach's mightiest and most popular favorites

211-212-213. Three Record Set (Counts As Three Selections.) "Her recordings during this period are one of the major pleasures of jazz." — N. Y. Times (Not available in stereo)

9. Also: Twelfth of Never, No Love, Come To Me, etc. \*

297. Also: Comanche, Johnny Reb, The Mansion You Stole, etc.

231. "Relentless motion... excitement." —S.F. Chronicle

280. "He plays magnificently!" —McCall's

100. "Superb... all the beauty & nobility captured."—HiFi Rev.

91. "Most lavish and beautiful musical, a triumph."—Kilgallen

272. "The undisputed queen of U.S. dramatic sopranos."—Life

190. Also: Pretend, And the Angels Sing, Cherry Pink, etc.

263. Two of the most popular and appealing violin concertos

293. Two of Richard Strauss's most popular tone poems

12. Also: Gunfight at O.K. Corral, Rawhide, etc.

135. Also: Mood Indigo, After You've Gone, etc.

**PORGY and BESS**  
ORIGINAL SOUNDTRACK RECORDING  
From The Samuel Goldwyn Motion Picture Production  
COLUMBIA

**MILES DAVIS**  
'ROUND ABOUT MIDNIGHT  
COLUMBIA

**I Have But One Heart JERRY VALE**  
SINGS GREAT ITALIAN LOVE SONGS  
COLUMBIA

**BACH**  
BRANDENBURG CONCERTO No. 5  
THREE CHORALE PRELUDES  
STOKOWSKI  
Philadelphia Orch.  
COLUMBIA

**CHOPIN:**  
The 14 Waltzes  
Brallozsky  
COLUMBIA

**ANDY WILLIAMS**  
SINGS MOON RIVER  
and other great movie themes  
COLUMBIA

**DRFF: CARMINA BURANA**  
The PHILADELPHIA ORCHESTRA  
soloists and chorus  
ORMANDY conducting  
COLUMBIA

54. All of You, Bye Bye Blackbird, Ah-Leu-Cha, etc.

403. Mama, Come Back To Sorrento, 'O Sole Mio, 12 in all

452. "A very great conductor!" — N. Y. Herald Tribune

284. Mr. Brailowsky is "a poet of the piano."—N.Y. Times

128. Love Is A Many Splendored Thing, A Summer Place, etc.

455. "This is one record I'd not pass up!"—Hi Fi Review

107. Also: Some Like It Hot, Magnificent Seven, Smile, etc.

HERE, INDEED, IS AN EXCEPTIONALLY FINE SELECTION OF RECORDINGS to add to your classical library. In addition, there's a wide choice of recorded entertainment from other fields of music — popular, jazz, show music, humor, country and western — music to satisfy your every mood. By joining now, you may have ANY SIX of these records — up to a \$36.88 retail value — for only \$1.99. What's more, you'll receive an adjustable record rack — FREE.

**TO RECEIVE YOUR 6 RECORDS FOR ONLY \$1.99** — mail the attached postage-paid card. Be sure to indicate whether you want your 6 records (and all future selections) in regular high-fidelity or stereo. Also indicate which Club Division best suits your musical taste: Classical; Listening and Dancing; Broadway, Movies, Television and Musical Comedies; Jazz.

**HOW THE CLUB OPERATES:** Each month the Club's staff of music experts selects outstanding records from every field of music. These selections are fully described in the Club's music Magazine, which you receive free each month.

You may accept the monthly selection for your Division... or take any of the wide variety of other records offered in the Magazine, from all Divisions... or take no record in any particular month. Your only membership obligation is to purchase 6 records from the more than 400 to be offered in the coming 12 months. Thereafter, you have no further obligation to buy any additional records... and you may discontinue your membership at any time.

**FREE RECORDS GIVEN REGULARLY.** If you wish to continue as a member after purchasing six records, you will receive — FREE — a record of your choice for every two additional selections you buy — a 50% dividend!

The records you want are mailed and billed to you at the list price of \$3.98 (Classical \$4.98; occasional Original Cast recordings somewhat higher), plus a small mailing and handling charge. Stereo records are \$1.00 more.

**MAIL THE POSTAGE-PAID CARD TODAY** to receive your 6 records — plus a free adjustable record rack — for only \$1.99.

**NOTE:** Stereo records must be played only on a stereo record player. If you do not now own one, by all means continue to acquire regular high-fidelity records. They will play with true-to-life fidelity on your present phonograph and will sound even more brilliant on a stereo phonograph if you purchase one in the future.

**COLUMBIA RECORD CLUB • Terre Haute, Indiana**



*Eugene Ormandy*



*Dave Brubeck*

<b>ALFRED DRAKE</b> KISMET Original Broadway Cast COLUMBIA	<b>BRAHMS</b> PIANO CONCERTO No. 1 SERKIN ORMANDY Philadelphia Orch. COLUMBIA	<b>FIRST TIME!</b> DUKE ELLINGTON MEETS COUNT BASIE COLUMBIA	<b>Revolution in Sound</b> the revolving bandstand of LES BROWN and his Band of Renown COLUMBIA	<b>FOUR VIVALDI CONCERTI</b> for Two Violins and Orchestra ISAAC STERN DAVID DISTKRAK EUGENE ORMANDY PHILADELPHIA ORCH. COLUMBIA	<b>QUIET VILLAGE</b> The Exotic Sounds of MARTIN DENNY LIBERTY	<b>Time Further Out</b> The Dave Brubeck Quartet COLUMBIA	<b>TIME OUT</b> THE DAVE BRUBECK QUARTET COLUMBIA	<b>BOBBY VEE</b> TAKE GOOD CARE OF MY BABY plus Run to Him Walkin' With My Angel 8 more LIBERTY
---	--	--	---	--	--	---	---	--

94. Stranger in Paradise, And This Is My Beloved, etc. \*

278. "Something no one should pass up." —Washington Star

215. "Walloping ensembles and stirring solos!" —High Fidelity

194. Lisbon Antigua, Peter Gunn, Man With A Horn, 14 in all

260. Gay and effervescent, this one is a real treat

145. Happy Talk, My Little Grass Shack Cha Cha Cha, etc.

51. "Music is agile and engaging." —N.Y. Journal-American

50. "It soars and it swings... a breakthrough." —Playboy

299. Twelve big hits by one of America's hottest singers

195. Oklahoma Bill, 46. Also: Like Some Make the Water-wheel Roll, 10 in all

233. "Most beautiful... an edge in sonic fidelity." —Atlantic

199. The Breeze and I, Ebb Tide, Sleepy Lagoon, 12 in all

200. Honky Tonk (Part I and II), Oedip I Do, Buster, etc.

251. "Richness of the harmonies... gorgeous." —Hi Fi Rev.

68. Together, Lonely, I'll Remember April, Love For Sale, etc.

144. "Hackett's cornet playing is just lovely!" —S.F. Chron.

285. "Performance: Superb. Recording: Excellent." —HiFi Rev.

© Columbia Records Distribution Corp., 1963 316

Music . . . soft and caressing . . . vibrantly alive . . . inspiring. The pure sound of Grommes stereo recreates each mood . . . with fidelity and presence of infinite superiority. Prices are sensible . . . quality unsurpassed.



Model 101M FM multiplex-stereo tuner. Magic bar tuning with exclusive Stereo Sentry to indicate stereo broadcasts. . . . \$139.95

Model 102M FM and AM multiplex tuner with all features of above. . . . \$159.95.

Write GROMMES

Division of Precision Electronics, Inc.,  
9101 King St., Franklin Park, Ill.

*Grommes*  
sets the  
scene . . .



# LETTERS TO THE EDITOR

## Bartók's Students

● I read with great interest the article "Studying Composition with Bartók" in the September issue of your magazine. The author, Gisella Selden-Goth, states that she had the privilege of being the only composition pupil of Bartók. However, in reading a Hungarian biography of Zoltán Kodály by László Eöszy published in Budapest in 1956, I find on page 19 indications that Mrs. Selden-Goth might be mistaken in believing herself to have been Bartók's only composition pupil. The passage describes the musical gatherings at the house of Mrs. Henrik Gruber (formerly Miss Emma Sándor), an excellent pianist who numbered among her guests both Bartók and Kodály. The author of the book states that Mrs. Gruber was a composition pupil of Bartók, but when Bartók was unable to hold the lessons because of concert engagements in Western Europe, she chose Kodály as her composition teacher in February, 1905. Eventually, Kodály became Mrs. Gruber's second husband.

DR. BELA KUHRNER  
St. Louis, Mo.

## Basic Repertoire Roundup

● Ever since I began reading HiFi/STEREO REVIEW, Martin Bookspan's "Basic Repertoire" has been an invaluable service to my record collecting. With every month, my appreciation and enjoyment has grown.

Surely there must be many readers who, like myself, have not subscribed to your magazine from its inception and thus have missed the first articles in Mr. Bookspan's series. Is there any way to obtain the earlier articles?

JOSEPH D. McCLATCHY, JR.  
Haverford, Penna.

*In response to many requests for reprints of Mr. Bookspan's articles HiFi/STEREO REVIEW is currently exploring the possibility of publishing "The Basic Repertoire" series in book form. A decision will be announced in a later issue.*

## Operatic Bach

● Since David Hall rated it "Best of the Month" in your September issue, I bought Otto Klemperer's recording of Bach's *St. Matthew Passion*, and on the whole I am extremely pleased with my purchase. In grandeur and dignity of conception I know no other recording to equal this one, and none to match its opulent sound.

Still, I should like to express a reservation that Mr. Hall failed to register in his review. There seems something discon-

certingly operatic in the over-all projection of the work, a certain agonized empathy in phrasing that is in keeping with the events told by St. Matthew but that, by its very humanization, diminishes the scope of the work.

I hope I am not too mystical in suggesting that the Passion of our Lord should not be conceived in human terms, for those terms are too confining. The medieval painters realized this when they painted Golgotha against flat, symbolic backgrounds. Bach's music, I feel, should be interpreted in somewhat the same, detached manner, which lifts it beyond the sphere of merely human suffering and merely human sympathy. In giving us an intensely human statement of the score, Klemperer has lifted the Passion from its golden Giotto-like background and set it into a realistic landscape. He did so, no doubt, with the reverent intention, but a mystery was lost.

HERBERT REID  
New York, N. Y.

## Standards of Judgment

● Having been conditioned to believe that a record critic's strongest term of approbation is "yes, but" while the corresponding height of disapproval is expressed by "no, but," it was something of a revelation to read Robert Offergeld's unstinting and unconditional praise of Vladimir Horowitz's new Columbia disc in the October issue of your magazine.

While so many other critics try to arrive at some objective standards for validating their opinions, Mr. Offergeld gives nothing but his own reasons for his. This may hamper his status among scholars, but it goes a long way to increase my trust in him; it does seem to me that the quality of a knowing person's subjective response is still the only index for measuring the effectiveness of an artistic performance.

HAROLD SAXON  
San Francisco, Calif.

● Robert Offergeld's feature review of the new Horowitz recording communicates an enthusiasm that lends new impetus to the nature of record criticism. As a music student, I appreciate the difficulty of writing a rave review without appearing to rave, though it seems to me that the heat of Mr. Offergeld's language conveys perhaps too forcibly his "personal convictions . . . impossible to dilute." Still, Mr. Offergeld should be encouraged to give us more of this kind of exciting and vital commentary.

MRS. GUNTHER GEOFFRIES  
New York, N. Y.

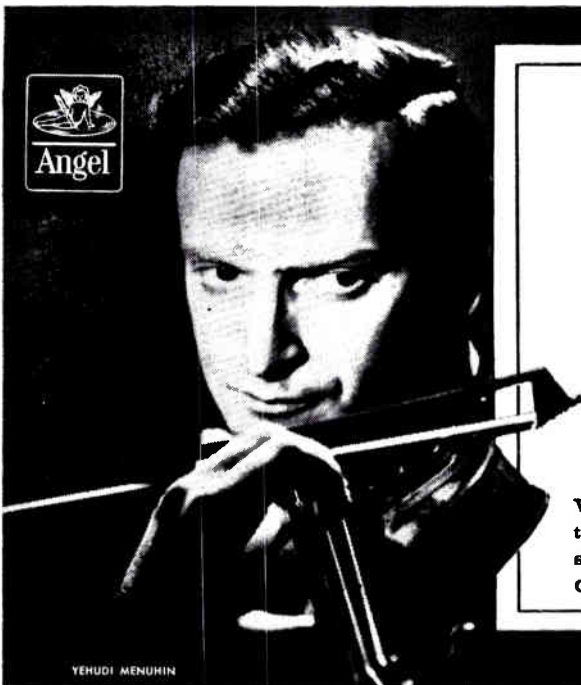

YEHUDI MENUHIN

# Any FIVE Albums only \$1.00 plus a small shipping charge

When you become a trial member of the Angel Division of the Capitol Record Club and agree to buy only six future selections from the several hundred available Angel and Capitol albums to be offered you during the next 12 months.



389. BEETHOVEN: CONCERTO IN D MAJOR FOR VIOLIN. Yehudi Menuhin conducts. Constantin Silvestri.



789. SIBELIUS. SYMPHONY NO. 5 and FINLANDIA. Herbert von Karajan conducts The Philharmonia Orchestra.



790. LALO. SYMPHONIE ESPAGNOLE, OP. 21. Leonid Kogan, violin. Kyril Kondrashin leads Philharmonia Orch.



368. NAT KING COLE. THE TOUCH OF YOUR LIPS. Not So Long Ago, I Remember You, Illusion, Funny, 8 more.



422. LAURINDO ALMEIDA. REVERIE FOR SPANISH GUITARS. 11 classical works by Ravel, Debussy, Tchaikovsky, others.



417. FRANK SINATRA. SWINGIN' SESSION! All time favorites. Always, Paper Moon, Blue Heaven, 9 more gassers.



747. CALLAS PORTRAYS PUCCINI HEROINES. Favorite arias from operas Manon Lescaut, Butterfly, Boheme, others. Monaural only.



804. BRAHMS: CONCERTO #2 IN B FLAT MAJOR. Richter-Haaser, piano; von Karajan conducting Berlin Philharmonic.

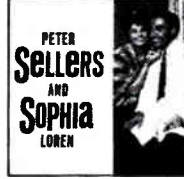

791. PETER SELLERS & SOPHIA LOREN. Love and wit by England's dizziest comedian and Italy's loveliest.

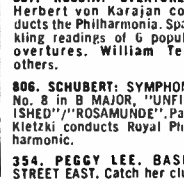

354. PEGGY LEE. BASIN STREET EAST. Catch her club performance of Fever, Them There Eyes, Yes Indeed, 12 more.

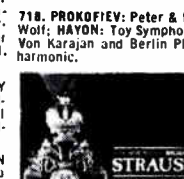

474. THE SOUND OF RICHARD STRAUSS. Erich Leinsdorf conducts the Philharmonia Orchestra: Salome's Dance, more.



802. VON KARAJAN. Mozart Symphonies. No. 38 in D Major ("Prague"); No. 39 in E flat Major. Philharmonia Orchestra.

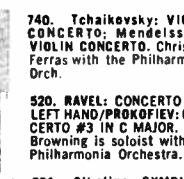

740. Tchaikovsky: VIOLIN CONCERTO. Mendelssohn: VIOLIN CONCERTO. Christian Ferras with the Philharmonia Orchestra.



420. KINGSTON TRIO. CLOSE-UP. 12 songs never before recorded: Sail Away, Ken Karanga, Jesse James, etc.

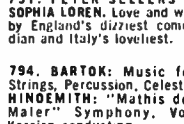

791. PETER SELLERS & SOPHIA LOREN. Love and wit by England's dizziest comedian and Italy's loveliest.

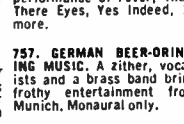

757. GERMAN BEER-DRINKING MUSIC. A zither, vocalists and a brass band bring frothy entertainment from Munich. Monaural only.



474. THE SOUND OF RICHARD STRAUSS. Erich Leinsdorf conducts the Philharmonia Orchestra: Salome's Dance, more.

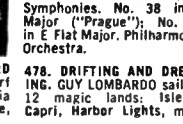

478. DRIFTING AND DREAMING. GUY LOMBARDO sails to 12 magic lands: Isle of Capri, Harbor Lights, more.

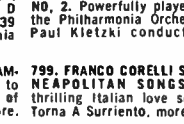

799. FRANCO CORELLI SINGS NEAPOLITAN SONGS. 10 thrilling Italian love songs: Torna A Surriento, more.



506. LATIN AFFAIR. George Shearing plays Juana Palangana, Mambo Balahu, latinizes American favorites.



753. VIENNESE DANCES #2. The Philharmonia under Vienna-born Henry Krips plays 6 scintillating waltzes.



779A & 779B. THE MIKADO Gilbert and Sullivan. Hear the biting wit and enchanting music of the Savoyards in a brilliant new album. Sir Malcolm Sargent leads the Glyndebourne Festival Chorus and the Pro Arte Orch. (2-Record set counts as two separate selections.)

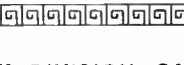

503. BIG PIANO/BIG BAND; BIG SOUND. Lee Evans thrills with Trolley Song, Blow Gabriel Blow, 11 others.

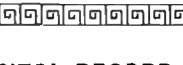

700. SOVIET ARMY CHORUS & BAND. 200 thundering male voices sing Russian folk ballads and army songs.



793. ENGLISH BALLETS OF THE 20TH CENTURY. Sir Malcolm Sargent conducts Royal Philharmonic in 3 selections.



324A & 324B. JUDY GARLAND AT CARNEGIE HALL. Best-seller from coast to coast! Enjoy the "greatest evening in show business history", 28 exciting songs—as only Judy can sing them! (2-Record set counts as two separate selections.)



779A & 779B. THE MIKADO Gilbert and Sullivan. Hear the biting wit and enchanting music of the Savoyards in a brilliant new album. Sir Malcolm Sargent leads the Glyndebourne Festival Chorus and the Pro Arte Orch. (2-Record set counts as two separate selections.)

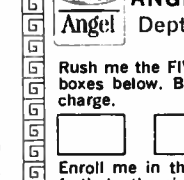

486. VIKI KING! Hollywood Bowl Symphony plays the Scandinavians: Grieg, Halvorsen, Sinding, Jarnefelt.

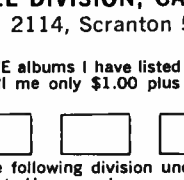

523. RIMSKY-KORSAKOV: SCHEHERAZADE. Erich Leinsdorf, the Concert Arts Symphony capture the magic of its bewitching melodies.

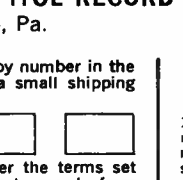

776. KURT WEILL IN BERLIN. Songs from the master tunesmith's hit shows, including Threepenny Opera.



392. MILES DAVIS. BIRTH OF THE COOL. Also Kai Windling J. J. Johnson, Gerry Mulligan and others in 11 "cool" tunes. Monaural only.

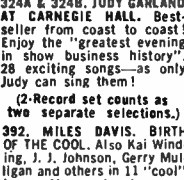

773. Beethoven: PIANO CONCERTO NO. 1; SONATA NO. 27. Solomon, piano. Herbert Menges conducts.

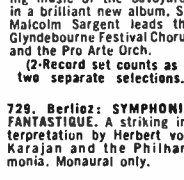

776. CHOPIN WALTZES. Malczuznski plays 14 delightful pieces. Minute Waltz, other favorites.

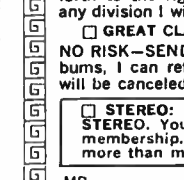

361. STAN FREBERG PRESENTS THE UNITED STATES. Offbeat fun! Yankee Doodle Go Home plus 9 other spoofs.

ANGEL DIVISION  
Capitol Record Club  
Dept. 2114  
Scranton 5, Pa.

ANGEL DIVISION, CAPITOL RECORD CLUB  
Dept. 2114, Scranton 5, Pa.

Rush me the FIVE albums I have listed by number in the boxes below. Bill me only \$1.00 plus a small shipping charge.

Enroll me in the following division under the terms set forth to the right. However, I may select records from any division I wish.

GREAT CLASSICS  POPULAR BEST SELLERS  
NO RISK—SEND NO MONEY! If not delighted with my albums, I can return them within 7 days and all charges will be canceled.

STEREO: Check here if you want all records in STEREO. You will be billed \$2.00 with your stereo membership. The Club sells stereo records for \$1 more than monaural.

MR. \_\_\_\_\_  
MRS. \_\_\_\_\_  
MISS \_\_\_\_\_ (Please Print)

ADDRESS \_\_\_\_\_

CITY \_\_\_\_\_ ZONE \_\_\_\_\_ STATE \_\_\_\_\_

To join through an authorized Angel-Capitol Record dealer, write his name and address in the margin. • Canada: Slightly higher prices. Mail to—1184 Castlefield Ave., Toronto.

HF-1

# STILLE

That's the German way of saying silent. Our way? Signal-to-noise ratio: minus 48 db!\* That's as quiet as many professional-type turntables. And that's silent enough to meet the stringent noise-level qualifications of the U.S. Navy. That's right. Dual Customs were chosen for installations aboard the "Polaris" atomic submarines. But if you don't take anyone's word for things, you'll check out the Dual-1006 Custom yourself. You'll watch it perform and hear it play, inspect all its features, read the fine print in the literature. Then you'll examine all other machines, regardless of price or brand name. Having done that, you'll never have to blame yourself or go back to anyone to ask: "Why didn't you tell me about the silent Dual-1006 Custom?" Price: \$89.95.

## UNITED AUDIO



OTHER UNITED AUDIO-DUAL PRODUCTS: THE DMS-900 MAGNETIC STEREO CARTRIDGE AND THE NEW TG 12 SK STEREO TAPE RECORDER. FOR THE COMPLETE STORY ON THE DUAL-1006, WRITE: UNITED AUDIO PRODUCTS, 12-14 WEST 18th STREET, NEW YORK, N. Y.

\*Signal-to-noise ratio referenced to 1.4 cm/sec peak velocity at 100 cps.



## JUST LOOKING

...at the best in new hi-fi components

● **Acoustic Research** is making available separately the stylus-pressure gauge that is normally furnished with the AR turntable. Designed as a beam balance, and operating with calibrated weights, the device registers stylus pressure from as low as  $\frac{1}{4}$  gram with an accuracy of 5 per cent. Price: \$1.00, available only on direct order from the manufacturer. (Acoustic Research, Inc., 24 Thorndike Street, Cambridge 41, Mass.)

circle 180 on reader service card

● **Heath** offers a kit version of the Thomas two-manual, transistorized electronic organ (Heathkit Model GD-232). The instrument has overhanging keyboards for easy bridging, each with 37 notes, and a 13-note pedal board. In addition to rocker-type register selectors, the organ has a separate bass pedal volume

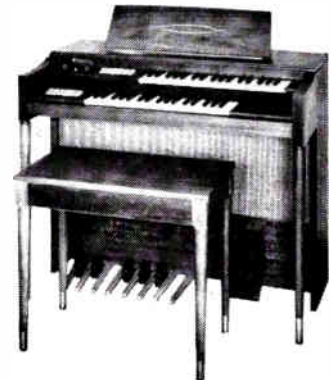

control, a balance control for adjusting the relative volume of the two manuals, a standard expression pedal, and variable vibrato.

The transistorized tone generators, guaranteed for five years, are assembled on circuit boards. Instructions are included for accurate tuning without special instruments. Amplifier and speaker are built in, and the entire instrument is housed in a walnut cabinet. A matching bench is optionally available. Dimensions:  $39\frac{3}{4}$  x  $34\frac{1}{2}$  x  $21\frac{1}{2}$  inches. Price: \$329.95. (Bench: \$24.95) (Heath Company, Benton Harbor, Mich.)

circle 181 on reader service card

● **Luxor** now offers a deck version of its stereo tape recorder for use in built-in installations. The Luxor D 101 has built-in playback preamplifiers, complete

(Continued on page 16)



*Introducing...*

*Traditional Patrician 800 illustrated with matching Contessa equipment console. In walnut, mahogany or cherry finishes.*



**THE PATRICIAN<sup>®</sup>**  
**800 SERIES**

**...a complete new collection of high fidelity loudspeaker systems and matching equipment consoles**

The Patrician 800, like its famous predecessors, is devoted to the reproduction of sound with absolute honesty. It speaks only when spoken to . . . with a voice that is no more spectacular—and no less so—than the music it is asked to duplicate.

As a result, the Patrician 800 is somewhat larger than most other speaker systems—even to its extraordinary 30-inch

woofer—simply because a system of this magnitude is required to reproduce the deepest musical sounds accurately and without compromise.

In appearance, the Patrician 800 achieves a new standard of elegance in both Traditional and Contemporary designs . . . for this system was conceived as the ultimate reflection of your good taste in

fine music and superb home furnishings.

We invite your critical appraisal of the entire new Patrician loudspeaker collection at your nearby Electro-Voice high fidelity demonstration center. Or we will be happy to send a catalog on request.

**ELECTRO-VOICE, INC.**, Consumer Products Division, Dept. 134F, Buchanan, Michigan

**CIRCLE NO. 28 ON READER SERVICE CARD**

**Electro-Voice<sup>®</sup>**  
SETTING NEW STANDARDS IN SOUND

*When Great Performers Get Together...*



*...One is  
always a*  
**ROBERTS!**



**ROBERTS '1057'**

STEREO TAPE RECORDER . . gets together with **Lawrence Welk**, in rehearsal with his fabulously popular dance band. He says, "My Roberts '1057' tape recorder is the closest to recording studio equipment that I have seen." No wonder, with these outstanding '1057' features: Combines matchless performance, ease of operation at a low, low price. Features 4-track stereo and monoral record/play. Sound-on-sound multiple recording in stereo, sound-with-sound (teacher/student feature), sound-over-sound mixing • Dual speakers • Stereo amplifiers • 4 stereo headset outputs • Automatic shut-off • 3 3/4 and 7 1/2 ips . . . . . **\$339.95**

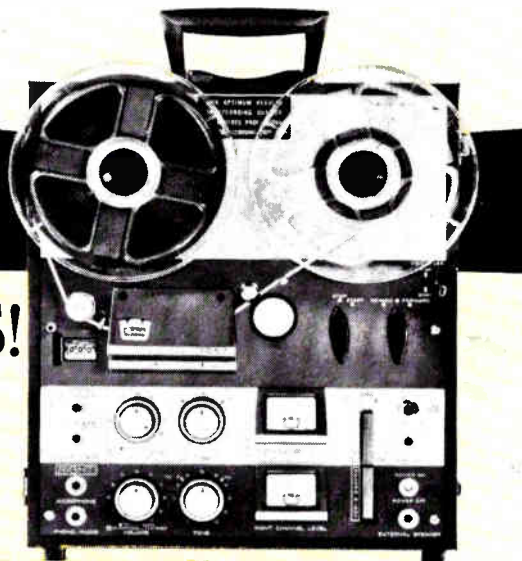

**ROBERTS**  
**ELECTRONICS, INC.**  
**LOS ANGELES 16, CALIF.**

CANADA: J. M. NELSON SALES CO.  
7725 ADERA ST., VANCOUVER 14, B.C.  
*Prices slightly higher in Canada.*

Roberts Electronics, Dept. HFSR-1-T  
5978 Bowcroft, Los Angeles 16, Calif.  
Please send me complete literature on Roberts Tape  
Recorders. I enclose 25¢ for postage and handling.

Name \_\_\_\_\_  
Address \_\_\_\_\_  
City \_\_\_\_\_ Zone \_\_\_\_\_ State \_\_\_\_\_

(Continued from page 14)  
stereo and mono recording facilities, and operates at 7 1/2, 3 3/4, and 1 7/8 ips. At 7 1/2 ips the frequency response is from 50 to 17,000 cps ± 3 db with a signal-to-noise ratio of approximately 50 db. Flutter and



wow are ± 0.09 per cent rms, and channel separation is better than 35 db. Terminals for permanent connection to other components are concealed at the rear; a microphone jack is located on the front panel. Dimensions: 14 x 11 x 8 3/4 inches. Price: \$234.00 (\$239.00 on West Coast). (Amelux Electronics Corporation, 60 East 42nd Street, New York 17, N.Y.)  
**circle 182 on reader service card**

● **Marantz** now offers an FM tuner, Model 10, that incorporates a number of circuit innovations derived from military and satellite communications practice. A small, built-in oscilloscope serves as tuning indicator, and also displays optimum antenna orientation. The built-in stereo section is automatically switched in when stereo signals are received.

The following minimum specifications are stated: sensitivity is 1.5 microvolts (IHF M), quieting at 2 microvolts is 40 db; alternate channel rejection is 100 db; image rejection is 100 db; harmonic distortion is 0.5 per cent, stereo separation is



40 db (with subcarrier filter in). Five i.f. stages are employed, with phase-linear bandpass filters and 200-kc. bandwidth; five dynamic limiters provide a limiting crest factor of 90 db. Dimensions: 15 3/8 x 5 3/4 x 15 inches. Price: \$555.00 (\$565.00 on West Coast). (Marantz Company, Inc., 25-14 Broadway, Long Island City, N.Y.)

**circle 183 on reader service card**

● **Shure** introduces an integrated tone arm and cartridge, the Model M222. Essentially an updated version of the popular M212, the new model is equipped with the Shure N22D tubular 0.5-mil stylus, which has a compliance of 22 x 10<sup>-6</sup> cm/dyne both vertically and laterally. The M222 tracks at pressures from  
(Continued on page 18)

\*Throughout the entire world... more people listen to stereo records reproduced by the STANTON Stereo Fluxvalve than any other magnetic pickup!

\*More stereo records are quality controlled and reviewed by professionals using STANTON Stereo Fluxvalves.

\*More high quality phonograph consoles use STANTON Stereo Fluxvalves than any other magnetic pickup.

\*More commercial background music systems use STANTON Stereo Fluxvalves than any other magnetic pickup.

\*More automatic phonograph systems use STANTON Stereo Fluxvalves than any other magnetic pickup.



And now...new dimensions for stereo from the world's most experienced manufacturer of magnetic pickups -

## STANTON 481

Calibration Standard Stereo Fluxvalve\*

**Model 481AA STANTON Stereo Fluxvalve**—an ultra-linear professional pickup for use with ultra-light-weight tone arms capable of tracking within the range from 1/4 to 3 grams. Supplied with the D4005AA V-GUARD diamond stylus assembly.

**AUDIOPHILE NET PRICE \$49.50**

**Model 481A STANTON Stereo Fluxvalve**—an ultra-linear professional pickup for use with manual tone arms, recommended tracking force is from 2 to 5 grams. Supplied with the D4007A V-GUARD diamond stylus assembly.

**AUDIOPHILE NET PRICE \$48.00**

**Model 481E STANTON Stereo Fluxvalve Set**—same as the Model 481A but includes two additional V-GUARD styli: the D4010A 1 mil for LP's and the D4027 2.7 mil for 78's.

**AUDIOPHILE NET PRICE \$60.00**

## STANTON 400

Professional Stereo Fluxvalve\*

**Model 400AA STANTON Stereo Fluxvalve**—an ultra-linear professional pickup for use with ultra-light-weight tone arms capable of tracking within the range from 1/4 to 3 grams. Supplied with D4005AA V-GUARD diamond stylus assembly.

**AUDIOPHILE NET PRICE \$40.50**

**Model 400A STANTON Stereo Fluxvalve**—an ultra-linear professional pickup for use with manual tone arms, recommended tracking force is from 2 to 5 grams. Supplied with D4007A V-GUARD diamond stylus assembly.

**AUDIOPHILE NET PRICE \$39.00**

**Model 400C STANTON Stereo Fluxvalve**—an ultra-linear professional pickup for use in automatic record changers, recommended tracking force is from 4 to 7 grams. Supplied with D4007C V-GUARD diamond stylus assembly.

**AUDIOPHILE NET PRICE \$33.00**



*"Fine audio components from the Professional Products Division of"*  
 **Pickering** PICKERING & COMPANY, INC., Plainview, N. Y.

\*The hermetically sealed STANTON Stereo Fluxvalve is warranted for a lifetime and is covered under the following patents: U.S. Patent No. 2,917,590; Great Britain No. 783,372; Commonwealth of Canada No. 605,673; Japan No. 261,203; and other patents are pending throughout the world.

*Teamwork  
for the  
Grandeur of Great Music*

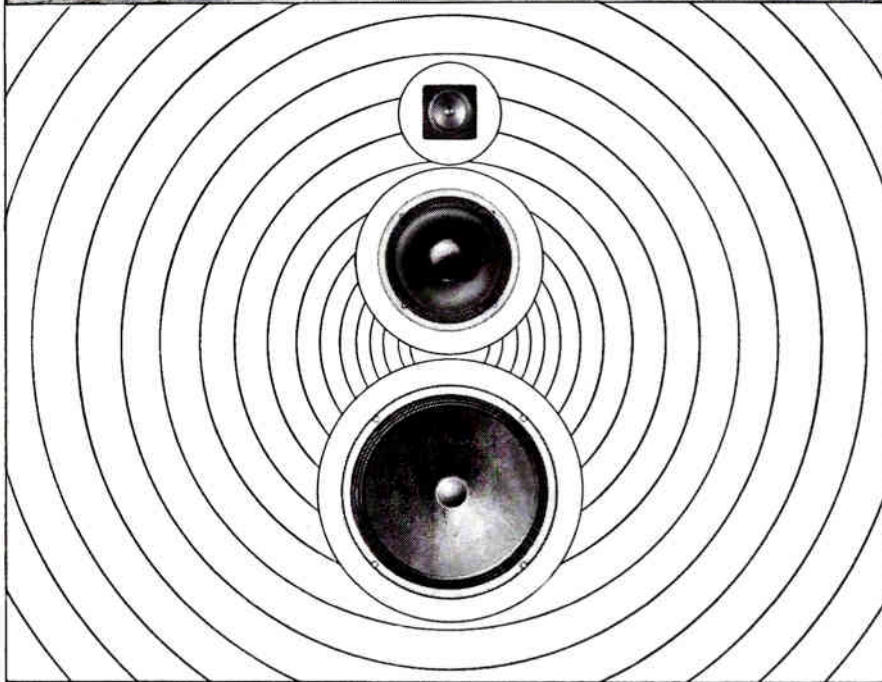

All Bozak Loudspeakers work together. The robust basso B-199A . . . incisive baritone B-209A or B-800 . . . join the sweet B-200Y soprano in perfect harmony to re-create The Very Best in Music. □ For your Bozak Speaker System a Bozak-built enclosure stages the sound to perfection. Or, if space is limited, you can build your Bozaks into a wall, cupboard, or treasured cabinet. □ Whatever its size and mounting, teamwork in your Bozak Speaker System assures you The Grandeur of Great Music in your home. □ Write for our illustrated catalog, and hear the Bozaks at your Bozak Dealer.

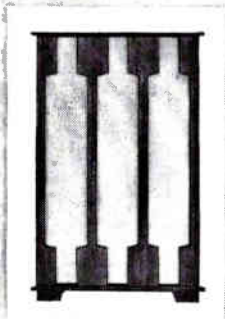

DARIEN/CONNECTICUT

(Continued from page 16)  
¾ to 1½ grams, has a frequency response from 20 to 20,000 cps, 22.5-db channel separation (at 1 kc.), and an output of 4.5 millivolts. Price: \$89.50. (The N22D stylus is also available separately at \$24.75 to replace the older stylus assembly in Model M212 and M216 integrated arms. It is furnished with a snap-on counterweight that provides the requisite lighter tracking pressures for those arms.) (Shure Brothers, Inc., 22 Hartrey Avenue, Evanston, Ill.)

circle 184 on reader service card

● Sony has added a miniature model to its line of capacitor microphones. The new C-17B is 3¾ inches long, has a di-



ameter of 5⁄8 of an inch and a cardioid directional pattern with 25 db front-to-back ratio. These design factors make the microphone especially suited for recording live performances, where the elimination of noises from the audience is important.

The plastic diaphragm of the microphone is only 0.0006 millimeters thick, with a 0.0003-millimeter coating of gold. Frequency response is from 20 to 15,000 cps ± 2 db. A four-position high-frequency attenuator is included in the power supply. Price: \$299.50. (Superscope, Inc., 8150 Vineland Avenue, Sun Valley, Calif.)

circle 185 on reader service card

● University's smallest speaker system, the MINI, measures only two inches in thickness. A veneer panel as big as the entire frontal area (18 x 13 inches) is directly coupled to the woofer voice coil and acts as low-frequency radiator. A separate tweeter provides the highs. Overall response is from 50 to 17,000 cps ± 10 db, and the unit handles 20 watts of program material. The MINI is finished in oiled walnut. Price: \$44.95. (University Loudspeakers, 80 South Kensico Avenue, White Plains, N.Y.)

circle 186 on reader service card

● Winegard introduces an antenna booster amplifier, called the Stereotron Model AP-320, that employs a low-noise nuvistor circuit to amplify weak signals without overloading on strong ones. The compact, weather-sealed unit is installed atop the antenna mast. Price: \$39.95. (Winegard Company, Inc., 3000 Kirkwood Blvd., Burlington, Iowa)

circle 187 on reader service card

# "I heard things I never heard before"

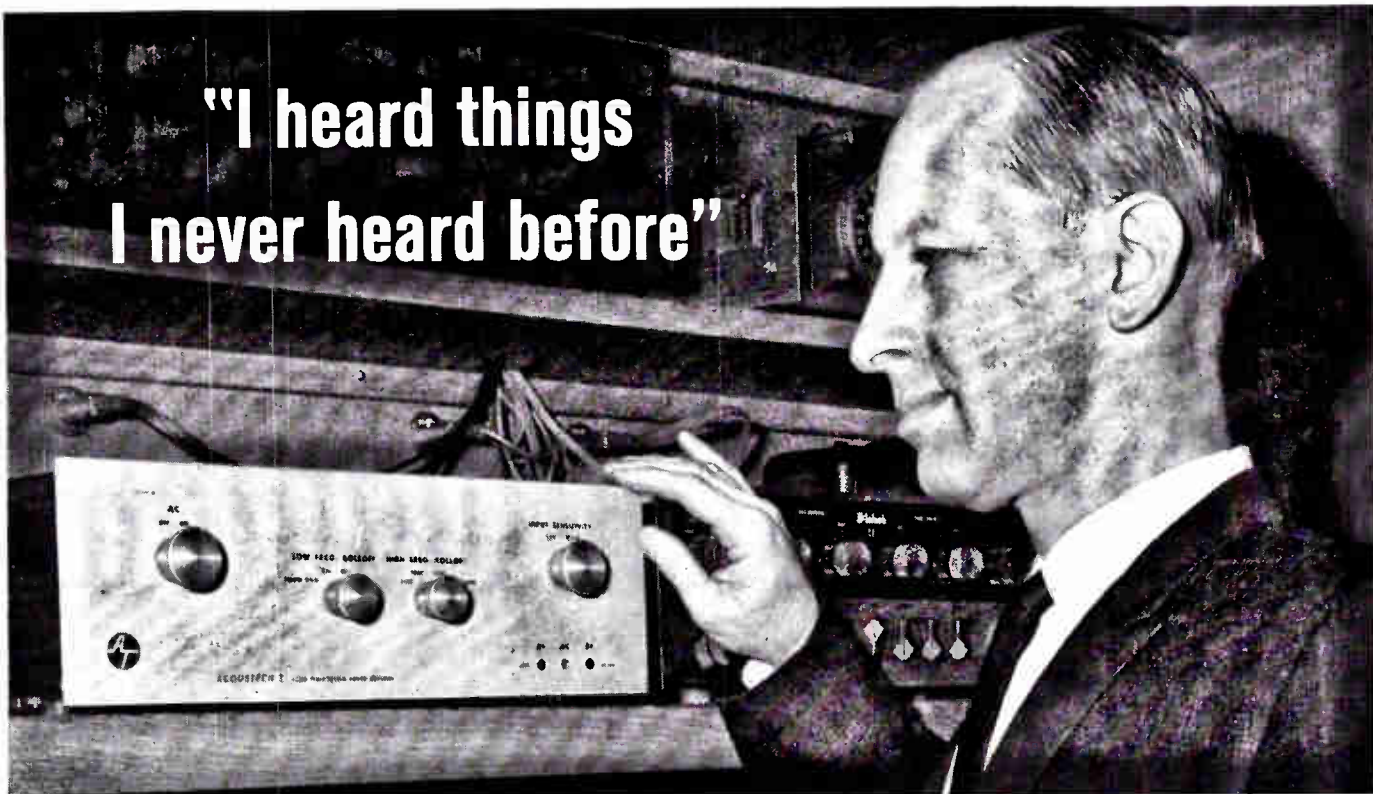

said Anton Schmitt of New York's famed Harvey Radio after listening to the Acoustech I solid state stereo power amplifier for the first time. "The dynamic range and transparency of sound permit me to hear shadings and subtleties I was never aware of," Anton continued. "Even when I turn up the bass controls on the preamp, I still hear more tightly controlled lows, not boom. This amplifier sets a new standard in sound reproduction."

This dramatic advance in the art of sound reproduction results from the sophisticated solid state circuitry of the Acoustech I. The expensive all-silicon output stage (beta cutoff above one megacycle) combined with direct-coupled circuitry (no driver or output transformers) provides unequalled transient response. Together with the high damping, these unique characteristics give a clarity and ease of listening that was as immediately obvious to Anton Schmitt as it will be to you.

Matching this unparalleled electrical performance is the Acoustech I's equally unparalleled reliability. Using the most advanced techniques found in precision scientific and military instrumentation, the Acoustech I will perform almost indefinitely at its original performance level. Operation of the amplifier with no load, capacitive load, switching transients, and shorted speaker leads which can disable many vacuum tube amplifiers do not harm the Acoustech I. Mil spec glass-epoxy circuit boards, computer-grade electrolytics, girder construction, cool running and conservative operation of all components permit the most extensive warranty in the industry. Unlike vacuum tube amplifier manufacturers who cannot provide extended warranty for tubes, Acoustech provides an unprecedented FIVE YEAR warranty on the silicon output transistors.

The Acoustech I can be heard at leading audio dealers across the country.

**MINIMUM SPECIFICATIONS:** 40 watts per channel, rms, both channels operating simultaneously, delivered 8-16 ohms, 20-20,000 cps, with less than 0.95% harmonic and IM distortion (IM measured with 60 and 6000 cps tones mixed 4:1) at rated output; Rise time 1.75  $\mu$ sec; Frequency response,  $\pm 1/4$  db, 5-50,000 cps;  $\pm 3$  db,  $2\frac{1}{2}$ -250,000 cps; Input impedance 150,000 ohms; Dimensions  $15\frac{3}{4}$ " w x 5" h x 12" d. **\$395** including cage. (Slightly higher West of Rockies).



Harvey Radio Corporation in New York City is one of the oldest and most influential audio dealers in the country. From high fidelity's early days, Harvey has invariably been among the first to recognize the importance of significant technological breakthroughs like magnetic cartridges, acoustic suspension speakers, and now, quality solid state power amplifiers.



**IMPORTANT OFFER** Fill out this coupon for complimentary copy of Acoustech's new booklet "Why Solid State Amplifiers Can Sound Better." Also included will be detailed information on both the Acoustech I and II and a list of dealers from whom a demonstration can be heard.

**TO: Acoustic Technology Laboratories, Inc. Dept. R-1  
139 Main Street, Cambridge 42, Massachusetts**

NAME.....

ADDRESS.....

CITY.....ZONE.....STATE.....

**ALSO ENCLOSE NAMES OF INTERESTED FRIENDS**

## COMING . . . Acoustech II solid state stereo decade control center

## ALL TAPE HEADS WEAR OUT!

Is head wear causing you to lose the clean, crisp sound which only tape can give you?

**SPOT CHECK HEADS IN 2 MINUTES**

... Look for  
A. Grooves or spots on surface.  
B. Thin vertical black line dividing either pole piece.

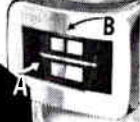

### **Nortronics** new head replacement program solves head wear problems!

There's no such thing as a wear-proof tape head. No matter who made the heads for your recorder... eventually they will wear out! When this happens, sound quality suffers... violins, castanets, triangles and cymbals are muffled or blurred.

Get the *most* from your investment in tape equipment by insisting on NORTRONICS correctly matched replacements for worn tape heads. NORTRONICS heads are selected by the nation's top manufacturers for use on their better recorders because of their premium quality, excellent performance and long life.

#### Have your tape heads checked for wear!

Now—for the first time—your Hi Fi dealer, Radio/TV serviceman or camera store can check the tape heads on your recorder and supply you with the correct NORTRONICS Replacement Heads and "Quik-Kit" mounting hardware. Easy to follow detailed drawings and instructions speed up installation! Replacements for more than 250 popular models are now available—with more to come!

If your local dealer or serviceman can't supply you, ask NORTRONICS for the name of your nearest source.

Write today for your FREE copy of "The NORTRONICS Guide to Tape Recording", a new information packed booklet for all tape enthusiasts.

#### MOST COMPLETE LINE OF CONVERSION KITS

In addition, NORTRONICS provides the most complete line of kits for converting monophonic and 2 track stereo to 4 track stereo.



*"Music Sounds Best on Tape —  
Tape Sounds Best on Nortronic Heads"*

**Nortronics**

8129 West 10th Ave., North  
Minneapolis 27, Minnesota.

CIRCLE NO. 41 ON READER SERVICE CARD



## BEGINNERS ONLY

by HANS H. FANTEL

**T**HE BASIC function of a loudspeaker enclosure, as explained last month, is to keep sound waves radiated by the rear of the speaker cone away from waves radiated by the front. Infinite baffles and acoustic-suspension speakers do this simply by shutting the back wave into a box. But the loss of the back wave to the listening ear must be made up in added amplifier wattage.

For amplifiers of moderate power, of less than twenty watts per channel, it is preferable to use loudspeaker enclosures that let the back wave contribute to the audible output of the speaker and help the speaker attain a given loudness with less wattage. The most popular enclosures of this kind operate on the bass-reflex principle: the back wave is let out of the box through a separate opening known as the port or vent. In some designs, the vent is joined to an interior duct, which has the effect of reducing the enclosure's necessary size.

To keep the liberated back wave from canceling the front wave of the speaker, the dimensions of the enclosure are such that they reverse the phase of the back wave so it emerges from the port reinforcing the front radiation. Offhand, this would seem an ideal solution to the problem of taming the troublesome back wave and, at the same time, getting efficient conversion of amplifier wattage into acoustic energy. However, there is one hitch. Any cavity or vented enclosure has its own natural resonance whose pitch depends on the air volume it contains. If the music to be reproduced has bass notes near the natural resonance of the enclosure, this resonance will be added to the sound, falsifying its character and making it boomy. If you have ever tried talking into a barrel, you know the effect. Speaker manufacturers get around this by matching the resonance of the enclosure to the resonance of the speaker cone in such a way that the two resonances largely suppress one another. Consequently, well-designed speaker systems of this kind are free of noticeable boominess. And by interior padding of the box and various special treatments of the vent it is possible to keep coloration at a minimum.

The most efficient of all loudspeaker enclosures, requiring very little amplifier power, are the horn systems, which work on still another principle. They use a tapered duct, acting like a megaphone, to transmit the sound from one side of the speaker cone into the listening room. Inherently nonresonant, horns present no problem of boominess, but to be effective over the whole audible range, they have to be quite long and their opening must be large. To make enclosures of this type presentable in the living room, the horn is usually doubled up and folded on itself to conserve space, and the whole structure is housed in attractive furniture, usually designed for corner placement. Still, such enclosures tend to be fairly big. But their owners usually claim that the richness of sound obtainable from horn enclosures justifies their space requirements.

In any type of enclosure, it is essential that its characteristics complement those of the speaker it contains. If you are buying speaker systems complete with their own enclosures, you need not worry about this. But if you buy speakers separately, follow the manufacturer's recommendations for a suitable enclosure.



## It's what you don't hear that counts!

That's why you buy a turntable. For silence. Silence of operation. Rondine 2 delivers both the sound and the silence you want. Minus 57 db silence even at full amplification. That's what you want in a turntable, what you're sure of getting with Rondine 2. Combine it with the Auto-Poise\* tonearm and you have the world's only true turntable with fully automatic operation. For complete catalog, write Dept. HS-1, Rek-O-Kut, 38-19 108th St., Corona 68, New York.



R Stereotable only .....	\$79.95
R 320 with S 320 Tonearm .....	129.95
R 320 A (illustrated) with Auto-Poise Tonearm ...	169.95
R Base (oiled walnut finish) .....	14.95

\*PAT. PEND.

**REK-O-KUT / rondine** 



# What kind of (active)

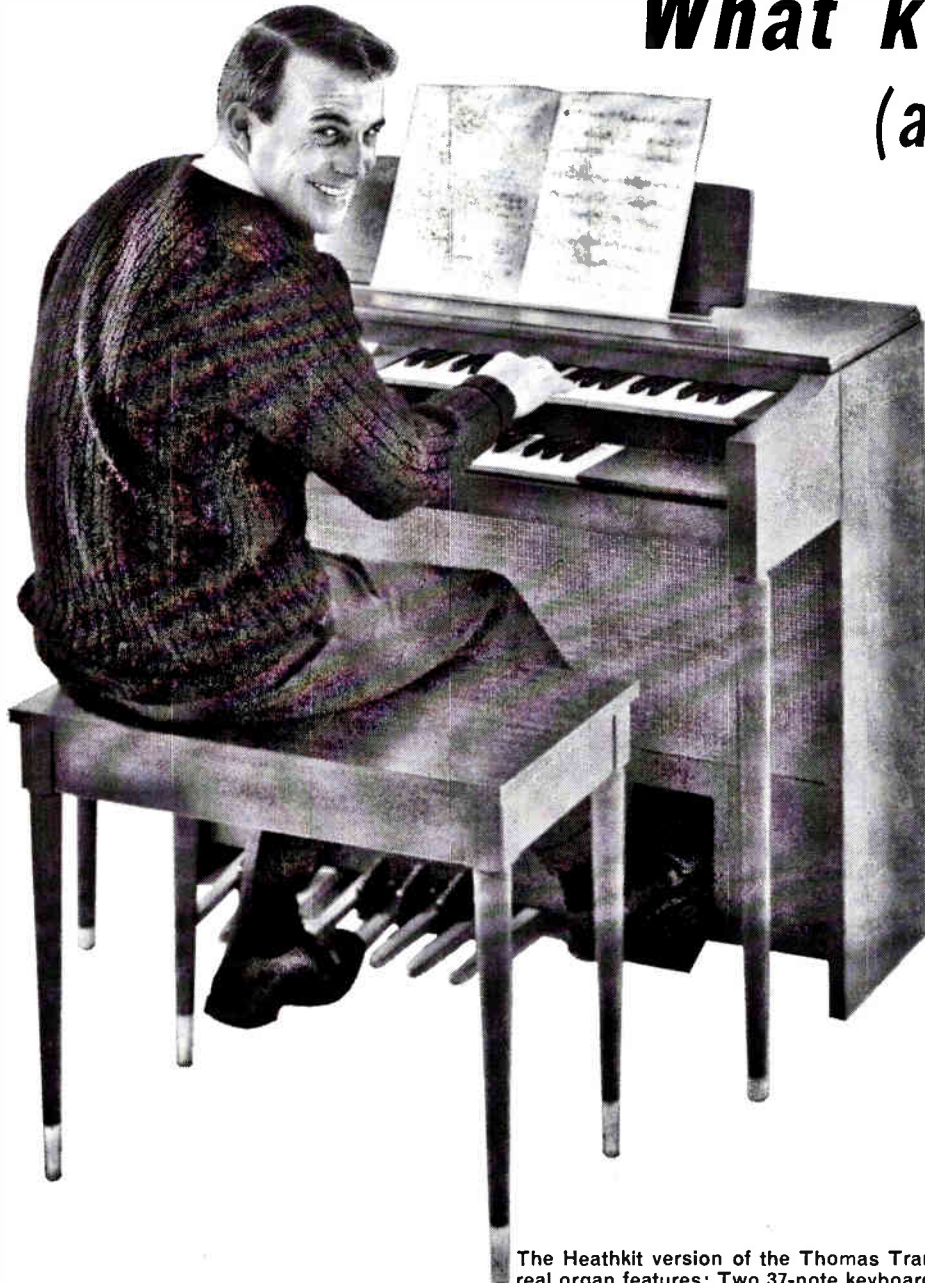

**This great, new transistorized organ offers full-toned, high fidelity standards of sound—a chance for creative expression.**

The Heathkit version of the Thomas Transistor Organ has these real organ features: Two 37-note keyboards, 10 true organ voices, 13-note bass pedals, variable vibrato, variable bass pedal volume, keyboard balance control, 20-watt peak power amplifier and speaker, deluxe walnut cabinet with matching bench.

Kit GD-232, no money down, \$22 mo..... \$329.95  
Bench GD-232-1,..... \$ 24.95

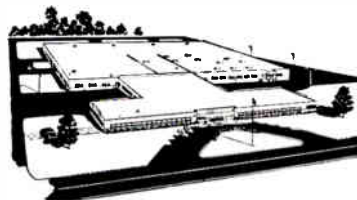

#### Who is Heathkit?

Heathkit is the pioneer and world's largest manufacturer devoted exclusively to the design and manufacture of do-it-yourself electronic kits. All our efforts are aimed at creating more kits, better kits, easier-to-build kits.



#### What are Heathkits?

Heathkits are electronic equipment in un-assembled form. All parts are packaged in convenient groups and a complete, easy-to-read, well-illustrated instruction manual tells you how to put them together. Heath offers over 250 kits from simple portable radios to big analog computers.



#### Who builds Heathkits?

Millions build Heathkits. People with absolutely no mechanical ability or knowledge of electronics as well as skilled electronic experts — all find value, economy, fun, relaxation, and pride of accomplishment in Heathkits. You can too.



# Heathkit® builder are you?

(passive)

(or both)

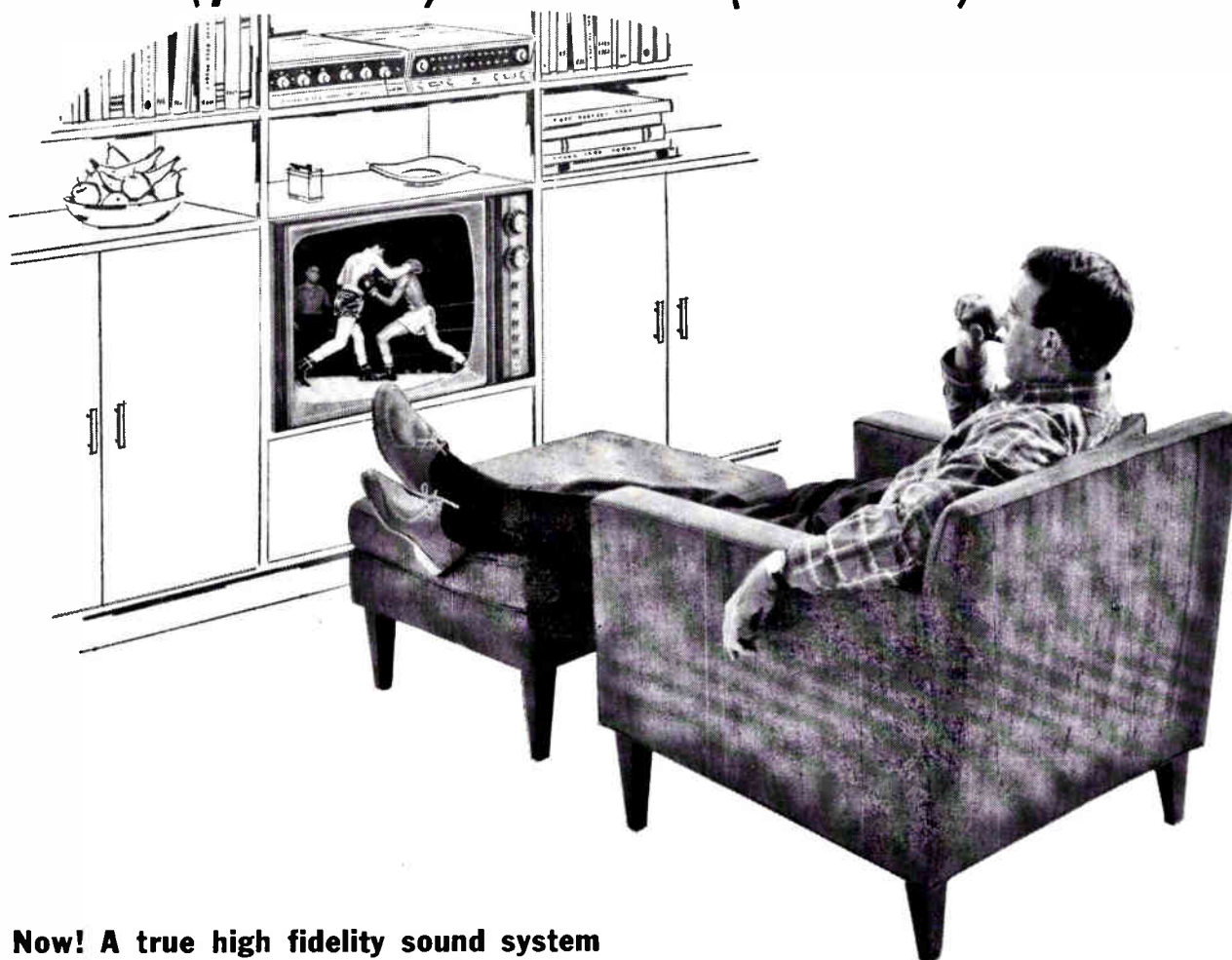

**Now! A true high fidelity sound system in a custom-quality 23" TV — relax and enjoy picture *and* sound for a change.**

This superb new Heathkit Hi-Fi TV set incorporates advance engineering to bring you the finest in picture quality **plus** truly high fidelity sound (the first TV receiver that earns the right to drive a hi-fi system)! Prebuilt assemblies make it easy to complete in 2 or 3 evenings. Optional UHF.

**Kit GR-22, chassis and all tubes, 70 lbs., \$16 mo.... \$169.95**  
With Wall Mount, \$189.95; With Console Cabinet, \$249.95.

**COMPARE THESE SUPERIOR FEATURES:** • high definition 23" tube with anti-glare bonded safety glass • spark-gap socket to protect tube • deluxe turret-type Nuvistor tuner • 20,000v. picture power • Transformer power supply • Line thermistor • Circuit breaker and B+ fuse • cathode follower sound output for hi-fi system ( $\pm 2$  db, 50-15,000 cps; harmonic dist. less than 1%) • separate sound output for 8 ohm speaker (2 watts,  $\pm 2$  db, 50-15,000 cps; harmonic dist. less than 3%) • Preassembled and tested hi-voltage section • Preassembled tuner and 3-stage IF strip • IF has 10 tuned circuits including 2 adjacent channel picture traps, 2 adjacent channel sound traps, and one sound trap • IF response 3.2 mc • Gated AGC and noise canceller • Vertical and horizontal retrace blanking • DC restorer • optional UHF easily added any time • AGC, Height, and Linearity controls available from front • Easy to assemble with circuit board plus wiring harnesses

## Money Back Guarantee

Heath Company unconditionally guarantees that each Heathkit® product assembled in accordance with our easy-to-understand instruction manual must meet our published specifications for performance or your purchase price will be cheerfully refunded.

### The famous Heathkit guarantee

This money back guarantee stands behind every Heathkit. It guarantees that you are getting equipment of the highest quality that will provide years of use and pleasure. Equipment second to none. Heathkit—world pioneer in the exciting hobby of kit building.



by Daystrom

**HEATH COMPANY**  
Benton Harbor 40, Michigan



**FREE**  
**1963 HEATHKIT CATALOG!**  
Largest kit catalog, 100 pages, over 250 easy to build kits. Send today.

Please send my free 1963 Heathkit Catalog.

NAME \_\_\_\_\_

ADDRESS \_\_\_\_\_

CITY \_\_\_\_\_ ZONE \_\_\_\_\_ STATE \_\_\_\_\_

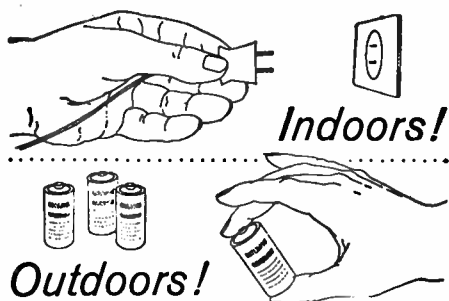

## The Tape Recorder that **WORKS or PLAYS** Anywhere!

With built-in battery and A. C. power, Mirandette is your ideal companion in office, plane, beach or party. Ultra-sensitive dynamic microphone with push button control, instantly captures every word, every mood. Two speeds give up to two hours per reel. Price: less than \$160.00\*, including microphone, 3" super-thin tape, extra reel, AC cord, carrying strap. (Other accessories available). At your camera store or write for illustrated brochure.



Oh that Miranda  
**MIRANDETTE**

ALLIED IMPEX CORPORATION  
300 PARK AVENUE SOUTH, NEW YORK 10, N. Y.  
CHICAGO 35, ILL. • DALLAS 7, TEX. • LOS ANGELES 16, CALIF.  
\*See Your Dealer For Exact Price. © Reg. By Allied Implex Corp., Excl. U. S. Importer  
**CIRCLE NO. 4 ON READER SERVICE CARD**

26

# THE **FOURTH** DIMENSION

A CONSIDERATION OF THE FACTOR OF TIME  
AS IT RELATES TO MUSICAL COMPOSITION

By FREDERIC GRUNFELD

**L**ISTENING to a piece of music, you rarely are conscious of its length. In fact, one of music's peculiar charms is that time virtually ceases for those absorbed in it. Whit Burnett illustrated this in a memorable short story about the "Everlasting Quartet" that played on into eternity, blissfully oblivious of the passing months and years. Few teachers of theory consider duration a factor worthy of analysis, and most students assume the works they study are about as long as is reasonable and proper.

Far from being a tributary issue, however, the time factor is actually basic to Western music. The evolution of instrumental forms, particularly, can be charted as a continuous process of expansion and experiment in the dimension of time. Chapter One of the Genesis of music reads: In the beginning was the song. And the song was short, because untrained voices have little staying power. The natural musical phrase is no longer than the duration of a normal breath, just as the primal beat of music is the musician's own pulse rate. The primitive pattern that emerged merely links a succession of parallel phrases and a concluding phrase. You find it in almost every children's folk song: "Go tell Aunt Rhody, go tell Aunt Rhody, go tell Aunt Rhody the old gray goose is dead." The common children's song lasts hardly a minute, and only the rare sophisticated folk song—usually a strophic ballad—will exceed three.

For centuries, musicians stayed within the natural time limits imposed by the frailties of the human voice. Even in their long, intricate settings of the Mass, church composers worked in multiples of the basic folk-song length. When eighteenth-century craftsmen at last produced instruments that surpassed the voice

in resonance, accuracy, and endurance—including strings and keyboard instruments that could be played without signs of strain for a solid hour—it did not immediately occur to composers to take advantage of this new-found mechanical stamina. Neither they nor their audiences were accustomed to think in terms of long pieces. A psychologist would say they had been conditioned to a short attention-span. For a time the conventions of vocal music were simply transplanted to the instrumental realm.

Bach's works, as Albert Schweitzer points out, are rooted in the Lutheran chorale, and Handel's grow out of the Italian operatic aria of his day. Not the least of Bach's achievements is that he expanded many old forms to gigantic proportions—some of his organ pieces, for example, soar to greater lengths than anyone had ever attempted. Still, Bach gave the world only an inkling that time is a coefficient of drama in music, for he subscribed to the unwritten Baroque rule that a formal unit of music could express just one "affection"; that it must maintain a single mood throughout. A suite or concerto might encompass several different moods, but only in separate compartments: first movement, cheerful; second, thoughtful; third, triumphant; and so on. That was another survival from the old vocal days—one could not sing a dirge and a paean in the same breath.

Instrumental music reached its full growth only after emotional contrasts had become possible, when a movement no longer had to reveal all its intentions in the first few measures, when composers could build climaxes using elements of surprise and deception, of conflict and resolution. This theatrical interplay of light and

(Continued on page 28)

when the British say  
**“the best pick-up arm in the world”**  
 it warrants serious consideration

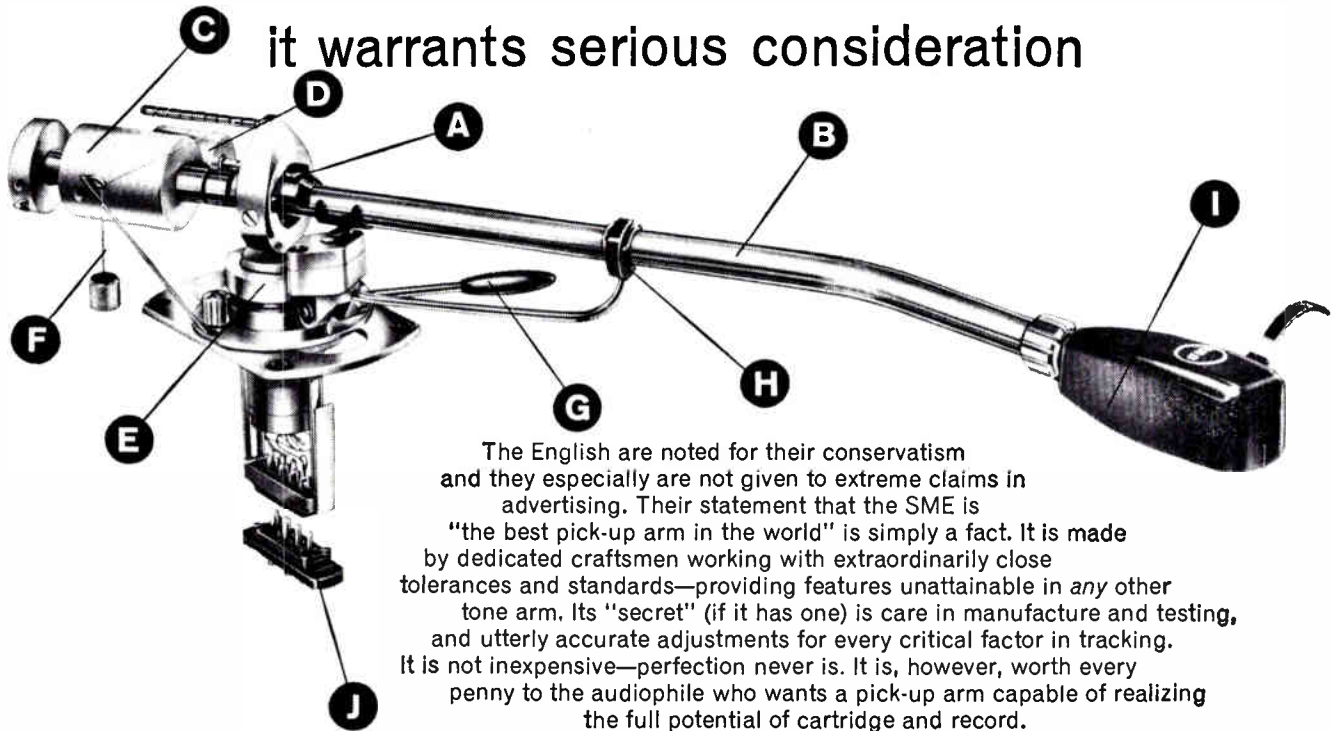

The English are noted for their conservatism and they especially are not given to extreme claims in advertising. Their statement that the SME is “the best pick-up arm in the world” is simply a fact. It is made by dedicated craftsmen working with extraordinarily close tolerances and standards—providing features unattainable in any other tone arm. Its “secret” (if it has one) is care in manufacture and testing, and utterly accurate adjustments for every critical factor in tracking. It is not inexpensive—perfection never is. It is, however, worth every penny to the audiophile who wants a pick-up arm capable of realizing the full potential of cartridge and record.

**SHURE SME DESIGN FEATURES**

**A.** Virtually frictionless knife-edge bearings. Pivot friction is less than 20 milligrams, horizontal and vertical!  
**B.** Wood-lined stainless steel tube arm. Resonances are outside recorded range, of small amplitude, and damped.  
**C.** Unique weight system statically balances arm longitudinally AND laterally.  
**D.** Rider weight adjusts tracking force from ¼ to 5 grams, adjustable for ¼ or ½ gm. increments, as accurate as a fine stylus pressure gauge.  
**E.** Sliding base offers alignment adjustment through 1 inch. Height is adjustable through ¾ inch. Fulfills optimum requirements of length, offset, overhang when adjusted with alignment protractor included.

**F.** “Anti-skating” bias adjuster counteracts tendency of the arm to move toward record center and “favor” inner groove.  
**G.** Hydraulic lever-operated set-down for “slow-motion” feather-light lowering onto any part of the recording.  
**H.** Nylon-jaw arm rest with stainless steel locking link.  
**I.** International standard 4-pin socket. Cartridge shells fitted with detachable pillars and mounting screws at standard ½ inch spacing.  
**J.** Output socket and plug provides a rigid junction for the “stiff wiring” and delicate pick-up lead, eliminating influence on free tone-arm movement.

**PRICES:**

Includes one shell, arm, template, alignment protractor, hardware  
 MODEL 3009 for 12" recordings . . . . . \$89.50 net  
 MODEL 3012 for 16" recordings . . . . . \$99.50 net  
 ADDITIONAL SHELL Model A30H . . . . . \$5.50 each

the  
 perfect companion  
 cartridge

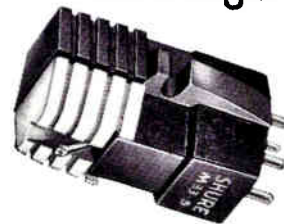

The Shure M33-5, of course. With the SME, provides absolute minimum tracking force . . . without distortion. Incredibly transparent sound. Peak-free high end, clean lows, astoundingly natural and clear in the middle range where most other cartridges suffer serious deficiencies. 22 x 10<sup>-6</sup> cm per dyne compliance. \$36.50 net.

**SHURE S M E** series 2 pick-up arm

LITERATURE:

SHURE BROTHERS, INC., 222 HARTREY AVE., EVANSTON, ILLINOIS

# THE SPOTLIGHT'S ON CONCERTONE 605



## A new standard of perfection from Concertone

Concertone introduces a new standard of perfection in professional quality tape recorders. The 605 brings you the ultimate in advances of the state of the art in tape recorder engineering. ■ Never before have so many features and so much professional quality been packed into one recording instrument...and for such a low price!

### IN THE SPOTLIGHT:

- Precision plug-in head assembly: Includes four precision heads.
- Separate microphone and line controls: Input can be mixed!
- Delay memory control circuit: Never spill or break tape!
- Automatic glass tape lifters: Including electric cue feature!
- Sound on sound and add sound: With convenient front panel switch!
- Solenoid operated brakes: For fast, sure action!
- Three motors: Includes 2-speed hysteresis synchronous drive.
- Automatic rewind: Fast rewinds at end of tape.
- All electric push button operation: Remote control optional.
- Reverse-O-Matic®: Play tape from end to end and back *automatically!*
- New magnetic heads: Ferrite erase, laminated and lapped. 4-track has no reverse channel cross-talk.
- Frequency response: 7.5 ips 50-15 KC  $\pm 2$  db.
- Wow and flutter: Less than .2% R.M.S. at 7.5 ips.

(Model 605 availability, October, 1962.)

(Broadcast Version Model 607: 19" x 14" in size; special plug-in transformers! Availability, January, 1963.)

For complete details of the versatile performer, write to:



**AMERICAN CONCERTONE, INC.**  
A DIVISION OF ASTRO-SCIENCE CORPORATION  
9449 WEST JEFFERSON BOULEVARD • CULVER CITY, CALIFORNIA

AMERICAN CONCERTONE, INC.  
9449 West Jefferson Boulevard • Culver City, California  
ATT: Dept. HSR-163  
Please send me complete information on the new Concertone 605:

name \_\_\_\_\_  
firm name \_\_\_\_\_  
address \_\_\_\_\_  
city \_\_\_\_\_ zone \_\_\_\_\_ state \_\_\_\_\_

FOR EXPORT: J. D. Marshall, Int., 170 W. Washington St., Chicago 2, Ill.

(Continued from page 26)

shadow first appears in the later symphonies of Haydn and Mozart, who created a new attention-span, or timetable, for instrumental forms.

With Beethoven, the orchestra began working overtime. Though his themes are actually short—sometimes less than a natural voice-phrase—Beethoven drives his symphonies to unprecedented lengths. There is seemingly no limit on how far he can carry the simplest musical idea, no end to his persistence in shaping and reshaping some germinal fragment of melody. Beethoven works in giant forms from sheer necessity: he seeks to impress listeners with his own epic vision of the universe, and for that he needs time and still more time.

His example had an unfortunate influence on the later nineteenth-century composers, who came to regard length as a sign of moral superiority. Wagner, Bruckner, and Mahler stretched time limits almost to the breaking point. Some of their less gifted imitators simply maundered along monumentally until they had conductors dropping from sheer exhaustion. Fortunately, Victorian audiences had been softened up by heavy doses of Dickens and Dumas, by architects who built overblown buildings, and by artists who painted expansive pictures.

In our own age of anxiety and distraction, the public attention-span has shrunk once more. Composers retrenched to the point that Anton Webern could write instrumental epigrams lasting less than the primary minute. The effect is like a cold shower after a warm bath. Yet even in this frantic era, when we jiggle our phones too fast and blow our horns too quickly, the pendulum is already swinging back. Musical comedy begins to sound Wagnerian. Jazz, as it moves further away from its vocal origins, tends toward longer and longer pieces, and seems bound on a course paralleling the evolution of classical music. Electronic instruments, being truly tireless, are giving rise to new forms. Interminable lengths threaten, if the radios that blare all day in bars and filling stations are any indication. Future generations may see the day of the Everlasting Electronic Quartet, fed to their homes and offices by computer-composers capable of creating endless variations.

**SEE EVERYTHING IN  
STEREO HI-FI and RECORDING**  
*including Exclusive New Transistorized Equipment*

**FREE**

SEND TODAY FOR YOUR  
MONEY-SAVING 464-PAGE

mail  
now

**ALLIED**

1963 CATALOG

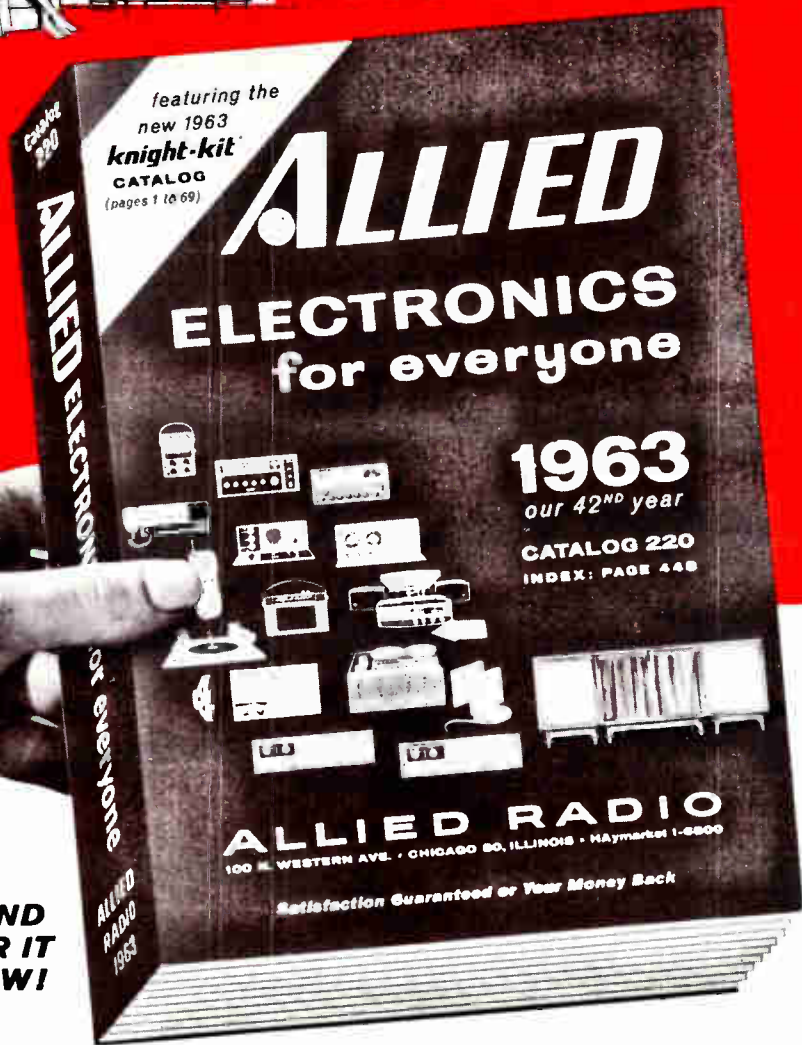

**SEND  
FOR IT  
NOW!**

**WORLD'S LARGEST HI-FI-ELECTRONICS CATALOG**  
**BIGGEST SELECTION • BIGGEST SAVINGS!**

*satisfaction guaranteed or your money back!*

**NO MONEY DOWN:** NOW! MORE BUYING POWER WITH  
YOUR ALLIED CREDIT FUND PLAN

SEE  
OTHER  
SIDE

For your FREE 1963 ALLIED Catalog,  
fill in card, detach and mail. (Please  
give second card to an interested  
friend.)

**SEND  
CARD  
TODAY**

mail  
now

Name  
PLEASE PRINT

Address

City \_\_\_\_\_ Zone \_\_\_\_\_

State \_\_\_\_\_



YOUR **FREE**  
**ALLIED**  
1963 CATALOG

Name  
PLEASE PRINT

Address

City \_\_\_\_\_ Zone \_\_\_\_\_

State \_\_\_\_\_



YOUR **FREE**  
**ALLIED**  
1963 CATALOG

mail  
now

**FREE** SEND CARD  
FOR YOUR  
464-PAGE

# ALLIED

## 1963 CATALOG

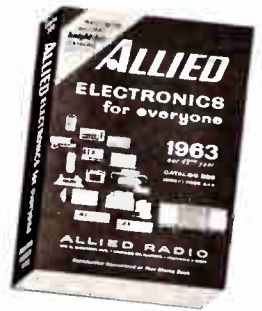

**WORLD'S LARGEST · BIGGEST SELECTIONS · BIGGEST SAVINGS!**

**NEW**

### Best Buys in Stereo Systems, Components & Records



Choose from the world's largest selection of components and complete systems. See the latest All-Transistor Stereo hi-fi and Stereo Multiplex FM. Save most on amplifiers, tuners, speakers and enclosures, record changers and players. Amazing discounts on famous-brand records. Get our unbeatable price on a hi-fi system of your own choice.

**NEW**

### Tape Recorders, Tape and Recording Accessories



Largest selection of complete recorders, including latest Stereo and professional types, tape decks, tape record/play preamplifiers and recording accessories. Unbelievable buys in quality recording tapes. Finest pre-recorded tapes at substantial savings. No greater recording values anywhere.

**NEW**

### MONEY-SAVING **Knight**® STEREO

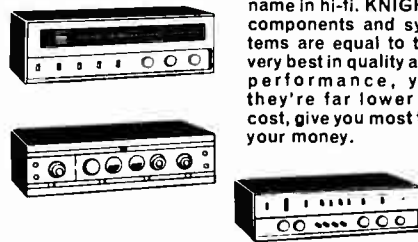

Fastest-growing value name in hi-fi. KNIGHT components and systems are equal to the very best in quality and performance, yet they're far lower in cost, give you most for your money.

### NEWEST **Knight-Kits**®



Build your own—build the best at big savings. It's easy, it's enjoyable to assemble your own KNIGHT-KIT stereo hi-fi—and you get absolutely professional performance and appearance.

**NEW**



### More for Your Money in Beautiful HI-FI Cabinetry

Widest selection in contemporary and authentic period styles—finest woods, construction and finish—at incomparable low cost. Includes complete equipment cabinetry, speaker enclosures of all types, special room-dividers and unique, economical shelf units.

**Save**

### Everything in Electronics for Everyone

- Transistor & FM-AM Radios
- Citizens Band 2-Way Radios
- TV Tubes, Antennas, Accessories
- Test & Lab Instruments
- Parts, Tubes, Transistors, Books
- Phonographs
- Amateur Equipment
- Tools & Hdwe.
- PA Systems & Intercoms

**NO MONEY DOWN:**  
Now! More Buying Power  
with Allied's Credit Fund  
Plan—Up to 24 Months  
to Pay!

*satisfaction guaranteed or your money back!*

**FREE** MAIL CARD TODAY FOR YOUR  
COPY OF THE 1963 ALLIED CATALOG  
**AND GIVE THIS CARD TO A FRIEND**

mail  
now

TO:

**ALLIED RADIO**  
100 N. WESTERN AVE.  
CHICAGO 80, ILL.

PLACE  
STAMP  
HERE

TO:

**ALLIED RADIO**  
100 N. WESTERN AVE.  
CHICAGO 80, ILL.

PLACE  
STAMP  
HERE



## mozart's clarinet quintet

**D**URING the last third of the eighteenth century, musical activities at the court of Mannheim were the envy of the whole continent. Carl Theodor, Duke of Mannheim, was himself a trained musician and brought to his service an impressive array of outstanding composers, conductors, and performers. Indeed, the orchestra at Mannheim may be said to have laid the foundation for our contemporary virtuoso symphony orchestras: in 1772 the English musicologist Charles Burney referred to the Mannheim group as "an army of generals."

In 1777 the twenty-one-year-old Wolfgang Amadeus Mozart visited Mannheim during the course of a concert tour. Not unexpectedly, he was bowled over by the quality of the orchestra, especially by the exotic sound of the two clarinets. "Oh, if only we had clarinets," Mozart wrote to his father. "You cannot guess the lordly effect of a symphony with flutes, oboes, and clarinets."

Mozart lost little time in employing just such a "lordly effect" in composition. On a visit to Paris the following year he was invited to provide a symphony for the season's opening of the brilliant orchestra of the *Concerts Spirituels*, which prided itself on the excellence of its wind players. Finding clarinets at hand, Mozart eagerly included them in the scoring of his new Symphony in D Major (K. 297), the "Paris" Symphony.

From its dawning in this charming work, the romance between Mozart and the clarinet persisted throughout the composer's life. Whenever he was afforded an opportunity to score for clarinet, he invariably did so. But the clarinet was still so new during Mozart's time that its availability was the exception rather than the rule. Sometimes, as in the great G Minor Symphony of 1788, he produced two versions of a work, one with and one without clarinets.

From 1781 to 1791, the last decade of his life,

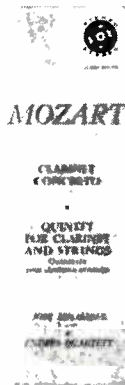

Mozart's charming and easily accessible Clarinet Quintet is given a sensitive and deeply felt performance by Reginald Kell and the Fine Arts String Quartet, beautifully recorded on Concert-Disc. Another stereo version by Jost Michaels and the Endres String Quartet on Vox is straightforward, while London's mono disc contains a fine reading by Alfred Boskovsky and members of the Vienna Octet.

Mozart lived in Vienna. The court orchestra had a superb first clarinetist named Anton Stadler, with whom Mozart soon developed a close friendship. From Stadler Mozart learned the capacities and the limitations of the instrument and for him he composed a series of works that explored the clarinet's resources with wondrous perception and penetration. Among them are the Trio in E-flat for Clarinet, Viola, and Piano (K. 498), the Clarinet Concerto in A Major (K. 622), and the Quintet in A Major for Clarinet and String Quartet (K. 581).

Alfred Einstein, the late Mozart scholar, in his study of the composer (*Mozart*, Oxford University Press, 1945) writes that the Clarinet Quintet is "a chamber music work of the finest kind, even though the clarinet predominates as *primus inter pares*.... There is no dualism here between solo and accompaniment, only fraternal rivalry." I have long felt that the Clarinet Quintet, with its clarity, long-breathed melodies, pages of hushed pathos, and final rollicking good spirits is the ideal introduction to the rarefied atmosphere of the chamber-music literature. Few can help but love this work, and from it relatively simple steps lead to Mozart's other chamber music, to the quartets of Haydn, to the early Beethoven quartets, and so *per ardua ad astra*.

The Clarinet Quintet is in four movements: an opening Allegro that emphasizes the general agility of the clarinet; a Larghetto of sustained, soaring melodic invention; a Minuet and Trio that actually has two trios, the first written for the strings alone, the second for the clarinet, with the strings accompanying; and a concluding Theme and Variations that is a kaleidoscope of shifting moods ending in a playful romp.

FOR YEARS during the 1930's and 1940's the standard recorded performance of the Quintet was Benny Goodman's with the Budapest String Quartet, an RCA Victor 78-rpm album. The recording was made at the height of his fame as the "King of Swing," but nowhere did Goodman permit himself the free-wheeling geniality and warmth that made great experiences of such swing classics as *Don't Be That Way*, *One O'Clock Jump*, or *Sing, Sing, Sing*. Rather,

perhaps cowed by the "serious" milieu, Goodman adopted a dead-pan performing demeanor that resulted in ennui. Goodman has twice rerecorded the score for LP, once with the American Art Quartet from California (Columbia ML 4483), and, about seven years ago, with the Boston Symphony String Quartet (RCA Victor LM 2073). Unhappily, both reveal the same inhibitions as the oldest one.

Another clarinetist who has recorded the Quintet three times is the distinguished English musician Reginald Kell. His first performance, with the Philharmonia String Quartet, had a brief currency in this country on Columbia toward the end of the 78-rpm era. It was an alert, sensitive performance, deeply felt and beautifully recorded. Kell's two subsequent performances of the music on LP—with Chicago's Fine Arts String Quartet (Decca DL 9600, and a later performance, Concert-Disc 1203, also available in stereo as Concert-Disc 203)—are noticeably more superficial. His playing is technically superb, however, and the stereo version of the Concert-Disc performance offers remarkably transparent sound.

Of the remaining five recordings currently listed in the Schwann catalog, Westminster's (XWN 18269) by Leopold Wlach with the Vienna Konzerthaus Quartet is a humorless, heavy-handed approach, while Columbia's (MS 6127, ML 5455) with David Oppenheim and the Budapest String Quartet seems too carefully planned.

London Records, which once had a superb recording of the Quintet in its catalog by Antoine de Bavier with the New Italian String Quartet (LL 573), withdrew that performance when it issued a newer one by Alfred Boskovsky and members of the Vienna Octet (CM 9121). This is a warm, sensitive reading, lacking a little in spontaneity, but my own favorite among the versions currently available.

If stereo is your prevailing consideration, I commend to your attention the performance on Vox (STPL 511110) by Jost Michaels with the Endres String Quartet, a straightforward, unpretentious account of the score that is complete on a single side, allowing for a performance of the Clarinet Concerto with the same direct virtues on the reverse side.





*Here's why you need this amplifier...*

Marantz Model 8B, Dual 35-watt Stereo Amplifier, \$264.

There are three amplifier characteristics which determine the realization of maximum performance quality from a given loudspeaker. First in importance is stability (a characteristic which is not fully understood by many in the industry). Next in importance are low distortion and wide power response. These are the prime factors which make one amplifier sound better than another. In *all* these respects the Marantz Model 8B is conceded to be in a class by itself. Other designs may have succeeded in approaching one or another performance characteristic, yet none have equalled the 8B amplifier in overall excellence. In fact, except for its conservative 35 watt rating, it is virtually identical in characteristics to the remarkable Marantz Model 9 amplifier.

Long term reliability is also important to the owner. As is true with all Marantz products, parts and construction are of the highest grade in the field. An individual report is packed with each amplifier stating its performance under rigid tests. Assurance of the continuation of its fine performance is backed by a full two year warranty.

The vast majority in the high fidelity industry use Marantz in their own personal systems, as well as for demonstrations and tests of their products. Follow their lead where only the best possible results are acceptable. Send for free booklet 56V.



The precision quality of the Model 7 Stereo Preamplifier makes it a perfect match for the 8B Amplifier. \$264. Cabinet extra

**marantz**

25-14 BROADWAY, LONG ISLAND CITY 6, NEW YORK

# The pace-setting new S-2100 FM Multiplex/AM stereo tuner

## THE EXTRAS THAT ARE STANDARD ON SHERWOOD



**Stereo Light . . .** Gives instant identification of those FM stations broadcasting stereo programs. Special sensing circuitry (pat. pend.) prevents false indication due to noise impulses, etc.



**Wide Band 3-mc Gated-Beam Limiter and 1-mc Balanced Ratio Detector . . .** Combine to suppress the background noise introduced by stereo FM, and create the pace-setting capture effect of 2.4 db.



**Automatic Frequency Control . . .** Electronically locks and holds the exact center of separation of the FM stereo signal.

**Fly Wheel Tuning . . .** Made with turntable accuracy for easiest, fastest tuning.



**FM Interchannel Hush . . .** Eliminates irritating "rushing" sound between stations when tuning.

**Dial Spread . . .** Only Sherwood offers communication-type 20% longer scales, with professional calibrations for slide-rule accuracy.

### specifications

**FM Sensitivity:** 1.8  $\mu$ v. for -30 db. noise and distortion (IHFM). **FM Selectivity:** 200 kc. @ -3 db. **FM Detector:** 1.0 Mc peak to peak. **FM Distortion:** 1/3% at 100% mod. 14 tubes plus rectifier plus 9 diodes.

### SHERWOOD MODEL SL-1 STEREO INDICATOR LIGHT



The only indicator light that rejects all false signals and identifies only true stereo broadcasts. Adjustable sensitivity — functions with any FM tuner. Small enough (2 1/4" x 2 1/2" x 7 1/2") to mount inside cabinet. \$29.50.

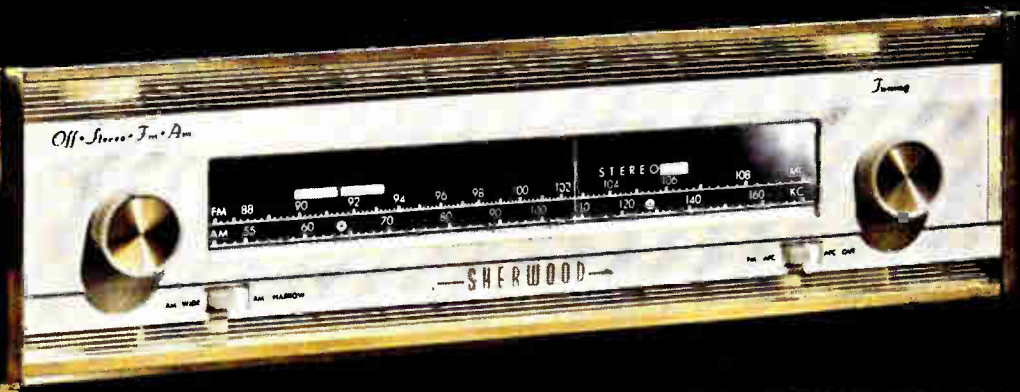

S-2100 Tuner: \$199.50. (Fair Trade). With Walnut Leatherette Case, \$207.00. Full year warranty.

## Who cares whether the coils are wound on Mylar\*? Only Sherwood—and you.

A good modern stereo tuner may contain over 1,000 component parts. Among those especially critical to sound quality are a dozen or more coils. These coils are the "nerve ends". They can make or break performance on drift . . . distortion . . . selectivity . . . sensitivity.

No place for a "standard" part, we feel.

That's why Sherwood—and Sherwood alone—custom designs all its coils. Only Sherwood winds them on low-loss Mylar forms. And Sherwood employs temperature-compensating ceramic capacitors across all its IF coils.

These refinements cost more, but the result is worth it: Complete freedom from temperature and humidity variations guaranteeing precise tuning . . . minimum distortion . . . no loss of sensitivity.

The Sherwood Coil is just one reason why we say "the care that goes in determines the quality that comes out".

For complete brochure, write Dept. R-1.

Sherwood Electronic Laboratories, Inc. • 4300 North California Avenue, Chicago 18, Ill.

# Sherwood

High Fidelity

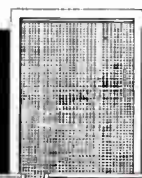

Stereo Receivers • Tuners • Amplifiers • Multiplex Adapters  
Stereo Light Adapters • Contemporary Cabinetry

\*DuPont Reg. T.M.

# TECHNICAL TALK

by JULIAN D. HIRSCH

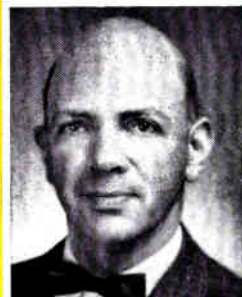

**T**HE NEED for matching the channels of a stereo system has long been debated. For the most part, it has been a one-sided debate, since almost everyone has conceded that matching is highly desirable. However, a few dissenters still hold that speakers with different tonal characteristics may actually enhance the stereo effect.

Disregarding this point of view for the moment, it is obvious that anyone who is assembling a stereo system from the beginning will inevitably obtain matched amplifiers, since all modern stereo amplifiers are actually two identical units constructed on one chassis. If the unit is an integrated amplifier, there remains little for the user to do except connect the inputs and outputs, and not much likelihood of difficulty.

Many of us have had mono systems for some time, and are reluctant to throw out perfectly good components in favor of more modern stereo types. In the case of the power amplifier, almost any combination of units will give satisfactory results, so long as the amplifiers are compatible with the speakers' power requirements. If two dissimilar amplifiers require different input levels for balanced outputs, their input-level controls should be adjusted for matched outputs. If they have no level adjustments, the preamplifier's level-setting adjustments will serve the same purpose. In the case where neither of these control facilities exist, the balance control will do the same job.

The only real problem is in matching the speakers. It would seem desirable for both speakers to have the same frequency-response characteristics. Large differences in response inevitably will result in a side-to-side shift of certain instruments as they are favored by one speaker or the other. A shift in balance of only about 3 db will cause the apparent position of the sound to change noticeably, and it is a rare speaker system whose response can be controlled to this tolerance in production. A few speakers are this good, but under practical listening conditions, speaker placement and room environment can easily introduce much larger apparent response variations, regardless of the intrinsic merits of the speakers.

As it happens, I rarely use matched speakers for stereo listening. With a steady flow of speaker systems of all types coming to me for testing, I have had

considerable experience in pairing off loudspeakers of different makes and models. I find that for best results the musical character of the speakers should be fairly well matched. For example, some speakers sound warm and mellow, some sweet and light, while others are bright and have a great deal of presence. Even a brief audition will reveal the basic character of a speaker.

So long as I avoid pairing speakers of obviously different characteristics, such as one with presence and one with a depressed mid-range response, I get excellent stereo performance. Of course, if one is assembling a stereo system from scratch, it is best to get two identical speaker systems, since they are more likely to harmonize with one another.

## SHURE M222 STEREO DYNETIC



● WHEN THE Shure Studio Dynetic was introduced some six years ago, it represented a radically different approach to pickup design. It was an integrated arm and cartridge, with an arm that did not move in the vertical plane. The cartridge was pivoted for vertical motion near the head of the arm and was capable of tracking severely warped records without producing audible wow, since its pivots were nearly in the plane of the record.

With the advent of stereo, Shure developed the first Stereo Dynetic, designated the Model M212, which required a minimum force of about  $1\frac{1}{2}$  grams and had a stylus compliance of about  $9 \times 10^{-6}$  cm/dyne. Recently there has been a trend toward extremely compliant styli, operating with correspondingly low tracking forces. As a result, Shure has now introduced the M222 Stereo Dynetic pickup, with a stylus compliance of  $22 \times 10^{-6}$  cm/dyne, and a 0.5-mil stylus instead of the former 0.7-mil stylus. The range of track-

ing forces of the M222 is from  $\frac{3}{4}$  gram to  $1\frac{1}{2}$  grams. As received from the factory, the unit I tested was set for a tracking force of  $1\frac{1}{2}$  grams, and this force was used through most of my tests. Lower forces can be used, since the pickup tracked very high-velocity test records satisfactorily at about 1 gram.

Using the CBS STR-100 test record, the frequency response of the M222 was within  $\pm 2\frac{1}{2}$  db up to 18,000 cps on one channel, and  $\pm 1\frac{1}{2}$  db up to the same frequency on the other channel. Channel separation was 25 to 30 db at middle frequencies, and remained as high as 5 to 10 db up to 20,000 cps. This is exceptionally good performance. The output of 6.8 millivolts at 5 cm/sec velocity at 1,000 cps is typical of most good modern pickups, and is sufficient to drive any standard preamplifier.

The tracking error of the arm, mounted according to the instructions, was rather high for a top-quality pickup, and reached its maximum of 6 degrees at a 2-inch radius, resulting in a distortion index of 3 degrees per inch. Although I could hear no unpleasant effects from this, it was still surprising for such a fine pickup to have so high a tracking error.

The listening quality of the Shure M222 was excellent, with a musical sweetness and definition that was to be expected from a pickup with such an extended, smooth frequency response. Needle talk was very low, and the pickup was not particularly sensitive to induced hum. Like its predecessors, the Stereo Dynetic was almost totally insensitive to jarring, even at tracking forces of 1 gram or less, and the mechanical design of the arm made it impossible to scratch or damage records.

The M222, which has a 12-inch arm, sells for \$89.50. Also available at the same price is the 16-inch M226. Owners of the popular Shure M3 and M7 cartridges who wish to modernize them can purchase for \$24.75 the N22D stylus used in the Stereo Dynetic pickups. Most of the performance characteristics of the M222 can be obtained by installation of the N22D stylus.

#### CONCORD 880 TAPE RECORDER

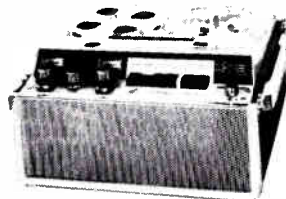

● THE CONCORD 880 is a portable tape recorder equipped for making four-track stereo or mono recordings and for playing back two-track or four-track stereo or mono tapes. The machine is housed in a handsome portable case, which is extensively reinforced at all edges with polished metal frames. Inside and out, the Concord 880 is constructed extremely ruggedly.

The recorder has separate record and playback

heads, allowing the use of optimum head gaps for both functions. This eliminates the compromise in gap design required when a combined record-playback head is used. Unfortunately, the same amplifiers are used for recording and playback, preventing the user from monitoring the tape while making a recording.

Electronic functions are selected by a single four-position switch. Colored lights indicate whether a program is being recorded or played back. A short cable supplied with the recorder interconnects the two amplifiers for making sound-on-sound recordings. Each channel has its own record-playback level control. Concentric with these are tone controls, which operate during playback only. A master volume control, combined with the power switch, controls playback volume through the internal monitor speakers.

The Concord 880 has one of the most foolproof transport mechanisms I have seen. Piano-key buttons control fast forward, reverse, normal tape motion, record, and stop. There is also an instant-stop button for cueing or editing purposes. To prevent accidental erasure, the record button must be operated simultaneously with the play button for making recordings. The machine can be switched from fast forward to rewind without any tape slack or excess tension. The button halts the tape in a fraction of a second, with no risk of damaging even half-mil tape. This remarkable performance is obtained with only one motor, plus some very effective brake mechanisms.

There are three operating speeds:  $1\frac{7}{8}$  ips,  $3\frac{3}{4}$  ips, and  $7\frac{1}{2}$  ips. The  $7\frac{1}{2}$ -ips playback response was excellent, measuring  $\pm 2\frac{1}{2}$  db from 30 to 15,000 cps. The over-all record-playback response at  $7\frac{1}{2}$  ips was  $\pm 3$  db from 50 to 12,000 cps. At  $3\frac{3}{4}$  ips it was  $\pm 4$  db from 50 to 8,000 cps, and at  $1\frac{7}{8}$  ips it was  $\pm 2\frac{1}{2}$  db from 60 to 3,500 cps.

The excellent mechanical design of the transport was reflected in the wow and flutter measurements, which were 0.07 per cent and 0.12 per cent at  $7\frac{1}{2}$  ips, 0.18 per cent and 0.20 per cent at  $3\frac{3}{4}$  ips, and 0.3 per cent and 0.25 per cent at  $1\frac{7}{8}$  ips. Rewinding 1800 feet of tape required  $2\frac{1}{4}$  minutes. The hum level of the machine I tested was rather high, -35.5 db referred to maximum recording and playback level. It was not noticeable when using the built-in monitor speakers, but it was clearly audible on a wide-range external speaker system.

The Concord 880 is supplied complete with two dynamic microphones (which are of quite good quality), all necessary cables, a right-channel speaker mounted in the removable cover, and a built-in left-channel speaker. Although the 880's performance is excellent in many respects, I would recommend that the buyer carefully check the unit he gets to ascertain that the hum level is not too high for comfort.

The Concord 880 is priced at \$399.95.

For additional product information, use the reader service card. Circle number 188 for the Shure Model 222, number 189 for the Concord 880 tape recorder.

Heifetz-Kreisler  
*Hindemith-Kabalevsky*  
 Horne-Kitt  
**Humperdinck - Kodaly**  
 Hampton-Krupa  
*Haydn - Krenek*  
 Hammerklavier-Kreutzer  
**Handy - Kern**  
 Holst - Ketelbey  
**Hovhanness - Kay**  
 Horowitz - Katchen  
 Honegger - Khachaturian  
 Hanson - Klemperer

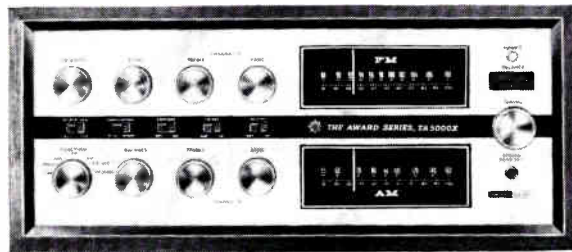

## Harman-Kardon

A new musical parlor game: "H-K". The rules are simple. Just start with Harman-Kardon. The rest will be pure pleasure. Harman-Kardon makes the handsome instrument you see above—the Stereo Festival III. It has much to do with how you hear your musical H's and K's.

The Festival brings out the sweetness of an early Haydn symphony or the tartness of a late Krenek sonata; the true sound of Heifetz the fiddler or Krupa the drummer.

H-K's Stereo Festival III is a high fidelity component—the electronic heart of your stereo home music system. It is made with all of the care and precision reserved for professional instruments. And yet it is remarkably easy to install and operate.

The Festival is the ideal way to start your home music system. One handsome chassis includes a sensitive AM/FM Stereo Multiplex tuner; a versatile stereo pre-amplifier and a powerful 50 watt stereo amplifier. To complete your stereo system, just add two speakers and a record player.

You will hear Horowitz and Holst, Kreisler and Kabalevsky as you've never heard them before—reproduced flawlessly by a precision stereo instrument. Visit your high fidelity component dealer for an exciting demonstration of the Festival and other fine H-K instruments including the famed Citation and Award Series.

Meanwhile, here's a gentle challenge for all music lovers. We'd like to see your list

of musical H's and K's. Originality and obscurity count more than neatness. Dash off a list and send it to us. We'll send you a useful brochure on high fidelity prepared by the Institute of High Fidelity Manufacturers and free literature describing the Stereo Festival III and other fine H-K products. Perhaps we'll even use your suggestions for another H-K ad. Write to Harman-Kardon, Dept. R-1 Plainview, N.Y.

The new Award Stereo Festival III, Model TA5000X is \$319.95. The optional, hand-rubbed walnut enclosure is \$29.95.

harman kardon

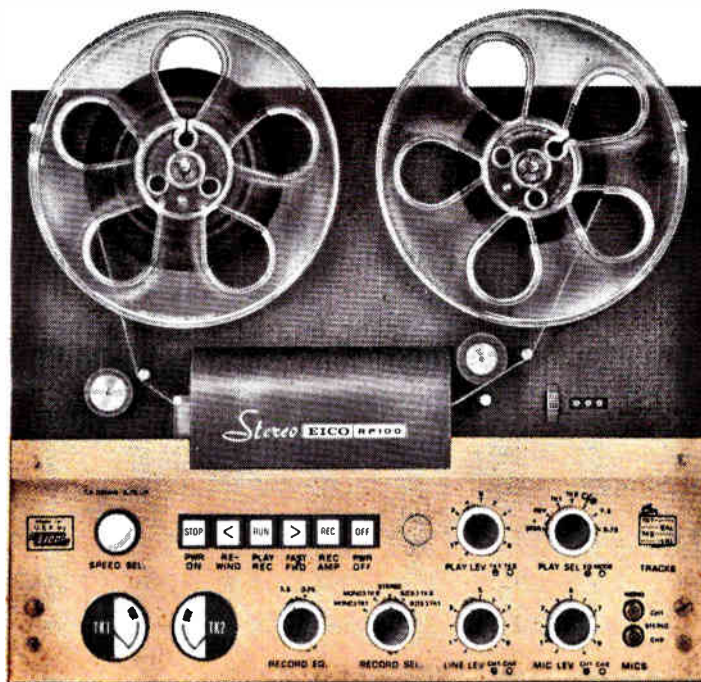

# 9 New Features Now In The New EICO RP100 Transistorized Stereo/Mono 4-Track Tape Deck

**A great tape recorder made greater:**

1. New professional studio recording hysteresis-synchronous capstan motor: 24 stator slots for ultra-smooth drive, ultra-quiet and vibrationless professional bearing system.
2. Two new take-up and rewind reel motors, both extra-powered for effortless operation.
3. New cored-out steel capstan flywheel with all the mass concentrated at the rim for improved flutter filtering.
4. New optimally designed capstan drive belt brings wow down to negligibility.
5. New relay provides instantaneous extra power to the take-up reel motor at start to minimize tape bounce. Provides near-perfect stop-and-go operation and eliminates any risk of tape spillage when starting with a nearly full take-up reel.
6. New automatic end-of-tape stop switch cuts off take-up reel motor power. Also permits professional editing techniques, whereby tape being edited out runs off the machine while you are listening to it.
7. Playback preamps remain "on" during stop-standby mode to permit cueing.
8. Recording level adjustment during stop-standby.
9. Shock-absorbent helical spring tape lifters practically eliminate tape bounce at start of fast winding.

## And All These Well-known RP-100 Features:

Separate stereo 1/4 track record and playback heads permitting off-the-tape monitor and true sound-on-sound recording; separate transistor stereo record and stereo playback amplifiers meeting true high fidelity standards; monaural recording on 4 tracks; digital turns counter; electrodynamic braking (no mechanical brakes to wear out or loosen); all-electric push-button transport control (separate solenoids actuate pinch-roller and tape lifters); unequalled electronic control facilities such as mixing mic and line controls, two recording level meters, sound-on-sound recording selected on panel, playback mode selector, etc. Modular plug-in construction.

**Wow and flutter:** under 0.15% RMS at 7 1/2 IPS; under 0.2% RMS at 3 3/4 IPS. **Timing Accuracy:** ± 0.15% (± 3 seconds in 30 minutes). **Frequency Response:** ± 2db 30-15,000 cps at 7 1/2 IPS, 55db signal-to-noise ratio; ± 2db 30-10,000 cps at 3 3/4 IPS, 50db signal-to-noise ratio. **Line Inputs Sensitivity:** 100mv. **Mike Inputs Sensitivity:** 0.5mv.

**Semikit: Tape transport assembled and tested; electronics in kit form \$299.95**  
**Factory-assembled: Handwired throughout by skilled American craftsmen \$399.95**

An original, exclusive EICO product designed and manufactured in the U.S.A. (Patents Pending)

**Carrying Case \$29.95**  
**Rack Mount \$9.95**



**FM-AM Stereo Tuner ST96**  
 Kit \$89.95 Wired \$129.95  
 Includes Metal Cover and FET



**70-Watt Integrated Stereo Amplifier ST70 Kit \$99.95\* Wired \$149.95\***  
**40-Watt Integrated Stereo Amplifier ST40 Kit \$79.95\* Wired \$129.95\***  
 \* Includes Metal Cover



**FM Multiplex Autodaptor MX99 (Patent Pending):**  
 Kit \$39.95  
 Wired \$64.95  
 Cover Optional \$2.95

**New Stereo FM MULTIPLEX TUNER ST97**  
 Semi-Kit \$99.95 Wired \$149.95  
 Includes Metal Cover and FET

Another brilliant example of EICO's no-compromise engineering, the new EICO ST97 combines the features of station-monitor quality and fringe-area reception capabilities with exceptional ease of assembly for the kit-builder. No test or alignment instruments are needed. The two most critical sections, the front-end and the 4-IF stage circuit board, are entirely pre-wired and pre-aligned for best performance on weak signals (fringe area reception). The front-end is drift-free even with AFC defeated. The four IF stages and 1MC-wide ratio detector achieve perfect limiting, full-spectrum flat response, very low distortion, and outstanding capture ratio. The 10-stage stereo demodulator—EICO's famous zero-phase-shift filterless detection circuit (pat. pend.)—copes successfully with all the problems of high fidelity FM stereo demodulation and delivers utterly clean stereo outputs. Excellent sensitivity, selectivity, stability, separation and clean signal add up to superb fringe-area reception. The automatic stereo indicator and station tuning indicator travel in tandem on twin slide-rule dials. **Antenna Input:** 300 ohms balanced. **IHFM Usable Sensitivity:** 3µV (30 db quieting), 1.5µV for 20db quieting. **Sensitivity for phase-locking (synchronization) in stereo:** 2.5µV. **Full Limiting Sensitivity:** 10µV. **IF Bandwidth:** 280kc at 6 db points. **Ratio Detector Bandwidth:** 1mc p-p separation. **Audio Bandwidth at FM Detector:** Flat to 53kc discounting pre-emphasis. **IHFH Signal-to-Noise Ratio:** —55db. **IHFH Harmonic Distortion:** 0.6%. **Stereo Harmonic Distortion:** less than 1.5%. **IHFH IM Distortion:** 0.1%. **Output Audio Frequency Response:** ±1db 20cps-15kc. **IHFH Capture Ratio:** 3db. **Channel Separation:** 30db. **Audio Output:** 0.8 volt. **Output Impedance:** low impedance cathode followers. **Controls:** Power, Separation, FM Tuning, Stereo-Mono, AFC-Defeat.

Over 2 MILLION EICO Instruments in use. Most EICO Dealers offer budget terms. Add 5% in West.  
 © 1963 EICO Electronic Instrument Co. Inc.  
 3300 Northern Boulevard, L. I. C. 1, N. Y.

**EICO, 3300 N. Blvd., L.I.C. 1, N.Y. HR-1**

Send free 32-page catalog & dealer's name

Send new 36-page Guidebook to HI-FI for which I enclose 25¢ for postage & handling.

Name \_\_\_\_\_

Address \_\_\_\_\_

City \_\_\_\_\_ Zone \_\_\_\_\_ State \_\_\_\_\_

\*Actual distortion meter reading of derived left or right channel output with a stereo FM signal fed to the antenna input terminals.

Listen to the EICO Hour, WABC-FM, N. Y. 95.5 MC. Mon.-Fri., 7:15-8 P.M. Export Dept., Roburn Agencies Inc., 481 Greenwich St., New York 18

# THE SOUND OF

## HISTORICAL UPS AND DOWNS IN THE QUEST FOR AN ELUSIVE STANDARD PITCH



GAFURIUS, THEORICA MUSICA, 1492

*By measuring the string of a monochord, an instrument that retained its name even after it acquired more than one string, the philosopher Pythagoras established the mathematical ratios of the principal intervals in the sixth century B.C.*

By KLAUS GEORGE ROY

**N**OT LONG ago I put on my favorite recording of the Beethoven "Pastoral" Symphony, the old and still wonderful Toscanini version. Something about the first phrases struck me as peculiar. They seemed a bit warmer in color, and at the same time a little brighter than usual, not quite the way I recalled them. And the Maestro's tempos, notoriously a shade on the fast side, seemed almost hectic. Was the trouble with me or the record? Did it have something to do with my playback system?

I had a sudden hunch. I tried an F on the piano. It sounded lower than the first note of the symphony,

so the turntable must have been revolving faster than  $33\frac{1}{3}$  rpm. My *Arrival in the Country* was more than halfway to F-sharp. At that rate, the *Thunderstorm* would have been of hurricane velocity. Beethoven, if he could have heard it, would have thrown one of his famous fits.

As a matter of fact, Beethoven might have been outraged even if the turntable had been running at the right speed. For the A to which he tuned his inner hearing was not the same pitch as our A. It was somewhat lower, by about fifteen cycles per second. So it seems that what we have been taking for granted is

# THE SOUND of A

really a complex and variable matter. Just what is this thing we call pitch?

Percy Scholes, in *The Oxford Companion to Music*, explains it thus:

The pitch of sound is determined by the frequency of the original sound-producing body and, hence, of the transmitting air. Slowly succeeding vibrations cause what we call "low" sounds; rapidly succeeding ones what we call "high" sounds.

When a violin string is set in motion by a bow or a finger, it vibrates. So does an air column in a clarinet when its mouthpiece is blown upon, or in your windpipe when you expel air through your vocal cords. The science of acoustics can count the frequency of these vibrations; the ear hears the sound and the mind gives it a name: A, B, C-sharp. The A we are most familiar with corresponds to 880 vibrations per second, or 440 double vibrations or cycles. It makes no difference whether it is loud or soft, whether a flute or a trombone makes the sound—440 cycles per second (cps) give us an A above middle C.

But the variations on the theme of A are legion. The 1954 *Grove's Dictionary of Music and Musicians* has fifteen pages on standard pitch, and the first thing it tells us is that in 1939 the International Standards Association decided that a frequency of 440 cps was to be the pitch for A above middle C, and that "this value shall be maintained within the closest limits possible by soloists, orchestras, choirs, etc., throughout all musical performances and also in recorded music."

If this decision had the force of law, the docket would be full of transgressing musicians. Some of the offenses are deliberate, but some are accidental, as when a recording engineer fails to notice changes in the voltage that raise or lower the pitch by speeding or slowing a tape—either for a horrible moment, as in the old Bruno Walter recording of Beethoven's Ninth, or for an entire record.

The very establishment of an internationally acceptable pitch is something of a wonder when you consider that, historically, there have been dozens, perhaps hundreds, of different A's. Some clavichords and organs from the eighteenth century had A above middle C between 370 and 440 cps—from a minor third to a major second lower than ours. And in earlier centuries, some A's went up to 496 cps, one even retaining that pitch-name, according to notation, at 567 cps. One can imagine the difficulties encountered in performing pieces for organ and orchestra in different localities where the keyboard pitches differed. In the old days, trumpet and horn players always carried toolboxes full of extra crooks—extension pipes—so they could adapt their tuning to the organs'. It was possible to tune strings without much trouble, but what could they have done with flutes and oboes?

**T**O ESTABLISH at least local standards, musicians in the time of Bach and Handel made use of *Kammer-Ton* and *Chor-Ton*—chamber pitch and choir pitch. One was used for music performed in the king's private chamber and the other for music performed in church with voices. There were even a high chamber pitch, a low chamber pitch, and other varieties. To draw all of these divergencies together for a performance must

*Generally considered the father of our system of pitch notation, the eleventh-century Benedictine monk Guido of Arezzo (shown here with his pupil Theodal at a monochord with pitch notations) was probably the perfecter of ideas proposed earlier by others. A quotation from the famous hymn "Ut queant laxis" (see first two Latin lines, opposite page) gives, with their associated neumes, or staffless pitch-signs, the rising syllables ut, re, mi, fa, sol, and la, the device with which Guido identified and taught the natural hexachord, and which still remains the basis for our solmization.*

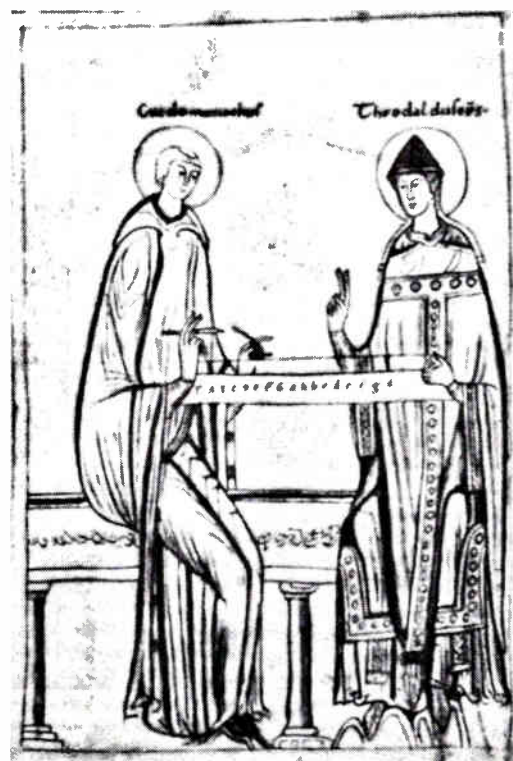

COD. 51 (BL. 35 V), NATIONALBIBLIOTHEK WIEN



have been a grim job, and sour intonation appears to have been quite common. All accounts point to unbelievable chaos in late Baroque pitch conventions.

A century later matters were not appreciably improved. An Italian scholar reported around 1820 that: the pitch of Rome is, in fact, much lower than that of Milan, Pavia, Parma, Piacenza, and all the other cities of Lombardy, and the pitch of Paris is not only sharper than that of Rome but much sharper than that of Lombardy. . . .

These conditions led to a musical congress in 1885 to establish *un corista di mezzo*, literally translated as "a mean pitch." The attempt was unsuccessful.

**I**N 1879, Adelina Patti simply refused to sing at the high English concert pitch of A-455, and who could blame her? Wagner had already been struck by this injustice in 1877, when he conducted in London. He "complained bitterly of the inconvenience his singers had been put to because the pitch to which they were obliged to sing here was so much higher than the pitch they were accustomed to." Perhaps it was the reaction of these two awesome figures that led the English in 1896 to set a standard "Philharmonic pitch" at A-439. They added an optimum temperature specification of 68 degrees Fahrenheit, "at which degree of heat the orchestra, the organ, and the piano should be in tune together." Thus they came to grips with another variable affecting pitch. Orchestra musicians will tell you that during a concert, as the players' labor heats the surrounding air, the pitch will go up noticeably. It is because the pitch of the oboe is least affected by temperature changes, as well as mechanical adjustments, that it usually sounds the tuning A.

In our own day, despite improved means of controlling pitch vagaries, togetherness is only achieved with some care. Of all the musical components of a concert ensemble, a choir is the most flexible, and so it must unquestioningly adopt the pitch proposed by the orchestra—high or low, steady or fluctuating. Woe to the singer who decides on a *Chor-Ton* of his own! Archibald T. "Doc" Davison used to warn his Harvard and Radcliffe choristers: "Flat, and the world flats with you; sharp, and you sharp alone." This seems a clear case of moral gravity: it is always easier to drag people down than it is to uplift them. Soloists carry more weight in such matters, and it takes a valiant conductor to tug them back into line. When a famous soprano was having trouble staying with the pitch of the orchestra accompanying her in rehearsal, the conductor (it *must* have been Sir Thomas) finally halted the proceedings with the request, "Madame, would you kindly give us *your* A?"

In the light of history, the abused soloist might justifiably have felt her A was as valid as the next person's. The inimitable Florence Foster Jenkins had every right to assert that she was grateful to have suffered an auto accident because afterward she could sing a higher F than ever before. As we have seen, there is indeed such an F, and musicians can only question La Jenkins's judgment in asserting her independence of the F everyone else was using. At concerts, audiences and critics do not generally give a soloist the benefit of the doubt. Even if a singer, violinist, or cellist has an especially keen sense of pitch, but hasn't made the conscious or unconscious adaptation to the pitch of the accompanying instruments, it won't help when the reviews come out. (Continued overleaf)

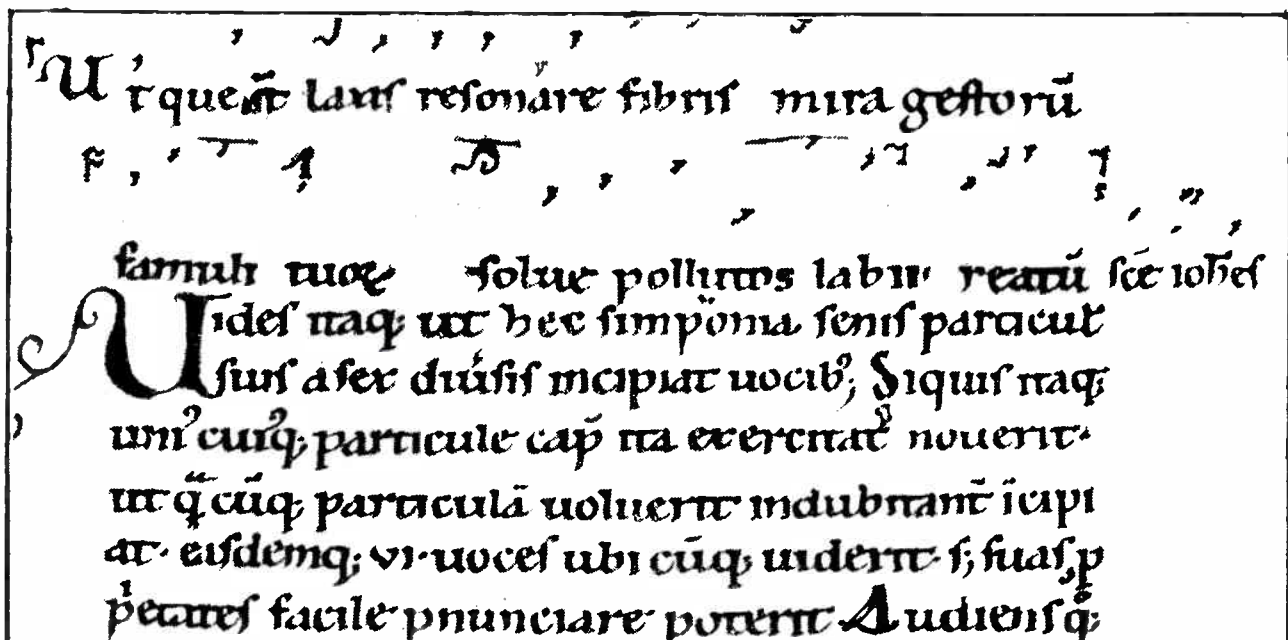

CODEX 2503. NATIONALBIBLIOTHEK WIEN

# THE SOUND of A

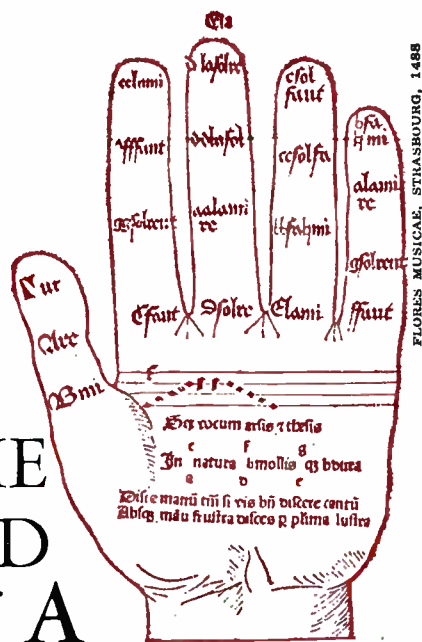

The "Guidonian Hand," teaching solmization of the hexachord.

Fortunately, the average soloist is willing to compromise in such matters, since most often his own sense of pitch is only relative anyway. But there remains a troublesome minority who have what is called perfect pitch. If you have it, and are asked for an A or a C-sharp, you can sing it precisely, as if you were a walking pitch pipe. Of course, some objection can be taken to the term "perfect pitch": pitch memory needs a reference point—an A-440, for example—and this has varied with the conventions already discussed. Sir Donald Francis Tovey once defined perfect pitch as "the pitch of your mother's piano."

Whatever the foundation for pitch memory, perfect pitch is a dubious gift for musicians. Choral directors sometimes require their groups to transpose a piece into another key at sight, in order to make it more comfortable to sing. Such cases turn the pitch-perfect choristers into musical schizophrenics, because they find it sheer agony to read in one key and sing in another. A similar plight is that of orchestral players who use transposing instruments, like clarinets in B-flat and horns in F, traditionally scored in a different key from the rest of the orchestral score. They must eternally read one note and hear their instruments play another.

But even a musician who has only relative pitch can detect when the pitch is incorrect. The feeling or color of the sound—orchestra, ensemble, solo—does not seem right to him. A person with a well-developed sense of relative pitch may be able to tell the key of a piece that follows a work, for instance, that he knows to be in the key of D Major. A listener with an advanced ear may be so familiar with the tone colors of

an orchestra or a piano that he can identify a key just by color association. There is something memorable about a Beethoven E-flat orchestral chord. By contrast, if Stravinsky scores the E-flat tonic triad the color is different and the key may be harder to recognize.

Offhand, the historical changeableness of pitch might seem to play havoc with the claim that each key has its own peculiar and identifiable color or feeling. How can we maintain that Mozart intended a piece to have the particular key-feeling of A Major when his tuning fork proves that his A, an A-422, is closer to what we would call A-flat today? We need to examine our habit of saying, of the Fifth Symphony or the *Coriolanus* Overture, for instance, "that's a typical C Minor piece." Is it possible that Beethoven meant them to have the key feeling of our B Minor? How could Schubert's B-flat Major Trio have been intended as an A Major piece, in the same key as the "Trout" Quintet—itself now to be considered as in A-flat?

Hindemith writes that he composes in his head, at any hour and any place, and that perfect pitch is essential for this, since he must be able to hear a score in his head in the right key to get the proper key feeling. But Mozart's perfect pitch differed sharply from Hindemith's, since he started with a lower-frequency A as a basis for his pitch memory. So is it possible to speak of a feeling common to a key used by both Hindemith and Mozart?

THE fact is that key color seems to have more to do with the relationship of overtones—the harmonic series, the upper partials—and the way the entire tonality is balanced internally than with the basic tonal note. Beethoven must have felt the key of F as we think he did—his other music is good evidence. At the pitch level he knew, there must have been enough of the quality we associate with C Minor to account for his characteristic music in this key. Mozart's D Major is almost invariably bright and festive, just as ours is. His E-flat is warm and a shade heroic, just as Beethoven later conceived it, and as we do today. The music fits the key, and the key the music; which comes first we could not always claim to know. Even within a span of cycles per second, a key retains a color spectrum identifiable by the ear with relative pitch.

The ability to recognize changes in pitch contributes greatly to our musical enjoyment. In a Mozart symphony—the "Jupiter," for instance—it is almost essential to distinguish between the simulated and actual returns to the main theme. At one point, Mozart repeats the tune in F instead of the tonic C, and the recognition of this so-called false recapitulation is an important—and diverting—part of the total musical experience.



The tablature of the lute (shown above in an Italian specimen by Vincenzo Capirola, circa 1517) replaced the staff and ordinary pitch-notation with letters, numbers, and other assorted signs. This tablature is indicated below on the neck of a lute.

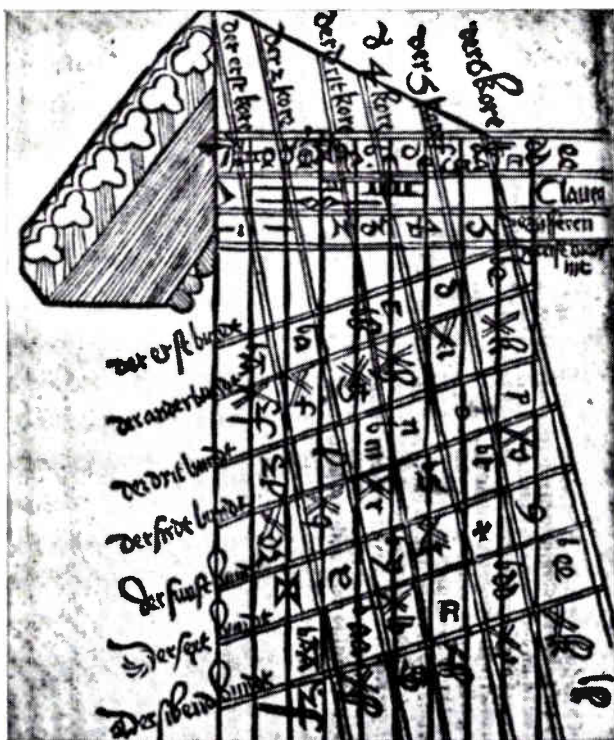

Musicians, like the nonprofessional listener, differ in their ability to hear such things. A singer or string player must have a highly developed sense of relative pitch. For a pianist, however, it is almost better to be a little tone-deaf, so that he cannot hear how flat his instrument sounds when he plays with an orchestra. The reason is that the tuning method for a keyboard instrument is totally different from that of orchestral instruments. Almost everyone knows that the 88-note keyboard of the piano is a compromise. It is evened out, or "well-tempered," which means that all the half-tones are approximately the same distance apart in pitch—similar in interval—throughout the scale. This makes it possible for the piano to travel from key to key without unsettling inequalities of interval. Bach proved the musical workability of the idea for keyboard instruments in his *Well-tempered Clavier*.

Orchestras and choruses, on the other hand, use a system of tuning closer to the pure scale invented by Pythagoras, in about 550 B.C. Unaccompanied choruses at times use what is called "just intonation," another variant. Members of a string quartet automatically make tiny adjustments to avoid the inequities of

## THE SOUND of A

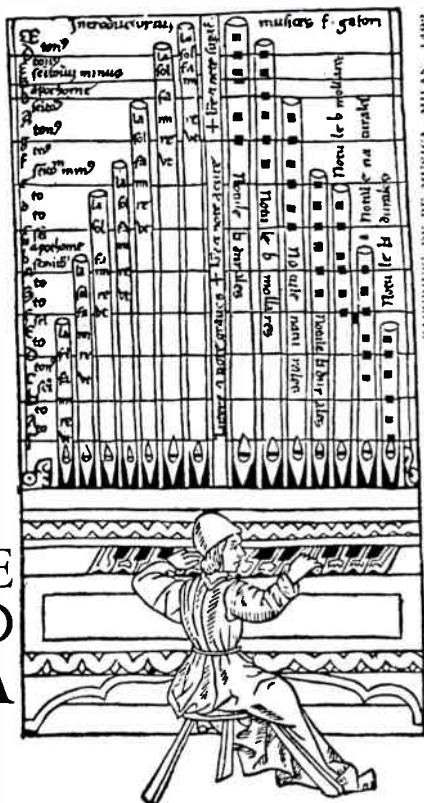

Pitch related to the openings of organ pipes by solmization.

absolutely precise modulation—if, for instance, the interval of the fifth were identical in every key and register and chord structure. For the pianist, G-flat and F-sharp sound the same—they are enharmonically interchangeable, as musicians say—but for the violinist, they are two different pitches, depending on the direction in which the passage moves, or the musical meaning of the chord. G-flat is thus likely to be a fraction lower in pitch than F-sharp.

Technically speaking, these tuning mutations vary with the location of the comma, which Willi Apel defines in his *Harvard Dictionary of Music* as “a scientific term for the minute differences which exist between the pitches of the same tone in different systems of tuning or calculation.” There are two types of comma: the Pythagorean and the Didymic—after Didymos, another Greek theorist, who lived about the first century B.C. The acoustician must know that “the Pythagorean comma is the sum of a schisma and the comma of Didymos,” and the Didymic comma is “the sum of a schisma and a diaschisma.” For the rest of us, they are important because they determine the subtle ratios, and thus the relative purity, of intervals, as different ages, societies, and scientists have defined purity. For example, without being aware of the mathematical reasons, members of a string quartet make “displacements of the comma” according to what modern ears hear as correct intervals.

So it is apparent that, in the final analysis, all these problems are resolved by what we are used to, by our tradition. If A-440 is now the norm, that will be what most people regard as right. The “Music Minus One” men are likely to be rather careful about the frequency of their recorded A’s, in order to make the work of the missing member easier in at least one respect. But orchestras, who do not have this rigid responsibility, can initiate their own traditions. The Boston Symphony, for one, has been playing for some years at A-444, making their tone seem a bit bright and brilliant. If we are generally exposed to A-440, we are bound to notice this, even if subconsciously. The Cleveland Orchestra, on the other hand, sticks resolutely to A-440; George Szell has been reported as saying an orchestra’s brilliance is less a matter of tuning than it is of playing. Many orchestras use a mixed tuning, in which certain instruments may be asked to tune slightly sharp so they come across more clearly.

The combination of tuning and playing style can largely determine the personality of an orchestra. When the Vienna Philharmonic toured this country some years ago, its tone seemed warmer and mellower than we were accustomed to. They played at A-435, so the keys of the of the program choices always seemed to have a bit of extra weight to our ears. Pieces in E-flat were more heroic, but some listeners missed an



*A new method of notation for the twelve-tone scale (proposed in the American Composers Alliance Bulletin) takes a symbol from the World Alphabet for each of the twelve tones, abolishing sharps and flats and emphasizing duodecuple independence.*

element of sparkle in the A Major selections, a key that shines with special brightness at the more customary frequency.

Speaking of Vienna, where music has been a habit for about two thousand years, the telephone exchange there provides many services, from giving you the time and weather to the joke of the day and a fairy tale for settling down the kids. Just by dialing 1507, you can get a scientifically exact A for tuning your instrument. A pure A-440, to be sure, and no mean pitch.

*Klaus George Roy, a practicing composer with fifty works to his credit, lectures on music to educational groups in the Midwest and in New England, has written liner notes for over a hundred records, and still finds time to be the director of publications and program-book editor for the Cleveland Orchestra.*

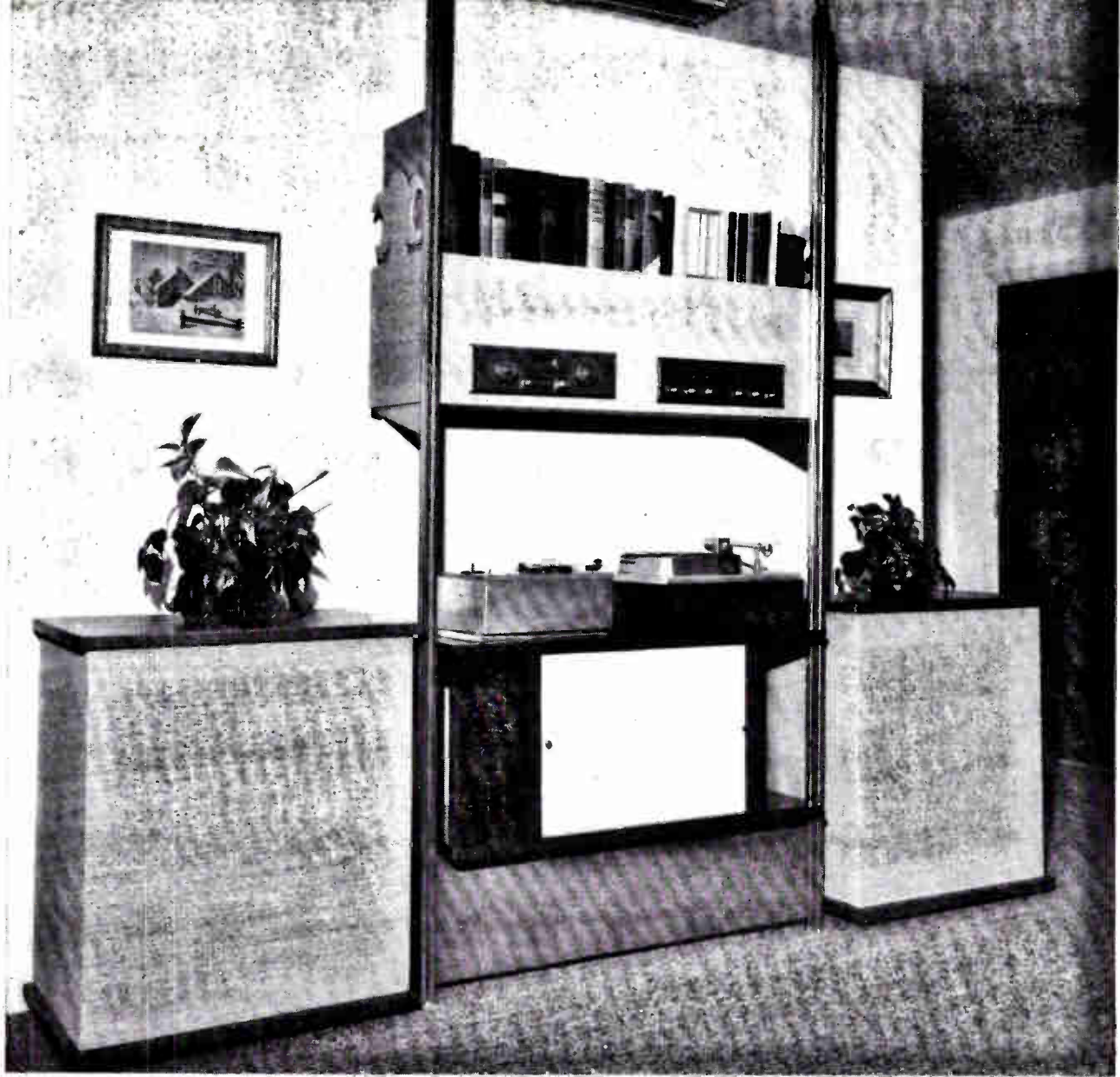

## INSTALLATION OF THE MONTH **BETWEEN TWO POLES**

**O**NE THING Mr. and Mrs. Sterling Black particularly liked about their new home in Largo, Florida, was the open, airy look of the living room. But this uncluttered vista appeared in danger when they had to decide where to put the sound components. Cabinets were definitely not the answer, for they would take up too much space. Nor did wall-mounted shelves seem promising, for the Blacks were hesitant about cutting holes in their new house. They finally solved the problem by means of two free-standing, adjustable ceiling poles on which shelf-supporting brackets can be attached by merely tightening a set-screw. This provided a shelf-type installation without anchorage to the wall.

To make the assembly more colorful, Mr. and Mrs. Black put painted panels around some of the components, thus making the top shelf a suspended cabinet

with front-panel cut-outs for their Scott 330 AM-FM tuner and Scott 130 stereo preamplifier. A home-assembled Dynakit Stereo 70 power amplifier rests on the floor, concealed behind an orange-painted panel. An intermediate shelf accommodates an Empire Troubadour turntable and arm, equipped with an ADC-1 cartridge, sitting next to a Sony 262-D tape deck. Immediately below is a record cabinet the Blacks bought from a furniture store.

Two Bozak B-207A speakers, flanking the shelves, are housed in infinite baffles five cubic feet in volume, built by Mr. Black to Bozak specifications. All interconnecting wires are hidden behind a white masonite panel attached to the rear of the middle shelf. What pleases the Blacks as much as the appearance of their sound system is that the cost of the whole installation was only \$125.

# LABORATORY



# TEST OF STEREO FM

# TUNERS!

## PART ONE



By JULIAN D. HIRSCH AND GLADDEN HOUCK JR.

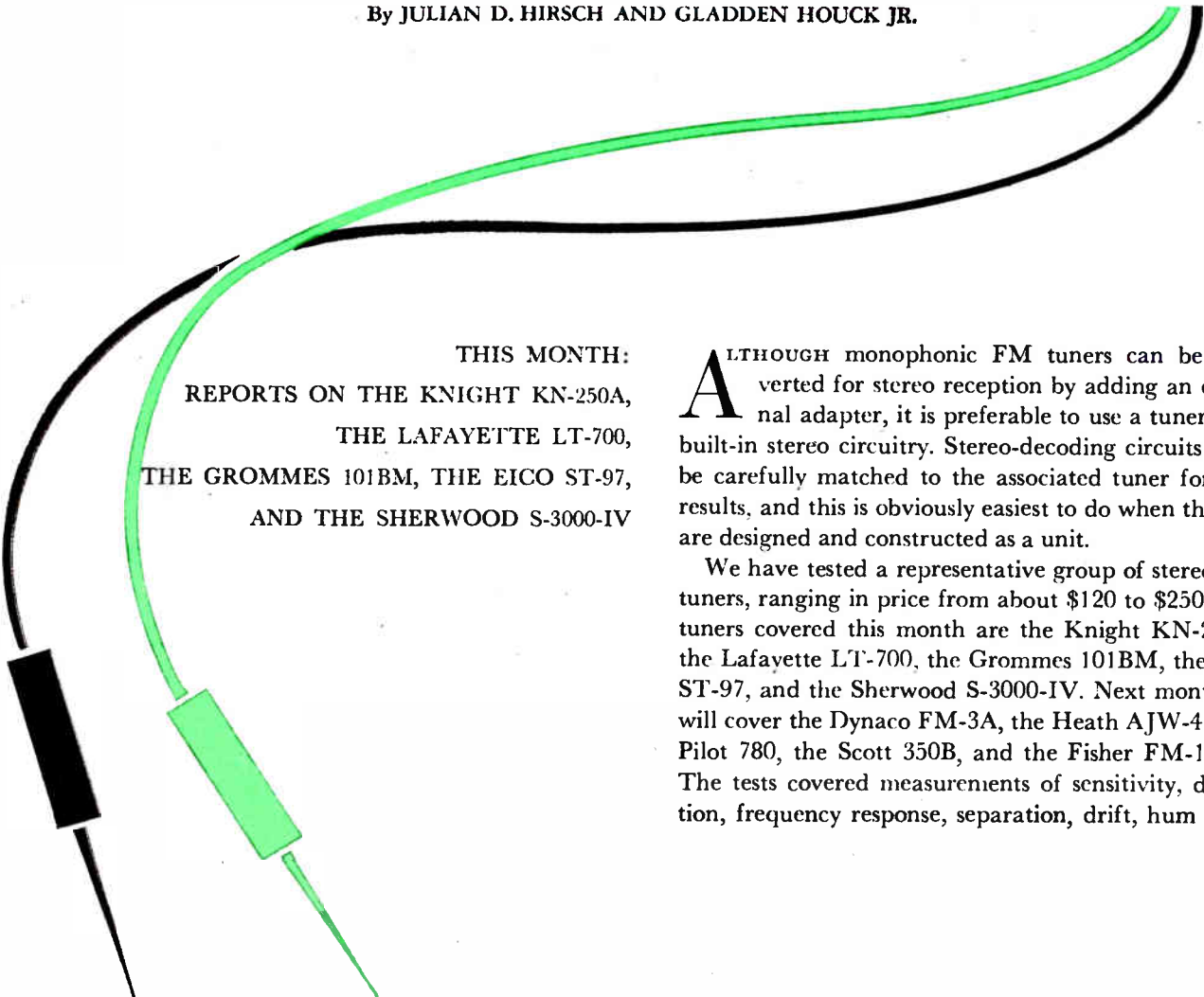

THIS MONTH:  
REPORTS ON THE KNIGHT KN-250A,  
THE LAFAYETTE LT-700,  
THE GROMMES 101BM, THE EICO ST-97,  
AND THE SHERWOOD S-3000-IV

ALTHOUGH monophonic FM tuners can be converted for stereo reception by adding an external adapter, it is preferable to use a tuner with built-in stereo circuitry. Stereo-decoding circuits must be carefully matched to the associated tuner for best results, and this is obviously easiest to do when the two are designed and constructed as a unit.

We have tested a representative group of stereo FM tuners, ranging in price from about \$120 to \$250. The tuners covered this month are the Knight KN-250A, the Lafayette LT-700, the Grommes 101BM, the Eico ST-97, and the Sherwood S-3000-IV. Next month we will cover the Dynaco FM-3A, the Heath AJW-41, the Pilot 780, the Scott 350B, and the Fisher FM-100-B. The tests covered measurements of sensitivity, distortion, frequency response, separation, drift, hum level,

capture ratio, and numerous other factors. In addition, each tuner was tested under listening conditions, using off-the-air mono and stereo programs, and laboratory-generated stereo transmissions. The latter enabled us to listen to each tuner with the same program material under controlled conditions.

In most instances, our test methods conformed to accepted IHFM or IRE standards. Many manufacturers do not employ these methods in establishing their ratings, so there may be discrepancies between our test results and published specifications. All the tuners were measured under identical conditions, so the test results do permit a fairly valid comparison of their various characteristics.

Capture ratio, measured by IHFM standards, is a measure of the tuner's ability to reject interference from a weaker station that is operating on the same frequency as the desired station. Lower capture-ratio figures, expressed in decibels, are indicative of better performance. Sensitivity figures are based on the IHFM usable-sensitivity test. The signal generator was modulated with a 75-kilocycle deviation at 400 cps, corresponding to 100 per cent modulation of an FM transmitter. Usable sensitivity is defined as the lowest signal level for which the total hum, noise, and distortion is 3 per cent.

Usable-sensitivity figures are a good measure of a tuner's true capability, since they in effect do not allow a tuner designer to increase sensitivity at the expense of reduced i.f. and discriminator bandwidth, which increases distortion. They therefore mean more than the so-called quieting-sensitivity figures sometimes used in advertised ratings, and consequently should not be compared to them.

Frequency response was measured by modulating our Boonton 202B signal generator with the output of an H. H. Scott Model 830 generator. A low-distortion audio oscillator was the signal source. Tuners having front-panel separation controls were adjusted for best separation at 1,000 cps. Rear-mounted adjustments were checked for optimum settings. Internal circuit adjustments were not disturbed.

Careful study of the test results will reveal that no one tuner was superior to the others in all respects, although more expensive tuners tended to have better over-all performance. Anyone considering the purchase of one of these tuners should consider all performance aspects, as well as price, before making a decision. Bear in mind, too, that the sensitivity figures are at best a rough guide, and that from twenty to a hundred times as much signal strength is required for noise-free stereo reception as for good mono reception.



## KNIGHT KN-250A TUNER

● THE KNIGHT KN-250A is one of the most compact stereo FM tuners we have seen, measuring only 9 $\frac{5}{8}$  inches wide by 7 $\frac{1}{2}$  inches deep by 2 $\frac{1}{2}$  inches high, complete with cabinet. This is made possible by the use of transistors in all stages except the front end (r.f. amplifier, mixer, oscillator, and AFC stage), where four tiny nuvistor tubes are used. There are four i.f. stages, a ratio detector, and a five-transistor stereo demodulator of the matrixing type.

On the front panel is a legible, clearly illuminated dial, plus controls for tuning and separation adjustment. A miniature meter is used for a tuning aid. Three slide switches control power, mono/stereo operation, and AFC. An unusual feature (for a transistorized tuner) is the neon stereo indicator, which lights when a stereo broadcast is being received. The low operating

voltages of transistors and nuvistors are insufficient to operate neon lamps, so a separate transistor stage and step-up transformer amplify the 19-kc. pilot carrier sufficiently to light the stereo indicator.

Although it was not shown on the schematic supplied with our test unit, there is a switch in the antenna circuit, presumably to prevent generation of spurious signals from powerful local stations.

We were unable to rate the sensitivity of the KN-250A by IHFM standards, since the distortion at 100 per cent modulation never fell to 3 per cent. At signal strengths of 300 microvolts or greater, the distortion was between 3.5 per cent and 4 per cent. At 30 per cent modulation, typical of average program levels, the distortion was under 0.7 per cent with signal strengths of 1,000 to 10,000 microvolts.

## STEREO FM TUNER TESTS

Residual hum and noise were  $-41$  db relative to full output. This was largely hiss, though some hum was audible. Channel separation was 18 db at middle frequencies, reducing to 3 db or less between 10,000 and 15,000 cps. There was considerable 38-kc. signal in the audio output, which may have introduced some error in measurement of channel separation at the higher frequencies. Frequency response was within  $\pm 2$  db from 50 to 15,000 cps. The use of long output cables should be avoided to prevent excessive loss of highs.

Warm-up drift was low, but the tuning was sensitive to line-voltage variations. However, the AFC correc-

tion factor of 5.6 prevented this from being a real problem. Capture ratio was 6 db.

The small size and cool operation of the Knight KN-250A may make it especially suitable for installations where space is limited. We would recommend its use only in strong-signal areas (1,000 microvolts or greater), or with a directional antenna that provides equivalent signal strengths. On mono programs, listening quality was satisfactory on many stations, even with a simple indoor dipole antenna, but distortion-free stereo reception was not possible at our location under these conditions. However, signals transmitted through our laboratory generator at high signal levels produced good sound on stereo as well as mono.

The KN-250A is priced at \$119.95, including case.

---

### LAFAYETTE LT-700 TUNER

● THE ATTRACTIVELY styled Lafayette LT-700 is housed in a two-tone tan case, with a gold and white panel and brown and gold knobs. It uses one twin-triode tube as a grounded-grid r.f. amplifier and mixer, and another as an oscillator and AFC reactance tube. Following two i.f. amplifiers and two limiters is a Foster-Sceley discriminator.

The two-tube stereo section uses conventional matrixing circuits, followed by de-emphasis networks, a ganged volume control, and feedback-type audio amplifiers. There is a screwdriver-adjustable separation control in the rear of the tuner, which was correctly set as received.

The Lafayette LT-700 had moderate sensitivity, about 13 microvolts. Full audio limiting occurred at 10 microvolts, but minimum distortion was not obtained until a 1,000-microvolt level was reached. However, the ultimate distortion was less than 0.45 per cent, which is as low as that produced by some of the most refined and expensive FM tuners we have tested.

Channel separation was between 18 db and 20 db from 50 cps to 2,000 cps, reducing to about 11 db in the 6,000-to-12,000-cps region. The audio output of 4 volts was exceptionally high. Frequency response was within



$\pm 1\frac{1}{2}$  db from 50 to 15,000 cps. Unfortunately, the high-impedance volume controls cause a loss of high-frequency response, amounting to as much as 6 db at 10,000 cps, unless they are left at maximum. This requires use of the amplifier's volume control alone if full frequency response is to be maintained. The tuner's output impedance is low enough so that ordinary interconnection cables will not affect high-frequency response, but cables longer than six to eight feet are not advisable.

The hum level of the LT-700 was  $-54$  db. Its capture ratio of 3 db was very good. Drift was moderate, and the AFC correction factor was adjustable from zero to a maximum of 3.85.

The neon stereo-indicator light on the LT-700 does not indicate a stereo broadcast but merely whether the mode switch is in mono or stereo position. The lack of a true stereo indicator is perhaps the only operational drawback to this otherwise smooth-handling tuner. In listening quality, the Lafayette LT-700 ranks with the finest, with noncritical tuning and low distortion. For best results, it should be used in a moderately strong-signal area, or with a good antenna.

The LT-700 is priced at \$124.50, including case.



## GROMMES 101BM TUNER



● FROM AN operating standpoint, the Grommes 101BM is perhaps the simplest tuner of this group. It has only two controls, a combined power switch and mono/stereo selector, and the tuning knob.

The bar-type tuning eye operates conventionally in mono reception. For stereo listening, it is actuated by the 19-kc. pilot signal and thus closes only during a stereo broadcast. The front end employs one twin-triode as a cascade r.f. amplifier and another as a mixer-oscillator. There is no AFC, but the drift was almost unmeasurable, making AFC superfluous. Two i.f. stages and a limiter feed into a ratio detector. Stereo demodulation is by means of switching circuits, and the stereo circuitry employs two tubes and four diodes. There is no volume control, but the output of 2 volts is suitable for driving almost any amplifier.

The sensitivity of the Grommes 101BM was 16 microvolts. Limiting was complete at 30 microvolts, and

the minimum distortion of slightly under 3 per cent was reached at that level. At 30 per cent modulation, a more typical figure, the distortion was about 0.9 per cent. Channel separation was better than 18 db up to about 2,000 cps, reducing to 11 db at 10,000 cps. The hum level was -51.5 db, and the capture ratio was 5.7 db. Frequency response was within  $\pm 1\frac{1}{2}$  db from 50 to 15,000 cps. Output cables should be kept as short as possible, since even a few feet of cable could appreciably reduce the unit's high-frequency response.

In listening tests, the Grommes 101BM produced excellent stereo sound when good signal strengths were available. It was easy to tune, and the tuning eye provided an unmistakable indication of a stereo transmission. Its control simplicity makes this a desirable tuner for the family in strong-signal areas.

The 101BM is priced at \$139.95. A metal case is available for \$7.50.

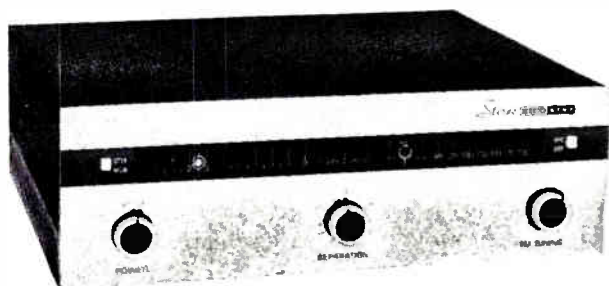

● THE EICO ST-97 has a tuning dial divided into two sections, with the right calibrated in megacycles and the left marked from 0 to 10 for logging purposes. The pointer of the calibrated dial is a small indicator tube, whose vertical bar shortens as a station is tuned in correctly. The pointer of the logging scale, which travels together with the main dial pointer, carries a neon lamp that lights up whenever a stereophonic broadcast is being received.

The front end uses a dual-triode tube as a neutralized r.f. amplifier and self-oscillating converter. A silicon voltage-variable capacitor provides AFC. Four i.f. stages (two of which act as limiters) drive a wide-band ratio detector. The stereo circuitry uses the same filter-

## EICO ST-97 TUNER

less switching design that is employed in the Eico MX-99 stereo adapter. Sharp cut-off filters in the audio outputs remove any 19-kc. or 38-kc. components remaining after the demodulation process.

The ST-97 was quite sensitive, with an IHFM sensitivity rating of 3.3 microvolts. Limiting was virtually complete at 5 microvolts, and harmonic distortion was about 1 per cent at 100 per cent modulation. With the front-panel separation control optimized, the channel separation was about 30 db at middle frequencies and was maintained at better than 18 db between 100 and 15,000 cps.

Frequency response was within  $\pm 1$  db from 50 to 15,000 cps, and was not affected by large capacitive

# STEREO FM TUNER TESTS

loads. Internal hum was an unusually low  $-65$  db at the detector output and  $-51.5$  db at the audio outputs, after passing through the stereo circuits. The drift of this tuner was 67 kc., the highest of the group, though not large enough to be troublesome. The AFC reduced drift by a factor of 4.7. Capture ratio was 3 db.

The Eico ST-97 is a very easy tuner to use and produces excellent sound. It has no output level control,

but the output of 0.9 volts is suitable for driving any amplifier. The tuning eye was equipped with a diffusing screen that masked much of its operation, and we would prefer to use it without the diffuser. The separation control can be adjusted reasonably well on stereo broadcasts when transmission is on one channel only, but it is questionable whether most users could obtain the outstandingly fine separation figures we measured in our tests.

The ST-97 is priced at \$149.95, including case, and is available in kit form (ST-97K) for \$99.95.

## SHERWOOD S-3000-IV TUNER

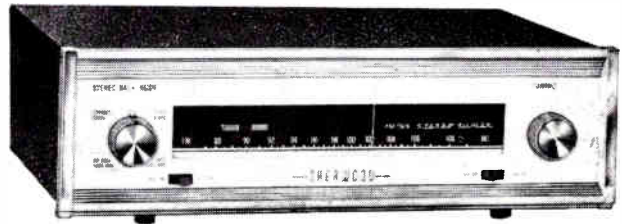

● THE SHERWOOD S-3000-IV is basically similar to Sherwood's S-3000-III monophonic FM tuner, with the addition of built-in stereo circuits. It has a cascade r.f. amplifier, two i.f. amplifiers, two limiter stages, and a Foster-Seeley discriminator. The stereo demodulator is of the switching type, employing four matched diodes. A triode-pentode tube serves as a 19-kc. oscillator and a 38-kc. doubler, whose output actuates the switching diodes.

The operating controls differ slightly from those of most other stereo tuners. There are two knob-operated controls, one for tuning and the other a combined on-off switch and stereo/mono selector. Concentric with the latter control is a blend control, which is actually a fine-adjustment control for stereo separation. Additionally, there are two slide switches, one controlling the AFC and the other the interchannel-hush circuit. There is a bar-type tuning-eye tube behind the dial face.

The Sherwood S-3000-IV receives either mono or stereo programs automatically when the selector switch is in the stereo position. In the absence of a stereo program, the signal appears as identical outputs from both channels. When a weak stereo signal is being received, the selector may be set to mono, disabling the 19-kc. oscillator and 38-kc. doubler circuits. In this condition the tuner operates as a conventional monophonic FM tuner, with an improvement in signal-to-noise ratio as compared to stereo operation.

The measured IHFM usable sensitivity of the S-3000-IV was 2.5 microvolts. Distortion was under 1

per cent at all signal levels greater than 4 microvolts, at 100 per cent modulation. Limiting action was exceptionally good, with virtually no change of audio output level over a range of input signal strengths from 2 microvolts to 100,000 microvolts. Frequency response was within  $\pm 1.5$  db from 50 to 15,000 cps. Channel separation was about 25 db through most of the audio range and exceeded 20 db from 50 to 10,000 cps. The front-panel separation adjustment had only a slight effect on measured separation and no audible effect on received programs.

Warm-up drift was moderate, but the AFC action was extremely strong, reducing drift by a factor of 10. Capture ratio was 3.2 db, and hum was  $-54$  db. The output impedance was rather high, so connecting cables should be as short as possible to avoid loss of high-frequency response.

As the measurements indicate, the S-3000-IV is a very sensitive tuner. Tuning is noncritical, and the smooth, flywheel tuning mechanism is a pleasure to use. However, we found the lack of a stereo indicator disturbing. Although the automatic stereo/mono circuit worked well, its use caused an increase in background noise when listening to mono programs. We found it preferable to set the selector to mono when not listening to stereo broadcasts.

The Sherwood S-3000-IV is priced at \$160.00. A case is available for \$7.50.

Coming Next Month: Reports on the Dynaco FM-3A, the Heath AJW-41, the Pilot 780, the Scott 350B, and the Fisher FM-100-B

# READERS' CHOICE: 1962

THE TWELVE BEST RECORDS  
OF THE YEAR, AS CHOSEN BY  
READERS OF HIFI/STEREO REVIEW

THE RECORDINGS listed in the following pages represent the preferences of our readers as polled in the concluding months of the past year. The selections were made from a broadly representative field of one hundred and forty-eight nominations.

Like the verdict of any popular poll, this list raises perhaps as many questions as it satisfies. Possibly the chief virtue of the popular poll is that it publishes statistical evidence of an articulate opinion on its subject. But it necessarily cannot publish a variety of dissenting opinion that may be more amply informed. The two things common to all the following choices are performers or scores of outstanding and well-established celebrity, most of them presented on labels that command widespread distribution. A major performer who happens to be new (folk singer Joan Baez on Vanguard is an example), or a magnificently performed major work that was deliberately written in defiance of easy popularity (Palestrina's *Missa Papae Marcelli*, on DGG Archive), or even a widely popular work or artist on a label with relatively narrow distribution: all or any of these may become collector's items in the next month or decade, but as of election day they are hopelessly outclassed.

Within these unavoidable limitations, the following choices offer interesting evidence of the almost fifty-fifty agreement between HIFI/STEREO REVIEW's readers and its critical staff. Five of these selections were reviewed in these pages as best-of-month choices. Four others were designated recordings of special merit. Two more received preponderantly favorable reviews, and only one frankly disappointed its local critic.

ILLUSTRATIONS BY JOSEPH PAFIN



VOX POPULI  
VOX DEI

# READERS' CHOICE

## SYMPHONIC



**STRAVINSKY:** *The Firebird*. Columbia Symphony Orchestra, Igor Stravinsky cond. COLUMBIA MS 6328, ML 5728.

Stravinsky's first recorded performance of the complete *Firebird* score ("the master's first masterpiece") was welcomed in these pages for the poetic quality of its interpretation, its superlative orchestral playing, and its warm-toned recording.



## CONCERTO



**CHOPIN:** *Piano Concerto No. 1, in E Minor, Op. 11*. Artur Rubinstein (piano); New Symphony Orchestra of London, Stanislaw Skrowaczewski cond. RCA VICTOR LSC 2575, LM 2575.

Reviewed here as a best-of-month selection, this release was cited as an ideal solution of the problem of the Chopin concerto, with Rubinstein presenting it as "a long introspective poem for piano."

## CHAMBER MUSIC



**BEETHOVEN:** *Serenade in D Major*. **KODALY:** *Duo for Violin and Cello*. Jascha Heifetz (violin), William Primrose (viola), Gregor Piatigorsky (cello). RCA VICTOR LSC 2550, LM 2550.

This issue, cited for special merit, completed the Heifetz-Primrose-Piatigorsky recording of the five Beethoven string trios with "electrifying" playing, and was "wonderfully precise" and "stylistically elegant."





## SOLO INSTRUMENTAL

**CARLOS MONTOYA:** *Malagueña*. Carlos Montoya (guitar). *La Virgen de la Macarena*; *Andalucía*; and eight others. RCA VICTOR LSP 2380, LPM 2380.

Called "the finest, most completely realized program he has thus far put on discs," this issue by the flamenco master was reviewed as a best-of-month selection—"a magnificent evocation of the passionate and *misterioso* instrumental music of the Spanish Gypsy."

## OPERA



**VERDI:** *Aida*. Leontyne Price, Rita Gorr, Jon Vickers, Robert Merrill, Giorgio Tozzi, Plinio Clabassi; Rome Opera House Orchestra and Chorus, Georg Solti cond. RCA VICTOR LSC 6158, LM 6158 (three 12-inch discs).

The stellar cast of this second stereo *Aida* was rated "an impresario's dream," with the sound representing "the last word in tonal splendor."

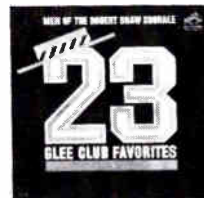

## CHORUS

**ROBERT SHAW:** *23 Glee Club Favorites*. Men of the Robert Shaw Chorale. *Five Reasons*; *The Pope*; and twenty others. RCA VICTOR LSC 2598, LM 2598.

This issue was recommended in these pages as a glee-club showcase. "The gentlemen who sing it can turn with equal ease from the ho-ho-ho-ing of *Landlord*, *Fill the Flowing Bowl* to the tenderest emotions of Schubert and Schumann."

# READERS' CHOICE

## CHORUS AND ORCHESTRA

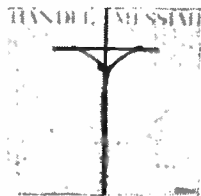

**HANDEL: *Messiah*.** Joan Sutherland, Grace Bumbry, Kenneth McKellar, David Ward, London Symphony Orchestra and Chorus; Sir Adrian Boult cond. LONDON OSA 1329, A 4327 (three 12-inch discs).

Of the three complete stereo *Messiahs*, this "soloist-oriented" issue was considered here to deserve a special-merit citation for "the most consistent level of technical and musical competence. . . ."



## JAZZ

**BILLIE HOLIDAY: *The Golden Years*.** Billie Holiday (vocals); various orchestras. Forty-eight selections. COLUMBIA C3L 21 (three 12-inch discs).

These "classic examples of the art of the greatest jazz singer we have had" constitute "an indispensable collection," spelling out the definition: "That's what a jazz singer is," and clarifying "what all the fuss about Billie Holiday is about."

## VOCAL RECITAL



**LEONTYNE PRICE: *Swing Low, Sweet Chariot*.** Leontyne Price; orchestra and chorus, Leonard dePaur cond. *His Name So Sweet; On Ma Journey*; and twelve others. RCA VICTOR LSC 2600, LM 2600.

It was noted here that Miss Price's approach to spirituals was "straightforward," possessing "dignity and understanding." But her overarranged accompaniment was criticized for being somewhat "overpowering."





## FOLK

**KINGSTON TRIO:** *Something Special*. Kingston Trio; orchestra, Jimmie Haskell cond. *Little Boy; Away Rio; Jane, Jane, Jane;* and nine others. CAPITOL ST 1747, T 1747.

This set was reviewed here as an example of a celebrated group coasting on "the excitement it generated in the old hard-driving days," with a loss of "youthful rhythmic drive" accentuating vocal weaknesses.

## FILM SCORE

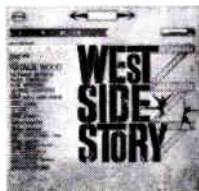

**WEST SIDE STORY** (Leonard Bernstein-Stephen Sondheim). Sound-track recording, Johnny Green cond. COLUMBIA OS 2070, OL 5670.

"Musically," said our best-of-month reviewer, the movie sound-track recording of Leonard Bernstein's score is "just as exciting, just as touching" as the stage version, and is "dramatically stronger" and "even more affecting."

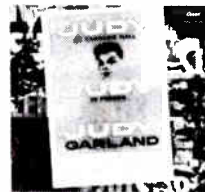

## POPULAR

**JUDY GARLAND:** *Judy at Carnegie Hall*. Judy Garland; orchestra, Mort Lindsey cond. Twenty-eight selections. CAPITOL SWBO 1569, WBO 1569 (two 12-inch discs).

Recorded at the celebrated Carnegie Hall event, these songs (said our critic, in a best-of-month review) are "mesmeric" and "as personal as entries in a diary," with Judy "at the top of her form."

# THE ART OF THE ALBUM

**A**BOUT FOURTEEN years ago, the recording industry handed the American commercial artist a blank cardboard envelope exactly twelve and three-eighths inches square and said, "Put something eye-catching on this, preferably something connected with the record inside." And certain companies apparently added a codicil: "If you can't figure out a connection, just keep the customer in a state of shock while he reaches for his billfold."

Today the more orgiastic album art—close-miked bosoms (as pertaining to everything but Bach's B Minor Mass) and naughtily gartered thighs (terrific for Offenbach!)—has all but disappeared. Most top-flight jacket designers today have come to grips with the creative issue involved, which is the invention of a new and appropriate art of the album, respectful of its size, its squareness, and, above all, its peculiar two-dimensionality. For the record album, as a portable physical object, is in effect a pure Euclidean plane.

In the opinion of *HIFI/STEREO REVIEW*'s editors, the seven handsome jackets here reproduced—chosen from a field of many dozens as the best of 1962—have met these challenges triumphantly and with notable taste. Turning the flatness of the given pictorial field

into a positive asset, Atlantic's Coltrane album uses pure typography with imagination to create a powerful and unmistakably contemporary pattern. Caedmon's "Beowulf" jacket interprets the archaic poetry within by superimposing a starkly calligraphic Carolingian portrait on an ancient specimen of manuscript writing. Vanguard's abstract bird for the Vaughan Williams *Fantasia* is a buoyant image of two-dimensional flight. Imaging the metaphysical poetry of John Donne, Caedmon offers a richly sombre representation, in a linear technique, of Donne's three principal themes: desire, time, and death. The jacket for Atlantic's Modern Jazz Quartet makes a zestful game of pure decoration by analyzing the disjointed elements of a *Commedia dell'Arte* Harlequin. And two albums exploit the plane surface as a basis for primitive bas-relief: Verve's Cal Tjader jacket and Riverside's Dizzy Gillespie album. The latter figure, for all its apparent modernity, was discovered in the 1880's in French Equatorial Africa, where an unknown native artist had left it (with several companion pieces) on the walls of his house. Adopting this indigenous folk art to an American jazz library, Riverside's art director, Ken Deardoff, has created one of the most-discussed album series of the past year.

*Atlantic's Modern Jazz Quartet album was designed by Loring Eutemey.*

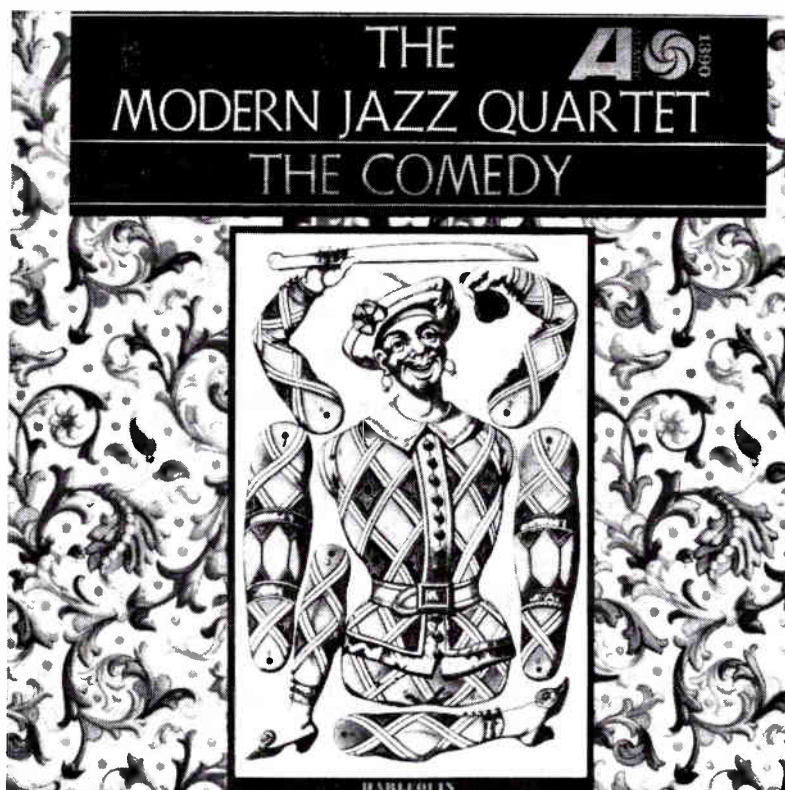





# Beowulf

M on laſte heolo. lan  
 Galehel. piddan inſſha f  
 ſaia ff ſixas. pma haer  
 pip onſann. bauna ſſynan. him  
 mible to megnum brohte. Semaſ

Caedmon's "Beowulf" jacket is by Ben Robinson; Riverside's Dizzy Gillespie album (below) was designed by Riverside art director Ken Deardorff.

## The Compositions of DIZZY GILLESPIE



Fritz Eichenberg designed Caedmon's John Donne album (right); Verve's Cal Tjader jacket (below) is a John Morello design executed by Blake Hampton.

### CAL TJADER PLAYS THE CONTEMPORARY MUSIC OF MEXICO AND BRAZIL

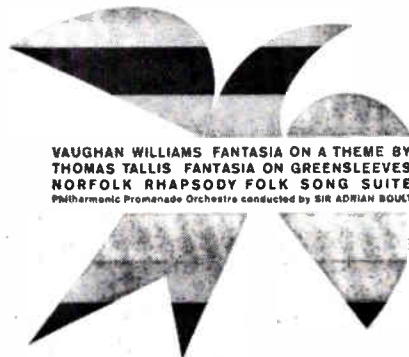
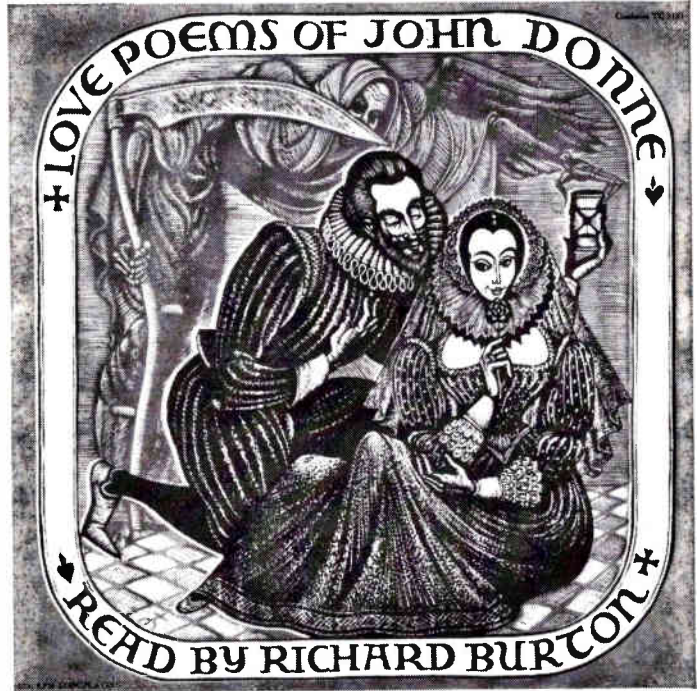
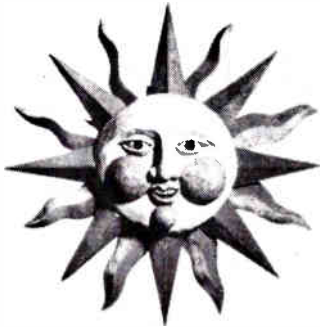

VAUGHAN WILLIAMS FANTASIA ON A THEME BY  
 THOMAS TALLIS FANTASIA ON GREENSLEEVES  
 NORFOLK RHAPSODY FOLK SONG SUITE  
 Philharmonic Promenade Orchestra conducted by SIR ADRIAN BOULT

Atlantic's "Olé" jacket is by John Jagel and Bob Slutzki; Vanguard's Vaughan Williams album is by Richard Schiffer.

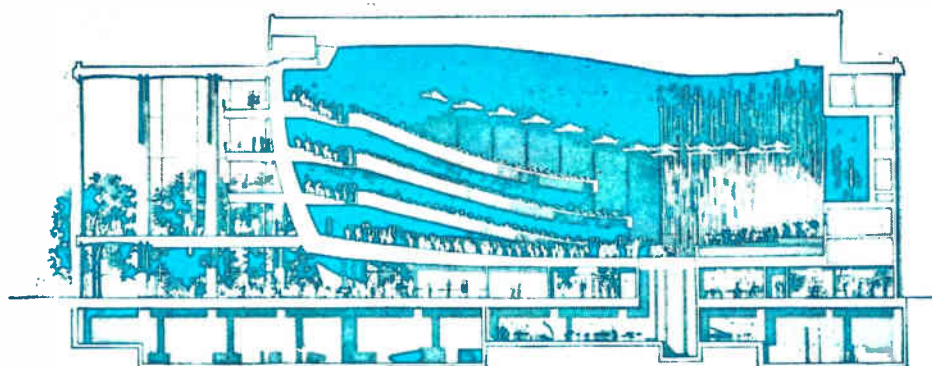

# MUSIC, ACOUSTICS, AND ARCHITECTURE

A REVIEW OF AN IMPORTANT NEW BOOK ON THE SCIENCE OF CONCERT-HALL DESIGN  
BY THE ACOUSTICAL CONSULTANT FOR LINCOLN CENTER'S PHILHARMONIC HALL

By EDGAR VILLCHUR

**T**HERE IS an excitement about musical sound in a concert hall that is never quite equaled in the hi-fi-equipped living room. Over and above the drama of the live performance there is a special quality to the sound itself, which has an aura of spaciousness. In reproduction this quality may at worst be converted to direct, hard tone; the subtle resinous bite of the strings can become hi-fi rasp.

Dr. Leo Beranek, distinguished M.I.T. lecturer and acoustical consultant for Lincoln Center's Philharmonic Hall, manages to convey some of this excitement in the pages of his recently published *Music, Acoustics, and Architecture* (John Wiley & Sons, Inc., New York, N.Y., \$17.50). He also makes it clear that a concert hall is not merely a passive device to keep out weather and noise. The concert hall has a positive role. It influences and shapes the sound, and forms part of the composer's and performer's musical intent, just as do the musical instruments.

This is an important concept, and one that needed reaffirming. Much of today's recorded and broadcast sound consists of the raw output of instruments playing in acoustically dead studios. (Concert halls with dry, dead acoustics, says Beranek, have come to be known as hi-fi halls.) A similar over-hard effect is produced when the voice of a singer is picked up by a microphone only a few inches away. The author quotes Joseph Wechsberg on hearing Wagner from the orchestra pit, where the hall has not yet colored the sound:

. . . [the conductor's] downbeat was followed by a crashing fortissimo that made me jump. The brassy clamor was amplified a hundred times by the walls of the pit, and it seemed inconceivable that this horrible racket should emerge in the auditorium as pure tonal beauty.

A large section of *Music, Acoustics, and Architecture* is devoted to the construction and acoustics of fifty-four of the world's concert halls. Recognizing that these halls should serve artistic ends, Beranek has interviewed conductors, musicians, and music critics who know them, and records their reactions.

They express themselves in language reminiscent of hi-fi talk. For example, here are two conductors commenting on New York's Carnegie Hall: "It has excellent high-frequency brilliance, but the middle- and low-frequency brilliance is not the best. There is a lack of body in the sound. The hall is extremely directional. . . ." and "This hall should have more lows and just a little less of the extreme highs." A conductor on Rochester's Eastman Theatre: "There is not a noble sound, it is a bit harsh. The Eastman Theatre does nothing to the sound." Bruno Walter said of Vienna's Grosser Musikvereinsaal: "This is certainly the finest hall in the world. It has beauty of sound and power." Herbert von Karajan notes of the same hall: "The sound is very full. It is rich in bass and good for high strings. One shortcoming is that the technical attack of instruments—bows and lips—gets lost. . . It has characteristics the opposite of a recording studio." (Beranek says von Karajan tends to favor dry halls.)

Isaac Stern describes Vancouver's Queen Elizabeth Theatre as having "almost a clinical accuracy." Conductor Irwin Hoffman says of this hall: ". . . the basses and the lower strings on the cellos are not strong in tutti passages, giving the strings a somewhat brittle sound." A music critic comments on Berlin's Musikhochschule Konzertsaal: "The sound is hard and glassy." *BBC Quarterly* notes that Philharmonic Hall in Liverpool has a low-frequency boom in the region of 110 cycles.

One of the things that emerges from these interviews is that there is general agreement on the qualities of various halls. The interviews also confirm the author's point that different types of halls are suitable for different types of music. Beranek goes so far as to say that Bach adapted his musical style in the B Minor Mass and *St. Matthew Passion* to the acoustics of the Thomaskirche, a church with a lower reverberation time than the older cathedrals. The acoustics allowed string parts to be heard, and did not blur sounds played in brisk tempo.

Beranek also relates the contrast of styles of Stokowski and Koussevitsky—the former with a long, flowing melodic line, and the latter with a clean precision and abrupt attacks and releases—to the acoustics of the home concert halls of each of these conductors. The Philadelphia Academy was dry, and needed the orchestra's help in sustaining tone, since its reverberation time was low. Boston Symphony Hall, Koussevitsky's base, provided a reverberant cloak to the musical sound so that slight imprecisions would not be audible.

Baroque music, with its small instrumental groups, counterpoint, and fast movements, was written for halls with lower reverberation times. Romantic music does not require the listener to separate each voice to the extent that Baroque and classical music does, and it thrives in an acoustical environment that is full and does not have high definition.

An extreme example of a hall suitable only for Romantic music is London's Royal Albert Hall, with an audience capacity of 7,000. Conductors have called it "one of the world's worst halls," "two of everything for the price of one" (a reference to the echo), and "too large and too long a reverberation time." Beranek

*The sound-reflecting ceiling panels of Lincoln Center's Philharmonic Hall are intended to provide the intimacy of a small hall and yet preserve the reverberation time of a larger hall.*



describes a concert he attended at the Royal Albert, in which he found a Grieg piano concerto very unsatisfying in sound quality. He continues:

But then the orchestra played Tchaikovsky's *Overture 1812* . . . The great organ sounded out at the climax and the 'cannon' boomed forth . . . The chimes clanged loudly through their part and, finally, in combination with the military fanfare theme, the *Russian Imperial Anthem* thundered forth. The echo enhanced the gunfire, the chimes, and the fanfare. The general reverberation swelled with the increased vigor of the composition. Above all, the great organ sounded like the voice of Jupiter. The audience was left breathless and tingling. It is for these moments of ecstasy that the Albert Hall continues to exist.

**T**HE OTHER extreme in acoustics is the dry hall with high definition and low reverberation time. An example is Royal Festival Hall in London. Sir Malcolm Sargent is quoted as saying: "Here the acoustics are first-class with regard to clarity, in fact frighteningly so. . . . One never gets the feel of a tremendous sound of a resonant chording. The part writing is always too clear when chordal climaxes are desired."

Most of the other conductors and music critics questioned about Royal Festival Hall also thought that there was too much definition and clarity, that it had a hard, overly precise quality that made sections of the orchestra sound as if they were isolated groups rather than part of an ensemble (shades of ping-pong stereo!). Leopold Stokowski said: "In the Royal Festival Hall the double basses simply cannot be heard. . . . There is also lack of sound diffusion. In this hall the sound is metallic and tinny. There is no warmth." Sir Adrian Boult told Beranek: "The Royal Festival Hall has amazing clarity and textural exactness. I would say that the designers tried so hard to project the sound outward that though a pianissimo string quartet will comfortably reach the back row of the top gallery, the extremes of fortissimo take on a rather hard quality and any forcing of tone by voices or brass instruments can become most unpleasant."

Yet there was general agreement that the hall was good for piano and chamber music, or music requiring high definition for contrapuntal lines. Two conductors liked Royal Festival Hall very much, providing a rare case of head-on difference of opinion about the acoustics of a particular hall among men in a position to judge. Von Karajan, already noted as having a taste for dry acoustics, considers it the best of the modern halls. He praises the tonal quality and says that there is perfect blend on short forte chords. Stanislaw Skrowaczewski comments: "I could hear each instru-

## ••• ACOUSTICS •••

ment distinctly, without losing good blend. I certainly liked the wonderful transparency."

Beranek himself considers the hall very good for appropriate music, including modern, except for the lack of bass. He concludes that one hall cannot be all things to all people, although he does not believe that hall acoustics are merely a matter of taste.

Another example of a hall that has been criticized for dryness but is well liked for certain types of music (or for speech) is Kresge Auditorium, in Cambridge, Massachusetts, for which Beranek's firm acted as acoustical consultants. Some of the comments have been: "For a full symphony orchestra, the reverberation is too short, the sound is too dry," and "The sound is somewhat too clear for full orchestra, but the hall is excellent for chamber music and piano."

There is much in *Music, Acoustics, and Architecture* that applies directly to high-fidelity reproduction, and I would like to digress a bit. Since the influence of the concert hall on the quality of musical sound is part of the intent of the composer, the performing musician, and the instrument maker, this influence cannot properly be left out of a recording or broadcast. To project the sound devoid of hall color into a living room is to be unfaithful to this intent. Living rooms provide poor acoustical environments for almost any kind of music, even string quartets.

This is not to say that the ideal listening-room environment for reproduced music—once the acoustics of the hall are included in the recorded signal—is an anechoic chamber (an acoustically dead enclosure). A very dead listening room, because of lack of reflections, increases the listener's sense of sound traveling along a narrow path between his ears and the speaker, or, even

worse, along two narrow "stereo" paths. In either case such an effect is most unnatural, taking concert-hall sound as the norm. But Beranek goes on to make this observation:

One wonders whether listening to radio, phonograph, and television in non-reverberant living rooms, even with reverberation artificially introduced, may accustom us to demand music with high definition and low fullness of tone. If so, one can foresee a time when the music of the Romantic period will pass from the repertoires of our symphony orchestras, and new compositions will be matched to the acoustics of the living room. Concert halls, if there is still any need for them, will then be built with low ceilings shaped to guide the sound directly from the performing group to the listeners, with high intimacy, high definition, and low fullness of tone.

This is a chilling thought. I personally am not so pessimistic; I do not think music will be wagged by its electronic tail. If the high-fidelity public keeps in touch with live music it will demand concert hall sound in reproduction. Live concerts ought to be part of every hi-fi show.

**D**R. BERANEK outlines a new rating system for concert halls that is a major contribution to the field. Mystery and cant are replaced by an analysis that will be of intense interest both to acoustical specialists and to concertgoers. He applies this rating system to the concert halls studied, and compares the results with the subjective evaluations of musical experts, reporting excellent correlation. Concert halls that rate at the top include Boston Symphony Hall, Vienna's Grosser Musikvereinssaal, and Amsterdam's Concertgebouw.

Beranek arrives at a numerical rating for a hall by assigning 40 points out of a total perfect score of 100 to intimacy or presence, 15 points to liveness (rever-

*London is the home of two of the world's least-satisfactory concert halls. Royal Albert Hall (left) is so echo-prone musicians remark it provides "two of everything for the price of one." Royal Festival Hall (right) is usually judged to lack tonal warmth.*



beration time at middle and high frequencies), 15 points to warmth (reverberation time at low frequencies, which largely determines the hall's "bass response"), 10 points to clarity, etc. Points are subtracted from the total for such negative characteristics as echo, noise, and distortion.

The sense of intimacy, which the author counts so heavily, is controlled by the time lapse between the direct sound and the first reflected sound at the ears of the listener. When this time lapse is relatively long the sound lacks intimacy. A small concert hall has intimacy, but the effect can also be achieved in a large hall by hanging panels below the main ceiling. These provide reflections similar to those of a small hall while preserving the longer reverberation time associated with a high ceiling. Intimacy can also be achieved in a large but narrow hall, where the path length of the reflected sound from the walls is not very much greater than that of the direct sound.

There will undoubtedly be discussion concerning the relative weightings in Beranek's system. Questions of the proper amount of each qualitative element for a particular hall must still be settled. The consensus of comment by music critics on Lincoln Center's Philharmonic Hall, for example, even after some tuning, points to insufficient warmth and too much intimacy and clarity. But I believe the value of the book's basic analytic approach will remain.

**I** ATTENDED Philharmonic Hall during its second week. At the price of a sacrifice of concert manners I was able to sample the sound from three widely separated seats in the orchestra. The hanging ceiling panels did their work: from all three seats the orchestra had a dramatic immediacy that contributed to making the concert a moving experience. (When the orchestral sound is remote, there tends to be less of an immediate emotional engagement on the part of the listener.)

Stimulating as was this intimate sound, I found it overly hard, a little too loud from the front seats, and, most important of all, lacking that airy, spacious quality I have always looked for in a concert hall. The quality was more like that of Kresge Auditorium than Carnegie Hall or Boston Symphony Hall.

I attended Boston Symphony Hall within a week of hearing the concert at Philharmonic Hall. I was again able to change seats, and had the good fortune to hear the same type of music. My memory had not served me falsely: the qualities I had missed in New York were present in Boston. The orchestra remained at a greater distance, and the hall gave support, color, and spaciousness to the sound. A Boston music critic once wrote that Boston Symphony Hall "is to the orchestra what a Stradivarius is to a great violinist." Philharmonic Hall reminded me more of a cold, clear glass window than an interpretive instrument. Dr. Beranek has said that it will take a year to tune Philharmonic Hall properly. I, for one, hope its intimacy will be reduced in favor of more liveness and warmth.

At \$17.50 a throw, everyone with an interest in music is not likely to rush out and buy Dr. Beranek's book. It will, I think, profoundly influence concert-hall design in the future, particularly because of its analysis of the elements that contribute to musical objectives. It is unusual for a book to appeal to both the professional and the layman. This book has that dual interest, at least so far as the music-loving section of the laity is concerned. If you didn't get it for Christmas, and don't want to pay the asking price, I recommend a trip to the public library.

---

*Edgar Villchur, once an instructor at New York University, left academic life when he invented acoustic-suspension loudspeakers in the mid-Fifties. He is now president of Acoustic Research, Inc., a firm that manufactures loudspeakers and turntables.*

*Two of the best concert halls in existence are Vienna's Grosser Musikvereinssaal (left), which Bruno Walter termed the finest in the world; and Boston's Symphony Hall (right), the first hall designed in accordance with scientifically derived acoustic principles.*

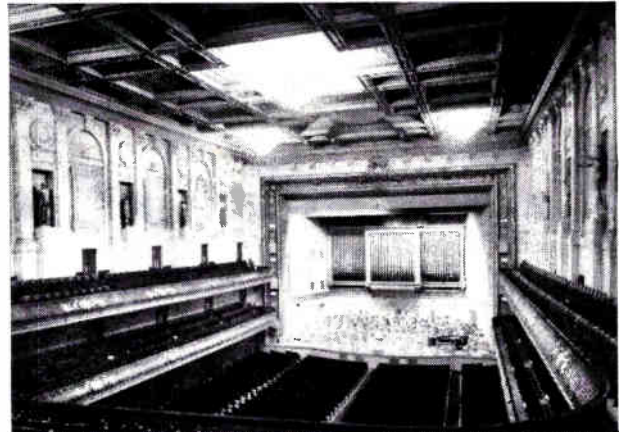
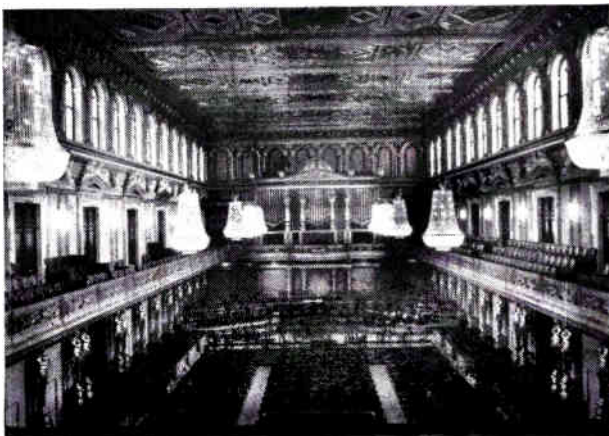

# S&Q

## SOUND AND THE QUERY

A FORUM FOR ELIMINATING  
THE MOST COMMON AND  
OFTEN MOST EXASPERATING  
PROBLEMS OF STEREO HI-FI

BY J. GORDON HOLT

### Low Gain

**Q.** My amplifier and preamp are all right, the cartridge and the pickup cables are new and check out well. Yet in order to get the volume I once got with the volume control set at one o'clock I now have to crank it up all the way. What might be wrong?

H. FENSTER  
New York, N. Y.

**A.** *There are very few defects that will cause both channels of a stereo system to lose gain simultaneously, so I would be inclined to suspect a mismatch between the pickup and the preamp.*

*If the new cartridge is the same type you had before, chances are it is plugged into the wrong inputs, i.e., it may be in the high-level magnetic phono inputs instead of the low-level ones. Or maybe it was formerly connected to the high-gain tape-head inputs, and is now in the correct inputs.*

*If the new cartridge is a different type, it may simply not have enough output to drive your amplifier adequately. If so, you'll have to add step-up transformers at the inputs of the preamplifiers.*

### Cone Flop

**Q.** When strong transients, from plucked violins, for example, come through my system, my woofer cone moves back and forth an inch or more. I note this effect to the same degree whether I use a magnetic or a ceramic cartridge. What causes this, and how might I cure it?

BILL WARRICK  
Seaside, Calif.

**A.** *That this disturbance occurs with the same severity regardless of the pickup cartridge indicates that the cartridge output—the transient—is triggering some instability elsewhere in the system. Low-frequency instability of this kind is generally the fault of the power amplifier, which may have a defective filter capacitor, or may simply be poorly designed. Have the amplifier checked by a factory-authorized repair agency.*

### TV Hum

**Q.** My system is plagued with a buzzing hum that has me completely stumped. The hum is present and unvarying regardless of the settings of the preamp's selector, bass, volume, and so on. The volume of the noise changes considerably when I move the shielded cables running from the preamp to the power amplifier. The cables are about eight feet long, and shifting or even touching them produces changes in the hum level.

I live within a quarter-mile of a powerful TV transmitter, and a friend suggested that some part of the TV signal is being picked up and converted into 60-cycle hum. Indeed, when the station is off the air, the hum is gone. My friend said there is nothing that can be done about this interference. Can you prove him wrong?

ANTHONY J. PASQUARELLO  
Columbus, Ohio.

**A.** *Your friend is right that some part of the TV signal could produce hum. The picture transmission carries a synchronizing pulse that locks*

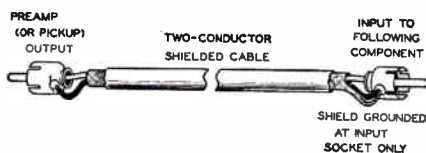

*the picture in place at the receiver to prevent rolling. The pulse recurs sixty times a second—a rate of 60 cycles—and is a sharp blip, explaining why it sounds like a buzz in your system.*

*Evidently, your preamp-to-amplifier interconnecting cables are picking up the picture transmission, and some non-linearity later in the system is rectifying the powerful synchronizing pulses. The easiest solution is to minimize the pickup of the signal by changing the resonant condition set up in the cables.*

*Try shorter interconnecting cables, that are not even fractions of eight feet—your cables may be a precise fraction of the TV signal's wavelength, increasing their efficiency as TV antennas. Also, try changing the length of your speaker leads. These, too, may be picking up the signal.*

*If the interference persists, you may have to replace your interconnecting cables with two-conductor shielded mike cables. At the preamp end of these cables, connect only the inner conductors to the output socket, using the black wire for ground. Ground the cable shield and the black wire at the power amplifier input.*

### Silent Light

**Q.** I am planning to install my equipment in a cabinet, and would like to illuminate the record player compartment. Will a light induce any interference in the tuner? Could I use a fluorescent lamp?

COL. M. M. LAWSON  
APO, San Francisco, Calif.

**A.** *You had better steer clear of the fluorescent lamp, as there is a good chance that this will cause audible interference with your phono as well as the tuner. As long as you keep the wiring away from audio circuits, incandescent bulbs will not cause interference problems.*

### Suffering Sibilants

**Q.** In recording onto tape from stereo discs, I find that all goes reasonably well until a singer pronounces a word with a strong "s" in it. In playback, this creates a hissing distortion, as if the gain had been set too high in recording.

My recording method is direct and should be as distortion-free as is possible. I plug the magnetic-pickup's output leads directly into the recorder's microphone inputs. When I listen through this setup, without recording onto tape, I hear no hissing sounds.

PHILIP A. IVES  
New York, N. Y.

**A.** *If this setup ever sounds satisfactory, I am surprised. A microphone input will not provide either the bass boost or the treble reduction that is needed to compensate for the frequency-response characteristics of modern discs. Your sound will be almost completely lacking in bass, and will have far too much treble.*

*The excess treble causes the difficulty in recording sibilant sounds. Their high-frequency energy, the excess of treble from the discs, and the treble boost normally used in a tape recorder to get flat response while recording are simply overloading your tape.*

*You will have to feed your pickup into a stereo preamplifier.*

## BEST OF THE MONTH



## CLASSICAL

## A NEW TOUCHSTONE FOR DVOŘÁK'S CELLO CONCERTO

*Starker and Dorati blend lyricism with power in spectacular stereo*

**A**FTER hearing a performance of Victor Herbert's Second Cello Concerto during his American sojourn, Antonin Dvořák composed his own vehicle for the instrument in 1895 before he left this country. A new interpretation by Janos Starker and the London Symphony Orchestra conducted by Antal Dorati confirms my opinion that

ANGEL RECORDS



JANOS STARKER

*Challenging Casals's cello supremacy*

it and Bloch's *Schelomo* are the lone works of the cello repertoire of genuinely heroic stature. At the same time, as might be expected, Dvořák leavened his heroic materials with a melodic prodigality that should endear him to any cello soloist, and provided as well a splendidly colorful orchestral accompaniment.

Such a work is done justice only by the finest solo playing, and orchestral cooperation on the same exalted level. Until now, the Pablo Casals-George Szell collaboration of 1938, now on Angel COLH 30, has been the touchstone for all performances. This new recording seriously challenges the musical supremacy of the earlier one. Save for the occasional lack of rhythmic tension on Dorati's part—for example, the statement of the opening theme and the mighty orchestral outbursts midway in the slow movement—this is a recorded performance whose merits will be ascendant for a long time to come. There are some essential differences between Starker-Dorati and Casals-Szell: they can be summed up by saying that where the latter display supercharged intensity, the former bring to the fore the lyrical, developing the give-and-take of long-arched phrases and extended chains of figuration fully and without loss of dramatic power.

Ever since Janos Starker startled listeners in (continued overleaf)



the mid-1940's with his performance of the Kodály Unaccompanied Cello Sonata, this artist has bid fair to equal the great Casals himself. Subsequent Starker recordings of virtually the whole cello repertoire culminate in this, his second go at the Dvořák. From start to finish, there is not the slightest trace of technical insecurity or uncertainty of conception on the part of the soloist or, for that matter, the conductor. The playing of the London Symphony throughout is wholly worthy of the rapport between Starker and Dorati.

Mercury's recording is among the finest the company has done over the past decade. The solidity and impact of the orchestral bass line—something sadly missing from too many recent stereo discs—is particularly spectacular.

The Bruch *Kol Nidrei* gets a properly soulful reading, but it must be said that this rather saccharine music is shown up by the Dvořák masterpiece. *David Hall*

© © DVOŘÁK: *Concerto for Cello, in B Minor, Op. 104*. BRUCH: *Kol Nidrei, Op. 47*. Janos Starker (cello); London Symphony Orchestra, Antal Dorati cond. MERCURY SR 90303 \$5.98, MG 50303\* \$4.98.

## NEW TONAL HEIGHTS IN BRAHMS'S REQUIEM

*Klemperer, Schwarzkopf, and Fischer-Dieskau  
in an unrivalled performance for Angel*

ANGEL's new release of the Brahms *German Requiem* has the several requisites of a major triumph. First, an up-to-date stereo treatment of this work is most welcome to augment other praiseworthy but sonically outdated efforts. Then, the new set brings together two soloists whose exceptional contributions to previous recordings of this score are fondly remembered by Brahms fans: Elisabeth Schwarzkopf (on Columbia SL 157, von Karajan conducting) and Dietrich Fischer-Dieskau (on RCA Victor LM 6050, Kempe conducting). Finally, Otto Klemperer presides over the vocalists and the splendid Philharmonia Orchestra.

Happily, everything lives up to the expectations aroused by these factors. Klemperer fuses the excellent solo and choral singing brilliantly. His reading is firm and vigorous, reverential but without the turgid solemnity that often hovers over performances of this majestic score. He



ELISABETH SCHWARZKOPF  
*Tonal loveliness for awe-inspiring Brahms*

obtains grandeur without overstatement, and the Philharmonia responds to his leadership with luminous tone and superb discipline.

Both soloists are in top form. Schwarzkopf's tones float with crystalline loveliness, Fischer-Dieskau's are projected with dignity and eloquence. The baritone's singing was already a model of tonal beauty and expressive fervor in his first recording of the *Requiem* several years ago. Now, enriched by deeper maturity and a more assured sense of style, it is unsurpassable. He also enunciates with remarkable clarity, an



achievement not always matched here by Miss Schwarzkopf.

While the *German Requiem* is hardly an opportunity for sonic fireworks, stereo has been employed to the best musical ends in this recording. In the choral climaxes alluding to the Last Judgment in Part Six, for instance, the widespread sonorities are awe-inspiring. For the most part, however, richness and depth are emphasized over spread and channel separation.

George Jellinek

© ④ BRAHMS: *Ein Deutsches Requiem, Op. 45*. Elisabeth Schwarzkopf (soprano); Dietrich Fischer-Dieskau (baritone); Ralph Downes (organ); Philharmonia Chorus, Reinhold Schmid (chorusmaster); Philharmonia Orchestra, Otto Klemperer cond. ANGEL S 3624 two 12-inch discs \$11.98, 3624 \$9.98.

## \* ENTERTAINMENT \*

### A CLASSIC ENGLISH NOVEL BECOMES A HIT MUSICAL

*Dickens's low-life London comes raffishly alive in Oliver!*

WHILE America's pre-eminence in the field of musical theater has not yet been seriously challenged, there is no doubt that the English musical stage is currently enjoying a renaissance. Among its brighter lights is Lionel Bart, whose score for the imported *Oliver!* was recorded by RCA Victor even before the New

York opening. A musical version of Dickens's *Oliver Twist*, it should win Mr. Bart further recognition on this side of the Atlantic. In words and music it is a remarkable evocation of the raffish spirit of London in the 1830's, and it captures in an engaging fashion the personalities of the book's characters: the innocent Oliver, the sly Fagin, and the trusting Nancy.

What is particularly admirable is that Mr. Bart's songs consistently convey the period flavor. He has, in fact, taken many of his musical cues from the street cries and popular music-hall songs of the day, thus giving a stylistic unity to his score. *Boy for Sale*, sung by Willoughby Goddard as he shuttles back and forth between the speakers, chillingly conjures up a situation all too common in Dickens's day. In *Who Will Buy?*, a song is created with seeming spontaneity out of street-vendor cries. *Consider Yourself, It's a Fine Life*, and *Oom-Pah-Pah* give us a taste of the uninhibited self-mocking gaiety of the town's low-lives.

The main ballad of the show, *As Long As He Needs Me*, is a doleful lament of self-sacrifice, sung with well-controlled pathos by Georgia Brown. The two solos for Fagin, delivered with Cockney relish by Clive Revill, tellingly reveal the man's mischief and humor, and Bruce Prochnik conveys all the urgent hopes of the much-abused Oliver in *Where Is Love?*

RCA has provided good, though slightly sharp, sound, and has used stereo with marked dramatic effectiveness throughout. The customary outlines and photographs are included on the jacket,

DAVID MERRICK



BRUCE PROCHNIK  
AND CLIVE REVILL  
*Tuneful imported mischief*

and the back cover is given over to a tribute to producer David Merrick. *Stanley Green*

© © OLIVER! (Lionel Bart). Original-cast recording. Clive Revill, Georgia Brown, Bruce Prochnik, Willoughby Goddard, Hope Jackman, Danny Sewell, Michael Goodman; orchestra and chorus, Donald Pippin cond. RCA VICTOR LSOD 2004 \$5.98, LOCD 2004\* \$4.98.

## THE NEW DIVERSITY OF JOAN BAEZ

*A major folk artist accommodates her personal style to many moods*

IN JOAN BAEZ'S third Vanguard album, entitled "Joan Baez in Concert," the young folk singer takes on the challenge of a wider range of material, and succeeds in imparting to all of it her unusually compelling expressive power and purity of sound. To the traditional, dark ballads at which she excels—*Black Is the Color*, *Geordie*, and *Matty Groves*—Miss Baez adds intriguingly diverse elements that reveal her full emotional expressivity.

Miss Baez has been criticized of late for being too cool. But in this recital the Brazilian love song *Ate Amanha* crackles with zestful sensuality. She also brings to poignant but incisive life the story of a beleaguered Gold Coast girl in the African *Danger Waters*. Miss Baez's growing interest in and affinity for country music are represented by *Copper Kettle*, a moonshining song, and *Gospel Ship*, an urgent white spiritual. Another preoccupation of Miss Baez is the peace movement, and she has found in Malvina Reynolds's *What Have They Done to The Rain* a new song that makes a chilling anti-test point at the same time it has considerable musical interest.

Throughout this heterogeneous material, Joan Baez is firmly herself. She has been criticized, too, for having an impregnable individuality by those who would like her to sing in a more ethnic or traditional manner. But she realizes that with her voice and her background, she can be much more effective by absorbing the varied musical elements of her repertoire into her own singular perspective. She bends enough to phrase in the style on country tunes, and she shows an understanding of the narrative curve that must be maintained in ballads of British origin. But she never tries to imitate the authentic folk style. Miss Baez respects the essential lineaments of



JOE ALPER

JOAN BAEZ

*Distilled intensity, remarkable musicianship*

each tradition, but brings a strong sense of her own epoch's feelings to her interpretations.

None of this deeply personal sense of direction would be effective, of course, without Miss Baez's remarkable musicianship. She has thorough control of her voice. There is no break, for example, in its clarity or color in the most pianissimo passages. Furthermore, her unerringly exact phrasing permits no wasted emphases. The words central to the song's mood are subtly set in relief without distorting the line of the story. In short, unlike many folk singers, she does not italicize, but goes instead for the core of each song.

The engineering is excellent, though there is no advantage to the stereo version. In fact, the narrowness of focus of the monophonic recording better fits the distilled intensity of this girl and her guitar.

*Nat Hentoff*

© © JOAN BAEZ: *In Concert*. Joan Baez (vocals and guitar). *Kumbaya*; *Danger Waters*; *House Carpenter*; *Lady Mary*; and nine others. VANGUARD VSD 2122 \$5.95, VRS 9112\* \$4.98.

# Aren't these the qualities you look for in a fine record player?

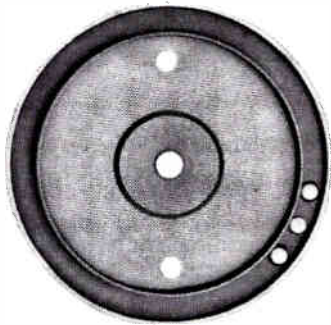

**1.**

Full size, dynamically balanced turntable, machined from a solid, one-piece casting.

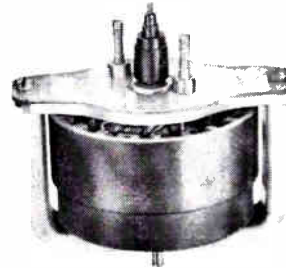

**2.**

High-torque, balanced motor, either 4-pole induction or hysteresis-synchronous.



**3.**

Finely balanced transcription arm with low resonance and minimum tracking error.

**4.**

Now consider that the Benjamin-Miracord embodies them all plus modern, automatic push-button convenience. You can play single records manually or automatically, or up to ten in automatic sequence. And yet, you enjoy the same quality of performance you associate with turntables that can only be played manually.



**BENJAMIN  
MIRACORD**

Model 10 with 4-pole induction motor, \$89.50; Model 10H with Papst hysteresis motor, \$99.50 (cartridge and base, extra).  
See your high fidelity dealer for complete details about the Benjamin-Miracord, or write direct:

BENJAMIN ELECTRONIC SOUND CORP. 80 Swalm Street, Westbury, New York

Sole U.S. Distributor for Electroacoustic® Record Playing Components

STEREO

MUSIC FOR ORGAN AND ORCHESTRA  
 New York Philharmonic Leonard Bernstein  
 The Philadelphia Orchestra Eugene Ormandy

E. POWER BIGGS  
 Organist



The incomparable E. Power Biggs adds brilliance to contemporary organ showpieces. Poulenc: Organ Concerto in G Minor; Barber: Toccata Festiva—Eugene Ormandy, Conductor; The Philadelphia Orchestra / Strauss: Festival Prelude for Organ and Orchestra—Leonard Bernstein, Conductor; New York Philharmonic; E. Power Biggs, Organist

Bernstein and the Philharmonic capture the sweep and splendor of this triumphant symphony.  
 Dvořák: Symphony No. 5 in E Minor ("From the New World")—Leonard Bernstein, Conductor; New York Philharmonic



The towering first symphony by Jean Sibelius authoritatively interpreted by Maestro Ormandy and The Philadelphia Orchestra.  
 Sibelius: Symphony No. 1 in E Minor Eugene Ormandy, Conductor; The Philadelphia Orchestra



STEREO

THE FABULOUS VOICE OF RICHARD TUCKER GREAT SONGS OF LOVE AND INSPIRATION

Arranged and conducted by SKITCH HENDERSON

ANNIVERSARY WALTZ  
 YOU'LL NEVER WALK ALONE  
 LOVE IS A MANY SPLENDORED THING  
 CLIMB EV'RY MOUNTAIN - LOVE LATTERS  
 THE GOODER SONG - I BELIEVE - FIFTHST  
 SOFTLY, AS IN A MORNING SUZUKER - BEALON  
 THE SWEETEST SOUNDS WITH THESE HANDS



Richard Tucker displays his glorious voice in a program of popular songs.  
 The Fabulous Voice of Richard Tucker  
 —Arranged and Conducted by Skitch Henderson

STEREO



1812 OVERTURE  
 THE PHILADELPHIA ORCHESTRA, EUGENE ORMANDY

The spectacular sound of Eugene Ormandy and the philadelphians reaches new heights in spectacular stereo. Tchaikovsky: Overture "1812"; Borodin: In the Steppes of Central Asia; Polovtsian Dances (from "Prince Igor"); Mussorgsky: Night on Bald Mountain—Eugene Ormandy, Conductor; The Philadelphia Orchestra

*Strauss waltzes and polkas done to a turn with Maestro Ormandy's imaginative stereo effects for good measure.  
 Carnival in Vienna—Eugene Ormandy, Conductor; The Philadelphia Orchestra*



THE SOUND OF GENIUS IS ON COLUMBIA RECORDS

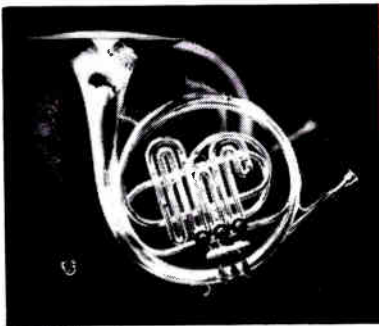

# classics

Reviewed by WILLIAM FLANAGAN • DAVID HALL

GEORGE JELLINEK • IGOR KIPNIS

## Explanation of symbols:

Ⓜ = monophonic recording

Ⓢ = stereophonic recording

\* = mono or stereo version  
not received for review

## RECORDING OF SPECIAL MERIT

Ⓢ Ⓜ BACH: *Brandenburg Concertos*. Gareth Morris and Arthur Ackroyd (flutes); Sidney Sutcliffe, Stanley Smith, and Peter Newbury (oboes); Cecil James (bassoon); Adolf Scherbaum (trumpet); Alan Civil and André Woodburn (horns); Hugh Bean (violin); George Malcolm (harpsichord); Philharmonia Orchestra, Otto Klemperer cond. ANGEL S 3627 two 12-inch discs \$11.96, 3627\* \$9.96.

Interest: Klemperer  
Performance: Immaculate  
Recording: Well-balanced  
Stereo Quality: Good

The most impressive thing about this latest set of the six Brandenburg Concertos is the high level of instrumental playing. For sheer ensemble work, beauty of tone, balance, and precision, this album is undoubtedly the best of all available versions. Otto Klemperer's solid manner here is very much as it was in his previous recordings of these concertos, made seventeen years ago for Vox and unfortunately very poorly recorded. His interpretations are thoroughly sincere, his tempos are logical and not rushed. But, on the other hand, dramatic excitement is often lacking. A good example is No. 5, which has the advantage here of the best balance of the violin, flute, and harpsichord to be found on discs. George Malcolm's harpsichord playing is wonderfully smooth, although the brilliance of the solo cadenza, perhaps in keeping with the performance itself, seems deliberately underplayed. The liveliest of the set is No. 4—Klemperer uses flutes rather than recorders—but the remaining concertos are somewhat sober. One cannot help admiring the lovely string sounds of No. 3, but the conductor makes no effort to supply a slow movement or improvisation for the two-chord cadence that separates the fast movements. Neither Klemperer's phrasing and

articulation nor his treatment of ornaments are as appropriate to the music as Thurston Dart's exciting and scholarly performances on L'Oiseau-Lyre, nor do his interpretations have the warmth of Menuhin's for Capitol. The recorded sound is superb, and the difficult problems of balance have been solved with remarkable success. I. K.

Ⓢ BACH: *Six Sonatas and Partitas for Unaccompanied Violin*. Joseph Szigeti (violin). VANGUARD BG 627/9 three 12-inch discs \$9.96.

Interest: Szigeti's Bach  
Performance: Much to admire  
Recording: Very good

Just over thirty years ago, Columbia issued the first disc performances of the G Minor and A Minor unaccompanied Violin Sonatas. Joseph Szigeti, the performer, has since had a long and distin-

in view of the over-all musicality and depth here one cannot object to such anachronisms. His sincerity, drive, and rhythmic vitality are not easy to duplicate even among the younger virtuosos. In short these are the summing up of a lifetime of association with this music.

But no amount of adulation of Szigeti the musician can negate the fact that the violinist was long past his prime when these taxing works were recorded. Most apparent to the ear is the lack of control in the bow arm: great unevenness of tone results. This is more evident in the slow movements than the fast, although in such a staggering section as the fugue from the C Major Sonata, the technical demands simply prevent Szigeti from maintaining a steady rhythmic pulse. Some of the rapid movements, for instance the "double" of the *Courante* in the first Partita or the final Presto from the G Minor Sonata, are comparatively free from strain and technically impres-



ALBAN BERG (PORTRAIT BY ARNOLD SCHOENBERG)  
In his masterpiece, medals for Stern and Bernstein

guished association with the six Bach Sonatas and Partitas. His readings of these works in concert have been praised by audiences for years, yet it is only on the anniversary of the violinist's seventieth birthday that we are finally given a new, complete set on records.

To an extent, Szigeti belongs to an older school of Bach playing, one that makes more use of gypsy-like slides and portamentos than today's performers, but

sive, but the sustained movements—the Grave from the Sonata in A Minor, for example—are distracting and almost uncomfortable to hear. I. K.

BALAKIREV: *Islamey* (see MOUS-SORGSKY).

## RECORDING OF SPECIAL MERIT

Ⓢ Ⓜ BARTÓK: *Two Rhapsodies for*

**Violin and Orchestra. BERG: Violin Concerto.** Isaac Stern (violin); New York Philharmonic, Leonard Bernstein cond. COLUMBIA MS 6373 \$5.98, ML 5773\* \$4.98.

Interest: Modern masterpiece

Performance: Electric

Recording: Superb

Stereo Quality: A-1

It is by common consent that Alban Berg represents the triumph of humanism over method where the twelve-tone techniques are concerned, and his opera *Wozzeck* has probably done more than any single work to bring public acceptance to the chillingly abstract intellectual conceits of Arnold Schoenberg.

But Berg's Violin Concerto, surely a less celebrated work than the opera, may very likely be his masterpiece. Certainly, there is no work in the repertoire of serious music quite like it—none that parallels the near-religious conviction that lies behind its despair. Neither Wagner nor Mahler was ever more romantic, and few works of the twentieth century bear more clearly the marks of musical genius, pure and simple, than this one.

Columbia, Leonard Bernstein, and Isaac Stern deserve all the medals for giving us this disc, not just because it's so good but because it brings the work into the hands of a top-drawer violinist for the first time on records. It is no mitigation of the accomplishments of the less talented men who have braved the work—when no one else was of a mind to—to suggest that it deserves the best available and that now, at last, it has it.

The Bartók rhapsodies tend to pale in such urgent company, but they are well served by all involved. W. F.

Ⓢ Ⓢ BEETHOVEN: *Symphony No. 4, in B-flat, Op. 60; Leonore Overture No. 3, Op. 72a.* Pittsburgh Symphony Orchestra, William Steinberg cond. COMMAND CC 11016SD \$5.98, CC 11016\* \$4.98.

Ⓢ Ⓢ BEETHOVEN: *Symphony No. 4, in B-flat, Op. 60; King Stephen Overture, Op. 117.* Czech Philharmonic Orchestra, János Ferencsik cond. PARLIAMENT PLP(S) 165 \$2.98, PLP 165\* \$1.98.

Interest: Lyric symphonies

Performance: Speed vs. moderation

Recording: Superb vs. diffuse

Stereo Quality: Good in both

In the Beethoven canon, the Fourth Symphony is *sui generis*, a unique and masterly achievement wherein the claims of melody, rhythmic tension and release, and dynamic contrast find a singularly felicitous and satisfying fulfillment. The measure of satisfaction, however, is de-

pendent almost wholly on the musical stature of the conductor; for of all the Beethoven symphonies, the Fourth is the one that "plays itself" least. It requires not only virtuoso string players and first-desk wind soloists but also acute judgment on the conductor's part, especially of ensemble balances and of the optimal relationship between tonal impact and momentum.

The late Sir Thomas Beecham, in a 1947 recording available briefly on LP as RCA Victor LM 1026, achieved this in flawless fashion, and among today's recordings, that by Ansermet and the Suisse Romande Orchestra (London CS 6070/CM 9255) is nearly in the same class and is graced by first-rate sound.

Judged by these standards, neither of the two newest Beethoven Fourths measures up. Despite its tremendously impressive sonics, the Command disc suffers from conductor William Steinberg's overly fast tempos. One has a sense of not having a fair chance to absorb the substance of phrase and melody, especially in the body of the first movement.

The Parliament disc, with János Ferencsik, is a good buy, with sensible tempos and highly competent orchestral playing, but the reading as a whole is lacking in distinction when compared to the recorded performances of Ansermet, Beecham, or Toscanini (in the pre-war BBC Symphony recording). The sound is rather diffused by the vast spaces of the auditorium in which the recording was made—presumably the Rudolfinium in Prague.

As for the overtures that begin Steinberg's disc and conclude Ferencsik's, *King Stephen* gets better treatment than it deserves (it's a potboiler if ever there was one), while Steinberg's handling of the mighty *Leonore No. 3* seems casual when one recalls the interpretations of Toscanini, Furtwängler, or Klemperer.

D. H.

BEETHOVEN: *Violin Sonata No. 8* (see BRAHMS).

BERG: *Violin Concerto* (see BARTÓK).

Ⓢ Ⓢ BOIELDIEU: *Piano Concerto in F Major.* HUMMEL: *Piano Concerto, in B Minor, Op. 89.* Martin Galling (piano); Innsbruck Symphony Orchestra, Robert Wagner cond. VOX STPL 512 250 \$4.98, PL 12 250\* \$4.98.

Interest: Concerto rarities

Performance: Excellent

Recording: Spacious

Stereo Quality: Very good

François Adrien Boieldieu (1775-1834) was a professor of piano at the Paris Conservatory in 1800. He wrote three piano sonatas but only one concerto. It is,

I regret to say, quite dreadful, especially its second movement, a set of empty variations on a pastoral air. Johann Nepomuk Hummel (1778-1837) is a horse of a different color. A student of both Mozart and Clementi, he was one of the keyboard titans of his time, noted for his improvisations. He wrote seven piano concertos, of which the fourth, recorded here, was composed in the early 1820's. It is a Beethovenesque work, with more than a hint of John Field, and makes a worthwhile addition to the list of lesser known classical concertos. (This, incidentally, is not the same Hummel concerto recorded over eleven years ago for Concert Hall by Artur Balsam.)

The twenty-eight-year-old German, Martin Galling, who has previously been heard playing harpsichord continuo on Epic Bach discs, makes a most promising piano debut in these two concertos. He



FRANCOIS ADRIEN BOIELDIEU

*Charming composer, dreadful concerto*

has a clean, strong technique and plenty of musical insight, and if he cannot prevent the Boieldieu from boring us, it is not his fault. The orchestral accompaniment is more than satisfactory, and its reproduction, with a fairly close-up piano, is spacious. The program notes are uninformative. I. K.

#### RECORDING OF SPECIAL MERIT

Ⓢ Ⓢ BRAHMS: *Violin Sonatas: No. 1, in G Major, Op. 78 ("Rain"); No. 2, in A Major, Op. 100 ("Thun"); No. 3, in D Minor, Op. 108.* BEETHOVEN: *Violin Sonata No. 8, in G Major, Op. 30, No. 3.* Henryk Szeryng (violin), Artur Rabinstein (piano). RCA VICTOR LSC 2619/20 \$5.98 each, LM 2619/20 \$4.98 each.

(Continued on page 72)

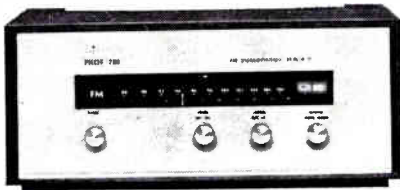

**MODEL 780 FM Multiplex Stereo Tuner.** The ultimate instrument for receiving FM and FM Multiplex Stereo broadcasts. Contains PIlOR's revolutionary signal sampling Multiplex circuit for perfect FM stereo channel separation (better than 30 db) across the entire audio spectrum. Features PIlOR's exclusive Automatic FM Stereo Indicator that eliminates all guesswork in finding FM Stereo broadcasts. FM sensitivity (IHFM): 1.8 microvolts; capture ratio: 1 db; frequency response ( $\pm 1$  db): 20-20,000 cps; FM detector bandwidth: 800 kc; FM IF stages: four; harmonic distortion 0.2% at 100% modulation. Has built-in line cord FM antenna plus terminals for external 300-ohm balanced antenna and 72-ohm coaxial cable. 199.50, less enclosure (metal enclosure: 9.50 extra; walnut enclosure: 22.50 extra).

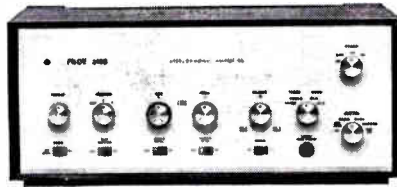

**MODEL 248B Integrated Stereo Amplifier.** A 74-watt stereophonic amplifier-preamplifier that takes up where others leave off. Only 0.1% harmonic distortion (IHFM); frequency response ( $\pm 1$  db): 5-50,000 cps; hum and noise: completely inaudible (80 db below full output). Speaker outputs per channel: 4, 8 and 16 ohms plus STEREO-PLUS CURTAIN OF SOUND connections (a pair of center speaker connections delivering a signal that is the sum of Channel A and B). Outputs for tape and headphones. 7 pairs of inputs. A total of 13 front and back controls and switches including separate bass and treble controls, scratch and rumble filters, stereo balance, tape monitor, mode and automatic shutoff. 269.50, less enclosure (metal enclosure: 9.50 extra; walnut enclosure: 22.50 extra).

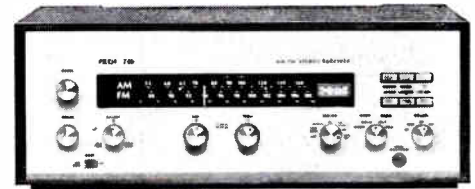

**MODEL 746 FM Multiplex-AM Stereo Receiver.** The perfect electronic "heart" for your high-fidelity stereo system—an AM/FM stereo tuner, a 60-watt stereo amplifier and a stereo preamplifier. With Automatic FM Stereo Indicator and precision AM/FM tuning meter. FM section: FM sensitivity: 1.8 microvolts (IHFM); harmonic distortion at 100% modulation: 0.2%; stereo separation across the entire audio spectrum: better than 30 db; AM sensitivity: 3 microvolts for 1 volt DC. Amplifier section: harmonic distortion (IHFM): 0.1%; hum and noise: completely inaudible (80 db below full output); speaker outputs per channel: 4, 8 and 16 ohms plus STEREO-PLUS CURTAIN OF SOUND connections; tape and headphone outputs. Preamplifier section features 8 inputs and 14 controls for complete stereophonic and monophonic flexibility. 399.50, less enclosure (metal enclosure: 9.50 extra; walnut enclosure: 27.50 extra).

**for more information, hear them.**

PiLOR offers a wide range of stereo components as well as a variety of 3-way speaker systems. For literature, write:  
PILOT RADIO CORPORATION, 37-22 36TH STREET, LONG ISLAND CITY 1, N. Y.  
JANUARY 1963 CIRCLE NO. 42 ON READER SERVICE CARD 71

Interest: Duo-sonata cornerstone  
 Performance: Immensely vital  
 Recording: Lots of presence  
 Stereo Quality: Tasteful

In this second stereo recording of the three Brahms violin sonatas, we encounter an interpretive approach to the music that contrasts sharply with the classical lyricism offered by Wolfgang Schneiderhan and Carl Seemann on their pair of DGG discs. Henryk Szeryng and Artur Schnabel are not only virtuoso exponents of the highest caliber, but they have an emotional fervor that probably stems from the Polish ancestry they share. As a result, we have performances of these three beautiful Brahms sonatas that are charged with feeling. Fortunately, the musicianship of the Szeryng-Schnabel team prevents it from transgressing the line between fervor and sentimentality.

The sparkling Beethoven G Major Sonata, music as fresh as a spring brook, gets an exciting performance here, too. But I wonder whether its slender musical substance can quite take the tonal and rhythmic intensity to which it is subjected on this disc.

The recorded sound is on the intimate and close-to side, but not uncomfortably so. The violin-piano balance is just, emphasizing the *pars inter pares* relationship so essential in chamber music of this type. The piano tone conveys a nice combina-

tion of impact and warmth, and the violin emerges with a pleasantly virile burr that recalls the sound of Joseph Szigeti.

All told, this pair of records provides a stirring experience. *D. H.*

© © BRAHMS: *Symphony No. 2, in D Major, Op. 73*. New York Philharmonic, Leonard Bernstein cond. COLUMBIA MS 6374 \$5.98, ML 5774\* \$4.98.

Interest: Philharmonic Hall first  
 Performance: Full-blooded  
 Recording: Loud and clear  
 Stereo Quality: Emphasizes placement

In a certain sense Columbia's subtitle for this Brahms recording by Leonard Bernstein and the New York Philharmonic—"The Sound of Lincoln Center"—is a trifle misleading: first of all, because the recording took place some ninety days before Philharmonic Hall was fully completed; and second, because the hall has been designed to have not just one type of sound but many—this because of the adjustable ceiling and wall screens. Thus Columbia conceivably could have set up Mr. Bernstein's orchestra on the Philharmonic Hall stage with some adjustments of the acoustical screens and come up with a Brahms Second recording that would give us a "sound of Lincoln Center" having little or no relation to that of this disc.

When I heard the final performance of opening week at Lincoln Center, it is fair to assume that the auditorium had reached a certain optimum of acoustical quality, and that designer Leo Beranek and his colleagues had done substantial tinkering with the ceiling panels and acoustical screens. From where I sat, the arrangement of stage and ceiling panels seemed to approximate the visual aspect of a gigantic exponential horn, and what I heard was startling in its power and brilliance—perhaps favoring the trumpets and the violin E-string register a little too much—and remarkable in clarity of texture and combined blend, with plenty of bass. Perhaps the most pleasing aspect of Philharmonic Hall for me was that it was not afflicted with the cold and sterile tone quality of many modern auditoriums. Both here and in Europe, for all the trouble taken with projective efficiency and optimum reverberation time, too little attention has been paid to resonant points that enhance musical sound rather than reduce it to a soulless neuter quality. The better radio microphone pickups from Philharmonic Hall, as heard on FM, have confirmed my initial impression.

Be that as it may, the present recording emphasizes Philharmonic Hall's projective qualities and clarity, perhaps at the expense of tonal warmth. The disc unquestionably has its value as a historic document, and it has substantial musical values, too—namely, a lusty and full-blooded Bernstein performance that stresses the passion and vitality of the music, leaving lyrical subtleties to Beecham and Walter. For sheer brilliance in both performance and recording, however, Steinberg and the Pittsburgh Symphony on Command enjoy a slight edge over Bernstein. *D. H.*

BROWN: *Music for Violin, Cello, and Piano* (see FELDMAN).

© © BRUCKNER: *Symphony No. 7, in E Major*. WAGNER: *Siegfried Idyll*. Philharmonic Orchestra, Otto Klemperer cond. ANGEL S 3626B two 12-inch discs \$11.96, 3626B\* \$9.96.

Interest: Bruckner favorite  
 Performance: Variable  
 Recording: Lacks richness  
 Stereo Quality: Good enough

Together with the Fourth ("Romantic") Symphony, the Seventh is the most immediately accessible of the Bruckner symphonies to the uninitiated listener. But despite its relative popularity (as Bruckner symphonies go), the Seventh has yet to enjoy a truly first-rate recorded performance in stereo. This rendition misses fire because of a combination of circumstances. For one thing, Klemperer  
*(Continued on page 74)*

The new Koss Professional Headset is designed to meet the rugged, sensitive listening requirements of the pros. Not everyone needs it, but you've never heard anything quite like it before. What a Christmas gift it will make! Ask for a demonstration.

Fluid-filled earpieces, connector for boom-mounted mike. \$45.00



**KOSS** ELECTRONICS, INC.  
 2227 NORTH 31ST STREET  
 MILWAUKEE 8, WISCONSIN



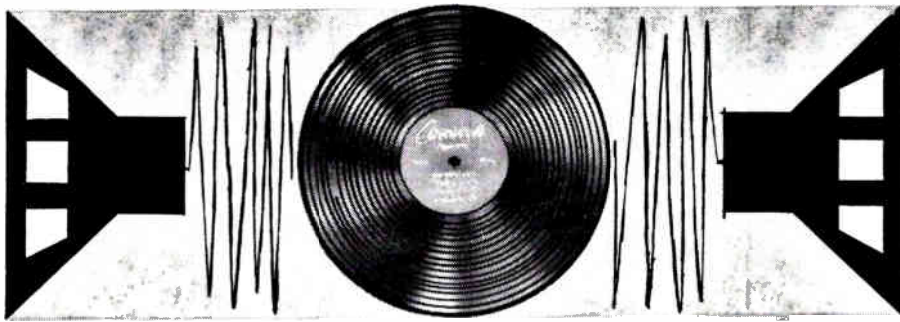

# Getting the Most Out of Your Hi-Fi/Stereo Equipment

Whether you are a complete stereo-ophile with a fully integrated sound system, or a relative neophyte just starting into hi-fi, the *fidelity of sound reproduction from your equipment can be no greater than the quality and sound content of the record being played. No matter how good all your other components may be, the ultimate excellence of the performance depends on the record. It is at this point that COMMAND has no peer.*

That's why COMMAND records are the overwhelming choice of discriminating, knowledgeable people who desire and demand the finest in recorded sound. COMMAND... world leader in recorded sound, provides you with the ultimate in musical enjoyment... sound so pure, full and honest that COMMAND records are used by leading manufacturers of stereo and hi-fi equipment to demonstrate the greatest potential of their equipment!

Beginning with the now famous PERSUASIVE and PROVOCATIVE PERCUSSION series, COMMAND launched a new concept in sound reproduction. Overnight the COMMAND label skyrocketed to the top of the industry. Critics were the first to recognize that "Stereo didn't make COMMAND; COMMAND made

*Stereo!"* COMMAND has indeed delivered what others have only promised... the true musical excitement of stereo.

And, to maintain their uncontested leadership, COMMAND painstakingly perfected the unbelievable world of 35/MM Sound... the miraculous new method of capturing the living essence of pristine sound.

Recording original masters on 35 millimeter magnetic tape represents a major "breakthrough" in the history of recorded musical sound... not only in the popular field but also in the more critical, highly demanding world of classical music.

The result is a milestone on the road to absolute perfection in recorded sound. For the very first time you will hear sound that is completely liberated... sound that is totally free... with no mechanical restrictions — performances that are an unprecedented combination of musical brilliance and startlingly real, completely unlimited sound reproduction.

Discover for yourself why COMMAND is truly the World Leader in recorded sound. Let COMMAND help you deliver the true potential of your high fidelity stereo equipment. COMMAND delivers what it promises — *the ultimate in musical enjoyment.*

**SEND FOR FREE FULL COLOR BROCHURE OF ALL COMMAND RELEASES**

**WORLD LEADER IN RECORDED SOUND**  
 **Command RECORDS**  
 1501 BROADWAY, NEW YORK 36, N. Y.

## SPECIAL STEREO OFFER!

To give you a sampling of what makes COMMAND the world leader in recorded sound, two special albums have just been released. The Command *Popular Sampler* Album contains 12 complete selections, from 12 different Command Popular Albums including *Carousel*. The Command *Classic Sampler* Album contains 8 complete selections from 8 different Command Classical Albums.

Unlike many sampler albums, there is no sales message... no talk! These sampler albums were created to give you full, *uninterrupted* musical pleasure — music raised to astounding reality through Command's technique of master recording originals on tape and on 35 mm magnetic film.



### POPULAR SAMPLER Including 12 Complete Selections

- HEAT WAVE (Stereo 35/MM)
- MOON RIVER (Great Themes From Hit Films)
- FINALE FROM CAROUSEL (Carousel) Alfred Drake, Roberta Peters
- CHEEK TO CHEEK (Enoch Light and His Orchestra At Carnegie Hall Play Irving Berlin)
- GUITAR ESPANOL (Spanish Guitar) Tony Mottola
- LOVE FOR SALE (The Big Band's Back In Town)
- VIENI VIENI (Rome Revisited) Ray Charles Singers
- FORTY-SECOND STREET (Off Beat Percussion)
- I'M OVER HERE (Something Wonderful)
- CLOSE YOUR EYES (The Persuasive Trombone of Urbie Green)
- THE CRY OF THE WILD GOOSE (Strange Interlude)
- NINA (Roman Guitar)

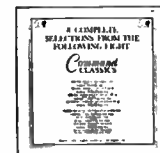

### CLASSIC SAMPLER Includes 8 Complete Selections From:

- BRAHMS Symphony #2 Steinberg; Pittsburgh Symphony
- BEETHOVEN Symphony #4 Steinberg; Pittsburgh Symphony
- WAGNER Der Ring des Nibelungen Steinberg; Pittsburgh Symphony
- SCHUBERT Symphony #3 Steinberg; Pittsburgh Symphony
- MUSSORGSKY-RAVEL Pictures At An Exhibition Vandernoot; Paris Conservatoire Orc.
- RAVEL Rapsodie Espagnole Dervaux; Colonne Orch. (Paris)
- RAVEL Alborada del Gracioso Dervaux; Colonne Orch. (Paris)
- BERLIOZ Symphonie Fantastique Vandernoot; National Orch. (Paris)

Here is your opportunity to savor the full range of Command artistry. Specially priced at \$2.98 each or both for \$5. — shipped prepaid! Not available in stores.

#### MAIL COUPON TODAY!

COMMAND RECORDS, Dept. 1-HSR  
1501 Broadway, N. Y. 36, N. Y.

Please send me the Command Stereo Sampler Albums checked below. I understand Command pays all postage and handling.

- POPULAR SAMPLER @ \$2.98 each  
 CLASSIC SAMPLER @ \$2.98 each  
 \$5 for BOTH

Enclosed is \$ \_\_\_\_\_

NAME \_\_\_\_\_

ADDRESS \_\_\_\_\_

CITY \_\_\_\_\_ ZONE \_\_\_\_\_ STATE \_\_\_\_\_

seems to concentrate on line and phrasing at the expense of dynamic contrast. For another, the Angel sound is oddly lacking in richness (in the bass line, especially). As a result, this is a Bruckner performance that sounds curiously monochromatic, even a bit dull. Then, too, there are just enough small roughnesses of orchestral attack at crucial moments to be annoying.

All told, this recorded performance is not up to the top Klemperer (or Angel) standard. Even so, I hope that Klemperer will be given the opportunity to record for Angel under better conditions such as the Mahler "Resurrection" symphonies.

Klemperer's reading of the Wagner *Siegfried Idyll*, which fills out the fourth side of this album, uses the chamber orchestration (one or two string players per part) for which Wagner originally conceived the music. A somewhat warmer recorded sound would have helped, but more important is the fact that the solo wind players of the Philharmonia Orchestra play their parts quite beautifully. D. H.

⑤ ⑥ **CHOPIN: *Twenty-four Preludes, Op. 28; Polonaise, in A-flat, Op. 53 ("Heroic").*** Ruth Slenczynska (piano). DECCA DL 710059 \$5.98, DL 10059 \$4.98.

Interest: Basic Chopin  
Performance: Erratic  
Recording: Splendid  
Stereo Quality: Big spread

Unless Artur Schnabel or Russia's Vladimir Ashkenazy can be persuaded to do the job, I frankly despair of ever hearing a wholly satisfactory modern recording of the Chopin Preludes. The most satisfying performance presently available, that of Guiomar Novaes on Vox, offers something less than the best piano sound—understandably, as it was recorded in 1950. When I put on my turntable Ashkenazy's Artia set of the *Études* or Rubinstein's RCA discs of the *Ballades*, the sad plight of the Preludes is brought home most forcibly. For all Ruth Slenczynska's intensity of effort and the imposing piano sound that emerges from this disc, the end result is far from satisfactory musically. In the lighter pieces she lacks the effortless ease that is part and parcel of truly great Chopin playing (Ashkenazy's *Études* are a prime instance), and where Rubinstein's fervor seems as natural as breathing, Miss Slenczynska is not at home in most of the big and stormy pieces. Her powerful rendering of No. 22, in G Minor, is one of the happy exceptions. There is no gainsaying the accuracy and power of Miss Slenczynska's virtuoso playing, but this has yet to be integrated with a wholly convincing formal and expressive con-

ception. Her reading of the celebrated A-flat Polonaise on this disc sums up the failure: as we hear the introduction, we are led, by virtue of her handling of the dramatic pauses and attacks, to expect a really thrilling performance, but the main body of the piece sounds more like a treadmill race. D.H.

⑥ ⑥ **COLERIDGE-TAYLOR: *Hiawatha's Wedding Feast.*** Royal Choral Society and the Philharmonia Orchestra, Sir Malcolm Sargent cond. ANGEL S 35900 \$5.98, 35900 \$4.98.

Interest: Musical curiosity  
Performance: Unimpeachable  
Recording: Splendid  
Stereo Quality: Highly effective

"Not many years ago *Hiawatha's Wedding Feast* disputed with Mendelssohn's *Elijah* for the distinction of occupying second place to *Messiah* in the affections of the English public, but in post-war years it has been neglected and a generation has grown up to many of whom it is quite unfamiliar. . . ."

So writes W. A. Chislett, Angel's annotator, about *Hiawatha's Wedding Feast*, an entirely disarming oratorio by the British composer Samuel Coleridge-Taylor (1875-1912). And in the last analysis, one can scarcely offer serious resistance to the innocent amiability that inspired the work—even as one might harbor mild astonishment at the public taste that accounted for its popularity.

Perhaps it is humorless to suggest that Angel's superb production—radiant musical performance, spectacularly spacious and live recording—might have been more appropriately lent to any of several unrecorded choral works of real musical importance that come to mind. But the thought persists. W.F.

⑤ ⑥ **DELIUS: *Brigg Fair—English Rhapsody; Dance Rhapsody No. 2; On Hearing the First Cuckoo in Spring; In a Summer Garden.*** Philadelphia Orchestra, Eugene Ormandy cond. COLUMBIA MS 6376 \$5.98, ML 5776\* \$4.98.

Interest: Belated tribute  
Performance: Philadelphian  
Recording: Gargantuan  
Stereo Quality: Enveloping

Claude Debussy and Frederick Delius, two impressionist masters from opposite side of the English channel, were both born in 1862, but understandably, the great Frenchman has fared better this year in terms of anniversary tributes, recorded and otherwise. In view of the wealth of material at Angel's disposal by Delius's greatest interpreter and champion, Sir Thomas Beecham—some of it, like the complete opera *A Village Romeo and Juliet*, never released on LP—we

might have expected a combined Delius-Centennial Beecham-In-Memoriam package. But though EMI issued a two-disc Beecham-Delius set in England last March that included the lovely neglected Violin Concerto, this side of the Atlantic received nothing. The one American record company commemoration of the Delius centennial has now come from Columbia, and from an unexpected source, Eugene Ormandy and the Philadelphia Orchestra. So whatever reservations I have about the performances, I hereby tender the Columbia Masterworks artist-and-repertoire department a bouquet of orchids for the right idea and a fine job with the forces at its disposal.

Three of the four pieces on the Ormandy disc are currently available in superlative stereo performances by Beecham. Ormandy's bathe Delius's tone-poetry in a Van Gogh glare as compared with Beecham's muted English pastels, a difference not merely in recorded sound but in interpretive view. Ormandy goes all out for the sensual, so that the delightfully sprawling *Brigg Fair*, based on the old Irish folk melody uncovered by Percy Grainger, and the exquisite *First Cuckoo* are of glowing beauty. He also manages to extract an extra measure of interest out of the late and somewhat dull *Second Dance Rhapsody*. But his treatment of the lovely *In a Summer Garden* is a trifle heavy-handed. The recorded sound throughout the disc is of the richest Philadelphian brand.

If Columbia and Mr. Ormandy, through this record, succeed in interesting the younger generation of record collectors in exploring the uniquely personal and currently unfashionable music of Delius—not just the impressionist idylls, but also the American pieces such as *Appalachia* and *Sea Drift*—they surely will have done these music lovers a good turn. For the best of Delius is a treasureable and poignant experience, especially when rendered by Beecham. For readers new to Delius and his work, I recommend hearing this disc, reading the Beecham biography, *Frederick Delius* (Knopf), and then exploring the Beecham recordings, whenever and however they can be found. D.H.

⑤ ⑥ **FELDMAN: *Durations. BROWN: Music for Violin, Cello, and Piano (1952); Music for Cello and Piano (1955); Hodograph (1959).*** Matthew Raimondi (violin), David Soyer (cello), David Tudor (piano), Don Hammond (flute), Philip Kraus (orchestra bells, vibraphone, marimba). TIME S 8007 \$5.98, 58006 \$4.98.

Interest: Super avant-garde  
Performance: Its own standard  
Recording: Highest hi-fi  
Stereo Quality: Tricky

(Continued on page 77)



TYPE  
**A**  
\$79.50

# THESE ARE GARRARD'S AUTOMATIC TURNTABLES

To understand why more fine component music systems are being built around these than any other record playing units, please turn the page . . .



MODEL  
**AT6**  
\$54.50

The original  
**AUTOMATIC  
TURNTABLE**



Laboratory Series  
**TYPE A**

... a new kind of record playing unit,  
which has become a legend.

The Type A established the concept of the Automatic Turntable, combining the professional performance of a dynamically-balanced tone arm, full-size turntable and Laboratory Series motor ... with the tremendous convenience of the world's gentlest record changing mechanism, to use when desired. Because it is the answer to today's most advanced stereo requirements, this Garrard has enjoyed the most dramatic acceptance ever accorded a high fidelity record playing component. Richly executed in grey, charcoal and chrome, the Type A is designed to enhance the finest music system, fulfilling the most critical requirements through excellent performance, utter reliability, durability, safety and convenience. An extravagant concept, this magnificent unit, refined and restyled, remains moderate in cost at \$79.50.

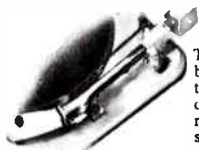

Type A includes a dynamically-balanced tone arm, with all the precision, balance, freedom from friction, and low resonance of the finest arms separately sold.



This advanced tone arm is balanced and set in two simple steps: First, the adjustable counterweight is moved until the arm floats level at zero stylus pressure.



Then, the correct stylus pressure for the cartridge is established by moving a pointer along a calibrated gram scale at the side of the arm. This built-in gauge sets tracking force more accurately than by a separate gauge.



The arm will now track perfectly even if the player is intentionally tilted, the record warped, or not concentric. It will bring out the best in any cartridge used, including those labelled "professional."



Turntable is full-sized, balanced, cast and polished. The weight of 6 lbs. has been determined as the optimum for perfect torque and flywheel action in the Type A.



Actually, it consists of two turntables balanced together ... a drive table inside and a heavy cast turntable outside. These are separated by a resilient foam barrier which damps out noise or vibration.



Type A is built around the Garrard "Laboratory Series" shaded 4-pole motor, designed specifically for it. It is shielded completely, top and bottom, with accurately oriented plates which prevent hum.



The great advantage of automatic play when desired ... and without compromise! The Type A accomplishes this with Garrard's exclusive pusher platform ... unquestionably the gentlest, most reliable automatic record handling device ever developed.



Installation and removal have been made very simple. Leads are connected with a built-in Amplug (for AC) and a female twin phono socket (for audio). No need to disengage wires from amplifier ... simply unplug at the player.

Type A is supplied fully wired for stereo, with a 4-pin/5-wire system utilizing separate connection for ground to eliminate hum.

**SPECIFICATIONS:**

4 speeds: 16 $\frac{1}{2}$ , 33 $\frac{1}{3}$ , 45 and 78 RPM; 100-130 volts, 60 cycles AC (50 cycle pulley available)

15 $\frac{1}{2}$ " left to right, 14 $\frac{1}{2}$ " front to rear, 4 $\frac{1}{2}$ " above and 2 $\frac{1}{2}$ " below top of motor board.

# BRILLIANT PERFORMANCE, CONVENIENCE AND STYLING

The proven results of skilled engineering, meaningful features, rigid quality control — yours to enjoy year after year!



Model  
**AT6**  
the compact, intermix  
**AUTOMATIC  
TURNTABLE**

Handsome dramatic in grey, charcoal and brushed aluminum, this precision model offers all the critical performance features required of a Garrard Automatic Turntable. These include a particularly sensitive tubular tone arm, dynamically balanced and counterweight-adjusted, with built-in stylus pressure gauge; plus an oversized turntable; the Laboratory Series motor; and an intermix automatic record changing mechanism, to use when desired. Yet, the Garrard engineers ingeniously have designed the AT6 to be so compact that it can be offered in this latest version at only \$54.50.



AT6 features a dynamically counterbalanced tubular tone arm of outstanding design, comparable with the most advanced, most popular, separately-sold tone arms.



Balance and tracking force are adjusted in two steps: First ... zero tracking pressure is established by moving the counterweight until the arm floats level, in perfect equal balance.



Next, correct tracking force is set on the stylus scale mounted upright at the side of the tone arm. Settings are more precise than by a separate stylus pressure gauge.



AT6 will now track each side of the stereo grooves perfectly at the lowest pressure specified, even for cartridges labelled "professional" ... and even if the player is intentionally tilted, or the record warped.



The Garrard plug-in shell will accommodate the cartridge of your choice. In the AT6, a bayonet fitting makes the shell instantly removable, rigidly held while playing, to avoid resonance.



The turntable is oversized, heavy and balanced. Torque is high; and there is no noise, rumble, wow, waver, or interference with the sound of records.



Responsible for the silence and perfect speed of the AT6 is the heavy duty, double shielded "Laboratory Series" motor, engineered specifically to match the AT6 turntable and drive linkage.



AT6 has center-drop turntable spindle, removable for safety in handling records. Actually, two interchangeable spindles are provided; one for automatic; the other, a short spindle for playing singles.



While on automatic play, AT6 is an intermix changer; takes records any size, any sequence.



Convenience—the compact size of the AT6 makes it fit every installation: a snap-in tone arm safety catch prevents accidents.



Leads are connected to unit with a built-in Amplug (for AC) and a female twin phono socket (for audio), mounted on the unit plate. Simply unplug at the player.

AT6 is supplied fully wired for stereo with a 4-pin/5-wire system utilizing separate connection for ground to eliminate hum.

**SPECIFICATIONS:**

4 speeds: 16 $\frac{1}{2}$ , 33 $\frac{1}{3}$ , 45 and 78 RPM; 100-130 volts, 60 cycles AC. (50 cycle pulley available.)

Minimum cabinet dimensions: 15 $\frac{1}{2}$ " left to right, 13 $\frac{1}{2}$ " front to rear, 4 $\frac{1}{2}$ " above and 2 $\frac{1}{2}$ " below top of motor board.



For Comparator Guide and list of dealers, write Dept. GY 1772, Garrard Sales Corp., Port Washington, N. Y.

Morton Feldman and Earle Brown are both exponents of the music of chance, in which the ordinarily predetermined elements of musical substance—melody, rhythm, harmony—are not necessarily predetermined. Their works are more often than not assembled on graph paper, and the performers are left a wide range of arbitrary selection where pitches are concerned. The theories that support the activities of this far-out avant-garde do not lend themselves to the limitations of magazine space. This is perhaps unfortunate, because the theories tend to exceed in interest the actual music they produce.

The sounds that are produced by these creations are not particularly shocking, nor, for that matter, are they particularly interesting. Feldman's *Durations* is all

knowledgeable musician whose work is totally without the high-flown avant-garde posturing or the chrome-plated chic that might make him better copy and, as a consequence, better known. His Second Symphony, composed in 1959, is "written on a single twelve-tone row," according to his own annotation. Its implications, however, are clearly tonal, and the piece, at its core, is traditional in the best sense. It is a solid, valuable, thoughtful work—if perhaps a shade wanting in humor and charm—and quite worthy of the attention of anyone seeking fresh musical experience.

Iain Hamilton's *Scottish Dances* will be a smart surprise to the listener who looks to be turned all warm and nostalgic and rural by British musical folklore, in

New York 24, N.Y., and Collector's Book Society, 327 West 41st St., New York 36, N.Y.)

Interest: Complete score  
Performance: Vital  
Recording: Small studio  
Stereo Quality: Variable

What with the monkeyshines of Bernard Goldfine and Billie Sol Estes, the England of 1728 depicted by John Gay in *The Beggar's Opera* packs quite a sting for Americans of today. In 1951 the enterprising Max Goberman conducted a recording of his edition of the Gay-Pepusch romp that was issued by the now-defunct Desto label. Now we have Mr. Goberman's edition of the complete score again, this time newly recorded in stereo and mono, as the companion piece for the handsome Argonaut Books edition of the original text. The spoken portions of the epoch-making ballad-opera are abbreviated, but the music is given complete and in a generally spirited and clean-cut performance, to which Goberman's own zestful conducting is the most vital contribution.

While this recorded performance is generally superior to the currently available London/Argo edition (mono only and first issued in this country by Westminster in 1956), I have reservations about it, at least from a theatrical point of view. In the past, the practice has been to use a dual cast of actors and singers to handle the spoken parts and the airs. In the absence of information to the contrary, it would seem that Mr. Goberman has let his singers do the speaking parts as well. The disturbing factor is that the spoken lines seem to have been delivered in a wholly different acoustical setting than the songs they lead up to, and the sudden jumps from close-miked speech to more distantly miked songs are discomfiting. Likewise, apparent editing lapses have made for sudden shifts of stereo localization unjustified by the action. In short, the whole production seems to have been put together from separate performances rather than gone through scene by scene, as in the theater. This may have been economical, but it detracts from the flavor of a highly theatrical piece. The delivery of the spoken lines, too, is stilted and sophomoric, particularly in the early portions of the work, though the actors improve as the action gets more exciting.

William McAlpine turns in a splendidly virile account of highwayman MacHeath, and Doreen Murray is fine as the gaoler's wronged daughter, Lucy Lockit. Jean Allister is an amplified-voiced Mrs. Peachum, and Mary Thomas an appealing Polly.

As one not familiar with the performing traditions of *The Beggar's Opera*, I wonder whether the generally refined delivery and pronunciation of this recorded



AT A PERFORMANCE OF "THE BEGGAR'S OPERA"  
Viewing eighteenth-century England through John Gay's tuneful jape

very, very consistent, and slow in tempo; the Brown pieces offer a wider variety of musical texture.

The recording, as is the norm with Time, is excellent. W.F.

© FINNEY: *Symphony No. 2*. HAMILTON: *Scottish Dances, Op. 32*. The Louisville Orchestra, Robert Whitney cond. LOUISVILLE ORCHESTRA FIRST EDITION RECORDS LOU 625 \$7.95.

Interest: Impressive American symphony  
Performance: Earnest  
Recording: Adequate

Ross Lee Finney, a fifty-six-year-old American composer with a somewhat intramural reputation, is an excellent and

short, the *Greensleeves* syndrome. Hamilton's piece is tart, snippy, and edged with anachronistic jazz commentary. It's a switch and even a relief, but a dubious success. W.F.

© GAY (arr. Pepusch): *The Beggar's Opera*. William McAlpine (tenor), MacHeath; Ronald Lewis (baritone), Peachum; John Frost (bass), Lockit; Mary Thomas (soprano), Polly; Doreen Murray (soprano), Lucy; Jean Allister (contralto), Mrs. Peachum; Edgar Fleet (tenor), Filch; chorus and orchestra, Max Goberman cond. LIBRARY OF RECORDED MASTERPIECES BO 1/2 two 12-inch discs \$11.95, mono or stereo. (Available to subscribers from Library of Recorded Masterpieces, 150 W. 82nd St.,

production are a matter of happenstance or of intent. *D.H.*

**HAMILTON:** *Scottish Dances, Op. 32* (see FINNEY).

**RECORDING OF SPECIAL MERIT**

© ® **HANDEL:** *Alcina*. Joan Sutherland (soprano), Alcina; Teresa Berganza (mezzo-soprano), Ruggiero; Monica Sinclair (contralto), Bradamante; Luigi Alva (tenor), Oronte; Graziella Sciutti (soprano), Morgana; Mirella Freni (soprano), Oberto; Ezio Flagello (bass), Melisso. London Symphony Orchestra and Chorus, Richard Bonyngé cond. LONDON OSA 1361 three 12-inch discs \$17.94, A 4361\* \$14.94.

Interest: First recording  
Performance: First-rate  
Recording: Excellent  
Stereo Quality: Tops

Complete recordings of Handel operas are uncommon enough to deserve praise for the issuing company's spirit of enterprise alone. But when it shows the corporate good sense to assemble a cast capable of meeting and surpassing the works' challenges, as London does in resurrecting the beauty of *Alcina*, a fuller measure of gratitude must be added.

Before joining forces for the recording, most of the principals had appeared in Franco Zeffirelli's elegant stagings of the opera in Venice, Dallas, and London. Thus we have a performance of a virtually forgotten work as fastidiously prepared as we can ever hope to hear. As with much opera of the time, for the listener to be entranced by every moment of this confusing and outdated plot concoction, he must completely and devotedly go for Baroque. But all tastes will find rewards in Handel's beautiful, vital, and endlessly inventive music, written in 1735 as he approached the height of his powers.

Zeffirelli's production was conceived for Joan Sutherland, and she has made the title role of the strange enchantress spectacularly her own. Vocal difficulties seem to evaporate as she bends the cascading and sparkling Handelian lines to her will with sovereign ease. But after hearing Miss Sutherland in a series of recorded roles, I feel she has become a captive of her mannerisms. Tone production is her primary concern; and textual meaning, enunciation, expressive thrusts, stresses, and other dramatic values are often sacrificed to it. At times her singing is a stream of unintelligible vowel sounds. No one can question her technical mastery of bel canto, but this vocal narcissism does less than full credit to Handel.

By contrast, the singing of Teresa Berganza never lacks tonal variety and expressive emphasis. Since it is also ad-

mirably musical and technically exquisite, her contribution is, for me, the set's top-ranking asset. Without quite matching Miss Berganza, Monica Sinclair carries off her taxing role with aplomb, and treats us to some lusty excursions into the low register. The light-voiced Misses Sciutti and Freni, perfectly cast, are above reproach. While vocalizing expertly, Luigi Alva manages to give character to his pompous role, and Ezio Flagello—a fine singer who ought to be recorded more frequently—sings the major aria, "*Pensa a chi geme*," in capital fashion.

Richard Bonyngé's reading has clarity, vigor, and a fine sense of balance. He is

**D Major; Symphony No. 41, in C Major.** Franz Opalensky (flute); Vienna State Opera Orchestra, Max Goberman cond. LIBRARY OF RECORDED MASTERPIECES HS 7 \$8.50 (subscription) \$10.00 (nonsubscription), mono or stereo. (Available from Library of Recorded Masterpieces, 150 W. 82nd St., New York 24, N.Y.)

Interest: Haydn Symphonies, Volume 7  
Performance: Splendid  
Recording: Superlative  
Stereo Quality: Excellent

Both these bright and cheerful symphonies are remarkably rich creations,



JOAN SUTHERLAND AS ALCINA  
*Sovereign in the role of Handel's strange enchantress*

abbed by the excellent orchestra and the imaginative George Malcolm's harpsichord continuo. The resonant and spacious sound and the dynamic use of stereo help in imparting a sense of action that *Alcina*, despite Handel's magnificent efforts, keenly needs. *G. J.*

**RECORDING OF SPECIAL MERIT**

© ® **HAYDN:** *Symphony No. 24, in*

particularly No. 41, composed before 1771, with its brilliant scoring for trumpets and drums. The slow movements are unusual in that they feature a solo flute, the Adagio of No. 24, written in 1764, in fact having been interpolated from a concerto. The stylish performances are simply splendid. Careful attention is given to dynamics, phrasing, and the often problematic execution of the  
(Continued on page 80)

# if you could buy only three albums in a lifetime...

These might be the ones. The composers: Bach, Beethoven, and Brahms. The conductor: Dr. Otto Klemperer. The recordings: three masterpieces performed by the supreme interpreter of the classics. The result: greatness, in every sense of the word. Here are a few reactions from the critics:

1. "... far and away the best all-around *St. Matthew* ever recorded, and its sound in stereo is magnificent." — Nathan Broder, *HIGH FIDELITY MAGAZINE*

"... this *St. Matthew Passion* is an outstanding achievement, easily surpassing all previous attempts at recording a work so dear to most of us." — Thomas Heinitz, *THE SATURDAY REVIEW*

2. "... the noble eloquence of Klemperer's performance is undeniable." "... this new album of '*Fidelio*' is one to cherish." — Alan Rich, *THE NEW YORK TIMES*

"It is the best-recorded '*Fidelio*' ever, ...". "... this '*Fidelio*' is of a time (1962), but it has much in it that promises to be timeless." — Irving Kolodin, *THE SATURDAY REVIEW*

"... if there is a greater recording of any opera I have not heard it." — Paul Hume, *THE WASHINGTON POST*

3. "... this recording is sensational." "... an affirmation of personal faith and courage and of consolation for the living. It is the strength of will, the defiant challenge to death's victory, that fire Klemperer in this dramatic reading ..." — *THE GRAMOPHONE*



Angel Records has a famous series of albums called, "Great Recordings of the Century." They are a collection of the most celebrated performances of great works by the supreme artists of the last 60 years. These new albums are not yet a part of the "Great Recordings" series. We think they will be.



(S) 3599 E/L

1.

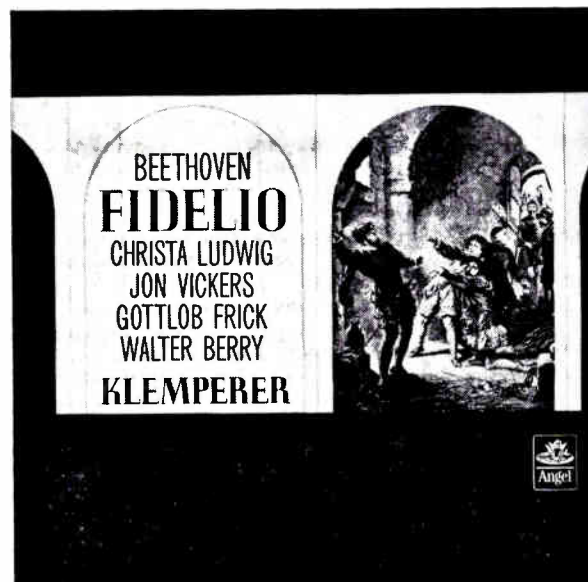

(S) 3625 C/L

2.

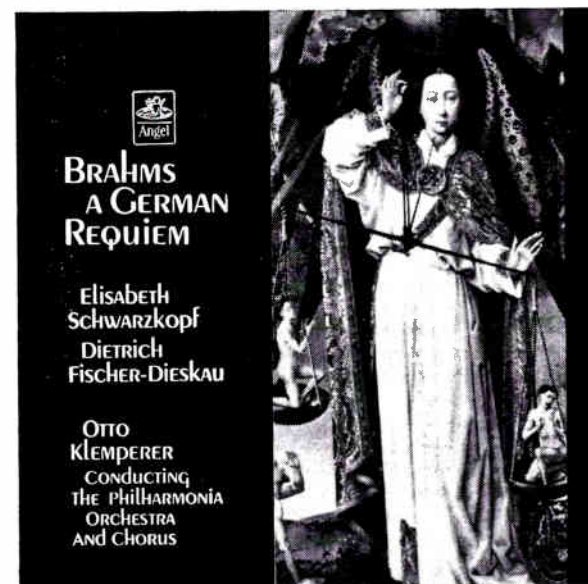

(S) 3624 B/L

3.

## NEW ANTENNA DEVELOPMENT FOR FM AND FM STEREO

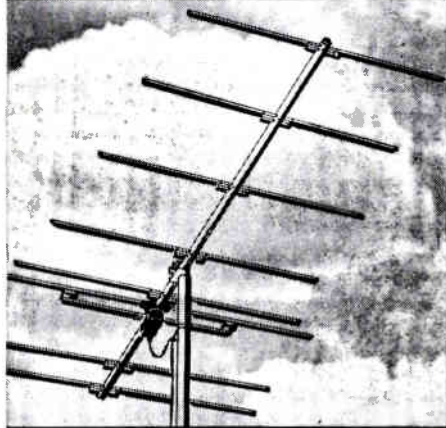

**Winegard**  
**STEREOTRON**

Responds to weakest signals but strong signals won't overload it

**New Stereotron Antenna and 2 Nuvistor FM amplifier will positively improve your FM set performance; pulls in far-away stations!**

Now an FM antenna has been designed by Winegard that will deliver unexcelled FM and FM stereo listening whether you live close to FM stations or 200 miles away. The new Stereotron is so powerful, so efficient that we actually guarantee better performance from your FM, *guarantee* that you will receive 85% of all FM stations in a 200 mile radius.

The Stereotron Antenna (model SF-8) with Stereotron 2 nuvistor amplifier (model AP-320) is the only antenna-amplifier combination that can be used anywhere. Nuvistor amplifier takes up to 200,000 micro-volts of signal without overloading—yet responds to signals of only 1 micro-volt. The Stereotron with nuvistor amplifier has minimum gain of 26 DB over a folded dipole and flat frequency response of  $\pm 1/4$  DB from 88 to 108 mc. Antenna is GOLD ANODIZED, amplifier completely weather-sealed. Available for 300 ohm or 75 ohm coax.

SF-8 Stereotron Antenna \$23.65

AP-320 Stereotron Amplifier \$39.95—can be used with any FM antenna.

Write for information and spec. sheets today on the Stereotron and other Winegard FM and TV antennas and accessories. Get FREE Station Log and FM map of U.S.—write today.

World's Most Complete Line of FM and TV antennas, FM-TV Couplers and Amplifiers



**Winegard**  
ANTENNA SYSTEMS

3018-1 Kirkwood Blvd. • Burlington, Iowa  
CIRCLE NO. 55 ON READER SERVICE CARD

tricky ornaments. As with the previous six volumes, these symphonies are a model of good Haydn playing. The recording is superb in both versions, and again the balance of winds, brasses, and strings is excellent. An admirable harpsichord continuo accompanies both works. The album contains miniature scores and H. C. Robbins Landon's thorough program notes. *I. K.*

⑤ ⑥ **HINDEMITH: *Mathis der Maler* (excerpts).** Dietrich Fischer-Dieskau (baritone), Pilar Lorengar (soprano), Donald Grobe (tenor). Radio Symphony Orchestra of Berlin, Leopold Ludwig cond. DEUTSCHE GRAMMOPHON SLPM 138769 \$6.98, LPM 18769\* \$5.98.

Interest: Excerpts from the opera  
Performance: Convincing  
Recording: Fine  
Stereo Quality: Suitable

Paul Hindemith's opera *Mathis der Maler* contains music that is among the most celebrated and popular of the twentieth century, yet the full work is all but unknown because it is virtually never produced.

So stated, this would constitute a riddle to anyone who did not know of the non-vocal symphony—similarly entitled *Mathis der Maler*—that is the composer's strongest, most enduring, and probably most valuable and inspired composition. Not surprisingly, the symphony contains musical materials that are essential to the score of the opera.

Now DGG has provided a big first in these vocal excerpts from the opera. I'm not sure they will take us far toward an answer to the looming question of how the opera stands up to the near-masterpiece that is the symphony, but they tell us much that is interesting.

For example, the curiously remote lyricism of the symphony does not find a counterpart in the composer's extended vocal writing, which summons up something more of Wagner than of the neo-Baroque grandiosity of the instrumental excerpts. We learn further that the thoroughly personal texture of the symphonic score is replaced by a much more conventional fabric in the vocal accompaniments. This is not to suggest that these vocal excerpts lack either conviction or power. But it is perfectly apparent that they have in lesser degree the unmistakable stamp of the composer's remarkable musical personality than does their symphonic namesake.

The performances seem altogether excellent, with Fischer-Dieskau, in particular, revealing an ease with the opera's rhetorical manner that one would not necessarily have expected from him. And DGG has provided smooth, mellow recorded sound fully worthy of a recording of much more than routine interest. *W. F.*

⑤ ⑥ **HONEGGER: *Le Roi David*.** Netania Davrath (soprano), Marvin Sorenson (tenor), Jean Preston (mezzo-soprano), Martial Singher (narrator), Madeleine Milhaud (*Witch of Endor*). University of Utah Chorus, Utah Symphony Orchestra, Maurice Abravanel cond. VANGUARD VSD 2117/18 two 12-inch discs \$11.90, VRS 1090/91 \$9.96.

Interest: Legendary Honegger  
Performance: Sympathetic  
Recording: Excellent  
Stereo Quality: Fine

*King David*, Arthur Honegger's celebrated oratorio, has been given an affectionate, careful, and highly expressive welcome to the long-playing catalog by Maurice Abravanel and the Utah Symphony Orchestra. If the work carries its years with dignity, it cannot be said at the same time that the subject looks less than its age. The wear and tear shows a bit around its modernism—an obvious line here, a sag there—and if we recognize a composer who, in hindsight, has failed to substantiate the big gesture that was his wont to enact, we can respect the sincerity of his performance in a role that was too big for him.

The people from Salt Lake City have given the piece their best, which is considerable. It would be beside the point to suggest that the Utah Symphony is not among the greatest were it not for the fact that this particular work needs all the superiority of re-creative forces it can command.

Vanguard's recording is spacious, resonant, and, at its best, quite exciting as pure sound. *W. F.*

**HUMMEL: *Piano Concerto in B Minor* (see BOIELDIEU).**

⑤ ⑥ **JANÁČEK: *Taras Bulba, Rhapsody for Orchestra; Sinfonietta*.** Czech Philharmonic Orchestra, Karel Ancerl cond. PARLIAMENT PLP 166 \$2.98, PLPS 166 \$1.98.

Interest: Little-known modern master  
Performance: Believable  
Recording: Serviceable  
Stereo Quality: Fair

Leos Janáček is not only Czechoslovakia's most celebrated and important contributor to this century's music, but he towers over any recent composer that this now highly Sovietized country has brought to the fore. Janáček was born in 1854, only thirteen years after Dvořák, and he lived to witness and compose through the violent birth of the musical styles and attitudes that were to form this century's music. Furthermore, he was responsive and alert to them and, like Verdi or Fauré, produced his most vital work dur-

(Continued on page 82)



David Izenzon is performing Scianni's **Horizon South**, written "for contrabass and electronic mutations."

## *contrabass with AR-3's*

The AR-3 loudspeakers on stage at New York's Town Hall were chosen because they have a musical quality that makes them particularly suitable for working with the live instrument.

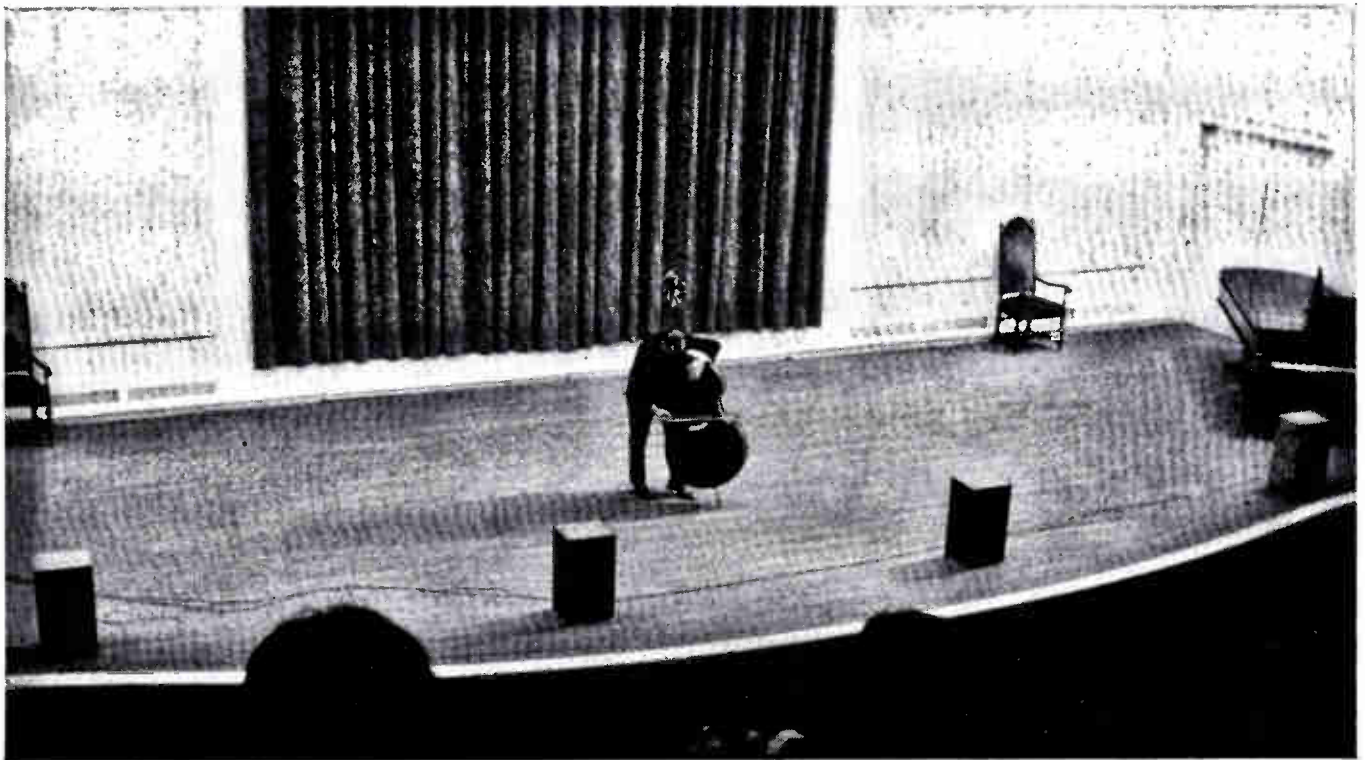

AR speakers are often used professionally, but they are designed primarily for natural reproduction of music in the home. They are on continuous demonstration at AR Music Rooms, on the west balcony of Grand Central Terminal in New York City, and at 52 Brattle Street in Cambridge, Massachusetts.

Prices are from \$89 to \$225. Literature, including a list of AR dealers in your area, is available on request. We will also send a brief description and order form for two books on high fidelity published by AR.

**ACOUSTIC RESEARCH, INC., 24 Thorndike Street, Cambridge 41, Massachusetts**

ing the years that most composers numbly repeat themselves or cease to compose entirely.

Of the two works here, *Taras Bulba*, a rhapsody for orchestra derived from an opera bearing the same title, is a big, splashy, pointedly nationalistic number that dates from 1915. The *Sinfonietta*, however, is one of the composer's few purely nonvocal works and was the product of the composer's seventy-third year. It is the more interesting of the two works, for just below the surface of the music's comparatively conventional façade, one observes the function of an alert, imaginative musical mind.

The recorded sound is not the last word in refinement, but the disc is a good buy for the more adventurous collector.

W. F.

Ⓢ Ⓢ MARTIN: *Concerto for Seven Wind Instruments, Timpani, Percussion, and String Orchestra; Etudes for String Orchestra*. Suisse Romande Orchestra, Ernest Ansermet cond. LONDON CS 6241 \$5.98, CM 9310\* \$4.98.

Interest: Switzerland's master composer  
Performance: Authoritative  
Recording: Good  
Stereo Quality: Ditto

Frank Martin—at seventy-two years of age Switzerland's most famous and accomplished composer-son, and a musician of remarkable staying power on the European scene—is not a composer about whom it is easy to generalize. One can grant him, for example, a command of the techniques of musical composition that need defer to no man's. And the music that springs from this civilized, highly disciplined, and versatile craft is perfection in every way: elegant (in its rather ponderous way), smoothly functional, and, as musical expression, totally consistent and assured.

What it seems to lack is the hard inner core of conviction, of urgency; one admires its complex perfection even as one senses an essential hollowness that precludes not only love for the music but, finally, strong conviction about it.

The two works here—brilliantly recorded and performed—could not better illustrate the point. With their composition, Martin has created an a priori problem about instrumentation and form; in short, he wishes to demonstrate a process by which his forms take on their own peculiarities and logic as a result of the problems posed by a preconceived instrumental concept.

His success is dazzling; he has met the challenge that he himself has created and, in the process, has satisfied our minds completely. What he has failed to do, however, is to engage our hearts, to make us care about his achievement.

Make no mistake about it, however, the pieces are attractive and listenable. The *Etudes* for string orchestra, in particular, owe their existence to a master hand, and the music, taken altogether, brings us face to face with a skill that stands with the best that contemporary European music has to offer. For this, and the total lack of sham that Martin's music represents, we must be grateful.

W. F.

Ⓢ Ⓢ MOUSSORGSKY: *Pictures at an Exhibition*. BALAKIREV: *Islamey*. Gary Graffman (piano). COLUMBIA MS 6391 \$5.98, ML 5791\* \$4.98.

Interest: A go at "the impossible"  
Performance: A success  
Recording: Fine  
Stereo Quality: Passable

Moussorgsky's *Pictures at an Exhibition*, in its original conception for solo piano, has long enjoyed the reputation of being unplayable. It is "too difficult," it is "unpianistic"—no pianist, even the greatest, can make it "musical" on a mere keyboard. Whether these judgments are correct or not, the fact remains that the work—a masterpiece in the original form—is largely known through Ravel's stunning orchestral version.

Now Gary Graffman, one of a handful

CAPTURE THE STRENGTH AND DELICACY OF EVERY SOUND

NEW SONY Stereorecorder 300

## 4 TRACK & 2 TRACK STEREOPHONIC RECORDER

Here, through your fingertips, you take complete control of sound, blending it to magnificent perfection.

A great symphony to record? With this superb instrument you are a professional. Touch your stereo level controls—feel that sensitive response. Dual V.U. Meters show precision readings as you augment the strings, diminish the brass. The richness of that low resonance is captured with your bass boost. The strength and delicacy of every sound—now yours to command.

Four track and two track, stereo and monophonic, recording and playback, the SONY STERECORDER 300 is truly the ultimate in tape recorder engineering. \$399.50, complete with two dynamic microphones, two extended range stereo speakers all in one portable case. For custom mounting, \$349.50.

Other world-famous Sony tape recorders start as low as \$89.50.

**SONY SUPERSCOPE** The tapeway to Stereo

For literature and the name of nearest franchised dealer, write Superscope, Inc., Dept. 3 Sun Valley, California.

of American pianists under forty destined for major importance, has come along to put the work on discs and to stand up for comparison with Horowitz's earlier version on Victor.

For my money, at least, Graffman comes through the ordeal with flying colors. He spares the piece the nervous virtuosity that can make it sound so impossibly difficult, so strained and awkward. He has not tried to overwhelm us with Big Keyboard Sound—although he has power aplenty—and the work sounds quite as convincing at Graffman's hand as I ever hope to hear it. I choose the word "convincing" because it is far easier to make the work sound torrential and overpowering than it is to make it sound musical, natural, and idiomatic.

The young pianist, for good measure, has filled out his release with a keenly honed, rather dry-textured Balakirev *Islamey*—another solo piano piece celebrated for its technical problems.

Columbia has provided a good, bright recording, avoiding the souped-up sound that might easily have been an irresistible temptation. *W. F.*

© © MOZART: *Clarinet Concerto, in A Major, K. 622*. STRAUSS: *Horn Concerto No. 1, in E-flat Major, Op. 11*. Robert Marcellus (clarinet); Myron Bloom (French horn); Cleveland Orchestra, George Szell cond. EPIC BC 1241 \$5.98, LC 3841\* \$4.98.

Interest: Vital concertos  
Performance: First-rate  
Recording: Good  
Stereo Quality: Well-balanced

Robert Marcellus and Myron Bloom are first-desk players of the Cleveland Orchestra, having assumed their posts during George Szell's tenure. Both display extraordinary technical mastery and thorough musicianship—qualities for which the orchestra is widely admired.

Marcellus's virile tone and Szell's incisive orchestral support contribute to an unusually dynamic reading of Mozart's K. 622 that should hold its own even against its strong recorded competition. In Strauss's youthful, Mendelssohnian, and thoroughly delightful Op. 11, Myron Bloom has only a single competitor—the late Dennis Brain (Angel 35496)—but a mighty one. Bloom cannot match the English virtuoso's incredible tonal suavity and, despite his remarkable technique, cannot toss off the final Presto with Brain's astonishing abandon. Still, this is a performance strong in tone, bold in attack, and accurate in execution. The orchestra is full of vitality, if a bit too intense for what is essentially a frothy and jovial piece of music.

Sonically, the monophonic Brain performance is completely outdistanced by the present recording. *G. J.*

#### RECORDING OF SPECIAL MERIT

© © MOZART: *Symphony No. 33, in B-flat (K. 319)*; *Symphony No. 36, in C (K. 425)* ("Linz"). English Chamber Orchestra, Colin Davis cond. L'OISEAU-LYRE SOL 60049 \$5.98, OL 50218\* \$4.98.

Interest: Mature Mozart  
Performance: Subtle and caressing  
Recording: Excellent  
Stereo Quality: Ideal

These readings reveal Colin Davis as a Mozartian of the first rank, with a flair for precision and clarity. One need not be misled by the innocuous name of his orchestra—it is a first-rate group, distinguished by a warm, singing tone and exceptional solo playing. Except for a slightly heavy-footed Minuet in the "Linz" Symphony, these performances are pleasing throughout. Of course, this "Linz" must compete against the top-notch versions of Bruno Walter, Jochum, and Leitner, all in stereo. On the other hand, this is the first stereo version of the seldom-heard K. 319, and as such it is extremely welcome. Its only serious rival, Leinsdorf's on Westminster 18186, is still appealing for its vigor, yet the more deliberately paced Davis performance is comparably excellent and has the advantage of superior sonics.

The orchestral sound is altogether admirable—warm, exquisitely balanced, and reproduced with amazing clarity. Stereo has been employed with brilliant results: there is excellent depth and separation, and such happy nuances as dialogues between the first and second violins and woodwind interjections are delightfully captured. *G. J.*

#### RECORDING OF SPECIAL MERIT

© © STRAVINSKY: *Les Noces*. Mildred Allen (soprano), Regina Sarfaty (mezzo-soprano), Loren Driscoll (tenor) and Robert Oliver (bass); Samuel Barber, Aaron Copland, Lukas Foss, Roger Sessions (pianists); Columbia Percussion Ensemble; The American Concert Choir, Margaret Hillis cond. *Renard*. George Shirley and Loren Driscoll (tenors), William Murphy (baritone), Donald Gramm (bass), Toni Koves (cimbalon); Columbia Chamber Ensemble. *Ragtime for Eleven Instruments*. Toni Koves (cimbalon), Columbia Chamber Ensemble. COLUMBIA MS 6372 \$5.98, ML 5772 \$4.98.

Interest: Stravinsky's Stravinsky  
Performance: Excellent  
Recording: Bright and clear  
Stereo Quality: Fine

Since I count myself as a Stravinsky lover, and since, in this year of the eight-

All in one volume!  
Completely up to the  
minute guide to  
stereophonic and  
monaural reproduction.



## HI-FI HANDBOOK

by STEVEN HAHN

based on HI-FI HANDBOOK  
by William J. Kendall

This easy-to-use manual gives you complete information about stereophonic and monaural systems and is a practical guide to the very latest developments in the complex field of high-fidelity reproduction.

First published in 1954, it has been rewritten from cover to cover and newly illustrated. Beginning with chapters on the nature of sound and of high-fidelity reproduction, the book proceeds to a detailed, systematic discussion of each component part of a hi-fi system, with a clear explanation of the function of each part. The adaptations of each component to stereophonic reception are described in detail, and the unique capabilities and limitations of transistors are fully surveyed. A final chapter covers the bewildering variety of available accessories: reverberation equipment, electronic crossover networks, head de-magnetizers, and many others. Especially valuable are the buying guides which show you how to get the best equipment in various price categories. The book is fully illustrated and indexed.

Here are the subjects covered in this unique book: Tuners: FM, AM, Multiplex • Turntables and Changers • Pickups and Arms • Tape Recorders • Preamplifiers and Audio Control Centers • Power Amplifiers • Integrated Amplifiers and Complete Receivers • Speakers: Electro-magnetic, Electrostatic, and Special Devices • Speaker Enclosure and Speaker Placement.

USE MONEY-BACK GUARANTEE COUPON TO  
ORDER YOUR COPY TODAY

THOMAS Y. CROWELL COMPANY, Dept. HFS  
P.O. Box 381, Cooper Station, New York 3, N.Y.  
Please send me postpaid \_\_\_\_\_ copies of HI-FI  
HANDBOOK at \$4.95 each. I understand that if  
I am not satisfied I may return the book(s)  
within two weeks for full refund of the purchase price.

Cash enclosed  Send C.O.D.

NAME \_\_\_\_\_

STREET \_\_\_\_\_

CITY \_\_\_\_\_ ZONE \_\_\_\_\_ STATE \_\_\_\_\_

CIRCLE NO. 24 ON READER SERVICE CARD

# LUXOR

## TAKES THE BIG STEP



# STEREO TAPE DECK

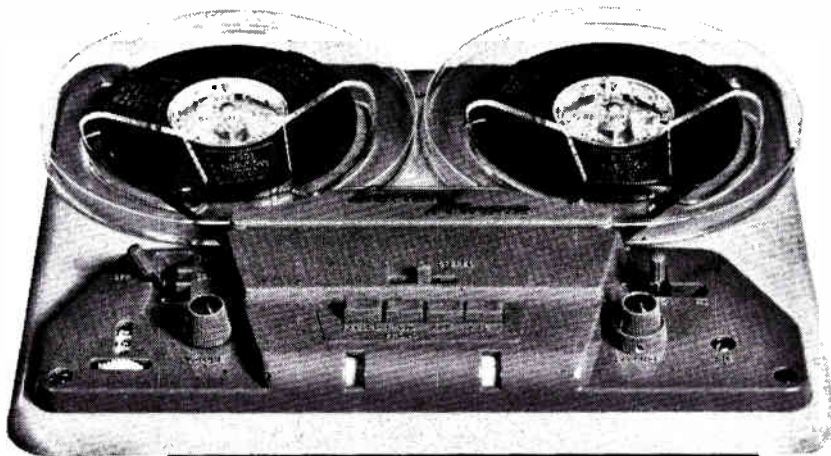

THE D101A



## With Complete Recording and Playback Pre-Amplifiers

Features include:

Standard NAB equalization; low input sensitivity guarding overload distortion; RCA type, rear mounted, pin plug connectors; stereo multiplex ready with Bias & Erase frequencies adjustable between 85 to 95 Kc.

Retail Price **\$234**  
**(\$239 Far West.)**

©1963 AMELUX ELECTRONICS CORP.

Please write for illustrated descriptive brochure

Amelux Electronics Corporation

33 West 42 Street • New York 36, N. Y.

Please send your free brochure to

NAME \_\_\_\_\_

ADDRESS \_\_\_\_\_

CITY \_\_\_\_\_ STATE \_\_\_\_\_

### Frequency Response:

7½ I.P.S. 40 to 20000 cycles  
(± 3 dB, 50 to 17000 cycles)  
3¾ I.P.S. 40 to 14000 cycles  
(± 4 dB, 60 to 12000 cycles)  
1⅞ I.P.S. 80 to 8000 cycles (± 5 dB)

### Playback Outputs:

0.3 Volt; 22,000 Ohms each channel  
2 Watts; 4-6 Ohms each channel

### Flutter & Wow:

± 0.09% RMS at 7½ I.P.S.  
± 0.18% RMS at 3¾ I.P.S.  
± 0.25% RMS at 1⅞ I.P.S.

### Crosstalk Rejection:

Channel separation (Stereo) better than 35 dB  
Crosstalk separation better than 60 dB

### Signal to Noise Ratio:

49 db, Stereo Mode

ieth anniversary of the master's birth he has been all but canonized by devotees and opponents alike, it calls for special courage for me to qualify my recommendation of this excellent disc with the confession that I do not particularly like *Les Noces*. I do not, I never have, and it seems unlikely that I ever shall. I recognize its charm, the beauty of its texture, its dazzling originality, and its highly special and significant place in the composer's catalog. But, although it is engaging at any given moment, I have never been able to convince myself that bar 20, bar 300, or bar 700 offers much that I haven't been exposed to in the first minute of the work. As Oscar Levant (I believe) once remarked about something quite different, listening to *Les Noces* is, for me at least, a little like being offered a meal, each course of which is exquisitely served stained glass.

Having delivered myself of so heretical a remark, I can now wholeheartedly endorse the superb, joyous performance of the work that Columbia has so fittingly preserved. There has been a tradition connected with American performances of *Les Noces*, dating back to the Twenties, that its piano parts be played by renowned American composers, and, if my memory serves me, both Aaron Copland and Roger Sessions were similarly involved with the piece in its American premiere. It's a work that composers can particularly relish because its bell-like sonorities *feel* so marvelous under the fingers. In point of fact, it's evident from the recorded performance that everyone involved with the project had great fun with it, so bright and enthusiastic is the reading.

It's good to have *Renard* available on records in so sassy and breezy a performance, and the little *Ragtime*, which dates from 1918, is a welcome encore.

Columbia has given this program its highest-level production, and the record is a top-priority must for those who admire the composer's work. *W. F.*

### RECORDING OF SPECIAL MERIT

Ⓜ **WAGNER: *Die Walküre, Act I.***  
Lauritz Melchior (tenor), Siegmund;  
Lotte Lehmann (soprano), Sieglinde;  
Emanuel List (bass), Hunding. Vienna  
Philharmonic Orchestra, Bruno Walter  
cond. ANGEL COLH 133 \$5.98.

Interest: Recording milestone  
Performance: Classic  
Recording: Dated

With the splendors of RCA Victor's new, complete *Die Walküre* still ringing in the mind's ear, the sonics of this venerable 1934 classic may seem faded, but no entry in Angel's Great Recordings of the Century series is more deserving of the name, and opera fans will welcome

this renewed opportunity to savor and acquire a valuable souvenir from what was a sumptuous period for Wagnerian singing.

Here, the heroic yet malleable and sensitively used voice of Lauritz Melchior was captured in its fullest glory, setting a standard no Siegmund has yet equaled. Here, too, Lotte Lehmann gave a display of lyric ardor ("*Du bist der Lenz*") and vivid narrative powers ("*Der Männer Sippe*") that claim the same veneration for her Sieglinde that operatic history has already accorded to her Marschallin. The Hunding, Emanuel List, is all one can ask for—his sonorous, menacing tones are filled with the sound of doom. The low-level, occasionally distorted recording is unjust to the sound of the Vienna Philharmonic, but it cannot entirely dim the authority and surging lyric power of Bruno Walter's reading. G. J.

#### RECORDING OF SPECIAL MERIT

© ① **WOLF: *Goethe Lieder*: Mignon: *Heiss mich nicht reden, Nur wer die Sehnsucht kennt, So lasst mir scheinen, Kennst du das Land?*; *Ganymed*; *Anakreons Grab*; *Die Spröde*; *Die Bekehrte*; *Blumengruss*; *Gleich und Gleich*; *Frühling übers Jahr*; *St. Nepomuks Vorabend*; *Epiphanias*. Elisabeth Schwarzkopf (soprano); Gerald Moore (piano). ANGEL S 35909 \$5.98, 35909\* \$4.98.**

Interest: For lieder specialists  
Performance: Absorbing  
Recording: Good  
Stereo Quality: Centered

In this generous offering from the fifty-one Goethe lieder that make up a significant part of Wolf's output, Miss Schwarzkopf demonstrates her mastery. She is in absolute control of her material, unvaryingly attentive to textual meaning, illuminating the musical line with a variety of inflections and subtle points of emphasis. Her singing is extremely polished, her tone colored with imaginative skill. Songs can be overinterpreted at times, and this artist has sometimes been criticized for excessive coyness and other interpretive mannerisms. I do not find this to be the case here. True, Miss Schwarzkopf is seldom satisfied with letting the musical line speak for itself, as the excellent Hilde Roessel-Majdan does in seven of the same songs on Westminster 18847. But her individual touches are, in my opinion, really masterfully effective. Her broadly theatrical dramatization of *Epiphanias*, for instance, implicitly carries out the meaning of Goethe's rustic humor and Wolf's appropriately pompous music. And while *Anakreons Grab* is such a gem that it responds to almost any respectful and musicianly treatment, the atmosphere of sublime repose here is almost magical. G. J.

JANUARY 1963



## New This Month

**ERNST HAEFELIGER: BACH & HANDEL ARIAS.** Arias from Mass in B Minor, "Julius Caesar," "Xerxes," Cantata No. 189, others. Munich Bach Orchestra cond. Karl Richter, with leaflet of texts.  
.....LPEM 19 268 Stereo SLPEM 136 268

**MOZART: THE MARRIAGE OF FIGARO—HIGHLIGHTS.** Dietrich Fischer-Dieskau, Maria Stader, Irmgard Seefried, Renato Capecchi, others; Berlin Radio Symphony cond. Ferenc Fricsay, with leaflet of texts.  
.....LPEM 19 272 Stereo SLPEM 136 272

**VERDI: DON CARLOS — HIGHLIGHTS.** Antonietta Stella, Fiorenza Cossotto, Boris Christoff, Flaviano Labo, others; La Scala Chorus & Orchestra cond. Gabriele Santini, with leaflet of texts.  
.....LPEM 19 274 Stereo SLPEM 136 274

**ANTONIETTA STELLA: OPERA ARIAS.** Arias from "Norma," "Turandot," others. Chorus & Orchestra of Florence May Festival cond. Bruno Bartoletti, with leaflet of Italian-English texts.  
.....LPEM 19 290 Stereo SLPEM 136 290

**SCHUBERT: DIE WINTERREISE.** The Complete Song Cycle. Hans Hotter, Baritone; Erik Werba, Piano, with booklet of notes & texts.  
.....LPM 18 778/9 Stereo SLPM 138 778/9

**TCHAIKOVSKY: SYMPHONY NO. 4 IN F MINOR.** Berlin Philharmonic Orchestra cond. Lorin Maazel.  
.....LPM 18 789 Stereo SLPM 138 789

**SUPERB RECORDINGS  
BEAUTIFULLY PACKAGED**

DIRECT IMPORT FACTORY SEALED

Send for the new illustrated 1963 catalogue of fine Deutsche Grammophon Recordings.  
Write: **MGM RECORDS, Classical Division, 550 Fifth Ave., N.Y. 36, N.Y., Dept. B**

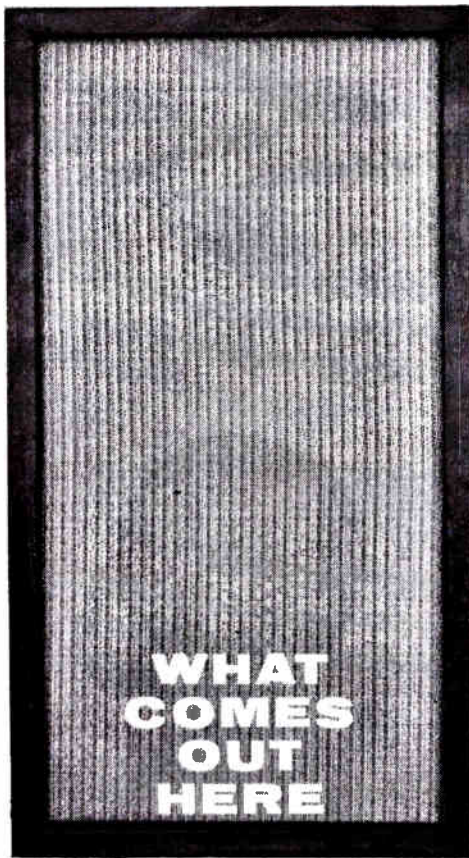

**DEPENDS  
ON  
WHAT  
GOES  
THROUGH  
HERE**

**"SKIMPING" ON THE CARTRIDGE  
JEOPARDIZES THE SOUND  
(AND SATISFACTION) OF THE  
WHOLE SYSTEM**

The hundreds, even thousands of dollars you put into speakers, pre-amps, amplifiers, turntables and recordings can be virtually nullified by an off-hand selection of the phono cartridge. For even though it is the lowest-cost single component in the typical system, it is charged with the frighteningly complex task of getting the music out of the grooves and translating it into precise electrical impulses . . . without addition, subtraction, or distortion. And without damaging the record grooves. Leading critics and noted audiophiles recognize this and (with due care and study) select a Shure Stereo



Dynetic cartridge for their personal systems. It was, from its inception, and is today the finest stereo cartridge your money can buy. And not much money, at that. The \$36.50 spent on a Shure M33-5 (if you have a fine tone arm that tracks between  $\frac{3}{4}$  and 1.5 grams) or Shure M33-7 (for tracking pressures from 1.5 to 3 grams) will audibly improve even fine quality stereo systems. Compliance is an astounding  $22 \times 10^{-6}$  for the M33-5 ( $20 \times 10^{-6}$  for the M33-7). Response is transparent and smooth not only at the top and bottom but in the critical middle range (where most music happens—and where most other cartridges garble the sound). No "peaks," no "shattering." Et cetera, et cetera. Better listen to it, and judge for yourself.

IF YOU INSIST ON A SHURE DYNETIC CARTRIDGE,  
YOU CAN EXPECT MORE FROM YOUR SYSTEM

**SHURE**

*Stereo Dynetic*

M33 SERIES HIGH FIDELITY PHONO CARTRIDGES  
SHURE BROTHERS, INC. • 222 HARTREY AVE., EVANSTON, ILLINOIS

CIRCLE NO. 48 ON READER SERVICE CARD

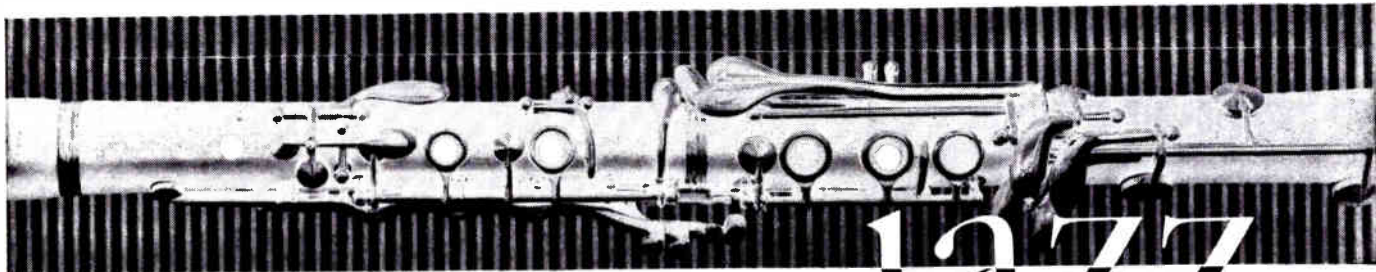

# Jazz

Reviewed by **JOE GOLDBERG** • **NAT HENTOFF**

**Explanation of symbols:**

- Ⓜ = monophonic recording
- Ⓢ = stereophonic recording
- \* = mono or stereo version not received for review

Ⓢ Ⓜ **MOSE ALLISON: *Mose Allison Takes to The Hills*.** Mose Allison (vocals and piano), Addison Farmer, Henry Grimes, or Aaron Bell (bass), Jerry Segal, Paul Motian, or Osie Johnson (drums). *V-8 Ford Blues; Hey, Good Lookin'; Life Is Suicidic; Ask Me Nice;* and eight others. EPIC BA 17031 \$4.98, LA 16031\* \$3.98.

Interest: **Refurbished blues**  
 Performance: **Small-scale but pungent**  
 Recording: **First-rate**  
 Stereo Quality: **Good**

Because he sings on every track, this is one of the more consistently entertaining of Mose Allison's collections. His previous custom has been to divide his sets about equally between instrumentals and vocals. Allison is a spare, nimble, modern jazz pianist; but if he didn't sing, there would be little to distinguish him from scores of other deft but unremarkable pianists.

In his vocals, Allison is most intriguing when he interprets the work, as in this album, of such seasoned Negro bluesmen as Willie Love, Sonny Boy Williamson, Percy Mayfield, and Lightnin' Hopkins. He does not sing these blues with the plunging intensity of their creators, but he excels at evoking the irony in the material, and through the light but tart texture of his voice, he communicates a wry personal attitude toward life and music.

Allison is less distinctive in his performances of popular standards, but he brings to the songs also an abrasively unsentimental thrust that revivifies the most familiar. Mose Allison is no major jazz force, but having recognized his limitations, he is cultivating his small garden with skill and contagious pleasure. *N. H.*

Ⓢ **DAVE BRUBECK: *Jazz: Red Hot and Cool*.** Dave Brubeck (piano), Paul Desmond (alto saxophone), Bob Bates (bass), Joe Dodge (drums). *Lover; Little Girl Blue; The Duke; Indiana;* and four others. COLUMBIA CS 8645 \$4.98.

Interest: **Pre-Morello Brubeck**  
 Performance: **Excellent**  
 Recording: **Good**  
 Stereo Quality: **Reprocessed**

This Brubeck album from 1954-1955, now electronically reprocessed for stereo, is probably among those that signalled the early disaffection of Brubeck fans. Shortly afterward, drummer Joe Morello was hired, and the group began to change.

This Brubeck unit habitually played three against four rhythmically and indulged the two soloists' penchant for counterpoint. Some of the old fervor had gone by this time, but the album is valuable for a prototypical Desmond solo on *Lover*: perfectly constructed, a flow of logical, charming melody, it typifies everything this remarkable player does best.

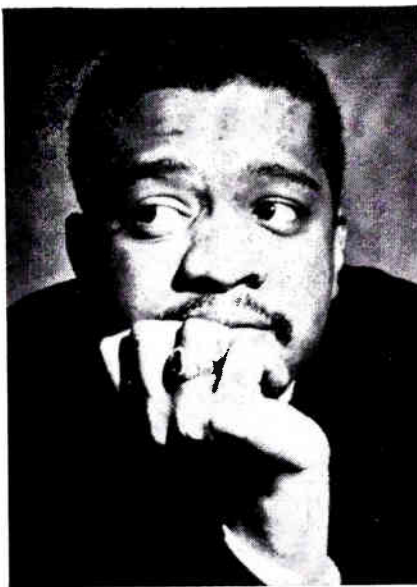

DONALD BYRD

*Growth and assurance, but blandness, too*

Brubeck, however, was beginning to repeat himself and to make the more bombastic elements of his style the basis of his work. The set, in this way, is a landmark in these two careers. The sound is fuller than on the original. *J. G.*

Ⓢ Ⓜ **DONALD BYRD: *Royal Flush*.** Donald Byrd (trumpet), Pepper Adams (baritone saxophone), Herbie Hancock (piano), Butch Warren (bass), Billy Higgins (drums). *Hush; Jorgie's; 6 M's;*

*Requiem;* and two others. BLUE NOTE S 84101\* \$5.98, 4101 \$4.98.

Interest: **Byrd's development**  
 Performance: **Professional**  
 Recording: **Excellent**

Trumpeter Donald Byrd grows in technique and assurance. A few years ago, he would have been unable to perform *I'm A Fool To Want You* as he does it here. At the same time, the emphasis in this set seems to be almost exclusively on the mechanics of playing the trumpet: there was a wit and conviction on his previous disc, "The Cat Walk," that is missing here.

Byrd has found an interesting new pianist, Herbie Hancock, who contributed *Requiem*, the session's major original composition. Byrd's own pieces tend to be highly derivative—one is a combination of *Witchcraft* and *All Of You*, another is based entirely on a phrase from Horace Silver's *Doodlin'*.

Pepper Adams's baritone is also growing in stature, but he, and the album as a whole, reflect the dangers of too much concentration on technique. As with the Jazztet, it can result in blandness. *J. G.*

Ⓢ Ⓜ **BARBARA DANE: *On My Way*.** Barbara Dane (vocals), Kenny Whitson (piano and cornet), Wellman Braud (bass), Billy Strange (guitar), Jessie Sailes or Earl Palmer (drums), the Andrews Sisters (vocals), Rocco Wilson (conga drums). *Take It Slow and Easy; Goodbye Daddy Goodbye; Good Old Wagon; The Hammer Song;* and eight others. CAPITOL ST 1756 \$4.98, T 1758\* \$3.98.

Interest: **A good blues try**  
 Performance: **Somewhat self-conscious**  
 Recording: **Very crisp and live**  
 Stereo Quality: **Excellent**

Barbara Dane, now thirty-five, has been trying for the past decade to establish herself as a convincing carrier of the Negro blues traditions of the 1920's. The fact that Miss Dane is not Negro doesn't automatically dictate failure as a blues singer, in view of the achievements of Jack Teagarden and Teddy Grace. But Miss Dane, to a large extent, does not measure up. On the slow and medium tempos of *Crazy*

# TWIN-PAKS: TWO FOR THE MONEY

Twin-Paks are 4-track stereo tapes, each containing the equivalent of two or more albums. That means up to 1 hour and 30 minutes of music on one reel of tape. And Twin-Paks are economical: double-album length Twin-Paks are priced from \$7.95 to \$12.95. Want some examples? Here are six best-selling stereo Twin-Pak tapes:



**ROMEO AND JULIET BALLET & CINDERELLA BALLET—**

Prokofiev. Ernest Ansermet, Orch. Suisse Romande. London K 80098—\$11.95

**I PAGLIACCI** (complete) Del Monaco, MacNeil, Tucci. London H 90021—\$12.95

**FIVE CENTURIES OF MUSIC** from Gabrieli to Khatchaturian. Vanguard C 1700—\$7.95

**THE FABULOUS FIFTIES**—Roger Williams. Kapp K 45008—\$11.95

**ELLA FITZGERALD SINGS GEO. GERSHWIN** (2 vols.) Verve P 244 & P 277—\$11.95 (each)

**FAMOUS FILM THEMES & PIANO ITALIANO**—George Greeley. Warner Bros. P 2402—\$11.95

**STEREO SOUNDS BEST ON TAPE**

If you would like to receive regular new-release information write: United Stereo Tapes, 88 Llewellyn Avenue, Bloomfield, New Jersey

**CIRCLE NO. 52 ON READER SERVICE CARD**

Blues and *Good Old Wagon*, she comes close to the proud, mocking cadences of the city blues, but she leaves an impression of coming at the material from the outside. Her exclamatory style seldom seems spontaneous or infused with the bite of personal experience. And when the tempo increases or the beat becomes insistent, Miss Dane sounds stiff.

Her accompaniment is good, particularly Kenny Whitson, a pianist who occasionally plays a bristling cornet with the right hand as he lays down piano chords with the left. On two gospel numbers, Miss Dane is joined by the ecstatic Andrews Sisters—no relation to the older troika of the same name. Their jubilant cries make this listener wish they had been given some time all to themselves to show their capacities. *N. H.*

**RECORDING OF SPECIAL MERIT**

© **MILES DAVIS: 'Round About Midnight.** Miles Davis (trumpet), John Coltrane (tenor saxophone), Red Garland (piano), Paul Chambers (bass), Philly Joe Jones (drums). *'Round Midnight; All of You; Tadd's Delight;* and three others. COLUMBIA CS 8649 \$4.98.

Interest: Classic Davis  
Performance: Masterful  
Recording: Good  
Stereo Quality: Added depth

This 1955 recording is the first LP Miles Davis made for Columbia. It features the best group he ever had—one of the most influential in modern jazz—and is possibly the best recording they ever made. On it, Davis employs rhythms and some songs appropriated from Ahmad Jamal, displays his introspective ballad approach, and resurrects some bop classics.

This album made a contemporary standard of *Bye Bye Blackbird*, and a star of John Coltrane. Coltrane, dismissed at the time by many, is so compelling on *Blackbird* and *'Round About Midnight* that he overshadows Davis himself, who plays very well on the set. The Davis rhythm section—Jones in particular—was never better.

The electronic stereo broadens the pinched upper register of Miles's horn. *J. G.*

© **DUKE ELLINGTON: Ellington at Newport.** Duke Ellington (piano and leader), Ray Nance (trumpet), Johnny Hodges (alto saxophone), Paul Gonsalves (tenor saxophone). *Newport Jazz Festival Suite; Jeep's Blues; Diminuendo and Crescendo in Blue.* COLUMBIA CS 8648 \$4.98.

Interest: Gonsalves's triumph  
Performance: Fine Ellington  
Recording: Good  
Stereo Quality: Artificial

One night at Newport in 1956, Paul Gonsalves played twenty-seven blues choruses on the saxophone and had everyone dancing in the aisles. The incident is detailed in the liner notes in George Avakian's fascinating prose, and started a trend Ellington has unfortunately tried to prolong ever since.

I say unfortunately, because everything else on this reprocessed-for-stereo set is musically superior to that juke-joint moment. Johnny Hodges is splendid on his showpiece *Jeep's Blues*. Ray Nance plays superb trumpet on *Blues To Be There*, the lovely second part of a generally undistinguished "Festival Suite."

But the high point of the set is Ellington's piano. In brief, idiosyncratic solo or in relentless accompaniment, his piano playing is one of the rarest delights in all jazz. Without it, there would be no Ellington band. And this disc is one of the finest demonstrations, short of the rare trio and



BARBARA DANE  
*Blues without bite*

solo performances, of that piano. Beside such powerfully compressed music, Gonsalves's solo stands exposed as meaningless time-killing. *J. G.*

© **RED GARLAND: The Nearness of You.** Red Garland (piano), Larry Ridley (bass), Frank Gant (drums). *Why Was I Born; Don't Worry about Me; All Alone;* and five others. JAZZLAND JLP 962 \$5.98, JLP 62\* \$4.98.

Interest: Mood jazz  
Performance: Rather shallow  
Recording: Good  
Stereo Quality: Well-balanced

Red Garland's languorous examination of eight standards can serve as calming background music, but his performances are pallid by jazz criteria. Each number is taken very slowly, and to maintain interest at this tempo throughout a whole album requires unusual melodic imagination or a uniquely absorbing harmonic sense. Garland has neither. His variations



are tasteful enough, but he rarely transmutes a tune into a deeply personal communication.

Garland's support, by Larry Ridley and Frank Gant, is unobtrusive and dependable. The album is one of Mr. Garland's more expendable efforts and reinforces this reviewer's opinion that Garland is an agreeable but minor jazz pianist. *N. H.*

⑤ ⑥ **TERRY GIBBS: *That Swing Thing*.** Terry Gibbs (vibraphone), Pat Moran (piano), Jimmy Bond (bass), Gary Frommer (drums). *Moanin'*; *Three Blind Mice*; *Blue Wednesday*; and three others. VERVE V6 8447 \$5.98, V 8447 \$4.98.

Interest: That swing thing  
Performance: Ingratiating  
Recording: Good  
Stereo Quality: Passable

Terry Gibbs recorded this set at The Mannehole, Shelley Manne's Los Angeles club, in April of 1961. Gibbs, who shows great delight in his work, is almost completely an entertainer. "That swing thing," as the album's title has it, is very much present, but little else of musical interest goes on. Perhaps in a club a group can just swing, swing, swing, and everybody will be happy, but it is less satisfying on the home phonograph.

Gibbs trots out a march, a waltz, *Three Blind Mice*, and just about every variant of funk one could imagine. It is as if he has discovered the jazz possibilities of gospel music at a time when it was becoming apparent to others that the trick had been overdone.

Pat Moran, who was a very fine pianist in another style, has become funky, too. She does it very well, but not nearly so well as her former style. Gibbs himself, like his group, is great for fun, but a group like Clark Terry-Bob Brookmeyer's has learned how to be entertaining while making music of substance. *J. G.*

#### RECORDING OF SPECIAL MERIT

⑤ ⑥ **DIZZY GILLESPIE: *On The French Riviera*.** Dizzy Gillespie (trumpet), Lalo Schifrin (piano), Leo Wright (alto saxophone and flute), Chris White (bass), Rudy Collins (drums), Tzigane Elek Bacsik (guitar), Pepito Riestria (percussion). *No More Blues*; *Desafinado*; *Here It Is*; *For The Gypsies*; and three others. PHILIPS PHS 600048\* \$4.98, PHM 200048 \$3.98.

Interest: A festive Dizzy  
Performance: Gillespie dominates  
Recording: Good

Recorded during the Third International Jazz Festival at Juan-les-Pins this past summer, the session, held at the local ca-

sino, reveals Dizzy Gillespie at his most buoyantly informal. It is Gillespie who makes this more than a proficient modern jazz recital. Although the other soloists, particularly Leo Wright, are competent enough, Gillespie's contributions are consistently brilliant. He has matured into a trumpeter of stunning technical assurance. His tone has become warmer and deeper, and he plays with the unabashed passion that has always been characteristic of his work.

The arrangements are undistinguished, but the program provides an instructively broad spectrum of Gillespie's skills—from his graceful, incisive muted horn in the bossa nova *Desafinado* and *For The Gypsies* to the more rambunctious flights in *No More Blues* and *Here It Is*. In *I Waited for You*, Dizzy demonstrates again the sweeping but penetrating lyricism of which he is capable on ballads. *N. H.*

⑤ **BENNY GOODMAN: *The Great Benny Goodman*.** Benny Goodman (clarinet), Harry James (trumpet), Lionel Hampton (vibraphone), Teddy Wilson (piano), Gene Krupa (drums), others. *Let's Dance*; *Memories of You*; *Moonglow*; *Sing Sing Sing*; *Don't Be That Way*; and six others. COLUMBIA CS 8643 \$4.98.

Interest: Vintage Goodman  
Performance: Best of the time  
Recording: Variable  
Stereo Quality: Electronic and adequate

This is an electronically reprocessed reissue of some of the best concert tapes, air checks, and the like that Goodman made between 1937 and 1939. Without nostalgia, the music seems pristine, elegant, and refined. In technical excellence and the control of instrumental passion, Goodman's small groups seem a counterpart of the Modern Jazz Quartet, with Hampton in Milt Jackson's role.

It is interesting, in the light of the great reliance placed on the bassist in today's small groups, that Goodman's quartet did without the instrument.

The big band is often refined in the same way, benefiting from their Fletcher Henderson arrangements. The great Goodman showpiece—*Sing Sing Sing*—is here, with its unique Jess Stacy piano solo. The sidemen—Goodman, Stacy, Hampton, Wilson, James, Krupa, Henderson, Christian—are a catalog of the most widely known musicians of the era. And in the playing of Christian one can detect the first seeds of revolt that would make this and other such bands irrevocably a thing of the past. *J. G.*

⑥ **AL GREY: *Snap Your Fingers*.** Al Grey (trombone), Billy Mitchell (tenor saxophone), David Burns or Donald Byrd (trumpet), Bobby Hutcherson (vibra-  
*(Continued on page 90)*

# ARGO JAZZ

## FINE ARTISTS MEMORABLE PERFORMANCES

LOREZ ALEXANDRIA  
GENE AMMONS  
MILT BUCKNER  
KENNY BURRELL  
DON GOLDIE  
AL GREY  
JOHNNY GRIFFIN  
AHMAD JAMAL  
THE JAZZTET  
ROLAND KIRK  
YUSEF LATEEF  
RAMSEY LEWIS  
MIKE MAINIERI  
DODO MARMAROSA  
JAMES MOODY  
SONNY STITT  
JOHN YOUNG

ARGO RECORDS  
2120 SOUTH MICHIGAN AVENUE  
CHICAGO 16, ILLINOIS  
SEND FOR FREE CATALOG

CIRCLE NO. 11 ON READER SERVICE CARD

phone), Flor Morris or Herb Hancock (piano), Herman Wright (bass), Eddie Williams (drums). *Minor On Top; African Lady; Hi-Fly; R.B.Q.*; and four others. ARGO 700 \$4.98.

Interest: New grouping  
Performance: Spirited  
Recording: Good

This group combines the best of the two extremely successful small bands of Al Grey and Billy Mitchell. Its sound suggests members of Cannonball Adderley's band soloing on Jazztet arrangements. This group, however, has more variety

than either of the two to whom it might be compared.

Particularly affecting here is Melba Liston's moody *Just Waiting*. Half of the disc was recorded before an audience at Birdland with guests Donald Byrd and Herb Hancock. The combination of night-club atmosphere and new blood makes this by far the more successful of the two sides. The single revelation of the set is Mitchell's urgent tenor solo on *Minor On Top*, the most compelling I have heard from him. J. G.

© ® LIONEL HAMPTON: *Many Splendored Vibes*. Lionel Hampton (vi-

braphone), others. *Where Are You; I Got It Bad; Hi-Fly; One Note Samba*; and eight others. EPIC BA 17027 \$4.98, LA 16027\* \$3.98.

Interest: Hampton at bay  
Performance: Hampton showcase  
Recording: Clear  
Stereo Quality: Good

If the producer of this recording had consciously set out to give Lionel Hampton inappropriate backing, he could not have done a better job. There is an organ, an ineffectual Latin group, and a bland cocktail unit. Since several of the songs are movie themes, this seems to have been intended as a pop Hampton date, with one bossa nova for insurance.

But even the most inapposite backing cannot quite quell Hampton's infectious, boundless energy. He is a master of rhythm and good humor here, so much so that it scarcely matters that he has done it all before. The ballads work out less well here than the up-tempo numbers! his style requires him to play so many fill-in notes at slow tempos that the sense of tension is lost. There are any number of better Hampton records, but few better demonstrations of Hampton himself. J. G.

© JOHNSON, WINDING, GREEN, DENNIS: *Four Trombones*. J. J. Johnson, Kai Winding, Bennie Green, Willie Dennis (trombones), Charles Mingus (bass), John Lewis (piano), Art Taylor (drums). *I'll Remember April; Stardust; Move; Blues for Some Bones*. FANTASY 6005 \$4.98.

Interest: Trombone seminar  
Performance: Discursive  
Recording: Adequate

This is a reissue of an album released on the now-defunct Debut label in the mid-1950's. It was recorded at a jazz concert, and the quality of sound is not high in terms of rhythm section balance and presence. The four trombonists have all the solo space, except for brief piano transitions by John Lewis.

All the hornmen can be classified as modernists, although Bennie Green has swing-era roots. Each of the protagonists has been more pointed and surprising in other settings, in which the solos have not been so ramblingly lengthy and the material has been more challenging. There is, furthermore, an inevitable blurred sameness of texture when an album consists mainly of four trombones chasing each other. Significantly, the one track in which only one trombonist is featured—Bennie Green in *Stardust*—is the most substantial pleasure here, proof again that cutting contests do not always insure memorable jazz. N. H.

(Continued on page 92)

## EXPERIMENTAL SERIES STEREO CARTRIDGE MK1

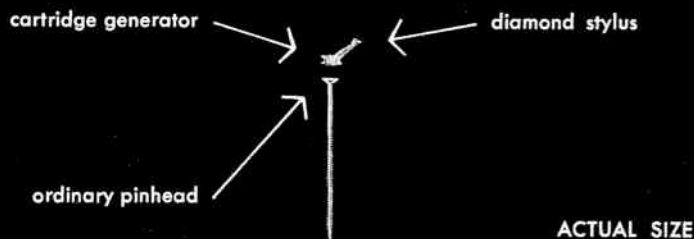

Grado Laboratories has conceived the smallest stereo cartridge generator the world has ever known. It consists of 1200 turns of fantastically fine wire on an armature the size of an ordinary pinhead. This patented moving coil stereo cartridge has a phenomenal frequency response (flat from 7-50,000 CPS). Ultra light tracking forces from 2/10 to 1 gram eliminate record and stylus wear (records may be played as many as 1000 times).

In listening, the MK1 stereo cartridge provides an extreme clarity and delicacy in sound never before achieved. Surface noise is completely inaudible, as is needle talk. Designed for stereo, yet plays monaural records superbly.

Each MK1 cartridge is assembled in our research division under the personal supervision of Mr. Grado. Each cartridge is covered by a diamond stylus guarantee of 5 years and is unconditionally guaranteed for 1 year.

PRICE \$75.00

PATENT #3,040,136

GRADO LABORATORIES, INC. 4614 Seventh Ave., B'klyn 20, N.Y.

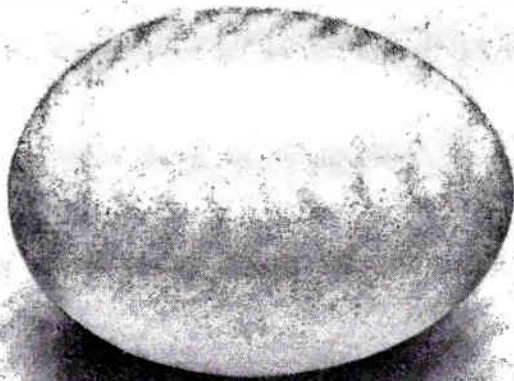

**THE WORLD'S MOST FUNCTIONAL PACKAGE**

**UNTIL NOW**



## **THE REMARKABLE NEW AWARD KITS BY HARMAN-KARDON**

The perfect blend of form and content. This is the unique achievement of the Award Kit Series.

There's sheer pleasure in just looking at the kit: in seeing how each component is packed precisely in the sequence in which it will be used; how the unique tool-box packaging, with pull-out trays, makes handling and identification easy.

An extraordinary instruction book lends a dimension never before available in a high fidelity kit. It contains simple, interesting explanations of how each section of the instrument works. For the first time the kit builder understands just what he is doing—as he is doing it. The handsome book is easeled, spiral-bound and provides complete integration of diagrams and text.

No detail has been overlooked in the creation of this exciting product group. Here is the electronic perfection and incompara-

ble performance of the famed Award Series: the total integration of the most advanced instruction material, packaging and construction techniques. From the moment you open the kit, until the final moment when the completed instrument is turned on, yours will be a totally gratifying experience.

The Award Kits include: Model A30K—handsome 30 watt integrated stereo amplifier kit—\$79.95. Model A50K—powerful 50 watt integrated stereo amplifier kit—\$119.95. Model F50XK—professional FM Stereo (Multiplex) tuner kit—\$129.95. All prices slightly higher in the West.

For more information write  
Dept. R-1A, Harman-Kardon,  
Inc., Plainview, New York.

**harman kardon**

Getting  
only half  
the sound?

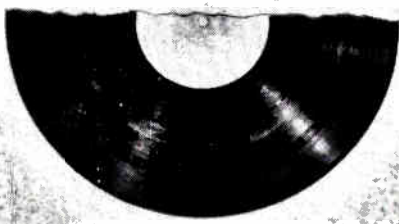

Hear it all with  
*Ortofon*

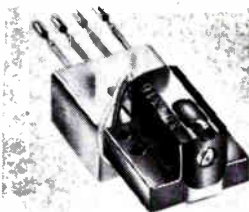

## Stereo Cartridges

All the stereo sound... the ultimate in sound from your records... is yours when you switch to the incomparable Ortofon stereo cartridge. Only Ortofon gives you clear, clean channel separation throughout the entire audible frequency range... not merely, as with ordinary cartridges, only at a specified single frequency!

Ortofon has long been recognized as a supplier of the finest recording and playback equipment to professional recording studios throughout the world. Today, ELPA, for the first time, brings Ortofon equipment to the high fidelity market here... tailored to your needs, but featuring the same Ortofon engineering perfection... superlative design... meticulous attention to every detail.

Of course, you'll want to assure the perfect tracking of your Ortofon cartridge by installing it in a low-inertia, high-precision Ortofon arm — though the new Ortofon SPU/T cartridge will fit any standard stereo arm. You'll find an Ortofon arm that's exactly right for your needs and budget. See and hear the Ortofon at your franchised dealer's today. Or write for information... including comparative cartridge tests made under identical conditions.

Guaranteed for One Full Year, \$49.95 Net



Ortofon RMG 212 arm — \$54.95 net... most thoroughly professional 12" stereo arm on the market. Ortofon arms cover the price range from \$19.95 to \$59.95 net.



ORTOFON DIVISION

ELPA MARKETING INDUSTRIES, Inc.  
New Hyde Park, N. Y.

CIRCLE NO. 57 ON READER SERVICE CARD

92

Ⓢ THE ORIGINAL DIXIELAND JAZZ BAND: *Their Historic Recordings in England*. Nick La Rocca (cornet), Emil Christian (trombone), Larry Shields (clarinet), Billy Jones (piano), Tony Sparbaro (drums). *At the Jazz Band Ball; Satanic Blues; Mammy o' Mine; Alice Blue Gown*; and thirteen others. RIVERSIDE RLP 156/157 two 12-inch discs \$10.00.

Interest: Early jazz document  
Performance: Invitation to nostalgia  
Recording: Poor to adequate

Riverside has added to its jazz archives series an evocative two-volume set of rare recordings by the Original Dixieland Jazz Band. Made in England on 12-inch 78-rpm discs in 1919 and 1920, these performances have never before been issued in America. For its conquering tour of England, the ODJB altered its personnel. Henry Ragas, the combo's original pianist, had died, and his place was taken by British ragtimer Billy Jones. Trombonist Eddie Edwards refused to make the voyage, and Emil Christian, a lusty New Orleans tailgater, substituted for him. The core of the quintet remained Nick La Rocca, a forceful ensemble cornetist but an indifferent soloist, drummer Tony Sparbaro, and the group's only outstanding jazz improviser, clarinetist Larry Shields.

As most jazz historians have agreed, the ODJB was rhythmically stiffer than its chief Dixieland rivals of the time, the New Orleans Rhythm Kings. The latter was much closer to the blues-strong roots of Negro New Orleans jazz, and its influence on later jazz players proved much more pervasive.

Yet, within its limitations, the ODJB was a swaggeringly entertaining unit. It played with bracing drive and swirling high spirits. It was at its best in boldly idiomatic tunes by its own members—like its crackling version of *Tiger Rag*. The first two sides in the set are composed entirely of such tunes, and accordingly, these are the most rewarding performances. When it tried other writers' pieces in the era's popular veins, the band often tended to lose its distinctive character, blurring the brassy edges of its New Orleans traditions with sentimentality. Even in the thick-textured interpretations of the final two sides, however, the bitter-sweet poignancy of Larry Shields's clarinet lends some measures jazz worth.

The sound is what could be expected from the recording conditions of the time, but I wonder if more patient remastering by Riverside might not have produced more vivid results. Much of the tang of the ODJB does come through in spite of all. And the collection illuminates the first white Dixieland style to have achieved wide success as well as the strutting optimism with which the 1920's began. *N. H.*

Ⓢ BUD SHANK: *Brazilliance, Vol. 2*. Bud Shank (alto saxophone and flute), Laurindo Almeida (guitar), Chuck Flores (drums and tabla), Gary Peacock (bass). *Simpatico; Nocturno; Mood Antigua; Lonely*; and six others. WORLD-PACIFIC S 1419\* \$5.98, WP 1419 \$4.98.

Interest: Bossa nova  
Performance: Light and airy  
Recording: Splendid

Several years ago, alto saxophonist Bud Shank and Brazilian guitarist Laurindo Almeida made a record containing a charming piece called *Blue Baiao*, anticipating the bossa nova by almost a decade. Now they are back at the same game in the height of the current furor. Their cooperation is a blend of Shank's West Coast jazz and Almeida's Brazilian delicacy. The result, largely because of Shank, tends to be slightly bloodless, but on the whole superior mood music. Almeida writes instantly affecting melodies, of which *Carioca Hills* is the best example on this set. The two do not have the superb musicianship of Charlie Byrd and Stan Getz, who are busy at a similar effort, but their lightly Latin jazz is infinitely preferable to much of the ersatz bossa nova with which we are now being inundated. *J. G.*

Ⓢ BILLY TAYLOR: *Impromptu*. Billy Taylor (piano), Jim Hall (guitar), Bob Cranshaw (bass), Walter Perkins (drums). *Capricious; Free and Cozy; Paraphrase; At La Carrousel*; and four others. MERCURY SR 60722\* \$4.98, MG 20722 \$3.98.

Interest: Polished piano jazz  
Performance: Leader lacking  
Recording: Warm and clear

In recent years, Billy Taylor has been splitting his time between playing, lecturing, and functioning as a jazz disc jockey, currently with WNEW in New York. As a jazz educator, Taylor is setting important critical standards for the music. As a pianist, however, he remains curiously insubstantial. Taylor is an unusually skilled technician with a particular capacity for improvising contrapuntally. But his work lacks the impact of a commanding and distinctive musical personality.

Everything Taylor plays is in proper taste. His original themes are attractive and neatly constructed, and his beat is fluid, but he seems to be shaping only surface emotions. He hardly ever persuades the listener that he *has* to express himself in personal ways. His music evinces little of the urgency to be heard in such otherwise widely varying pianists as Bill Evans, Cecil Taylor, and Paul Bley.

By contrast, guitarist Jim Hall, al-  
(Continued on page 94)

# MOST AMAZING STEREO RECORD EVER MADE!

**THE TRIPLE PLAY MIRACLE...** a revolutionary innovation in stereo listening. Using regular stereo controls the listener can create infinitely variable blends of lilting pop music with spicy jazz; or play back pop or jazz music separately. This Triple Play Process offers at least three times more musical entertainment than the conventional stereo album!

Benny Golson has orchestrated and conducted special scores for the Triple Play Process. Musicians included are: Bill Evans, Curtis Fuller, Wayne Shorter, others.

Selections included are: You're Driving Me Crazy, Out Of Nowhere, Whispering, Autumn Leaves, Lover Come Back To Me, Moten Swing, Groovin' High, Quicksilver, Ornithology, others.

Stereo—AFSD 5978

**TRIPLE PLAY STEREO**  
Each Triple Play Stereo is engineered to be played 3 different ways and contains the musical arrangement value of 3 conventional long playing records.

**POP+JAZZ=SWING**  
ORCHESTRATED AND CONDUCTED BY BENNY GOLSON

**POP**  
music on the left

**JAZZ**  
music on the right

The most amazing Stereo record ever made!

The Triple Play miracle... Using regular stereo controls you can create infinitely variable blends of lilting pop music with spicy jazz or you can create separate pop or jazz concerts.

See how it's done

## AMAZING PRODUCTION!

The ultimate exercise in stereophonics!

**STEREO SPECTACULAR DEMONSTRATION & SOUND EFFECTS**

A fast-moving, guided tour through the magical, exciting world of stereophonic sound. Astounding situational stereo effects have been ingeniously conceived and precision engineered to provide stunning, dramatic entertainment. DFS 7013

**SOUND EFFECTS U.S. AIR FORCE FIREPOWER**

## NOW... A NEW KIND OF STEREPHONIC SOUND EXPERIENCE UNEQUALLED ON RECORDS!

THE AWESOME, DRAMATIC SOUNDS OF THE SPACE AGE: A LISTENING EXPERIENCE WITH STUNNING IMPACT! Crackling, screaming, roaring, booming sounds of jets, rockets and missiles as they were heard at the Eglin Air Force Base demonstration for President John F. Kennedy and the Executive Party. U.S.A.F. weapons heard include: B52's, air-to-air rockets, Starfighters, Delta Darts, Delta Daggers, Falcon and Genie rockets, Hound Dog, Side-winder and Bull Pup missiles, cannons, machine guns and NUCLEAR EXPLOSION!

Stereo—DFS 7012, Mono—DFM 3012

**SOUND EFFECTS Volumes 1, 2, 3**

Doctored for Super Stereo

## THE MOST COMPLETE LIBRARY OF SOUNDS

Auditory images recreated to capture every distinctive overtone! Add realism to home movies, educational and unique listening entertainment.

DFM 3006/DFS 7006, Vol. 1  
DFM 3010/DFS 7010, Vol. 2  
DFM 3011/DFS 7011, Vol. 3

Unprecedented!

It's a new beat... a fresh musical diversion... it's BOSSA NOVA!... the new Brazilian jazz creating musical excitement and interest across the country

JUST RELEASED!

Featuring Lalo Schifrin with Leo Wright, Rudy Collins, Christopher White and others playing: Boato, Chora Tua Tristeza, Poema Do Adeus, Bossa Em Nova York, 8 others.

STEREO—AFSD 5981/MONO—AFLP 1981

**BOSSA NOVA**

NEW BRAZILIAN JAZZ  
LALO SCHIFRIN

**LEVEE LOUNGERS**  
at the Golden Garter

**LEVEE LOUNGERS** at the Golden Garter—Hey-Lylee and other rousers including: Daisy, Cotton & Corn, Five Foot Two, Railroad. AFLP 1977/AFSD 5977

**MOVIE THEME HITS**

**MOVIE THEME HITS**, Jo Basile & Accordion—Tonight, Ai Di La, Moon River, Never On Sunday, Pepe, Maria, others. AFLP 1979/AFSD 5979

**EL DEBKE**

**EL DEBKE, Naif Agby & Orch.**—Music of the Middle East, Ya Samra, Melie Ya Helwee, Kabber-Kabber, Rakbat Wadad, others. AFLP 1980/AFSD 5980

For FREE, complete catalogs of records and tapes, write to: AUDIO FIDELITY Inc., 770 Eleventh Ave., New York 19, N.Y.

# The Most Valuable Cartridge System You'll Ever Own...

## the New FAIRCHILD F-7

Today's conventional cartridges not only have to trace the groove, they have to generate a voltage sufficient to operate today's pre-amplifiers. This is usually accomplished through the use of comparatively massive (from a cartridge design philosophy) generators—usually magnets or coils, or ceramic elements. These massive generators can cause excessive record and stylus wear and distortion. But FAIRCHILD has disregarded the need for a normally useable output level from this type of tracing device and took a completely unique approach with this one basic concept — *the cartridge must trace only the groove ... effortlessly and accurately.* Therefore, the NEW FAIRCHILD F-7 is a low, low mass, moving coil tracing element. The F-7 traces the groove at a pressure of well under a gram, and in turn translates minute impulses into a transistorized pre-preamplifier which then generates a sufficient signal for today's preamplifiers. The transparent highs, the outstanding transient response, and the unbelievably low distortion of the FAIRCHILD F-7 system now allows you to hear a new world of recorded definition and dimension.

### HIGHLIGHTS OF THE FAIRCHILD "F-7"

- Low, low mass moving coil transducer tracks at ½ gram.
- Frequency response ± 1 db to beyond 30 kc, separation 25 db in the critical stereo perception areas.
- Low impedance eliminates hum problems and high frequency losses due to cable capacity. Long leads can be used.
- Transistor amplifier allows full low end reproduction, no restrictions due to transformers in pickup circuit.

FAIRCHILD F-7 Cartridge Systems are available in limited quantities at authorized FAIRCHILD dealers. Complete specifications available.

**FAIRCHILD**  
RECORDING EQUIPMENT CORPORATION  
10-40 45th Ave., Long Island City 1, N.Y.  
CIRCLE NO. 58 ON READER SERVICE CARD  
94

though essentially a lyrical player, improves with an unmistakable personal impact. Hall, in fact, along with the team of Walter Perkins and Bob Cranshaw, provide this session with what emotional depth it has. Taylor glides, but his colleagues dig in more deeply. N. H.

⑤ ⑥ **JACK TEAGARDEN:** *Think Well of Me.* Jack Teagarden (trombone and vocals), Don Goldie (trumpet), with orchestra conducted by Russ Case and Bob Brookmeyer. *Where Are You; Don't Smoke in Bed; Country Boy Blues;* and eight others. VERVE V6 8465\* \$5.98, V 8465 \$4.98.

Interest: Unaffected nostalgia  
Performance: Big T is nonpareil  
Recording: First-rate

Having performed several Willard Robison compositions in his previous Verve set "Misery and the Blues," Jack Teagarden has now undertaken an entire album (with the exception of Jimmy McHugh's *Where Are You*) of Robison pieces.

Now sixty-nine, Robison is a sentimental composer of themes and lyrics so naturally spun that they seem to be authentic Americana of forty or more years ago. The best-known Robison numbers in this collection are *Old Folks* and *Cottage for Sale*, but just as gently evocative are such twilight vignettes as *In A Little Waterfront Cafe*, *Don't Smoke in Bed*, and *Country Boy Blues*.

Jack Teagarden's ruminative singing and his glowing trombone are exactly suited to the unhurried Robison idiom. Teagarden is himself so naturally homespun that the listener rejoices for the refreshing absence of coyness.

The album could have been a distinguished success, but Verve inadvisedly decided to back Teagarden with an unnecessary string section and a gratuitous harp. The arrangements by Bob Brookmeyer and Russ Case are serviceable and not too treacly, but Teagarden would have been far better served by a small combo or a stringless big band.

Fortunately, an opposite second solo horn is present in the clear, singing trumpet of Don Goldie. By and large, Teagarden and Goldie manage to surmount the boneless arrangements. N. H.

⑤ ⑥ **CLARK TERRY:** *All American.* Clark Terry (trumpet, flugelhorn), Budd Johnson (tenor saxophone), Lester Robinson (trombone), George Barrow (baritone saxophone), Eddie Costa (piano, vibraphone), Art Davis (bass), Eddie Shaughnessy (drums). *What A Country; Nightlife; Same Language;* and five others. MOODSVILLE S26\* \$5.98, 26 \$4.98.

Interest: Terry  
Performance: Exuberant  
Recording: Good

**VANGUARD**  
Recordings for the Connoisseur  
Two new sumptuous recordings by



### I SOLISTI DI ZAGREB Antonio Janigro, conductor

"An array of dulcet sounds seldom heard from one musician, much less a group... It would be impossible to imagine an ensemble playing any better technically."  
*N. Y. Herald Tribune on the October 8, 1962 concert.*

### NOTTURNO

A collection of charmers including Mozart's EINE KLEINE NACHTMUSIK, Respighi's ANCIENT AIRS & DANCES, works of Pergolesi, Sibelius, Vaughan Williams and Barber.

VRS-1095 (Mono)—VSD-2126 (Stereo)

### THE VIRTUOSO FLUTE

Guest artist: Julius Baker

Telemann: Suite in A minor, flute and Orch.

Mozart: Concerto for Flute, Harp and Orch. K. 299 (with Hubert Jelinek, harp).

BG-636 (Mono)—BGS-5048 (Stereo)

Forthcoming—

The Virtuoso Trumpet, Vol. 2

Send for Catalog, Vanguard 154 W. 14 St. N. Y.

CIRCLE NO. 54 ON READER SERVICE CARD

## PURCHASING A HI-FI SYSTEM?

TIME PAYMENTS AVAILABLE

Up to 2 years to pay!

Send Us  
Your List Of  
Components  
For A  
Package  
Quotation

Jim Lansing\*  
Aitec Lansing  
Electrovoice  
Jensen  
Hartley\*  
University  
Acoustic Research  
Janszen  
Wharfedale  
USL Citizen Band  
International Crystals  
Gonset • Hallcraft  
Texas Crystals  
Concertone • Viking  
Bell • G.E.  
Weathers  
Harman—Kardon  
Eico • Pilot • TEC  
Sherwood\*  
ESL • Frazier  
Superscope  
Dual Changer  
Bogen • RCA  
Dynakit • Fisher  
H. H. Scott  
Thorens\*  
Finco • ECI  
DeWald  
Sony • Roberts  
Challenger  
Browning • National  
Garrard • Norelco  
Miracord  
General Radio  
Rek-O-Kut  
Polytronics  
Tandberg\*  
Fairchild  
Pickering • Sonar  
Audio Tape  
Magnecord\*  
Rockford Cabinets  
\*Fair Traded

**AIREX  
WON'T BE  
UNDERSOLD**

All merchandise is  
brand new, factory  
fresh & guaranteed.

Free Hi-Fi Catalog

**AIREX  
RADIO**  
CORPORATION

85-MR Cortlandt St., N.Y. 7, WO 4-1820

CIRCLE NO. 3 ON READER SERVICE CARD  
HI-FI/STEREO REVIEW

This is an essay in how to make silk purses out of unpromising show tunes. Oliver Nelson drastically altered the original *All American* score, using only a septet, and was apparently unhampered by the economic factors that make most major undertakings from Prestige emerge slightly shoddy.

Clark Terry, for whom this was done, is a master. He is more consistently inventive and refreshingly witty than any trumpet player except Gillespie. On *Same Language*, his magnificent growl and Nelson's voicing change an indifferent song into a study in Ellingtonia. Budd Johnson is still a young, fresh saxophonist. The late pianist Eddie Costa, who plays well here, was rather strongly influenced by Dave Brubeck. The rhythm team of Art Davis and Eddie Shaughnessy is quietly apt.

Since Clark Terry makes so few records as a leader, any of his discs are

worth having. This one, because of the material, is not top-quality, but some of Terry's solos are as good as his best. *J. G.*

◎ **CAL TJADER:** *Saturday Night/Sunday Night at The Blackhawk, San Francisco.* Cal Tjader (vibraphone), John Rae (drums), Lonnie Hewitt (piano), Freddie Schreiber (bass). *Summertime; This Can't Be Love; Weep; Stompin' At the Savoy; Noonies Groove;* and three others. VERVE V 8459 \$4.98.

Interest: Little MJQ

Performance: Superior Tjader

Recording: Fine for location date

Do not be deceived by the title—this is not the well-known Miles Davis set. Do not be deceived by the music, either—this is not the MJQ on a bad night. When Cal Tjader gets away from his Latin predilections, as he does here before a

San Francisco night-club audience, he can be a very good vibraphonist. The only trouble is, he speaks almost completely in the vocabulary of Milt Jackson, and he has mastered only the more obvious turns of phrase. The sidemen are all commendable, particularly bassist Freddie Schreiber.

The set is well-recorded, and the players seem to benefit from being before an audience: I cannot recall hearing Tjader play so well. There is a good selection of tunes—some standards and the obligatory Miles Davis-styled piece, here called *222 Time*.

This is a fine, cohesive group. It is perhaps unfortunate for such musicians that the MJQ exist, for they must stand the comparison. But, were it not for the MJQ, they would not play as they do; here they do it with neither the inventiveness nor the subtlety of their models.

*J. G.*



*This is probably the last man who will ever see  
the inside of your KLH speaker system.*



KLH RESEARCH AND DEVELOPMENT CORPORATION  
30 CROSS STREET, CAMBRIDGE 38, MASSACHUSETTS

*Descriptive literature, with the name of  
your nearest franchised KLH dealer,  
is available on request.*

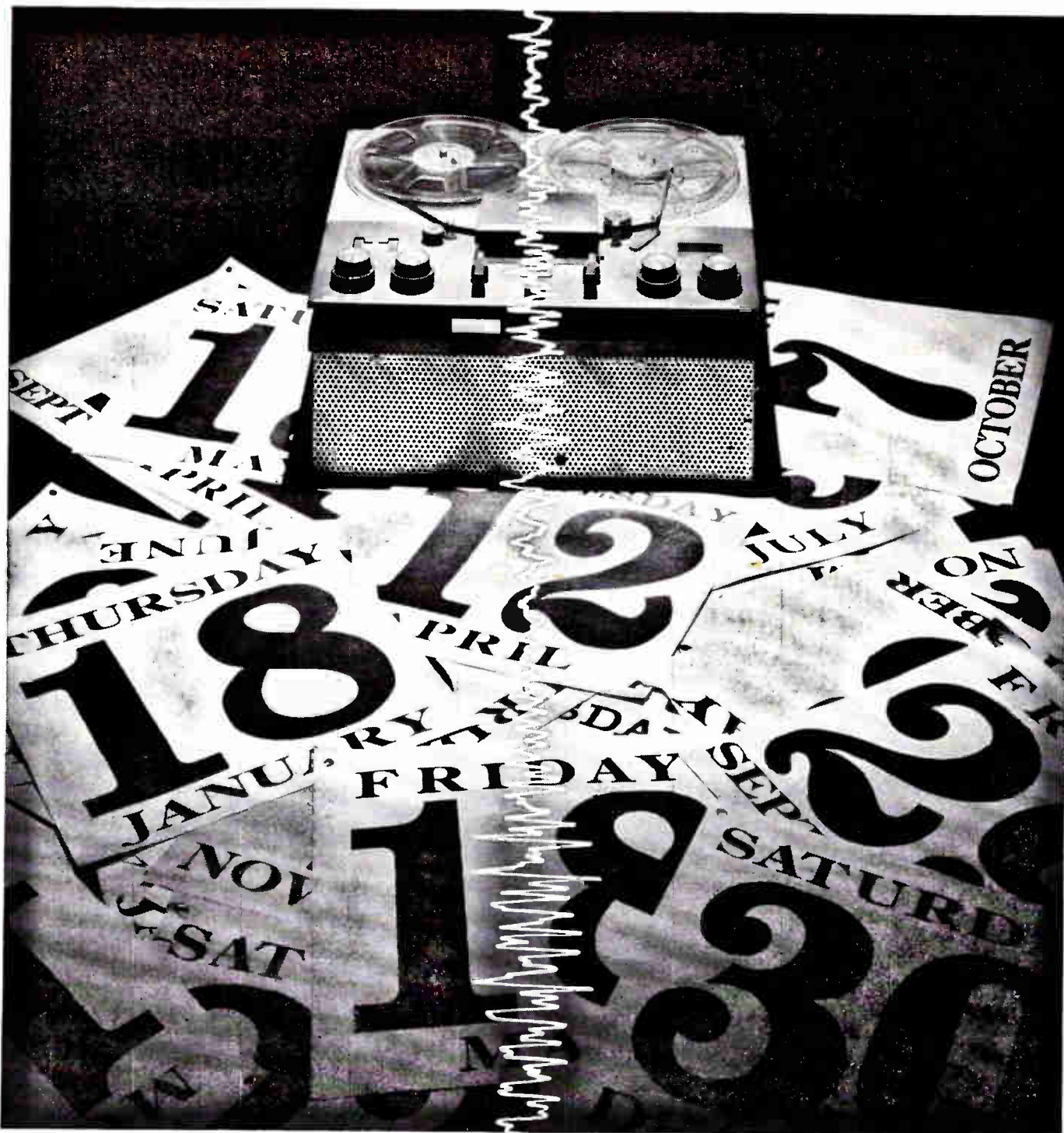

Who builds a tape recorder so perfect they guarantee it for a full year? **AMPEX**

The finest home tape recorder on the market today is the Ampex Fine Line 1200. No wonder: It's a product of the engineering skills and magnetic recording technology that produce the standard-setting recorders of the entire audio industry. So superior are the materials used, so precise the engineering in the Fine Line 1200, that Ampex *extends its warranty to a full year*. Now your new Ampex recorder is protected by the new "Four Star"



One-Year Warranty: Ampex will replace or repair any defective part for a full year. Ask your dealer to demonstrate the Fine Line 1200. And while you're there, pick up a free copy of the Ampex booklet, "How to Tape It in Stereo." Or write the only company providing recorders, tapes and memory devices for every application: Ampex Corporation, 934 Charter St., Redwood City, California. Sales and service throughout the world. **AMPEX**



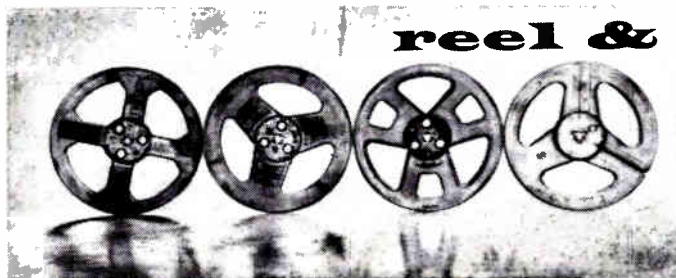

## cartridge

● CHRISTIE BARTER

### Explanation of symbols:

Ⓜ = monophonic recording

Ⓢ = stereophonic recording

## 4-TRACK CLASSICS

### RECORDING OF SPECIAL MERIT

Ⓢ **BERLIOZ: *Romeo and Juliet, Op. 17.*** Rosalind Elias (mezzo-soprano), Cesare Valletti (tenor), Giorgio Tozzi (bass-baritone); New England Conservatory Chorus and Boston Symphony, Charles Munch cond. RCA Victor FTC 7003 \$14.95.

Interest: Symphonic drama  
Performance: Stirring  
Recording: Transparent  
Stereo Quality: Tops

If Charles Munch has carved a special niche among contemporary conductors, it is in the Berlioz repertoire. No other conductor today possesses his unique sense of proportion as an interpreter of these scores, and no other is as watchful of instrumental balances and the precise time values of the notes that sound so often in a context of silence. Without this special insight a sprawling score like Berlioz's *Romeo and Juliet* can become hopelessly mired in technicalities, a pallid bore punctuated by bombast.

In Munch's hands it most emphatically is not. His exposition of Romeo's first flights of fancy is glowing, and the *Love Scene* is a moment of revelation. *The Capulets' Ball* is all stateliness and grace, and the "Queen Mab" Scherzo a marvel of gossamer airiness unequalled by any recording to date.

His singers generally are worthy of his direction. Giorgio Tozzi is a compelling Italianate Friar Lawrence, though it is evident that French is not his native tongue. Rosalind Elias reports Romeo's "premières transports" with tender conviction and gratifying vocal security. The Berlioz style is best served by establishing a fairly restricted, even monochromatic, range of vocal color, and never allowing that color to vary from one extreme of the voice to the other. Miss Elias has mastered this style. To Valletti it comes naturally, and his "Mab" aria is a model of stylistic finesse. The New England Conservatory Chorus has some trouble with enunciation at this point but otherwise acquits itself superbly.

The recording, the first on tape, is exemplary. The sound is clean, a trifle weak on bass but bright and razor-sharp on top. Especially notable are the silken string texture, the burnished brass, and the limpid clarity of the chorus, in contrast to the two-disc LP edition, which sounds a little grainy and murky. The elegant Soria disc box, however, comes with libretto and



ROSALIND ELIAS

*Romeo's transports imparted tenderly*

notes printed in Italy. The tape does not include these extras, nor is there the usual invitation to the buyer to send for a free booklet. C. B.

Ⓢ **GILBERT AND SULLIVAN: *Patience.*** D'Oyly Carte Opera Company, Isidore Godfrey cond. LONDON LOS 90045 two reels \$15.95.

Interest: Savoyard spoof  
Performance: Appealing  
Recording: Very good  
Stereo Quality: Satisfactory

It is especially good to have this rarely performed Gilbert and Sullivan complete on two reels, with the intact spoken dialogue of Gilbert's caustic satire on pre-Raphaelite aesthetic pretensions. The D'Oyly Carte performs its accustomed chores with considerable flair, though there is a little too much affectation on the part of the ladies of the company. Isidore Godfrey maintains unusually high spirits throughout. His chorus is excellent, and among the principals, John Reed's Bunthorne and Philip Potter's Lieutenant

are distinguished. Stereo effects are not unduly emphasized, but the sound is airy and bright. Altogether, this *Patience* is marvelously entertaining, and the recording of both music and voices cannot be faulted. C. B.

Ⓢ **MOZART: *Horn Concerto No. 1, in D Major, K. 412; Horn Concerto No. 2, in E-flat Major, K. 417; Horn Concerto No. 3, in E-flat Major, K. 447; Horn Concerto No. 4, in E-flat Major, K. 495.*** Albert Linder (horn); Vienna State Opera Orchestra, Hans Swarowsky cond. VANGUARD VTC 1648 \$7.95.

Interest: Complete Mozart horn canon  
Performance: Assured  
Recording: Good  
Stereo Quality: Good

Considering the virtuoso demands of Mozart's four horn concertos, and these serene, glowing untroubled performances by Albert Linder, this album richly deserves its title, "The Virtuoso Horn." A young Dane with a highly polished technique, Linder plays with a suppleness of phrase rarely come by, fine warmth of tone, and a gratifying sense of flourish (which, after all, is what the horn is for). At first the trills in K. 447 give him some trouble, but lapses of this kind are few in what follows, and for the most part these performances are magnificently controlled. Swarowsky's accompaniments are models of stylistic discretion. Although the winds are a little out of focus, the recorded sound is agreeably balanced. Stereo separation is wholly adequate. C. B.

Ⓢ **SCHUBERT: *Quintet, in A Major, for Piano and Strings, Op. 114 ("Trout").*** Clifford Curzon (piano); Members of the Vienna Octet. LONDON LCL 80092 \$7.95.

Interest: Schubert suprême  
Performance: Suave  
Recording: Good  
Stereo Quality: Effective

Of the eight (!) stereo recordings of the "Trout," this is clearly one of the best. Its only real competition on tape is the marvelously sanguine performance by Frank Glazer and the Fine Arts Quartet for Concert-Disc (CS 1201-S). Curzon's tends to be more reserved, smaller in scale, and somewhat more mannered. Still, the music flows with precision and

FOR FULL QUALITY  
STEREO-MULTIPLEX  
OR MONOPHONIC  
FM RECEPTION

use

**FINCO**®

World's most  
Complete Line of  
Hi Fi Phased  
FM Antennas...

## THE TOP PERFORMANCE FM ANTENNA LINE

• No matter how well your FM unit is performing, you'll hear the difference a FINCO makes. Rich, luxurious distortion-free sound is yours when you pick just the right FM antenna from FINCO's complete line.

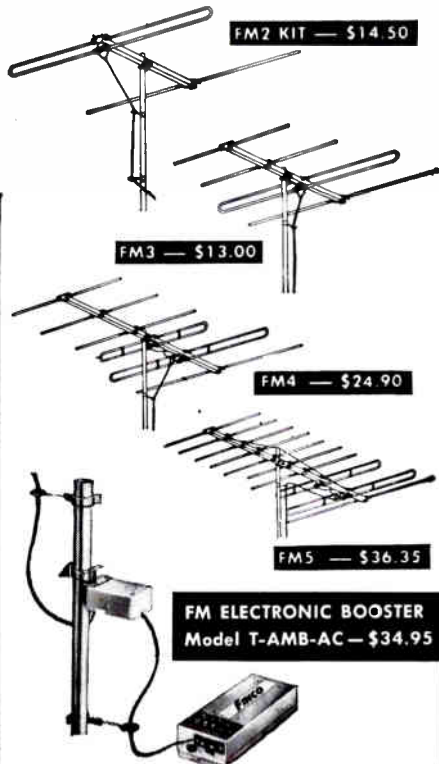

FMT-1 Turnstile Kit — \$14.50  
Write for Catalog #20-213

**THE FINNEY COMPANY**  
Dept. H.D.

34 W. Interstate Road Bedford, Ohio

grace throughout, and except for a few lapses, the string playing is impeccable. The sound is attractive, favoring integrated ensemble with just the right degree of separation. Intimacy and clarity of detail are uppermost. C. B.

### RECORDING OF SPECIAL MERIT

© SCHUMANN: *Symphony No. 3, in E-flat Major, Op. 97 ("Rhenish")*. New York Philharmonic, Leonard Bernstein cond. COLUMBIA MQ 475 \$7.95.

Interest: *Urtext* Schumann  
Performance: Exuberant  
Recording: Robust  
Stereo Quality: Impressive

The composer's joyful sense of discovery that life could be beautiful in Düsseldorf is admirably conveyed here. Leonard Bernstein's "Rhenish" is the first and only tape recording so far, and it should easily remain the best one for some time to come, even if George Szell's excellent Epic recording is later transferred to tape. For Bernstein's youthful, optimistic outlook matches this music perfectly. That he returns to Schumann's original scoring and makes it sound well despite the generally thicker textures is further evidence of the conductor's keen ear for orchestral balances. The recording itself creates an aura of wide-open spaces, especially in the "cathedral movement," which is seldom invested with such grandeur. Stereo directionality is high, but in no way impairs the superb blend of instrumental color. The Philharmonic's gleaming brasses are beautifully offset by the warmth of the strings, the mellowness of the winds, and the rock-solid pedal point of the bass. C. B.

### RECORDING OF SPECIAL MERIT

© STRAVINSKY: *Petrouchka (revised 1947 version)*. Columbia Symphony. Igor Stravinsky cond. COLUMBIA MQ 474 \$7.95.

Interest: Basic Stravinsky  
Performance: Definitive  
Recording: Gem-like  
Stereo Quality: Near-perfect

This *Petrouchka*, the first Stravinsky has recorded in many years, is the second tape released in honor of his eightieth birthday. The first was his new *Firebird* (Columbia MQ 450), and while he now prefers the latter work in its early, fully orchestrated version of 1910, he finds the later, revised *Petrouchka* of 1947 "very much less amateur" today—rewritten, as he frankly states, for the dual purpose of preserving his copyright and adapting the score for a smaller orchestra. The thinner textures emerge from this superb recording with chamber-like clarity. The score's interior details are defined almost clinically, and orchestral timbres fairly shim-

mer. Stravinsky moves deftly from one tableau to the next, dramatizing each with the subtle accents and sudden insights of a master story-teller. Altogether, the performance is angular, brassy, and kaleidoscopic in color. The impeccable solo work by members of the Columbia Symphony contributes greatly to the impact. The stereo engineering is absolutely first-rate. C. B.

© VERDI: *Rigoletto*. Cornell MacNeil (baritone), Rigoletto; Joan Sutherland (soprano), Gilda; Renato Cioni (tenor), Duke of Mantua; Cesare Siepi (bass), Sparafucile; Stefania Malagu (mezzo-soprano), Maddalena; Fernando Corena (bass), Monterone; Giuseppe Morresi (baritone), Marullo. Orchestra and Chorus of L'Accademia di Santa Cecilia, Nino Sanzogno cond. LONDON LOG 90044 two reels \$19.95.

Interest: Operatic staple  
Performance: Spotty  
Recording: Excellent  
Stereo Quality: Realistic

London's new *Rigoletto* has many assets. Among them is the strong cast headed by Cornell MacNeil, Joan Sutherland, and Renato Cioni. Another is the superb sound, which has by now become standard for any of London's operatic undertakings. Still another is the fact that the Verdi opera has here been recorded in full for the first time. This in itself is a fairly minor consideration since the traditional cuts—portions of the Gilda-Rigoletto and Gilda-Duke duets in the second act (or Act I, scene two, as they have it here), as well as the Duke's impassioned "Possente amor" further on—account for only a few minutes' playing time. Still, the restorations have been made, and they make sense dramatically.

The trouble with this performance lies mainly in its over-all blandness, for all the excitement Sanzogno occasionally whips up in the orchestra, and in the vocal eccentricities he allows Miss Sutherland to get away with. Departures from tradition, which, as noted, are commendable when it comes to presenting the score in its entirety, are inexcusable in instances where the score is arbitrarily tampered with to accommodate the personal whims of any one of the principals. The unwritten high D to which Miss Sutherland soars (with marvelous ease) as she enters Sparafucile's hideaway in the last act is both unexpected and, as it turns out, effective. Elsewhere she takes liberties with the notes as Verdi wrote them that simply disfigure the musical line and impede the established, logical flow of action. By singing ever so slightly behind the beat a good deal of the time, she frosts with bathos a Gilda bowed down by a most terrible melancholy.

Miss Sutherland's "Caro nome," to be

sure, is lovely, trills and all. She is in splendid voice throughout. And so is MacNeil. His Rigoletto has not yet the depth, the inner turmoil or exterior bite, with which Leonard Warren and Tito Gobbi invested the role, but the potential is clearly there. MacNeil's fairly limited range at present is especially evident in "Cortigiani, vil razza" and at other moments, ironic or serious, when the full weight of a crucial dramatic situation rests solely and squarely on his shoulders. Nevertheless, his unerring musicianship and frequent flashes of insight hint of greatness to come.

Renato Cioni, the young tenor who co-starred with Miss Sutherland in London's recent *Lucia*, is a fine Duke. By contrast with his two Anglo-Saxon colleagues, he brings a kind of Mediterranean ardor to his portrayal that, dramatically, would stand up on any stage. His "La donna è mobile" caps an altogether convincing performance that is marred only by strain in the upper registers. Cioni's is not a big voice, but perhaps he should consider himself blessed. He may thus be forced to use it intelligently, which he does in this recording.

The rest of the cast lends solid support. Sanzogno's tempos are relaxed, generally slower than most, but fortunately never quite so droopy as Miss Sutherland appears to have wanted them.

Both scenes of the first act fit neatly on the first reel; Acts II and III share the second reel, one each to a sequence.

C. B.

#### RECORDING OF SPECIAL MERIT

© WAGNER: *Die Walküre*. Birgit Nilsson (soprano), Brünnhilde; Gré Brouwenstijn (soprano), Sieglinde; Rita Gorr (mezzo-soprano), Fricka; Jon Vickers (tenor), Siegmund; George London (bass-baritone), Wotan; David Ward (bass), Hunding; Marie Collier, Julia Maylon, Margreta Elkins, Joan Edwards, Judith Pierce, Noreen Berry, Maureen Guy, Josephine Veasey (sopranos and mezzo-sopranos), Valkyries. London Symphony, Erich Leinsdorf cond. RCA Victor FTC 9500 three reels \$32.95.

Interest: Wagnerian masterpiece  
Performance: Overwhelming  
Recording: Superb  
Stereo Quality: Totally satisfying

Any new recording of *Die Walküre* can be cause for rejoicing, but one as good as this on four-track stereo tape should be greeted with rapture. In the opera house *Die Walküre*, like any other of the *Ring* operas, can become tedious. Hearing it on tape, one has a greater sense of its entirely human passions as well as a clearer understanding of the conflicts and tensions that make the work's musical and dramatic structure.

Conveying these passions with vigor

# DYNACO

for superlative sound

Superlative sound means the very best sound available, sound so realistic that skilled listeners can not distinguish the difference between "live" and "recorded" music in a side by side comparison. This comparison has been performed dozens of times before thousands of people in programs sponsored by Dynaco, Inc. and AR, Inc. with "live" portions performed by the Fine Arts Quartet. In these comparisons, the superlative sound capabilities of the Dynakits were amply demonstrated since the vast majority of the audiences readily admitted that they could not tell the difference between the electronic reproduction using the Dyna Mark III amplifiers and PAS-2 pre-amplifier and the instrumental rendition by the members of the Fine Arts Quartet.

Such perfection of reproduction means that listeners at home, using home type components, can truly have concert hall realism — a level of fidelity of reproduction which cannot be improved regardless of how much more money were to be spent on the components used. This is truly reproduction for the audio perfectionist, and all Dyna components are of a quality level which permits reproduction indistinguishable from the original. This is achieved through exclusively engineered designs coupled with prime quality components. Further, the unique designs and physical configuration of all Dynakits make them accurately reproducible, so that everybody can hear the full quality of which the inherent design is capable. Dynakits are the easiest of all kits to build—and yet they provide the ultimate in realistic quality sound.



**FM-1**—An outstanding FM tuner with provision for internal insertion of the FMX-3 Stereomatic multiplex integrator. The FM-1 is a super-sensitive (better than 4  $\mu$ v), drift-free tuner with less than .5% distortion at all usable signal levels. Better than 30 db separation on stereo usage using the FMX-3, and automatic transition to stereo with the visual Stereocator. FM-1 kit \$79.95, wired \$119.95; FMX-3 kit \$29.95; FM-3A (Wired tuner with multiplex), \$169.95.



\***SCA-35**—Integrated stereo amplifier and pre-amplifier with low noise, low distortion, and moderate power output. 17.5 watts per channel continuous (45 watt total music power) with less than 1% distortion over the entire 20 cps to 20 kc range. Unique feedback circuitry throughout. Inputs for all hi fi sources including tape deck. SCA-35 kit \$89.95; wired \$129.95

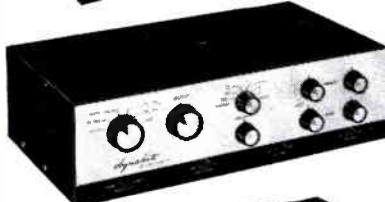

**PAS-2**—Fully flexible stereo preamplifier with less than .1% distortion at any frequency. Wide band, lowest noise with every necessary feature for superb reproduction. Acclaimed throughout the world as the finest unit available. PAS-2 kit \$59.95; wired \$99.95

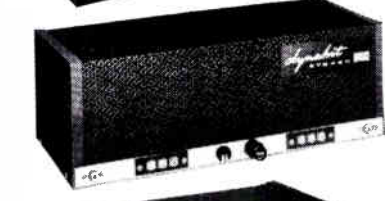

\***STEREO 35**—A basic power amplifier similar to that used in the SCA-35. Extremely low distortion over entire range at all power levels. Inaudible hum, superior transient response, and outstanding overload characteristic makes this unit outperform components of much higher nominal rating. Features new type Dynaco output transformer (patented design). Fits behind PAS-2 or FM-3A units. ST 35 kit \$59.95; wired \$79.95



**STEREO 70**—One of the most conservatively operated and rated units in the industry. The Stereo 70 delivers effortless 35 watts per channel continuous power. Its wide band Dyna circuit is unconditionally stable and handles transient wave forms with minimum distortion. Frequency response is extended below 10 cps and above 40 kc without loss of stability. This amplifier is admirably suited to the highest quality home listening requirements with all loudspeaker systems. ST 70 kit \$99.95; wired \$129.95

\* **NEW!** LOWER PRICED COMPONENTS WITH FULL DYNA QUALITY

Write for descriptive literature

DYNACO INC. • 3912 POWELTON AVE. • PHILA. 4, PA.  
Cable: DYNACO Philadelphia

and insight, and delineating the structure with the utmost lucidity, Erich Leinsdorf has achieved the best recorded performance of his career. It is interesting to note that he made his American debut conducting *Die Walküre* at the Metropolitan Opera in 1938. A quarter of a century later he returned to the same house to conduct the complete "Ring." This recording, made in London with at least three principals familiar to Met audiences (Birgit Nilsson, Jon Vickers, George London), obviously benefited greatly from his opportunity to restudy the score and to reacquaint himself with its complex design before committing it

indelibly to tape. Eloquence, imagination, and taste are at all times evident in his reading.

Of the singers with whom American audiences are unfamiliar, Gré Brouwenstijn makes the most favorable impression. Her Sieglinde is youthful and vocally radiant in both the Act I narrative and the love duet that follows. Later on, the ecstasy with which she receives the news that she is to bear the Volsung hero Siegfried is overpowering. Vickers, who joins her in the Act I duet, quickly establishes the fact that he is one of the finest Siegmunds of our day. By the time he has finished the "Spring Song" in Act I he

has drawn a compelling portrait of the great Wagnerian hero. But to the strength and splendor of primitive emotions he so magnificently conveys throughout he adds tenderness, for example in Act II, thus rounding out a supremely moving vocal characterization. David Ward, too, in the Act I scene he shares with Mr. Vickers, is fine as Hunding.

Mme. Nilsson and Mr. London are both in splendid voice, and both, though they fill the dramatic shoes of gods, reveal masterfully the all-too-human frailties Wagner intended they have. Their several scenes together are outstanding, ranging from the touching exchange that precedes Wotan's narration, through the savage encounters of Acts II and III, to the transfigured dialogue that brings the opera to a close. The only real weakness in the production is Rita Gorr: her Fricka is menacing and strong-willed, but the singing is plagued with vibrato. Her scene with Mr. London is nevertheless beautifully enhanced by the stereo engineering, which assigns each of the singers to a separate channel and an almost godlike isolation, as if they were addressing one another across the gap between two Olympian peaks.

Generally the recording makes limited use of stereo stage perspectives. Singers are introduced on one or another channel and rarely budge. When, in Act III, Wotan moves from left to right between the first and second scenes, and to the left again for the final scene, the effect is inappropriate. Otherwise, stereo renders striking service to the orchestra. The full impact of its size is immediately felt, and the intricacies of the score are projected with immaculate clarity. The sound is spacious, with the voices occupying a kind of aesthetic middle distance. The brasses, normally warm and full, tend to whiteness at the climaxes.

Tape has an advantage over discs in that each reel contains an act. The first and second acts break at appropriate moments, but the sequence break in Act III, not only in the middle of one of Wotan's stanzas but in mid-sentence as well, is inexcusable. A handsomely printed libretto is available free to buyers who return the post card enclosed with each set.

C. B.

#### 4-TR. ENTERTAINMENT

© ELLA FITZGERALD: *Ella Fitzgerald Sings the George and Ira Gershwin Song Book, Vol. 2*. Ella Fitzgerald (vocals); orchestra, Nelson Riddle cond. *Soon; I've Got a Crush on You; Bidin' My Time; Aren't You Kind of Glad We Did?*; and twenty-two others. VERVE VSTP 277 \$11.95.

Interest: Single-reel reissue  
Performance: Disarming  
Recording: Good  
Stereo Quality: Good



*Decorate your home with sound*

### BELL Stereo Systems

have long been recognized as among the finest available. Be sure to see and hear such outstanding components as the new T-347 tape deck that gives you sound-on-sound, off-the-tape monitoring and Duo-Sound. Ideal in combination with the 2445-SI Stereo Receiver for off-the-air stereo recording. Send for complete literature today!



### Bell Stereo Systems

Thompson Ramo Wooldridge Inc.

6325 Huntley Rd., Columbus 24, Ohio

Please send me complete information on the entire Bell Stereo Line



Name \_\_\_\_\_

Store Name \_\_\_\_\_

Address \_\_\_\_\_

City \_\_\_\_\_ Zone \_\_\_\_\_ State \_\_\_\_\_

The five reels it took initially to get Ella Fitzgerald's Gershwin song book onto tape now are compressed into a compact two. This twin-pack begins where the first (VSTP 244) ended, midway in reel three of the original set, and continues through reels four and five. As such it represents a remarkable bargain. The artist and the songs she sings are, of course, unrivaled.

C. B.

© **DIZZY GILLESPIE:** *An Electrifying Evening with Dizzy Gillespie.* Dizzy Gillespie (trumpet), Leo Wright (alto sax and flute), Lalo Shifrin (piano), Chuck Lampkin (drums), Bob Cunningham



RIVERSIDE RECORDS

ODETTA

*Close to the blues' stinging source*

(bass). *Kush; Salt Peanuts; Night in Tunisia; The Mooche.* VANGUARD VSTC 275 \$7.95.

Interest: Dizzy in concert  
Performance: Glinty  
Recording: Clean  
Stereo Quality: Pronounced

This is Dizzy Gillespie's fourth reel, and it is his best. Recorded at New York's Museum of Modern Art in February of 1961, the set has greater immediacy and freedom than any of the others. Except for the saucy bit of nonsense he calls *Salt Peanuts*, the program has a distinct Near Eastern flavor. *Kush* has a quietly pulsat-

ing, almost hypnotic Casbah beat, *Night in Tunisia* a lusty informality, and *The Mooche* a few exotic opening bars quickly giving way to hard bop, yet each possesses an individual style. The on-the-spot recording is very good.

C. B.

#### RECORDING OF SPECIAL MERIT

© **ODETTA:** *Sometimes I Feel Like Cryin'.* Odetta (vocals), Dick Wellstood (piano), Buster Bailey (clarinet), Vic Dickenson (trombone), Buck Clayton (trumpet), Panama Francis (drums), Tedell Saunders (harmonica), Leonard Gaskin and Abdul Ahmed Malik (bass). *I Just Can't Keep From Cryin'; Special Delivery; If I Had Wings; Darlin' Baby;* and eight others. RCA VICTOR FTP 1153 \$7.95.

Interest: Odetta and the blues  
Performance: Gutsy  
Recording: Fine  
Stereo Quality: Ditto

Here Odetta sings the blues, and her choice of songs embraces several in the Bessie Smith tradition—*Special Delivery, Poor Man, and Stranger Here*—as well as the current urban style exemplified by Pete Seeger's *Empty Pocket Blues*. But, coming closer than most fare-thee-well singers to the true source of the blues, she draws upon Ma Rainey and Blind Lemon Jefferson, as well as the Archive of American Folk Song at the Library of Congress. The bitter nostalgia of *House of the Rising Sun* has been no more poignantly expressed since Libby Holman. The recording is definitely top-quality.

C. B.

© **FRANK SINATRA:** *Nice 'n' Easy.* Frank Sinatra (vocals); orchestra, Nelson Riddle cond. *Nice 'n' Easy; That Old Feeling; How Deep Is the Ocean; I've Got a Crush on You;* and eight others. CAPITOL ZW 1417 \$7.98.

Interest: Sinatra retrospective  
Performance: Mellow  
Recording: Good  
Stereo Quality: Adequate

Aside from the title song, a new one credited, cryptically, to "Spence-Keith-Bergman" and comfortably tailored to Sinatra's what's-your-hurry style, this tape contains a selection of some of the slow swing numbers with which the singer has been identified over the years. And he sings them about as well as he ever has. The delivery is direct and for the most part unmannered, the mood is relaxed, and signs of strain are few. Sinatra's singing here is tinged by a kind of nostalgia, a wistful mellowness that just stops short of fatigue. Nelson Riddle's backing is tasteful and restrained. The recording, though it tends to be juke-boxy in the bass, is otherwise passable.

C. B.

portable  
perfection  
for  
hi-fi fans



From Denmark comes this aristocrat of portables. Superb AM-FM-Shortwave performance with all the features you've ever wanted in a portable: 12 transistor power with push-pull output and a 5" x 7" speaker, flywheel tuning, full range independent tone controls, pushbutton selection, loudspeaker-earphone output and separate tuner output, plus plug-in connection for an auto antenna for over-the-road hi-fi.

Complete information is available on request. Write for the name of your nearest dealer.



By appointment  
to the Royal Danish Court

**DYNACO**

DYNACO, INC.  
3912 Powelton Ave., Phila. 4, Pa.

CIRCLE NO. 56 ON READER SERVICE CARD



## CHRISTMAS MUSIC BOX FAVORITES DELIGHTFUL! CHARMING! SPECIAL LOW PRICE!

AN IRRESISTIBLE  
CHRISTMAS GIFT  
SPECIAL!

MONO or  
STEREO

**2.98**

SELECTIONS INCLUDE:

- SILENT NIGHT
- THE FIRST NOEL
- HARK THE HERALD ANGELS SING
- JINGLE BELLS
- ADESTE FIDELES and others

AFLP 1982 (mono), AFSD 5982 (stereo)

MANUFACTURER'S NATIONALLY ADVERTISED PRICE



The Sound of  
MAGNIFICENT MANDOLINS,  
Dick Dia & his Mandolin Orch.—

Big, rapturous, multiple mandolin sound performed and arranged by virtuoso, Dick Dia. Selections: Summertime in Venice, Never On Sunday, Pearl Fishers, etc.

AFLP 1962 (mono)  
AFSD 5962 (stereo)



Danceable and listenable tunes like: Playboy Theme, Skyway, Time Was, Sweet and Gentle, etc.  
DM 4303 / DS 4603 (Dauntless)



A different musical idiom interpreting: Moon River, Limbo Twist, Dacron, Wabeen Woman, Lazy Man, etc.  
DM 4302 / DS 4602 (Dauntless)

Latest and most popular

from ...

# Audio Fidelity

RECORDS



OSCAR CASTRO NEVES, one of the original architects of bossa nova, in his first American album plays: Desafinado, Once Again, One Note Samba, Little Brown Boy, etc.  
AFLP 1983 / AFSD 5963



Authentic bossa nova band recorded in Brazil playing the big hits in Rio: Desafinado, Apito No Samba, One Note Samba, Chega de Saudade, etc.  
DM 4802 / DS 6304 (Dauntless)



Oscar Brand makes his own deathless contribution to the "sing along" trend. Results are hilarious good "clean" fun. Includes: Ball Of Yarn, Clementine, etc.  
AFLP 1971/AFSD 5971



The Puleo group projects distinctively the many moods of these great movie scores, including: Col. Bogie, Never On Sunday, Moon River, Tonight, etc.  
AFLP 1969/AFSD 5969



Smooth, full orchestral tones. Special theatrical effects include: Vibra Harp, Banjo, Guitar, Glockenspiel, Snares. Selections: Hey Look Me Over, Moon River, Till There Was You, etc.  
AFLP 1968/AFSD 5968



Vividly refreshing accordion treatment. Selections invested with Basile's rhythmic and melodic invention are: If Ever I Would Leave You, Sound of Music, Bilbao Song, etc.  
AFLP 1972/AFSD 5972

AVAILABLE AT RECORD SHOPS EVERYWHERE

Audio Fidelity list: Mono (AFLP)—\$4.98; Stereo (AFSD)—\$5.95

Dauntless list: Mono (DM)—\$3.98; Stereo (DS)—\$4.98

Please write for FREE complete catalogs of Audio Fidelity records and tapes. AUDIO FIDELITY Inc. • 770 Eleventh Ave., New York 19, N.Y.

HiFi/Stereo

ENTERTAINMENT

POP HUMOR FILMS  
 Pops Theater FOLK

Reviewed by STANLEY GREEN • NAT HENTOFF • JOE GOLDBERG

Explanation of symbols:

- Ⓜ = monophonic recording
- Ⓢ = stereophonic recording
- \* = mono or stereo version not received for review

Ⓢ Ⓜ HARRY BELAFONTE: *The Many Moods Of Harry Belafonte*. Harry Belafonte (vocals), instrumental combo, Bill Eaton cond. *Betty An' Du-gee; Zombie Jamboree; Try To Remember; Dark As A Dungeon*; and seven others. RCA VICTOR LSP 2574 \$4.98, LPM 2574\* \$3.98.

Interest: Expert entertaining  
 Performance: Carefully paced  
 Recording: Excellent  
 Stereo Quality: Very good

Once folk circles understand that Harry Belafonte is a pop entertainer who adapts folk songs to his own style, much of the controversy about him will dissipate. Belafonte may think of himself as a folk singer, but his performances are much too finely blueprinted to allow even the appearance of spontaneous self-revelation that is the *sine qua non* of true folk style.

In terms of popular vocalizing, however, Belafonte is a remarkable craftsman, and his material is chosen with imagination and taste. In this set, for example, there are new, quasi-folk pieces (*Long About Now* and *I'm on My Way to Saturday*) as well as rarely sung but caressing show tunes (*Summertime Love* from *Greenwillow* and *Try to Remember* from *The Fantasticks*). Belafonte's engaging if rather brittle calypso beat is heard in *Tongue Tie Baby* and *Zombie Jamboree*. He is beyond his depth only in songs that demand raw and fearful emotions, such as *Who's Gonna Be Your Man* and *Dark as a Dungeon*. Here the line between the pop performer and the folk singer, authentic or self-made, is most clearly revealed. When Belafonte attempts to plunge deeper than a supper-club entertainer is normally expected to go, he reveals his limitations. N. H.

Ⓢ Ⓜ TONY BENNETT: *At Carnegie Hall*. Tony Bennett (vocals); orchestra, Ralph Sharon cond. *Firefly; Just In Time; Love Is Here to Stay*; and twenty-

five others. COLUMBIA C2S two 12-inch discs \$9.96, C2L 23\* \$7.96.

Interest: Considerable  
 Performance: Surprisingly good  
 Recording: Satisfactory  
 Stereo Quality: Atmospheric

Ⓢ Ⓜ TONY BENNETT: *Tony's Greatest Hits*. Tony Bennett (vocals); orchestras. *Stranger In Paradise; Rags to Riches; Just In Time*; and nine others. COLUMBIA CS 8652 \$4.98, CL 1229\* \$3.98.

Interest: For the fans  
 Performance: Average  
 Recording: Satisfactory  
 Stereo Quality: Not noticeable

Granted that Tony Bennett's vocal equipment may be slight, he is a remarkably effective song stylist when he is before



TONY BENNETT  
*Easygoing charm in Carnegie Hall*

an audience. The raw edginess of his voice and his tendency to strain for a note just beyond his grasp seem to give way to a more relaxed, even mellow quality when he is performing on stage. As a result, his Carnegie Hall program has a welcome feeling of intimacy and well-controlled exuberance.

Twenty-eight songs were sung in this performance, including many that have long been identified with the singer. By

far the biggest ovation is after *I Left My Heart In San Francisco*, a piece whose appeal has so far eluded me. But by the time the recital is half finished, every song is greeted by applause after the first recognizable bars.

Among the highlights are *Climb Ev'ry Mountain*, which is begun almost as a lullaby; the delicately worded *It Amazes Me*; a surprisingly up-tempo *One for My Baby*; and a *Lost In the Stars* that begins beautifully but unfortunately ends in pretty ragged condition. Ralph Sharon provides sympathetic backing throughout.

"Tony's Greatest Hits," originally released in 1958, has been stereophonically rechanneled, though to what advantage I cannot testify. It still sounds to me like only a good monophonic recording. Five of the selections here are also among Mr. Bennett's Carnegie Hall choices. S. G.

Ⓢ Ⓜ BROOK BENTON. *Lie To Me*. Brook Benton, Merry Melody Singers (vocals); orchestra. *Lie To Me; Chains Of Love; Valley of Tears; Send For Me; Looking Back*; and seven others. MERCURY SR 60740 \$4.98\*, MG 20740 \$3.98.

Interest: Benton's blues  
 Performance: Top pro  
 Recording: Good

On the front cover, this album is titled "Lie To Me." On the back cover and spine, it is called "Singing The Blues," and on the record itself, "Lonely and Blue." Whatever the title, it is another masochistic sop to the teenage market, milking the theme of the unhappiness of "first and only" love.

Benton is one of the best current pop singers. He has a sly, smooth, ingratiating voice that operates with equal facility over an amazingly wide range. He allows this facility to dictate his style, and tempers it with a touch of gospel. The set was recorded in Nashville, and is replete with the contributions to popular music that have been made by the studio musicians of that town. All the songs are blues or near-blues, the most durable being Lonnie Johnson's *Tomorrow Night*. One track, *True Confession*, is so hilarious as to qualify for a satirical cabaret act, but it was very probably intended seriously. J. G.

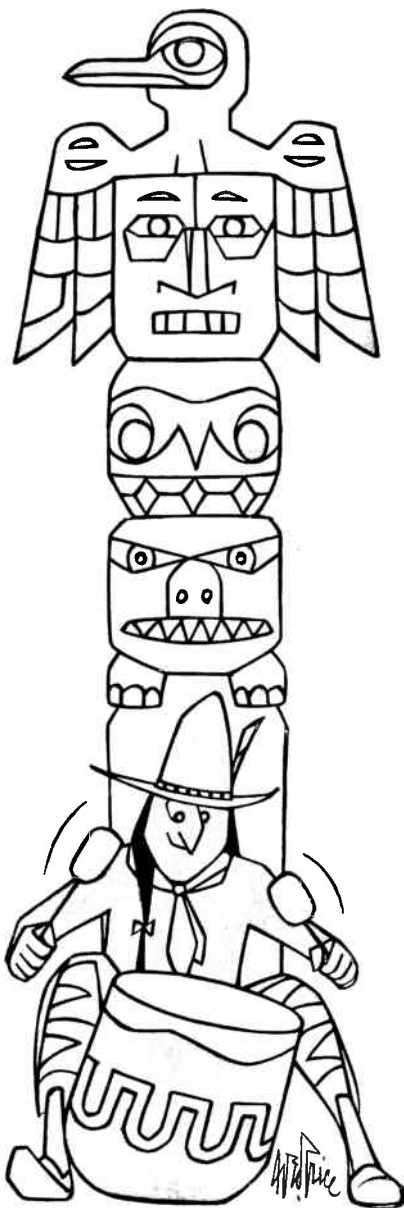

## True bass notes:

General Electric's VR-1000 stereo cartridge reproduces those deep bass throbs *factually*, with no irritating growl • Same applies at the other end. General Electric doesn't roll off the highs on you, say above 15,000 cycles. The VR-1000 delivers *all* the high harmonics that make the difference between music and noise. • Separation? Scalpel clean. Left is left, right is right, and never the twain shall "cross-talk." This is the VR-1000. Audition it where you buy your records and/or components.



AUDIO PRODUCTS DEPARTMENT, DECATUR, ILL.

*Progress Is Our Most Important Product*

**GENERAL ELECTRIC**

CIRCLE NO. 32 ON READER SERVICE CARD  
106

### RECORDING OF SPECIAL MERIT

Ⓢ Ⓜ JACQUELINE BOYER: *Chanteuse*. Jacqueline Boyer (vocals); orchestra, Franck Pourcel cond. *Le Guinick*; *Jenny, O Jenny*; *Magdalena*; and nine others. CAPITOL ST 10313 \$4.98, T 10313\* \$3.98.

Interest: Winning program  
Performance: A charmer  
Recording: Slightly close  
Stereo Quality: Satisfactory

Jacqueline Boyer has a youthful, clear, bright, accurate, well-placed, intimate, and thoroughly professional voice, and, as you might guess, I am completely smitten. She is the most exciting young singer that France has produced in a long time, and is unquestionably well on her way to the international acclaim that was once showered on her mother, Lucienne Boyer. Her repertoire consists of such irresistible pieces as *Pepe*; *Moi, j'aime la vie*; and *Pianissimo*; but perhaps the most distinctive number on the disc is the exotic, throbbing *Magdalena*, which she emotes with almost as much dramatic intensity as Édith Piaf. There are no translations on the jacket. S. G.

Ⓢ Ⓜ HERMAN CHITTISON: *That's All!* Herman Chittison (piano). *That's All*; *Smoke Gets In Your Eyes*; *Tangerine*; and seven others. L'ELEGANT LES 1000 \$4.98, LE 1000\* \$3.98.

Interest: Attractive program  
Performance: Fine stylist  
Recording: Lively sound  
Stereo Quality: Inconsequential

Herman Chittison has a boldly masculine way of attacking a melody that conveys a sense of purposefulness, and his flights of fancy never take him too far beyond bounds. *Little Girl Blue*, for example, may occasionally get lost, but the basic structure of Chittison's musical design always gives his work a solid foundation. I wish he had been a bit less assertive on *The Touch of Your Lips*, which might have benefited from the kind of warm approach he gives to *Smoke Gets In Your Eyes*. S. G.

Ⓢ Ⓜ JUNE CHRISTY: *The Best of June Christy*. June Christy (vocals); various accompanying groups. *Midnight Sun*; *Bewitched*; *Nobody's Heart*; *Willow Weep For Me*; and seven others. CAPITOL ST 1693 \$4.98, T 1693\* \$3.98.

Interest: Christy's hits  
Performance: Variable  
Recording: Excellent  
Stereo Quality: Excellent

Another in Capitol's series of hit singles compilations, this one is devoted to June

Christy. Like another ex-Kenton vocalist, Chris Connor, her style stems from that of Anita O'Day—all singers who have spent some time with the Kenton band tend to sound somewhat alike.

Miss Christy is so excessively mannered that it is often difficult to understand her. Her performance of the lovely *Nobody's Heart* is unbearably stolid, and a singer whose stock in trade is disillusioned sophistication should not have chosen a naive Doris Day-type song like *Sing Something Simple*. She is much better on *Something Cool*, one of those little tales of understated desperation that pass for art in the East Side supper clubs, and are the negative aspect of Mabel Mercer's legacy.

Four tracks are remakes of songs Miss Christy recorded with Kenton, and only *Willow Weep For Me* surpasses the original. Two tracks are electronically reprocessed stereo. Side by side with Capitol's mastery of the real thing, they are pitifully inadequate. J. G.

Ⓢ Ⓜ PERRY COMO: *By Request*. Perry Como (vocals); Ray Charles Singers; orchestra, Mitchell Ayres cond. *Maria*; *Moonglow*; *Moon River*; and nine others. RCA VICTOR LSP 2567 \$4.98, LPM 2567\* \$3.98.

Interest: Standard ballads  
Performance: Casual approach  
Recording: Splendid  
Stereo Quality: Satisfactory

Although his approach is, if possible, more offhand than ever, Perry Como manages to combine diffidence with sincerity. He may slur over the words and bend melodies a bit to suit his limited voice, but he does convey the feeling that he believes what he is singing. The warmth of the approach is well captured in the arrangements, particularly in *More than Likely* and *What's New?*, in which, for a time, Tony Mottola's guitar furnishes the only accompaniment to the singer. S. G.

Ⓢ Ⓜ SERGIO FRANCHI: *Romantic Italian Songs*. Sergio Franchi (vocals); orchestra and chorus, Wally Stott cond. *O sole mio*; *Mattinata*; *A vucchella*; and nine others. RCA VICTOR LSC 2640 \$5.98, LM 2640 \$4.98.

Interest: Pleasant repertoire  
Performance: Impressive  
Recording: Fine  
Stereo Quality: Good enough

Heralded by a continual barrage of promotional fanfare, Sergio Franchi here lays claim to the American audience that had once drooled over Mario Lanza. Mr. Franchi's voice is a remarkable tenor of great range and power, and it gives the  
(Continued on page 108)



# Scott Stereo Tuner Kit Wins Rave Reviews from every Leading Hi-Fi Expert!

Just one year ago Scott introduced the LT-110 FM Stereo Tuner Kit. High Fidelity Dealers built this superb kit themselves, examined its many features, and recommended it without reservation. Enthusiastic kit builders deluged us with mail. Now the verdict is in from all the leading technical experts. Never before in the history of the industry has a single kit received such unanimous praise. We reprint a few excerpts below.

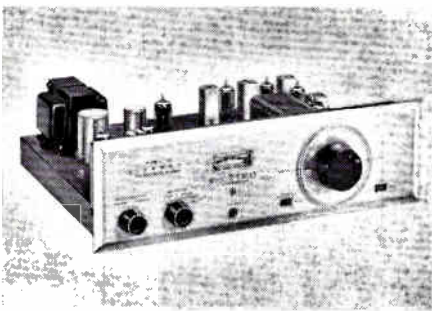

## from POPULAR ELECTRONICS

"No commentary on *Scott Kits* would be complete without first mentioning that this company pioneered new areas in the hi-fi kit market and brought forth several (then-radical) innovations. One of them continues to fascinate all purchasers of a *Scott Kit* — the full-color instruction manual. . . . Scott also pioneered the Kit-Pak — a shipping container which serves as a temporary workbench and storage box . . . a test model of the LT-110 was wired at POPULAR ELECTRONICS in just under five hours. Another 40 minutes was used for careful alignment and the tuner was "on the air." . . . The LT-110 met or exceeded all the manufacturer's detailed specifications on sensitivity, distortion, output level, a.c. hum, and capture ratio . . . the audio response is excellent, being within  $\pm 1$  db, from approximately 20 to 16,000 cycles. . . . Channel-to-channel crosstalk is particularly excellent both in terms of uniformity and the fact that it holds up well above 10,000 cycles. . . . Frequency drift of the LT-110 from a cold start is extraordinarily low — less than 5 kc. The a.c. hum level (referred to 100% modulation) is low and exceeds the manufacturer's rating by 5 db. . . . It's difficult to imagine a kit much simpler to assemble than the LT-110. The full-color instruction book eliminates just about the last possible chance of wiring errors. . . . From a plain and simple operational standpoint, the LT-110 *works well and sounds good.*"

Popular Electronics, Oct. 1962

## from ELECTRONICS WORLD

"Construction time for the unit we tested was 6½ hours, without alignment . . . in listening tests, the tuner showed its high useable sensitivity to good advantage. Using an in-door antenna which produced marginal signal to noise ratios on most other tuners we were able to get noise-free, undistorted stereo reception. It's quite non-critical to tune, hardly requiring the use of its tuning meter."

Electronics World, Nov. 1962

## from AUDIO

"The LT-110 (is) so simple to build that we unhesitatingly recommend it for even the novice. . . . We found that the useable sensitivity (IHFM) was  $2.1\mu\text{V}$  . . . a fine stereo tuner and an unusually easy kit to build."

Audio, April 1962



## from RECORD GUIDE

"It seems to me that every time I turn around I am building another of H. H. Scott's kits. And each time I end up praising the unit to the skies.

The Scott instruction books should be a model for the industry. They feature full-color, step-by-step, illustrated directions. Each resistor or other component is shown in the progressive phases in its color code and in its proper position. . . .

There is no audible drift in the LT-110 whatever. You can shut the tuner off on a station and pick it up the next day, perfectly tuned,

without touching the tuning dial. No AFC circuits are included in this tuner and none are needed.

This tuner kit has to be ranked on the same plane as H. H. Scott's factory-wired units. It is an excellent product, and because of its conservative parts very likely to give long, trouble-free service."

American Record Guide, Sept. 1962

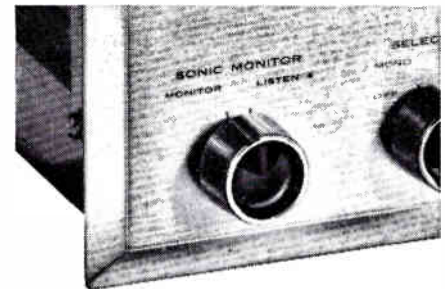

## Now Sonic Monitor\* Added

Scott's unique Sonic Monitor has now been added to the LT-110. This foolproof stereo signaling device tells you audibly when you are tuned to a stereo station. If you want the best in kits, visit your Scott dealer. Choose from:

- LT-110 FM Stereo Tuner Kit . . . \$159.95
- LK-48 48-Watt Stereo Amplifier Kit . . . \$124.95
- LK-72 80-Watt Stereo Amplifier Kit . . . \$159.95
- LC-21 Stereo Control Center Kit . . . \$99.95
- LK-150 130-Watt Stereo Power Amplifier Kit . . . \$169.95

\*Patent Pending. (All prices slightly higher West of Rockies.)



H. H. Scott, Inc., 111 Powdermill Rd., Maynard, Mass. 01454

Rush me complete details on your LT-110 FM Stereo Tuner Kit and other superb Scottkits. Be sure to include your new, free Stereo Record, "The Sounds of FM Stereo" showing how new FM stereo sounds, and explaining important technical specifications.

Name \_\_\_\_\_

Address \_\_\_\_\_

City \_\_\_\_\_ State \_\_\_\_\_

Export: Morhan Exporting Corp., 458 Broadway, N.Y.C.  
Canada: Atlas Radio Corp., 50 Wingold Ave., Toronto

# Build Your Record Library!

...INEXPENSIVELY, CONVENIENTLY,  
QUICKLY

## NO "AGREE TO PURCHASE" OBLIGATION and CHOOSE THE RECORDS YOU WANT

Our special membership plan enables you to buy your records at cost price ... Classical, popular, jazz, show hits, folk, etc. — Monaural and Stereo.

Citadel is a unique kind of record club that features:

- No "agree to purchase" obligations. Buy as few or as many records as you want, when you want them ... the choice is yours.
- No "preselected" record list. You choose the records you want from catalog containing virtually all artists and all labels.
- No "list price" purchases. You never pay more than the club price.
- Periodic specials. Outstanding buys are made available periodically, and again, you are under no obligation to purchase any of these specials.
- Prompt service. Many orders are shipped the day received ... rarely later than the next several days.

We invite you to join thousands of other Citadel members who are purchasing their records at cost price, are enjoying complete freedom of selection and have not obligated themselves in any way. For complete details write...

### CITADEL RECORD CLUB

545 Fifth Ave. Dept. S New York 17, N. Y.

CIRCLE NO. 19 ON READER SERVICE CARD

## CUT A SPEAKER SYSTEM IN TWO?

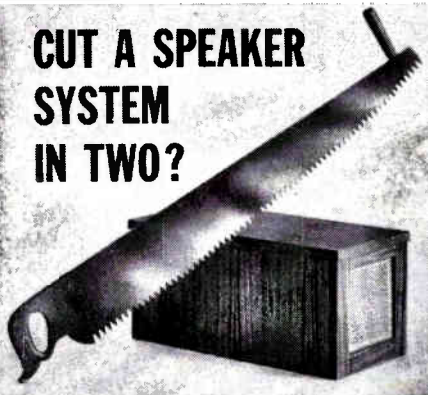

NOT ANYMORE! Now experience true stereo and separation without the usual struggle of shifting dual enclosures to obtain a stereo effect.

American Sintronics has critical speaker placement built right into the heart of its single enclosure **STEREO MULTIPLIER SPEAKER SYSTEMS**. The design of its new Trisonic speakers and built-in speaker placement virtually multiplies the stereo effect as well as the tonal qualities of your most demanding recording. There isn't any rule to follow (save those you have for taste and decor) to achieve optimum stereo effect... just plunk the single enclosure down anywhere in the room and—Voilà!—true stereo without the slightest adjustment of the speaker enclosure. Hard to believe? Convince yourself, hear this fantastic speaker system at your dealer today. Prices start at \$159.95 for Model 220, shown above, in Walnut or Blond Mahogany.

**AMERICAN SINTRONICS**

55 East Merrick Road, Freeport, L. I., N. Y.

CIRCLE NO. 7 ON READER SERVICE CARD

impression of simply bursting out of the man. Occasionally, as in *Mattinata*, Mr. Franchi's high notes may seem a bit unsure, but this is amply compensated by his strong musical and dramatic projection. No translations are on the jacket.

S. G.

© MAHALIA JACKSON: *Great Songs of Love and Faith*. Mahalia Jackson (vocals); orchestra and chorus, Johnny Williams cond. *My Task; My Friend; The Rosary*; and nine others. COLUMBIA CS 8624 \$4.98, CL 1824\* \$3.98.

Interest: Unaccustomed material  
Performance: Not always at ease  
Recording: Very good  
Stereo Quality: Passable

There is no question that Mahalia Jackson's intense and totally involved approach to gospel music has made her the outstanding singer in that specialized field. This set finds her in far less comfortable surroundings. Ranging through *Because, Danny Boy, and A Perfect Day*, it offers songs of a somewhat lesser emotional level that are not well served by such tear-stained interpretations. Moreover, her vocal power cannot always compensate for the oddness of pronunciation and inflection that, for example, renders two lines in *Trees* as: "Oy think that I shall never see-hee or porm as lovely as a tree."

S. G.

© LALO SCHIFRIN: *Bossa Nova*. Lalo Schifrin Group. *Samba de Uma Nota So; Menina Feia; Ouca*; and nine others. AUDIO FIDELITY AFSD 5981 \$5.98, AFLP 1981 \$4.98.

Interest: Brazilian jazz  
Performance: Expert  
Recording: Great  
Stereo Quality: Excellent

The new Brazilian rhythm wrinkle, the bossa nova, turns out to be a lively jazz variation on the samba. It is quite infectious, allowing a prolonged melodic line by either a flute or saxophone—both played here by Leo Wright—to be easily adapted to a variety of tempos. Mr. Schifrin, an Argentinian, plays a strong, propulsive piano and leads a rhythm section, including a Brazilian tambourine and a beaded gourd.

S. G.

### RECORDING OF SPECIAL MERIT

© FRANK SINATRA: *The Great Years*. Frank Sinatra (vocals), orchestras, Axel Stordahl, Nelson Riddle, Gordon Jenkins, and Billy May cond. *Lean Baby; All of Me; Love and Marriage; Come Fly with Me; High Hopes; Nice 'N' Easy*; and thirty others. CAPITOL SWCO 1762 three 12-inch discs \$17.98, CAPITOL WCO 1762\* \$14.98.

# YOU SAVE MONEY!

RUSH US YOUR LIST OF HI-FI COMPONENTS FOR A SPECIAL QUOTATION

WRITE FOR FREE AUDIO DISCOUNT CATALOG A-15

New low prices on amplifiers, tuners, tape recorders, speakers, etc.

# KEY

ELECTRONICS CO.  
120 LIBERTY ST.  
NEW YORK 6, N.Y.

CIRCLE NO. 37 ON READER SERVICE CARD

## Send HiFi/Stereo Review Every Month

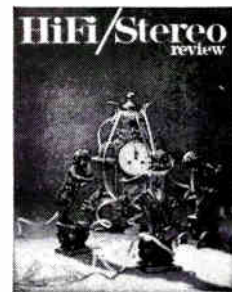

Check one:  3 years for \$12  
 2 years for \$9  1 year for \$5  
IN THE U. S. and POSSESSIONS  
 Payment Enclosed  Bill Me

Foreign rates: Canada and Pan American Union countries, add \$0.50 per year; all other foreign countries, add \$1.00 per year.

name \_\_\_\_\_  
address \_\_\_\_\_  
city \_\_\_\_\_ zone \_\_\_\_\_  
state \_\_\_\_\_

Mail to:

**HIFI/STEREO REVIEW**

6501

436 S. Wabash Ave. Chicago 5, Ill.

HIFI/STEREO REVIEW

Interest: Sinatra in retrospect  
 Performance: Nonpareil  
 Recording: Generally good  
 Stereo Quality: Passable

Since Frank Sinatra left to record on his own label, Capitol has been rereleasing his recordings in several ways. These discs cull representative selections from 1953 to 1960. As the liner notes point out, Sinatra was at the nadir of his career when he joined Capitol, and by the time he left he had become a show business suzerain.

Sinatra's recordings in those decisive years had much to do with his renaissance, although his acting and his shrewd investments were also vital factors. Musically, the Sinatra of the Fifties was a more mature and compelling singer than the limited crooner of the Forties. Not all the selections in this expensive package are the very best of the lot, but there is an extraordinary consistency throughout. A sizable number of these performances should be remembered for decades—I *Can't Get Started* and *When Your Lover Has Gone*, for example.

Among the reasons for Sinatra's pre-eminence is his supple and thoughtful phrasing, which often makes lyrics more meaningful than even the composer envisioned. His way with lyrics owes much to a superb sense of timing: not only does he swing, but he is expert at delaying and otherwise elasticizing the beat. Finally, there is Sinatra's irreverent but oddly boyish wit. He sees himself as a sophisticate, but when he alters and plays with the lyrics, he is at heart a hip adolescent doing brash parodies for admiring contemporaries. Nonetheless, his humor is infectious, and he is capable of switching from showboating to exceptionally subtle and sensitive lyricism.

The arrangements—especially Nelson Riddle's, who scored twenty-seven of these tracks—are specifically and accurately shaped to Sinatra's skills. The quality of sound is first-rate, but I question the value of so-called duophonic recordings. Twenty of the songs are duophonic remasterings of monophonic originals to produce two-channel sound. For this listener, the effect is equivalent to that of a double image in photography.

The final section of the liner notes argues that Sinatra is close to the end of his career as a singer. Capitol's strong implication is that, as a result, we have in this package the best of Sinatra's great years. Several of his post-Capitol Reprise albums do not lend support to this thesis. The recent "Sinatra and Swingin' Brass," for example, is as good as much of his singing in this anthology. But for fans who did not collect these interpretations when they were first issued, these three LP's are a superior cross-section of Sinatra in his prime. N. H.

(Continued on page 110)

Puccini's three one-act operas

# IL TRITTIKO

- IL TABARRO
- SUOR ANGELICA
- GIANNI SCHICCHI

Renata Tebaldi; Giulietta Simionato;  
 Mario Del Monaco; Robert Merrill;  
 Fernando Corena; Chorus and  
 Orchestra of The Maggio Musicale  
 Fiorentino — Lamberto Gardelli

Stereo OSA-1364 (3 records) Mono A-4364

(Each opera also available separately)

Tebaldi sings the 3 soprano roles

**LONDON**  
 RECORDS



CIRCLE NO. 60 ON READER SERVICE CARD

**New!**

RECORDS  
 SOUND-ON-SOUND

## LAFAYETTE PROFESSIONAL QUALITY 4-TRACK STEREO TAPE RECORDER



A complete recording studio in one case

Here is professional quality at Lafayette's low price. Compare this dependable portable tape machine with others and you will agree, the RK-155 is tops.

- Playback 4 and 2-track stereo; 4-track monaural • Record 4-track stereo and monaural • Dual level meters • Built-in amplifiers and 2 full-tone stereo speakers for hi-fi sound
- Response: 40-18,000 cps at 7½ ips • 2 Speeds: 3¾ ips & 7½ ips • Plays reels up to 7 inches • Complete with 2 dynamic mikes, output cable, tape reel and 1200 ft. of tape.

RK-155WX With Carrying Case ..... Net 169.95

**169.95**  
 NO MONEY DOWN

LAFAYETTE Radio ELECTRONICS  
 Dept. HMA-3 P.O. Box 10,  
 Syosset, L.I., N.Y.

Rush me FREE 388  
 Giant Sized Pages  
 1963 Catalog.

**FREE!**

RK-155WX \$..... enclosed

LAFAYETTE Radio ELECTRONICS  
 Syosset, L.I., N.Y.

OTHER LOCATIONS

Jamaica 33, N.Y. Scarsdale, N.Y.  
 New York 13, N.Y. Paramus, N.J.  
 Plainfield, N.J. Newark 2, N.J.  
 Bronx 58, N.Y. Boston 10, Mass.  
 Natick, Mass.

NAME .....

ADDRESS .....

CITY ..... ZONE ..... STATE .....

CIRCLE NO. 39 ON READER SERVICE CARD

**ROCK** GET OUR QUOTE  
**BOTTOM**  
 STEREO • HIGH FIDELITY  
**PRICES**

PLUS THESE RABSONS EXTRAS

- Established 1905 - 58 Years of Reliability
- Franchised Protection - Plus
- Rabsons Special Six Month Guarantee
- Easy Payment Plan - Up to 24 Months to Pay
- Each Component Double Packed to insure Safe Arrival - At no extra charge
- Rabsons Sells ONLY Factory Fresh Merchandise in Original Factory Sealed Cartons

SO WRITE RABSONS  
 Whatever your HI-FI requirements and receive

**FREE** A \$1.00 genuine Miracle Record Cleaning Cloth with EVERY Quotation from Rabsons on a component or system of your choice

**RABSONS -57 ST. INC.**  
 119 West 57th St., New York 19, N.Y.  
 Diagonally opposite Carnegie Hall

**CIRCLE NO. 43 ON READER SERVICE CARD**

STATEMENT REQUIRED BY THE ACT OF AUGUST 24, 1912, AS AMENDED BY THE ACTS OF MARCH 3, 1933, JULY 2, 1946 AND JUNE 11, 1960 (74 STAT. 208) SHOWING THE OWNERSHIP, MANAGEMENT, AND CIRCULATION OF HIFI/STEREO REVIEW, published Monthly at Chicago, Illinois for October 1, 1962.

1. The names and addresses of the publisher, editor, managing editor, and business managers are: Publisher, Ziff-Davis Publishing Company, 434 S. Wabash Ave., Chicago 5, Ill.; Editor, Furman Hebb, 1 Park Avenue, New York 16, N.Y.; Managing editor, Robert Campbell, 1 Park Avenue, New York 16, N.Y.; Business manager, M. T. Birmingham, Jr., 1 Park Avenue, New York 16, N.Y.

2. The owner is: (If owned by a corporation, its name and address must be stated and also immediately thereunder the names and addresses of stockholders owning or holding 1 percent or more of total amount of stock. If not owned by a corporation, the names and addresses of the individual owners must be given. If owned by a partnership or other unincorporated firm, its name and address, as well as that of each individual member, must be given.) Ziff-Davis Publishing Company, 434 S. Wabash Ave., Chicago 5, Ill.; Estate of William B. Ziff, 1 Park Avenue, New York 16, N.Y.; A. M. Ziff, 1 Park Avenue, New York 16, N.Y.

3. The known bondholders, mortgagees, and other security holders owning or holding 1 percent or more of total amount of bonds, mortgages, or other securities are: (If there are none, so state.) None.

4. Paragraphs 2 and 3 include, in cases where the stockholder or security holder appears upon the books of the company as trustee or in any other fiduciary relation, the name of the person or corporation for whom such trustee is acting; also the statements in the two paragraphs show the affiant's full knowledge and belief as to the circumstances and conditions under which stockholders and security holders who do not appear upon the books of the company as trustees, hold stock and securities in a capacity other than that of a bona fide owner.

5. The average number of copies of each issue of this publication sold or distributed, through the mails or otherwise, to paid subscribers during the 12 months preceding the date shown above was: (This information is required by the act of June 11, 1960 to be included in all statements regardless of frequency of issue.) 156,922.

Matthew T. Birmingham, Jr., Business Manager.  
 Sworn to and subscribed before me this 19th day of September, 1962.

[SEAL] MICHAEL A. LALLI, Notary Public.  
 My commission expires March 30, 1964

**FOLK**

**RECORDING OF SPECIAL MERIT**

© CYNTHIA GOODING: *A Treasury of Spanish & Mexican Folk Song*. Cynthia Gooding (vocals), El Niño Peregrino or Sandalio Jibaro (guitar). *El Carcelero*, *El Toro Jubilo*; *Sandunga*; *Cascabel*; and thirty-three others. ELEKTRA EKL 218 two 12-inch discs \$4.98.

Interest: Valuable  
 Performance: Conscientious  
 Recording: Very good

Cynthia Gooding, midwestern by birth, has trained herself in several folk disciplines. She is at her most persuasive, however, in Spanish and Mexican material, as this bountiful, bargain-price anthology makes clear. Miss Gooding has also written the detailed notes and rendered the complete translations in the accompanying booklet. But this treasury is not intended to be a definitive survey of types or a history of Spanish and Mexican folk song. Its purpose is Miss Gooding's wish to share her pleasure in the shapes, colors, and unbridled emotions of this music. In this the album succeeds admirably.

Miss Gooding's choice of songs is broadly diversified. The cross-section includes Spanish romances, Mexican corridos, war and work songs, lullabies, love plaints, children's tunes, and religious invocations. The predominant mood is dark, proud in its human vulnerability, and, for all its lyric tension, graceful.

For someone who was not raised in these traditions, Miss Gooding has absorbed this subtle musical language remarkably well. Her voice, moreover, is strong, deep, and pliable. Two superior guitarists alternate on her accompaniment, and occasionally she sings a capella with impressive control. The range of emotions she has to illuminate is wide, but she is equally absorbing whether singing fragile lullabies, desperate or sardonic love songs, or brooding tales of death.

N. H.

© OLATUNJI: *Flaming Drums!* Olatunji (percussion), Hosea Taylor (alto saxophone, oboe, flute), Clark Terry (trumpet), Al Sackman (guitar), Calvin Riddle and George Duvivier (bass), drummers and singers. *Abana*; *African Spiritual*; *Uhuru*; *Mystery of Love*; *Adofo*; *Hail The King*. COLUMBIA CS 8666 \$4.98, CL 1866\* \$3.98.

Interest: A fusion of cultures  
 Performance: Resourceful  
 Recording: Very good  
 Stereo Quality: Tops

The initial American recordings by Nigerian drummer Olatunji tended to focus

more on tumultuous evocations of exotica than on thoughtfully developed musical structures. In this new collection, most of the variegated numbers are more substantial musical experiences than have been associated with Olatunji up to now. All the pieces are African at bottom, but there are eclectic admixtures of European practices—the use of the oboe, for example—and jazz colors.

The rhythmic cores of the performances, as in previous albums, are the steaming polyrhythms of Olatunji and his percussion aides. But here the bold melodies in the foreground are more fully developed, especially in the sensuous, sinewy *Mystery of Love* and the alternately joyful and reflective *Uhuru (Freedom)*. The other tracks are slighter, but nonetheless ingratiating, except for the singers' occasional tendency to sound self-conscious. Columbia has provided unusually competent liner notes by Dr. Akinsola Akiwowo, Professor of Social Anthropology at Adelphi College. N. H.

© SABICAS: *Concierto En Flamenco*. Sabicas (guitar), Orquesta de Conciertos de Madrid, F. Moreno Torroba cond. *Concierto en Flamenco, for Guitar and Orchestra*; *Salera Gaditano*; *El Albaicin*; *Camino de Linares*; *Con un Clavel*. DECCA DL 710057 \$5.98, DL 10057 \$4.98.

Interest: Inflated flamenco  
 Performance: Sabicas survives  
 Recording: Superb  
 Stereo Quality: First-rate

More than half this album is concerned with an attempt to place an improvising flamenco guitarist within the framework of the classical concerto for solo instrument and symphony orchestra. Spanish composer Federico Moreno Torroba has based each of the four movements on a traditional flamenco form—*Fandangos*, *Siguiriyas*, *Algerias*, *Soledá por Bulerías*.

The orchestral writing is romantic and continually agreeable though not distinguished. There is no obvious awkwardness in the juxtaposition of the folk guitarist and the concert ensemble. But the orchestra merely sounds gratuitous, since it only adumbrates the fiercely personal emotions that are at the base of full-strength flamenco. What gives the performance its character is the indomitable individuality of Sabicas, who improvises his part throughout.

Much more stimulating are the four solos by Sabicas that conclude the album. By himself, he is flamenco, and there is more substance in his blazing, complex variations on these four dances than in all of the Torroba concerto. The quality of sound in both the stereophonic and monophonic versions cannot be faulted.

N. H.

(Continued on page 112)

# HiFi / STEREO MARKET PLACE

## AUDIO unlimited

Specializes in

### SAVING YOU MONEY

- ✓ FACTORY FRESH COMPONENTS
- ✓ LOWEST POSSIBLE QUOTATIONS
- ✓ FAST DELIVERY

We are FRANCHISED for most Hi-Fi lines. Orders SHIPPED PROMPTLY from our large stock. RECORDING TAPE AT LOWEST PRICES. FREE STEREO CATALOG.

715-S Second Ave., (Nr. 38 St.) New York 16, N.Y. **Visit Our Showroom**



## SAVE

... WHEN YOU BUY FROM HI-FIDELITY SUPPLY

Write for quotation on any components. All factory new and shipped immediately.

### HI-FIDELITY SUPPLY

2817-K THIRD AVE., NEW YORK 55, N. Y.



## PROFESSIONAL GRADE 7" REEL RECORDING TAPE

SPLICE FREE (except 2400')

Cellophane Sealed Boxes

ASSORT ANY WAY		3-11	12-23	24 & OVER
Please add 15¢ per Reel for Postage.	1200' ACETATE	\$1.09	\$1.05	\$ .98
Add 10¢ on 24 and up.	1800' ACETATE	1.73	1.57	1.37
	1800' MYLAR	1.89	1.85	1.79
	2400' MYLAR	2.58	2.49	2.37

GET OUR LOW QUOTES ON ALL YOUR HI-FI NEEDS

57th ST. RECORD SHOP, Inc.

119 West 57th St., New York 19, N. Y.

## DON'T BUY HI-FI..

components or tape recorders until you get our low, low return mail quotation. "Easy-Pay-Plan" 15 day free home trial \*Trades accepted \*We guarantee not to be Undersold. Best Buy Hi-Fi List and Stereo Tape Catalog Free.

### ELECTRONIC WORLD HI-FI RECORDING TAPE

guaranteed 1st quality

35M	3 1/4"	600'	Mylar	3-23	24--
12A	7"	1200'	Acetate	1.09	.99
12M	7"	1200'	Mylar	1.19	1.09
18M	7"	1800'	Mylar	1.89	1.79
24M	7"	2400'	Mylar	2.59	2.39
24MT	7"	2400'	Ten.	2.89	2.79

Any Asst. permitted for 24+ price. Add 15¢ per reel postage & handling—10¢ 24+ Continental U.S.A. Write for complete listing & 100+ prices. We ship throughout entire world.



1797-H First Ave. N.Y. 28, N.Y.

## NATIONWIDE DELIVERY...



on all your Stereo needs. Recorders, Tuners, Amplifiers Turntables, etc.

LET US PROVE that we can supply your requirements PROMPTLY AT LOWEST COST. FREE CATALOG.

STEREO COMPONENT Supply Co., Dept. S  
148-25 — 12th AVE., FLUSHING 57, N. Y.

## SAVE MONEY ON HI-FI COMPONENTS

TAPE RECORDERS  
TAPES, ACCESSORIES  
SLEEP LEARN KITS

### MERITAPE

Low cost, high quality recording tape, in boxes or cans.

FREE 1963 CATALOG

**DRESSNER** 1523 JERICHO TPKE.  
NEW HYDE PARK 21, N. Y.

## Buying LP's?

### LOOK WHAT MAGNUM OFFERS!

- Virtually all labels—all artists
- No obligations — no requirements
- Every LP at low discount prices
- Choose the records you want from free catalog of over 25,000 LP's

Magnum offers a complete one-stop record service. You get lowest possible prices, complete freedom of choice, no purchase obligations or requirements of any kind, unlimited selection, 100% quality guarantee . . . Special offer includes free catalog and free record cleaning cloth. For complete details write . . .

**magnum** RECORD SERVICE  
447 West 50th Street, Dept. RS, New York 19, N. Y.



### ARTISAN ORGAN

"King of Kits"

- The ultimate in organ tone & styling
- No previous technical skill required
- Skip dealer profits and factory labor
- The original build-it-yourself organ
- Pay as you build & play as you build
- Choice of models from \$1750 to \$5500

WRITE TODAY FOR DETAILS

4949-SR YORK BLVD., LOS ANGELES 42, CALIF.

## LOW WAREHOUSE PRICES WAREHOUSE DIRECT SHIPMENTS

SPECIAL WAREHOUSE PACKAGE DEALS  
ALL BRAND NEW COMPONENTS  
FRESH FROM WAREHOUSE

GET OUR WAREHOUSE PRICE LIST

# STEREO WAREHOUSE

228-S Greenway Terrace, River Edge, N. J.

## ALL NEW BIG RECORD BRUSH



"Here's a brush that covers the entire tracking surface of your records. Designed especially for manual operating turntables, turns out of the way for automatic operation. Made of MACHINED ALUMINUM with a LARGE CAMEL'S HAIR BRUSH that will last the life of your turntable. After several revolutions of the record, you will notice an improvement in sound caused by the removal of dust particles from the playing surface. This is not a toy, but a fine piece of equipment with quality and service built into every inch. Makes a PERFECT GIFT. ONLY \$4.95 (postpaid). Send check or money order to PRECISION MANUFACTURING CO., BOX 28, AURORA, INDIANA.

GIVE YOUR RECORDS A CLEAN-SWEEP TODAY



PROMPT DELIVERY

LOW PRICES

AMPLIFIERS — MULTIPLEX — TAPE RECORDERS, TUNERS SPEAKER SYSTEMS, ETC. AIR MAIL QUOTES — COMPARE WRITE FOR CATALOG

AUDIO DIVISION  
**L. M. BROWN SALES CORP**  
Dept. S—242 West 10th Street • New York 14, N. Y.

## AMAZING RACK HOLDS 200 RECORDS



Black wrought-iron cabinet is just waiting for your collection to grow into "shows-off" 200 LP albums. Ten compartments to file records by symphonies, operas, ballets, jazz, folk, chamber and show music! Sturdy 25"x22"x12". Fully assembled! Remit \$9.95. Exp. chg. collected on delivery. Dealer inquiries invited. MONEY-BACK GUARANTEE! \$9.95

© Leslie Creations • Dept. E11 • Lafayette Hill, Pa.  
Rush my Record Cabinet! I enclose \$9.95 Ck. or M.O.  
Name .....  
Address .....  
City ..... Zone ..... State .....

## HiFi/Stereo Market Place (Cont.)

### SAXITONE RECORDING TAPE

\*Oxide guaranteed not to rub off or squeak—or money back. Compare ours with other "Bargain" tape. You'll find it's more than just "price" when you deal with us. We are original pioneers in the tape recorder business and our reputation means everything to us.



800' acetate (plastic), 5 inch... .75  
 800' MYLAR 5 inch reel... .85  
 900' MYLAR (Polyester), 5 inch... .89  
 1200' MYLAR 1/2 mil, 5 inch reel... 1.15  
 1200' Acetate (plastic), 7 inch... 1.15  
 1200' MYLAR 1/2 mil, (strong)... 1.29  
 1800' acetate (plastic), 7 inch... 1.39  
 1800' MYLAR 1 mil, 5 inch... 1.39  
 2400' MYLAR, untonalised, 7 inch... 2.39  
 2400' MYLAR, tonalised, 7 inch... 2.39

(Large Users Even Lower)  
 Plus Postage

SAVE 30% 4-track stereo music on tape

### NORELCO SPEAKERS

Famous AD3800M, twin cone 8" (75-19,000 cycles) comparable net 9.90 now 4.95, 2 for 9.00, plus postage. OTHER Norelco models at BIG DISCOUNTS. Specifications on entire Norelco line sent on request.

**SAXITONE TAPE SALES**  
 div. Commission Electronics, Inc.  
 1776 Columbia Rd., Wash., D.C.



## FAST SHIPMENTS

### COMPONENTS • KITS

### RECORDERS • TAPES

- BEST-BY-COMPARISON PRICES
- FACTORY SEALED CARTONS
- SEND FOR "QUOTES" ON PACKAGE DEALS AND SAVE MORE

WRITE FOR MONTHLY SPECIALS  
 VISIT OUR STORE  
**CARSTON Studios**  
 125-H East 88 St., New York 28, N. Y.

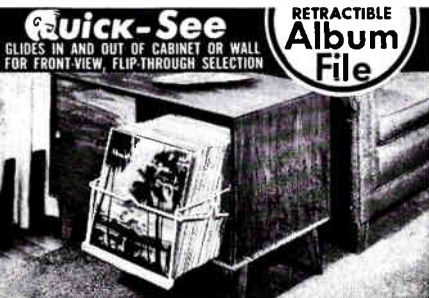

**Quick-See** RETRACTABLE Album File  
 GLIDES IN AND OUT OF CABINET OR WALL FOR FRONT-VIEW, FLIP-THROUGH SELECTION

Storage cabinets available or do-it-yourself  
 Eliminates visibility problem of edge-stacked albums, slope jacket-bottom wear. Installs anywhere in five minutes with 4 screws. Sturdy welded steel construction, ball-bearing tracks, balanced suspension. 9 models for LP's & tape, hold to 125 albums; black or brass, \$6.95 up. Write for brochure. Dealer inquiries invited  
**KERSTING MFG. CO., 504 S. DATE, ALHAMBRA, CALIF**

## DIXIE

### HIGH FIDELITY WHOLESALE

Largest discount High Fidelity component distributors in the South. Wholesale prices on package or individual components. Latest models in factory sealed cartons. Special attention given to Audio Clubs, Churches and Schools.

Are prices too high?—Write  
**DIXIE HI-FI**

12402 Connecticut Ave., Silver Spring, Md.



## ANTENNAE

THE FINEST OF ITS KIND...

Get more FM stations with the world's most powerful FM Yagi Antenna systems.

To be fully informed, send 30¢ for book "Theme And Variations" by L. F. B. Carini and containing FM Station Directory.



## APPARATUS DEVELOPMENT CO.

Wethersfield 9, Connecticut

## DOWN TO EARTH

Everyone's going for Audion's "Down to Earth" Hi-Fi Values.

Check with **AUDION** before buying Hi-Fi components

Write for free catalog.

**audion** 25 K OXFORD ROAD MASSAPEQUA, L.I., N.Y.

## RENT GO

### STEREO TAPES

- Over 2500 different, 4-track & 2-track
- No deposit on tapes rented
- Postpaid 2 to 5 day delivery (48 States)

FREE BROCHURE **stereo-parti**  
 811-B CENTINELA, INGLEWOOD, CALIF

## LEARN WHILE YOU SLEEP

### Headquarters

Experiment in this fascinating, educational new field. Use your phonograph, recorder or amazing new *Electronic Educator* endless tape recorder. We carry a full line of endless repeating tape cartridges for all makes of standard recorders plus automatic timers, pillow speakers and complete outfits. Also over 200 unusual educational and self-help courses on tape and record for sleep-learning and hypnosis experimenters. Write for free 300 items catalog and full astonishing details.



**Sleep-Learning Research Association**  
 P. O. Box 24-Y, Olympia, Washington

## THEATER

© © **OLIVER!** (Lionel Bart). Stanley Holloway, Alma Cogan, Violet Carson, Denis Waterman, Tony Tanner, Leslie Fyson, Charles Granville, the Rita Williams Singers; orchestra, Tony Osborne cond. CAPITOL ST 1784 \$4.98, T 1784\* \$3.98.

Interest: Appealing score  
 Performance: Road company  
 Recording: Fine  
 Stereo Quality: Lacks theatrical flavor

Even before *Oliver!* opened in New York, record purchasers had the opportunity of choosing between two different versions, the original cast on RCA Victor and the above studio cast imported from England. This Capitol set is acceptable both vocally and orchestrally, but it is wide of the mark in creating either a theatrical or a Dickensian flavor. Stanley Holloway (as Fagin) prances through his numbers as if he were still playing Alfred P. Doolittle in *My Fair Lady*, and most of the other singers are equally unconvincing. Only Alma Cogan's slightly raspy voice seems right for her part as the unhappy Nancy. The musical arrangements are not especially inventive and become downright sluggish in the case of the joyous *Who Will Buy?* S. G.

## FILM

© © **ALL NIGHT LONG.** Dave Brubeck (piano), Charles Mingus (bass), Tubby Hayes (tenor saxophone and vibraphone), various artists. *Overture; Sapphire; Noodlin'; Scott Free;* and eleven others. EPIC BA 17032 \$4.98, LA 16032\* \$3.98.

Interest: British jazz  
 Performance: Variable  
 Recording: Very good  
 Stereo Quality: Very good

This is the sound track for the British film *All Night Long*, a contemporary reworking of *Othello* in a jazz milieu. Dave Brubeck and Charles Mingus (who would probably make a compelling *Othello*, but does not play the role) figure in the film. The two played a duet both have called one of the most satisfying musical experiences of their lives; however, it does not appear on the album, and reportedly has been almost completely cut from the film.

The most interesting moments are provided by Dave Brubeck's playing of two of his rhythm experiments with a British alto player, trumpeter, bassist, and drummer. It proves that his is special music that needs special men like Paul Desmond to bring it off. There are so few good jazz scores that one hopes anew for each one. This one, however, is more bland and disappointing than most. J. G.



## HIFI/STEREO REVIEW—JANUARY 1963

READER SERVICE NO.	ADVERTISER	PAGE NO.	READER SERVICE NO.	ADVERTISER	PAGE NO.
1	Acoustic Research, Inc. ....	81		57th St. Record Shop, Inc. ....	111
2	Acoustic Technology Laboratories, Inc. ....	21	30	Finney Company, The ....	100
3	Airex Radio Corporation ....	94	31	Fisher Radio Corporation ....	2nd COVER, 1
4	Allied Impex Corporation ....	26	32	General Electric ....	106
5	Allied Radio ....	29, 30	33	Grado Laboratories, Inc. ....	90
49	AmeLux Electronics Corporation ....	84	34	Grommes, Division of Precision Electronics, Inc. ....	12
6	American Concertone, Inc. ....	28	35	Harman-Kardon ....	37, 91
7	American Sintronics ....	108	36	Heath Company ....	24, 25
8	Ampex Corporation ....	96		Hi-Fidelity Center ....	111
9	Angel Division, Capitol Record Club ....	13		Hi-Fidelity Supply ....	111
10	Angel Records ....	79	59	KLH Research and Development ....	95
	Apparatus Development Co. ....	112		Kersting Mfg. Co. ....	112
11	Argo Records ....	89	37	Key Electronics Co. ....	108
	Artisan Organ ....	111	38	Koss Electronics, Inc. ....	72
12	Audio Devices, Inc. ....	4th COVER	39	Lafayette Radio Electronics ....	109
13	Audio Dynamics Corporation ....	3rd COVER		Leslie Creations ....	111
14	Audio Fidelity Records ....	93, 104	60	London Records ....	109
	Audion ....	112		Magnum Record Service ....	111
	Audio Unlimited ....	111	40	Marantz ....	33
15	Bell Stereo Systems ....	102	41	Nortronics ....	22
16	Benjamin Electronic Sound Corp. ....	67	61	Pickering & Company, Inc. ....	17
17	Bozak ....	18	42	Pilot Radio Corporation ....	71
18	British Industries (Garrard) ....	75, 76		Precision Manufacturing Co. ....	111
	Brown Sales Corp., L.M. ....	111	43	Rabsons—57th Street, Inc. ....	110
	Carston Studios ....	112	44	Rek-O-Kut Company, Inc. ....	23
19	Citadel Record Club ....	108	45	Roberts Electronics, Inc. ....	16
20	Collector's Book Society ....	5		Saxitone Tape Sales ....	112
21	Columbia LP Record Club ....	8, 9, 10, 11	46	Scott, Inc., H. H. ....	107
22	Columbia Records ....	68	47	Sherwood Electronic Laboratories, Inc. ....	34
23	Command Records ....	73	48	Shure Brothers, Inc. ....	27, 86
	Commissioned Electronics, Inc. ....	112		Sleep-Learning Research Association ....	112
24	Crowell Company, Thomas Y. ....	83		Stereo Component Supply Co. ....	111
25	Deutsche Grammophon ....	85		Stereo-Parti ....	112
	Dixie Hi-Fi ....	112		Stereo Warehouse ....	111
	Dressner ....	111	50	Superscope, Inc. ....	82
26	Dynaco, Inc. ....	101	51	United Audio Products ....	14
56	Dynaco, Inc. ....	103	52	United Stereo Tapes ....	88
27	EICO Electronic Instr. Co., Inc. ....	38	53	University Loudspeakers ....	2
28	Electro-Voice, Inc. ....	15	54	Vanguard Records ....	94
57	Elpa Marketing Industries (Ortofon Div.) ....	92	55	Winegard Antenna Systems ....	80
29	Empire Scientific Corp. ....	6, 7			
58	Fairchild Recording Equipment ....	94			

## HiFi / STEREO REVIEW PRODUCT INDEX

As an additional reader service we have indicated the products advertised in this issue by classifications. If there is a specific product you are shopping for, look for its listing and turn to the pages indicated for the advertisements of manufacturers supplying that equipment.

CLASSIFICATION	PAGE NUMBERS	CLASSIFICATION	PAGE NUMBERS
Accessories	22, 29, 30, 109	Records	8, 9, 10, 11, 13, 68, 73, 79, 85, 89, 93, 94, 104, 109
Amplification Systems	1, 2, 17, 21, 29, 30, 33, 34, 37, 38, 71, 75, 76, 91, 101, 103, 109	Speakers and Speaker Systems	Cover 2, 1, 2, 18, 28, 29, 30, 34, 75, 76, 81, 95, 108, 109
Antennas, FM	29, 30, 80, 100, 109	Tapes, Prerecorded	29, 30, 89
Cabinets	109	Tape, Recording	29, 30, 109, Cover 4
Cartridges, Phonograph	6, 7, 17, 27, 29, 30, 75, 76, 86, 90, 92, 94, 101, 103, 106, 109, Cover 3	Tape Recorders and Decks	16, 26, 28, 29, 30, 38, 82, 96, 102, 109
Headphones	29, 30, 72, 94	Tone Arms	6, 7, 17, 27, 29, 30, 75, 76, 86, 92, 101, 103, 109, Cover 3
Multiplex Adaptors	Cover 2, 1, 17, 29, 30, 34, 37, 38, 91, 109	Tuners and Tuner-Amplifiers	1, 2, 12, 29, 30, 33, 34, 37, 38, 71, 91, 101, 102, 103, 107, 109, Cover 2
Portable Phonographs	95, 109	Turntables and Changers	6, 7, 14, 23, 29, 30, 67, 75, 76, 109



IF  
YOU  
USE

THIS

OR

THIS

OR

THIS

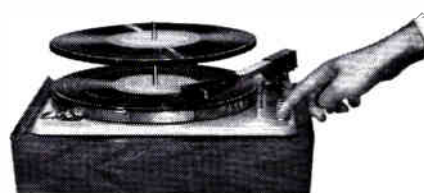
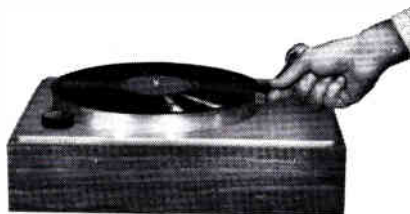

MAKE  
A  
MAJOR  
IMPROVEMENT  
IN YOUR  
SYSTEM

AT MINIMUM COST  
WITH THE NEW  
ADC-3 UNIVERSAL STEREOPHONIC CARTRIDGE!



For owners of turntables, automatic turntables, or record changers, we believe that the new ADC-3 universal stereophonic phonograph cartridge, at \$29.50, is the best buy on the market.

#### ADC-3 SPECIFICATIONS

TYPE: Miniature moving magnet • SENSITIVITY: 10 millivolts per channel  $\pm$  2 db at 1,000 cps (5.5 cm/sec recorded velocity) • FREQUENCY RESPONSE: 10 to 20,000 cps  $\pm$  3 db • CHANNEL SEPARATION: 30 db 50 to 7,000 cycles • STYLUS TIP RADIUS: .0007" (accurately maintained) • STYLUS TIP MASS: .8 milligrams • LATERAL AND VERTICAL COMPLIANCE:  $15 \times 10^{-6}$  cms/dyne minimum • RECOMMENDED LOAD IMPEDANCE: 47K ohms • TRACKING FORCE: 2 to 5 grams • MOUNTING CENTERS: Standard  $\frac{1}{2}$ " and  $\frac{7}{16}$ " centers. Unit adapts to virtually all tone arms

We urge you to listen to the ADC-3 cartridge at your high fidelity dealer and then make a major improvement in your system at a minimum cost with the new ADC-3 cartridge at \$29.50—the best buy in the market.

ADC

**AUDIO DYNAMICS CORPORATION**

Pickett District Road, New Milford, Connecticut

CIRCLE NO. 13 ON READER SERVICE CARD



Tri-School  
March 22nd  
9-10

## *crunch*

Apples taste better when you're six years old. What's more they *sound* better. Those crunching noises reverberating through your head are exciting. You keep wondering if they can be heard on the "outside." Remember?

Naturally, you'll never hear an apple like that again. But if you've retained even a little sonic sensitivity, we can offer you an experience almost as pleasant.

Make your next recording on Audiotape.

You'll find that the wonderful quality of this tape provides more clarity, more range, eliminates noise and distortion problems. And you'll find this quality is consistent from reel to reel and within every reel of Audiotape.

Whether you're taping a small apple-cruncher or a great symphony orchestra, there's an Audiotape exactly suited to your needs. From Audio Devices, for 25 years a leader in the manufacture of sound recording media—Audiodiscs\*, Audiofilm\* and ...



# audiotape

TRADE MARK  
*"it speaks for itself"*

AUDIO DEVICES INC., 444 Madison Ave., New York 22, N.Y.  
Offices in Los Angeles • Chicago • Washington, D. C.

\*TRADE MARK