

# RADOLEK



**RADIO  
PROFIT  
GUIDE**

*Everything in Radio* **1941** *at Lowest Prices*

**RADOLEK COMPANY**

**601 West Randolph Street, Chicago, Illinois**

Year's  
Biggest

VALUE

5 Tube  
AC-DC

SUPER

**The 1941 Sales Leader**

Here is a radio that has rich, appealing tone quality, brilliant performance, power, dependability and beautifully designed cabinet. The high quality and fine craftsmanship together with the remarkably low price, makes this radio one of the biggest values of the year.

**5 Tube AC-DC Superhet**

The powerful superheterodyne circuit has a tuning range of 540 to 1730 Kc, covering full broadcast band and upper police band. **Built-in antenna**—no aerial or ground necessary. **Large aeroplane-type dial.** Unparalleled tone quality and power with **5" permanent magnet speaker** and beam power output. **Variable tone control** to suit every individual preference. **Automatic Volume Control** minimizes and often eliminates fading. All working multi-purpose tubes give performance equal to much larger sets. Tubes used: 12SQ7, 12SK7, 12SA7, 50L6GT, 35Z5GT. The gracefully streamlined cabinet is available in either gleaming Ivory or beautifully figured Walnut finish. Louvre grill carries out streamline design. Size 12<sup>3</sup>/<sub>8</sub>x7<sup>1</sup>/<sub>8</sub>x7" deep. Operates on 110 volts 50/60 cycles AC or DC.

D17591—In Walnut Plastic Cabinet. Complete with tubes. List, \$14.95.

**YOUR PRICE, Each \$9.99**  
In Lots of 3, Each .....

D17592—In Ivory finished Cabinet. Complete with tubes. List, \$16.95.

**YOUR PRICE, Each \$10.85**  
In Lots of 3, Each.....



**Personal AC-DC Supers**

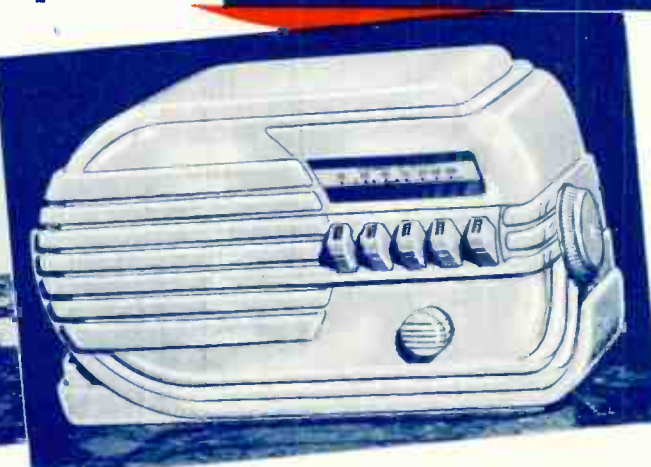

**6 Tube AC-DC Superhet**

**Push Button Tuning—Built-In Antenna**

Built-in antenna eliminates external aerial and ground. Push-Button Automatic Tuning. 6 Pre-selected stations can be changed at will. Control knob is on side for manual tuning. Superheterodyne Circuit with R.F. stage provides excellent selectivity and sensitivity. Tunes 535 to 1730 Kc. A.V.C. minimizes fading. Beam Output and Dynamic Speaker provide amazing power and true tone. Tubes: 12SA7, 2-12SK7, 12SQ7, 35L6GT, 35Z5GT. Beautiful plastic cabinet of distinctive modern design. Size 12<sup>1</sup>/<sub>2</sub>"x7"x6". Operates on 110 volt AC or DC. Tubes included.

D17573—In Walnut Plastic Cabinet. List Price, \$23.50.

**YOUR PRICE** in single lots .....  
In lots of 3, Each... **\$11.95**  
In lots of 3, Each... **\$11.25**

D17574—In Ivory finished Cabinet. List, \$24.95.

**YOUR PRICE** in single lots .....  
In lots of 3, each.. **\$12.95**  
In lots of 3, each.. **\$12.25**

**5 Tube AC-DC Superhet**

**Push Button Tuning—Built-In Antenna**

A quality, high-efficiency radio with 5 actual working tubes—featuring **automatic push-button tuning of 5 preselected stations and built-in antenna.** No bothersome aerial or ground—no hunting for stations—just plug it in anywhere—push a button and there's the broadcast you want. Station selection easily changed without tools. Slide-rule dial. **Tuning range 540 to 1650 Kc.** Control knob provided for manual tuning. Features beam power output, A.V.C. and full sized dynamic Speaker. Cabinet in modern streamlined styling harmonizes with any surroundings. Tubes: 12SA7, 12SK7, 12SQ7, 35L6GT, 35Z5GT. Size: 6<sup>3</sup>/<sub>8</sub>"x12x6". For 110 volt AC-DC operation. Tubes included.

D17593—In Walnut Plastic Cabinet. List, \$19.95.

**YOUR PRICE, Ea. \$9.95**  
In Lots of 3, Each..... **\$9.45**

D17594—In Ivory finished Cabinet. List, \$21.95.

**YOUR PRICE, EACH, \$10.95**  
In Lots of 3, Each.. **\$10.45**



# AUTOMATIC RECORD CHANGING UNITS



Luxurious record-reproducers with built-in Automatic Record Changers. Wireless Models have built-in 2 tube "wireless oscillator" and will operate at some distance from any radio set without direct connection. Does not interfere with set operation. Changer plays ten 12" or twelve 10" records automatically, re-

jects any record at will, uses crystal pickup, has needle-cup, on-off switch and volume control. Selected walnut veneer cabinet hinged lid. Table Model size: 21"x16 3/4"x12 1/2". Console Model size 21"x16 3/4"x31". For 110 volt 60 cycle AC operation.

**D17672**—Wireless Type Table Model. Complete with tubes.  
YOUR PRICE ..... **\$36.75**

**D17674**—Wireless Type Console Model. Complete with tubes.  
YOUR PRICE ..... **\$42.75**

**D17673**—Wired Type Table Model. Same as above except requires single connection to radio or amplifier.  
YOUR PRICE ..... **\$31.50**

**D17675**—Wired Type Console Model. Same as above except requires single connection to radio or amplifier.  
YOUR PRICE ..... **\$37.50**

## 4 TUBE RADIO-PHONOGRAPH

A 4 tube superheterodyne table model radio and record player compactly housed in attractive rich dark brown leatherette covered case with hinged lid. Has A.V.C., beam power output, and 5" P.M. dynamic speaker. Illuminated airplane dial covers complete broadcast and upper police bands from 540 to 1720 Kc. Phonograph has high fidelity tri-tracking crystal pick-up. Self-starting constant speed quiet electric motor. Plays both 10" and 12" records. Tubes used: 1 each 12SQ7, 12SA7, 50L6GT and 35Z5GT. Size, 11 1/2" x 9 3/8" x 11 1/2" deep.

**D17638** — Table Model 4 tube Phono-Radio Combination. Complete with tubes. For 110 volt 60 cycle AC. List. \$19.95.  
YOUR PRICE ..... **\$13.85**



## NEWEST RECORD PLAYERS WITH BUILT-IN AMPLIFIERS

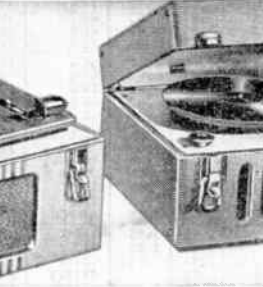

Completely self-contained electric phonographs. Will play 10 or 12" records at 78 RPM. No additional accessories required as each unit has its own built-in 2 watt amplifier and PM Dynamic speaker. Amplifier uses 3 tubes in an inverse feedback circuit that develops a rich faithful tone

quality. Phono motor is self-starting rim drive type running at 78 RPM. Also included are high fidelity offset head crystal pickup, pickup arm rest, volume control and on-off switch. Complete with tubes. 110-120 Volt 60 cycle AC operation.

**D17660**—Economy electric table model, smartly housed in leatherette covered case, size 7 1/2" wide x 12" deep x 8 3/4" high. Complete as described above with high fidelity offset crystal pickup, pick-up arm rest, volume control, on-off switch and tubes. No accessories required.  
YOUR PRICE, Each ..... **\$11.72**  
In Lots of 3, ..... **\$11.20**  
Each .....

**D17661**—DeLuxe table model. Smartly designed walnut cabinet with hinged lid. Plays 10 or 12" records with lid closed. Cabinet size 13 1/2" long x 12 1/4" deep x 9 3/4" high. Complete as described above except also includes needle cup and jeweled pit light.  
YOUR PRICE, Each ..... **\$17.95**  
In Lots of 3, ..... **\$16.95**  
Each .....

**D17662**—Portable Type. Similar to other models except has more powerful amplifier and speaker, needle cup, tone control and changer which plays ten 12" or twelve 10" records. Portable case with carrying handle is covered with airplane luggage cloth. Size, 16 x 16 x 14" high.  
YOUR PRICE, Each ..... **\$39.75**  
In Lots of 3, ..... **\$37.95**  
Each .....

**D17663**—Portable Model in worn effect striped airplane luggage leatherette with hinged lid and handle. Removable compartment holds eight 10" records. Size, 13 3/4" x 13 3/4" x 9". Complete as described above except includes tone control and needle cup.  
YOUR PRICE, Each ..... **\$15.95**  
In Lots of 3, ..... **\$15.25**  
Each .....

## WIRED AND WIRELESS TYPE RECORD PLAYBACK UNITS

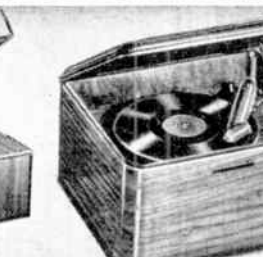

converts any radio into an electric phonograph. Each model is equipped with 78 RPM self-starting constant speed rim drive electric motor, light weight metal pickup, arm rest, volume control, on-off switch and needle cup. Plays all 10" and 12" records. Wireless Models do not require connection to radio and will operate with any set. Includes highly efficient built-in 2

tube oscillator that allows operation up to 50 ft. from receiver. Wired Models provide better reproduction than wireless models but are recommended for use only with sets having 2 or more tubes in the audio system. For 110-120 Volts 60 cycles AC operation.

used in an attractive open type walnut cabinet with graceful roll over edge. Size 12" long x 10 1/2" deep x 7 1/2" high.  
**D17664**—Wired Model.  
YOUR PRICE, Each ..... **\$8.10**  
In Lots of 3, ..... **\$7.65**  
Each .....  
**D17665**—Wireless Model.  
YOUR PRICE, Each ..... **\$11.35**  
In Lots of 3, ..... **\$10.95**  
Each .....

Housed in a handsome walnut cabinet with streamlined curved hinged lid. Cabinet size 13 1/4" long x 10 1/2" deep x 7" high.  
**D17666**—Wired Model.  
YOUR PRICE, Each ..... **\$11.35**  
In Lots of 3, ..... **\$10.95**  
Each .....  
**D17667**—Wireless Model.  
YOUR PRICE, Each ..... **\$13.95**  
In Lots of 3, ..... **\$13.25**  
Each .....

Offered in a DeLuxe Cabinet of selected walnut with solid hinged lid. Cabinet size 15 1/2" long x 13 1/4" deep x 8 1/2" high.  
**D17668**—Wired Model.  
YOUR PRICE, Each ..... **\$14.25**  
In Lots of 3, ..... **\$13.75**  
Each .....  
**D17669**—Wireless Model.  
YOUR PRICE, Each ..... **\$17.95**  
In Lots of 3, ..... **\$16.95**  
Each .....

Portable model in leatherette covered carrying case with hinged lid and sturdy handle. Size 14 1/2" long x 12 1/2" deep x 7" high.  
**D17670**—Wired Model.  
YOUR PRICE, Each ..... **\$8.95**  
In Lots of 3, ..... **\$8.45**  
Each .....  
**D17671**—Wireless Model.  
YOUR PRICE, Each ..... **\$11.95**  
In Lots of 3, ..... **\$11.35**  
Each .....



# PHILCO QUALITY RADIO TUBES

PHILCO Radio Tubes are of the very latest type, design and construction. Scientifically engineered, precision built, and subjected to 100% thorough tests in every stage of their manufacture. PHILCO tubes furnish long, dependable and economical service. The line is COMPLETE—concentrate on PHILCO TUBES. Make

EXTRA PROFIT, in addition to sales of radio sets.

Nationally advertised for replacement in all radio receivers and for replacement in over 10,000,000 PHILCO Receivers in use throughout the United States.

**Finest Quality**

*Tubes May Be Assorted to Obtain Quantity Price*

**Prices Subject to Market Change**

Tube Type	Stock Num.	List Price	Price, Each 1-9	10-99	Tube Type	Stock Num.	List Price	Price, Ea. 1-9	10-99
024	D1769	\$1.60	\$0.86	\$0.80	6A8G	D1687	\$0.80	\$0.43	\$0.40
024G	D1738	1.25	.67	.62	6A8GT	D1661	1.00	.54	.50
1A5G	D1740	1.00	.54	.50	6B5	D1642	2.10	1.13	1.05
1A6	D1553	1.25	.67	.62	6B7	D1578	1.25	.67	.62
1A7G	D1748	1.25	.67	.62	6C5	D1752	1.00	.54	.50
1A7GT	D1654	1.25	.67	.62	6C5G	D1707	.80	.43	.40
1C5GT	D1655	1.25	.67	.62	6C6	D1579	.80	.43	.40
1C6	D1557	1.25	.67	.62	6D6	D1580	.80	.43	.40
1C7G	D1675	1.25	.67	.62	6E5	D1651	1.00	.54	.50
1D5GP	D1500	1.25	.67	.62	6F5	D1753	1.00	.54	.50
1D5GT	D1501	1.25	.67	.62	6F5G	D1708	.80	.43	.40
1E4G	D1739	1.25	.67	.62	6F6	D1754	1.00	.54	.50
1F7G	D1680	1.00	.86	.83	6F6G	D1690	.80	.43	.40
1H4G	D1681	.80	.43	.40	6F7	D1581	1.25	.67	.62
1H5G	D1743	1.00	.54	.50	6F8G	D1776	1.25	.67	.62
1J6G	D1683	1.25	.67	.62	6G5	D1641	1.60	.86	.80
1LA4	D1656	2.10	1.13	1.05	6H6	D1755	.80	.43	.40
1LA6	D1657	2.10	1.13	1.05	6H6G	D1691	.80	.43	.40
1LH4	D1658	2.10	1.13	1.05	6J5G	D1692	.80	.43	.40
1LH5	D1659	2.10	1.13	1.05	6J7	D1756	1.00	.54	.50
1N5G	D1744	1.00	.54	.50	6J7G	D1693	.80	.43	.40
1N5GT	D1660	1.25	.67	.62	6J7GT	D1662	1.00	.54	.50
1Q5G	D1745	2.10	1.13	1.05	6J8G	D1777	1.60	.86	.80
2A3	D1565	2.10	1.13	1.05	6K5G	D1694	.80	.43	.40
2A4G	D1793	1.60	.86	.80	6K6G	D1695	.80	.43	.40
2A5	D1566	.80	.43	.40	6K7	D1757	1.00	.54	.50
2A7	D1568	1.00	.54	.50	6K7G	D1696	.80	.43	.40
3W4	D1749	1.00	.54	.50	6K7GT	D1697	1.00	.54	.50
5X4G	D1502	.80	.43	.40	6L6	D1758	1.60	.86	.80
5Y3G	D1706	.60	.32	.30	6L6G	D1709	1.25	.67	.62
5Y4G	D1686	.80	.43	.40	6L7G	D1697	1.25	.67	.62
5Z3	D1572	.80	.43	.40	6N6G	D1710	2.10	1.13	1.05
5Z4	D1750	1.25	.67	.62	6N7	D1760	1.25	.67	.62
6A6	D1576	1.25	.67	.62	6N7G	D1698	1.25	.67	.62
6A7	D1577	.80	.43	.40	6Q7	D1761	1.00	.54	.50
6A8	D1761	1.25	.67	.62	6Q7G	D1699	.70	.38	.35

Deduct An Extra 10% Discount When Ordering 100 or More Tubes.

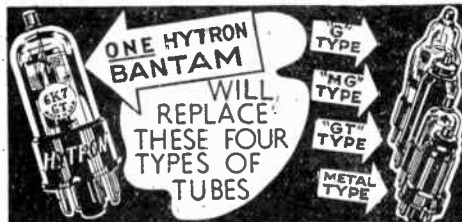

## HYTRON BANTAM RADIO TUBES

Interchangeable with Octal Base "G," "MG" and "GT" Type and Metal Tubes. The greatest contribution to compact radios. Diameter, 1/4". Overall height ranging from 2 1/2" to 3 1/2". Short connection leads and metal shield and about base adds greatly to stability of receiver operation. Low inter-electrode capacitance. Tube elements are rigidly braced making tubes especially desirable for use where excessive vibration is encountered. Complete freedom from gas liberated from envelope by use of glass instead of metal envelopes. Tubes replace any octal base "G," "MG" and "GT" type or metal tubes bearing same type number with exception of the letter "T" or "GT" includes external metal shield shown at right at no extra cost so that tube may be used to replace metal tubes and not require re-alignment of receiver circuit.

*Tube Prices Subject to Market Change*

Tube Type	Stock Num.	List Price	Price, Each 1-14	15-99	Tube Type	Stock Num.	List Price	Price, Each 1-14	15-99
1A5GT	D1900	\$1.25	\$0.67	\$0.62	6K5GT	D1924	\$0.80	\$0.43	\$0.40
1A7GT	D1901	1.25	.67	.62	6K6GT	D1925	.80	.43	.40
1C5GT	D1902	1.25	.67	.62	*6K7GT	D1926	.80	.43	.40
1D8GT	D1903	2.10	1.13	1.05	*6K8GT	D1927	1.25	.67	.62
1G4GT	D1904	1.00	.54	.50	6P5GT	D1928	.70	.38	.35
1G6GT	D1905	1.25	.67	.62	*6Q7GT	D1929	.80	.43	.40
1H5GT	D1906	1.00	.54	.50	*6R7GT	D1930	.80	.43	.40
1N5GT	D1907	1.25	.67	.62	*6SA7GT	D1931	1.00	.54	.50
1P5GT	D1908	1.25	.67	.62	*6SF5GT	D1932	1.00	.54	.50
1Q5GT	D1909	1.25	.67	.62	*6SJ7GT	D1933	1.00	.54	.50
1T5GT	D1910	1.25	.67	.62	*6SK7GT	D1934	1.00	.54	.50
2W3GT	D1911	2.25	.67	.62	*6SQ7GT	D1935	1.00	.54	.50
3A5GT	D1912	2.10	1.13	1.05	6V6GT	D1936	1.00	.54	.50
3Q5GT	D1913	1.60	.86	.80	6W6GT	D1937	1.60	.86	.80
5W4GT	D1914	1.00	.54	.50	6X5GT	D1938	1.00	.54	.50
*6A8GT	D1915	1.00	.54	.50	6Y6GT	D1939	1.60	.86	.80
6AC5GT	D1916	1.00	.54	.50	12A7GT	D1940	1.60	.86	.80
6AE5GT	D1917	1.60	.86	.80	12A8GT	D1941	1.00	.54	.50
*6C5GT	D1918	.80	.43	.40	12B8GT	D1942	1.40	.86	.80
*6F5GT	D1919	.80	.43	.40	12F5GT	D1943	.80	.43	.40
6H4GT	D1920	1.60	.86	.80	12J5GT	D1944	.80	.43	.40
*6H6GT	D1921	1.00	.54	.50	12J7GT	D1945	1.00	.54	.50
*6J5GT	D1922	.80	.43	.40	12K7GT	D1946	1.00	.54	.50
*6J7GT	D1923	.80	.43	.40	12K8GT	D1947	1.60	.86	.80

Tubes May Be Assorted to Obtain Quantity Price. Write for Prices on Larger Quantities.

**H. F. Bantams**

*With Ceramic Base*

D1972-6A8GT X PRICE EACH  
D1973-6J5GT X PRICE EACH  
D1974-6J7GT X PRICE EACH  
D1975-6K7GT X PRICE EACH  
D1976-6K8GT X PRICE EACH

Each \$1.30

Laboratory built Bantam tubes, specially designed and tested for high frequency communications receivers. Provides maximum signal gain and circuit stability. Replaces similar type octal base tubes.

**Bantam Jr. Tubes**

2" High, 5/8" dia. High sensitive. Lowest battery drain. Long service. Miniature 5 prong base.

D1977 HY123 \$1.71  
D1978 HY145 2.45  
D1979 HY155 2.45



# Revised Prices on Raytheon Tubes

Effective as of Nov. 15, 1940

*Tubes May Be Assorted To Obtain  
Quantity Price*

Tube prices subject to market change.  
Write for larger quantity prices.

## Standard Base Glass Tubes

Type Num.	Stock Num.	List Price	Your Price 1-14	Ea. 15-Up	Type Num.	Stock Num.	List Price	Your Price 1-14	Ea. 15-Up
I-A	D561	\$0.80	\$0.43	\$0.40	33	D611	\$1.20	\$0.65	\$0.60
-V	D563	.90	.49	.45	34	D612	1.20	.65	.60
A4P	D564	1.50	.81	.75	35/51	D613	.90	.49	.45
34T	D565	1.50	.81	.75	37	D614	.90	.49	.45
45	D566	1.20	.65	.60	38	D615	.75	.40	.37
B4/951	D562	1.20	.65	.60	38	D616	1.00	.54	.50
B5	D567	1.20	.65	.60	39/44	D617	.90	.49	.45
C6	D568	1.20	.65	.60	41	D619	.75	.40	.37
F4	D569	1.20	.65	.60	42	D620	.75	.40	.37
F6	D570	1.50	.81	.75	43	D621	1.00	.54	.50
A3	D571	1.85	1.00	.92	45	D622	.70	.38	.35
A5	D573	.90	.49	.45	46	D623	1.00	.54	.50
16	D574	.90	.49	.45	47	D624	1.00	.54	.50
17	D575	1.00	.54	.50	48	D625	2.75	1.48	1.37
B7	D576	1.20	.65	.60	49	D626	1.20	.65	.60
2E5	D577	1.20	.65	.60	50	D628	2.75	1.48	1.37
5Z3	D578	1.00	.54	.50	53	D629	1.50	.81	.75
6A3	D579	1.85	1.00	.92	55	D630	1.00	.54	.50
6A4/LA	D580	1.50	.81	.75	56	D632	.70	.38	.35
6A6	D581	1.50	.81	.75	57	D633	1.00	.54	.50
6A7	D582	.90	.49	.45	58	D634	.80	.43	.40
6B5	D660	1.50	.81	.75	59	D633A	1.50	.81	.75
6B5	D583	1.85	1.00	.92	71A	D635	.80	.43	.40
6B7	D584	1.20	.65	.60	75	D636	.75	.40	.37
6C6	D585	.90	.49	.45	76	D637	.80	.43	.40
6D6	D586	.90	.49	.45	77	D638	.80	.43	.40
6E6	D587	1.00	.54	.50	80	D640	1.50	.81	.75
6E6	D588	1.85	1.00	.92	79	D640	1.50	.81	.75
6F7	D589	1.50	.81	.75	80	D641	.60	.32	.30
6N5	D660	1.50	.81	.75	81	D642	1.85	1.00	.92
6G5/6U5	D662	1.20	.65	.60	82	D643	1.20	.65	.60
6Z4	D592	1.00	.54	.50	83	D644	1.20	.65	.60
12A	D596	.90	.49	.45	83V	D645	1.85	1.00	.92
12A5	D597	2.25	1.21	1.12	84	D646	1.00	.54	.50
12A7	D598	1.85	1.00	.92	85	D647	.80	.43	.40
12Z3	D599	.90	.49	.45	89	D648	.90	.49	.45
15	D600	1.85	1.00	.92	V99	D649	2.75	1.48	1.37
19	D601	1.20	.65	.60	X99	D650	2.75	1.48	1.37
20	D602	2.75	1.48	1.37	182B	D651	1.85	1.00	.92
24A	D604	.80	.43	.40	183/483	D652	1.85	1.00	.92
25	D567	1.00	.54	.50	482B	D663	1.85	1.00	.92
25Z5	D606	1.85	1.00	.92	85	D654	1.85	1.00	.92
26	D606	.65	.35	.32	90	D655	6.50	3.51	3.25
27	D607	.60	.32	.30	BA	D656	3.65	1.97	1.82
38	D608	.90	.49	.45	BA	D657	2.65	1.43	1.32
31	D609	.90	.49	.45	BR	D657	2.65	1.43	1.32
25V5	D665	2.25	1.21	1.12	VR150	D666	2.25	1.21	1.12
32	D610	1.20	.65	.60	RX385	D667	3.70	2.00	2.00

## All Metal Octal Base Tubes

0Z4	D818	\$1.50	\$0.81	\$0.75	6SC7	D826	1.20	.65	.60
5W4	D800	1.00	.54	.50	6SF5	D827	.90	.49	.45
ST4	D668	1.85	1.00	.92	6SJ7	D828	1.00	.54	.50
5Z4	D801	1.20	.65	.60	6SK7	D829	.90	.49	.45
6A8	D802	1.20	.65	.60	6SQ7	D830	.90	.49	.45
6B8	D669	1.85	1.00	.92	6V6	D821	1.85	1.00	.92
6C5	D804	1.00	.54	.50	6K5	D834	1.50	.81	.75
6F5	D805	1.00	.54	.50	12C8	D831	1.85	1.00	.92
6F6	D806	1.00	.54	.50	12SA7	D832	.90	.49	.45
6H6	D807	1.50	.81	.75	12SC7	D833	1.20	.65	.60
6J7	D822	.80	.43	.40	12SF5	D671	1.00	.54	.50
6K7	D808	1.20	.65	.60	12SJ7	D834	1.00	.54	.50
6L7	D809	1.00	.54	.50	12SK7	D835	.90	.49	.45
6M8	D823	1.20	.65	.60	12SQT	D836	.90	.49	.45
6L6	D810	1.85	1.00	.92	25A6	D672	1.85	1.00	.92
6L7	D811	1.50	.81	.75	25L6	D820	1.50	.81	.75
6Q7	D802	1.50	.81	.75	25Z6	D817	1.20	.65	.60
6Q7	D815	1.20	.65	.60	1851	D673	3.90	2.10	2.10
6R7	D813	1.50	.81	.75	1852	D674	2.25	1.21	1.12
6S7	D870	1.50	.81	.75	1853	D675	1.85	1.00	.92
6SA7	D825	.90	.49	.45					

## "G" Type Octal Base Glass Tubes

Type Num.	Stock Num.	List Price	Your Price 1-14	Ea. 15-Up	Type Num.	Stock Num.	List Price	Your Price 1-14	Ea. 15-Up
0A4	D770	\$1.85	\$1.00	\$0.92	6D8-G	D717	\$1.50	\$0.81	\$0.75
0Z4-G	D742	1.50	.81	.75	6F5-G	D718	1.00	.54	.50
1A5-G	D767	1.00	.54	.50	6F6-G	D719	.80	.43	.40
1A7-G	D768	1.50	.81	.75	6F8-G	D763	1.20	.65	.60
1B7-G	D779	1.20	.65	.60	6G6-G	D764	1.20	.65	.60
1C5-G	D769	1.50	.81	.75	6H6-G	D720	1.00	.54	.50
1C7-G	D760	1.20	.65	.60	6J5-G	D721	.80	.43	.40
1D5-GP	D770	1.20	.65	.60	6J6-G	D722	.80	.43	.40
1D5GT	D770	1.20	.65	.60	6J8-G	D765	1.50	.81	.75
1E4-G	D781	1.20	.65	.60	6K5-G	D723	1.00	.54	.50
1F7-GH	D740	1.50	.81	.75	6K6-G	D724	.90	.49	.45
1G4-G	D782	1.20	.65	.60	6K7-G	D725	1.00	.54	.50
1G5-G	D743	1.20	.65	.60	6K8-G	D777	1.20	.65	.60
1G6-G	D783	1.50	.81	.75	6L6-G	D727	1.85	1.00	.92
1H4-G	D705	.90	.49	.45	6L7-G	D728	1.50	.81	.75
1H5-G	D771	1.20	.65	.60	6M6-G	D729	2.25	1.21	1.12
1J6-G	D708	1.20	.65	.60	6N6MG	D730	2.25	1.21	1.12
1N5-G	D772	1.50	.81	.75	6N7-G	D731	1.50	.81	.75
1N6-G	D784	1.20	.65	.60	6P5-G	D778	.75	.40	.37
1Q5-G	D786	1.50	.81	.75	6Q7-G	D734	.80	.43	.40
2A4-G	D787	2.75	1.48	1.37	6T7-G	D730	1.20	.65	.60
4A6-G	D773	1.85	1.00	.92	6U7-G	D749	.90	.49	.45
5Y4-G	D780	.90	.49	.45	6V6-G	D750	1.00	.54	.50
5W4-G	D755	.80	.43	.40	6V7-G	D751	1.20	.65	.60
5X4-G	D676	1.00	.54	.50	6W5-G	D757	1.85	1.00	.92
5Y3-G	D711	.60	.32	.30	6X5-G	D737	.90	.49	.45
5Y4-G	D712	.65	.35	.32	6ZY5-G	D760	1.20	.65	.60
5Z4MG	D756	1.20	.65	.60	25A6-G	D738	1.00	.54	.50
6AC5-G	D762	1.20	.65	.60	25A7-G	D752	1.50	.81	.75
6AF5G	D677	1.20	.65	.60	25AC5G	D731	1.50	.81	.75
6AF6-G	D776	1.50	.81	.75	25B6-G	D741	1.85	1.00	.92
6B6-G	D771	1.20	.65	.60	25B7-G	D790	1.85	1.00	.92
6B4-G	D714	1.85	1.00	.92	25L6-G	D753	1.20	.65	.60
6B6-G	D715	1.00	.54	.50	25Z6-G	D739	.90	.49	.45
6B8-G	D746	1.20	.65	.60	35Z6-G	D678	1.20	.65	.60
6C5-G	D716	.90	.49	.45	50C6G	D679	1.85	1.00	.92
6C8-G	D747	1.50	.81	.75					

## "GT" Type Octal Base Glass Tubes

1A5GT	D680	1.00	.54	.50	6V6GT	D871	1.00	.54	.50
1C5GT	D852	1.20	.65	.60	6X6GT	D685	.90	.49	.45
1D5GT	D861	1.20	.65	.60	12A8GT	D877	.90	.49	.45
1D6GT	D681	1.85	1.00	.92	12B8GT	D878	1.50	.81	.75
1H5GT	D853	1.00	.54	.50	12F5GT	D879	.90	.49	.45
1N5GT	D854	1.20	.65	.60	12J5GT	D880	.90	.49	.45
1P5GT	D855	1.50	.81	.75	12K7GT	D881	1.00	.54	.50
1Q5GT	D856	1.50	.81	.75	12M7GT	D882	.90	.49	.45
1T5GT	D857	1.00	.54	.50	12Q7GT	D883	.80	.43	.40
1U5GT	D858	2.25	1.21	1.12	12S7GT	D884	1.20	.65	.60
3Q5GT	D857	1.50	.81	.75	12V5GT	D885	1.00	.54	.50
6A8GT	D858	.90	.49	.45	12J7GT	D886	1.00	.54	.50
6C5GT	D863	.90	.49	.45	12K7GT	D887	1.00	.54	.50
6F5GT	D859	.90	.49	.45	25A6GT	D688	1.00	.54	.50
6H4GT	D860	1.85	1.00	.92	25A7GT	D889	.80	.43	.40
6H5GT	D861	1.00							





# Revised Prices on Radiotron Tubes

Effective as of Nov. 1, 1940

*Tubes May Be Assorted To Obtain Quantity Price*  
 Tube prices are subject to market change. Write for larger quantity prices.

R.C.A.				GLASS TUBES			
Type Num.	Stock Num.	List Price	Your Price	Type Num.	Stock Num.	List Price	Your Price
A	D155	\$2.25	\$1.21	32	D202	\$1.20	\$0.65
A4P	D156	1.80	.43	33	D203	1.20	.65
14P	D157	1.50	.81	34	D204	1.20	.65
15	D158	1.20	.65	35/51	D205	.90	.49
74	D159	1.20	.65	37	D206	.90	.49
75	D160	1.20	.65	38	D207	.75	.40
76	D161	1.20	.65	39	D208	1.00	.54
77	D162	1.20	.65	40	D209	.90	.49
78	D163	1.50	.81	41	D211	.75	.40
79	D164	1.20	.65	42	D212	.75	.40
80	D165	1.50	.81	43	D213	1.00	.54
81	D166	1.50	.81	44	D209	.90	.49
82	D167	1.50	.81	45	D215	.70	.38
83	D168	1.85	1.00	46	D216	1.00	.54
84	D169	.90	.49	47	D217	1.00	.54
85	D170	1.00	.54	48	D218	2.75	1.48
86	D171	1.20	.65	49	D219	1.20	.65
87	D172	1.50	.81	50	D220	2.25	1.21
88	D173	1.50	.81	51	D221	1.50	.81
89	D174	1.50	.81	52	D222	1.00	.54
90	D175	1.00	.54	53	D223	.70	.38
91	D176	1.50	.81	54	D224	.80	.43
92	D177	1.50	.81	55	D225	.80	.43
93	D178	.90	.49	56	D226	1.50	.81
94	D179	1.50	.81	57	D227	.80	.43
95	D180	1.20	.65	58	D228	.75	.40
96	D181	.90	.49	59	D229	.80	.43
97	D182	1.00	.54	60	D230	.80	.43
98	D183	1.50	.81	77	D231	.80	.43
99	D184	1.20	.65	78	D232	1.50	.81
100	D185	1.50	.81	79	D233	.60	.32
101	D186	1.50	.81	80	D234	1.85	1.00
102	D187	1.20	.65	81	D235	1.20	.65
103	D188	1.50	.81	82	D236	1.20	.65
104	D189	.90	.49	83V	D237	1.85	1.00
105	D190	.80	.43	84	D238	1.00	.54
106	D191	1.85	1.00	85	D239	.80	.43
107	D192	1.85	1.00	86	D240	.90	.49
108	D193	1.20	.65	87A	D243	2.70	1.46
109	D194	.80	.43	87B	D244	8.00	4.32
110	D195	.90	.49	87C	D250	2.70	1.46
111	D196	.65	.35	88	D251	3.75	2.00
112	D197	.90	.49	89S	D252	3.75	2.00
113	D198	.65	.35	90	D253	2.25	1.21
114	D199	.60	.32	91	D254	2.25	1.21
115	D200	.90	.49	92			
116	D201	.90	.49	93			

Octal Base Glass "G" Type Tubes			
Type Num.	Stock Num.	List Price	Your Price
0A4G	D357	\$1.85	\$1.00
0Z4G	D337	1.50	.81
1A5G	D338	1.00	.54
1A7G	D339	1.50	.81
1C5G	D340	1.50	.81
1C7G	D302	1.20	.65
1D5GP	D303	1.20	.65
1D7G	D304	1.50	.81
1E5GP	D316	1.50	.81
1E7G	D305	2.25	1.21
1F5G	D306	1.20	.65
1F7GV	D307	1.50	.81
1G4G	D280	1.20	.65
1G6G	D281	1.50	.81
1G8G	D308	.90	.49
1H4G	D341	1.20	.65
1H5G	D309	1.20	.65
1H6G	D310	1.20	.65
1J6G	D342	1.50	.81
1N5G	D255	2.75	1.48
2A4G	D256	2.75	1.48
2V3G	D317	.90	.49
3U4G	D285	1.50	.81
5V4G	D286	1.00	.54
5X4G	D287	.60	.32
5Y3G	D311	.65	.35
6A5G	D327	1.20	.65
6A8G	D288	.90	.49
6AD7G	D257	1.50	.81
6B5G	D348	1.20	.65
6F6G	D343	1.50	.81
6B6G	D345	1.00	.54

"GT" Type Tubes			
Type Num.	Stock Num.	List Price	Your Price
1A7GT	D401	\$1.20	\$0.65
1D8GT	D448	1.40	.65
1D9GT	D402	1.85	1.00
1H5GT	D403	1.00	.54
1N5GT	D404	1.20	.65
1P5GT	D449	1.50	.81
1Q5GT	D405	1.50	.81
1T5GT	D406	1.50	.81
3A8GT	D493	2.25	1.21
3Q5GT	D494	1.50	.81
6A5GT	D451	1.20	.65
6A8GT	D454	.90	.49

Loctal Tubes			
Type Num.	Stock Num.	List Price	Your Price
7A6	D417	\$1.20	\$0.65
7A7	D410	1.20	.65
7A8	D411	1.20	.65
7B5	D499	1.20	.65
7B6	D362	1.20	.65
7B7	D412	1.20	.65
7B8	D262	1.20	.65
7C5	D263	1.20	.65
7C6	D349	1.20	.65
7C7	D261	1.20	.65
7Y4	D414	1.20	.65
35A5	D415	1.20	.65
35Z3	D416	1.20	.65

Octal Base Metal Tubes			
Type Num.	Stock Num.	List Price	Your Price
Z4	D388	\$1.50	\$0.81
W4	D389	1.85	1.00
Z4A	D390	1.20	.65
Z4B	D365	1.20	.65
Z4C	D378	1.85	1.00
AC7	D379	2.25	1.21
AG7	D380	2.25	1.21
B5	D354	1.85	1.00
C8	D366	1.00	.54
F5	D367	1.00	.54
F5F	D368	1.00	.54
IH6	D369	1.00	.54
IJ5	D370	.80	.43
IJ6	D371	.90	.49
IJ7	D372	1.00	.54
IJ8	D385	1.20	.65
IJ9	D372	1.85	1.00
IL6	D373	1.50	.81
IN7	D374	1.50	.81
IQ7	D375	1.20	.65
IR7	D376	1.50	.81
IS7	D377	1.50	.81
ISA7	D389	.90	.49
ISC7	D390	1.20	.65

"GT" Type Tubes (Continued)			
Type Num.	Stock Num.	List Price	Your Price
6F5GT	D407	.90	.49
6J5GT	D408	.80	.43
6J7GT	D409	1.00	.54
6K6GT	D440	.90	.49
6K7GT	D346	.90	.49
6Q7GT	D347	.80	.43
6V6GT	D441	1.00	.54
6X5GT	D496	.90	.49
12A5GT	D349	.90	.49
12F5GT	D442	.90	.49
12J5GT	D443	.90	.49
12K7GT	D350	.90	.49
12Q7GT	D351	.80	.43
25A5SGT	D497	1.50	.81
25L6GT	D356	1.00	.54
25Z6GT	D353	.90	.49
35L6GT	D354	.90	.49
35Z4GT	D355	.70	.38
35Z5GT	D445	.75	.40
45Z5GT	D498	1.00	.54
50E6GT	D446	1.00	.54
50V6GT	D465	1.00	.54
70L7GT	D488	1.85	1.00
11Z6GT	D491	1.50	.81
11Z7GT	D492	2.25	1.21



**Radio Tube Manual**

192 Pages of complete information covering all current types of receiving tubes. Contains charts, diagrams, theory, circuit design data and other very useful information. Size, 5 1/2 x 8 1/2".

**D12465—YOUR PRICE... 25¢**

D12462—Ham Tips—Published monthly. Full of up to date tips and instructions on Amateur Radio.

Free with order for RCA Tubes





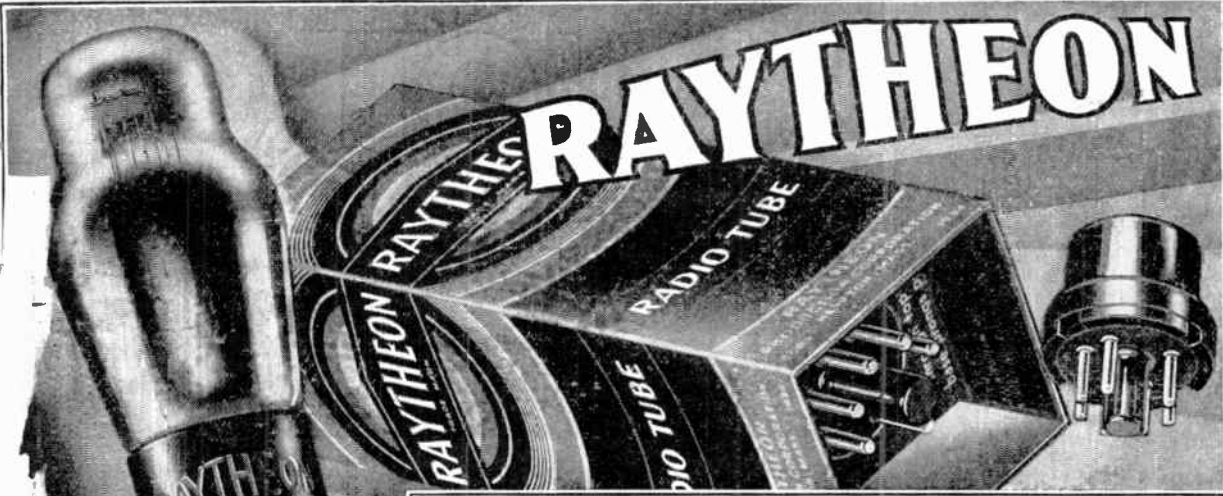

Tube Prices  
Are Subject to  
Market Change

Tubes May Be  
Assorted to Obtain  
25-50 Lot Price

### Standard Base Glass Tubes

2-1/2 2-1/4 2-1/8 2 1 1/2 1 1/4 1 1/8 1 3/4 3/8 3/16 1/8 1/16 1/32	Stock Num.	List Price	Your Price Ea. 1-14	15-Up	Type Num.	Stock Num.	List Price	Your Price Ea. 1-14	15-Up
4AT	D561	\$0.80	\$0.43	\$0.40	33	D611	\$1.25	\$0.67	\$0.62
4AT	D563	.80	.43	.40	34	D612	1.25	.67	.62
4AT	D564	1.25	.67	.62	35/51	D613	.80	.43	.40
4AT	D562	1.25	.67	.62	36	D614	.80	.43	.40
4AT	D565	1.25	.67	.62	37	D615	.70	.38	.35
4AT	D566	1.25	.67	.62	38	D616	1.00	.54	.50
1B5	D567	1.00	.54	.50	39/44	D617	.80	.43	.40
1C6	D568	1.25	.67	.62	41	D619	.70	.38	.35
1F4	D569	1.00	.54	.50	42	D620	.70	.38	.35
1T6	D570	1.00	.86	.80	43	D621	1.00	.54	.50
2A3	D571	2.10	1.13	1.05	45	D622	.70	.38	.35
2A5	D573	.80	.43	.40	46	D623	1.00	.54	.50
2A6	D574	.80	.43	.40	47	D624	1.00	.54	.50
2A7	D575	1.00	.54	.50	48	D625	2.70	1.46	1.35
7B7	D576	1.25	.67	.62	49	D626	1.00	.54	.50
7E5	D577	1.25	.67	.62	52	D628	2.70	1.46	1.35
5Z3	D578	.80	.43	.40	53	D629	1.25	.67	.62
6A3	D579	2.10	1.13	1.05	55	D630	1.00	.54	.50
6A4/LA	D580	1.25	.67	.62	56	D631	.70	.38	.35
6A6	D581	1.25	.67	.62	57	D632	.50	.43	.40
6A7	D582	.80	.43	.40	58	D633	.80	.43	.40
6A8/5	D600	1.00	.86	.80	59	D634	1.60	.86	.80
6B5	D583	2.10	1.13	1.05	71A	D635	.80	.43	.40
6B7	D584	1.25	.67	.62	75	D636	.70	.38	.35
6C6	D585	.80	.43	.40	76	D637	.70	.38	.35
6D6	D586	.80	.43	.40	77	D638	.80	.43	.40
6E4	D587	1.00	.54	.50	78	D639	.50	.43	.40
6E6	D588	1.00	.86	.80	79	D640	1.25	.67	.62
6F7	D589	1.25	.67	.62	80	D641	.80	.43	.40
6N5	D660	1.00	.86	.80	81	D642	1.60	.86	.80
6G5/6G5	D662	1.00	.54	.50	82	D643	1.00	.54	.50
6Z4	D592	1.00	.54	.50	83	D644	1.00	.54	.50
12A	D596	.80	.43	.40	83V	D645	1.00	.86	.80
12A5	D597	2.10	1.13	1.05	84	D592	1.00	.54	.50
12A7	D598	1.00	.86	.80	85	D647	.80	.43	.40
12Z3	D599	.80	.43	.40	89	D648	.80	.43	.40
15	D600	1.00	.86	.80	V99	D649	2.70	1.46	1.35
19	D601	1.25	.67	.62	X99	D650	2.70	1.46	1.35
20	D602	2.70	1.46	1.35	182B	D651	1.60	.86	.80
20A	D603	.80	.43	.40	183/483	D652	1.00	.86	.80
255	D604	1.00	.54	.50	482B	D653	1.60	.86	.80
25Z5	D605	.80	.43	.40	485	D654	1.60	.86	.80
26	D606	.60	.32	.30	950	D655	3.50	3.51	3.25
27	D607	.80	.43	.40	BA	D656	6.50	1.97	1.82
30	D608	.80	.43	.40	BH	D657	2.65	1.43	1.32
31	D609	.80	.43	.40	BR	D658	2.10	1.13	1.05
35	D610	2.10	1.13	1.05	VR150	D666	2.50	1.35	1.25
35Y5	D611	1.25	.67	.62	WX885	D667	3.70	2.08	2.00
32	D612	1.25	.67	.62					

### All Metal Octal Base Tubes

2-1/2 2-1/4 2-1/8 2 1 1/2 1 1/4 1 1/8 1 3/4 3/8 3/16 1/8 1/16 1/32	Stock Num.	List Price	Your Price Ea. 1-14	15-Up	Type Num.	Stock Num.	List Price	Your Price Ea. 1-14	15-Up
0Z4	D818	\$1.80	\$0.86	\$0.80	65C7	D828	1.25	.67	.62
5W4	D800	1.00	.54	.50	65F5	D829	1.00	.54	.50
5T4	D801	1.00	.86	.80	65J7	D828	1.00	.54	.50
5Z4	D801	1.25	.67	.62	65K7	D829	1.00	.54	.50
6A8	D802	1.25	.67	.62	65Q7	D830	1.00	.54	.50
6B8	D669	1.00	.86	.80	6V6	D821	1.60	.86	.80
6C5	D804	1.00	.54	.50	6X5	D814	1.60	.86	.80
6F5	D805	1.00	.54	.50	12C8	D831	1.60	.86	.80
6F6	D805	1.00	.54	.50	12S A7	D832	1.25	.67	.62
6H6	D806	1.00	.54	.50	12S C7	D833	1.25	.67	.62
6L5	D822	1.00	.54	.50	12S F5	D671	1.25	.67	.62
6J7	D808	1.00	.54	.50	12S J7	D834	1.00	.54	.50
6K7	D809	1.00	.54	.50	12S K7	D835	1.00	.54	.50
6K8	D823	1.25	.67	.62	12S Q7	D836	1.00	.54	.50
6L6	D810	1.60	.86	.80	25A6	D672	1.60	.86	.80
6L7	D811	1.25	.67	.62	26A6	D820	1.25	.67	.62
6N7	D812	1.25	.67	.62	25Z6	D817	1.25	.67	.62
6Q7	D813	1.00	.54	.50	1851	D673	3.90	2.10	2.10
6R7	D813	1.25	.67	.62	1852	D674	2.70	1.46	1.35
6S7	D670	1.25	.67	.62	1853	D675	2.70	1.46	1.35
6SA7	D825	1.00	.54	.50					

### "G" Type Octal Base Glass Tubes

Type Num.	Stock Num.	List Price	Your Price Ea. 1-14	15-Up	Type Num.	Stock Num.	List Price	Your Price Ea. 1-14	15-Up
0A4-G	D740	\$1.00	\$0.86	\$0.80	6D8-G	D717	\$1.25	\$0.67	\$0.62
0Z4-G	D742	1.25	.67	.62	6F5-G	D718	.80	.43	.40
1A5-G	D747	1.25	.67	.62	6F6-G	D719	.80	.43	.40
1A7-G	D768	1.25	.67	.62	6F8-G	D713	1.25	.67	.62
1B7-G	D779	1.25	.67	.62	6G6-G	D784	1.25	.67	.62
1C5-G	D769	1.25	.67	.62	6H6-G	D720	1.00	.54	.50
1C7-G	D790	1.25	.67	.62	6J5-G	D721	.80	.43	.40
1D5-GP	D791	1.25	.67	.62	6J7-G	D722	1.00	.54	.50
1D5-GT	D790	1.25	.67	.62	6J8-G	D765	1.60	.86	.80
1E4-G	D781	1.25	.67	.62	6K5-G	D723	.80	.43	.40
1F7-GH	D740	1.60	.86	.80	6K6-G	D724	1.00	.54	.50
1G4-G	D732	1.00	.54	.50	6K7-G	D725	1.00	.54	.50
1G5-G	D713	1.25	.67	.62	6K8-G	D777	1.25	.67	.62
1G6-G	D733	1.25	.67	.62	6L6-G	D727	1.60	.86	.80
1H4-G	D708	.80	.43	.40	6L7-G	D728	1.25	.67	.62
1H5-GT	D771	1.00	.54	.50	6N6-G	D729	2.10	1.13	1.05
1J6-G	D708	1.25	.67	.62	6N6MG	D730	1.60	.86	.80
1N5-G	D772	1.25	.67	.62	6N7-G	D731	1.25	.67	.62
1N6-G	D784	1.25	.67	.62	6P5-G	D778	.70	.38	.35
1Q5-G	D786	1.25	.67	.62	6Q7-G	D734	1.00	.86	.80
2A4-G	D737	2.10	1.13	1.05	6R7-G	D733	1.25	.67	.62
4A6-G	D773	1.60	.86	.80	6U7-G	D749	.80	.43	.40
5U4-G	D744	1.00	.54	.50	6V6-G	D750	1.00	.54	.50
5W4-G	D755	1.00	.54	.50	6V7-G	D751	1.25	.67	.62
5X4-G	D676	1.00	.54	.50	6W5-G	D757	1.25	.67	.62
5Y3-G	D711	.60	.32	.30	6X5-G	D737	1.00	.54	.50
5Y4-G	D712	.60	.32	.30	6Z7.5-G	D760	1.00	.54	.50
6A6-G	D756	1.60	.86	.80	25A6-G	D738	1.00	.54	.50
6AC5-G	D732	1.00	.54	.50	25A7-G	D732	1.60	.86	.80
6AF5G	D677	1.25	.67	.62	25AC5G	D789	1.60	.86	.80
6AF6-G	D776	1.25	.67	.62	25B6-G	D741	1.60	.86	.80
6A8-G	D713	.80	.43	.40	25C6-G	D790	1.60	.86	.80
6B4-G	D714	1.60	.86	.80	25L6-G	D753	1.25	.67	.62
6B6-G	D715	1.00	.54	.50	25Z6-G	D739	.80	.43	.40
6B8-G	D746	1.25	.67	.62	35Z6-G	D678	1.25	.67	.62
6C6-G	D716	.80	.43	.40	50C6G	D679	1.60	.86	.80
6C8-G	D737	1.25	.67	.62					

### "GT" Type Octal Base Glass Tubes

Type Num.	Stock Num.	List Price	Your Price Ea. 1-14	15-Up	Type Num.	Stock Num.	List Price	Your Price Ea. 1-14	15-Up
1A5GT	D850	1.00	.54	.50	6V6GT	D875	1.00	.54	.50
1A7GT	D851	1.25	.67	.62	6X5GT	D885	1.00	.54	.50
1C5GT	D852	1.25	.67	.62	12A8GT	D877	1.00	.54	.50
1D5GT	D861	1.25	.67	.62	12B8GT	D878	1.60	.86	.80
1D8GT	D681	2.70	1.13	1.05	12F5GT	D879	.80	.43	.40
1H5GT	D853	1.00	.54	.50	12J5GT	D880	.80	.43	.40
1N5GT	D854	1.25	.67	.62	12J7GT	D881	1.00	.54	.50
1P5GT	D856	1.25	.67	.62	12K7GT	D882	1.00	.54	.50
1Q5GT	D859	1.25	.67	.62	12O7GT	D885	.80	.43	.40
1T5GT	D858	1.25	.67	.62	12S A7GT	D884	1.25	.67	.62
3A8GT	D682	2.10	1.13	1.05	12S F5GT	D885	1.00	.54	.50
3Q5GT	D857	1.60	.86	.80	12S J7GT	D886	1.00	.54	.50
6A8GT	D858	.80	.43	.40	12S K7GT	D887	1.00	.54	.50
6C5GT	D863	.80	.43	.40	12S Q7GT	D888	1.00	.54	.50
6F5GT	D858	.80	.43	.40	25A6GT	D888	1.60	.86	.80
6H6GT	D860	1.60	.86	.80	25A7GT	D890	1.60	.86	.80
6H8GT	D862	1.00	.54	.50	25B8GT	D891	2.10	1.13	1.05
6J5GT	D863	.80	.43	.40	25L6GT	D892	1.60	.86	.80
6J7GT	D864	1.00	.54	.50	25Z6GT	D893	.80	.43	.40
6K6GT	D865	1.00	.54	.50	32L7GT	D894	1.60	.86	.80
6K7GT	D866	1.00	.54	.50	35L6GT	D895	1.00	.54	.50
6K8GT	D867	1.25	.67	.62	35Z4GT	D896	.70	.38	.35
6P5GT	D868	.70	.38	.35	35Z6GT	D897	.80	.43	.40
6Q7GT	D869	.70	.38	.35	45Z6GT	D898	1.25	.67	.62
6R7GT	D874	.80	.43	.40	50L6GT	D899	1.25	.67	.62
6SA7GT	D879	1.00	.54	.50	50V6GT	D899	1.25	.67	.62

# RADIOTRON



All tubes are supplied in factory sealed cartons. Carry the same guarantee against electrical and mechanical defects as other well known brands. RCA transmitting tubes are listed on page 154. Radolek will supply you promptly

with all RCA Radio Test Instruments Parts and Accessories at lowest prices. See Page 12 for RCA Test Instruments. RCA Phonograph parts shown on Page 93 and 95. Place your orders with Radolek for all RCA items.

**Tubes May Be Assorted To Obtain Quantity Price**

Tube prices are subject to market change. Write for larger quantity prices.

## R.C.A.

## GLASS TUBES

## Octal Base Glass "G" Type Tubes

Type Num.	Stock Num.	Last Price	Your Price Ea.	Type Num.	Stock Num.	Last Price	Your Price Ea.
			1-14 15-Up				1-14 15-Up
00A	D155	\$2.40	\$1.23 \$1.05	32	D202	\$1.25	\$0.67 \$0.62
01A	D156	1.80	.43 .40	33	D203	1.25	.67 .62
1A4P	D157	1.25	.67 .62	34	D204	1.25	.67 .62
1A6	D158	1.25	.67 .62	35 51	D205	80	.43 .40
1B4P	D159	1.25	.67 .62	36	D206	80	.43 .40
1B5	D160	1.00	.54 .50	37	D207	.70	.38 .35
1C6	D161	1.25	.67 .62	38	D208	1.00	.54 .50
1F4	D164	1.00	.54 .50	39	D209	.80	.43 .40
1F6	D165	1.00	.86 .80	40	D211	.70	.38 .35
1R5	D162	1.00	.86 .80	42	D212	.70	.38 .35
1S4	D166	1.60	.86 .80	43	D213	1.00	.54 .50
1S5	D173	1.60	.86 .80	44	D209	.80	.43 .40
1T4	D174	1.60	.86 .80	45	D215	.70	.38 .35
1-V	D163	.80	.43 .40	46	D216	1.00	.54 .50
2A3	D167	2.10	1.23 1.05	47	D217	1.00	.54 .50
2A5	D168	.80	.43 .40	48	D218	2.70	1.46 1.35
2A6	D169	.80	.43 .40	49	D219	1.00	.54 .50
2A7	D170	1.00	.54 .50	50	D220	2.10	1.13 1.05
2B7	D171	1.25	.67 .62	53	D221	1.25	.67 .62
5Z3	D172	.80	.43 .40	55	D222	1.00	.54 .50
6A4	D176	1.25	.67 .62	56	D223	.70	.38 .35
6A6	D177	1.25	.67 .62	57	D224	.80	.43 .40
6A7	D178	.80	.43 .40	58	D225	.80	.43 .40
6AB5	D185	1.50	.86 .80	59	D226	1.60	.86 .80
6B5	D172	2.10	1.13 1.05	71A	D227	.30	.43 .40
6B7	D179	1.25	.67 .62	75	D228	.70	.38 .35
6C6	D180	.80	.43 .40	76	D229	.70	.38 .35
6D6	D181	.80	.43 .40	77	D230	.80	.43 .40
6E5	D182	1.00	.54 .50	78	D231	.80	.43 .40
6F7	D183	1.25	.67 .62	79	D232	1.25	.67 .62
6G5	D184	1.00	.54 .50	80	D233	.40	.32 .30
6N5	D246	1.60	.86 .80	81	D234	1.60	.86 .80
6U5	D184	1.00	.54 .50	82	D235	1.00	.54 .50
10	D187	2.70	1.46 1.35	83	D236	1.00	.54 .50
112A	D190	.80	.43 .40	83V	D237	1.00	.86 .80
12A7	D186	1.60	.86 .80	84	D238	1.00	.54 .50
12Z3	D191	1.30	.43 .40	85	D239	.80	.43 .40
15	D192	1.60	.86 .80	89	D240	.80	.43 .40
19	D193	1.25	.67 .62	87A	D243	2.70	1.46 1.35
24A	D196	.80	.43 .40	87B	D244	8.00	4.32 4.00
25Z5	D197	.80	.43 .40	879	D250	2.70	1.46 1.35
26	D198	.60	.32 .30	884	D251	3.75	2.00 2.00
27	D199	.60	.32 .30	885	D252	3.75	2.00 2.00
30	D200	.80	.43 .40	VR105-30	D253	2.30	1.25 1.25
31	D201	.80	.43 .40	VR150-30	D254	2.30	1.25 1.25

Type Num.	Stock Num.	Last Price	Your Price Ea.	Type Num.	Stock Num.	Last Price	Your Price Ea.
			1-14 15-Up				1-14 15-Up
0A4G	D337	\$1.60	\$0.86 \$0.80	6B8G	D320	\$1.25	\$0.67 \$0.62
0A6G	D337	1.25	.67 .62	6C5G	D289	.80	.43 .40
1A5G	D338	1.25	.67 .62	6C8G	D328	1.25	.67 .62
1A7G	D339	1.25	.67 .62	6D8G	D321	1.25	.67 .62
1C5G	D340	1.25	.67 .62	6F5G	D290	.80	.43 .40
1C7G	D302	1.25	.67 .62	6FG	D291	.80	.43 .40
1D5GP	D303	1.25	.67 .62	6F8G	D329	1.25	.67 .62
1D7G	D304	1.25	.67 .62	6G6G	D330	1.25	.67 .62
1E5GP	D316	1.25	.67 .62	6H6G	D292	1.00	.54 .50
1E7G	D305	2.10	1.13 1.05	6J5G	D318	.80	.43 .40
1F5G	D306	1.25	.67 .62	6J7G	D293	.80	.43 .40
1F7GV	D307	1.60	.86 .80	6K5G	D312	.80	.43 .40
1G4G	D280	1.00	.54 .50	6K6G	D313	.80	.43 .40
1G5G	D326	1.25	.67 .62	6K7G	D324	.80	.43 .40
1G6G	D281	1.25	.67 .62	6L5G	D322	1.00	.54 .50
1H4G	D308	.80	.43 .40	6L6G	D314	1.60	.86 .80
1H5G	D341	1.00	.54 .50	6L7G	D295	1.25	.67 .62
1H6G	D309	1.00	.54 .50	6N6G	D322	2.10	1.13 1.05
1J6G	D310	1.25	.67 .62	6N7G	D296	1.25	.67 .62
1N5G	D342	1.25	.67 .62	6P5G	D283	.70	.38 .35
2A6G	D255	2.70	1.46 1.35	6Q7G	D297	.70	.38 .35
5V3G	D256	3.00	1.95 1.95	6R7G	D298	.80	.43 .40
5U4G	D317	1.00	.54 .50	6T7G	D323	1.25	.67 .62
5V4G	D285	1.60	.86 .80	6G7G	D324	1.25	.67 .62
5X4G	D286	1.00	.54 .50	6U7G	D331	.80	.43 .40
5Y3G	D287	.60	.32 .30	6V6G	D319	1.00	.54 .50
5Y4G	D311	.60	.32 .30	6X5G	D299	1.00	.54 .50
6AC5G	D327	1.00	.54 .50	6Y7G	D260	1.60	.86 .80
6AD7G	D288	.80	.43 .40	6Z5YG	D334	1.00	.54 .50
6A6G	D257	1.25	.67 .62	25A6G	D300	1.00	.54 .50
6A7G	D258	1.25	.67 .62	25B6G	D315	1.60	.86 .80
6AF6G	D343	1.25	.67 .62	25L6G	D325	1.25	.67 .62
6B6G	D345	1.00	.54 .50	25Z6G	D301	.80	.43 .40

## Octal Base Metal Tubes

Type Num.	Stock Num.	Last Price	Your Price Ea.	Type Num.	Stock Num.	Last Price	Your Price Ea.
			1-14 15-Up				1-14 15-Up
0Z4	D388	\$1.00	\$0.86 \$0.80	6SF5	D391	\$1.00	\$0.54 \$0.50
5T4	D359	1.60	.86 .80	6SJ7	D392	1.60	.86 .80
5W4	D360	1.60	.86 .80	6SK7	D393	1.00	.54 .50
5Z4	D361	1.25	.67 .62	6SQ7	D394	1.00	.54 .50
6A8	D365	1.25	.67 .62	6SR7	D358	1.00	.54 .50
6AB7	D378	2.70	1.46 1.35	6V6	D387	1.60	.86 .80
6AC7	D379	2.70	1.46 1.35	6X5	D377	1.60	.86 .80
6AG7	D380	2.70	1.46 1.35	12C8	D395	1.60	.86 .80
6B8	D354	1.60	.86 .80	12K8	D381	1.25	.67 .62
6C5	D396	1.00	.54 .50	12SA7	D386	1.25	.67 .62
6C6	D397	1.00	.54 .50	12S6Z7	D387	1.25	.67 .62
6F6	D368	1.00	.54 .50	12SF5	D336	1.00	.54 .50
6H6	D369	1.00	.54 .50	12S7	D398	1.00	.54 .50
6J5	D363	1.00	.54 .50	12S7K	D399	1.00	.54 .50
6J7	D370	1.00	.54 .50	12SQ7	D400	1.00	.54 .50
6K7	D371	1.00	.54 .50	12SR7	D348	1.00	.54 .50
6K8	D385	1.25	.67 .62	25A6	D382	1.00	.86 .80
6L6	D372	1.60	.86 .80	25L6	D384	1.25	.67 .62
6L7	D373	1.25	.67 .62	25Z6	D383	1.25	.67 .62
6N7	D374	1.25	.67 .62	16Z0	D511	4.05	2.50 2.50
6Q7	D375	1.60	.86 .80	16Z1	D512	4.05	2.50 2.50
6R7	D376	1.25	.67 .62	16Z2	D513	5.10	2.75 2.75
6S7	D386	1.25	.67 .62	18S1	D514	3.00	2.10 2.10
6SA7	D389	1.00	.54 .50	18S2	D515	2.70	1.46 1.46
6SC7	D390	1.25	.67 .62	18S3	D516	2.70	1.46 1.35

## "GT" Type Tubes

Type Num.	Stock Num.	Last Price	Your Price Ea.
			1-14 15-Up
1A7GT	D401	\$1.25	\$0.67 \$0.62
1A5GT	D448	1.25	.67 .62
1D8GT	D402	2.10	1.13 1.05
1H5GT	D403	1.00	.54 .50
1N5GT	D404	1.25	.67 .62
1P5GT	D449	1.25	.67 .62
1Q5GT	D405	1.25	.67 .62
1T5GT	D406	1.25	.67 .62
3A8GT	D493	2.10	1.13 1.05
3Q5GT	D494	1.60	.86 .80
6Y5GT	D451	1.60	.86 .80
6ARCT	D344	1.00	.54 .50
6F5GT	D407	.80	.43 .40
6J5GT	D408	.80	.43 .40
6J7GT	D409	1.00	.54 .50
6K6GT	D440	1.00	.54 .50
6K7GT	D346	1.00	.54 .50
6Q7GT	D347	.80	.43 .40
6V6GT	D441	1.00	.54 .50
6X5GT	D496	1.00	.54 .50
12A8GT	D349	1.00	.54 .50
12F5GT	D442	.80	.43 .40
12Y5GT	D443	.80	.43 .40
12K7GT	D350	1.00	.54 .50
12Q7GT	D351	.80	.43 .40
25AC5GT	D497	1.60	.86 .80
25L6GT	D356	1.00	.54 .50
25Z6GT	D353	.80	.43 .40
35L6GT	D354	1.00	.54 .50
35Z4GT	D355	.70	.38 .35
42S5GT	D445	.80	.43 .40
42S6GT	D498	1.00	.54 .50
50Y6GT	D446	1.25	.67 .62
70A4	D447	1.00	.54 .50
70L7GT	D488	2.10	1.13 1.05
11Z76GT	D491	1.60	.86 .80
11Z7N7GT	D492	2.10	1.13 1.05

## Loctal Tubes

Type Num.	Stock Num.	Last Price	Your Price Ea.
			1-14 15-Up
7A6	D417	\$1.25	\$0.67 \$0.62
7A7	D418	1.25	.67 .62
7A8	D419	1.25	.67 .62
7B5	D499	1.25	.67 .62
7B6	D462	1.25	.67 .62
7B7	D412	1.25	.67 .62
7B8	D262	1.25	.67 .62
7C5	D263	1.25	.67 .62
7C6	D413	1.25	.67 .62
7C7	D261	1.25	.67 .62
7Y4	D414	1.25	.67 .62
35A5	D415	1.25	.67 .62
35Z3	D416	1.25	.67 .62

### Radio Tube Manual

192 Pages of complete information covering all current types of receiving tubes. Contains charts, diagrams, test data and other very useful information. Size, 4 1/2 x 6 1/2 inches.

**FREE WITH ORDER**

**D12465—YOUR PRICE... 25¢**

**D12462—Ham Tips—Published Monthly.** Full of up-to-date tips and instructions on Amateur Radio. Free with order for RCA Tubes.



# RADIO *Readrite* TESTERS

## RANGER

### Direct Reading Tube Checkers for Tubes of Today and Tomorrow With "Red Dot" Meter



Model 432A and Model 432A-742 tube checkers are supplied with the famous Triplett "Red Dot" lifetime guaranteed Meters as your assurance of life time service. No tester is better than the meter used in it. Triplett makes only quality instruments and uses the "Red Dot" insignia to bring to your attention the quality construction of these instruments.

**Model 432A**  
D17027—As illustrated at left.  
Size 9x8½x7".  
**YOUR PRICE \$1749**

D17014 — With tool and parts compartment in case.  
Size 9½x10½x6¾".  
**YOUR PRICE... \$1847**

The outstanding tube tester buy—quality without extravagance. Designed to test the tubes of tomorrow as well as today. A safeguard against further tube changes is provided by the flexible filament switching arrangement giving any voltage from 1 to 120. Tester has sockets for Loctal, Single Ended, Bantam Jr., Gaseous Rectifier, Ballast and all regular type tubes. Separate plate tests on slightest shorts and leakages. The large 3" square "Red Dot" Triplett Precision Meter has a 1 M. A. D'Arsonval movement with direct reading 3 color scale and best quality sapphire jewel bearings. Separate line voltage meter permits constant line voltage indication and control without readjusting controls. The instrument is designed for professional appearance as well as simple operation. Modernistic etched panel in silver and black. Housed in portable leatherette covered carrying case with removable hinged cover—suitable for either counter or portable use. Up-to-date charts are furnished as new tubes appear. Complete with operating instructions. For 105-120 volt, 60 cycle AC operation.

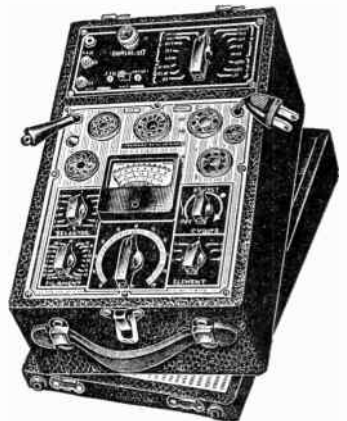

**Model 432A-742**  
Has Built-In Volt-Ohm-Milliampere Tester

D17029—In case as illustrated at right. Size 12½x8½x7½".  
**YOUR PRICE... \$2631**

D17013 — In case with compartment for parts and tools. Size 13x10½x7".  
**YOUR PRICE... \$2729**

This Tube Tester-Volt-Ohm-MA Tester Combination gives the serviceman everything he could expect from separate units. An outstanding quality model at a price within reach of everyone. The tube testing unit is exactly identical with model 432A listed at left. The Volt-Ohm-MA section is a separate panel with range selector switch, ohmmeter zero adjuster and jacks. Ranges provided: AC-DC Volts, 0-10-50-250-500-2500 (DC at 1000 o.p.v.). DC Milliamperes, 0-1-10-100. Resistance: .5 to 500 ohms (25 mid-scale), 0-100,000 ohms and 0-1½ megohms. Ohmmeter is battery operated. The circuit is favored by servicemen who demand more accuracy than obtained from ordinary ohmmeter power supply cases. Both units are housed together in attractive black leatherette covered case with removable hinged cover... suitable for either counter or portable use. Panels are etched and finished in silver and black. Complete with test leads and instructions. Less battery, use 1½v. flashlight type.

plates and rectifiers are provided. Neon shorts indicator instantly shows the slightest shorts and leakages. The large 3" square "Red Dot" Triplett Precision Meter has a 1 M. A. D'Arsonval movement with direct reading 3 color scale and best quality sapphire jewel bearings. Separate line voltage meter permits constant line voltage indication and control without readjusting controls. The instrument is designed for professional appearance as well as simple operation. Modernistic etched panel in silver and black. Housed in portable leatherette covered carrying case with removable hinged cover—suitable for either counter or portable use. Up-to-date charts are furnished as new tubes appear. Complete with operating instructions. For 105-120 volt, 60 cycle AC operation.

### "Big Boy" Volt-Ohm-Milliammeter

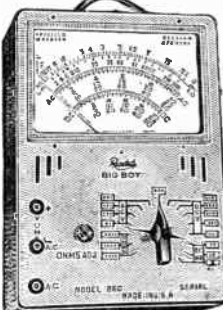

With 6" Scale Meter  
**Model 860**

D17012—Model 860. Complete with test leads and instructions. Battery provided for ohms ranges up to 100,000 ohms. (Has provisions for self-contained 22½ volt C battery for higher ohm ranges).  
**YOUR PRICE... \$1749**

Incorporates a fine quality giant 6 inch scale D'Arsonval movement type meter featuring two genuine sapphire jewel bearings. All scales are easily and readily readable. Ranges: DC Volts, 0-10-50-250-500-1000 at 1000 o.p.v. AC Volts, 0-10-50-250-1000 at 400 o.p.v. DC Ma., 0-1-10-100. Resistance, 0-500-100,000-1.5 megohms with zero adjustment. Selector switch makes all ranges instantly available at three tip jacks. Attractively designed metal case finished in maroon with cream-yellow panel and red trim and markings. Size 11½x7¾x4½". Attached handle for carrying.

### Model 557 All Wave Signal Generator

Direct Reading

A17004 — Complete Signal Generator to tune from 110 to 20,000 Kc. Batteries, cables, tubes and instructions included. List Price, \$31.50.  
**YOUR PRICE... \$1852**

Covers from 110 Kc. to 20 Mc. all on fundamental frequencies. Each of the five plug-in coils supplied is calibrated by an exclusive method of peaking with built-in trimmer condensers. Large full vision direct reading dial with translucent dial pointer. Guaranteed Accuracy of 1% from 110 to 3,000 Kc.; 2% for higher frequencies. Separate radio and audio generator stages. Free from frequency shift due to output attenuation or battery voltage. Completely shielded from static and magnetic fields. Effective attenuation and stability together with strong signal strength either modulated or unmodulated. Supplied complete with two type 30 laboratory tested aged tubes and all batteries. Size 12"x6½"x5¾" high. The instrument is housed in an all metal case and placed in a fabricoid covered carrying case.

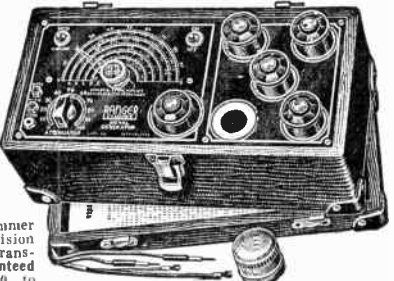

### Radio Set Analyzers



**Model 710A**

D17026—Model 710A. Complete with analyzer plug and cable, adaptors and test leads.  
**YOUR PRICE... \$1617**

Checks all parts of radio tube circuits by plugging directly into the receiving set socket. For all 4-5-6-7 and octal prong tube types except loctals and miniature types (loctal adaptors must be purchased separately). Ranges: DC Volts, 0-15-60-300-600; DC Mils., 0-15-150; and AC Volts, 0-10-140-700. Selector switch and jacks are provided to make individual range connections for each of the three meters. Black leatherette covered case. Size, 11"x8½"x4".

### Model 720A Point to Point Set Analyzer

Measures resistance, capacity, continuity and voltage of any tube circuit. Point-To-Point tests are made by plugging into the receiving set sockets. Accommodates all 4, 5, 6, 7 and octal prong tubes except loctals and miniature types (loctal adaptors must be purchased separately). Tester socket terminals are arranged to RMA standards, making it unnecessary to remove chassis from cabinet. Rotation of tube elements does not affect tests. Has two meters—DC scale reading 15-150-300-600 volts, 15-150 milliamperes; AC scale reading 10-25-150-750 volts. Black leatherette covered case similar to above in appearance. Size, 11"x8½"x4". Removable hinged cover.

D17021—Model 720-A. Complete with Analyzer cable, 5 adaptors and voltmeter at 1,000 o.p.v.  
**YOUR PRICE... \$1470**

D17022—Model 730-A. Same as Model 720-A, but has Triplett DC test leads.  
**YOUR PRICE... \$1823**

D12053—Socket Adapter 73c  
D12054—Plug Adapter \$1.18

### Readrite Volt-Ohm Milliammeters

With Triplett "Red Dot" Meters

A quality constructed volt-ohm-milliammeter tester at an exceptionally low price. Attractive molded case has corners rounded with modernistic silver and black panels. Precision life-time guaranteed 3" Sq. D'Arsonval movement meters have 2 genuine sapphire jewel bearings and zero scale adjustment screw. Range selector switch provides: AC-DC Volts, 0-15-150-750-1500 (DC at 1000 o.p.v.). DC Milliamperes, 0-1½-15-150. Ohms, 0-500 (25 ohms at mid-scale) and 0-500,000. Has ohmmeter adjuster for battery deterioration. Case size: 3½"x5¾"x2¾".

C17030—Model 739. Complete with test leads, battery and instructions.  
**YOUR PRICE... \$970**

C17031—Model 738. Same as above Model 739 but does not have AC voltage ranges.  
**YOUR PRICE... \$735**

### Model 612 Multi-Tester

A universal wide range instrument. Has "Red Dot" life-time guaranteed Triplett AC repulsion type 3" sq. meter with two genuine sapphire jewel bearings. Ranges: AC-DC Volts, 0-15-150-450 at 60 ohms per volt sensitivity. AC-DC Mills, 0-15. Capacity, .01 to 20 Mfd. Ohms, 0-20,000-100,000 with zero adjuster. Does not use batteries; current source is obtained from AC-DC lines. Selector switch. Black molded case. Size, 3½"x5¾"x2¾".

C17015—Model 612. Complete with test leads, cord and plug.  
**YOUR PRICE... \$779**



### Carrying Case

C17016—For Models 738-739-612. All leather case with strap carrying handle. Has space for accessories.  
**YOUR PRICE... \$353**



# TRIPLETT INSTRUMENTS

## Now On Time Payments

All instruments listed below, except Model 1181-B, contain the new Triplett "Red Dot" Life-time Guaranteed Meter as your assurance of life time service.

### Model 1612 Modernistic Tube Tester



#### New Low Price—Superlative Features

With Large 6" Scale Square Meter  
And Roll Chart for Speed and Convenience

**C17036—Model 1612 for Counter** \$29<sup>24</sup>  
use. Size, 15 1/4 x 11 1/2 x 6".  
YOUR PRICE.....

Or \$4.50 Down and \$3.70 for 8 Months.

**C17044—Model 1613 for Portable and Counter use.** \$34<sup>14</sup>  
Has metal detachable cover with carrying handle. Size, 15 1/4 x 11 1/2 x 6 1/2".  
YOUR PRICE.....

Or \$5.25 Down and \$4.35 for 8 Months.

Graceful, flowing, streamline appearance, color contrast and the new low price. Will instantly appeal to the dealer and serviceman. Includes many features incorporated in higher priced Triplett Tube Testers. The large square "Red Dot" quality, life-time guaranteed meter has direct reading 6" scale and two sapphire jewel bearings. Illuminated roll chart indicates all control settings. Completely protected against obsolescence. Tests all tubes including octals, Loctals, single ended, Bantam Jrs., gaseous rectifiers, new high voltage series, ballasts and pilot lamps. Filament voltages from 1 to 120 volts are available. Separate line voltage meter eliminates necessity of readjustment of controls. Has jack for using headphones for noise indication (no headphones included). Complete shorts and leakage tests are provided with neon bulb indication. Anyone can make tube tests with the greatest speed and accuracy.

#### New Streamline Design

Modernistic heavy steel case is beautifully finished in baked-on silvered grey suede enamel with trimming and controls in maroon. For 105-120 volt 50-60 cycle AC operation.

## Anti-Obsolescence Tube Testers

### New Sectional Panel Design With Large 6" Square Meter

#### Model 1620

**D17057—Model 1620 Counter Model Tube Tester.** Complete with operating instructions. \$37<sup>08</sup>  
YOUR PRICE.....

Or \$5.70 Down and \$4.75 for 8 Months

A sensational new tube tester with every facility for convenience of operation and non-obsolescence due to future tube releases. Constructional features include spare socket and three sectional front panel, either section of which may be changed individually, at minimum cost, should now unlooked for new tube releases ever require it. New lever type, highly flexible switching system, provides individual connections for each tube element. Simple to operate. Socket panel accommodates all present receiving tubes including octals, loctals, Bantam, Jr. and all miniature types. Filament voltages from 1.1 to 110 volts are provided. "Large 6" square D'Arsonval movement, direct reading, "Red Dot" Lifetime Guaranteed meter indicates tube quality. Phone jack is provided for noise tests. Neon shorts indicator shows slightest shorts and leakage. Separate line voltage meter permits constant observation of line voltage fluctuation. Speed roll chart indicates all control and switch lever settings. Chart can be quickly removed for replacement and is furnished free should new tubes be announced during the period of one year after purchase. Impressively designed natural finish wood case. Brown-tan finish sliding panel with ivory knobs and sockets and polished chrome trim with inlaid color. Size 18 1/2 x 10 3/4 x 6 3/4". For 105-120 volt 50-60 Cycle AC operation.

### Model 1621 Tube Tester

Counter type tube tester identical to above Model 1620 except more compactly constructed and uses a 4" square meter. Can quickly be converted for portable use by inserting into carrying case listed below. Size 12 1/2 x 7 x 10".

**D17058—Model 1621. Counter Model illustrated at left.** No carrying case included. \$34<sup>14</sup>  
YOUR PRICE.....

Or \$5.25 Down and \$4.35 for 8 Months

#### Carrying Case for Model 1621

**D17059—Portable Carrying Case with removable hinged cover for Model 1621.** Durable finished in snappy two-tone tweed cloth. \$4<sup>90</sup>  
YOUR PRICE.....



### Model 666H Universal Volt-Ohm-Milliammeter

#### Molded Bakelite Case

**C17045**  
YOUR CASH PRICE..... \$14.20

Or \$2.20 Down and \$1.80 for 8 Months on total purchase of \$25.00

Exceptionally compact AC-DC Volt, Ohm, and Milliammeter; easily fits into the pocket. Service engineers will find it especially useful and convenient. Contains sensitive 0-400 micro-ammeter. "Red Dot" life-time guaranteed, D'Arsonval movement, 3" square meter with zero adjustment. Ranges: AC-DC Volts, 0-10-50-250-1000-5000 at 1000 ohms per volt AC and DC; DC Ma., 0-10-100-500. Resistance, 0-300-250-0-0-ohms. Zero ohms adjustable for compensating battery deterioration. Rotary selector switch selects any desired range. Test leads include attachable alligator clips. Entire case of molded bakelite. Size: 3 1/2 x 5 1/2 x 2 1/4".



**C17037—Model 666.** Identical to above except has ranges: AC-DC Volts, 0-10-50-250-500-1000, DC Ma., 0-1-10-50-250. Resistance, 0-300-250,000 ohms.  
YOUR PRICE..... \$13.72

Or \$2.10 Down and \$1.75 for 8 Months  
On Total Purchase of \$25.00.

#### Carrying Case

A good quality leather carrying case. Protects your smaller portable instruments. Fitted with leather carrying handle and snap fastener. 6 1/4" wide, 2 1/4" deep. Rich looking black finish.

**D15839—Model 669.**  
YOUR PRICE..... \$3.59

#### Triplett Model 1181-C

### Portable Laboratory

With Volt-Ohm-Milliammeter,  
Set Analyzer and Battery Operated  
Signal Generator

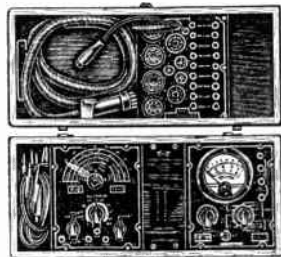

For  
105-120 Volt  
60 Cycle AC  
Operation

**D17038—Model 1181-C. Portable Laboratory.** Complete with test leads, adapters, batteries and operating instructions. \$43<sup>94</sup>  
YOUR PRICE.....

Or \$6.75 Down and \$5.50 for 8 Months.

Three instruments combined in one case for complete circuit analysis. Well adapted for servicing radios in rural districts. Includes:

#### Point to Point Test

Model 1125-A Universal Volt-Ohm-Milliammeter for testing receiver circuits directly at the receiver when accessibility permits, thus locating trouble quickly. 3 1/2" 400 microammeter has 16 scale readings; AC-DC volts: 0-15-75-150-750 at 1000 ohms per volt; DC ma.: 0-1.5-15-150; AC ma. 0-15-150; ohms: 0-1500-1.5 and 3 meg. All ranges controlled by selector switch.

#### Standard Analysis

Auxiliary Set Tester Model 1166C for free-point test and receiver analysis. For localizing set trouble without removing chassis from cabinet. Invaluable for estimating service costs. Includes test for new octal, loctal, bantam and all miniature radio receiving tubes.

#### Overall Performance

Model 1151B new Improved All-Wave Oscillator for alignment testing tubes and methods of increasing overall gain. Oscillator covers all frequencies from 115 KC to 18 MC with four bands. 180° Dial is directly calibrated in frequencies. Has self-contained batteries. Oak case has removable cover. Size: 16 1/2 x 7 1/2 x 4 1/4". Ship. wt. 17 lbs.

## Anti-Obsolescence Vibrator Tester

#### Model 1672

**D17033—Model 1672 DeLuxe Vibrator Tester** with all accessories and instructions. \$29<sup>24</sup>  
YOUR PRICE.....

Or \$4.50 Down and \$3.70 for 8 Months

Checks all standard 6 volt auto and home radio type vibrators. Tests are made under actual operating conditions. Easy to use. Roll chart indicates setting of all controls. Practically obsolescence proof. Individual element switches provide for testing new vibrators regardless of socket arrangement. Square case, lifetime guaranteed. 3" meter has three scales: (1) 0-10 volt scale shows input voltage supplied to vibrators; (2) 0-100 scale shows percentage of output voltage as reflected by change in input voltage; (3) Good-Bad scale indicates condition of output. Fused against damage from shorted vibrators. Blue-gray suede-enamel finished metal carrying case with snap-on cover. Attractive three tone panel. Size, 11 1/2 x 7 1/2 x 4 1/2".

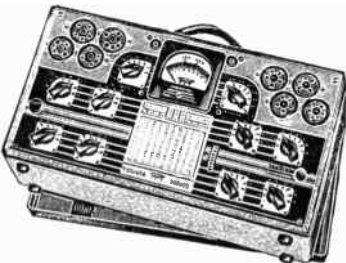



# TRIPLETT TESTERS

with the Famous "Red Dot"  
Life-Time Guaranteed Meters

## Triplet Now on Time Payment

Any Triplet instrument either singly or in combination with other Triplet instruments to make a total of \$25.00 or more can be purchased on time. Use the pink time payment order blank bound into catalog at page 34 when placing order on time payment basis.

### Volt-Ohm-Milliammeters With Tilting Meter Model 1200A



**C17046—**  
**YOUR PRICE..... \$21.40**  
Or \$3.30 Down and \$2.70 Monthly for 8 Months.

Has separate AC and DC "Red Dot" lifetime guaranteed meters in tilting type case. Scale reading: AC-DC Volts, 0-10-50-250-500-1000 at 2000 ohms per volt; DC Ma., 1-10-50-250; Resistance, 0-5-500 ohms with 15 ohm reading in center of scale, 0-1500 ohms, and 0-1-0-3 megohms. Resistance measurements have individual zero adjustment. Selector switch for all instrument readings. Contains 22½ and 1½ V. batteries. Test leads included. Black suede enamel finished metal carrying case with snap-on protective cover. Size, 7½"x6½"x5½".

### Model 1200E 25000 Sensitivity

**C17047—** Same as above except has 25,000 ohms per volt sensitivity on DC volt ranges. Also measures 0-50 microamps, and up to 40 megohms resistance.  
**YOUR PRICE..... \$25.32**  
Or \$3.90 Dn. & \$3.20 for 8 Months.

### Model 1200C

**C17050—** Similar to 1200A except 5000 o.p.v. Also tests 0-250 microamps and 0-7½ megohms.

**YOUR PRICE..... \$22.38**  
Or \$3.45 Dn. & \$2.40 for 8 months.

## Triplet Portable Appliance Tester

### Model 2000

Provides quick and accurate means of testing power consumption of radios and all electrical household appliances. Tester contains a "Red Dot" life-time guaranteed watt-meter and voltmeter in a twin instrument style case for checking line voltages and wattage simultaneously. Ranges: 0-750 Watts at 110 volts, 0-1500 watts at 220 volts (Current rating 0-7.5 amperes). Dual Voltmeter scale reads 0-130 and 0-260 Volts. Instrument may be used on either AC or DC lines varying from 110 to 220 volts without appreciable error. Has cord to plug into wall socket and female receptacle for appliance under test. On-off switch cuts wattmeter in or out of circuit.

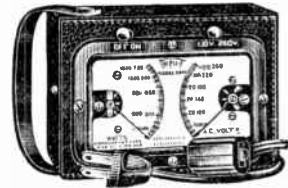

**C17056—** Triplet Model 2000. In heavy leather carrying case with a leather pocket to flap to fold over the instrument meter. Has space for all accessories included. Size 6½"x4½"x3½".  
**YOUR PRICE..... \$18.94**  
Or \$2.90 Down and \$2.30 for 8 Months  
On Total Purchase of \$25.00

error. Has cord to plug into wall socket and female receptacle for appliance under test. On-off switch cuts wattmeter in or out of circuit.

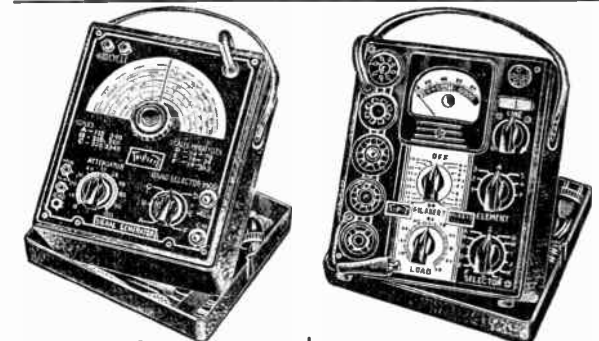

### Signal Generators Models 1231A-1232A

**C17041—** Model 1231A. Battery Operated. With batteries.

**YOUR PRICE..... \$26.95**  
Or \$4.10 Down and \$3.40 for 8 Months

**C17042—** Model 1232A. For 110 volt 60 cycle AC operation.  
**YOUR PRICE..... \$29.24**  
Or \$4.50 Down and \$3.70 for 8 Months

Six bands cover 1½ Kc. to 30.5 Mc. on fundamentals. Direct reading dial. Frequency stabilizing circuit. 400 Cycle note modulates output signal approximately 50%. Audio osc. can also be used alone. Continuously variable attenuator circuit with three tap jacks. Completely shielded. Line filter and band selection switch. Metal carrying case with protective cover. Black suede finish. Size, 7½"x6½"x5½".

### Tube Tester

#### Model 1213

**C17043—** For 100-150 volts, 50-60 cycle operation.  
**YOUR PRICE..... \$21.56**  
Or \$3.30 Down and \$2.70 for 8 Months.  
On Total Purchase of \$25.00

Tests all present day tubes, including Locals, Bantam Jrs., new high voltage series, single ended types, gasoson rectifiers, ballasts and pilot lamps. Provides filament voltages of from 1 to 110 volts. Large 3" Triplet lifetime guaranteed direct reading meter. Neon short indicator. Simple to operate. Only four controls used for tube tests. Chart shows all control settings. Separate shadow type AC line meter. Black enamel suede finished carrying case with snap-on cover. Size, 7½"x6½"x5½".

## Combination Tube and Set Testers

### Model 1183

**D17060—** Combination Tube Tester, Volt-Ohm-Milliammeter and Free Point Tester.  
**YOUR PRICE..... \$48.84**  
Or \$7.50 Down and \$6.20 Monthly for 8 Months

### Model 1184

**D17062—** Combination Tube Tester and Volt-Ohm-Milliammeter only.  
**YOUR PRICE..... \$43.94**  
Or \$6.72 Down and \$5.60 Monthly for 8 Months

### Model 1182

**D17063—** Tube Tester Only.  
**YOUR PRICE..... \$34.14**  
Or \$5.25 Dn., \$4.35 for 8 Mos.



An attractively styled tube tester housed in portable metal carrying case. Model 1183 and 1184 incorporate a complete Volt-Ohm-Milliammeter tester. Model 1183 also includes a Free Point Analyzer built into the removable cover. A "Red Dot" Lifetime Guaranteed meter is used on all models.

Tube Tester tests all tubes including local and miniature types regardless of filament voltage. Neon shorts indicator. Lever type switch gives instant movable control for each tube prong. Roll chart indicates control settings. Volt-Ohm-Milliammeter ranges: AC and DC Volts, 0-10-250-500-1000 at 1000 o.p.v. on DC. DC Ma., 0-1-10-50.

250, 0hms 0-500-1500-150,000-1,500,000. Free Point Set Analyzer makes all series and parallel meter connections at tester. Simply plug analyzer cable into tube socket and tube into analyzer socket. Takes all tubes, but plug adapters for analyzer cable must be purchased separately for local and miniature types. Metal case finished in brown suede with three tone panel. Detachable cover included. Size 14½"x7½"x3½". For 110 volts, 60 cycle AC operation. Complete with accessories and instructions.

Local and miniature cable adapters for above. Specify Type. **YOUR PRICE, Each..... \$1.64**

## Automatic Volt-Ohm-Milliammeter

### Push Button Operated 25,000 Ohms Per Volt DC Model 1200F

**D17061—** Model 1200F. Complete with accessories and instructions.  
**YOUR PRICE..... \$27.28**  
Or \$4.20 Down and \$3.50 Monthly for 8 Months.

Push button switch instantly selects desired range. High sensitivity of DC ranges permit this instrument to be used on extremely low current circuits. Ranges available: AC and DC volts, 0-10-50-250-500-1000 at 25,000 o.p.v. on DC and 1000 o.p.v. on AC. DC Ma., 0-1-10-50-250. DC Microamps, 0-50. Resistance, 0-500-300,000 ohms and 0-3-30 megohms. Self contained batteries and triple zero ohms adjusters. Output readings available on AC volt ranges thru .5 mfd. condenser and separate jacks. High quality "Red Dot" life-time guaranteed 4" square meter. Plug-in rectifier. Sturdy metal carrying case with snap-on cover. Finished in brown suede enamel with three tone panel. Size 7½"x6½"x5½".



## "Little Triplets" Pocket Meters

### The Little Testers With The Big 3 Inch Meters

A complete series of matched pocket size testers. Each instrument is completely self contained and incorporates a Triplet 3 inch size "Red Dot" Lifetime Guaranteed, D'Arsonval movement meter. Large easily readable scales. Red molded cases, size 3½"x7½"x2½". Panels are ivory with red markings and trim. Selector switch used on all models except ammeters instantly selects desired range. No test leads included.  
**YOUR PRICE, Each..... \$8.82**  
Any Type Below.....



**D17162—** Model 673—AC Voltmeter, rectifier type. Ranges 0-5-10-25-50-100-250-500-1000 AC volts.

**D17163—** Model 675—DC Milliammeter. Ranges 0-1-5-10-25-100-250-500-1000 Milliamperes.

**D17164—** Model 676—DC Microammeter. Ranges 0-50-100-250-500-1000 DC microamperes. External resistors can be used in series with this meter to provide highly sensitive voltmeter readings at 20,000 ohms-per-volt sensitivity.

**D17165—** Model 677—DC Voltmeter. Ranges 0-1-2.5-5-10-25-50-100-250-500-1000 DC Volts at 1000 ohms per volt sensitivity.

**D17166—** Model 678—Ohmmeter. With self contained batteries for readings from 2 ohms to 10 megohms, 0-1000-10,000-100,000 ohms and 0-1-10 megohms. Has 10 ohm center scale reading on the 1000 ohm scale

**D17167—** Model 674—DC Ammeter. Ranges 0-1-2.5-5-10-25 10' amperes. Equipped with 6 terminal posts instead of selector switch.

**D17168—** Model 672—Three Range AC Voltmeter for general power line testing. Ranges 0-150-300-750 AC volts.

**D17169—** Model 671. AC Milliammeter. Ranges 0-5-10-25-50-100-250-500-1000 AC milliamperes.

**D17170—** Model 670—AC Ammeter. Ranges 0-1-2.5-5-10-25 AC amperes. Equipped with 6 terminal posts instead of selector switch. (For use on 60 cycles).

**Carrying Case for Above**  
**D17171—** Carrying case with compartment. Holds any three "Little Triplets" listed above. Size 10½"x8½"x3½".  
**YOUR PRICE..... \$2.45**



# SUPREME INSTRUMENTS

## Easiest Installation Terms

### Model 589 Tube and Battery Tester

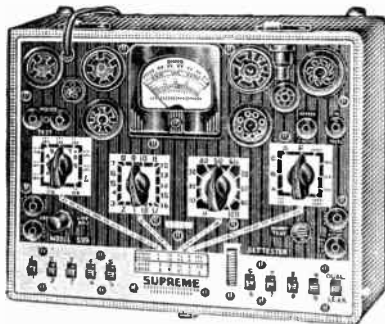

**Portable Model With 4" Meter**  
**D17077—**  
**YOUR CASH PRICE \$29.35**  
 Or \$4.00 down and \$3.63 monthly for 8 months.  
**Counter Model With 7" Meter**  
**D17078—**  
**Your Cash Price \$39.15**  
 Or \$4.50 down and \$4.39 monthly for 9 months.  
**Counter Model With 9" Meter**  
**D17079—**  
**Your Cash Price \$41.65**  
 Or \$5.00 down and \$4.18 monthly for 10 months.

11 1/4 x 9 1/4 x 5 7/8"

**Tube Testing Circuit** Tests every type tube from 1.4 volts to 117 volts, at correct plate potential and impedance load. Tests separate sections in multi-purpose tubes. Checks leakages, shorts, noise, open elements and filament continuity. Fastest and easiest to operate—simply follow arrows to proper settings indicated by correlated roll chart. Headphones may be used for noise test. Large English reading meter scale, illuminated in the 7" and 9" models which also have both standard 200M ohm and super-sensitive 2 meg. hot leakage test. Patented Double Floating Filament Return Selector Switch automatically allows rearranging of tube element connections to any possible tube base arrangement—your best possible assurance against obsolescence resulting from subsequent new tube releases. Complete information covering switch settings and testing of new tubes is supplied at least every 3 months, for one year, at no extra charge.

**Battery Testing Circuit** makes all tests under proper load for battery being tested. Battery condition is read on plainly marked English reading scale. Tests all type 1.5, 4.5, 6.0, 45 and 90 volt portable radio and flashlight types. Supreme engineering and construction plus the best materials the market affords, make the 589 your biggest dollar value. Portable Model durably housed in attractive luggage type case. Counter Model: durably housed in attractive metal case with chrome trim. Instrument panel has ribbed wrinkle finished by satin finished highlights, with bright red arrow-ways. Bakelite housed meter has 3-color scale. For 105-120 V. 50-60 Cyc. operation.

### Model 599 Tube, Battery and Set Tester



Has same tube and battery testing circuits and is same size as Model 589 above. In addition has complete volt-ohm-milliammeter section with provisions for checking condenser leakage.

**D17080—Portable Model. \$38.71**  
**YOUR CASH PRICE** .....  
 Or \$4.50 down and \$4.33 monthly for 9 mos.  
**D17081—Counter Model with 7" Meter. \$48.95**  
**YOUR CASH PRICE** .....  
 Or \$5.50 down and \$4.50 monthly for 11 mos.  
**D17082—Counter Model with 9" Meter. \$51.45**  
**YOUR CASH PRICE** .....  
 Or \$5.75 down and \$4.33 monthly for 12 mos.

### Volt-Ohm-Milliamper Section

D.C. Volts—0/6/15/150/600/1500 at 1000 ohms per volt. A.C. and Output Volts—(0/6/15/150/600). Copper oxide rectifier fully protected from overload. NO BATTERY TO HOLD DOWN—NO EXTERNAL CONDENSER necessary. D.C. Mills—(0/6/60/600). Ohms—0/200/20,000/2 meg./20 meg. Tests all paper and electrolytic condensers for leakage on direct reading resistance scales. For 105-120 volt 60 cyc. AC operation.

### Model 542 Pocket Multimeter

**D17083—Model 542 Pocket Multimeter**  
**YOUR CASH PRICE \$15.97**

Compact in size, accurate and dependable performance. Plug jack connections. Ranges: D.C. Volts: 0/0.3/0.30/150. D.C. Voltages at 5,000 ohms per volt. 0/6/150/300/1,500. A.C. and Output Voltages 0/6/30/150/600. Ohms 0/2,000/20,000/200,000/2 megs. Decibels: -6 to +10, +8 to +24, +22 to +28, +34 to +50. 3" Square meter with knife edge pointer and rugged, accurate 200 microampere movement (5,000 ohms per volt). Molded bakelite case. Batteries for ohmmeter self contained. Size 5 1/2 x 2 1/2 x 3 1/2". Ship. wt. 2 lbs.



### Model 543 Pocket Multimeter

**D17084—Model 543 Pocket Multimeter**  
**YOUR CASH PRICE \$11.71**

Uses same bakelite case as Model 542. Attractive two-color panel. 3" x 1 Ma 1,000 (0)-P-V. meter. Single rotary switch selects all functions and ranges. Ohms:—0/200/200,000. DC Mills:—0/6/60/600. DC Mills—0/15/150/600/3000. AC or DC Volts:—0/15/150/600/3000. Batteries self contained. Size, 5 1/2 x 2 1/2 x 3 1/2". Shipping wt., 2 lbs.

Model 542 or 543 may be purchased with other Supreme equipment on Time Payment. Cash price will be divided and added to other payments. No additional down payment or finance charges are made.



### Model 547 Multimeter

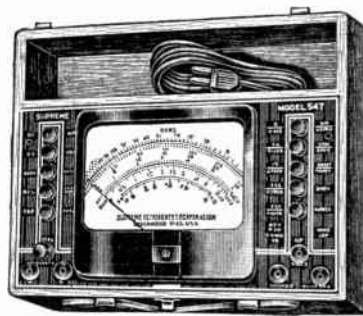

14 Buttons give instant selection of 36 Ranges

**D17085—In Metal Case. Size—13 1/2 x 12 1/2 x 5 1/2".**  
**YOUR CASH PRICE. \$33.27**  
 Or \$4.00 down and \$4.17 monthly for 8 months.

**D17086—In Solid Oak Case. Size—13 1/2 x 11 1/2 x 5 1/2".**  
**YOUR CASH PRICE. \$35.77**  
 Or \$4.00 down and \$4.02 monthly for 9 months.

Simplest, fastest and most convenient of all multimeters. Large 7" illuminated meter allows exceptionally accurate reading. All meter multipliers are metal resistors aged for stability. Wire-wound resistors used for all shunts. Ranges, D.C. Volts: 0/6/30/150/300/600/3000, at 1000 ohms per volt. D.C. Mills: 0/6/30/150/300/600. Accuracy 2% on all ranges except 3000 volt which is 3%. A.C. Volts: 0/6/30/150/300/600/3000. Output Volts: 0/6/30/150/300/600/3000. Decibels: -10/+4/+18/+32/+38/+44. Capacity: 0/2/2/20 mfd. No external condenser necessary. Copper oxide rectifier fully protected. Fully compensated for temperature variations. Ohms: 0/2000/20,000/200,000 ohms and 0/2 meg/20 meg. Megohm ranges operate from 105-120 volt 60 cycle A.C. line supply; other ranges from self-contained battery. Supplied in metal case, for shop use or in portable Oak carrying case with removable cover and large compartment for test leads, tools, etc.

### Model 592 Set Tester

**D17088—Model 592 Set Tester. \$43.07**  
**YOUR CASH PRICE** .....

Or \$5.00 down and \$4.33 monthly for 10 mos. Fast push button selector sets up all ranges and functions, all of which terminate at a single pair of pin jacks, except the 14 ampere DC range, for which heavy binding posts are supplied. Push button switch selects either of two DC voltage measuring sensitivities on large 4" meter, 1000 ohms per volt for regular measurements and 25,000 ohms per volt for high resistance circuit measurements.

Ranges: D.C. volts at 1000 or 25,000 ohms per volt 0/3.5/7/35/140/350/700/1400. Ohms: with self contained battery, 0/500/5,000/50,000/500,000/5 megs/50 megs. Low-ohm scale 1/4 to 500 ohms. A.C. and Output Volts: 0/7/35/140/350/700/1400. No external condenser needed. Decibels 5 ranges cover—10 to +46. Durably housed in quartered oak carrying case with removable hinged cover. Size, 9 1/2 x 7 1/2 x 6 1/2". Ship. wt. 9 lbs.



### Model 504 Tube Tester and Set Analyzer

**D17089—Model 504 complete in Portable Oak Carrying Case size 14 1/2 x 12 1/2 x 6".**  
**YOUR CASH PRICE \$64.63**  
**YOUR CASH PRICE** .....

Or \$7.25 down and \$5.94 monthly for 11 mos.

The finest instrument of its type in the entire Supreme line. TUBE TESTER SECTION incorporates improved circuit that correctly tests all tubes from 1.4 to 117 filament volts using normal operating voltages and loads. Tests local, octals, batmans, nidges, single ended, television types, magic eyes, kaseous rectifiers, pilot lamps and ballasts. Tests separately, each section of all multi-section tubes and each plate of rectifiers and double diodes. Makes "hot" leakage tests up to 2

Megs. Checks shorts, open elements, filament continuity and noise. Push-button selector automatically allows rearrangement of tube element connections to any possible tube base arrangement—your best insurance against obsolescence resulting from subsequent new tube releases. Fast and easy to operate—simply follow the arrows to proper settings indicated by correlated tube chart. English reading meter scale shows tube condition. SET ANALYZER SECTION provides 31 test ranges selected by 20 push-buttons. All ranges terminate at a single pair of tip jacks. DC Volts: 0/2.5/25/100/250/1000/2500, at 1000 ohms per volt. AC and Output Volts: 0/5/10/50/250/1000. DC Microamps: 0/2/20. DC Mills: 0/2.5/10/50/250. DC Amps: 0/1/10. Ohms: 1/10/200/2M/20M and 0/2/20 Meg. Accuracy: 2% on DC and 3% on AC ranges. Tests all paper, mica and electrolytic condensers for leakage up to 20 Megs. at any one of seven test voltages from 15 to 450 volts. Results are indicated directly on "Good-Bad" capacitor meter scale.

### Model 549 Electronic Voltmeter

**D17090—With Metal Case. Size—11 1/8 x 10 x 1 1/4".**  
**YOUR CASH PRICE \$39.15**

Or \$5.00 down and \$3.90 monthly for 10 mos.  
**D17091—In solid Oak Carrying Case. Size—11 1/8 x 10 1/4 x 5 1/8".**  
**YOUR CASH PRICE \$41.65**

Or \$5.00 down and \$4.18 monthly for 10 mos. Ranges: DC Volts — 0/2/6/20/60/200/600. Input Impedance 15 Meg. DC Mills: 0/5/15/50/150/500. DC Amps: 0/1/5. Ohms: 0/50/150/500 and 0/1/10/100. Megohms with self contained battery. AC and Output Volts: 0/5/15/50/150/500. Copper oxide rectifier fully protected, temperature error corrected over a working range of 40° to 100° F. Available in metal case, for shop use or in portable Oak case with removable hinged cover and large compartment for tools, test leads, etc.

**D17092—High voltage test probes and multiplier, for extending meter range from 600 to 6000 volts D.C. at 150 Megs input impedance.**  
**YOUR PRICE, Per Pair \$564**  
 Or if purchased with Model 549, add 63c net to each of the ten monthly payments.





# SUPREME INSTRUMENTS

## Supreme by Comparison

### Combined Audio and Radio Frequency Oscillator



**Model 561**  
**C17073** — Model 561 Oscillator. Complete with accessories and instructions. For 105-120 volt, 60 cycle AC operation.  
**YOUR CASH PRICE... \$8673**

Or \$9.50 down and 12 monthly payments of \$7.32

A combined AF and RF Oscillator that feeds into the receiver, a practical duplicate of the signal from a broadcast station and allows complete control over this signal as regards carrier frequency, audio frequency modulation, percentage of modulation and amplitude of signal. Specifically designed to be used in conjunction with the Vedolyzer.

lyzer, Audolyzer, or Oscilloscope listed on this page. May also be used by itself in the same manner as any individual AF or RF Oscillator. Combines in one compact convenient instrument the complete functions of a laboratory type Radio Frequency Signal Generator (Oscillator), Audio Frequency Oscillator, and Continuously Variable Frequency Modulator. Has output level indicating meter which combined with the ladder type attenuator provides an accurate means of determining AF or RF output of generator. Meter may also be used to determine % of audio modulation.

**R.F. Oscillator**—Range is 65 Kc. to 20.5 Mc. on fundamentals and 60 Mc. on harmonics in 5 bands with push button, band switch. Accuracy guaranteed to within 1/2 or 1% at all frequencies. Shadow tuning with hair line indicator or 6" dial eliminates parallax. Dual ratio tuning mechanism for locating desired frequency quickly and accurately. Extremely stable—not affected by normal line voltage variations.

**A.F. Oscillator**—Range is 15 to 15000 cycles. 4 push buttons select output

impedances of 50, 600, 5000, or 50,000 ohms single or push pull. Power output 150 milliwatts at less than 5% distortion over entire range. Response is flat within ±1 db. between 30 and 10,000 c.p.s. Has zero beat adjustment. Variable control allows 0 to 15000 c.p.s. modulation of R.F. signal from 0 to 75% at any R.F. frequency. Audio output is available separately for audio tests. Shadow tuning with hair line indicator on 6" dial eliminates parallax. Attenuators—AF and RF outputs are fully controllable from zero to maximum. RF has ladder type attenuator employing 4 push buttons and vernier control, allowing continuous variation from 15 to 100,000 microvolts.

**Output Meter**—Built-in vacuum tube voltmeter indicates actual output of RF generator in microvolts. Also indicates percentage of modulation.

**Built-in Frequency Modulator**—Employs electronic lock center synchronize circuit. Has standard hand pass of 30 Kc. and may be used at any test frequency.

**Housed in Solid Oak Case** with carrying handle. Size 17 1/2 x 9 3/4 x 12". Ship. wt. 33 lbs.

### Model 560 Vedolyzer

The Vedolyzer presents Supreme's new method of dynamic testing. A system that speeds up radio set servicing and keeps it on a profitable basis.

**C17074** — Model 560 Vedolyzer. Complete with all necessary accessories and easily understood instructions. For 105-120 volt, 50-60 cycle AC operation.

**YOUR CASH PRICE**

**\$126<sup>90</sup>**

Or \$13.50 down and 12 monthly payments of \$10.63



The Vedolyzer traces the radio signal through every stage of a receiver. You see the actual signal and can study its characteristics on the screen of the cathode ray tube. If the signal cuts out, becomes distorted, or weakens it is immediately apparent on the tube. It is easy to SEE THE SIGNAL whether it be RF, IF, AF, television video, or whether it be a frequency modulated, audio modulated, or unmodulated wave. You SEE modulation factor, all types of signal distortion and amounts of amplification. The built-in vacuum tube voltmeter allows you to measure the actual RF, IF or AF voltage in MICROVOLTS. With this set-up, you can check for location, frequency, and amount of hum, and check correct IF and oscillator frequency. Using the vacuum tube volt-ohmmeter alone, you can check AVC voltages, DC Grid voltages, insulation resistance up to 1000 megohms, and all receiver voltages up to 6000 volts DC or 3000 AC. Contains a direct reading wave analyzer for determining the frequency and strength of an UNKNOWN SIGNAL. Both fundamentals and harmonics can be measured. A multiple probe input

circuit gives a progressive check of receiver stages for intermittents, dead stages, noisy resistors, leaky condensers, bad soldered joints, etc.

The Vacuum Tube Voltmeter ranges are: DC Volts, 0/2/6/20/200/600/6000. AC Volts, 0/3/9/30/90/300/900/3000 at 15 megohms input. Resistance, 0/1M/10M/100M ohms and 0/1/10/100/1000 megohms. The Oscilloscope has all controls regularly found on an oscilloscope such as the 546 and can be used as a normal cathode ray oscilloscope. Its linear sweep, horizontal amplification and synchronization circuits result in easily located R.F. wave. Has an internal sinusoidal line supply frequency sweep for use in beam measurements, etc., as well as an internal linear sweep from 15 to 30,000 cycles for viewing images. Attractively designed panel with all controls clearly marked. Housed in solid oak case with leather carrying handle. Size, 17 1/2 x 13 1/2 x 12". Ship. wt. 40 lbs.

### Model 562 Audolyzer Dynamic Channel Tester

A new dynamic channel tester at a new low price. Operation is very similar to that of the Vedolyzer described above. The principle difference being that you hear the signal instead of see it. Eliminates all magic eye tubes and multiple probes. Connect a signal generator such as the 562A or 561 to the antenna post of the receiver under test and touch the Audolyzer probe successively to the grid and plate circuits of the RF, IF, Oscillator, Detector and Audio Stage. You hear the demodulated signal in the speaker of the Audolyzer until on reaching the defective stage, the signal disappears. You then use the built-in vacuum tube volt meter to check the DC operating voltages of the defective circuit. You can do this way quickly and profitably service even the "toughest" receiver. Vacuum tube voltmeter has ranges of 0, 1, 3, 10, 30, 100, 300, 1000 volts DC at 15 megohms input impedance. This means a meter sensitivity of 15,000,000 ohms per volt on the low range and 1 1/2 million ohms per volt on the 10 volt scale. Such high impedance permits

check of voltage while set is in operation without disturbing receiver operation. VT voltmeter can also be used for comparative gain measurements in each stage. Audolyzer can be used to determine accurately the frequency to which any circuit is tuned. Also checks oscillator output, R.F. and audio amplifier of Audolyzer can be used separately with VT voltmeter to locate intermittents, checks AVC voltages accurately. Also checks AFC circuits. Gives accurate check on trimmer adjustments. Can be used with cathode ray oscilloscope for visual distortion indication. Housed in oak case with carrying handle. Size, 17 1/2 x 9 3/4 x 12". Ship wt. 32 lbs.

**C17075**—Model 562 Audolyzer. Complete with all necessary accessories and instructions. For 105-120 volts, 50-60 cycle AC operation.  
**YOUR CASH PRICE... \$76<sup>90</sup>**

Or \$8.50 down and 12 monthly payments of \$6.49.



### Model 571 Signal Generator

Accurate To Within 1/2 of 1%  
 At All Frequencies

Direct Reading On All Bands



**C17076**—Model 571 Signal Generator. Complete with accessories. For 100-120 volt, 50-60 cycle AC operation.  
**YOUR CASH PRICE... \$39<sup>15</sup>**

Or \$4.50 down and \$4.39 Monthly for 9 Months.

An oscillator you'll be proud to own. Has unusually wide frequency range of 85 Kc. to 20.5 Mc. on fundamentals, and up to 82 Mc on harmonics. Dual ratio drive dial is directly calibrated and illuminated, with hair line shadow indicator which completely eliminates parallax. Guaranteed accuracy 1/2 to 1%. A 400 cycle audio oscillator is incorporated for modulating the RF carrier at either 30% or 75%. However, the RF output may also be externally audio modulated or externally frequency modulated for visual alignment work. The 400 cycle oscillator may also be used separately. Double shielded ladder type attenuator extends to the complete chassis to minimize leakage. This instrument may also be used as a multi-vibrator by setting the dial to either 100 or 1000 Kc. and using the harmonics of these signals. An electron coupled oscillator circuit is employed using air dielectric capacitors and iron core coils. Absolutely free from temperature and humidity drift and line leakage. Beautiful black metal panel with red and silver trimming. Housed in attractively solid oak case with leather carrying handle. Size, 10 1/2 x 8 1/2 x 12". Ship. wt. 19 lbs.

### Model 546 Oscilloscope

Featuring High Stability and Simplicity of Operation

An excellent companion piece for Supreme Model 561, or any other good frequency modulated R.F. Signal Generator. Especially useful in connection with all signal tracing devices for actually seeing the signal. A far faster and more accurate means of locating and correcting causes for hum noise, distortion, low gain, intermittents etc.

**D17095**—546 Oscilloscope complete with tubes. For 100-120 volt, 50-60 cycle AC operation.

**YOUR CASH PRICE... \$63<sup>21</sup>**

Or \$7.00 Down and \$5.33 Monthly for 12 Months.

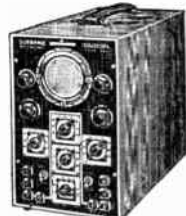

Flexible in operation, has simple and logically arranged controls with sensitive linear amplifiers producing undistorted output. Has high impedance input circuit, wide frequency range and vertical and horizontal amplifier with 15 to 90,000 C.P.S. range and individual gain controls. Saw tooth sweep circuit oscillates linearly from 15 to 30,000 cycles. Means for either internally or externally synchronizing the signal under test with the sweep frequency. Vertical and horizontal spot centering controls. Intensity and focus controls. Snap-lock synchronizing control snaps image into place. No "wandering" or "waver-ing." Linear sweep range control and fine frequency adjuster. Separate power supply for cathode ray tube. Uses six tubes: 1-3 Cathode Ray Tube, 1-8M5, 2-6C6's and 2-80's, carefully shielded and mounted in solid oak carrying case with leather handle for portable or laboratory use. "No-Glare" panel. Size, 14 1/2 x 12 1/2 x 12". Ship. wt. 23 lbs.



# Radio Test Instruments

## VoltOhmyst RCA-Rider CHANALYST



**C17156—RCA Model 163 Rider Volt-Ohmyst.** For 105-130 volt, 25-60 cycle AC operation. Complete with tubes, special test leads and instructions. **YOUR PRICE.....\$57<sup>50</sup>**

A new combination Electronic Vacuum Tube DC Voltmeter and Ohmmeter providing accurate test of voltages from 0.05 to 5000 on 9 ranges and resistance measurements on 6 ranges from 0.1 ohm to 1000 megohms. The high input resistance of 16 megohms on ranges up to 500 volts and 160 megohms on higher ranges permits voltage measurements without noticeable effect upon circuit operation under test. Especially designed for measuring DC potentials at plate, screen, cathode, control grid, AVC and AFC during operation. Ohmmeter is suitable for all resistance measurements and testing leakage and insulation resistance. Meter has 4" long scales. Directly calibrated with 3 basic voltage and one ohmmeter scale. Circuit is independent of tube characteristics or line voltage variations. No zero drift.

No readjustment required when changing ranges. Resistors matched to 1%. Tubes used: 2-6X6's and 1-6X7G. Constructed of finest quality components. Stopping etched chrome plated brass panel. Steel cabinet finished in crystalline gray. Size 7½x8¼x11" high. Weight 14 lbs.

### Junior Volt Ohmyst

**D17352—RCA Model 165.** Electronic vacuum tube AC-DC voltmeter and ohmmeter containing many characteristics mentioned above. Ranges provided: DC Volts, .05 to 3/10 30/10 /300/1000. AC Volts, .25 to 10 30/100/300/1000. Input resistance of 11 megohms. Six Ohms ranges covering 0.1 to 1000 megohms. Has signal tracing probe for checking AVC, AFC-FM discriminator and oscillator voltages, etc., with signal present. Size 6x7½x10¾" high. For 105-125 volt, 50-60 cycle AC operation. **YOUR PRICE.....\$34<sup>95</sup>**



**C17155 — RCA Model 162 Rider Chanalyst.** Complete with accessories and instructions. For 105-117 volt, 50-80 cycle AC operation. **YOUR PRICE.... \$107<sup>50</sup>**

The original dynamic channel tester that quickly localizes and identifies the most elusive troubles in any particular stage of a receiver or amplifier. Testing is done without plugs or adapters, being independent of tube types or circuit complications. Provides 5 basic test channels with four electric eye indicators to visualize operation. The channels and uses are:

**RF-IF Channel Amplifier:** Traces the radio signal from first RF stage thru the second detector. (Can also be used as a receiver, field strength meter, for zero beat indication and for antenna pick-up checking. Uses five tubes. Range 95 to 1700 Kc. Jack output to headphones or oscillograph.

**Oscillator Channel Amplifier:** Similar to RF-IF Channel but has wider range and is less sensitive. Checks frequency output, drift, etc., of oscillators in superhets. Employs three tubes. Covers 600 to 15000 Kc., on fundamental, to 70 Mc. on harmonics.

**AF Channel Amplifier:** Checks gain or loss of signal thru audio stages and

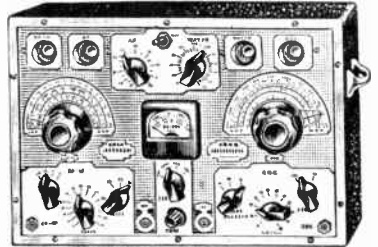

indicates where it becomes distorted or takes on hum. Uses three tubes. Flat frequency response range of 50 to 50,000 cycles. Input range of 1 to 1000 volts. Output jack to headphones or oscillograph.

**Wattage Indicator:** Indicates power consumption of receiver from 25 to 250 watts either AC or DC.

**Electronic Voltmeter:** Measures DC potentials or the actual control voltages in RF, IF, AF, AVC and AFC circuits without disturbing operation or loading the circuit. Meter has center zero and indicates both positive and negative voltages. Four ranges measure -500 -100/-25/-5/0/+5/+25+100/+500 volts. 10 Meg. input resistance on all scales. Accuracy 5%.

**Construction:** Heavy chromium plated etched brass panel. Metal case with carrying handles. Size, 14x9x9¾".

## Other RCA Test Equipment

All equipment for 105-130 volt, 50-60 cycle AC operation. Supplied complete with tubes and accessories. We can supply any RCA Test Instrument. Descriptive literature will be sent on request.

Stock Number	RCA Model	DESCRIPTION	Your Price
C17241	151-2	2" Cathode Ray Oscillograph	\$ 49.95
C17242	155	3" Cathode Ray Oscillograph	63.95
C17243	160	5" Cathode Ray Oscillograph	130.00
C17244	150	Electronic Sweep Oscillator	64.50
C17245	9595	Battery Powered Oscillator	34.50
C17246	9600	Universal AC Operated Bridge	49.65
C17247	9558	Frequency Modulator—Motor Driven	27.50
D17351	154	Beat Freq. Audio Oscillator	49.95
D17353	156D	Portable Tube Tester	39.95
D17354	156E	Counter Tube Tester	37.95
D17355	161	Signalizer	107.50
D17356	167	AC Test Oscillator	34.50

## Precision Test Instruments

### Tube Tester

**D17304—Model 910MCP.** **YOUR PRICE.....\$29<sup>35</sup>**  
Or \$6.10 Down and \$4.60 Monthly for 6 Months.



High grade, attractive tube checker indicating tube quality by dynamic mutual conductance method. Tests all receiving tubes including local, miniature types, gaseous rectifiers and ballasts, regardless of pin arrangement or filament voltage requirements. 3" Sq. meter. Neon shorts and leakage indicator. Jacks for noise tests with headphones. Roll chart quickly indicates all settings of push buttons and other controls. Open type portable metal case. Size 12x10¼x6".

## Meissner "Analyst"

The latest type servicing instrument using the signal tracing method. Five channels trace signal from antenna to speaker. Quickly solves the most difficult receiver failures. All indications read on five magic eyes. Audio Channel permits complete analysis of the audio system of any set including gain measurements, hum location, etc. Electronic Voltmeter with a constant input of 10 megohms on five ranges of 0 to 500 volts checks all operating and control voltages without affecting receiver performance. Oscillator Channel for complete analysis of oscillator circuits of super-hets. RF-IF Channel for tracing signals through the RF and IF systems of any receiver. Range, 95 to 1700 kc. Line Current Indicator shows power consumption of receiver. All controls accurately calibrated and clearly marked. Any number of channels may be used at same time. Uses type 1-6S7Q, 1-6F51, 3-6SK7, 1-6H6, 1-1852, 1-6X5G and 5-6E5 tubes. Extremely easy to operate. Cabinet finished in black crackle. Size, 9½x13½x10¾". Shlp. wt., 35 lbs.

**D17349—Meissner Analyst.** Complete with tubes, test leads and operating instructions. Ready for operation. **YOUR PRICE.....\$68<sup>11</sup>**

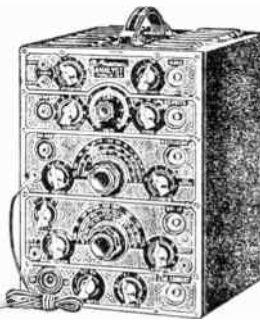

## Model 832 AC-DC Multi-Tester

**D17310 — With battery.** Less test leads. **YOUR PRICE.....\$14<sup>65</sup>**

Features 3" sq. meter providing 31 ranges: DC Volts, 0-6-30-150-300-600-1200 at 1000 O.P.V. AC Volts, 0-12-60-300-600-1200-2400. DC Ma., 0-1-2-12-120-600. Ohms, 0-5000-500M on self contained 3 V. battery. Ohmmeter adjuster. Derivels, -10 to +62 on six ranges. All resistors at 1% accuracy. Heavy etched brass panel. Hardwood w a i n u t finished carrying case. Size 7x4½x3".



## Other Precision Instruments

Literature on any model will be sent on request. When ordering on time payments be sure to use order blank on page 2.

Stock Num.	Model Number	Your Cash Price	Time Pay. Amt. Down	Per Mo.	For Mos.
D17316	872	\$17.59	\$3.40	\$2.80	6
D17318	844L	22.49	4.50	3.55	6
D17324	844P	24.45	5.00	3.85	6
D17313	854L	37.15	7.60	5.85	6
D17312	854P	39.15	7.75	6.20	6
D17309	910C	33.27	6.70	5.25	6
D17308	910P	33.27	6.70	5.25	6
D17307	912C	35.23	7.15	5.55	6
D17305	912P	35.23	7.15	5.55	6
D17306	912MCP	31.31	6.60	4.90	6
D17301	920C	\$2.87	10.90	8.30	6
D17300	920P	\$2.87	10.90	8.30	6
D17302	920MCP	48.95	10.00	7.70	6
D17333	E200	35.23	7.15	5.55	6
D17331	015	50.91	10.45	8.00	6
D17332	022	66.59	13.45	10.50	6



## Aerovox L-C Checker And R.F. Signal Generator

Tests condensers and coils for capacity and inductance and permanent or intermittent shorts or opens, under actual operating conditions. All checks made at radio frequencies and in the majority of cases, without disconnecting any parts from the circuit in which they are operating. This regardless of whether or not any other condensers or resistors may be connected in parallel therewith. In addition will check: RF and IF alignment • Oscillator tracking • Natural resonant points of RF chokes, to be sure such are beyond operating range • Location of dead spots and resonant periods of antenna and transmission lines • Resonant points in shorted windings of unused coils • Frequency range of receivers and signal generators • Distributed capacity of coils • Tuning of wave, traps and image rejection circuits • Calibration of wacemeters • And many other things much too numerous to mention here. Send for complete descriptive folder.

**RF Oscillator Range** 60 kc to 26 mc in 6 ranges. Accuracy: 1% on low frequency ranges and 5% at higher frequencies. Capacity and inductance measurements made well within 10% limits. Tubes: 1 each, 6J5G, 25Z5, 6E5 and V1R105. Dimensions: 10½x7½x5½". Wt., 6 lbs.

**C17087—Model 95** complete with tubes, output cable, capacity prod. inductance probe and terminal test leads. For 110 V, 50-60 cycle AC operation. **YOUR PRICE.....\$28<sup>91</sup>**



# Popular Test Instruments

## Clough-Brengle Instruments

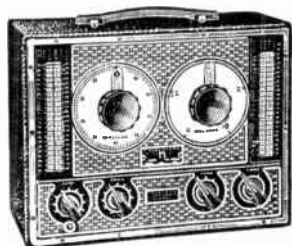

### RF Signal Generator

**Rivals Costliest Designs**  
**C17138—Model OCX.** Complete with tubes and shielded coaxial output cable. **YOUR PRICE..... \$33.80**

Hand calibration to ten or more points on each of five bands guarantees accuracy of 1/2%. Range, 100 Kc-30 Mc. Visi-Vider dial reads to 1/10%. Output, 1/2 to 100,000 microvolts. Unmodulated RF, 400 cycle 30% audio modulated RF and pure sine-wave 400 cycle audio, outputs available. Attenuation: Dual, continually variable. Drift: Held to 1/10 percent. Steel case finished in dark green, black and silver. Size, 9 1/2 x 12 1/2". Wt., 13 lbs.

### Other Clough-Brengle Instruments

Stock Num.	Type Instrument	Your Price
D17134	110-A RF Oscillator	\$48.51
D17124	79D Audio Oscillator	63.21
D17149	225 Tube Checker	46.55
D17125	131 Universal Speaker	19.11
D17126	220 Unimeter	58.30
D17127	250 A-C Bridge	41.65



### Universal Meter

**2000 Ohms Per Volt**  
**C17140—C-B Model 185-A.** Complete with steel cover and test leads. **YOUR PRICE..... \$28.91**

Thirty-one ranges, including capacity and decibels, are combined with new speed and safety provisions to make this the most useful all-purpose instrument yet devised. DC Sensitivity, 2000 ohms per volt. AC, 1250. DC Volt Range: 0-5-20-100-500-1000. AC Volts: 0-3-32-160-800-1600. DC Mills: 0-5-10-100-Short Pos. Ohms: 0-4000; 0-40,000; 0-4 megs. from battery included. With ext. battery, 0-20 megs. DB: -15 to +59. AC Output: Same as AC volts. Mfids: .0005-1-10. Hertz: 1-140-14,000. Finished in dark green and silver. Size, 9 1/2 x 9 1/2 x 4 3/4". Wt., 9 lbs.

**Complete catalogs covering any of the lines represented on this page will be mailed to you promptly on request.**

## Jackson Test Instruments

**C17280—**  
 Model 660  
 Signal Analyzer  
**YOUR CASH PRICE**  
**\$77.91**

Or \$21.50 down and \$11.00 per month for 6 months.

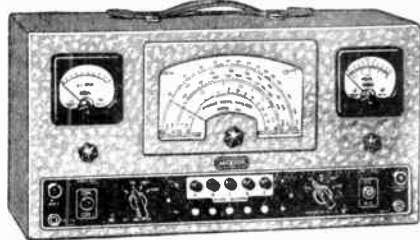

Traces a regular broadcast or test as-ellator signal from one end of the radio to the other. Indicates signal gain or frequency, extent of distortion, and all circuit voltages (including AVC and AFC) at any point in the receiver. Tests resistors, condensers and inductances for proper operation, without breaking any connections. Tests tube performance and antenna efficiency. All indications are read directly on meters. All audio signals, distortion or noise may be listened to at any point in the receiver. All tests made under actual operating conditions. Voltage regulated power supply. Frequency Range of RF Voltmeter—40 Kc. to 16 Mc. Push Button Selection. RF Gain Meter Ranges of 10/100/1000/10,000. V.T.V.M. AC or DC Volts, 0-5/0-10/0-50/0-100/0-500. Input resistance, 10 megs. Sensitivity on 0-5 range, 2,000,000 ohms per volt. Illuminated Frequency Dial and Meter scales. Welded steel case finished in two tone gray. For 105-120 V. 50-60 cycle. Size, 17 1/2 x 13 1/2 x 4 1/2". Wt., 25 lbs.

### Other Jackson Instruments

Stock Number	Type Instrument	Your Cash Price	Time Payment Plan		
			Amt. Down	Per Month	For Month
D17256	640 Test Oscillator	\$29.35	\$ 8.00	\$ 5.00	5
D17270	420 Universal Oscillator	\$8.31	15.50	10.00	5
D17277	642 20,000 O.P.V. Multimeter	39.35	11.00	6.50	5
D17278	643 1,000 O.P.V. Multimeter	26.41	5.65	6.00	4
D17250	634 Tube Tester	26.41	5.65	6.00	4
D17252	637 Dynamic Tube and Set Tester	48.51	12.50	8.50	5
D17253	523 3" Oscilloscope	\$8.31	15.50	10.00	5
D17112	638 Dynamic Tube Tester	34.25	8.50	6.00	5
D17113	636B Bench Style Tube Tester	29.35	8.00	5.00	5
D17114	636C DeLuxe Counter Tester	35.11	11.00	6.50	5
D17115	650A Condenser Tester	29.35	8.00	5.00	5
D17116	652 Audio Frequency Oscillator	62.21	21.00	8.50	6
D17117	610 Multimeter	10.73	Purchasable on time with other Jackson instruments		
D17120	615 Multimeter	15.63			

## Triumph Test Instruments

### Model 130 Video Signal Generator

**C17365**  
**YOUR PRICE COMPLETE..... \$29.35**



Wide range, 100 Kc to 96 Mc., includes all frequencies needed in radio and television service. Direct reading 360° dial with knife edge pointer. Accuracy, 1/2 of 1%. Unmodulated RF, 400 cycle, 0-75% modulated RF, and pure sine-wave 400 cycle audio and externally modulated RF outputs available. Housed in black wrinkle finished metal cabinet with ivory, red and black front panel. Has leather handle. Size, 13 1/2 x 10 x 8". Wt., 22 lbs.

### Model 830 Oscilloscope and Wobbulator

**D17366—**  
**YOUR PRICE COMPLETE..... \$78.35**

Combines in one instrument all features of a complete 3" cathode ray oscilloscope and electronic frequency modulated wobbulator. Simple to operate. Positive lock in on all frequencies gives clean steady pattern. Amplifier response, 10 to 100,000 cycles. Sweep range, 7 to 30,000 cycles. Wobbulator fundamental 1000 cycles. Sweep width variable 0 to 50 cycles. Deflection sensitivity, with amplifier .4 volts per inch or direct to plates 18 volts per inch. Housed in black wrinkle finished steel case with leather handle, ivory, black and red front panel. Size, 10 1/2 x 14". Wt., 38 lbs.

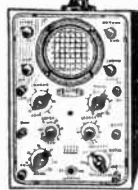

### Other Triumph Instruments

Stock Num.	Type Instrument	Description	Your Price
D17390	333 Multi-Quantum-Meter	28 Range Volt-Ohm-Milliammeter	\$21.51
D17391	334 Ullitester	22 Range Volt-Ohm-Milliammeter	13.67
D17392	332 Percent-O-Meter	"A" and "B" Battery Tester	23.47
D17393	443 Tube Tester	Portable Model with Cover Chart	23.47
D17394	443 Tube Tester	Counter Model with Cover Chart	23.47
D17395	444 Tube Tester	Portable Model with Roll Chart	29.35
D17396	444 Tube Tester	Counter Model with Roll Chart	29.35

## HICKOK AC-DC Volt-Ohm-Milliammeter

### "Jumbo"

**D17237—Model 4922-S "Jumbo" AC-DC Volt-Ohm-Milliammeter.** Complete with test leads. **YOUR CASH PRICE..... \$37.63**

Or when purchased with other Hickok instruments—\$9.41 down and \$5.60 for 6 mos.

Giant 9" meter, readable from great distance at any angle. Extremely rugged. Withstands severe overloads. Accuracy of all ranges within 3%. Rectifier guaranteed for one year. DC Volts: 0-10-50-25-500-2500. AC Volts: Same as DC volts. DC Microamps: 0-500. DC Mills: 0-5-50-500. Ohms: 0-50-10,000. Meg. 10 Megs. Mid scale readings: 8-150-15,000-150,000. Decibels: -10 to +15. AC Output volts same as DC volts. Attractively finished steel case with handle and etched panel. Size, 13" x 10 1/2" x 7 3/4". Wt., 15 lbs.

**D3935—Shunt.** Increases range of 4922-S to 0-5-50 amps. DC. Wt. 2 lbs. **YOUR PRICE..... \$5.99**



## Weston

### Model 772 Analyzer

**C17340—Model 772 Super Sensitive Analyzer.** Complete with test leads and instructions. Less Socket Selector Unit. **YOUR PRICE..... \$49.50**

New all-purpose Super-Sensitive 20,000 Ohms Per Volt Analyzer. Gives dependable reading on low current circuits. Ranges: AC & DC Volts, 0-2.5-10-50-250-1000, 20,000 o.p.v. on DC; DC Ma., 0-1/10/100/250 and 0-1/10 Amps. Ohms, 0-3,000/30,000 and 0-3/30 Megs.; Decibels, -14 to +27/+14/+28/-12/+34. Ranges selected by selector switch. Equipped with pin jacks for mounting Model 666 Socket Selector Unit. Attractive red and black panel. Oak carrying case has removable hinged cover. Size, 15 1/2 x 13 1/2 x 7 1/2". Net wt., 18 1/2 lbs. **C17370—Model 776 Tube Tester.** For use with model 772 above, increases range to 5000 volts at 100 Megs. input impedance. Insulated against 11,000 volts breakdown in accord with A.I.E.E. safety standards. **YOUR PRICE..... \$187.50**

### Other Weston Instruments

Stock Num.	Type Instrument	Your Price	Stock Num.	Type Instrument	Your Price
D17371	787 High Freq. Osc.	\$93.75	D17336	697 Volt-Ohmmeter	\$24.00
D17343	776 RF Oscillator	65.25	D17368	774 Checkmaster	69.75
D17372	665 Analyzer	58.50	D17383	689 Ohmmeter	37.50
D17387	609 V. T. V. Meter	49.50	D17370	778 Service	69.50
D17376	692 Test Oscillator	51.56	D17374	663 Volt-Ohmmeter	49.13
D17363	777-1 Tube & Bat. Test.	49.50	D17388	791 Port. Tester	20.00
D17364	777-2 Tube & Bat. Test.	54.75	D17385	564 Volt-Ohmmeter	28.00
D17379	764 Capacity Meter	48.38	D17389	767 Filatrol	4.95
D17380	695 AC-DB Meter	28.50	D17386	666 Socket Selector	15.83

### Other Hickok Instruments

Stock Num.	Type Instrument	Cash Price	Time Payment Plan		
			Amt. Down	Per Month	For Months
D17258	TS-50 Univ. Spkr. & Vib. Test.	\$55.86	\$15.84	\$ 6.00	8
D17259	110 AC-DC V.T.V. Meter	\$2.92	12.48	6.00	8
D17265	177 Signal Generator	47.63	12.44	6.00	7
D17267	177X Signal Generator	\$7.04	13.19	6.50	8
D17268	177X Signal Generator	\$6.45	14.60	6.60	8
D17269	188X Signal Generator	\$6.86	15.27	7.50	8
D17357	2108 Zero Current Meter	61.74	14.56	7.00	8
D17274	510X Tube and Set Tester	67.62	15.28	7.75	8
D17281	530 Mut. Cond. Tube Tester	\$5.27	11.17	6.50	8
D17358	530M Display Tube Tester	70.56	18.74	12.50	6
D17359	155 Trucometer	120.54	33.76	13.00	8
D17360	RF05 Oscilloscope	95.26	20.87	11.00	8
D17361	4955 Volt Ohm Milliammeter*	27.05	0.00	***	**

\*May be purchased on time when purchased with other Hickok Instruments—payments being increased proportionately.





# Radio TEST INSTRUMENTS

## RCP "DEPENDABLE" TEST INSTRUMENTS

### Portable and Counter Model Tube Testers

D17202

**\$23<sup>37</sup>**



**Model 310P**

D17202 — Portable Model 310P. (Illustrated at left). With Rollindex Chart and compartment. Size 11 1/4 x 12 3/4".

**YOUR PRICE..... \$23<sup>37</sup>**

D17201 — Portable Model 309P. Without Rollindex Chart and compartment. Size 11 1/4 x 10 7/8".

**YOUR PRICE \$16<sup>61</sup>**

D17203 — Counter Model 309C. (Illustrated at right). Size 9 1/2 x 2 3/4". Without Rollindex chart.

**YOUR PRICE..... \$15<sup>63</sup>**

D17204 — Counter Model 310C. As above but with Rollindex chart.

**YOUR PRICE..... \$21<sup>51</sup>**

D17203

**\$15<sup>63</sup>**



**Model 309C**

Simple to operate. Tests all tubes including localities, miniature types, ballasts and pilot lights. Direct reading 3" sq. D'Arsonval movement meter. Filament voltages to 117 are available. Neon shorts and leakage indicator. Jacks provided for noise test with headphones. Tests individual sections of multi-purpose tubes. Chart indicates control settings. Model 310P and 310C include built-in "Rollindex" Roll chart. Spare socket provided for new tubes. All models in leather covered case with attractive sloping panel. Portable models have removable hinged cover and handle. For 105-125 volt, 50-60 cycle AC operation.

### Multi-Range Testers

Compact testers for complete point-to-point receiver analysis. All instruments have rugged bakelite case; D'Arsonval movement meters, etched aluminum panels, self-contained batteries and ohmmeter and ohmmeter adjuster. Accuracy 2%. Test leads included.



**DC Model 433**

D17206—With 3" Meter. 7 Ranges thru tip jacks. DC Volts, 0-5-50-500-1000 at 1000 ohms per volt sensitivity. DC Ma., 0-1. Ohms, 0-500-500,000. Attractive panel. Hardwood case. Size 6x3x2 3/4". Wt. 21 oz.

**YOUR PRICE..... \$63<sup>32</sup>**

**DC MODEL 432**

C17213—With 2" Meters. 9 Ranges thru tip jacks. DC Volts, 0-5-50-500-1000 at 1000 ohms p.v. DC Ma. 0-1-10. Ohms, 0-500-50,000-500,000. Metal case. Size, 5 7/8 x 3 1/2".

**YOUR PRICE..... \$58<sup>93</sup>**

**AC-DC MODEL 456**

C17214—With 2" Meters. 16 Ranges thru tip jacks. AC-DC Volts, 0-5-50-500-1000 (DC at 1000 ohms p.v.). DC Ma., 0-1-10. Ohms, 0-500-500,000. Decibels, -12 to +8/+28/+48/+54. Hardwood case. Size, 6x3x2 3/4".

**YOUR PRICE..... \$77<sup>9</sup>**

**AC-DC Model 446**

C17215—With 3" Meters. 25 Ranges thru selector switch: DC Volts, 0-5-50-250-500-2500 at 1000 ohms p.v. AC Volts, 0-10-100-500-1000. Output Volts, 0-10-100-500-1000. DC Ma., 0-1-10-100-1000. DC Amps., 0-10. Ohms, 0-500-100,000-1 meg. Decibels, -8 to +15/+35/+49/+55. Hardwood case. Size, 3x8x5".

**YOUR PRICE..... \$97<sup>5</sup>**

**AC-DC MODEL 411**

5000 Ohms Per Volt Sensitivity  
C17217—With 3" sq. meter. 23 Ranges thru tip jacks. AC-DC Volts, 0-10-100-250-1000-5000. DC Ma., 0-10-100. AC Ma., 0-500. DC Microamps, 0-2.5-25. Decibels, -10 to +69 in 5 ranges. Ohms, 0-4 megas in 4 ranges. Solid walnut case. Size, 7 1/2 x 5 1/2 x 3 1/2".

**YOUR PRICE..... \$15<sup>92</sup>**

D17221—Portable Model 411. As above except in portable carrying case with removable hinged cover.

**YOUR PRICE..... \$17<sup>59</sup>**

### Model 802 Tube and Set Tester

C17209—

Model 802, Tube and Set Tester.

**YOUR PRICE**

**\$27<sup>39</sup>**



D17223—

Model 803. Same as above with Rollindex Chart

**YOUR PRICE**

**\$32<sup>29</sup>**

A light compact combination instrument that provides complete set and tube testing. Tube Tester checks all tubes including localities and ballast types. Provides filament voltages from 1 to 120. Neon leakage and short indicator. Jack provided for noise tests with headphones. Chart gives control settings. Model 803 includes built-in "Rollindex" Roll chart. Direct reading 4 1/2" D'Arsonval movement meter. Built-in Set Tester measures AC-DC Volts: 0-10-50-500-1000, DC at 1000 ohms p.v. DC Ma., 0-1-10-100-1000. DC Amps, 0-10. Ohms, 0-5-500-1 Meg.-10 Mega. Decibels, -8/+15/+29/+49/+55. Set Analyzer Unit eliminates necessity of removing radio chassis from cabinet for testing. Measures all voltages and currents at tester with the set in operation. All adapters included. Leatherette covered carrying case with removable cover. Attractive aluminum panel. Size, 12x12 1/2x6". For 115 volt, 50-60 cycle AC operation.

### Model 414P Multi-tester

With 4 1/2" Sq. Meter

D17205—Model

414P. Complete with test leads and instructions.

**YOUR PRICE**

**\$24<sup>01</sup>**

Range selector switch. Ranges: DC Volts, 0-5-50-250-2500-5000 at 2000 ohms per volt. AC Volts, 0-10-100-500-1000-5000. DC Ma., 0-10-50-250-1000. DC Amp., 0-1-5-25. Capacity, 0-0.03-3-30-300 Mfd. Resistance, 0-100-15,000-150,000 ohms and 0-1.5-15 megohms. Inductance, .25-1000 mh. and .25-100-1000-10000 henries. Built-in power supply. For 105-120 volt, 50-60 cycle AC operation. Solid maple carrying case. Size 9 1/2 x 12 1/2 x 6".



### Model 702 RF and AF Signal Generator

Has an extremely wide fundamental coverage of 95 Kc. to 25 Mc. on five bands. Accurately calibrated large direct reading dial with dual ratio knob. RF output can be unmodulated or modulated 30% at 400 cycles. The 400 cycle audio can be used separately. Five step attenuator with output of 1 microvolt to .5 volts. Leakage minimized by individually shielded circuits, filtered power supply and complete overall shielding provided by the leaded steel case and chassis. Coils when not used are shorted out of circuit. Double fused power supply cord. Contains all latest improvements in circuit and mechanical design.

D17222—Model

702 Signal Generator.

Complete with connection leads.

Housed in grey wrinkle metal cabinet with carrying handle. Size 8 x 11 1/2 x 5".

For 105-120 volt, 50-60 cycle AC operation.

**YOUR PRICE**

**\$22<sup>49</sup>**



### Million Model DF Tube Tester

D17218—For 105-125 volt 50-60 cycle AC operation.

**YOUR PRICE..... \$16<sup>95</sup>**

Provides quick and accurate emission test of all tubes including Octal, Localtis, "S" series, hearing aid, etc. Direct reading 3" sq. D'Arsonval movement meter. Filament voltages from 1.4 to 120 are available. Easy to operate, only 3 rotary switches and one slide switch used for tube tests. Neon short and leakage indicator also tests condensers. Cream colored panel with black markings. Black leatherette covered carrying case. Size, 10x10x4 1/2". Complete with charts and instructions. Ship. wt. 10 lbs.



With Neon Leakage Indicator

### Million Model OD Oscillator

Range 100 Kc to 25 Mc on 6 Bands

Greatest dollar value is represented in this fine low priced oscillator. Tunes 100 to 25,000 Kc (fundamental) on 6 bands with over 40 inches of accurately calibrated scale length. Separate coils for each band individually trimmed eliminates possibility of dead spots. Double range type attenuator provides fine and coarse adjustment. Output can be varied from a few microvolts to approx. 20,000 microvolts. 400 Cycle audio modulator can also be used separately. Uses 76 type tube as RF oscillator, 6C6 as RF amplifier, 76 as audio modulator and 12Z3 as rectifier. Full shielding and line filter practically eliminates leakage and line loss. Attractive etched bronze panel with ivory knobs. Wrinkle finish steel case with carrying handle. Size, 7x10x6 1/2".

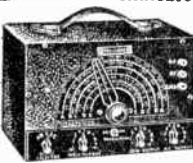

C17191—For 105-120 volt AC-DC operation.

**YOUR PRICE..... \$19<sup>95</sup>**

### American RF and AF Signal Generator

Model 4102

100 Kc to 30 Mc on Six Bands

A fine signal generator priced within the reach of every radio serviceman. Features a fundamental coverage of 100 Kc. to 30 Mc on six bands. Large 6" directly calibrated dial, accurate to within 1/4 of 1% on IF frequencies, 1% on broadcast and 2% on higher frequencies. Employs an improved electron-coupled oscillator circuit with minimum drift and a Hartley AF oscillator. RF can be unmodulated or modulated and the AF can also be used separately for testing of amplifiers, etc. Audio and modulation is available at three frequencies of 400, 1000 and 5000 cycles. Controls on panel are RF tuning selector, band selector, audio selector, full range attenuator, power switch, modulation switch and output jacks for RF and AF. Completely shielded. Heavy gauge frosted aluminum panel finished in chrome, red and black. Grey wrinkle finished streamlined cabinet with carrying handle. Size 14x6x11".



D17199—Model 4102. RF and AF Signal Generator. Complete with tubes, shielded cables and instructions. For 90-125 volt 50-60 cycle AC operation. Ship. wt. 15 lbs.

**YOUR PRICE..... \$15<sup>53</sup>**



# SIMPSON "1941" Radio Test Equipment

## Portable Tube Tester

Model 300

D17233—For 105-120 V.  
50-60 cyc. operation.

YOUR PRICE **\$25<sup>97</sup>**



Tests every type of Radio Receiving Tube as well as ballast tubes, pilot lamps, Xmas tree lights and flashlight bulbs. Provides from .5 to 120 filament volts. Tests localities, single ended tubes, bantams, miniatures and gaseous rectifiers as perfectly as the balance of the popular radio tubes. Double filament switching permits testing tubes without use of special adapters or sockets regardless of filament terminal location. Neon bulb provides high sensitivity short check. Line voltage adjustable from 100 to 130 volts. 4 1/2" Fan shaped meter has Good-Bad "English Reading" scale as well as percentage scale for matching and comparing tubes. Has attractive two toned metal panel. Instrument housed in black fabricoid covered, portable carrying case, size 8x10 3/4 x 5 1/2". Simplified instructions and tube charts conveniently carried in removable cover. Wt. 12 lbs.

## DeLuxe Tube Tester

Model 400

D17234—For 105-120 V., 50-60 cyc. operation.

YOUR PRICE **\$35<sup>28</sup>**



One of the finest, most complete tube testers on the market. Tests all tubes released to date including localities, bantams, miniatures, ballasts, gaseous rectifiers, Xmas tree lights, flashlight bulbs and pilot lamps. Provides from .5 to 120 filament volts. Front panel divided into 3 sections—any of which may be changed individually, at minimum cost, should now unlooked for new tube releases ever require it. Individual 3 position switches for each tube element guards against objectionable "Speed Roll Chart," has "quick-locator" index which facilitates spotting of any desired setting. Heavy black lines tie all readings with associated knobs, speeding operation and guarding against error. Large 4 1/2" meter with English reading scale shows tube condition, and percentage scale checks comparative efficiency. Housed in durable crackle finish metal case with handle. Your Name Engraved Free when you make your purchase. Size: 10 1/2 x 13 1/2 x 4". Wt. 16 lbs.

D17286—Durable Leatherette carrying case with removable cover, for Model 400.  
YOUR PRICE **\$4<sup>90</sup>**

## Giant Tube Testers

Models 500 and 350



D17236—Model 500 Giant Tube Tester—Same as Model 400 above except uses giant "3 3/4" meter with black, red and green scale on silver etched background, illuminated indirectly by two 6V. bulbs. Housed in durable crackle finished metal case with sloping panel for either vertical or horizontal mounting. For 105-120 V. 50-60 cyc. operation.

YOUR PRICE **\$42<sup>14</sup>**

D17236—Model 350 Giant Tube Tester—same as Model 500, above, except has 7" meter and does not have roll chart or unit panel construction.

YOUR PRICE **\$34<sup>30</sup>**

By simply removing panel screws, lifting panel and chassis assembly unit from case and turning same end for end before placing in case again, either of the above models can instantly be converted for vertical or horizontal use.

## Giant Volt-Ohm-Millammeter

Model 320

9" Meter—51 Ranges

D17229—**\$36<sup>75</sup>**  
YOUR PRICE.....

Incorporates a truly giant D'Arsonval Movement Meter, 9" wide by 8 1/4" high housed in a modernistic designed black bakelite case. Meter dial has silver etched metal background with all DC scales in black and AC scales in red. Knife edge pointer permits accurate readings. Dial is indirectly illuminated.

AC and DC Volts at 1000 ohms per Volt: 0-3-7.5-30-75-150-300-750-1500-3000. DC Current: 0-1.5-7.5-30-75-150-300-750 Mills. and 0-15 amps. Resistance: 0-500 ohms (20 ohms mid-scale) 0-20,000-50,000 ohms and 0-5-50 Megs. Capacity: .0001 to .05 Mfd., .001 to .5 Mfd., .01 to 5 Mfd. and 1 to 50 Mfd. Decibels: -20 to +48. The 48" test leads included and high voltage jacks are insulated to 3000 volts. Meter panel is steel gray background with large distinct two tone red and black characters. All ranges, except 1500 and 3000 volts, are selected by a single rotary switch with a large bakelite handle. Steel cabinet is finished in black wrinkle enamel. Size, 10x16x5". For 105-120 volt, 50-60 cycle AC operation.

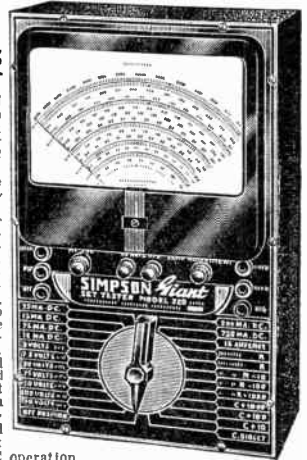

## Tube and Set Tester

Model 450

Combines Complete Tube Testing with Complete Point-to-Point Set Testing.

4 1/2" Meter

D17224—For 110 V.

60 Cyc. AC operation.

YOUR PRICE **\$38<sup>95</sup>**



Tube Tester Section tests all tubes yet to be released. Provides from .5 to 120 filament volts. Tests localities, single ended tubes, bantams, midkets, miniatures, ballasts, magic eye tubes, gaseous rectifiers, Xmas tree lights, flashlight bulbs and pilot lamps. Has neon hot cathode leakage test and neon short check. Double circuit switching allows test of all tubes without adapters or special sockets. English reading "Good-Bad" Scale shows tube condition. Point-to-Point Tester Section, 4 1/2" Meter, 1000 0-P-V type. Ranges: AC-DC and Output volts: 0-7.5-30-75-150-300-750-1500-3000. Ohms entirely AC operated: 500, 50,000-5 Megs. DC Mills: 0-3-15-75-300-450. Decibels: -10 to +40. Instrument housed in fabricoid covered carrying case with removable cover which also holds instructions and tube charts. Size: 10x11x5 1/2". Wt. 14 lbs. For 105-120 V. 60 cyc. AC operation.

## Volt-Ohm-Millammeter

AC-DC Model 215

D17228—

YOUR PRICE **\$22<sup>38</sup>**

Similar in construction and appearance to model 214, below. Ranges: AC and DC Volts: 0-2.5-10-250-1000-5000 at 5,000 ohms on DC and 1000 ohms on AC. DC microamps: 0-250. DC Milliamps: 0-10-100-500. Decibels: -12 to +55. Resistance: 0-4000-400,000-4 Megs.

Model 260

20,000 O.P.V. on DC Ranges

AC and DC Volts: 0-2.5-10-50-250-1000-5000. DC Milliamps: 0-10-100-500. DC Microamps: 0-50-100. Resistance: 0-1000-100,000-10 Megs. Decibels: -10 to +52. Incorporates 4 1/2" D'Arsonval movement meter. Has zero ohms adjuster. Molded bakelite case with leather handle. Size: 5 1/2 x 7 3/8". Comes complete with 48" 5000 volt insulated test leads and self-contained battery.

D17227—Model 260.  
YOUR PRICE **\$26<sup>95</sup>**

## MICRO TESTERS



Extremely useful where narrower ranges will meet your requirements. All are housed in sturdy red bakelite cases. Panels are of silver satin finished metal with black bakelite binding posts. Size of each: 2 1/2 x 5 1/4 x 1 1/4". Test leads and carrying case extra.

D17185—Model 280 AC Ammeter 0/1/2/5/5/10/25 Amps

YOUR PRICE **\$9<sup>55</sup>**

D17186—Model 282 Ohmmeter 0/1000/10,000/100,000/1 meg/10 Megs.

YOUR PRICE **\$9<sup>55</sup>**

D17187—Model 283 DC Milliammeter 0/1/5/10/25/50/100/250/500/1000 mills.

YOUR PRICE **\$9<sup>07</sup>**

D17188—Model 284 Microammeter 0/50/100/250/500/1000 microamps.

YOUR PRICE **\$9<sup>55</sup>**

D17189—Model 286 AC Voltmeter 0/5/10/25/50/100/250/500/1000 volts.

YOUR PRICE **\$9<sup>55</sup>**

D17190—Model 281 AC Voltmeter 0/150/300/600 V.

YOUR PRICE **\$9<sup>07</sup>**

D17193—Test leads & Pr. Either Type **\$1<sup>22</sup>**

D17192—Sturdy leatherette carrying case to hold 3 Micro-testers. YOUR PRICE, Each... **\$2<sup>45</sup>**

D17231—Model 235 DC Voltmeter 0/10-50-250-500-1000. DC Mills: 0-10-100-500. DC Microamps: 0-250. Resistance: 0-2000-200,000-2 Megs. Has zero ohms adjuster and self contained battery. Complete with pair of 48" test leads. Red molded bakelite case. Size, 2 1/2 x 5 1/4 x 1 1/4".

YOUR PRICE **\$9<sup>75</sup>**

Rotary switch selects DC Volts at 5000 0-P-V: 0-10-50-250-500-1000. DC Mills: 0-10-100-500. DC Microamps: 0-250. Resistance: 0-2000-200,000-2 Megs. Has zero ohms adjuster and self contained battery. Complete with pair of 48" test leads. Red molded bakelite case. Size, 2 1/2 x 5 1/4 x 1 1/4".

Model 240 AC-DC

Rotary switch selects AC Volts at 1000 0-P-V: 0-15-150-750-3000. DC Volts at 150-750. Resistance: 0-3000-300,000. Has zero ohms adjuster. Battery self contained. High voltage plug-in jacks insulated up to 5000 volts. Complete with 48", 5000 volt insulated test leads with alligator clips. Red molded bakelite case. Size, 2 1/2 x 5 1/4 x 1 1/4".

D17235—Model 240 AC-DC.  
YOUR PRICE **\$14<sup>45</sup>**

# Newest CONDENSER ANALYZERS

## Solar Capacitor and Resistance Bridge Analyzer

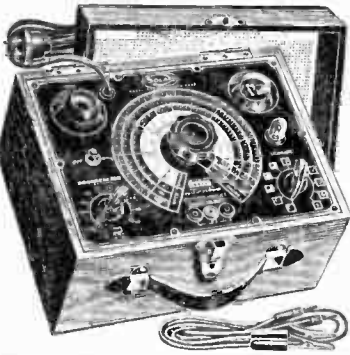

C17180—For 105-120 volt, 50-60 cycle AC operation. Complete, less tubes. **\$18.82**

**YOUR PRICE**.....  
C15304—Set of Sylvania Tubes for above. **97¢**

Measures capacity and shows exact condition of all types of electrolytic, paper, mica and air condensers from .0001 to 70.0 Mfd. Indicates power factors from zero to 50%. Accurately measures resistance of all types of carbon and wirewound resistors from 50 to 2,000,000 ohms. Measures leakage resistance up to 1,000 megohms with an applied voltage of up to 450 volts DC. Detects shorts, opens, leaks and other defects in condensers. May be used as continuity meter for testing any circuit. All measurements are made simply and directly on five color-coded scales with more than 45 linear inches of accurately calibrated markings. Simple, fast and accurate in operation. A type 6E5 Cathode Ray tube, used as a visual bridge detector, gives a positive indication of balance on all capacity, resistance and power factor measurements. Requires no external meters, standards, headphones, or similar accessories. Uses 1-6E5, 1-1V tube. Oak finished portable carrying case with removable hinged cover. Size, 9 1/2"x7 1/2"x3 1/2".

## Cornell-Dubilier Condenser Analyzer

Self-Contained



D17196—Model BF-50. Complete with instructions, cord and plug and alligator clip test leads, but less tubes.

**YOUR PRICE**.....  
**\$24.40**

D1303—1-12A7 and 1-6E5 Sylvania tubes for above tester. **YOUR PRICE**.....  
**\$1.40**

Quickly and accurately determines the capacity and operating conditions of any paper, mica and electrolytic condensers; including AC motor starting types, of from .0001 to 240 mfd. capacity. Also measures power factor from 0 to 50%, and shows insulation resistance up to 1500 megohms. Uses visual eye for leakage indication and bridge balance. High sensitivity detects all leaks, shorts, and opens. Provides sharp or broad balances for quick and accurate readings. All readings are made simply and directly on six color coded linear calibrated scales. Employs Wien bridge circuit which insures accuracy and stability of measurements. Not affected by 1-voltage variations. Portable walnut carrying case with sloping panel and removable hinged cover. Size: 6 1/2"x12 1/2"x7". Net wt. 9 lbs. For 110 volt, 50-60 cycle AC operation.

## Solar Condenser "Quick Check"



D17181—Model QC-1-60. With test leads and instructions. **YOUR PRICE**.....  
**\$11.61**

Quickly indicates condition of all types of paper, mica, air and electrolytic condensers without removing them from the circuit. Consists of a balanced RF oscillator, a visual indicator and a source of power to permit positive indication of good, shorted and open condensers, intermittent defects and RF impedance of the condenser. Simple to operate. Housed in compact metal case. Size: 4 1/2"x6 1/2"x2 1/2" high. Wt. 5 1/2 lbs. For 110 volt, 60 cycle AC operation.

With Capacity Bridge

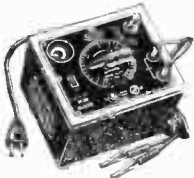

D17182—Model QC-1-60. Similar to above except combines the RF oscillator with a Wien bridge to perform condenser tests as mentioned above and also measure capacity from .0001 to 70 mfd., power factor and to serve as a continuity meter for circuit testing. **YOUR PRICE**.....  
**\$15.43**

All other Solar Instruments supplied promptly

## C-D Service Mike

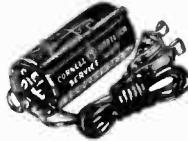

D17130—**\$2.21**  
**YOUR PRICE**.....

Provides a capacity range from 18.75 mfd. to 150 mfd. in twelve separate steps. Designed for emergency repair of motors employing electrolytic motor starting capacitors. Can be used to determine capacity required with a given motor where the original capacity is unknown. Encased in hermetically sealed insulated aluminum container. Terminals are provided with test leads, clips and jumpers for connections. Size: 1 1/2"x3 1/2".

## C-D "Test-Mike"



D17129—"TEST-MIKE". Complete with Test Leads, Clips and Pilot Lamp. **YOUR PRICE**.....  
**\$5.88**

Contains the same capacitor unit as the "SERVICE MIKE" except furnished in a heavy bakelite case with six toggle switches to facilitate selection of twelve capacity values from 18.75 mfd. to 150 mfd. A pilot lamp provides a method of observing that part of a motor starting cycle during which voltage is applied to the capacitor. Size 3 1/2"x3 1/2".

## Compact Condenser Bridge

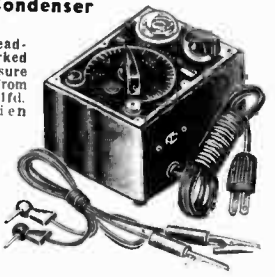

Has 3 direct reading scales marked in Mfd. to measure capacity from .0001 to 50 Mfd. Employs Wien bridge circuit using electric eye tube to show correct balance. Indicates power factor, 0 to 50% and 5 shorted condensers, 110 volt, 60 cycle AC. Walnut bakelite case, 3 1/2"x5 1/2". Complete with instructions and test leads. Uses 1-12A7, 1-6A6F6G tubes.

C17197—Model BN. Less Tubes. **YOUR PRICE**.....  
**\$9.70**

## New Radolek Universal Foundation Meters

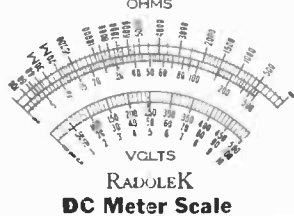
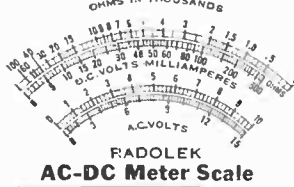
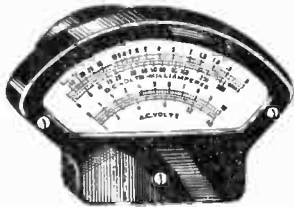

Foundation units for building a high class volt-ohm-milliammeter. All meters have rugged DC D'Arsonval movements with 2% accuracy, sapphire jeweled bearings, knife-edge pointers and zero adjustment. Supplied with either DC or AC-DC calibrated dial scales. AC-DC meters are for use with external 100 ohm shunt. All types have black bakelite cases. Fan Type Meters measure 1 1/2"x3 1/2" across front and mount in 2 1/2" round hole. 3 1/2" Round Meter fits 2 1/2" hole. Giant 5 1/2" Meter requires 1 1/2" hole. All meters extend 1 1/2" back of panel. Wiring diagram for building a multi-tester included.

**0-1 Ma. DC Movement (1000 O.P.V.) Meter**  
50 Ohms internal resistance. 0-1 Ma. DC movement.

**Fan Type Meter**  
C10475—With DC Scale.  
C10476—With AC-DC Scale.  
**YOUR PRICE, Each..... \$4.41**

**Round Meter**  
Available with DC scale only.  
D10290-3 1/2" Dia. **\$4.66**  
**YOUR PRICE**.....  
D10291-5 1/2" Dia. **\$6.57**  
**YOUR PRICE**.....

**5,000 Ohms Per Volt Foundation Meters**

6-20 D.C. microampere movement. Meter resistance 50 ohms.  
C10484—A.C.-D.C. Scale. **C10486—A.C.-D.C. Scale.**  
C10485—D.C. Scale. **C10487—D.C. Scale.**  
**YOUR PRICE, EA..... \$5.88** **YOUR PRICE, EA..... \$4.98**

**20,000 Ohms Per Volt Foundation Meters**

0-50 DC microampere movement. Meter resistance 1,550 ohms.  
C10480—A.C.-D.C. Scale. **C10482—A.C.-D.C. Scale.**  
C10481—D.C. Scale. **C10483—D.C. Scale.**  
**YOUR PRICE, EA..... \$10.58** **YOUR PRICE, EA..... \$9.98**

## Aerovox Capacity and Resistance Bridge



D17200—Complete with Tubes and Testing Manual. **YOUR PRICE**.....  
**\$35.03**

Portable, easily operated Cap. and Resist. Bridge. Makes capacity, leakage and power factor tests of all condensers under actual working conditions. Built-in power supply provides any voltage between 15 and 600 volts. Capacity range .0001 to 100 mfd. in 8 ranges. Resistances of 10 ohms to 1 megohm are measured on 5 ranges. Insulation resistance can be read up to 10,000 megohms. Also provides following ranges for external tests: DC Volts, 0-60-300-600 at 1000 o.p.v. DC Ma., 0-6-60. Vacuum tube voltmeter measures other minute values. Readings are made from chart and meter. Three tubes are used: 6X4G, 45 and 1V. Red gunwood case has removable hinged cover and carrying handle. Size, 10 1/2"x7 1/2"x8 1/2". For 105-130 volt, 60 cycle operation.



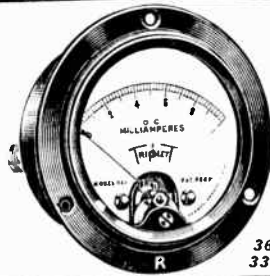

**TRIPLET**



361-321-223  
331-341-233

# PRECISION METERS D'Arsonval Moving Coil Type

Amateurs—Service Men—Engineers—Rugged dependable meters, accurate to within 2% at 70° F. Clear white enameled dials. Balanced aluminum indicating pointers. Zero adjustment. Genuine polished Sapphire jeweled bearings.

Models 321 DC—331 AC—341 RF—361 Watts: Flush type wide flange, 3 1/2" diameter. Scale length 2 3/4", mounting hole required. Bakelite case. Models 223 DC—233 AC: Flush type. Fits into 2" hole. Metal case has narrow rim. Mounts with rear clamp. Models 326 DC—336 AC: 3" Square Type. Scale length 2 3/4". Wide flange. Bakelite case. 2" Mounting hole required.

326-336

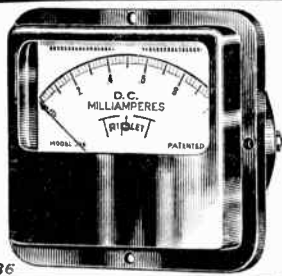

## RF THERMO AMMETERS

With Internal Couples—Accuracy 2%

Stock Number	Amps. Range	Approx. Resis.	Model	Your Price
C10261	.5	.93	341	\$6.53
C10262	1	.35	341	6.53
C10263	1.5	.21	341	6.53
C10264	2.5	.13	341	6.53
C10265	5	.06	341	6.53

## D. C. AMMETERS

Amps.	326	321	Net	223	Net
0-10	10196	10211	\$3.75	10226	\$2.94
0-25	10197	10212		10227	

## A. C. MILLIAMMETERS

MA.	336	331	Net	233	Net
0-0		10236		10242	
0-500	10231	10237	\$3.75	10243	\$2.94

## A. C. AMMETERS

Amps.	336	331	Net	233	Net
0-1	10232	10238		10244	
0-3	10233	10239	\$3.75	10245	\$2.94
0-10	10234	10240		10246	

## D. C. MILLIAMMETERS

MA.	Model 326 Sq.	321 Rd.	Your Price	Model 223 Rd.	Your Price
0-1	10186	10211	\$4.57	10216	\$3.75
0-5	10188	10203		10218	
0-10	10189	10204		10219	
0-50	10190	10205	\$3.75	10220	\$2.94
0-100	10191	10206		10221	
0-200	10192	10207		10222	
0-500	10194	10209		10224	
0-750	10266	10267		10214	
0-1000		10268		10215	

## D. C. VOLTMETERS

1000 Ohms Per Volt

Volts	326	321	Net	223	Net
0-10	10121	10133	\$5.39	10145	\$4.24
0-100		10134	5.71	10146	5.06
0-300	10123	10135	6.53	10147	5.72
0-1000		10136	7.13	10148	6.53
*0-750		10271	8.98	10274	7.84
*0-1000		10272	10.45	10113	9.31
*0-2000		10273	16.17	10114	15.01

\*Supplied with external multiplier.

## D. C. VOLTMETERS

125 Ohms Per Volt

Volts	Model 326 Sq.	321 Rd.	Your Price	Model 223 Rd.	Your Price
0-10	10115	10127	\$3.75	10139	\$2.94
0-50	10116	10128		10140	
0-150	10117	10129		10141	
n-250		10130	\$4.57	10142	\$3.75

## A. C. VOLTMETERS

Volts	336	331	Net	233	Net
0-1.5		10162		10173	
0-6				10178	
0-10	10154	10165	\$3.75	10176	\$2.94
0-15	10171	10175		10182	
0-25		10166		10177	
0-100		10168		10179	
0-150	10158	10169	\$4.57	10180	\$3.75
0-300	10159	10170	5.39	10181	4.73

## WATTMETERS—Amateur Type

Model 361—With External Shunt

Stock Number	Range Volts	Volts Limit	Mills Limit	Your Price
C10275	250	1000	250	\$12.00
C10276	500	1500	350	17.38
C10277	750	2000	350	13.45
C10278	1000	3000	350	16.34
C10283	1000	2500	400	15.69

## Readrite Panel Meters

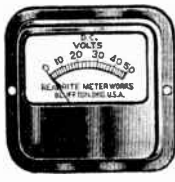

Accuracy guaranteed within 5%. White dial, black lettering, metal shell. Mounting clamp included. Requires 2 3/4" mounting hole.

## D. C. Voltmeters

Without Zero Adjustment 55 Round				With Zero Adjustment 55 Round			
Stock Num.	Your Price	Stock Num.	Your Price	Scale Volts	Ohms Resist.	Stock Num.	Your Price
A10300		A10380		0-1	30	A10313	
A10301	59c	A10381	79c	0-3	175	A10314	73c
A10302		A10382		0-6	550	A10315	
A10304		A10383		0-8	850	A10317	
A10365	59c	A10384	79c	0-10	1,475	A10318	73c
A10308		A10385		0-25	1,625	A10321	
A10309		A10386		0-50	2,350	A10322	
A10311	\$1.03	A10388	\$1.21	0-150	9,750	A10324	\$1.18

## D. C. Milliammeters

Stock Num.	Your Price	Stock Num.	Your Price	Scale Volts	Ohms Resist.	Stock Num.	Your Price
A10326	\$1.32	A10389	\$1.53	0-5	2,160	A10338	\$1.47
A10327	1.18	A10390	1.39	0-0	700	A10339	1.32
A10328		A10391		0-25	85	A10340	
A10329		A10392		0-50	20	A10341	
A10330		A10393		0-100	5.5	A10342	
A10331	59c	A10394	79c	0-200	1.9	A10343	73c
A10332		A10395		0-400	5	A10344	

## D. C. Ammeters

Stock Num.	Your Price	Stock Num.	Your Price	Scale Volts	Ohms Resist.	Stock Num.	Your Price
A10334		A10396		0-3		A10346	
A10335	59c	A10397	79c	0-5		A10347	73c
A10336		A10398		0-10		A10348	
A10337		A10399		0-0-20		A10349	

## A. C. Voltmeters

Model 55				Model 95			
Stock Num.	Your Price	Scale Volts	Stock Num.	Your Price	Scale Amps.	Stock Num.	Your Price
A10351	\$1.62	0-10	A10430	\$1.82	0-5	A10434	\$1.82
A10352		0-15	A10431		0-10	A10435	
A10353	\$2.65	0-50	A10432	\$2.85	0-50	A10436	\$2.40
A10354	4.56	0-750	A10433	4.76	0-50ma	A10437	1.82

## Filament Meter

Special Value Oxidized Bronze Finish, flanged 2" in diam. Mount 2-in. hole. 0-10 volts D.C.

A10359—YOUR PRICE 29c

## Readrite Meter Flange

Wide flange 2 3/4 inches diameter. Fits any Model 55 Meter for flange mounting. Black finish.

A10361—YOUR PRICE 9c

## Metal Meter Cabinets

Conveniently and safely houses any 2" or 3" meter. Finished in marine gray tripple enamel with red striped chrome trim. Size 3 1/4 x 4 1/2 x 1 1/2" high.

D17962—With 2 3/4" Hole.

D17963—With 2 3/8" Hole.

YOUR PRICE, Each 88c

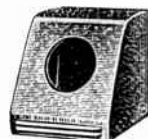

## Readrite Volt-Ohmmeters

Handy pocket size instruments adaptable to voltage and continuity testing of radio receivers. Testers have square Readrite meters with large easy-to-read dial scale. Case is black wood. Test leads attached with switch terminal jacks at sides. Size only 2 1/2 x 3 1/2 x 1 1/2". Complete with self-contained 3 volt battery.

C10248—Ranges: DC Volts, 0-300, Ohms, 0-10,000. YOUR PRICE \$220

C10249—Ranges: DC Volts, 0-3-30-300, Ohms, 0-10,000. YOUR PRICE \$279

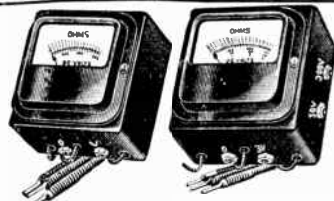

## Rotary Switches

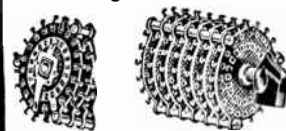

Especially designed for use in testing equipment. 19 active and 1 off positions per deck. Smooth operating, new positive click type. Low resistance contacts. Single hole mounting. Bakelite insulation. Bakelite pointer knob included.

Stock Number	Decks	1st Price	Your Price
A11093	One	\$2.00	\$1.30
A11094	Two	2.50	1.63
A11095	Three	3.00	1.96
A11096	Four	3.50	2.29
A11097	Five	4.00	2.62
A11098	Six	4.50	2.94
A11099	Seven	5.00	3.27

## Tuning Meters



For Accurate Visual Tuning

For replacement in A.V.C. sets. With Type TM103 circuit is brought into resonance when needle swings to farthest point. Has opaque dial with window at bottom for illumination from tuning dial light. Type TM121 has shadow effect to indicate resonance. To select proper tuning meter, it is necessary to know plate current of tubes with which used. Less escutcheon. Type TM121 supplied with G.3 volt bulb.

D. C. Scale Defect.	Type TM103	Type TM121	YOUR PRICE
5 M.A.	K10362	K10366	
7 M.A.	K10363	K10367	
10 M.A.	K10364	K10368	
15 M.A.	K10365	K10369	88c
Escutch.	K10370	K10371	18c

## Resistance Meter

Model 501 Direct reading volt ohm meter. 0-4 1/2 volts, 0-10,000 ohms. 2" flange type meter. Requires 4 1/2 volt battery in series with the meter and resistance. Accuracy within 10% with fresh batteries.

A10360—YOUR PRICE 88c

# METER REPAIR SERVICE AND ACCESSORIES

## Meter Dial Scales

Designed for use with one milliamper movement meters but can be used with other meters by adjusting circuit. Two types are available: etched metal and printed bristol board. For greatest satisfaction we recommend the etched metal dials. These have clear black numerals and scales etched on white silver background.

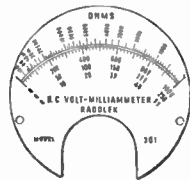

### DC Volt Milliammeter Scale

Upper scale calibrated in ohms for use with 4½ volt battery. 50 divisions marked 50, 250, and 1000 for D.C. Volt, and Milliamper. Ranges.

Etched Dial stock Num.	For Meter	Printed Dial Stock Num.
C10650	Weston Model 301	C10640
C10651	Jewell Type 88	C10641
C10652	Jewell Type 54, 199	C10642
C10653	Triplet Model 321	C10643

### DC Volt-Ohms Ma. Scale

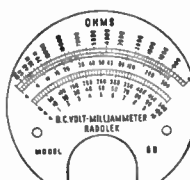

Upper scale is for 4½ volt Ohmmeter. Middle scale indicates ohms when unknown resistance is shunted across 50 ohm movement carrying 1 M.A. Lower scale has 50 uniform divisions marked, 10, 100, and 500 volts. Use resistor in series with meters less than 50 ohms resistance.

C10657	Weston Model 301	C10644
C10658	Jewell Model 88	C10646
C10659	Jewell Model 54, 199	C10647
C10660	Triplet 3½, 321	C10649
C10661	Triplet 5½, 321	C10654

### AC-DC Scale

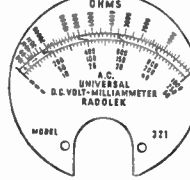

For use with Weston Universal A.C.-D.C. Meter or equivalent 1 Mil. meters equipped with copper oxide rectifiers. 50 scale divisions marked 50, 250, 1000 volts or Milliamperes according to external circuit employed. Top Scale in ohms for 4½ Volt battery.

C10665	Weston Model 301	C10662
C10666	Jewell Model 88	C10663
C10667	Triplet Model 321	C10664

Etched Dials YOUR PRICE Each.....	39c	Printed Dials YOUR PRICE Each.....	18c
---	-----	--	-----

## Continental Carbon Precision Resistors



Precision 1 watt carbon resistors each hermetically sealed in glass and moulded into a bakelite shell. Impervious to moisture and exceptionally stable. Suitable for use in radio servicing equipment, photo-electric circuits, television sets, etc. Supplied in two accuracies, ±2% and ±5%. Size, 1½" long x ¼" dia.

±5% Acc. Stock Num.	Resist. Ohms	±2% Acc. Stock Num.	Resist. Ohms	±5% Acc. Stock Num.	Resist. Ohms	±2% Acc. Stock Num.	Resist. Ohms
C3691	100	C3700	40,000	C3718	40,000	C3719	50,000
C3693	400	C3701	36,73	C3719	50,000	C3720	75,000
C3694	500	C3702	36,75	C3720	75,000	C3721	85,000
C3695	1,000	C3703	36,76	C3721	85,000	C3722	100,000
C3695	2,950	C3704	36,77	C3722	100,000	C3723	150,000
C3697	4,000	C3705	36,78	C3723	150,000	C3724	200,000
C3698	4,450	C3706	36,79	C3724	200,000	C3725	250,000
C3699	4,950	C3707	36,80	C3725	250,000	C3726	300,000
C3660	5,000	C3708	36,81	C3726	300,000	C3727	400,000
C3663	7,450	C3709	36,82	C3727	400,000	C3728	450,000
C3664	8,500	C3710	36,83	C3728	450,000	C3729	500,000
C3665	8,950	C3711	36,84	C3729	500,000	C3730	600,000
C3666	9,950	C3712	36,85	C3730	600,000	C3731	750,000
C3667	10,000	C3713	36,85	C3731	750,000	C3732	900,000
C3669	15,000	C3714	36,86	C3732	900,000	C3733	1 Meg.
C3697	20,000	C3715	36,87	C3733	1 Meg.	C3734	
C3670	25,000	C3716	36,88	C3734		C3735	
C3671	30,000	C3717	36,89	C3735			

Accuracy ± 2% YOUR PRICE Each.....	29c	Accuracy ± 5% YOUR PRICE Each.....	18c
--	-----	--	-----

## Manganin Resistance Wire Double Silk Covered

Use 30 gauge for all series multiplier purposes. 26 gauge for shunts carrying less than 50 MA. 22 gauge for shunts up to 1000 MA. Temperature coefficient 0.00025 ohms per °C. Practically no thermal co-efficient in contact with copper.

Stock Num.	Feet	Wire Size	Ohms Per Foot	Your Price
D4800	10	22	0.452	\$0.25
D4805	100	22	0.452	1.21
D4801	25	26	1.147	.25
D4806	200	26	1.147	1.05
D4802	30	30	2.899	.25
D4807	300	30	2.899	1.15

### Bare Resistance Wire

For use at extreme high temperatures in heater elements. Temperature co-efficient 0.00012 ohms per °C up to 500° and fairly constant to 1000° C. Non-oxidizing in air. Non-magnetic.

D4803	10	22	1.015	.25
D4808	100	22	1.015	1.10
D4804	60	32	10.150	.25
D4809	500	32	10.150	1.10

## Full Wave Copper Oxide Rectifiers



### Type A 5 Milliamper Capacity

¾" Square, ¼" Mtg. Ctrs.

Miniature copper oxide rectifier. Guaranteed the finest made. For converting D. C. instruments drawing less than 5 milliamperes to A. C.

K3850—  
YOUR PRICE.....

\$2.59



### Type B 20 Milliamper Capacity

Size ¾" round discs, ¼" long.

Medium miniature size copper oxide rectifier for use in A. C. circuits of less than 5000 cycles frequency and rectifying not over 20 milliamperes D. C. Has 6-32 insulated mounting bolt.

K3851—  
YOUR PRICE.....

\$1.95



### Type C 40 Milliamper Capacity

Size ¾" round disks, overall size 1½"x1"

Copper oxide rectifier for A. C. circuits of less than 5000 cycles frequency and not to exceed 40 milliamperes D. C. current. Excellent for rectification of 110-115 volt A. C. current for field excitation of dynamic speakers with 2250 to 3000 ohm field.

Not recommended on circuits exceeding 600 volts.  
R3852—  
YOUR PRICE.....

\$1.75

## Conant "CRS" Rectifiers

Especially designed for use with DC meters in making AC measurements. Complete instructions included with each rectifier.

A3853—Type B—Very small full-wave rectifier. Very efficient at high frequencies. Max. rating 10 volts AC input and 5 Ma. output. Body size, TYPE B

A3854—Type M—Full wave rectifier. Used in many test instruments. Rated 10 volts AC input max. with 20 Ma. output. Can be overloaded 200% at intervals. Size 3½"x¾".

YOUR PRICE, Each.....

\$2.06

## Meter Repair Service



BEFORE AFTER

Guaranteed Precision Meter Repair Service for burned out or damaged meters. Typical rates given below. For other repairs send meter for quote. Send Prepaid. We return collect.

1. Burned out or open armatures of standard 301 Type 2½" meters, including polishing of jewels and three point calibration.  
YOUR COST.....

\$3.75

2. Repair of sluggish or Erratic movement of meters where armature is not burned or shorted, also cleaned and calibrated.  
YOUR COST.....

\$2.95

Any additional parts required, such as pointers, springs, zero adjuster, Jewel screws, case, glass, etc., will be charged for at the lowest prices. Note: Be sure your name, address, and instructions are attached to merchandise you send in.

## Analyzer Case

Oak or Walnut  
K15805—  
YOUR PRICE  
\$2.95

A professional type carrying case for your portable instruments. Takes standard 7" x 14" x 3½" bakelite panel listed at left. Partition for panel support provides room for analyzer cable, test leads, etc. Inside dimensions 8¼"x14"x3½" deep. Sliding hinged cover has 1½" inside clearance. Metal handle. Clasp lock. Lacquer finished.

## INSTRUMENT CASES AND BAKELITE PANELS

High quality walnut or oak cases. Natural finish, hand rubbed and lacquered. Especially designed for custom built test equipment.

They give to your equipment that professional laboratory appearance. Exceptionally strong. Interlocking corner joints. Rounded corners.

### Standard Model—Less Cover

Oak or Walnut  
C15800 — For external 4¾"x7". Inside size: 4" W., 6¼" L, 3½" D.  
C15801 — For Panel 5½"x8½". Inside Size: 4½" W., 7¾" L, 4½" D.  
C15803 — For Panel 6"x9". Inside Size: 5½" W. x 8¾" L. x 4" D.  
YOUR PRICE, Ea. 79c

### With Cover

Cover allows 1¼" inside clearance above panel. Panel fits flush inside lower section. Cover is detachable.  
K15802 — For Panel 4¾"x7". Inside size: 4¾" wide, 7" long, 3½" deep.  
YOUR PRICE.. \$1.59  
K15803 — For Panel 5½"x8½". Inside size: 5½" wide, 8½" long, 4½" deep.  
YOUR PRICE.. \$1.95

### Portable Case—With Cover

Imitation Leather Covered  
Body built of thin but very strong wood. Covered outside and top rim with finest quality black leatherette. Attractively grained. This case will stand years of hard service. Takes any 5½"x8½" panel. Leather handle. Detachable cover with clasp lock. Height 6½" inches.  
K15804—  
List Price, \$3.50.  
YOUR PRICE .. \$1.69

### Black Bakelite Test Panels

For Instrument Cases  
Polished Bakelite to fit Professional Type Instrument Cases. Supplied square. Corners must be filed round to fit exactly on the standard cases.  
K11300—¾"x4¾"x7" Net Each 52c  
K11301—¾"x4¾"x7" Net Each 59c  
K11302—¾"x5¼"x8½" Net Each 59c  
K11303—¾"x5¼"x8½" Net Each 79c  
K11340—¾"x6"x9" Net Each 72c  
K11304—¾"x7"x14" Net Each 89c



# RIDER'S Trouble-Shooters Manuals



## You Need All Eleven!

Every serviceman who wants to service radios faster, eliminate guess work, and have real alignment and circuit data, should use Rider's manuals. In these 11 Manuals there is a wealth of information about every radio set manufactured—from the first in 1919 to the latest model at the time of

Volume XI publication. For only a few cents per day, you can have complete needed information on every set made. Information that will help you do your work faster, better, and enable you to make more money. Work with full confidence! Be sure of your technical facts!

### VOLUME XI

**You Need This Manual to Properly Install and Service Latest Model Radio Receivers.**

**D15310—**  
YOUR PRICE ..... **\$980**  
POSTPAID .....

The latest edition to the Rider's series of service manuals. Never before has such a stupendous compilation of technical servicing material been collected in one complete volume. No details were too minute—nothing was deemed to be too trivial to be included if it was of any value in radio servicing. Contains 1652 pages of radio service data not published in previous manuals. New "How It Works" section contains 18 pages of technical explanation of the various circuits. A supplementary "Vest Pocket Manual" is also included containing 52 pages of useful information including frequency ranges of push-button tuning units of hundreds of models of radio receivers. Cumulative index covers all previous editions, a total of 14,500 pages! Supplied with loose-leaf pages bound in stiff fabricated covers. Size 9x11½".

### Volume X

**Covers 1939 and 1940 Models Announced to October 1939**

**C15309—**  
YOUR PRICE ..... **\$980**  
POSTPAID .....

Covers all radio models announced after publication of Volume IX, up to October, 1939. 1650 pages of service data on radio sets, television receivers, facsimile receivers, wireless record players, etc. Also contains data on receivers not previously published. "How It Works" Section contains 64 pages of technical explanation of the circuits contained in the Volume X. Cumulative index covers all previous editions. Supplied with loose-leaf pages bound in stiff fabrikkoid covers. Size, 9x11½".

### VOLUME IX

**Covers 1938 and 1939 Models Announced up to October, 1938**

**A15308—**  
YOUR PRICE ..... **\$980**  
POSTPAID .....

Covers all radio models announced after publication of Volume VIII, up to about October, 1938. Double spread pages are used so that complicated diagrams can be easily read. A special 36 page "How It Works" section is devoted to explanations of electrical and mechanical operations of the more complicated 1938-1939 receivers. 156 Page Index also covers all previous volumes. 1640 loose-leaf pages. Stiff fabrikkoid covers. Size, 9x11½".

### VOLUME VIII

**Covers 1937 and 1938 Models Announced Up to November, 1937**

**R15307—**  
YOUR PRICE ..... **\$980**  
POSTPAID .....

Over 1600 pages of real data and circuit diagrams on 1937 and 1938 models. Also information on Intercommunication Systems, Electronic Musical Devices and Public Address Systems. Stiff fabrikkoid covers. Size, 9x11½".

### VOLUME VII

**Covers 1936 and 1937 Models Announced Up to November, 1936**

**R15306—**  
YOUR PRICE ..... **\$980**  
POSTPAID .....

Over 1600 pages of real data and circuit diagrams on the 1936 and 1937 models. Also includes important changes in older models. No duplication of contents. Stiff covers. Size, 9"x11½".

### VOLUME VI

**Covers 1935 and 1936 Models Announced Up to November, 1935**

**R15305—**  
YOUR PRICE ..... **\$735**  
POSTPAID .....

Contains 1240 pages of practical data on over 940 models, representing over 115 manufacturers. Includes information on I.F.A. amplifiers, test equipment, auto radios, etc. Index also covers previous volumes. Size: 9x11½" inches. Stiff covers.

### VOLUME V

**Covers 1934 and 1935 Models Announced Up to November, 1934**

**R15304—**  
YOUR PRICE ..... **\$735**  
POSTPAID .....

Contains 1200 pages of data on 946 models, representing over 100 manufacturers. Enables you to quickly locate trouble and repair radios listed in this volume. All necessary information for easier service work. Separate 64 page index includes all previous volumes. Loose-leaf binding. Stiff fabrikkoid covers. Size: 9x11½".

### VOLUME IV

**Covers Standard Receivers from June, 1933 Up to February, 1934**

**R15303—**  
YOUR PRICE ..... **\$735**  
POSTPAID .....

1660 pages—loose-leaf binding—with stiff fabrikkoid covers. Size: 9x11½" inches. Includes complete cumulative index for all previous Rider's Manuals. Discusses and clarifies the new tubes, reflexed circuits, A.V.C. systems, S.W. and All-Wave sets that have appeared during the period covered by this manual.

### VOLUME III

**Covers Sets between June, 1932 and June, 1933**

**R15302—**  
YOUR PRICE ..... **\$735**  
POSTPAID .....

1070 Pages. Size 9x11½". Fabrikkoid covers.

### VOLUME II

**Covers Sets from March, 1931 to June, 1932**

**R15301—**  
YOUR PRICE ..... **\$735**  
POSTPAID .....

800 Pages. Size 9x11½". Fabrikkoid covers.

### VOLUME I

**Covers Early Receivers between 1919 and April, 1931**

**R15300—**  
YOUR PRICE ..... **\$735**  
POSTPAID .....

1000 Pages. Size 9x11½". Fabrikkoid covers.

## Frequency Modulation

By John F. Rider

**D12511—**  
YOUR PRICE ..... **98c**

Become fully acquainted with the latest thing in radio right at the start. This book explains the complete theory of transmission and reception of frequency modulated signals. Special attention is given to the different types of FM receivers now available including their adjustment and maintenance. Data concerning best types of antennas is also given. Fully illustrated. Contains 136 pages. Flexible cloth cover.

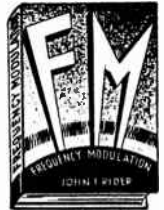

## Servicing by Signal Tracing

By John F. Rider

**D12524—**  
YOUR PRICE ..... **\$1.96**

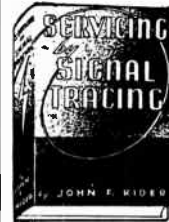

Completely explains a system of locating defects in radio and communication systems, both transmitting and receiving. This system is fundamental because it is based on the common denominator of all sets regardless of circuit—the signal! Also discusses functions of various parts, paths of signal currents, development of control voltages, etc. Covers all modern circuits including television and facsimile. Profusely illustrated. 300 Pages bound in hard covers.

## A.F.C. Systems

By John F. Rider

**D12531—**  
YOUR PRICE ..... **95c**



Contains complete information on automatic frequency control circuits. Clearly explained and easily understood. Book is devoted to DC voltages, phase relations to inductive, capacitive and transformer circuits with particular reference to their use in A.F.C. circuits. Also covers operation of discriminator circuits and various control tube circuits including push-pull

type, reflected reactance type and mutual inductance type. 102 Illustrations. 144 Pages. Hard covers.

## The Cathode Ray Tube At Work

By J. F. Rider

**K12521—**  
Your Price Postpaid **\$2.45**

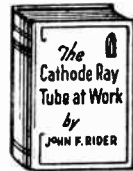

Gives you complete theory underlying the operation of the cathode-ray tube and its associated circuits. Everything to which the cathode-ray tube can be applied to check electrical phenomena. Half of the volume is devoted to specific practical applications of commercial oscilloscopes to servicing and adjustment problems. 338 pages.

## Servicing Receivers by means of Resistance Measurement

By J. F. Rider

**K12519—**  
YOUR PRICE ..... **95c**



This book explains the usual resistance network which reduces all types of Sets and Amplifiers to common level. Take the guesswork out of servicing by using an ohmmeter in your diagnosis. Tells how to get the resistance between points in any circuit by working thru the socket contacts. Cloth-bound. 203 pages. Size: 5½x7¾ inches.

## Servicing Superhets

By John F. Rider

**K12520—**  
YOUR PRICE ..... **95c**

Latest revised and enlarged edition covering a comprehensive and easily understood explanation of the superheterodyne circuit. Important information on electron coupled superhets, AVC systems, and Dual I. F. bands. 238 Pages profusely illustrated. Cloth-bound. Hard covers. Size: 5½x7¾ inches.



# An Hour a Day with Rider BOOKS

## On Alternating Currents In Radio Receivers



**N12526—  
YOUR PRICE ..... 59¢**

A comprehensive book covering the basic functions of the various components of a radio receiver. . . . what each unit does and how it works. Various types of parallel and series resonant circuits. . . . different kinds of coupling. . . . Inductance, reactance, impedance and how these electrical phenomena are employed in radio practice. A combination of theory and practice that explains alternating currents in a brand new way. Profusely illustrated. 96 Pages.

## On Resonance and Alignment



**N12527—  
YOUR PRICE ..... 59¢**

A clear explanation of what happens when a circuit is tuned to resonance. All types of circuits—single, double, and triple tuned systems—described and how and why they work. . . . How these circuits should be aligned so that maximum efficiency is obtained. Knowledge of the latest high-fidelity I.F. amplifiers is becoming more and more necessary and this book tells you everything you should know about all this in Rider's easy to understand style. Profusely illustrated. 96 Pages.

## Mallory-Yaxley

**Encyclopedia of Radio Service  
New Third Edition  
C12441  
YOUR PRICE, Only 75¢**



The most complete radio service encyclopedia ever published. Gives finger tip reference to information never before published. Practically every radio receiver model is completely analyzed giving all information necessary for complete, quick radio service work. Provides parts replacement information instantly and accurately covering volume controls, condensers, vibrators, tube complement and I.F. peak frequency. See page 45 for more descriptive listing.

## On D. C. Voltage Distribution



**N12528—  
YOUR PRICE ..... 59¢**

Every receiver contains some sort of D.C. distribution system supplying the D.C. voltages from the power unit to the elements of the tubes. The many different forms these systems take are thoroughly described in this new Rider book, which explains networks from the simplest to the most intricate. The calculations of the value of the resistors and their wattage ratings are clearly described in this brand new combination of theory and practice. Profusely illustrated. 96 Pages.

## On Automatic Volume Control

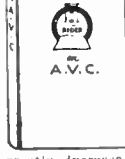

**N12529—  
YOUR PRICE ..... 59¢**

Every well made, modern receiver now has automatic volume control as a standard feature. Noise suppression systems—time delay circuits—audio frequency volume expander systems and other such networks come under this general heading and greatly increase servicing problems. A complete description of how these circuits operate in all receivers—new and old—and how they should be serviced makes this book invaluable, as it is written in a brand new manner, combining theory and practice. Profusely illustrated. 96 Pages.

## Books for Radio Beginners



A series of Gernsback books written especially for the beginner in radio and electricity. Written so everyone can understand. Every book is fully illustrated. Size, 5x7 1/2".

- C12434—Radio for Beginners.
- C12433—How to Read Radio Diagrams.
- C12432—How to Have Fun with Radio.
- C12431—Beginners' Radio Dictionary.
- C12430—All About Aerials.
- C12429—Alternating Current for Beginners.
- C12450—Television.
- C12451—Simple Electrical Experiments.
- C12428—How to Make the Most Popular All-Wave 1 and 2 Tube Receivers.
- C12427—How to Build a Doerle Short-Wave Sets.

**YOUR PRICE Any Title, Each..... 10¢**  
5 for 40¢ 10 for 75¢

## Aligning Philco Receivers

By John F. Rider



**C12530—  
YOUR PRICE..... 95¢**

Contains complete alignment instructions for all Philco home and auto receivers—from the very first to the latest 1937 set. Will enable you to quickly align correctly any of 8,000,000 Philco radio sets now in use. Prepared with the cooperation of Philco engineers. The book is authentic and complete in every respect. Every trimmer is located for you in the many large diagrams. The alignment frequencies and procedures are clearly stated. 170 Pages. Profusely illustrated. Size 5x7 1/2".

## Oscillators at Work

By J. F. Rider



**C12510—  
YOUR PRICE..... \$1.47**

Explains workings of all types of oscillators and not only tells how and why they work, but how the various oscillators are used in receivers and testing equipment. Written so anyone can understand. Theory on different oscillators is given first with practical applications given later in the text. Profusely illustrated with diagrams and oscillograms. Provides all the information on oscillators that you need. 200 Pages. Bound in hard covers.

# GERNSBACK'S Manuals

## Official Radio Service Manuals

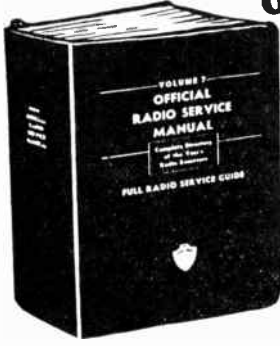

**Volume VII  
Covers 1937 and Early 1938 Receivers  
C12556—Postpaid ..... \$9.80  
YOUR PRICE.....**

Complete radio servicing data on over 1,600 radio models. All new material—no reprint or refresh from previous editions. Over 1,800 pages and 3,000 illustrations. Includes in my 1938 models not found in other manuals: Data on cathode-ray oscilloscope I.F. alignment procedure for many of the complicated superhets. 1-use-leaf pages. Flexible leatherette cover. Size 9x12". Includes 74 page index covering all previous manuals.

## VOLUME VI

**Covers 1936 and Early 1937 Receivers  
C12555—Postpaid..... \$6.86  
YOUR PRICE.....**

Over 1,250 pages, 2,500 illustrations. Contains specific information accompanied with diagrams for each set released after publication of Vol. V.

## VOLUME IV

**Covers 1933 and Early 1934 Receivers  
C12553—Postpaid..... \$3.00  
YOUR PRICE.....**

Over 2000 diagrams—over 400 pages—many valuable illustrations, charts, layouts and schematics. Data includes information on P. A. Systems, test equipment, radio tubes and auto radio.

## VOLUME II

**Data on 1931 and Early 1932 Receivers  
C12551—Postpaid..... \$4.00  
YOUR PRICE.....**

1000 pages with 2000 diagrams, charts and illustrations. Loose-leaf leatherette binder.

## Refrigeration Manual

**C12570—Second Edition..... \$4.00  
YOUR PRICE.....**  
Explains and illustrates the servicing of standard type refrigerators. Explaining every part and tools necessary for servicing. 350 Pages.

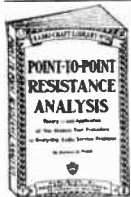

## Gernsback's Radio-Craft Series

You can form an inexpensive library with these Radio-Craft Books. Each book contains 64 pages of easy understandable, carefully compiled authentic information, and from 50 to 130 illustrations. Bound in stiff covers. 6x9 inches.

- YOUR PRICE, Any Title..... 35¢**
- C12574—"Practical Public Address."
  - N12575—"Point-to-Point Resistance Tests."
  - N12576—"Servicing with Set Analyzers."
  - N12578—"Bringing Electric Sets Up-to-Date."
  - N12582—"Radio Questions and Answers."
  - C12546—"Radio Kinks and Short Cuts."
  - A12547—"Home Recording and All About It."
  - A12548—"Practical Radio Circuits."
  - A12549—"The Cathode-Ray Oscilloscope."
  - R12573—"The ABC of Refrigeration."
  - C12571—"Breaking Into Radio Servicing."

## A.R.R.L. Publications

**Radio Amateur Handbook  
Latest Edition**

**C12492  
YOUR PRICE..... \$1.00**

Includes latest and best information covering all fundamentals of amateur radio from the beginning to its present day development. Gives suggestions on how to learn the code through explanations on traffic handling procedure and good operating practices. Also includes information on design construction and operation of amateur equipment, valuable data on U.H.F., antenna design, etc. Illustrated. 560 Pages. Size, 6 1/2 x 9 1/2".

## Radio Amateur License Manual

**C12424—Gives in simple, easy to understand language the information you need to pass the examination to become a licensed amateur. Also includes 198 typical questions and answers such as asked in the government Class A, B and C examinations. 40 Pages. Latest Edition.**

## How to Become a Radio Amateur

**C12425—Describes the construction and operation of an inexpensive amateur transmitting station incorporating features heretofore confined only to more advanced stations. Includes other valuable data of interest to the beginning amateur.**

## Building an Amateur Radiotelephone Transmitter

**C12426—An introduction into amateur radiotelephony for the man who has a Class B or C license. Contains simple description and design of inexpensive low-power transmitter and modulator with complete operating instructions and some antenna data of particular interest to the amateur.**

**YOUR PRICE Any Book, Each..... 25¢**

## Antenna Book

**C12499—A comprehensive manual of amateur antenna design and construction. Data on doublets to multi-element rotaries including rhombos, vees, u.h.f. elements, masts and feeding systems. Over 100 pages in "cut" format.**  
**YOUR PRICE..... 50¢**



# New Radio E.P.A. BOOKS

## Ghirardi's New Twin Gadgets Pocket Trouble Shooters



Spot troubles in a flash. Just a flip of a card and both the "test" and "remedy" for a busy trouble are given. Consists of a set of pocket-size cards printed on both sides in two colors and eyeletted together to cover over 400 troubles commonly encountered in radio service.

**C12590—Home Sets**  
**C12591—Auto Sets**  
**YOUR PRICE, Either Type** **50¢**

## Popular Radio Books

### Drake's Cyclopedia of Radio and Electronics

By Manly and Gorder

**C12435—Complete non-technical reference book on over 500 radio subjects including sound pictures, short-wave, television, photo-cells and P.A. Data is simple and direct, easily understood. 1000 pages, 1178 illustrations, 235 tables and graphs.**  
**YOUR PRICE** **\$3.92**

### Short-Wave Radio Handbook

By Clifford E. Denton

**C12483—Everything on short-wave radio. Contains latest circuits on oscillators, TRF and super-heter receivers with valuable charts and tables on coil winding. 128 Pages, 150 Diagrams and Illustrations. Size 8½x8½".**  
**YOUR PRICE, Postpaid** **\$1.00**

### "Radio" Handbook

**C12482—The greatest handbook published. 600 pages of valuable information for every man in radio. Tells how to build receivers and transmitters. Hundreds of illustrations.**  
**YOUR PRICE** **\$1.50**

### Motorola Service Manual

**D12684—Complete manual including detailed schematics, service notes, alignment data and parts lists on 72 Motorola Autordadio models up to date. 96 Pages. Size 8½x11".**  
**YOUR PRICE** **\$1.00**

### Look and Listen

#### The Television Handbook

By M. B. Sleeper

**D12561—Contains latest theory and practice on television. Tells how to build, install and service a television set. Shipped described. Over 100 illustrations. Size 6½x9".**  
**YOUR PRICE, Postpaid** **98¢**



## Thordarson Manuals

**C6792—Complete Transformer Catalog on P.A., A.M.T. and Replacement types. Specify one FREE on your next order.**

**C6793—Contains sections covering radio receivers and amplifiers, amateur transmitters, transformer replacement data, etc. Also includes complete catalog. Approximately 114 8½x11 pages.**  
**YOUR PRICE** **21¢**



**D12598—Amplifier Guide only as contained in above manual. Includes valuable data on building amplifiers.**

**D12599—Transmitter Guide only as contained in above manual. Includes valuable data on building transmitters.**  
**YOUR PRICE Each** **9¢**



### Amateur Radio

A Beginner's Guide

**D12565—A fascinating textbook by J. D. Fortune of Thordarson Electric Co. that takes you step-by-step through everything you need to know to become a licensed radio amateur and how to build and operate your own radio station. Cloth covered volume. 180 Pages. Over 100 Illustrations. Size 6x9".**  
**YOUR PRICE** **73¢**

## Radio Physics Course

By A. A. Ghirardi

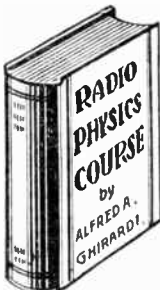

**N12586—YOUR PRICE \$4.00 POSTPAID**

Radio instructors in many leading schools endorse and use this outstanding comprehensive, clearly written and profusely illustrated text for teaching radio. Ghirardi's RADIO PHYSICS COURSE has also been placed on the "Approved Textbook List" of almost every State Education Department in the country and was selected as the training text for radio courses conducted by the exacting training staffs of the U. S. Army and Navy. You can really learn radio from this great book yourself—at home! Contains a complete course in the fundamentals of Sound, Electricity, Radio, Television and Sound Motion Pictures—all in one, sturdily bound 972 page volume with over 500 illustrations.

## Modern Radio Servicing

By A. A. Ghirardi

**C12587—YOUR PRICE \$4.00**

An outstandingly complete revised edition showing how to master the art of radio servicing. Packed full of new ideas, the latest tips and angles, the most up-to-date methods used by successful technicians. Written in easy-to-understand language—profusely illustrated with over 700 diagrams and charts. Contains a complete explanation of the construction and use of Cathode Ray Oscillographs and a test testing instruments. Complete data on noise and interference elimination. 1300 pages. 706 illustrations. Size 5½x8 inches. Hard covers.



## Radio Trouble-Shooter's Handbook

By Alfred A. Ghirardi

**C12572—YOUR PRICE \$3.00**



Contains a comprehensive collection of servicing reference data and information designed specifically to assist and save time for the serviceman on all service jobs. Includes "Case Histories" for over 3,300 receivers, IF peak frequency and alignment data for over 15,000 super-hets including latest sets and auto radio data on interference elimination, installation plus ear ignition and electrical wiring diagrams. Also includes trouble-shooting charts for "Home" and "Auto Radio" receivers and data on servicing sound recorders, intercommunication, P.A. systems and Trade Directories. Has over 30 charts and tables on grid-bias resistors for tubes, coil, filter, transformer design, wire sizes, RMA color codes, up-to-the-minute tube charts of every conceivable description, etc. 500 Pages. Bound in sturdy gold-stamped black fabricoid covers. Size, 8½x11".

**SPECIAL COMBINATION OFFER. Save money by buying Modern Radio Servicing and Radio Trouble-Shooter's Hand book together at only**

**C12589 \$6.50**

## Practical Dynamic Testing and Visual Alignment

By A. G. Mohaupt

**C12545—YOUR PRICE 98¢**

Contains a comprehensive discussion of the cathode ray oscilloscope and frequency modulated signal generator as used for visual alignment of amplitude modulated receivers. Their use and construction is completely described and illustrated with many diagrams and wave form charts which make this type of testing extremely simple and easy to understand. Connections to all parts of receiver circuits are shown and explained. This book is very helpful in getting full benefit from your oscilloscope. 48 Pages. Stiff paper covers. Size, 8½x11".



## Mallory-Yaxley Radio Service Encyclopedia

### Special Bargains While They Last

First Edition  
**C12595**

Was \$1.47 **39¢**  
Now Only

Second Edition  
**C12444**

Was \$1.91 **59¢**  
Now Only



We have only a few of these manuals left—when they are gone, there will be no more—so buy yours now and avoid disappointment! Contains complete servicing data for over 12,000 different sets and models with hundreds of schematics, illustrations, charts and formulas. Worth twice the original cost.

## McGraw-Hill Books

### Principles and Practice of Radio Servicing

By H. J. Hicks

**D12567—Shows and explains how to install, test and repair radio receivers. Written with a minimum of mathematics in excellent self-study style for servicemen who want to improve their skill, and readers who want to learn this practical field. Includes data on public address systems. 300 Pages. 212 Illustrations. Size, 6x9".**  
**YOUR PRICE** **\$2.94**



## Radio Construction and Repairing

By Moyer and Wostrel

**D12487—Contains 444 pages of up-to-date radio repairing information enabling you to tackle the hardest kind of radio repair job and solve any form of radio trouble. 170 Illustrations.**  
**YOUR PRICE** **\$2.45**



## Radio Operating Questions and Answers

**D12486—All you need to know for your Commercial License application in 600 questions and answers. Includes regulations pertaining to police, aeronautical, marine and amateur station operating. 427 Pages, 106 Illustrations. 7½x8" cloth binding.**  
**YOUR PRICE** **\$2.45**

## Radio Service Trade Kinks

By Lewis S. Simon

**D12563—YOUR PRICE \$2.94**

A quick reference manual of frequently encountered radio set troubles and their repair. Saves time in testing and trouble shooting by showing weakness and key trouble spots of specific sets. A practical method of repair and adjustment taken from successful radio servicing experience is given. Covers hundreds of makes and models of both household and auto radio receivers. Illustrated. 260 Pages. Size 9x11". Spiral bound to open flat. Sturdy stiff covers.



## Radio and Electronic Dictionary

By H. P. Manly

**A12436—YOUR PRICE \$2.19**

Contains 3800 definitions of technical radio words and terms. Illustrations were made especially for this book to help greatly in simplifying the definitions. 370 pages, 500 Illustrations, size 6x9". Cloth binding.



## Elementary Mathematics

By A. C. Shainmark

**D12562—Simplified study-course in mathematics. Contains basic data required for solving perplexing mathematical problems. Many illustrations and examples. A chapter is devoted to radio problems. 61 Pages. Size, 6x9".**  
**YOUR PRICE, POSTPAID** **50¢**



# CARRON REPLACEMENT

## "A Carron Cone Improves The Tone"

If the cone you need is not listed here—here's how to help us give you FAST SERVICE:  
 1—Send in your old cone with voice coil attached.  
 2—Specify if possible set name and model number,

also make and model number of speaker from which cone is removed. 3—Be sure your name, address and instructions are attached to package. In most cases we can make immediate shipment.



- 1**— One-piece seamless cones.
- 2**— Due to improved molded construction, these cones surpass the originals in tone quality and durability.
- 3**— Coils are machine wound, same number of turns and size of wire as originals.

### For Majestic Speakers

Models G1, G2

One piece moulded, seamless fibre. The original part in these Speakers is of heavy paper and does not provide reproduction at all comparable with that of these replacements.

**N16109**—For G1  
**R16110**—For G2  
**YOUR PRICE, EACH ... \$1.32**



### For RCA Victor Speakers

Models RE32, 45, 57, 75

Made of reinforced one piece fabric, coated with metallized lacquer. Apex is double reinforced, a feature not used in the original. Bakelite voice coil bobbin with 4 layers of precision wound wire. Far superior to the original part.

**N16181**—  
**YOUR PRICE, EACH ... \$1.03**



Set, Spkr. Mod. or Part Num. Dia. In. Stock No. Your Price

**Admiral**  
 5A, 5N, 8B, 6M, A1, A2, A3 6 1/2 16132 \$1.03

**Aircastle**  
 885, 4068 8 16133 1.18

**Airline**  
 (Mont. Ward)  
 173, 175, 176, 177, 178, 179 6 3/4 16270 .88  
 175, 176, 190 8 16015 1.32  
 198, 425, 475 5 16271 .73

236, 263 5 3/4 16272 .73  
 274, 288, 290, 326, 336, 350, 351, 352 5 16269 .73  
 518 5 16352 .73

**Atwater Kent**  
 43, 46, 55, 60, 66, 67, 64, F4 (Pt. No. 15142) 10 3/4 16020 1.32  
 43, 46, 55, 60, 66, 67, 64, F2(Pt. No. 14374) 10 3/4 16021 1.32

80, 82, 82Q, 83, 84, 84D, 85, 85Q, 90, 90P, 135Z, 184, 206, 225, 246, 266, 267, 337, 356, 376, 425, 427, 435, 465, 467, 469Q, 525, 558D, 558E, 735, (Pt. 19465) 8 3/4 16022 1.18

**H2, L, F, P, H, N,**  
 (Pt. No. 18081) 10 3/4 16023 1.32  
 83, 85, 87, 87D, 89, 89F, 94, 94F, 96, 96F, 99, 188, 188F, 215Z, 269F, 286, 310, 318, 325, 328, 376, 408, 448, 469, 469D, 469F, 475, 480, 510, 559, 788, 808 (Pt. 20737) 10 3/4 16024 1.32  
 112, 511, 711, 810, (Pt. 26243), 710 10 3/4 16019 1.32

**Belmont**  
 401A 5 16170 .73  
 425 5 16134 .73  
 517 5 16135 .73  
 575 5 16010 .73  
 683 5 16090 .73  
 686, 690 5 16136 .73  
 667, 740 (Oper.) 5 3/4 16273 .88  
 777 (Jensen F6R) 6 1/2 16270 .88  
 16089 .88

**Bosch**  
 5A, 39A 7 16033 .88  
 48, 58 9 3/4 16031 1.62  
 501, 505, 565W, 634A, 640 6 1/2 16027 .88

**Brunswick**  
 21, 31, S21, S31, 81, 82, S81, S82 12 16039 1.70

**Crosley**  
 308, 408, M45, 628, 262, Dynacolor 8 3/4 16050 1.47  
 68, 143, 146, 157, 315-4, 325-4, 711-2, A157, 517, 547, 5517, 515 (Utah 219B), 418 8 16137 1.32  
 516 5 16055 .73  
 515 (Mag.), A366 5 1/4 16105 .73  
 516 5 1/4 16138 .73  
 516 6 1/2 16056 .88  
 828B 5 16220 .73  
 645 6 16139 .88  
 717 8 16131 1.18

**Emerson**  
 A07, 111 5 16170 \$0.73  
 (Alumavox) 5 1/4 16105 .73  
 K116, K121, K123 5 16271 .73  
 A130, 132, 140, 149 5 3/4 16290 .73  
 157 5 16135 .73  
 BA199, BA201 5 16124 .73  
 250AV 5 16090 .73

**Fada** 365C, 366C, KU45, 65, 41, 412, 42, 422, 44, 46, 47, 12A, 12H, KG43, KG761, 762, 766, 45Z, KW48, 49 8 16141 1.18  
 10 3/4 16059 1.62

**Fairbanks-Morse**  
 C4, C5, A4 6 3/4 16139 .88  
 58T1, 58T2, 68T6 6 16143 .88

**General Electric**  
 H31, H32, 51, 71, H172 (Pt. 85558) 10 3/4 16060 1.18  
 S22, S22N, S42, S42B, S242P, T41, K62, KZ62P, J75, J80, 385, S132, JZ835 (Pt. 86001) 10 3/4 16061 .88  
 B40, C41 (Pt. 9023) 5 16062 .59  
 A62, A55, A64, A65, A70, AN3 6 3/4 16096 .59  
 A52, A55, A64, A65, A70, AN3 8 16097 .73  
 E81, F88, F81, E86, E26, E105, M10F, E76, E95, E106 12 16274 1.18

**Grunow**  
 6-G31-3 6 3/4 16277 .88  
 12A1, 12A2, 12A6, 12C4-1 12 16072 1.70  
 108C-2, 108C9, 108C10 6M 10 16276 1.62  
 500, 504 (6B) 6 3/4 16069 .88  
 566, 80G1-1 8 16278 1.32

650, 651, 750, 661, 70 (8A3, 8A4, 84) 8 3/4 16070 1.32  
 450, 460, 660, 662, 40, 6C, 81B3, 81B3, 81C1, 701, 752, 751, 753, 674, 1152, 613, 1162 (10A1-2, 170) 10 16066 1.62  
 901, 902, 1101, 1291, 1264-1 12 16072 1.70  
 1151, 1161(12A3) 12 16073 1.70

**Jensen** D7, D8 11 1/4 16012 1.70  
 D9 (Inside Spider) 11 3/4 16008 1.62  
 T3 5 16081 1.73  
 G6R, PM6C 6 16093 .88  
 PM5E 5 16280 .73  
 PMND, ESR 8 16281 1.32  
 PM10C 10 16144 1.62  
 PM12C, G12R 12 16095 1.70  
 Series "F8R" 8 16088 1.18  
 Series "F6R" 6 16174 .88  
 Series "F5R" 5 16090 .73

**Kadette**—68 5 16135 .73  
 21, 22, 23, 86 5 16146 .88

**Lyric**—412 12 16147 1.70

**Magnavox**—195 5 16104 .73  
 D7, D8, D6, D80, D90, 100 8 3/4 16035 1.62  
 132, 162 11 3/4 16148 1.70  
 152X, 252PM, 160, 170 10 16107 1.62  
 48C, 154D, 158, 168, 254PM(2 pt. sprdr.) 8 16108 1.32

**Majestic**  
 G1—71, 72 9 16109 1.32  
 G2—71, 72, 91, 92, 181 9 16110 1.32  
 G10B-C-D-E—151 7 3/4 16113 1.18  
 G13, 154, 155, 156 1.53, G11C, 151, 253, 254, 201, 203, 204, 211, 214 10 16114 1.41

Set, Spkr. Mod. or Part Num. Dia. In. Stock No. Your Price  
**Majestic (Cont.)**  
 G13B, G13C, 353, 215 12 6 16115 \$1.47  
 G2A—116, Ford 6 16120 .88  
 G26A—41, 413, 414A, 413A, 371, 373, G26C 5 16122 .73

**Operadio**—7505 10 16149 1.62

**For Philco**  
 Pt. 36-3029; Models 54, 57, 58, 59, 600, 602, 604, 37-600, 37-602, 37-604, C16158—5 3/4 in. .59  
 YOUR PRICE .59  
 Pts. 02861, 02970, 36-3027; Models 11, 28(2P1), 45(P19), 48, 50, 50A, 51 & 51A(P1), 52(P1), 80, 81, 610. C16156—5 3/4 in. .59  
 YOUR PRICE .59

Pts. 36-3014, 36-3157; Models 34, 38, 38A, 60, 66, 84, 611, 620, 625, 37-84, 37-89, 37-610, 37-611 (S15), 37-620, 700, 37-60, 37-62, 38-15, 38-7, 38-8, 38-9, 57. C16154—7 1/4 in. .59  
 YOUR PRICE .59  
 Pts. 02823, 36-3020, 36-3150, 36-3174; Models 14, 18(K17), 19, 28(K27), 32, 38(K23), 39, 43, 45(K22), 47, 49(K13), 71, 89(K23), 91, 97(K31), 118(K17), 144(K23), 623, 630, 635, 640 (K31), 642, 643, 645, 655, 37-630 (K38), 37-640 (K34), 37-650 (K35), 37-660 (K36), 37-670 (K37), 6, 7, 8, 9, 10, 10-12, 12 (KR) CT11. C16150—7 3/4 in. .59  
 YOUR PRICE .59  
 Pts. 02996-2769B; Models 20, 20A, 21, 46, 70, 70A, 90 & 90A(45's) or 1-47, 60(K17), 470A, 490, 650(K17). C16152—8 3/4 in. .73  
 YOUR PRICE .73  
 C16180 Ford C32, 816, (FT9) 1/2 in. .59  
 C16163 Ford 817 .59  
 YOUR PRICE .59

Pts. 02625, 02807; Models 14 & 15 (28) Spkrs., 18, 18(12-113), 19, (28), 29, 44, 49(H13), 97 (H21), 116 (121), 118(H13), 144(H16), 640(H21), 650(H13), 660, 665, 37-630(H24), 37-640(H25), 37-650(H26), 37-660(H27), 36-670(H28), 29X, 61, H9. C16160 10 in. .82  
 YOUR PRICE .82  
 Pts. 02874, 02497, 02974R, 2814B, 2844A, 36-3170; Models 45, 65, 76, 77, 87, 90(2-47-8), 90 & 90A(45's) or 1-47-12), 95, 96, 111, 111A, 112 & 112A (45's) .82  
 YOUR PRICE .82  
 (P14) (P15), F1540, G1528, 926, CB2 to C56. C16155—10 3/4 in. .73  
 YOUR PRICE .73

C16161—6 in. .59  
 YOUR PRICE .59  
 Model C1608. C16297—6 in. .59  
 YOUR PRICE .59  
 Model F1640. C16298—7 1/2 in. .88  
 YOUR PRICE .88  
 Pt. 36-3981; Models 38-12, code 121, 38-14, code 121, 38-15, code 121, 38-17. C16290—5 1/4 in. .73  
 YOUR PRICE .73  
 Pt. 45-1344; Model 38-12, code 121, Run 6. C16291—5 1/4 in. .59  
 YOUR PRICE .59  
 Pt. 45-2607; Model C1550. C16292—7 3/4 in. .73  
 YOUR PRICE .73  
 Pt. 45-2653; Model 927. C16293—8 in. .88  
 YOUR PRICE .88  
 Pt. 45-2664; Model 928K. C16294—7 3/4 in. .88  
 YOUR PRICE .88  
 Pt. 36-4095; Models 39-6, 39-7, (121). C16304—5 in. .73  
 YOUR PRICE .73

**RCA-Victor**  
 Pt. 8558, Speaker 106, Models RE20, R35, R39, 46, 1350, R55, RE57, RAE55, 92, 64, 66, 67, RE73, RAE79, R80, R82, R86 10 3/4 16060 \$1.18

Pt. 8601, Models 48, R6, 107, 17A, R7LW, R8, R9DC, R19, R17DC, R9DC, R10, R10DC, R11, R12, RE16, RE16A, RE18, RE19, R21, R023, RAE26, R43, RE73 10 3/4 16061 .88

Pt. 9023, M34, M105 5 16062 .59  
 Pt. 8987 Models R28, R29P, R22S, R22W, RE40, RE, 40P, 100, 101, 110, 111, 114, 115, M116, 300, 301 5 16177 .59  
 Pt. 10801, Model C132 R35, R38, RE45, RE52, R75, E135, R152, RE154, RE156 9 16181 1.03

Pt. 9428, 9492 Model R37, R37P R38, R38P, R12, 121, 122, 124, 126B, 310, 320, 241B, M107, 118, M123, AC136 6 1/2 16187 .59  
 Pt. 13667, 14934, 5T6, 5T7, 5T8, M104, 6M, 6M2, M101, 67M1, 86T, 86T1, 86T3, 86T6, 86T7, 87T1, WR203, AV1303 6 1/2 16192 .59  
 6 3/4 16258 .59  
 5 16259 .59  
 4 16251 .59  
 6 1/2 16252 .59

**Roia, G12**  
 K10 12 16203 1.70  
 K10 8 16205 1.32  
 K12 10 16206 1.47  
 K12 12 16207 1.70  
 T-6-DP 5 3/4 16211 .73

**Sentinel**  
 19A, 51, 223, R224, 72A, 72A-E, 600 6 16171 .88  
 6 3/4 16350 .88

**Sparton**  
 737, 931, 89A, 99, 101, 109, 110, 111, 301, 589, 59, 593, 600, 610, 620, 737, 740, 750, 930(Mag-navox D7) 8 3/4 16035 1.62  
 737, 921 (Jensen D7) 11 1/4 16012 1.70  
 518, 537, 547, 548, 568, 577, 57, 593, 67, 68, 616, 691 6 16089 .88  
 6 16171 .88

**Stewart-Warner**  
 102A, 104A, R110, R204A, R206, A207, 208, 209, 210, R218A, 223A 8 16231 1.32  
 R116, R118, R123, 1220, 1223, R224, 1231 to 1230 6 16233 .88  
 1181, to 1183) 6 16236 1.70  
 R149, 1491 to 1499 10 3/4 16237 1.62  
 138A 8 16235 1.32  
 R273 8 16239 1.70  
**Utah**—F12P, G173, E12P, 121F, 12PG6 12 16260 1.70  
**Wells-Gardner**  
 61D, 7J 6 3/4 16270 .73  
**Westinghouse**  
 WR209, WR211 6 3/4 16027 .88

Set, Spkr. Mod. or Part Num. Dia. In. Stock No. Your Price  
**RCA-Victor**  
 Pt. 8558, Speaker 106, Models RE20, R35, R39, 46, 1350, R55, RE57, RAE55, 92, 64, 66, 67, RE73, RAE79, R80, R82, R86 10 3/4 16060 \$1.18

Pt. 8601, Models 48, R6, 107, 17A, R7LW, R8, R9DC, R19, R17DC, R9DC, R10, R10DC, R11, R12, RE16, RE16A, RE18, RE19, R21, R023, RAE26, R43, RE73 10 3/4 16061 .88

Pt. 9023, M34, M105 5 16062 .59  
 Pt. 8987 Models R28, R29P, R22S, R22W, RE40, RE, 40P, 100, 101, 110, 111, 114, 115, M116, 300, 301 5 16177 .59  
 Pt. 10801, Model C132 R35, R38, RE45, RE52, R75, E135, R152, RE154, RE156 9 16181 1.03

Pt. 9428, 9492 Model R37, R37P R38, R38P, R12, 121, 122, 124, 126B, 310, 320, 241B, M107, 118, M123, AC136 6 1/2 16187 .59  
 Pt. 13667, 14934, 5T6, 5T7, 5T8, M104, 6M, 6M2, M101, 67M1, 86T, 86T1, 86T3, 86T6, 86T7, 87T1, WR203, AV1303 6 1/2 16192 .59  
 6 3/4 16258 .59  
 5 16259 .59  
 4 16251 .59  
 6 1/2 16252 .59

**Roia, G12**  
 K10 12 16203 1.70  
 K10 8 16205 1.32  
 K12 10 16206 1.47  
 K12 12 16207 1.70  
 T-6-DP 5 3/4 16211 .73

**Sentinel**  
 19A, 51, 223, R224, 72A, 72A-E, 600 6 16171 .88  
 6 3/4 16350 .88

**Sparton**  
 737, 931, 89A, 99, 101, 109, 110, 111, 301, 589, 59, 593, 600, 610, 620, 737, 740, 750, 930(Mag-navox D7) 8 3/4 16035 1.62  
 737, 921 (Jensen D7) 11 1/4 16012 1.70

518, 537, 547, 548, 568, 577, 57, 593, 67, 68, 616, 691 6 16089 .88  
 6 16171 .88

**Stewart-Warner**  
 102A, 104A, R110, R204A, R206, A207, 208, 209, 210, R218A, 223A 8 16231 1.32  
 R116, R118, R123, 1220, 1223, R224, 1231 to 1230 6 16233 .88  
 1181, to 1183) 6 16236 1.70  
 R149, 1491 to 1499 10 3/4 16237 1.62  
 138A 8 16235 1.32  
 R273 8 16239 1.70

**Utah**—F12P, G173, E12P, 121F, 12PG6 12 16260 1.70  
**Wells-Gardner**  
 61D, 7J 6 3/4 16270 .73  
**Westinghouse**  
 WR209, WR211 6 3/4 16027 .88



# SPEAKERS AND FIELD COILS

Set, Spkr. Mod. or Part Name	Dia. In.	Stock No.	Year	Set, Spkr. Mod. or Part Name	Dia. In.	Stock No.	Year
Zenith Pt. 49-27, Models 52, 53, 54, 57, 59, 62, 63, 64, 67, 71, 72, 73, 77, 78, 79, 78, 78, 78 (Oxford)	12	16125	\$1.70	Zenith (Cont.) Pt. 49-162, Models 5F134, 5F235, 5F238	6 1/4	16219	\$0.88
Above (LL15) 6D119, 6M192, 6M91	12 1/2	16238	1.70	Pt. 49-81	6 1/2	16270	.88
				Pt. 49-115	6 1/2	16090	.73
				Pt. 49-116, 49-152	8	16015	1.32
				Pt. 49-117	8	16041	1.32
				Pt. 49-143	6 1/4	16089	.88
				Pt. 49-163	6 1/4	16219	.88
				Pt. 49-237, 49-238, 49-242, 49-262	5	16042	.78

## FOR AUTO SETS Replacement Coils

Set, Spkr. Mod. or Part Name	Dia. In.	Stock No.	Year	Set, Spkr. Mod. or Part Name	Dia. In.	Stock No.	Year
Avrio 10 (Operadio) 15, 20A, 25, 29	5	16010	.31	Cadillac-5X	6 1/4	16253	.88
46, 47A, 518	6 1/4	16270	.88	Meterola-45	6 1/4	16375	.88
518, 568	6	16243	.73	60, 65, 100	8	16378	1.32
	5	16044	.73	65 (Rola K8B)	7 1/4	16086	1.32
Crosley-A157	5	16352	.73	65, 70 (Jensen)	8	16079	1.32
Dolee 500, 630, 1201540	6 1/4	16045	.88	75 (Jensen F&R)	6 1/4	16089	.88
623, 632, 1106, 3205	6 1/2	16210	.88	Golden Voice	10	16097	1.62
631, 640 (Operadio)	5 1/4	16286	.78	Philco 3 (Pt. 02999)	8	16152	.73
681, 640, 4009 (Maj.)	5 1/4	16105	.73	5, 11, 48, 51, 51A, 52, R, J (Naah, Stude), Hup, R (Chr. 6, Dodge, Ply.) (Pt. 02861)	5 1/4	16158	.58
R669	5	16352	.73	6, 7, 8, 9, 10, 10-122, 12, 800, 800-122, 802, 808, 809, 809 (Dash)			
666, 666	6	16146	1.32	Paq, P.D. C. 122, H. D-122, E. C. 122, H-122 (Pt. 36-3159)	7 1/4	16159	.53
R1135, R1193	8	16124	.73	700, G-122 (Chr. 6, Ply. Dodge, Chr. Air, Des. Air, Hup, Q (Naah, Stude) (Pt. 36-3157)	7 1/4	16154	.73
4048	5	16055	.73	805, 806 (Pt. 36-3406)	6 1/4	16379	.88
Ford-G24 (Maj.) CB4, F1540 (Philo)	6	16129	.88	Model C32 Ford, 816, F79	5	16380	.59
C32 (Philo)	6	16158	.59	Model C1608	6	16297	.59
F1640 (Philo)	7 1/4	16298	.59	RCA-M34, 105	5	16062	.88
Gen. Elect.-B40	5	16002	.89	Stewart-Warner R232, R131	6 1/4	16138	.88
General Western Chevrolet-601308	8	16076	1.82	Wells Gard. 6L 05A, 05BA	5 1/4	16272	.88
985225, 985400	5 1/4	16273	.73	6K	6 1/4	16283	.88
985252	8	16078	1.32	6J	6 1/4	16253	.88
985283	6 1/4	16270	.88				
985284	6 1/4	16080	1.18				
985285	7 1/4	16082	1.18				
985300	8 1/4	16079	1.32				
985301	5 1/4	16385	.73				
985336							
(Cont. ID-1400)	5 1/4	16000	.78				
B-O-P-405062	8	16078	1.32				
982084, 982126	8	16205	1.32				
983534	8	16085	1.32				
983626	8	16205	1.32				
1304873, 8272749	6 1/4	16129	.88				

Every Model in the Service has the characteristics of the original. Thoroughly impregnated, will withstand extreme moisture. Resistance guaranteed accurate.

**Field Coils Supplied for All Speakers**

We can supply any field coil not included in these listings. When ordering coils not listed, give name and model number of both speaker and receiver, or send defective unit as sample. \*Tapped at 2400 ohms.

Set or Speaker	Field Ohms	Stock No.	Price	Set or Speaker	Field Ohms	Stock No.	Price
Atwater Kent Early Late 55, 60 (Speaker F4) 145	1,100 2,000	5498 5493	\$2.53 1.76	Philco 20, 21 (Pt. 2708) 68, 69, 77, 83, 87, 95, 96, 111 (Pt. 2850)	3,100 3,200	5612 5613	\$2.18 2.00
Bosch 5A 505, 514	2,000 1,500	5502 5547	2.35 1.65	70, 70 (A.V.C.) 90 (With Spkr.) 470, 490 (Pt. 02867 coil only)	3,600	5618	1.18
Brunswick D11 12, 16, 33, 88	2,400	5504	2.47	Silver Marshall 30 (Jensen)	1,900	5642	2.59
Crosley 145 167 (Magnavox) 269	1,000 1,100 10,000	5521 5517 5514	1.32 1.65 2.35	Spartan 600	5,000	5648	2.35
Grunow 5A 5B	1,850 2,500	5530 5528	2.85 1.18	Stewart Warner 116A	2,000	5650	2.59
Jensen D7-D8 D9-D15	2,500 2,500	5533 5538	2.94 1.47	Victor RE32-45-75	2,950	5670	3.41
Majestic G1 G2 G3	3,100 2,780 2,780	5570 5571 5572	4.78 4.78 4.42	Wells-Gardner 002	5,000	5676	3.15

**Speaker Field Coils For APEX, GLORITONE U. S. Radio Television and Montgomery Ward Sets**

High grade coils. Wound more accurately and impregnated more thoroughly than the original.

\*Tapped at 2400 ohms. †Tapped at 8000 ohms.

**YOUR PRICE \$1.39**

Set Model	Spkr. Num.	Stock Num.	Field Ohms	I.D.	O.D.	L.
28	2288	D5466	*11,500	1 1/4	2 1/4	1 1/2
28A	2467	D5467	*11,500	1	2 1/4	1 1/2
28P	2758	D5468	*11,500	1	2 1/4	1 1/2
26P	2925	D5469	*11,500	1 1/4	2 1/4	1 1/2
27	1936	D5471	11,000	1	2 1/4	1 1/2
8A	2801	D5473	16,000	1 1/4	2 1/4	1 1/2
10B	2802	D5474	16,000	1 1/4	2 1/4	1 1/2
99A	3261	D5475	1,000	1 1/4	2 1/4	1 1/2
31		D5476	2,500	1 1/4	2 1/4	2 1/4
24		D5477	2,500	1	2 1/4	4
46		D5478	2,500	1 1/4	3	3

## Universal Field Coils

Fits Pole Piece 1/4 to 1/2". Length 1/2 to 1/2". Outside diameter 1 1/4".

D5486-450 Ohms	D5487-1000 Ohms	D5488-1500 Ohms	D5489-2000 Ohms	D5490-2500 Ohms	D5491-3000 Ohms
List Price, \$1.00			Your Price Each... <b>59c</b>		

Fits Pole Piece 1/4 to 1". Length 1/2 to 1". Outside diameter 2".

D5455-450 Ohms	D5456-1000 Ohms	D5457-1500 Ohms	D5458-2000 Ohms	D5459-2500 Ohms	D5454-3000 Ohms
List Price, \$1.50			Your Price Each... <b>88c</b>		

## Dual Winding Field Coils

Windings may be connected either in series or parallel to provide a more universal resistance replacement range. Can also be used to replace any field coil having resistance within 10% plus or minus of values given below. Coils are supplied with insert tubes to decrease inside diameter 1/8" and 1/4" to fit smaller pole pieces. Wipers increase length of coil up to 1/4" more. Accurately wound.

Stock Number	Resistance	Size: 1 1/4" ID, 2" OD, 1 1/4" Long
D5400	418	1,675
D5401	625	2,500
D5402	750	3,000
D5403	1,000	4,000
D5404	1,250	5,000

Size: 1 1/4" ID, 2 1/4" OD, 1 1/4" Long

D5405	419	1,675
D5406	625	2,500
D5407	750	3,000
D5408	1,000	4,000
D5409	1,250	5,000

Size: 1 1/4" ID, 2 1/4" OD, 1 1/4" Long

D5420	419	1,675
D5421	625	2,500
D5422	750	3,000
D5423	1,000	4,000
D5424	1,250	5,000

Size: 1 1/4" ID, 2 1/4" OD, 1 1/4" Long

D5435	419	1,675
D5436	625	2,500
D5437	750	3,000
D5438	1,000	4,000
D5439	1,250	5,000

List Price, \$3.10. YOUR PRICE, All Types, Each... **\$1.92**

Size: 1 1/4" ID, 2 1/4" OD, 1 1/4" Long

Stock Number	Resistance	Price
D5410	419	1,675
D5411	625	2,500
D5412	750	3,000
D5413	1,000	4,000
D5414	1,250	5,000

Size: 1 1/4" ID, 2 1/4" OD, 1 1/4" Long

D5415	419	1,675
D5416	625	2,500
D5417	750	3,000
D5418	1,000	4,000
D5419	1,250	5,000

### Magnetic Speaker Replacement Coils

#### For Utah Orthovox Speakers



Exactly duplicate coils of 5, 6, 8 and 12" Utah Orthovox speakers. All coils center-tapped for either angle or push-pull output tubes.

**D5680**—High Impedance Type (For tube output of 12,000 ohms or over).

**D5681**—Medium Impedance Type (7000 to 12,000 output impedance coils).

List Price, 75c. YOUR PRICE, Each... **44c**

#### For Best Kinemats



Center tapped for single or push-pull tubes.

**D5685**—High Impedance Type (For tube output of 12,000 ohms or over).

**D5686**—Medium Impedance Type (7000 to 12,000 ohms output impedance coils).

List Price, 75c. YOUR PRICE, Each... **44c**

### For RCA Radios

**D6700**—Used in RCA 30, 100 and Western Electric 540AW.

**D6701**—Used in RCA 30A, 50, 51, 300A, 100B and 410B.

Each, Per Pair... **44c**

### Magnetic Speaker Coils

#### Rewound or Duplicated

**DX1195B**—Send speaker coil only and we will rebuild or duplicate it. State type of output tubes with which speaker coil is to be used. Send prepaid. Be sure your name and address is on the package.

YOUR PRICE ... **85c**

### UTAH and BEST Magnetic Speaker Coils Installed



All work is done under the direction of skilled, experienced speaker engineers. We guarantee that the repaired speakers (assuming that only the coil is defective) will be returned to you in perfect working condition.

**DX1195O**—Coils replaced in any size Utah Orthovox or Best Kinematic magnetic speaker. Send in defective speaker transportation charges prepaid. Be sure to state type of output tubes with which speaker is to be used. Price includes cost of coil. Be sure your name and address is on package.

YOUR PRICE ... **95c**



# Radio Noise Filters

## Continental Filternoys

### For Elimination of Electrical Radio Interference

Each unit is a complete filter, containing the correct capacitors or combination of inductances and capacitors, to effectively reduce or eliminate man-made static. For most effective noise elimination correct interference at source.

#### Suppression Type Units For Use At Interference

Combination capacitor—inductive type with capacitors shunted across receiving terminals. Prevents interference from entering power lines.

#### Rejection Type Units For Use at the Radio Set

Combination capacitor—inductive type with capacitors shunted across prong terminals. Prevents noise from entering the receiver power supply.

#### For Grounded Lines

**C8411**—Suppression Unit, Type F011L.

**C8416**—Rejection Unit, Type R011L.

List Price, 75c.

**YOUR PRICE, Either Type..... 44c**

Plug-in type. Will work very efficiently in eliminating moderate interferences on power supply lines having one side grounded. For 110 volts AC or DC lines with loads up to 300 watts. Metal case, 1 1/2 x 2 1/2".

#### For Ungrounded Lines

**C8412**—Suppression Unit, Type F011H.

**C8413**—Rejection Unit, Type R011H.

List Price, \$1.00.

**YOUR PRICE, Either Type..... 59c**

Plug-in type with lead for connection to suitable ground or frame of device causing interference. Efficiently blocks moderate interferences on ungrounded power lines of 110 volts AC or DC. Type F011H rated 330 watts; type R011H, 550 watts. Metal case, 1 1/2 x 2 1/2".

#### For Severe Interference Noises

**C8408**—Rejection Unit, Type R051H. For 110-volt AC or DC lines, up to 250 watts. List, \$3.00.

**C8406**—Suppression Unit, Type F051H. For 110-volt AC or DC lines up to 250 watts. List, \$4.00.

**YOUR PRICE..... \$176**

**YOUR PRICE..... \$235**

Aluminum container. For elimination of severe noises on grounded or ungrounded lines. Has plug-in receptacle, 3' cord with plug and ground connection lead.

#### Wire-In Type Suppression Units

##### For Permanent Installations

**C8415**—Type G01DH.

List, \$1.00.

**YOUR PRICE 59c**

Condensers grounded in a container.

For 110 volt AC or DC lines, up to 300 watts load.

Size 1 1/2 x 3 1/2".

**C8407**—Type F1005DH.

List, \$5.00.

**YOUR PRICE \$294**

For oil burners, neon signs, etc. Separate ground lead.

For 110-220 volt AC or DC lines up to 1100 watts load.

Size 3 1/2 x 4 1/2".

#### Wire-In Type Diverter Units

Employ capacitors only to divert interference from the high potential side of power line to ground. Use of field coils of motors as chokes makes a very effective method of silencing noisy motors. Units have no current limitation.

**C8414**—Type G01D.

Two dual capacitors grounded to case. Size 3/2 x 2 1/2".

For 110V. lines.

**C8419**—Type G14T.

Triple capacitors grounded to case. For use on hand operated motor driven devices.

Size 5 x 1 1/2".

**PRICE, Each... 29c**

**For Severe Cases**

**C8409**—Type F05D.

List, \$2.50.

**YOUR PRICE... \$147**

Dual capacitor in aluminum container with mounting bracket.

For obstinate cases of noise interference. Separate ground lead.

For 110-220 V. AC or DC. Size 2 1/2 x 1 1/2".

#### Plug-In Diverter

For Use at Appliance or Radio

**C8410**—Type F18.

List, 50c.

**YOUR PRICE 29c**

Display Card of 24 for \$6.35

In most cases, very effectively eliminates interference noise from home appliances, shavers, etc. Consists of 0.1 mfd. capacitor in compact bakelite plug-in case. For 110 volt AC or DC lines.

#### Radiation Suppressor

**C8418**—List, \$1.50.

**YOUR PRICE..... 88c**

Type OB15. Carbon element suppressor for use on ignition systems of oil or gas heating systems. 15,000 Ohms in isolantite jacket. Two usually required for each installation. Size 3 1/2 x 1 1/2". Solderless connections.

## Belden Power Line Filter

Effective on Both Short-Wave and Broadcast Bands

**D8405**—Type 8100. List, 9.50.

**YOUR PRICE..... \$558**

An efficient power line filter for use at the radio or interference source. Efficient with all types of receivers. Effectively reduces line interference on both broadcast and short wave bands. Incorporates two dual condenser sections with two dual high "Q" choke coils. Separate ground connection is provided by three wire power supply cord. Maximum load rating, 3 amperes. For use on 110 volt AC or DC lines.

Underwriter's Approved

## Cornell-Dubilier "Quietone" Interference (Radio Noise) Filters

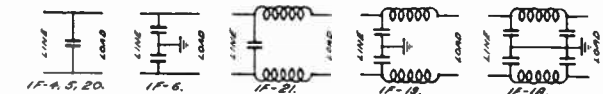

Every Quietone is a complete filter containing the correct condensers or combinations of chokes and condensers to very effectively eliminate practically every man-made noise that is radiated through power lines. Capacitive-inductive type units will eliminate the most severe noises in both broadcast and short-wave receivers. IF-6, IF-18 and IF-19 have split capacitor with separate ground connection for attaching to frame of motor or suitable ground. All units for use on 110 volts AC or DC with loads up to 550 watts, except IF-21 takes up to 175 watts.

#### For Preventing Interference Pick-up at the Radio Receiver

C-D Type	Stock Number	Walnut	List Price	Your Price Each	Type	Case	Size Inches
IF-4	C8905	C8907	\$0.75	\$0.44	Capacitive	Metal	1 1/2 x 2
IF-18*	C8906	C8908	5.00	2.94	Cap.-Ind.	Metal	3 1/2 x 5 x 2 1/2

#### For Correcting Interference at the Source

Specifically designed for use with home appliances and other portable equipment.

C-D Type	Stock Number	List Price	Your Price Each	Type	Case	Size Inches	
IF-20	C8909	C8935	0.50	0.29	Capacitive	Bakelite	1 1/2 x 1 1/2
IF-5	C8930	C8936	1.75	.44	Capacitive	Metal	1 1/2 x 2
IF-6*	C8931	C8937	1.25	.73	Capacitive	Metal	1 1/2 x 2
IF-21	C8932	C8938	2.50	1.47	Cap.-Ind.	Porcelain	2 1/2 x 3 x 2 1/2
IF-19*	C8933	C8939	4.00	2.34	Cap.-Ind.	Porcelain	2 1/2 x 3 x 2 1/2
IF-18*	C8906	C8908	5.00	2.94	Cap.-Ind.	Metal	3 1/2 x 5 x 2 1/2

## C-D Quietones for Industrial Equipment

For Use at the Interference Source

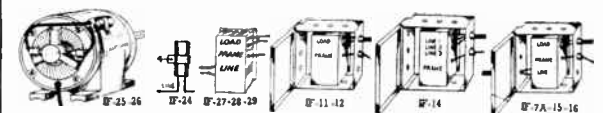
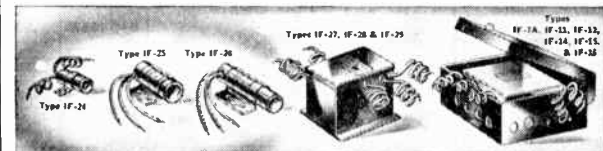

For elimination of interference caused by motors, generators, oil burners and other industrial electrical apparatus. Designed for quick installation. Capacitive type units have no current limitations. All units for single phase circuits except IF-14 is for 2 or 3 phase (3 wire) circuits.

C-D Type	Stock Num.	Line Volts	Type	Max. Amps.	Size Inches	List Price	Your Price
IF-24	C8987	110	Capacitive	5	3 1/2 x 2	\$0.75	\$0.44
IF-25	C8988	110/220	Capacitive	10	1 1/2 x 3 1/2	3.00	1.76
IF-26	C8989	110/220	Capacitive	10	1 1/2 x 5 1/4	5.00	2.94
IF-27	C8990	110	Cap.-Ind.	5	5 x 3 x 3 1/2	4.50	2.65
IF-28	C8991	110	Cap.-Ind.	10	5 x 3 x 3 1/2	8.00	4.70
IF-29	C8992	110	Cap.-Ind.	20	7 x 3 x 3 1/2	14.00	8.23

#### Housed in Cut-Out Boxes With 1/2" and 3/4" Knockouts

C-D Type	Stock Num.	Line Volts	Type	Max. Amps.	Size Inches	List Price	Your Price
IF-11	C8993	110	Capacitive	6	6 x 6 x 4	7.00	4.11
IF-12	C8994	110/220	Capacitive	6	6 x 6 x 4	10.00	5.83
IF-14*	C8995	110/220	Capacitive	9	9 x 6 x 4	14.00	8.23
IF-7A	C8996	110/220	Cap.-Ind.	5	6 x 6 x 4	7.50	4.41
IF-15	C8997	110/220	Cap.-Ind.	10	9 x 8 x 4	15.00	8.42
IF-16	C8998	110/220	Cap.-Ind.	20	8 x 12 x 5	22.00	12.34

## Tube Power Line Filterettes

For Use on 110 Volt AC or DC Lines

**Type RF-2**  
**C8376**—List, \$4.75.

**YOUR PRICE \$279**

250 Watt Capacity

**D8374**—Razor Filterette. Reduces interference from electric razors and clippers. Bakelite case. Underwriters' listed.

**D9986**—Model 7. Capacitive type filter in metal case. Price, Each EITHER TYPE..... **59c**

**D9985**—Filterette Jr. Has terminal post for ground connection. Underwriters' listed. PRICE EACH... **73c**



# Everyday Shop Necessities

## Cabinet Repair Kit

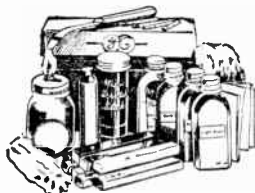

**C5708—**  
YOUR PRICE  
**\$1.91**

A complete, practical kit for cabinet repair jobs. Easy to use—with a little practice anyone can do as good a touchup job as a professional cabinet finisher. Material included makes possible a professional job on dents, knicks and scratches in wood, plastic or bakelite cabinets, knobs, etc. Kit includes Magic Scratch Remover for slight scratches; 9 assorted Shellac Sticks for deep knicks; bottles of light and dark oil stain; metal shading lacquer; polish; alcohol lamp with fuel; spatula touch up brushes; steel wool; sandpaper, and wiping cloth. Kit comes in handy black leatherette finish box.



**Creme-O-Wax Polish**  
C5706—4 oz. Bottle. **27c**  
YOUR PRICE.....  
C5707—16 oz. Bottle. **44c**  
YOUR PRICE.....

For Radio Cabinets, Planos and All Fine Furniture. Polish the cabinet of a repaired set before you return it to your customer. Then sell him this quality polish made particularly for fine radio cabinets. Contains no oil. Leaves a hard film of glossy protective wax.

## Radio Service Solvent

For loosening cement on speaker cones, spiders and voice coils. Can also be used as a solvent or thinner for most cements listed on this page. Makes an excellent cleaner for volume controls and contacts.

C8704—4 oz. Bottle. **29c**  
YOUR PRICE.....  
C5705—8 oz. Bottle. **44c**  
YOUR PRICE.....



## Non-Slip Dial Compound



C5712—  
Your Price **18c**

For aiding in repair of slipping, friction and cable or cord driven dials. Saves much work and insures a perfect job. Easy to use. Powder form. Should be applied freely to all slipping parts. Generous supply in cardboard container: 2"x3 1/4" high.



**Radio Contact Lubricant**  
C5710—2 oz. Bottle. **21c**  
YOUR PRICE.....

Eliminates noise on controls and contacts. Protects from dirt and dust. Insures proper and lasting repairs for all air-exposed contacts. Used for lubricating switches, tube prongs, electric motors, etc. Cleanses and lubricates. A cream solution, cannot spill.

## Speaker Centering Shims

C5750—Celluloid.  
Your Price, Per Kit.. **35c**

For centering and adjusting cone in pole piece of speaker. Insure simple, positive—spacing and centering for Voice Coils and Armatures. Makes Speaker Repairs and replacements easier to handle. Kit includes four each of 5 size shims in following thicknesses—.005", .0075", .010", .0125", and .015". Shims are made of very flexible celluloid. Each shim is distinctively colored to denote size.



## Speaker Centering Shims Swedish Steel

C5751—  
YOUR PRICE, per Kit.. **38c**

Serve same purpose as above shims but are made of best grade Swedish Steel. Very flexible yet strong enough so that with reasonable care will last a life time. 4 each of 4 sizes are furnished in a handy gold lettered partitioned snap case—.004, .006, .008, and .010 inches. Color coded to indicate different sizes.



## Dial Lite Coloring

K5715—  
List. 50c. **29c**  
Your Price.....

Kit includes five 1/4 oz. screw top bottles: Red, Green, Blue, Amber and Solvent. Dip dial in light in the coloring and the job is done. Dries in one minute. Color remains permanently. Many new sets have several colored dial lites, replace with one of the same color and ask more money for the job.



## New Air Drying Black Crystallizing Lacquer

No Baking or Heating Required  
N5724—3-oz. Can. **21c**  
YOUR PRICE.....  
K5717—Half-Pint. **59c**  
YOUR PRICE.....  
K5718—Pint can **\$1.05**  
YOUR PRICE.....  
K5719—Quart can. **\$1.76**  
YOUR PRICE.....



Gives any metal a professional crystalline (crackle) finish. Easy to work with—just paint the panels and let it air dry. Dries in twenty minutes. Produces small swirling type designs.

## Gray and Brown Crystallizing Lacquer

A5770—Gray } YOUR PRICE **21c**  
A5771—Brown } 2 Oz. Can. Ea. ....  
C5772—Gray } YOUR PRICE **59c**  
C5773—Brown } 8 Oz. Can. Ea. ....  
E5793—Gray } YOUR PRICE **\$1.05**  
E5794—Brown } 16 oz. Can. Ea. ....

Note: Other colors are available on special order.

## Cement for Bakelite Glass or Metal

K5730—  
YOUR PRICE, PER CAN **21c**

Made for sticking Bakelite to Bakelite, glass, metal parts, etc. For cementing loose inserts, moldings, tube base, caps, etc. Finds many uses around the shop. Generous supply in metal can.



## Furniture Scratch Remover



K5725—List. 50c. **22c**  
YOUR PRICE.....

Just a touch of stain with the brush and the scratch disappears forever. Always ready for use, suitable for any color finish. Indispensable in Radio store, for touching up minor scratches and defects. Packed in permanent case, easily carried in the respect.

## 5000 Volt Insulating Cambric



C5736—Roll of 210 square inches. List Price, 50c. **29c**  
YOUR PRICE.....

For insulating and preventing grounds and shorts on field coils, transformers, resistors, condensers, wires, etc. Will safely withstand up to 5000 volts. A dry cambric.

## Radio Repair Cement

For Speaker Cones, Anchoring Wires Etc.

K5731—  
YOUR PRICE,  
Per Set **29c**



For cementing speaker cones and voice coils, anchoring R.P. coil wires, etc. Waterproof. Makes extra strong durable joint. Sets almost instantly. Brush for applying and can of thinner included.

## Silverene Enamel

K5714 1/2 Pint Can. **59c**  
YOUR PRICE.....

Gives a very high lustre and an extremely smooth brilliancy. Non-porous (air and water tight). Will not peel, chip or crack. Highly reflective to heat and light. Suitable for use on Wood or Metal.



## Adhesive Rubber Cushion

Stops Rattles and Vibrations  
10 Foot Roll  
K5740—1/2" thickness **20c**  
K5741—3/8" thickness **24c**  
K5742—1/2" thickness **32c**  
50 Foot Roll.  
K5743—3/8" thickness. **PRICE \$1.10**



K5744—3/4" thickness. **\$1.36**

A live sponge rubber material that can be quickly and easily applied wherever the prevention of vibration or shock is desired. 3/4" wide. Coated with an adhesive compound that instantly seals with slight pressure. Rubber may be compressed to one-half normal thickness. Uses: Cushions radio chassis, speakers, vibrators, condensers, etc.

## Amphenol Coil Dope

Extremely Low Loss  
C5790—2 Oz. **29c**  
YOUR PRICE.....  
C5791—4 Oz. **38c**  
YOUR PRICE.....



A new synthetic resin polystyrene base product for impregnating coils, paper tubing, fibre, ceramics, fabrics, and other moisture absorbent materials. Provides complete protection against moisture and dust. Non-hygroscopic. Rapid drying. Can be applied by dipping or with brush.

Thinner for Above  
C5792—2 Oz. Bottle. **15c**  
YOUR PRICE.....

## Insulating Varnish

K5720—Pint Size. **73c**  
YOUR PRICE.....  
A5727—1/2 Pint Size. **44c**  
YOUR PRICE.....

For use in treating coils, noisy transformers, chokes, etc. Composed of highest quality ingredients. High dielectric strength. Is waterproof, oil proof, and non-corrosive. Can be used as dipping varnish or applied with brush. Dries in air.



## Cone Cement

In Handy Metal Tube  
K5732—  
YOUR PRICE **24c**

For cementing cloth and fibre cones, paper rings or felt to metal speaker frames. Dries in less than ten minutes and will hold permanently. Supplied in a metal tube containing three ounces.



## Cabinet Touch-Up Kit

Removes Scratches  
R5709—  
YOUR PRICE... **35c**

A practical touch-up kit that will touch up those accidental scratches and dents on cabinets. Contains 4 bottles, camels hair brushes, a portion of dark wax for filling deep scratches and a rubbing cloth. A Touch and a dark stain, and varnish stain are included. Varnish stains can also be used to touch up scratched metal escutcheons, etc.



## Desk Type Stapler

For Home Office or Shop



A high quality, low priced, stapler. Just the thing you have always wanted for your desk or writing table at home or at the shop. The cost is low! Performance is unsurpassed! Holds 50 Staples Including Magazine. Rubber base Prevents Slipping or Marring of Surface on which used. New Streamlined Modern design. Grades Even the Finest Desk.

D14199—Stapler, Desk Type. Complete with 500 staples. **49c**  
YOUR PRICE, 50c.  
Less 2%.....  
D14198—Extra Staples For Above. **24c**  
YOUR PRICE Per Box of 2000 25c each. Less 2% cash discount.....

# Littlefuses

## For Test Instruments

Especially designed for protection of delicate equipment. Break circuit in 1/100 part of time required to burn instruments. May be used on 250 Volts D.C. or A.C. The smaller sizes have been used without arcing up to 1500 volts D.C. on a 2KV supply. Illustration is actual size. Length 1 inch.



Stock Num.	Rating Amps	Max. Load M.A.	Resist. 5M.A. Load	Your Price Each	Your Price Dozen	Use to Protect—		
						Volts meters Ohms per volt	Milliammeters All Magnetic Movements	Thermocouple Measurements
A11159	1/200	5	500	18c	\$1.95	Over 1000	Galv. Up-1	Up-5
K11160	1/100	10	110	12c	\$1.32	500-1000	Up-10	10-25
K11161	1/50	25	20			100-500	10-25	25-60
K11162	1/25	60	5.0			20-100	25-75	60-115
K11163	1/15	100	3.0					
K11164	1/10	200	6.2			10-20	75-150	115-200
K11165	1/5	300	3.0	9c	\$1.00	5-10	150-250	200-300
K11166	1/3	400	2.5			3-5	250-350	300-400
K11167	1/2	600	4.0				350-500	400-600
K11168	1	1000	.24				500-750	600-1000
K11169	1 1/2	1500	.18	6c	65c		750-1000	1000-1500
K11170	2	2000	.14				1000-1500	1500-2000

## 3AG Type Littlefuses Underwriters Approved

Glass enclosed 3AG type. These radio fuses have many points of merit which are distinctly Littlefuse features. 1 1/4" long, 3/8" diameter. Fuse element pure rosin coated zinc. Locked end caps. No cement to loosen.

**For Radio Receivers 250 Volts**

Stock Number	Rate Amps.	Max. Load Watts	Your Price
K11171	1	60	Each 5c
K11172	1 1/2	80	Dozen 50c
K11173	2	150	Each 6c
K11174	3	300	Dozen 65c
D11155	4	400	
D11157	5	400	
D11158	6	500	

## For Amplifiers 250 to 500 Volts

Stock Num.	Rate Amps.	Peak Load Mils.	Your Price
K11175	1/4	75 mls.	Each 9c
K11176	1/2	150 mls.	Dozen \$1.00
K11177	3/4	300 mls.	
K11178	1	500 mls.	



**Fuse Mountings For SFE, 3AG and Littlefuses**

For 3AG, SFE14 or SFE20 type fuses. Cadmium plated steel shell, to which shielding can be soldered. Size 2 1/2 x 3/8".

**B11425—YOUR PRICE, EACH..... 4c**  
10 for 35c

**C11419—Jumbo Fuse Holder, 2 1/2" x 3/8".** Used in Delco, Philco, Motorola and others. For 3AG, SFE14, SFE20 or SFE30 Type Fuses. **YOUR PRICE, EACH..... 10c**  
10 for 89c



**"Meter-Back" Mounting**

Mounts directly on one meter binding post. Will not touch other post on smallest standard meter. Linen bakelite base.

**K11180—For Instrument Littlefuses.** Size 1" x 1 1/4" x 3/8". **YOUR PRICE, EACH..... 12c**

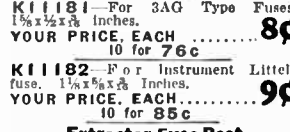

**Standard**

Tinned shake-proof terminals and extra quality phosphor bronze, nickel-plated fuse clips. Molded bakelite base. Overall length 1 1/2" x 3/8" inches. **YOUR PRICE, EACH..... 8c**  
10 for 76c

**K11182—For Instrument Littlefuse.** 1 1/2" x 3/8" inches. **YOUR PRICE, EACH..... 9c**  
10 for 85c

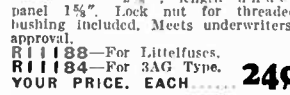

**Extractor Fuse Post**

Knob extracts fuse when unscrewed. Knob is recessed in shoulder and can be removed with screwdriver or dime coin.

Shock-proof—no live parts exposed. Safe rating 500 watts, 125 volts. Takes panel up to 3/8" thick. 1/2" diam. mounting hole. Overall length 2 1/2". length in order panel 1 5/8". Lock nut for threaded bushing included. Meets underwriters' approval.

**R11188—For Littlefuses.**  
**R11184—For 3AG Type.** **YOUR PRICE, EACH..... 24c**

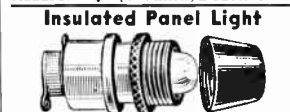

**Insulated Panel Light**

Compact panel light assembly. Entire unit made of phenolic insulating material. Fits into 3/8" hole, up to 1/4" deep. Bulb easily changed from front.

**Red Base** **Green Base**

**A10590—Min. Screw Bayonet** **A10592—A10591—A10593**

**YOUR PRICE, EACH..... 24c**

## Pilot Light Sockets

Lug connection mountings. No bulbs included.

Screw Socket	Bayonet Socket	Type	Your Price
C10611	C10617	B	5c
C10612	C10615	C	5c
C10614		E	5c
C10626	C10616	F	Ten for 40c

## BUSS FUSES

**Type 3AG.**

Fuse element enclosed in glass tube with brass caps on ends. Size 1 1/4" x 3/8". Will blow at a 30% overload.

Stock Number	Amps.	Box of 5	Per 100
A11190	1	14c	\$2.65
A11192	2	14c	2.65
A11193	3	14c	2.65
A11195	5	10c	1.60
A11196	10	10c	1.60
A11197	15	10c	1.60
A11198	20	7 1/2c	1.20
A11199	30	17c	2.80

## BUSS SFE Fuses New Standard Sizes

Auto and radio manufacturers are now using these new type fuses instead of the older 3AG. Different length for each rating eliminates replacing with incorrect fuse. All 1/2" dia.

Stock Number	Amps.	Length	Box of 5	Per 100
A11150	4	1 1/2"	12 1/2c	\$2.00
A11151	6	1 3/4"	12 1/2c	2.00
A11152	9	1 7/8"	10c	1.60
A11153	14	1 3/4"	10c	1.60
A11154	20	1 7/8"	7 1/2c	1.20
D11154	30	1 7/8"	17c	2.80

# Radio Panel Lamps Mazda Licensed

Finest quality American made Mazda Licensed pilot light bulbs. Fully equal in efficiency and length of life to any pilot light bulb on the market. At our low prices you can afford to stock up and be prepared for any requirement. Packed ten bulbs in attractive carton. S-T: Screw base tubular bulb. B-T: Bayonet base tubular bulb. B-R: Bayonet base round bulb.

Radolek Stock Number	Equivalent to Mazda	List Each	Rating		Price Per Box of 10		
			Volts	Amps.	One Box	10 Box Lots*	30 Box Lots*
B10451	(S-T) 41	\$0.09	2.5	0.50	41c	39c	37c
B10453	(S-T) 40	.09	6.3	0.15			
B10454	(S-T) 46	.09	6.3	0.25			
B10458	(B-T) 44	.09	6.3	0.25			
B10462	(B-R) 51	.07	6.8	0.20	39c	37c	34c
B10463	(B-R) 55	.07	6.8	0.40			

## Genuine Mazda Panel Lamps Clear Tubular Bulb—Miniature Screw Base

Radolek Stock Number	Max. Num.	Bead Color	List Each	Rating Volts	Amps.	Price One Box	10 Box Lots*	30 Box Lots*
D10573	48	Pink	\$0.15	2.0	0.06	\$0.88	\$0.82	\$0.78
D10560	41	White	.09	2.5	0.50	.54	.50	.47
D10561	42	Green	.12	3.2	0.35	.71	.66	.62
D10562	40	Brown	.09	6.3	0.15	.54	.50	.47
D10563	46	Blue	.09	6.3	0.25	.54	.50	.47
D10559	292	White	.12	2.9	0.17	.71	.66	.62

## Clear Tubular Bulb—Miniature Bayonet Base

Radolek Stock Number	Max. Num.	Bead Color	List Each	Rating Volts	Amps.	Price One Box	10 Box Lots*	30 Box Lots*
D10564	43	White	\$0.09	2.5	0.65	\$0.54	\$0.50	\$0.47
D10558	47	Brown	.09	6.3	0.15	.54	.50	.47
D10565	44	Blue	.09	6.3	0.25	.54	.50	.47

## Clear Round Bulb—Miniature Bayonet Base

Radolek Stock Number	Max. Num.	Bead Color	List Each	Rating Volts	Amps.	Price One Box	10 Box Lots*	30 Box Lots*
D10566	51	White	\$0.07	6-8	0.2	\$0.41	\$0.39	\$0.36
D10567	55	White	.07	6-8	0.4	.41	.39	.36

\* Boxes May be Assorted. See Pages 88, 77 for Other Lamps.

## Reflector Type Panel Light



**K10624—Less Bulb.**  
**YOUR PRICE 35c**

Takes standard tubular pilot lights. Illuminates meters on a test panel. Mounts in a 3/8" hole in 1/8" panels.

## Jumbo Pilot Light



For use as signal light indicator on transmitters, test panels, etc. Jewel measures 1 1/2" across. Chrome plated finish. Mounts in 1" hole. Bulbs can be replaced from front.

**Brackets Only**  
A10580—110V. Candelabra Base  
A10581—Miniature Bayonet Base  
A10582—Miniature Screw Base  
**YOUR PRICE, 10c**

## Jewels for Above

A10583—Red A10585—Blue  
A10584—Green A10586—Amber  
A10587—Opal  
**YOUR PRICE, 44c**  
Each

## Jeweled Pilot Light Brackets



Used as short indicators, signal light on test panels. Makes excellent soldering iron pilot when connected across 3 ohm resistance in series with a 100 watt iron. (2 1/2" bulb required.) Bracket sized pilot light fits into 3/8" hole on any panel not over 1/8" thick.

**R10620—With Red Jewel.** **10c**  
**YOUR PRICE, EACH..... 10c**

**C10609—Miniature Screw Bracket Only.**  
**C10625—Miniature Bayonet Bracket Only.** **YOUR PRICE, EACH..... 3c**

## Jewels for Above Brackets

Colored jewel on threaded shank with mounting nut. Requires 3/8" hole in panel not over 1/8" thick.

**K10621—Red**  
**K10622—Amber**  
**K10623—Green.**  
**R10618—Crystal.**  
**R10619—Blue.**  
**YOUR PRICE, EACH..... 7c**

## Type 3AG Fuses

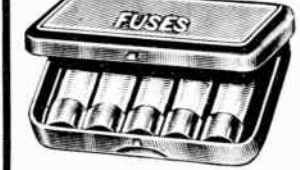

**Best Quality**

For Automotive and Radio use. Packed 5 fuses in a handy metal box. Boxes may be assorted to obtain quantity price.

## Type 3AG. Size, 1/4" x 1 1/4" Long

Stock Number	Amps	Box of 5	20 Boxes
B11103	20		
B11102	15	5c	95c
B11101	3		
B11100	2	11c	\$1.95

## SFE Type 1/4" Dia.

Stock Number	Amps.	lgth.	Box of 5	Per 100
D11104	14	1 1/4"	7c	\$1.25
D11103	20	1 1/4"	5c	.85
D11199	30	1 3/8"	10c	1.95

## 1 Inch Pilot Light



Jumbo pilot assembly that will pass Underwriters' approval. Faceted jewel lens. Mounts in 1" hole. All metal parts are made of brass, chrome finished. Socket is porcelain. Rated 75 watts at 125 volts. Takes Standard S6 Mazda 110 V. candelabra base bulb.

**A10575—Red A10577—Amber**  
**A10576—Green A10578—Opal**  
**A10579—Blue**  
**YOUR PRICE, 74c**  
Each

## A10589—Mazda S6, 110 volt. 6 Watt candelabra base bulb.

**YOUR PRICE, 15c**  
Each..... 10 for \$1.45



## Amperite Voltage Control Tubes



Designed to deliver constant voltage to the receiver from the power line although the line voltage may vary from 110 to 140 volts. Eliminates excessive line voltage. Easily installed. Connect in series with power line.

### For 105-120 Volt A.C. Receivers

Stock Num.	Use Amperite	Set Name and Model Number
K9819 A9822	9-20 11-30	Brunswick 14, 21, 31 Bruno, 814, 821, B-T, 83, 84; Grebe 21950, 270C, 285, 450. (Replaces Dumst. 110)
K9819 K9820 K9822 K9824	9-20 5-16 9-10 7-0	Bremer-Tully 881, 882 General Electric B-86 Majestic 90, 91, 92 Majestic 70, 71, 72
K9820 K9825 K9826 K9827 K9820 K9829	5-16 12-20 18-10 10-V-10 5-16 14-10	R.C.A. R-223 Scott A.C. 10 Star Raider Victor R32, 52 Victor (32V. Set) Zenith 108

### For 2 Volt Battery Radios

D9840	5E1(1A1)	Bosch 042, Eria 660.
D9839	30(1A2)	Silvertone 6, 242, 326.
D9831	31(1B2)	Silvertone, 223X, 224X, 266, 267, 1576, 1712, 1718, 1714.
D9840	5E1(1A1)	Sparton 81, 82.

List Price, Each, \$1.25  
**YOUR PRICE, EACH... 73c**

### For A.C.-D.C. Receivers

The following replace Octal Base Ballast Tubes with numbers and letters as noted below. Will control line voltages from 85 to 140 volts. \*Except L55B and M55B; but includes following: 42A, 49A, 50A, M50B, M45B.

Stock Number	Amperite Number	First Letter: Numbers From	K, L, M or BK Last Letter
A9848	KL-25	10 to 36	A, B, C or D
A9844	KL-45*	36 to 67	A, B, C or D
A9849	KL-50H	36 to 67	F, G or H
A9850	KL-75	67 to 105	A, B, C or D
A9851	KL-75H	67 to 105	F, G or H

**K9885—Amperite 4P-4S, 4 Prong Base.** Replaces Ballasts 185R, 185E, 185B, 185A, 185L, 185L4, 185L4, 185B, 185B4, 185E4, 185L4, 185L4, 140R, 140B4, 140B4, 140L4, 141L, 140L4, 300 50X, 5B.  
List Price, \$1.00.  
**YOUR PRICE, EACH... 59c**

## AC-DC Line Cord Resistor



Replacement for voltage resistors on cords in sets and sets. Complete inbuilt resistor for reducing line voltage to the correct value for the tube filaments.

Stock Num.	Total Resist.	Filament Voltage Drop	Your Price
C3889	830	18.0 to 24.0	<b>20c</b>
C3885	290	25.0 to 31.5	
C3882	250	32.0 to 44.5	<b>Each</b>
C3883	220	45.0 to 52.0	
C3884	180	53.0 to 61.0	
C3886	160	62.0 to 68.0	
C3886	135	69.0 to 75.2	<b>\$2.45</b>

### Tapped Line Cords

\*Tapped at 22.5 ohms for brown bead 0.15 amp. 6.3 volt pilot light. †Tapped at 40 ohms for blue bead 0.25 ampere, 6.3 volt pilot light.

D3890	190†	62.5
D9831	187.5*	62.5
D3892	165*	68.0

### Universal Line Cord

D3889  
List, \$1.50.  
**YOUR PRICE**



Provides any resistance from 22 ohms to 330 ohms in steps of 22 ohms each. Six coded leads. Instructions included.

## Resistance Tubes Ballast Tubes

For A.C.-D.C. Radios  
These resistance tubes are of excellent quality and will give excellent and satisfactory service. K series are for .15 amp. pilot bulb, L for .35 amp., M for .2 amp. Types are interchangeable providing correct pilot bulb is used as stated above. For example K49B can be used instead of M49B if a .15 amp. bulb is used. List Price, 80c.  
**YOUR PRICE, EACH 24c**  
10 for \$2.10



### Octal Base Tubes

Tube Type Num.	Other Manufacturers' Type Number	Stock Number
K38B2	K38B2	A9826
L40S2	L40S2	A9821
K42B	K42B, K40B	A9802
L42B	L42B, L40B	A9806
L42C	L42C, L40C, 69.2037	A9807
BK49B	BK49B	D9905
BK49D	3334, 3334A, 115.28	A9822
K49B	K49B, W42357, 135K1	A9808
K49C	K49C, A19047	A9810
L49B	2UR324, L49B, 69.2033	A9811
L49C	L49C	A9812
L49D	3CR241, L49D	A9813
50A2MG	50A2MG, KZ49C	A9827
50B2MG	50B2MG, KZ49B	A9828
BK55B	3613	A9829
K55B	K55B	A9814
K55C	K55C	A9815
K55CP	K55CP, K55CPR	A9823
K55H	K55H, 55H	A9824
L55B	L55B, 2UR215, 8598, L55BG	A9816
L55BJ	100-70	D9903
L55C	L55C, L555.5C	A9817
L5551	L5551	A9818
L5552	L5552	A9819
80A	80A	A9820
K80B	K80B	A9825
K80C	K80C	A9821
100-33	L42CJ	D9901
100-79	100-79	D9904

### 4 Prong Base Tubes

KX98B	300R4	D9905
KX105C	320R4	D9920
KX23B	60R30G, 60R30	A9899
KX23R	87R48	A9898
165R4	50B2, KX49B, 165KB, K49X, 5B	A9894
165R3	K49Y, 50A2, KX49C, 165KC, 6B	A9895
185R	80W, 60X3, 50X300, 185A, KX55A	A9896
185R4	KX55B, 185KB	A9897
185R3	50X3T, KX55C, 185KC	A9898
140R4	140R4, KX42B	A9932
140R3	140R3, KX42C	A9933
200R	200R	C9840
250R	245A, 250A	C9841

## Clarostat Ballasts

Universal Replacement  
Universal replacement metal tube type resistors for use in AC-DC sets. Operates efficiently regardless of line voltage variations or pilot lamp current or base. All the types listed will take care of 95% of your calls. Replaces AC-DC Ballast tubes with first letters BK, BL, K, L, M and other combinations as given below.  
**YOUR PRICE, EACH... 57c**  
10 for \$6.25



Stock Numbers	Mfg. Code	Tube Numbers	Last Letter
D9950	D9954	10*23A	A, B, C, D
D9942		10*23E	E
D9943		10*23F	F, G, H
D9944	D9951	23*55A	A, B, C, D
D9945		23*55E	E
D9952		23*55F	F, G, H
D9946	D9953	60*92A	A, B, C, D
D9947		60*92E	E
D9948		60*92F	F, G, H
D9949	D9955	92*105A	A, B, C, D

## Clarostat Resistor Tube Service Manual

D12505—Contains a short explanation of ballast tubes, replacement chart and cross index chart giving the correct replacement ballast to use in sets up to 1940. Size 8 1/2" x 11". 32 pages.  
**YOUR PRICE... 15c**



## Line Ballasts Metal Shielded

Compensates line changes. Sets designed for use with ballast will maintain the normal voltage across the primary of the power transformer within allowable limits for efficient operation, regardless of line fluctuation between 95 and 135 volts. List Price Each, \$1.75.  
**YOUR PRICE... 85c**

Num.	Type	Set Name and Model Number
K9871	1516	Majestic 70, 71, 72P, 1928
K9872	1508	Majestic 70B, 72, 72P, 1928
K9873	1012	Majestic 180, 181, 82P
K9874	1210	Majestic 90, 91, 92, 100
K9875	5001	Stewart-Warner 900-61816
K9876	5002	Stewart-Warner 950-62162
K9877	5003	Stewart-Warner R100-66786

### Clarostat A.C. Line Voltage Regulator

For sets with critical line voltage requirements where a dependable regulator must be employed.

Stock Num.	Type	Watts of Set	List Price	Your Price
K9880	O	Up to 60	\$1.75	57c
K9881	A	80 to 100		
K9882	B	100 to 150		

### Automatic Voltage Control For Reducing Line Voltages

N9891 — List, 75c.  
**YOUR PRICE... 44c**

Ten for \$4.10

Protects tubes, resistors, and condensers by automatically compensating for line surges as voltage rises. Air-cooled type. Supplies 135 volts A.C. or D.C. on any line up to 180 volts. For use with any set consuming up to 50 watts.

**Heavy Duty Model**  
A9889—For sets of 50 to 150 watts.  
**YOUR PRICE... 97c**

### Line Voltage Reducer

Reduces Excessive Line Voltages

C9890—List, \$1.00.  
**YOUR PRICE... 50c**

Ten for \$2.73

Maintains a constant potential on line on which voltage climbs. Protects tube heaters and resistors against line surges by automatically reducing line voltage to a normal operating voltage.

### Continental "Votatron" Line Voltage Regulator

C9884 — List Price, \$1.25.  
**YOUR PRICE... 73c**

Will regulate line voltage perfectly for radios of from 4 to 10 tubes drawing up to 100 watts. Three position switch, high, medium and low, keeps line voltages of from 110 to 135 volts at proper value for most efficient and safe operation.

### Adjustable Ballast Tubes

For AC-DC Radios  
Three new universal type ballast tubes that will take care of 95% of your calls for replacement ballast. Standard Octal or 4 prong base; same size and appearance as 32A tube. Easily changed jumpers on tube prongs make possible exact duplicate replacements. Complete with instructions. Keep at least one each of these Ballasts on hand at all times and you will be able to make immediate replacement of all but the very unusual types.

A9934—Type A. Octal Base. } **YOUR PRICE... 59c**  
A9935—Type B. Octal Base. }  
A9936—Type C. 4 Prong. } **EACH... 59c**

In Lots of 5 or more, Each, 55c

### Serviceman's Ballast Tube-Kit

D9959—Consists of 5 of above ballast tubes (3-Type A, 2-Type B and 1-Type C), 40 Page ballast tube replacement manual, template to simplify cutting operation and outer tool are included free.  
**YOUR PRICE... \$2.75**  
For Kit





# CONNECTORS SOCKETS

# AMPHENOL

# ADAPTERS PLUGS



Type RS  
Type RCP has prongs



Type S



Type CP

## Molded Bakelite Radio Tube Sockets

Made of molded bakelite with tube locating groove. Cadmium plated phosphor bronze contacts for easy soldering, recessed in individually molded chambers, protects them from damage. "S" and "CP" Type sockets and plugs mount without screws or rivets and are held to chassis with locking ring of spring steel. Mount in 1 1/2" keyed hole except those \* which fit 1 3/8" hole. Easy to mount on any material up to 3/8" thick. Use die listed on opposite page for punching chassis holes to fit these units. "RS" and "RCP" Type sockets and plugs. "S" sockets and "CP" plugs assembled on steel plate with slotted holes to fit mtg. ctrs. of 1 1/2" to 1 7/8". Take the place of water sockets.

"RS" Socket Stock Number		"CP" Plug Stock Number		"RS" Socket Stock Number		"RCP" Plug Stock Number	
Number	Price Each	Number	Price Each	Number	Price Each	Number	Price Each
C12212	6 2c	C12361	6 2c	4	C12366	C12373	7c
C12213		C12362		5	C12367	C12374	
C12214		C12363		6	C12368	C12375	
C12215		C12364		7 Small	C12369	C12376	
C12216*				7 Large	C12370		
C12217*	8c			7 Comb.	C12371	C12377	9c
C12218	10c	C12365	10c	8 Octal	C12372		9c
C12360				8 Loktal			11c

## Chassis Shell For Mounting Above Sockets and Plugs



A light weight aluminum shell which permits extending sockets or plugs 3/8" above or below surface. Knockouts in side of shell provide wire entrances from four sides. 3 Mtg. holes on 1" radius circle. Body 1 1/2" diameter. C12378—For 4, 5, 6, 7 Small, octal and Loktal Sockets and plugs. C12379—For 7 large and 7 Combination. YOUR PRICE, Each..... 6c

## "Molded in Plate" Bakelite Sockets

New compact bakelite sockets with molded in plate. Unequaled in strength, appearance and quality. Perfect insulation between mounting centers. Requires 1 1/2" hole. 20 Prong mounts in 1 1/2" hole.

Stock Num. Black	Your Price Each	Number of Prongs	Stock Num. Red	Your Price Each
C12275	6c	4	C12382	7c
C12276	Each	5	C12383	Each
C12277		6	C12384	
C12278		7S	C12385	
C12279	7c	7L	C12386	8c
C12280	7c	8 Octal	C12387	8c
C12281	10c	8 Loktal	C12388	11c
C12282	12c	9	C12389	10c
		11	C12390	13c
F12330	1 7c	12	D12332	1 c
D12331	2 c	20	D12333	3 c

## Ultra Low-Loss Sockets

Made of transparent "512-A" polystyrene material. Extremely low loss. Electrical and low loss properties far exceed steatite sockets. For all U. S. F. applications, both with 1 1/2" mtg. ctrs. Miniature mounts in 3/8" hole and is held in place by retainer ring.

D12283—Octal Socket.	24c
YOUR PRICE.....	
D12119—Loktal Socket.	27c
YOUR PRICE.....	
D12120—Miniature 7 contact Socket for 1S4, 1T1, 1R3, 1R5 tubes.	21c
YOUR PRICE.....	

## Tube Shield Base

K12228—PRICE, EACH... 2c  
For use with above type S sockets except 7L and 7 Comb. Mounts between socket and chassis without use of any rivets or screws. Cadmium plated, rust proof metal. Fits all standard size shields. Overall dia. 1 1/2". No socket included.

## Low-Loss Steatite Sockets

Exceptionally high dielectric strength, low power factor and high electrical resistivity. Easy to mount. Metal adapter plate can be screwed or riveted to panel or removed and socket mounted directly into chassis by spring retainer ring. Socket mounts in 1 1/2" hole (large size seven prong in 1 1/2" hole). Slotted holes in steel adapter plate 1 1/2" to 1 7/8" mounting centers.

Stock Number	Number of Prongs	Price Each
K12229	4	24c
K12230	5	
K12231	6	
K12232	7S	
K12233	7L	29c
K12234	8 (octal)	24c

C12391—6 Prong Plug. Has same electrical and mechanical specifications as above sockets. YOUR PRICE..... 24c

## Speaker Plugs

One piece molded extra heavy black bakelite body, 1 1/2" diameter by 1 1/2" high. Prongs are set deeply into in individually molded pockets, preventing short circuits due to wire insulation nulling back. Prongs are plated for easy soldering. 12 Prong plug is 1 1/2" dia., 20 prong 1 7/8" dia.

Stock Number	Number Prongs	Your Price
C12392	4	6c
C12393	5	6c
C12394	6	6c
C12395	7S	6c
C12396	8	8c
C12397	12	10c
D12334	19	15c
D12335	20	25c



## Plug and Receptacle For 110-250 Volt Retainer Ring Mounting

Underwriters approved standard auxiliary plugs and receptacles, for mounting directly on chassis up to 1/4" thick. Compact in size—quickly and easily mounted. 2 Pole receptacle accommodates polarized plugs as well as standard appliance plugs. 3 Pole has blades set at different angles for positive polarization. Fits 1 1/2" hole either keyed or plain.

D12398—Receptacle.	2 Pole
D12399—Standard plug.	2 Pole
D12350—Polarized plug.	3 Pole
YOUR PRICE, Each.....	15c
D12336—Receptacle.	3 Pole
D12337—Plug.	3 Pole
YOUR PRICE, Each.....	21c

## With Mounting Plate and Shell

Plugs and receptacles same as above. Surface mounting type is set in a nickel plated steel plate with mtg. ctrs of 1 1/2" to 1 7/8". Recessed mounting type is set in a nickel plated steel shell, 3/8" deep, fits 1 1/2" hole, 1 1/2" mtg. ctrs.

Surface Mount.	Type Connectors	Recessed Mount.
C12417	Receptacle	C12413
C12411	Standard Plug	C12414
C12412	Polarized Plug	C12415
PRICE Each... 16c		PRICE Each... 24c

D12338—Receptacle	D12340
D12339—Plug	D12341
PRICE Each... 22c	PRICE Each... 30c

## Cable Connectors

For 110-250 Volt

D12043—Receptacle	2 Pc'e
D12044—Standard Plug	2 Pc'e
D12045—Polarized Plug	2 Pc'e
YOUR PRICE, Each.....	21c
D12342—Receptacle	3 Pole
D12343—Plug	3 Pole
YOUR PRICE, Each.....	27c

## Miniature Sockets

Molded of high dielectric black bakelite. All mount in 3/8" hole except Raytheon type, 3/2". Retainer ring firmly holds socket in place.

D12344—7 Contact, for RCA button-type tubes.

D12345—5 Contact, for Raytheon (K-50), etc., hearing aid tubes.

D12418—5 Contact, for Hytron HY113, etc., hearing aid tubes.

YOUR PRICE, Each..... 10c

D12346—3 Contact, for RCA Peewee, and Geon Photo cells.

YOUR PRICE, Each..... 8c

## Shielded Connectors

Suitable as cable connectors or cable plugs. Molded bakelite sockets and plugs can be quickly removed from the insulated steel caps for making connections. Rubber grommet with a 3/8" hole protects cable where it passes through the cap. Female section has cadmium-plated phosphor bronze contacts. Size 1 1/2 x 1 1/4" dia.

Male Section	Female Section	Number Contacts
K12241	K12245	4
K12242	K12246	5
K12243	K12247	6
K12244	K12248	7S
D12347	D12348	7L
R12239	R12240	8

EACH PIECE PRICE ..... 15c

## Rubber Handle For Shielded Connectors

The above plugs snap into this rubber handle and are held securely in place by an inner molded shoulder. Allows easy removal of plug in recessed or hard to get at places. Also protects connection from damage. Molded from black live rubber.

C12046—YOUR PRICE..... 9c

## Cable Clamps C12047—YOUR PRICE 6c

Positive gripping cadmium plated steel. Attaches to shell of shielded connectors above and relieves all pulling or twisting strain from soldered connections. May also be mounted on chassis or panels. Mounts in hole 3/8" to 5/8".

## Connector Locking Covers

Cadmium plated threaded steel covers that slip over above shielded connectors. Lock connectors firmly together preventing accidental disconnection.

C12048—Cable Type—Consists of two shells to slip over connectors.

C12049—Chassis Type—Consists of a shell for connector and a threaded steel flange that mounts on socket.

YOUR PRICE PER SET..... 15c

## Tip Jacks and Plugs

Molded bakelite. Jacks mount in 3/8" hole in panels up to 1/4" thick and are held in place by retainer ring.

Jacks Stock Num. Red	Jacks Stock Num. Black	Plugs Stock Num. Red	Plugs Stock Num. Black
D12006	D12010	Use Phone tips	
D12007	D12011	1/4"	D12014 D12017
D12008	D12012	3/8"	D12015 D12018
D12009	D12013	1/2"	D12016 D12019
PRICE Each... 4 1/2c		PRICE Each... 3c	

## Bulb-Tester Socket

C12051 Your Price 26c  
Standard 7S-7L combination socket with small socket in center for testing all miniature base bulbs either screw or bayonet type.



**Shielded Cable  
Connectors  
3 and 4 Contact**



Three or four contact polarized plug and socket covered by heavy chrome plated brass shell. In destructible and moisture proof. Male and female sections can be locked together by means of a threaded collar. Spring cable protector.  
**A12252 MC3M—3 Prong Male Section.**  
**A12254 MC4M—4 Prong Male Section.**  
 Includes locking nut. Removal of cap on other end permits screwing into any microphone having 5/8" threaded hole. Size 1 1/4" long, 3/8" diameter. MC3M takes up to 3/8" dia. cables, MC4M up to 3/4".

**D12253 MC3F—3 Hole Female Section.**  
**D12255 MC4F—4 Hole Female Section.**  
 Has male thread to receive locking nut.

**Prices**

Three Prong and Three Hole Connectors. List Price. \$1.00. Your Price, Ea. **59¢**  
 Four Prong and Four Hole Connectors. List Price. \$1.10. Your Price, Ea. **65¢**

**Chassis Connectors for Above**

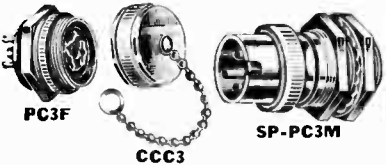

Females have thread. Males have locking ring. For mounting on chassis or wall plate. With lock washer and locking nuts. Requires 3/8" mtg. hole.  
**C12258—PC3F—3 hole, Female.**  
**YOUR PRICE, EACH..... 29¢**

Similar to above except contacts are shielded front and rear. Plus up to 1/4" prong length.  
**A12235—SP-PC3F—3 hole Female.**  
**A12236—SP-PC3M—3 prong Male.**  
**YOUR PRICE, EACH..... 59¢**

Cap and Chain Protects against dirt and tampering. For use on plug, chassis or wall outlets.  
**A12237—CC3—Fits connectors listed above.**  
**D12238—CC3—Fits PCI and MCI connectors listed at upper right.**  
**YOUR PRICE, EACH..... 29¢**

**Miniature Shielded  
Connectors  
Chassis Sockets**

Type PCG-F female and PCG-M male. Socket shell contacts shell of cable connectors. Can be mounted on surface or behind panel. Required hole with 1/4" mtg. etc.

Num. Contacts	Stock Female	Numbers Male	Price Each
3	D12219	D12223	18c
4	D12220	D12224	18c
5	D12221	D12225	20c
6	D12222	D12226	20c

**Cable Connectors**

Type MPF-L female and MPM-L male. Bakelite element held in cadmium plated shell by screw.

Num. Contacts	Stock Female	Numbers Male	Price Each
3	D12227	D12103	18c
4	D12100	D12104	20c
4	D12101	D12105	22c
6	D12102	D12106	22c

**Miniature Sockets  
and Plugs**

Type S-S and 78-F sockets and type 71-S plugs. Compact construction for connecting speakers, microphones, doublet antennas, etc. Socket mounts in 5/8" round hole and is held in place by round retainer. Plug has moulded finger grip rim for easy pull-out.

Num. Contacts	Stock Socket	Numbers Plug	PRICE Each
3	D12416	D12420	8c
4	D12417	D12421	8c
5	D12418	D12422	10c
6	D12419	D12423	10c

**Pressure Type Connectors**



Handy connectors for use with microphone cable. Easy to connect. Polished nickel finish.  
**D12263—MC1F. Female cable connector.**  
**YOUR PRICE..... 29¢**  
**D12264—MC1M. Male cable connector.**  
**YOUR PRICE..... 24¢**  
**C12265—PC1M. Male for chassis mounting.**  
**YOUR PRICE..... 18c**

**D12257—CL-PC1M. Male for chassis mounting.** Prevents open grid hook by means grid to ground when connector is removed.  
**YOUR PRICE..... 24¢**

**D12267—SP-PC1M. Same as CL-PC1M except does not short out. Has spring tension center contact.**  
**YOUR PRICE..... 24¢**

**Phone Plug Adapter**

Screws into the coupling ring of the MC1F Cable Connector above, permitting plugging into any standard phone jack.  
**D12271—MC1F. Phone Plug Adapter.**  
**YOUR PRICE..... 27¢**

**Microphone Switch**

Compact and easily installed, fully shielded. Threads fit above MC1F connector and any mike using the PC1M male connector. Push and release button to talk for standby or temporary use or slide switch forward for permanent connection.  
**D12273—MC1S Switch.**  
**YOUR PRICE..... 59¢**

**Plug-In Type Connectors**

New, improved connectors for shielded 1 or 2 conductor cables. Male prong fits snugly into female contact. Male plugs have coupling ring for locking connectors together. Chassis type have female contact.

	Price
D12107 80-F Single Contact Female.....	38c
D12108 80-M Single Contact Male.....	38c
D12109 80-C Single Contact Chassis.....	24c
D12110 MC2F Two Contact Female.....	47c
D12111 MC2M Two Contact Male.....	47c
D12112 PC2F Two Contact Chassis.....	27c

**Heavy Duty Connectors**



Approved by Underwriters Laboratories

Ideal for low-impedance microphone or heavy-duty power lines, etc. Each prong carries 10 amps. at 250 volts, 15 amps. at 125 volts. Moulded bakelite element in brass cadmium plated shell.

**D12159—92-M Male with coupling ring.**  
**D12260—92-F Female with coupling threads.**  
**D12262—92-C Female Chassis Mounting type with coupling threads.**  
**YOUR PRICE, Each..... \$1.47**

**Tap Change Switch**

Single pole, 8 position rotary switch for circuit changing use in impedance matching, tapped transformer and similar applications. Bakelite knob. Set screw in side locks switch. Fits in 1 1/4" hole with 1/4" mounting centers. White tap designations.

**D11028—36-1 With Numerals 1 to 8**  
**D11027—36-2 With Impedance Markings of 0-24-8-16-30-500**  
**YOUR PRICE, EITHER TYPE..... 44¢**

If you have any special connector problems or wish to use any Amphenol products to fit a special application, Write us giving full details. We will assist you in every way possible.

**Unwired Adaptors**

Makes any Combination Adaptor

Make your own adaptors for modernizing tube chassis, analyzers and radio sets. Also may be used for bringing out connections from tube circuits for phone, headphones, etc. Self-tapping screws hold assembly together. Screws supplied with bottom sections. Hole on side of base permits bringing out leads or grid cap stud may be used. Only units bearing same type size can be used together. Grid stud not supplied.



Socket Tops	Number Prongs	Type Size	Plug Bases
Stock Num.	Mtg. Diam.		Insi-De Diam. Stock Num.
C12206	1/4"	4 Small	1 1/8" C12200
C12207	1/4"	5 Small	1 1/8" C12201
C12208	1/4"	6 Small	1 1/8" C12202
C12209	1/4"	7 Small	1 1/8" C12203
C12150	1/4"	7 Large	1 1/4" C12204
C12210	1/4"	7 Comb.	Large
C12211	1/4"	8 Octal	Small 1 1/8" C12205
		8 Octal	Large 1 1/4" C12152
C12151	1/4"	8 Loktal	Small

**YOUR PRICE, Each..... 12c**  
**D12153—Metal tube grid cap stud.**  
**YOUR PRICE, Each..... 6¢**

**For Analyzer Plugs**

**C12154** Small 7 Contact socket top with latch-lock type center stud. Mtg. diam. 1-1/8". Fits above wall type bases.  
**YOUR PRICE..... 18c**

**Adapter Kits**

Wired and unwired adaptors for testing loktal, single ended and RCA miniature tubes in the octal socket of any tube tester. Complete with full instructions. All adaptors supplied with octal bottom section.

**D12296—Loktal to Octal Adapter Kit.** Takes all but the 7E7 and 7F7 Loktal tubes. Kit of 5 adaptors, wired.  
**YOUR PRICE, Per Set of 5..... \$2.75**  
**D12297—Adaptors as above, unwired.**  
**YOUR PRICE, Per Set of 5..... \$1.47**

**D12113—Wired Adaptor for 7E7 Tube.**  
**D12114—Wired Adaptor for 7F7 Tube.**  
**YOUR PRICE, Each..... 59¢**

**D12115—Octal to Octal kit of 5 adaptors for the single ended series tubes, wired.**  
**YOUR PRICE, Per Set of 5..... \$2.75**

**D12116—Kit of 5 as above, unwired.**  
**YOUR PRICE, Per Set of 5..... \$1.47**

**D12117—RCA Miniature to Octal.** Kit of 3 wired adaptors to test the RCA 184, 1T4, 1H5 and 185 tubes.  
**YOUR PRICE, Per Set of 3..... \$1.76**

**D12118—Adaptors as above, unwired.**  
**YOUR PRICE, Per Set of 3..... 88¢**

**Magic Eye Assembly**

**D10605** For 6 Prong Tube.  
**YOUR PRICE..... 73¢**

Complete assembly, except tube, for adapting magic eyes to P-M and broadcast receivers, signal tracing devices, etc. Includes modern escutcheon, adjustable tube support, screws, shield, wind-6 prong socket with 220 leads and wired-in 1 meg. resistor.

**913 Cathode Ray Assembly**

**D12270—913.** Assembly with mounting bracket, and wired-in octal socket for type 913 or 902 cathode ray tube.  
**YOUR PRICE..... 59¢**

**Chrome Plated Wall Plates**

Single gang 2 1/2"x1 1/2" plates to fit standard wall switch or outlet boxes. Mtg. holes 3/8" made of brass with polished chrome finish. Plate only is supplied. No sockets included.

**C12155—With Single 3/8" hole for PC3F chassis connector listed at left.**  
**C12156—With Single 3/8" hole for PC1M or CL-PC1M chassis connector listed at lower left.**  
**C12157—(Illustrated)** With one 3/8" hole and one 1.172" (1-11/64") keyed hole.

Accommodates a PC3F chassis connector listed at left and an 110-250 volt receptacle.  
**YOUR PRICE, Each..... 44¢**

**EXACT  
DUPLICATE**

# Majestic REPLACEMENT PARTS

## Majestic Stator Plate Assembly Original Part Number 52

Used In Series 70, 90, 100, 130, and 180

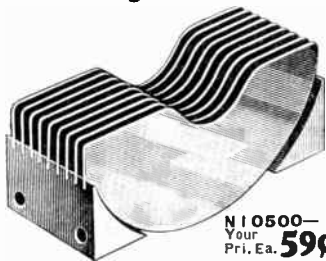

**N10500—**  
Your  
Pri. Ea. **59¢**

No further need to replace the large and expensive variable condensers used in Majestic chassis 15, 15B, 25, 25B, 70, 70-B, 90, 90-B, 100, 100B, 130, 130A, 150, 180, and 230A; models 71, 72, 90, 91, 92, 93, 101, 102, 103, 130, 131, 132, 151, 153, 154, 155, 156, 181, 233, 251, 251B, 253, 253B, 254, and 254B. Use this stator plate assembly to repair only the damaged sections. Eliminates necessity of discarding the entire variable condenser when only one or two sections are damaged. Easy to install. Operation requires removal of only four screws. Assembly consists of stator plates securely mounted in aluminum casting. Radolek is first to make these replacements available. Size 1 3/4" wide, 3-3/16" long.

## Five Gang Condenser Part Num. 321

Used in chassis 90, 90B, and 100; models 90, 91, 92, 93, and 101. Identical to original. Frame constructed of durable rolled steel. Plates and stators of improved design and cast aluminum construction. Length 1 1/2", width 3/4".



**C10501—**  
YOUR PRICE..... **\$2.95**

## Four Gang Condenser Part Num. 51



**Part Num. 51**

Used in chassis 70 and 70-B, models 71 and 72. Exact replacement conforms in every respect to original manufacturer's specifications. No changes necessary in receiver to make quick and accurate installation. Includes pulley wheel and pilot light socket.

**C10502—**  
YOUR PRICE..... **\$2.45**

## Popular Majestic Replacement Parts

Stock No.	Part Number And Description	Your Price
C16109	#32 Speaker Cone for G1 Spkr.	\$1.25
C16110	#35 Speaker Cone for G2 Spkr.	1.25
C6109	#61 Filament Transformer for 70, 70B, 71, 72, (7P6).	2.73
C6108	#67 Plate Transformer for models 70, 71, 72, (7P6).	2.53
C10512	#379 R.F. Choke for models 90, 90A, 90B, 91, 92, 93, 100, 100B, 101, 102, 103.	.45
C6111	#552 Power Transformer for models 90, 90B, 91, 93, 100, 101, 102, 103.	3.76
C6106	#3910 Power Transformer for 20, 21, 22, 23.	3.76
C10514	8 Ft. #5151 Auto Radio Drive	1.20
C10515	10 Ft. #5177 Cable and housing	1.50
C10516	12 Ft. #5178 for 110, 111, 114.	1.80
C6114	#5400 Power Transformer for 15, 15B, 150, 151, 153, 154, 155.	2.09
C6753	#7785 Pilot Light Dimmer for models 300, 300A, 320.	.85
C10525	#7855 Voltage Divider for models 300, 300A, 303, 304, 307, 320, 324.	1.47

## Dial Assemblies

### Part Num. 10160

Complete spring friction dial and drive assembly used in chassis 460 and 490; models 151, 164, 461, 463, 491, 493, 776, 886, and 996. (Clockwise reading; Police to 150 to 55, Diameter 3 3/4". Fits 1/2" shafts.)



**D10507**  
YOUR PRICE... **\$1.35**

### Celluloid Dial Scale

#### Part Num. 1902

N10504—Used on drum dials in Majestic chassis numbers 70, 70B and 180; models 71 and 72.



**YOUR PRICE..... 59¢**

### Bronze Dial Scale

#### Part Numbers 606, 1265 and 1266



Dial scale assembly for models 20, 30, 90, 90B, 100, 100B, 130A, and 230A. Exactly calibrated. Made of brass with black background, 5/8" diameter. For 3/8" shafts. Replaces aluminum and celluloid scales.

**D10503—**  
YOUR NET PRICE ..... **98¢**

### Remote Control Knob Part Number 8208

C10513 — Large bakelite knob with calibrated dial scale for Ford-Majestic Model 111 auto radio.



**YOUR PRICE..... 95¢**

Send for your FREE copy

D12503—Genuine Majestic Replacement Parts Catalog listing complete line at lowest wholesale dealer prices ..... **FREE**  
Radolek can supply Genuine or Exact Duplicate replacement parts for practically any Grigsby-Grunow Majestic Radio Set.

# REPLACEMENT COILS for all Majestic RADIOS

**Exact Original Manufacturers Specifications**  
Each coil is completely assembled and an exact electrical and physical duplicate of the original. Size, mounting holes, trimmers and color coded leads are all carefully followed.

**Transformers Pre-Tuned at Factory**  
Coils are all precision machine wound. Highest quality materials and workmanship.

The word "Complete" after any coil description signifies that the shield can and trimmer condenser are included.

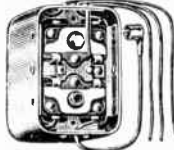

Majestic Part Number	For Majestic Model Numbers	Description	Stock Number Complete Assembly	Your Price	Stock Number Coil Only	Your Price
4428	15, 15B, 150	1st 1P/Osc.	C9540	\$1.15	C9550	30¢
4429-8384	15, 15B, 55, 150	2nd 1P	C9541	.75	C9506	34¢
5490	15, 15B, 55, 150	1st RF			C9542	59¢
5488	15, 15B, 55, 150	2nd RF			C9543	44¢
3908	20, 21, 22, 23	1st 1P	C9544	1.25		
3907-3960	20, 21, 22, 23	2nd 1P	C9545	1.35		
6506	50	1P and Osc.	C9507	1.60		
4439	60, 160	1st 1P	C9555	1.50		
4267-4464	60, 160	2nd 1P	C9556	1.35		
6984	120B	1st 1P	C9508	.80		
379	90, 90A, 91, 92, 93, 100, 100B, 101, 102, 103	RF Choke			C10512	45¢
6250	200	1st 1P	C9567	1.10	C9518	36¢
6203	200	1P and Osc.			C9569	73¢
6127	210	3rd 1P	C9572	.70	C9522	36¢
7187	290, 300, 310, 330, 460, 520, 800	RF Plate			C9536	39¢
7812	310A-B, 330, 800	2nd 1P			C9575	41¢
00148)						
10149)	460, 490	1st 1P	C9581	.75	C9532	36¢
10253)						
11014)	460, 490, 570, 800	2nd 1P			C9582	40¢
9747-9748	460, 490, 520, 570, 10196)	Ant. Coil			C9583	47¢
10197)	460, 490, 520	Osc. Coil			C9584	35¢
9750-9751)	460, 490, 570, 800	RF Trans.			C9585	47¢

## Condenser Blocks Models 7P6, 8P6, 9P6

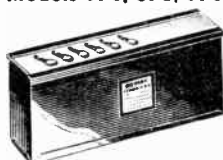

Exact duplicate Majestic replacement condenser blocks. Built to the original specifications they fit exactly and will give better service due to increased safety factors. All terminals plainly marked.

**Part No. 7P6 for Model 70**  
Total 9 mfd. Five lug terminals. Container 9x4x2 1/4 inches.  
C8461—List. \$9.00.  
YOUR PRICE ..... **\$1.70**

**Part No. 8P6 for Model 180 8P3 and 8P6 Power Packs**  
Total 9 mfd. Six lug terminals. Container 9x4x2 1/4 inches.  
C8462—List. \$12.00.  
YOUR PRICE ..... **\$2.95**

**Part No. 9P6 for Model 90**  
Total 7 mfd. Six lug terminals. Container 9x4x2 1/4 inches.  
C8463—Supplied with resistors in place of chokes.  
YOUR PRICE ..... **\$1.85**

C8464—Pt. No. 284. Supplied with chokes—reduces hum.  
YOUR PRICE ..... **\$2.95**

## Dial Cables

Model Number	Stock Num.	Your Price
70, 71, 72—Exactly duplicates original (42 strands)		
70, 71, 72—(18 strands)	C4183	12¢
180	C4184	09¢
52, 60—Linen Cord	C4185	15¢
	C4187	15¢

## Aerovox Electrolytic Condensers

For Majestic Receivers

Majestic Model	Maj. Pt.No.	Stock Num.	Your Price
201, 203, 204	C7722	6277	\$1.18
291, 293, 294	C7725	7173	.56
324, 344, 363		7988	.41
311, 314, 315			
331, 336-77, 344, 363			
		8118	C7731 .35
153, 154, 155			
156	8385		C7733 .94
381	8755		C7736 .76
411, 411A, 413, 413A		9661	C7740 1.06
40, 49, 194 (440)	10536		C7743 1.00
55, 59, 75, 195, 560, 556			
Chassis 500	10827		C7744 1.09

## Automatic Cut-Out

For Use On Any Car

Saves Battery, Vibrator, Etc.

D10533  
YOUR PRICE **\$1.73**

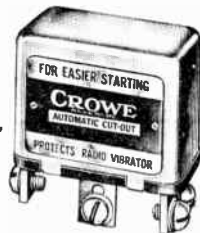

Instantly cuts out all electrical accessories including lights, radio, heater, etc. on car when starter switch is depressed. Increases voltage and spark intensity resulting in quick motor starting. Saves battery, gasoline and time. Saves radio vibrator points from becoming pitted or fused as usually occurs when battery voltage drops under load of starter. Maximum contact current 38 amps. Supplied with mounting and installation instructions.



# Popular EXACT DUPLICATE Replacements

## Exact Duplicate Condenser Blocks

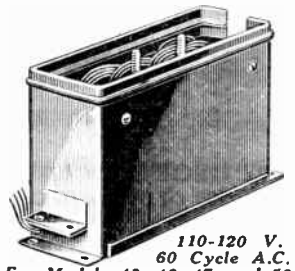

**110-120 V. 60 Cycle A.C.**  
For Models 43, 46, 47, and 53  
Condenser Only  
N8457—Condenser only for the power pack used in models 43, 46, 47, and 53. List, \$6.06.  
YOUR PRICE ..... **\$3.50**

**Models 55, 55C, 60, 60C Condenser Assembly**  
Part Number 14340  
Total 8.2 mfd., 7 terminals. Container size 3 3/4 x 3 x 2 3/4 inches.  
K8451—List Price, \$7.19.  
YOUR PRICE ..... **\$3.10**

### Only New High Quality Materials Used

**For ATWATER KENT**  
No refitting or redrilling necessary to install these exact duplicate Power Units. They match the original electrical and physical specifications.

For Models 40, 40F, 42, 42F, 44, 44F, 45, 52, 56 and 57  
DB455—Condenser only for the power pack used in above models. List, \$3.00.  
YOUR PRICE ..... **\$1.47**

For Models 37 and 38  
**Condenser and Choke**  
Contains 3 mfd. filter block and 3 chokes, two high voltage filter chokes and one speaker choke. Six color coded insulated 6" leads and ground terminal. Size 5 1/4 x 3 1/4".  
A8450—List, \$6.00.  
YOUR PRICE ..... **\$2.94**

**Atwater-Kent Line Ballast Resistors**  
Models 42, 43, 44 and 52.  
Size 3 3/4 x 1 1/4".  
C3867—Model 42, 43 and 52. Pt. No. 13645, 28 Ohms.  
R3868—Model 44-Pt. No. 13755, 21 Ohms.  
YOUR PRICE, EACH ..... **42¢**

### SPARTON By Pass Condensers

Exact replacement for Sparton receivers—2 3/4" long—1 1/4" diameter. Bracket on end for 1/2" screw. Mounting lug with slot at side. Fibro case with hermetically sealed ends. Paper and foil type. 1928-31 models. Working Volts 600



Stock Number	Cap. Mfd.	Price Each	Ton For
K7265	.25	26¢	\$2.46
K7266	.5	29¢	2.75
K7267	1.0	31¢	2.94

### A.K. By-Pass Condensers

Part No. 14902 For Models 37, 38, 40, 42, 44 and 46  
Exactly duplicates the original speaker by-pass condenser used in the above sets. 0.3 Mfd. 450 volts. Size, 3 1/4" x 1 1/2" x 5/8".  
A8453—List, 75¢.  
YOUR PRICE ..... **59¢**  
Part No. 9497 For Models 37, 38, 39, 40, 42, 46, 52  
.25-.25-.25 mfd. bypass condenser size 3 1/2 x 1 1/2. Three leads.  
K8452—List, \$1.50.  
YOUR PRICE ..... **59¢**

### SPARTON Condenser Blocks

**Model 930**  
Exact duplicate of the original part used in the Model 930 Sparton receivers. Total capacity 6.1 mfd. Individual sections: 3 1/2 mfd., 1-2 mfd., 1-1 mfd., 1-1 mfd. All 600 volts. Leads are insulated and color coded exactly like those on the original part. Dimensions 5 1/4" high, 3 1/2" wide, 2 1/2" deep. New merchandise and fully guaranteed.  
K8468—  
YOUR PRICE ..... **\$3.95**

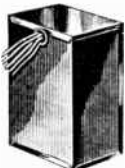

**Models AC69A, 79A, 89, and 78A**  
Total capacity 7 1/2 mfd. 8 color coded 10" leads. Dimensions: 5 1/4" high, 3 1/2" wide, 2 1/2" deep. 2 1/2" mounting hole centers.  
K8469—  
YOUR PRICE ..... **\$4.25**

**Model 89A**  
Total 6 mfd. Five leads. Container size 7 x 4 1/2 x 3 inches.  
K8470—List, \$12.00.  
YOUR PRICE ..... **\$3.70**

## Exact Duplicate Dial Repair Parts



**Dial Drive Assembly For R.C.A. Victor Receiver**  
R.C.A. part 2999. Complete tuning dial drive shaft with mounting screws, lock washers and friction rubber. Exact replacement for R.C.A. Victor models: R-7A, R-9D, C, R-43, R-11, R-TD, C, R-7L, W, R-10, BE-18, RA-26, DE-18A, R-10D, C, R-7, R-9, R-4, R-6 and R-8.  
N10544—List, 40¢.  
YOUR PRICE ..... **21¢**



**Crosley Tuning Pinion**  
Exact replacement tuning drive gear casting for Crosley models 26, 53, 57, 608, 706 Gembox and Showbox.  
R10534—List, 63¢.  
YOUR PRICE ..... **41¢**



**FADA Tuning Drum**  
Same as original number 1716X. For all early models 4 1/2" diameter, 1/2" track. Shpg. wt. 1 lb.  
K10538—  
EACH ..... **\$1.03**



**FADA Tuning Bracket**  
For all of the older models of Fada Receivers. Part number stamped on casting. Shpg. wt. 1 lb.  
K10535—Part No. 858MP  
K10536—Part No. 872MP  
YOUR PRICE, EACH ..... **88¢**

### FADA Friction Drive Shaft

For use with drum dial number 871MP illustrated above. Supplied complete with all washers, spring, etc. Assembled ready for use. Shpg. wt. 1 lb.  
K10539—2 1/4" long. Part No. 1724X  
K10540—2 1/2" long. Part No. 1724R  
K10541—2 3/4" long. Part No. 1724B  
YOUR PRICE, EACH ..... **59¢**

### FADA Dial Scale and Drum

Same as original Fada Part number 871MP. For all early models. Scale riveted to drum. Shpg. wt. 2 lbs.  
K10537—Part No. 871MP  
YOUR PRICE ..... **\$1.26**



## Aerovox Exact Duplicate Replacement Condensers

Model Receiver	Part Number	Cap. Mfd.	D.C. Work. Voltage	Stock Num.	Your Price	Model Receiver	Part Number	Cap. Mfd.	D.C. Work. Voltage	Stock Num.	Your Price	
<b>ATWATER KENT</b> 155 (1 & 2) 275, 825	24602	8-8-8	150	A7650	50.97	<b>MOTOROLA-34.</b> (Galvin) 100 75 (Later) 57 (Early)	34	3-6x10	200x25	A7749	50.82	
	26158	8-14-8	150	A7652	1.15		1388	8-8x25	350x25	A7750	1.18	
								1468	6-4x6	200x12	A7752	.82
<b>BELMONT—425</b> (Freshman)—545	A11093-1	5-25-5	200	A7659	1.35	1424	2-4					
	C-525-B	5-25-5	100	A7657	.94	80944E New	4-12-16	150		A7756	1.65	
	103-4	16	500	A8037	.56	80944A Old	4-12-16	150		A7756	1.09	
	103-8	16	500	A8039	.79							
<b>CROSLLEY 124, 125</b> 148, 167	W23801	6-8	450	A7668	.85	G. E. RCA K60, R37, R38, K65, R37P, R38P, K63, 120	6487 }	4-4x10x4	300x150x25	A7760	1.21	
	W27488A	8x6	25x300	A7674	.56		66155 }					
	W29150B	6x7x8	450x400x25	A7679	1.06	C-30	100, 101, 103	6661 }	8-8x5-5	450x50	A7766	1.29
	W29264A	16x16x8	125x100x20	A7680	1.18	K43	T-48, T-49	66185-2 }				
169	W30962	8-8x8	450x250	A7685	1.29	K66	222	6691 }	8-4x4-4	350x150x25	A7767	1.21
166, 172	W30124	16x16-8	100x125	A7686	1.27	K52	R28, R28P,	66189-2 }				
175	W30964	8-25	150	A7688	.85	K53	RE40, T52,					
182	W32374	8-8x8	450x250	A7685	1.29	K58	110, 111, 115, 117, 118, 119, 128, 128P, 210, 211, 224E, 226, 310					
175	W36057	40	350	A8045	1.18	F63		7589 }	4x4	150x450	A7769	.62
555, 915, 1055, 1155, 6615, 6625						F65		66143 }				
555, 715, 725, 855, 865, 915, 955, 1055, 6625	W36055	30	500	A8041	1.06	F70		K12J6	12-8	450	A7772	.91
<b>DETROLA</b>	1460	4-8-20	150	A7692	1.06	F75		K12J11	12-8-8-10	450-450-350-25	A7773	1.29
	9442	4-10-7-7	150	A7693	1.27	F75						
<b>ERLA—580</b> 31B74, 32B69	2272	8-20	150	A7820	.79	<b>SIMPLEX P. R</b>						
						<b>Model V</b>						
<b>EMERSON 32</b> 19 31B5	GGC-137	8-16x5-5	150x25	A7698	1.21	<b>SPARTON</b>						
	KKC-143	12-8	150	A7700	.79	<b>A-9560</b>						
	UUC-179	12-8x5-5	150x25	A7700	1.15	<b>STEWART WARNER</b>						
106 108, 110	ZCC-192A	4-8-16	150	A7701	1.12	<b>R-115, R-116</b>						
	ZCC-222	12-12	150	A7691	.79	<b>R-112</b>						
<b>GRUNOW</b> 501-550 Chassis 513 070, 871 Chassis 613	2DC-203	8-16	150	A7703	1.03	<b>UNITEDMOTORS</b>						
	27151	4x8-20-4	25x150	A7708	1.29	<b>6508</b>						
	30091-1	8-8x8-12-12	450x475x25	A7709	1.58	<b>6201</b>						
						<b>4443341</b>						
<b>INTERNATIONAL</b> ES19, ES20, ES25, ES30, 60, 65, 80, 85	A-407	4-4	150	A7710	.50	<b>R13183 }</b>						
	A-412	8-30	150	A7712	.91	<b>1210514 }</b>						
	A-427	3.5-3.5x3.5	100x25	A7715	.70	<b>1042</b>						
	A-421	3.5-3.5x3.5	150x25	A7716	.76	<b>81043</b>						
40, 41, 42, 46 6¢, 66X	A-422, A443	8-30	150	A7747	.68	<b>WELLS-GARDNER</b>						
	A468	8-8x8-8	150x250	A7718	1.35	<b>1042</b>						
1019						<b>81043</b>						
						<b>5401, 4P26,</b>						
						<b>22-407B</b>						
						<b>2-4-8</b>						
						<b>450</b>						
						<b>A7803</b>						
						<b>1.15</b>						

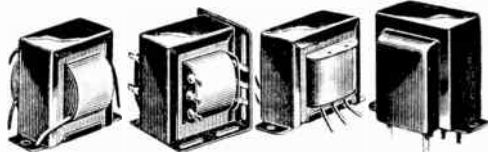

FIG. A FIG. B FIG. C FIG. D

**Class A Audio Transformers**

\* Peaked for coupling detector tube to first audio.

Thor Type	Stock Num.	Your Price	Application	Turns Ratio	Pri. M.A.	Fig.	Size W x D x H
T-13A34	R6600	\$0.79	Single Plate to	1:3	8	C	2 1/4 x 1 1/2 x 1 1/2
T-29A99	R6616	1.03	Single Grid. Plate	1:3.26	8	A	2 1/2 x 2 x 1 1/2
T-47A25	R6615	1.03	Imp. 10,000 Ohms	1:3.20	8	B	2 1/2 x 1 1/2 x 2 1/2
T-57A36	R6617	1.18	Couples all tubes	1:3	8	D	2 1/2 x 2 1/2 x 3
T-57A38	R6620	1.62		1:3	8	D	2 1/2 x 2 1/2 x 3
T-17A02	C6642	1.32	Universal Sgle or P.P.	1:3	10	D	2 1/2 x 2 1/2 x 3
T-13A35	R6601	.88	Single Plate to	1:3	8	C	1 1/2 x 2 x 1 1/2
T-14A22	R6623	1.32	P.P. Grid. Plate	1:3.26	8	B	2 1/2 x 1 1/2 x 2 1/2
T-33A91	R6621	1.18	Impedance 10,000	1:3.20	8	A	2 1/2 x 2 x 2 1/2
T-57A40	R6624	1.62	Ohms. Couples all radio receiving tubes	1:3	8	A	2 1/2 x 2 x 3
T-57A41	R6626	1.76	Operated in Class A	1:3	8	D	2 1/2 x 2 1/2 x 3
T-57A42	C6644	1.91	Audio.	1:3	8	A	2 1/2 x 2 x 3
T-74A31	R6609	1.91		1:1	8	D	2 1/2 x 2 1/2 x 3
T-86A03	R6622	1.18		1:3.26	8	C	2 1/2 x 2 x 2 1/2
T-14A92	C6643	.73		1:3	8	C	2 1/2 x 1 1/2 x 1 1/2
T-13A36	R6602	1.18	P.P. Plate to P.P.	1:1	8	D	2 1/2 x 2 1/2 x 3
T-58A70	R6610	1.91	Grid. Pri. Imp.	1:1.5	10	C	2 1/2 x 2 1/2 x 3

**Class AB Driver Transformers**

\*Ratio of 1/2 primary to secondary.

Thor Type	Stock Num.	Your Price	Application	Turns Ratio*	Pri. M.A.	Fig.	Size W x D x H
T-171001	C6649	\$1.18	1-61F6, 42, 2A5 to	1:7.1	31	C	2 1/2 x 2 x 2
T-181042	C6604	1.91	1-2-61F6, 42, 2A5, 61A6	1:5.1	31	D	2 1/2 x 2 1/2 x 3
T-74D32	C6611	1.91	2-6C5, 76 to 2-61F6, 42 or to 4-2A3, 61A6	3:1	10	D	2 1/2 x 2 1/2 x 3
T-84D59	C6675	1.91	2-6C5, 76 to 2-61F6, 6V6 (Split Sec.)	5:1	10	D	2 1/2 x 2 1/2 x 3

**Class B Driver Transformers**

Thor Type	Stock Num.	Your Price	Application	Turns Ratio*	Pri. M.A.	Fig.	Size W x D x H
T-67D47	C6631	1.47	1-6N7, 6A6 to 1-6N7 6A6, 53	5.3:1	10	D	2 1/2 x 2 1/2 x 3
T-67D78	C6607	1.75	1-46, 59 to 2-46, 59	2:2.1	32	D	2 1/2 x 2 1/2 x 3
T-78146	C6630	.88	1-30 to 1-19 or 2-30's	2.4:1	7	A	1 1/2 x 1 1/2 x 2
T-84D59	C6675	1.91	2-6A6, 53 to 2-6N7, 6A6, 53 (Split Sec.)	5:1	10	D	2 1/2 x 2 1/2 x 3
T-14D93	C6645	1.03	76 Triode to 1-6A6 or 6N7	4:1	8	C	1 1/2 x 2 x 1 1/2

**Output Transformers**

For use in Class A, B, or AB audio amplification

Thor Type	Stock Num.	Your Price	Application	Turns Ratio*	Pri. M.A.	Fig.	Size W x D x H
T-13837	C6646	\$0.73	7,000 Ohms	36	C	1 1/2 x 1 1/2 x 1 1/2	
T-13839	C6776	.73	4,000 Ohms	36	C	1 1/2 x 1 1/2 x 1 1/2	
T-13840	C6647	.88	14,000 Ohms	40	C	2 1/2 x 1 1/2 x 1 1/2	
T-13843	C6777	.73	16,000 Ohms	10	C	1 1/2 x 1 1/2 x 1 1/2	
T-14881	C6647	.73	7,000 Ohms	40	C	1 1/2 x 1 1/2 x 1 1/2	
T-14882	C6648	.73	1,500 Ohms	55	C	1 1/2 x 1 1/2 x 1 1/2	
T-58S72	C6608	2.20	3,000 Ohms	60	D	2 1/2 x 3 x 3 1/2	
T-65894	C6613	2.35	8,000 Ohms	55	D	2 1/2 x 3 x 3 1/2	
T-67848	C6637	2.06	8,000 Ohms	36	D	2 1/2 x 2 1/2 x 3	
T-67852	C6641	2.35	5,000 Ohms	60	D	2 1/2 x 3 x 3 1/2	
T-67854	C6640	2.35	5,000 Ohms	0	D	2 1/2 x 3 x 3 1/2	
T-67892	C6687	2.35	1,500 Ohms	80	D	2 1/2 x 3 x 3 1/2	
T-75875	C6688	2.35	10,000 Ohms	45	D	2 1/2 x 3 x 3 1/2	
T-89874	C6612	2.20	4,000 Ohms	70	D	2 1/2 x 2 1/2 x 3	
T-89875	C6613	2.35	6,600 Ohms	80	D	2 1/2 x 3 x 3 1/2	
T-81801	C6658	.88	10,000 Ohms to 2-4-8 V. C.	15	A	1 1/2 x 1 1/2 x 2	
T-89868	C6614	3.82	3,300 Ohms to 50-125-200-250-333-500 Ohm Line	150	F	3 1/2 x 3 1/2 x 4 1/2	

**Universal Output Transformer**

For any Single or Push Pull Tube to any Voice Coil .1 to 29 Ohms

\*Combination lug and lead terminals. Primaries are center tapped.

Thor Type	Stock Num.	Your Price	Pri. Imp.	Sec. Imp.	Fig.	Size W x D x H	
T-13841	C6779	\$1.62	3,000	10,000 P.P.	60	A	2 1/2 x 2 x 3
T-13842	C6780	.88	1,500	7,000 Single	55	C	2 1/2 x 1 1/2 x 1 1/2
T-13838	C6689	.88	4,000	7,000	36	C	2 1/2 x 1 1/2 x 1 1/2
T-17857	C6635	1.32	8,000/10,000/14,000	CT.	36	B	2 1/2 x 1 1/2 x 2 1/2
T-57801	C6634	1.18			36	A	2 1/2 x 2 x 2 1/2

**Audio Reactors—Impedance Chokes**

\*For use as output plate impedance choke.

Thor Type	Stock Num.	Your Price	D.C. Ohms	Max. M.A.	Inductance Henries at M.A.	Fig.	Size W x D x H	
T-18C92	C6650	\$0.88	405	35*	22	35	C	2 1/2 x 1 1/2 x 2 1/2
T-29C27	C6655	.88	6150	8	700	5	A	2 1/2 x 1 1/2 x 2 1/2
T-68C08	C6690	1.03	405	35*	22	35	D	2 1/2 x 1 1/2 x 2 1/2
T-74C30	C6691	.88	2100	15	42	15	A	2 1/2 x 1 1/2 x 2 1/2

**Thorardson Transformer Headquarters**

If the transformer you require is not listed send us your order and we will make quick shipment at Regular Dealer Price.

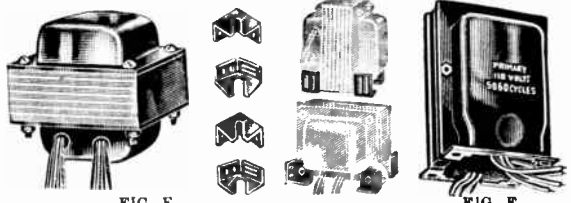

FIG. E FIG. F

**Power Transformers—Fig. E**

All Primaries for 105-120 Volts, 50-60 Cycles A. C.

\*All voltage windings are center tapped except rectifier filament. †Has tap at 2.5 Volts for using either 2.5V. or 6.3V. tubes.

Thor Type	Stock Num.	Your Price	Rect. Fil. V.	A.	Rect. A.C. V.*	M.A.	Filament V.*	A.	Size W x D x H
T-13R00	R6693	\$2.50	5	3	550	70	5.0	0.5	2 1/2 x 2 1/2 x 3 1/2
T-13R01	R6694	1.62	5	3	650	40	2.5	10.5	2 1/2 x 2 1/2 x 3 1/2
T-13R02	R6695	2.06	5	3	700	50	2.5	7.3	2 1/2 x 2 1/2 x 3 1/2
T-13R03	R6696	2.20	5	3	700	70	2.5	9.0	2 1/2 x 2 1/2 x 3 1/2
T-13R04	R6697	2.50	5	3	700	100	2.5	12.5	3 1/2 x 3 1/2 x 3 1/2
T-13R05	R6698	2.35	5	3	700	70	2.5	9.0	3 1/2 x 3 1/2 x 3 1/2
T-13R06	R6699	3.09	5	3	700	120	2.5	12.5	3 1/2 x 3 1/2 x 4 1/2
T-13R07	R6740	3.23	5	3	800	110	2.5	15.0	3 1/2 x 3 1/2 x 4 1/2
T-13R08	R6741	2.65	5	3	700	90	6.3	3.3	3 1/2 x 3 1/2 x 3 1/2
T-13R09	R6742	3.67	5	3	750	180	6.3	6.0	3 1/2 x 3 1/2 x 4 1/2
T-13R11	R6743	1.62	5	3	580	50	6.3	2.0	2 1/2 x 2 1/2 x 3
T-13R12	R6744	2.06	5	3	700	70	6.3	2.5	2 1/2 x 3 1/2 x 3
T-13R13	R6745	2.35	5	3	700	90	6.3	3.5	3 1/2 x 3 1/2 x 3 1/2
T-13R14	R6746	2.50	5	4	700	120	6.3	4.7	3 1/2 x 3 1/2 x 3 1/2
T-13R15	R6747	3.38	5	4	750	150	6.3	5.0	3 1/2 x 3 1/2 x 4 1/2
T-13R16	R6748	3.67	5	4	800	200	6.3	5.1	3 1/2 x 3 1/2 x 4 1/2
T-13R17	R6749	2.35	5	3	600	60	6.3	2.5	2 1/2 x 3 1/2 x 3 1/2
T-13R18	R6720	2.65	5	3	700	90	6.3	3.5	2 1/2 x 3 1/2 x 3 1/2
T-13R19	C6782	1.47	5	2	480	40	6.3	2.0	3 1/2 x 3 1/2 x 4 1/2

**Upright Mtg. Power Transformers—Fig. F**

C6721—T-56R03—Secondaries: 5V @ 2A., 650 V CT @ 70Ma., 2.5V CT @ 3A., 5V CT @ 1.5A., 1.5V @ 1A., 1.5V @ 1A. Size, 3 1/2" W, 3 1/2" D, 1 1/2" H. YOUR PRICE..... \$3.23

C6722—T-56R03—Secondaries: 5V @ 3A., 700V CT @ 10Ma., 2.5V CT @ 3A., 2.5V CT @ 1.7A., 1.5V @ 5A., 1.5V @ 1A. Size, 3 1/2" W, 3 1/2" D, 1 1/2" H. YOUR PRICE..... \$3.53

C6723—T-56R05—Secondaries: 5V @ 3A., 700V CT @ 110Ma., 2.5V CT @ 9A., 2.5V CT @ 3A., 2.5V CT @ 3A. Size 3 1/2" W, 3 1/2" D, 4 1/2" H. YOUR PRICE..... \$3.53

**Filter Chokes**

1600 Volt Insulation. T-74C29 has 2000 V. Insulation

Thor Type	Stock Num.	Your Price	D.C. Ohms	Max. M.A.	Inductance Henries at M.A.	Fig.	Size W x D x H	
T-13C26	C6760	\$0.53	530	40	8	40	C	1 1/2 x 1 1/2 x 1 1/2
T-13C27	C6761	.65	475	40	10	40	C	2 x 1 1/2 x 1 1/2
T-13C28	C6762	.71	460	65	10	65	C	2 1/2 x 1 1/2 x 2
T-13C29	C6763	.94	250	85	9	85	C	2 1/2 x 2 x 2
T-13C30	C6764	1.18	200	150	8	150	A	2 1/2 x 2 x 2 1/2
T-14C61	C6783	.88	200	55	8	55	C	2 1/2 x 1 1/2 x 1 1/2
T-14C62	C6784	.59	250	55	8	55	C	2 1/2 x 1 1/2 x 1 1/2
T-14C63	C6785	.59	300	55	8	55	C	2 1/2 x 1 1/2 x 1 1/2
T-14C64	C6786	.59	350	55	10	55	C	2 1/2 x 1 1/2 x 1 1/2
T-17C00B	C6854	1.62	231	150	12	150	D	2 1/2 x 3 x 3 1/2
T-18C02	C6850	.88	405	35	22	35	C	2 1/2 x 1 1/2 x 1 1/2
T-43C92	C6765	.97	260	75	10	75	B	1 1/2 x 2 x 2 1/2
T-44C02	C6766	.88	405	80	12	80	C	1 1/2 x 2 x 2 1/2
T-47C07	C6651	.97	410	75	12	75	C	2 1/2 x 2 x 2 1/2
T-53C19	C6767	.88	290	120	8	120	A	2 1/2 x 2 x 2 1/2
T-57C51	C6769	.88	138	80	6	80	A	2 1/2 x 2 x 2 1/2
T-57C52	C6770	1.03	138	80	5	80	D	2 1/2 x 2 x 2 1/2
T-57C53	C6653	1.18	200	110	10	110	A	2 1/2 x 2 1/2 x 3
T-57C54	C6771	1.32	200	110	10	110	D	2 1/2 x 2 1/2 x 3
T-67C49	C6772	1.62	80	200	5	200	D	3 1/2 x 3 1/2 x 3 1/2
T-88C07	C6652	1.18	375	85	15	85	A	2 1/2 x 2 1/2 x 3
T-74C29	C6776	2.20	200	150	15	150	F	3 1/2 x 3 1/2 x 4 1/2
T-75C49	C6774	.88	290	120	8	120	C	2 1/2 x 2 x 2 1/2
T-75C51	C6775	2.94	121	250	13	250	F	3 1/2 x 3 1/2 x 5

**Six Volt Vibrator Transformers**

Thor Type	Stock Num.	Your Price	D.C. Volts To Filter	Sec. M.A.	Mtg. Fig.	Size W
-----------	------------	------------	----------------------	-----------	-----------	--------



# STANCOR

Power Transformers  
Chokes-Audios-Outputs

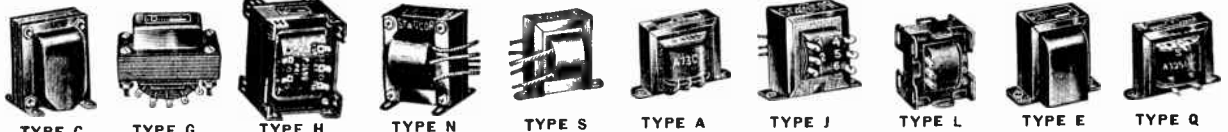

## Power Transformers

For 105-120 Volt, 50-60 Cycle AC Operation  
Fully Shielded Replacements—Type C  
For 6.3 Volt Tubes

Stancor Type	Stock Num.	Your Price	Plate		Rectifier		Fil. #1		Mtg. Area	Mtg. Ctrs.	
			V.*	Ma.	V.	A.	V.*	A.			
P-4076	C6441	\$2.06	650	40	5	2	6	3	2	2 1/2 x 2 1/2	2 1/2 x 1 1/2
P-4077	C6442	2.21	700	50	5	2	6	3	2	3 x 2 1/2	2 1/2 x 1 1/2
P-4078	C6443	2.65	700	70	5	2	6	3	2	3 1/2 x 3	2 1/2 x 1 1/2
P-4079	C6444	2.88	700	90	5	3	6	3	3	3 1/2 x 3 1/2	2 1/2 x 1 1/2
P-4080	C6445	3.38	700	110	5	3	6	3	4	3 1/2 x 3 1/2	2 1/2 x 1 1/2
P-4081	C6446	3.94	800	160	5	3	6	3	4	3 1/2 x 3 1/2	2 1/2 x 1 1/2
P-4004	C6447	5.00	1800	175	5	3	16	3	2	3 1/2 x 3 1/2	3 x 2 1/2

## For 2.5 Volt Tubes—Type C

Stancor Type	Stock No.	Your Price	Plate		Rec.		Fil. #1 #2 #3			Mtg. Area	Mtg. Ctrs.		
			V.*	Ma.	V.*	A.	V.*	A.	V.*			A.	
P-4042	C6478	\$2.65	700	70	5	3	2	5	3	2	5	3 1/2 x 3	2 1/2 x 1 1/2
P-4043	C6479	3.09	700	90	5	3	2	5	3	2	5	3 1/2 x 3	2 1/2 x 1 1/2
P-1504	C6328	3.23	700	120	5	3	2	5	3	2	5	3 1/2 x 3	2 1/2 x 1 1/2
P-1505	C6329	3.35	700	120	5	3	2	5	3	2	5	3 1/2 x 3	2 1/2 x 1 1/2

\*Has extra 6.3 C. T. 2.5 Amp. Fil. wdg. also 80 volt bias tap and separate 2.5 volt 1.75 Amp. Fil. wdg. for bias rectifier. \*Indicates center tapped.

## Flush Mounting Replacements—Type G For 2.5 Volt Tubes

Stancor Type	Stock Num.	Your Price	Plate		Fil. #1		Fil. #2		Fil. #3		Mtg. Area	Mtg. Ctrs.
			V.*	Ma.	V.*	A.	V.*	A.	V.*	A.		
P-2750	C6310	\$1.32	650	40	5	2	2	2	2	2	2 1/2 x 3	2 x 2 1/2
P-2868	C6312	1.68	650	40	5	2	2	2	2	2	2 1/2 x 3	2 x 2 1/2
P-2869	C6313	1.91	700	50	5	2	2	2	2	2	2 1/2 x 3	2 1/2 x 2 1/2
P-2859	C6314	2.21	700	70	5	3	2	2	2	2	3 1/2 x 3 1/2	2 1/2 x 3 1/2
P-2860	C6315	2.35	700	90	5	3	2	2	2	2	3 1/2 x 3 1/2	2 1/2 x 3 1/2
P-050	C6316	3.38	700	110	5	3	2	2	2	2	3 1/2 x 3 1/2	3 x 3 3/4

## For 6.3 Volt Tubes—Type G

Stancor Type	Stock Num.	Your Price	Plate		Fil. #1		Fil. #2		Mtg. Area	Mtg. Ctrs.	
			V.*	Ma.	V.*	A.	V.*	A.			
P-2751	C6317	\$1.41	650	40	5	2	6	3	1.6	2 1/2 x 3	2 x 2 1/2
P-2771	C6318	1.47	650	40	5	2	6	3	2	2 1/2 x 3	2 x 2 1/2
P-047	C6321	1.82	700	50	5	2	6	3	2	2 1/2 x 3 1/2	2 1/2 x 2 1/2
P-948	C6319	2.35	675	70	5	3	6	3	2 1/2	3 1/2 x 3 1/2	2 1/2 x 3 1/2
P-049	C6320	2.75	700	120	5	3	6	3	3	3 1/2 x 3 1/2	2 1/2 x 3 1/2
P-055	C6322	3.83	800	160	5	3	6	3	4	3 1/2 x 3 1/2	3 x 3 3/4
P-0700	C6323	4.41	1950	175	5	4	6	3	4	3 1/2 x 3 1/2	3 x 3 3/4

## Universal Mounting Replacements—Type H

Overall Size: H. 4 1/2" x W. 3 1/2" x D. 4 1/2".  
\*Center Tapped.

Stancor Type	Stock Number	Your Price	Plate		Fil. #1		Fil. #2		Fil. #3		Mtg. Area	Mtg. Ctrs.
			Volts	Ma.	V.	A.	V.*	A.	V.*	A.		
P-841	C6334	\$4.27	1200	150	7 1/2	3 1/2	7 1/2	3 1/2	2 1/2	2	1 1/2	6.3
P-844	C6335	4.27	1200	150	7 1/2	2 1/2	7 1/2	2 1/2	2 1/2	10 1/2		

## Filter Chokes—Type A

Stancor Type	Stock Num.	Your Price	Henry Ind.	D.C. Ohms	M.A. Cap.	Mtg. Ctrs.	Size HxWxD	
							H.	W.
C1723	C6528	\$0.50	4.4	330	50	2"	1 1/2 x 2 1/2	1 1/2 x 1 1/2
C1708	C6529	.53	5	300	50	2"	1 1/2 x 2 1/2	1 1/2 x 1 1/2
C1707	C6530	.53	7	500	50	2"	1 1/2 x 2 1/2	1 1/2 x 1 1/2
C1003	C6535	.73	30	550	50	2 1/2"	1 1/2 x 3	1 1/2 x 1 1/2
C1708	C6531	.70	10	460	65	2 1/2"	1 1/2 x 3	1 1/2 x 1 1/2
C1002	C6536	.91	30	400	75	3 1/4"	2 1/2 x 3 1/2	1 1/2 x 1 1/2
C1709	C6532	.94	9	250	85	2 1/2"	1 1/2 x 3	1 1/2 x 1 1/2
C1001	C6537	1.09	30	200	110	3 1/4"	2 1/2 x 4	2 x 1 1/2
C1710	C6533	1.18	8	200	150	3 1/4"	2 1/2 x 4	2 x 1 1/2

## For AC-DC Receivers—Type A

Stancor Type	Stock Num.	Your Price	Henry Ind.	D.C. Ohms	M.A. Cap.	Mtg. Ctrs.	Size HxWxD	
							H.	W.
C1080	C6358	53¢	15	200	50	2 3/4"	1 1/2 x 2 1/2	1 1/2 x 1 1/2
C1277	C6360		15	300	50	2 3/4"	1 1/2 x 2 1/2	1 1/2 x 1 1/2
C1227	C6361		15	350	50	2 3/4"	1 1/2 x 2 1/2	1 1/2 x 1 1/2
C1279	C6362	Each	15	400	50	2 3/4"	1 1/2 x 2 1/2	1 1/2 x 1 1/2
C1215	C6364		15	500	50	2 3/4"	1 1/2 x 2 1/2	1 1/2 x 1 1/2

## Output Choke—Type A

\*Center tapped—can be used for P.P. tubes.

Stancor Type	Stock Num.	Your Price	Henry Ind.	D.C. Ohms	M.A. Cap.	Mtg. Ctrs.	Size HxWxD
C1003	D6355	\$0.73	30	550	50	2 1/2"	1 1/2 x 3
C1034	D6354	.73	30	1150*	30	2 1/2"	1 1/2 x 2 1/2

## Universal Output Transformers

Adjustable for Any Single or Push Pull Tube to Any Speaker  
Voice Coil Impedance from 1 to 30 Ohms

Primaries are center tapped. \*Combination lug and lead terminals.

Stan. Type	Stock Num.	Your Price	Primary Impedance C.T.	Sec. Impedance	Pri. M.A.	Type	Size HxWxD
A3856	C6564	\$0.76	4000, 7000, 8000, 10000, 14000	15	35	Q	1 1/2 x 2 1/2
A3849	C6565	.88	1500, 2000, 4000, 5000, 7000	15	35	Q	1 1/2 x 2 1/2
A3823	C6520	.88	4000, 7000, 8000, 10000, 14000	40	40	Q	1 1/2 x 2 1/2
A3850	C6566	.89	4000, 7000, 8000, 10000, 14000	40	40	J	2 1/2 x 2 1/2
A3852	C6567	1.12	4000, 7000, 8000, 10000, 14000	40	40	J	2 1/2 x 2 1/2
A2855	C6342	1.03	4000, 7000, 8000, 10000, 14000	50	50	I	2 1/2 x 2 1/2
A3890	C6569	1.62	4000, 7000, 8000, 10000, 14000	50	50	E	2 1/2 x 2 1/2
A3830	C6521	1.62	3000, 5000, 6600, 7000, 8000, 10M	60	60	J	2 1/2 x 3 1/2

## Output Transformers

For Use in Class A, B, or AB Audio Amplification

\*10% Inverse feedback winding used. †Windings marked "CT" are center-tapped for either single or Push-Pull tubes.

Stancor Type	Stock Num.	Your Price	Impedance		Pri. M.A.	Type	Size HxWxD
			Pri.	Sec.			
A3822	D6514	\$0.67	7M/10M	7.1, 1.4, 2.2, 8.4	45	Q	1 1/2 x 2 1/2
A3825	D6515	.94	2500	1.2, 4	75	Q	1 1/2 x 2 1/2
A3824	D6519	1.12	8000(CT)	1.2, 4	75	Q	1 1/2 x 2 1/2
A3848	D6571	.73	16000	1.2, 4	10	Q	1 1/2 x 2 1/2
A3856	D6572	.73	1500	2, 1.6	55	A	1 1/2 x 2 1/2
A3400	D6573	.78	14000(CT)	3, 5	45	A	1 1/2 x 2 1/2
A3876	D6544	.53	2000		60	A	1 1/2 x 2 1/2
A3877	D6545	.53	5000		40	A	1 1/2 x 2 1/2
A3878	D6546	.53	7000		30	A	1 1/2 x 2 1/2
A3879	D6547	.53	10000		40	A	1 1/2 x 2 1/2
A3881	D6548	.53	15000		10	A	1 1/2 x 2 1/2
A3857	D6574	.76	25000(CT)		10	A	1 1/2 x 2 1/2
A2203	D6344	.71	4000		40	A	1 1/2 x 2 1/2
A2313	D6347	.82	7000		40	A	1 1/2 x 2 1/2
A2201	D6349	.88	8000(CT)		40	A	1 1/2 x 2 1/2
A2312	D6351	.88	14000(CT)		40	A	1 1/2 x 2 1/2
A3851	D6516	2.55	4400*(CT)	4, 8, 15, 250, 500	70	C	3 1/2 x 2 1/2
A3301	D6576	2.35	3000(CT)	4, 8, 15, 500	55	C	3 1/2 x 2 1/2
A5528	D6577	1.62	4000(CT)	4, 8, 15, 500	65	C	3 1/2 x 2 1/2
A3800	D6578	2.56	5000(CT)	4, 8, 15, 250, 500	80	C	3 1/2 x 2 1/2
A3801	D6579	2.79	6500(CT)	4, 8, 15, 250, 500	150	C	3 1/2 x 2 1/2
A3304	D6580	2.24	7M/10M(CT)	4, 8, 15, 500	60	C	3 1/2 x 2 1/2
A3303	D6581	2.06	14000(CT)	4, 8, 15, 500	55	C	3 1/2 x 2 1/2

## Audio Transformers

Any Single Plate to Any Single Grid

Stancor Type	Stock Num.	Your Price	Turns Ratio	Pri. M.A.	Core Size	Type	Size HxWxD
A53	C6522	\$0.68	3:1	10	1 1/2 x 1 1/2	A	1 1/2 x 2 1/2
A63	C6523	.79	3:1	10	1 1/2 x 1 1/2	A	1 1/2 x 2 1/2
A73	C6373	1.00	3:1	10	1 1/2 x 1 1/2	A	2 x 3 1/2

## Push-Pull Inputs

Any Single Plate to Any P.P. Grids

Stancor Type	Stock Num.	Your Price	Turns Ratio	Pri. M.A.	Core Size	Type	Size HxWxD
A63C	C6524	\$0.73	3:1	10	1 1/2 x 1 1/2	A	1 1/2 x 2 1/2
A63C	C6525	.85	3:1	10	1 1/2 x 1 1/2	A	1 1/2 x 2 1/2
A4740	C6582	.85	3:1	10	1 1/2 x 1 1/2	A	2 x 3 1/2
A73C	C6374	1.06	3:1	10	1 1/2 x 1 1/2	A	2 1/2 x 3 1/2
A4750	C6583	1.06	3:1	10	1 1/2 x 1 1/2	A	2 1/2 x 3 1/2
A4719	C6584	1.65	3:1	10	1 1/2 x 1 1/2	E	2 1/2 x 3 1/2
A2132	D6523	1.91	1:1	10			

# EXACT DUPLICATE

# STANCOR REPLACEMENTS

# POWER TRANSFORMERS

### Exact Fit Guaranteed

THEY FIT! Mounting holes, lugs, voltages and everything exactly like the original. Better insulation and higher safety factor than the original but otherwise the same. We can supply any Transformer you require.

### Complete Stock—Quick Shipments

**Airline 62-060, 62-070, 62-1800, and Apex 26**

Stancor Type No. P-1405.

Weight, 5 lbs.

List Price, \$3.90.

**C6004—**

**YOUR PRICE \$2.29**

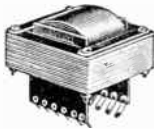

**Atwater-Kent Models 70, 72, 74, 76 Chassis Models L1, L2, H1, H2, P**

List Price, \$6.75.

Stancor Type No. P-1068.



**C6026—**

**YOUR PRICE \$3.97**

RADIO MODEL	Stock No.	Stancor Type	Your Price
<b>ATWATER-KENT</b> 82, 85, 87, 89, 89P, 99(1st & 2nd) 145, 165, 185, 185A, 186, 325, 425, 475, 525, 665, 735, 944	<b>C6028</b> <b>C6030</b>	P-1084 P-1089	<b>\$3.82</b> <b>4.41</b>
310, 510 (Late), 559	<b>C6014</b> <b>C6031</b>	P-6018 P-6017	<b>2.71</b> <b>3.97</b>
<b>BOSCH</b> —575F, 575Q, 575T, 585, 585Y, 585Z	<b>D6046</b>	P-6094	<b>3.38</b>
<b>BRUNSWICK</b> 2KR0, 3KR0, 3KR16, 5KR1, 5KR0, 5KR6 3-NC8, 5-NC8	<b>D6044</b> <b>C6045</b>	P-791 P-715	<b>2.65</b> <b>3.23</b>
<b>CLARION</b> AC-260 AC-300 AC-360 (360) 480	<b>C6051</b> <b>D6059</b> <b>C6056</b> <b>C6058</b>	P-1494 P-1915 P-1861 P-1560	<b>3.70</b> <b>4.06</b> <b>4.41</b> <b>4.00</b>
<b>CROSLLEY</b> 505, 515, 516, 525, 5515, A-126, 6516 517, 547, 567, 5517 534, 635, 655 526, 555, 616, 5526, 5555	<b>C6032</b> <b>D6037</b> <b>C6039</b> <b>C6040</b>	P-5095 P-5093 P-5092 P-5094	<b>1.91</b> <b>2.21</b> <b>2.12</b> <b>2.24</b>
1117 1127 1137	<b>C6235</b> <b>C6236</b> <b>C6237</b>	P-6278 P-6274 P-6280	<b>2.94</b> <b>3.09</b> <b>3.23</b>

We can supply Exact Duplicate transformers for practically any Model Crosley Radio. Even if it is not shown in above listing send us your order giving model number of receiver. We will be able to fill your order 99% of the time.

<b>EDISON</b> —R-6, R-7	<b>D6065</b>	P-5091	<b>4.41</b>
<b>GENERAL ELECTRIC</b> A-52, A-55 A-82, A-86, A-87 A-83, A-85 A-125 E-61, E-62, E-68 E-71, E-72, E-76, E-79 E-81, E-86 E-91, E-95, E-101, E-105, E-106	<b>C6090</b> <b>C6239</b> <b>C6123</b> <b>C6124</b> <b>C6125</b> <b>C6126</b> <b>C6151</b> <b>C6152</b>	P-6031 P-6284 P-6032 P-6035 P-6097 P-6033 P-6098 P-6034	<b>3.23</b> <b>3.53</b> <b>3.97</b> <b>4.12</b> <b>2.50</b> <b>2.50</b> <b>3.00</b> <b>3.38</b>
H-31, H-51, H-51-R, H-71, H-91, H-91R H-32, H-72 H-70, J-75 J-80, J-82, J-85, J-86, J-8-132, J-835 J-100, J-105, J-107, J-109 K-50, K-50P, K-51, K-51P K-52, K-53, K-53M, K-54, K-54P, K-55, K-58 K-62, K-62P	<b>C6076</b> <b>C6154</b> <b>C6077</b> <b>C6078</b> <b>C6163</b> <b>C6164</b> <b>C6079</b>	P-713 P-6073 P-1487 P-1483 P-6048 P-6055 P-1474	<b>4.12</b> <b>3.97</b> <b>2.71</b> <b>3.35</b> <b>4.26</b> <b>2.35</b> <b>3.63</b>
M-51, M-51A, M-56, M-61, M-66, M-62, M-67, M-69, M-655, S-22, S-22A, S-22X M-81, M-85, M-86, M-89, M-106, M-107, M-125, M-129, M-130 S-42, S-42P T-12, T-12E T-41	<b>C6189</b> <b>C6188</b> <b>C6080</b> <b>C6082</b> <b>C6083</b>	P-6047 P-6061 P-1481 P-1493 P-927	<b>2.53</b> <b>3.65</b> <b>2.79</b> <b>2.79</b> <b>3.53</b>

We can supply Exact Duplicate transformers for practically any Model General Electric Radio Set. Even if it is not shown in above listing send us your order giving model number of receiver. We will be able to fill your order 99% of the time.

### Additional Models

We are constantly adding to our stock additional Models of Replacement Power Transformers. If the transformer you require is not quoted here, write us for price, stating make and model of the receiver and the number and type of tubes used. We will promptly send you a low quotation on the job and guarantee an exact replacement.

RADIO MODEL	Stock No.	Stancor Type	Your Price
<b>GRAYBAR</b> —GB-310, GB-311, GB-320, GB-321 GB-330, GB-340 GB-500, GB-550 GB-600 GB-4 GB-8 GB-8-A GB-9 GB-678 GB-700, GB-770, GB-900 GB-989, GC-14, GT-8 GC-13, GT-7	<b>C6044</b> <b>C6045</b> <b>C6091</b> <b>C6092</b> <b>C6082</b> <b>C6080</b> <b>C6081</b> <b>C6079</b> <b>C6083</b> <b>C6076</b> <b>C6078</b> <b>C6077</b>	P-791 P-715 P-714 P-883 P-1493 P-1481 P-1482 P-1474 P-927 P-713 P-1483 P-1487	<b>\$2.65</b> <b>3.23</b> <b>3.29</b> <b>4.27</b> <b>2.79</b> <b>2.79</b> <b>2.79</b> <b>3.65</b> <b>3.53</b> <b>4.12</b> <b>3.35</b> <b>2.71</b>
<b>GRUNOV</b> 460, 460X, 461, 461X 580, 581, 640, 641 660, 661, 662, 670, 671, 690, 691 1151, 1152, 1161, 1162	<b>C6190</b> <b>C6194</b> <b>C6033</b> <b>C6034</b>	P-6080 P-6090 P-6081 P-6088	<b>2.53</b> <b>3.94</b> <b>3.76</b> <b>5.00</b>

### Majestic Models, 91, 92 (90 Chassis), 101 (100 Chassis)

**Power Transformer**  
Stancor Type No. P-757.  
List Price, \$6.80.  
**C6112—**

MAJESTIC	Stock No.	Stancor Type	Your Price
21, 22, 23 (Unmounted 20 chassis) 71, 72 (Plate, 70 chassis) 90, 91, 93 (90 chassis) 102, 103 (100-B chassis) 151, 153 (Unmounted 15 chassis), 154 (Unmounted 15-B chassis), 155 (Unmounted 150 chassis), 156 (Unmounted 15 chassis), 181 (Plate, 180 chassis)	<b>C6106</b> <b>C6108</b> <b>C6111</b> <b>C6114</b> <b>C6115</b>	P-954 P-790 P-939 P-906 P-789	<b>\$3.76</b> <b>2.65</b> <b>3.76</b> <b>2.35</b> <b>5.29</b>

**PHILCO**  
We can supply Exact Duplicate transformers for practically any Model of Philco Radio Set. Even if it is not shown in listing below send us your order giving model number of receiver. We will be able to fill your order 99% of the time.

<b>PHILCO</b> 14 (Late), 18, 118 (Code 124) 19, 44, 60, 66, 80, 264, 265, 20, 220 (Chassis 20) 57, 58, 59 65 (Chassis 65) 70, 70A, 270, 370, 470, 470A, 570 80, 81 86 (Chassis 86) 87 (Chassis 87) 90, 90A, 490 (Chassis 90, 1-47) 95, 96, 296 111, 111A, 211 (Chassis 111), 112, 112A, 212 (2-450) 112, 212 (2-475) 37-9, 37-10, 37-650, 37-665, 37-2650, 38-3 (121), 38- 665, 38-2650 (321) 37-69, 37-61, 37-89, 37-610 (121), 37-620, 37-630 (121), 37-2620, 38-60 (125), 38-89 (125), 38- 610 (121), 38-620, (121), 38-630 (121), 38-2620, 38-2630 21 38-640 (121-125) 39-55 Power Trans. Fil. Trans. 39-116 Power Trans. Fil. Trans.	<b>C6132</b> <b>C6207</b> <b>C6133</b> <b>C6128</b> <b>C6136</b> <b>C6137</b> <b>C6209</b> <b>C6140</b> <b>C6141</b> <b>C6142</b> <b>C6146</b> <b>C6147</b> <b>C6148</b> <b>C6214</b> <b>C6215</b> <b>C6250</b> <b>C6251</b> <b>C6252</b> <b>D6256</b> <b>C6253</b> <b>D6256</b>	P-1568 P-5021 P-762 P-760 P-711 P-1119 P-5018 P-786 P-763 P-1468 P-787 P-788 P-882 P-5040 P-5038 P-6257 P-5039 P-6259 P-6260 P-6256 P-6260	<b>\$3.53</b> <b>2.06</b> <b>3.71</b> <b>1.91</b> <b>3.68</b> <b>3.68</b> <b>1.91</b> <b>3.53</b> <b>3.53</b> <b>3.53</b> <b>3.53</b> <b>3.97</b> <b>3.88</b> <b>3.68</b> <b>2.65</b> <b>4.12</b> <b>3.09</b> <b>3.82</b> <b>1.03</b> <b>4.12</b> <b>1.03</b>
<b>RCA—RADIOLA—</b> <b>VICTOR</b> R-64, R-67 R-32, R-52, RE-45, RE-75 R-4, R-6 5T, 5T4, 5T5, 5U, 6K1, 6T5 C6-12, C6-11, 6K, 6T, 7K, 7T, 8K, 8K1, 8T	<b>C6159</b> <b>C6160</b> <b>C6077</b> <b>C6216</b> <b>C6228</b>	P-827 P-717 P-1487 P-6067 P-6074	<b>9.41</b> <b>4.70</b> <b>2.70</b> <b>2.24</b> <b>2.06</b>

### Diagram of Connections

Each unit is packed in an individual carton containing a planograph which plainly designates the connecting leads, the voltages, and gives the circuit. When ordering, state name, model number of the set for which transformer is required to gether with the stock number and you will be assured of prompt shipment.

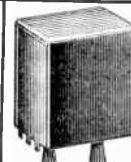

### RCA Victor Radiola Models R 80, R 82, R 86

**Graybar GB 700, GB 770, GB 900**

**Westinghouse WR5, WR6, WR6R, WR7**

Stancor Type No. P-713.  
List Price, \$7.00.  
**C6076—YOUR PRICE \$4.12**

**RCA Victor R 44, R 46AC, R 47 Graybar 500, 550**

Stancor Type No. P-714.  
List Price, \$5.60.  
**C6091—YOUR PRICE \$3.29**

RADIO MODEL	Stock No.	Stancor Type	Your Price
<b>RCA</b> —Continued R-7, R-7LW, R-9, RE-16 R-7A, RE-16A R-8, R-10, R-12, RE-19, R-23, R-71, R-72 9K2, 9T, 9U, 9U2, 10K, 10L 9K3, T10-3, D11-2, T11-8 10K1, T10-1, C11-1, HF-1 U-105, U-107 R-42, R-48 13K, 15K R-60, R-62 R-66 85T5, 85T, 85T1, 86T4, 86T44, U101, U103	<b>D6080</b> <b>D6080</b> <b>C6078</b> <b>C6229</b> <b>C6230</b> <b>C6231</b> <b>C6083</b> <b>C6232</b> <b>C6045</b> <b>C6092</b> <b>C6216</b> <b>C6164</b> <b>C6189</b> <b>C6220</b> <b>C6175</b> <b>C6176</b> <b>C6177</b> <b>C6178</b> <b>C6180</b> <b>C6101</b>	P-1481 P-1481 P-1483 P-6043 P-6063 P-6062 P-927 P-6042 P-715 P-883 P-6067 P-6055 P-6047 P-6045 P-6191 P-6250 P-6190 P-6192 P-6197 P-6195	<b>\$2.79</b> <b>2.79</b> <b>3.35</b> <b>2.94</b> <b>3.97</b> <b>2.65</b> <b>3.53</b> <b>4.29</b> <b>3.23</b> <b>4.27</b> <b>2.24</b> <b>2.35</b> <b>2.53</b> <b>2.59</b> <b>3.38</b> <b>3.23</b> <b>3.82</b> <b>4.59</b> <b>6.47</b> <b>2.65</b>

We can supply Exact Duplicate transformers for practically any RCA Radio Set. Even if it is not shown in above listing send us your order giving model number of receiver. We will be able to fill your order 99% of the time.

### Sparton Models 235, 589, 591, 593, 931 Power Transformer

Stancor Type No. P-5097.  
List Price, \$6.25.  
**C6186—**

<b>SPARTON</b> 67, 68, 68A, 68S, 85XS, 86X 103, 301, 564, 570, 578, 740, 750 616, 616M, 616MX, 616X, 666, 666M, 666MX, 666X, 685, 686, 691, 716, 766, 766X, 766XP, 766XS 104, 105X, 105XS, 135, 930, 966, 966X	<b>C6221</b> <b>C6184</b> <b>C6221</b> <b>C6222</b> <b>D6223</b> <b>C6233</b> <b>D6234</b> <b>C6004</b> <b>C6003</b> <b>C6083</b> <b>C6076</b> <b>C6076</b> <b>C6080</b> <b>C6081</b>	P-6116 P-1372 P-6116 P-6118 P-834 P-6085 P-834 P-1405 P-1358 P-927 P-713 P-713 P-1481 P-1482	<b>\$3.23</b> <b>5.29</b> <b>3.23</b> <b>2.94</b> <b>3.35</b> <b>3.23</b> <b>3.76</b> <b>2.29</b> <b>2.65</b> <b>3.53</b> <b>4.12</b> <b>4.12</b> <b>2.79</b> <b>2.79</b>
<b>STEWART WARNER</b> R-102A, B & E, R-104	<b>C6233</b>	P-6085	<b>3.23</b>
<b>STROMBERG-CARLSON</b> 641, 642, 652, 654	<b>D6234</b>	P-834	<b>3.76</b>
<b>U. S. RADIO &amp; TELEVISION CORP.</b> 26 (Cloritone-26 Chassis) 26-P (Cloritone-26-P Chas.)	<b>C6004</b> <b>C6003</b>	P-1405 P-1358	<b>2.29</b> <b>2.65</b>
<b>WESTINGHOUSE</b> WR-4 WR-5, WR-6, WR-6R, WR-7 WR-7-R, WR-8, WR-8-R WR-10, WR-12, WR-13, WR-13A WR-10A	<b>C6083</b> <b>C6076</b> <b>C6076</b> <b>C6080</b> <b>C6081</b>	P-927 P-713 P-713 P-1481 P-1482	<b>3.53</b> <b>4.12</b> <b>4.12</b> <b>2.79</b> <b>2.79</b>



**EXACT  
DUPLICATE**

# STANCOR

**POWER  
TRANSFORMERS**

**REPLACEMENTS**

## ZENITH

We can supply Exact Duplicate transformers for practically any Zenith Radio. Even if it is not shown in this listing send us your order giving model number of receiver. We will be able to fill your order 99% of the time.



RADIO MODEL	Stock No.	Stancor Type	Your Price
50, 52, 53, 54, 55, 60, 61, 62, 64, 67, 70, 71, 72, 73, 77	C6206	P-712	\$4.70
4P26, 4T26, 4P51, 4T51, 5R123, 5R135, 5R165, 5S119, 5S126, 5S127, 5S151, 5S161			
513312, 5R316, 5R317, 5R337, 5R303, Ch. 5529, 5S319, 5S330, 5S327, 5S338, 5S339, Ch. 5529	D6210	P-5087	1.47
6-S-27, 6-S-52, 6-S-128, 6-S-137, 6-S-147, 6-S-152, 6-S-157, 6-S-28, 7-S-53, 8-S-129, 8-S-154	C6298	P-5083	2.21
6S301-6S306 incl., 6S322, 6S340, Ch. 5651, 6S321, 7S323, 7S342, 7S343, 7S-386, 7S364, Ch. 5714, 6S330, 6S361, Ch. 5648, 6S254AT, 6S256AT, Ch. 5644AT	C6299 C6287 C6258	P-6179 P-6181 P-6271	1.76 2.21 4.41



## Exact Duplicate AUDIOS

Replacements for All Popular Sets

Made exactly like the original transformers. Mounting holes, dimensions, lugs, voltages and color of leads exactly duplicate the originals. In many instances the insulation and the safety factor have been increased wherever the originals were not entirely satisfactory. Many additional replacements have been added to our listing.

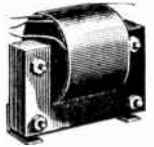

RADIO MODEL	Stock No.	Part	Your Price
CLARIDN-AC-60 AC-61	C6526 C6264	P. P. Inp. P. P. Inp.	\$1.91 1.76
GENERAL ELECTRIC II-31, H-51, H-51R, II-71	C6272	Inp.-Out. Assembly	2.06
GRAYBAR GB-700, GB-770, GH-900	C6272	Inp.-Out. Assembly	2.06
PHILCO-76, 77, 86, 87, 20, 20-A, 21, 20, 20-A, 21, 65, 76, 77, 86, 87, 90, 90-A, (2-245's) 95, 96, 111, 111-A, 112, 112-A, (2-45's)	C6280 C6282	P. P. Inp. P. P. Inp.	1.62 1.18
65, 95, 96, 111, 111-A, 112, 112-A (2-45's)	C6283	P.P. Out.	1.26
37-38, 37-623, 37-624, 37-643, 38-643 (all 121)	C6285 D6284	P.P. Inp. Output	2.12 .94

RADIO MODEL	Stock No.	Part	Your Price
PHILCO-Cont. 37-38, 37-623, 37-624, 37-643, 38-38, 38-59, 38-623, 38-624, 38-643	D6286	Input	\$1.18
RCA-RADIALA-VICTOR R-35, R-39, R1-57, RAE-68, RE-73, R-80, R-82, R82-R, R-86, R-86R, R-32, R1-45, R-52, RE-75	C6272 C6259	Inp.-Out. Assembly Inp.-Out. Assembly	2.06 4.94
STROMBERG-CARLSON 10, 11, 25, 26	C6293	P.P. Inp.	4.70
WESTINGHOUSE WR-5-6, -6R, -7, -7R, -21, -23, -24	C6272	Inp.-Out. Assembly	2.06
ZENITH 50, 52, 54, 60, 61, 62, 64, 67, 70, 71, 72, 73, 77	C6296	P.P. Inp.	2.53

# STANCOR Universal Mounting Power Transformer

## For 2.5 Volt Tubes

Stock Number	Stancor Type	Your Price	Number Tubes	Plate Volts	Mids	Rect. Volts	Fil. Amps	Tube Volts	Fil. Amps	Size of Lamination	Thick-ness
C6500	P6001	\$1.47	4 or 5	650CT	40	5CT	2	2.5CT	4	2 1/2 x 3"	2 3/4"
C6501	P6002	1.91	5 or 6	700CT	50	5CT	2	2.5CT	7 25	2 1/2 x 3"	3 1/4"
C6502	P6003	2.06	6 or 7	700CT	70	5CT	3	2.5CT	9	2 1/2 x 3 3/4"	3 1/4"
C6503	P6005	2.35	6 or 7	700CT	70	5CT	3	2.5CT	9	2 1/2 x 3 3/4"	3 1/4"
C6539	P6009	2.35	6 or 7	550CT	70	5CT	3	2.5CT	10 5	2 1/2 x 3 3/4"	3 3/4"
C6504	P6004	2.50	8 or 9	700CT	90	5CT	3	2.5CT	12 5	3 1/2 x 3 3/4"	3 3/4"
C6505	P6007	3.23	10 to 12	800CT	110	5CT	3	2.5CT	15	3 1/2 x 3 3/4"	3 3/4"
C6506	P6006	3.09	11 to 13	700CT	120	5CT	3	2.5CT	12 5	3 1/2 x 3 3/4"	3 3/4"

## For 6.3 Volt Tubes

Stock Number	Stancor Type	Your Price	Number Tubes	Plate Volts	Mids	Rect. Volts	Fil. Amps	Tube Volts	Fil. Amps	Size of Lamination	Thick-ness
C6542	P6297	\$1.39	4 or 5	480CT	40	5CT	2	6.3CT	2	2 1/2 x 3"	2 3/4"
C6507	P6010	1.47	4 or 5	650CT	40	5CT	2	6.3CT	2	2 1/2 x 3"	2 3/4"
D6516	P6289	1.53	5 or 6	420CT	40	5CT	2	6.3CT	2	2 1/2 x 3"	2 1/2"
D6517	P6119	1.64	6 or 7	600CT	55	5CT	2	6.3CT	2 7	2 1/2 x 3"	2 1/2"
C6508	P6011	1.91	6 or 7	700CT	70	5CT	3	6.3CT	2 5	2 1/2 x 3"	3 1/4"
D6518	P6120	2.06	7 or 9	630CT	70	5CT	3	6.3CT	3 5	2 1/2 x 3 3/4"	3 1/4"
C6509	P6012	2.35	8 or 9	700CT	90	5CT	3	6.3CT	3 5	2 1/2 x 3 3/4"	3 3/4"
C6510	P6013	2.50	11 to 13	700CT	120	5CT	3	6.3CT	4 7	3 1/2 x 3 3/4"	3 3/4"
C6511	P6014	3.38	13 to 15	750CT	150	5CT	3	6.3CT	5	3 1/2 x 3 3/4"	3 3/4"
C6540	P6201	3.67	13 to 15	750CT	150	5CT	3	6.3CT	5	3 1/2 x 3 3/4"	3 3/4"
C6541	P6105	3.67	14 to 16	800CT	200	5CT	4	6.3CT	5	3 1/2 x 3 3/4"	3 3/4"
C6512	P6008	3.67	14 to 16	750CT	180	5CT	3	6.3CT*	3 3	3 1/2 x 3 3/4"	3 3/4"
								2.5CT*	6	3 1/2 x 4 1/4"	3 3/4"

## Universal Type-6.3 and 2.5 Volt Combinations

The separate filament windings can all be used at one time at full rating if desired. All secondary windings are center tapped. \*Tapped filament winding.

Stock No.	Stancor Type	Your Price	Number Tubes	Plate Volts	Mids	Rect. Volts	Fil. Amps	Tube Volts	Fil. Amps	Size of Lamination	Thick-ness
D6487	P6293	\$2.35	6 or 7	600	50	5.0	3.0	2.5	7.5	2 1/2 x 3 3/4"	3 1/4"
D6488	P6294	2.79	8 or 9	750	85	5.0	3.0	2.5	9.0	2 1/2 x 3 3/4"	3 1/4"
D6489	P6295	2.79	8 or 9	700	90	5.0	3.0	2.5	9.0	2 1/2 x 3 3/4"	3 1/4"
D6490	P6296	3.53	11 or 13	750	125	5.0	3.0	2.5	12.0	3 1/2 x 3 3/4"	3 1/4"
								2.5	1.75		
								16.3, 3.5, 2.5	4.0	3 1/2 x 3 3/4"	3 1/4"

## Stancor Auto Radio Demonstration Packs

### 110 Volt AC to 6 Volt DC

Reliable well filtered power packs for use as a substitute for 6 volt storage battery in demonstrating and testing battery and auto radios. Also useful for charging storage batteries and to operate other 6 volt DC equipment. Features dry disc rectifiers, fused line, on-off switch, binding post terminals and black wrinkle finished chassis. Operates from 110-120 volt, 50-60 cycle AC.



**Model 132 Super Pack**  
D5996—Delivers 8 to 12 volts in seven steps without load. 3 to 6 volts at 12.5 ampere load continuously and 2 to 5 volts at 16 ampere intermittently. Voltmeter indicates output. Overload relay. Size 1 1/2 x 3 x 6" high. Ship. wt. 26 lbs.  
**YOUR PRICE \$19.55**

### Model 131 Economy Pack

D5995—Low priced compact unit. Delivers 11 volts at no load, 6.5 volts at 7 ampere continuously and 4.5 volts at 12 ampere intermittently. Has pilot light indicator. Size 8 x 6 1/4 x 7 1/4" high. Ship. wt. 16 1/2 lbs.  
**YOUR PRICE \$13.67**



Highly efficient compact transformers designed to fit the majority of present day receivers. Universal mounting brackets present a neat appearance and give flexibility in mounting in any position. Transformers are fully shielded to meet Underwriters' approval. Quality construction. Color coded wire leads. All transformers are for 105-115 volt 50-60 cycle AC operation.



\*Both windings may be used at one time at full rating.

†Has additional Tuning Motor Winding tapped at 18-24-50 volts.

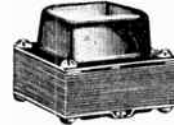

**New Type Shell Allows Two Point Flush Mounting**



**Stancor Catalog**  
C5987—Complete Replacement Transformer Catalog including public address and exact duplicate types. . . . **FREE.**

**Stancor Hamanual**  
C6993—Completely describes seven transmitters giving parts content, transformer listing and working diagrams. . . . **FREE.**

## Stancor Testing Autometer

D5981—Pt. P6299. **\$411**  
**YOUR PRICE . . . . . \$111**  
Applies overload voltages in set for testing, causing hard to find intermittently defective parts to break down and thus indicate their location. Tap switch provides 90 to 150 volts output. 150 Watts capacity. For 115 volt, 50-60 cycle AC operation. Size 3 7/8 x 3 1/4 x 4 3/4".

## Speaker Field Substitute

D5985—Pt. C2302. **\$235**  
**YOUR PRICE . . . . . \$235**  
Takes place of speaker field when checking receiver on test bench without set speaker. 3000 ohms tapped at 2500, 1000 and 750. Provides resistances of 250, 750, 1000, 1750 ohms at 60 Ma. or 75 Ma. intermittently and 500, 1500, 2000, 2250, 2500, 3000 ohms at 40 Ma. or 55 Ma. intermittently. Size 3 x 2 1/4 x 3".



# Big Savings on Transformers!

## KEYSTONE Universal Replacements

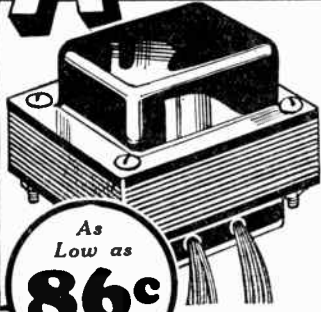

As Low as **86¢**

### POWER TRANSFORMERS

Exceptional Quality at Low Cost

Keystone Power Transformers are the finest quality, best transformer values obtainable at these low prices. Expert engineering and high grade materials are used throughout. The compact sizes and universal mountings are designed to meet the majority of your replacement needs. Conservatively rated to assure ample safety factor. Precision machine wound coils, proper impregnation, and carefully stacked heavy oversize laminations provides highest efficiency, low operating temperature and long life. Shells are black enamel finish. 90-day RMA Guarantee. Diagram furnished. All primaries are for 105-120 volt, 50-60 cycle AC operation.

#### Universal Mounting

Transformers may be mounted in any position. Mounting centers are sufficiently adjustable to allow replacement in most radios without drilling holes. Fully shielded. Coiled leads.

#### Flush Mounting

These Transformers fit the physical and electrical requirements of the majority of receivers. Any combination of tubes may be used providing the current ratings are not exceeded.

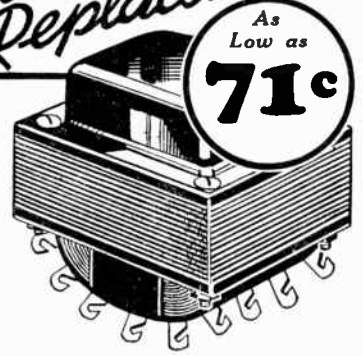

As Low as **71¢**

Tinned soldering lugs firmly attached to coil.

These 4 Universal Mounting Brackets are furnished with Universal Type only.

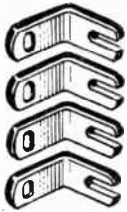

#### Universal Type

#### For 2.5 Volt Tubes

#### Flush Mounting

Stock Number	Your Price	Number Tubes	Plate		Rect. Fil.		Tube Fil.		Size of Lamination	Thick-ness	Trans. Mtg. Ctrs.	Stock Number	Your Price
			Volts	Mills	Volts	Amps.	Volts	Amps.					
B6550	\$0.86	4 or 5	650CT	45	5	2	2 5	3 75	2 1/2"x3"	2 3/4"	2" x2 1/2"	B6417	\$0.71
B6551	1.12	5 or 6	650CT	50	5	2	2 5CT	7 0	2 1/2"x3"	3 1/4"	2" x2 1/2"	B 420	.86
B6552	1.29	6 or 7	700CT	70	5	3	2 5CT	9 0	2 1/2"x3 3/4"	3 1/4"	2 1/4"x2 7/8"	B6422	1.25
B6553	1.49	8 or 9	700CT	90	5	3	2 5	12 5	3 1/2"x3 1/4"	3 1/4"	2 1/2"x3 1/4"	B6423	1.59
B6554	1.85	10 to 13	700CT	110	5	3	2 5CT	14 0	3 1/2"x3 1/4"	3 1/4"	2 1/2"x3 1/4"	B6424	1.85

#### For 6.3 Volt Tubes

B6555	\$0.88	4	650CT	40	5	2	6 3	1 6	2 1/2"x3"	2 3/4"	2" x2 1/2"	B6411	\$0.73
B6556	.97	4 or 5	650CT	40	5	2	6 3CT	2 0	2 1/2"x3"	2 3/4"	2" x2 1/2"	B6413	.86
B6557	1.38	6 or 7	700CT	70	5	3	6 3CT	2 5	2 1/2"x3 1/4"	3 1/4"	2" x2 1/2"	B6415	1.03
B6558	1.75	8 or 9	700CT	90	5	3	6 3CT	3 5	2 1/2"x3 1/4"	3 3/4"	2" x2 1/2"	B6560	1.55
B6559	2.08	10 to 13	700CT	120	5	3	6 3CT	4 7	3 1/2"x3 1/4"	3 3/4"	2 1/2"x3 1/4"	B6561	1.89

### Exact Duplicate Replacement Power Transformers

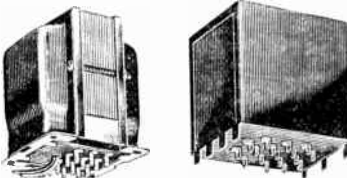

Identical in electrical and physical specifications to original. Highest grade materials. Best workmanship. Primaries for 105-120 Volts, 50-60 cycles AC operation.

#### For Philco Sets

Stock Num.	Part Num.	Set Models	List Price	Your Price
D6450	6804	14,91 (Code 221-3)	\$5.50	\$2.71
D6453	4234	20,220	7.00	2.28
D6454	4813	21	7.00	2.35
D6456	3516	65	7.50	2.28
D6457	5117	70,270,370,470,570	6.50	2.28
D6458	6457	71 (Twin Spkrs.)	6.50	2.59
D6459	3868	76,77	7.50	2.28
D6460	3271	86	7.50	2.28
D6461	3100	87	7.50	2.28
D6462	5382	90,490, (1-47)	6.25	2.35
D6464	4938	90, (2-45)	7.50	2.35
D6465	6554	91	5.25	2.35
D6466	3752	95,96,296	8.00	2.28
D6469	3073	511	7.50	1.98

#### For RCA-Brunswick-Sparton

D6750	RCA Radiola 17, 18, 33, 50, 51, Victor 7-11, 7-26, 8-25, 17-8, Brunswick 2KR0, 3K1R0, 3K1R6, 5KR, 5KR0, 5KR6.	\$4.00	\$1.72
D6757	RCA Victor RE32, E35, RE45, R52, RE75, E135, E152, RE154, RE156.	6.00	2.63
D6758	Sparton 591, 593, 931.	7.00	3.15

### Public Address Transformers

#### Microphone Input Transformers

##### Unshielded Type

Couples carbon microphone to 60,000 ohm tube grid input of P.A. Amplifier. 6" Wire leads.

D6738—For Single Button Carbon Mike. Horizontal mounting. Core 1 1/2"x1 1/2". Mtg. ctrs. 2". 1-Rx1 1/2"x1 1/2" h.

YOUR PRICE ..... **55¢**

D6739—For Double Button Carbon Mike. Vertical mounting. Core 1 1/2"x1 1/2". Mtg. ctrs. 2". 1 1/2"x1 1/2" h.

YOUR PRICE ..... **79¢**

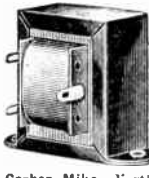

#### Microphone Input Transformers

##### Shielded Type

For mounting on top of chassis. 6" wire leads come out of bottom. Core 3/4"x3/4". Mtg. ctrs. 1 1/2"x1 1/2".

D6988—For double button carbon mike to 100,000 ohm tube grid input. Size 2x2x2 1/2" high.

D6989—Input Tapped at 4, 8, 15 and 30 ohms. For matching low impedance phono pickups or dynamic microphone to 200,000 ohm tube grid input of P.A. amplifier. Size 2x2 1/2"x2 1/2" high.

YOUR PRICE ..... **\$1.47**

EITHER TYPE .....



#### Thordarson Line-to-Speaker Transformer

A6659—Type T-60S48.

List. \$3.00.

YOUR PRICE ..... **\$1.76**

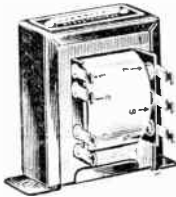

Couples up to 6 speakers on 500 ohm line. Tapped primary impedance 500/1000/1500/2000/2500/3000. Tapped secondary impedance .08 to 8 ohms when used on 500 line. 12 to 16 ohms when used on 1000 ohm line, etc. 10 Watts. Size 3 1/2"x2 1/2"x3 1/2" high.

#### Universal Tube to 500 Ohm Line

Stock Num.	Mfg. Type	Primary Imped.	Ma. Watt	Max. Volt	Your Price
D6669	T61825	2500 to 7000	60	10	\$1.91
D6661	T61826	8000 to 14000*	65	10	2.06

#### Universal Tube to Universal Speaker

Secondary is adjustable .1 to 20 ohms.

D6603	T13842	1500 to 7000	55	10	.88
D6634	T57801	4000 to 14000*	36	8	1.18
D5696	T13841	3000 to 16000*	60	20	1.62

\*Center tapped for single or push pull output tubes. Size: T61825, T61826 and T13841: 3 1/2"x2 1/2"x3 1/2" high. T13842: 2 1/2"x1 1/2"x1 1/2" high. T57801: 2 1/2"x2 1/2" high.

#### Tube Tester Transformers

With Tapped Primary

Supplies Filament Voltages of 1.5 to 110 Volts.

D6728—YOUR PRICE **\$1.39**

For constructing or modernizing tube testers. Supplies correct filament voltages for testing all receiving tubes.

Volts provided: 1.5, 2.0, 2.5, 3.3, 5.0, 6.3, 7.5 at 2 amps.; 12.6, 25.0, 32.5, 45, 70 and 110 volts at 1.5 amps. Tubes of other filament voltages should be tested on next lower voltage specified above. Primary tapped for 95-105-115-125 volt, 50-60 cycle AC operation, compensates for varying line voltages. Also suitable for use with tube testers having line voltage adjustment. 8" Leads. Channel frame mounting. Size 2 1/2"x2 1/2"x3 1/2" wide. Mtg. ctrs. 3 1/2".

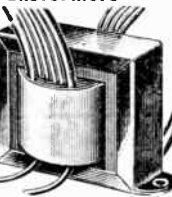

#### With Plate Winding

D6729—Supplies a plate voltage of 250 volts AC at 40 Ma. In addition to filament voltages specified above. Other specifications and sizes exactly as above.

YOUR PRICE ..... **\$1.95**



# Audio - Input - Output TRANSFORMERS

# Filter CHOKES

## Output Transformers

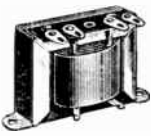

A type and size to fit every dynamic speaker requirement. Output transformers of these specifications and characteristics are standard equipment on thousands of speakers. The two sizes listed fit any standard make of speaker. Match practically any dynamic speaker voice coil.

### For Single Tubes

Stock Num.	Plate Imped.	Prl. Ma.	Core Size	Mtg. Ctrs.	Your Price
C6429	7000	25	1 3/4"	2 1/16"	45c
C6933	25000	8	2 1/2"	2 1/16"	49c
C6923	2000	30	1 3/4"	2 3/8"	49c
C6924	7000	30	1 3/4"	2 3/8"	49c
C6925	10000	30	1 3/4"	2 3/8"	49c
C6931	2000	35	1 3/4"	2 1/8"	65c
C6932	7000	35	1 3/4"	2 1/8"	65c

### For Push Pull Tubes

Stock Num.	Plate Imped.	Prl. Ma.	Core Size	Mtg. Ctrs.	Your Price
C6430	14000	25	1 3/4"	2 1/16"	49c
C6927	4000	30	1 3/4"	2 3/8"	54c
C6928	14000	30	1 3/4"	2 3/8"	54c
C6929	20000	30	1 3/4"	2 3/8"	54c
C6935	4000	35	1 3/4"	2 1/8"	69c
C6936	14000	35	1 3/4"	2 1/8"	69c

\*For Portable Battery Operated Radios having type 1A5G or 1E7G output tubes and 3 to 6 ohm P.M. Dynamic Speakers.

## Special Value

### Heavy Duty Output Transformer

C6854—Same mounting style as above transformer. Matches any single or P.P. tube requiring 4000 to 5500 ohm load impedance to speaker voice coil of 6 to 15 ohms. 65 Ma. capacity. Slotted Mtg. ctrs. 3/4 to 3/8". Size, 2 7/8"x1 3/4"x2 3/8".

YOUR PRICE ..... **34c**

### Universal Output Transformer

Matches Any Tube To Any Speaker

Equipped with a high impedance center tapped primary and a secondary having a combination of taps making it possible to correctly match any single or P.P. tube to any speaker voice coil of 1 to 30 ohms impedance. Cadmium plated channel frame. Constructed of high quality materials. Thoroughly impregnated. Instructions included.

C6409—Handles 4 Watts Output. Size, 1 3/4"x1 1/4". Mtg. Ctrs. 2".

YOUR PRICE ..... **39c**

C6909—Handles 8 Watts Output. Size, 1 3/4"x1 1/4". Mtg. Ctrs. 2 1/2".

YOUR PRICE ..... **48c**

### Heavy Duty Universal Output Transformers

Correctly Matches All Tubes to any Speaker

An essential stock item for every serviceman. Designed with a high impedance primary having a special tapped secondary to permit ratio of turns in winding to match any standard power tube plate impedance, singly or in push-pull. Matches any voice coil between 0.11 ohm and 51 ohms. Complete with instructions.

#### Will Handle 12 Watts Output

C6850—With Vertical Mounting Frame as Illustrated. Mounting hole centers 2 1/2".

C6983—With Horizontal Mounting Frame. Mounting hole centers 2 1/2".

YOUR PRICE, Each ..... **69c**

#### Will Handle 18 Watts Output

C6851—With Horizontal Mounting Mounting centers 3 1/2".

YOUR PRICE, Each ..... **85c**

### Thordarson Class "B" Output Transformer



For Push-Pull 19, 30, 1L6G, 1G6G, 49 and other Class "B" power tubes requiring 10,000 ohm load at 15 Ma. Secondary is tapped at 3 and 8 ohms. Black enameled steel frame. 6" Leads. Size 1 3/4"x1 1/2"x2" high. Mounting ctrs. 2 1/4".

C6658—Code T81S01. List, \$1.50.

YOUR PRICE ..... **88c**

## Class "B" Audio Driver Transformer

Single 30 to 1-19, 1-1J6G, or 2-30's

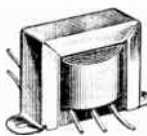

Couples a type 30 tube to push-pull 19, 1L6G or 2-30 tubes in Class "B." Used in battery receivers. Cadmium plated frame. 6" Leads. 5/8"x 1/2" Core. Size, 1 1/2"x2 1/2"x 1/2" high. Mounting ctrs. 2 1/2".

C6908—List, \$1.25.

YOUR PRICE ..... **59c**

C6906—Same as above except 1 1/2"x1 1/2" core. 2" Mtg. Ctrs.

YOUR PRICE ..... **55c**

### THORDARSON Class "B" Driver Transformer For Battery Sets



Couples a type 30 tube plate to grid of a type 19, 1L6G, or 2-30 tubes in Class B. Primary impedance 20,000 ohms at 7 Ma.; 1/2 secondary, 3500 ohms. Size, 1 1/2"x1 1/2"x2" high. Mounting ctrs. 2 1/2".

C6630—Code T78D16. List, \$1.50.

YOUR PRICE ..... **88c**

### Push-Pull Input Transformer

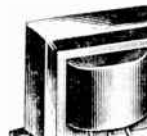

High quality transformer carefully constructed. Fully impregnated for protection against moisture.

For use as replacement in all Class "A" circuits. Ratio of overall winding is 1 to 3. May be used as straight audio by disregarding secondary center tap. Core area is 3/4" square. Semi-shielded. Cadmium plated channel frame. 6" insulated leads. Size: 1 7/8" high, 1 1/2" long, and 1 1/8" deep. Mounting centers 2 1/2".

C6736—

YOUR PRICE ..... **69c**

### Special Value Push Pull Input

C6431—1:3 Ratio. Semi-shielded. Cadmium plated channel frame. Core size, 5/8"x5/8". Ht. 1 1/2". Wd. 1 1/8". Depth, 1 1/2". Mtg. Ctr. 2 1/2".

YOUR PRICE ..... **59c**

C6853—Straight Audio for Sgle. plate to sgle. grid. 1:3 Ratio. 10 Ma. Prl. Cap. Size: 2x2x 2 1/2". Mtg. Ctrs. 2 1/2". Fully shielded.

YOUR SPECIAL PRICE ..... **29c**

### Universal Replacement Audios and Output Transformers

Three different mountings. All types have universal electrical characteristics. High quality transformers suitable for use in the finest receivers. Bright cadmium rust-proof finish. Diagrams and instructions included. For use on either A.C. or D.C. receivers.

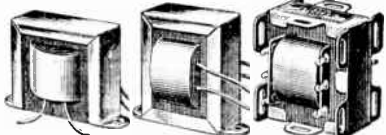

#### Physical Dimensions

Horizontal Frame—Overall 2 1/2" wide, 1 1/2" deep, 1 1/2" high. Mtg. Centers 2 1/2".

Vertical Frame—Overall 1 1/2" wide, 1 1/2" deep, 2 1/2" high. Mtg. Centers 2 1/2".

Universal Bracket—Overall 2 1/2" wide, 1 1/2" deep, 2 1/2" high.

#### Straight Audios

Ratio 3:1. Feeds from any type of general purpose tube into a stage of single audio.

K6400—Horizontal Frame.

K6401—Vertical Frame.

K6402—Universal Bracket.

YOUR PRICE ..... **69c**

#### Push-Pull Audio Inputs

Overall ratio 3:1. Feeds from any general purpose tube either in single or push-pull into a stage of single or push-pull audio.

K6403—Horizontal Frame.

K6404—Vertical Frame.

K6405—Universal Bracket.

YOUR PRICE ..... **69c**

#### Universal Output Transformers

Couples all combinations of power tubes, either single or push-pull to all dynamic or magnetic speakers. For voice coil impedances 1 to 50 ohms.

K6406—Horizontal Frame.

K6407—Vertical Frame.

K6408—Universal Bracket.

YOUR PRICE ..... **69c**

## 30 Henry Filter Chokes

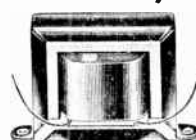

Layer wound and layer insulated coils. Silicon steel core. Cadmium plated rust-proof frames. 6" inch insulated leads.

K6385—30 Henries. 50 M.A. D.C. Resistance 550 ohms. Dimensions: Core 3/4"x 3/4", Height 1 1/2", Depth 1 1/2". Length 2 1/2". Mounting hole centers 2 1/2".

YOUR PRICE ..... **43c**

C6386—30 Henries, 75 Ma. DC Resistance 200 Ohms. Dimensions: Core 3/4"x3/4". Height 1 1/2". Depth 1 1/2". Length 2 1/2". Mounting centers 2 1/2". List Price, \$1.60.

YOUR PRICE ..... **55c**

C6387—30 Henries, 100 Ma. DC Resistance 160 Ohms. Dimensions: Core 5/8"x5/8". Height 2 1/4". Depth 1 1/2". Length 2 1/2". Mounting centers 3 1/2". List Price, \$2.00.

YOUR PRICE ..... **69c**

## Replacement Chokes

For A.C., D.C. Receivers

Open type, cadmium plated, rust-proof frames. Silicon steel core. 6 inch insulated leads. A size for practically every replacement. Highest quality chokes fully guaranteed. Core Size 1/2"x1/2". Mtg. Hole Centers 2". Dimensions: 1 3/8"x2 1/2"x1 1/8".



15 Henries at 50 M. A.

Stock Number	D.C. Resist.	Stock Number	D.C. Resist.	List Price \$1.00	Your Price
K6388	200	K6392	400	23c	Each
K6390	300	K6394	500		

10 asstd. for \$2.10

## Universal Line Output Transformer

Correctly Matches any Speaker to Line

High grade, electro silicon, laminated. Climate proof impregnation. Will match any speaker with 1 to 30 ohms voice coil to 500, 1000, 1500 or 2000 ohm P.A. amplifier output or line. Especially desirable to obtain correct impedance match when a number of speakers are to be used. Wiring instructions included.

C6948—Will Handle 12 Watts Output. 3 1/2" core. 2 1/2" Mtg. Ctrs. List, \$1.95.

YOUR PRICE ..... **69c**

C6949—Will Handle 18 Watts Output. 7/8" core. 2 1/2" Mtg. Ctrs. List, \$2.35.

YOUR PRICE ..... **95c**

## BARGAIN

### Power Transformer For Philco 511

Part Number 3073

For replacement in Philco 511 or other seven tube radio sets using 4-26, 1-27, 1-71A and 1-80. Primary 105-125 volts, 60 cycles A.C. Secondaries: 375 V. (1 P. @ 37 Ma., 1 1/2 V. @ 4.3 amps., 2.5 V. @ 1.95 amps., 5 V. @ 2 amps. Size: 3 1/2"x3 1/2"x1 1/2" high.

C6852—

YOUR PRICE ..... **95c**

## Filament Transformers

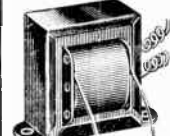

R6725—

YOUR PRICE ..... **59c**

110 V. primary. Secondary 2 1/2 V. @ 1/4 amp. Mtg. centers 2 1/2". 2 3/8" high, 1 1/2" wide.

3.3 Volt 1.5 Amp. Filament Transformer

Center Tapped.

D6724—

YOUR PRICE ..... **59c**

6.3 Volt 3 Amp. Filament Transformer

Size and appearance identical to R6725 transformer. Delivers 6.3 volts at 3 amps. For use with the new 6.3 volt tubes on 115 volt A. C. Can also be used on 7.5 volt tubes. 20 watts.

K6727—

YOUR PRICE ..... **84c**



# Metallized

# RESISTORS-CONTROLS

## IRC Fixed Power Wire Wound Resistors



Machine wound evenly spaced high quality wire on a non-moisture absorbing ceramic core. Covered overall with a newly developed moisture-proof cement coating. Tolerance 5%.

### 10 Watt—Type AB Size 1 1/4" x 5/16"

Stock Number	Resist. Ohms	Stock Number	Resist. Ohms
K2750	10	K2772	3,000
K2751	15	K2773	3,500
K2752	20	K2774	4,000
K2753	25	K2775	4,500
K2754	50	K2776	5,000
K2755	75	K2777	6,000
K2756	100	K2778	7,000
K2757	150	K2779	7,500
K2758	200	K2780	8,000
K2759	250	K2781	9,000
K2760	300	K2782	10,000
K2761	400	K2783	11,000
K2762	500	K2784	12,000
K2763	600	K2785	12,500
K2764	750	K2786	15,000
K2765	800	K2787	20,000
K2766	1,000	K2788	25,000
K2767	1,250	R2789*	30,000
K2768	1,500	R2790*	35,000
K2769	2,000	R2791*	40,000
K2770	2,250	R2792*	50,000
K2771	2,500		

List. 40c. YOUR PRICE, Each ..... **24c**

## IRC Adjustable Wire Wound Resistors



### 10 Watt—Type ABA Size 1 1/4" x 5/16"

Can be adjusted to desired resistance up to total rating. Very desirable in emergency to supply exact value required. Evenly spaced, best quality resistance wire machine wound on non-moisture absorbing ceramic core. Moisture-proof cement coating. Tolerance 5%.

Stock Number	Resist. Ohms	Stock Number	Resist. Ohms
A2700	5	A2710	1,000
A2701	10	A2711	1,250
A2702	25	A2712	1,500
A2703	50	A2713	2,000
A2704	100	A2714	2,500
A2705	150	A2715	3,000
A2706	200	A2716	4,000
A2707	250	A2717	5,000
A2708	500	A2718	7,500
A2709	750	A2719	10,000

List Price, 60c. YOUR PRICE, Each ..... **35c**

## IRC Center Tapped Wire Wound Resistors



Completely enclosed in molded bakelite. Withstands high temperatures. For balancing circuits in receivers or transmitters. Will carry up to 5 watts using special mounting bracket supplied or 2 1/2 watts in open air. Bracket mounting centers 2 1/2".

### Type MW-2J

Stock Number	Resist. Ohms	Stock Number	Resist. Ohms
A2650	10	A2653	75
A2651	20	A2654	100
A2652	50	A2655	200

List Price, 35c. YOUR PRICE, Each ..... **21c**

## New IRC Insulated Resistors

### Types BW and BT



Highest quality molded bakelite insulated resistors. Fully protected against shorts or moisture break down. 1/2" leads are securely anchored. Metallized resistance element has exceptional low noise level; unsuited for use in any circuit. Wirewound types are especially designed for use in circuits requiring lower resistances. Accuracy ± 10%. Will stand over loads of 100% for short periods. Individually marked as well as color coded.

1/2 Watt Size 5/8" x 3/16"      1 Watt Size 1 1/4" x 1/4"      2 Watt Size 1 1/4" x 5/16"

List. 17c. YOUR PRICE, Each. **10c**      List. 20c. YOUR PRICE, Each. **12c**      List. 30c. YOUR PRICE, Each. **18c**

### Type BW—Wirewound

Resistance Ohms	1/2 Watt Stock Number	1 Watt Stock Number	2 Watt Stock Number
0.5	A2660	A2720	A2850
1	A2661	A2721	A2851
2	A2662	A2722	A2852
3	A2663	A2723	A2853
5	A2664	A2724	A2854
7.5	A2665		
10	A2666	A2725	A2855
15	A2667	A2726	A2856
25	A2668	A2727	A2857
50	A2669	A2728	A2858
75	A2670	A2830	A2859
100	A2671	A2831	A2860
120	A2672	A2832	A2861
150	A2673	A2833	A2862
200	A2674	A2834	A2863
250	A2675	A2835	A2864
300	A2676	A2836	A2865
350	A2677	A2837	A2866

### Type BT—Metallized

Resistance Ohms	1/2 Watt Stock Number	1 Watt Stock Number	2 Watt Stock Number
1000	A2482	A2414	A2604
1500	A2484	A2416	A2606
2000	A2485	A2417	A2608
2500	A2487	A2419	A2610
3000	A2488	A2420	A2611
4000	A2490	A2422	A2612
5000	A2491	A2423	A2613
6000	A2492	A2424	A2614
7500	A2494	A2426	A2616
10000	A2497	A2429	A2617
12,500	A2498	A2432	A2618
15,000	A2500	A2433	A2619
20,000	A2502	A2435	A2620
25,000	A2504	A2437	A2621
30,000	A2505	A2438	A2622
40,000	A2507	A2440	A2623
50,000	A2508	A2441	A2624
60,000	A2510	A2443	A2625
75,000	A2512	A2445	A2626
100,000	A2513	A2446	A2627
150,000	A2515	A2448	A2629
200,000	A2516	A2449	A2630
250,000	A2517	A2450	A2632
300,000	A2518	A2451	A2633
500,000	A2520	A2453	A2643
600,000	A2521	A2454	
750,000	A2522	A2455	A2634
1.0 Meg.	A2523	A2456	A2635
2	A2525	A2458	A2637
2.0	A2529	A2461	A2639
10.0	A2531	A2464	A2642
20.0	A2532	A2465	A2644

## Resistor Assortments With Metal Cabinet

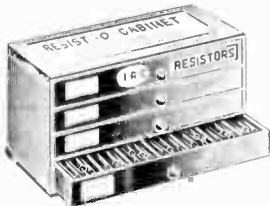

Durable metal cabinet. Holds a complete supply of resistors. Drawers have firmly attached metal partitions. Size: 1 1/2" x 3 1/2" x 5 1/2" high. Can be stacked one above the other.

**C15819**—Contains 50 resistors: 2 Type BT 1/2 Watt Metallized, 37 Type BT 1 Watt Metallized, 10 Type AB 10 Watt Wirewound and 1 Type ABA 10 Watt Wirewound Resistors. List value resistors, \$15.16. **YOUR PRICE, with Cabinet ... \$891**

**C15817**—Contains 100 Type BT 1/2 Watt Metallized Resistors. List value of resistors, \$17.00. **YOUR PRICE, with Cabinet ... \$980**

**C15818**—Contains 83 Type BT-1 1/2 Watt Insulated Metallized Resistors. List value of resistors, \$16.60. **YOUR PRICE, with Cabinet ... \$976**

### With Bristol Board Chest

**D15820**—Contains 56 assorted Type BT-1 1/2 Watt Insulated Metallized Resistors in Bristol-board chest. 6 Drawers. Size 1 1/2" x 5 1/2" x 8 1/2" high. List value of resistors, \$11.20. **YOUR PRICE, with Chest ... \$659**

**D15821**—Chest only. **YOUR PRICE ... 88c**  
Only Popular Values Are Supplied.

## IRC Calibrated Resistance Indicator

A continuously variable calibrated indicator. For use as a voltage divider, for determining correct resistance values by the substitution method, etc. Covers range from 0 to 1 megohm. Direct reading. Etched scale. Reads 0 to 30,000 ohms on high current carrying wire wound element and continues to 1 megohm using metallized type resistance element. 4-leads with alligator clips.

**R2742—YOUR PRICE ..... \$485**

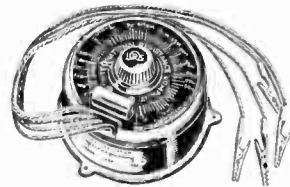

## IRC All Metal Power Rheostats

Constructed with sturdy cast aluminum frame for rapid heat dissipation. Heat is uniformly distributed permitting safe operation at full rated load down to 25% of full rotation. Silent spiral connector gives positive contact between rotor arm and center terminal. Terminals mounted on porcelain and insulated from frame. Heavy mica insulation between element and frame. 1/2" Shaft 1/2" long. Single 3/8" hole mounting in panels up to 3/8" thick. Size: 25 Watt, 1-21 3/2" dia. x 31 3/2" deep. 50 Watt, 2 1/2" dia. x 1 1/2" deep. 1 1/2" Arrow knob included.



### PR-25—25 Watt

Stock Num.	Ohms Resist.	Max. W.	Your Price
C12965	1	5,000	\$2.65
C12966	6	2,040	
C12967	8	1,770	
C12968	10	1,580	
C12969	25	1,000	<b>\$235</b>
C12970	50	709	
C12971	100	315	Each
C12972	250	217	
C12973	350	267	
C12974	500	222	
C12975	1000	155	
C12976	1500	129	\$2.65
C12977	2500	100	Each
C12978	5000	70	\$2.79

### PR-50—50 Watt

Stock Num.	Ohms Resist.	Max. W.	Your Price
C12979	1	7,070	\$2.94
C12980	6	2,880	
C12981	12	2,040	
C12982	22	1,500	
C12983	50	1,000	<b>\$265</b>
C12984	80	700	
C12985	150	575	Each
C12986	300	407	
C12987	500	315	
C12988	1000	223	
C12989	1600	177	\$2.79
C12990	2500	140	Each
C12991	5000	100	\$2.94
C12992	10000	70	\$2.94



# CARBON



# RESISTORS

The Only Safe Kind to Use

Radolek Quality is always the Best

## New Insulated Carbon Resistors

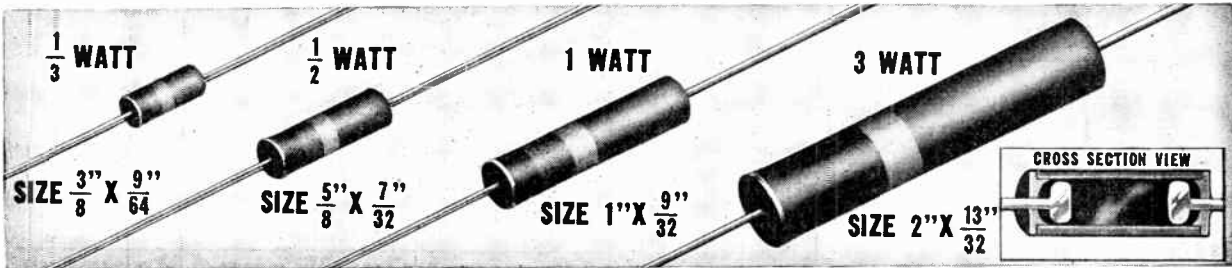

### Certified Quality

Finest quality, new fresh stock direct from the factory. The development of years of extensive research and manufacturing experience. Resistance is permanent, within a narrow range even when overloaded at overloads for a long period of time. Fully insulated. Impervious to moisture, heat, and mechanical strain. Resistors may touch each other without shorting. Conservative wattage rating.

Variations from values are negligible. Ratings guaranteed within 10%. Average variations close to 5%. Unusually quiet and become MORE QUIET the longer in use. Very strong and sturdy. Will stand all reasonable handling in manufacturing and repairing. All have heavy 1 1/2" long tinned copper wire leads. Perfect and permanent electrical and mechanical contact. Each resistor marked with standard R.M.A. color code or labeled with rated resistance. Accuracy and quality guaranteed.

### Buy With Confidence

These Radolek highest quality carbon resistors are made by the recognized leading Resistor Manufacturers. We well know that there are resistors offered by many others at lower prices than quoted here. But Radolek refuses to handle products of doubtful quality. Servicemen can always be sure of receiving only the Highest Quality Carbon Resistors when dealing with Radolek. We always have supplied only the finest quality resistors as "Radolek Certified Carbon Resistors."

No Serviceman Can Afford to Waste His Time or Jeopardize His Reputation Using Inferior "Job Lot" or "Surplus" Resistors. Resistors Offered At Lower Prices Are of Inferior Quality and Expensive At any Price.

### Resistance Indicator



Handy pocket size color code indicator with three rotary discs in colors. Indicates value of any resistor which is color coded according to RMA standards. Free with order for any 24 resistors.

**C2299—PRICE, If Purchased Separately..... 9c**

**Metal Storage Cabinets for resistors are listed on page 63**

<b>1/3 WATT</b> Each 4c 10 for .. <b>29c</b> Per Hundred .....\$2.74	<b>1/2 WATT</b> Each 5c 10 for .. <b>37c</b> Per Hundred .....\$3.54	<b>1 WATT</b> Each 6c 10 for .. <b>47c</b> Per Hundred .....\$4.44	<b>3 WATT</b> Each 9c 10 for .. <b>74c</b> Per Hundred .....\$6.65
---	---	---	---

Resistance Ohms	1/3 Watt Stock No.	1/2 Watt Stock No.	1 Watt Stock No.	3 Watt Stock No.	Resistance Ohms	1/3 Watt Stock No.	1/2 Watt Stock No.	1 Watt Stock No.	3 Watt Stock No.	Resistance Ohms	1/3 Watt Stock No.	1 Watt Stock No.	3 Watt Stock No.	
100	D2000	D2065	D2135	D2205	3,500	D2021	D2086	D2156		100,000	D2041	D2106	D2176	D2236
150	D2001	D2066	D2136	D2206	4,000	D2022	D2087	D2157	D2220	150,000	D2042	D2107	D2177	D2237
200	D2002	D2067	D2137		4,500	D2023	D2088	D2158		200,000	D2043	D2108	D2178	D2238
250	D2003	D2068	D2138	D2207	5,000	D2024	D2089	D2159		250,000	D2044	D2109	D2179	D2239
300	D2004	D2069	D2139	D2208	6,000	D2025	D2090	D2160	D2222	300,000	D2045	D2110	D2180	D2240
										400,000	D2046	D2111	D2181	D2241
350	D2005	D2070	D2140	D2209	7,000	D2026	D2091	D2161	D2223	Megohms				
400	D2006	D2071	D2141		8,000	D2027	D2092	D2162	D2224	.5	D2047	D2112	D2182	D2242
450	D2007	D2072	D2142		9,000	D2028	D2093	D2163	D2225	.6	D2048	D2113	D2183	
500	D2008	D2073	D2143	D2210	10,000	D2029	D2094	D2164	D2226	.75	D2049	D2114	D2184	D2243
600	D2009	D2074	D2144		12,500	D2030	D2095	D2165	D2227	.9	D2050	D2115	D2185	
700	D2010	D2075	D2145	D2211	15,000	D2031	D2096	D2166	D2228	1.0	D2051	D2116	D2186	D2244
800	D2011	D2076	D2146	D2212	17,500	D2032	D2097	D2167		1.5	D2052	D2117	D2187	
900	D2012	D2077	D2147	D2213	20,000	D2033	D2098	D2168	D2229	2.0	D2053	D2118	D2188	
1,000	D2013	D2078	D2148	D2214	22,500	D2034	D2099	D2169		2.5	D2054	D2119	D2189	
1,250	D2014	D2079	D2149	D2215	25,000	D2035	D2100	D2170	D2230	3.0	D2055	D2120	D2190	
1,500	D2015	D2080	D2150	D2216	30,000	D2036	D2101	D2171	D2231	3.5	D2056	D2121	D2191	
1,750	D2016	D2081	D2151		40,000	D2037	D2102	D2172	D2232	4.0	D2057	D2122	D2192	
2,000	D2017	D2082	D2152	D2217	50,000	D2038	D2103	D2173	D2233	5.0	D2058	D2123	D2193	
2,250	D2018	D2083	D2153		60,000	D2039	D2104	D2174	D2234	6	D2059	D2124	D2194	
2,500	D2019	D2084	D2154	D2218	75,000	D2040	D2105	D2175	D2235	10.0	D2060	D2125	D2195	
3,000	D2020	D2085	D2155	D2219										

## The RADISTOR Kit

Twenty-Four "Certified" Insulated Resistors

In Compact Lacquered Metal Carrying Case

Without Metal Case

A3990—1 Watt Kit.....	\$1.55	C3993—1 Watt Kit.....	\$1.10
K3991—1/2 Watt Kit.....	1.33	C3994—1/2 Watt Kit.....	.88
G3992—1/3 Watt Kit.....	1.14	C3995—1/3 Watt Kit.....	.69

**CASE ONLY R3996—49c**

These kits enable the serviceman to make practically any resistor repair regardless of any unusual value resistance needed. Twenty-four of the most popular value resistors are included as follows: 1 each—100; 250; 400; 500; 800; 1,000; 2,000; 3,000; 5,000; 6,000; 10,000; 12,500; 15,000; 20,000; 25,000; 40,000; 50,000; 60,000; 75,000; 100,000; 250,000; 500,000 ohms; 1 megohm; 2 megohms. If value wanted is not in kit, combinations can be made to give a resultant resistance of any exact value needed. Simple chart and calculating formulae included in kit. Accuracy guaranteed within 10%, and most values are actually within 5%.

### In the Metal Box

Resistors are always ready and safe. Strong, green lacquered heavy gauge steel boxes protect the resistors against the roughest handling. Drop the kit in your tool box, on the job, you are always sure to have the correct dependable resistors ready to use. The right resistor when you want it.

## SPECIAL BARGAIN Carbon Resistor Kits



A3997—Kit of 50 assorted Resistors in 1/4 and 1/2 watt sizes.

**YOUR PRICE ..... 51c**

A3998—Kit of 100 assorted Resistors in 1/4 and 1/2 watt sizes.

**YOUR PRICE ..... 97c**

A3999—Kit of 100 Resistors. Contains: 25-1 watt, 50-1/2 watt and 25-1/4 watt resistors.

**YOUR PRICE ..... \$1.14**

Kits are made up of resistances most commonly used in factory made sets. R.M.A. color coded. 1 1/2" tinned wire leads. Outstanding values!



**GUARANTEED**

Color Code Chart Free





# New Test Instruments

## D. pendable Volt-Ohm-Milliammeter Kits

Has  
3" Meter  
1000 Ohms  
Per  
Volt

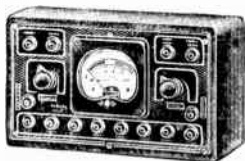

A one Ma. foundation meter of the D'Arsonval type. Has easily read calibrations on long multi-range scales. Square bakelite case. Scale ranges of: 0-5, 50-250, 500-2500 Volts DC, 0-10, 100-500, 1000-5000 Volts AC; 0-1, 10, 100, 1000 DC Ma.; 0-3, 10 DC Amps; 0-50, 100, 1000, 1000, 1000 Ohms; -8 to +15/4-12 to 4.35 -26 to +19, +32 to -55 DB. Accuracy within 2%. Complete operating instructions and all necessary wiring diagrams are included. Ohmmeter circuit requires 3 flashlight cells, 1 1/2 volts each, which are furnished with the DC parts kit. Necessary parts for building complete testers are listed below.

**D17151**—Meter only. **\$294**  
YOUR PRICE

### Parts Kit for D.C. Ranges

All parts needed for above DC ranges. Includes a drilled and al etched aluminum panel 7 1/2"x3 1/2"; selector switch, 13 bakelite tip jacks, ohmmeter control rheostat, 2 knobs, 12 specially calibrated resistors (6 wire-wound); 3-1 1/2 V batteries. Complete instructions and wiring diagram.

**D17152**—DC parts kit only. **\$293**  
YOUR PRICE

### Parts Kit for A.C. Ranges

Add this kit to the above DC kit to make a complete AC-DC instrument having all of the ranges indicated in the description above. Includes a copper oxide rectifier, specially calibrated multiplier, jack, mounting bracket.

**D17153**—AC parts kit only. **\$162**  
YOUR PRICE

### Instrument Case

**D17154**—Hardwood meter box to house either of above kits. 8 1/2"x5 3/4". **\$3c**  
YOUR PRICE

## Solar Model CE Exam-eter

Tests for Capacity, Shorts, Opens, And Impedance under Actual Operating Conditions

**D17172**—Solar Model CE Exameter complete with all necessary tubes, test leads and instructions. For 110 volts, 60 cycle A.C. operation. **\$31.31**  
YOUR PRICE

Makes all measurements necessary to determine the true condition of any type condenser used in radio receivers. Tests for shorts, opens, R.F. Impedance, intermittents (dynamic circuit). Has capacity range from 10 mmfd. to 2000 mfd. in 10 steps. Measures resistance in five ranges from 50 ohms to 10,000 meg-ohms; leakage measurements are made directly on meter in Ma.; Bridge meter plus power factor scale shows power factor from 10 to 50%. Has variable DC voltage supply of 0 to 550 volts. DC vacuum tube voltmeter measures D.C. voltage from 0 to 600 in three ranges; A.C. vacuum tube voltmeter (input resistance 10 meg.) has range from 0 to 30 volts; meter can also be used to check continuity. Employs 1-6L6, 2-6J5GT's. With leads. Portable case is 8 1/2"x11 1/2"x5 1/2" high. For 110 volts, 60 cycles A.C. Complete with tubes.



## New Carron Test Units and Kits

### Signal Tracing Amplifier



Model CCH  
**D17287**—  
YOUR PRICE  
**\$39.20**

Makes gain and frequency measurements over a range of 50 Kc to 17 Mc in 5 h a m d s. Uses 6L7 electron eye as an indicator tube; 4 step 60 db. attenuator; built-in speaker; direct reading dial; input capacitance of only 2 mmf. Tests all RF, IF and oscillator functions. Grey wrinkled metal cabinet. Complete with 30' co-axial cable and 7 tubes. Size, 9"x9"x3 1/2". Shpg. wt., 11 lbs. For 115 V. 60 cycle.

### Model CCH Kit

**D17288**—Essential Kit. Consists of 5 hand 2 stage RF assembly, two-gang condenser, dial and tube, chassis panel, case, switch and RF cable. **\$17.15**  
YOUR PRICE

**D17289**—Tubes and Miscellaneous Parts. Includes resistors, condensers, sockets, power transformer, 3" dynamic speaker, etc. 2-6BK7, one each 6X5, 6F6G, 5Z4, 6T5, 6V6G. **\$12.45**  
YOUR PRICE

### B.F. Audio Oscillator

Model CCA  
**D17326**—  
YOUR PRICE  
**\$24.45**



This instrument is indispensable for providing overall fidelity checks on audio amplifiers and receivers, determination of modulation capabilities, checking for speaker rattle, etc. Covers from 20 to 16,000 cycles per second. Has sinusoidal wave form with maximum distortion under 2%. Output flat within 1.8 db. over range. Has a 15-volt RMS output into a 100,000 ohm load. Grey wrinkle finish metal cabinet 7 1/2"x7 1/2". Full-vision dial. Uses 2-6BK7, 2-6C5, 1-5Z4, 1-6T5. Has a 60 cycle calibrator. Complete with tubes. For 115 V. 60 cycles.

### Model CCA Kit

**D17327**—Kit contains oscillator unit, filter, 385 mmf. variable condenser, a punched and drilled 7 1/2"x12" chassis base, panel and cabinet, hardware, dial parts, etc. **\$10.25**  
YOUR PRICE

**D17328**—Tubes and Miscellaneous Parts. Contains resistors, condenser, transformer, sockets, etc. Includes 2-6BJ7, 2-6C5, 1-5Z4, 2-6T5 tubes. **\$9.75**  
YOUR PRICE

## Special Value Paper Condensers

Quality paper dielectric condensers made by a well known manufacturer. Use them for general replacement or experimental purposes.



### Tubular Types

**D8691**—25 Mfd. at 400 volts. In 1/2"x2 1/4" moisture-proof cardboard tube, 1" Leads.  
**D8692**—45, 65, 105, 165 Mfd. at 125 volts AC (100V D.C.). 1/2"x2 1/4" Long cardboard tube. Has 3 leads. Note: .005 is coded by longer insulation on lead. See diagram at upper left.

Either Type  
YOUR PRICE, Each... **4c**  
Ten for 30c. 100 for \$2.00

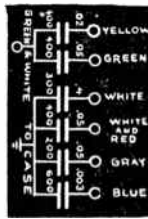

### In Metal Container

**D8690**—Six condensers in metal container with spade type mounting lugs. See diagram at lower left for capacity and voltage ratings. Size, 2 1/2"x2 1/2" high.

YOUR PRICE, Each... **8c**  
Ten for 60c. 100 for \$4.50

## Special Value Carbon Resistors



1/2, 1 and 2 Watt

Fine quality carbon resistors. RMA Color coded for easy identification. These resistors represent values that you cannot afford to miss.

1/2 and 1 Watt Resistors, Each **3c** 100 for **\$2.25** | 2 Watt Resistors, Each **4c** 50 for **\$1.75**

Ohms Resistance	Stock Number			Ohms Resistance	Stock Number		
	1/2 Watt	1 Watt	2 Watt		1/2 Watt	1 Watt	2 Watt
100	B2300	B2316	B2332	20,000	B2308	B2324	B2340
400	B2301	B2317	B2333	25,000	B2309	B2325	B2341
500	B2302	B2318	B2334	50,000	B2310	B2326	B2342
1,000	B2303	B2319	B2335	100,000	B2311	B2327	B2343
2,500	B2304	B2320	B2336	150,000	B2312	B2328	B2344
5,000	B2305	B2321	B2337	250,000	B2313	B2329	B2345
10,000	B2306	B2322	B2338	500,000	B2314	B2330	B2346
15,000	B2307	B2323	B2339	1 Meg.	B2315	B2331	B2347

## STANDARD Metallized CONTROLS

Absolutely quiet! Features metallized resistance element, spiral spring contactor, 3 finger contactor and bakelite case with dust-proof metal shield. Available in large size Type CS measuring 1 1/2"x1 1/2" dia., and Midget Type D size 1/2"x1 1/2" dia. Include 300 ohm resistor.

TAPERS: A Linear resistance, C For Grid circuits, D for combination Antenna and Cathode Bias, F For Plate, Screen or Cathode Bias circuits.

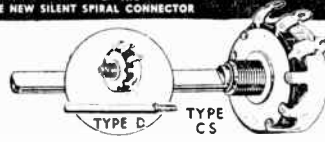

**Standard Controls—Type CS**  
With attached 1/2"x3" long shaft. Less wiring. List, \$1.00.  
YOUR PRICE, Each... **59c**

Resistance Ohms	Taper	Mfg. Code	Stock Number
500	A	11-103	<b>A12750</b>
1,000	A	11-108	<b>A12751</b>
2,000	A	11-110	<b>A12752</b>
3,000	A	11-112	<b>A12753</b>
4,000	A	11-113	<b>A12754</b>
5,000	A	11-114	<b>A12755</b>
7,500	A	11-115	<b>A12757</b>
10,000	A	11-116	<b>*A12758</b>
10,000	C	13-116	<b>A12759</b>
10,000	D	14-116	<b>*A12760</b>
10,000	E	16-116	<b>*A12761</b>
15,000	D	14-125	<b>*A12762</b>
15,000	F	16-118	<b>*A12763</b>
20,000	F	16-119	<b>*A12764</b>
25,000	A	11-120	<b>A12765</b>
25,000	D	14-120	<b>*A12766</b>
25,000	F	16-120	<b>A12767</b>
50,000	A	11-123	<b>A12768</b>
50,000	C	13-123	<b>A12769</b>
75,000	C	13-125	<b>A12770</b>
75,000	D	14-125	<b>*A12771</b>
100,000	A	11-128	<b>A12772</b>
100,000	C	13-128	<b>A12773</b>
200,000	A	11-129	<b>A12774</b>
250,000	C	13-130	<b>A12776</b>
350,000	C	13-132	<b>C12650</b>
500,000	A	11-133	<b>A12778</b>
500,000	C	13-133	<b>A12779</b>
500,000	C	13-137	<b>A12780</b>
1.0 Meg.	C	13-139	<b>A12781</b>
2.0 Meg.	C	13-139	<b>A12781</b>
3.0 Meg.	C	13-140	<b>A12782</b>
5.0 Meg.	A	11-141	<b>A12783</b>
10.0 Meg.	A	11-143	<b>A12785</b>

**Tapped Controls—Type CS**  
With tap for automatic bass compensated volume control grid circuits. List Price, \$1.50.  
YOUR PRICE, Each... **88c**

Resistance Ohms	Tap	Mfg. Code	Stock Number
250M	125M	13-130X	<b>A12786</b>
350M	75M	18-132X	<b>A12787</b>
500M	125M	13-133X	<b>A12788</b>
1 Meg.	250M	13-137X	<b>A12789</b>
1 Meg.	500M	VC-539X	<b>A12790</b>
2 Meg.	500M	13-139X	<b>A12791</b>

**Midget Controls—Type D**  
With 1/2"x3" long plug-in shaft. Less switch. List, \$1.00.  
PRICE, Each, With Shaft... **59c**

Resistance Ohms	Taper	Mfg. Code	Stock Number
100,000	C	D13-128	<b>C12673</b>
250,000	C	D13-130	<b>C12674</b>
350,000	C	D13-132	<b>C12675</b>
500,000	C	D13-133	<b>C12676</b>
1 Meg.	C	D13-137	<b>C12677</b>
2 Meg.	C	D13-139	<b>C12678</b>

**Attachable Switch**  
Snaps on. Rated 2 Amps. at 125 volts, 10 amps. at 6 volts. Underwriter's approved. \*For battery sets.

Type CS	Type D	Switch	Price
D12703	D12708	SPST 1A..	<b>29c</b>
D12704	D12710	SPDT	
D12705	D12709	DPST	
D12706	D12711	4PST	

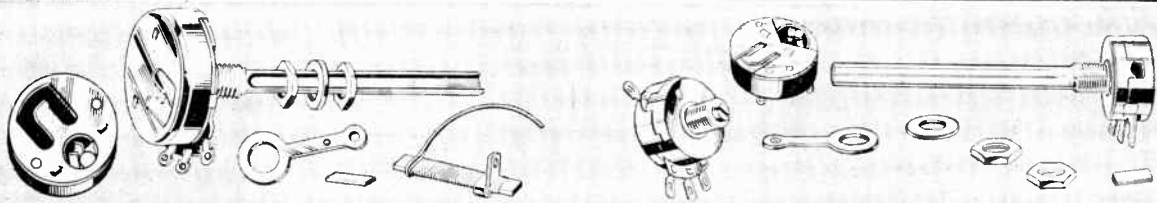

## STANDARD SINGLE CONTROLS

## MIDGET REPLACEMENT CONTROLS

Ruggedly constructed, quality controls. 3" long fluted aluminum shaft, easily cut or filed. Size  $\frac{3}{8}$ " deep by 1 $\frac{1}{2}$ " dia. on carbon types and 1 $\frac{1}{2}$ " on wire wound. H.R.—Are high resistance carbon types. W.W.—Are wire wound. \*Have adjustable minimum bias feature. HR types are supplied with external bias resistor (when used as cathode bias control). †Have slotted shaft for auto sets. ‡Have  $\frac{3}{4}$ " long shaft with additional  $\frac{1}{2}$ " long slotted extension shaft and coupling, for auto sets.

Ruggedly constructed midget replacement controls. Supplied in plug-in shaft type or with shaft attached. Control measures 1 $\frac{1}{2}$ " in dia. by  $\frac{1}{2}$ " deep,  $\frac{3}{8}$ " bushing. Supplied less switch.

**Price**  
All Types Below  
No Switch or Knob Included  
List Price, \$1.00.  
YOUR PRICE, EACH ..... **59c**

Control Number	Type	Resistance Ohms	Curve	Control Number	Type	Resistance Ohms	Curve
Q	W.W.	2	IV	*H	W.W.	15M	II
R	W.W.	6	IV	*H7	W.W.	15M	VII
S	W.W.	10	IV	*M12	H.R.	15M	I
T	W.W.	20	IV	*Y	H.R.	20M	I
U	W.W.	30	IV	*A20MP	W.W.	20M	IV
V	W.W.	60	IV	*J	H.R.	25M	II
W	W.W.	100	IV	Y25MP	H.R.	25M	IV
X	W.W.	200	IV	*K	H.R.	50M	II
A400P	W.W.	400	IV	K12	H.R.	50M	II
A	W.W.	500	IV	Y50MP	H.R.	50M	IV
A550P	W.W.	550	IV	*Z	H.R.	75M	II
A	W.W.	1000	IV	Z12	H.R.	75M	I
UC-500	W.W.	1000	II	L	H.R.	100M	I
A1MP	W.W.	1000	IV	*UC-510	H.R.	100M	II
*A2MP	W.W.	2000	IV	Y100MP	H.R.	100M	IV
*C	W.W.	2000	II	UC-502	H.R.	150M	IV
*C12	W.W.	2000	II	Y200MP	H.R.	200M	IV
*D	W.W.	3000	II	M	H.R.	250M	I
*D7	W.W.	3000	VII	*UC-509	H.R.	250M	II
*D12	W.W.	3000	IV	UC-511†	H.R.	250M	I
*A3MP	W.W.	3000	IV	Y250MP	H.R.	250M	IV
*E	W.W.	5000	II	N	H.R.	500M	I
*E7	W.W.	5000	VII	UC-512†	H.R.	500M	I
*E8MP	W.W.	5000	IV	UC-513	H.R.	500M	II
*E12	H.R.	5000	I	UC-515†	H.R.	500M	I
*Y5MP	H.R.	5000	IV	Y500MP	H.R.	500M	IV
*F	W.W.	7500	II	UC-503	H.R.	750M	I
*F7	W.W.	7500	VII	O	H.R.	1 Meg.	I
*F12	H.R.	7500	I	UC-514†	H.R.	1 Meg.	I
*G	W.W.	10M	II	Y1000MP	H.R.	1 Meg.	IV
*G7	W.W.	10M	VII	P	H.R.	2 Meg.	I
*A10MP	W.W.	10M	IV	UC-504	H.R.	3 Meg.	I
*G12	H.R.	10M	I	UC-505	H.R.	4 Meg.	I
UC-501	H.R.	10M	II	UC-506	H.R.	5 Meg.	I
Y10MP	H.R.	10M	IV	UC-507	H.R.	5 Meg.	II
				UC-508	H.R.	9 Meg.	I

**Plug-In Shaft Type**  
With these compact controls and Plug-In Shafts listed below at right any type special replacement control can be made. \*Have slip clutch-switch cannot be attached.  
Price Less Switch-Less Switch  
List Price, \$1.25.  
YOUR PRICE, Each..... **73c**

Control Number	Ohms Resist.	Resis. Taper
UM114	5M	IVA
UM118	10M	I
UM119	10M	II
UM120	10M	IV
UM121	15M	I
UM122	15M	II
UM124	20M	I
UM128	25M	II
UM129	25M	IV
UM134	50M	II
UM135	50M	IV
UM138	75M	II
UM141	100M	IV
UM142	100M	I
UM143*	100M	I
UM144	150M	I
UM147	250M	I
UM149	250M	IV
UM150*	250M	I
UM151	350M	I
UM154	500M	I
UM156	500M	IV
UM157*	500M	I
UM158	750M	I
UM161	1 Meg.	I
UM162*	1 Meg.	I
UM163	2 Meg.	I
UM165	3 Meg.	I

**With Attached Shaft**  
Milled aluminum shaft  $\frac{3}{8}$ " diameter x 3" long firmly attached.  
Price With Shaft Less Switch  
List Price, \$1.00.  
YOUR PRICE, EACH..... **59c**

Control Number	Ohms Resist.	Resis. Taper
MR14	5M	IVA
MR18	10M	I
MR19	10M	II
MR20	10M	IV
MR21	15M	I
MR22	15M	II
MR24	20M	I
MR28	25M	II
MR29	25M	IV
MR33	50M	II
MR34	50M	IV
MR35	50M	II
MR36	75M	I
MR37	75M	II
MR39	100M	I
MR40	100M	II
MR41	100M	IV
MR42	150M	I
MR44	250M	I
MR45	250M	II
MR48	500M	I
MR50	500M	IV
MR51	750M	I
MR53	1 Meg.	I
MR55	2 Meg.	I
MR57	3 Meg.	I

### Standard Dual Controls

Same construction as single controls. No switch included—use standard attachable switch. \*Are wire wound types, remaining are carbon type. ( ) Indicates taper curve.  
List Price, \$2.50.  
YOUR PRICE, EACH..... **\$1.47**

Cont. No.	Front Ohms	Rear Ohms	Use
*CE	2M (1)	5M (1)	Ant. & Bias
*GE	10M (7)	10M (4)	Ant. & Bias
*GG	10M (7)	50M (4)	Ant. & Bias
*GK	10M (1)	50M (4)	Ant. & Bias
*KK	10M (4)	50M (4)	Grid & Bias
LL	100M(1)	100M(1)	Aud. Shunt
LM	100M(1)	250M(1)	Aud. & Tone
MM	250M(1)	250M(1)	Aud. Shunt
MN	250M(1)	500M(1)	Aud. Tone
NN	500M(1)	500M(1)	Aud. Shunt

### Standard Tapped Controls

Standard size volume controls with tap for tone compensation. Same physical specifications as above single controls. All are taper curve V. No switch included—use standard attachable switch. †Also suitable for phonograph volume control.  
List Price, \$1.50.  
YOUR PRICE, EACH..... **88c**

Control Number	Ohms Resist.	Tapped at Ohms
TRP600	30M	2500
TRP601	60M	4000
TRP622	44M	7000
TRP617	60M	10000
TRP602	63M	3000
TRP623	250M	50000
TRP603	250M†	125000
TRP604	350M	25000
TRP605	350M†	75000
TRP614	350M	75000
TRP616	500M	50000
TRP606	500M	100000
TRP607	500M	250000
TRP608	1 Meg.	200000
TRP609	1 Meg.†	500000
TRP610	1 Meg.	20000
TRP611	1 Meg.	170000
TRP612	2 Meg.	25000
TRP618	2 Meg.	200000
TRP613	2 Meg.	450000
TRP620	2 Meg.	1 Meg.
TRP624	2½ Meg.†	250000
		500000
TRP615	3 Meg.	1 Meg.

### Standard Switch

Fit all Yaxley Standard size Controls. Easily attached. Underwriters' approved. Depth  $\frac{3}{8}$ ".  
A 12720—Code 6-9-S.P.S.T.  
YOUR PRICE, EACH..... **29c**  
D12721—Code 6T-S.P.S.T. With dummy lug.  
A 12722—Code 7-D.P.S.T. **35c**  
A 12723—Code 8-S.P.D.T. **EACH**  
A 12724—Code 13-3 Pole \*  
A 12725—Code 14-4 Pole \*  
\*Shorting type for battery sets.

### Midget Tapped Controls

**Plug-In Shaft Type**  
For Tone Compensation Circuits  
Price Less Switch-Less Switch  
List Price, \$1.25.  
YOUR PRICE, Each..... **73c**

Control Number	Ohms Resist.	Tapped at Ohms	Res. Taper
TM219*	250M	50M	V
TM220	250M	50M	V
TM221	250M	125M	V
TM222*	250M	125M	V
TM225	350M	75M	V
TM228	500M	5M	VI
TM229*	500M	125M	V
TM230	500M	125M	V
TM231	500M	250M	V
TM232*	1 Meg.	250M	V
TM240	1 Meg.	200M	V
TM241*	1 Meg.	200M	V
TM242*	1 Meg.	450M	V
TM243	2 Meg.	500M	V
TM245	2 Meg.	5M	VI
TM246	2 Meg.	25M	V
TM247	2 Meg.	50M	V
TM248	2 Meg.	200M	V
TM249	2 Meg.	500M	V
TM251	2 Meg.	1 Meg.	V
TM252*	2 Meg.	1 Meg.	V
TM253	2 Meg.	5 & 500M	Spec. IV
TM257	3 Meg.	1 Meg.	I

### Midget Switches

Fit all Yaxley Midget Controls. Snaps into place. Underwriters' approved. \*For battery sets.  
D12715—M26—SPST  
YOUR PRICE, Each..... **29c**  
D12719—M26T—SPST with dummy lug.  
D12716—M27—DPST  
D12717—M28—SPDT  
D12718—M23—3 Pole\*  
D12726—M24—4 Pole\*  
YOUR PRICE **35c** EACH

### Plug-In Shafts

For Midget Controls at Left.  
List Price, 25c.  
YOUR PRICE, EACH..... **15c**

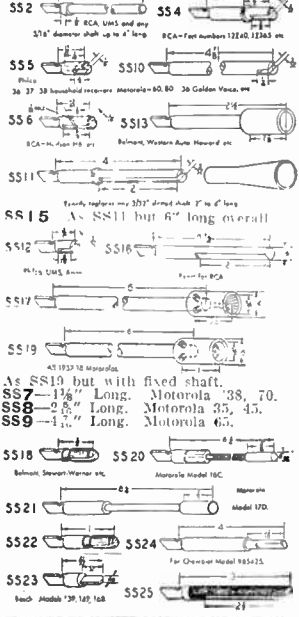





**Controls Exactly Fit — No Changes are Necessary**

See Your Centralab Volume Control Guide or Listing Below for Proper Replacement or Specify Receiver Name, Year and Model and We Will Ship Correct Control.

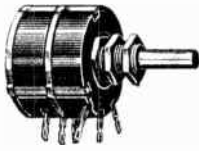

Radolek has in stock practically every Centralab Exact Duplicate Replacement Control for immediate delivery. Controls shown below are the most popular types and help you select the correct replacement by manufacturers' part number. If the control you need is not shown below, give set name, model number and other available information and we will make immediate shipment. (Centralab controls have a uni-

versal reputation for superior performance and quality construction. Controls have improved characteristics over originals. Shafts exactly duplicate original and require no changes for installation. Switch type control will be supplied where original has switch. When ordering controls from Centralab Volume Control Guide, deduct 40% & 2% from list price to obtain your net price.

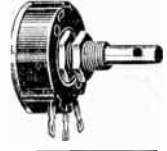

Radio Name and Part Number	Centralab Replace't	Your Price	Radio Name and Part Number	Centralab Replace't	Your Price	Radio Name and Part Number	Centralab Replace't	Your Price	Radio Name and Part Number	Centralab Replace't	Your Price
<b>AIRLINE—See Wells-Gardner</b>			<b>GRUNOW-27687</b>			<b>PHILCO-Cont.</b>			<b>SPARTON-5663</b>		
<b>ATWATER-KENT-5510</b>	72-112	\$0.88	29404	2211905	\$1.18	2015901	2015901	\$1.18	Models 69, 79A,	75-543	1.76
15160	G-122	1.76	33300	2211901	1.18	33-5115, 33-5142-1	2221909	1.18	101, 109, 110AC,		
16270, 16630	G-121	1.76	33775	2015900	1.18	33-5121	D-257	.88	301, 591, 593,		
17270	25-426	1.76				33-5139, 33-5148	D-257	.88	930, 931	1010963	.88
17736, 21816	G-121	1.76							Models 89A, 103,		
<b>BOSCH-99836</b>			<b>MAJESTIC-105</b>			33-5152			E-238	1.18	
Model 28, 29	74-501	1.47	393 (Equal)	72-180	.88	33-5153, 33-5155	2221906	1.18	564, 570, 574, 600,	1010964	.88
	72-207	.88	559	78-007	.88	33-5158, 33-5166	R-103	.88	610, 620, 737, 740		
<b>CLARION-P1813</b>			3189			33-5202			D-257	.88	
55-004	55-004	1.18	4682, 8304	74-523	1.18	33-5216	R-110	.88	<b>STEW.-WARN.</b>	30-010	.88
<b>CROSLEY-7022</b>	72-019	.88	5316	55-014	1.18				66033, 66389		
7564	51-037	.88									
23818A	211905	1.18									
<b>DELCO-1210545</b>			<b>PHILCO-3076</b>			33-5224, 33-5225			R-110	.88	
120040, 1202073	R-108	.88	4093	24-016	.88	33-5232, 33-5233	R-110	.88	<b>STROMBERG CARLSON</b>		
1211774	74-517	1.47	4094, 5039	72-177	.88	33-5511, 38-5280	E-237	1.18	Models 846, 848	72-205R*	.88
	88-109	1.18	5232	74-559	1.47	38-5534, 38-5058	E-236	1.18	72-206R*	72-206R*	.88
<b>GEN. ELECT. Also See RCA</b>			7439			38-5534, 38-5058			E-236	1.18	
<b>RV-028, -029, -030</b>	R-109	.88	33-5006	2021900	1.18	38-5534, 38-5058	E-236	1.18			
36X200	9011005	1.18	33-5013 (2 meg)	2021001	1.18	38-5534, 38-5058	E-236	1.18			
Series E61 to 106	8-101	1.18	33-5013 (350M)	2221903	1.18	38-6605, 38-6786	1210916	.88			
<b>GREBE-SK44C</b>			33-5017, 33-5154			<b>RCA-VICTOR</b>			3092, 3094	1210900	.88
	74-515	1.47	33-5022, 33-5023	1010980	.88	4790, 72291-7	5018	1.18	1211903	1.18	
			33-5022 (350M)	2211900	1.18				S-103	1.18	
				2221903	1.18				D-256	.88	
				2021909	1.18				1210913	.88	
				2021901	1.18				R-100	.88	
				2211904	1.18				1210912	.88	
				2211900	1.18				74-600	1.47	
				1010989	.88				74-524	1.47	
				33-5105	1.18				74-526	1.47	
				33-5106-2	1.18				1210912	.88	
				33-5108, 33-5110	1.18				1210913	.88	
				2221909	1.18				63-985	.88	

Radolek will fill your order promptly and at lowest prices for all your Centralab requirements. Centralab catalogue sent on request.

\*Front and rear controls are matched, do not purchase separately.

**Taper Curve Chart**

Curve 1. Uniform resistance change at either end of control. Used in any circuit where negligible amount of current flows through control as in voltage divider circuits.  
 Curve 2. Current type control used as series rheostat in cathode, plate or screen grid circuits where current flows through control.  
 Curve 3. Combination Antenna-Cathode Bias type volume control. Controls bias of 1 or 2 tubes and also antenna input.  
 Curve 4. Same as curve 3 control but for higher current cathode circuits (controls cathode of 2 or more tubes and antenna input).  
 Curve 6. Proper control for use in antenna (low resistance types) and grid or tone control circuits (high resistance types) where little or no current flows through control.  
 Curve 10. Curve of tapped controls used in audio grid circuits having tone compensation.

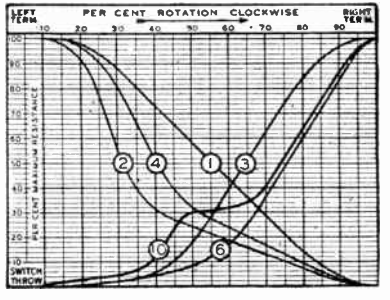

**Knurled Shaft Midget Radiohms**



New midget controls with long 1/4" diameter brass knurled shafts. Shafts are slotted for easy cutting to length. Electrical and physical specifications are exactly similar to other midget controls listed on opposite page. Priced less switch. Uses attachable switch listed on opposite page.

Resist. Ohms	Cur.	Stock No.	Mfg. Code	Shaft Lgth.	List Price	Your Price
250M	6	C12950	NK-139	4"	\$1.00	59¢
500M	6	C12951	NK-140	4"	1.00	
1 Meg.	6	C12952	NK-141	4"	1.00	
2 Meg.	6	C12953	NK-142	3 3/4"	1.00	Each

**Tapped Controls**

Resist. Ohms	Cur.	Stock No.	Mfg. Code	Shaft Lgth.	List Price	Your Price
500M	10	C12954	NK-143	3 3/4"	1.50	88¢
1 Meg.	10	C12955	NK-144	3 3/4"	1.50	Each

**Centralab Control Guide**

Handy pocket size Volume Control Replacement Guide. 216 Pages covering every radio and model giving manufacturer's part number. Also includes data on Power, rheostats, Attenuators, Resistors, etc.

**A12458 YOUR PRICE 10¢**

FREE with order for 5 or more Centralab Controls.

**New RADOLEK Volume Controls**

A new high quality series of replacement volume controls made for us by one of the oldest and foremost variable resistance manufacturers in the industry. Each All terminals are insulated. Lots of 5, Each, 25¢ plus shipping. 1/2" long. 3/8" Bushing, 3/8" case. Two nuts included. For Taper explanation see curve chart at left.

**Less Switch 28c**

**Low Resist. Wirewound Controls**

**Safely Dissipate 4 Watts**

Wire element wound on fibre strip, fully insulated from case and shaft. Strong spring bronze contact rider. Body size, less switch 1 1/2" Dia., 1/2" Deep.

Resistance Ohms	Taper	Stock Number	Resistance Ohms	Taper	Stock Number
10	1	A12600	3000	1	A12610
100	1	A12604	5000	1	A12631
200	1	A12605	5000	6	A12634
600	1	A12607	10000	6	A12633
1000	1	A12608	10000	6	A12632

**High Resistance Carbon Controls**

**Rated 1 Watt**

A dependable volume control. Smooth contact assures quiet operation. Body size, less switch: 1 1/2" Dia., 1/2" Deep.

Resistance Ohms	Taper	Stock Number	Resistance Ohms	Taper	Stock Number
5000	1	A12612	30000	6	A12622
10000	6	A12615	50000	1	A12623
10000	1	A12616	75000	2	A12624
10000	3	A12630	100000	6	A12625
15000	1	A12618	200000	6	A12626
20000	6	A12619	250000	6	A12627
25000	1	A12620	500000	6	A12628
25000	6	A12621	1 Meg.	6	A12629

**Special Replacement Volume Controls**

**For RCA Victor Receivers**

RCA Victor Models R32, RE45, R52, RE75, R154, RE155

3.800 ohms each section. Replaces part number 10450 and Stack pole 77150-1.

**A12860—List. \$2.50. YOUR PRICE 90¢**

For Models R-14, R-15, RE-17, R-42 R-48 Part Number 7129

A dual type wire wound control. The exact control specified by R.C.A. for the above receivers.

**A12859—List. \$2.50. YOUR PRICE \$1.14**

**For Philco Receivers**

Philco Models 20, 30A, 21, 220, 40DC, 41DC, 42DC, 77A. Philco Part No. 4094. A12850.

**YOUR PRICE 92¢**

Philco Models 70, 70A, 270A, 370, 90 (2-45), 90A (2-45), 470, 470A. (Part No. 5039.) A12851.

**YOUR PRICE \$1.06**

**Genuine Philco Controls**

Radolek can supply any Philco part. Give Philco part number and description and we will ship at lowest dealer price.

**Snap-On Switches**

Converts any Universal Radolek Control into switch type. Underwriters' Approved Switch.

**A12700—SPST — For Wirewound Controls.**

**A12701 — SPST — For H R Carbon Controls.**

**YOUR PRICE 12c**

Either Type.....

# KEYSTONE Electrolytic CONDENSERS

**WORLD'S GREATEST VALUES!**

## Compare These Construction Features

Typical of all Keystone Condensers

- 1-Condenser unit wound with highest quality aluminum foil, 99.8% pure.
- 2-Two thicknesses of high-grade cellulose separators. Will stand up under abnormal surge voltages.
- 3-DOUBLE-SEALED. First, with a Moisture-proof "Humidostat" Wrapper, then a coating of heat resistant mineral plastic over condenser unit.
- 4-Terminal leads securely and permanently anchored to condenser unit. Special method of tab construction eliminates corrosion of leads.
- 5-Machine wound insuring uniform capacity characteristics.
- 6-Six inch insulated, push-back leads.
- 7-Sturdy cardboard container. Wax impregnated. Fully moisture-proof.
- 8-Mounting tabs securely support condenser in place. May be cut off.

**Guaranteed for 1 Year!**

All Keystone Condensers are guaranteed for 1 full year! Should any fail to provide 12 months of satisfactory performance when operated at correct rated voltage, we will replace it, no charge. "KEYSTONES" are the world's finest condenser values!

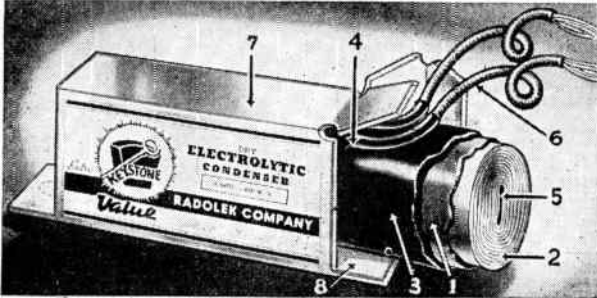

## Dry Electrolytics In Tab Cardboard Containers

**8 MFD.** 450 W.V. D.C. **20c**  
In Lots of 10 or More, Assorted, In Single Lots, Each, 24c

B7230—Size  $\frac{1}{2} \times 1 \frac{1}{2} \times 2 \frac{3}{4}$ "

Stock Number	Cap. Mfd.	Work. Volts	Peak Volts	Size Inches	No. of Leads	Price Each	In 10 Lots, Each
B7230	8	450	600	$\frac{1}{2} \times 1 \frac{1}{2} \times 2 \frac{3}{4}$	2	24c	20c
B7231	8x8	450	600	$1 \frac{1}{2} \times 1 \frac{1}{2} \times 2 \frac{3}{4}$	4	44c	38c
B7232	16x12	200	250	$1 \frac{1}{2} \times 1 \frac{1}{2} \times 2 \frac{3}{4}$	7	45c	39c
B7233	10x10	30	35	$1 \frac{1}{2} \times 1 \frac{1}{2} \times 2 \frac{3}{4}$	4	52c	45c
B7233	8x8	200	250	$1 \frac{1}{2} \times 1 \frac{1}{2} \times 2 \frac{3}{4}$	6	52c	45c
B7233	20	200	250	250f			

## Dry Electrolytics In Inverted Stud Mounting Metal Containers

Same high quality as above dry Electrolytic Condensers. Hermetically sealed in stud mounting metal tubular container. Condenser is insulated from container. 6" insulated wire leads. Lock nut included. 1" DIA. units mounts in  $\frac{3}{8}$ " hole, others  $\frac{1}{2}$ ". \*With lug terminal; condenser is grounded to container.

**8 MFD.** 450 W.V. D.C. **27c**  
In Lots of 10, Each,.....

Stock Number	Cap. Mfd.	Work. Volts	Peak Volts	Size Inches	No. of Leads	Price Each	In 10 Lots, Ea.
B7234	8	450	600	$1 \frac{1}{2} \times 3 \frac{3}{8}$	2	29c	27c
B7116	8	450	600	$1 \frac{1}{2} \times 3 \frac{3}{8}$	2	38c	34c
C7108	8*	450	600	$1 \frac{1}{2} \times 3 \frac{3}{8}$	1 Lug	38c	34c
C7179	16	450	600	$1 \frac{1}{2} \times 3 \frac{3}{8}$	2	45c	40c
B7235	8x8	450	600	$1 \frac{1}{2} \times 3 \frac{3}{8}$	4	52c	48c



## Dry Electrolytics in Round Cardboard Containers—Spade Lugs

Moisture-proof cardboard aluminum coated containers. Sealed with high melting point compound. Mounting lugs take 6/32 nuts. 6" Long insulated wire leads.

**8x8 MFD.** B7236 **38c**  
In Lots of 10, Each,.....

Stock Number	Cap. Mfd.	Work. Volts	Peak Volts	Size Inches	No. of Leads	Price Each	In 10 Lots, Ea.
B7236	8x8	450	600	$1 \frac{1}{2} \times 3 \frac{3}{8}$	4	44c	38c
B7237	16x12	200	250	$1 \frac{1}{2} \times 3 \frac{3}{8}$	7	45c	39c
B7238	10x10	30	35	$1 \frac{1}{2} \times 3 \frac{3}{8}$	4	40c	34c
B7238	16x12	200	250	$1 \frac{1}{2} \times 3 \frac{3}{8}$	4	40c	34c



## New "Mini-Mikes" Electrolytics

Aluminum Containers Enclosed in Fibre Tubes



Latest development in dry electrolytics. Pkt into smallest spaces. Full capacity. Low leakage. Low R.F. impedance. Will withstand high surges and high temperatures. Hermetically sealed. Absolutely protected against "blow-ups." Will not deteriorate no matter how long you keep them in stock. 2" leads.

**8 Mfd.** 450 W.V. D.C. **23c**  
In Lots of 10, Each,.....

**16 Mfd.** 150 W.V. D.C. **20c**  
In Lots of 10, Each,.....

**10 Mfd.** 35 W.V. D.C. **18c**  
In Lots of 10, Each,.....

Cap. Mfd.	Work. Volts	Peak Volts	Dimensions	Long	Stock Num.	List Price	Price Each	In 10 Lots, Each
4	450	525	$1 \frac{1}{2} \times 1 \frac{1}{2}$	$1 \frac{1}{2}$ "	D7129	\$0.55	24c	22c
8	450	525	$1 \frac{1}{2} \times 1 \frac{1}{2}$	$1 \frac{1}{2}$ "	D7181	.60	25c	23c
16	450	525	$1 \frac{1}{2} \times 1 \frac{1}{2}$	$2 \frac{3}{4}$ "	D7132	.90	39c	37c
8	250	300	$1 \frac{1}{2} \times 1 \frac{1}{2}$	$1 \frac{1}{2}$ "	D7137	.50	22c	20c
N	250	300	$1 \frac{1}{2} \times 1 \frac{1}{2}$	$1 \frac{1}{2}$ "	D7139	.75	33c	31c
16	150	200	$1 \frac{1}{2} \times 1 \frac{1}{2}$	$1 \frac{1}{2}$ "	D7182	.50	22c	20c
20	150	200	$1 \frac{1}{2} \times 1 \frac{1}{2}$	$1 \frac{1}{2}$ "	D7142	.60	26c	24c
10	35	50	$1 \frac{1}{2} \times 1 \frac{1}{2}$	$1 \frac{1}{2}$ "	D7183	.40	20c	18c
16-16	400	250	$1 \frac{1}{2} \times 1 \frac{1}{2}$	$2 \frac{3}{4}$ "	D7148	1.05	45c	42c
8-8	250	525	$1 \frac{1}{2} \times 1 \frac{1}{2}$	$2 \frac{3}{4}$ "	D7149	1.00	44c	42c

## Wet Electrolytic Condensers

With Inverted Stud Mounting

These Keystone High-Grade Wet Electrolytic Condensers are now offered in popular capacities at such low prices that they make the hazards of using "job-lot" wet not worth the small difference in cost. Self-healing, they withstand high voltage overloads without harm. PROPERLY VENTED. Leak-proof. Long-life. Aluminum can is negative.

**8 MFD.** 500 V. DC **29c**  
In Lots of 10, Each,.....

Stock Number	Cap. Mfd.	D.C. Volts	Size Inches	Hts Hole	Price Each	In 10 Lots, Ea.
D7250	8	500	$1 \frac{1}{2} \times 4 \frac{3}{8}$	$\frac{3}{8}$ "	36c	29c
D7251	8	500	$1 \frac{1}{2} \times 4 \frac{3}{8}$	$\frac{3}{8}$ "	36c	29c
D7254	8	500	$1 \frac{1}{2} \times 4 \frac{3}{8}$	$\frac{3}{8}$ "	45c	39c
D7252	16	500	$1 \frac{1}{2} \times 4 \frac{3}{8}$	$\frac{3}{8}$ "	45c	39c
D7253	25	500	$1 \frac{1}{2} \times 4 \frac{3}{8}$	$\frac{3}{8}$ "	55c	49c



## Tubular Condensers

Paper Dielectric

Wax Filled

Carefully made of finest materials. Wax impregnated and hermetically sealed in tubular fibre cases. 1/2" Leads. Sizes vary from 1 1/2" to 2 1/2" long and 1 1/2" to 1 3/4" in diameter. Guaranteed 1 year.

Stock Number	Cap. Mfd.	DC Wkg. Volts	Price Each	In Ten Lots Ea.
C5583	.001	600	<b>6c</b>	<b>5c</b>
C5586	.006	600		
C5587	.01	600		
C5588	.02	600		
C5589	.03	600	<b>7c</b>	<b>6c</b>
C5590	.05	600		
C5568	1	400	<b>7c</b>	<b>7c</b>
C5570	.25	400		
C5571	3	400		
C5575	5	400		
C5593	.1	600	<b>9c</b>	<b>8c</b>
C5595	.25	600		
C5596	.5	600		

## Tubular Condensers

High Voltage



1000 W.V. DC  
3000 Volts Peak  
Polystyrene Dielectric  
Wax Filled

Though rated at 3000 D.C. volts peak, these condensers are no larger than the usual 600 W.V. type yet have a longer life. These quality tubular condensers offer you a safe, replacement for radio receivers, power amplifiers, etc. 1/2" Tinned wire leads. Completely hermetically sealed.

Stock Num.	Cap. Mfd.	Size	Price Each	In Ten Lots, Ea.
D8550	.001	$\frac{3}{8} \times 1 \frac{1}{2}$	<b>9c</b>	<b>8c</b>
D8551	.002	$\frac{3}{8} \times 1 \frac{1}{2}$		
D8552	.003	$\frac{3}{8} \times 1 \frac{1}{2}$		
D8553	.005	$\frac{3}{8} \times 1 \frac{1}{2}$		
D8554	.006	$\frac{3}{8} \times 1 \frac{1}{2}$		
D8555	.01	$\frac{3}{8} \times 1 \frac{1}{2}$	<b>9c</b>	<b>8c</b>
D8556	.02	$\frac{3}{8} \times 1 \frac{1}{2}$		
D8557	.05	$\frac{3}{8} \times 1 \frac{1}{2}$		
D8558	.1	$\frac{3}{8} \times 1 \frac{1}{2}$		
D8559	.25	$\frac{3}{8} \times 2$		
D8560	.5	$\frac{3}{8} \times 2$		

## Buffer Condensers

Oil Filled



1600 W. V. DC  
Paper Dielectric  
Metal Shell  
Type

Finest quality oil impregnated and oil filled paper dielectric condensers. Securely sealed in compact round metal containers and fully insulated with waxed cardboard tube overall. Container is grounded to one lead. Impervious to moisture. Extremely compact.

Stock Number	Cap. Mfd.	Size Dia.xL.	Net Each	In Ten Lots Ea.
C8750	.005	$\frac{3}{8} \times 1 \frac{1}{2}$	19c	17c
C8751	.01	$\frac{3}{8} \times 1 \frac{1}{2}$	24c	22c
C8752	.02	$\frac{3}{8} \times 1 \frac{1}{2}$	27c	25c
<b>Wax Filled Type—1600 Volt</b>				
An economical and commonly used type. Constructed with oil impregnated paper windings, placed in a treated fibre tube, then thoroughly sealed with wax. Tinned copper wire leads.				
C8753	.005	$\frac{3}{8} \times 1 \frac{1}{2}$	<b>16c</b>	<b>14c</b>
C8754	.01	$\frac{3}{8} \times 1 \frac{1}{2}$	18c	16c
C8755	.02	$\frac{3}{8} \times 1 \frac{1}{2}$	20c	18c

Note: All Condensers On This Page May Be Assorted To Obtain Ten Lot Price



# Bargain Condensers

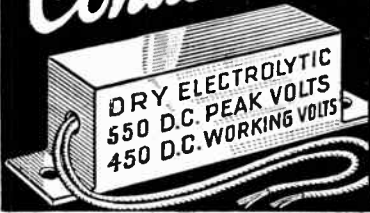

## Dry Electrolytics 450 D.C. Working Volts —550 Peak

Compact Dry Electrolytic Condensers. Housed in sturdy cardboard containers. Mounting flanges. Long insulated wire leads. Built to a high standard by a reputable manufacturer. Fully guaranteed.

### 8 Mfd.

R7202—8 Mfd. at 450 Volts. Body size: 2 3/4" long, 1 1/2" wide, and 4 1/2" high. Length with flanges: 3 3/4".  
**YOUR SPECIAL PRICE, EACH..... 14c**

10 for \$1.22 25 for \$3.09

### 8-8 Mfd.

R7203—Dual 8 Mfd. at 450 Volts. 4 leads. Body size: 2 3/4" long, 1 1/2" wide and 1 1/2" high.  
**YOUR SPECIAL PRICE, Each..... 33c**

10 for \$2.90

### 16-8-5-5 Mfd.

R7228—For AC-DC receivers. 16-8 Mfd. at 240 DC working volts and 5-5 Mfd. at 35 DC working volts. Has 7 leads. Body size: 3" long, 1 1/2" wide and 1 3/4" high.  
**YOUR SPECIAL PRICE, Each..... 34c**

10 for \$3.15

## Mica Condensers

Suitable for all by-passing uses. Compact molded bakelite case. Moisture proof. Tinned Wire Leads. Size 3/4" Square.

Stock Number	Cap. Mfd.	Your Price
K8505	.000025	Each
K8506	.00004	6c
K8507	.00006	10 for 55c
K8508	.0001	
K8509	.00015	
K8510	.0002	
K8511	.00025	Each
K8512	.0003	8c
K8513	.0004	10 for 75c
K8514	.0005	
K8515	.00075	
K8516	.001	Each
K8517	.0015	10c
K8518	.002	10 for 95c
K8519	.0025	Each
K8520	.003	12c
K8521	.004	10 for \$1.10

## By-Pass Condensers

### Metal Cased

Best quality paper dielectric. Hermetically sealed in metal containers. Metal foil elements. Size 1 1/2 x 1 1/2 inches.

Stock Number	Cap. Mfd.	D.C. Working Volts	Your Price
K8628	.05	400	12c
K8629	.1	400	15c
K8630	.25	400	19c
K8631	.5	400	22c
K8632	1	400	26c

Size 1 1/2 x 1 1/2 inches.

K8637	.25-25	400	30c
K8638	.5-5	400	37c
K8639	1	400	31c
K8632	1	400	39c

## Special Value Tubular Condensers

Paper and Foil Type

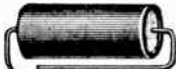

Wax impregnated. Tubular fibre cases. 1 1/2" wire leads. 2 1/2" Long. 1/2" to 1 1/4" Diam.

Stock Num.	Cap. Mfd.	Work. Volts	Price Each	Ten Ten
K8605	.01	600		
K8606	.012	600		
K8607	.014	600	3c	29c
K8608	.016	600		
K8609	.01	600		
K8610	.02	600	4c	39c
K8611	.05	600		
K8612	.1	600	5c	45c
K8613	.25	400	7c	69c
K8614	.5	400	10c	91c
K8617	1	400	15c	\$1.35
K8615	.25	600	9c	85c
K8616	.5	600	13c	\$1.17

## Uncased Replacement Condenser Sections



Wax-sealed, paper dielectric. Guaranteed for one full year—free replacement when used under proper conditions. 6" Insulated leads.

Stock Num.	Cap. Mfd.	Wk. Volts	Size Inches	Your Price
K8620	1	300	2 3/4 x 1 1/2 x 3/4	11c
K8621	1	300	2 3/4 x 1 1/2 x 3/4	11c
K8622	2	300	2 3/4 x 1 1/2 x 3/4	29c
K8623	.5	500	2 3/4 x 1 1/2 x 3/4	18c
K8624	1	500	2 3/4 x 1 1/2 x 3/4	28c
K8625	2	500	2 3/4 x 1 1/2 x 3/4	54c
K8626	1	600	2 3/4 x 2 1/4 x 3/4	33c
K8627	2	600	2 3/4 x 2 1/4 x 3/4	50c

## Sprague "ATOMS" Midget Dry Electrolytics Etched Foil Type

450 V. Wkg.—525 V. Peak

Unconditionally guaranteed. Extremely low leakage. High surge voltage. Low power factor. The smallest sized condensers of their capacity. Hermetically sealed in metal tubular containers (single units only) insulated with impregnated fiberboard. Absolutely protected against "Blow-up." Sturdy solid wire leads support condenser in any position and offer quicker and easier mounting. Uniform size lengths permit several of these condensers to be bound in one unit with strap listed below.



Stock Number	Cap. Mfd.	Container Diam.	Length	List Price	Your Price
A8294	4	3/8"	1-3/8"	\$0.55	32c
A8295	8	3/8"	1-3/8"	.60	35c
A8296	12	3/8"	1-3/8"	.75	44c
A8297	16	3/8"	2-1/8"	.90	53c
A8298	20	3/8"	2-1/8"	1.00	59c
A8272	8-8*	1 1/4"	2-1/8"	1.05	62c
C8274	8-8*	1 1/4"	2-1/8"	1.35	79c

\*3 leads. com. neg. 14 Leads Sep. Sections.

## Low Voltage "Atoms"

Ideal for Compact Radio Receivers Save Time! Money! Space!

Handy compact condenser units for use in any bypass or filter circuit. 150-200 Volt types are especially designed for the midget AC-DC type receivers. 25-50 Volt types are for by-pass work.

Stock Number	Cap. Mfd.	Work. Volts	Container Diam.	Length	List Price	Your Price
A8281	10	25	3/8"	1 3/8"	\$0.40	24c
A8282	25	25	3/8"	1 3/8"	.50	29c
C8285	10	50	3/8"	1 3/8"	.45	27c
A8284	25	50	3/8"	1 3/8"	.55	32c
A8285	4	150	3/8"	1 3/8"	.40	24c
A8286	8	150	3/8"	1 3/8"	.45	26c
A8285	12	150	3/8"	1 3/8"	.50	29c
A8287	16	150	3/8"	1 3/8"	.55	32c
A8288	20	150	3/8"	1 3/8"	.60	35c
A8289	40	150	3/8"	1 3/8"	.65	38c
A8290	4	250	3/8"	1 3/8"	.45	26c
A8291	8	250	3/8"	1 3/8"	.50	29c
A8292	12	250	3/8"	1 3/8"	.55	32c
A8293	16	250	3/8"	1 3/8"	.75	44c

## Dual Cardboard Tubulars

Stock Number	Cap. Mfd.	Work. Volts	Container Diam.	Length	List Price	Your Price
C8299	10-10	50	3/8"	2 3/8"	.80	47c
C8256	8-8	150	3/8"	2 3/8"	.80	47c
C8257	20-20	150	3/8"	2 3/8"	1.05	62c
C8200	8-16	250	3/8"	2 3/8"	1.05	62c
C8273	16-16	200	3/8"	2 3/8"	1.05	62c
C8201	8-16	450	1"	2 3/8"	1.35	79c

# ILLINOIS Dry Electrolytic Condensers

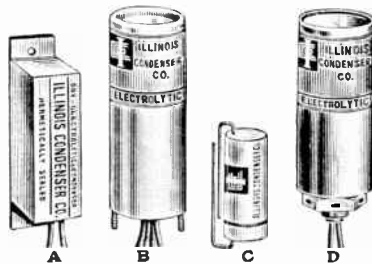

Illinois condensers are known for their uniformly high quality. They are produced in a modern factory employing special forming and sealing equipment. Skilled engineering results in close control, with accurate capacitance and low power factor. Only pure chemicals and the finest of raw materials are used. Multiple units have separate leads for each section. FRESH STOCK. PACKED IN INDIVIDUAL CARTONS.

## A—Rectangular Cardboard Case

Cap. Mfd.	Stock Num.	Peak Volts	Size Inches	Price Each	In Ten Lots Each
8	D8756	600	2 3/4 x 3/4 x 1 1/8	37c	33c
8-8	D8757	600	3 1/8 x 1 1/4 x 1 1/4	29c	26c
16-12	D8758	250	3 x 1 x 1 1/4	53c	47c
25	D8759	250	3 x 1 x 1 1/4	75c	67c
8-8	D8759	250	3 x 1 x 1 1/4		
16-12	D8760	250	3 x 1 x 1 1/4	65c	58c
10-10		35			

## B—Lug Mtg. Cardboard Container

Cap. Mfd.	Stock Num.	Peak Volts	Size Inches	Price Each	In Ten Lots Each
8-8	D8761	600	1 3/4 x 3 1/4	59c	53c
16-12	D8762	250	1 3/4 x 3 1/4	49c	44c
16-12	D8763	250	1 3/4 x 3 1/4	65c	58c
10-10		35			

## C—Tubular Cardboard Container

Cap. Mfd.	Stock Num.	Peak Volts	Size Inches	Price Each	In Ten Lots Each
8	D8764	250	3/4 x 1 3/4	29c	26c
16	D8766	250	3/4 x 2 3/4	41c	37c
10	D8765	35	3/4 x 1 3/4	19c	17c
10-10	D8767	35	3/4 x 1 3/4	25c	23c

## D—Inverted Stud Mounting Metal Case

Cap. Mfd.	Stock Num.	Peak Volts	Size Inches	Price Each	In Ten Lots Each
8	D8768	600	1 x 3 3/4	41c	37c
8-8	D8779	600	1 3/4 x 3 3/4	41c	37c
8-8	D8769	600	1 3/4 x 3 3/4	63c	56c

NOTE: May be assorted to obtain ten lot Price.

## "Illini Hy-Cap" Tubular Electrolytics



A compact etched foil condenser which has full capacity and voltage rating. Metal cased with varnished Bristol-board insulating sleeve.

Stock No.	Cap. Mfd.	Wkg. Vol.	Size Inches	Price Each	In 10 Lots Eac.
D8770	8	450	3/4 x 1 3/4	24c	22c
D8771	8x8*	450	1 x 3 3/4	41c	37c
D8772	16	150	1 1/4 x 1 3/4	22c	20c
D8773	24	150	1 1/4 x 1 3/4	24c	22c
D8774	40	150	3/4 x 1 3/4	28c	25c
D8775	30x20*	150	3/4 x 2 3/4	45c	40c
D8776	25	60	1 1/4 x 1 3/4	22c	20c
D8777	10	25	1 1/4 x 1 3/4	15c	14c

\*4 separate leads.

## High Voltage Paper Condensers

To Replace Electrolytic Units

### Cardboard Cased Units

For replacing defective electrolytics of the values specified below. Cardboard containers are identical in size and appearance to electrolytic units. 6" long heavy insulated leads. All single units have 1 Pos. and 1 Neg. lead. Dual condensers have 2 Pos. and 2 Neg. leads. Non-inductive.

### 475 DC Wkg. Volts—600 Peak

Stock Number	Cap. Mfd.	Size L. W. D.	Your Price
K8420	2	4 3/4 x 1 3/4 x 1 1/4	\$0.44
K8421	4	4 3/4 x 1 3/4 x 1 1/4	.50
K8422	8	4 3/4 x 1 3/4 x 1 1/4	.62
K8425	8-8	4 3/4 x 1 3/4 x 2 1/4	1.06

### 600 DC Wkg. Volts—1000 Peak

K8426	2	4 3/4 x 1 3/4 x 1 1/4	\$0.56
K8427	4	4 3/4 x 1 3/4 x 1 1/4	.68
K8428	8	4 3/4 x 1 3/4 x 1 1/4	.88
K8429	4-4	4 3/4 x 1 3/4 x 1 3/4	1.09
K8430	8-8	4 3/4 x 1 3/4 x 2 1/4	1.44

### Inverted Stud Mounting Aluminum Container

To replace electrolytics. Identical in size and appearance to standard electrolytics in the aluminum can. Neutral container 6" long insulated leads. All single units have 1 Pos. and 1 Neg. lead. Dual units have 2 Pos. and 2 Neg. leads. Non-inductive. If grounded container is desired the negative lead may be connected directly to the chassis.

### 475 DC Wkg. Volts—600 Peak

Stock Number	Cap. Mfd.	Size Diam. H.	Your Price
K8432	8	1 3/4 x 4 3/4	\$0.76
K8434	8-8	1 3/4 x 4 3/4	1.32

### 600 DC Wkg. Volts—1000 Peak

K8435	4	1 3/4 x 4 3/4	\$0.82
K8436	8	1 3/4 x 4 3/4	1.00
K8437	8-8	1 3/4 x 4 3/4	1.56

NOTE: Capacities given are sizes of electrolytics replaced and NOT actual capacity of Paper Condenser quoted.

# ELECTROLYTIC AEROVOX CONDENSERS

## Tubular Dry Electrolytics



Plain foil type. Will stand up longer than etched foil and should therefore be used in preference where condenser is subject to hard service. Housed in cardboard tube containers. Completely sealed. Light and compact. 2 1/2" leads. Single section—2 leads. Double section—3 leads.

### PR450—450 D.C. Working Volts

Stock Number	Cap. Mfd.	Size Inches Dia. x Long	Your Price
A7873	2	1 1/2 x 2 1/4	38c
A7874	4	1 1/2 x 2 1/4	44c
A7875	8	1 1/2 x 2 1/4	56c

### PR100—100 D.C. Working Volts

D7862	10	1 1/2 x 2 1/4	41c
A7870	25	1 1/2 x 2 1/4	56c

### PR50—50 D.C. Working Volts

A7864	5	1 1/2 x 2 1/4	29c
A7865	10	1 1/2 x 2 1/4	38c
A7867	25	1 1/2 x 2 1/4	47c
A7858	50	1 1/2 x 2 1/4	70c
D7863	5-5	1 1/2 x 2 1/4	44c

### PR25—25 D.C. Working Volts

A7859	5	1 1/2 x 2 1/4	29c
A7869	10	1 1/2 x 2 1/4	29c
A7857	20	1 1/2 x 2 1/4	35c
A7861	25	1 1/2 x 2 1/4	38c
D7871	10-0	1 1/2 x 2 1/4	44c

## Cartridge Condensers

Paper Di-electric Non-inductive foil type wound. Wax impregnated. 2 1/2" leads.

### Type 284—Type 484

Stock Number	Your Price	Cap. Mfd.	Stock Number	Your Price
A7890	8c	001	A7908	9c
A7891	8c	002	A7909	9c
A7892	8c	005	A7910	9c
A7893	8c	006	A7911	9c
A7894	8c	01	A7912	9c
A7895	8c	015	A7913	9c
A7896	8c	02	A7914	9c
A7897	8c	03	A7915	9c
A7898	8c	05	A7916	9c
A7899	11c	1	A7917	12c
A7901	14c	15	A7918	15c
A7902	21c	25	A7919	21c
A7903	23c	1-0	A7920	21c
			A7921	23c

### Type 684—Type 1084

Stock Number	Your Price	Cap. Mfd.	Stock Number	Your Price
A7926	9c	001	A7937	12c
A7934	9c	002	A7943	12c
A7935	9c	005	A7944	12c
A7937	9c	006	A7938	12c
A7924	9c	01	A7939	12c
A7929	9c	02	A7940	15c
D7936	12c	03		
A7930	12c	05	A7941	21c
A7931	15c	1	A7942	21c
A7932	21c	25		
A7933	29c	5		
D7925	47c	1-0		

## Vibrator Condensers

### Type 1684

Stock Number	Cap. Mfd.	Size Inches Dia. x Long	Your Price
A7960	005	1 1/2 x 1 1/2	21c
A7954	007	1 1/2 x 1 1/2	21c
A7955	01	1 1/2 x 1 1/2	21c
A7956	02	1 1/2 x 1 1/2	21c
A7957	03	1 1/2 x 1 1/2	21c
A7958	04	1 1/2 x 1 1/2	24c
A7959	05	1 1/2 x 1 1/2	26c

## Auto Filter Condensers



Kills static from generators and electrical accessories.

C7945—Type 1140, .5 mfd. 5/8x2".  
C7946—Type 1120, 1. mfd.

**Ford Distributor Type**  
Fits bolts on Ford distributor cap.  
C7953—Type 1114, C7947—Type F or 1937-38-39, 1150, For 1936.

**YOUR PRICE, Each** ..... **29c**  
All Types

## Space-Saver Midget Dry Electrolytics

For use where space is limited. New etched foil process allows same capacity as larger units without lowering wkg. volts rating or service life. Adjustable brackets cover a wide range of mounting requirements.

### Type PBS450

Stock Number	Cap. Mfd.	Size Inches Dia. x W. x Len.	List Price	Your Price
A7974	2	1 1/2 x 1 1/2 x 2 1/4	\$0.65	38c
A7975	4	1 1/2 x 1 1/2 x 2 1/4	.75	44c
A7976	6	1 1/2 x 1 1/2 x 2 1/4	.90	53c
A7976	8	1 1/2 x 1 1/2 x 2 1/4	.95	55c
A7998	10	1 1/2 x 1 1/2 x 2 1/4	1.15	67c
A7977	12	1 1/2 x 1 1/2 x 2 1/4	1.30	75c
A7963	16	1 1/2 x 1 1/2 x 2 1/4	1.40	86c

### PBS450—525 Peak, 450 Volts W.V. Double Section—4 Leads

Stock Number	Cap. Mfd.	Size Inches Dia. x W. x L.	Your Price
A7978	4-4	1 1/2 x 1 1/2 x 2 1/2	\$0.70
A7979	4-8	1 1/2 x 1 1/2 x 2 1/2	.79
A7980	8-8	1 1/2 x 1 1/2 x 2 1/2	.88
A8085	8-16	1 1/2 x 1 1/2 x 3	1.11

### Triple Section—6 Leads

A7981	8-8-8	1 1/2 x 1 1/2 x 3	1.29
-------	-------	-------------------	------

## Wet Electrolytics

High capacity. Compact size. Self healing feature instantly reforms condenser when subjected to high surge voltages. Double sealed vent provides outlet for gas pressure and prevents leakage of liquid electrolyte. Container is negative. Lug terminal. Stud mounts in 3/8 inch hole.

### PG500—500 Volts Surge

Stock Number	Cap. Mfd.	Size Inches Dia. x Long	Your Price
A8036	4	1 1/2 x 3 1/4	\$0.47
A8046	6	1 1/2 x 3 1/4	.50
A8037	8	1 1/2 x 3 1/4	.56
A8047	10	1 1/2 x 3 1/4	.62
A8038	12	1 1/2 x 3 1/4	.67
A8039	16	1 1/2 x 4	.79
A8048	18	1 1/2 x 4	.88
A8040	20	1 1/2 x 4 1/2	.88
A8041	30	1 1/2 x 4 1/2	1.00
D8042	40	1 1/2 x 4 1/2	1.12

### PG600—600 Volts Surge

D8000	4	1 1/2 x 3 1/4	\$0.79
D8001	8	1 1/2 x 4 1/4	.88
D8002	16	1 1/2 x 4 1/4	1.18

### PGM500—500 Volts Surge

Same as PG500 series above, except smaller in diameter.

D8003	8	1 x 3 1/2	\$0.56
D8004	16	1 x 4 1/2	.79

## Uncased Replacement Condensers

Impregnated Paper Di-electric

For replacing "blown" condenser block sections in filter circuits. Non-inductively wound. 8 inch wire leads.

### UC400—400 Working Volts

Stock Number	Cap. Mfd.	Dimensions Ht. x Wd. x D.	Net
A7880	1	2 x 1 1/2 x 1 1/2	21c
A7882	5	2 x 1 1/2 x 1 1/2	29c
A7883	1	2 x 1 1/2 x 1 1/2	44c

### UC600—600 Working Volts

A7885	1	3 1/2 x 1 1/2 x 1 1/2	53c
A7886	2	3 1/2 x 1 1/2 x 1 1/2	79c

### UC1000—1000 Working Volts

A7888	1	4 3/8 x 1 1/2 x 1 1/2	88c
A7879	2	4 3/8 x 2 1/4 x 1 1/2	1.47

## Paper Replacements for Electrolytics

High grade paper dielectric sections in aluminum case (PWC) or cardboard case (PWP). Used to replace electrolytics where subjected to high AC component or high surge peaks. Capacity used is actually less than electrolytic being replaced but is adequate due to improved filtering action.

PWC Stock Num.	Rep'g Act. Mfd.	Size Mfd.	Size D x L	Your Price
D8050	4	2	1 1/2 x 1 1/2	\$0.79
D8051	8	2.75	1 1/2 x 1 1/2	1.03
D8052	8-8	1.75	1 1/2 x 1 1/2	1.65
PWP600	8-00	1.75	1 1/2 x 1 1/2	1.65
PWP600	8-00	1.75	1 1/2 x 1 1/2	1.65
D8053	4	2	4 3/8 x 1 1/2 x 1 1/2	.71
D8054	8	3	4 3/8 x 1 1/2 x 1 1/2	.94

## DANDEES

### Miniature Electrolytics Etched Foil Type



Size reduced to smallest proportions consistent with full rated capacity and voltage. For crowded places where maximum capacity and working voltage must be squeezed into minimum bulk. Aluminum can electrically insulated by special varnished paper jacket. Properly vented. Expensive gas pressure escapes.

### PR5450—450 Working Voltage

Stock Number	Cap. Mfd.	Size Inches Dia. x Long	Your Price
D7846	4	1 1/8 x 1 1/8	31c
D7847	8	1 1/8 x 1 1/8	35c
D7848	12	1 1/8 x 1 1/8	44c
D7849	16	1 1/8 x 1 1/8	52c
D7809	20	1 1/8 x 1 1/8	59c
D7821	*8-8	1 x 2 1/2	62c
D7810	*8-8	1 x 2 1/2	75c
D7822	*8-16	1 x 2 1/2	76c

### PR5350—350 Working Voltage

C7843	8	1 1/8 x 1 1/8	31c
C7845	16	1 1/8 x 1 1/8	47c
C7823	24	1 1/8 x 1 1/8	52c

### PR5250—250 Working Voltage

D7838	4	1 1/8 x 1 1/8	26c
D7839	8	1 1/8 x 1 1/8	29c
D7840	12	1 1/8 x 1 1/8	36c
D7841	16	1 1/8 x 1 1/8	44c
D7811	16-16	1 x 2 1/2	97c

### PR5200—200 Working Volts

D7824	*8-8	1 1/2 x 2 1/2	46c
D7825	*8-16	1 1/2 x 2 1/2	59c
D7818	*16-16	1 1/2 x 2 1/2	68c

### PR5150—150 Working Voltage

D7831	4	1 1/8 x 1 1/8	24c
D7832	8	1 1/8 x 1 1/8	26c
D7833	12	1 1/8 x 1 1/8	29c
D7834	16	1 1/8 x 1 1/8	31c
D7835	24	1 1/8 x 1 1/8	35c
D7836	30	1 1/8 x 1 1/8	38c
D7837	40	1 1/8 x 1 1/8	41c
D7819	*20-20	1 1/2 x 2 1/2	62c
D7812	*20-20	1 x 2 1/2	79c

### PR550—50 Working Voltage

C7828	10	1 1/8 x 1 1/8	26c
C7829	25	1 1/8 x 1 1/8	31c
C7807	50	1 1/8 x 1 1/8	47c
C7830	10-10	1 1/2 x 1 1/2	47c

### PR525—25 Working Voltage

C7826	10	1 1/8 x 1 1/8	24c
C7827	100	1 1/8 x 1 1/8	29c
C7802	*10-10	1 1/2 x 1 1/2	35c

### \*3 Leads +4 Leads

## Upright Mounting Dry Electrolytics



### Self Healing

Surge proof. Mount in any position. Individual sections. Container acts as a common negative. Complete with mtk. rings for universal mounting.

### Type E450

### 525 V. D.C. Peak 450 V. D.C. Working

Stock Number	Cap. Mfd.	Size Inches Dia. x Ht.	Your Price
A7850	5-15	2 1/2 x 4 1/2	\$1.35
A7852	8-8	2 1/2 x 4 1/2	1.05
A7854	8-8-8	3 x 4 1/2	1.59
A7855	6-9-18	3 x 4 1/2	2.20

### Motorola 65 and 70 Replacement Condenser

Motorola Part Num. 3321, Type 1466  
1000 Mfd.  
C8080—List, 50c. **29c**  
YOUR PRICE



# CORNELL DUBILIER

## Replacement Condensers

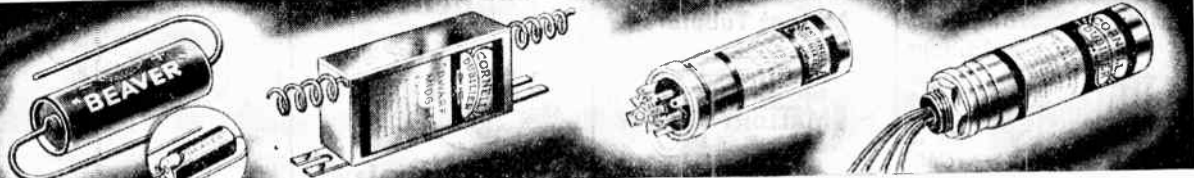

### Blue Beaver Midget Electrolytics

#### Type BR Tubulars

In spite of its extremely small size, full capacity and voltage ratings are built into this unit. Will fit tight spaces where other condensers will not. Carry exact duplicates, contained in an all-aluminum tube protected by varnished cardboard sleeve. Properly vented to allow escape of gases. 3" Wire leads.

Stock Num.	Cap. Mfd.	DC Volts Wkg./Peak	Size In. Dia. x Lgth.	Your Price
C8800	10	25 50	3/8 x 1 1/4	\$0.24
C8801	20	25 50	3/8 x 1 1/4	.26
C8802	25	25 50	3/8 x 1 1/4	.29
C8803	50	25 50	3/8 x 1 1/4	.35
C8804	5	50 75	3/8 x 1 1/4	.24
C8805	10	50 75	3/8 x 1 1/4	.26
C8806	20	50 75	3/8 x 1 1/4	.29
C8807	25	50 75	3/8 x 1 1/4	.32
C8808	50	50 75	3/8 x 1 1/4	.41

Stock Num.	Cap. Mfd.	DC Volts Wkg./Peak	Size In. Dia. x Lgth.	Your Price
C8809	4	150 200	3/8 x 1 1/4	.24
C8810	8	150 200	3/8 x 1 1/4	.26
C8811	12	150 200	3/8 x 1 1/4	.29
C8812	16	150 200	3/8 x 1 1/4	.32
C8813	20	150 200	3/8 x 1 1/4	.35
C8814	40	150 200	3/8 x 2	.41

Stock Num.	Cap. Mfd.	DC Volts Wkg./Peak	Size In. Dia. x Lgth.	Your Price
C8815	4	250 300	3/8 x 1 1/4	.26
C8816	8	250 300	3/8 x 1 1/4	.29
C8817	12	250 300	3/8 x 1 1/4	.32
C8818	16	250 300	3/8 x 1 1/4	.35
C8819	20	250 300	3/8 x 1 1/4	.38
C8820	40	250 300	3/8 x 2	.46

### Type BR Large Size Dry Electrolytics

#### In Cardboard Containers

Rectangular cardboard container with cardboard mounting tab. Dual units are separate section with 4 leads. Triple unit has common negative 4 leads. 6" wire leads.

Stock Num.	Cap. Mfd.	DC Volts Wkg./Peak	Size In. Dia. x Lgth.	Your Price
C8821	4	350 400	5/8 x 1 1/4	.29
C8822	8	350 400	5/8 x 1 1/4	.32
C8823	12	350 400	5/8 x 2	.41
C8824	16	350 400	5/8 x 2	.47

### Type BR Dual Beavers

#### With Common Negative Lead

Stock Num.	Cap. Mfd.	DC Volts Wkg./Peak	Size In. Dia. x Lgth.	Your Price
C8825	4	450 525	5/8 x 1 1/4	.32
C8826	8	450 525	5/8 x 1 1/4	.35
C8827	12	450 525	5/8 x 2	.44
C8828	16	450 525	5/8 x 2	.53
C8829	20	450 525	1" x 2 1/2	.59

Stock Num.	Cap. Mfd.	DC Volts Wkg./Peak	Size In. Dia. x Lgth.	Your Price
C8830	8	500 600	3/4 x 1 1/4	.50
C8831	16	500 600	1" x 2 1/2	.76

### Type JR Midget Dry Electrolytics

#### In Cardboard Containers

For use where space is limited. New electro-chemical etching process eliminates corrosion and assures full rated voltage and capacity. Multiple units have individual leads from each section. 8" Leads.

Stock Num.	Cap. Mfd.	Size Inches LxWxH	Your Price
C8849	8	2 1/2 x 1 1/2 x 1 1/4	\$0.56
C8850	12	2 1/2 x 1 1/2 x 1 1/4	.76
C8851	16	2 1/2 x 1 1/2 x 1 1/4	.85
C8852	8-8-8	2 1/2 x 1 1/2 x 1 1/4	.88
C8853	8-8-8	2 1/2 x 1 1/2 x 1 1/4	1.29

Stock Num.	Cap. Mfd.	Size Inches LxWxH	Your Price
C8854	8	2 1/2 x 1" x 1 1/4	\$0.47
C8855	10	2 1/2 x 1" x 1 1/4	.55
C8856	12	2 1/2 x 1" x 1 1/4	.58
C8857	16	2 1/2 x 1" x 1 1/4	.64
C8858	8-8-8	2 1/2 x 1" x 1 1/4	.76
C8859	10-16	2 1/2 x 1" x 1 1/4	1.06
C8860	8-8-8	2 1/2 x 1" x 1 1/4	1.06

### Type EH Large Size Dry Electrolytics

#### In Cardboard Containers

Rectangular cardboard container with cardboard mounting tab. Dual units are separate section with 4 leads. Triple unit has common negative 4 leads. 6" wire leads.

Stock Num.	Cap. Mfd.	DC Volts Wkg./Peak	Size Inches LxWxH	Your Price
C8861	8	4 1/2 x 1 1/2 x 1 1/4	4 1/2 x 1 1/2 x 1 1/4	\$0.56
C8862	16	4 1/2 x 1 1/2 x 1 1/4	4 1/2 x 1 1/2 x 1 1/4	.85
C8863	4-8	4 1/2 x 1 1/2 x 1 1/4	4 1/2 x 1 1/2 x 1 1/4	.79
C8864	8-8	4 1/2 x 1 1/2 x 1 1/4	4 1/2 x 1 1/2 x 1 1/4	.88
C8865	8-8-8	4 1/2 x 2" x 2"	4 1/2 x 2" x 2"	1.29

### Mica Condensers

Stock Number	Code	Cap. Mfd.	Your Price
C8866	5W-5Q1	.00001	\$0.12
C8867	5W-5Q2	.00002	.12
C8868	5W-5Q3	.00003	.12
C8869	5W-5Q5	.00005	.09
C8870	5W-5T1	.0001	.09

Stock Number	Code	Cap. Mfd.	Your Price
C8871	5W-5T15	.00015	.09
C8872	5W-5T2	.0002	.09
C8873	5W-5T25	.00025	.12
C8874	5W-5T5	.0005	.12
C8875	1W-5D1	.001	.15

Stock Number	Code	Cap. Mfd.	Your Price
C8876	1W-5D15	.0015	.15
C8877	1W-5D2	.002	.18
C8878	1W-5D25	.0025	.21
C8879	1W-5D3	.003	.24

Stock Number	Code	Cap. Mfd.	Your Price
C8880	1W-5D15	.0015	.29
C8881	1W-5D16	.006	.35
C8882	1W-5D17	.007	.38
C8883	1W-5D1	.01	.44

### Type UP Twist Lock Dry Electrolytics

#### In Metal Containers

A new type dry electrolytic rapidly replacing the older types in radio set manufacture. Advanced engineering assures operation equal to or better than larger units. Mounting is by means of metal tongues which fit into slots in chassis and twist to lock condenser in place. Complete with necessary mounting plates. Multiple units have common negative grounded to can. Size, 1" diameter.

Stock Num.	Cap. Mfd.	Wkg. Volts	Your Price
C8884	10	450	\$0.44
C8885	20	450	.65
C8886	40	450	.94
C8887	20-20	150	.59
C8888	30-30	150	.65

Stock Num.	Cap. Mfd.	Wkg. Volts	Your Price	
C8889	2	15-15/20	250/25	.65
C8890	2	10/10	450/450	.65
C8891	2	20	25	.76
C8892	2	10-10/20	350/25	.71
C8893	2	15-30	150	.59

### Type DT Paper Cartridge Condensers

#### Halowax Impregnated, non-inductively wound, protected against humidity.

2 1/2" Wire leads.

Stock Number	Cap. Mfd.	Size Inches LxWxH	Your Price
C9015	.01	1 1/4 x 3/4	\$0.09
C9016	.015	1 1/4 x 3/4	.09
C9017	.02	1 1/4 x 3/4	.09
C9018	.03	1 1/4 x 3/4	.09
C9019	.05	1 1/4 x 3/4	.09
C9020	.1	2 1/4 x 1 1/4	.12
C9021	.2	2 1/4 x 1 1/4	.15
C9022	.25	2 1/4 x 1 1/4	.15
C9023	.5	2 1/4 x 1 1/4	.21
C9024	1.0	2 1/4 x 1 1/4	.29

Stock Number	Cap. Mfd.	Size Inches LxWxH	Your Price
C9025	.0001	1 1/4 x 3/4	\$0.09
C9026	.00025	1 1/4 x 3/4	.09
C9027	.0005	1 1/4 x 3/4	.09
C9028	.001	1 1/4 x 3/4	.09
C9029	.002	1 1/4 x 3/4	.09
C9030	.004	1 1/4 x 3/4	.09
C9031	.005	1 1/4 x 3/4	.09
C9032	.01	1 1/4 x 3/4	.09
C9033	.015	1 1/4 x 3/4	.09
C9034	.02	1 1/4 x 3/4	.09
C9035	.025	1 1/4 x 3/4	.12
C9036	.03	1 1/4 x 3/4	.12
C9037	.04	1 1/4 x 3/4	.12
C9038	.05	1 1/4 x 3/4	.12
C9039	.06	1 1/4 x 3/4	.12
C9040	.1	2 1/4 x 1 1/4	.21
C9041	.2	2 1/4 x 1 1/4	.21
C9042	.25	2 1/4 x 1 1/4	.21
C9043	.5	2 1/4 x 1 1/4	.29

Stock Number	Cap. Mfd.	Size Inches LxWxH	Your Price
C9044	.005	1 1/4 x 3/4	\$0.21
C9045	.007	1 1/4 x 3/4	.21
C9046	.0075	1 1/4 x 3/4	.21
C9047	.01	1 1/4 x 3/4	.21
C9048	.01	1 1/4 x 3/4	.21
C9049	.02	2 1/4 x 1 1/4	.21
C9050	.02	2 1/4 x 1 1/4	.21
C9051	.05	2 1/4 x 1 1/4	.26

1600 DC Wkg. Volts—2000V. Peak Oil Impregnated—For Use as Buffer

### Type KR Compact Dry Electrolytics

#### In Aluminum Cans

Stud mounting container. Multiple units have separate sections with individual leads. Container is insulated from condenser. 3" Leads.

Stock Number	Cap. Mfd.	Size Inches Dia. x Ht.	Your Price
C9053	4	3 1/2 x 1 1/4	\$1.08
C9054	8	4 1/2 x 1 1/4	1.53
C9055	16	4 1/2 x 1 1/4	2.06

Stock Number	Cap. Mfd.	Size Inches Dia. x Ht.	Your Price
C9056	8	2 1/2 x 1	\$0.62
C9057	12	3 1/2 x 1	.82
C9058	16	3 1/2 x 1	.91
C9059	4-8	3 1/2 x 1	.85
C9060	8-8	3 1/2 x 1	.94
C9061	8-8-8	4 1/2 x 1 1/4	1.35

Stock Number	Cap. Mfd.	Size Inches Dia. x Ht.	Your Price
C9062	8	2 1/2 x 1	\$0.56
C9063	25	3 1/2 x 1	.88
C9064	8-8	4 1/2 x 1 1/4	.85

### Stud Mounting Wet Electrolytics

#### Type EY

Use Wet Electrolytics for applications subjected to high voltage surges. Self heating feature re-forms condenser instantly if overloaded. Improved vent construction provides proper escape of gas without leakage of electrolyte. Positive lug terminal connection. Can is negative.

Stock Num.	Cap. Mfd.	Peak Volts	Size In. L x D	Your Price
C9065	8	600	4 1/2 x 1 1/4	\$0.88
C9066	16	600	4 1/2 x 1 1/4	1.18

### Dry Electrolytics

#### In Metal Containers

Mounts in any position. For replacement in older model radios. Can is common negative except Dual 8 has separate sections insulated from can. Complete with mounting ring.

Stock Number	Cap. Mfd.	Size Inches Dia. x Ht.	Your Price	
C9075	8	3 1/2 x 1	.53	
C9076	18	3 50	4 1/2 x 1 1/4	.73
C9077	24	3 50	4 1/2 x 1 1/4	.88
C9078	30	3 50	4 1/2 x 1 1/4	.94

Stock Number	Cap. Mfd.	Size Inches Dia. x Ht.	Your Price	
C9079	20	200	4 1/2 x 1	.64
C9080	40	200	4 1/2 x 1	.73

### Inverted Stud Mounting Dry Electrolytics

#### Type EB

In full sized aluminum containers. Preferred for quality repair jobs where there is plenty of space. Dual units are separate sections. All units are insulated from container. 8" Flexible wire leads. Has single lug connection, container is negative. 7500 DC working volts, 575 volts surge.

Stock Num.	Cap. Mfd.	Size Inches Dia. x Lgth.	Your Price
C8841	4	1 1/2 x 2 1/2	\$0.50
C8842	8	1 1/2 x 2 1/2	.62
C8843	8 1/2	1 1/2 x 2 1/2	1.03
C8844	8 1/2	1 1/2 x 2 1/2	.62

Stock Num.	Cap. Mfd.	Size Inches Dia. x Lgth.	Your Price
C8845	12	1 1/2 x 2 1/2	.82
C8846	16	1 1/2 x 2 1/2	.91
C8847	4-8	1 1/2 x 2 1/2	.85
C8848	8-8	1 1/2 x 2 1/2	.94

### Dry Electrolytic Condensers

#### Midget Rectangular Containers



Type CS  
CN & CM

Extremely small. Internal metal seal protects unit against atmospheric conditions. Metal mounting flanges may be pushed under various parts on chassis, soldered down, or bent out of way. g" insulated leads.

#### Single Section Units

450 DC Wkg. Volts, 525 Peak

Stock Num.	Cap. Mfd.	Size	Your Price
D7405	2	2 1/2 x 1 1/2 x 3/8	37c
D7406	4	2 1/2 x 1 1/2 x 3/8	44c
D7408	8	2 1/2 x 1 1/2 x 3/8	56c
D7410	12	2 1/2 x 1 1/2 x 3/8	76c
D7433	16	2 1/2 x 1 1/2 x 3/8	85c

#### Dual and Triple Sections

Dual 4 leads, Triples 6 leads  
Has 3 Leads—Common Negative.

D7423	4-4	2 1/2 x 1 1/2 x 3/8	71c
D7424	4-8	2 1/2 x 1 1/2 x 3/8	79c
D7417	8-8	2 1/2 x 1 1/2 x 3/8	88c
D7425	8-8	2 1/2 x 1 1/2 x 3/8	88c
D7426	8-8-8	3 x 1 1/2 x 1 1/2	\$1.29

#### Tubular Condensers

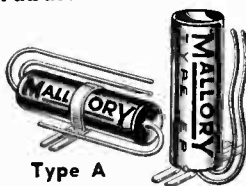

Type A

Type B

Types ST, TN, 2N, 2P, 2S, 3N, 3S  
Between these and the type BB condensers you can select a replacement condenser for practically any radio service job. Compact size and efficient performance eliminate need of exact duplicates. \*30 mf. section rated at 25 wkg. volts.

#### Type A—Single Units

Stock Num.	Cap. Mfd.	Wkg. Volts	Size D x L	Your Price
D7382	8	250	3/4 x 2 1/2	29c
D7383	16	250	1 x 2 1/2	44c
D7384	24	250	1 1/8 x 2 1/2	56c
D7385	8	350	1 1/8 x 2 1/2	32c
D7386	16	350	1 1/2 x 2 1/2	47c
D7387	8	450	3/4 x 2 3/4	35c
D7388	12	450	1 x 2 3/4	44c
D7389	16	450	1 1/8 x 2 3/4	53c

#### Multiple Units

Type A—Common Negative

D7312	8-8	450	1 x 3 1/2	62c
D7338	10-10-20*	150	1 x 3	85c
D7316	40-20-20	150	1 1/2 x 3	97c

#### Type A—Separate Section

D7344	8-8	250	3/4 x 2 1/2	\$0.65
D7345	16-16	250	1 x 2 1/2	.97
D7347	8-8	450	3/4 x 3	.79
D7348	8-16	450	1 x 3 x 3	.97
D7349	16-16	450	1 1/2 x 3	1.18
D7321	8-8-20*	450	1 1/2 x 3 1/2	.97

#### Type B—Common Negative

D7334	8-8	150	3/4 x 2 1/2	47c
D7335	16-16	150	1 x 2 1/2	56c
D7336	20-20	150	1 1/8 x 2 1/2	62c
D7337	40-20	150	1 1/2 x 2 1/2	67c
D7310	16-16-20*	150	1 1/2 x 2 3/4	79c
D7314	16-8-4	150	3/4 x 2 1/2	71c
D7315	20-10-10	150	1 x 2 1/2	82c

#### Type B—Common Positive

D7340	16-8	150	1 1/2 x 2 1/2	65c
D7341	16-16	150	1 x 2 1/2	73c
D7342	20-20	150	1 1/2 x 2 1/2	79c

#### Midget Tubulars



Type BB

Compact metal cased dry electrolytic condensers. Container is insulated with paper sleeving. New process in construction results in compact size and greater safety factor.

#### 25 D.C. Wkg. Volts, 40 Peak

Stock Num.	Cap. Mfd.	Size Inches	Your Price
D7645	10	1 1/2 x 1 1/2	23c
D7630	25	1 1/2 x 1 1/2	29c
D7631	50	1 1/2 x 1 1/2	35c

#### 50 D.C. Wkg. Volts, 75 Peak

D7646	5	1 1/2 x 1 1/2	23c
D7647	10	1 1/2 x 1 1/2	26c
D7648	25	1 1/2 x 1 1/2	32c
D7649	50	1 1/2 x 1 1/2	41c

#### 150 DC Wkg. Volts, 200 V. Peak

D7632	4	1 1/2 x 1 1/2	23c
D7633	8	1 1/2 x 1 1/2	26c
D7634	12	1 1/2 x 1 1/2	29c
D7635	16	1 1/2 x 1 1/2	32c
D7636	20	1 1/2 x 1 1/2	35c
D7637	30	1 1/2 x 1 1/2	38c
D7635	40	1 1/2 x 1 1/2	41c

#### 250 DC Wkg. Volts, 300 V. Peak

D7616	8	1 1/2 x 1 1/2	29c
D7617	12	1 1/2 x 1 1/2	36c
D7618	16	1 1/2 x 1 1/2	44c

#### 450 DC Wkg. Volts, 525 V. Peak

D7642	4	1 1/2 x 1 1/2	32c
D7643	8	1 1/2 x 1 1/2	35c
D7644	10	1 1/2 x 1 1/2	41c
D7619	12	1 1/2 x 1 1/2	44c
D7629	16	1 1/2 x 1 1/2	53c

#### Stud Mounting Condensers

##### Type RS, RN & RM

Reduced size. Special hardware listed on this page enables these condensers to be mounted in any popular type mounting. \*Insulated wire leads. Aluminum can containers, supplied with locknut and flat washer.



#### Single Section Units

450 DC Wkg. Volts, 525 Peak Volts

Stock Num.	Cap. Mfd.	Size L x D	Your Price
D7444	8	2 3/4 x 1	\$0.62
D7445	12	2 3/4 x 1	.82
D7439	16	3 1/2 x 1	.91

#### Dual and Triple Sections

Separate Sections. \*Has Com. Neg.

D7449	4-8	3 x 1 1/2	.84
D7457	4-8	3 x 1 1/2	.85
D7458	8-8	3 x 1 1/2	.94
D7459	8-8-8	4 x 1 1/2	1.35

#### Wet Electrolytic Stud Mounting Condensers

Improved units. Container is negative. lug terminal is positive. For vertical mounting.

#### 500 D.C. Peak Voltage

D7460	4	3 1/2 x 1 1/2	\$0.47
D7461	8	3 1/2 x 1 1/2	.56
D7368	8	3 1/2 x 1 1/2	.56
D7462	12	4 x 1 1/2	.67
D7463	16	4 x 1 1/2	.79
D7369	20	4 x 1 1/2	.88
D7465	30	4 x 1 1/2	.99
D7370	40	4 x 1 1/2	1.12

#### Fabricated Plate Condensers

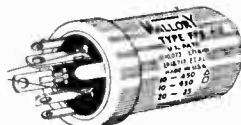

#### Dry Electrolytic

Incorporates improved engineering features that assure quality, service and dependability. Small size. Low R.F. impedance. Long life. Improved sealing prevents deterioration even under severe conditions of humidity or heat. Round aluminum cans. Lug connections.

#### Type FPS—Single Section

Stock Num.	Cap. Mfd.	Wkg. Volts	Size Inches	Your Price
D7273	50	150	2 x 1	\$0.56
D7274	15	300	2 x 1	.38
D7275	30	300	2 x 1	.59
D7391	10	450	2 x 1	.44
D7392	15	450	2 x 1	.59
D7393	20	450	2 x 1	.65

#### Type FPD—Two Section

D7280	40-40	25	2 x 1	.59
D7281	20-20	150	2 x 1	.59
D7282	30-30	150	2 x 1	.65
D7283	50-50	150	3 x 1	.76
D7381	20-20	250	2 x 1	.65
D7284	40-40	250	3 x 1	.85

D7286	30-30	350-300	3 x 1	.88
D7394	10-10	450	2 x 1	.71
D7287	20-20	450	3 x 1	.97
D7288	40-40	450	3 x 1 1/2	1.56
D7289	80-10	450	3 x 1 1/2	1.62

#### Type FPT—Three Section

Size, 1" dia., x 2" long

Stock Num.	Cap. Mfd.	DC Wkg. Volts	Your Price
D7299	30-20-20	150x25	\$0.67
D7301	15-15-20	250x25	.75
D7304	10x10x20	450x450x25	.66
D7308	20-20-20	25	.53
D7309	20-20-20	150	.71
D7327	10-10-10	300	.61

#### Size, 1" dia., x 3" long

D7300	50-50x20	150x25	.85
D7302	30-30x20	250x25	.79
D7303	40-15x20	300x25	.85
D7305	20-20x20	450x25	1.03
D7306	30-10x20	450x25	1.03
D7325	40-40-40	150	.91
D7326	30-15-10	250	.76

D7328	20x15-10	450x300	.88
D7330	10-10-10	450	.91
D7331	15-15-10	450	1.03

#### FP Mounting Wrench

D7357—Simplifies twisting mounting ears of above condensers when making installations.

YOUR PRICE..... 44c

#### Mounting Plates for Above

Can Size	Stock Num.	Bakelite	Metal	Price Each
3/4"	D7395	D7398		3c
1 1/4"	D7396	D7399		
1 3/4"	D7397	D7400		

#### Mounting Accessories



Type A016 Type A-017 Type 015-1

D7570—A016. Terminal connector 1 1/2" High. 10 for... 29c

D7571—A017. Washers for clamp mounting 1" stud condensers. 29c

D7572—015-1. Washer 1 3/8" Dia. 10 for... 18c

D7574—10-1-1. Mounts stud condensers over chassis base. 6c

Each..... 6c

Ring Clamps

D7575—105-1. 1" Dia. EACH 4c

D7576—106-1. 1 1/2" Dia. EACH 4c

D7577—107-1. 1 1/2" Dia. EACH 6c

#### Bypass Condensers

Paper Dielectric



Safety rated. Non-inductively wound. Low impedance contact between unit and leads. Durable cardboard container. Completely sealed against moisture.

#### 200 D.C. Working Volts

Stock Num.	Cap. Mfd.	Size Inches	Your Price
D7560	.05	1 3/8 x 1 1/2	9c
D7561	.1	1 3/8 x 1 1/2	12c
D7562	.25	2 x 1 1/2	15c
D7563	.5	2 1/8 x 1 1/2	21c
D7564	1.0	2 1/2 x 1 1/2	29c

#### 400 D.C. Working Volts

D7556	.05	1 3/8 x 1 1/2	9c
D7557	.1	1 3/8 x 1 1/2	12c
D7558	.25	2 x 1 1/2	15c
D7559	.5	2 1/8 x 1 1/2	21c
D7568	1.0	2 1/2 x 1 1/2	29c

#### 600 D.C. Working Volts

D7540	.0001	1 1/8 x 3/8	9c
D7541	.00025	1 1/8 x 3/8	12c
D7542	.0005	1 1/8 x 3/8	15c
D7543	.001	1 1/8 x 3/8	21c
D7544	.002	1 1/8 x 3/8	29c
D7545	.005	1 1/8 x 3/8	37c
D7546	.006	1 1/8 x 3/8	45c
D7547	.01	1 1/8 x 3/8	53c
D7548	.02	1 1/8 x 3/8	61c

D7565	.03
-------	-----



# TUNGAR BULBS-NEON LAMPS-BATTERY CLIPS

## Genuine G.E. Tungar Rectifier Bulbs

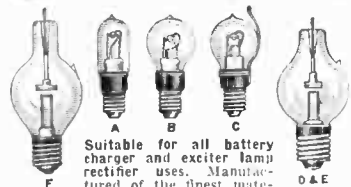

Suitable for all battery charger and exciter lamp rectifier uses. Manufactured of the finest materials and thorough-ly tested.

Types A, B, and C have 3 terminal screw base. Type C has outside top lead wire, which may be cut off.

- C1802**—Type A. G.E. #289881. Filament 1.8 volts at 6 amps. Output 7.5 volts at 0.5 amps.
- C1803**—Type B. G.E. #271465. Filament 2.0 volts at 12 amps. Output 60 volts at 2 amps.
- C1804**—Type B. G.E. #12X825. Filament 2.0 volts at 12 amps. Output 75 volts at 2 amps.
- C1805**—Type C. G.E. #195528. Filament 2.0 volts at 12 amps. Output 60 volts at 2 amps.  
List Price, \$4.00.  
**YOUR PRICE, Each.... \$2.94**
- C1806**—Type D. G.E. #189048. Filament 2.2 volts at 18 amps. Output 60 volts at 6 amps.
- C1807**—Type E. G.E. #189049. Filament 2.2 volts at 18 amps. Output 90 volts at 6 amps.  
List Price, \$5.00.  
**YOUR PRICE, Each. \$3.67**
- C1808**—Type F. G.E. #212783. Filament 2.5 volts at 27 amps. Output 60 volts at 15 amps.  
List Price, \$10.00.  
**YOUR PRICE..... \$7.35**

### Special Tungar Type Bulbs

Quality Guaranteed

Specifications Similar to Above G.E. Type

- C1822**—Type A. } **YOUR PRICE, Ea. \$1.85**
- C1823**—Type B. (75V.) }
- C1824**—Type C. }
- C1825**—Type D. } **YOUR PRICE, Ea. \$2.89**
- C1826**—Type E. }
- C1827**—Type F. Each..... **\$6.50**

### Mercury Type Charger Bulb

**K1828**—Type D 6 amperes. Long life, efficiency in operation and lower operating cost. For use in battery chargers of 6 ampere capacity.  
List Price, \$5.00.  
**YOUR PRICE..... \$2.89**

### Radio Battery Cables



Stranded conductors, rubber insulated and covered with fabric. It is A. color coded. 5 ft. length.

Stock Number	Conductors	Your Price	Stock Number	Conductors	Your Price
K4911	5	24c	K4914	8	40c
K4912	6	28c	K4915	9	45c
K4913	7	32c	K4916	10	50c

### Mallory Grid Bias Cell

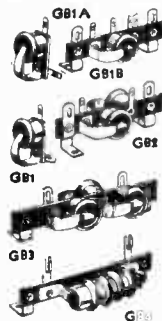

Small acorn shaped, no current potential device. Supplies 1 Volt plus or minus 10%. Adaptable to all circuits of grid bias where current does not exceed one microampere. Circuit is identical to "C" battery. Designed principally to bias first audio tubes in high gain amplifiers. Eliminates the necessity of high capacitive cathode by-pass condensers. Will give indefinite life if not overloaded.

**A3905**—1 Volt Cell.  
**A3904**—1/4 Volt Cell.  
List Price, 30c.  
**YOUR PRICE, EACH..... 18c**

### Bias Cell Mountings

Stock Number	Type Number	Num. Cells	List Price	YOUR PRICE
K3906	GB-1	1	10c	6c
K3907	GB-1A	1	10c	6c
K3908	GB-1B	1	15c	9c
K3909	GB-2	2	20c	12c
K3910	GB-3	3	25c	15c
K3911	GB-4	4	35c	21c

## Neon Glow Lamps

Genuine G.E. neon gas lamps that glow with a brilliant orange-red radiance. Both electrodes glow on A.C. One remains dark on D.C. Operate on extremely minute current. Used in tube checkers for inter-element short tests; in series with A.C. or D.C. for continuity, leakage, and high resistance tests. Used as pilot or signal lamp on all types of electrical circuits. Check addition leakage in radio-circuit noise elimination work. Voltages listed are minimum striking voltage; minimum operating voltage may be approximately 50 volts lower for A.C. or 20 volts lower for D.C.

**D10545**—1/4 Watt. Candelabra Base Tubular Shape (Clear Bulb). 3/16" diameter. Replacement for Weston and other tube testers employing neon short tests. For 105-125 volts A.C. or D.C.  
**YOUR PRICE, Each..... 36c**  
**TEN FOR..... \$3.25**

**D10546**—1/4 Watt. Double contact bayonet base. 3/16" diam. Tubular shape (clear bulb). 3/16" diameter. Used as replacement in Tube-Condenser Analyzer and other test equipment requiring a neon bulb without a resistance in the base. For 105-125 volts A.C.  
**YOUR PRICE, Each..... 41c**  
**TEN FOR..... \$4.05**

**D10547**—1/2 Watt. Standard Edison medium screw base. (Clear Globular Bulb). 1 1/4" diameter. Electrodes shaped like half cylinders. Approximately 5/100 candle power. For 105-125 volts A.C. only.  
**YOUR PRICE, Each..... 36c**  
**TEN FOR..... \$3.25**

**D10548**—1/2 Watt. Same as above but with skirted candelabra base.  
**YOUR PRICE, Each..... 41c**  
**TEN FOR..... \$3.65**

**D10549**—1 Watt. Standard Edison medium screw base. (Clear Globular Bulb). 1 1/4" diameter. Approximately 5/100 candle power. Central cylindrical electrode surrounded by wire spiral electrode. For 105-125 volts A.C. or D.C.  
**YOUR PRICE, Each..... 36c**  
**TEN FOR \$3.25**

**D10551**—1 Watt. Double contact bayonet base. Otherwise same as above.  
**YOUR PRICE, Each..... 45c**  
**TEN FOR..... \$4.05**

**D10550**—1 Watt Standard Edison medium screw base. (Clear Globular Bulb). 1 1/4" diameter. Electrodes shaped like half cylinders. For 200-240 volts A.C. or D.C.  
**YOUR PRICE, Each..... 36c**  
**TEN FOR..... \$3.25**

**D10552**—2 Watt Standard Edison medium screw base. Clear pear shaped bulb. Diameter 1 3/4". Electrodes in shape of split disc. Approx. 1/2 candle power. For 105-125 volts A.C. or D.C. Used in tube testers. Also popular size for night-light, advertising, exit indicator, stroboscope, and signal use.  
**YOUR PRICE, Each..... 45c**  
**TEN FOR..... \$4.05**

**D10553**—3 Watt standard Edison medium screw base. (Clear pear shaped bulb. Diameter 1 3/4". Electrodes in shape of split disc. For 105-125 volts AC or D.C. Used in tube testers. Also very popular size for night-lights, signal lamps, etc.  
**YOUR PRICE, Each..... 54c**  
**TEN FOR..... \$4.86**

### Cathode Glow Neon Indicator Lamps

Used on many types of test apparatus. Clear glass cylindrical bulb, about 1/2" diameter, 1" long. Wire leads about 5/8" long. Electrodes consist of two small parallel cylinders sealed in neon gas. Operate on A.C. or D.C. average voltage break-down, 60 volts A.C. or 80 volts D.C. when no resistor is used. On D.C. only the negative electrode glows. Voltage Range 105-125 Volts. 1105-250 Volts.

Stock Num.	Nominal Watts	Resistance Supplied (in ohms)	Ma.	Life Hours	Ea.
D10520		None (use 200,000)	.3	3,000	10c
D10521	*1/25	one 200,000 mtd. in lead	.3	3,000	14c
D10522	†1/10	one 600,000 mtd. in lead	.4	2,000	14c

## Universal Alligator Clips



Small clips with slender elongated jaws. Both screw and banana terminal connections. The barrel will also take the large end of a standard jack tip. Teeth mesh perfectly on all three sides. Rating 5 amps. Cadmium plated steel. 2 3/8" long. Jaws spread 1/4".

**K11435**—Alligator clip only less insulators. Each, 5c. **YOUR PRICE**  
**BOX OF 10** 100 for..... **\$3.43** **39c**

### Colored Rubber Insulators

For above clips. Internal recess at end of insulator snaps around tubular barrel and holds clip firmly.  
**K11445**—Red **K11446**—Black  
**YOUR PRICE, EACH 4c.**  
**BOX OF 10** 100 for..... **\$2.69** **28c**

## Universal Battery and Radio Clips



No. 45—Pee Wee Clip. For Radio Test Work. Teeth on both jaws which mesh. Jaw spread 3/8". Length 1 1/2". Steel (cadmium plated. With screw.  
**K11436**—Each, 4c. **29c**

No. 45C—Pee Wee High Frequency Test Clip. Suitable for transmitters. Made of solid copper. Phosphor-bronze spring, brass screws—entirely non-ferrous. Will not heat up in H.F. work. 1 1/2" long. 3/8" jaw spread. 10 Amps.  
**K11497**—Each, 7c. **54c**

No. 48B—A small clip for "B" radio batteries and general use. Teeth on both jaws which mesh. 10 lb. spring. Jaw spread, 3/4" in. Cadmium plated.  
**K11437**—Each, 4c. **32c**

No. 48C—Solid Copper for High Frequency use. Size same as above.  
**K11498**—Each, 9c. **65c**

Type 21A—25 amp. Capacity. For radio storage "A" batteries. Teeth on one jaw and notch on the other; fits round battery post, 17 lb. spring with copper shunt. Jaw spread, 1". Lead coated. 2 1/8" long.  
**K11438**—Each, 7c. **59c**

Type 21A—50 amp. 33 lb. spring protected by a copper shunt. Jaw spread, 1 1/4". Steel. Lead coated. 4" long.  
**K11439**—Each, 12c. **\$1.08**

Type 11A—100 amp. Capacity, 38 lb. spring. Jaw spread, 1 1/2" in. Lead coated, 5 1/2" in. long.  
**K11440**—**YOUR PRICE, Each..... 42c**

**NOTE.** Clips marked \* and —. Half and Half will be supplied unless otherwise specified.

### Rubber Insulators

For Use with Universal Battery Clips



Protect against electric shock. Furnished half red, half black to indicate polarity.

	Per Pair	Ten For
D11447—For 45	18c	59c
D11448—For 48B	19c	69c
D11449—For 21A	43c	\$1.52
D11450—For 11A	73c	2.55
D11451—For 11A	\$1.19	4.10

## Porcelain Sockets

### For Neon Glow Lamps

#### Sub-panel Mounting

Quality porcelain sub-panel socket for neon glow lamps. Top of socket mounts flush with panel. Screw terminals. Used in short checkers, continuity testers and other test apparatus.

**D11254**—Candelabra Base. **28c**  
**YOUR PRICE, Each.....**  
**D11255**—Edison Medium Screw Base. **16c**  
**YOUR PRICE, Each.....**

**Cleat Mounting**  
**D11256**—**YOUR PRICE, Each..... 9c**  
Cleat mounting Edison base porcelain socket. May be mounted on baseboard for experimental work. Screw terminals.

# Aerials and Accessories

## ICA Tennescope

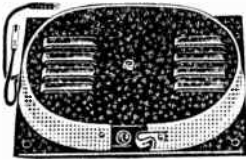

C9960—  
YOUR PRICE..... **\$1.03**

Eliminates the use of an outside aerial and ground on any midget or console radio set. Easily connected without changes in circuit wiring. No soldering necessary. For broadcast band use only. Has trimmer adjustment for proper set matching and maximum selectivity. Static shielded. Instructions included.

## Inside Aerial and Noise Filter

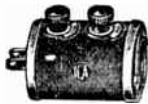

DB404—  
YOUR PRICE **80¢**

Combination in-door aerial and noise filter. Plugs into power line and has outlet receptacle for radio power cord. Serves to reduce line noises and eliminate outdoor aerials simultaneously. Binding post connections for aerial and ground.

## Aerial Eliminator



D9965—  
YOUR PRICE **\$1.05**

Eliminates outdoor aerials. Built-in coil and condenser allows reception equivalent to 75 feet of aerial wire. Binding post terminals for set aerial, set ground and external ground connections. Compactly constructed for installation in receiver cabinets. Size 5x2 1/2 x 1 1/2".

## Galvanized Guy Wire For Supporting Aerial Masts



K4917—50 foot coil.  
Your Price, **15¢**

Ten rolls for **\$1.39**  
A special grade, tough, non-stretching galvanized wire. Annealed.

## All-Wave Antenna Systems

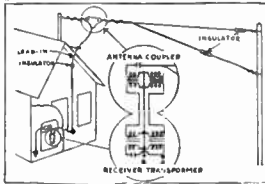
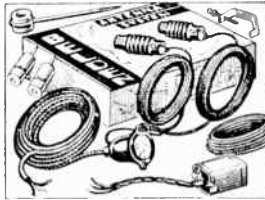

Belden No. 8300

### Clear-Channel Antenna

The "L" type antenna plus an additional half-douplet, shielded low loss transmission line and newly developed dual iron core transformer couplers produce clear channel reception with maximum efficiency at all frequencies from 400 to 20,000 kilocycles. Up to four radios can be operated from the same antenna.

Includes: 60' and 25' coil 7x22 enameled aerial wire, 50' coil shielded transmission cable, receiver and antenna coupling transformers, 25' coil ground wire, 2-porcelain nail-on knobs, 2-porcelain insulators, 6" stand-off insulator, ground clamp and instruction sheet. Lightning arrestor not necessary.

A15322—List, \$8.35. **\$4.94**

YOUR PRICE.....

A4971—Iron Core Coupling Transformer. One required for each additional radio receiver. **\$1.11**

### RCA Model 395 Antenna System



C15332—RCA 395. Complete Kit. Factory Assembled. List Price, \$3.95. **\$2.25**

YOUR PRICE.....

### RCA "Magic-Wave" Aerial System

Operates 1 to 16 Radios

C15333—RCA 9812. Complete Kit for One Radio Set. List Price, \$5.95. **\$3.43**

YOUR PRICE.....

Has greater noise reducing properties and is more easily installed. No doublers or critical transmission line and aerial wire lengths. Adaptable to many different installations including vertical mast type. Transmission line can be installed underground. Covers 530 to 23,000 kc. By using distribution transformer and additional receiver coupling transformers, up to 16 radios can be used on one aerial. Completely assembled. Content: Iron Core Antenna and Receiver Coupling Transformers; 60 ft. Antenna Wire; 45 ft. Transmission Line; 5 ft. Ground Wire; 3 Porcelain Insulators; Ground Clamp; Instructions.



### Accessories Used in "Magic-Wave" Aerial System

C4967—RCA 9819. Antenna Coupling Transformer only with built in lightning arrestor. For "L" type and vertical mast antennas having transmission line lead-ins. **\$1.15**

C4962—RCA 9813. Receiver coupler (for each outlet). **1.47**

C4964—RCA 12429. 45-ft. transmission line (for underground). **1.15**

## All-Wave Ant. Coupler

A4932—  
YOUR PRICE **38¢**

Fixed, all-wave antenna coupler designed to properly match all-wave radio receivers to antenna transmission lines. Matches all types of receivers. Effectively reduces noise and increases signal strength. Shielded in round aluminum container. Simple to install.



## Vertical Pole Antenna

A new type vertical pole antenna, built in appearance to over head wires. Four telescopic sections are adjustable from 6 to 24 feet in height. Easy to erect in small space. No guy wires or footing necessary. 5 ft. pipe driven into ground serves as ground connection and support. Can also be used with Parapet Mast Support shown below. For best results use RCA Magic Wave Receiver and Antenna Coupling Transformers with under-ground transmission line lead-in as listed at left. Any number of radios can be accommodated by using one distribution transformer and one receiver coupling transformer for each set to be used. Made of steel heavily cadmium plated. Wt. 20 lbs.

A15382—  
YOUR PRICE **\$5.88**



## Insulator Bracket

For clearing lead-in wires over gutters, eaves, etc. Insulator can be placed in 4 different positions. 8" formed steel arm. **A15383—Your Price, Ea., 15¢**  
Ten for \$1.40



## Parapet Mast Support

Supports mast or vertical antenna on fire walls and parapets up to 24" wide. Fits round or square masts from 3/4 to 2". Green enameled. Ship. wt. 8 lbs.

A15384—  
YOUR PRICE **\$1.47**



## Adjustable Tubular Steel Masts

Strong telescoping masts made of high carbon steel tubing. Baked green enamel finish. Base adjustable to fit any roof angle. Simply nail or screw base to roof and bend upright. Masts are fitted with guy wire discs at top and guy rings at intermediate sections. A clamping device locks sections at any height. Length collapsed 50 inches. **K15880—Two Section. Extends 7 feet. Shpg. Wt. 5 lbs. List, \$2.00. YOUR PRICE \$1.18**

**K15881—Three Section. Extends 10 feet. Wt. 7 lbs. List, \$3.00. YOUR PRICE \$1.76**

**K15882—Four Section. Extends 13 feet. Wt. 10 lbs. List, \$4.00. YOUR PRICE \$1.35**



**N4775—Each, Ten for 80¢ 9¢**

## Antenna Insulators

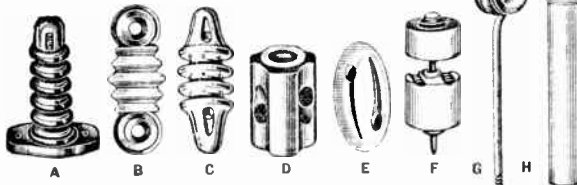

An insulator for practically every antenna installation. Finest quality for dependable service under all weather conditions.

Stock Num.	Type Ins.	Size	Description and Type	Price Each	10 for	100 for
D4754	A	4" High	Glazed Porcelain Standoff	10¢	50.9¢	\$8.50
D4770	B	3" Long	Tempered Glass Insulator	2 1/2¢	.19	1.80
D4751	C	2 1/2" Long	Glazed Porcelain Insulator	2 1/2¢	.19	1.80
D4752	C	3 1/2" Long	Glazed Porcelain Insulator	5 1/2¢	.45	4.25
D4753	C	5" Long	Glazed Porcelain Insulator	9¢	.84	7.50
D4755	D	1 1/2 x 1 1/2 x 2 1/4"	Glazed Porcelain Strain	6¢	.54	4.85
D4756	E	3/4 x 3/4 x 1 1/4"	Glazed Porcelain Strain	3¢	.20	1.80
D4766	F	1 1/4 x 1 1/4" H	Glazed Porcelain Nail Knob	2¢	.18	1.64
D4767	G	3 1/2" Long	Glazed Porcelain Screw Eye	2¢	.17	1.60
D4768	G	7 1/2" Long	Bakelite Bushing Screw Eye	3¢	.26	2.45
D4750	H	3/4 ID x 3" L	Porcelain Wall Tube	2¢	.18	1.64
D4765	H	5/8 ID x 6 3/4" L	Porcelain Wall Tube	2 1/2¢	.20	1.80

## RCA Wave Trap

Gives excellent suppression of following interferences: code, blanketing, image reception, cross modulation, heterodyning and overloading caused by powerful or nearby amateur and broadcast stations. Has adjustable range of from 450 to 2100 kc. Attenuation of tuning frequency is 40 to 1 average. Iron core Litz wound coil. **C4968—List, \$1.85. YOUR PRICE \$1.09**

## Copper Plated Ground Rods

Made of hard drawn steel, heavily copper plated for rust prevention and assures positive electrical grounding. 3/4" Screw type clamp, 3/8" Dia. **K15884—4 Foot Rod. YOUR PRICE, 28¢ EACH Ten for \$2.65**

**K15885—6 Foot Rod. YOUR PRICE, 38¢ EACH Ten for \$3.60**





# Aerials and Accessories

## Doublet Arresters



A dependable air gap doublet arresster. Porcelain case 3 3/4" x 1 1/2" x 1 1/2".  
**K4795—EACH.....17¢**  
**TEN FOR \$1.40**

### I. C. A. Doublet Arresster



Absolutely weatherproof and non-grounding. Can be installed indoors or outdoors. Made of black enameled porcelain. Supplied with mounting screws. Special quality carbon resistance used.  
**N4793—List, 40c.**  
**YOUR PRICE.....23¢**

### Duplex Vis-O-Glow Neon Lightning Arresster



Arresster electrodes are suspended in a neon gas tube. No resistance element is used. It is more sensitive than any other radio arresster and also will carry the heaviest discharge. Causes no loss of signal strength. Particularly desirable for Short-Wave and All-Wave receivers. You can see it operate.  
**K4790—List, \$1.40.**  
**YOUR PRICE.....78¢**

### Antenna Lead-In Window Strips

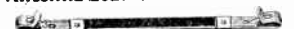

Duo impregnated web covered conductors. Waterproof insulation. Fits between sash and sill.  
**K4781—12 inches long. Palmstock connectors. EACH.....3¢**  
**Ten for.....23c**

**A4783—12 inch. Screw Connectors. EACH.....5c**  
**10 for 40c**

Rubber Covered Lead-In Strips. 12" long. Will withstand bending.  
**C4784—With Clip Term. 8c**  
**EACH.....**  
**Ten for 69c**

### Duplex Lead-In Strip



For transmission line lead-ins. Completely insulated. 12" long.  
**C4776—With Clip Term. 8c**  
**YOUR PRICE.....**  
**Ten for 72c**  
**C4782—With Screw Term. 9c**  
**YOUR PRICE. EACH.....**  
**Ten for 81c**

### Antenna Spring Tightener



Takes up slack in Aerial.  
**K4779—Complete with insulator. EACH.....7¢**  
**10 for 60c**

### Spring Aerial Adjuster



Automatically keeps antenna tight and straight. Prevents swaying. Particularly desirable on doublet type of aerial installations. Ends equipped with porcelain insulators. Length, 9 1/2".  
**K4780—List, 50c.**  
**YOUR PRICE. EACH.....24¢**  
**TEN FOR.....\$2.25**

## Zenith All-Wave Doublet Antenna

Part Num. S5000

**A15940—List Price, \$5.00. 89c**  
**YOUR PRICE.....**

Genuine Zenith All-Wave Doublet Antenna

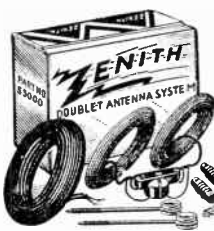

System as supplied for Zenith Radio Sets. Scientifically designed for highest efficiency of operation on both the standard broadcast and short-wave bands. Consists of 2-30 ft. lengths 7-24 tinned copper antenna wire coupled to 50 ft. rubber covered transmission cable through porcelain junction box, 2 porcelain antenna insulators, 2 5/8" screw eye stand-off insulators and 10 insulated staples.

**A4972—Coupling transformer for use with above antennas on older model sets which do not have provisions for connection of doublet antenna. Similar to Zenith Part Num. 95-376.**  
**YOUR PRICE.....59¢**

## Aerial Kits—Low Priced

STANDARD KIT CONTAINS:

50 ft. No. 7/26 stranded aerial wire; 80 ft rubber covered lead-in wire; 1 approved lightning arresster; 2 porcelain insulators; 1 ground clamp; 1 window lead-in; 2 porcelain nail knobs.  
**K4945—YOUR PRICE.....37¢**

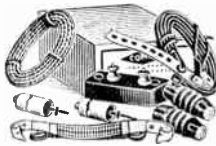

SPECIAL KIT CONTAINS:

100 ft. No. 7/26 stranded aerial wire; 40 ft. rubber covered lead-in wire; 25 ft. ground wire; 1 standard approved lightning arresster; 2 porcelain insulators; 3 porcelain nail knobs; 2 galvanized screw eyes; 1 window lead-in strip; 1 ground clamp; 1 instruction sheet.  
**K4946—YOUR PRICE.....69¢**

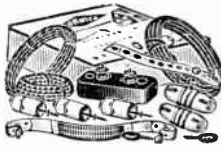

## I. C. A. Window Pole Aerial

A beautifully nickel plated telescopic window aerial. Especially suited for use in apartment buildings, homes, offices, etc. Ideal for radio demonstration purposes. May be tilted to any angle. Very efficient on short wave bands. Requires only two screws for installation on any wood window sill. Most sections are made of rust proof brass, highly nickel plated. Sturdy insulator. Includes window lead-in strip and screws.  
**D15900—With 3 telescopic sections adjustable to 8 feet. List Price, \$2.75. 162c**  
**YOUR PRICE. Each.....**  
**D15901—With 4 telescopic sections adjustable to 12 feet. List Price, \$3.75. 220c**  
**YOUR PRICE. Each.....**



Special Value

### Flex-O-Mast Antenna



For Efficient Portable Installations. Quickly and easily installed. Made of finest steel rod. Ideal antenna for demonstration purposes. Does not deface the building. Approved by landlords. Requires no tools for installation. Thumb screw securely holds antenna on window frame. Heavy rubber insulator. Finished in durable black enamel.  
**C15966—5 Ft. Mast. 59c**  
**YOUR PRICE.....**  
**C15967—2 Sec. 7 Ft. Mast. 88c**  
**YOUR PRICE.....**

## Keystone Vertical Mast Antenna

Eliminates all overhead wires. Requires little space. Easy to erect. Universal mounting bracket may be installed on vent pipe, window frame, chimney, gables, cornices, wall copings, etc. Sturdily constructed. 4 Section nickel-plated brass metal mast extends to 12 feet. Guaranteed rust-proof. Includes attaching clamps, screws, 40 ft. lead-in wire, lightning arresster, and 10 ft. ground wire.  
**D15902—List Price, \$3.95. 190c**  
**YOUR PRICE.....**  
**D15904—Same as above but less lead-in, ground wire and arresster. Includes mast with attaching bracket and clamps. List Price, \$3.50. 169c**  
**YOUR PRICE.....**

### Keystone Special Vertical Antenna



**C15879—4 Section 12 Ft. Mast. Serves same purpose as above aerials but is not quite as durable. Mast is made of hand tempered spring steel zinnite plated. Includes insulated brackets for mounting on sill pipe, cornice, walls, window sills, etc. 40 ft. No. 16 Rubber covered lead-in wire also included. Less lightning arresster. List Price \$3.00. 158c**  
**YOUR PRICE. Each.....**  
**In Lots of 6 or More, Each \$1.45**

## Single Lead Arresters



A dependable air gap type arresster. Porcelain case.  
**C4796—Each.....7c**  
**TEN FOR.....62c**  
**100 FOR.....\$6.10**

### Bakelite Arresster



Moulded bakelite body. Suitable for use inside or out of doors. Sturdy. Reliable. Underwriters standard. Furnished with \$100.00 lightning damage guarantee.  
**K4798—List, 25c. 13c**  
**YOUR PRICE.....**  
**TEN FOR.....\$1.10**

### ICA Champion Arresster Carbon Resistor Type



Individually tested to meet the requirements of the National Board of Underwriters. Black enameled porcelain case. Packed in individual cartons.  
**C4774—List, 30c. 18c**  
**YOUR PRICE. Each.....**  
**TEN FOR \$1.62**

### Glass Arresters



Base of clear crystal glass. Carbon element held between brass conductors. Clearly visible. \$100.00 insurance.  
**K4797—List, \$1.00. 47¢**  
**EACH.....**

### ELECTRO-STATIC

Lightning Arresster Static Arresster



Has choke coil and condenser connected between aerial and set terminals which act as a static and noise reducer and filter. \$100.00 free insurance bond.  
**K4794—List Price, \$1.00. 43¢**  
**YOUR PRICE.....**

### Bargain Ground Clamp

Vise grip. Rustproof hardened steel frame. Has separate screw for attaching wire. A quality ground clamp at an unusually low price. Fits pipe up to 1 1/2" diameter. Sold only in lots of 10 or more.  
**N4777—22¢**  
**10 FOR.....**  
**100 FOR \$1.95**

### Mueller Ground Clamp

Reinforced frame. Teeth cut through rust and paint. Separate screw for attaching wire. Fits pipe up to 1 1/2 inches diameter.  
**K4778—6¢**  
**EACH.....**  
**Ten for.....46c**  
**Per Hundred.....\$4.24**

# Lead-in WIRE Aerial

## Single Conductor Combination Lead-in and Aerial Wire

Copper wire, rubber insulated. Used for lead-in and ground wire. Also suitable for wiring tube filament and other high current circuits.

**Solid Conductor—Size 16 Rubber Covered**  
With outer weatherproof braid.

Stock Number	Coil Feet	Per Coil	Ten Coils for
K4605	25	14c	\$1.30
K4606	50	27c	2.50
K4607	100	52c	4.85
K4608	1000	\$4.95	

### Stranded Conductor Size 18 (16x30)

Also makes a good aerial wire. Rubber Covered—No outer braid.

Stock Number	Coil Feet	Per Coil	Ten Coils for
K4609	25	\$0.11	\$1.05
K4610	50	.20	1.95
K4611	100	.37	3.65
K4612	1000	3.40	

## Special Bargain Hook-Up and Lead-in Wire

C4734—1000 ft. Spool only  
**\$1.95**

Number 20 gauge Stranded Tinned Copper Wire with 1/8" rubber covering overall. Suitable for radio hook-up—lead-in—aerial wire, etc.

## Belden All-Rubber Wire For Lead-Ins and Grounds



Insulated with special rubber compound which strips easily. Tinned seven strand copper conductors.

Stock Number	Equiv. Size	Feet in Coil	Your Price
A4440	18	100	\$0.41
A4441	18	500	1.82
A4436	16	50	.29
A4437	16	100	.50
A4438	16	250	1.22
A4439	16	500	2.38
A4434	14	50	.42
A4435	14	250	1.92

## Shielded Lead-in and Ground Wire



Size 18 stranded inner conductor. Rubber insulated with outer braided shield of tinned copper wire. When used as lead-in, by grounding the outer shield, the tendency to pick up man-made static between aerial and receiver is practically eliminated.

R4585—50 foot coil.	<b>60c</b>
R4586—100 foot coil.	<b>\$1.18</b>
R4587—250 foot coil.	<b>\$2.90</b>

## Twisted Pair Twisted Pair Lead-in



### RUBBER COVERED With Cotton Braid Overall

Each conductor is of No. 20 (10x30) stranded tinned copper wire. lateral paper wrapped, 5/7 rubber covered, twisted together and a heavy weather-proof impregnated cotton braid overall.

K4591—50 Ft. Roll. **46c**  
YOUR PRICE

K4592—100 Ft. Roll. **89c**  
YOUR PRICE

K4593—250 Ft. Roll. **\$2.10**  
YOUR PRICE



## SHIELDED SOLID ENAMELED Cotton Braid Over Conductors

Each conductor is of No. 19 solid enameled copper wire, cotton served and covered with an impregnated cotton colored braid. Conductors are twisted together and a bare copper shield is tightly woven overall.

K4594—50 Ft. Roll. **85c**  
YOUR PRICE

K4595—100 Ft. Roll. **\$1.62**  
YOUR PRICE

K4596—250 Ft. Roll. **\$3.82**  
YOUR PRICE

## TRANSMISSION LINE CABLE Superior Quality



For the majority of all-wave receivers and of any half-wave dipole antenna. Conductors are size 18 stranded. Insulation is cotton wrapped, over which is a rubber sleeve. Two such conductors, color coded, are twisted together and covered with a weather-proofed cotton braid over-all.

A4555—50 foot Coil. **\$1.10**  
EACH

A4556—500 foot Spool. **\$6.95**

## SHIELDED TWISTED PAIR Superior Quality



Conductors are size 18 stranded. Insulation is cotton wrapped and color coded rubber covered. Two such conductors are twisted together and covered with paper wrap over which is a woven tinned copper shield and a weather-proofed over-all cotton braid. This is the most efficient type of transmission line.

A4557—75 foot Coil. **\$2.12**  
EACH

A4558—500 foot Spool. **\$13.96**

## Giant Spaghetti For Insulating Resistors, etc.

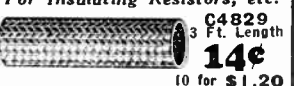

C4829  
3 Ft. Length **14c**  
10 for \$1.20

## Tinned "Bus" Wire

No. 14. Cut into two-foot lengths. Makes rigid neat job. Can be used bare or covered with spaghetti. Hand drawn copper. Round.

R4910—  
Ten Lengths. (20 feet) for. **14c**  
100 lengths (200 feet).....**\$1.29**

## Wire Prices

Are subject to market change Prices quoted are lowest at time of catalog publication. We expect to maintain these prices during life of this catalog. If prices decline, we give you the benefit of any reduction. In case of market advances, we reserve the right to adjust our prices.

## Indoor Aerial Wire

For A.C., D.C. and Midget Sets.  
K4831—25 foot coil.  
YOUR PRICE **7c**

10 Coils for **65c**  
K4832—100 foot coil.  
YOUR PRICE **27c**  
10 Coils for **\$2.49**

Extremely flexible. A well insulated stranded conductor is covered with a brown cotton braid. Will not kink and can be easily concealed. Also suitable for loop aeriels.

## Stick Tape Aerial

For Interior and Auto Use.  
K4833—  
1 list. \$1.00.  
YOUR PRICE **35c**  
10 for **\$3.20**

Sticks on any surface. Metallic alloy of great capacity adhesive rubber coating on back. Clip terminal. Easily installed. 40 feet to the roll.

## Pigtail Wire

K4834—10 foot. List Price, 35c.  
YOUR PRICE **20c**

A braided wire cable made up of very fine threads of copper wire, which gives it extreme flexibility. Use it to avoid high frequency resistance losses.

## "Spaghetti" Tubing



Takes Up to #14 Wire  
30-inch lengths. The best quality spaghetti made. Made of high grade cambric tubing impregnated with high insulation transparent varnish.

K4820—Black K4825—Blue  
K4821—Yellow K4826—White  
K4822—Brown K4827—Gray  
K4823—Green K4828—Maroon  
K4824—Red

YOUR PRICE **52c**  
10 lengths for

## Wire Stripper

K11690—  
YOUR PRICE **9c**

Strips insulation from radio wire easily and cleanly. Saves time. Cutting edge of tempered steel that will retain its hardness and last for years.

## Belden Test Prod Lead Wire

Flexible and Kinkless



Extra flexible No. 18 lead wire. Consists of 65 strands No. 36 tinned copper wire with wrap of cellophane and a 2/4 wall of durable rubber insulation overall. Will withstand highest voltages encountered in radio test work. Supplied only in Red or Black.

K4425—14 foot spool. Consists of 7 ft. of red and 7 ft. of black wire.  
YOUR PRICE **23c**

100 Foot Rolls  
K4423—Red Your  
K4424—Black Pr., Ea. **\$1.10**

## Belden Shielded Grid Wire

For grid leads. Neat, compact overall size. Very flexible. Tinned conductor size 18 stranded. Covered with .025" rubber over which is finely woven tinned copper wire shield.

C4550—100 foot Coil. **\$1.45**  
YOUR PRICE

## Copper Aerial Wire



Hard drawn, high grade bare copper wire. High conductivity and very little stretch. Meets every requirement for all types of aeriels; single wire, doublet, cage type. For all sets; All-Wave, Short-Wave or Broadcast. Our prices are lowest for wire of standard gauge, full length coils and highest quality.

## Stranded Bare Copper Wire

Stock Num.	Wire Size	Coil Feet	Per Coil	Ten Coils
C4700	18(7x26)	50	10c	\$0.95
C4703	18(7x26)	75	13c	1.20
C4706	18(7x26)	100	19c	1.79
C4709	18(7x26)	250	46c	4.37
C4701	16(7x24)	50	14c	1.29
C4704	16(7x24)	75	20c	1.90
C4707	16(7x24)	100	27c	2.55
C4710	16(7x24)	250	66c	6.45
C4702	14(7x22)	50	20c	1.95
C4705	14(7x22)	75	29c	2.80
C4708	14(7x22)	100	38c	3.75
C4711	14(7x22)	250	92c	9.25

## Stranded Enamelled Copper Wire

Stock Num.	Wire Size	Coil Feet	Per Coil	Ten Coils
C4712	18(7x26)	50	16c	\$1.40
C4716	18(7x26)	75	20c	1.90
C4720	18(7x26)	100	30c	2.70
C4724	18(7x26)	250	73c	6.62
C4713	16(7x24)	50	22c	1.95
C4717	16(7x24)	75	27c	2.60
C4721	16(7x24)	100	36c	3.50
C4725	16(7x24)	250	99c	9.50
C4714	14(7x22)	50	27c	2.55
C4718	14(7x22)	75	37c	3.50
C4722	14(7x22)	100	53c	4.98
C4726	14(7x22)	250	\$1.31	12.37
C4715	12(7x20)	50	43c	4.15
C4719	12(7x20)	75	64c	6.18
C4723	12(7x20)	100	85c	8.25
C4727	12(7x20)	250	\$2.06	19.25

## Solid Enamelled Copper Wire

Stock Num.	Wire Size	Coil Feet	Per Coil	Ten Coils
C4730	14	100	42c	\$4.05
C4729	12	100	61c	5.90
C4728	10	100	94c	9.10
C4733	14	250	98c	9.50
C4732	12	250	\$1.45	13.75
C4731	10	250	2.30	21.95

## Belden Antenna Wire



The dependable Belden standard product. Regular Belden Packaging. Guaranteed quality, sizes and lengths.

## Stranded Bare Copper Wire

Stock Num.	Wire Size	Coil Feet	Per Coil
D4668	16(7x24)	50	15c
D4669	16(7x24)	75	22c
D4670	16(7x24)	100	28c
D4664	14(7x22)	50	22c
D4665	14(7x22)	75	32c
D4666	14(7x22)	100	42c

## Stranded Enamelled Copper Wire

Stock Num.	Wire Size	Coil Feet	Per Coil
D4652	14(7x22)	75	44c
D4653	14(7x22)	100	58c
D4654	14(7x22)	150	86c
D4650	12(7x20)	100	96c

## Solid Enamelled Copper Wire

D4659	11	100	47c
D4657	12	100	69c



# Hook-Up WIRE Magnet

## Push-Back Hook-Up Wire



Tinned copper conductors, cotton served and covered with an outer waxed, damp-proof, cotton braid. This is the style wire mostly used on factory production sets. For making a soldered connection, just push back the insulation, solder and slide insulation back up to joint. Makes neat smooth job. Excellent value. Superior quality. All Standard R.M.A. colors for every wiring job.

### Solid Copper Core

Num. 22			Num. 20			Num. 18		
25 Ft. Stock Num.	Lengths Braid Color	100 Ft. Stock Num.	25 Ft. Stock Num.	Lengths Braid Color	100 Ft. Stock Num.	25 Ft. Stock Num.	Lengths Braid Color	100 Ft. Stock Num.
C4100	Red	C4109	C4309	Red	C4318	C4345	Red	C4354
C4101	Yellow	C4110	C4310	Yellow	C4319	C4346	Yellow	C4355
C4102	Blue	C4111	C4311	Blue	C4320	C4347	Blue	C4356
C4103	Green	C4112	C4312	Green	C4321	C4348	Green	C4357
C4104	Black	C4113	C4313	Black	C4322	C4349	Black	C4358
C4105	Brown	C4114	C4314	Brown	C4323	C4350	Brown	C4359
C4106	White	C4115	C4315	White	C4324	C4351	White	C4360
C4107	Gray	C4116	C4316	Gray	C4325	C4352	Gray	C4361
C4108	Maroon	C4117	C4317	Maroon	C4326	C4353	Maroon	C4362
<b>PRICE EACH</b>	<b>PRICE EACH</b>		<b>PRICE EACH</b>	<b>PRICE EACH</b>		<b>PRICE EACH</b>	<b>PRICE EACH</b>	
<b>10c</b>	<b>33c</b>		<b>11c</b>	<b>36c</b>		<b>14c</b>	<b>51c</b>	
10 Rolls for 85c	10 Rolls for \$2.90		10 Rolls for 99c	10 Rolls for \$3.45		10 Rolls for \$1.30	10 Rolls for \$4.75	

### Stranded Copper Core

Num. 22 (7x30)			Num. 20 (10x30)			Num. 18 (16x30)		
25 Ft. Stock Num.	Lengths Braid Color	100 Ft. Stock Num.	25 Ft. Stock Num.	Lengths Braid Color	100 Ft. Stock Num.	25 Ft. Stock Num.	Lengths Braid Color	100 Ft. Stock Num.
C4118	Red	C4127	C4327	Red	C4336	C4363	Red	C4372
C4119	Yellow	C4128	C4328	Yellow	C4337	C4364	Yellow	C4373
C4120	Blue	C4129	C4329	Blue	C4338	C4365	Blue	C4374
C4121	Green	C4130	C4330	Green	C4339	C4366	Green	C4375
C4122	Black	C4131	C4331	Black	C4340	C4367	Black	C4376
C4123	Brown	C4132	C4332	Brown	C4341	C4368	Brown	C4377
C4124	White	C4133	C4333	White	C4342	C4369	White	C4378
C4125	Gray	C4134	C4334	Gray	C4343	C4370	Gray	C4379
C4126	Maroon	C4135	C4335	Maroon	C4344	C4371	Maroon	C4380
<b>PRICE EACH</b>	<b>PRICE EACH</b>		<b>PRICE EACH</b>	<b>PRICE EACH</b>		<b>PRICE EACH</b>	<b>PRICE EACH</b>	
<b>11c</b>	<b>36c</b>		<b>12c</b>	<b>41c</b>		<b>17c</b>	<b>58c</b>	
10 Rolls for 99c	10 Rolls for \$3.39		10 Rolls for \$1.05	10 Rolls for \$3.95		10 Rolls for \$1.63	10 Rolls for \$5.55	

## Belden Hook-Up Wire



### Cellulose Acetate Push-Back

Attractive high gloss lacquer covered. Tinned copper conductor with heavy cellulose acetate wrap and basket-weave abrasion proof lacquered rayon outer braid. 1550 Volt insulation.

### Rubber Push-Back

6900 Volt insulation. Tinned copper conductor with cotton wrap. .010" rubber insulation and basket-weave abrasion proof lacquered rayon outer braid.

Solid			Stranded			Number 20		
25 Ft. Stock Num.	Lengths Braid Color	100 Ft. Stock Num.	25 Ft. Stock Num.	Lengths Braid Color	100 Ft. Stock Num.	25 Ft. Stock Num.	Lengths Braid Color	100 Ft. Stock Num.
D4560	Red	D4572	D4565	Red	D4615	D4640	Red	D4635
D4561	Black	D4573	D4566	Black	D4616	D4641	Black	D4636
D4562	Green	D4574	D4567	Green	D4617	D4642	Green	D4637
D4563	Blue	D4575	D4568	Blue	D4618	D4643	Blue	D4638
D4564	Yellow	D4576	D4569	Yellow	D4619	D4644	Yellow	D4639
<b>25 Ft. Rolls EACH</b>	<b>100 Ft. Rolls EACH</b>		<b>25 Ft. Rolls EACH</b>	<b>100 Ft. Rolls EACH</b>		<b>25 Ft. Rolls EACH</b>	<b>100 Ft. Rolls EACH</b>	
<b>17c</b>	<b>50c</b>		<b>18c</b>	<b>59c</b>		<b>18c</b>	<b>54c</b>	
<b>Number 18</b>			<b>Number 18 (16x30)</b>			<b>Stranded</b>		
D4577	Red	D4582	D4620	Red	D4625	D4645	Red	D4685
D4578	Black	D4583	D4621	Black	D4626	D4646	Black	D4686
D4579	Green	D4584	D4622	Green	D4627	D4647	Green	D4687
D4580	Blue	D4613	D4623	Blue	D4628	D4648	Blue	D4688
D4581	Yellow	D4614	D4624	Yellow	D4629	D4649	Yellow	D4689
<b>25 Ft. Rolls EACH</b>	<b>100 Ft. Rolls EACH</b>		<b>25 Ft. Rolls EACH</b>	<b>100 Ft. Rolls EACH</b>		<b>25 Ft. Rolls EACH</b>	<b>100 Ft. Rolls EACH</b>	
<b>18c</b>	<b>60c</b>		<b>21c</b>	<b>66c</b>		<b>20c</b>	<b>60c</b>	

### Belden Heavy Rubber Push-Back



Stranded tinned copper conductor with rubber insulation and basket-weave abrasion proof lacquered rayon outer braid.

### 10,000 Volt Insulation

### Number 18 (16x30) Stranded

Stock Num.	Your Price	Braid Color	Stock Num.	Your Price
D4690	36c	Red	D4676	\$1.24
D4691	EACH	Black	D4677	EACH
D4692		Green	D4678	
D4693		Blue	D4679	
D4694		Yellow	D4680	

## Serviceman's Magnet Wire

Every serviceman should have an assortment of magnet wire in his workshop. These convenient sized spools eliminate the necessity of buying more wire than is actually needed. Finest quality. Excellent for rewinding relays, short wave and transmitting coils, small motors, small field coils, etc. Wire is wound on spools marked with type and size. Number of feet of wire included on each spool is given below.



**YOUR PRICE**  
EACH. Any Spool..... **13c**  
Lots of 10 or More Assorted, Each, 12c

Plain Enameled			Double Cotton			Single Cotton Enamel			Double Silk		
Stock Num.	Feet Per Spool	Wire Size	Stock Num.	Feet Per Spool	Wire Size	Stock Num.	Feet Per Spool	Wire Size	Stock Num.	Feet Per Spool	Wire Size
C4257	25	14	C4271	25	14	C4225	21	14	C4285	19	14
C4258	40	16	C4272	35	16	C4226	33	16	C4286	25	16
C4259	50	18	C4273	45	18	C4227	42	18	C4287	31	18
C4260	90	20	C4274	60	20	C4228	60	20	C4288	42	20
C4261	140	22	C4275	81	22	C4229	81	22	C4289	60	22
C4262	200	24	C4276	110	24	C4230	110	24	C4290	85	24
C4263	300	26	C4277	150	26	C4231	148	26	C4291	101	26
C4264	450	28	C4278	175	28	C4232	168	28	C4292	120	28
C4265	600	30	C4279	200	30	C4233	192	30	C4293	141	30
C4266	800	32	C4280	220	32	C4234	216	32	C4294	165	32
C4267	1200	34	C4281	250	34	C4235	242	34	C4295	190	34
C4268	1600	36	C4282	275	36	C4236	266	36	C4296	220	36
C4269	2000	38	C4283	294	38	C4237	294	38	C4297	243	38
C4270	2500	40	C4284	325	40	C4238	325	40	C4298	275	40

## Belden Magnet Wire

Finest quality. Uniform. Carefully inspected insulation. One continuous length only on each spool. Sizes are exact standard B & S gauge. Specifications conform to those given by leading manufacturers for radio apparatus, motor and generator windings, etc. Guaranteed. Quality considered, our prices represent the very best values obtainable.



### Plain Enameled

Size	1/2 lb. Spool		2 lb. Spool	
	Stock Num.	Your Price	Stock Num.	Your Price
14	C4455		C4469	\$0.64
16	C4456	27c	C4470	.67
18	C4457		C4471	.70
20	C4458	29c	C4472	.73
22	C4459	29c	C4473	\$0.76
24	C4460	30c	C4474	.79
26	C4461	35c	C4475	.85
28	C4462	38c	C4476	.88
30	C4463	42c	C4477	.94
			1 lb. Spool	
32	C4464	27c	C4478	\$0.54
34	C4465	30c	C4479	.61
36	C4466	38c	C4480	.72
38	C4467	52c	C4481	.87
40	C4468	74c	C4482	1.22

### Double Cotton Cov.

Size	1/2 lb. Spool		2 lb. Spool	
	Stock Num.	Your Price	Stock Num.	Your Price
14	C4483	30c	C4495	\$0.73
16	C4484	32c	C4496	.82
18	C4485	33c	C4497	.91
20	C4486	36c	C4498	1.04
22	C4487	38c	C4499	1.18
24	C4488	42c	C4500	1.36
			1 lb. Spool	
26	C4489	27c	C4501	\$0.79
28	C4490	30c	C4502	.93
30	C4491	35c	C4503	1.06
32	C4492	48c	C4515	1.54
34	C4493	60c	C4516	1.67
36	C4494	71c	C4517	2.14

### Double Silk Covered

Size	1/2 lb. Spool		1 lb. Spool	
	Stock Num.	Your Price	Stock Num.	Your Price
18	C4506	\$0.27	C4518	\$0.45
20	C4507	.28	C4519	.51
22	C4508	.29	C4520	.53
24	C4509	.32	C4521	.59
26	C4510	.38	C4522	.71
28	C4511	.45		
30	C4512	.56		
				<b>We can supply other sizes.</b>
32	C4513	.75		
34	C4514	1.05		

### Rubber Covered Hook-Up Wire

Flexible color coded rubber insulation. Conductor of stranded tinned copper wire size 20. Will not dry out or crack. Easy to skin.

25 Foot Coils	Each	Price
A4630	Red	13c
A4631	Black	
A4632	Green	Five for 57c
A4633	Blue	
A4634	Yellow	

### Belden Colorrubber Hook-Up Wire

Finest quality color coded rubber covered hook-up wire. Stranded tinned copper conductor, equivalent size 18 (16 strand No. 30 wire). .025" colored rubber insulation, waxed.



25 foot coils	Color	100 foot coils
A4428	Red	A4400
A4429	Black	A4401
A4430	Green	A4402
A4431	Blue	A4403
A4432	Yellow	A4404
A4433	Brown	A4405

EACH. **18c** | EACH. **47c**

### DeLuxe Coil Winder

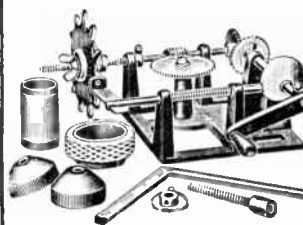

**K11691 - \$4.35**  
YOUR PRICE

For winding Honey Comb, Spider Web and Solenoid Coils of different widths and diameters. Will use wire of different gauges. Accurate coils can be made. Equipped with necessary accessories for winding various types of coils. Has a recorder with adjustable pointer for counting number of turns

# Public Address WIRE Auto Radio

## Belden High Quality Cables

Extraordinary High Quality Cables made by "Belden" one of the largest wire manufacturers, noted for the quality of their products. Only the best quality pure copper wire and the highest grade insulating materials are used. The construction of these cables eliminates all possibility of chafing between the single conductors or shield and insures the longest possible life. This cable is far superior. No finer cable is made.

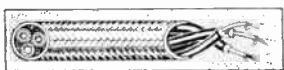

### Glazed Braid Overall

Particularly recommended for Connection of Magnetic and Dynamic Speakers on Indoor Installations where cable will not be subject to wear. Also for use as battery cables.

Each conductor size 20 (10 strands No. 30) tinned copper wires, paper wrapped for flexibility and quick soldering, .02" rubber insulated. Each covering is distinctively colored for easy tracing. Individual conductors are cabled together and covered with brown glazed abrasion proof "basket-weave" braid overall. Very Flexible.

Stock Number	Num. Cond.	10 feet for	100 feet for
K16502	3	20c	\$1.56
K16503	4	25c	2.09
K16504	5	29c	2.48

For Single Conductor use fixture cord or hook-up wire. For Two Conductor use lamp cord or twisted pair transmission line.

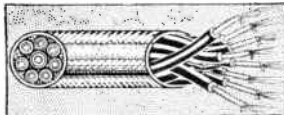

### Analyzer Cable

6, 7, 8 and 9 Conductor

Has Two Heater Leads of size 16 Stranded Tinned Copper Wire with .051 rubber insulation. Balance of conductors are size 20 with .021" rubber insulation. All conductors are color coded. Paper wrapped for flexibility and quick soldering. Individual conductors are cabled together and covered overall with a glazed brown abrasion proof "basket-weave" braid. The flexibility and long life of the cable are greatly increased by the Jute Filler Center.

Stock Number	Num. Cond.	15 feet for	10 feet for	100 feet for
K16508	6	23c	41c	\$3.55
K16509	7	25c	45c	4.11
K16510	8	32c	59c	5.32
K16511	9	34c	63c	5.65



### Shielded Covering Overall

Particularly recommended for Microphone and other lines that are subject to hum pickup.

Each conductor size 20 of stranded tinned copper wires, paper wrapped for flexibility and quick soldering 1/64" rubber insulated and lacquered braid covered. Each covering is distinctively colored for easy tracing. Individual conductors are cabled together and covered overall with woven shield of fine size tinned copper wires. Very flexible. Perfect Electrostatic Shield.

Stock Number	Num. Cond.	10 feet for	100 feet for
K16512	2	30c	\$2.42
K16513	3	36c	3.01
K16514	4	49c	3.67

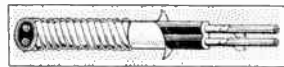

### Armored Speaker Cable

Two conductor size 18—(4) strands No. 34) cotton wrapped, rubber wrap paper wrap and overall tinned steel armor. Size, .155"x.260". Particularly recommended for speaker extension on Public Address Systems. Radio sets, etc.

A16550	—10 Feet for	29c
	250 feet for	\$6.20



### Rubber Jacket Overall

Particularly recommended for Speaker Lines for Indoor or Outdoor Installations where cables will be subjected to wear and moisture.

Two and three conductor cable size 18 (4) strands No. 34) of tinned copper wires, cotton served, 1/64" rubber insulated. Four and five conductor cable of 2 size 18 (4x34) and balance size 20 (10x30). Individual conductors are color code and cabled together with a Jute filler, cotton served and enclosed in outer waterproof super seether rubber jacket overall. Extremely flexible.

Stock Number	Num. Cond.	10 feet for	100 feet for
K16515	2	25c	\$2.10
K16516	3	29c	2.59
K16517	4	44c	3.45
K16518	5	54c	4.41



### Woven Shield Covered With Rubber Jacket Overall

The Finest Cable made. Very Flexible. Will stand hardest use.

Each conductor size 20 (26 strands No. 34) of tinned copper wires cotton served and 1/64" rubber insulated. Each covering is distinctively colored for easy tracing. Individual conductors are cabled together, cotton served, and covered overall with close woven shield of fine size tinned copper wire. Over shield is another cotton serve and an outer super-rubber rugged jacket providing a waterproof practically wear-proof covering.

Stock Number	Num. Cond.	10 feet for	100 feet for
K16521	2	49c	\$4.04
K16522	3	54c	4.51
K16523	4	69c	5.70
K16524	5	83c	7.06
K16525	6	98c	8.23
K16526	7	\$1.17	9.55



### Low Capacity Shielded Mike and Auto Aerial Lead-in Cable

Rubber Jacket Overall

Absolutely essential for high impedance circuits. Protects loss of signal in cable when used for microphone to grid inputs, auto aerial lead-in circuits, etc. Single size 26 conductor consists of combination stranding of tinned copper and phosphor bronze wire for extra flexibility and ten-tie strength. Conductor is covered by low capacity rubber core with celanese braid covered by tinned copper shielding with double celanese wrap and rubber jacket overall. Fully water-proof. Capacity per foot, 29 Mmf. Outside Dia., .215".

D16529	—10 Feet for	44c
	100 feet for	\$3.67

D16527—Same as above except has 25 Mmf. capacity per foot. Outside diameter .245".

	100 feet for	\$4.19
--	--------------	--------

### Heavy Duty Cable

D16530—Consists of single size 20 tinned stranded copper conductor otherwise same as above. Fully waterproof and very rugged. Cap. per foot 44 Mmf. Outside dia., .260".

	100 feet for	\$3.30
--	--------------	--------

### For Phono Pick-ups

D16631—Shielded phonograph pick-up wire with cotton braid overall. Size 20 conductor. Cap. per foot 55 Mmf. Outside diameter .160".

	100 feet for	\$1.57
--	--------------	--------

## Belden PA and Communication System Cables For Inside or Outside Use



### With One Shielded Conductor

Consists of size 19 solid tinned copper conductors each with 1/2" rubber insulation and color coded waxed cotton braid. Conductors are cabled together with fillers and covered overall with weatherproof impregnated cotton braid for indoor or outdoor use. Tinned woven copper shield on one conductor.

D16540—Two Conductor. One shielded, one plain. .315" O.D. 10 feet for ..... 39c

500 feet for \$15.60

D16541—Three Conductor. Two plain, one shielded. .380" O.D. 10 feet for ..... 49c

500 feet for \$20.45

## Amphenol Co-Axial Cable

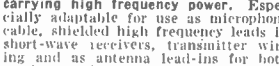

A concentric transmission line for carrying high frequency power. Especially adaptable for use as microphone cable, shielded high frequency leads in short-wave receivers, transmitter wiring and as antenna lead-ins for both receiver and transmitter. 12 solid copper wire is insulated from woven shield with beads made of Amphenol "912-A" pure polystyrene insulation. Two cotton braided coverings over shield are lacquered to repel moisture and prevent abrasion. Outside diameter .38". Radius of maximum bend 1". Impedance, 72 Ohms. Loss per 1,000 ft., 1.75dB. Inductance per ft., .1 microhenry. Capacity per ft., 11.5 mmf. Resistance per ft., .024 ohms. Conductance per ft., .092x10-16 ohms. (All measurements made 1,000,000 c.p.s.) Net wt. 1 oz. per ft.

A16599—Per Foot .. 30c

YOUR PRICE, Per foot .. 30c

The above cable is available with other various smaller sized conductors or with copper tubing shield at no extra cost and also with synthetic resin outer covering at slightly higher cost.

Also available in two-conductor type for balanced transmission lines.

## Belden Rubber Covered Co-Axial Cable

Similar to above except has porcelain beads and rubber covering overall. Outside diameter .487". Impedance 73.9 ohms. Capacity per ft., 17.7 mmfd. at 1500 Kc.

D16598—Per Foot ..... 34c

100 Ft. Coil, Price, \$29.40

## Amphenol Cable Connectors

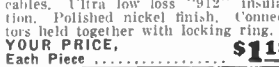

For Co-Axial Cables

Fits Belden and Amphenol Co-Axial cables. Ultra low loss "912" insulation. Polished nickel finish. Connectors held together with locking ring.

YOUR PRICE, \$1.18

Each Piece

Type	Stock Num.	Male	Female
With Coupling Ring	C12008	C12003	
With Coupling Ring	C12001	C12004	
Chassis Connector	C12002	C12005	

## Belden Shielded Loom

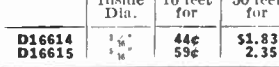

Finely woven tinned copper shielding over impregnated loom. Provides low capacity shielding for auto antenna lead-ins.

	Inside Dia.	10 feet for	50 feet for
D16614	1 1/8"	44c	\$1.83
D16615	1 3/8"	59c	2.35

## Belden Automotive and Auto Radio Cables and Shielding



### Shielded Low Capacity Cable

Without Rubber Jacket

For auto antenna lead-in and other high impedance circuits where a low-loss cable is essential for best performance. Consists of size 20 (10x20 tinned) stranded copper conductor with cotton wrap, heavy solid rubber core insulation with celanese braid and closely woven tinned copper shielding overall. Outside diameter, .225". Capacity between conductor and shield, 27 mmf.

C16548—10 feet for ..... 34c

100 feet for \$2.86

With Rubber Jacket Overall

As above but with moisture proofing rubber jacket overall. Very rugged. Outside diameter, .290".

C16547—10 feet for ..... 49c

100 feet for \$4.04

## Shielded Ignition Cable

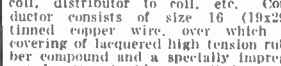

7 M/M shielded secondary high tension wire. For leads from plugs to coil, distributor to coil, etc. Conductor consists of size 16 (19x29) tinned copper wire, over which is covering of lacquered high tension rubber compound and a specially impregnated cotton braid. Overall is woven shielding of tinned copper wire. Very flexible.

R16613—10 feet for ..... 83c

100 feet for \$7.06

D16611—Unshielded. As above but without copper shielding.

Ten feet for ..... 69c

100 feet for \$5.88

D16612—Shielded Commercial Grade Spark Plug Ignition Wire. Tinned copper shielding.

Ten feet for ..... 59c

100 feet for \$4.77

## Shielded Automotive Primary Wires



Suitable for automotive and other low voltage, high current circuits. Consists of stranded tinned copper conductor with cellophane wrap, rubber insulation, lacquered glazed cotton outer braid and finely woven copper shield overall.

Stock Num.	Wire Size	10 ft. for	100 ft. for
D16635	12(19x25)	39c	\$3.23
D16636	14(19x27)	34c	2.65
D16637	16(19x29)	29c	2.21

### Without Shielding

D16638	12(19x25)	34c	\$2.79
D16639	14(19x27)	29c	2.21
D16640	16(19x29)	26c	1.62

## Copper Shielding

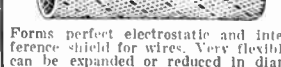

Forms perfect electrostatic and interference shield for wires. Very flexible; can be expanded or reduced in diameter and length by pushing together or stretching. Diameters given provide a shielding coverage of 80 to 85%.

### Individual Wires Tinned

Stock Num.	For Wire	Inside Diam.	10 ft. for	50 ft. for
D16619	1/8"	1/8"	11c	\$0.49
D16622	3/16"	3/16"	14c	.59
D16621	1/4"	1/4"	19c	1.29
D16623	5/16"	5/16"	23c	1.60



# for Complete Home Wiring

Prices on Electrical wiring materials subject to market change

## Single Braid Rubber Covered Building Wire



Underwriters' Approved  
Flame Retarding  
Moisture Resistant

Stock Num.	Wire Size	Braid Color	Your Price 100 Feet	1000 Feet	Per M Ft. In 2500 Ft. Lots
C16600	14	Black			
C16601	14	White	65c	55.95	\$5.80
C16602	14	Red			
C16603	12	Black			
C16604	12	White	87c	58.20	\$7.95
C16605	10	Black			
C16606	10	White	\$1.24	\$12.00	\$11.00
C16607	8	Black			
C16608	8	White	\$2.10	\$20.00	\$19.75

A high quality code building wire suitable for home and factory wiring. Solid tinned conductor and rubber insulation. Will not fray or push back. Easily stripped clean. Uniform quality. Slick finish, easily pulled through rigid or thin wall conduit.

## Armored Service Entrance Cable



Underwriters' Approved  
Weather and Flame Proofed

For entrance wiring from power lines to service switch, and other high current indoor or outdoor wiring systems. Stranded copper wire conductors fully insulated and protected by galvanized steel armor with double wrap of rubber tape and heavy protective covering. One conductor in cable is concentrically laid to serve as ground or neutral.

Stock Num.	Wire & Size	Ft. in Coil	YOUR PRICE Per Ft.	Per Coil
D16631	2-#8	250	9 1/2c	\$21.25
D16632	3-#8	250	12c	25.45
D16633	3-#6	150	15c	19.75

## Service Entrance Cable Fittings

### A—Malleable Cable Straps

Stock Num.	For Wire	Price Each	10 for	100 or
D16721	2-8	1 1/2c	15c	\$1.37
D16758	3-8	2c	19c	1.84
D16759	3-6	2c	19c	1.84

B—Non-Watertight Connectors  
\*For 1/2" KO. 1/4" KO. 1/2" KO.

D16750	2-8	3c	26c	\$2.45
D16751	3-8	10c	90c	8.45
D16750	3-6	10c	90c	8.45

### C—Watertight Connectors

D16761	2-8	21c	\$1.95	\$18.50
D16762	3-8	23c	2.00	19.40
D16763	3-6	23c	2.00	19.40

## Porcelain Exposed Wiring Accessories



For 6, 32 and 110 volt systems. Made of white glazed porcelain. Cleats and wall tubes are unglazed. Nail knobs and cleats include leather collared nails. Type E, F and G have exposed screw terminals.

Stock Num.	Type	Your Price 10 for	100 for
D4750	A-3' Wall Tube	7c	59c
D4755	A-6' Wall Tube	14c	\$1.25
D4785	B-Solid Knob	13c	.95
D4766	C-Nail Knob	17c	1.47
D4757	D-2 Wire Cleat	23c	2.10

D13876	E—Rosette for drop cord	Ten for 85c. Each.....	9c
D11256	F—Receptacle	Ten for 55c. Each.....	6c
D13877	G—Fused Switch, 2 wire, 30 ampere type. Less fuses.	Ten for \$3.40. Each.....	35c

## Wire Holders

Brown glazed porcelain insulator with firmly anchored galvanized screw.  
D4758—1 1/2"x2" High. Ten for 95c. Each..... 10c  
D4759—1 1/2"x3" High. Has No. 22 screw. Ten for \$1.60. Each..... 17c

## House Brackets

Sturdy galvanized bracket with brown porcelain insulator.  
D4760—2 Wire, 11" Long. Ten for \$4.30. Each..... 46c  
D4761—3 Wire, 15" Long. Ten for \$6.40. Each..... 67c

## Entrance Caps

For bringing in service wires. Has 2, 3, or 4 wires. For vertical pipe.  
C13843 3/4" Each 19c Ten for \$1.67  
C13844 3/8" Each 24c Ten for 2.16  
C13845 1" Each 31c Ten for 2.81

## Complete Yard Light

Consists of baked enamel reflector, cadmium plated wall mounting flange and 3/4" goose neck conduit, keyless porcelain socket and two 3 ft. lengths of #14 wire. Easily assembled. Takes 60 or 100 watt bulb. Extends 24" from wall.  
D16766—Ten for \$11.27. Each..... \$1.22

## Heavy Duty Yard Lights

Consists of porcelain enameled steel reflector, cadmium plated cast iron "bayonet type" detachable socket housing, patented armored socket, 1/2" cadmium plated steel pipe 16" long, cadmium plated wall flange, two lag screws for mounting flange and two lengths of #14 wire. Easily assembled. Less bulb.  
Num. Dia. Watts Each Ten for  
D16767 12 60-100 \$1.72 \$15.97  
D16768 14 150 1.91 19.54  
D16769 16 200 2.23 20.70

## Rigid Iron Conduit

For Permanent Installation  
Underwriter's approved. Supplied in 10 ft. lengths with threaded ends and one coupling.



### Black Enamel Finish For Indoor Use

Stock Num.	Size	Your Price Per 10 ft.	Per 100 ft.
C16700	1/2"	55c	55.22
C16701	3/4"	72c	6.64
C16702	1"	98c	9.52

### Galvanized Finish For Indoor and Outdoor Use

Stock Num.	Size	Your Price Per 10 ft.	Per 100 ft.
C16703	1/2"	61c	\$5.71
C16704	3/4"	78c	7.34
C16705	1"	\$1.12	10.52

## Rigid Conduit Fittings



### A—90° Elbows

Black Stock Num.	Your Price	Size	Galvanized Stock Num.	Your Price
C16706	14c	1/2"	C16709	16c
C16707	18c	3/4"	C16710	20c
C16708	27c	1"	C16711	31c

### D—One Hole Malleable Strap

Stock Number For Thinwall	For Rigid Conduit	Size	Your Price for 10 for	Per 100 for
C16718	C16721	1/2"	15c	51.37
C16719	C16722	3/4"	25c	1.95
C16720	C16723	1"	30c	2.30

### B—Couplings

C16712	5 1/2c	1/2"	C16715	6c
C16713	7c	3/4"	C16716	8c
C16714	10c	1"	C16717	11c

### E—Galvanized Lock Nuts

Stock Num.	Size	Your Price Per 10	Per 100
C16724	1/2"	5c	45c
C16725	3/4"	8c	63c
C16726	1"	14c	\$1.08

### F—Galvanized Bushings

C16727	1/2"	8c	68c
C16728	3/4"	14c	\$1.10
C16729	1"	25c	2.08

### F—With Grounding Screw

D16770	1/2"	8 1/2c	75c
D16771	3/4"	10c	90c
D16772	1"	16 1/2c	\$1.55

## Thin Wall Conduit and Fittings



### Thin Wall Conduit

Strong-light weight conduit. Much easier to use than old style conduit. Saves time. Cuts with a hack saw. Does not require threading. Easily bent. Outside hot galvanized, inside is enamel coated. Supplied in 10 ft. lengths. Underwriter's approved.



Threadless water tight conduit coupling. Made of steel, cadmium plated. Spring tight grip. cannot come loose.

### Connectors

Stock Num.	Size	Each	Your Price Per 10	Per 100
C16733	1/2"	6 1/2c	54c	\$5.24
C16734	3/4"	8 1/2c	79c	7.23
C16735	1"	15c	\$1.32	12.22

Stock Num.	Size	Your Price Per 10 Ft.	Per 100 Ft.
C16730	1/2"	39c	\$3.50
C16731	3/4"	53c	4.85
C16732	1"	76c	6.95

### Couplings

C16736	1/2"	7 1/2c	64c	\$6.11
C16737	3/4"	10 1/2c	88c	8.29
C16738	1"	15c	\$1.32	12.22

## ABC Armored Bushed Cable (B.X.)



Tinned copper conductors, rubber insulated and wrapped with cotton braid saturated with moisture resisting, flame retarding, compound. Protected overall by heavy kraft paper wrapping and heavy flexible galvanized steel armor. 20 Anti-shock bushings furnished free with each 250 ft. of cable. Underwriter's approved.

Stock Num.	Wires and Size	Per Ft.	Your Price Per 250 ft.	Per 1000 ft.
C16739	2-14	3 1/2c	\$7.00	\$26.75
C16740	3-14	4 1/2c	9.12	35.50
C16741	2-12	4 1/2c	9.12	35.50
C16742	3-12	5 1/2c	12.12	45.75
C16743	2-10	6 1/2c	14.90	52.75

## Non-Metallic Sheathed Cable

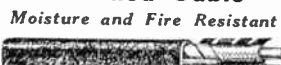

Approved by Underwriter's. Meets code requirements in most cities and can be used instead of BX or Conduit to save time and labor. Especially recommended for farm wiring. Very flexible, will take right angle bends without cracking.

Stock Num.	Wires and Size	Per Ft.	Your Price Per 100 ft.	Per 1000 ft.
C16744	2-14	3c	\$2.30	\$21.50
C16745	3-14	3c	4.70	44.00
C16746	2-12	5c	4.20	39.25
C16747	3-12	7c	6.30	60.00
C16748	2-10	6c	5.40	52.00

## Box Connectors for Armored and Non-Metallic Cables

For 1/2" knock-outs  
C16754—A—Squeeze type box connector for Armored (BX) cable.  
C16755—B—Twin screw. For Non-metallic cables.  
Either Type.  
Ten for 26c. Each..... 3c  
D16756—C—90° Elbow. For Armored or Non-metallic cable.  
Ten for 85c. Each..... 9c



D16757—D—Twin Screw Duplex. Connects two cables into one knock-out. For Armored or Non-metallic.  
Ten for 54c. Each..... 6c

# "ELECTRIC FENCE" One Wire

## Safe · Dependable

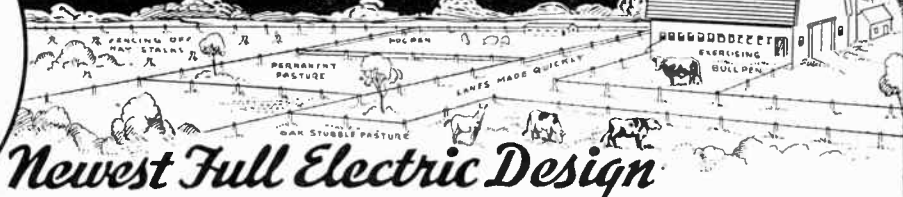
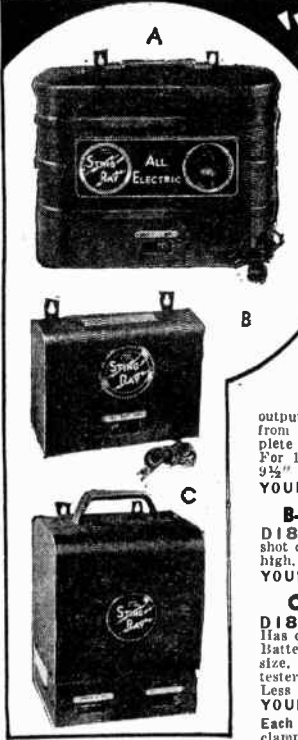

### Newest Full Electric Design

### The New Economical Way of Farm Fencing

**A—For 110 Volt AC Operation**  
**D18047—Model 5A4CJ.** Uses type 76 and 2A4G radio tubes for safe current output control. Fence line is completely isolated from power line. Window shows operation. Complete with tubes and 25 line and 4 corner insulators. For 110 volt, 50-60 cycle AC use. Size 6½x12¼x9½" high. Wt. 17 lbs. List, \$17.95. **\$11.95**  
**YOUR PRICE.....**

Farmers everywhere have been sold on the safety, effectiveness and economy of electric fences. Get your share of profits being derived from national advertising on electric fences. A simple demonstration will clinch the sale to even the most skeptical farmer prospect.

#### Saves on Material and Labor

Only one wire, or two at the most, is required to effectively hold the stock. As the cattle do not attempt to push this fence, only widely spaced small sized stakes are necessary to support the wire. Saves on time and labor. One man can quickly install the complete fence. Temporary fences, easily erected with very low labor and material costs, thus reducing to a profitable level the cost of fencing in temporary pastures and harvested fields. Profits of many times the cost of the fence are obtained by "hogging down" corn fields, "gleaning" husked corn fields, feeding over fields of pasture oats, barley, wheat, etc.

#### Low Operating Cost

Intermittent application of current, about once per second, makes current consumption very low. On the battery model a set of dry cells, or a "hot-shot" battery will, when properly installed, last an entire season. 3 Position switch provides either high or low voltage output to suit various fence lengths and climatic conditions. Only one moving part used. Power cost on the AC model runs only a few cents per month. Heavy wrinkle finished, steel case. Suitable for indoor or outdoor installation. No oiling or adjustment is necessary. Operates in any position. Fully guaranteed against all defects. Complies with state regulations. Harmless to man or beast, shock interval is so short the effect is that of a sting. Effective under all weather conditions.

**B—For 6 Volt Battery Operation**  
**D18045—Model S31.** Operates from 6 volt hot shot or 4 dry cells. Less batteries. Size 3½x8x6¼" high. Wt. 6 lbs. List, \$6.95. **\$4.95**  
**YOUR PRICE.....**

**C—With Battery Compartment**  
**D18046—6 Volt Battery Operated Model S3S1.** Has compartment for hot shot battery or 4 dry cells. Battery compartment size, 3x7½x10½". Overall size, 6½x8x12¼" high. Built-in detachable fence tester. Includes 25 line and 4 corner insulators. Less batteries. Wt. 16 lbs. List, \$11.95. **\$7.95**  
**YOUR PRICE.....**

Each above include lightning arrestor, ground clamp, 6 ft. ground wire and instructions.

### Electrical Wire and Cables

Wire Prices Subject to Market Change.

#### Waterproof Cable For Underground Wiring

Lead and Rubber Covered



Heavy, pure seamless lead covering over rubber covered solid copper wires give permanent water tight protection to underground or underwater wiring. Where there is danger of mechanical injury, cable should be installed in rigid or thin wall conduit. Underwriter's approved. Can be supplied in continuous lengths up to 2500 ft.

Stock Num.	Wires and Size	Your Price In Lots of		
		100 ft.	500 ft.	1000 ft.
C16625	2-14	\$4.30	\$20.06	\$37.60
C16626	3-14	11.04	51.50	96.58
C16627	2-12	6.62	30.91	57.96
C16628	2-10	7.87	36.75	68.90

#### Heavy Rubber Cord Underwriter's Approved



Use for extension cables that get hard wear. Two conductor size 18, 41 strands of size 34 wire. Individual wires rubber insulated and color coded, cotton wrapped and covered with heavy rubber cover overall. Overall dia. .310".

<b>D16629</b>	Ten feet for	<b>20c</b>
<b>YOUR PRICE, Ten feet for</b>	<b>100 ft. for</b>	<b>\$1.90</b>
<b>C16630</b>	—Extra Heavy Duty similar to above but has heavier covering of .395" overall dia.	<b>30c</b>
<b>YOUR PRICE, Ten feet for</b>	<b>100 ft. for</b>	<b>\$2.87</b>

#### Rubber Lamp Cord



New flexible rubber jacketed two conductor cord. Splits exactly down the center when pulled apart leaving two perfect separate conductors. Conductors are size 18 stranded copper wires with a cotton wrap and individual solid rubber coverings.

Stock Number	Color	10 feet for	100 feet for
K16533	Black	<b>12c</b>	<b>96c</b>
K16534	Brown		
K16535	Green		
K16536	Ivory		

#### Building Wire Small Diameter



#### U.S. Rubber Laytex Type RU

For rewiring installations where it is impractical to increase conduit size to increase wire capacity. Insulation is superior to regular building wire and fully complies with 1940 National Electric Code. Consists of solid tinned copper wire with .018" Laytex pure rubber insulation, cellophane wrap and fibrous wrap with flame-moisture resistant finish. Underwriter's approved.

Stock Num.	Wire Size	Color	YOUR PRICE
D16551	14	Black	..... <b>\$1.55</b>
D16552	14	White	..... per 100 ft.
D16553	14	Red	\$6.95 per 500 ft.
D16554	14	Green	13.20 per M ft.
D16555	12	Black	\$2.10 per 100 ft.
D16556	12	White	9.25 per 500 ft.
D16557	12	Red	17.60 per M ft.
D16558	10	Black	\$2.85 per 100 ft.
D16559	10	White	12.65 per 500 ft.
D16560	10	Red	24.00 per M ft.

#### Fixture Cord

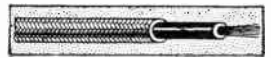

Good quality No. 18 single conductor wire. Well insulated. Cotton braid overall. Underwriter's Approved.

D16545	—Oak Tan.	<b>54c</b>
D16546	—Brown.	
<b>YOUR PRICE, 100 feet for</b>	<b>1000 Ft. Roll. Price</b>	<b>\$4.95</b>

#### Cotton Lamp Cord



Size 18 stranded copper conductors, cotton served, and rubber insulated. Tightly woven cotton braid with tracer over insulations. Underwriter's Approved with 3/8" Rubber Insulation.

D16537	—Green and Yellow.	<b>12c</b>
D16538	—Black.	
<b>YOUR PRICE, Ten feet for</b>	<b>100 ft. for</b>	<b>97c</b>

### Electric Fence Accessories

#### Fence Insulators



Glazed white porcelain insulators for supporting electric fence wire to any type posts.

D4785	—A—Fence Post Knob 13c	Ten 100 for for \$0.95
D4762	—B—Fence Post Knob 15c	1.25
D4763	—C—Fence Post Knob with double head nail, . . . . .	1.75
D4764	—D—Large Post Knob 23c	2.00
D4764	—D—Large Type Knob 29c	2.75
D4771	—E—Leather Nail Head Washers. Prevents breakage when fence post knobs are nailed down.	<b>39c</b>
<b>Per Box of 1000</b>		

#### Lightning Arrestor Kit

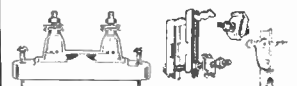

**D4791**—Consists of Twin Tower lightning arrestor with mounting screws, ground clamp and wire terminal clamp. **37c**  
**YOUR PRICE, Per Set**

**D4792**—8 Point Ground Clamp as above. Fits any rod or pipe 3/8 to 1 1/8" dia. Cadmium plated. **7c**  
**YOUR PRICE, Each**

**D4799**—Wire Terminal Clamp. Insures good electrical contact for wire connections. **8c**  
**YOUR PRICE, Per Pkg. of 4**  
 10 Pkgs. for **65c**

#### Twistite Pin

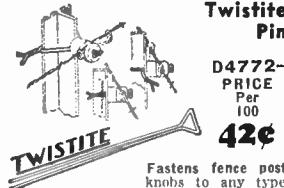

**D4772—PRICE Per 100**  
**42c**

Fastens fence post knobs to any type metal posts. No galvanizing wire.

#### Kwik-Klip Wire Holder



**D4788 PRICE Per 100**  
**32c**

Easy, quick, secure way of fastening fence wire to insulators. Can be used over and over.

#### 4x8" Metal Sign



**D4773 Each**  
**5c**  
 10 for **39c**

Yellow background with 1" black letters. Attaches to fence wire or post. Required by law in some states

#### Fence Tester



**D10306**—Handy pocket size tester with built-in neon bulb. Indicates when electricity is operating correctly. Can also be used for testing power lines, auto ignition, etc., either AC or DC. Phenolic, insulated case. Insulated test leads. **59c**  
**Your Price, Each**

#### "Hot Shot" Type Battery



**D130 YOUR PRICE. \$120**  
 Four No. 6 dry cells sealed in one water-proof unit. Fits in side case of battery operated fence control. Size, 2½x6x10½".



# POPULAR ELECTRICAL SUPPLIES

## Belden "Corditis-Free" Appliance Cord Set



A nationally advertised appliance cord set. Includes 6 ft. glazed cotton braid covered, size 18, 3000 cycle, heater cord wire. Impact resistant appliance plug. Rubber plug on other end. By Underwriters.

Entire cord set approved by Underwriters.

**C4409—Complete Cord Set. Five for \$1.57. Each..... 36¢**

**D4410—Appl. plug only. Ten for \$1.30. Each..... 19¢**

For Coffee Makers, etc.

**C4411—Miniature cord set. Components underwriters approved. Five for \$1.65. Each..... 40¢**

## Special Cord Sets



Very serviceable though not as high quality as those listed above. Includes 6 ft. 3000 cycle, glazed cotton covered heater cord, bakelite handle and bakelite appliance plug. Component parts approved by Underwriters. Available with or without switch.

**Switchless**

**C4445—Cord Set. Ten for \$1.95. Each..... 20¢**

**C4446—Appliance Plug Only. Ten for 55¢. Each..... 6¢**

**Switch Type**

**C4447—Cord Set. Ten for \$2.90. Each..... 30¢**

**D4448—Appl. Plug Only. Ten for \$1.40. Each..... 15¢**

## Belden Extension Cord



Non-breakable all rubber construction. Consists of soft rubber duplex plug receptacle, extra flexible size 18 rubber covered cord and narrow rubber attachment plug.

**C4412—Brown 10 ft. Each .45 Five for \$1.95**

**C4413—Ivory 10 ft. .49 2.10**

## Extension Cord Sets



Consists of rubber covered #18 wire, unbreakable rubber plug and switch socket. Underwriters approved.

**C10400—12 ft. Each 26c Ten for \$2.39**

**C10401—15 ft. 29c 2.69**

**C10402—20 ft. 33c 2.98**

## Power Supply Cords



For replacement on radios, lamps, fans, etc. Waterproof, washable, kinkless 7/2 foot long rubber cord with unbreakable soft rubber plug attached to one end. Wires on other end are already stripped and tinned, easy to attach. Underwriters Approved.

**YOUR PRICE**

**K4415—Black 18¢ EACH**

**K4416—Brown 18¢ EACH**

**K4417—Ivory 10 for \$1.85**

## Cord Connectors

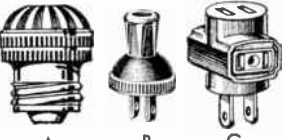

**D11260—A—Two Piece Plug. Ten for 47¢. EACH..... 5¢**

**D11261—A—Prong Plug Only Ten for 19¢. EACH..... 2¢**

**D11262—A—Screw Plug Only. Ten for 28¢. EACH..... 3¢**

**D11267—B—Rubber Handle Cap. Ten for 35¢. EACH..... 4¢**

**D11264—C—Bakelite Trio-Plug. Ten for 40¢. EACH..... 4 1/2¢**

**D1127—C—Bakelite Extension Trio-Plug has wire connection instead of prongs. For extension cords. Ten for 47¢. EACH..... 5 1/2¢**



**D11265—D—Rubber Connector. Ten for \$1.57. EACH 18¢**

**D11263—D—Bakelite Connector. Ten for 98¢. EACH 11¢**

**E—Triple Outlet for wall or table use. Bakelite body. Each Ten for**

**D11258—Brown 8c 70c**

**D11257—Ivory 11c 99c**

For 110 volt service. Screw caps protect connections. Composition body. Overall length 2 1/2".

**C11266—Each..... 14¢ Ten for \$1.30**

## Fusible Plug



Ideal for fusing equipment not already protected. Takes two 3A4 type fuses for fusing both sides of line. Fuses are inserted from the prong end. Brown molded bakelite body.

**K11253—Your Price, Ea. 22¢**

## Three Way Socket with Pull Chain



Socket threaded for shade holder. Two outlets on side. Pull chain controls light only. Brown bakelite construction.

**RI1272—Ea. 16¢**

**D10499—Less pull chain. Ten for 70¢. EACH..... 8¢**

**D11278—Bakelite Twinlite. Has two light sockets, no outlets. Ten for 70¢. EACH..... 8¢**

## Drop Cord Pendant Switch With Triple Outlet



For ceiling lights in kitchens, etc. Switch controls light. Requires 3-wire cable for connection. Made of bakelite. Underwriters approved.

**C10403—Brown 23c Ten for \$2.19**

**C10404—Ivory 29c 2.80**

## Feed Thru Toggle Switch



Brown Bakelite Construction. Underwriters approved.

**RI1209—Each 13¢ Ten for \$1.10**

## Friction Tape



Best quality. Cotton fabric. Free from pinholes. Impregnated with adhesive rubber compound. Holds fast.

Stock Number	Size Roll	Tape Width	Your Price
K5745	4 oz.	3/4"	9¢
K5746	4 oz.	3/4"	
K5747	8 oz.	3/4"	17¢
K5748	8 oz.	3/4"	

## Rubber Tape

Made of highest grade rubber compound. Moulds into one solid mass making a waterproof joint that can never be separated. Will safely withstand 10,000 volts.

N5785	4 oz.	3/4"	11c
N5786	8 oz.	3/4"	20c

## Scotch Tape

### 1700 Volt Insulation



**C5737—30 Foot Roll. 1/2" Wide. YOUR PRICE... 29¢**

For use on all radio and electrical work. Has all the advantages of varnished cambric and friction tape, plus greater adhesive properties and flexibility. Adheres to flat or irregular surfaces: wood, metal, paper, glass, bakelite, cloth, etc. Thickness 10 mils.

## OK Plug Fuses



Tested finest quality. Porcelain body. Speaks for itself. "OK" in window vanishes when fuse is blown. Special construction expels gases, but will not allow flame to escape. Amperage marked on each fuse. Underwriters approved.

Stock Num.	Amps.	Carton of Five
K11273	10	15¢
K11274	15	
K11275	20	Per 100
K11276	25	
K11277	30	

**\$2.50**

## Cartridge Fuses

Tested fine quality. Brass ferrule contacts, fibre casing. Amperage stamped on each fuse. U.L. approved.

Stock Num.	Amps.	Each
C10412—15		4¢
C10413—20		
C10414—25		10 for 35¢
C10415—30		
C10416—35		Each 8¢
C10417—40		
C10418—50		10 for 69¢
C10419—60		

## Quintet Receptacle with Plate



A combination of five outlets embodied in a single gang bakelite plate. Fits ordinary receptacle box. Will take five flat caps or two round caps and one flat cap.

**C13865—Brown 18c Ten for \$1.65**

**C13866—Ivory 23c 2.15**

## Electric Heating Elements

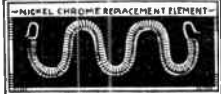

**D11270—Nichrome Wire Lengths. Coiled in a heavy gauge wire stretched to any length. Each length is 660 watts at 110 volts. Ten for 65¢. EACH..... 7¢**

**D11268—Air Heater Element. Coiled nichrome wire wound on ceramic form. 600 to 660 watts on 110-120 volts. Ten for \$1.80. EACH..... 20¢**

**D11269—Laundry Iron Element. Standard replacement fits 90% of the 6 pound irons such as Westinghouse, S un-beam, etc. Ten for \$1.70. EACH..... 19¢**

## Bells and Buzzers



Have double coil magnets, silver contacts, iron box housing and gray finish. Will operate from 2-1 1/2 volt dry cells or transformers listed below.

**C10405—Bell with 2 1/2" gong. Each..... 24¢ Ten for \$2.19**

**C10406—Buzzer. Ten for \$2.10. Each..... 23¢**

**Economy Models**

Similar to above but has only one coil magnet and bronze contact.

**C10407—With 2 1/2" gong. Ten for \$1.79. Each..... 19¢**

**C10408—Buzzer. Ten for \$1.69. Each..... 18¢**

## Bell-Buzzer Combination



**C10409 Each..... 49¢ Ten for \$4.50**

Combines bell for front door, buzzer for back door in one heavy gauge metal container. Operates from 2-1 1/2 volt dry cells or transformers listed below.

## Bakelite Push Button



For door bells, test circuits, etc. Brown finish.

**C10410—1 1/2" Square Ten for 69¢. EACH..... 8¢**

## Bell Transformers



**A6716—For 3 1/2" or 4" octagon and 1/4" sq. boxes. YOUR PRICE... 65¢ Ten for \$5.70**

**A6715—With mounting brackets. YOUR PRICE... 46¢ Ten for \$4.00**

Suitable for door chimes and bells. For 110 volt, 50-60 cycle AC operation. Supplies 10 volts at 5 watts.

## Bell Wire

Size 18 copper wire insulated with paraffined cotton braid.

**K4300 50 ft. roll..... 12c**

**K4301 100 ft. roll..... 22c**

### New Insulated Staples



Drive like a nail. Easy to start and long. Sharp Spacing.

Number	Instl. Color	50 for	1000 for
D11280—Copper		5c	90c
D11230—Brown			
D11231—Buff		5 1/2c	98c
D11232—White			

## Plug-In Nightlight



For Dark Halls, Nursery, Bedroom, etc. Has built-in On-Off switch. Complete with 5 watt 110-120 volt bulb.

**C11755—Each 17¢ Ten for \$1.50**

# Electrical Wiring Material

## Brass Shell Sockets



Has snap-on cap with 1/8" pipe thread. Hard rubber bushing is supplied so that socket may be used for extension and drop cords. Bottom is threaded for shade holder. Will stand an average of 60,000 on-offs at 250 watts. Brushed brass finish. Approved by Underwriters.

Type Socket	Each	Ten For
D13800—Keyless	8 1/2 c	\$0.78
D13801—Key	9 c	.83
D13802—Push Thru	11 c	1.05
D13803—Pull Chain	11 c	1.05

## Porcelain Shell Sockets



Pendant cap for use in damp places as garages, basements, etc. Underwriters approved.

Type Socket	Ea.	Ten For
D13804—Keyless	17 c	\$1.50
D13806—Key	18 c	1.57
D13806—Pull Chain	21 c	1.86

## Porcelain Fixture Sockets



### (Sign Receptacle)

For replacement in ceiling fixtures, kitchen lights and bathroom lights. Underwriters Approved.

C13807—Less Switch with 9" wire leads. Ten for 49c. Each..... 5 1/2¢

C13808—Has pull switch with 4 ft. cord. Concealed terminals. Ten for \$1.05. Each..... 11¢

## Weatherproof Socket

One piece molded rubber body. Fully weatherproof. 5" Long = 11 wire leads. 1 1/2" Dia. shade holder groove. Rated 600 watts at 250 volts. Underwriters approved.

C13809—Each..... 7 1/2¢  
Ten for 70c

## Box Receptacles

Porcelain socket mounted on steel box cover. Fits octagon boxes. Has groove for clamp-on shade holder. Screw terminals. Underwriters approved.

Size	Each	10 for
D13810 3 1/4"	11 c	\$0.98
D13811 4"	12 c	1.10

## Porcelain Receptacle



1 Piece white porcelain with groove for clamp on shade holder. Switch tabs have pull chain and 36" cord. Underwriters approved. Available with or without convenience outlet and switch.

Less Switch and Outlet	Size	Ea.	Ten For
C13812	3 1/4"	10 1/2 c	\$0.95
C13813	4"	13 c	1.20
With Switch	Less Outlet		
C13814	3 1/4"	13 1/2 c	\$1.25
C13815	4"	20 c	1.85
With Switch and Outlet			
C13816	3 1/4"	24 c	\$2.20
C13817	4"	32 c	2.90

## Toggle Switches

Flush wall mounting type with bakelite handle and porcelain body, finest quality construction. Aproved by Underwriters. Rated at 10 amps. 125 V., 5 amps 250 V. Fit any switch box.



Single Pole (S. P. S. T.)	Each	Ten For
D13818—Brown	9 c	\$0.78
D13819—Ivory	10 c	.85
3 Way (S. P. D. T.)		
C13820—Brown	13 c	1.20
C13821—Ivory	14 c	1.30

## Duplex Flush Receptacles



Bakelite body. High quality construction. Phosphor bronze spring contacts. Approved by Underwriters. Rated at 15 amps. 125 V., 10 amps. 250 V.

C10490—Brown bakelite. 10 for 60c Each.....	6 1/2¢
D10489—Ivory bakelite. 10 for 80c. Each.....	8 1/2¢
C10491—Brown bakelite mounted on 3/4" metal box cover. 10 for 90c. Each.....	9 1/2¢
C10492—Brown bakelite mounted on 1" metal box cover. 10 for \$1.00. Each.....	10 1/2¢

## Switch and Receptacle Wall Plates

Strong durable bakelite plates in either brown or ivory. Have ribbed design with decorative border. Come complete with screws to match plate. Underwriters Approved.

**Brown Bakelite**  
C10493—For Single Toggle Switch. Ten for 40c. Each 4 1/2¢  
C10494—For Duplex Receptacle. Ten for 40c. Each 4 1/2¢

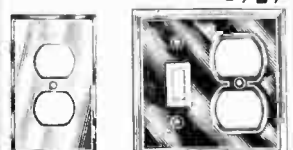

C10495—For 1 Toggle Switch and 1 Duplex Receptacle. Ten for 80c. Each..... 9¢

**Ivory Bakelite**  
C10496—For Single Toggle Switch. Ten for 75c. Each..... 8¢  
C10498—For 1 Toggle Switch and 1 Duplex Receptacle. Ten for \$1.50. Each..... 17¢

## Box with Bracket

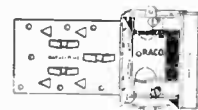

Box with quick mounting bracket. One end mounts to wall stud, other end has latch support. Fits flush with finished wall.

For Non-Metallic and Armored (BX) Cables. With clamps.	Depth	Each	Ten For
C13839—3"	14 c	\$1.35	
C13840—2 1/2"	15 c	1.40	
Less Clamp			
C13841—2 1/4"	14 c	1.35	
For Rigid or Thin-Wall Conduit. 1/2" K.O.'s			
C13842—2 1/2"	14 1/2 c	\$1.40	

## Handy Boxes



For mounting switches, receptacles, etc. on surface of garage, basement walls, attic, work benches, etc. Heavy galvanized rust resisting finish. 1 1/2" Knockouts for rigid iron or thin wall conduit. Size: 4 1/2" x 2 1/4" x 2 1/4". Underwriters approved.

C13831—Each..... 10¢  
Ten for 95c

## Handy Box Covers



Heavy galvanized rust resisting finish. For use with above handy boxes. Size: 4 1/2" x 2 1/4". Underwriters approved.

C13832—For Duplex Receptacle. Ten for 60c. 6 1/2¢  
C13833—For Toggle Switch. Ten for 35c. Each..... 4¢

## Universal Boxes



For old or new work. 14 Gauge steel, black enamel finished. Reversible and adjustable and mounting ears. Removable slides for gangling boxes. 1/2" K.O.'s. Underwriters approved.

**For Rigid or Thin Wall Conduit**

Depth	Each	Ten For
C13835—2"	9 1/2 c	90 c
C13836—2 3/4"	10 c	95 c

**With Clamps to hold Armored (BX) and Non-Metallic Cable**

C13837—2"	10 1/2 c	\$1.00
C13838—2 1/2"	11 c	1.05

## Surface Toggle Switches

Bakelite construction. Underwriters approved. Rated 10 amps. at 125 volts. Single pole.

	Each	Ten For
C13827—Less Plate	11 c	\$1.00
C13828—For 3 1/4" Box	16 c	1.50
C13829—For 1" Box	18 c	1.65

## Fused Entrance Switches

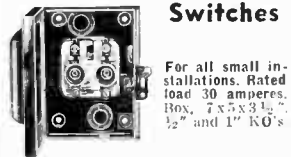

For all small installations. Rated load 30 amperes. Box, 7 1/2" x 3 1/2" x 1 1/2" and 1" K.O.'s.

C13882—2 Wire ckt. 1 Plug Fuse, 1 Switch blade. 1 Solid neutral. For 125 volt use. Ten for \$7.84. Each..... 82¢  
C13883—2 Wire ckt. 2 Plug Fuses, 2 Switch blades. For 125 volt use. Ten for \$8.33. Each..... 92¢  
C13885—3 Wire ckt. 2 Plug Fuses, 2 Switch blades, 1 Solid neutral. For 125 or 250 volt use. Ten for \$9.80. Each..... \$1.08

## Fused Branch Cutouts

Dead front fused cutout boxes with 1/2" and 3/4" knockouts. Cast aluminum plated. Hinged cover. Size 5 1/2 x 7 1/4 x 2 1/4". Each circuit 30 amps.

	Each	Ten For
D13889—Two Fuse.	\$1.08	\$ 9.90
D13890—Four Fuse.	1.42	13.37

## Octagon and Square Boxes

Used as junction box and for ceiling and wall outlets. 11 Gauge steel black enamel finish. 1 1/2" Deep. May be used with conduit, BX or non-metallic cable. Underwriters approved.

With 1/2" Knockouts	Each	Ten For
C13846 3 1/2" Octagon	6 c	\$0.55
C13847 4" Octagon	9 c	.85
C13848 4" Square	10 c	.95
With 1/2" and 3/4" Knockouts		
C13849 4" Octagon	9 c	.85
C13850 4" Square	11 c	1.05

## Shallow Ceiling Boxes



14 Gauge steel. Underwriters approved. For Conduit

C13851—4" Dia., 1/2" deep. Has 1/2" K.O.'s and ears. Ten for 55c. Each.....	6¢
C13852—As above less ears. Ten for 50c. Each.....	5 1/2¢

**For Armored Cable (BX)**

C13853—3 1/2" Dia., 3/4" deep. Has four K.O.'s with clamps to hold cable, fixture stud and ears. Ten for \$1.05. Each.....	11¢
C13854—3 1/2" Dia., 1 1/2" deep. Has four K.O.'s in side, four in bottom, with clamps to hold BX cable and ears. Ten for \$1.05. Each.....	11¢

## Set-up Box with Hanger



Has hanger for mounting to ceiling. Locks clamps for holding iron, non-metallic or BX cable; fixture stud and ears. Four K.O.'s in side, four in bottom. 3 1/2" Dia., 1 1/2" deep. Underwriters approved.

C13855—Each..... 21¢  
Ten for \$1.98

## Box Covers

Heavy gauge steel, black enamel finish. Underwriters approved.

3 1/4" Dia. Round Cover

	Each	Ten For
C13856—Flat Blank	3 c	25 c
C13857—Raised blank and bushed for drop cord	3 1/2 c	30 c
C13858—Raised blank and bushed for drop cord	3 1/2 c	30 c
C13859—Spider for surface toggle switch	4 c	35 c
C13860—Flat Blank	3 1/2 c	32 c
C13861—Raised and bushed for drop cord	4 1/2 c	40 c
C13862—Spider for surface toggle switch	4 1/2 c	40 c
C13863—With plaster ring and ears	5 1/2 c	50 c
4" Square Box Covers		
C13864—Flat Blank	5 c	41 c

Each Ten for 70c

Each Ten for 70c

Each Ten for 70c

Each Ten for 70c

Each Ten for 70c

Each Ten for 70c

Each Ten for 70c

Each Ten for 70c

Each Ten for 70c

Each Ten for 70c

Each Ten for 70c

Each Ten for 70c

Each Ten for 70c

Each Ten for 70c

Each Ten for 70c

Each Ten for 70c

Each Ten for 70c

Each Ten for 70c

Each Ten for 70c

Each Ten for 70c

Each Ten for 70c

Each Ten for 70c



# MAZDA LAMPS

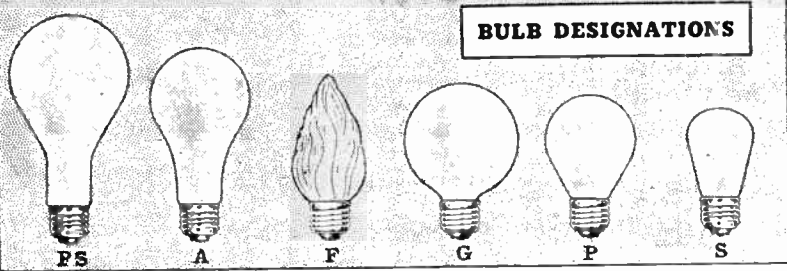

## BULB DESIGNATIONS

When your customers think of light bulbs, they think of Mazda. Cash in on the Mazda reputation by identifying yourself as a Mazda dealer. In bulb designations, the letter indicates style of bulb, the numeral gives approximate dia. in indicated multiples of one eighth of an inch. Lamps may be assorted to obtain quantity discount.

### For 110, 115 and 120 Volt Operation

#### General Lighting—Inside Frosted

The standard bulb for general lighting use in homes, offices, factories, etc. Have long life.

Stock Num.	Watts	Bulb	Std. Pkge. Quan.	Your Price	Yr. \$4.25 Net Drds. Ea.	Std. Price	Each Pkgs.
D14200	15	A-15	120	.10	8 1/2c		8c
D14201	25	A-19	120	.10	8 1/2c		8c
D14202	40	A-19	120	.13	11c		10 1/2c
D14203	50	A-19	120	.13	11c		10 1/2c
D14204	60	A-19	120	.13	11c		10 1/2c
D14205	75	A-21	120	.15	12 1/2c		12c
D14206	100	A-23	120	.15	12 1/2c		12c
D14207	150	A-25	60	.20	17c		16c
D14284	200	PS-30	60	.27	23c		21 1/2c
D14285	300	PS-35	24	.50	42 1/2c		40c

#### Daylight IF Blue Lamps

Tinted blue glass, provides light closely approximating daylight. Inside Frosted.

D14208	60	A-19	120	.25	21 1/2c		20c
D14209	100	A-23	120	.25	21 1/2c		20c
D14210	150	A-25	60	.45	38 1/2c		36c

#### Vibration & Rough Service Lamps

A19 and A23 Will stand up under severe shocks and bumps. Inside frosted.

P19 Withstands high frequency vibration such as produced by high speed machinery. Clear bulb.

D14211	50	A-19	120	.25	21 1/2c		20c
D14212	50	P-19	120	.20	17c		16c
D14213	100	A-23	120	.35	29 1/2c		28c

#### Silvered Bowl Reflector Lamps

Bowl has permanent Mirror Silver coating forming an efficient reflecting surface. Use base for indirect lighting. Inside frosted.

D14214	60	A-19	120	.23	19 1/2c		18 1/2c
D14215	100	A-23	120	.25	21 1/2c		20c
D14216	150	A-25	60	.45	38 1/2c		36c
D14217	200	PS-30	60	.62	52 1/2c		49 1/2c

#### American Made Quality Lamps

For 110-125 Volts AC or DC



A high quality American made lamp priced so that you may meet competition yet give your customers merchandise that you can stand back of. Guaranteed for 1000 burning hours. These types fill all requirements for standard purposes and will produce excellent light at the lowest cost per light hour.

#### Type A Inside Frosted Lamps

Stock Num.	Watts	Type	List	Each	Lots of 12 Ea.
D14239	15	A17	13c	9 1/2c	9c
D14240	25	A19	13c	9 1/2c	9c
D14241	40	A19	13c	9 1/2c	9c
D14242	60	A19	13c	9 1/2c	9c
D14243	75	A21	15c	11c	10 1/2c
D14244	100	A23	15c	11c	10 1/2c
D14245	150	A25	20c	14c	13 1/2c
D14246	200	PS30	27c	23c	21c
D14247	300	PS35	50c	38c	34c

#### Three Light Lamps Inside Frosted

Have Special Bases for I.E.S. Fixtures \*Has Mogul base, all other medium base.

D14248	20-40-60	A21	45c	32c	30c
D14249	40-60-100	A21	45c	32c	30c
D14250	50-100-150	PS25	45c	32c	30c
D14251	*50-100-150	PS25	45c	32c	30c
D14252	*100-200-300	PS30	60c	42c	39c

#### Three-Lite Lamps—Inside Frosted

Two separate filaments produce three levels of illumination. Requires special 3 contact mogul base.

Stock Num.	Watts	Bulb	Std. Pkge. Quan.	Your Price	Yr. \$4.25 Net Drd. Ea.	Std. Price	Each Pkg.
D14228	50						
D14228	150	PS25	60	.45	38 1/2c		36c
D14229	100	G30					
D14229	300	Indirect	24	.60	51c		48c

#### Lamps For Decorative Lighting

\*Candelabra Base. C-Clear. IF-Inside Frosted. R-Red. Y-Yellow. AO-Amber. Orange. W-White.

D14230	6	S6 C	120	.15	12 1/2c		12c
D14231	6	S14 F	120	.15	12 1/2c		12c
D14232	6	S14 R	120	.20	17c		16c
D14233	6	S14 Y	120	.20	17c		16c
D14234	6	S14 AO	120	.20	17c		16c
D14280	7 1/2	G11 W	120	.10	8 1/2c		8c
D14281	7 1/2	G11 R	120	.10	8 1/2c		8c
D14235	10	S14 F	120	.13	11c		10 1/2c
D14236	10	S14 R	120	.18	15 1/2c		14 1/2c
D14237	10	S14 Y	120	.18	15 1/2c		14 1/2c
D14238	10	S14 AO	120	.18	15 1/2c		14 1/2c

#### Flame Shape Mazda Lamps

\*Candelabra Base. I-Ivory. W-White. F-Flame tint.

D14222	15	F10* I	60	.20	17c		16c
D14223	15	F10* W	60	.20	17c		16c
D14224	15	F10* F	60	.20	17c		16c
D14225	25	F15 I	120	.15	12 1/2c		12c
D14226	25	F15 W	120	.15	12 1/2c		12c
D14227	25	F15 F	120	.15	12 1/2c		12c

#### G.E. Type D Lamps for Lighting Fixtures

Primarily used in unshaded fixtures. \*IF-Inside Frosted. I-Ivory. F-Flametint.

D14220	30	G19*IF	60	.10	8 1/2c		8c
D14282	30	G19* I	60	.10	8 1/2c		8c
D14283	30	G19* F	60	.10	8 1/2c		8c

#### Metal Shade Light Reflectors

Plain enameled green outside, white inside. 10" Dia. For indoor use only. Fits shadeholders listed below.

D15894	—Deep Type	Each	Ten For
D15895	—Shallow Type	18c	\$1.70
		25c	2.35

#### Porcelain Enameled

3" (not vitreous porcelain enameled, rust proof for indoor or outdoor use. White inside, green outside. Best reflecting surface. Rolled rims. Easy to keep clean.

D15892	—12" Dia.	Each	Ten For
D15893	—14" Dia.	42c	\$3.92
		55c	4.90

#### Shade Holder

Made of brass. Fits all standard sockets and shades with 2 1/2" filter. D13867—Threaded to fit brass shell sockets.

Ten for 45c. Each..... 5c

D13868—Clamp type for brass shell sockets. Ten for 60c. Each..... 6 1/2c

D13869—Clamp type for light shades. Fits porcelain, bakelite and other sockets with shadeholder groove. Ten for 65c. Each..... 7c

D13870—Clamp type for heavy shades. Fits porcelain, bakelite and other sockets with shadeholder groove. Ten for 70c. Each..... 7 1/2c

## Spot and Flood Lamps

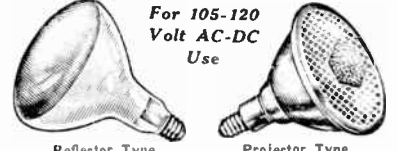

New type lighting units providing spot and flood lighting at only a fraction of cost formerly required. Useful for lighting window displays, gardens, night clubs, etc. Consists of lens, reflector and filament in one complete unit. Fits standard medium screw base sockets. Spot lamps have a concentrated beam for illuminating distant objects. Flood lamps cover twice the area of the spot type. Burn in any position. Average life 1000 hours. Projector and 300 Watt Reflector lamps are for use in porcelain sockets only.

#### R-40 Reflector Lamps

For indoor use or outdoors when protected against weather. Size 5" dia. 6 1/2" long.

Stock Number	Watts	Type	Price Each	PRICE EACH \$4.25 Orders	Std. Pkgs.
D14267	150	Spot	\$0.93	\$0.79	\$0.74 1/2
D14268	150	Flood	0.93	0.79	.74 1/2
D14269	300	Spot	1.67	1.42	1.33
D14270	300	Flood	1.67	1.42	1.33

#### PAR-38 Projector Lamps

Made of rugged heat resisting glass with reflecting surface on inside. For indoor or outdoor use. Size 3 1/2" dia. 5 1/2" long.

D14271	150	Spot	\$1.37	\$1.17	\$1.10
D14272	150	Flood	1.37	1.17	1.10

Packed 12 to Standard Package

#### Swivel Socket Adapter

Permits above lamps to be adjusted to any angle when used in stationary sockets. Made of glazed porcelain, fully insulated. Retains its fixed position.

D13879 YOUR PRICE..... 39c  
In Lots of 12 or More, Each 35c

#### Holder for Above Lamps

D13878—YOUR PRICE..... 92c  
In 12 Lots, Each 86c

3x3" Cast Iron base has two holes for fastening down permanently or mounting onto walls. Adjustable porcelain socket with metal protective shell. Black wrinkle finish. 7 ft. Rubber cord and plug. No bulb included.

#### Color Lens Sets

For use with any of above lamps. Each set contains one lens holder and 4 glass lenses in the following colors: red, green, blue and amber.

D13887—For Projector (PAR-38) Lamps.  
D13888—For Reflector (R-40) Lamps.  
Either Type. YOUR PRICE, Per Set ..... 85c  
In 12 Lots or More, Each Set 80c

#### Bench or Desk Lamp

D13871—Less bulb. YOUR PRICE ..... 78c  
In lots of 6 or More, Each 73c

Why work under improper lighting conditions—equip your work bench or office with any number of these inexpensive desk lamps. Equipped with 12" flexible "goose neck" and 6 1/2" dia. metal shade. Turn key knob socket with 6 ft. cord and plug. Heavy cast iron base. Finished in antique green with inside of shade brightly finished. A fine quality lamp.

#### Clamp-On Type Lamp

D13872—As above but has clamp instead of cast iron base. Clamp opens to 2" and has screw holes for permanently fastening to bench. YOUR PRICE ..... \$110  
6 Lots or More, Each 93c

See Page 120 for a complete line of Fluorescent Fixtures and accessories

# Radio Hardware



**900**  
Piece  
**Hardware Assortment**

Contains Only  
Useful Items

At 1826  
YOUR PRICE

**95c**

A real Bargain! Purchased separately, this assortment would cost over \$2.50. Contains all these type items the busiest serviceman would ordinarily use. Included are approximately: 225 machine screws; 175 nuts; 100 wood

screws, escutcheon screws, set screws, etc.; 150 rivets and eyelets; 250 fiber washers, rubber grommets; brass washers, lock washers, solder lugs, eyelet lugs. Packed in neat box with removable compartments.

## Convenient PARTS RACK

Keeps Your Small Parts Always Handy  
A17375—32 Jar Metal Rack. Less jars

YOUR PRICE .... **\$1.37**

FREE with purchase of 32 Glass jars and \$9.95 worth of radio hardware.

A11825—2 Oz. Glass Jars for above.

YOUR PRICE Ea. .... **5c**

32 for \$1.25  
**SERVICEMEN!** This jar and rack assembly will conveniently provide a place for keeping radio hardware, resistors, pilot bulbs, etc. Protects parts against dust and moisture. Ruggedly constructed black crackle



finished rack holds 32 square clear glass jars of 2 oz. capacity each. Jars have black enameled screw-on caps. One or more racks can be placed side by side to provide a larger rack. Can be placed on the work bench or mounted on wall.

## Round Head Machine Screws

Brass - Nickel Plated

Supplied in 10c Packages or in Gross Packages

Stock Num.	Size & Length	Quant. in 10c Pkg.	Price Gross
A11855	3/8x1/2"	45	\$0.28
A11856	3/8x3/4"	32	.33
A11857	3/8x1"	25	.42
A11858	3/8x1 1/4"	24	.55
A11859	3/8x1 3/4"	16	.76
A11860	3/8x2"	12	1.05

## Steel-Cadmium Plated

A11861	4/36x1/2"	72	\$0.18
A11862	4/36x3/4"	58	.20
A11863	4/36x1"	55	.21
A11864	4/36x1 1/4"	50	.24
A11865	4/36x1 3/4"	45	.27
A11867	3/8x1/2"	100	.13
A11868	3/8x3/4"	84	.16
A11869	3/8x1"	80	.17
A11870	3/8x1 1/4"	78	.17
A11871	3/8x1 3/4"	72	.19
A11872	3/8x2"	65	.20
A11873	3/8x2 1/4"	65	.20
A11874	3/8x2 3/4"	50	.27
A11875	3/8x3"	38	.35
A11877	3/8x3 1/2"	28	.45

A11878	3/8x3/4"	72	.19
A11879	3/8x1"	59	.23
A11880	3/8x1 1/4"	54	.27
A11881	3/8x1 3/4"	48	.28
A11882	3/8x2"	37	.37
A11883	3/8x2 1/4"	30	.41
A11884	3/8x2 3/4"	25	.52
A11885	3/8x3"	20	.63
A11886	3/8x4"	10	1.35

A11887 3/8x1 1/2" 42 .30  
A11888 3/8x1 3/4" 27 .45

## Size 6/32 Flat Head Machine Screws

Steel-Cadmium Plated  
Supplied in 10c Packages or 1 Gross Packages

Stock Num.	Length Inches	Quant. in 10c Pkg.	Price Gross
A11889	1/2"	110	12c
A11890	3/4"	100	13c
A11891	1"	80	17c
A11892	1 1/4"	72	19c
A11893	1 3/4"	65	20c

## Spade Lug

For Anchoring Shield Cans to Chassis, etc. Steel Cadmium plated. Illustration is actual size, 6/32 screw.

A11814—TEN FOR ..... **5c**  
100 FOR ..... **25c**  
PER 1000 ..... **\$2.35**

## Ornamental Head Screws

Attractively embossed. Wide flat head, 3/8 inch diameter 6/32 screws. Antique or Statuary Bronze Finish.

Number	Length	Per Screw	Per Dozen	Per Hundred
C11926	3/8"	8c	8c	44c
C11927	1/2"	8c	8c	50c
C11928	1 1/4"	10c	8c	68c

## Hexagon Nuts

Chamfered and countersunk for quick assembly work.



Brass-Nickel Plated

Stock Num.	Screw Size	Size Dia	Quant. in 10c Pkg.	Price Gross
A11931	1/8"	1/4"	45	25c

## Steel-Cadmium Plated

A11932	4/36	1/2"	50	23c
A11933	3/8	3/4"	50	23c
A11934	1/2	1"	50	23c
A11935	3/4	1 1/4"	25	49c

## Palnuts

New stamped design. Nuts firmly grip screw eliminating need of lock washers. Cadmium plated. Can be used with socket wrench.



A12145	4/36	1/2"	65	15c
A12146	3/8	3/4"	65	15c
A12147	1/2	1"	65	15c
A12148	3/4	1 1/4"	60	17c
A12149	10/24	3/4"	40	25c

## Flat Washers

Proper size for radio work. Hole fits screw size given below.



Brass-Nickel Plated

Stock Num.	Size Hole	Quant. in 10c Pkg.	Price Gross
A11843	6	50	24c

## Steel-Cadmium Plated

A11844	4	65	19c
A11845	6	80	22c
A11846	8	50	25c
A11847	10	30	35c

## Split Lock Washers

Proper size for radio work. Made of high grade tempered steel.



Stock Number	Size Hole	Quant. in 10c Pkg.	Price Gross
C11965	4	62	21c
C11966	6	65	20c
C11967	8	72	18c
C11968	10	80	16c

## Round Head Wood Screws

Steel-Nickel Plated

Stock Num.	Length Inches	Quant. in 10c Pkg.	Price Gross
A11895	5/8x1/2"	50	24c
A11896	5/8x3/4"	42	27c
A11897	5/8x1"	32	32c
A11898	5/8x1 1/4"	25	45c

## Escutcheon Plate Screws

No. 1 Round Head Brass Wood Screws. Will fit practically every escutcheon plate. Length 1/4" inch.

A11930—PER DOZEN ..... **29c**  
40 Screws in Packet for 10c

## Radio Hardware Assortments In Glass Jars

Any Assortment Below

YOUR PRICE EACH..... **22c**  
Ten for \$2.10

## Machine Screw, Washer and Nut Assortment

C11827—Contains 60-6/32 round head machine screws from 1/4" to 1" long, 60 washers and 60 nuts.

C11900—55 Assorted Size 6/32 Brass Nickel plated screws, 1/2-2"

C11901—105 Assorted Size 4/36 Steel Cadmium plated screws, 1/2-1"

C11902—115 Assorted Size 6/32 Steel Cadmium plated screws, 1/2-2"

C11903—85 Assorted Size 8/32 Steel Cadmium plated screws, 1/2-2"

C11894—65 Size 10/32 Steel Cadmium plated screws. Contains 40 screws 1 1/4" long, 25 of 1 1/4" length.

C11854—Contains 90 assorted machine screws, 15-6/32x3/4 to 3/8", nickel plated and 20-4/36x1/4 to 3/8", 40-6/32x1/4 to 1" and 15-8/32x1/4 to 7/8" steel cadmium plated types.

## Nut Assortment

C11969—Contains 100 nuts: 15-6/32 brass nickel plated and 20-4/36, 40-6/32, 15-8/32 and 10-10/32 steel cadmium plated types.

## Palnut Assortment

C11970—Contains 120 Palnuts: 20-4/36, 35-6/32-1/4", 35-6/32-3/8", 20-8/32 and 10-10/32 sizes.

## Flat Washer Assortment

C11971—Contains 120 Flat Washers: 18-#6 brass nickel plated and 21-#4, 48-#6, 18-#8 and 12-#10 steel cadmium plated types.

## Locking Lugs and Washers

Insure permanent tight connections. When nut is tightened down they will not loosen regardless of vibration or shaking. Tinned.

A11849—3/8" lug with #6 hole.

A11849—3/8" lug with #8 hole.

A11850—3/8" washer with #6 hole.

A11851—3/8" washer with #8 hole.

PER HUNDRED 20c  
**\$1.90**

## Fahnstack Connectors

Wires held firmly in spring grip. may be instantly released.

A11433—Single connector. 3/8" wide. 1" overall length.

Dozen ..... 10c  
Per Hundred ..... 69c

A11434—Double connector. 3/8" wide. 1 1/2" long.  
Dozen ..... 26c  
Per Hundred ..... \$1.40

A11441—Screw grip type. Takes screws up to 3/16" dia. Has lug for soldering lead. 1" long.  
YOUR PRICE, Each ..... **4c**  
Ten for 35c

## Self-Topping Screw Assortment

C11925—Contains 50 self-tapping screws in blunt and gimlet points with square and round heads. In popular sizes.

## Lock Washer Assortment

C11972—Contains 120 lock washers. Includes split-lock and shake-proof. 10 of #1 hole, 65-#6, 25-#8 and 20-#10.

## Fiber Washer Assortment

C11829—Contains 75 fiber washers. Complete range of sizes. Plain and shoulder types are included.

## Solder Lug Assortment

C11973—Contains 90 solder lugs of assorted types. Listed below including locking type.

## Angle Bracket Assortment

C11828—Contains 24 angle brackets best suited for radio work. Made of brass, nickel plated.

## Rubber Grommet Assortment

C11809—Contains 30 rubber grommets of assorted popular sizes.

## Spacer and Bushing Assortment

25 Spacers and bushings in 1/4 and 3/8" diameters from 1/4 to 3/4" long.

D11954—Insulated Type.  
D11955—Brass Type.  
YOUR PRICE. Less Jar .... **39c**

## Lugs

Quality brass solder lugs. Fully tinned for easy soldering. Illustrations below are actual size.

C11920—A  
C11852—B  
C11921—C  
C11921—D

Each ..... 10c  
50 for ..... 50c  
100 for 18c  
1000 for \$1.55

C11922—E  
25 for ..... 15c  
100 for 49c  
1000 for \$4.11

C11923—As E but larger, 1/4" Hole. 1" Long overall.  
25 for ..... 21c  
100 for 75c  
1000 for \$5.85

C11924—F  
25 for ..... 12c  
100 for 38c  
1000 for \$3.10





# Indispensable Hardware for Servicemen

## Angle Brackets

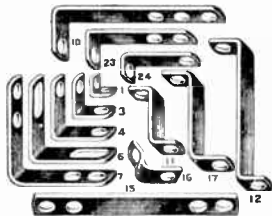

Brass nickel plated. For mounting panels, tubes, coils, grid leaks, etc. Width  $\frac{1}{2}$  inches.

Stock Number	Code Num.	Size Inches	Ten For
K11936	1	$\frac{1}{2} \times \frac{1}{2}$	9c
K11937	3	$\frac{3}{4} \times \frac{3}{4}$	15c
K11938	4	$\frac{3}{4} \times \frac{1}{2}$	19c
K11939	6	$1 \frac{1}{2} \times 1 \frac{1}{2}$	25c
K11940	7	$1 \frac{1}{2} \times 1 \frac{1}{2}$	32c
K11941	10	$\frac{1}{2} \times 2 \frac{1}{2}$	35c
K11942	11	$\frac{3}{4}$ high	10c
K11943	12	2 high	39c
K11944	15	3 long	29c
K11945	16	$\frac{3}{4} \times \frac{3}{4}$	16c
K11946	17	1 high	25c
K11947	23	$\frac{1}{2} \times 1 \frac{1}{2}$	29c
K11948	24	$\frac{1}{2} \times \frac{3}{4}$	15c

## With Tapped Hole

C11966—Size,  $\frac{1}{2} \times \frac{3}{4}$ ,  $\frac{1}{2}$ " Wide. One hole is tapped for 8/32 screw, other is plain. **16c**  
Ten for \$1.49

"U" Type Bracket  
C11957—Size,  $\frac{1}{2} \times \frac{3}{4} \times \frac{1}{2}$ ,  $\frac{3}{8}$ " Wide. 2 Holes on top and center. Hole on bottom. **15c**  
Ten for \$1.32

## Rivet and Eyelet Punch Set

Produces Factory-Like Job.

Properly sets any rivet or eyelet used in radio work. Tools are made of hardened steel. Holder is made of cast iron. Hexagonal side permits tool to be placed in a vise. Assortment of tubular rivets and eyelets included.  
RI1756—YOUR PRICE **\$1.32**

## Rivet Clinching Tool For Tubular Rivets

Special machined face centers on rivet and a slight blow with hammer will turn the rivet body back against the material and clinches as securely as a power driven rivet. Size:  $3 \frac{1}{8}$ " long,  $\frac{1}{2}$ " dia. For  $\frac{1}{8}$ " and  $\frac{3}{16}$ " body diameter rivets.  
KI1750—YOUR PRICE. Each..... **34c**

## Tubular Rivets "Eyelets"

Rivets for replacement and repair are a necessity for every serviceman. These are the most popular sizes. Body diameter  $\frac{1}{8}$ ".  
KI1815— $\frac{3}{16}$ " long. **9c**  
KI1816— $\frac{1}{4}$ " long. **9c**  
Per Gross, 28c Per 1000, \$1.85

## Combination Rivet—Solder Lug

Rivet fits  $\frac{3}{16}$ " hole. Illustration exact size. Plated with solder coating.  
KI1813—**29c**  
PER HUNDRED  
Per Thousand \$1.95

## Self Tapping Screws

Hardened steel cadmium plated screws. Screws cut own thread. No nut or tapping required. Simply drill hole and drive in screw. Ideal for replacing rivets. Supplied in blunt point with hexagon or round heads.



Round Stock Num.	Hex. Stock Num.	Size & Lgth.	Quant. 10c/pkg.	Price Per Gr.
A12300	A12314	6x $\frac{3}{8}$ "	15	\$0.76
A12301	A12315	6x $\frac{1}{2}$ "	14	.82
A12302	A12316	6x $\frac{3}{4}$ "	13	.88
A12303	A12317	6x1"	12	.94
A12304		6x1 $\frac{1}{2}$ "	12	1.00
A12305	A12319	8x $\frac{3}{4}$ "	15	.79
A12306	A12320	8x $\frac{1}{2}$ "	14	.82
A12307	A12321	8x $\frac{3}{8}$ "	13	.88
A12308	A12322	8x $\frac{1}{2}$ "	12	.97
A12309	A12323	8x $\frac{3}{4}$ "	11	1.06
A12310	A12324	8x1"	10	1.18
A12311	A12325	10x $\frac{3}{8}$ "	11	1.06
A12312	A12326	10x $\frac{1}{2}$ "	10	1.12
A12313	A12327	10x1"	9	1.29

## Sheet Metal Screws

Self tapping steel cadmium plated screws with round head and hardened gimlet point. No nut required.

Size No. 6 Stock Num.	Price Gross	Lgth. In.	Size No. 8 Stock Num.	Price Gross
A11905	30c	$\frac{1}{4}$ "	A11915	34c
A11906	32c	$\frac{3}{8}$ "	A11916	36c
A11907	35c	$\frac{1}{2}$ "	A11918	40c
A11909	40c	$\frac{3}{4}$ "		

## Bakelite Tubing

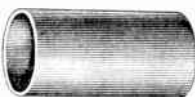

Smooth polished surface. All tubing listed has  $\frac{1}{8}$ " wall.

### Length 3 Inches

Stock Number	Outside Diam.	Price Each	Ten For
C11328	1"	9c	\$0.80
C11329	1 $\frac{1}{4}$ "	12c	1.05
C11330	2"	15c	1.39
C11331	2 $\frac{1}{2}$ "	18c	1.55
C11332	3"	21c	1.85

### Length 6 Inches

Stock Number	Outside Diam.	Price Each	Ten For
C11401	1"	18c	\$1.60
C11402	1 $\frac{1}{4}$ "	24c	2.10
C11403	2"	30c	2.76
C11404	2 $\frac{1}{2}$ "	36c	3.10
C11405	3"	42c	3.70

### Small Diameter Tubing

Phenolic "bakelite" tubing does not absorb moisture. High electrical and tensile strength. Easy to cut. Concentric hole full length. Supplied in 12" lengths.

Stock Number	Outside Diam.	Diam. Hole	Your Price
C11348	$\frac{1}{8}$ "	$\frac{1}{16}$ "	25c
C11350	$\frac{3}{16}$ "	$\frac{1}{16}$ "	27c
C11351	$\frac{1}{4}$ "	$\frac{3}{16}$ "	29c
C11352	$\frac{5}{16}$ "	$\frac{1}{4}$ "	32c
C11353	$\frac{3}{8}$ "	$\frac{1}{4}$ "	32c
C11355	$\frac{1}{2}$ "	$\frac{3}{8}$ "	35c

## Solid Rods

Same material as above but solid.

Stock Number	Diam. Inches	Price 12" Long	Price 24" Long
C11354	$\frac{1}{8}$ "	15c	29c
C11356	$\frac{3}{16}$ "	21c	41c
C11358	$\frac{1}{4}$ "	29c	59c

## Radio Tweezer



RI1599—YOUR PRICE ..... **21c**  
For holding wires, nuts, etc. Tempered spring. Size  $\frac{5}{16}$ " long.

## All Steel Metal Parts Cabinet

Convenient and Practical  
A15865—YOUR PRICE. Only..... **\$3.53**

In Lots of 3 or More, Each, \$3.37  
A cabinet value that is hard to beat. Provides a very convenient storage place for all small radio parts and tools. Sturdy all steel construction. Finished in dark green crackle enamel with drawers in smooth green enamel. The 6 drawers have compartments properly divided with permanently fastened partitions to accommodate a variety of different size radio parts: 1 drawer has fifteen divisions, each  $2 \frac{3}{4} \times 2 \frac{1}{2}$ "; 1 with 12 divisions, each  $2 \frac{3}{4} \times 3 \frac{1}{4}$ "; 2 with 6 divisions, each  $4 \frac{1}{4} \times 1 \frac{1}{4}$ "; remaining two drawers have 1 division, one size  $3 \times 8 \frac{1}{4}$ " and three of  $2 \frac{3}{4} \times 9 \frac{1}{4}$ ". Card holders on each drawer. Size of cabinet:  $10 \frac{1}{2} \times 11 \frac{1}{2} \times 13 \frac{1}{4}$ " deep. Two or more can be used to provide a larger unit.

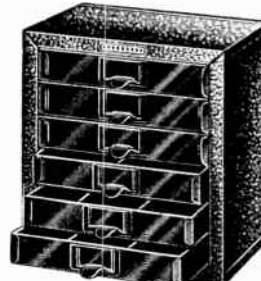

C15867—Same as above cabinet in construction, and finish but smaller in size. Measures  $9 \frac{1}{2}$ " high, 8" wide, 8" deep. 6 Drawers, each  $5 \times 8 \frac{1}{2}$ ". 2 Drawers have ten compartments, 2 have six and 2 have 3. Ship. wt., 6 lbs. **\$1.76**  
YOUR PRICE. Each.....  
In Lots of 3 or More, Each, \$1.65

## Economy All-Steel Parts Cabinets



D15866—Small Size 4 Drawer Cabinet. An outstanding value at this low price. Four  $5 \times 8 \frac{1}{2}$ " drawers; 2 drawers have six compartments and 1 has three. Size  $5 \frac{1}{2} \times 8 \frac{1}{2} \times 11 \frac{1}{4}$ " high. Smooth green enamel finished. Ship. wt., 4 lbs. **88c**  
YOUR PRICE. Each.....  
In Lots of 3, Each 83c

D15868—Large Size 4 Drawer Cabinet. Sectional construction permits any number to be grouped and bolted together. Has four  $9 \times 11 \frac{1}{2} \times 2 \frac{1}{2}$ " drawers divided into 12 equal compartments. Two-tone green finished; wrinkle finished case with smoothly enameled drawers. Size  $10 \frac{1}{2}$ " wide,  $11 \frac{1}{2}$ " deep,  $10 \frac{1}{2}$ " high. Ship. wt.  $10 \frac{1}{2}$  lbs. **\$1.89**  
YOUR PRICE. Each.....  
In Lots of 3 or More, Each \$1.79

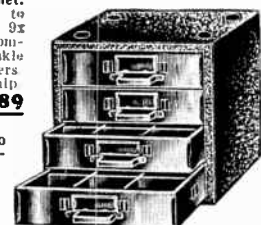

D15864—2 Drawer Cabinet. Similar to above. Two  $9 \times 11 \frac{1}{2}$ " drawers, one has 9 various sized compartments. Dark green enamel finished. Size  $9 \frac{3}{4} \times 11 \frac{1}{2}$ " deep,  $5 \frac{1}{2}$ " high. Ship. wt. 6 lbs. **\$1.10**  
YOUR PRICE. Each.....  
In Lots of 6 or More, Each 98c

## Insulating Washers

For insulating equipment mounted on flat metal panels or chassis.

Stock Number	Outside Diameter	Hole Diameter	Thickness	Ten for
KI1831	1 $\frac{1}{2}$ "	$\frac{3}{8}$ "	$\frac{1}{16}$ "	8c
KI1832	1 $\frac{1}{2}$ "	$\frac{1}{2}$ "	$\frac{1}{16}$ "	Per Hundred <b>56c</b>
KI1833	1 $\frac{1}{2}$ "	$\frac{3}{4}$ "	$\frac{1}{16}$ "	
KI1834	1"	$\frac{3}{8}$ "	$\frac{1}{16}$ "	
KI1835	1 $\frac{1}{2}$ "	$\frac{1}{2}$ "	$\frac{1}{16}$ "	
KI1836	1 $\frac{1}{2}$ "	$\frac{3}{4}$ "	$\frac{1}{16}$ "	
KI1837	1 $\frac{1}{2}$ "	$\frac{1}{2}$ "	$\frac{1}{16}$ "	

## Extruded Washers

Shoulders fit into panel holes. Insulating shaft, etc., in passing through panel.

Stock Number	Outside Diam.	Hole Diam.	Shoulder Diam.	Washer Thick.	Shoulder Raise	Ten for
KI1838	1"	$\frac{3}{8}$ "	$\frac{3}{8}$ "	$\frac{1}{16}$ "	$\frac{1}{16}$ "	10c
KI1839	$\frac{3}{4}$ "	$\frac{3}{8}$ "	$\frac{3}{8}$ "	$\frac{1}{16}$ "	$\frac{1}{16}$ "	Per Hundred <b>84c</b>
KI1840	$\frac{1}{2}$ "	$\frac{3}{8}$ "	$\frac{3}{8}$ "	$\frac{1}{16}$ "	$\frac{1}{16}$ "	
KI1830	$\frac{3}{4}$ "	$\frac{3}{8}$ "	$\frac{3}{8}$ "	$\frac{1}{16}$ "	$\frac{1}{16}$ "	
KI1842	$\frac{1}{2}$ "	$\frac{3}{8}$ "	$\frac{3}{8}$ "	$\frac{1}{16}$ "	$\frac{1}{16}$ "	

## Insulated Grommet Bushings



Made of hard insulating material. Supplied complete with knurled nuts.

Stock Num.	Black	Red	Fits Hole	In-side Dia.	Lgth.	Ten for
R12060	R12061	R12062	$\frac{3}{16}$ "	$\frac{3}{16}$ "	$\frac{3}{8}$ "	38c
R12061	R12065	R12066	$\frac{1}{4}$ "	$\frac{1}{4}$ "	$\frac{3}{8}$ "	44c
R12062	R12066	R12067	$\frac{1}{2}$ "	$\frac{1}{2}$ "	$\frac{3}{8}$ "	58c
R12063	R12067		$\frac{3}{4}$ "	$\frac{3}{4}$ "	$\frac{3}{8}$ "	58c

## Rubber "Feet"—Bumpers

For use on bottom of cabinets, amplifiers, etc. Recessed cavity for head of screw. Cannot scratch. Fits size 6 or 8 screws.



C11806— $\frac{3}{8}$ " diam.,  $\frac{3}{16}$ " high.  
C11807— $\frac{1}{2}$ " diam.,  $\frac{1}{16}$ " high.  
Per Hundred, 95c  
Per dozen..... **19c**

## Rubber Grommets

For insulating holes in any metal plate about  $\frac{1}{16}$ " thick. Prevents cutting wires. Strong black rubber.

Stock Num.	Fit Hole	Inside Diam.	Per Doz.	Per Hu.
C11800	$\frac{1}{8}$ "	$\frac{1}{8}$ "	8c	52c
C11801	$\frac{1}{4}$ "	$\frac{1}{4}$ "	14c	54c
C11802	$\frac{3}{8}$ "	$\frac{3}{8}$ "	17c	59c
C11803	$\frac{1}{2}$ "	$\frac{1}{2}$ "	19c	62c
C11804	$\frac{3}{4}$ "	$\frac{3}{4}$ "	20c	68c

A11805—Assortment of 80 Grommets, 12 each of above, YOUR PRICE..... **47c**

## Rubber Head Tack Bumpers

For use on bottom of cabinets and cases. Prevents marring of surface. Nail is firmly imbedded in rubber head.



C11818— $\frac{3}{8}$ " Dia.  
C11819— $\frac{1}{2}$ " Dia.  
Ten for..... **9c**  
100 for 49c 1000 for \$3.85

# SERVICEMEN'S SUPPLIES: JACKS - PLUGS

## Standard Phone Plugs



Screw connection for one or two sets of cords with either phone tip or eyelet ends. In red or black molded bakelite or shielded metal barrel handles. All metal parts brass, nickel plated.

### 1 Circuit—2 Lead Type

Stock Num.	Barrel Type	Barrel Size	Pr. Ea.	Yen for
C12121	Red Bak.	3/8 x 1 1/2"	17c	\$1.69
C12122	Black Bak.	3/8 x 1 1/2"		
C12123	Red Bak.	3/4 x 1 1/2"		
C12124	Black Bak.	3/4 x 1 1/2"		

C12124	Shielded	3/8 x 1 1/2"	28c	\$2.60
C12125	Shielded	3/4 x 1 1/2"	22c	2.10
C12126	Shielded	3/4 x 1 1/2"	3c	3.60

### 2 Circuit—3 Lead Type

C12127	Black Bak.	3/4 x 1 1/2"	39c	\$3.60
C12128	Shielded	3/4 x 1 1/2"	59c	5.45

## Portable (Line) Jacks



For extension purposes where jack is not mounted on panel. All metal parts are brass, nickel plated. Available in black molded bakelite or shielded barrel types or less barrel with insulating washers for chassis mounting. Phosphor bronze springs. Size 3/4" dia., 1 3/4" long.

### 1 Circuit—2 Lead Type

C12129	Bakelite	3/4 x 1 3/4"	28c	\$2.60
C12130	Shielded	1 1/4 x 2 1/4"	49c	5.50
D12131	Less Barrel		1c	1.60

### 2 Circuit—3 Lead Type

C12131	Bakelite	3/4 x 1 3/4"	35c	\$3.20
C12132	Shielded	1 1/4 x 2 1/4"	59c	5.45
D12134	Less Barrel		21c	1.98

## Barrels for Plugs and Jacks

Will fit above Plugs and Jacks and any others of equivalent size. Metal barrels have rubber grommet in end for insulation.

Stock Num.	I.D.	Outside D x L.	Type	Your Price
D12135	1 1/2"	3/4 x 1 1/2"	Black Bak.	9c
D12136	1 1/2"	3/4 x 1 1/2"	Black Bak.	
D12137	1 1/2"	3/4 x 1 1/2"	Red Bak.	Each
D12138	1 1/2"	3/4 x 1 1/2"	Red Bak.	
D12139	1 1/2"	3/4 x 1 1/2"	Nickel Plated	24c
D12140	1 1/2"	3/4 x 1 1/2"	Plated	18c
D12141	1 1/2"	3/4 x 1 1/2"	Brass	24c
D12142	1 1/2"	3/4 x 1 1/2"	Brass	17c

## Standard Jack Plugs



Moulded body, 1 1/4 inch diameter with eyelet diameter with inch cord.

**C11250—YOUR PRICE 12c**  
Ten for \$1.05

## Carter Flat Plug

Popular flat type plug. Ideal for wall plate connection. Body made of bakelite 1 1/4" dia., 3/4" thick. Set screw connections take plug-in tips or wire ends.

**C11208—YOUR PRICE... 33c**

## Short Jacks

Smallest made. Solder lugs widely spaced. Heavy bakelite insulators eliminate leakage. Mount in 3/8 inch hole on 3/8 to 1/2 inch panels.

Take any standard plug.  
**C11220—No. 1—Open Circuit.**  
**C11221—No. 2A—Single, Closed Circuit.**  
**YOUR PRICE, Each... 14c**  
Ten for \$1.25

## Infant Jack

A single circuit jack. Plated phosphor bronze spring will not lose tension. Tinned lugs. Bakelite insulation.

**K11156—1st. 25c.**  
**YOUR PRICE... 15c**

## Rotary Tap Switches

Requires 3/8" hole, in 1/2" or thinner panel. Single deck type extends 5/8" back of panel. Knob shaft, 1/4" dia., 3/8" long beyond bushing. Motor grounded to frame. Wiping spring contacts. Will carry 3 Amps. at 110 Volts A.C. Non-Shorting Type.

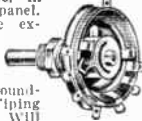

Stock Num.	Number Contacts	Stock Num.	Number Contacts
D13200	3	D13205	8
D13201	4	D13206	9
D13202	5	D13207	10
D13203	6	D13208	11
D13204	7	D13209	12

**Price Each 27c**      **Price Each 40c**

## Push Button Switches

Yaxley Type 2190

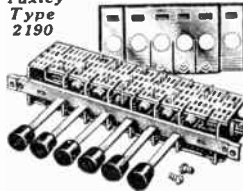

For use in test equipment and other switching circuits. Switches are non-shorting type, each button providing P.D.T. action. Depressing one button automatically releases others. Low loss construction. Includes statory bronze esutheon, brown bakelite knobs and blank inserts with transparent strip for identification window.

Stock Number	Mfg. Code	Num. of Buttons	Your Price
C10987	2194	4	\$2.35
C10988	2196	6	2.94
C10989	2198	8	3.53

## Head Phone Cords



For Double Unit Headphones  
Fine quality durable merized braid covering. Length 5 ft.

**R4906—With pin tips on both ends.**  
**R4907—With slide tips on phone unit end, pin tips on other end.**  
**TEN FOR \$1.65.**  
**PRICE EACH... 17c**

## Two Conductor Cords

For Speakers or Single Unit Headphones

Finest quality glossy merized, covering. Length 5 ft.  
**R4908—Pin tips one end, EACH**  
**R4909—Pin tips both ends, EACH**  
**Ten for 74c**

## Extension Cords



Fine Stranded Copper Wire Conductors. Each conductor rubber insulated and covered with cotton braid. Two conductors. Braid covering over all. Cord tips each end.

Stock Number	Length Feet	Price Each	Ten For
R4900	10	18c	\$1.71
R4901	20	22c	2.10
R4902	30	33c	3.20
R4903	50	49c	4.65

## Extension Connector

Takes phone tip ends.  
**C11252—Ten for 75c**  
**EACH... 8c**

## Yaxley Push Button Jack Switches

Contacts made and broken by pressure on knob. Non-locking type returns to original position when pressure released. Locking type remains in depressed or raised position.



**Single Pole—Single Throw**  
Makes Contact in Single Circuit.  
**K11126—Code 2001. Non-locking.**  
**K11127—Code 2001L. Locking.**  
List Price \$0.90.  
**YOUR PRICE, Each... 53c**

**Single Pole—Double Throw**  
One circuit completed in up position. In depressed position, first circuit broken and one of contacts switched to second circuit.  
**K11130—Code 2003. Non-locking.**  
**K11131—Code 2003L. Locking.**  
List Price \$1.00.  
**YOUR PRICE, Each... 59c**

**Double Pole—Double Throw**  
Two separate circuits closed in "up" position. In depressed position, one contact from each circuit is connected to a second set of separate circuits.  
**K11136—Code 2006. Non-locking.**  
**K11137—Code 2006L. Locking.**  
List Price \$1.50.  
**YOUR PRICE, Each... 88c**

## Circuit Opening Twin Tip Jacks

Circuit opens when both pin tips are in place. Closed while either one alone is in position. Used in circuits for current and voltage measurements. Mounts above or below panel with standard 5/2 screw. 1/2" holes required with 1/2" centers for use under panels less than 2" thick.  
**R11200—No. 432.**  
**YOUR PRICE, Each... 17c**  
Ten for \$1.50

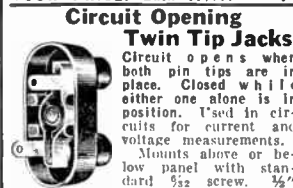

**Porcelain Base Knife Switches**



Glazed white porcelain bases. Copper contacts and blades with screw lug connections.

Stock Num.	Type	Size Inches	Your Price
N11105	S.P.S.T.	1 1/2 x 2 1/2	9c
N11106	S.P.D.T.	1 1/2 x 2 1/2	11c
N11107	D.P.S.T.	1 1/2 x 2 1/2	17c
N11108	D.P.D.T.	1 1/2 x 2 1/2	19c

## Small Bakelite Base Knife Switches

Base lengths—  
Double Throw 2 1/2 inches;  
Single throw 1 1/2 inches.  
Moulded bakelite base and handle. Contacts and blades brass nickel plated.

Stock No.	Poles	Each Net	Stock No.	Poles	Each Net
K11109	1	\$0.32	K11114	1	\$0.38
K11110	2	.44	K11115	2	.50
			K11116	3	.74
K11112	4	.88	K11117	4	.96
K11113	5	1.29	K11118	5	1.32

## Miniature Switches

Compact, substantial. For base panel mounting. Bakelite base 1 1/4" long. Nickel plated blades and posts. S. P. 1/2".  
**wide, D. P. 1" wide.**  
**K11120—S.P.S.T. Each... 9c**  
**K11121—S.P.D.T. Each, 15c**  
**R11123—D.P.S.T. Each, 21c.**  
**R11122—D.P.D.T. Each, 24c.**

## Centralab Tone Switches

Constructed chiefly for use as tone switches. Can be used in any circuit. Current capacity 1 ampere at 6 volts. "Ticker" movement, 2 1/4" milled shaft. Body only 1/2" deep.



**N12745—Code 1460. 1 Pole 2 Positions. Size 1 1/4" x 1 1/4".**  
**N12746—Code 1461. 1 Pole 3 Positions. Size 1 3/4" x 1 1/4".**  
**YOUR PRICE, EACH... 29c**  
**N12747—Code 1462. 2 Pole 2 Positions. Size 1 1/4" x 1 1/4".**  
**YOUR PRICE... 35c**

## Centralab Lever Switches

Low Capacity—Compact



For extremely compact mounting. Very little space required behind panel: 1 1/2" deep, 1 1/2" high and 1/2" wide for each switch. Knob includes "Spring" action returns lever to mid-position from either side. "Spring" action to mid position from one side only. With spring return action to original position. Others positive action in all positions.

Stock Num.	Mfg. Code	Stock Num.	Mfg. Code	Poles	Positions
B10910	1452	B10915	1454	2	3
B10911	1453	B10916	1455	2	3
B10912	1466	B10917	1467	2	3
B10913	1459	B10918	1458	4	2
B10914	1456	B10919	1457	4	2

## Mounting Plates for Above

Num.	Gangs	Price	Black crackle finished steel plates. Size 2 1/2" high by 3 1/2" long for each switch used.
B10920	1	12c	
B10921	2	18c	
B10922	3	21c	
B10923	4	26c	
B10924	5	29c	

## C-H S. P. D. T. Toggle Switch With "Off" Position

Makes or breaks two circuits and has "off" position in center. Toggle shaft is insulated from a switch. Mounting sleeve diameter 1/2" length 3/4". Overall body size 1 1/2" x 1 1/2" deep. Three screw terminal connections.  
**C11070—YOUR PRICE... 20c**  
Ten for \$1.80



**Push Button Switch**  
**C11075—Open Circuit.**  
**YOUR PRICE 10c**  
Ten for 95c

Fine quality. Pearl center with polished nickel rim. Fits 3/8" hole. Screw connectors eliminate soldering. Suitable for circuits up to 250 volts 2 amps. Phosphor bronze contact.

## Rotary Canopy Switch

**C11089—Single pole on-off rotary switch. Rated 1 ampere at 250 volts. Shank mounts in single 3/8" hole in panels up to 3/4" thick. Brown bakelite knob. 6" Insulated leads.**  
**YOUR PRICE... 21c**  
Ten for \$1.90



Sure contact, nickel tip jacks mounted in bakelite strip, 2" long, 1 1/2" wide. Mounting holes 1 1/4" centers.  
**K11202—Plain (not marked).**  
**K11203—Marked "Phono."**  
**K11204—Marked "Speaker."**  
Ten for 44c.  
**YOUR PRICE, Each... 5c**



# TOGGLE · PUSH BUTTON · ROTARY SWITCHES

## Toggle-Panel Switches

Underwriters approved, 3 amp., 125 V.—1 amp., 250 V. For controlling radio sets, motors, lamps, meters, etc. Two locknuts included. Best quality. H. & H. brand. Laminated fiber construction. Solder lug connections. Available in Nickel or Statuary Bronze.

### Single Pole—Single Throw

Makes and breaks a single circuit. Standard "ON" and "OFF" switch. Mounting sleeve  $\frac{3}{8}$ " diameter, 3A, 125V. 1A, 250V.

Stock Number	Slv. Lgth.	Your Price	Ten For
C10925	C11010 $\frac{1}{2}$ "	17c	\$1.53
C10926	C11011 $\frac{3}{4}$ "	17c	1.53
C10928	C11013 1"	20c	1.80

### Single Pole—Single Throw Heavy Duty

Same as above switch except will handle heavier current. 6 amps., 125 V. or 3 amps., 250 V.

Stock Number	Slv. Lgth.	Your Price	Ten For
C10994	C10997 $\frac{1}{2}$ "	18c	\$1.65
C10995	C10998 $\frac{3}{4}$ "	18c	1.65
C10996	C10999 1"	22c	2.02

### Single Pole—Double Throw or Three Way

Can be used as Three way or single pole double throw. Mounting sleeve  $\frac{3}{8}$ " diameter, 3A, 125 V.—1A, 250V.

Stock Number	Slv. Lgth.	Your Price	Ten For
C10929	C11014 $\frac{1}{2}$ "	21c	\$1.89
C10930	C11015 $\frac{3}{4}$ "	21c	1.89
C10932	C11017 1"	24c	2.16

### Double Pole—Single Throw

Cuts two circuits in and out. "On" and "Off" for two circuits. Mounting sleeve  $\frac{3}{8}$ " diameter, 3A, 125V.—1A, 250V.

Stock Number	Slv. Lgth.	Your Price	Ten For
C10933	C11018 $\frac{1}{2}$ "	30c	\$2.70
C10934	C11019 $\frac{3}{4}$ "	30c	2.70
C10936	C11021 1"	30c	2.70

### Double Pole—Double Throw

Feeds two circuits into either one of two pairs of circuits. A new development of many uses. Mounting sleeve  $\frac{3}{8}$ " diameter, 3A, 125V.—1A, 250V.

Stock Number	Slv. Lgth.	Your Price	Ten For
C10937	C11022 $\frac{1}{2}$ "	35c	\$3.15
C10938	C11023 $\frac{3}{4}$ "	35c	3.15
C10940	C11025 1"	38c	3.42

## Streamline Sliding Lever Switch

For modernizing appliances, panels, etc. Bakelite slide lever can be pried off and plate removed. Fits hole  $\frac{11}{16}$ " x  $\frac{1}{4}$ " deep. Polished nickel plate, size  $\frac{11}{16}$ " x  $\frac{3}{8}$ ". For A.C. or D.C. Rated 3 amps. at 125 volts. "One circuit is 'on', other 'off'."

Stock Number	Type	Price Each	Ten For
A11000	S.P.S.T.	33c	\$3.10
A11001	Two Circuit*	40c	3.80
A11002	S.P.D.T.	40c	3.80
A11003	D.P.S.T.	45c	4.27
A11004	D.P.D.T.	54c	5.13

### Momentary Contact

Switch must be held in position. For A.C. operation only. \*Normally off.

Stock Number	Type	Price Each	Ten For
A11005	S.P.S.T.†	39c	\$3.70
A11006	Two Circuit*	45c	4.27
A11007	S.P.D.T.	45c	4.27
A11008	D.P.S.T.†	54c	5.13
A11009	D.P.D.T.	59c	5.60

## Rotary Panel Switches

Underwriters approved, 3 amps. at 125V., 1 amp. at 250 volts. Best quality. H. & H. brand. Cadmium plated lugs. Supplied with locknuts. Mounts in  $\frac{3}{8}$ " hole. Shaft extends 1" out of sleeve.

### Single Pole—Single Throw

Stock Number	Sleeve Length	Price Each	Ten For
A11030	$\frac{3}{4}$ "	15c	\$1.35
A11031	$\frac{1}{2}$ "	15c	1.44
A1032	1"	22c	2.05

### Single Pole—Double Throw

Stock Number	Sleeve Length	Price Each	Ten For
A11034	$\frac{3}{4}$ "	20c	\$1.79
A11035	$\frac{1}{2}$ "	21c	1.89
A11036	1"	29c	2.75

### Double Pole—Single Throw

Stock Number	Sleeve Length	Price Each	Ten For
A11038	$\frac{3}{4}$ "	32c	\$2.88
A11039	$\frac{1}{2}$ "	32c	2.88
A11040	1"	34c	3.20

### Double Pole—Double Throw

Stock Number	Sleeve Length	Price Each	Ten For
A11042	$\frac{3}{4}$ "	37c	\$3.33
A11043	$\frac{1}{2}$ "	37c	3.33
A11044	1"	38c	3.60

## Key Lock Switch

Single Pole—Single Throw  
A11055  
Your Price  
**25c**  
Ten for **\$2.37**  
C11056—D. P. S. T.  
YOUR PRICE, EACH..... **47c**  
Ten for **\$4.55**

Key removable when circuit is broken. Mounting sleeve  $\frac{3}{8}$ " diam.,  $\frac{1}{2}$ " long. Attractive lock nuts included. One key supplied. Underwriters approved. 3 amp. at 125 volts. Body size  $\frac{3}{4}$ " deep,  $\frac{3}{8}$ " wide,  $\frac{1}{2}$ " long.

## Two Circuit Push Button Switches

Two circuit non-indicating slow make and quick break momentary contact switches. One circuit is normally ON and the other is normally OFF. Pressing the push button reverses the "off" and "on" position of the circuits. When pressure on the push button is released the condition of the circuits returns to normal. Finest quality. Laminated bakelite or fibre insulation. Tinned copper solder lug connections. Rating 75 watts, 125 volts, A.C. Standard  $\frac{3}{8}$ " diam. bushing  $\frac{1}{4}$ " long.

### With Metal Plunger

Same switch as used on Supreme and other makes of instruments.  
A11046  
Your Price **22c**  
Each..... **\$1.99**  
Ten for

### With Bakelite Button Plunger

Supplied with a black or red bakelite concave button on end of plunger.  
A11048—Red Button  
A11049—Black Button  
Your Price, **29c**  
Each..... **\$2.60**  
Ten for

## "OFF" - "ON" TOGGLE SWITCH PLATE

For use with any standard panel type toggle switch. Available in nickel or statuary bronze.  
C11059—Statuary Bronze.  
C11058—Nickel.  
YOUR PRICE, Each..... **2c**  
Ten for **12c**

## New Yaxley Rotary Tap Switches

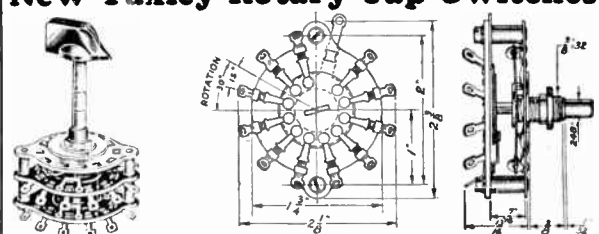

Series 1200L and 1300L

Switches are identically same construction as used and specified by majority of radio manufacturers making all-wave receivers. All contacting members are heavily silver-plated to withstand severe wear throughout life. Lowest contact resistance and capacity permits use of this switch in any circuit. Most perfect and positive indexing system used eliminates possibility of setting switch between contacts.

Adjustable stop feature provides various circuit combinations in each switch.  $\frac{1}{4}$ " Aluminum shaft 2" long is knotted to permit easy cutting at popular lengths. Multiple gang switches have  $\frac{1}{2}$ " spacing between decks. Shorting switch provides a continuous circuit without any break between contact settings. Supplied with four knobs. All switches take 30 degree dial plates listed below.

Shorting Stock Num.	Yaxley Code	Non-Shorting Stock Num.	Yaxley Code	Num. of Ganges	Circuits per Switch	Contacts per Circuit	List Price	Your Price
R13250	1216L	R13262	1316L	1	1	1 to 6	\$1.00	59c
R13251	1211L	R13263	1311L	1	1	1 to 11	1.15	68c
R13252	1215L	R13264	1315L	1	2	1 to 5	1.25	73c
R13253	1213L	R13265	1313L	1	3	1 to 3	1.35	79c
R13254	1212L	R13266	1312L	1	4	1 to 2	1.45	85c
R13255	1226L	R13267	1326L	2	2	1 to 6	1.60	94c
R13256	1221L	R13268	1321L	2	2	1 to 11	1.75	\$1.03
R13257	1225L	R13269	1325L	2	4	1 to 5	2.00	1.18
R13258	1223L	R13270	1323L	2	6	1 to 3	2.10	1.23
R13259	1231L	R13271	1331L	3	3	1 to 11	2.25	1.32
R13260	1241L	R13272	1341L	4	4	1 to 11	3.00	1.76

## Yaxley Series 3100J and 3200J

### Single Gang Combination Switches

Newly designed compact single gang switches used in majority of compact all-wave receivers. Heavily silver-plated contact points. Low capacity and low contact resistance. Various circuit combinations are provided when only certain sections of the switch are used and with the use of the adjustable stop plate.

New 2" long,  $\frac{1}{4}$ " dia. universal shaft is notched to provide easy cutting at popular lengths. Shaft bushing fits into  $\frac{3}{8}$ " hole. Body thickness  $\frac{1}{2}$ ". Maximum body depth including terminal lugs is  $\frac{11}{16}$ ". Diameter  $\frac{1}{4}$ ". Take 30 degree plates. \*Have adjustable stop feature and diameter of  $\frac{11}{16}$ ". Take 20 deg. plates.



Shorting type recommended for Radio use. Non-Shorting for Test Instruments.  
Bar Knobs Included.

Shorting Stock Num.	Yaxley Code	Non-Shorting Stock Num.	Yaxley Code	No. of Circuits (Poles)	Contacts per Circuit (Throws)	List Price	Your Price
R13275	3115J	R13285	3215J	1	1 to 5	\$0.75	44c
R13276	3112J	R13286	3212J	1	1 to 12	.75	
R13277	31117J*	R13287	32117J*	1	1 to 17	1.35	79c
C13273	3122J	R13288	3222J	2	1 to 2	.75	44c
C13274	3123J	R13289	3223J	2	1 to 3	.75	44c
R13278	3126J	R13290	3226J	2	1 to 6	.75	44c
R13279	3129J	R13291	3229J	2	1 to 9	1.35	79c
R13280	3131J	R13292	3231J	3	1 to 4	.90	53c
R13281	3136J*	R13293	3236J*	3	1 to 6	1.59	88c
R13282	3142J	R13294	3242J	4	1 to 2	.85	50c
R13283	3143J	R13295	3243J	4	1 to 3	.90	53c
R13284	3163J	R13296	3263J	6	1 to 3	1.50	88c

## Bat Handle Toggle Switches

Bat handle permits quicker, easier operation. Best quality H. & H. brand. Nickel plated sleeve and handle. Two nuts included. Mounts in  $\frac{3}{8}$ " hole. 3 Amps. at 125 V., 1 amp. at 250 V. Solder lug terminals. Underwriters approved. Heavy duty type, 6 amps. at 125 V., 3 amps. at 250 V.



Stock Number	Type	Slv. Lgth.	Price Each	Ten For
D10907	S1ST	$\frac{1}{2}$ "	17c	\$1.53
D10908	S1ST	$\frac{3}{4}$ "	17c	1.53
D10909	S1ST	1"	18c	1.65
D10941	S1ST	1"	20c	1.80
D10942	S1DT	$\frac{1}{2}$ "	21c	1.89
D10943	S1DT	$\frac{3}{4}$ "	21c	1.89
D10944	DPST	$\frac{1}{2}$ "	30c	2.70
D10945	DPST	$\frac{3}{4}$ "	30c	2.70
D10946	DPDT	$\frac{1}{2}$ "	35c	3.15
D10947	DPDT	$\frac{3}{4}$ "	35c	3.15
D10948	DPDT	1"	38c	3.42

## Etched Dial Plates For Above Tap Switches

Bright aluminum raised figures on black background,  $\frac{11}{16}$ " Dia.  $\frac{3}{8}$ " Hole.  
PRICE EACH..... **9c**



Numerals 30 Degree Stock Num.	Spacing 20 Degree Stock Num.	Dial Markings
R13302	R13312	1 to 3
R13303	R13313	1 to 4
R13304	R13314	1 to 5
R13305	R13315	1 to 6
R13307	R13317	1 to 8
R13308	R13318	1 to 9
R13309	R13319	1 to 10
D13337	D13347	1 to 10
R13310	R13320	1 to 11
R13311	R13321	1 to 12
	R13324	1 to 15
	R13326	1 to 17
	R13327	1 to 18

For Volume Controls  
D13300—Dia.  $2\frac{1}{4}$ " 0-100.  
YOUR PRICE, Each..... **15c**



## Xcelite Nut Drivers

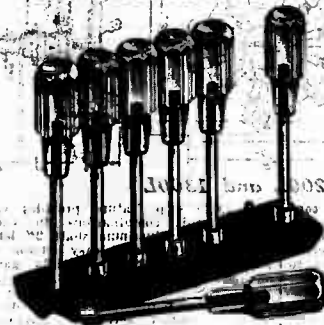

### Unbreakable Shockproof Handles

Transparent firm grip handle will withstand 5000 volts. Guaranteed against splitting and breaking. Seams free from burrs, truly formed, and deep enough to handle two nuts. Hollow shaft stem up to 1 1/2" permits removal of nuts on long projecting screws. Sockets and 3" long shanks expertly tempered, fully polished. Steel mounting rack.

### 6 Inch Length 9 Inch Length

Stock Number	For Max. Nut	Stock Number	Your Price
A11974	1/2"	A12077	44c
A11975	3/8"	A12078	44c
A11976	1/2"	A12079	44c
A11977	3/8"	A12080	44c
A11978	1/2"	A12081	44c
A11979	3/8"	A12082	44c
A11980	1/2"	A12083	44c

A12084	1/2"	A12085	56c
--------	------	--------	-----

### Shaft Type

Stock Number	Fits Volume Control Nuts
A11981	1/2"
A11982	3/8"

All have smooth handles. Tumble nickel finish. Black handles, polished head.

A11982 - Dull Mounting Rack - Will hold any seven above wrenches. **12c**

A11982 - Dull Mounting Rack - Will hold any seven above wrenches. **12c**

A11982 - Dull Mounting Rack - Will hold any seven above wrenches. **12c**

### Universal Socket Wrench

**C12073**  
YOUR PRICE **\$3.18**

An ingenious pocket sized tool for installing auto radios.

heaters, and for general radio work. The head of the tool takes any of the 17 standard popular socket wrenches provided. All wrenches not in use fit in the hollow handle and lock in place. Socket sizes furnished are 7/16", 1/2", 9/16", 5/8", and 3/4".

### Genuine Klein Pliers

These pliers are made of the best fine tool steel, and are of the highest quality on the market.

### Oblique Plier

Cuts close, the narrow head permitting use in cramped places. Knives perfectly filed so that they meet accurately at all points.

**C11685** 5 inch Each..... **\$2.00**

**C11686** 6 inch Each..... **\$2.15**

### Long Nose Side Cutting Plier

Pe. No. 208  
Fine cutting action. Knives carefully filed. Body of the plier is hardened and tempered. Point 1/4 inch round.

**C11857** 5 inch Each..... **\$2.05**

**C11688** 6 inch Each..... **\$2.30**

## Krauter Pliers

The Choice of Skilled Mechanics

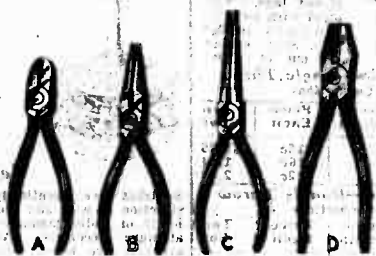

Only the best material and perfect workmanship go into the production of Krauter pliers. Pliers are drop forged of extra high grade steel. Blued steel finish knurled handles will withstand a pressure of 140 to 165 lbs. without breaking. Jaws are milled and tested for pulling strength. Cutting edges are expertly tested. First, to cut blow steel wire; second, to cut alk covered wire; third, for cutting hard drawn nails. Heads are highly polished. Made in America. Pliers are especially suitable for delicate work such as meter or watch repairs. Spring fully polished finish.

Stock Number	Type	Description	Length Overall	Your Price
C11998	A	Side Cutting	4 1/2"	\$1.27
C11999	A	Side Cutting	5 1/4"	.79
C12000	A	Side Cutting	6"	1.25
C12001	A	Side Cutting	6 1/2"	.95
C11964	B	Needle Pt. Nose	5 1/2"	1.00
C11965	B	Long Nose	6"	.75
C11966	C	Extra Long Nose	7 1/2"	1.11
C12002	C	Needle Pt. Nose	7 1/2"	1.25
C11967	D	Electrical Pliers	6 1/2"	.75
C11968	D	Electrical Pliers	7 1/2"	.85
C11969	D	Electrical Pliers	8"	.95

### Amberyl Nut Drivers

With Transparent Unbreakable Handles

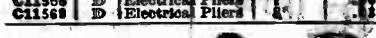

You can save time, temper and money by using these high quality nut drivers for your radio service work. Shank is firmly embedded in clear transparent unbreakable shock-proof handle that will not chip or crack even when subjected to hammer blows. Handles are large enough and properly formed for best grip. Hardened steel socket. Stems made to take projecting screws from 1/4" to 3/4" long depending on socket size. Overall length 6".

Stock Num.	For Max. Nut	Your Price
C11998	1/2"	19c
C11999	3/8"	50c
C11971	1/2"	50c
C11972	3/8"	64c
C11993	1/2"	64c

### Amberyl Nut Drivers

With Transparent Unbreakable Handles



You can save time, temper and money by using these high quality nut drivers for your radio service work. Shank is firmly embedded in clear transparent unbreakable shock-proof handle that will not chip or crack even when subjected to hammer blows. Handles are large enough and properly formed for best grip. Hardened steel socket. Stems made to take projecting screws from 1/4" to 3/4" long depending on socket size. Overall length 6".

Stock Num.	For Max. Nut	Your Price
C11998	1/2"	19c
C11999	3/8"	50c
C11971	1/2"	50c
C11972	3/8"	64c
C11993	1/2"	64c

### Volume Control Nut Drivers

Full length hollow shaft handles take volume control shifter up to 4 1/2" long. Cross bracket in handle positively prevents handle from turning.

Stock Num.	For Max. Nut	Your Price
C13028	1/2"	59c
C13029	3/8"	59c

## Amberyl "Lifetime" Screw Drivers

Guaranteed Unbreakable - Rust-Proof

Finest quality screwdrivers at a new economy price. Clear transparent unbreakable shockproof Amberyl handle will not chip or crack even when subjected to most severe hammer blows. Handles are large enough and properly formed for best grip. The blades are forged of a tough crucible steel. Correctly oil tempered and cadmium plated to prevent rust. Blades positively will not turn in the handle. A size for every need is listed below.

### With 1/8" Round Blades

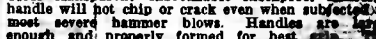

Will fit knob screws. Narrow blade tip properly formed for radio work.

Stock Num.	Blade Length	Price Each	C13012 - Set of 4 Screwdrivers. YOUR PRICE <b>78c</b>
C13008	2"	29c	
C13010	3"	29c	
C13011	4"	30c	

### With 3/16" Round Blades



All 1/8" and 3/16" dia. blade screwdrivers except 8" long type have finger on blade at handle. This will prevent blade from being driven thru handle when hit heavily with a hammer.

Stock Num.	Blade Length	Price Each	C13018 - Set of 4 Screwdrivers. YOUR PRICE <b>\$1.31</b>
C13013	2"	35c	
C13014	3"	35c	
C13015	4"	35c	
C13016	5"	35c	
C13017	6"	35c	

### With 1/4" Round Blades

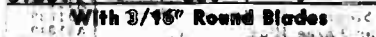

All 1/4" and 3/8" dia. blade screwdrivers except 8" long type have finger on blade at handle. This will prevent blade from being driven thru handle when hit heavily with a hammer.

Stock Num.	Blade Length	Price Each	C13024 - Set of 4 Screwdrivers. YOUR PRICE <b>\$1.49</b>
C13019	1 1/2"	35c	
C13020	2"	35c	
C13021	3"	35c	
C13022	4"	35c	
C13023	5"	35c	

### With 1/4" Square Blades

For Heavy Duty Use



Stock Num.	Blade Length	Price Each	C13026 - Set of 4 Screwdrivers. YOUR PRICE <b>\$1.50</b>
C13025	2"	34c	
C13026	3"	34c	

### Grip-Paint Screw Drivers



Holds screw firmly by engaging revolving ring in screw slot. Easily operated with one hand. Quickly sets screw in inaccessible places. Highest quality hardened tool steel blade. Transparent unbreakable handle as above screwdrivers.

Stock Num.	Takes Screws	Blade Length	Overall Length	Your Price
C13027	1/4"	4 1/2"	7 1/2"	69c
C13028	3/8"	4 1/2"	8"	74c
C13029	1/2"	4 1/2"	8 1/2"	82c

### "Phillips" Screw Drivers



For use with Phillips self-centering screws commonly recognized by the cross slots in the head. Special design prevents driver from slipping out of screw slot. Best quality forged, tempered alloy steel blade. Same transparent unbreakable handles as above screwdrivers.

Stock Num.	Takes Screws	Blade Length	Overall Length	Your Price
C13030	1/4"	4 1/2"	7 1/2"	69c
C13031	3/8"	4 1/2"	8"	74c
C13032	1/2"	4 1/2"	8 1/2"	82c

### 10% Discount

Order any 10 or more of the above Amberyl Screwdrivers or Nut-drivers and obtain an additional 10% from the single list price. These may be assorted or all of one kind.



# INCREASE Your Profits

## Premier Radio Blower

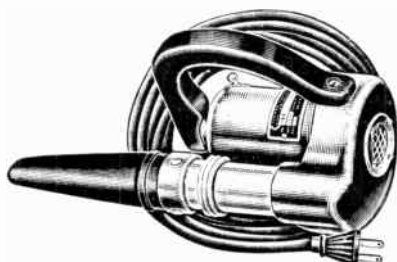

**NI1697**—Radio Blower. Operates on any 110 volt current. **\$8.25**  
YOUR PRICE .....

Quickly blows accumulated dust and dirt from the most inaccessible corners of the most intricate radio set. Flexible rubber nozzle eliminates possibility of damage to any of the chassis components. Eliminates static, cutouts, shorts, and all other radio disturbances caused by the destructive action of dust and dirt on radio parts. Made by one of the oldest and largest manufacturers of vacuum cleaners. Constructed of brightly finished cast aluminum. Hard rubber form fit handle. On-Off switch controls operation. 14 foot all-rubber cord fitted with rubber plug. Powerful ball bearing motor.

## "Tool Tap" Trouble Lamp Push-Thru Switch in Handle

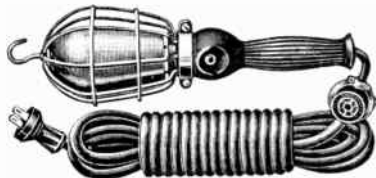

**NI1693**—Trouble Lamp complete with 25 ft. heavy rubber covered cable. **\$1.39**  
YOUR PRICE .....

**NI1694**—Trouble Lamp complete with 50 ft. heavy rubber covered cable. **\$1.91**  
YOUR PRICE .....

Consists of heavy rubber cable, molded rubber handle with Push-Thru switch, light socket body, reinforced type dual outlet, large rubber handle spring prong plug and a heavy duty spot welded wire guard with cadmium plated reflector. Completely assembled and wired, ready to use. Will take up to a 300 watt bulb. The "Tool Tap" is an unbreakable rubber double outlet connected in cable below the handle. Provides plug-in connections for electric tools or extra connections for any electrical apparatus. Sturdy hook for hanging. Ruggedly constructed. Cable connections reinforced at all points with metal discs which prevent cable from pulling out. No Bulb.

## Super Value Trouble Lamp With Switch and 25 Ft. Cord

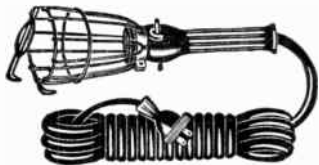

**CI1641**—YOUR PRICE ..... **85c**  
In Lots of 6 or More, Each, 79c

An indispensable cord set of good quality suitable for all portable light extension purposes. Consists of heavy rubber shock-proof construction; Spring prong rubber plug; All rubber handle-type light socket with push-thru switch and heavy rubber covered cord. Cadmium plated guard with hook for hanging. No bulb included.

## Miniature Flashlight



A very useful item. Compact bakelite construction. Size 1/2"x3".

**CI1659**—Complete with battery and Mazda bulb. YOUR PRICE..... **25c**

## Signal Electric Drills Model OB-8 and OB-4

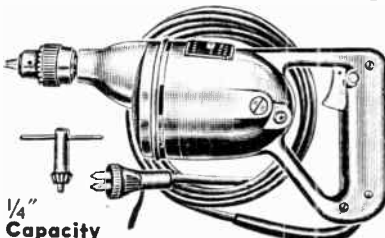

1/4" Capacity

A high quality electric drill. Durable cast aluminum alloy housing. Special neck permits drilling in close quarters. Bronze wood packed bearings with thrust ball bearing on spindle shaft. Around three jaw key type chuck. Gears are of special heat treated alloy. Brushes can be replaced by removing set screws at the sides. Trigger type switch in handle can be locked for continuous operation. Universal 110-120 volt, AC-DC motor. 8 ft. power cord has ground connection lead.

**CI1698**—Code OB8. 1/4" Drill Capacity. For light duty use. Speed, 2950 RPM. 12" Long overall. Net wt. 5 1/2 lbs. **\$12.67**  
Ship. wt. 7 1/2 lbs. YOUR PRICE .....

**CI1744**—Code OB4. 1/4" Drill Capacity. For standard duty use. Speed 1700 RPM. 12 3/4" Long overall. Net wt., 7 lbs. Ship. wt., 8 lbs. **\$16.81**  
YOUR PRICE .....

**CI1743**—Model OB-5. YOUR PRICE ..... **\$30.26**  
This quality drill is a 1/2" Capacity. Lots of power, proper speed, correct balance and right price. Same general specifications as above except takes up to 3/8" drill bits and has high grade ball bearings on armature and spindle. Speed 400 RPM at no load. Detachable pipe handle at top. Length overall 16". 15 ft. Power cord. Ship. wt., 16 lbs.

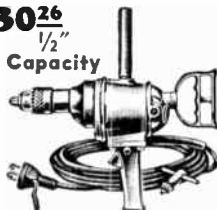

## New Electric Drill

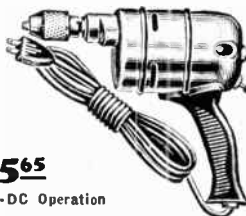

Takes Up to 1/4" Drills

**DI1699** YOUR PRICE **\$5.65**  
For 110 Volt AC-DC Operation

A sensational new value in electric drills. A fine high quality high speed electric drill at a price that you would expect to pay for a good hand-drill. Indispensable to servicemen and radio dealers for use in auto radio installation and general radio work. Very rugged, yet light and easy to handle. Ample ventilation permits motor to run cool. Handy on-and-off thumb controlled switch. A knurled collar permits easy removing and inserting of drill bits. Entire assembly constructed for durability and hard wear. Finished in aluminum and red. 6" Rubber covered cord.

## Adjustable Handy Lamp

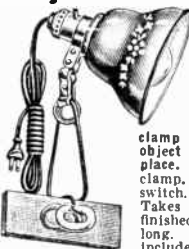

**AI1692**—YOUR PRICE **89c**

Handy for supplying light when servicing radios. Clamps on side of cabinet. Double ball swivel joint allows adjustment to any angle. Strong spring clamp securely fastens to any object and holds light firmly in place. Rubber covering on clamp. Push through type switch. Shade diameter 5 1/2". Takes any size bulb. Nickeled finished. All rubber cord 5 1/2' long. Bakelite plug. Bulb not included.

## Acro Chassis Cradle

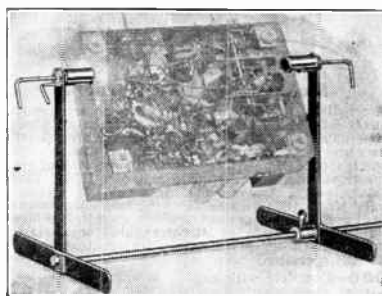

**NI1654**—Adjustable radio chassis holder. Complete with clamps. Holds any chassis up to 21" long. **\$3.25**  
YOUR PRICE .....

**CI1651**—Extra Set Clamps, Pair..... **\$1.95**  
Holds any make or size radio, P. A. Amplifier, or power supply chassis in any desired position. Prevents damage to radio components and tubes mounted on the chassis. No more broken dials, smashed tubes or damaged coils—just place chassis in rack and tilt to working position, upside down if you wish. Special mechanical clamps hold chassis in vise like grip—no danger of chassis slipping or falling. Entire assembly sturdily constructed of cold rolled heavy steel.

## Radio Chassis Guards

**CI1649**—YOUR PRICE ..... **\$1.23**  
Per Pair.....

New type low cost, practical chassis guard cradle that conveniently supports radio chassis and protects dial, tubes, coils, etc. against damage when chassis is inverted or carried around. Easily and quickly applied. Adjustable to fit any chassis.

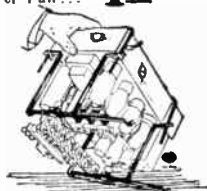

## Radio Chassis Jacks

**DI1650**—YOUR PRICE Per Pair... **73c**

These New All-Metal Chassis Jacks provide a strong yet flexible means of supporting a radio chassis on your work bench. They are quickly adjustable to any chassis regardless of size or shape. They require little space on the bench when not in use. Two pairs of these jacks in any service shop will more than pay for themselves in time saved.

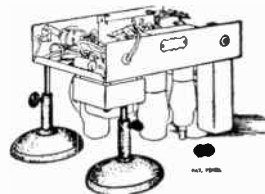

## Bench Stools With Back Rest

**CI1665**—26" High, Metal Seat, Your Price, Each..... **\$3.15**  
With Wood Seat

**CI1666**—24" High, Each **\$4.50**  
**CI1667**—28" High,  
**CI1668**—28" High.

These stools enable the radio serviceman to "take the load off his feet" while working. Welded construction. Stool will never become wobbly as rivet types inevitably do. Properly reinforced to stand rough handling. Back rest, adjustable in height, can be easily removed and re-installed. Heavy spring bar and hinged back rest provide proper tension for correct body posture. 14" Dia. seat. Bottom of legs well formed to prevent marring floor. Finished in durable olive green enamel.

## Stools without Back Rest

With Metal Seat With Wood Seat

**CI1660**—26" High **CI1662**—24" High  
**CI1670**—28" High **CI1663**—28" High  
**CI1671**—30" High **CI1664**—28" High  
Each **\$1.95** Each **\$2.57**

Note: All above stools can be supplied with rubber feet on special order at 40c extra.



# SOCKET WRENCHES-SCREW DRIVERS

Handy Shop Accessories

## Probe Flashlight

With New Unbreakable Lucite Rod



### Makes Light Turn Corners

A practical, low cost flashlight for radio servicemen, electricians, mechanics and technicians of all kinds. New unbreakable lucite rod takes light around corners and fully illuminates those hitherto inaccessible tough-spots. Saves time and effort in making inspections, diagnosing trouble and identifying parts values, serial numbers, etc. Invaluable for reading numbers on tube sockets, checking bad solder joints, bad switch contacts and tracing circuits. Flashlight case is made of "Unbreakable" onyx plastic material. On-off switch allows intermittent or permanent operation.

D96—Complete with batteries and Mazda Bulb.  
YOUR PRICE.....**59c**  
D60—Extra batteries for above.  
YOUR PRICE, Per Set of 2.....**8c**

## Handiprobe

Speedy Trouble Shooter

K11594—List Price, \$4.00.  
YOUR PRICE...**\$2.25**

A fountain pen size analyzer for quick diagnosis of radio and other electrical troubles. Tests open and shorted condensers while in operation. Tests up to 2000 volts and distinguishes between A.C. and D.C. Tests for static, alignment, output, open and shorted transformers, dielectric efficiency, low volume, oscillation, distortion, fading, etc. Number of tests limited only to ingenuity of user. Overall size is only 9"x3/4". Made of best quality fiber tubing. Comes equipped with 20" flexible lead and insulated alligator clip. 1/4 watt Neon bulb, and complete instructions on how to make all tests.



## Magic Electric Pencil

Engraves and Embosses

An electrically heated scriber about the size of a fountain pen. Embosses in beautiful colors—copper, gold, silver, green, blue, purple, on any material. Reproductions can be made of drawings, designs, initials, emblems, etc. Very useful for marking test panels, tools, books, advertising materials, tube bases, etc. Enough embossing paper supplied to emboss hundreds of words. Works on 100-120 volt A.C. or D.C. Heats quickly. Maintains even temperature. 8 feet cord.

R5775—List, \$2.00.  
YOUR PRICE.....**78c**



### Extra Foil for Electric Pencil

C5776—Gold C5778—Red C5780—Blue  
C5777—Silver C5779—Green C5781—Purple  
Each contains 8-6x12 inch sheets.  
YOUR PRICE, EACH.....**59c**

## Socket Wrench and Driver Set



N11632—List Price, 75c.  
YOUR PRICE.....**36c**

A set of seven detachable sockets, together with handle. Fine quality steel. Sizes: 1/4", 3/8", 1/2", 5/8", 3/4", 1" and 1 1/4" for turning knurled nuts and a screw driver attachment that handles all sizes of radio screws. Cadmium plated. Wood handle.

## Adjustable Socket Wrench

C12074  
YOUR PRICE  
**98c**



A very practical and useful socket wrench. Has double adjustable end sockets to fit hexagonal, square, round and odd shape nuts from 1/8" up to 1 1/2". Turning of handle provides adjustment. Drop forge construction of chrome nickel steel. Supplied with 3/8" square, 2 1/4" long tempered screw-driver bit and with transparent unbreakable mallet head for converting wrench into a useful mallet. Fully guaranteed.

## Genuine Spintite

### Hollow Stem Socket Wrenches

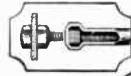

For Small Hexagon Nuts

Extra fine quality Spintite wrenches. Built to please the most exacting craftsman. Wood handle fits the hand. Stem is hollow to permit use on long projecting screws. Hardened tool steel.

Stock Number	Socket Size	Price Each	K11608 Complete set Seven Wrenches
K11601	1/8"	36c	<b>Your Price \$2.68</b>
K11602	3/16"	36c	
K11603	1/4"	36c	
K11604	5/16"	36c	
K11605	3/8"	36c	
K11606	1/2"	48c	
K11607	5/8"	48c	

### Hollow Stem Hex-Nut Wrenches

High quality tools. Have deep hollow in socket to take any ordinary projection of screw above nut. Fine tool steel shanks. Sockets of specially hardened tool steel. Shank and socket cadmium plated. Finely finished wood handles.



6" Long Stock Number	For Hex. Nuts	9" Long Stock Number
A11610	1/8"	A11617
A11611	3/16"	A11618
A11612	1/4"	A11619
A11613	5/16"	A11620
A11614	3/8"	A11621
A11615	1/2"	A11622

YOUR PRICE, Each...**11c** Six for 60c  
YOUR PRICE, Each...**12c** Six for 65c



### With 90° Offset Shanks, 7" Overall

Easily and quickly handle nuts in positions not accessible with straight shank wrenches.

Stock Num.	For Hex. Nuts	YOUR PRICE EACH
K11624	1/8" In.	<b>12c</b>
K11625	3/16" In.	
K11626	1/4" In.	
K11627	5/16" In.	
K11628	3/8" In.	
K11629	1/2" In.	

K11630 Complete Set of six wrenches  
YOUR PRICE.....**65c**



### Hollow Handle Radio Wrench Set



N11633—YOUR PRICE.....**47c**

The handiest tool in the serviceman's kit. Hollow handle holds screwdriver socket and 5 wrench sockets: size 1/4", 3/8", 1/2", 5/8" and 1". Handle and shank are 7/8" inches long. Handle is heavily knurled. Finished in white nickel.

### Socket Wrench Set

A11758—YOUR PRICE.....**73c**

Contains 8 3/4" combination screw driver and socket handle, 3 3/4" extension, 4" extension and one each 1/4", 3/8", 1/2", 5/8", and 1" square sockets. Also one socket for knurled nuts. Packed in steel box.

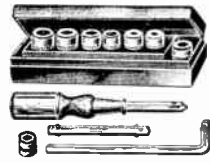

A11734—Similar to above but contains: Flexible Shaft socket wrench holder (also used as screw driver), 5" extension, 3" straight extension and 8 sockets (3/8" to 1 1/2" inc.). List Price, \$3.00.  
YOUR PRICE.....**\$1.76**

### Unbreakable Midget Screw Driver

10 for.....**81c**  
A11749—List, 15c. YOUR PRICE, EACH...**9c**

Particularly shaped to fit small screws. Unbreakable amber colored transparent handle 5/8" dia. Specially hardened blade 2 1/4" long, 1/8" dia. Overall length, 4 1/4". Includes pocket clip.

## 3/32" Blade Knob Screw Drivers

With Transparent High Insulation Handles



Especially designed to fit knob screws, adjustment screws of iron core coils, etc. Will fit the smallest screw used in radio work. Transparent unbreakable shock-proof handle will not loosen. 3/8" Diameter blades of hardened tool steel. Blade tip is no wider than the blade. Supplied with handy pocket clip.

C12086—With 2" Blade } Each  
C12087—With 3" Blade } **18c**  
C12088—With 4" Blade } Set of 3 **49c**

### 1/4" Blade Screw Driver Set

C11642—Same quality and design as above but with 1/4" diameter blades.  
YOUR PRICE, Set of Three.....**32c**

## Maple Handle Screw Drivers

Extra High Quality



K11645—Set of 4  
YOUR PRICE **75c**

Substantially made to stand the gaff yet low in price. Handles are of white hardwood in natural varnish finish, fluted for sure grip. Blades of hardened and polished tool steel. Will not turn in handles. Extra heavy steel ferrules. Four drivers with 6, 5, 4, and 3 inch blades. Fits practically every screw used in radio work.

A11635—Screwdrivers similar to above except not as high in quality. Per set of Four.....**54c**



### Hold-E-Zee Screw Drivers

Holds Any Size Screw

Insulated Unbreakable Handle  
Quickly places any type screw in spots not accessible with ordinary screw driver. Screw gripper holds screw firmly while screw is being placed and instantly releases it when desired. Gripper slips along blade to upper end when not in use. Strong insulated unbreakable handle. Hexagonal tool steel blade 3/8" diameter.

C11646—3" Blade, Each.....**33c**  
C11647—4" Blade, Each.....**43c**  
C11648—10" Blade, Each.....**46c**

## Super Grip Screw Drivers

Insulated Handles—Insulated Blades



The finest made and at bargain prices! Tight grip, moulded, polished black composition handles. Offer perfect insulation. Radio sizes have slender hardened steel blades, diameter 3/8" inch. Reach the difficult spots. Blades can never get loose or turn in handle. Blade 3/8" dia.

Stock Blade Price  
Number Length Each  
K11637 3" 12c  
K11638 4" 13c  
K11639 5" 14c  
K11640 6" 18c

R11636—Set of 4  
One of each size.  
YOUR PRICE  
**62c**

## Special Socket Wrench Set



K11631—Handle and five sockets.  
YOUR PRICE.....**59c**

A specially selected socket wrench set for radio work. Fine quality steel sockets. Sizes: 1/4", 3/8", 1/2" and 5/8" inch for hexagonal nuts. Follow stems take screws projecting not over 1/4" inch.



# TOOLS EVERY RADIO-MAN NEEDS

## 11 Pc. Tap and Die Set

*In Handy Wood Case*



**C11817—YOUR PRICE \$1.59**

The most practical tap and die set for radio servicemen. Supplied with three drills, three taps and three dies for cutting either male or female 8/32, 6/32, and 4/32 threads. Also includes "T" wrench for holding taps and wing wrench for holding dies. Fine quality. Packed in handy hinged wood box. Box size 1 1/2 x 3 x 1 1/4". Made in U.S.A.

### Tap Wrench with Drills and Taps



**K11684—Per Set \$1.15**

Three taps and three drills, one each for 1/8, 1/16 and 1/32 screws. Wrench to hold taps and drills.

### Diagonal Jaw Nippers



**K11661—Your Price \$32¢**

For fine electrical and radio work. Made of hardened tool steel. Cuts wire clean in tight places. Size 5 1/2 inches.

### Long Nose Pliers



**K11662—Your Price \$38¢**

5 1/2" Long. The handiest pliers for radio work. A fine quality tool made of fine hardened tool steel.

### Special Thin Nose Pliers



**K11664—YOUR PRICE \$37¢**

Handy radio pliers with long thin jaws for reaching into narrow places. Stub nose will hold nuts firmly. Overall length 6 1/2". Drop forged steel.

### Mayhew Center Punch Set



Tool steel hammer forged center punch set. Set consists of 3 punches: 4" long, 3" long, 2 1/2" long.

**R11665—Set of three. YOUR PRICE \$29¢**

### Keyhole Hack Saw



Cuts steel, bakelite, wood, etc. quickly and cleanly. Strong tight grip frame. 7 1/2 inch long saw blade. Gets into hard corners. Reaches many places ordinary hacksaw cannot touch. Blade very durable; almost unbreakable. Blade easily replaced. Very fine teeth, 18 per in.

**K11667—Frame with one blade. \$26¢**  
**K11668—Extra blades. Six for \$79¢**

### Pistol Grip Hack Saw



**R11669—List, \$1.00. YOUR PRICE \$42¢**

American made. Finest quality. A real bargain. Strong, adjustable to take 8, 10 or 12 inch blades. Moulded handle. One 8" blade included.

### Hack Saw Blades



**Best American Made**

24 Teeth per inch. Best for radio use.

**C11670—8-in. Dozen. Your Price \$29¢**  
**C11671—10-in. Dozen. Your Price \$35¢**  
**C11672—12-in. Dozen. Your Price \$42¢**

## Circle Cutters

*Adjustable from 1" to 4"*

**K11673—YOUR PRICE \$1.88**

For cutting socket holes, meter holes, etc., in wood, bakelite, hard rubber, linoleum, brass, tin, sheet metal, etc. Does first class job and makes clean cut. Drills and pilot hole, cuts out material and puts bead or scroll around hole all in one operation. Made of best materials. Best high speed steel cutting bits for use in breast drill, hand brace or drill press.

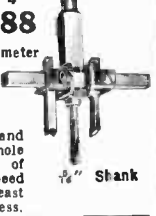

1/2" Shank

**K11674—Same as above but without beading Cutter. YOUR PRICE \$1.10**

### Heavy Duty



For cutting the heaviest of materials. Will cut 1/2" cold rolled steel, 3/8" aluminum. Dashboards of cars, etc. Adjustable from 1" to 3 1/2".

**K11675—Square Shank. Your Price \$1.88**

**K11676—1/2" Round Shank. YOUR PRICE \$1.88**

**K11677—Extra cutter for either of above. YOUR PRICE \$24¢**

### New All-Purpose Circle Cutter



**Cuts Holes From 1/4" to 8 Inches**

**K11679—List, \$4.00. Your Price \$2.35**

A new heavy duty, all-purpose circle cutter. All parts are hardened steel, insuring long life and ability to do the toughest jobs. Hexagon shaft fits brace or electric drill. 1 inch diameter cutting bar holder is fitted with removable centering drill. Any size pilot pin may be used in centering drill's place. 3/8" square cutting bar holds 1/2" high speed cutting bit. A quality, sturdy tool for machine shop, laboratory or serviceman's bench.

### Replacement Parts

**A11666—Cutter for above. Your Price .29¢**  
**A11680—Drill for above. Your Price .21¢**

### HIGHEST QUALITY Alloy Steel Twist Drills

*American Made*



Made of alloy steel consisting in part of tungsten which makes these drills far superior to ordinary carbon drills. Straight shanks. Particularly intended for electric drills. Perfectly pointed, precision ground. Extra strong web prevents splitting of drill. Correctly tempered to insure long life. Quality considered, our prices represent extra-ordinary values.

**K11681—Seven drills in Hardwood Box. Sizes 1/8, 1/16, 1/8, 3/16, 1/4 and 5/16 inch. YOUR PRICE \$89¢**

**K11682—Eight drills in Hardwood Box. Sizes 1/16, 1/8, 3/16, 1/4, 5/16 and 3/8 inch. YOUR PRICE \$2.45**

**K11683—Eleven drills in Fibre Roll. Sizes 1/16, 1/8, 3/16, 1/4, 5/16, 3/8, 7/16, 1/2 and 5/8 inch. YOUR PRICE \$1.35**

### Tapered Reamer



Enlarges holes in wood, bakelite, or metal. Cutting edge 3/8" long and tapered from 1/8" to 1/2". High grade steel. Properly ground edge provides quick, easy reaming.

**C11999—YOUR PRICE \$69¢**

## Radio Servicemen's Tool Box

All are of heavy gauge cold rolled steel, baked-on enamel green finish, Nickel plated catches and lock with one key. Panelled sides, ends, top and bottom for rigidity and strength.

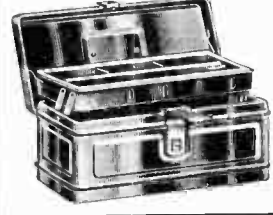

**K15870—YOUR PRICE \$69¢**

Handy size for servicemen. Very strong and light. 12 3/4" long, 5 1/2" deep, 6" wide. Safety lock and cantilever tray with adjustable partitions.

### Cantilever Tray Tool Box

*Tray Raises as Lid is Opened*



**C15872—Size 6x8 1/2 x 18". YOUR PRICE \$1.25**

**C15871—Size 6x6 1/2 x 14". YOUR PRICE \$98¢**

Tray is so fastened that as cover is raised tray is automatically lifted, permitting easy access to bottom compartment. Box has gold rule of full size scale on cover.

### Portable Model Servicemen's Vises



**N11685—YOUR PRICE \$79¢**

Sturdily built, accurately fitted. Machine cut steel screw. Polished jaws 1 1/2" wide. Red japan body. Convenient to carry in tool box. Slng. wt., 2 lbs.

### Journeyman's Swivel Bench Model



**K11686—YOUR PRICE \$2.68**

Replaceable hardened steel jaw faces, knurled surfaces. Cold rolled steel bar, screw and handle. Pipe jaws hold pipe 3/8 to 1 1/4". Jaws open 3 1/2" width 3". Swivel base with improved lock, holds fast at any angle. Rugged anvil. The finest vise on the market for Radio and electrical work.

### Handy Pocket Tool Case

*Saves the Pocket and the Tools*



**K5711—Pocket tool case only. List Price, \$1.00. YOUR PRICE \$59¢**

Made of high grade, genuine leather. Double sewed for strength. Has snap fastener on flap. May be carried in hip pocket or fastened to belt. Two partitions large enough to hold all necessary tools for ordinary service call. Saves your pockets from wear and tear. No tools included.

### Radio Wrench Set

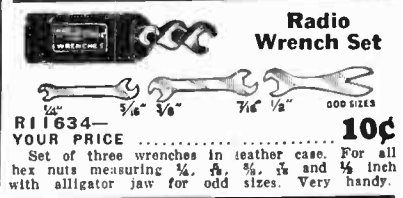

**R11634—YOUR PRICE \$10¢**

Set of three wrenches in leather case. For all hex nuts measuring 1/4, 3/8, 1/2 and 5/8 inch with alligator jaw for odd sizes. Very handy.

# NEUTRALIZING AND ALIGNMENT TOOLS

## 4 in 1 Aligning Tool Genuine Bakelite

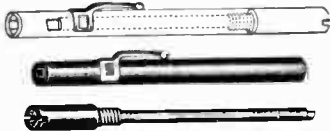

**A11577**—Handy 4 in 1 alignment tool. Has  $\frac{1}{4}$ " and  $\frac{3}{8}$ " hex socket, key slot and  $\frac{1}{4}$ " dia. screw driver section with securely attached metal nib. Sections fit into each other to form one convenient tool. Made of bakelite. Length overall, 6". Handy pocket clip.  
**YOUR PRICE**..... **28¢**

## 4 in 1 Aligning Tool With Metal Socket Ends

**C11581**—Heavy Duty 4 in 1 Tool similar to above but has  $\frac{1}{4}$ " and  $\frac{3}{8}$ " metal socket ends. Recommended for shop use where considerable alignment is done. Screw driver is  $\frac{3}{8}$ " dia. 5" Long overall. With pocket clip.  
**YOUR PRICE**..... **59¢**

## Alignment Tools



**A11596**—Push Button Tuner Adjusting Tool. Insulated handle  $\frac{3}{8}$ " dia., 1 $\frac{1}{2}$ " long. Shank  $\frac{1}{2}$ " long.  $\frac{3}{16}$ " dia. socket has recessed screw-driver nib. Fits adjustment screws of variable from cores used in push button tuners and I.F. & R.F. coils.  
**YOUR PRICE**..... **29¢**



**C11588**—6" Fibre Tube with full length  $\frac{1}{4}$ " hex. hole. Ends can be cut when worn.  
**YOUR PRICE**..... **12¢**

**A11589**—3" Long. Price..... **15¢**



**A11590**—Adjustable No Metal Screw Driver and  $\frac{1}{4}$ " Socket Wrench. Made of strong insulating material. Adjustable from 6" to 11".  
**YOUR PRICE**..... **34¢**

**C11591**—Adj. from 10" to 18". Price..... **49¢**

**A11592**—7" Screw Driver Section Only. Beveled at both ends. Price..... **19¢**



**D11579**—U.H.F. Alignment Tool. Molded of pure polystyrene material having no body capacity effect on critical high frequency circuits. Ideal for R.F., P.M., Television and Short-Wave alignment. With pocket clip.  
**YOUR PRICE**..... **24¢**



**A11574**—Metal  $\frac{1}{4}$ " Hex. Socket Wrench and Screw Driver nib are securely fastened on 5" long insulated shaft. Fits into  $\frac{1}{4}$ " hole.  
**YOUR PRICE**..... **28¢**



**A11597**—For RCA & Philco.  $8\frac{1}{2}$ " x  $\frac{3}{8}$ " dia. Insulated rod has  $\frac{3}{8}$ " hex. socket at one end and specially shaped hook at other.  
**YOUR PRICE**..... **73¢**



**A11580**— $\frac{3}{8}$ " Alligator Wrench and Screw Driver nib are securely fastened on  $\frac{1}{4}$ " insulated shaft.  $4\frac{1}{2}$ " long.  
**YOUR PRICE**..... **21¢**

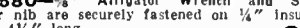

**A11586**—Tuning Wand.  $6\frac{1}{2}$ " insulated bakelite rod with brass cylinder at one end (inserting end in coil lowers inductance) and iron core at other end (to increase inductance). Indicates proper coil adjustment without affecting trimmer condenser setting.  
**YOUR PRICE**..... **49¢**



**D11558**— $\frac{3}{8}$ "x6" Long fibre alignment screwdriver with metal nib on one end and metal hook on other. For air trimmer condensers.  
**YOUR PRICE**..... **24¢**

## Neutralizing and Aligning Tool Kit



**K11559**—With Leatherette Case. **\$2.94**  
List Price, \$5.00.

**YOUR PRICE**.....  
Every serviceman needs these balancing instruments. This complete outfit provides every tool that you will ever need to neutralize, balance or re-align the variable condenser or IF sections of any receiver. Twelve tools, ingeniously designed to telescope into each other, become only four pieces when assembled into the attractive black leatherette carrying case. Also includes flexible shaft screw driver and tuning wand. Bodies are extra strong, made of fine high dielectric hard rubber, fiber and bakelite. Fittings are polished nicked brass.

Same as above but without flexible screw driver and tuning wand, making twelve distinct tools which telescope into four pieces.

**K11560**—Complete with leatherette case. List Price, \$4.00.  
**YOUR PRICE**..... **\$2.30**

## Five-in-One Neutralizer Compensator and "Tool Kit"



**N11582**—**59¢**  
**YOUR PRICE**.....

Combines in a fountain pen size compact tool that can be carried in your vest pocket,  $\frac{1}{4}$ " and  $\frac{3}{8}$ " nut wrenches, miniature blade screw driver for neutralizing and a full size insulated handle general purpose screw driver. Made of fine quality extra strength fiber. Fountain pen clip prevents losing from pocket. When closed, no sharp points are exposed to wear clothing.

## Fused Test Leads

Heavy duty laboratory type test leads. Long phono needle type prods have provisions for inserting any 3AG or 8FE fuse. Can be used without fuses. 50" kinkless rubber covered wire leads. Insulated banana type plugs on other end with interchangeable fittings. Coded red and black. Fuse included.  
**D11578**—**\$1.47**  
PRICE, Per Pair.....

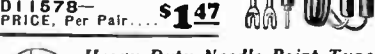

**Heavy Duty Needle Point Type**  
**D11142**—With Spade Ends.  
**D11587**—With Alligator Clips.  
Per Pair, Each..... **53¢**

**D11598**—With Insulated Phone Tip Ends.  
Per Pair..... **65¢**  
6" Long slim handle heavy duty prods with removable phono needle chuck. 50" Long kinkless rubber covered wire leads. Coded red and black.

## High Voltage Test Leads

**D11543**—**\$1.47**  
**YOUR PRICE**, Per Pair.....  
Heavy duty laboratory type test leads constructed for safely testing voltages up to 10,000 volts. Recommended for television and transmitter testing. Consists of 10" long heavily insulated bakelite prods with finger grip guards, 50" long, 18 gauge, 67x36 stranded flexible wire leads with heavy rubber covering measuring  $\frac{3}{8}$ " in diameter and 2" long insulated plugs on other end. Prods and plugs have replaceable threaded phone tips. Prods and leads coded red and black.

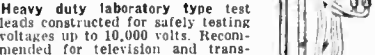

## Testing Leads

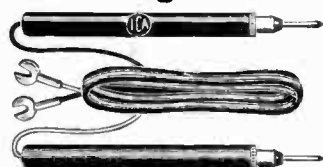

**For Heavy-Duty Laboratory Use**

**C11548**—Spade Ends.  
**YOUR PRICE PER PAIR**..... **42¢**

**D11542**—With insulated solderless phone tip plugs.  
**YOUR PRICE**, Per Pair..... **59¢**

Polished, lustrous high dielectric handles  $5\frac{1}{2}$ " long (over-all)  $\frac{3}{8}$ " diameter. One red, one black for polarity indicating. 50" long flexible heavy duty leads in colors to match prods. Point screws into prod handle. All connections are soldered, providing low resistance connections.

## With Phone Tip Prods



Polished lustrous high dielectric handles, 3" long (overall)  $\frac{3}{8}$ " diameter. One red, one black for polarity indicating. 50" long flexible cables.

## With Finger Grip Molded Tips

5" pencil type prods made of high dielectric insulation material. Sharp pointed threaded tips screw into handles. 60" long kinkless wire leads. Phone tips molded into dielectric finger grips. All connections soldered. Finger grips and prods are one each red and one each black.

**D11547**—**71¢**  
**YOUR PRICE**, Per Pair.....

## With Renewable Phono Needle Prods

**K11552**—Spade Ends.  
**K11553**—Tip Ends.  
**YOUR PRICE**..... **27¢**  
Per Pair.....

**K11554**—Alligator Spring Clip Ends.  
**YOUR PRICE**..... **34¢**  
Per Pair.....

Polished lustrous high dielectric handles,  $4\frac{1}{2}$ " long (overall)  $\frac{3}{8}$ " diam. One red, one black. 50" Long leads. Needles easily changed.

## With Unbreakable Test Prods

**C11512**—**42¢**  
**YOUR PRICE**, Per Pair.....  
Prods are made of  $6\frac{1}{2}$ " long,  $\frac{3}{8}$ " dia. solid brass with needle point tips and Red and Black shock-proof live rubber sleeves. 50" kinkless, flexible rubber wire with insulated solderless plug ends.

## Slender Prod Test Leads With Interchangeable Tip Ends

New long overall,  $8\frac{1}{2}$ " dia. test prods. Extra strong, high insulation fibre handles. Spring prod ends provide a quick positive means of changing from one type of tip to another. Included are one pair each; alligator spring clips; tapered spade lugs and the new needle point phone tips for piercing insulation. Prods also fit all standard phone tip jacks. Complete with one black and one red 5 foot flexible wire.  
**D11546**—**73¢**  
Per Set.....



## With Non-Interchangeable Ends

**C11555**—With Spade Ends.  
**C11556**—With Phone Tip Ends..... **45¢**  
Per Pair.....

**C11567**—With Alligator Clips.  
Per Pair..... **49¢**

7" Long,  $\frac{3}{8}$ " dia. prods with sharp phone type tips, 5 ft. flexible wire leads. Above end fittings permanently attached to leads.

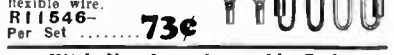

**C11555**—With Spade Ends.  
**C11556**—With Phone Tip Ends..... **45¢**  
Per Pair.....

**C11567**—With Alligator Clips.  
Per Pair..... **49¢**

7" Long,  $\frac{3}{8}$ " dia. prods with sharp phone type tips, 5 ft. flexible wire leads. Above end fittings permanently attached to leads.

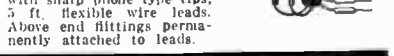



# TEST LEADS • PRODS • JACKS • PLUGS

## Neon Tattelite Tester

  
**With Non-Breakable Neon Lamp**  
 A11186—List, \$1.00.  
**YOUR PRICE 59¢**  
 Convenient testing light for locating electrical voltages, defective fuses, resistors, condensers, etc. Shows whether current is AC or DC (AC causes both electrodes to glow, on DC only negative glows). Glows at only .0005 ampere current. Operates on 90 to 550 volts. 5" Insulated leads fitted with pin tips.

**Short Tester**  
 A11179—Complete with battery and bulb.  
**YOUR PRICE 88¢**  
 Handy test prod with built-in battery and bulb. Indicates whether circuits are opened or closed.

**Probe Light**  
  
 C11754—YOUR PRICE 88¢  
 An indispensable fountain pen size probe light. Provides plenty of light where and when you want it. Bulb is completely protected. Supplied with 6 foot cord and plug. For 105-120 volt, AC-DC operation.

**Snap Type Insulated Test Handle**  
 K11452—Black Color.  
 K11453—Red Color.  
**YOUR PRICE EACH 38¢**  
  
 A new "deep sea" electric test clip that eliminates danger of short circuits. A 6" long insulated fibre tube is fitted with spring contact jaws operated by a push of the thumb. Test wire connected under insulated binding post. Will pick up screws, etc., dropped into inaccessible places.

**Alligator Test Clips**  
  
 New type. Long thin jaws. Strong spring will grasp the smallest terminal lug or lead with a tight, sure, positive contact. Barrel end will fit Banana Type Spring Contact Plug-in prongs or can be securely soldered to test cable.  
 K11457—Small size. 2" long. 1/4" wide.  
**YOUR PRICE, EACH 4¢**  
 Ten for.....30c

C11500—Small size as above but with screw for solderless lead connection.  
 K11458—Large size. 2 3/4" long. 3/8" wide.  
**YOUR PRICE, Either Type, EACH 5¢**  
 Ten for 45c

**Insulated Alligator Clips**  
  
 Fits Banana Plugs  
 High di-electric insulated 3/4" handle is forced over barrel end of clip. 3/8" wide. Fits banana plugs or can be soldered to leads. 2 1/4" Long overall.  
 C11459—Red } PRICE 8¢ Ten for 70c  
 C11460—Black } EACH

**Wee Pee Wee Test Clip**  
  
 Smallest alligator clip. Made of spring temper phosphor bronze. Will not heat up in RF circuits.  
 A11442—YOUR PRICE, Each Ten for 60c **9¢**

**Alligator Tip Clip**  
  
 Combines the utility of an alligator test clip with standard phone tip. Clips onto bare wires or plugs into binding post or tip jack.  
 C11400—YOUR PRICE, Each. Ten for 88c **12c**

See page 89 for rubber insulators and complete listing of other clips.

**Long Test Prod Handle**  
 With Sharp Point Phone Tip End  
  
 Hollow high di-electric insulated handle. 5 1/2" long overall. 3/8" diameter. Sharp point phone tip terminal. Fits standard phone tip jack. No soldering necessary.  
 C11485—Red } PRICE Ten for \$1.35  
 C11486—Black } EACH... 14¢

**With Needle Point Tips**  
 Has removable needle type chuck with high di-electric insulated handle. 7" Long overall.  
 D11461—Red } PRICE Ten for \$1.70  
 D11462—Black } EACH... 18¢

**ICA 7" Test Prod Handles**  
  
 Long narrow test prods. Made of sturdy Fenolite material. Brass nickel plated fittings, screw into handle. 7" Long overall. 3/8" Diameter. EACH  
 C11502—Red } Solderless  
 C11503—Black } Phone Tip Ends **18c**  
 C11454—Red } Phone  
 C11455—Black } Needle Ends Ten for \$1.70

**High Voltage Test Prods**  
  
 Heavy duty bakelite prod handle with finger guard for safely testing high voltages. Removable threaded phone tip. 6" Long overall.  
 D11473—Black. Type A. **50¢**  
**YOUR PRICE, Each.**

**High Voltage Test Plug**  
 Heavy duty bakelite plug handle with removable threaded phone tip. 2" Long overall. Type B. **18¢**  
**YOUR PRICE, Each.**  
**Insulated Midget Phone Tip Plug**  
 Bakelite handle with removable threaded phone tip. 1 1/4" Long overall. Type B. **6c** Ten for 55c  
 D11475—Red } PRICE  
 D11476—Black } EACH

**Replacement Threaded Phone Tip**  
 D11479—Brass nickel plated threaded tip to fit prods having removable threaded phone tips.  
**YOUR PRICE. 4c** Ten for 38c

**Short Test-Prod Handle**  
 With Phone Tip End  
  
 No soldering necessary. Hollow high di-electric insulated handle. 2" long overall. 3/8" diameter. Solderless.  
 C11471—Red } PRICE **6¢**  
 C11472—Black } EACH  
 Ten for 49c 100 for \$4.50

**Solderless Tip Plug**  
 K11812—YOUR PRICE, Each... **4¢**  
 Ten for 29c. Per hundred, \$2.80  
 No soldering necessary. Positive connection. Brass nickel finish. 1 1/8" Long overall. 3/8" Tip.

**Midget Solderless Plug**  
 Brass nickel plated. 1 1/4" Long overall. 3/8" Tip.  
 D11480—YOUR PRICE, Each **3¢**  
 10 for 25c. Per 100 \$2.35

**Solder Cord Tips Brass Nickel Plated**  
 A11811—FIFTY FOR **29¢**  
 Per hundred... 45c

**Heavy Duty Cord Tip**  
  
 Brass nickel plated. 1 1/2" Long.  
 C11751—YOUR PRICE, Each Ten for 29c **6¢**  
 Two for.....

**Grip-Rite Molded Phone Tip Plug**  
  
 Standard phone tip fits any tip jack. Neat and compact in appearance. More convenient to use than old type tips. Made of Fenolite insulation.  
 C11507—Red  
 C11508—Black  
**YOUR PRICE, Each Ten for \$1.10 12¢**

**Heavy Duty Plugs and Jacks**  
  
 Improved heavy duty type for transmitters, diathermy apparatus, etc. Will handle heavy RF currents. Heavy insulated bakelite handles and threaded leads.  
 Plugs: 1/2 x 3/8" Contact. 1/2 x 2" Handle. 3/8 x 3/8" Each  
 D11485—Black } **15c**  
 D11486—Red & Black }  
 Jacks: Size 3/4 x 2". Fits panels up to 3/8" thick. Each  
 D11487—Black } **32c**  
 D11488—Red & Black }

**Standard Tip Jacks**  
  
 Solid brass, nickel plated. Takes any phone tip. Positive connection. Requires 3/16" hole on panels up to 3/8" thick. With nut and solder lug.  
 A11810—**3¢**  
**EACH**  
 12 for 29c. Per Hundred \$2.40

**Insulated Top Jacks**  
 For Standard Phone Tips  
  
 Insulated top. Hold phone tips straight and tight. Fits 3/16" holes in panels up to 3/8" thick. Fiber shoulder washer and nut included.  
 C11477—Red } PRICE Ten for 48c  
 C11478—Black } EACH... 6¢  
**With Bakelite Tops**  
 C11752—Red } PRICE Ten for 65c  
 C11753—Black } EACH... 7¢

**Hexagon Insulated Top Jacks**  
  
 Quality tip jacks with positive contact phosphor bronze spring. Fits standard solder cord tips listed above. Mounts in 3/4" hole in panels up to 3/8" thick. \*Includes insulating washers.  
 A11211—Red\* } A11213—Brown  
 A11212—Black\* } A11214—Orange  
 A11210—Green\* } A11215—Yellow  
**PRICE, Each... 9¢** A11216—Blue **7c**  
 2 for 15c **PRICE, Each...**

**Insulated Banana Jacks**  
  
 Insulated top banana jack. Provides a secure low resistance connection. Fits 1/4" holes in panels up to 3/8" thick. Shoulder washer included for metal panels. Solder lug terminal also included.  
 C11525—Red } PRICE Ten for 47c  
 C11526—Black } EACH... 6¢  
**With Bakelite Top**  
 C11148—Red } PRICE Ten for 65c  
 C11149—Black } EACH... 7¢

**Metal Jack**  
  
**For Banana Type Prongs**  
 Made of brass nickel plated. Hold prongs securely. Provide sure contact. Fits 1/4" hole. Shank 3/8" long. Lock nut and solder lug included. **29¢**  
 K11545—Ten for

**Threaded Banana Plugs**  
  
 C11544—YOUR PRICE, Each... **4¢**  
 Ten for 29c  
 Fits jacks listed below. Provides secure contact. Threaded shank and nuts for mounting on coils, terminal strips, etc. 1 1/8" Long overall.

**Insulated Banana Plugs**  
  
**Split Contact Prongs**  
 High di-electric insulated hollow handle 3/8" long. Solderless screw connection for test lead.  
 C11519—Red } PRICE Ten for 48c  
 C11520—Black } EACH... 6¢

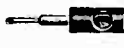
**Banana Plug End Fittings**  
  
 Insulated handles color coded. Fit above and all other standard banana plugs. Can also be soldered on wire leads.  
**Tip End Spade End**  
 C11143—Red —C11145  
 C11144—Black —C11146  
 Ten for 55c. **6¢**  
 PRICE, Each

C11147—Spade end as above but not insulated. **4¢**  
 TWO for.....  
 10 for 18c 100 for \$1.65

**Complete Alignment Tool Kit**  
  
 D11593—Contains 21 individual alignment tools, consisting of trimmer wrenches, screw-drivers, tuning wand, test leads, etc., to service practically every radio receiver. Leatherette carrying case included. List price of tools if purchased individually... \$15.40.  
**YOUR PRICE, Only \$8.08**

# Soldering Irons and SOLDERING NECESSITIES

## ICA Electric Soldering Irons



Stock Number	Watts	Tip Diam.	Length Overall	List Price	Your Price
K11724	60	3/4"	10"	\$3.75	\$2.05
K11725	85	7/8"	11 1/2"	4.50	2.45
K11726	115	1"	13 1/2"	6.50	2.95

A large Radio manufacturing company formerly experienced much trouble with their electric soldering irons. So they put their highly trained Engineering Department on the job of building a long lasting trouble free solder iron. Here it is! One of the finest ever made! And what a value! Bound to give long satisfactory service. (Absolute Guarantee on Heating Element for a Full Year of Use!)

Heats quickly, holds heat a long time. 3/4" solid copper alloy tip. Fine quality 6 foot heater cord. Unbreakable rubber attaching plug. Polished nickel barrel. Black rubberized handle. First quality in every point! For 105-120 volt current A.C. or D.C.

Snap-on Holder is supplied FREE with every ICA Soldering Iron



## Soldering Iron Bargain



C11737—For 105-125 volt current. YOUR PRICE ..... **27c**

An amazingly low priced electric iron for all light soldering. Ideal for use where only occasional soldering is done. 3/4" Tip. 3 ft. Cord and plug. 10 for \$2.55

## Kester Quality Solder

**Kester Rosin Core Solder**  
Best for fine radio connections. Flux is in the solder. Makes strong, low resistance joint.

3/32" Diameter		
Stock Num.	Quantity	Your Price
C5755	4 oz. Can	17c
C5756	1 lb. Spool	64c
C5757	5 lb. Spool	\$3.00
C5752	20 lb. Spool	\$10.95

1/16" Diameter		
Stock Num.	Quantity	Your Price
C5753	1 lb. Spool	66c
C5754	5 lb. Spool	\$3.25

## Kester Acid Core Solder

C5758—Per Can C5759—1 lb. Spool  
YOUR PRICE 17c YOUR PRICE..... **64c**

## Kester Aluminum Solder

Flux Filled

C5760—Per can C5765—1 lb. Spool  
YOUR PR. 17c YOUR PRICE..... **\$1.96**

## Kester Tinning Block

Replaces ordinary sal-ammoniac. Cleans and "tins" soldering irons very speedily. Will not crumble or cause any corrosion on the work.

C5766—1/4 lb. Size, YOUR PRICE ..... **15c**  
C5767—1/2 lb. Size, YOUR PRICE ..... **25c**  
C5782—1 lb. Size, YOUR PRICE ..... **44c**

## Gardiner Rosin Core Solder

Dependable quality at a substantial saving. Non-corrosive, pure rosin core assures perfect connection.

C5763—3 oz. Can, 3/8" Dia. YOUR PRICE **12c**  
C5764 — 1 lb. Spool, 3/8" Dia. YOUR PRICE **58c**

## Solder Paste

C5768—2 oz. Can. Non-corrosive. Assures perfect electrical connection. YOUR PRICE..... **10c**

Solder Prices are Subject to market change

## "Esico" General Purpose Electric Soldering Irons



Extraordinary high quality irons. One piece blued steel cases. Rich dark mahogany handles. Replaceable forged copper tips. Grade "A" nickel chrome elements wound on highest quality mica insulation. Underwriters approved 5 ft. cords with unbreakable rubber plugs. For 105-120 volts A.C. or D.C. operation. Guaranteed for one year.

### With Screw-On Pointed Tips

D11710—Esico Niek Nack. 55 watts 5/8" tip. Length 11 3/4". **65c**  
YOUR PRICE.....

Electric Soldering Irons				Extra Tips	
Stock Number	Watts	Tip Dia.	Your Price	Stock Number	Your Price
C11710	55	5/8"	\$ 6.65	C11714	12c
C11711	65	3/4"	1.03	C11715	18c
C11712	100	7/8"	1.62	C11716	18c
C11713	150	1"	2.94	C11717	26c

### With Plunger-Type Pointed Tips

C13062	65	3/8"	\$1.03	C13065	18c
C13063	100	1/2"	1.62	C13066	18c
C13064	150	3/4"	2.94	C13067	26c

## "ESICO" Constant Duty Industrial Soldering Irons



Hard drawn tinned copper plunger type tips, replaceable. One year guarantee. Grade A nickel chrome resistance wire wound on lava insulators encased in blue steel one-piece case. Long life. Quick heat. Maintains a constant even temperature. 6 foot heavy duty cord. Handle never gets hot. For use on 105-125 volt current.

Stock Number	Watts	Tip Diam.	Length Overall	List Price	Your Price
K11706	65	3/4"	10 1/4"	\$5.00	\$2.94
K11707	110	3/4"	12 3/4"	5.50	3.23
K11708	200	7/8"	14 1/4"	8.75	5.15
K11709	310	1"	14 3/4"	10.25	6.03

## Hotspot Soldering Irons



An exceptionally fine quality iron suitable for continuous use under severe conditions. Unbreakable bakelite handle with spring cord protector and cord strain relief. Heat retarding fins keep handle cool. Grade A chromel element with highest grade amber mica insulation wound on steel core. Plunger type tip easily replaced. 5 3/4" Cord. Metal stand included. For 110-120 Volt, AC-DC operation.

Stock Number	Watts	Tip Diam.	Length Overall	List Price	Your Price
C13068	85	3/8"	12 3/4"	\$4.00	\$2.35
C13069	100	3/8"	13 1/4"	4.50	2.64
C13070	150	1/2"	13 1/4"	5.50	4.23
C13071	200	3/4"	13 1/4"	7.50	4.41

## Copper Replacement Soldering Tips Fit Drake, American Beauty, Etc.

Stock Number	Tip Diam.	Tip Length	Your Price
D11730	3/8"	2 3/8"	18c
O11731	3/8"	4 1/2"	26c
O11732	3/8"	3 1/2"	26c
D11732	3/8"	3 1/2"	27c
D11729	3/8"	1 1/2"	21c

## Sal-Ammoniac Cake For Cleaning Iron Tips

Speedily cleans and brightens the soldering copper, causing solder to flow smoothly. Insures good solid joints with minimum of resistance. Will last many months in continuous service. Most convenient to use. **K5769—Per 1/2 lb. Cake .... 29c**

## Soldering Iron Holder

C11733 — **67c**  
PRICE. Each  
A practical stand and carrying case for hot iron. When job is done simply insert hot iron into the holder. Saves time.

## Drake Soldering Irons

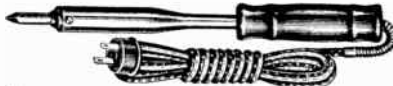

Guaranteed perfect in workmanship and material. Gives quick heat and long satisfactory service. Meets Underwriters' approval. Highest quality nichrome wire element wound on amber mica enclosed in one piece nickel plated housing. Tips machined from hard copper rod and nickel coated to prevent corrosion. Set screw securely holds tip. Perfectly balanced handle always keeps cool. Spring at handle prevents cord wear. 5' high grade cord fitted with rubber plug. For 105-120 volts, A.C. or D.C. operation. "Magic Cup" Stand described below supplied free.

### With Plunger Type Pointed Tips

N11745—Code 225, 80 Watt, 3/4" tip. Length, 12 3/4". List Price, \$3.15. **YOUR PRICE ..... \$1.85**  
N11746—Code 325, 100 Watt, 3/4" tip. Length, 12 3/4". List Price, \$3.75. **YOUR PRICE ..... \$2.20**  
N11747—Code 425, 200 Watt, 3/4" tip. Length, 14". List Price, \$7.50. **YOUR PRICE ..... \$3.89**

## Drake Midget Soldering Iron



An extra small iron particularly suited to servicing midget radios. Same high quality construction as above irons, 10 3/4" long overall, 3/8" dia. plunger type tip. 80 Watt element. Has 6 ft. heater cord and rubber plug. Magic Cup stand described below. **D11700—YOUR PRICE ..... \$2.35**

## Drake "Magic Cup" Iron Stand

A twist of the iron tip and all oxide coating disappears. **D11701—Your Price 29c**

## Drake Heat Control

C11740—Without guard over iron rest. **YOUR PRICE... \$2.06**  
C11741—With guard over iron rest as shown. **YOUR PRICE... \$2.35**  
Has built-in resistance unit to provide low heat for keeping iron warm when not in use. A flip of the switch provides high heat and iron is ready for use. Protective guard over iron rest. Adjustable iron rest takes any iron. Has outlet receptacle and 4 ft. cord with plug. Sturdy all metal construction, cadmium plated.

## Quality at Low Price



**Plunger Type Tip**  
Nowhere on the market will you find the equal of these irons at such low prices. Plunger type tips firmly held by set screws are easily removed. Wire elements wound on steel core with mica insulation. Gun-metal finished tubes, 6 Ft. cord with rubber plug. Well constructed handle. For 105-120 volt, AC-DC operation. All irons 12" long.

**C13052—3/4" plunger tip. Wt. 8 oz. YOUR PRICE ..... 59c**  
**C13053—5/8" plunger tip. Wt. 10 oz. YOUR PRICE ..... 82c**  
**C13054—3/4" plunger tip. Wt. 14 oz. YOUR PRICE ..... 95c**

## Jackson Soldering Pencil

A small handy soldering tool for quick light work. For use by radio servicemen, jewelers, dentists and for household repairs. Heats quickly and is easy to handle. Black insulated handle, cord and finger guard. 6 Ft. rubber cord. Stand included. For 110 volt, AC-DC operation.  
**C13043—25 Watt Iron. Includes three 3/8" dia. plunger type replacement tips. YOUR PRICE ..... 88c**  
**C13044—40 Watt Iron. Has 3/8" plunger type tip. YOUR PRICE ..... \$1.15**



# Popular Service Items

## Shield Grid Caps



**Type A** **Type B** **Type C**  
For standard glass, all-metal and "T" type tubes. Made of spring steel to insure close contact with terminal. Cadmium plated.

**Standard Glass Octal Base**  
A11411 **Type A** A11413  
A11412 **Type B** A11414  
C11409 **Type C**  
100 for 45c. 10 for..... **5c**

## Insulated Grid Cap

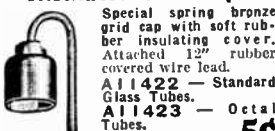

Special spring bronze grid cap with soft rubber covering insulating cover. Attached 12" rubber covered wire lead.  
A11422—Standard Glass Tubes.  
A11423—Octal Tubes.  
Your Price, Ea... **5c**  
Ten for 45c  
A11424—866 Rect.  
YOUR PRICE, Each..... **9c**

## Double Grid Clip

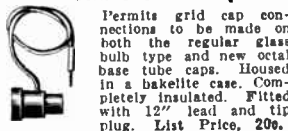

Permits grid cap connections to be made on both the regular glass bulb type and new octal base tube caps. Housed in a bakelite case. Completely insulated. Fitted with 12" lead and tip plug. List Price, 20c.  
R11416—Red  
R11415—Black  
YOUR PRICE, EACH..... **12c**

## Mueller Insulated Grid Clip Assembly



Insulated clip on 9" flexible wire lead with phone tip on other end. Clip fits grid caps of all tubes. Used on many new tube checkers.  
C11408 Ten for **15c**  
PRICE, Each \$1.30

## Contact Terminal Strip and Plug



C12362 Plug Each..... **4c**  
Ten for 35c  
For speakers, radio, P.A., etc. Spring contacts, 1/2" ctrs. mtd. on Bak. Strip.

Stock Number	Number Contacts	Price Each	Ten for
C12353	2	6c	\$0.54
C12354	3	9c	.81
C12355	4	9c	.81
C12356	5	10c	.90
C12357	6	12c	1.04
C12358	7	15c	1.35
C12359	8	20c	1.80

## Coil Shield with Base



Shield is 2 1/2" inside diameter 1 1/2" overall height. Grid lead hole in wall near top. Bases have oblong mounting holes to fit either 1 1/4 or 1 1/8" socket centers. Bright Aluminum finish.  
R11780—**10c**  
Ten for 85c

## Grid Cap Shields For Metal Tubes

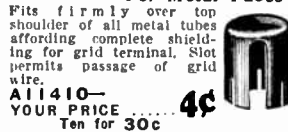

Fits firmly over top shoulder of all metal tubes affording complete shielding for grid terminal. Slot permits passage of grid wire.  
A11410—**4c**  
YOUR PRICE.....  
Ten for 30c

## New Close Fitting Ventilated Tube Shields



For 55, 57, 58, 6A7, etc., Small Diameter Dome Shaped Tubes  
Ventilated shell has three formed ribs which press against the side of the tube to hold it rigidly—dampens vibration and microphonic disturbances. Natural finish aluminum metal. A wide range of base mounting sizes. Cap height 1 1/2" slotted for grid lead. Shell diameter 1 1/2", height of body 3", chimney extension 5/8". Overall height assembled 4 1/4".

Aluminum Stock Number	Base Mounting Centers	Price Each	Ten for
K11767	1 1/2"	15c	75c
K11768	1 3/8"	15c	75c
K11769	1 1/2"	15c	75c

## Standard Type Ventilated Tube Shields Improved Non-Rattle Type

Ventilated shell has three formed ribs which press against the side of the tube to hold it rigidly—dampens vibration and microphonic disturbances. A wide range of base mounting sizes. Cap height 1 1/2". Shell diameter 1 1/2", height 3 1/2". Overall height assembled 4 1/2".

Aluminum Stock Num.	Base Mounting Centers	Price Each	Ten for
K11770	1 1/2"	15c	75c
K11771	1 3/8"	15c	75c
K11772	1 1/2"	15c	75c

Price Each **9c**  
Ten for 75c  
Hundred \$6.50

## Sub Panel Sockets Wafer Type With Tube Locating Ring Midget Size



Tubes easily and quickly inserted. Firm positive contacts. With mounting holes 1/2 inch centers. Overall length 1 1/2". Width 1 1/4".

Stock Number	Number Prongs	Price Each	Ten For
K12172	4	5c	45c
K12173	6	5c	45c
K12175	7S	5c	45c
K12176	8 (Octal)	5c	45c

**Standard Size**  
Mounting holes 1 1/8 inch centers. Overall length 2 1/4". Width 1 1/4".

Stock Number	Number Prongs	Price Each	Ten For
K12177	4	5c	45c
K12178	6	5c	45c
K12179	6	5c	45c
K12180	7S	5c	45c
K12181	7L	5c	45c

## Bakelite Sockets



Moulded black bakelite. Have guide for tube prongs. Tubes quickly and easily inserted. Perfect contact. Easy to mount above panel or below panel of any material not over 3/8 inch thick. Mounting holes have 1 1/8" centers. \*T combination type.

Stock Number	Prongs	Price Each	Ten For
K12161	4	15c	\$1.45
K12162	5	15c	\$1.45
K12163	6	15c	\$1.45
K12165	7-7S	21c	2.05
K12166	8 (Octal)	23c	2.15

## Improved Form-Fitting Tube Shields

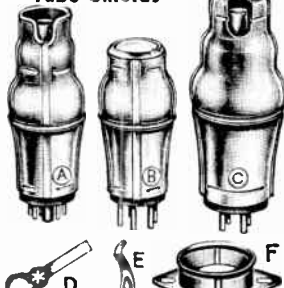

For use where space is limited or to replace spray-shield type tubes. Two parts of shield fit snugly around tube and are firmly held in place by clamp ring. Grounding clip D for connecting shield to No. 1 pin of octal tubes. E for grounding to chassis. F has slotted mtg. ctrs. of 1 1/2 to 1 3/8". List Price, 12c.

YOUR PRICE, Each..... **5c**  
10 for 45c 100 for \$4.25

Type	Tube Bulb Type*	With Clip D	With Clip E	With Clip F
A	ST121	11773D	11773E	11773F
A	ST12C	11774D	11774E	11774F
B	ST12	11775D	11775E	11775F
B	ST12C	11780D	11780E	11780F
C	ST14	11781E	11781F	

\*ST12D type includes all dome type tubes except those specified below. ST12C types are 6C6, 57 and 58. ST14 types are 22, 24A, 26, 32, 33, 34, and 35/51.

## Bantam Shields

Designed for bantam, 1.5 volt and other tubes having T9 bulb, inside dia., 1 1/8" by 3 1/2" long.  
C11798—1 Pc. Plain shield. No top included. PRICE, Each..... **2 1/2c**  
Ten for 20c

2 Pc. (Shield and top) with type D or E grounding clips illustrated above. C11799D—with Clip D PRICE, Each..... **4c**  
Ten for 35c

## Non-Removable Bakelite Top Binding Posts

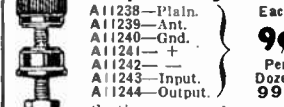

A11238—Plain. Each **9c**  
A11239—Ant.  
A11240—Gnd.  
A11241—+  
A11242—Pr.  
A11243—Input.  
A11244—Output.  
Captions engraved on polished black bakelite post. Diameter, 1/4 inch. Size, 6/32 screw, 3/8 inch long. Nut included.

## Bakelite Binding Post Kit

K11245—Consists of 25 non-removable top bakelite binding posts like above with assorted captions as we select.  
YOUR PRICE..... **97c**

## Insulated Binding Posts With Built-in Banana Jack



Moulded, high dielectric, knurled grip, non-removable top. Takes either banana plug, phone tip, spade end or wire. Extends 5/8" above panel when top is screwed down. Fitted with 8/32 screw 3/8" long and two nuts.  
C11483—Red. Pr. Ea. **7c**  
C11484—Black } Ten for **62c**

## Insulated Binding Posts

High dielectric, insulated top, diameter 1/2". Mounted on 10/32 screw 3/8" long. Threaded metal base washer 1/2" diam., 1/8" thick.  
C11489—Red  
C11490—Black } **35c**

## Terminal Strip Assemblies



Genuine laminated bakelite strip 1/4" thick, 3/8" wide. Latest type screw and collar terminals with rigid-non-shift lug. Collar and lug is one single piece and mounted rigidly and securely through the terminal strip. Screws are brass nickel plated. Centers between terminals, 5/8".

Stock Number	Terminals	Length	Price Each	Ten For
K11360	2	2 1/4"	9c	\$0.74
K11361	3	2 1/4"	12c	.98
K11362	4	3 1/8"	15c	1.25
K11363	5	4"	19c	1.55
K11364	6	4 1/2"	23c	1.80
K11365	7	5 1/8"	28c	2.50
A11217	8	5 1/2"	34c	3.00
A11218	9	6 1/8"	40c	3.55
A11219	10	7"	46c	4.00

## Terminal Strips



An attractive brown bakelite 1/4" thick terminal strip made for light duty radio work, experimental uses, P.A., etc.

Stock Number	Number Terminals	Price Each	Ten for
C13075	2	6c	55c
C13076	3	7c	65c
C13077	4	11c	95c
C13078	5	12c	\$1.15
C13079	6	13c	1.25

## Screw and Lug Assembly

2" long, 3/8" wide. Mounting holes 1 1/8" centers. Wide head cadmium plated screws on 3/8" centers. Solder lugs riveted on, extend 1/2".  
K11206—PRICE EACH..... **4c**  
Ten for .33c Per Hundred, \$2.95

## Terminal Lugs

Nickel plated phosphor bronze terminal lugs. Screw included. Illustration is actual size.  
C11207—**19c**  
Ten for.....  
100 for \$1.75

## Tie Terminal

A single terminal entirely insulated from the mounting lug. Handy for tying three or four lugs together.  
K11370—Ten for..... **19c**  
Per Hundred, \$1.16

## New Lug Terminal Strip

Bakelite Insulation  
C11371—**14c**  
Ten for.....

Simplifies wiring and provides a ready means of mounting resistors. Center terminal may be grounded by mounting directly to chassis. 1 1/4" long. Lugs tinned.

## Terminal Strips



Tinned lugs mounted securely on laminated bakelite strips. High insulation factor. Lugs widely spaced. Two lug mounting.

Stock Number	Terminals	Price Each	Ten For
D11359	1	3c	14c
D11372	2	3c	14c
K11366	3	4c	18c
K11367	4	4c	33c
K11368	5	4c	33c
K11369	6	4c	33c

# DIALS AND DIAL REPAIR PARTS

## Attractive Designs • Improved Construction

Improved model dials for all-wave and broadcast receivers. Dials have smooth friction or cable drives. No backlash. Cadmium plated frames. Fits  $\frac{3}{8}$ " condenser shaft but supplied with reducer bushings for use with  $\frac{1}{4}$ " shafts. All dials include Escutcheon plate and pilot lamp sockets.

### Airplane Dials



Airplane type dials with peach colored translucent dial scales. Upper scale is marked 0-100 with clockwise rotation. Lower scale is marked 0-100 counter-clockwise. Dual pointer.

friction type drive. Has glass protected dial face. Attractive antique bronze escutcheon.

#### Giant 5' Dial

A10645—Has 6" Escutcheon and 14 to 1 ratio drive. **YOUR PRICE..... \$139**

#### 4' Airplane Dial

A10632—4" Escutcheon. 10 to 1 ratio drive. **YOUR PRICE..... \$105**

#### 3 1/2' Airplane Dial

A10630—4" Escutcheon. 6 to 1 ratio drive. **YOUR PRICE..... 83¢**

#### 2 3/4' Airplane Dial

A10628—2 3/4" Square Escutcheon. 6 to 1 ratio drive. **YOUR PRICE..... 68¢**

### 4 1/2" Oval Dial



With Escutcheon and Lamp Sockets  
A10648  
Your Price **\$132**

Square, edge lighted glass dial scale measures  $4\frac{1}{2}$ " x  $5\frac{1}{2}$ ". Calibrated 0-100 outer and 100-0 inner scale. Pointer covers 180° rotation. White letters and pointer. Black background. Ratio 6 to 1. Friction drive.

### Dial Cable Tension Spring

Keeps proper tension on all types of dial cable drives. Made of high grade music wire. Nickel plated. Size:  $\frac{3}{16}$ " dia.,  $\frac{3}{8}$ " long.  
A4253—Set of 3. **9¢**  
**YOUR PRICE** 100 for **\$2.65**

### Slide Rule Dials

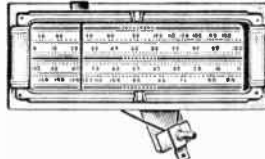

Beautiful new slide rule dials. Long scale lengths make tuning easier. Has four separate calibrations: 55 to 150, 0 to 100, 100 to 0 and 150 to 55. Attractive antique bronze finished escutcheons. Dial scale is protected by unbreakable clear celluloid lens. Dials have flexible shaft couplings to compensate for any misalignment of condenser mounting. Smooth cable drive.

#### Giant 11' Dial

A10636—11" x 4" Escutcheon. 9 1/2" Dial scale. 10 to 1 ratio. **YOUR PRICE..... \$376**

#### 8 1/2' Wide Dial

A10637—8 1/2" x 4 1/2" Escutcheon. 7 1/2" x 4" Dial scale. 10 to 1 ratio drive. **YOUR PRICE..... \$259**

#### 6 1/2' Wide Dial

A10638—6 1/2" x 2 1/2" Escutcheon. 5 to 1 ratio drive. **YOUR PRICE..... \$206**

### Crowe Slide Rule Dial

D10655  
Your Price **95¢**

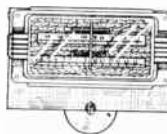

Attractive 3 color finish with embossed effect on calibration of a gold background. Two scales 550 to 1700 KC and Universal 0-100. Direct drive fits  $\frac{3}{4}$ " shaft. Requires panel opening size  $1\frac{1}{2}$ " x  $3\frac{3}{4}$ ". Complete with pilot light sockets and escutcheon with unbreakable crystal.  
D10656—Similar to above with 7-1 ratio drive. Mtg. hole required,  $1\frac{1}{8}$ " x  $\frac{5}{16}$ ". **YOUR PRICE..... \$141**

### Victor R-32 Pilot Lamp



American Made  
110 Volt, 10 Watt  
Especially for Victor R-32 and Colonial Receivers. May also be used in continuity tests to indicate open or short circuits. Intermediate base. Sprayed white.

C10598—EACH **15¢**  
Ten for \$1.44

### Shaft Couplings, Reducers, Extenders

#### Brass and Fibre Shafting

Machined brass fittings for coupling shafts of uniform or dissimilar diameter; for extending rheostat, volume control or switch shafts. Extension fittings are furnished to expand or reduce shaft diameter. Shafting is available in brass or fibre.

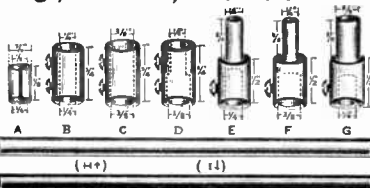

Stock Number	Style	Length	Description	Your Price
K11785	A	3/4" Long	3/4" Hole I.D. 3/4" O.D. Dial Bushing	5c
K11786	B	3/4" Long	3/4" Hole I.D. 1/2" O.D. Coupling	9c
K11787	C	3/4" Long	1/2" Hole I.D. 1/2" O.D. Coupling	9c
K11788	D	3/4" Long	3/8" Hole I.D. 3/8" O.D. Coupling	9c
K11789	E	1-1/4" Long	3/4" Hole I.D. 3/4" O.D. Extender	9c
K11790	F	1-1/4" Long	3/4" Hole I.D. 3/4" O.D. Reducer	9c
K11791	G	1-1/4" Long	3/4" Hole I.D. 3/4" O.D. Reducer	9c
K11792	H	6" Long	3/4" Diameter Brass Shafting	9c
K11793	H	12" Long	3/4" Diameter Brass Shafting	18c
K11794	I	6" Long	3/4" Diameter Fibre Shafting	9c
K11795	I	12" Long	3/4" Diameter Fibre Shafting	18c

### Dial Belt Kits

Complete assortment of dial belts containing a replacement for practically any radio. Each assortment housed in attractive baked wrinkle finish 2 1/2 gauge steel cabinet, size 6 3/4" x 1 1/4" x 1 3/8". Includes measuring device and replacement chart. Cabinet will hold up to 100 belts.  
D15295—Kit of 25 asstd. **\$367**  
**YOUR PRICE.....**  
D15296—Kit of 50 asstd. **\$686**  
**YOUR PRICE.....**  
D15297—Kit of 100 asstd. **\$1323**  
**YOUR PRICE.....**



### Bronze Dial Cable

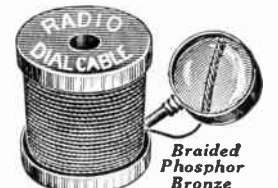

B4239—5 Ft. Length. **19¢**  
PRICE, EACH.....  
D1240—25 Ft. Spool. **69¢**  
YOUR PRICE, EACH.....  
D4241—50 Ft. Spool. **\$1.24**  
YOUR PRICE, EACH.....

Right size, flexibility, and strength for any make drum dial. Six individual cables each consisting of seven fine strands of phosphor bronze wire are scientifically braided together and around a strong center fibre cord making a cable  $\frac{3}{16}$ " diameter. Best quality cable made.

### Braided Bronze Dial Cable

16 number 36 bronze wires braided over strong linen thread core.  
B4243—25 foot coil ..... **22c**  
B4244—50 foot coil ..... **36c**  
B4245—100 foot spool ..... **54c**

### Linen Dial Cable

Light Linen Cable

Strong extra thin linen cable tightly braided. Dia. approx. .024".  
D4195—75 foot coil. **12¢**  
YOUR PRICE.....

D4196—25 foot spool. **44¢**  
YOUR PRICE.....

D4197—100 foot spool. **\$147**  
YOUR PRICE.....

### Medium Weight Linen Cable

Made of finest linen. Tightly braided. Tensile strength 150 lbs. Diam. Approx. .032".  
A4250—5 foot. **19¢**  
YOUR PRICE.....

D4246—25 foot spool. **64¢**  
YOUR PRICE.....

K4247—100 foot spool. **\$2.15**  
YOUR PRICE.....

### Heavy Linen Cable

Tensile strength 200 lbs. Used on Philco and Brunswick receivers and many other sets. Diam. Approx. .04".  
K4248—25 foot spool. **78¢**  
YOUR PRICE.....

### Dial Cable Kit

D4242—Your Price **\$230**  
Per Kit

Kit contains: Four 25 ft. spools of popular type Dial Cable; 25 ft. 42 strand Bronze, 25 ft. Special Thin GE-RC Cable, 25 ft. Light Linen Cable, and 25 ft. Heavy Linen Cable. With this Kit you are supplied FREE an assortment of Eyelets and Clamps for making Ready Made Cables. The contents are put up in a neat box that will make a permanent container for the Dial Cable Spools.

### Eyelet and Clamp Ass't.

D4151—Your Price **15¢**  
Contains 50 assorted eyelets and clamps same as used on ready made dial cables. Make your own cables and save time.

D4152—Cable Eyelet Tool. Consists of base which may be inserted in vise and punch for turning small rivets and eyelets. **29¢**  
YOUR PRICE, Per Set.....

### Dial Drive Rubber

For repairing complete dial assemblies in many Awtwater-Kent, and Stewart-Warner receivers. Made of rubber. Size,  $\frac{5}{8}$ " dia.,  $\frac{3}{16}$ " thick.  
C4149—10 for **59¢**  
YOUR PRICE, EACH..... **10¢**

### Dial Drive Springs

D4254  
Kit of 25 Assorted  
Your Price **59¢**

A new kit of hard to get dial drive tension springs. Six assorted sizes that will take care of all dial repairs. Every service man should have a kit of these springs. Springs are cadmium plated. Packed in a neat box.

### Push-On Knob Springs

D4251  
Kit of 35 Assorted  
List, 60c  
Your Price **35¢**

At last!—that hard-to-get item that Radio Men have needed! These push-on knob springs are put up in an assortment of various types needed for all knobs. Spring knobs that are used in Majestic, RCA, Philco, General Electric, etc. This kit will come in handy to replace those lost or broken springs. Every Serviceman needs a kit.  
D4252—Kit of 100 Springs. List Price, \$1.25. **73¢**  
YOUR PRICE.....

### Radio Knob Felts

D4256—Box of 25 Felts. For use behind Radio Knobs to prevent rubbing and scratching cabinets. **15¢**  
YOUR PRICE.....

### Set Screw Assortment

Headless set screws for replacement use in all types of knob shaft couplings, etc. Bottom of screw in cup form to provide a firm grip. Kit includes screws in 13 sizes of 6/32, 8/32, and 10/32. Lengths  $\frac{1}{4}$ " to  $\frac{1}{2}$ " in metal case.  
D4154—Kit of 100. **73¢**  
YOUR PRICE.....

D4153—Kit of 50. **44¢**  
YOUR PRICE.....

### Set Screws

C11910—6/32x1/4" L. **11¢**  
C11911—8/32x3/8" L. **11¢**  
C11912—8/32x3/8" L. **11¢**  
C11913—10/32x1/2" L. **11¢**

### Dial Drive Rubbers

Especially designed for use on Awtwater-Kent, R. C. A., Stewart-Warner, Emerson, Kennedy and others.

C4150—24 Assorted. **84¢**  
YOUR PRICE.....

Kit includes screws in 13 sizes of 6/32, 8/32, and 10/32. Lengths  $\frac{1}{4}$ " to  $\frac{1}{2}$ " in metal case.

D4154—Kit of 100. **73¢**  
YOUR PRICE.....

D4153—Kit of 50. **44¢**  
YOUR PRICE.....

C11910—6/32x1/4" L. **11¢**  
C11911—8/32x3/8" L. **11¢**  
C11912—8/32x3/8" L. **11¢**  
C11913—10/32x1/2" L. **11¢**

Especially designed for use on Awtwater-Kent, R. C. A., Stewart-Warner, Emerson, Kennedy and others.

C4150—24 Assorted. **84¢**  
YOUR PRICE.....



# EVEREADY Radio Batteries

TRADE MARK



## No. 482 Minimax 45 V. "B"

For Portable Radios

A new compact battery source of "B" power that will give the same number of listening hours as batteries twice the size. Physically and Electrically they meet the requirements of practically any make portable radio. The dealer who keeps Minimax in stock can, with rare exception, supply batteries for every make of battery receiver. May be used in either battery, or combination battery—AC-DC operated portables. Used with Minimax "A" batteries at left, they will fit practically all radios that otherwise usually require a special pack. Plug-in terminals. Size 3 1/2" L x 1 1/2" W x 5 5/8" H. Net wt. 2 lbs.  
**D53—Less plug, List, \$1.50.**  
**YOUR PRICE, Each..... \$1.13**  
 In Lots of 2, Each \$1.03.

## No. 745-746 1 1/2 and 6 V. "A"

For Portable Radios



A companion unit to the Mini-Max "B" battery shown at left. Eveready Mini-max "A" and Portable "B" batteries used in correct combination, will fit many radios that would otherwise require special packs. Will give approximately the same life as Mini-Max "B". Has plug-in type connection. Plug not supplied.

**No. 745—1 1/2-Volts**  
 Size—L. 10 3/4"—W. 1 1/2"—H. 3 3/8". Weight 3 lbs. List, 95c.  
**D41—YOUR PRICE, Each..... 66c**

**No. 747—6-Volts**  
 Size—L. 10 3/4"—W. 1 1/2"—H. 3 3/8". Weight 3 lbs. List, \$1.00.  
**D44—YOUR PRICE, Each..... 69c**

## New Smaller Minimax

### No. 467—67 1/2 Volts

Same type construction as No. 482 above. Has double the service life of ordinary batteries of the same size. Size L. 2 1/2"—W. 1 1/2"—H. 3 3/8". Wt. 10 1/2 oz Snap type connections.  
**D76—List, \$2.50.**  
**Net Each..... \$1.72**

### "B" Batteries



**No. 762**  
 45-Volts  
 Size—L. 4 1/4"—W. 2 3/8"—H. 5 1/8".  
 Weight 3 1/2 lbs.  
 Plug-in type.  
 Less plug.  
 List, \$1.50.  
**D70—\$1.03**  
 Each.....

### No. 738—45-Volts

Size—L. 2 3/8"—W. 2 3/8"—H. 4 3/8".  
 Weight 1 1/2 lbs. Plug-in type, tapped at +2 1/2 Volts. Less plug.  
**D61—List, \$1.50. Net Each \$1.03**



Exclusive flat-cell construction eliminates waste space and insures long life and a maximum of operating efficiency. Plug-in type tapped at +2 1/2 Volts. No plug-in connector included.

### No. 585—45 Volt

Averages 375 hours life. Size—L. 8 3/8"—W. 3 3/8"—H. 7 3/8". Weight 9 lbs. Tapped at +2 1/2 Volts.  
**D75—List, \$1.39. Net Each \$1.12**  
 In Lots of 6, Each \$1.02

### No. 485—45-Volt

Averages 500 hours life. Size—L. 8 3/8"—W. 3 3/8"—H. 7 3/8". Weight 9 1/4 lbs. Tapped at +2 1/2 Volts.  
**D78—List, \$1.69. Net Each \$1.29**  
 In Lots of 6, Each \$1.18

### No. 486—45-Volt

Averages 750 hours life. Size—L. 8 3/8"—W. 4 3/8"—H. 7 3/8". Weight 14 lbs. Tapped at +2 1/2 Volts.  
**D79—List, \$2.10. Net Each \$1.46**  
 In Lots of 6, Each \$1.46

### No. 386—45-Volt

Averages 915 hours life. Size—L. 8 3/8"—W. 4 3/8"—H. 7 3/8". Tapped at +2 1/2 Volts. Weight 15 lbs.  
**D74—List, \$2.45. Net Each \$1.87**  
 In Lots of 6, Each \$1.70

## Clip-In Plugs

**D10**—For all 45 Volt plug-in type batteries.  
**D11**—For No. 768 "C"  
**D12**—For No. 771 "C"  
**D13**—For Nos. 740, 741, 742, 743, A1390 "A" batteries.  
**YOUR PRICE Any Type, Each... 4c**

## "C" Batteries



**No. 768**  
 22 1/2 Volt  
 Size—L. 4 1/2"—W. 2 1/2"—H. 2 3/8".  
 Weight 2 lbs. Plug in type tapped at -3, -1 1/2, -16 1/2 Volts.  
 List, 98c.  
**D69—YOUR PRICE, Each..... 68c**

**No. 763—22 1/2-Volt**  
 Size—L. 3 3/4"—W. 1 3/4"—H. 2 3/8".  
 Weight 1 lb. Binding post terminals. No taps. List, \$1.20.  
**D66—YOUR PRICE, Each. 90c**  
 In Lots of 5, Each 82c

**No. 771—4 1/2-Volt**  
 Size—L. 4 3/8"—W. 1 1/8"—H. 3 3/8".  
 Weight 8 oz. Plug in type tapped at 3 Volts. Less plug. List, 35c.  
**D67—YOUR PRICE, Each..... 26c**  
 In Lots of 5, Each 24c

**No. 761T—4 1/2-Volt**  
 Size—L. 4 3/8"—W. 1 1/8"—H. 3 3/8".  
 Weight 1 lb. Binding post terminals tapped at -1 1/2, -3 Volts. List, 55c.  
**D68—YOUR PRICE, Each..... 41c**  
 In Lots of 5, Each 37c

## 7 1/2 Volt "C" Batteries



**No. 773**  
 7 1/2 Volts  
 Size—L. 4 3/8"—W. 7/8"—H. 3 3/8".  
 Weight 3/4 lb. Binding post and wire terminals tapped at -1 1/2, -3, -4 1/2, -6 Volts. List, 65c.  
**D65—YOUR PRICE, Each..... 48c**  
 In Lots of 5, Each 43c

**No. 774—7 1/2-Volt**  
 Size—L. 4 3/8"—W. 1 1/8"—H. 3 3/8".  
 Weight 3/4 lb. Plug in type tapped at -1 1/2, -3, -4 1/2 Volts. Less plug. List, 65c.  
**D63—YOUR PRICE, Each. 48c**  
 In Lots of 5, Each 42c

## 90 Volt "B" Battery



**No. 749**  
 90 Volts  
 Size—L. 15 3/4"—W. 3"—H. 7 3/8".  
 Weight 18 lbs. Plug in type not tapped, less plug. List, \$3.45.  
**D62—YOUR PRICE, Each... \$2.33**

## Battery Testers



Portable type battery testers to test "B" Batteries, Dry Cells, Storage Batteries, etc. Long insulated cord with 1" prod on end, for testing batteries with socket terminals.  
**C10376**—0-40 Amps. for Dry Cells  
**C10377**—0-50 Volts for B Batteries  
**YOUR PRICE, Each..... 59c**  
**D10372**—0-1.5 V. & 0-90V.  
**D10373**—0-7.5V. & 0-90V.  
**C10378**—0-40 Amp. & 0-50 V.  
**YOUR PRICE, Each..... 88c**

## "A" Batteries



All are plug in type without taps and supplied without plug-in connector.  
**No. 742**  
 1 1/2 Volt  
 Size—L. 2 3/8"—W. 2 3/8"—H. 4". Weight 1 3/4 lbs.  
 List, 50c.  
**D77—Ea. 34c**

**No. 746—4 1/2-Volt**  
 Size—L. 3 3/8"—W. 1 1/4"—H. 4 3/8".  
 Weight 1 lb. List, 45c.  
**D42—YOUR PRICE, Each. 34c**  
 In Lots of 2, Each 31c

**No. 741—1 1/2-Volt**  
 Size—L. 3 3/8"—W. 2 3/8"—H. 5 3/8".  
 Weight 3 3/4 lbs. List, 95c.  
**D72—YOUR PRICE, Each. 66c**

**No. 743—1 1/2-Volt**  
 Size—L. 3 3/8"—W. 2 3/8"—H. 3 3/8".  
 Weight 2 1/4 lbs. List, 75c.  
**D40—YOUR PRICE, Each. 51c**

**No. 718—6-Volt**  
 Size—L. 3 3/8"—W. 2 3/8"—H. 5 3/8".  
 Weight 3 3/4 lb. List, \$1.00.  
**D43—YOUR PRICE, Each. 69c**

## Air Cell "A" Batteries



**No. A2300—2-Volt**  
 Size—L. 8 3/8"—W. 5 1/4"—H. 8 3/8".  
 Weight 11 lbs. Dry. For sets drawing up to 660 Ma. 500 hour life.  
 List, \$4.25.  
**D86—YOUR PRICE, Each..... \$2.92**

**No. A2600—2-Volt**  
 Size—L. 9-6/8"—W. 6 1/8"—H. 10 3/8".  
 Weight 21 lbs. dry. For sets drawing up to 660 Ma. 1000 hour life.  
**D83—YOUR PRICE, Each..... \$4.51**

**No. SA2600—2-Volt**  
 Size—L. 9-6/8"—W. 6 1/8"—H. 10 3/8".  
 Weight 21 lbs. dry. For sets drawing up to 750 Ma. 800 hour life.  
 List, \$8.00.  
**D84—YOUR PRICE, Each. \$5.40**

**No. A1300—1 1/2-Volt**  
 Size—L. 5 1/4"—W. 4 3/8"—H. 8 3/8".  
 Weight 6 lbs. dry. 660 Ma. capacity. 1500 hours life on 200 Ma.  
 List, \$2.45.  
**D85—YOUR PRICE, Each. \$1.69**

**NOTE:**  
 All Eveready Prices Shown Are Net. 2% Cash Discount Already Deducted

The batteries listed on this page will satisfy practically every replacement requirement. We supply special batteries for every Radio made. Send in your order. Lowest prices.

## "A" Batteries



**No. 711 1 1/2-Volts**  
 Size—Dia. 2 3/8"—H. 6 1/4". Weight 2 lbs. 2 oz. List Price, Each 45c.  
**D50—Your Price, Ea. 33c**  
 In Lots of 12, Each 30c

**No. 6 1 1/2-Volts** Size—Dia. 2 3/8"—H. 6 1/4". Weight 2 lbs. 2 oz. List, 40c.  
**D51—YOUR PRICE, Each..... 28c**  
 In Lots of 12, Each 26c

**No. 16 1 1/2-Volts** Size—Dia. 2 3/8"—H. 6 1/4". Weight 2 lbs. 2 oz.  
**D52—YOUR PRICE, Each. 21c**  
 In Lots of 12, Each 19c

## Dry "A" Batteries



**No. X125—3-Volts**  
 Size, L-1 1/4"—W, 4 3/8", H-7 1/4". Weight 20 lbs. Clip connectors.  
 List Price, \$3.50.  
**D80—YOUR PRICE, Each... \$2.28**

**No. 740—1 1/2-Volts**  
 Size, L-4 1/4"—W, 3 3/8", H-7 3/8". Weight 7 lbs. Plug-in type. Less plug.  
 List Price, \$1.80.  
**D81—YOUR PRICE, Each... \$1.23**

## Flashlight Cells



**No. 950 1 1/2-Volts** Size—Dia. 1 1/4"—H. 2 1/2". List Each, 10c.  
**D58—Your Price 78c**  
 12 for.....

**No. 935 1 1/2-Volts** Size—Dia. 1 1/4"—H. 2". List Each, 10c.  
**D59—Your Price 78c**  
 12 for.....

**No. 915 1 1/2-Volts** Size—Dia. 1 1/4"—H. 2". List Price, Each 5c.  
**D60—Your Price, 12 for..... 39c**

## Test Batteries



**No. 750—3-Volts**  
 Size, L. 1 1/4"—W. 3 3/8"—H. 2 3/8". List, 15c.  
**D57—Price, Each..... 10c**

**No. 751—4 1/2-volts**  
 Size, L. 2"—W. 3 3/8"—H. 2-6/8". List, 30c.  
**D56—Price, Each..... 20c**

**No. 703—4 1/2-volts**  
 Size, L. 2 1/8"—W. 3 3/8"—H. 3 1/8". List, 30c.  
**D55—Price, Each..... 20c**

**No. 781—4 1/2-volts**  
 Size, L. 2 3/8"—W. 3 3/8"—H. 3 1/8". List Price, 40c.  
**D64—Price, Each..... 30c**  
 Lots of 5, Ea. 27c

**No. 409—6-Volts**  
 Size, L. 2 3/8"—W. 2 3/8"—H. 3 3/8". List Price, 50c.  
**D46—Price, Each..... 34c**

# Radio Experimenter's Supplies

## Microphones for Experimenter



### Desk Models

Make your own broadcast over your own radio to entertain your friends at gatherings, parties, etc. These microphones will provide much amusement and surprise. Mikes are supplied with adapters, attachment cords and instructions for easily attaching to any radio.



**Carbon Microphone**  
C9968—Single button carbon mike in brown enameled metal case. 3 3/4" high. Supplied with cord and adapters.  
**YOUR PRICE \$4c**

**Quam Microphone**  
C9984—High impedance permanent microphone. Can be used as wireless record player, radio sets, etc. Connects directly to tube grid. No field excitation necessary. Freq. range 60 to 8000 cps. Output —50 Db. Case 5 3/4" high. 5 ft. Cord with phone tips, no adapters supplied.  
**YOUR PRICE \$17c**



### Hand Microphones

C9964—Similar to Type B but not quite as well made. Has wooden handle with switch. Complete with cord.  
**YOUR PRICE 98c**

C9969—Type A. Single button carbon microphone in metal case. Looks like a professional crystal type mike. Has switch in handle and 10 ft. cord.  
**YOUR PRICE \$1.18**

C9970—Type B. Single button carbon microphone in attractive cast metal case trimmed in bright nickel. With switch in handle and 10 ft. cord.  
**YOUR PRICE \$1.62**



Type A

Diagrams and instructions included.

Type B



### Permo-Magnetic Microphone

With High Impedance Output

D9967—A high quality microphone using the new type high impedance permanent magnet unit. The high impedance output permits direct connection to tube grid and ground. Highly sensitive. Frequency range of 60 to 8000 cycles assures perfect response. For either hand or desk use with receivers, amplifiers, transmitters, record players, recorders, etc. Contained in attractive, professional type crystalline finished case with metal base. 5 Ft. Cord with phone tips and full installation instructions included.  
**YOUR PRICE \$2.32**

### Microphone-Speaker



#### Oxford P.M. Type

A new midsize 3 1/2" PM dynamic speaker housed in a brown bakelite case, size 4 1/2 x 4 1/2". Useful for many applications such as auxiliary extension speaker, intercommunication systems, etc. Requires no field excitation. The microphone model is of dynamic type and is unusually sensitive with good frequency response. Just connect to output transformer of receiver or to grid of tube when used as microphone. Sturdy construction. Voice coil imp. 3 1/2 ohms.

D15658—For use as speaker. Less output transformer. Use output transformer on receiver or transformer listed below.  
**YOUR PRICE \$2.06**

D15659—For use as microphone. Includes shielded input transformer for matching speaker to tube grid of amplifier or radio.  
**YOUR PRICE \$2.65**

D6953—Universal Tube Output Matching Transformer for above.  
**YOUR PRICE 50c**

### Grid Cap Adapters



Inserts between grid cap and tube for connecting high impedance crystal or magnetic phono-plug-ups, microphones or matching transformers to tube grid. Does not interfere with circuit wiring.

Has split grid connection. Completed connection is made by using jumper across clips, or switch may be inserted for cutting in and out.  
D12329—For Large Grid Caps.  
D12274—For Small Grid Caps.  
List Price, 50c.  
**YOUR PRICE, Each 26c**

### Carbon Mike Kit



#### Adapters

For matching any carbon microphone to a high impedance input such as a tube grid of an amplifier or radio. Consists of carbon mike-to-grid matching transformers, 4 1/2 volt battery and current limiting control with on-off switch, dial plate and knob.  
D13587—Kit for Single Button Carbon Mike.  
**YOUR PRICE \$1.49**  
D13588—Kit for Double Button Carbon Mike.  
**YOUR PRICE \$1.75**

### Mike or Phono Adapters

D12186—5 Prong.  
D12187—6 Prong.  
D12188—7S Prong.  
D12189—8 Prong.  
for Octal tubes.  
**YOUR PRICE 54c**

### Wafer Adapters

For making connection to any tube prong. Two discs of bakelite riveted together. Holes punched for tube prongs. In each hole is a metal contact connected to a lug. Lugs can be bent to any position or clipped off if not needed.  
D12190—4 prong. PRICE, Each  
D12191—5 prong. 12c  
D12192—6 prong. 10 for \$1.05  
D12193—7 prong. 10 for \$1.05

D12194—8 prong. For Octal base tube.  
**YOUR PRICE, EACH 19c**

## 4 Tube AC-DC TRF Kit

Complete kit of parts for a quick, easily assembled, extremely compact, sensitive AC-DC TRF set. Uses a pair of high gain IITZ wire wound coils covering 1550 to 540 Kc with a 2 gang variable tuning condenser. Built-in wire antenna. Circuit employs four metal tubes, types, 6K7 as RF Amplifier, 6J7 Detector, 25L6 Output Amplifier and 25Z6 Rectifier. 3 1/2" Electro-dynamic speaker delivers plenty of volume. Volume control has attached on-off switch. Pilot light. Line cord resistor. Includes punched and drilled chassis finished in black wrinkle enamel, size 4 1/2 x 1 1/2". For 105-120 volt, AC or DC operation.  
D16421—Complete kit of parts less tubes, and cabinet.  
**YOUR PRICE \$4.75**

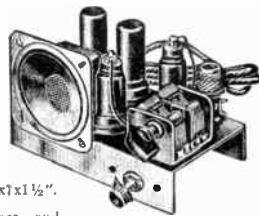

D1334—Set of 4 tubes when purchased with above.  
**YOUR PRICE \$1.65**

## "Wireless" Phono Oscillator Kit

A complete kit of parts for constructing your own phonograph oscillator. Permits any record player having a high impedance magnet or crystal pickup to be played on any broadcast receiver without connection between the two. Compactly designed so as to fit into the record player case. Chassis finished in gray crackle lacquer. Adjustable trimmer permits oscillator to operate between 900 to 540 Kc. Uses 70L7GT tube. For use on 105-120 volt, AC or DC use.  
D16422—Less tube.  
**YOUR PRICE \$1.75**



D1335—Sylvania 70L7GT Tube.  
**YOUR PRICE \$1.13**

### Plug-in Coil Kits

Space wound on 1 1/4" dia. 2 1/2" high bakelite coil forms. 4 Prong coils have primary and secondary. 6 Prong coils have primary, secondary and tieback. For use with .00011 mfd. tuning condenser. Instructions for building an efficient short wave and broadcast receiver are included.  
D9803—4 Prong }  
D9804—5 Prong } **10c**  
D9801—5 Prong }  
D9802—6 Prong } Each



### Short Wave Coils

Set of 4 coils to cover 9.5 to 200 meters or 1500 Kc. to 31.5 Mc.  
C13491—4 Prong Kit. **85c**  
**YOUR PRICE \$1.35**  
C13492—6 Prong Kit. **\$1.35**  
**YOUR PRICE \$1.75**

### Broadcast Coils

Set of 2 coils to cover 100 to 570 meters or 525 Kc. to 3000 Kc.  
C13493—4 Prong Kit. **65c**  
**YOUR PRICE \$1.05**  
C13494—6 Prong Kit. **85c**  
**YOUR PRICE \$1.35**

### Low Loss Type

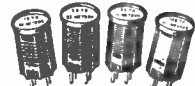

Wire wound on 4 prong low-loss bakelite ribbed forms. 1 3/4" Diameter. 2 1/4" high. Rim handle makes it easy to change coils. Uniformity and mechanical accuracy of the space wound primary and secondary windings insures a high degree of efficiency. Printed insert signifies wave length of coil. For use with 140 or 150 mmfd. tuning condenser.  
D9560—Broadcast Coil Kit, 2 Coils cover 190 to 550 meters.  
**YOUR PRICE, Per Set 94c**  
D9561—Shortwave Coil Kit, 4 Coils cover 9 1/2 to 217 meters.  
**YOUR PRICE, Per Set \$1.15**

### Bakelite Coil Forms

Bakelite forms measuring in 1 1/4" dia., by 2 1/4" high. Rim on top makes it easy to insert and pull out of socket. Rim is grooved for color coding.  
D9800—1 Prong }  
D9801—5 Prong } **10c**  
D9802—6 Prong } Each



### Small Ribbed Type

Low-loss ribbed amber colored bakelite forms with rim for easy changing. Size 1 3/4" dia., 2 1/4" high.  
D9803—4 Prong } **12c**  
D9804—5 Prong }  
D9805—6 Prong } Each



### Large Ribbed Type

Low loss ribbed molded bakelite construction. Size 1 3/4" dia., 3 1/4" high.  
D9806—4 Prong } **17c**  
D9807—5 Prong }  
D9808—6 Prong } Each



### Code Practice Set



C9961—Single Unit.  
**YOUR PRICE 85c**

C9962—Double Unit with 50 ft. wire for two-way communication.  
**YOUR PRICE \$1.85**

Suitable for code practice or sending and receiving between two stations. Consists of high frequency buzzer and blinker light with change-over switch for using either, and telegraph key. Uses 2 standard size flashlight cells at each unit. Code instruction card mounted on top of unit. Less batteries.  
C58—Flashlight Cells. **6 1/2c** Each.

## Morse Code Linguaphone Records

Learn the Morse Code Quickly and Easily  
D15393—List, \$12.50.  
**YOUR PRICE, Per Set \$7.50**

Learn the International Morse Code quickly and easily by the sight and sound method. Consists of 5 double faced records with album and code book. You learn the code by playing the records and watching the dot and dash equivalent in the code book. No tedious drudgery of practice. Study at home in your leisure time. A scientifically correct way to learn the code as it simulates actual operating conditions. Sending speed can be adjusted to suit personal requirements by varying phonograph speed.





# Radio Experimenters's Supplies

## Meissner Radio Set Kits

### 4-5-6 Tube Sets

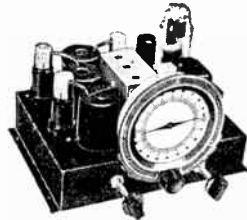

These new radio set kits are designed to obtain the highest efficiency possible from the number and types of tubes used. The finished job will surpass the performance of most factory built sets of equal number of tubes. Particularly recommended for beginners in radio who wish to gain experience by building their own sets. Tuning range 335-1600 kc. Complete kits include punched and drilled chassis base, tuning condenser, airplane dial and escutcheon, resistors, controls, condensers, sockets, all coils, shields, knobs, hardware, wire, solder, power transformer (A.C. sets only) and complete pictorial and schematic wiring diagrams. Tubes, speaker, cabinet and panel are not included.

- C16450**—4 Tube AC-DC TRF Kit. For 105-120 volt, AC-DC operation. Chassis size, 7x11 1/2". **YOUR PRICE..... \$9.55**
- C1300**—Set of 4 Sylvania Tubes: 6K7, 6J7, 25A6, and 25Z6. **YOUR PRICE..... \$2.42**
- C16451**—5 Tube AC TRF Kit. (Illustrated.) Has 3 gang tuning condenser and tone control. For 105-120 volt, 50-60 cycle AC operation. Chassis size, 9x7". **YOUR PRICE..... \$13.82**
- C1301**—Set of 5 Sylvania Tubes: 2-6K7s, 6J7, 6F8 and 5Y4G. **YOUR PRICE..... \$2.48**
- C16452**—6 Tube AC TRF Kit. Has 4 tuned circuits, AVC, tone control, iron core coils and calibrated dial. For 105-120 volt, 50-60 cycle operation. Chassis, 12x10". **YOUR PRICE..... \$21.17**
- C1302**—Set of 6 Sylvania Tubes: 3-6K7s, 6J7, 6V5G and 5Y4G. **YOUR PRICE..... \$2.80**
- C16453**—Metal Cabinet and Panel for 6 Tube Set. Drilled and cut. Black crackle finish overall. Size, 11x14x10". **YOUR PRICE..... \$3.72**

### Speakers for Above

- C15747**—5" P.M. Dynamic for 4 tube set. With output transformer. **YOUR PRICE..... \$1.33**
- Electro-Dynamic Speakers for 5 tube and 6 tube sets. Supplied with universal output transformer and 1800 ohm field. **\$1.47**
- C15748**—5" Speaker **..... \$1.74**
- C15749**—6" Speaker **..... \$1.60**
- C15617**—8" Speaker **..... \$2.50**

### 1 1/2 Volt Battery Set Kits

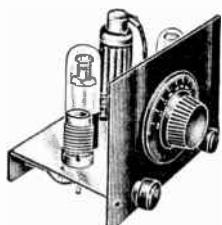

Latest developments in radio design are incorporated in these new battery sets. Particularly designed for the radio beginner and experimenter. Easy to wire and remarkably efficient in operation. Chassis base is punched and drilled to take up to 3 tubes so that a one tube set can be later converted to a 2 or 3 tube set. Each kit includes all necessary parts such as chassis, panel, sockets, resistors, condensers, wire, hardware, knobs, broadcast band, plug-in coil, etc. Tubes, batteries, headphones and cabinet are not included. Three tube set has sufficient volume to operate a speaker.

- C16454**—One Tube Set. Uses 1E4G tube and 1-1 1/2 V. "A" and 1-45V. "B" batteries. **YOUR PRICE..... \$2.94**
- C16455**—Two Tube Set. Uses 1E4G, 100G tubes, 1-1 1/2 V. "A," 1-7 1/2 V. "C" and 2-45V. "B" batteries. **YOUR PRICE..... \$3.53**
- C16456**—Three Tube Set. Uses 1C5G, 1E4G and 1H5G tubes, 1-1 1/2 V. "A," 1-7 1/2 V. "C" and 2-45V. "B" batteries. **YOUR PRICE..... \$4.41**

### Add-On-Kits for Above

- C16457**—Converts 1 tube set to 2 tube. **YOUR PRICE..... \$4.4c**
- C16458**—Converts 2 tube set to 3 tube. **YOUR PRICE..... \$1.99**

### Accessories for Above Sets

- C9718**—Plug-In Short Wave Coil Set. 3 Coils cover 17 to 20 meters. **YOUR PRICE, Per Set..... \$1.05**
- C9410**—Single Headphone with Band. Pr. **59c**
- C52**—1 1/2 V. A Eveready Battery. Price..... **19c**
- C65**—7 1/2 V. C Eveready Battery. Price..... **43c**
- C75**—45 V. B Eveready Battery. Price..... **43c**
- C1152**—Sylvania 1C5G. Price..... **68c**
- C1169**—Sylvania 1E4G. Price..... **68c**
- C1226**—Sylvania 1H5G. Price..... **54c**

## Carron Crystal Sets

Provides real economical radio enjoyment in localities near broadcasting stations. Housed in attractive solid walnut cabinets. Full instructions included with each set.



- Midget Model**
- A16400**—Set with single headphone and roll of ground wire. Size, 4 1/2 x 3 5/8 x 2 1/4". **YOUR PRICE..... \$1.31**
- D16401**—Set only. **YOUR PRICE..... 88c**

### Junior Model

- A16402**—Set with single headphone with headband and roll of ground wire. Size, 5 3/8 x 1 3/8 x 2 3/8". Illustrated below. **YOUR PRICE..... \$1.98**
- D16403**—Set Only. **YOUR PRICE..... \$1.47**

### DeLuxe Model

- A16404**—Looks like a real AC radio. Has variable tuning condenser with tapped coil for adjustment of selectivity and sensitivity. Superior sensitive crystal. Supplied with headphones and ground wire. Size, 6 3/8 x 5 1/8 x 3 3/8". Complete with headphone and roll of ground wire. **YOUR PRICE..... \$3.29**
- A16405**—Set Only. **YOUR PRICE..... \$2.35**



## Philmore Crystal Sets

### "Little Wonder Set"



**D9006**—**YOUR PRICE.... 59c**  
Compact in size but big in results. Receives broadcasts within 25 miles from station. Open type, super-sensitive crystal detector permits finest adjustments to be made. Sifter is provided for station selection. Attractive bakelite case.

### The "De Luxe"

- C9001**—**YOUR PRICE..... \$1.95**

Looks like a midget receiver. All one has to do is to hook up the aerial and the ground and headphones and tune in. Two pairs of headphones can be used. Housed in beautiful bakelite case. Crystal detector is set to most sensitive spot and permanently sealed. Tuning dial is operated by knob for station selection. Complete with headphones and aerial.



### The "Supertone"

- C16407**—**YOUR PRICE..... 69c**
- A well constructed crystal set. Gives loud and clear reception. Has glass enclosed fixed crystal detector. Bakelite case. Range about 25 miles.



## Crystal Sets

- "Top Notch"**
  - C9000**—**YOUR PRICE 80c**
- A super sensitive crystal set. Crystal is mounted under dust proof glass cover. Brings in stations with full volume and clarity. Housed in black crystalline metal case. Complete but less headphones and aerial.



### "Low-Loss"

- C9002**—An inexpensive crystal set that will bring in many programs. Has adjustable slider for station selection. Simple to operate. Complete less headphones and aerial. **YOUR PRICE..... 59c**

## Philmore 1 and 2 Tube Radio Sets and Kits

Efficiently designed 1 and 2 tube radio sets and kits. Easy to wire. Large picture diagrams makes errors almost impossible. Uses plug-in coils to tune the broadcast and short-wave bands (13 to 550 meters) covering police calls, amateur bands, etc. Sets are complete including broadcast coil. Batteries, tubes, headphones, short-wave coils and aerial are not included.



- 1 Tube Battery Set**—Uses one type 30 tube, one 1 1/2 volt A battery and one 45 volt B battery. **C16410**—Kit. **YOUR PRICE..... \$1.18**
- C16411**—Wired. **YOUR PRICE..... \$1.65**

- 2 Tube Battery Set**—Uses two type 30 tubes, one 1 1/2 volt A battery and two 45 volt B batteries. **C16412**—Kit. **YOUR PRICE..... \$1.49**
- C16413**—Wired. **YOUR PRICE..... \$1.98**

- 2 Tube AC-DC Set**—Uses two type 76 tubes. Operates on 110 volts either AC or DC current. **C16414**—Kit. **YOUR PRICE..... \$2.25**
- C16415**—Wired. **YOUR PRICE..... \$2.85**

### 2 Tube AC-DC Kit

Uses two type 76 tubes and plug-in coils tuned by a variable condenser giving excellent selectivity and volume for headphone reception. For 110 volt AC or DC operation. **D16408**—Kit. **YOUR PRICE..... \$3.23**

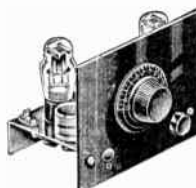

- Set of 4 Short Wave Coils, 13 to 240 Meters. **C9675**—For Battery Sets. **C9676**—For AC-DC Sets. **YOUR PRICE, Per Set..... 72c**

### "3 in 1" Radio Tuner

- D9005**—**YOUR PRICE 27c**



For installation in antenna circuit to serve as wave trap for elimination of undesirable signals, aerial eliminator or an antenna tuner to improve selectivity of set. Instructions included.

### Mounted Detector Crystal

- C10556**—Sensitive mounted detector crystal. Fits all standard crystal holders. **YOUR PRICE..... 40c**

### Meter Tested Crystal

- C9012**—Genuine Galena. Tested on sensitive laboratory meters to provide highest efficiency. **YOUR PRICE..... 10c**

### Cot Whiskers

- C9013**—Spring wire silvered to give best results. Correct tension holds sensitive spot. Set of Three..... **8c**
- 10 Sets for 70c

### Crystal Detector Assembly

- C9010**—Universal joint swivel arm for quick adjustment. Includes crystal. **YOUR PRICE..... 12c**



### Enclosed Crystal Detector

- C9011**—Ideal for crystal reflex circuits. Dust proof glass enclosed assembly. Includes crystal. **YOUR PRICE..... 22c**

### Fixed Crystal Detector

- C9003**—Sensitive Galena Crystal with contact permanently set for maximum efficiency. Mounted in moided case. Screw terminals. **YOUR PRICE..... 43c**



# BATTERY CHARGERS--POWER SUPPLIES

## Gas Engine Driven AC-DC Generator

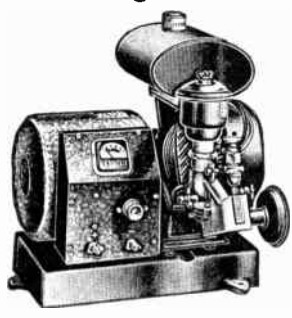

**300 Watt Model**  
**C16899**—Delivers 110 Volts, 60 Cycle AC at 300 Watts or 6 Volts DC at 200 Watts. 5/8 HP Engine. 1 Gallon fuel tank in base for 12 to 16 hours operation. Size, 17"x16"x17" high. Wt., 103 lbs.  
**YOUR PRICE.....\$5788**

**450 Watt Model**  
**C16888**—Delivers 110 Volts, 60 Cycle AC at 450 Watts and 6 Volts DC at 200 Watts. Equipped with 1 HP engine. 3 Qt. fuel tank at top for 5 to 6 hours operation. Size, 17"x15"x17" high. Wt., 90 lbs.  
**YOUR PRICE.....\$8873**

**C16887**—Radio Noise Filter necessary when above generators are used with radio sets.  
**YOUR PRICE.....\$441**

A dependable, economical source of electric power for operating sound systems, radios, lights, etc. Especially adaptable for mobile use. Both AC and DC outputs can be used at one time, providing full capacity of either is not used. DC Output terminals on panel. AC available thru BX cable connection at side. 4 Cycle, single cylinder, air-cooled gasoline driven engine.

Equipped with AC voltmeter, push-button starting on control panel and rope-pull auxiliary starter. Hand starting not necessary when used with 6 volt battery. The 6 volt DC output can be used to keep starting battery fully charged. Governor assures constant frequency and uniform voltage output. Sturdily constructed.

## Homcharger Battery Chargers



Especially designed for keeping any 6 volt automotive and home radio storage batteries fully charged. Tapered charging rate decreases as battery becomes charged—no chance of overloading battery. Attractively designed—sturdily constructed. All types are non-radio interfering. For 105-120 volt, 50-60 cycle AC operation.

**5-3 Ampere Booster**  
**A16915**—Includes auto steering post mounting connector and cables.  
**YOUR PRICE.....\$441**



**6 Ampere Charger**  
**A16917**—Vibrator type, 6 volt storage battery charger. Self-polarizing; entirely automatic in operation. With cord, plug, car clamp and cables.  
**YOUR PRICE.....\$735**



**10 Ampere Charger**  
**A16916**—Heavy duty type charger. Supplies 10 amperes for fast charge. Complete with built-in ammeter, 10 ft. cable and auto dash mounting receptacle and plug.  
**YOUR PRICE.....\$1147**

## GTC Porta-Power Packs



For operating battery sets on 105-125 volt 50-60 cycle AC lines when testing, servicing, demonstrating, etc. Also used for converting battery sets for AC line operation. GTC Porta-Power Packs supply all voltages necessary. Ruggedly built and dependable in operation. Complete with line cord, and on-off switch. There's a model for every battery set.

**For 1.5 Volt Battery Sets**  
**D16913**—Model U. Provides "A" 1.5 V. up to 250 M.A. "B" 90 to 101 V. for 1 1/2 V. 4 and 5 Tube battery sets. Plug-in sockets accommodate practically any type battery plug. Size 2x3 1/2 x 6". Light weight—fits in cabinet in place of "A" and "B" batteries. Operates in any position.  
**YOUR PRICE.....\$441**

**For 2 Volt Battery Sets**  
**D16912**—Model L. Supplies "A", "B" and "C" Power for 4 to 8 tube battery sets designed for 2, 2.5 or 3 volt operation. Delivers 2 volts DC at 100 Ma. for tube filaments. "B" voltages of 6 1/2, 90, 112 1/2 and 135 volts and 1, 2 or 3 "C" voltages from 1 1/2 to 2 1/2 volts as desired. "B" section can be adapted to supply 45 volts also if needed. Power consumption less than 30 watts. Has screw type terminal connections. Size: 6x3 1/2 x 7".  
**YOUR PRICE.....\$585**

**D16914**—Model G. Same as Model U above except for larger 5 and 6 tube sets including consoles. Size: 3 1/2 x 6 x 4 3/4" high.  
**YOUR PRICE.....\$558**

**For 6 and 12 Volt Sets**  
**D16911**—Model P. Converts 6 and 12 Volt Battery Sets to all-electric operation. Providing two separate 6 volt DC 1 1/2 amp. power sources. Size: 3 1/2 x 6 1/2 x 7 1/2". Wt. 3 lbs.  
**YOUR PRICE.....\$820**

## Stancor "A-B" Battery Power Packs

**For 6 Volt DC Operation**  
**D16919**—Pt. 138. Permits 4, 5 or 6 tube sets using 1 1/2 Volt "A" and "B" batteries to operate from a 6 volt "hot shot", storage battery or other DC source. Provides 1.4 volts at 300 Ma. and 90 volts at 18 Ma. Well filtered. Has plug-in connections for battery plugs and battery clips. Heyday control in pack allows "on-off" operation from battery switch on radio. Black wrinkle finished metal case. Size 5 1/2 x 2 3/4". Ship. wt. 3 1/2 lbs.  
**YOUR PRICE.....\$735**



**D16920**—Pt. 135. As above but supplies 2 volts DC at 480 Ma. and 67, 90, 112 or 135 volts at 20 Ma. Size 5 1/2 x 5 1/2".  
**YOUR PRICE.....\$820**

**For 110 Volt AC-DC Operation**  
**D16921**—Pt. 137. Permits 4, 5 or 6 tube sets using 1 1/2 volt "A" and "B" batteries to operate on 110 volt AC or DC lines. Supplies 1.4 volts DC at 300 Ma. and 90 volts at 18 Ma. Plug-in connections. Black wrinkle finished metal case. Size 6 1/2 x 1 1/2". Ship. wt. 2 lbs.  
**YOUR PRICE.....\$526**



## DC to 110 Volt AC Inverters

With Radio Interference Filter  
 Operates AC radios, sound systems, small appliances, etc. from DC voltage sources. Uses ten contact dual arm vibrator with 1/4" contact points assuring long life and reliable service. Includes voltage regulator, fuse protection and on-off switch. All deliver 110 volts, 60 cycle AC. Size 7 7/8 x 3 1/4". C16863 Size, 7 7/8 x 9 1/2 x 6 1/4". Less interference filter. \*For shavers, etc.



Stock Number	Input Volts	Output Max.	Watts Cont.	Your Price
C16860	6	100	75	\$14.08
C16861	12	125	100	14.08
C16862	110	250	150	15.26
C16863	110	325	225	20.58

**Compact Low Power Inverters**  
 Less interference filter. \*For shavers, etc.

C16864	6*	20	15	\$4.09
C16865	110*	75	35	6.43

## Globe-Union 6 Volt Radio Storage Batteries



Highest Quality materials and workmanship. Extra heavy thick plate construction. Designed especially for radio and P.A. service. Holds charge longer than other batteries of similar capacities. Equipped with handle. F.O.B. Shipping Point Near You. 18 Month guarantee.  
**100 Ampere Hours. A18050—YOUR PRICE \$639**  
**150 Ampere Hours. A18051—YOUR PRICE \$976**  
**180 Ampere Hours. A18052—YOUR PRICE \$1249**

## 10 Ampere Bulb Type Battery Charger



**Charges 1 or 2 Batteries**  
**D16918**—Complete.  
**YOUR PRICE \$1666**  
 For 105-120 Volt, 50-60 Cycle AC Operation  
 A complete charger that can be taken right to the car and connected to the battery. Particularly made for the used car dealer, small or medium sized oil stations, radio stores, etc. Charges batteries at the more efficient 10 ampere rate in about 6 hours. Can be used for charging either 1 or 2 batteries at once at the 10 ampere rate. Uses a bulb type rectifier providing greatest economy, life and performance. Fully guaranteed against transformer burnouts and defective workmanship or materials. Insulation in this charger is fire-proof, moisture-proof and vermin-proof. Easily replaced, plug fuse. Sturdy steel case with carrying handle, size 5 1/2 x 8 1/2" high.

## Hydrometer

Provides accurate readings for all wet cell batteries. Large size, suitable for garage use. Octagon nozzle prevents instrument from rolling. Beaded float does not adhere to side of tube when testing. Length approx. 13".  
**NI1281—YOUR PRICE 28¢**  
**NI1282**—Beaded hydrometer floats. Fit 3/4" tubes. Length 4 1/2".  
**YOUR PRICE 10¢**

## Battery Terminal Connectors

**D11456—18¢**  
**PRICE. Each \$1.69**  
**TEN FOR \$1.69**  
 Fasten to post of any auto storage battery to adapt it for use with radio set. Has binding screw for connecting lead wire.

## Carter Genemotors



Heavy duty "B" power supplies for mobile, marine and aircraft radio, amplifiers and transmitters operating from 6 volt storage battery. Constructed for continuous operation. Sealed oil-less bearings. Brushes replaceable from outside of unit. Size, 2 7/8 x 1 1/2 x 6 1/4" long. Type 420A to 520A inclusive are 7 1/2" long.

Stock Num.	Mfg. Code	DC Output Volts	Output Ma.	Amp. Drain	Your Price
C16830	351A	350	100	10	\$17.64
C16831	355A	350	150	15	19.99
C16832	415A	400	150	20	23.52
C16833	420A	400	200	25	23.52
C16834	425A	400	225	30	24.11
C16835	450A	400	250	33	24.70
C16836	520A	500	200	33	26.46

## Mallory Vibrapacks

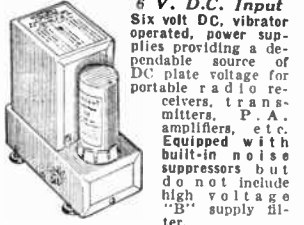

**6 V. D.C. Input**  
 Six volt DC, vibrator operated, power supplies providing a dependable source of DC plate voltage for portable radio receivers, transmitters, P. A. amplifiers, etc. Equipped with built-in noise suppressors but do not include high voltage "B" supply filter.  
**C16837**—VP551. Delivers 125, 150, 175 or 200 DC Volts at 100 Ma. Uses synchronous vibrator.  
**YOUR PRICE.....\$882**  
**C16838**—VP552. Delivers 225, 250, 275 or 300 DC Volts at 100 Ma. Uses synchronous vibrator.  
**YOUR PRICE.....\$1088**  
**C16839**—VP554. Delivers 225, 250, 275 or 300 DC Volts at 100 Ma. Uses tube rectifier. Required only for applications where B—cannot be at ground potential.  
**YOUR PRICE.....\$1176**



# NEWEST Auto Radio Aerials

## Ward Auto Aerials

A Type for Every Installation  
Guaranteed Rust and Rattleproof

Finest quality auto aerials. Designed for quick, easy installation on any automobile—from an old-time "jalopy" to the latest streamliner. Improved anti-rattle telescopic construction, adjustable to any height. Lower sections are made of seamless bronze tubing. Top telescopic rod is of electric bronze with anti-static ball tip. Split proof caps protect ends of tubes. Heavy chrome plated—guaranteed not to rust. 36" low-loss shielded loom lead-in cable included. Lead-in has universal set connector to fit radios with either standard bayonet sockets or Motorola type sockets.

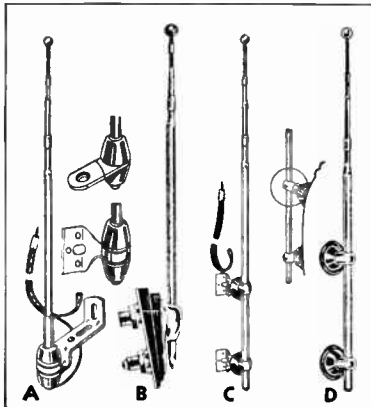

**Type A—Tri-Mount Aerial.** All necessary installation brackets are included to accommodate three types of installations—Side Underhood, Alligator and Hinge.

Stock Num.	Model Num.	Num. Sers.	Adjust. In Hgt.	List Price	Your Price
D15932	T2-48	2	48"	\$1.95	\$1.15
D15933	T3-68	3	68"	2.90	1.70

**Type B—Single Mount Flex-Angle Cowl.** Single stanchion double bolt mounting. By means of an adjusting nut at base the antenna can be swung through a range of 16° so that it will stand vertically on any cowl design.

D15935	E3-68	3	68"	\$3.35	\$1.97
--------	-------	---	-----	--------	--------

**Type C—Double stanchion Under-Hood Cowl.**

D15964	U3-93	3	94"	\$3.65	\$2.15
--------	-------	---	-----	--------	--------

**Type D—Side Cowl.** Double stanchion type with low-loss glazed ceramic insulators. Necessary conversion parts for Torpedo and Chrysler bodies are included.

D15916	5XX1	3	66"	\$2.95	\$1.72
D15917	8X1	3	94"	3.45	2.03
D15930	151L	4	100"	3.95	2.32

**D15906—Single Aerial Display Rack.** Attractive display to help you sell Ward aerials. Mounts any above aerial. With Order for Ward Aerials..... **FREE**

## DeLuxe Auto Radio Aerials for Cowl Mounting

Finest Quality at Substantial Savings

Only finest nationally advertised Auto Radio Aerials compare with the Radolek DeLuxe Auto Aerial line. Guaranteed Rust Proof—Guaranteed Rattle Proof. Require only two small holes to mount on side of car between door and hood. Holes are positively sealed against any possible water seepage. Bottom sections are of corrosion resisting admiralty Bronze with highly polished heavy chrome finish. Top section is rod of polished stainless steel which telescopes into bottom sections. Attractive red catalin ball on top section. Solid right installation quickly and easily made. Each Aerial comes equipped with 36" flexible low loss shielded loom cable lead-in. Have male bayonet type set connector except where otherwise specified.

**D15980—3 Section Cowl Aerial.** Extends to 66" closes to 27".  
**YOUR PRICE, Each in Lots of 6..... 99¢**  
In Single Lots, Each \$1.15

### Additional Cowl Aerial Models

Stock Num.	Num. of Sections	Length Open	Length Closed	Price Each	In 10 Lots Each
D15906	Two	50"	24"	\$0.95	\$0.89
D15979*	Three	66"	27"	1.15	0.99
D15907	Four	66"	20"	1.45	1.28
D15908	Four	96"	29"	1.65	1.44
D15909	Four	117"	35"	1.96	1.84

\*Has Motorola Type plug-in set connector.

### Auto Radio Booster



Improves radio reception. Quickly installed without tools in antenna lead-in circuit of radio. Has male and female bayonet end fittings. Completely shielded.  
**D15919—List Price, 75c.**  
**YOUR PRICE..... 39¢**

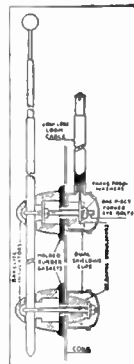

## DeLuxe Concealed Hood Mounting Models

Designed especially for installation on late model cars will also make an excellent installation on older cars. All models incorporate the quality construction features of cowl models shown above. Guaranteed Rust Proof—Guaranteed Rattle Proof. Each aerial comes equipped with 36" flexible low loss shielded loom cable lead-in.

### ← Universal Mounting Type

Three Section extends to 69" closes to 30". Illustrated at left. Comes complete with three mounting brackets. Bottom—For old style "Side lift hood" cars. Top—For new front lift "Alligator" hoods. Center—For hinge pin mounting. Illustrated left.  
**D15981—Has lead-in with male bayonet set connector.**

**D15989—Has lead-in with Motorola type set connector.**  
**YOUR PRICE, Either Type \$1.15**  
In Lots of Six, Each.....  
In Single Lots, Each \$1.24

### → Dual Mounting Type

Three Section extends to 66" closes to 27". Illustrated at right. Double stanchions are adjustable up to 20" apart allowing very rigid installation. Designed for use with cars having straight sided hoods. Illustrated right.

**D15910—Has lead-in with male bayonet type set connector.**  
**D15911—Has lead-in with Motorola type set connector.**  
**YOUR PRICE, Either Type \$1.13**  
In Lots of Six, Each.....  
In Single Lots, Each \$1.25

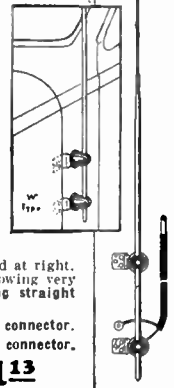
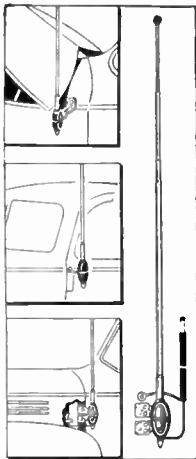

## Ward Concealed Cowl Aerial

Compact—Inconspicuous Installation does not detract from the appearance of even the finest automobile. Easily and quickly installed in any car. Many 1940 cars already have knock-out in hood, eliminating drilling. Antenna when lowered is housed in an air tight moisture proof shielded casing. Aerial sections made of bronze. Guaranteed rustproof. Highly chrome plated. Equipped with 36" low capacity shielded loom lead-in.

**D15968—2 Section,** extends 42".  
List, \$3.75.  
**YOUR PRICE \$2.20**  
**D15934—3 Section,** extends 62".  
List, \$4.25.  
**YOUR PRICE \$2.50**

## Variable Signal Booster

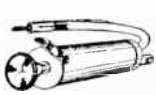

For use in antenna lead-in circuit of any car radio. Provides signal gain of from 5 to 12 Db. Tuneable over entire broadcast range. Has male and female combination Motorola and bayonet end fittings. Mounts below car dash.  
**D15936—List Price, \$1.95.**  
**YOUR PRICE..... \$1.15**

## Standard Quality Auto Radio Aerials

Good Quality Aerials with which you can meet and beat competition. Fully equal to many Aerials selling at much higher prices. Bottom sections are of Admiralty Bronze triple chrome plated. Top section is rod of polished stainless steel. Guaranteed Rust Proof. Insulators are of black glazed ceramic except hinge types which have black rubber insulator. All have 36" plain lead-ins.  
**D15922—Two Section Hinge Mtg.** Extends to 47" closes to 26". Type D.

**YOUR PRICE 49¢**  
In Lots of 6, Each.....  
In Single Lots, Each 65¢

**D15990—Two Section Heavy Duty Hinge Mtg.** Extends to 50" closes to 28". Type D.

**YOUR PRICE 72¢**  
In Lots of 6, Each.....  
In Single Lots, Each 79¢

**D15982—Three Section Cowl Mtg.** Extends to 55" closes to 24". Type A.

**D15983—Three Section Under Hood Mtg.** Extends to 55" closes to 24". Type B.

**D15984—Three Section for Alligator Hood Mtg.** Extends to 55" closes to 24". Type C.

Any one of the above Three Aerials  
**YOUR PRICE 72¢**  
In Lots of Six, Each.....  
In Single Lots, Each 79¢

## Cowl Conversion Kit

Converts any side cowl aerial to fit cars with extremely sloped cowls. Consists of moulded rubber extension block with size 10/32, 2 3/4" long eye bolt.  
**D4018—List Price, 20c.**  
**YOUR PRICE..... 12¢**



# KEYSTONE

## For 6 Volt Auto and Home RADIOS

### Replacement Vibrators

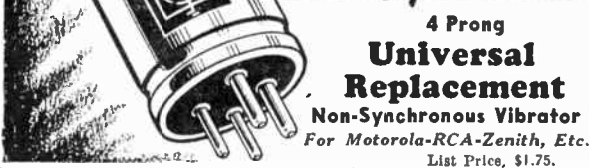

**4 Prong Universal Replacement Non-Synchronous Vibrator**  
 For Motorola-RCA-Zenith, Etc.  
 List Price, \$1.75.  
**Your Price Each 90c**  
 In Lots of 6 or More In Single Lots Each ..... **92c**

### Special Non-Synchronous Vibrators

**D5111-A.** Standard 4 prong plug-in vibrator. Used in certain models of Stewart Warner, Zenith, etc. Size, 3 1/2" x 1 1/2".

**D5186-B.** Special 4 prong plug-in vibrator. Fits standard 6 prong socket. Size, 3 1/2" x 1 1/2". Used in Delco R640. List Each, \$2.95.

**ANY TYPE, YOUR PRICE, Each. 92c.**  
 In Lots of 6 or More, Each.....

**D5119-C.** Six prong plug-in vibrator used in Arvin, A.K., Bosch, Emerson, Ford, Mont. Ward, Silver-tone, Zenith, etc. Size, 3 1/2" x 1 1/2".

to R644 and R663 to R669, United Motors, Silver-tone and Colonial.

### Exact Duplicate Replacements for Philco

**D5100—Replaces Philco part 38-3036 and 41-3186.** Size, 4 1/2" x 1 1/2". Used in all sets up to 1936. 816, 818B-C-P, PT14X, T2, T3, T5, T6, NT15, ST15, PHXD. List, \$3.00.

**D5101—Replaces Philco part 41-3170.** Size, 3 1/2" x 1 1/2". Used in Models 817, 818, 819, 826, 827, 828, and many other 1936, '37, '38 Models. List, \$2.50.

**ANY TYPE, YOUR PRICE, Each. 92c.**  
 In Lots of 6 or More, Each.....

**D5102—Replaces Philco part 41-3398.** Size, 3 1/2" x 1 1/2". Used in Model 920, 921, 922, 936, 937, 938K, C1806, C1608, S1616, P1617, S1622, G1628, P1630 also many other 1938-39-40 sets. List, \$2.50.

**D5114—Replaces Philco part 83-0017.** Used in Model 933 and 1939-40 radio sets. Size, 1 1/2" x 2 1/2". List, \$2.50.

### Exact Replacements for Motorola

**D5102—Replaces Motorola vibrator part numbers 2404, 3333, 3340, 3552 and 38X2333 as used in Models 34, 35, 45, 50, 60, 65, 70, 80, 90 etc. Size 2 1/2" x 2 1/2".**  
**YOUR PRICE, Each, Either Type, 92c.**  
 In 6 Lots or More, Each.....

**D5147—Replaces Motorola vibrator part number 1062 in Models D6 and T8. Size 2x4 1/2".** List, \$3.95.

**90c**

### Popular Genuine Replacement Vibrators

	Philco	Your Price, Ea.	Motorola	Your Price, Ea.
D5385	Philco Replaces #38-5036 and #41-3186	\$1.76	D5399	Motorola #333 \$1.76
D5387	Philco #11-3398	\$1.47	D5392	RCA #12236 2.40
D5386	Philco #41-3170		D5390	RCA #7604 2.23
D5388	Philco #83-0017			

### Synchronous CROSS INDEX OF EQUIVALENT VIBRATORS

Keystone	Mallory	Radiart	Utah	Delco—U.M.S.	Meis. & Elec.
B5149	245, 281, 285	5413, 5409	SP5	5651125, 5053185	715
B5138	273C	4613, 3461	SP51	5039661, 5038055	704
B5146	246, 46	4416, 5411	SP66	5052525	712
B5148	245C, 45C	5410, 2679	SP55	5053181	718
B5113	273D	4611	SP52	5041376, 5043853	718
B5196	248, 286S, 257M	5400, 3883	SP62	5053501, 5052869	723, 728
B5112	514, 715, 515	5426	SP54	6050498	726
B5134	222, 223	3315, 3308	SL5	5053120, 1208152	700

### Non-Synchronous

Keystone	Mallory	Radiart	Utah	Delco—U.M.S.	Meis. & Elec.
B5384	4-4	SU1	Ace	5052378, 5040000	454
B5100	507P	5323	NP483	5042240	P450
B5101	505P	5320	NP49	5042703	P454
B5102	294, 94, 508P	5300, 5325P	NP42	5052378	
B5114	Philco Pt. 83-0017	For 1939	Philco Auto Sets	5050673	
B5196	294C	5303	NP45	5052374	435
B5119	296, 96	3263, 5312	NP6	5052374	452
B5105	221, 292	3313, 2807	NL3	1207758, 5053699	400
B5111	294SW 854	5331	NP43		440
B5147	253	3417	NP89		438

### Reduce Your Stock! Save Money!

You don't have to carry a big stock on hand when you standardize on Keystones. The few Keystones on this page will take care of 98% of your vibrator needs. The other 2% we'll supply on special order at equally attractive prices. For Greatest Customer Satisfaction always replace the Buffer Condensers when replacing Vibrators. Longer life and more efficient performance will result.

**Best Quality! Guaranteed for 1 Year!**  
 Keystone vibrators are finest quality throughout, yet exceptionally low in price. They will work perfectly on any 6 volt receiver. Made for Radolek by one of America's largest vibrator manufacturers. Constructed and tested to conform with R.M.A. Standards, they will give quiet operation and long satisfactory service. Guaranteed for one year against defects in workmanship.

### Special Synchronous Vibrators

**B5149—A.** Standard 5 prong used in Household and Auto Sets such as Arvin, Delco, Emerson, Sentinel, Firestone, RCA & Stew.-Warn. Size, 3 1/2" x 1 1/2".

**B5148—B.** Special 5 prong used in Household sets of Admiral, Continental, Simpler and private brand radios made by them. Size, 3 1/2" x 1 1/2".

**B5112—C.** Special 5 prong vibrator without buffer condensers. Used in R.O.P. United Motors Models 980534-35-66-67 and other sets.

**B5146—D.** Standard 6 prong used in Crosley, G.E., Silver-tone, Traveler, Wells Gardner, Zenith and Silver-tone Home sets. Size, 3 1/2" x 1 1/2".

**B5196—E.** Reversible 6 prong vibrator used in G.E., Mont. Ward, RCA, Wells Gardner, United Motors, Delco and others. Size, 3 1/2" x 1 1/2".

**Housed In Plug-In Type Containers**  
 Finest quality synchronous plug-in type vibrators. Built to exacting standards. Will mechanically and electrically replace many of the synchronous types in present day use.

**ANY TYPE, List, \$4.95.**  
**YOUR PRICE, Each, \$1.95**  
 In Lots of 6 or More, Each..... **\$1.75**

### Plug-In Type Synchronous Vibrators

**With Built-In Buffer Condensers**  
**B5138—Special 5 prong plug-in type vibrator.** Complete with buffer condensers. Used in Buick, Chevrolet, Delco, 625 to 629, General Motors, Oldsmobile, Pontiac, United Motors and other auto radio receivers. Size, 1 1/2" x 2".

**B5113—Special 5 prong plug-in type vibrator with buffer condensers.** Used in Buick, RCA, Delco and others. Size 4 1/2" x 2".

**EITHER TYPE, List, \$5.50.**  
**YOUR PRICE, EACH, \$2.20**  
 In Lots of 6 or More, Each..... **\$1.95**

### Wire Lead Type Vibrators

**Synchronous**  
**B5134—Has 5 leads and self-contained buffer condensers.** Used as replacement for Sparton, Westinghouse, United Motors and Delco Auto Radios. Size, 2 1/2" x 1 1/2" x 1 1/2". List Price, \$5.50.

**YOUR PRICE, Each..... \$2.20**  
 Lots of 6 or More, Each..... **\$1.95**

**Non-Synchronous**  
**B5105—Has 3 leads.** Used in Delco 2035, 4036 etc., Montgomery Ward, Wells Gardner, United Motors, 980383, 980393 and 36441, Stewart Warner and many others. Size, 2 1/2" x 1 1/2" sq. (can be used in your old container. List Price, \$3.45.

**YOUR PRICE, Each..... \$1.25**  
 Lots of 6 or More, Each..... **\$1.10**





**Vibrator Circuit Diagrams**

Illustrations below are given for your convenience in selecting a vibrator for automobile radios of unknown make or model.

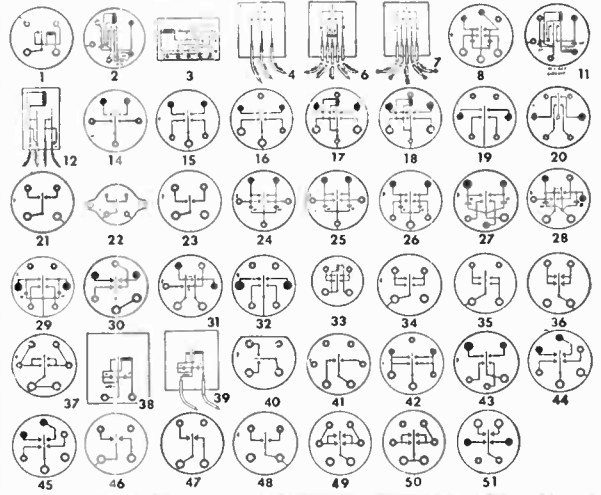

**Most Complete Vibrator Selection**

Mallory, Utah and Radiart Vibrators have achieved an enviable record of excellent performance. Due to the varied preference among the many radio servicemen and dealers, it is necessary for us to list these three most popular makes. Select the proper replacement vibrator from your copy of the manufacturers vibrator guide or specify on your order the radio make, model and any other necessary information, and we will ship you the proper vibrator for your requirements. An exact duplicate replacement is supplied for practically every installation. Long trouble free operation is assured. Vibrators are guaranteed for one year.

**Synchronous Vibrators**

**5 Prong—Plug-in 6 Volt Synchronous**

Mallory		Radiart		Utah		Either Type			
Stock Num.	Mfg. Code	Stock Num.	Mfg. Code	Stock Num.	Mfg. Code	Wtr. Dia.	List Price	Your Price	Lots of 6 Each
C5011	210	C5312	3318			2	\$7.50	\$4.41	\$3.97
C5028	230			C5340	SP5	11	7.50	4.41	3.97
C5014	245	C5287	5400	C5341	SP56	14	4.95	2.91	2.62
C5014	245A	C5285	5413	C5342	SP55	14	4.95	2.91	2.62
C5034	245C	C5276	5410			15	4.95	2.91	2.62
						24	5.95	3.50	3.15
C5046	270B	C5208	3283	C5343	SP51	25	5.95	3.50	3.15
C5047	271			C5344	SP52	26	5.50	3.23	2.91
C5050	273C	C5282	4613	C5345	SP54	27	5.50	3.23	2.91
C5014	273D	C5240	5426			43	4.95	2.91	2.62
C5089	514					43	4.95	2.91	2.62
C5030	716								

**6 Prong—Plug-in 6 Volt Synchronous**

Mallory		Radiart		Utah		Either Type			
Stock Num.	Mfg. Code	Stock Num.	Mfg. Code	Stock Num.	Mfg. Code	Wtr. Dia.	List Price	Your Price	Lots of 6 Each
C5025	224	C5277	5411	C5346	SP66	8	7.00	4.12	3.70
C5041	271	C5245	3789	C5347	SP6	16	4.95	2.91	2.62
C5036	247	C5245	5400	C5348	SP62	17	4.95	2.91	2.62
C5038	248	C5274	5400			19	4.95	2.91	2.62
C5096	275 XS	C5326	4603	C5349	SP68	28	7.50	4.41	3.97
C5054	277R					29	5.95	3.50	3.15
C5058	285 XS					31	7.00	4.12	3.70
C5097	1285Y					30	4.95	2.91	2.62
C5059	286S					32	5.50	3.23	2.94
C5000	722A	C5329	5434	C5351	SP64	44	4.95	2.91	2.62
C5006	728A					45	4.95	2.91	2.62
C5056	951P					16	5.25	3.09	2.77
C5061	954	C5241	5404			51	4.95	2.91	2.62

**7 Prong—Plug-in 6 Volt Synchronous**

Mallory		Radiart		Utah		Either Type			
Stock Num.	Mfg. Code	Stock Num.	Mfg. Code	Stock Num.	Mfg. Code	Wtr. Dia.	List Price	Your Price	Lots of 6 Each
C5039	249	C5275	5406	C5352	SP71	20	4.95	2.91	2.62
C5063	289Y	C5319	4414	C5353	SP72	20	4.95	2.91	2.62
C5021	725					20	5.50	3.23	2.91

**Miscellaneous Synchronous—Plug-in**

Mallory		Radiart		Utah		Either Type					
Stock Num.	Mfg. Code	Stock Num.	Mfg. Code	Stock Num.	Mfg. Code	Volt	No. of Prgs.	Wtr. Dia.	List Price	Your Price	Lots of 6 Each
C5099	W245	C5287	5400	C5354	48P5	4	5	14	\$4.95	\$2.91	\$2.62
C5005	W245A	C5242	5415	C5355	48P56	4	5	14	4.95	2.91	2.62
C5001	W246	C5318	5427	C5356	48P66	4	6	16	4.95	2.91	2.62
C5017	F247	C5260	4404	C5357	32SP6	32	6	18	5.50	3.23	2.91
C5074	G286S					12	6	32	7.50	4.41	3.97
C5081	G725					12	7	20	6.50	3.82	3.44

**Uncased Synchronous**

Mallory		Radiart		Utah		Either Type					
Stock Num.	Mfg. Code	Stock Num.	Mfg. Code	Stock Num.	Mfg. Code	Volt	No. of Prgs.	Wtr. Dia.	List Price	Your Price	Lots of 6 Each
C5022	222	C5216	3315	C5358	SL5	6	6	6	5.50	3.23	2.91
C5023	223					6	6	7	5.95	3.50	3.15
C5024	F223					32	6	7	5.95	3.50	3.15
C5029	231	C5223	4607			6	6	12	7.25	4.26	3.83
C5031	235					6	6	12	7.25	4.26	3.83

**COMPLETE VIBRATOR GUIDES**



Mallory Radiart Utah  
C12534 C12536 C12535

The increased listings of the vibrator replacements prohibits incorporating a complete guide in our catalog. However, complete vibrator replacement guides will be sent FREE on request. Write, or specify on your next order. **FREE**  
Order by above stock number



**Radiart Vibrator Manual and Auto Radio Guide**

C12537—Contains data on vibrators, vibrator "B" power supplies, auto arials, and other useful information. Pocket size, 4 1/2 x 7", 128 pages.  
**YOUR PRICE 25c**  
With Order of Six or More Radiart Vibrators . . . . . **FREE**

**PLEASE NOTE** the extra 10% discount quoted on purchases of 6 or more vibrators. Vibrators may be assorted to obtain this saving.



**Non-Synchronous Vibrators**

**4 Prong—Plug-in 6 Volt Non-Synchronous**

Mallory		Radiart		Utah		Either Type			
Stock Num.	Mfg. Code	Stock Num.	Mfg. Code	Stock Num.	Mfg. Code	Wtr. Dia.	List Price	Your Price	Lots of 6 Each
C5010	205	C5313	3443	C5359	NP482	1	\$6.50	\$3.82	\$3.44
C5041	253	C5226	3417			21	2.95	2.32	2.09
C5043	253Y	C5273	5321	C5360	NP44	22	3.95	2.32	2.09
C5066	294	C5270	5300	C5361	NP42	34	2.95	1.73	1.56
C5091	294C	C5292	5303	C5362	NP480	35	2.95	1.73	1.56
C5068	294SW	C5279	5331	C5364	NP43	36	2.95	1.73	1.56
C5077	500P	C5221	5320	C5365	NP41	34	2.50	1.47	1.32
C5078	501P			C5366	NP44	34	2.50	1.47	1.32
C5004	505P	C5320	5320	C5367	NP49	34	2.50	1.47	1.32
C5015	507P	C5293	5323	C5368	NP483	34	2.50	1.47	1.32
C5016	508P	C5233	5325P	C5369	NP484	34	2.50	1.47	1.32
C5017	510P	C5234	5327P			23	3.00	1.76	1.59
C5002	825					34	4.50	2.65	2.38
C5033	851					47	2.95	1.73	1.56
C5045	860	C5235	5333			47	2.95	1.73	1.56
C5049	901M	C5236	5341M			34	4.50	2.65	2.38
C5050	902M	C5237	5340M			46	2.50	1.47	1.32
C5053	903M	C5239	5342M	C5370	NP485	34	2.50	1.47	1.32

**6 Prong—Plug-in 6 Volt Non-Synchronous**

Mallory		Radiart		Utah		Either Type			
Stock Num.	Mfg. Code	Stock Num.	Mfg. Code	Stock Num.	Mfg. Code	Wtr. Dia.	List Price	Your Price	Lots of 6 Each
C5069	216	C5207	3263	C5371	NP6	37	2.95	1.73	1.56
C5070	217			C5372	NP61	49	3.95	2.32	2.09
C5009	219	C5258	4320			50	3.95	2.32	2.09
C5003	506P	C5327	5324	C5363	NP64	42	3.95	2.32	2.09

**Miscellaneous Non-Synchronous Plug-in**

Mallory		Radiart		Utah		Either Type					
Stock Num.	Mfg. Code	Stock Num.	Mfg. Code	Stock Num.	Mfg. Code	Volt	No. of Prgs.	Wtr. Dia.	List Price	Your Price	Lots of 6 Each
C5008	F204					32	4	1	\$6.75	\$3.97	\$3.58
C5011	F211					32	5	2	7.50	4.41	3.97
C5040	F251	C5224	3395			32	4	21	4.45	2.62	2.35
C5067	F294	C5224	3395			32	4	34	4.45	2.62	2.35
C5071	F297	C5255	4314			32	6	37	4.95	2.91	2.62
C5079	F5021	C5257	4319			32	4	40	5.95	3.50	3.15
C5032	F826					32	4	23	4.75	2.79	2.51
C5072	302S					6	2	38	6.50	3.82	3.44
C5076	F312					32	2	38	7.50	4.41	3.97

**Uncased Non-Synchronous**

Mallory		Radiart		Utah		Either Type					
Stock Num.	Mfg. Code	Stock Num.	Mfg. Code	Stock Num.	Mfg. Code	Volt	No. of Prgs.	Wtr. Dia.	List Price	Your Price	Lots of 6 Each
C5018	220B	C5227	3442	C5373	N13M	6	3	3	3.95	2.32	2.09
C5019	F220C	C5231	3460			32	3	5.00	2.94	2.65	
C5020	221	C5243	3313			6	4	3.95	2.32	2.09	
C5064	292	C5201	2867	C5374	N13	6	4	3.45	2.03	1.82	

**Special Value Universal Vibrators**

**Standard 4 Prong Non-Synchronous Type**

Popular vibrators priced to meet competition. Quality construction. Compact universal size permits this vibrator to be used in hundreds of receiver models including: Airline, Arvin, A.K., Crosley, Delco, Emerson, Fairbanks-Morse, G.E., Motorola, Philco, RCA, Radiolec, Sencel, Silvertone, Stewart-Warner, Trav-Ler, Wells-Gardner, Zenith and many others. Fits standard 4 prong socket and measures only 1 1/2 x 3 1/2".

C5098—Mallory "4-4" Vibrator  
C5375—Utah "ACE" Vibrator  
C5244—Radiart "SUPERIOR" Vibrator



**93c**

List Price, \$1.75.  
In Lots of 6 or More, Each . . . . . **\$103**  
In Single Lots, YOUR PRICE, Each . . . . . **\$103**

# Crowe Auto Radio Remote Controls STAR

## Panel Kits for Use with Crowe and Star Control Head Mechanism



Provides custom instrument panel installation for the majority of auto radio sets in most cars. Each kit contains correct type of escutcheon, dial assembly, mounting hardware and knobs.

### Crowe Panel Kits

Supplied with porthole, slide-rule and round dials (according to car) calibrated 55 to 150 for clockwise shaft rotation. (If 150-55, 0-100 or 100-0 is wanted, please specify on order.)  
List Price, \$3.00.  
**YOUR PRICE, Each Kit... \$1.76**

### Star Panel Kits

Available only with round dials calibrated 55 to 150 which is adapted to fit all automobiles. Can be used for either clockwise or counter-clockwise condenser shaft rotation.  
List Price, \$2.25.  
**YOUR PRICE, Each Kit... \$1.32**

### Crowe Plates

Stock Num.	Automobile	Stock Num.
C10810	BUICK '40	C13964
C10888	Buick '39	C13900
C10866	Buick 40, 60, 80, 90, '38	C13901
C10800	Buick '37	C13902
C10802	Buick '36	C13904
C10896	Cadillac '40	D13976
C10817	CHEVROLET '40	D13977
C10889	Chevrolet '39	C13906
C10868	Chevrolet '38	C13907
C10804	Chevrolet '37	C13908
C10805	Chevrolet '36	C13909
C10806	Chevrolet '35	C13909
C10819	CHRYSLER '40	C13966
C10883	Chrys. All '38	C13910
C10808	Chrys. Imperial '37	C13911
C10808	Chrys. Royal '37	C13913
C10825	DESOTO '40	C13967
C10890	DeSoto '39	C13914
C10882	DeSoto '38	C13915
C10815	DeSoto '37	C13916
C10826	DODGE '40	C13968
C10891	Dodge '39	C13917
C10869	Dodge '38	C13918
C10820	Dodge '37	C13919
C10827	FORD '40	C13969
C10892	Ford '39	C13922
C10871	Ford '38	C13923
C10824	Ford '35	C13924
C10824	Ford Deluxe early '36	C13925
C10824	Ford Std. early '36	C13926
C10828	Ford Std. late '36	C13927
C10830	Ford Deluxe '37	C13929
C10831	Ford Standard '37	C13930
C10832	Ford '34	C13931
C10873	HUDSON '40	C13970
C10837	LaFayette '37	C13932
C10838	LaFayette '36	C13933
D10807	LaSalle '40	D13977
C10870	Lincoln Zephyr '38	C13935
C10823	Lincoln Zephyr '37	C13936

Above listing contains only popular types. We can supply plates for most cars.

## Star Control Head Mechanism

One Star control mechanism with other supplementary units listed below and a panel kit listed at left fits all cars and all radios. Adjustable to fit all types of installations. No drilling or filing necessary. Supplied with interchangeable gears to provide ratios of 6, 8, 10, 12 and 16 to 1, either clockwise or counter-clockwise. A pair of end fittings, housing adapters, pilot light socket with bulb and lead, and mounting hardware are also furnished. No plate kit included. Less switch and tone control.

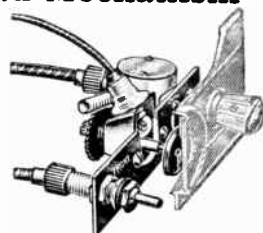

C14010—Code 3801. List, \$3.50.  
**YOUR PRICE..... \$2.06**

### Tone Controls

Tone and volume control combination with wing knob. Displaces volume control unit on above control head mechanism.

**Less Switch**  
C14011 Code T-1. Tap Type Control.  
C14012 Code T-2. Continuously variable 100,000 ohm control.  
**YOUR PRICE, Each..... \$1.18**

**With Switch**  
With on-off switch, fuse retainer, pilot light socket, bulb and leads.  
C14013—Code ST-1, 3 Tap Type.  
C14014—Code ST-2, Continuously variable, 100,000 ohms.  
**YOUR PRICE, Each..... \$1.76**

### Molded Knobs

Tapered design  $\frac{3}{8}$ " long,  $\frac{3}{8}$ " dia. For  $\frac{1}{2}$ " and  $\frac{1}{4}$ " shafts.  
**PRICE EACH 9¢**

Stock Number	Color	Stock Number
C14000	Black	C14005
C14001	Brown	C14006
C14002	White Tenite	C14007
C14003	Pearl Gray	C14008
C14004	Chrome	C14009

### Ready Made Cables

Consists of a pair of flexible shafts and housings with fittings to exactly fit either Crowe or Star control head mechanisms. Other end exactly fits radios specified, 23" Long.  
C14030—For Arvin 1939, '38, '37  
C14031—For Delco 1939, '38, '37  
C14032—For Philco 1937, '36, '35  
List Price, \$1.75.  
**YOUR PRICE, Either set \$1.03**  
**Single Cable with End Fittings**  
C14033—For Philco 926, 927, 928K  
C14034—For Philco 936, 937, 937K, 938K and 938KX. List, 85¢.  
**YOUR PRICE, Each..... \$0.66**

### Attachable Switches

Mounts in place of plate on tuning unit of above mechanism.  
C14015—Code S-1, SPST Switch with fuse retainer, pilot light socket and with bulb and leads. For power on-off use. List, \$1.00.  
**YOUR PRICE 59¢**

C14016—Code S-2, SPST Switch only for sensitivity (local-distance) use. No leads included.  
**YOUR PRICE..... 29¢**

### Chevrolet Panel Plates

For 1939  
C13963  
**YOUR PRICE \$2.06**

For 1940  
D13984—**YOUR PRICE \$1.76**

Only this plate is necessary to retain all your 1936, 1937, or 1938 Delco LMS or Chevrolet custom built radio into the 1939 Chevrolet car. Sturdily constructed and finished to match car dash. Easy to install.

### Star Conversion Kits

**For Delco and Philco Sets**  
C14017—Converts any 1939, '38, '37, '36 or '35 Delco Auto Radio for use with any Star Panel Kit listed at left. Consists of 12 to 1 ratio tuning control unit, combination volume control unit with on-off switch and tone control, all necessary plugs, flexible shafts and hardware for easy installation.  
**YOUR PRICE..... \$4.14**  
C14018—For Philco 1939, 1939 Auto Radios. Includes complete control head mechanism with flexible shaft, fittings, etc. for use with any Star Panel Kit listed at left.  
**YOUR PRICE..... \$4.17**

## Crowe Control Head Mechanism

### Volume and Tone Control Units

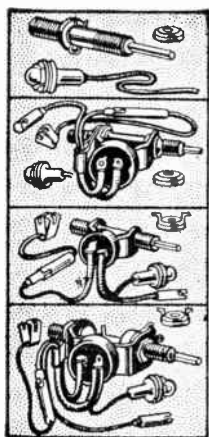

C10762—Code 700-V1. Volume control only. No switch. No built-in tone control.  
List, 75¢.  
**YOUR PRICE 44¢**

C10763—Code 700-V2. Volume control with switch operated by volume control knob.  
List, \$1.85.  
**YOUR PRICE \$1.09**

C10764—Code 700-V3. Volume control with independent switch operated by wing knob.  
List, \$1.85.  
**YOUR PRICE \$1.26**

C10765—Code 700-V6. Volume control with switch and built-in continuously variable tone control unit. (Switch is operated by volume knob, tone by wing knob.)  
List, \$2.90.  
**YOUR PRICE \$1.65**

For use in conjunction with tuning control units listed at right. Fits flexible shafts with tongue type end fittings. (Type 2 on Page 158.) Select the proper unit in accordance with the requirements of the radio you are installing. All units include pilot light bulb with bracket and 24" lead. Switch type units include fuse, fuse holder and connection wire. Built-in tone controls, are of the continuously variable type and mounted in unit.

C10769—Code 700-V81. For Philco models 926, 927, 928K, 936U, 937, 937K, 938K and 938KX. Special volume control unit connected to radio by electrical leads not by flexible shaft. Includes volume control on-off switch, fuse retainer with fuse, light socket with bulb and all leads.  
**YOUR PRICE..... \$2.65**

C10770—Code 700-V85. For Delco '37 and '38 models including R-676 ('39). Similar to code 700-V6 except also includes shielded tone control lead with pin plug.  
**YOUR PRICE..... \$2.09**

### Plug Button Assortment

D10899—Code S-17579. Chrome plated snap-on buttons designed to conceal holes in panels, automobiles, etc. Contains 40 pieces, 10 each of sizes to fit  $\frac{1}{8}$ ",  $\frac{3}{16}$ ",  $\frac{1}{4}$ " and  $\frac{5}{16}$ " dia. holes.  
**YOUR PRICE, Per Set of 40 \$73¢**

## Tuning Control Units

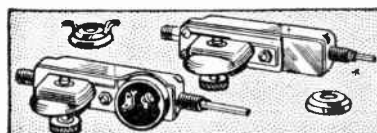

For use with volume control units. Switches operated by secondary wing knob are for sensitivity and tone control purposes only. (Power supply switch should be controlled by volume control unit.) To determine gear ratio of any condenser first open condenser and then count turns of flexible shaft required to close condenser. Multiply this figure by two.

**Less Switch** List, \$1.75. **YOUR PRICE, Each... \$1.03**  
**With Switch** List, \$2.35. **YOUR PRICE, Each... \$1.38**

Gear Ratio	No Switch		With Switch	
	Stock Number	Code Number	Stock Number	Code Number
6 to 1	C10750	706-T1	C10759	712-T2
8 to 1	C10751	710-T1	C10760	716-T2
10 to 1	C10752	710-T1	C10761	720-T2
12 to 1	C10753	712-T1		
14 to 1	C10754	716-T1		
16 to 1	C10755	720-T1		



# Auto Aerials and Accessories

## RUNNING BOARD AERIAL

Completely Sealed In Rubber

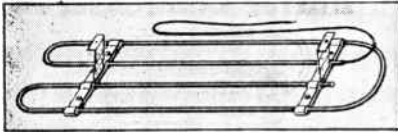

Mounts under running board, using bolts or holes which are already in the running board supports. No drilling necessary. Brackets are adjustable along entire length of aerial. Aerial consists of continuous 15 ft. length of steel rod fully sealed in rubber covering which provides protection against all weather conditions. Moisture, ice or mud does not affect aerial nor interfere with radio reception. Will not rattle. Size: 46" long. Includes 36" lead-in wire.

### Use the BUMPER for the AERIAL

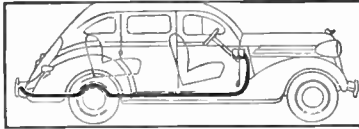

### Does Not Weaken Bumper

A15948—Complete set of fittings including—four rubber insulated brackets, 5 foot insulated shield cable for front, 10 foot regular cable for rear and 5 mounting clips. Full instructions for easy installation included. 1st Price, \$4.50. **YOUR PRICE, \$2.65**

A practical satisfactory answer to the antenna question. By insulating the rear bumper it will provide maximum pick-up with elimination of projecting poles, rods, etc. Reduces fading. Less static. Shielded lead-in and distance of bumper from ignition system insures least electrical interference. Fits all cars and all bumpers. Easily and quickly installed.

## Auto Radio Cable Fittings

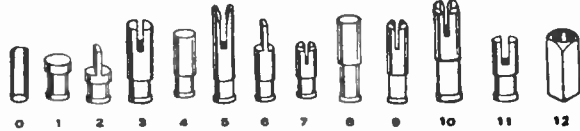

A type for every cable now in use. Match old fitting with illustration and order by stock number. Best quality. Made of brass. Exact duplicates of fittings used on the majority of auto radio cables.

Stock Num.	Type	Your Price	Stock Num.	Type	Your Price	Stock Num.	Type	Your Price
D10710	0	<b>3 1/2c</b>	D10718	8	<b>5c</b>	D10716	6	<b>6c</b>
D10711	1		D10719	9				
D10717	7	<b>5c</b>	D10713	3	<b>5 1/2c</b>	D10720	10	
D10712	2		D10715	5		D10704	12	
D10714	4							

## Cable Service Machine

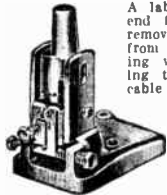

A labor saving cable end fitting tool that removes old fittings from cable and housing without destroying them, swages cable to prevent unraveling and clamps fittings on cable and housing. For use with either .130" or .150" cables. Can be used in ordinary vise or with base. Easy to use. Made of hardened tool steel. 6 3/4" high overall with base.

C10727—For use in vise. No base is included. **YOUR PRICE, \$7.35**

C10728—Heavy Base for above tool. Can be permanently mounted to work bench. Bolts included. **YOUR PRICE, \$2.94**

## Cable Housing Ends



For securing cable housing to remote control head mechanisms or radio receiver. A and B are for use with "C" and fit 1/4" cable housings listed below. C has inside thread diameter of 3/8". D and E are for new 3/8" cable housings used on the majority of 1937 radios. D has inside diameter of 3/8" and fits "Crowe and Star dial mechanisms. Made of rust proof material.

C10730—Type A } Price **3 1/2c**  
 C10708—Type E } Each  
 C10731—Type C } Price **4c**  
 C10707—Type D } Each

C10729—Type A Each **5 1/2c**

**Housing Adaptor**  
 C10725—Holds 3/8" and 1/2" auto radio cable housing to control mechanisms. Fits Crowe, Star, etc.  
 Your Price, Each... **24c**

## Cable Only



Highest quality flexible shaft. Properly swaged at ends to prevent unraveling. No fittings are included.

Length Inches	Stock Number	1st Price	Your Price
18	K10736	40c	24c
24	K10737	50c	29c
30	K10738	60c	36c
36	K10739	75c	42c

## Casing Only



Parkerized rust proof finish. Casing easily cut to size required. 3/4" Dia.

Length Inches	Stock Number	1st Price	Your Price
18	K10744	30c	13c
24	K10745	35c	15c
30	K10746	45c	26c
36	K10747	55c	31c

## Low Loss Auto Antenna Lead-in Cable



Specially designed low-loss lead-in cables for use on practically every auto radio and aerial. Antenna lead is protected by a shielded loom covered with process braided heavily lacquered. One end has a bayonet male connector for plugging into auto radio.

Stock Num.	Length	Type Terminal for Antenna	Your Price
B4741	2 ft.	Female	<b>26c</b>
B4742	2 ft.	Male	
B4740	2 ft.	Eyelet	26c
B4743	4 ft.	with	38c
B4744	6 ft.	Ground	49c
B4745	8 ft.	Connection	72c

## For Motorola Sets

C4747—36 Inch Lead-in. Set end has small pin type plug to fit Motorola Radios. Antenna end has eyelet with ground connection.  
**YOUR PRICE, Each... 38c**

## Midget Shielded Auto Radio Connectors



Positive contact, small size. Single terminal with shield. Will stand severe vibration. Cadmium plated.  
 C12021—Plug. **YOUR PRICE, 6c**  
 C12022—Line Jack. **YOUR PRICE, 15c**  
 C12023—Chassis Jack for above plug (not shown). **YOUR PRICE, 9c**

## Plugs and Jacks

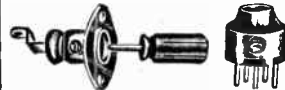

### Motorola Type

D12024—Plug Each **6c** Ten for **54c**  
 D12025—Jack Each **12c** Ten for **\$1.10**

### Buick Type

D12026—Plug } Each **12c**  
 D12027—Socket } Ten for **\$1.10**

## Cable Adapters



Allows the plugging in of cables, ending in male bayonet type connectors, into antenna input sockets of Motorola and Buick auto sets. Every auto radio service shop should keep a supply on hand at all times.  
 D4014—Connects between Bayonet type male output and Motorola input Jack.  
 D4015—Connects from Bayonet male output plug to Buick input.  
**YOUR PRICE, Ea. 15c**  
 Either Type... Ten for **\$1.35**

## Antenna Coupler

Two piece metal container. Has bayonet lock ends. Powerful spring contact insures perfect electrical connection for conductor inside shield.  
 B11426—YOUR PRICE, Each **4c** Ten for **25c**



**Fuse Retainer**  
 For 3AG SFE14, or SFE20 type fuses. Cadmium plated steel shell, to which shielding will solder. Size 2 1/2 x 3/8".  
 B11425—YOUR PRICE, Each **4c** Ten for **35c**  
 C11419—Jumbo Fuse Holder, 2 1/2 x 3/8". Used in Delco, Philco, Motorola and others. For 3AG, SFE14, SFE20, or SFE30 type fuses.  
**YOUR PRICE, 10c**  
 EACH... 10 for **89c**

## Type 3AG Fuses

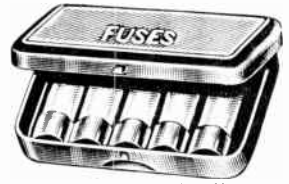

### BEST QUALITY

For Automotive and Radio use. Packed 5 fuses in a handy metal box. Boxes may be assorted to obtain quantity price.

Stock Number	Amps	Box of 5	20 Boxes For
B11103	20	<b>5c</b>	<b>95c</b>
B11102	15		
B11101	3	<b>11c</b>	<b>\$1.95</b>
B11100	2		

### SFE Type 1/4" Dia.

Stock Num.	Amps	Lgth.	Box of 5	Per 100
D11104	14	1 1/4"	7c	\$1.25
D11103	20	1 1/4"	5c	.95
D11199	30	1 1/4"	10c	1.85

## Wheel Static Collector

For All Cars  
 B3950—**YOUR PRICE, Ea. 5c**  
 10 for **37c**  
 Eliminates radiation of static created by the front wheels of automobiles. Simply installed in the hub cap.

## Auto Antenna Replacement Parts Fit ICA and Other Aerials



### For Hinge Aerials

D4000—Rubber Insulator. 1/2" #20 bolt on ea. end. **YOUR PRICE, Each... 18c**  
 D4001—As above but with hinge pin clamp on bottom. **YOUR PRICE, Each... 29c**

### For Cowl Aerials

Moulded bakelite insulator. Upper type has two holes in sides for passage of tube through insulator. Lower type has only one hole in side. No brass inserts are supplied.

Stock Upper	Numbers Lower	Tube Hole	Price Each
C4002	C4006	1/4"	<b>21c</b> Ten for <b>\$1.95</b>
C4004	C4008	3/8"	
C4005	C4009	1/2"	

Brass inserts for above. Has 10/32 screw attached. No nuts included.

C4010—For 1/4" Tubes } **9c**  
 C4011—For 3/8" Tubes } Each  
 C4012—For 1/2" Tubes } Ten for **81c**

C4013—Rubber Gaskets for above cowl insulators. Ten for **55c**. Each... **6c**

## Antenna Coupler



**Signal Booster for all Auto Radios**  
 Connects in antenna circuit of auto radio. Increases signal strength. Mounted in moisture proof, shielded, metal connector. Operates efficiently with any type receiver.  
 D4016—Bayonet Type  
 D4017—Motorola Type  
**YOUR PRICE, Each... 24c**  
 Ten for **\$2.16**

# AUTO RADIO NOISE SUPPRESSORS

## Powerflo Auto Spark Suppressors

Inductive Wire Wound

Low Resistance

Saves Gasoline

For Spark Plugs

D3958—Type A

For Distributor

D3960—Type B

Either type

Your Price, **20c**

10 for \$1.79

Special Plug Type

For Ford V8.

D3959—Type C

Your Price, **25c**

10 for \$2.20

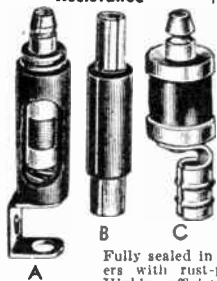

Steps radio noises—suppresses disturbances in electrical system that cannot be eliminated otherwise—prevents reduction of speed—insures full engine power—allows faster acceleration—saves excess fuel. The Niehroms Wire Core that is used gives thousands of miles more service from spark plugs, coil and ignition points, than any type of carbon suppressor! A full flow of current from distributor to spark plugs without interruption—efficiency is constant. Not affected by heat or humidity. Will not break, crack down or burn out at any speed. Resistance 12,500 ohms. Ford type 25,000 ohms resistance.

## Master Distributor Noise Suppressor

Eliminates Individual Spark Plug Suppressors

B3957—List Price, 50c.

YOUR PRICE **27c**

10 for \$2.45

New inductive type. Eliminates necessity of individual spark plug suppressors and on most late model cars will give as good results. Mounts in center socket of distributor cap only. On cars with dual ignition systems two are required. Impervious to heat, oil and moisture. Resist. 10,000 ohms.



## Compact Suppressors

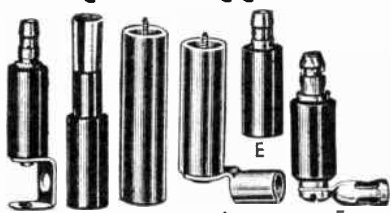

## Highly Efficient

K3961—Type A Spark Plug Type **75c**

K3962—Type B Distributor Type **8c**

K3963—Type C Cable Type **81c**

K3964—Type D Elbow Type **81c**

K3965—Type E Regular, 10,000 ohms **8c**

D3974—Type E '39-'40 Fords, 20,000 ohms **8c**

A3966—Type F Regular, 10,000 ohms **8c**

D3975—Type F '39-'40 Fords, 20,000 ohms **8c**

\*Fit all makes of connecting wires. End terminal screws open for connecting wires.

Latest design new small size suppressors for use on new model cars. Highly efficient noise suppressors for auto-radio installations. Carbon resistance element is encased in a heat-proof and moisture-proof tube. Metal parts are securely fastened. Leakage is at an absolute minimum.

## Noise Eliminator Distributor Brush for Ford V8

Replaces Original

Brushes

C3976—For 1933, '34, '35, '36 Fords.

C3977—For 1937, '38, '39 Fords.

List Price, 30c.

YOUR PRICE, EACH **9c**

Ten for **81c**

A high resistance brush for the distributor of the Ford V8 to eliminate radio interference. Takes the place of the original distributor brush and acts as the distributor suppressor.



## Auto Spark Suppressors

Saves Gas and Improves

Performance

200 Ohm Inductive Type

A new type low resistance Automobile ignition noise suppressor.

Inductive type. Presents very high impedance to the oscillator discharge of an ignition spark but less than 200 ohms to the initial surge which fires the cylinder. Filter is of solid, vibration proof construction, moisture

resistant by motor heat, and oil proof, not affected this item both as an improved filter and as an economy item. The low resistance usually results in 2 to 5 miles more per gallon of gas. The jerky idling of a motor with high resistance suppressors is smoothed out.

K3964-B—Distributor Type.

K3963-A—Spark Plug Type.

K3966-C—Slip-on Suppressor

List Price, 60c. YOUR PRICE **27c**

10 for \$2.40

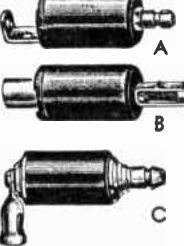

as an economy item. The low resistance usually results in 2 to 5 miles more per gallon of gas. The jerky idling of a motor with high resistance suppressors is smoothed out.

K3964-B—Distributor Type.  
K3963-A—Spark Plug Type.  
K3966-C—Slip-on Suppressor  
List Price, 60c. YOUR PRICE **27c**  
10 for \$2.40

## Eliminates Motor Noise

### Interferotrol

A Scientifically Designed Auto Radio Noise Eliminator

A highly efficient easily installed ignition noise eliminator which does not interfere in any way with the functions of the car ignition system. For noise-free Auto Radio reception. Consists of a combination high-frequency filter and an adjustable balancing circuit that completely eliminates the use of spark plug suppressors. Shielded metal container fitted with bracket for mounting. Installed in series with antenna lead of receiver.

D9980—List, \$2.25.

YOUR PRICE **\$1.04**



## Capacitive and Inductive Type Auto Filter Units

A Filter For Every Purpose

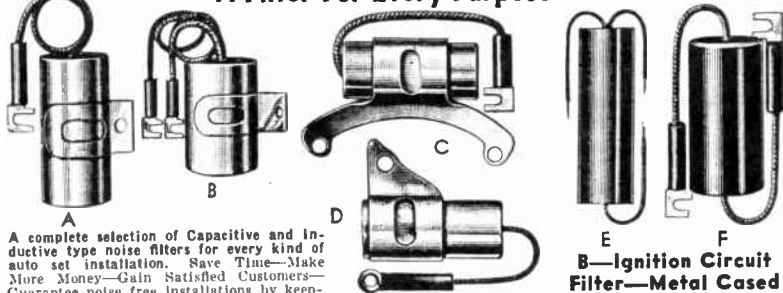

A complete selection of Capacitive and Inductive type noise filters for every kind of auto set installation. Save Time—Make More Money—Gain Satisfied Customers—Guarantee noise free installations by keeping your shop fully prepared with a selected stock of these items to effectively and promptly service all types of noisy installation complaints.

### A—For Ignition Coils & Accessories

Filter Condensers—For use on Interruptor and battery sides of Ignition coil, tail light, windshield wiper, heater and other electrical accessories. D8665, D8666 and D8667 are especially desirable for use on car generators. Use D8667 where car generators are set to charge over 18 amperes.

D8665—5 Mfd. Size  $\frac{1}{2} \times \frac{1}{2} \times \frac{1}{2}$  long.

Your Price Ea. **11c**

10 for **98c**

D8664—.25 Mfd. Size  $\frac{1}{2} \times \frac{1}{2} \times \frac{1}{2}$  long.

YOUR PRICE, **12c**

10 for **\$1.10**

D8666—1.0 Mfd. Size  $1 \frac{1}{2} \times \frac{1}{2} \times \frac{1}{2}$  long.

YOUR PRICE, **20c**

10 for **\$1.80**

D8667—1.5 Mfd. Size  $1 \frac{1}{2} \times \frac{1}{2} \times \frac{1}{2}$  long.

YOUR PRICE, **32c**

10 for **\$2.90**

### B—Generator Noise Filter—

Two 5 Mfd. capacitors properly grounded for connection across generator cut out. Kills interference resulting from an idling generator as well as from higher charging rates—a feature not found in single section units. Size  $1 \frac{1}{2} \times 2 \frac{1}{2} \times \frac{1}{2}$ .

D8669—Dual 5 Mfd. filter. Metal Cased.

List Price, \$1.50.

YOUR PRICE, Each **34c**

## Buffer Condensers



### For Auto Radio Replacements

OIL FILLED—WAX FILLED  
1600 WKG. VOLTS D.C.

The condensers offered here are of exact specifications required for auto receivers and are of a make used by many of the foremost receiver manufacturers as original equipment. Because of unusually severe conditions existing in electrical systems of most automobiles, the original condensers are frequently damaged to such an extent as to require replacement. You will make and save money by stocking and using these condensers and yet be assured of the very best quality and dependability. Stock is always fresh and clean. SPECIAL NOTE: Vibrator manufacturers recommend replacement of buffer condensers whenever a new vibrator is required in an auto radio receiver. This is to insure satisfactory vibrator service and longer vibrator life.

**Oil Filled—Metal Shell Type—1600 Volt**  
Condensers are securely sealed in compact cylindrical metal containers. Fully insulated waxed cardboard tube overall. Tinned copper wire leads 2 1/2 inches long. Impervious to moisture.

Stock Num.	Cap. Mfd.	Size Dia. x L.	List Price	Net Each	Ten For
D8750	.005	1/2 x 1 1/4	45c	19c	\$1.69
D8751	.01	5/8 x 1 1/4	55c	24c	2.19
D8752	.02	3/4 x 1 3/8	60c	27c	2.43

### Wax Filled Type—1600 Volt

Oil impregnated paper windings, placed in treated fibre tube, the entire condenser being then thoroughly sealed in moisture proof wax. Tinned copper wire leads 2 1/2 inches long.

Stock Num.	Cap. Mfd.	Size Dia. x L.	List Price	Net Each	Ten For
D8753	.005	1/2 x 1 1/4	35c	16c	\$1.39
D8754	.01	5/8 x 1 1/4	40c	18c	1.59
D8755	.02	3/4 x 1 3/8	45c	20c	1.79

## Capacitive and Inductive Type Auto Filter Units

A Filter For Every Purpose

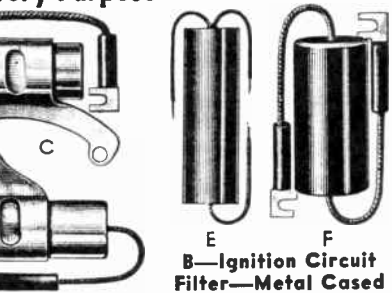

A complete selection of Capacitive and Inductive type noise filters for every kind of auto set installation. Save Time—Make More Money—Gain Satisfied Customers—Guarantee noise free installations by keeping your shop fully prepared with a selected stock of these items to effectively and promptly service all types of noisy installation complaints.

### A—For Ignition Coils & Accessories

Filter Condensers—For use on Interruptor and battery sides of Ignition coil, tail light, windshield wiper, heater and other electrical accessories. D8665, D8666 and D8667 are especially desirable for use on car generators. Use D8667 where car generators are set to charge over 18 amperes.

D8665—5 Mfd. Size  $\frac{1}{2} \times \frac{1}{2} \times \frac{1}{2}$  long.

Your Price Ea. **11c**

10 for **98c**

D8664—.25 Mfd. Size  $\frac{1}{2} \times \frac{1}{2} \times \frac{1}{2}$  long.

YOUR PRICE, **12c**

10 for **\$1.10**

D8666—1.0 Mfd. Size  $1 \frac{1}{2} \times \frac{1}{2} \times \frac{1}{2}$  long.

YOUR PRICE, **20c**

10 for **\$1.80**

D8667—1.5 Mfd. Size  $1 \frac{1}{2} \times \frac{1}{2} \times \frac{1}{2}$  long.

YOUR PRICE, **32c**

10 for **\$2.90**

### B—Generator Noise Filter—

Two 5 Mfd. capacitors properly grounded for connection across generator cut out. Kills interference resulting from an idling generator as well as from higher charging rates—a feature not found in single section units. Size  $1 \frac{1}{2} \times 2 \frac{1}{2} \times \frac{1}{2}$ .

D8669—Dual 5 Mfd. filter. Metal Cased.

List Price, \$1.50.

YOUR PRICE, Each **34c**

### "A" Line R.F. Filter

Two .5 Mfd. condensers and a choke in a single can with two flexible leads for connecting in series with A supply to radio. Overcomes interference resulting from unbalanced ignition circuits caused by varying rates of battery charge. Size  $1 \frac{1}{2} \times 2 \frac{1}{2} \times \frac{1}{2}$ .

D8668—Dual Capacitor and Choke. **39c**

List Price, \$1.75. YOUR PRICE, Each... **39c**

### C & D—Ford Distributor Filter

Especially designed for the Ford V8 distributor. Metal bracket exactly fits bolts in distributor can. YOUR PRICE

D8672—Type C, for '31 '35 '36 Each, Net

D8673—Type D, for '37 '38 Any, Net

D8674—Type A, for '39 '40 Type **17c**

Ten for **\$1.59**

### E—Efficient Dome Light Filter—

A .5 Mfd. capacitor and choke in moisture sealed fiber tube especially developed for eliminating dome light interference. Can also be used to kill stubborn interference resulting from other lighting and electrical accessories. Fiber case.

D8671—Dome Light Filter. Size 1x3.

List Price, \$1.50. YOUR PRICE, Ea. **24c**

Ten for **\$1.95**

### F—Where Mounting is Not Grounded

A .5 Mfd. filter used for concealed-in- upholstery installations or where no-grounded mounting is available. Size  $1 \frac{1}{2} \times 2 \frac{1}{2} \times \frac{1}{2}$ .

D8670—In Moisture Sealed Fiber Case. **13c**

YOUR PRICE, Ea. **13c**



# SPEAKER BAFFLES - P.A. CARRYING CASES

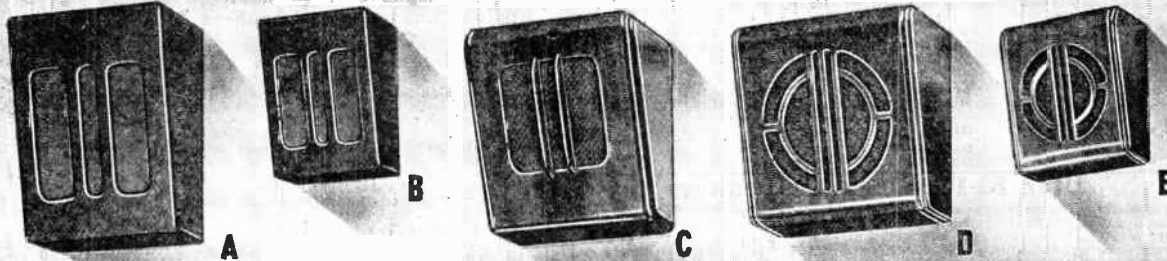

## Speaker Wall Baffles for Extension Uses

Provide a convenient means of mounting extension speakers for proper sound distribution. Can be placed or mounted in any desired position on desk or wall. Grille design provides ample protection for speaker and eliminates other vibration producing protective materials.

**D15700—Type A—Blue Fabric Covered Baffle.** For up to 12" speakers. An economical speaker wall baffle made of 3/4" plywood. Includes speaker mounting board with hole cut for 12" speaker. Size, 13 1/2"x16 1/2" high, 5 1/2" to 8 1/4" deep.  
**YOUR PRICE, Less Speaker, ..... \$1.95**  
In Lots of 10 or More, Each **\$1.75**

**D15701—Type B—As above but for 8" Speakers.** Size 5 1/2"x11" high, 6" deep at bottom.  
**YOUR PRICE, Less Speaker, ..... \$1.45**  
In Lots of 10 or More, Each **\$1.35**

**D15646—Type C. 12" DeLuxe Walnut Veneer Type Wall Baffle** in polished walnut finish Extra well built, designed for DeLuxe appearance and performance. For use with highest priced P.A. installations. Takes up to 12" speakers. 3/4" Side panels. Heavily reinforced. Open back. All corners rounded. Square rounded—corner speaker opening has two 1 1/2" vertical walnut fins. Grille cloth. Size, 14 1/4"x15" high, 5 to 9 1/2" deep.  
**YOUR PRICE, Less Speaker, ..... \$4.20**  
In Lots of 10 or More, Each **\$3.95**

**D15642—Type D. 12" Walnut Finished Baffle.**  
**D15644—Type D. 12" Unfinished Baffle** ready for painting any color. Takes up to 12" speakers. Made of veneer with 3/4" side panels. Reinforced. Rounded corners. Grille cloth. Size 14 1/4"x14 1/4"x6 to 9" deep.  
**YOUR PRICE, ..... \$3.45**  
Either Type, Less Spkr. ....  
In Lots of 10 or More, Each **\$3.25**

**D15643—Type E. 8" Walnut Finished Baffle.**  
**D15645—Type E. 8" Unfinished Baffle** for painting. Takes up to 8" speaker. Size 9 1/2"x10 1/2"x1 to 6 1/2" deep. Same construction as above except has 1/2" side panels.  
**YOUR PRICE, Either Type, Less Spkr. .... \$2.10**  
In Lots of 10 or More, Each **\$1.85**

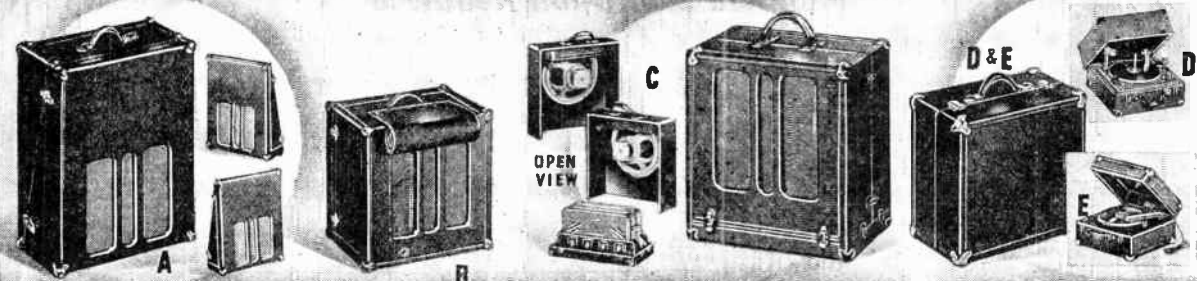

**A—Dual Speaker Case**  
A split type carrying case that will house two speakers up to 12" in size. Speaker openings covered with grille cloth and protected by vertical bars. Sections serve as speaker baffles and may be placed on floor or hung from wall. Each section contains bracket for holding up to 50 feet of speaker cable. Constructed of sturdy plywood, covered with waterproof blue fabricoid. Metal reinforced corners. Carrying handle. Rubber bumpers at top and bottom. Heavy snap fasteners. Closed size, 21 1/2" high, 16 1/4" wide, 9" deep.  
**D15816—Less speakers, ..... \$4.95**  
**YOUR PRICE, ..... \$4.95**

**B—Single Speaker Case**  
Durable Fabricoid covered plywood case with metal corner guards. Takes 8" to 14" cone speaker. Removable back fitted with snap type clasps and brackets for holding up to 50 ft. of speaker cable. Ample baffle surface for excellent tone reproduction. Grille cloth covered opening. Button-up Fabricoid flap over speaker opening. Size, 13x13x11 1/2".  
**D15824—Less speaker, ..... \$4.75**  
**YOUR PRICE, ..... \$4.75**  
**D15823—Same as above, but less metal corner guards and protective flap. Less speaker, ..... \$2.75**  
**YOUR PRICE, ..... \$2.75**

**C—P.A. System Case**  
Houses complete P.A. System Accommodates amplifier, two speakers up to 12" with cable, take-down microphone stand and microphone. Sturdy, extra heavy plywood construction. Metal reinforced corners. Waterproof blue fabricoid covered. Separates into three units. Baffles may be stood on floor or mounted on wall. Grille cloth covered speaker openings. P.A. equipment not included.  
**D15831—Size inside 11" deep, 17" wide, 19" high, ..... \$6.95**  
**YOUR PRICE, Case only, ..... \$6.95**  
**D15832—Size inside 11 1/4" deep, 20 1/2" wide, 22 1/4" high, ..... \$9.20**  
**YOUR PRICE, Case only, ..... \$9.20**

**D and E Phono. Cases**  
Constructed of heavy plywood with metal reinforced corners. Covered with attractive blue waterproof fabricoid. Heavy clasp fasteners.  
**D15826—Type D—For manual record player. Includes blank motorboard. Size inside, 12 1/2"x13 1/4"x7 1/4".**  
**YOUR PRICE, Case Only, ..... \$3.95**  
**D15828—Type E—Similar to above but better construction. Size inside, 11x15x7 1/4".**  
**YOUR PRICE, Case Only, ..... \$7.15**  
**For Automatic Record Changers**  
Fine sturdily constructed case.  
**D15833—For RCA DeLuxe Changer, ..... \$7.15**  
**D15834—For Webster Std. Model, ..... \$7.15**  
**D15840—For Gen. Industries Model, ..... \$7.15**  
**D15841—For Radolek D15337, ..... \$7.15**  
**YOUR PRICE, ..... \$7.15**  
Any Type .....  
**D15842—For Webster DeLuxe, ..... \$7.45**  
**YOUR PRICE, ..... \$7.45**  
Case Only .....  
**Case Only ..... \$7.45**

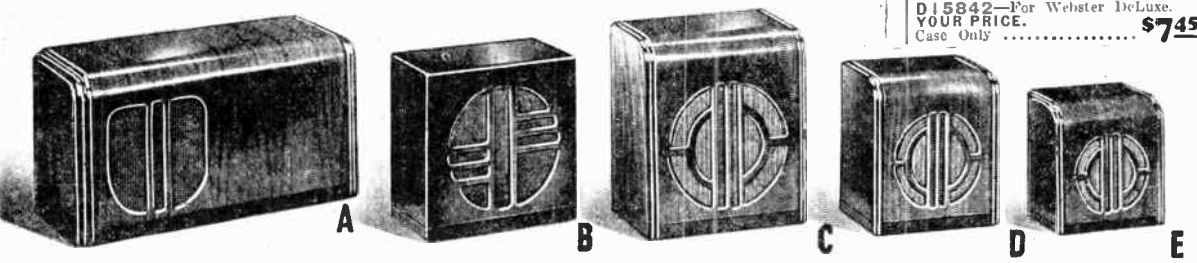

## Table Type Radio, Extension Speaker and Intercommunicator Cabinets

**Type A—Modern Design Lay-Down Cabinet** in a pleasing rich two tone walnut finish. Will accommodate a good sized radio chassis or may be used for intercommunication systems. Hinged panel and top of cabinet are made of genuine walnut veneer with soft grainwood ends. Inside Dimensions 17" wide, 8 1/2" high, 7 1/2" deep. Will rate up to 6 1/2" speakers.  
**D17609—Type A Cabinet, ..... \$2.75**  
**YOUR PRICE, Each, ..... \$2.55**  
In Six Lots or More, Each **\$2.55**

**Type B. Special Value Speaker Cabinet** in attractive new design. Front and sides finished in rich warm walnut brown with contrasting dark base trim. Two tone gold figured grille cloth. Removable back cover is same design and finish as front. Sturdily constructed. Size inside, 8 1/2" wide, 8 1/2" high, 5 1/4" deep. Takes up to 8 1/2" speakers.  
**D15811—Type B. Cabinet, ..... \$1.40**  
**YOUR PRICE, ..... \$1.32**  
In Six Lots or More, Each **\$1.32**

**Type C, D and E. Attractive walnut extensions, intercommunication systems, top design. Removable veneered back, with sides and bottom edge in contrasting darker shade. Mounted speaker grille cloth. Felt feet. No speakers supplied.**  
**D15843—Type C—For 8" Speakers, Inside size 8 1/2" wide, 19 1/4" high, 6" deep, ..... \$2.15**  
**YOUR PRICE, Each, ..... \$1.95**  
In Six Lots or More, Each **\$1.95**

veneered cabinets suitable for speaker call systems and many other uses. Rigidly constructed. Light walnut finish.  
**D15844—Type D—For 6" Speakers, Inside size 6 1/4" wide, 17 1/2" high, 4 1/2" deep, ..... \$1.55**  
**YOUR PRICE, Each, ..... \$1.37**  
In Six Lots or More, Each **\$1.37**  
**D15845—Type E—For 5" Speakers, Inside size 5 1/2"x8 1/4"x4", ..... \$1.10**  
**YOUR PRICE, Each, ..... \$0.95**  
In Six Lots or More, Each **\$0.95**

# UTAH PUBLIC ADDRESS REPRODUCERS

## Utah Wall Type Reproducer



Ideal for all sound systems where wide coverage of voice and musical frequencies of high quality is desired, as in night clubs, theatres, music stores, restaurants, sweet shops, taverns, etc. Uses 8" P.M. dynamic with 12 oz. magnet. Molded, non metallic case attractively finished in platinum grey crackle with dark brown trim. Size: 13x11". Ship. wt. 4 lb.

Stock Num.	Utah Code	V.C. Imp.	Input Normal	Watts Max.	List Price	Your Price
D15660	W-810	6-8	8	12	\$9.50	\$5.58
D6969	8747	Line trans.			.85	.49
D6979	8750	Univ. Plate Trans.			.85	.49

## Utah Bi-Directional Speakers

Especially designed for paging systems in factories, clubs, offices, garages, parking lots, hotels, large homes, etc. Gives clear, easily understandable voice reproduction from front and back. Sturdily constructed. Swivel joint bracket insures correct mounting. Molded, non-metallic baffle, finished in platinum grey crackle with dark brown trim. Line transformer included. Size: Housing 9 1/2 x 5". Brkt. 3" high. Ship. Wt. 6 1/4 lb.



Stock Num.	Utah Code	Cone Dia.	Magnet Wt.	V.C. Imp.	Input Normal	Watts Max.	List Price	Your Price
D15661	W800	8"	12 Oz.	6-8	8	12	\$10.75	\$6.32

With transformer tapped at 500, 1000, 1500, 2000 ohms for 1 to 8 speakers across a 250 or 500 ohm line.  
D15662 W801 8" | 12 Oz. | 6-8 | 8 | 12 | 10.75 | 6.32  
With transformer tapped at 2500, 3750, 4000, 4750 ohms for 9 to 20 speakers across a 250 or 500 ohm line.

## Utah Baflex Reproducer

Materially Improves Reproduction of Radios, Phonographs, Amplifiers Comes

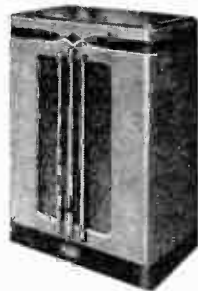

### Complete with Speakers

Incorporates the latest developments and improvements for high fidelity reproduction of music and voice from radio sets and public address amplifiers. Ideal for schools, dance halls, taverns, auditoriums, homes, etc. All "back-radiation" has been eliminated. Back response greatly improved. High frequency response up to 9500 Cycles is clear and without cabinet resonance or vibration distortion. Cabinets are sturdy in construction and attractively finished in two tone satin bronze.

### Specifications

Stock Num.	Utah Code	Cone Dia.	Magnet Wt.	V.C. Imp.	Input Normal	Watts Max.	Overall Size	List Price	Your Price
D15663	M-820	8"	20 oz.	8	12	15	11 1/4 x 17 1/4 x 2 1/4"	\$29.50	\$17.34
D15664	M-831	8"	31 oz.	8	12	18	11 1/4 x 17 1/4 x 2 1/4"	33.50	19.70
D15665	M-123	12"	46 oz.	8	17	26	12 1/2 x 22 3/4 x 3 1/4"	44.50	26.16
D15666	M-127	12"	7 lb.	8	22	33	12 1/2 x 22 3/4 x 3 1/4"	59.50	34.98

### Output Transformers

Line	Univ. Plate	For Model	List Price	Your Price
D6971	D6970	M-820	\$1.50	\$0.88
D6986	D6985	M-831	1.95	1.14
D6958	D6957	M-123	1.95	1.14
D6903	D6902	M-127	2.25	1.32

# UTAH PERMO-MAG PERMANENT MAGNET DYNAMIC SPEAKERS

## No Field Excitation Required



Use these speakers for your Public Address installations. Especially suited for use where extremely long lines must be run as only two connecting wires are needed. The savings effected in wire very often pays the entire cost of the speaker. True high fidelity reproduction, high volume carrying capacity and amazing high efficiency make these speakers fully equivalent in every way to the corresponding type of electro dynamic speakers.

Improved tone quality is definitely assured due to the exceptionally high magnetic flux made possible by Utah's latest magnet design and special alloy construction. Speakers are far superior in tone quality and ruggedness of construction over previous types of P.M. speakers, insuring permanency and freedom from trouble. Voice coils are specially impregnated and baked to take abnormal sound peaks. \*Especially designed for trumpet type baffle.

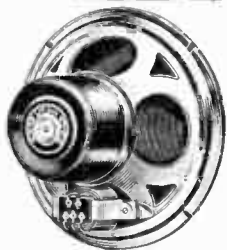

### Output Transformers

Univ. Tube	Line Matching	For Speaker Type	List Price	Your Price
D6970	D6971	G6P, E12P, 12P	\$1.50	\$0.88
D6985	D6986	H8P	1.95	1.15
D6957	D6961	K15P, L15P	4.00	2.35
D6902	D6903	E12P, G12P	2.25	1.32
D6998	D6991	G812P, H12P	2.25	1.32
		G815P, H15P	2.25	1.32

### For Utah Permo-mag Speakers

Stock Num.	Utah Code	Cone Dia.	Magnet Wt.	V.C. Dia.	V.C. Imp. Ohms	Input Normal	Watts Max.	Output Trans.	List Price	Your Price
D15720	*12P	12"	12 Oz.	1"	6-8	10	15	None	\$8.75	\$5.14
D15575	E12P	12"	20 Oz.	1 1/2"	6-8	13	20	None	12.50	7.35
D15721	G6P	6"	20 Oz.	3/4"	6-8	5.5	8	None	7.50	4.41
D15722	*H8P	8"	31 Oz.	1 1/4"	8	12	18	None	11.75	6.91
D15578	F12P	12"	31 Oz.	1 1/4"	6-8	16	24	None	14.00	8.23
D15579	G12P	12"	46 Oz.	1 1/2"	6-8	17	26	None	18.50	10.88
D15527	G812P	12"	4 Lb.	1 1/2"	6-8	20	30	None	27.50	16.13
D15528	G815P	15"	4 Lb.	1 1/2"	6-8	22	33	None	29.50	17.34
D15580	H12P	12"	7 Lb.	1 1/2"	6-8	22	33	None	33.75	19.84
D15581	H15P	15"	7 Lb.	1 1/2"	6-8	24	36	None	39.50	23.23
D15723	K15P	15"	15 Lb.	2"	8	27	40	None	76.50	46.74
D15724	L15P	15"	23 Lb.	2"	8	30	43	None	104.50	61.44

The Universal Tube Transformers listed on this page match speakers to any output tubes either single or P.P.  
The Universal Line Transformers listed on this page have secondaries tapped at 500, 1000, 1500 and 2000 ohms.

# REPLACEMENT SPEAKERS TO FIT ANY RADIO

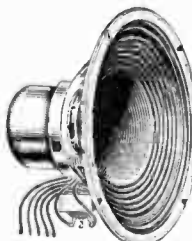

## Utah 12 In. Speakers

Excellent sound reproduction and high output combined with ruggedness of construction make these speakers especially suitable for DeLuxe Console Receivers. Will handle peak loads of 15 watts. Recommended field input on field excited models, 9 watts; no field excitation required on P.M. types. Voice coil, 8 ohms. Universal Output Transformers match any tube, Single or P.P. Line Transformer tapped for 500-1,000-1,500-2,000 ohm lines.

Stock Num.	Mfg. Code	C. Dia.	Field Ohms	Out'p Trans.	List Price	Your Price
A15582	Q1210	12"	1000	Univ.	\$7.50	\$4.11
A15583	Q1215	12"	1500	Univ.	7.50	
A15584	Q1220	12"	2000	Univ.	7.50	
A15585	Q1225	12"	2500	Univ.	7.50	Each

### P. M. Dynamic Speakers

A15586 | 12P | 12" | 12 Oz. | None | \$ 8.75 | \$5.14

### Output Transformers for 3", 4" or 5" Speakers

Stock Number	Tube Imped.	Stock Number	Tube Imped.	Your Price
C6963	2000	C6965	10,000	Each
C6964	4000	C6966	25,000	35c
C6967	2000	(25L6) for 3" Spkrs		

## 3, 5 and 6 In. Speakers

Utah  
For use in compact radios. Strong rugged construction combined with true high-fidelity sound reproduction. P.M. types adapted for use as either speaker or mike. Output Transformers match any tube, Single or P.P. Voice coil impedance, 3 to 5 ohms.

### Electro-Dynamics

Stock Num.	Mfg. Code	C. Dia.	Field Ohms	Out'p Trans.	List Price	Your Price
D15716	Q330	3 1/2"	3000	None	\$2.25	\$1.32
C15589	Q345	3 1/2"	450	None	2.25	1.32
D15717	Q427	4"	2750	None	2.25	1.32
D15718	Q445	4"	450	None	2.25	1.32
C15590	Q508	5"	6	None	2.25	1.32
C15591	Q518	5"	1800†	None	2.25	1.32
C15592	Q530	5"	3000†	None	2.25	1.32
C15517	Q510	5"	1000	None	2.25	1.32
C15518	Q545	5"	450	None	2.25	1.32
C15593	Q606	6"	6	Univ.	3.40	2.00
C15594	Q610	6"	1000	Univ.	3.40	2.00
C15595	Q618	6"	1800†	Univ.	3.40	2.00
C15596	Q625	6"	2500	Univ.	3.40	2.00

†Tapped at 1,500. ††Tapped at 2,500.

### P. M. Dynamic Speakers

Stock Num.	Mfg. Code	C. Dia.	Field Ohms	Out'p Trans.	List Price	Your Price
D15710	3PY	3 1/2"	1 1/2"	None	\$1.60	\$0.94
D15711	3PZ	3 1/4"	2 1/4"	None	1.85	1.09
D15597	3P	3"	5"	None	2.70	1.58
D15712	4PY	4"	1 1/2"	None	1.65	.97
D15713	4PZ	4"	2 1/4"	None	1.60	1.12
D15714	5PY	5"	1 1/2"	None	1.75	1.03
D15715	5PZ	5"	2 1/4"	None	1.95	1.15
D15598	6P	6"	5"	None	2.75	1.61
D15599	6P	6"	5"	None	3.00	1.94

## 8 and 10 In. Speakers

Especially desirable as replacement speakers for console cabinet receivers. Excellent tone reproduction. Speakers easily handle 10 watts without distortion. Voice coil impedance 6 to 8 ohms. Supplied with Universal Output Transformer to match any tube, Single or Push-Pull.

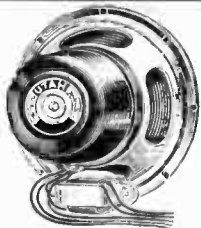

### Electro-Dynamic Speakers

Stock Number	Mfg. Code	Cone Dia.	Field Ohms	List Price	Your Price
C15615	Q810	8"	1000	\$4.60	\$2.70
C15617	Q818	8"	1800†	4.60	Each
C15618	Q825	8"	2500	4.60	Each
C15619	Q1010	10"	1000	6.50	
C15620	Q1015	10"	1500	6.50	\$3.82
C15621	Q1020	10"	2000	6.50	
C15622	Q1025	10"	2500	6.50	Each

†Tapped at 300 ohms.

### P. M. Dynamic Speakers

Stock Number	Mfg. Code	Cone Dia.	Field Ohms	List Price	Your Price
C15623	8P	8"	5 Oz.	\$4.00	\$2.35
C15624	8EP	8"	7 Mag.	4.50	2.64
C15625	10P	10"	12 Wt.	6.25	3.67

### Output Transformers for PM Speakers

Univ. Tube	Univ. Line	For Speaker	Each
C6968	C6968	8P & ESP	50c
C6970	C6971	10P	88c





# RADIO'S FAVORITE VOICE

A complete line of field excited Electro Dynamic replacement speakers. Each unit is rigidly welded to form a one piece rugged assembly. No screws or fastenings to get out of adjustment. Universal speaker mounting bracket packed with 4", 5", 6 1/2" models. Field coil pots on these models are also drilled and tapped for chassis mounting. These features allow replacement of speaker on practically any set. All models are dustproof.

Quam Permanent Magnet Dynamic Speakers are designed especially for replacement purposes where high quality dynamic speakers which do not use field excitation are required. Excellent for automobile and battery set replacement. Particularly adaptable to Public Address Systems as extension speakers. Fully dust and weather proof. Rigid, welded construction insures long, trouble-free life.



### 4 and 5 Inch Electro-Dynamic Speakers

For AC and AC-DC midget sets. Conservatively rated at 3.5 watts output. Voice coil impedance 4 ohms at 400 cycles. 4" Model: Extra shallow for Tee Wee sets. Depth, 1 1/2". Mounting dia. 4 1/4". 5" Model: Mounting dia., 5"; Depth, 2 1/4".

### 4 Inch Model 40SM Less Transformer

Stock Number	Field Ohms	Stock Number	Field Ohms
A15435	3000	A15437	1800
A15436	2500	A15439	450

### 5 Inch Model 50S Less Transformer

Stock Number	Field Ohms	Stock Number	Field Ohms
A15440	3000	A15443	1000
A15441	2500	A15444	450
A15442	1800	A15445	5.5

List Price, \$2.00  
YOUR PRICE, Each  
**\$1.18**



### 6 1/2 Inch Model 65M Electro-Dynamics

For table model radios, extension speakers, and automobile radio sets. Conservative output rating 4.5 watts. Voice coil impedance 4 ohms at 400 cycles. Dia., 6 1/2". Depth 3". Ship wt., 2.3 lbs.

### Less Transformer

Stock Num.	F'd. Ohm	Stock Num.	F'd. Ohm
A15415	3000	A15418	1000
A15416	2500	A15419	450
A15417	1800	A15420	5.5

List Price, \$2.80  
YOUR PRICE, Each  
**\$1.65**

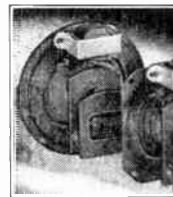

### Junior PM Dynamics

Incorporates new developments and manufacturing methods that have enabled considerable savings in cost. Desirable for replacement in auto sets, intercommunication systems and low-priced battery receivers. Dust proof construction. 10" Leads. Voice coil imp. 4 ohms. Conservatively rated. No field excitation necessary. 4" Model is supplied with square frame, others with round frame. Supplied less output transformer.

Stock Number	Model Num.	Cone Size	Magnet Weight	Input Normal	Watts Normal	Watts Max.	List Price	Your Price
D15558	4JP2	4"	2 oz.	1.5	2.25	3.75	\$1.60	\$0.94
D15556	4JP4	4"	4 oz.	2.5	3.75	5.25	2.00	1.18
D15559	5JP2	5"	2 oz.	1.5	2.25	3.75	1.60	.94
D15557	5JP4	5"	4 oz.	2.5	3.75	5.25	2.00	1.18
D15560	6JP4	6 1/2"	4 oz.	2.5	3.75	5.25	2.50	1.47
D15561	8JP5	8"	5 oz.	3.5	5.25	7.50	3.00	1.76
D15562	8JP7	8"	7 oz.	6.0	9.00	13.50	3.50	2.06

### Junior Electro-Dynamics Models 40J, 50J, 65J and 80J

Meets the demand for a lower priced replacement speaker yet carries a full guarantee of satisfaction and service. Used by set manufacturers. Well designed and constructed of quality materials to give excellent performance characteristics. Baked brown finish. 4" Model is supplied with square frame, others with round frame. Supplied less output transformers.

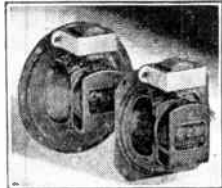

Stock Num.	Field Ohms	Stock Num.	Field Ohms	Cone Dia.	Input Normal	Watts Normal	Watts Max.	List Price	Your Price
D15563	3000	D15572	2500	4"	2.5	3.25	4.75	\$1.70	<b>\$1.00</b>
D15564	1800	D15573	1000	4"	2.5	3.25	4.75	1.70	
D15565	450			4"	2.5	3.25	4.75	1.70	
D15566	3000	D15574	2500	5"	2.5	3.25	4.75	1.70	<b>\$1.15</b>
D15567	1800	D15600	1000	5"	2.5	3.25	4.75	1.70	
D15568	3000	D15601	2500	6"	3.5	5.25	7.50	1.95	
D15569	1800	D15602	1000	6"	3.5	5.25	7.50	1.95	<b>\$1.76</b>
D15570	3000	D15603	2500	8"	4.0	6.00	8.25	3.00	
D15571	1800	D15604	1000	8"	4.0	6.00	8.25	3.00	

### Output Transformers

Designed to exactly fit speakers for which specified. All transformers are unshielded.

For Models 4JP2, 4JP4, 5JP2, 5JP4, 6JP4, 40SM, 50S, 65M, 40PM and 50 PM  
Core Size 1/2" x 1/2"

Stock Num.	Imped. Ohms	For Sgle. or P.P.	Your Price
A6800	2000	Sgle.	<b>35c</b>
A6801	4000	Sgle.	
A6802	7000	Sgle.	
A6803	10000	Sgle.	

For Models 8JP5, 8JP7, 80PM and 65PM Core Size 1/2" x 5/8"

Stock Num.	Imped. Ohms	For Sgle. or P.P.	Your Price
A6804	2000	Sgle.	<b>41c</b>
A6805	4000	Sgle.	
A6806	7000	Sgle.	
A6807	10000	Sgle.	
A6808	10000CT	P.P.	
A6809	500 & 1000 Line		41c
A6810	Universal		59c

### For Model 80PM Core Size 3/4" x 5/8"

Stock Num.	Imped. Ohms	For Sgle. or P.P.	Your Price
A6811	2000	Sgle.	<b>50c</b>
A6812	4000	Sgle.	
A6813	7000	Sgle.	
A6814	10000	Sgle.	

Stock Num.	Imped. Ohms	For Sgle. or P.P.	Your Price
A6815	14000CT	P.P.	<b>59c</b>
A6816	8000CT	P.P.	
A6817	10000CT	P.P.	
A6818	500 & 1000 Line		

A6819 Universal 79c

### For Models 80PM, D80PM, M120PM and 120 PM Core Size 3/4" x 3/4"

Stock Num.	Imped. Ohms	For Sgle. or P.P.	Your Price
A6820	2500	Sgle.	<b>65c</b>
A6821	4000	Sgle.	
A6822	7000	Sgle.	
A6823	10000	Sgle.	

Stock Num.	Imped. Ohms	For Sgle. or P.P.	Your Price
A6824	14000CT	P.P.	<b>76c</b>
A6825	10000CT	P.P.	
A6826	5000CT	P.P.	
A6827	500 & 1000 Line		

A6828 Universal 94c

### 4 Inch Model 40PM PM Dynamic

Very compact. Unsurpassed for replacement in midget radios and intercommunicating systems. 4" P.M.'s can also be used as a combination dynamic microphone and speaker. Conservatively rated at 2 watts output. Voice coil impedance 4 ohms at 400 cycles. Frequency response 180 to 8,000 c. p. s. 5 oz. Magnet. Mounting dia., 4 1/4". Transformer not included. Ship. wt., 2 1/2 lbs.

C15446—List, \$3.00  
YOUR PRICE... **\$1.76**

A15447 — For use as a microphone. Complete with special transformer. List Price, \$3.90.  
YOUR PRICE... **\$2.29**

### 5 Inch Model 50PM PM Dynamic

Remarkable performance on battery receivers, automobile sets, intercommunicating systems, and as extension speakers. Conservative output rating 3.5 watts. Voice coil impedance 4 ohms at 100 cycles. 5 oz. Magnet. Outside dia. 5". Depth, 2 1/4". Less transformer, Ship. wt., 2 1/2 lbs.

C15430—List, \$3.00  
YOUR PRICE... **\$1.76**

### 6 1/2 Inch Model 65PM PM Dynamic

Highly efficient — Exceptional tone quality. For battery receivers, automobile sets and extension speakers. Voice coil impedance 4 ohms at 100 cycles. Conservatively rated at 5.5 watts output. Outside dia., 6 1/2". Depth, 3 1/2". 8 oz. Magnet. Less transformer, Ship. wt., 2 1/2 lbs.

A15431—List, \$3.80  
YOUR PRICE... **\$2.23**

### 8 Inch Model 80PM PM Dynamic

Excellent volume and brilliant tone fidelity. Ideal for large battery receivers, automobile sets, amplifiers, P.A. systems and extension speakers. Voice coil impedance has 4 ohms, 7 has 6 ohms. Less transformer.

Stock Num.	Spkr. Model	Size Magnet	Watts Normal	List Price	Your Price
D15432*	80PM	8	7	\$4.50	\$2.65
D15433*	80PM	28	10	8.40	4.94
D15434*	D80PM	48	15	11.00	6.47

### 12 Inch Permanent Magnet Dynamics

Suitable for large receivers and public address uses. Features unusual power handling capacity with excellent frequency response characteristics. Arc welded construction insures perfect alignment of integral parts. Speaker does not require field excitation. Completely dust proof. Voice coil impedance 6 ohms. Supplied less output matching transformers.

Model	Watts Normal	Watts Max.	List Price	Your Price
Model M120PM	15	28	\$10.95	<b>\$6.44</b>
Model 120PM	25	48	\$14.85	<b>\$8.73</b>

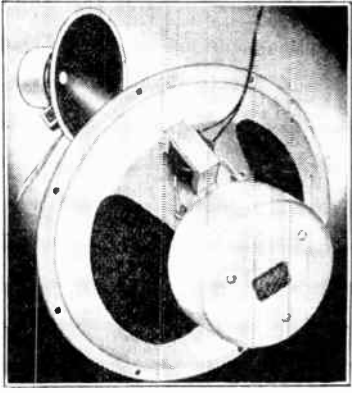

# RADIO and PUBLIC ADDRESS SPEAKERS

## Radolek Electro-Dynamic Speakers Use External Field Excitation

For replacement in radio sets which supply speaker field current or where a low priced efficient unit is required. Models are listed for replacement in practically any radio set. Heavy pressed steel frame holds assembly absolutely rigid, assuring perfect alignment of voice coil under severe operating conditions. All speakers fully dustproof. Speakers with field coil resistance other than those listed can be supplied on special order at slightly higher prices.

## Radolek P.M. Dynamic Speakers Require No Field Excitation

Made of finest materials by one of the largest speaker manufacturers in the country. Equal to other speakers selling for much more than the low prices below. Latest type highly saturated permanent magnets are used, which retain their strength indefinitely. For practical applications these speakers are superior to field excited dynamics. Heavy pressed steel frame holds assembly absolutely rigid assuring perfect alignment of voice coil even under severe operating conditions. All speakers fully dustproof.

### 12" and 15" Public Address Dynamic Speakers

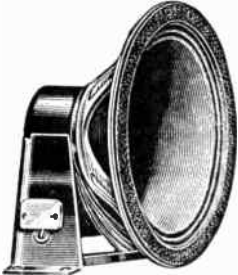

Electro-Dynamic

#### For All Public Address and Radio Replacement Uses

Fine quality, highly efficient dynamic speakers. Designed particularly for Public Address Installations and Radio Set replacement use where high power handling capacity must be combined with high sensitivity and faithful reproduction. Made of best quality materials. Rigid pressed steel frame finished in smooth black enamel. One piece moulded weatherproof cones. Entire unit fully dustproof. Supplied less output transformer. Electro-Dynamic Speakers are supplied with base stand as shown at left, above. P.M. Dynamics are supplied less stand as illustrated.

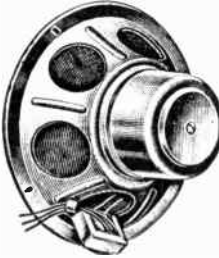

P.M. Dynamic

### 12 Inch Electro-Dynamic Speakers

Stock Number	Model Number	Watts Normal	Peak	Field Ohms	Spkr. Depth	Voice Dia.	Coil Imp.	Shp. Wt.	List Price	PRICE EACH
C15611	R12Q†	9	13	1000	5 1/4"	1"	5.5	8 1/4 lbs.	\$ 6.50	<b>\$3.69</b>
C15612	R12Q†	9	13	2500	5 1/4"	1"	5.5	6 1/4 lbs.	6.25	
C15613	R12F	16	24	1000	7 1/4"	1 1/2"	8.0	11 lbs.	10.25	<b>\$5.75</b>
C15614	R12F	16	24	2500	7 1/4"	1 1/2"	8.0	11 lbs.	10.25	
C15632	R12G	20	30	1000	7 1/4"	1 1/2"	8.0	16 lbs.	16.75	<b>\$8.29</b>
C15633	R12G	20	30	2500	7 1/4"	1 1/2"	8.0	16 lbs.	16.75	

†Supplied with Universal Sgl. or P.P. Output Transformer—less Stand.

### 12 Inch P.M. Dynamic Speakers

Stock Number	Model Number	Watts Normal	Peak	Field Ohms	Spkr. Depth	Voice Dia.	Coil Imp.	Shp. Wt.	List Price	PRICE EACH
C15629	R12H†	10	15	12 oz. mag.	5"	1"	7.0	7 lbs.	\$ 8.50	<b>\$ 3.65</b>
C15634	R12H*	10	15	12	4 1/4"	1"	8.0	5 1/2 lbs.	8.75	
C15635	R12EP	13	20	20	5 1/4"	1"	8.0	8 1/4 lbs.	12.50	<b>6.67</b>
C15636	R12EP	16	24	31	5 1/4"	1 1/4"	8.0	8 1/4 lbs.	14.00	
C15637	R12GP	17	24	46	5 3/4"	1"	8.0	11 1/4 lbs.	18.50	<b>9.80</b>
C15638	R12GTP	20	30	64	6 1/4"	1 1/2"	8.0	12 1/4 lbs.	25.00	
D15640	R12HP	22	33	7 lbs.	6 3/4"	1 1/2"	8.0	15 1/4 lbs.	33.75	<b>14.75</b>

\*Special High Fidelity Model.

### 15 Inch P.M. Dynamic Speaker

C15639	R15HP	24	36	110 oz. mag.	7 1/2"	1 1/2"	8.0	18 1/2 lbs.	\$39.50	<b>\$17.38</b>
--------	-------	----	----	--------------	--------	--------	-----	-------------	---------	----------------

### 5", 6" and 8" Radio Replacement Speakers

Also Suitable for P.A. Extension Uses

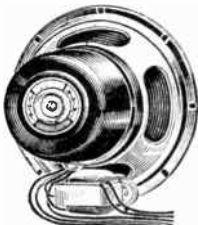

#### Electro-Dynamics

Use these speakers on small radio sets which provide speaker field supply or where speaker field is part of filter system. May also be used for P.A. extension where field supply is available. Fully dustproof.

#### 5" Speakers

For replacement in Mantel type AC-DC receivers and Auto Radios. Handles up to 3 1/2 watts without overloading or chattering. 3/2 ohm voice coil. 3/2" dia. Size, 5" dia. 1 1/2" deep. Less output transformer.

C15539	—6 Ohm Field	List Price, \$2.25
C15500	—450 Ohm Field	YOUR PRICE
C15501	—1000 Ohm Field	
C15502	—1800 Ohm Field	Each
	Tapped 1500-300	
C15538	—3000 Ohm Field	<b>95c</b>
	Tapped 2500-500	

#### 6" Electro-Dynamic Speakers

Adequately fulfills requirements for reproduction in medium sized radios. Handles up to 6 watts peak, 4 watts average power output. 3 1/2 Ohms voice coil, 3/2" dia. Size, 6" dia., depth 2 1/2". Complete with Universal Sgl. or P.P. Tube Matching Transformer.

C15514	—6 Ohm Field	List Price, \$3.40
C15510	—1000 Ohm Field	YOUR PRICE
C15513	—1800 Ohm Field	
	Tapped 1500-300	Each
C15511	—2000 Ohm Field	
C15512	—2500 Ohm Field	

#### 8" Electro-Dynamic Speakers

Suitable for replacement in large table model radios, small console receivers, multi-speaker sound distribution systems and small Public Address systems. Handles up to 10 watts peak, 6 watts normal. Voice coil dia., 3/2". Resistance, 3 1/2 ohms. Size, 8" dia., depth 4 1/2". Complete with Universal Single or P.P. Tube Matching Transformer.

C15520	—1000 Ohm Field	List Price, \$3.75
C15522	—2500 Ohm Field	Price, Ea. <b>\$2.25</b>

#### P.M. Dynamics

Especially suited for replacement in Pee Wee radio sets, midjet radios, table models and small console sets. Also used to a great extent as extension speakers in large P.A. sound distribution systems. Fully dustproof. All models quoted Less Output Transformer. Voice coil impedance 3 1/2 ohms.

#### Special 5" Speaker

5" Dia. Depth 2 1/2". Power handling capacity 2 watts, 3 watts peak. 1 1/2 Oz. Magnet. 1/2" dia. Voice Coil. Shp. wt. 3/4 lbs.

C15689	—List Price, \$1.75.	<b>97c</b>
YOUR PRICE		

#### High Fidelity 5" Speaker

5" Dia. Overall depth 2 3/4". Power handling capacity 3 watts, 4.5 watts peak. 5 Oz. Magnet. 1/2" Dia. Voice Coil. Shp. wt., 1 1/4 lbs.

C15675	—List Price, \$2.75.	<b>\$1.38</b>
YOUR PRICE		

#### 6 Inch Speaker

6" Dia. Overall depth 2 27/32". Power handling capacity 4 watts, 6 watts peak. 5 Oz. Magnet. 3/4" Dia. Voice Coil. Shp. wt. 1 1/4 lbs.

C15677	—List Price, \$3.30.	<b>\$1.80</b>
YOUR PRICE		

#### 8 Inch Speaker

8" Dia. Depth 3 1/4". Power Handling Capacity 7 watts, 11 watts peak. 5 Oz. Magnet. 3/4" Dia. Voice Coil. Shp. wt., 2 1/2 lbs.

C15685	—List Price, \$4.00.	<b>\$2.25</b>
YOUR PRICE		

#### High Fidelity 8 Inch Speaker

8" Dia. Overall depth 3 3/4". Power handling capacity 7 watts, 11 watts peak. 7 Oz. Magnet. 3/4" Dia. Voice Coil. Shp. wt. 2 3/4 lbs.

D15680	—List Price, \$4.50.	<b>\$2.49</b>
YOUR PRICE		

### Output Transformers

All speakers on this page are listed less transformer. Proper size transformers for each speaker are listed below. Same transformer may be used for either Electro-Dynamic or Permanent Magnet Dynamic Speakers. Universal Type Transformers match all tubes in single and P.P.

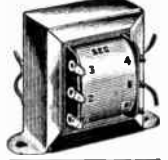

Stock No.	Transformer Impedance	For Speaker	Your Price
C6973	2000	3 1/2" 4"	Each <b>30c</b>
C6974	4000	3 1/2" 4"	
C6975	10,000	3 1/2" 4"	Ten for <b>\$2.80</b>
C6976	25,000	3 1/2" 4"	

### Universal Output Transformers

Tube Stock No.	Line Stock No.	For Speaker Models	Your Price
C6977	C6978	C15675-5" 6" 8"	<b>49c</b>
C6979	C6980		
C6981	C6982		

### For 12" and 15" Speakers at Left

Tube Stock No.	Line Stock No.	For Speaker Models	Your Price
C6950	C6951	R12Q, R12H, R12P	<b>\$0.75</b>
C6900	C6901	R12EP, R12F, R12G	
C6902	C6903	R12FP, R12GP	<b>1.05</b>
C6904	C6905	R12GTP, R12HP	<b>1.18</b>
		R15HP	<b>1.18</b>

### New Midjet Speakers

#### 3 1/2" Electro-Dynamics

For replacement in AC-DC Midjet sets where economy of space is important. Excellent frequency response. 3/2 Ohm voice coil, 3/2" dia. Handles up to 3 1/2 watts. Size, 3 1/2" dia. x 2 1/2" deep. Less Output Transformer.

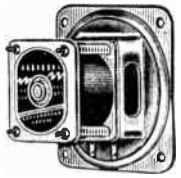

D15686—450 Ohm Field  
D15690—3000 Ohm Field  
List, \$2.25.  
Your Price, Ea. **95c**

#### 3 1/2" P.M. Dynamic

3 1/2" Dia. Depth 2". Power handling capacity 2 watts, 3 watts peak. 1 1/2 Oz. Magnet. 2 1/2 Ohm voice coil. 3/2" dia. Shp. wt. 1 1/4 lbs. Less Output Transformer. D15691—List Price, \$1.80.  
YOUR PRICE..... **87c**

#### 4" Electro Dynamics

4" Dia. depth 2 1/4" power handling capacity 2 watts 3 1/2 watts peak. 2 1/2 Ohm voice coil 3/4" dia. Shp. wt. 1 1/2 lbs. Less Output Transformer.  
D15692—450 ohm field. } List, \$2.25. **\$1.03**  
D15693—2750 ohm field. } Each .....

#### 4" P.M. Dynamic

4" Dia. depth 2 1/4" power handling capacity 2 1/2 watts 3 1/2 watts peak. 2 1/2 Ohm voice coil 1/2" dia. 2 1/2 oz magnet—Less Output Transformer.  
D15694—List, \$1.90. **\$1.01**  
YOUR PRICE, Each .....

### 2 Inch Permug Speaker

This new midjet speaker will provide unlimited new applications. Especially designed for hearing aid devices, communication systems and more compact radio and other sound equipment. Highly sensitive. Excellent voice frequency response permits use as microphone as well as speaker. Powerful, high permeability, permanent magnet. Voice coil impedance, 3 to 4 ohms. Normal rating 1 watt. Complete dust proofing. Size, 2 1/2" dia.  
D15609—List Price, \$1.75. **\$1.03**  
YOUR PRICE, Each .....

Transformers for Above  
C6952—Voice Coil to Single Grid. For using speaker as microphone. Sintered.  
YOUR PRICE, Each .....

C6953—Universal Output Transformer. Load Imp. 2000 to 7000 ohms. V.C. 3-5 ohms.  
YOUR PRICE, Each .....

C6954—Universal Output Transformer. Load Imp. 2000 to 7000 ohms. V.C. 3-5 ohms.  
YOUR PRICE, Each .....



# P.A. BAFFLES - PROJECTORS - HORNS

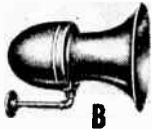

These fine quality public address speaker baffles give an even directional distribution of sound and have sufficient flare to effectively reduce feed-back. All units are ruggedly constructed for both indoor and outdoor use. Very well adapted for mobile installations. All steel baffles are finished in durable weather-proof baked-on gray enamel.

## Fine Quality All-Metal Speaker Baffles and Trumpets

**A—Re-Entrant Baffle**  
**D15150**—All-Steel Trumpet for 8" speakers. Light in weight. 22 3/4" Dia. bell. 17 3/4" long. 11 1/2" high from base 27". Welded on mounting support bracket. Fits standard 1/2" pipe fittings. With Crowfoot swivel mounting support.  
**YOUR PRICE, Less Speaker . . . . . \$18.14**  
**D15151**—As above but complete with Heavy Duty 8" PM speaker.  
**YOUR PRICE . . . . . \$22.95**

**B—Midget Baffle**  
**D15182**—Suitable for call systems. Takes any 8" or smaller cone speaker. Sturdy all-steel vibration-less two piece construction. Welded on bracket socket takes 1/2" pipe fittings. Bell 10" dia., 5" deep. Overall depth, 9 1/2". Grey wrinkle finish. With pipe bracket but less pipe fittings.  
**YOUR PRICE, Less speaker. . . . . \$4.41**

**C—Steel Aluminum Baffles**  
**D15176**—Steel Aluminum Baffle. Designed for all 12" cone speakers. Rugged construction. Popular with mobile installations. Has breather holes to relieve speaker back pressure. Bell is of spun aluminum, back of heavy gauge steel. Easily demountable into two sections. Loops provided for hanging. Can also be mounted to wall or ceiling by use of standard pipe fittings or used with bracket listed below. Bell 18" dia., 10" deep. Length overall 20". Less speaker. . . . .  
**YOUR PRICE . . . . . \$4.25**  
**In 6 Lots or More, Each \$3.95**

**Weather-Proof Horn Covers**  
 For above metal horns. Provides complete protection against rain, snow, dust, wind, etc. for speaker cone when not in use. Slips over bell openings. Made of water-resisting cloth with elastic band.  
**D12443**—For 12 to 18" bells.  
**YOUR PRICE . . . . . \$5.95**

**D—All Steel Baffles**  
 For 12" Speakers. Two piece wedge-fit rattle-proof all steel construction. Has screened breather openings to relieve speaker back pressure. Welded on mounting bracket fits 1/2" pipe fittings. Less speaker and adjustable bracket. Bell 17" dia. Overall depth 20".  
**D15180**—With 1/2" pipe fittings as described.  
**YOUR PRICE . . . . . \$7.20**  
**D15184**—Adjustable Crowfoot Mounting support for above.  
**YOUR PRICE . . . . . \$1.47**  
**D15183**—Less pipe fittings but with eye rings for suspension.  
**YOUR PRICE . . . . . \$6.98**

**E—P.A. Trumpet**  
**With 8" PM Speaker Unit**  
**D15165**—Trumpet and Speaker. A scientifically designed speaker-baffle combination suitable for outdoor installations where sound must be distributed over a great distance with minimum feed back. Includes a powerful 8" permanent magnet driver speaker that will handle up to 15 Watts power output without distortion. Speaker voice coil impedance 8 ohms. Baffle is constructed of heavy spun-steel. Bell diameter 24". Length overall 36". Ship. wt. 17 lbs. Welded on bracket fits 1/2" standard pipe fittings. Less adjustable mounting support.  
**YOUR PRICE . . . . . \$24.95**  
**D15167**—Horn, Less Speaker. . . . . **\$20.46**  
**D15166**—Adjustable crowfoot mounting support bracket for above.  
**YOUR PRICE . . . . . \$1.98**

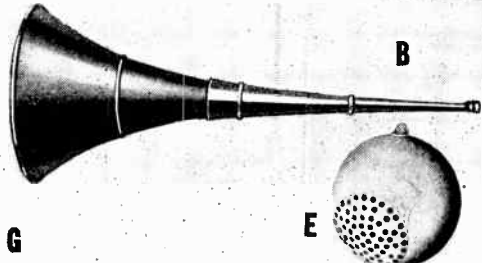
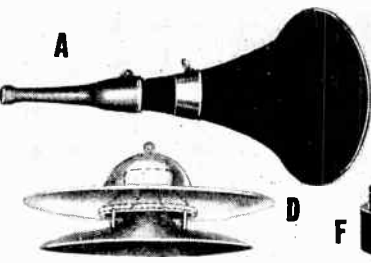

## Racon High Quality Public Address Sound Equipment

**A & B Racon Trumpets**  
 Best for adequate distortionless coverage of large areas as in auditoriums, fields, etc. Demountable for easy transportation. For use with Type F Horn Units.  
 Type A. For indoor use. Made of patented acoustic material which does not vibrate. Cast aluminum throat. Has suspension hook eyes.  

Stock Num.	Total Lgth.	Bell Dia.	Throat Lgth.	Wt. Lbs.	List Price	Your Price
D15185	3 1/2'	22"	10"	10	\$28.50	\$16.75
D15186	4 1/2'	25	25	11	50.00	26.46
D15187	6'	30	34	18	62.50	36.75

Type B. For indoor and outdoor use. Made of 12 gauge aluminum with cast aluminum throat.  

Stock Num.	Total Lgth.	Bell Dia.	Throat Lgth.	Wt. Lbs.	List Price	Your Price
D15188	3 1/2'	22"	10"	7	\$27.50	\$16.17
D15189	4 1/2'	25	25	11	50.00	29.40
D15190	6'	30	34	19	68.50	40.27

**C—Racon Re-Entrant Trumpets**  
 Takes up very little space and yet has long air column delivering highly concentrated clearly audible sound over long distances. Sturdily constructed with cast aluminum tone chamber and heavy spun aluminum bell. For indoor or outdoor use. Center reflecting section treated with special acoustic material.  

Stock Num.	Col. Lgth.	Bell Dia.	Size Lgth.	Wt. Lbs.	List Price	Your Price
D15192	3'	14"	12 1/2"	5 1/2	\$17.50	\$10.29
D15193	4 1/2'	24 1/2"	23 1/2"	11	40.00	23.52
D15194	6'	25 1/2"	28"	20	55.00	32.34

**G—Racon Swivel Bracket**  
 For supporting all types of cone projectors as illustrated at top of page. Tooth ratchet swivel. Base has holes for mounting.  
**D15195**—Without base. **YOUR PRICE . . . . . \$1.76**  
**D15196**—With base. **YOUR PRICE . . . . . \$2.65**

**D—Racon Radical Cone Baffle**  
 Distributes sound over a 350° area with even intensity. Brings out high frequencies lacking in directional type horns. Upper deflector and speaker housing made of heavy gauge steel. Lower deflector of special acoustic material to prevent resonant effects. Storm proofed for all weather conditions.  
**D15140**—For 10" or 12" cone speakers. Reflector dia., 12". Total height, 14". Wt. 10 lbs.  
**List Price, \$27.50.**  
**YOUR PRICE, Less Speaker . . . . . \$16.17**  
**D15141**—For 5" or 6" cone speakers. Reflector dia., 31". Total height, 7". Wt. 3 1/2 lbs.  
**List Price, \$9.50.**  
**YOUR PRICE, Less Speaker . . . . . \$5.58**

**E—Racon Ball Type Baffle**  
 Projects sound over a 45° beam area. Blends with all types of architecture. Excellent for reproduction of both voice and music. Made of steel finished in silver enamel.  
**D15142**—For 6" cone speaker. 9 1/2" Dia. Wt. 3 1/2 lbs. List Price, \$7.50.  
**YOUR PRICE, Less Speaker . . . . . \$4.41**  
**D15143**—For 8" cone speaker. 12" Dia. Wt. 6 lbs. List Price, \$9.00.  
**YOUR PRICE, Less Speaker . . . . . \$5.29**  
**D15144**—For 10" cone speaker. 14" Dia. Wt. 9 lbs. List Price, \$12.00.  
**YOUR PRICE, Less Speaker . . . . . \$7.95**

**Baffle Supports**  
**Floor Stand for Speaker Baffle**  
**K15178**—Stand only, no speaker or baffle included.  
**YOUR PRICE . . . . . \$5.95**  
 For use with speaker baffle listed at top of page. Recommended for large Public Address Systems that are not permanent or where it is impractical to mount speakers on wall or ceiling. Collapsible stand provides stable base and ease of portability. Height of stand can be adjusted from 48 inches to 96 inches. Equipped with tilting bracket so that baffle can be placed at any angle.

**Car-Top Horn Carrier**  
*No holes required — Will not mar finish*  
 For temporary or permanent installations of horns or trumpet on car-tops. No drilling necessary. Consists of maple platform, with sturdy supporting brackets secured to four large vacuum cups. Cups securely hold to any metal car top to which a film of glycerine has been applied. (Also fits Ford 1933-36, Plymouth '34-'36, Chevrolet, '33-'34 or other fabric tops not wider than 41 1/2"). Doubly secured by straps anchored to drip rail over doors by rubber protected hooks.  
**D15199**—Ship wt. 9 lbs.  
**YOUR PRICE . . . . . \$4.08**

**F—Racon P.M. Type Units**  
 High grade compression units for use with straight and re-entrant type trumpets. Made from finest grade Alnico steel magnets and Armco iron throughout. All units are carefully measured and tested for highest flux density and power handling capacity.  

Stock Num.	Watts Cap.	Cz. Mag.	Wt. Lbs.	List Price	Your Price	
D15145	8	15	46	7 3/4	\$35.00	\$20.58
D15147	10-12	20	60	9	44.00	25.87
D15147	12-15	25	194	13	55.00	32.34
D15148	12-15	25	130	17	66.00	38.80

# ASTATIC MICROPHONES



**D10003-A—Model WR-20 Double Dual-Diaphragm Crystal Microphone** with tilting head. Response free from peaks and dips to 10,000 c.p.s. High impedance output at -56 db. Cannot be acoustically overloaded. 25 Ft. cable and connector. Chrome finish. **\$1735**  
**YOUR PRICE** .....

**D10000-B—Model T-3 Crystal Microphone.** Response 30 to 10,000 c.p.s. Perfect for entertainers and orchestras. Output level—52 db. Satin chrome finish. Genuine Blomph crystal. Semi-directional, but has tilt head for aiming direct at sound. Chrome finished. Has plug-in connector with 25 ft. cable. **\$1470**  
**YOUR PRICE** .....

**D10001-C—Model GT-3 Crystal Microphone** with desk stand. Same as above. Grip-to-talk switch built in stand tubing. Gripping stand with palm of hand puts mike in operation. With 8 ft. cable. **\$1764**  
**YOUR PRICE** .....

**D10004-D—Model D-104 Crystal Microphone.** Especially designed for speech. Rising frequency above 500 c.p.s. stresses important speech frequencies. High impedance output at -48 Db. Response 500 to 4000 c.p.s. With connector and 8 ft. cable. Fits 5/8"—27 stands. Chrome finish. **\$1323**  
**YOUR PRICE** .....

**D10040-D—Model D104HS Crystal Hand Microphone.** Same as Model D-104 listed above, but has convenient handle. Thumb off-on switch built in handle. Perfect for mobile work. Will not overload or block from close talking. Chrome finish. **\$1499**  
**YOUR PRICE** .....

**D10005-E—Model UT-48 Crystal Microphone.** Designed for clean crisp speech with rising characteristics above 500 c.p.s. to a maximum of 3500 c.p.s. High impedance output at -18 db. Tilting head. Chrome finish. 7 Ft. cable with connector. **\$970**  
**YOUR PRICE** .....

**D10012-F—Model DN-HZ Dynamic Microphone** with tilting head. High impedance output at -53 db. Response 50 to 7000 c.p.s. Two tone gray and chrome finish. Plug-in microphone connector with 25 ft. cable. **\$1323**  
**YOUR PRICE** .....

**D10014-G—Model R-3 Crystal Microphone.** High impedance output at -52 db. Response 30 to 5000 c.p.s. Brown finish with metal grille. 7 Ft. attached cable. **\$585**  
**YOUR PRICE** .....

**D10041-H—Model JT-30-TT Crystal Microphone.** Wide range, semi-directional. Response 30 to 6000 c.p.s. High impedance output at -52 db. Finished in opalescent-gray and chrome. 7 ft. attached cable. **\$970**  
**YOUR PRICE** .....

**D10042-H—Model JT-31-TT.** Same as model JT-30-TT above except furnished with cable connector and 25' cable. **\$1117**  
**YOUR PRICE** .....

Above microphones for 5/8"—27 thread stands.

# SHURE MICROPHONES

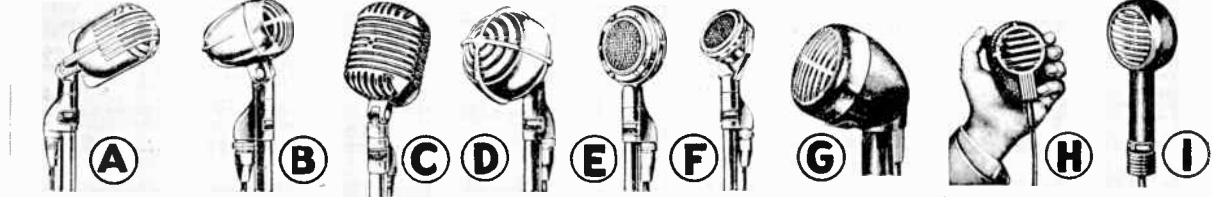

Microphones feature appealing modern design and excellent performance. Dynamic microphones are very rugged and practically unaffected by climatic conditions. Ideal for severe indoor or outdoor use. Smooth frequency response. Wide pickup angle at front and dead at rear. solves feedback problems. Tilting head (except E) for variable directional pickup. Detachable cable connector. Rich satin chrome finish. All types have high impedance output and fit 5/8"—27 thread stands.

**D10016-A—Model 708A "Stratoliner" Crystal Microphone.** Output -50Db. **\$1029**  
**YOUR PRICE** .....

**D10018-B—Model 508C "Stratoliner" Dynamic Microphone.** Output -60 Db. **\$1617**  
**YOUR PRICE** .....

**D10010-B—Model 705A "Rocket" Crystal Microphone.** Response 30 to 10000 c.p.s. Output -58 Db. 25 Ft. cable. **\$1470**  
**YOUR PRICE** .....

**D10019-C—Model 55C "Unidyne" Cardioid Dynamic Microphone.** Response 40 to 10000 c.p.s. Output -56 Db. 25 Ft. cable. **\$2646**  
**YOUR PRICE** .....

**D10011-D—Model 730A "Uniplex" Cardioid Crystal Microphone.** Sensitive at front and dead at rear. Response 30 to 10000 c.p.s. Output -63 Db. 25 Ft. cable. **\$1911**  
**YOUR PRICE** .....

**D10020-E—Model 70H "Super Level" Crystal Microphone.** Has wide response and high output level of -47.5 Db. 7 Ft. cable. **\$1323**  
**YOUR PRICE** .....

**D10023-F—Model 700D "Ultra" Crystal Microphone.** Has wide response of 30 to 10000 c.p.s. Output -58 Db. 25 Ft. cable. **\$1470**  
**YOUR PRICE** .....

**D10021-G—Model 707A Crystal Microphone.** An exceptional value! Smooth response. High impedance output at -50 Db. Iridescent gray finish with chrome grille. 7 Ft. attached cable. Fits 5/8"—27 stands. **\$585**  
**YOUR PRICE** .....

**D10022-G—Model 500C Dynamic Microphone.** As above. Output -63 Db. **\$1029**  
**YOUR PRICE** .....

**D10033-H—Model 750B Crystal Hand Microphone.** Compact and light weight. Iridescent gray finished with chrome trim. Excellent response. High impedance output at -50Db. Built-in on-off switch. 7 Ft. cable. **\$1323**  
**YOUR PRICE** .....

**D10026-I—Model 717A Crystal Hand Microphone.** Light weight brown plastic case. Excellent response. Output -50 Db. **\$585**  
**YOUR PRICE** .....

# ELECTRO-VOICE

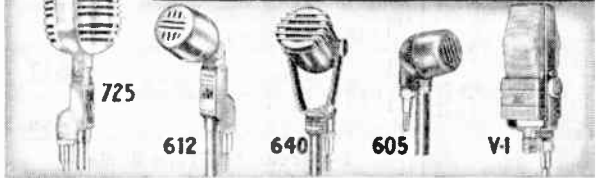

**D10027—Model 725 Cardak Dynamic Microphone.** Response 30 to 10,000 c.p.s. Output -52 db. On-off switch. Chrome finished. **\$2911**  
**YOUR PRICE** .....

**D9997—Model 612G Dynamic Microphone** with on-off switch and tilting head. Response 40 to 9000 c.p.s. Output -56db. Gun-metal. **\$1353**  
**YOUR PRICE** .....

**D9988—612C. Chrome. \$14.70**  
**D9989—Model 630G Dynamic Microphone** similar to Model 612. On-off switch and tilt head. Response 40 to 10,000 c.p.s. Output -55 Db. Gun-metal finish. **\$1470**  
**YOUR PRICE** .....

**D9990—630C. Chrome. \$16.17**  
**D9991—Model 640G Dynamic Microphone** with tilting head. Response 30 to 10,000 c.p.s. Output -52 Db. Gun-metal finish. **\$1617**  
**YOUR PRICE** .....

**D9992—640C. Chrome. \$17.64**

**D9993—Model 605G Dynamic Microphone.** Has fixed head. Response 45 to 8000 c.p.s. Output -58 Db. Gun-metal finished case. **\$1058**  
**YOUR PRICE** .....

**D9994—605C. Chrome. \$11.17**

**D10049—Model V1 Velocity Microphone** with switch and tilting head. Response 40 to 10,000 c.p.s. High impedance output at -65 db. Compact gun-metal finished case with chrome screen. **\$1470**  
**YOUR PRICE** .....

**D10043—Model V2.** Same as V1 but larger. Response 35 to 11,000 c.p.s. **\$20.58**  
**YOUR PRICE** .....

**D9995—Model V3.** Same as V2 but with variable output at 50, 200, 500 ohms or high impedance. **\$2940**  
**YOUR PRICE** .....

All Electro-Voice Microphones include 20 ft. cable with connector. fit 5/8"—27 stands and have high impeded. output.

# AMPERITE

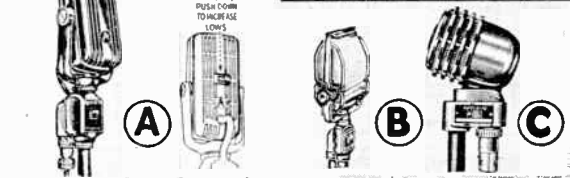

Type A and B Velocity Microphones feature acoustic compensator that increases the high or low frequencies by a mere flip of the finger. Makes microphone suitable for either close or distant pickup and for various room acoustic conditions. Type C Anti-feedback Dynamic is very rugged and practically unaffected by climatic conditions. All models except RAH and RAL have on-off switch and detachable cable connector. All have tilting head for variable directional pick-up and 5/8"—27 thread stand fitting. Available in either chrome or gun-metal finish. \*High impedance for grid connection.

Stock Chr.	Numbers	Gunmetal	Type	Model Num.	Output Imped. Db.	Response c.p.s.	Cable Lgth.	Price Each
D10009	D10056	A	RSHK	*2000	-68	{60 to } {8000 }	12 ft.	\$18.82
D10008	D10055	A	RBSK	200	-68	{6000 }	12	
D10007	D10054	A	RSHK	*2000	-65	{40 to } {11000 }	25	\$24.70
D10006	D10057	A	RBMK	200	-65			
D10104	D10061	B	RAH	*2000	-68	{60 to } {7500 }	12	\$12.94
D10102	D10108	B	RAL	200	-68	{40 to } {15000 }	8	
D10067	D10109	B	SR80FFH	*2000	-56		25	\$47.04
D10066	D10110	B	SR80FN	200	-56		25	
D10103	None	C	PGAH	*High	-57	{70 to } {8000 }	12	\$14.70
D10105	None	C	PGAL	200	-57	{40 to } {10000 }	12	\$18.82
D10106	None	C	PGH	*High	-55		25	
D10107	None	C	PGL	200	-55		25	



# KEYSTONE QUALITY MICROPHONES

## A Microphone for Every Public Address Requirement

Low in Cost—High in Performance

The microphones listed below have been selected on the basis of quality and utility and will fulfill the requirements of your public address jobs. All are made by well known standard microphone manufacturers and are same quality as microphones ordinarily sold at considerably higher prices. All microphones fit standard 5/8"-27 thread microphone stands and are equipped with detachable cable connectors. All units except D10045 Dynamic have a high impedance output for direct connection to tube grid of amplifier. Type D10045 is recommended where long microphone cables are necessary or microphone must operate under noisy line conditions.

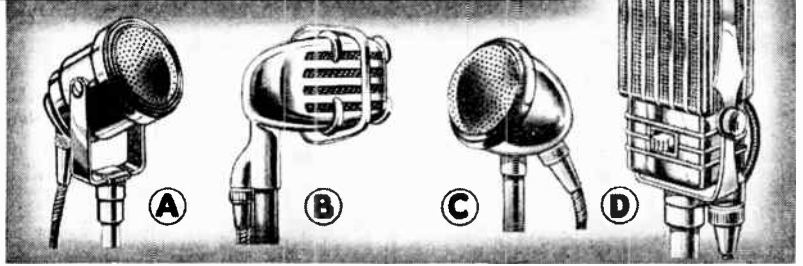

### A—Dynamic Mike

Extremely rugged construction. Smooth high level semi-directional response. Tilting head. Range of 50 to 9000 c.p.s. Purposely not flat to allow better intelligibility under poor acoustical conditions. Output —54 db. No blasting under close talking conditions. Not affected by wind when used outdoors. Case attractively finished in pearl grey. Complete with 25 ft. cable and connector.

**D10038—High Impedance Output Dynamic**  
YOUR PRICE ..... **\$9.95**  
**D10045—Low Impedance (50 Ohms) Output Dynamic**  
YOUR PRICE ..... **\$9.50**

### B—Anti-Feedback Mike

A new directional crystal microphone. For use wherever feedback has been a problem. Can be operated close to speakers, in low ceiling rooms, in front of noisy crowds. Ideal for rental sound systems which must work under various adverse acoustics. High level —58 db. allows use of cables up to 50 ft. Flat response from 30 to 10,000 c.p.s. with no peaks. Moisture-proof crystal with barometric compensator. 90° tilting head permits aiming at sound to be picked up. Finished in polished chrome.

**D10046—Complete with 25 ft. cable and connector.**  
YOUR PRICE ..... **\$10.95**

### C—Crystal Mike

Broadcast quality and streamline appearance at new low cost. Here is a mike that will give you excellent all-purpose performance with truly high grade professional appearance of higher priced models. High impedance output. Range 30 to 8000 c.p.s. with no peaks to cause feed-back. Crystal cushion mounted. Output —52 dB. Semi-directional pick-up. Will not blast. Not affected by wind when used outdoors. Streamlined case beautifully chrome finished.

**D10036—Complete with 25 ft. cable and connector.**  
YOUR PRICE ..... **\$6.25**

### D—Velocity Mike

Particularly desirable for use where high-fidelity hum free pickup for public address, recording or radio broadcast is required. Has narrow pickup arc of approximately 90°. Built-in on-off switch. Response essentially flat with slight accentuation of lows. High impedance output. May be used with most any amplifier having 4 stages or more. Cast metal case in grey wrinkle finish. Shock-proof swivel mounting. Fits 5/8"-27 stands.

**D10039—Complete with 25 ft. cable and connector.**  
YOUR PRICE ..... **\$10.25**

# TURNER CRYSTAL AND DYNAMIC MICROPHONES

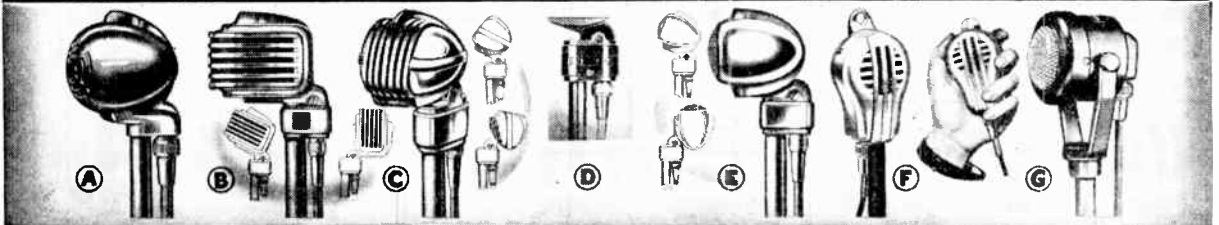

**D10068—A—Model CX Crystal Microphone.** Fine quality, low priced and dependable. Suitable for all P.A., recording and ham use. Remarkably free from feedback and will not blast from close talking. High impedance output at —52 db. Freq. range 50 to 7000 c.p.s. Rich brushed chrome finish. Fits 5/8"-27 thread stands. 7 Ft. cable with detachable connector included.  
YOUR PRICE ..... **\$8.82**

**D10069—A—Model CD Dynamic.** Same as above except has a more rugged high impedance output dynamic unit.  
YOUR PRICE ..... **\$9.70**

**D10095—B—Model 44X Crystal Microphone.** 90° Tilting head provides directional and non-directional pick-up. Freq. range 30 to 10,000 c.p.s. High impedance output at —58 db. Rich satin chrome finish. Fits 5/8"-27 thread. 25 Ft. cable with detachable connector included.  
YOUR PRICE ..... **\$16.17**

**D10096—B—Model 44X with switch D.**  
YOUR PRICE ..... **\$17.35**

**D10070—C—Model 33X Crystal Microphone.** 90° Tilting head provides semi or non-directional pick-up. High impedance output at —52 db. Freq. range 30 to 10,000 c.p.s. Satin chrome finish. Fits 5/8"-27 thread stands. 25 Ft. cable with connector included.  
YOUR PRICE ..... **\$13.23**

**D10071—C—33X with switch D.**  
YOUR PRICE ..... **\$14.41**

**D10077—C—Model 33D Dynamic.** As above but has range 10 to 8,500 c.p.s.  
YOUR PRICE ..... **\$14.70**

**D10078—C—33D with switch D.**  
YOUR PRICE ..... **\$15.88**

**D10091—E—Model 22X Crystal Microphone.** Has all features of above Model 33X but with freq. range of 30 to 7000 c.p.s.  
YOUR PRICE ..... **\$10.58**

**D10097—E—22X with switch D.**  
YOUR PRICE ..... **\$11.76**

**D10092—E—Model 22D Dynamic.** As above but has range 40 to 8,000 c.p.s.  
YOUR PRICE ..... **\$12.64**

**D10098—E—22D with switch D.**  
YOUR PRICE ..... **\$13.82**

**D10062—F—Han-D Crystal Microphone.** Fills the job of two mikes. Has built-in suspension hook for hanging, can be held snugly in your hand or mounted on a 5/8"-27 thread banquet or floor stand. High impedance output at —48 db. Freq. range 60 to 7,000 c.p.s. Built-in on-off slide switch. Rich brushed chrome finish. 7 Ft. cable and detachable connector included.  
YOUR PRICE ..... **\$13.23**

**D10063—F—Han-D Dynamic Microphone.** Same as above except with a rugged high impedance output dynamic unit.  
YOUR PRICE ..... **\$14.70**

**D10075—G—Model 88 Dynamic Microphone.** Tilting head provides semi or non-directional pick-up. Has crisp natural reproduction. Wind and blast proof. No "boomy" response. Weighted frequency response, 40 to 3,000 c.p.s. High impedance output at —51 db. Chrome finished. Fits 5/8"-27 thread stands. 25 Ft. cable with detachable connector included.  
YOUR PRICE ..... **\$14.70**

Literature will be sent on above Turner microphones on request. We can make quick shipment on other models not listed.

# CARBON MICROPHONES



### B—Radolek Ring Model

**D10037—Fine quality double button carbon microphone.** Carefully selected after exhaustive tests. No frills, just real microphone quality priced very low. 24 kt. gold button contacts. Response 50-4500 c.p.s. 200 Ohms per button, total 400 ohms. Faithfully reproduces voice and music. Not to be confused with toy microphones selling at same price. This is a well assembled instrument for long trouble-free service. 2 1/2" Dia., 1/2" thick. Gun metal finish.  
YOUR PRICE ..... **\$2.94**

### C—Radolek Stand Type

**D10034—A streamlined stand type carbon mike** that looks and performs like the more expensive crystal models. Sensitivity can be adjusted over a wide range for close talking or for minimum feedback, to full orchestral pickup. The high output makes it especially suitable for use with the audio amplifier of a radio receiver or low gain P.A. amplifier. Shockproof, mounted in a handsome moulded, gunmetal finished metal case. Fits stands with standard 5/8"-27 threads.  
YOUR PRICE ..... **\$4.41**

### A—Electro-Voice Model 202

**D10028—Single button carbon hand microphone.** Has built in suspension hook for hanging or can be held conveniently in the palm of your hand. Speech is crisp, clean and blast proof. Push-to-talk switch is right at your thumb. Has 6 ft. rubber covered shielded cable. Ideal for amateur use and P.A.  
YOUR PRICE ..... **\$7.35**

### D—Universal Model W

**D10032—Watch Model.** A compact single button carbon microphone. Only 1 1/2" in dia., 1/2" thick. Highly sensitive. Has pure gold spot center diaphragm. Ideal for detecting work.  
YOUR PRICE ..... **\$1.76**

### E—Universal Model XX

**D10030—Double Button Carbon Microphone** for ring mounting. One of the finest carbon mikes made. Truly faithful and natural tone. Freq. range 40 to 6000 c.p.s. Pure gold contacts. Duralumin stretched diaphragm. Ruggedly built for long service. 2 1/2" Dia., 1" thick. 200 Ohms per button.  
YOUR PRICE ..... **\$5.88**

# MICROPHONE ACCESSORIES and STANDS

## Dual Channel Microphone Pre-Amplifiers

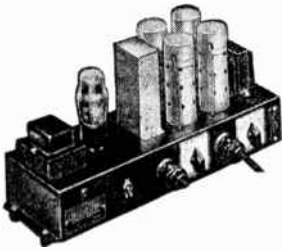

These Radolek Pre-Amplifiers, when coupled to your amplifier will supply the additional gain (65 D.B.) that is needed to utilize the advantages of Crystal, Velocity or Dynamic mikes. Compact in size. Single unit construction. High impedance microphones can be connected without use of coupling transformers. Plug-in outputs and inputs. Output has 500 and 200 ohm taps for line connections and high impedance tap for direct connection. All tube noises, AC hum, motorboating and oscillation troubles have been eliminated. Size: 7 1/2 x 3 1/2 x 1 1/2". Two input channels. 5 Tubes. Two microphones or one microphone and phono can be used at the same time and mixed or faded in any proportion. Operates on 105-120 Volt, 50-60 Cycle AC.

**C15065**—Factory Wired. Laboratory Tested. Instructions Included. As described. Less Tubes. List Price, \$44.00.  
**YOUR PRICE..... \$19.95**

**C15066**—As above but With Five Sylvania Matched Tubes, 2-75's, 2-6D6's, and 1-80.  
List Price, \$49.30.  
**YOUR PRICE..... \$21.77**

## Microphone Stand On-Off Switch



May be used with any type of microphone equipped with female 3/8"-27 thread and stand with male 3/8"-27 thread. Two holes in back with strain relief clamp for mike cable. Chrome plated.

**D11085**—With shorting slide switch.

**D11086**—With "push-to-talk" push button switch.  
**YOUR PRICE, Each..... 98¢**

**D11084**—Similar to above except has rotary switch and cable receptacle for Amphenol MC 1F mike cable plug.  
**YOUR PRICE..... \$2.35**

## Microphone Springs



Loop ends. Tempered spring steel. Heavy cadmium plated finish to prevent rusting.

**K10074**—Eight for.... **15¢**

## Carbon Granules



Carefully selected and highly polished. Acid treated to reduce ash content. Will stand higher current without burning. Vial contains sufficient granules to repack two double-button carbon microphones.

**K10082**—Size No. 100. Higher sensitivity and higher background noise. Provides best quality reproduction but packs easily.

**K10083**—Size No. 80. Best general purpose granules. Lower hiss, good quality reproduction and does not pack easily.

**K10084**—Size No. 60. Best for sound trucks and hard usage. Low hiss, more freedom from packing, fair quality reproduction.  
List Price Per Vial, \$1.00.  
**YOUR PRICE..... 40¢**

## Ribbons for Velocity Microphones

Will fit practically any Ribbon-Velocity Mike including Amperite, Bruno, RCA, Universal, Electro-Voice, etc. Tempered to give extreme strength. .0023" thick.  
**A9977**—3"x1/4".  
**A9978**—3"x1/2".  
**YOUR PRICE, EACH..... 45¢**

## Duralumin Diaphragms

For Carbon Microphones. Size 4"x4"x.002".  
**C10081**—  
**YOUR PRICE..... 50¢**

## Brunswick-Vocalion Double Faced Record Assortment

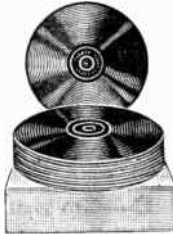

### An outstanding value!

These new record assortments contain popular hits announced up to January 1939. All electric recordings of principally dance music by many famous artists and band leaders. Records are Genuine Brunswick-Vocalions electrically cut with recordings on both sides. 10" Diameter. Packed in separate envelopes. Guaranteed perfect! All brand new—never been used. No factory rejects or seconds are supplied. Suitable for all P.A. and record playing purposes. It will not be possible for us to state exactly what numbers are included in each assortment. Duplication between assortments is at a very low percentage so order any quantity.

**10 Record Assortment**  
**B15395**  
**YOUR PRICE, ONLY..... \$1.19**

**25 Record Assortment**  
**B15394**  
**YOUR PRICE, ONLY..... \$2.38**

## Cable Rack



### Fits Any Mike Stand

**C15265**—Black only—no stand. List, \$1.25.  
**YOUR PRICE..... 74¢**

**Ten for \$6.75**  
A new, convenient method of storing microphone cable that eliminates tangling and tripping. Will save you enough money in increased cable life, to more than pay for its low cost. Snaps on to mike stand, and holds secure even with a heavy load. Will hold up to 100 feet of regular mike cable. Phosphor bronze spring clamps. Smooth black enamel finish.

## Microphone Cable Guide



Cable Guide—Holds Cable neatly to outside of Microphone stand. Attach to tubing near base. Made of black gum rubber. Can be stretched to pass over obstacles.  
**D12266**—For 1 1/4" or 3/4" diameter tubing Stands. List, 35¢.  
**YOUR PRICE..... 21¢**

## Third Hand Holds the Mike



**C9971**—  
**YOUR PRICE..... \$1.45**  
If you announce sports events, drive a sound equipped automobile, operate a transmitter or need both hands free while talking over a microphone, the Third Hand holds the mike close to your mouth yet keeps it out of your line of vision. Slips over your head, fits comfortably. Weighs only 12 oz. less mike. Flexible goose neck allows adjustment of microphone to any position. Fits any standard microphone having 3/8"-27 thread female mounting.

## Microphone Handle

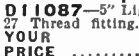

**D11087**—5" Light weight handle. 3/8"-27 Thread fitting. Gun-metal gray.  
**YOUR PRICE..... 30¢**

## Suspension Yoke



**D11088**—Two hole suspension yoke for any mike with 3/8"-27 thread fitting. Gray wrinkle finish.  
**YOUR PRICE..... 30¢**

## Desk Stand



**R10073**—List, \$2.24.  
**YOUR PRICE..... \$1.32**  
A modernistic desk stand finished in black crackle. Octagon shaped ring is 3/4 inches in diameter. Will mount practically any carbon microphone. Heavily weighted 5" dia. base prevents stand from tipping. Overall height 9". 8 microphone springs included.

## Suspension Ring

**D10072**—Similar to above except with loop for suspending mike from ceiling. With 8 mike springs. No base included.  
**YOUR PRICE..... 88¢**

## Radolek Special Microphone Stands Best Quality—Best Values

### Our Finest Floor Model



**K15260**—List Price, \$17.50.  
**YOUR PRICE..... \$8.70**

The finest in workmanship and quality of materials. Attractive modernistic design. Particularly suited for High Class Broadcast and Public Address Installations. Fourteen pound Cast Base 12" diameter finished in Baked Black enamel. Rigid seamless brass two piece standard is adjustable from 40" to 72". Lower section 1 1/4" Dia. New friction clutch allows instant raising and lowering of microphone. Clutch keeps smooth constant pressure which prevents collapsing of stand even with the heaviest velocity microphone. Standard finished in triple plate highly polished chrome. Comes with Swivel joint coupling for microphones having either 3/8" pipe thread or 3/4" 27 thread fitting. No Ring or Microphone Included.

### De Luxe Floor Stand



**K15261**—  
List, \$10.00.  
**YOUR PRICE..... \$4.55**

A neat and attractive floor stand built for convenience and hard usage. Nine pound 10 1/4" diameter cast base makes stand very rigid. Seamless brass spinning covers casting. Rigid seamless brass two piece standard is adjustable from 40" to 68". New friction clutch allows instant raising and lowering of microphone. Clutch keeps smooth constant pressure which prevents collapsing of stand even with the heaviest velocity microphone. Entire stand finished in highly polished triple plate chrome. Comes with Swivel Joint coupling for microphones having either 3/8" pipe thread or 3/4" 27 thread fitting. No ring or microphone included.

### Standard Floor Stand



**K15262**—List, \$8.50.  
**YOUR PRICE..... \$3.55**

Identical construction to above stand except base only 9" Dia. and weighs only 6 lbs. Stand includes swivel joint with coupling for microphones having either 3/8" pipe thread or 3/4" 27 thread fitting. Triple chrome plated. No Ring or Microphone included.

### Portable Floor Stand

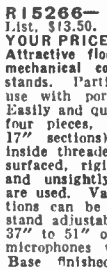

**R15266**—  
List, \$13.50.  
**YOUR PRICE..... \$4.95**

Attractive floor stand similar in mechanical construction to above stands. Particularly designed for use with portable P.A. systems. Easily and quickly detachable into four pieces, (9" base and three 17" sections). Each section is inside threaded to form a smooth surfaced, rigid stem. No bulky and unsightly external couplings are used. Various number of sections can be used to make mike stand adjustable from 20" to 34", 37" to 51" or 54" to 68". Fits microphones with 3/8"-27 thread. Base finished in black wrinkle enamel. Stem and clutch are polished chrome.  
Weight 8 lbs.

### Banquet Stand



**R15267**—  
List, \$2.50.  
**YOUR PRICE..... 88¢**

A very attractive banquet stand. Suited for all public address and amateur purposes. Height without microphone 10". Heavy cast metal base has 3 feet which allows cord to come out at bottom. Base is black crackle finish, stem of highly polished chrome. Thread fits microphones or rings having 3/8" 27 thread. No ring or microphone included. Weight 3 lbs.



# Crystal and Magnetic Phone Pickups

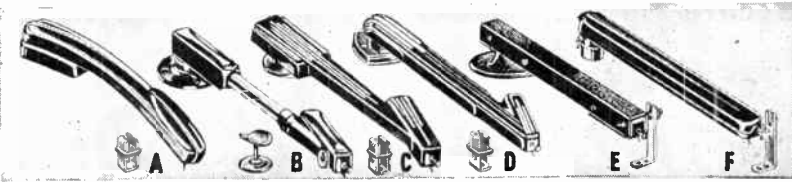

## Astatic Crystal Phonograph Pickups

**D9466—TYPE A. Model FP18.** Modern low pressure pickup with permanently attached sapphire stylus. Eliminates needle changing. Stylus protected against damage. Low stylus pressure of 1 oz. and reduced torque of wire coupling vibrating system greatly prolongs record life. Freq. range 30 to 7000 c.p.s. High impedance output at 0.85 volts. Plays up to 12" records. True tracking arm in statuary brown finish. **\$970**  
YOUR PRICE .....

**D9467—TYPE A. Model FP38.** As above except has freq. range of 30 to 10,000 c.p.s. with 0.65 volts output. **\$970**  
YOUR PRICE .....

**D9468—TYPE A. Model FL58.** As above in appearance but has pressure of 2 oz. Freq. range 30 to 6500 c.p.s. Output 1.25 volts. Astatic replaceable type FT needle suitable for 500 playings is recommended. **\$794**  
YOUR PRICE .....

**D9469—FT Needle.** Each 59¢

**D9364—TYPE B—Model B-10.** Provides full bass note and high fidelity reproduction. True tracking head design. Ball bearing swivel base. Finished in black and chrome. High impedance output at 2.5 volts. Needle pressure 2 3/4 ozs. Plays up to 12" records. **\$1029**  
YOUR PRICE .....

**D9365—TYPE B—Model B-16.** As above but plays up to 16" records. **\$1323**  
YOUR PRICE .....

**D9369—TYPE C—Model AB8.** High performance crystal housed in die cast true tracking arm. Statuary brown finish. Plays up to 12" records. **\$588**  
YOUR PRICE .....

**D9347—TYPE D—Model O-7.** Has short mounting centers of 7". High performance crystal cartridge has 2.9 volts output. True tracking arm finished in black and chrome. Plays up to 12" records. **\$382**  
YOUR PRICE .....

**D9348—TYPE D. Model D9.** Compact low cost high performance pickup. Finished in statuary brown with single hole mounting bracket. Output 1.4 volts. Mtg. ctrs. 7". Plays up to 12" records. **\$291**  
YOUR PRICE .....

**D9362—TYPE D—Model S-8.** Popular pick-up with improved features. Axial cushioning reduces motor noise pick-up. High quality performance crystal with 2.5 volts output. Black wrinkle finished arm. Plays up to 12" records. **\$588**  
YOUR PRICE .....

**D9363—TYPE D—Model S-12.** As above but plays up to 13" records. **\$735**  
YOUR PRICE .....

**D9470—TYPE F. Model SL-8.** Straight die cast arm pick-up in statuary brown finish. Recommended for playback of lightly cut home recordings up to 12". Mtg. ctrs. 7 or 8". Needle pressure 2 3/4 oz. Output 1.4 volts. **\$291**  
YOUR PRICE .....



## Audak Magnetic Pickups

**Model AT-10**

**C9372—A** scientifically designed, streamlined magnetic type phonograph pickup featuring exceptionally light needle pressure, wide range frequency response of set head and ball bearings. High impedance output. Will play up to 12" records. Attractive black and silver finish. **\$4.70**  
YOUR PRICE .....

**D9373—Model AT-12.** Same as above but with a wider range frequency response. **\$735**  
YOUR PRICE .....

**Microdyne Model D24E**

**C9374—The new Microdyne magnetic pickup** is designed to get the most out of modern phonograph records by boosting the bass response and leveling out the highs. Frequency response is flat within ±3 Db to 7000 C.P.S. with a rising bass characteristic reaching about +12 Db at 50 c.p.s. Needle pressure of 2 3/4 oz. prolongs record life. Appearance and other features as above. **\$1088**  
YOUR PRICE .....

**D9492—Model D28E.** As above but for playing records up to 16". **\$1735**  
YOUR PRICE .....

**Microdyne Model D31E**

**D9493—Similar to Model D24E** in appearance and construction but with superior performance characteristics and lower needle pressure. Flat within ±2 1/2 Db to 7500 c.p.s. **\$1441**  
YOUR PRICE .....

## Webster Crystal Pickups

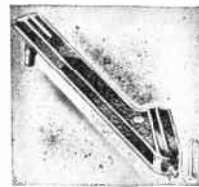

A high impedance output crystal pick-up that features wide appeal and possesses excellent electrical and mechanical characteristics. Interlocking bearing system prevents displacement or crystal fracture by accidental pressure or blows on needle screw. Rubber cushioned, true-tracking metal arm assembly with single hole mount.

Plays up to 12" records. Finished in brown wrinkle enamel. Output 1.8 volts.

**D9471—Model GX80A3D.** Needle pressure 2 1/2 oz. Freq. response 50 to 7000 c.p.s. **\$291**  
YOUR PRICE .....

**D9472—Model X82A3D.** Needle pressure of 2 oz. Freq. response 30 to 8500 c.p.s. **\$323**  
YOUR PRICE .....

**With Sapphire Needle**

**D9473—Model X82AND.** Has high needle point compliance cartridge with replaceable sapphire point needle, good for many thousand playings. Output 1.5 volts. Needle pressure 1 oz. Response 30 to 7000 c.p.s. **\$397**  
YOUR PRICE .....

## RCA Crystal Pickups

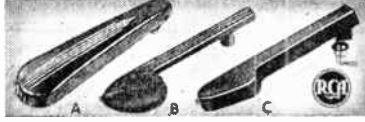

High fidelity crystal pickups. Flat frequency response from 70 to 7,000 c.p.s. High impedance output at 1.5 volts. Plays up to 12" records. True tracking tangent arm design.

**D9375—Type A—RCA Pt. 9868.** Brown bakelite arm. Needle pressure 2.7 oz. **\$320**  
YOUR PRICE .....

**D9376—Type B—RCA Pt. 9869.** Top needle loading. Brown wrinkle finished metal arm. Needle pressure 3 oz. **\$379**  
YOUR PRICE .....

**D9377—Combination Needle Box and Pickup Rest.** For RCA 9869 pickup only. **\$9¢**  
YOUR PRICE .....

**D9378—Type C—RCA Pt. 9891.** Fine quality low priced pick-up. Brown wrinkle finished arm. Needle pressure 2.7 oz. **\$291**  
YOUR PRICE .....

## Brush Crystal Pickups

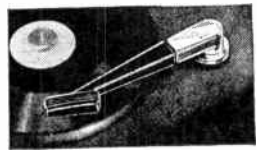

**Low Pressure Type With Permanent Sapphire Stylus**

**D9371—Model PL-50**  
YOUR PRICE **\$44.10**

New high fidelity crystal pickup with permanently attached sapphire stylus. Needle pressure 1/2 oz. Produces no measurable wear on recordings. 15,000 satisfactory playings of 12" discs possible. Stylus protected against injury. Freq. response ± 1 1/2 Db. from 30 to 10,000 c.p.s. Output 0.18 volts. Supplied with high impedance frequency equalizer. Molded black bakelite tangent 1 1/4" arm with satin chrome finished metal pivot assembly. Adjustable for various turntable heights. Plays up to 16" records.

**D9409—Model PL-20.** Same as above except has 1 oz. stylus pressure. Sapphire suitable for 5000 satisfactory playings of 10" discs. Output 2 volts. Freq. response ± 2 1/2 Db. up to 6000 c.p.s. Taupe colored bakelite arm with antique bronze finished metal parts. High impedance frequency equalizer included. **\$22.05**  
YOUR PRICE .....

**D9429—Model PL-25.** Uses same cartridge as PL-20 but has 10 1/2" arm of less expensive design. Plays up to 12" records. Less equalizer. **\$16.17**  
YOUR PRICE .....

## Shure Crystal Pickups

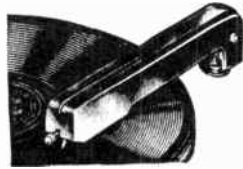

**Model 94A**  
**D9434—**  
YOUR PRICE **\$291**

Compact design for mounting in limited space. Plays up to 12" records. Needle tilted for true tangent arm. Needle pressure 2 3/4 oz. Output 2 1/4 volts. Full range freq. response. Single hole mounting. Rubber cushioned pivot bearing assembly. 8" Long cast arm with wood tone finish.

**SHURE "ZEPHYR"**

Modernistic molded bakelite arm crystal pick-up. Flat response 50 to 7000 c.p.s. High impedance output at 2 1/4 volts. Needle pressure 2 3/4 oz. Plays up to 12" records.

With streamlined mounting base

**D9457—Model 99CW—Walnut } PRICE**  
**D9368—Model 99C—Black } EACH... **\$441****

With single hole mounting base

**D9458—Model 98AW—Walnut } PRICE**  
**D9463—Model 98A—Black } EACH... **\$382****

## Special Value Pickups



**B9339—Crystal Pickup** **\$2.45**  
**B9367—Magnetic Pickup**  
YOUR PRICE, Either Type .....

Reproduce recorded music with exceptional clarity, depth and fullness of tone. Both pickups have high impedance outputs for direct tube grid connection. Play records up to 12". Ship. wt., 3 lbs. **B9339** — Uses Brush Licensed Crystal mounted in special offset arm to reduce tracking error and record wear. Accurately balanced arm with full floating, rubber cushioned pivot bearing. Wide range frequency response. **B9367** — Has alnico steel magnet assuring full performance and long life.

## Replacement Crystal Cartridges

For Astatic, Webster, Shure, RCA and other crystal pickups having a needle pressure of 2 to 3 ozs. \*For 1/2 oz. pickups.

**Type A. Bakelite case, size 1/2"x2 1/4"** long. Mtg. hole ctrs. 1 1/2"x4".

**D13100—Lug term.** For Webster X82CH; Astatic S8, Shure 914.

**D13105 — Screw terminals.** Used in Astatic AB8 and S12.

**D13106—3" Wire lead term.**

**D13107—Pin term.**

**YOUR PRICE, Each... **\$2.94****

**D13108—Screw terminals.** For Astatic B10 and B16. **\$3.53**  
YOUR PRICE .....

**D13101 — B.** For Webster X82CH; Astatic AL8, D9, S18. **\$2.32**  
YOUR PRICE .....

**D13109\* — B.** For Webster X82CH; Astat. FL58. **\$3.53**  
YOUR PRICE .....

**D13102\* — B.** With sapphire point needle. For Webster X82CH, S82CN. **\$3.06**  
YOUR PRICE .....

**D13115 — C.** Has "needle tilt." For Shure 94, 99, 910. **\$2.35**  
YOUR PRICE .....

**D13103—D.** Replaces Webster X79C, X80C. **\$2.12**  
YOUR PRICE .....

**D13110—E.** For Astatic 07. **\$2.94**  
YOUR PRICE .....

**D13111\* — F.** With built-in sapphire stylus. For Astatic FP18 and FP38. **\$4.70**  
YOUR PRICE .....

**D13120—G.** RCA PL 31050 for #9842 pick-up.

**D13121—G.** RCA PL 33217 for #9891 pick-up.

**D13122—H.** RCA 33122 for #9868. **\$2.25**  
YOUR PRICE, Each .....

**D13123—H.** RCA Pt. 33905 for #9869 pick-up. Top needle loading. **\$2.55**  
YOUR PRICE .....

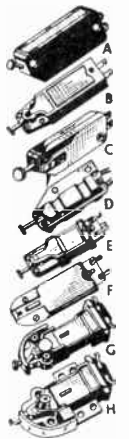

# PHONOGRAPH ACCESSORIES

## Record Albums

For 10" and 12" Records

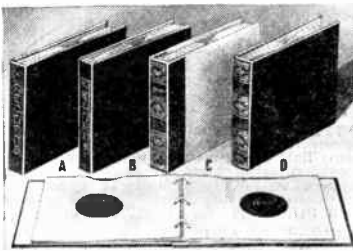

Attractive albums for conveniently storing records. Opens flat. Loose-leaf design permits quick accessibility to records and enables them to remain in pocket until ready to be played when removed from the album. Pockets have reinforced metal eyelets. Each album has a capacity of 12 records. Style A. Rich wine colored cover with alligator grain matching marooned colored cloth end. A most attractive low priced album.

Stock Number	Record Size	YOUR PRICE EACH
D14900	10"	39c
D14901	12"	49c

Style B. Completely covered in leatherette cloth. Extremely durable.

D14902—Blue	10"	55c	49c
D14903—Russet	10"		
D14904—Maroon	10"	66c	59c
D14905—Blue	12"		
D14906—Russet	12"		
D14907—Maroon	12"		

Style C. Cork-grain cover with ends of brown swirl cloth bearing gold stamped design. A credit to any record library.

D14908	10"	65c	62c
D14909	12"	79c	75c

Style D. A deluxe aristocratic album. Full cloth bound in brown swirl design with padded covers and fine gold stamped, rounded metal reinforced binder.

D14910	10"	90c	86c
D14911	12"	\$1.10	\$1.05

## Record Album Cabinet



Holds Nine 10" or 12" Albums

D17600—Walnut Finished.

D17601—Mahogany Finished.

YOUR PRICE Either Type **\$8.75**

A fine, sturdily constructed cabinet that provides a quickly accessible storage space for your records. Designed

to hold up to nine 10" or 12" record albums of the type listed above or others not measuring over 2x 14x13" high. Sectional dividers hold albums upright. Overall size 26" wide, 26" high and 16" deep. Fashioned of choice grained veneers and hardwood richly finished. Albums not included.

## DeLuxe Album Cabinet



Holds Ten 10" or 12" Albums

D17602—Walnut Finished.

D17603—Mahogany Finished.

YOUR PRICE Either Type **\$9.95**

A beautifully constructed record album cabinet. Quality built throughout of choice grained

veneers and hardwood. Richly finished. Attractive carved legs and trim. Sectional dividers hold the albums upright. Cabinet holds up to ten 10" or 12" albums of the type listed above or others not measuring over 2x14x13" high. Albums not included.

## Record Holding Racks

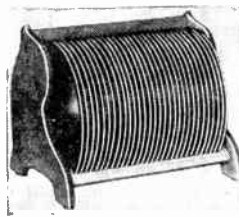

Holds Thirty 10" Records

D14914  
YOUR PRICE **65c**

A practical inexpensive record holder having provisions for storing up to 30 10" records. Each record division is numbered. Index cards included. Walnut finished end pieces. Size 13x10x1 1/2". Shipped knocked-down, easy to assemble.

Holds Fifty 10" or 12" Records  
D14912—Somewhat similar to above in appearance but holds up to 50 10" or 12" records.  
YOUR PRICE **97c**

## Wire Record Rack

Holds Up to Fifty 10" or 12" Records

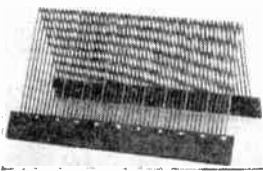

D14913  
YOUR PRICE **95c**

A new handy wire rack at a sensible price. Securely and conveniently holds up to fifty 10" or 12" records. Heavy steel wires are covered with cotton fabric. Wood bases are covered with a fine quality brown Spanish Du-Pont fabrikoid. Numbered every five divisions.

## Record Carrying Case



All-Metal Holds Up to 65 10" Records  
D15848—Size 10 1/2"x10 3/4"x 6 1/4".  
YOUR PRICE **\$3.25**

Just the thing to carry popular recordings with portable sound equipment. Also serves as an ideal storage case for surplus records. All steel exceptionally, sturdily

construction finished in black crackle enamel. Cloth lined for protection to records. Hinged cover and front panel, strong double snap lock fasteners.  
D15849—As above but holds up to 95 10" records. Size 10 1/2"x10 3/4"x9 1/4".  
YOUR PRICE **\$3.50**

Fabrikoid Covered Record Case  
D15857—Sturdy Fabrikoid covered wood carrying case. Holds 50 10" records. Ideal for portable sound systems.  
YOUR PRICE **\$1.95**

## Bakelite Needle Cup

Brown mottled bakelite needle cup with removable cover. Can be used with or without cover. Mounts in 1 1/2" hole.  
D9309—Ten for 55c. Each ... **6c**



## Metal Needle Cup



May be bolted onto motorboard or mounted in 1 1/2" hole. Spring hinged cover. Overall size 1 1/2" dia. x 1/2" high. Holds approximately 100 needles.  
D9303—YOUR PRICE **8c**

## Phono Pickup Scratch Filter

D9340—YOUR PRICE **79c**

For use with crystal pickups. Tuned to point of greatest scratch intensity. Sealed against atmospheric changes.



## Needles For Playback



For Manual Play Only

D9394—Type A—Genuine RCA Victor Full Tone Needles. For commercial records.  
10 Pkgs. for 75c. Per Pkg. of 100..... **10c**

D14100—Type B—Genuine RCA Victor Red Seal Needles for playing Red Seal records.  
10 Pkgs. for \$1.85. Per Pkg. of 50..... **20c**

D14101—Type C—Trailing shoe-needle for playing acetate recordings with heavy acoustic or electric pickups weighing 2 1/2 oz. or more. Plays approx. 25 records perfectly.  
YOUR PRICE, Per Pkg. of 100..... **63c**

D9304—Type D—Actone Green Shank Transcription Type. Tested under magnification of 200 times to assure perfection. Plays 5 pressed records without change.  
YOUR PRICE, Per Pkg. of 100..... **38c**

D9307—Type D—Actone Red Shank Type. Perfectly formed and tested as above Type D. Excellent for playing acetate discs.  
YOUR PRICE, Per Pkg. of 100..... **38c**

D14102—Type E—Hi-fidelity Transcription Needles for professional and home use. Shadow-tested. Fine enough to play the best acetate and commercial records in any studio. Famous for uniformity and hi-fidelity.  
YOUR PRICE, Per Pkg. of 75..... **49c**

D9399—Type F—Bamboo Needles for playback of aluminum and commercial recordings.  
YOUR PRICE, Per Pkg. of 100..... **54c**



Sapphire for Manual Play

Waco Sapphire Playback Needle. Tip is shaped to fit record groove. Will play approximately 2,000 commercial records and 5,000 acetate recording discs without injury.

D14103—Type H—Bent Shank type for pickups having 2 1/2 oz. or more needle pressure.

D14104—Type G—Straight Shank type for new light weight crystal pickups.  
YOUR PRICE, Either Type, Each ..... **88c**

For Record Changer and Manual Play  
D9301—Type I—Very quiet in operation with true, natural reproduction of voice and music. Plays 10 to 15 records without change.  
YOUR PRICE, Pkg. of 30 Needles..... **23c**

D14105—Type J—Eldeen Classic. High grade inexpensive needle tipped with a precious metal that minimizes wear and reduces surface noise. Gives 2,000 perfect playings.  
YOUR PRICE, Each ..... **29c**

D14106—Type K. Permo-Elliptical Point Needle, with tip coated with osmium-iridium composition. Plays over 2,000 pressed records with excellent tone. Recommended for coin machines.  
YOUR PRICE, Each ..... **29c**

D14107—Type L. Permo-Fidelitone Needle as Type K but with round tip having wider freq. response and lower surface noise.

YOUR PRICE, Either Type, Each..... **50c**

Lots of 5, Each..... **45c**

D14108—Type M. Presto-Transcriptone Needle same as Type K but has excellent high fidelity response. Recommended for playback of acetate coated discs.  
YOUR PRICE, Each ..... **\$1.00**

## Phonograph Adapters

Adapts any radio set for phonograph operation, without changes in circuit wiring. For use with high impedance magnetic or crystal pickups. Includes 18" shielded leads and phono-radio switch that can be mounted anywhere. Instructions included.



D14115—A. With octal adapter. For radios using a 6116 2nd detector tube.

D14116—B. With 5 prong adapter. For radios using a 27, 37, 56, 76 etc. (tubes without grid cap) as detector or first audio.

D14117—C. With grid cap adapter. Fits both large and small grid caps. For sets having detector or first audio tubes with grid caps.

D14118—D. With octal adapter. For sets having 6C5, 6J5, etc. metal tubes without grid caps as first audio amplifier.  
YOUR PRICE, Each ..... **71c**



# AUTOMATIC PHONOGRAPH RECORD CHANGERS

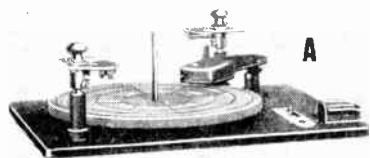

## A—RCA DeLuxe Changer

**Compact—Efficient—Dependable**

Plays Seven 12" or Eight 10" records automatically. Exceptionally efficient—practically fool-proof in operation. Rejects any undesired record at will. Includes new top loading crystal pickup with automatic needle ejector and receptacle. Pickup is 1½ volt output, wide range type, matches input of any public address amplifier or can be used in conjunction with practically any radio set. Compact, easily slipped into limited space. Ideal for replacing manually operated phonographs. Requires mounting space of only 14½" wide x 11½" long x 4¾" under mtg. plate x 4½" above mtg. plate. Operates on 110-120 volts, 60 cycle AC.

**A15386**—RCA DeLuxe Automatic Record Changer. List Price, \$34.95.  
**YOUR PRICE** ..... **\$20<sup>55</sup>**

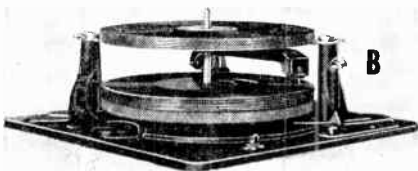

## B—General Industries Changer

**Plays Twelve 10" or Ten 12" records**

Requires no more space for installation than most manually operated units. Plays twelve 10" or ten 12" records at 78 RPM. Fully enclosed direct drive motor. One lever to set for record size or manual operation. Any record may be ejected at will. Mechanism is positive—quiet in operation and will not jam or damage records in any way. Sturdy base-plate assures complete rigidity. Size: Base plate 14x14". Mechanism extends 4½" above and 3½" below.

**D15364—G.I.—C120 Automatic Record Changer.** Complete with true-tangent crystal pickup, and on-off switch. List Price, \$58.00.  
**YOUR PRICE** ..... **\$34<sup>80</sup>**



## C—Webster Standard Changer

**Compact—Quiet—Jam Proof**

Compact construction permits installation in same space usually required by manual units. Automatically plays ten 12" or twelve 10" records at 78 RPM. Push buttons for 10" to 12" changeover, record rejection and manual playing. Positive trip action insures changer operation as soon as needle reaches eccentric groove at end of record. Entire unit rubber mounted for noise-free operation. Grey wrinkle finish. Size: plate 14x14". Projects 5½" top and bottom. For 110 V. 60 cyc. AC.

**D15389—Webster W5570 record changer with crystal pickup.** List, \$34.50.  
**YOUR PRICE** ..... **\$20<sup>29</sup>**

## Webster DeLuxe Changer

Plays up to 17 mixed 10" and 12" records.

**D15373—Model 5590**  
List Price, \$55.00.

**YOUR PRICE** ..... **\$32<sup>34</sup>**

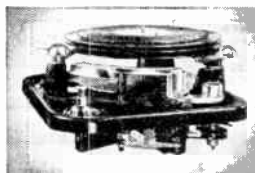

Finer construction, appearance and operation than Model W5570 above. Automatically plays up to 17 mixed ten and twelve inch records—at 78 RPM. Pickup balanced to 2 oz. needle pressure, minimizing record wear. Mechanism stops automatically after last record has been played. Heavy die-cast mounting plate. Hammered bronze enamel finish. Size, Mounting plate 13½"x17½". Mechanism 5½" above and 4¾" below plate. Ship wt. 30 lbs.

# GENERAL INDUSTRIES PHONOGRAPH MOTORS

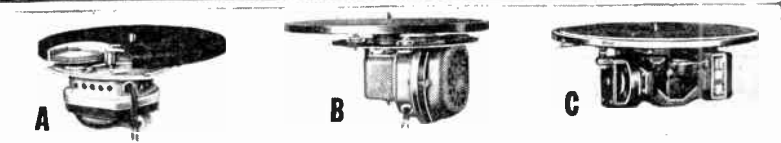

## Self-Starting—Constant Speed

Low Cost—Light Weight—Compact. Have same power to play 10" and 12" records. Fan cooled motors, designed to comply with Underwriters Lab. requirements. Can be installed in small cases without overheating. Quiet in operation. For 110 Volt 60 cycle AC operation.

### Rim Drive Types

Self-starting 78 RPM friction rim drive. Motor is rubber insulated from both mounting plate and turntable to insure quiet operation. Oil-less bronze bearings.

**D15367—A—Model LX** with 9" turntable and 2 pole motor. Depth from mounting plate to bottom, 2". List Price, \$4.65.  
**YOUR PRICE** ..... **\$2<sup>79</sup>**

**D15368—A—Model RX** with 10" turntable and 4 pole motor. More powerful and smoother running than Model LX. Depth from mounting plate to bottom, 2¾". List Price, \$6.35.  
**YOUR PRICE** ..... **\$3<sup>81</sup>**

### Gear Driven Types

**D15370—B—Model CX.** 78 RPM. Extra dependable performance at exceptionally low cost. 12" turntable. Very quiet in operation. Powerful synchronous motor rubber insulated from turntable, minimizing motor rumble. Positive direct drive through silent, helical cut gears sealed in oil. Mounting hardware furnished. Depth from mounting plate to bottom, 3¾". List, \$9.55.

**YOUR PRICE** ..... **\$5<sup>73</sup>**

## Governor Controlled Motors

**D15369—C—Model A.** 78 RPM. Centrifugal governor speed control provides a positive means of accurate maintenance of uniform speed even with fluctuating line voltage. Silent operating induction motor, rubber suspended from mounting plate, directly drives 12" turntable through helical gears. Motor dimension 6¼"x3½"—suspend: 3" below baseboard. Mounting hole centers 3x4½". Mounting hardware included. For 105-120 V. 60 cyc. AC operation. List Price, \$13.70  
**YOUR PRICE** ..... **\$8<sup>22</sup>**

**D15365—C—Model D.** Dual Speed 33½-78 RPM. 12" turntable. Overall dimension of motor 8¾"x5¾". Suspend 3¾" below baseboard. Mounting hole centers 3¼"x5¼". Otherwise same specifications as Model A above.  
List Price, \$18.10.  
**YOUR PRICE** ..... **\$10<sup>86</sup>**

**D15366—C—Dual Speed model** with special lightweight 12" turntable which is very essential to best reproduction of 33½ RPM records. Automatic stop switch included. Otherwise same specifications as Model D above.  
List Price, \$20.60.  
**YOUR PRICE** ..... **\$12<sup>36</sup>**

**D15372—C—Model G.** AC-DC-78 RPM. Same specifications as model A above except operates on 110 V. AC-DC line power.  
List Price, \$20.45.  
**YOUR PRICE** ..... **\$12<sup>27</sup>**

## Special Value Motor

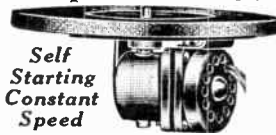

**Self Starting Constant Speed**

**D15399**  
List, \$8.50.  
**YOUR PRICE, Each** ..... **\$3<sup>95</sup>**

A dependable well built unit. Maintains uniform speed regardless of ordinary record drag or line fluctuation. Large, well oiled bearings and special helical cut laminated bakelite gears assure smooth silent operation and long life. For 105-120 volt, 60 cycle AC operation. Complete with 9" turntable, and mounting screws.

**D15396—A** dependable unit at a sensationally low price. Smooth-running friction rim drive eliminates gears. Motor is shock mounted to prevent vibration.  
**YOUR PRICE** ..... **\$2<sup>45</sup>**

# RCA RECORD PLAYERS - PHONOGRAPH RECORDS - RECORD RACK

## RCA Record Player

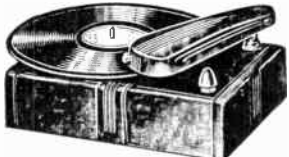

A Compact, High Quality Portable Electric Phonograph suitable for use in conjunction with Radio Sets or Public Address Amplifiers. Will play up to 12 inch records at 78 R.P.M. Operates on 110-120 Volt, 60 Cycle AC current. Consists of RCA Midget True Tracking Crystal Pickup, RCA Synchronous Midget Phono Motor and Volume Control all mounted in an attractive Walnut Bakelite case, size 11¾"x9¾"x3¾". High Impedance output. Has connector for connecting to RCA Records. List, \$9.95.

**D15377—RCA Model R-93-F.** **\$5<sup>28</sup>**

**YOUR PRICE** ..... **\$4<sup>95</sup>**

**C4959—RCA 9824** connecting switch and cable for connecting above player to any radio receiver. Switch changes from radio to record.  
**YOUR PRICE** ..... **\$9<sup>6</sup>**

## Victor Records and Rack

**\$3.50 List Value for only \$1.35**

Special to purchasers of RCA Model R-93-F and VA-21 RCA Record Players we will include 6-10" RCA Victor Black Label double faced Records listing at 50c each and 1 RCA-Victor Record Rack valued at 50c list—all for only \$1.35 net. Titles are pre-selected by RCA and all are currently popular semi-classical numbers—No obscure.

**D15380—Model R-93-F** RCA Victor Record Player and 6 RCA Victor 10" Records and Rack. List Value, \$14.95.  
**YOUR PRICE** ..... **\$6<sup>63</sup>**

**D15381—Model VA-21** RCA Victor Wireless Record player and 6 RCA Victor 10" Records and Record Rack as outlined above. List Value, \$7.95.  
**YOUR PRICE** ..... **\$1<sup>14</sup>**

## RCA Victor Wireless Record Player

Plays up to 12" records with full tone and volume through any radio set, operating within 30-50 feet of player. No connecting wires used. Has crystal pickup, volume control, on-off switch and constant speed 78 RPM motor. Comes in attractive rich brown bakelite cabinet of modern design. Size 12½"x12½" deep. Ship. Wt. 13 lbs. For 110 V. 60 cyc. AC operation. List Price, \$15.95.

**D15379—RCA Model VA-27** Wireless Record Player **\$10<sup>09</sup>**

**YOUR PRICE** ..... **\$10<sup>09</sup>**

## RCA Synchronous Type Phonograph Motor

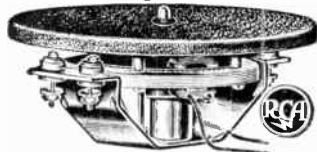

Compact, synchronous type phonograph motor complete with 7" turntable. Same as used in above RCA 7" player. For playing either 10" or 12" records. Speed 73 R.P.M. Can be used in conjunction with power amplifier for Public Address or with practically any radio set. Motor is only 7" dia., 2½" deep. Compact size particularly adapts unit for installations in limited space. Operates from 110-120 volts, 60 cycles AC.

**D15379—RCA Code Pt. 33343.** List, \$5.95. **YOUR PRICE** ..... **\$3<sup>50</sup>**



# Recording Discs-Needles-Accessories



## Highest Quality Acetate Recording Discs

Make Big Money Selling Recording Discs. The recent introduction of high quality, low cost, home recording equipment has opened up a large and profitable market for acetate recording blanks. Prospects are everywhere. Homes, Schools, Churches,

Preachers, Lawyers, Teachers, Dramatic Clubs, Music Clubs, Students of Foreign Languages, Civic Clubs, Sales Organizations, Political Groups, Night Clubs, Orchestras, Broadcast Stations, and many more.

## Bristol-Board Acetate Discs

The Most Popular Types for Home Recordings

### High Quality at Lowest Cost



Acetate coated discs on bristol-board base. Amazingly good quality at lowest possible cost. Most popular type home recording disc on the market. Used also by professional studios. Low background noise. Coated on two sides. Non-inflammable.

### Professional Quality at Low Cost



Acetate coated discs on bristol-board base. An excellent low cost disc of professional quality for studio and home recording. Background noise so low as to be practically inaudible. Coated on two sides. Non-inflammable.

Stock Num.	Dia.	Overall Thickness	YOUR PRICE		
			Each	6 for	36 for
D9325	8 1/2"	.082"	9¢	42¢	\$2.25
D9326	8"	.082"	16¢	75¢	3.80
D9327	10"	.082"	24¢	\$1.15	5.75

Stock Num.	Dia.	Overall Thickness	YOUR PRICE		
			Each	6 for	36 for
D9335	6 1/2"	.052"	15¢	\$0.76	\$4.23
D9336	8"	.052"	25¢	1.35	7.41
D9341	10"	.052"	36¢	1.94	10.58

## Aluminum Base Acetate Discs

### Heavy Weight Discs



For Broadcast, Studio and Home Use  
A very high quality, acetate coated, aluminum disc, especially suited for Broadcast, Professional and Home Recordings where the exceptionally fine results are desired. Surface noise practically inaudible. Coated on two sides.

### Presto GREEN SEAL Discs



Highly perfected acetate\* disc on heavy aluminum base. .051" thick overall. Developed especially for broadcast, professional and home recordings where the very finest results are desired. Surface noise is practically inaudible. Coated on two sides.

Stock Num.	Dia.	Overall Thickness	YOUR PRICE		
			1-9	10-24	25 & up
D9328	6"	.049"	37¢	32¢	39¢
D9329	8"	.049"	52¢	46¢	41¢
D9330	10"	.049"	73¢	66¢	59¢
D9331	12"	.052"	92¢	81¢	74¢
D9332	16"	.060"	\$1.84	\$1.64	\$1.47

Stock Num.	Dia.	Price Each	Stock Num.	Dia.	Price Each
D9311	8"	.55	*D9315	16"	2.00
D9312	10"	.80	*Extra heavy. .064" for broadcast station use		

### Standard Weight Discs

For Studio and Home Recordings

Excellent quality acetate on aluminum base, for low cost, high quality Studio and Home Recordings. Will produce recordings closely approaching the quality the heavier discs listed above. Best obtainable, at moderate cost. Surface noise extremely low. Coated on two sides. Non-inflammable.

Stock Num.	Dia.	Overall Thickness	YOUR PRICE		
			1-12	13-24	25 & up
D9358	6"	.032"	15¢	13¢	12¢
D9359	8"	.032"	22¢	19¢	18¢
D9360	10"	.032"	29¢	24¢	24¢
D9361	12"	.032"	48¢	43¢	42¢

## Audiodiscs

### Yellow Lobel Type



For Broadcast, Professional and Home Use  
An extremely high quality aluminum base acetate recording disc\* with wide latitude characteristics. Exclusive machine-coating process produces a smooth flat cutting surface. Background noise practically non-existent. Coated on two sides.

Stock Number	Diameter	Overall Thickness	Price Each
D9400	6"	.037"	\$0.40
D9401	8"	.037"	.55
D9402	10"	.046"	.80
D9403	12"	.046"	1.00
D9404	16"	.054"	2.00

Blue Label Type same as above except on lighter gauge aluminum base.\*

D9424	6"	.024"	\$0.30
D9425	8"	.024"	.45
D9426	10"	.027"	.65
D9427	12"	.027"	.85

Special Discounts to Dealers, Schools and Broadcast Stations.

### Presto ORANGE SEAL Discs

High quality acetate\* disc on aluminum base. .036" thick overall. Surface noise practically inaudible. Excellent for professional and home use. Coated on two sides.

Stock Num.	Diam.	Your Price Each		
		1-49	50-99	100-249
D9316	6"	\$0.40	38¢	36¢
D9317	8"	.55	52¢	49¢
D9318	10"	.80	76¢	72¢
D9319	12"	1.00	95¢	90¢

### Presto BLUE LABEL Discs

High quality acetate\* disc on aluminum base. .025" thick overall. Surface noise extremely low. For good quality professional and home recordings at moderate cost. Coated on two sides.

D9451	6"	25¢	23¢	22¢
D9452	8"	40¢	38¢	36¢
D9453	10"	60¢	57¢	54¢
D9454	12"	75¢	67¢	67¢

### Presto MONOGRAM Discs

High quality acetate\* disc on special Bristol Board base. .050" thick overall. Low surface noise. For good quality professional and home recordings at very low cost. Coated on two sides.

D9333	6"	20¢	18¢	15¢
D9334	8"	35¢	33¢	31¢
D9337	10"	50¢	47¢	45¢
D9338	12"	70¢	66¢	63¢

Special discounts on all Presto discs to dealers, Schools and Broadcast stations.

## Plain Aluminum Discs

Not acetate coated. For use on earlier type recorders. Can be recorded on both sides.

### Pre-Grooved Blank

Stock Num.	YOUR PRICE	Size	Playing Time	Stock Num.	YOUR PRICE
D9381	16¢	6"	1.5 min.	D9385	15¢
D9382	23¢	8"	2.0	D9386	20¢
D9383	39¢	10"	3.0	D9387	29¢
D9384	55¢	12"	4.5	D9388	42¢

## Recording Needles For Ungrooved Acetate Discs



Precision made. Long life. All recording needles have flat on shanks to keep from turning.

### Sapphire & Stellite

D9305 - Type A. GENUINE PRESTO SAPPHIRE. Fine sapphire made for best quality recording. Average cutting life 5 hours.

Can be resharpened. **\$6.00**  
YOUR PRICE.....  
D9397 - Type A. PRECISION GROUND SAPPHIRE. Will give good results. Average cutting life 5 hours. Can be resharpened. **\$3.40**  
YOUR PRICE, Each.....

D9395 - Type A. SAPPHIRE POINT NEEDLES. For cutting and recording ungrooved aluminum discs. D9396 - Type A. SAPPHIRE POINT NEEDLES. For recording on pregrooved Victor or aluminum discs. **\$2.20**  
YOUR PRICE, Either type.....

D9300 - Type A. STELLITE CUTTING NEEDLES. Make recordings that compare favorably with sapphire. Average cutting life two hours. Can be resharpened. **\$9¢**  
YOUR PRICE, Each.....

## Steel Cutting Needles



D9308 - Type B. High quality steel recording needles for acetate discs. Gives good quality, quiet recordings. Will make about ten 10" records. **\$1.00**  
YOUR PRICE, Pkg. of 3.....

D9308 - Type B. Steel cutting needles for acetate coated discs. Special alloy steel hand-polished. Gives acceptable quality recordings. Will make about five 10" records. **\$9¢**  
YOUR PRICE, Pkg. of 5.....

D9370 - Steel recording needles for Victor Home Recording Discs. **\$25¢**  
YOUR PRICE, Pkg. of 8.....

## RESHARPENING SERVICE

Sapphire recording needles resharpened, Ea. **\$1.95**  
Stellite recording needles resharpened, Ea. **.65**

## Astatic Crystal Recording Head



Replaces Early Magnetic Types  
Makes excellent replacement unit for home and professional recorders using General Industries or similar type crystal recording head. Records with great brilliance of tone and wide range. Impedance, 60,000 ohms. Size 1 3/4" x 3 3/4". Finished in telephone black. **\$6.76**  
D9414 - Crystal recording head and connector cord. **\$6.76**  
YOUR PRICE.....

D9415 - Tone Equalizer for above. Four positions, Bass, Medium, Hi-Fidelity and Out. Single hold mount. Chrome and black finish. Size: 2 1/2" x 3" high. **\$1.47**  
YOUR PRICE.....

D9416 - Matching transformer. Adapts above recording head to low impedance input circuits. Pri. 500 ohms. Sec. 60,000 ohms. Finished in telephone black. Size: 2 3/4" x 2 3/4". **\$4.11**  
YOUR PRICE.....

## Webster Magnetic Recorder Heads



Not affected by normal heat or temperature changes. Makes an excellent replacement unit, especially for crystal types as used in General Industries and similar home and professional recorders. Frequency range flat from 30 to 8000 cyc. Only 1 watt required for maximum recording level. Standard 1 1/2" in. spacing between mounting holes. Telephone Black finish. Polished Trim. Size: 2 3/4" x 1 1/2" wide. **\$7.35**  
D9421 - Type R-84 recording head. Impedance: 8 ohms at 400 cycles. **\$7.35**  
D9422 - Type R-84G recording head. Impedance: 500 ohms at 400 cycles. **\$7.35**  
YOUR PRICE, Either Type.....

## Recording and Playback Pickup



D9352 - Complete with recording weight and stationary bracket. Single hole mount. Records on pre-grooved aluminum, or Victor Home Recording Discs, direct from radio or amplifier. Requires only 3 watts of power. Same head can also be used for playback. Response is flat from 60 to 6500 cycles. Impedance: 10,000 ohms. Sturdy bronze finish. Length 9 in. Shipping wt., 1 lb. **\$3.23**  
YOUR PRICE.....



# RECORDERS FOR HOME & STUDIO

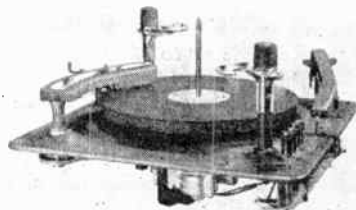
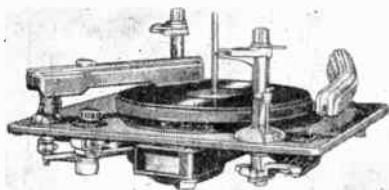

## Basic Recording and Record Playback Units

### Radolek Recorder & Record Changer

Big Value in recording and playback unit. Records at 78 RPM on acetate discs up to 10". Automatically plays fourteen 10" or ten 12" commercial records. Manually plays both acetate and commercial records up to 12" dia. Powerful induction motor uses rim drive to weighted 10" turntable. Cutting head is wide range magnetic type. High impedance crystal pickup is true tracking type. Size 14x16x3 1/2" above and 3" below mounting plate.

D15357—Radolek Recorder and Record Changer Chassis less power cord, connecting cable.

YOUR PRICE ..... **\$29<sup>95</sup>**

D15397—Radolek Record Changer less Recording Mechanism. For playback only. Size 14x14x3" below plate.

YOUR PRICE ..... **\$16<sup>95</sup>**

### G. I. Recorder and Playback Unit

Records up to 10" Discs  
Plays Back up to 12" Commercial or Acetate Discs  
At 78 RPM

Records at 78 RPM on acetate discs up to 10" Dia., cutting 109 lines per inch. Manually plays commercial and acetate discs up to 12" dia. Feed screw automatically engages when cutter is placed on record. Depth of cut and needle angle adjustment easily accessible. Powerful induction motor uses rim drive to weighted 10" turntable. Motor and turntable are rubber mounted and insulated for quiet operation. Cutting head and play-back unit are high impedance crystal type. Size 15" Wide x 10" front to back. For 110 V. 80 cyc. operation.

D15385—Model G.I.—R70 Chassis less power cord and connecting cable.

List. \$45.00. YOUR PRICE ..... **\$27<sup>00</sup>**

### Webster Standard Model Recorder

With Record Changer

D15391—Webster-Chicago Model 5575 recording and play-back chassis with record changer, less power cord and connecting cable.

List Price, \$55.00. YOUR PRICE ..... **\$32<sup>34</sup>**

Records on acetate or composition blanks up to 10" dia. Will play back all 78 RPM records up to 12". Silent operating, lam-proof record changer holds up to ten 12" or twelve 10" commercial records. Push buttons provide for record rejection and manual operation. Automatic velocity trip device insures positive record changer action at conclusion of the record. Heavy duty, constant speed synchronous motor operates turntable at 78 RPM through positive gear drive. Retractable record driving pin for acetate discs automatically allows playing of commercial records without manual adjustment. Crystal type high impedance recording head cuts at 90 lines per inch from outside to center. Only 3 to 5 watts needed for full needle deflection. Recording arm adjustable for cutting depth, cutting angle and use of either long or short shank needles. High impedance crystal play-back unit balanced to 2 oz. needle pressure, minimizing record wear. Entire assembly attractively finished in brown wrinkle enamel. Mounting plate 15 1/2 x 14 1/2" overall. Mechanism extends 5" below plate and 6" above plate. Wt. 30 lbs.

## Complete Portable Recorders



### Deluxe Recorder with Record Changer

For those who want the best in high quality at low cost. Records at 78 RPM on acetate and composition discs up to 10" dia. Automatically plays back fourteen 10" or ten 12" commercial records. Cutting head is low impedance high fidelity magnetic type. Wide range crystal phone pickup is true tracking type. Depth of cut and needle angle adjustment easily accessible. Powerful induction motor uses rim drive to 10" weighted turntable. Motor and turntable are rubber mounted and insulated for quiet operation. Built-in high gain recording amplifier including volume and tone controls and magic eye cutting level indicator with 6" PM speaker permits high quality recording and reproduction. Complete assembly attractively housed in durable imitation leather covered carrying case. Size 22x18x11. Wt. 50 lbs.

D15356—Assembly complete, with tubes and desks type crystal mike. For 110 V. 60 Cyc. AC operation.

YOUR PRICE ..... **\$58<sup>95</sup>**



### Standard Recorder and Playback Unit

A low price, high quality—recorder and playback unit in a portable case with crystal desk mike for home and professional use. Records at 78 RPM on acetate discs up to 10" Dia., cutting 109 lines per inch. Manually plays commercial and acetate discs up to 12" dia. Depth of cut and needle angle adjustment easily accessible. Powerful induction motor uses rim drive to weighted 10" turntable. Motor and turntable are rubber mounted and insulated for quiet operation. Cutting head and play-back unit are high impedance crystal type. Built-in 4 1/2 Watt recording amplifier including volume and tone controls, and 6 1/2" PM dynamic speaker permits high quality recording and gives brilliant reproduction. Complete assembly attractively housed in durable imitation leather covered carrying case. Size, 16 1/2 x 13". Ship. Wt. 30 lbs.

D15353—Assembly complete with tubes, six 6 1/2" recording blanks and one recording needle and desk type crystal mike.

YOUR PRICE ..... **\$35<sup>25</sup>**

### Webster DeLuxe Model

With Record Changer

Records up to 10" Discs  
Plays and Automatically Changes up to Seventeen Mixed 10" and 12" Records  
At 78 RPM



Finer construction, appearance and operation than Model W5575 above. Records on acetate or composition blanks up to 10" dia. Automatically plays up to 17 mixed ten and twelve inch records—at 78 RPM. Pickup balanced to 2 oz. needle pressure, minimizing record wear. Mechanism stops automatically after last record has been played. Heavy die-cast mounting plate. Other specifications same as given for Model W5575 above. Hammered bronze enamel finish. Size, mounting plate 13 1/2 x 11 1/2". Mechanism 5 1/2" above and 4 1/2" below plate. Ship wt. 35 lbs. Comes complete with crystal pickup and AC switch.

D15373—Model 5595 Recording and Playback Chassis with record changer, less power cord and connecting cable. List Price, \$75.00.

YOUR PRICE ..... **\$44<sup>10</sup>**



### 30 Watt Recording Amplifier

For use with all types of home and professional recording and play back units. Specifications: 30 Watts class "A" high fidelity beam power output, feeding a 2, 4, 8, 16, 250 and 500 line output. Resistance coupled throughout. Inverse feedback in final stage. Response is flat within ±2 Db from 50 to 10,000 cycles. Hum level less than .1 of 1%. 135 Db. Usable gain for both mike channels. Has three polarized plug-in channels—2 for mike, 1 for phono with separate electronic mixing and fading controls. Dual tone controls for base and high frequency response. Tubes used: 2-6X5's, 1-6X4's, 1-6X7, 2-6L6's, 1-5Y4's, 1-6X5's. Durably housed in red crackle enamel finished steel case with chromium bands and carrying handles. Overall size: 7 1/2 x 6 1/2 x 16 1/2" long. See page 104 for complete description.

D15019—30 watt Recording Amplifier, factory wired and tested, less tubes.

List Price, \$50.00. YOUR PRICE ..... **\$24<sup>45</sup>**

D15021—Complete amplifier with 8 matched Sylvania tubes. List Price, \$60.88.

YOUR PRICE ..... **\$29<sup>89</sup>**

### Techniques of Recording

By Goldsmith and Geisel

D12560—YOUR PRICE ..... **\$12<sup>5</sup>**

A practical hand-book containing 43 pages of concise data on recording, its associated equipment and their individual applications. The 16 chapters each deal with specific facts and functions of recording. Clearly written and fully illustrated. As a recording operator you should have this helpful book in your library. You will refer to it again and again for expert solution of problems that are sure to arise. The authors, both fully versed in the design and operation of recording apparatus, have presented their facts in a very practical and fully useable manner.

# HOME & PROFESSIONAL RECORDING EQUIPMENT

## Make Commercial Quality Recordings Right in Your Own Home or Studio

### Presto Model "K" Portable Recorder

Records up to 12" Discs at 78 or 33-1/3 RPM—Illustrated at right

Designed to fill the need of those who require a dependable, high quality recording system. Will record voice and music with fidelity fully equal to the finest commercial recordings. Suitable for radio entertainers, musicians and schools in speech, dramatic and foreign language classes and rehearsals. Operating features: 12" turntable driven at rim by self-starting, constant speed motor. Allows reproduction without slightest waver or "wow." Cutting head from outside to inside. Built-in 4 stage amplifier has 3 watts output, uses 6 tubes, 1-6F5, 1-6SN7, 2-45's, 1-80. 10" Speaker is mounted in the detachable cover of carrying case. Case is grey airplane cloth covered and measures 19 1/2"x15 1/2"x14". Recorder comes complete ready to operate with tubes, high quality crystal microphone mounted on adjustable floor stand and operating instructions. Recording discs and needles not included. For 110 volt 60 cycle AC operation. Complete descriptive literature on above equipment or other recorders will be sent on request.

**D17630**—Model K6—As above with single speed 78 RPM motor.  
**YOUR PRICE** ..... **\$208.00**

**D17631**—Model K7 Recorder with dual speed 78 and 33 1/3 RPM.  
**YOUR PRICE** ..... **\$223.00**

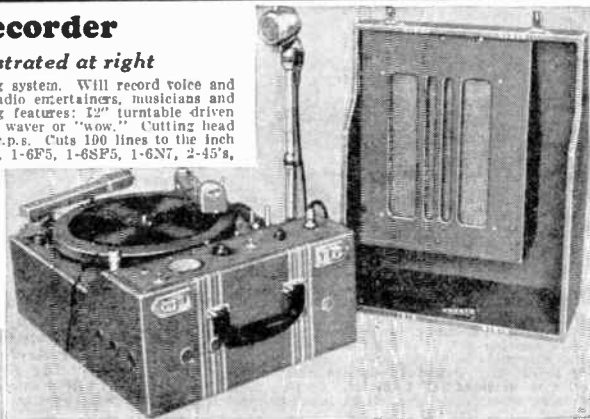

### Presto Model "Y" Recorder

Cuts up to 17 1/2" Discs at 78 or 33-1/3 RPM

**D17645**—Model "Y." A complete portable recorder incorporating all advantages of portability and capable of producing the finest recordings. Designed to fill the requirements of schools and colleges, radio broadcast stations, advertising agencies, commercial recording studios, etc. Features: 18" Rim driven turntable, 50-8000 cycle recording range, cuts 112 lines per inch, records from inside-out or outside-in. 10 Watt Amplifier incorporates frequency stabilizers to boost bass or treble response and mixer for 2 mikes and phono. Volume indicator shows recording level. Recorder housed in portable case 20 1/2"x15 1/2". Wt. 44 lbs. Amplifier and 10" speaker housed in separate portable case, size 23 1/2"x12"x20". Wt. 47 lbs.

**YOUR PRICE, Less Recording Discs and Needles** ..... **\$595.00**

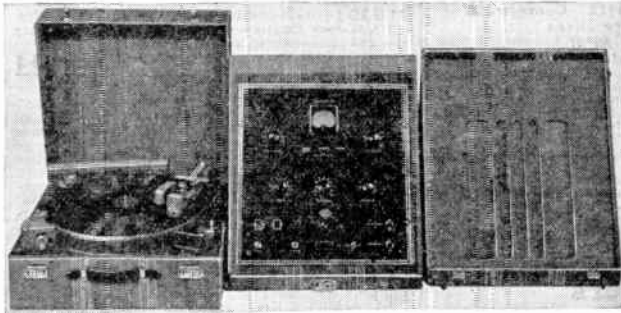

## Recorders for Home and Studio

### Speak-O-Phone Model 88

Records up to 12" Discs at 78 RPM

**D17632**—Complete recorder ready to operate. Less discs and needles.  
List Price, \$87.50.  
**YOUR PRICE** ..... **\$58.33**

A compact, efficient recording and playback assembly — complete in every detail — nothing else to buy except recording discs and needles. Consists of a 3 stage amplifier, speaker, crystal microphone, desk-type stand, motor, 10" turntable, recording unit, playback pickup and gearing mechanism all mounted in a compact carrying case, size 15 1/2"x15 1/2"x3 3/4". Case covered by an impressive looking simulated pigskin. Amplifier frequency range is to 5,000 c.p.s. Power output is 4 watts. Driving mechanism consists of a powerful motor specially designed for recording equipment. The specially weighted turntable is driven by means of an idler gear, thus tending to cut down motor rumble and noises. Tracking mechanism is completely positive. The Ortho-acoustic speaker arrangement has been designed as an integral part of the lid of carrying case, using an 8" built-in dynamic speaker. Playback reproduction is "wide-range" in its true meaning. Playback pickup is the latest Astatic model. For operation on 110 volts, 60 cycle AC.

Order all of your recording equipment from Radolek. Radolek's stock is complete! Write for literature on any other models in which you may be interested.



### Speak-O-Phone Model 1-52A

Records up to 12" at 78 and 33-1/3 RPM

**D17633**—Complete recorder ready to operate. Less discs and needles. For operation on 110 volts 60 cycles.  
List Price, \$179.50.

**YOUR PRICE** ..... **\$119.66**

A compact, efficient recording and playback assembly complete in every detail—nothing else to buy except recording discs and needles. May be used equally well on 8", 10" or 12" aluminum or acetate discs. Consists of a 3 stage 4 watt high fidelity amplifier, speaker, quality crystal microphone, collapsible chrome plated floor stand, dual speed motor and 12" turntable, cutting head and play-back pick-up. Meter for monitoring volume level during recording has illuminated dial. Drive mechanism consists of a powerful rim driven General Electric motor and turntable, constant speed type. Speed is instantly adjustable for either 78 or 33 1/3 RPM. Tracking mechanism is entirely cone-tailed; has patented positive feed cutting arm. Cutting head is a true fidelity magnetic unit with adjustable needle angle. Cutter can be used for aluminum or acetate. Crystal playback pick-up follows same arc as cutting head. Housed in compact leatherette covered case 16x10x20", with inclined front panel on which all controls are mounted.



## Carron Portable Recorder and Playback Combination

**D17636**—Carron recorder complete as described below, ready to operate, but less recording discs and needles.

**YOUR PRICE** ..... **\$19.75**

A Complete Self-Contained Recorder

A completely self-contained portable recorder and electric phonograph for cutting up to 8" acetate discs and playing up to 12" records. Reasonably good results may be obtained for microphone or radio recordings. Consists of combination record cutter and playback pickup, constant speed 78 RPM motor with weighted 8 1/2" turntable, built-in 3 tube amplifier complete with tubes, Volume control, PM dynamic speaker, Crystal microphone and desk stand. Complete unit is housed in Alligator grain fabricoid covered case, size 13"x13"x7". Uses standard acetate discs and needles. For 110 Volt 60 cycle AC operation.



## Carron Basic Recorder

For Recording and Playback

**D17637**—**YOUR PRICE** ..... **\$7.25**

Recording and playback chassis as used in above recorder. Includes combination cutting and playback pickup with feed mechanism constant speed 78 RPM motor with 8 1/2" weighted turntable and needle cup installed on 3/8" leatherette covered mounting board ready to use with your own microphone and recording amplifier. May also be used in conjunction with most radio receivers. Mounting space required 12 1/2"x12 1/2". Includes 3" glow board and 3/8" above board. For 110 volt 60 cycle AC operation.



## Brush Crystal Cutting Head

A dependable and exceptionally high quality cutting head suitable for use in cutting acetate or vinylite blanks. Cutting response within ±3DB from 50 to 9000 CPS. Only 3 watts driving power required. Metal case size 3 1/8" long x 1 1/8" high x 3/4" thick. Net Wt. 4 1/2 ozs.

**D13124**—**YOUR PRICE** ..... **\$11.76**

We can promptly supply other types of cutting heads and recording arms.



## Big Value Recorder and Playback Unit for Home Use

May be used with Any Radio

A compact quality built assembly designed for conjunction with the audio amplifier and speaker of any radio receiver. Records on acetate discs from microphone or radio. Records and playback up to 12" records at 78 RPM. Consists of magnetic cutting head with worm gear drive mechanism, heavy duty constant speed rim drive motor with weighted 10" turntable, crystal playback pickup, built-in preamplifier, volume control and high grade crystal microphone with table stand. Housed in wrinkle metal cabinet size 10x15x8 1/2" high overall. Also includes connecting clips and instructions. For 110 volt 60 cycle AC operation.



**D17634**—Complete as described. Less discs and needles.  
**YOUR PRICE** ..... **\$29.50**



### Basic Unit Only

**D17635**—For use with your own amplifier and mike. Includes turntable, motor, cutting head, feed mechanism and playback pickup mounted on 10x15" brown enameled steel plate.  
**YOUR PRICE** ..... **\$14.95**



# RADOLEK INTERCOMMUNICATORS

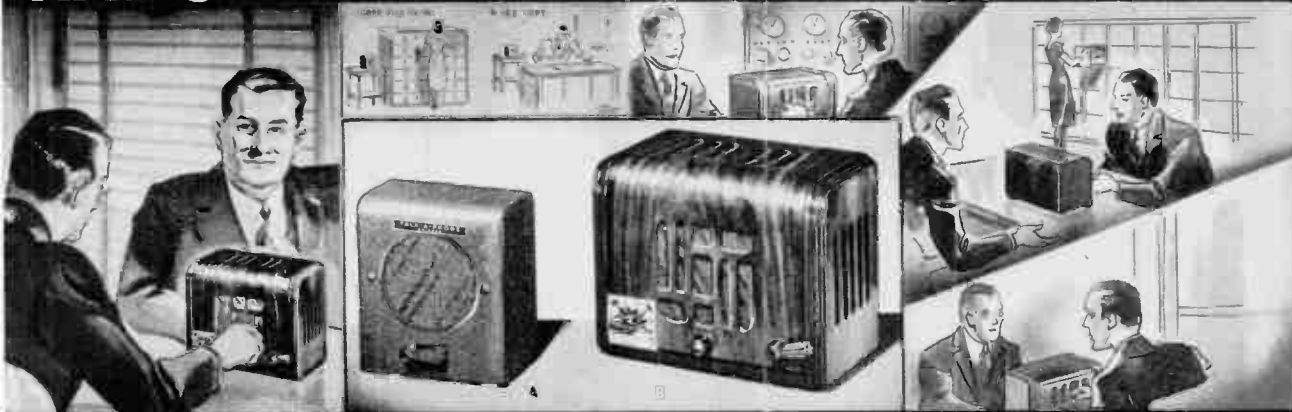

## Master Selective Intercommunicator

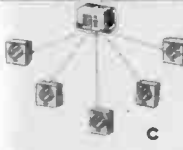

The most economical system to install and operate, yet fulfills most intercom requirements. Designed for use where an executive or other centrally located person wishes to call up to five outlying Sub-stations. Each Sub-station can be called individually for private conversation, or all Sub-stations can be called at one time for paging purposes. All Sub-stations can call or answer the Master station, but Sub-stations cannot call each other.

Power output supplies sufficient volume from substation for calls to be heard up to 100 feet from substation. Volume level is controlled at master station. As much as 2000 feet of wire may be used between master and substations without cutting down efficiency. Quiet position shuts out noise unless substation or master calls. Master station is housed in wood cabinet of polished Walnut, size 9 3/4" long x 5 3/4" deep x 8" high. Sub-station is housed in Brown wrinkle enamel metal cabinet, size 5 3/4" long x 3 3/4" deep x 7" high. For 105-120 volts AC or DC operation. Operates as shown in diagram C.

D17685—Type B Master station for up to 5 substations. Complete with tubes and instructions, less connecting cable. List Price, \$27.50.  
**YOUR PRICE** ..... **\$13.95**

D17686—Type B Master Station for up to 10 Substations. Identical in features and operation to master described above but will operate any number of sub-stations up to 10. Complete with tubes and instructions. Less connecting cable. List, \$31.00.  
**YOUR PRICE** ..... **\$17.95**

D17687—Type A Substation for use with either of above master stations. Less connecting cable. List, \$9.95.  
**YOUR PRICE** ..... **\$4.95**

D16565—Master to substation connecting cable, 10 ft. for ..... 19c

## Super Selective Intercommunicator



The most flexible and versatile intercom setup. For use where the greatest amount of utility is required from an inter-communicating system. Consists entirely of master stations and any number from two to five may be used. Any station may call and converse with any other station with complete privacy. Two complete conversations may be maintained at the same time without interferences from another station.

Will operate with full power with up to 2000 ft. of cable between furthest units. Volume may be adjusted at each master from a whisper to a loudness that can be heard 25 to 50 feet away. Silent feature prevents noise between conversations yet does not interfere with incoming calls. Cabinet is of choice walnut, 9 3/4" x 5 3/4" x 8". For 105-120 Volt AC-DC.

D17691—Type B Master station for up to 5 stations. Complete with tubes and instructions, less cable. List, \$32.00.  
**YOUR PRICE** ..... **\$15.95**

D16566—Connecting cable for up to 5 stations, 10 ft. for ..... 50c

D17692—Type B Master station for use in a 10 master station group. Up to five 2-way private conversations may take place without interference. Complete with tubes and instructions, less cable. List, \$36.00.  
**YOUR PRICE** ..... **\$17.95**

D16567—Connecting cable for up to 10 stations, 10 ft. for ..... 75c

### Combination Systems

Similar to above systems but allows intermixing of master stations and substations as shown in diagram E, permitting the following type of inter-communication: (1) Master stations may converse with each other, (2) Any master may call any substation, (3) Each master may in addition have substations which it alone may call. For 105-120 Volt AC-DC.

	List Price	YOUR PRICE
D17693—Type B 5 Sta Master	\$34.00	<b>\$17.95</b>
D16568—Cable for above, 10 ft. for	58c	
D17694—Type B 10 Sta Master	39.95	19.95
D16569—Cable for above, 10 ft. for	93c	
D17695—Type A Sub-station, Less Talkback Switch	8.95	4.50
D16563—Cable for connecting Substa to Master Sta, 10 ft. for	15c	

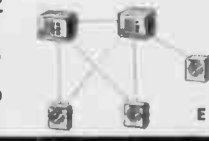

## DeLuxe Intercommunicator with Earphone

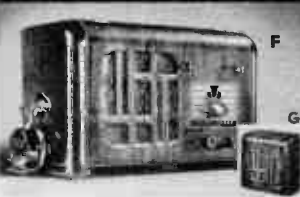

A DeLuxe line of intercommunicators that operate in the same manner as the Master Selective and Super Selective intercommunicators outlined above. However, the DeLuxe line is more powerful allowing operation of units with up to 3000 feet of cable between them. Up to 10 stations may be used and a privacy earphone is included with each master. Privacy earphone may or may not be used as desired. When it is in use communicator acts

like a telephone, voice does not come out of loudspeaker and loudspeaker is used only as a microphone. Housed in wood cabinet of polished walnut, size 11 1/4" x 6" x 7 3/4". For 105-120 Volt AC-DC operation.

D17688—Type F DeLuxe Master Selective Station for use with up to 10 substations, operates as shown in diagram C. Complete with privacy earphone, tubes and instructions, less cable. List Price, \$62.50.  
**YOUR PRICE** ..... **\$31.95**

D17689—Type G DeLuxe Substation only in wood cabinet of polished Walnut, size 7 1/4" x 4" x 3 3/4". List, \$14.95.  
**YOUR PRICE** ..... **\$7.95**

D16566—Connecting cable for interconnecting masters to substation, 10 feet for ..... 35c

D17690—Type F DeLuxe 10 station Master for use in a Super Selective setup in conjunction with 9 other masters. Operates as shown in diagram D. Complete with privacy earphone, tubes and instructions. List Price, \$62.50.  
**YOUR PRICE** ..... **\$31.95**

D16567—Cable for interconnecting master stations, 10 ft. for ..... 75c

## Power Stage for Paging

### For use in Noisy Locations

Designed for use in conjunction with the master units listed on this page for high power paging where large areas must be covered in noisy locations. An unlimited number of power stages may be connected together in a single network, operating from a single channel of the master. Also additional speakers may be connected to each power stage obtaining their power from it. Volume may be adjusted to desired level at each power stage. Power stages may have up to 3000 ft. of cable connected between it and the master station. Housed in sturdy brown wrinkle enamel steel case, size 12" x 12" x 8". Complete with 8" 20 oz. magnet PM Speaker. For 105-120 Volt AC operation.



D17696—Type H 15 watt Power Stage. Complete with tubes and instructions. Less cable. List, \$43.50.  
**YOUR PRICE** ..... **\$22.50**

D17697—Type H 8" PM Extension Speaker in metal case. Less Switch and Volume Control. List Price, \$15.95.  
**YOUR PRICE** ..... **\$7.95**

D16563—Cable for connecting power stages to master stations, 10 feet for 15c

### Communicator for Use with Power Stages

Power stages in themselves cannot be used for talkback to master station. If talkback feature is required the communicator station is connected to power stage, and talkback to master is carried on over this unit. For use with Master Selective and Combination Masters only.

D17698—Type A Communicator station only. List Price, \$9.95.  
**YOUR PRICE** ..... **\$4.95**

D16563—Cable for connecting communicator station to power stage, 10 feet for 15c

D16566—Cable for connecting communicator station to Master station, 10 feet for 19c

# P. A. Accessories As Included With Sound Systems

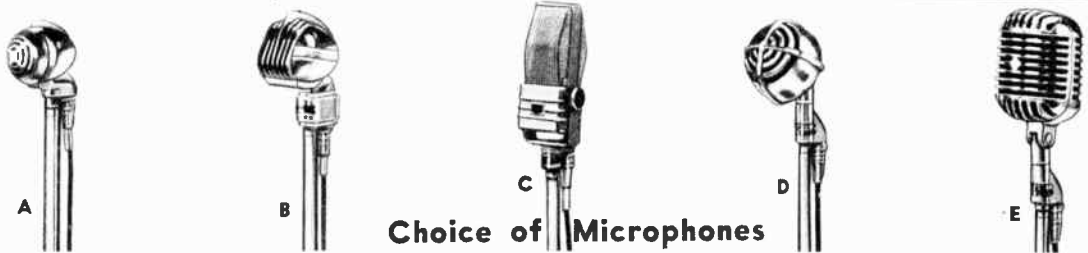

## Choice of Microphones

To suit the needs of your individual installation Radolek offers you a choice of microphones for use with the Sound Amplifying Systems shown on the following pages. Any of these microphones are satisfactory for use under most conditions. However each microphone has specific characteristics which particularly adapt it to certain operating conditions. The selection we offer will cover the requirements of

practically any operating conditions that may be encountered. All microphones have built-in cable connector and are supplied complete with 25 ft. of heavy duty rubber covered shielded microphone cable having an Amphenol locking type plug at each end for screw on connection to amplifier and microphone. Amplifiers are equipped with correct socket, so that any microphone may be used with any amplifier.

**TYPE A Bullet Crystal Microphone** is an excellent all around indoor or outdoor microphone that may be used very satisfactorily for the reproduction of either speaking and singing voice or instrumental music. Rich Satin Chrome Finish. Size 2 1/4" dia. x 3 3/4" long. One Type A microphone will be supplied with any system at no extra charge, and will always be supplied with systems except where some other choice is indicated.

**TYPE B Bullet Dynamic Microphone** has approximately the same response characteristics as TYPE A but is considerably more rugged and is recommended for use where microphone must withstand rough handling and extremes of heat and humidity. Rich Satin Chrome Finish. Size 2 3/4" dia. x 4 3/4" long. One Type B microphone will be supplied with any system instead of Type A at an extra charge of \$3.50.

**TYPE C Velocity Microphone** is best for reproduction of instrumental music. May also be used for voice reproduction if the microphone is kept approximately 12" away from the mouth. Semi-directional characteristic assists in reducing feedback. This microphone is not recommended for outdoor use where wind is likely to affect its performance.

Head tilts through 180° angle and has built-in On-Off switch. Baked Grey Wrinkle Enamel Finish. Size 2 1/2" Wide x 2" deep x 6 1/2" high. One Type C microphone will be supplied with any system instead of Type A at an extra charge of \$3.50.

**TYPE D Shure Uniplex Crystal Microphone** is recommended for reproduction of speaking or singing, voice and instrumental music in either indoor or outdoor installations. Gives finest reproduction over entire frequency range. Special design eliminates sound pickup from rear of microphone yet allows wide angle pickup at front. This feature allows placement of microphones in practically any position with respect to loudspeakers without danger of feedback. Head tilts through 90° angle. Rich Satin Chrome Finish. Size 3 1/4" dia. x 3 3/4" deep. One Type D microphone will be supplied with any system instead of Type A at an extra charge of \$8.00.

**TYPE E Shure Unidyne Dynamic Microphone** is essentially the same as the Uniplex in response and anti-feedback properties. Rugged shockproof construction particularly recommended this unit for use in installations where microphone is subject to

rough handling or extremes of heat and humidity. Head tilts through 90° angle. Rich Satin Chrome Finish. Size 4 1/4" high x 3 1/4" wide x 3 1/2" deep. One Type E microphone will be supplied with any system instead of Type A at an extra charge of \$13.50.

## Extra Microphones

Only one microphone is supplied with each sound system at the prices quoted for complete systems. When more than one microphone is required for your installation, additional microphones may be purchased for the prices specified below at the same time as the complete sound system is obtained. Microphones are supplied complete with floor stand, 25 ft. of cable and 2 connection plugs.

Stock Num	Type	YOUR PRICE
D15073	A	\$ 9.95
D15074	B	12.50
D15075	C	14.70
D15076	D	19.11
D15077	E	26.46

## Speakers and Speaker Baffles

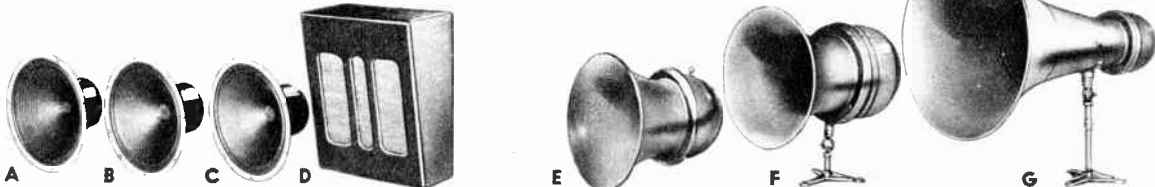

The Dynamic Speakers supplied with Radolek Sound Systems are of the latest design Permanent Magnet type which eliminate the need of supplying magnetizing power to the speaker either from the amplifier or an external power supply. Dust covers protect voice coils from foreign substances and prolong the life of the speaker. Each speaker is equipped with universal line matching transformer so that long speaker lines may be run without power loss. Each speaker is also equipped with a parallel wired outlet socket into which an additional speaker or speaker combination may be plugged making it unnecessary to run each speaker cable back to amplifier. Only two wires are used for connection to amplifier. This feature saves many feet of cable.

**TYPE A 12" Permanent Magnet Dynamic Speaker** with 20 oz. Magnet supplied as standard equipment on 15 Watt Sound Amplifying Systems. Two of these speakers when properly baffled will handle the entire output of the 15 watt amplifier without distortion.

**TYPE B 12" Permanent Magnet Dynamic Speaker** with 31 oz. Magnet, supplied as standard equipment on 30 and 50 Watt Sound Amplifying Systems. Two when properly baffled will handle the output of the 30 watt amplifier, four the output of the 50 watt amplifier.

**TYPE C 12" Permanent Magnet Dynamic Speaker** with 46 oz. Magnet supplied as standard equipment on 50 and 100 Watt Sound Amplifying Systems. Three when properly baffled will handle the entire output of the 50 watt amplifier, six the output of the 100 watt amplifier.

**TYPE D Wall Baffle.** A flat type baffle that will spread sound over the widest possible area but will not project the sound as far as the projector or trumpet type baffles. Constructed of 3/4" plywood with dark blue leatherette covering. Size 16 3/4" x 13 3/4" x 5 3/4" to 8 1/4" deep. Has separate speaker mounting board.

**TYPE E Projector Baffle** has moderate directional qualities which allow wide coverage and sound projection over a somewhat greater distance than Parabolic. Especially desirable for use in over-crowded "dead spots" and eliminating "feedback." Bell is of spun aluminum. Back is of spun steel. Will withstand reasonably rough usage. Bell Size 18" dia., 10" deep. Speaker housing 12 3/4" dia. x 10" deep. Has two rings for ceiling suspension.

**TYPE F DeLuxe Projector Baffle.** Has essentially same characteristics as Type E but of steel construction, will withstand much rougher usage and will offer much better protection to speaker against weather when used outdoors. Mounting bracket fits standard 1/2" pipe. Two rings for ceiling suspension. Size 20 1/2" long, 17 1/2" bell dia. Supplied with systems using Type E at an extra charge of \$3.00 for each baffle. See page 89 for price of adjustable crossflow stand.

**TYPE G Trumpet Baffle** projects sound in a more directional beam and over a greater distance than the other types described. Recommended for installations such as Athletic Fields, Stadiums, Betty Chime Systems Etc. Comes complete with 8" 31 oz. Permanent Magnet Dynamic Speaker, which will handle a full 15 watts of power. Horn is of heavy duty all steel construction. Size, Bell dia. 25" overall length 34". Equipped with mtg. bracket threaded to fit standard 1/2" pipe. Supplied less crossflow bracket but complete with 8" speaker instead of Type E baffle and 12" speaker on systems specifying Type E at an extra charge of \$13.00 per baffle.

**Additional Speakers**  
In many installations extra speakers are required. For your convenience speakers are available separately complete with 25 ft. of connecting cable, speaker outlet socket, and amplifier connection plug. Any speaker may be used on any amplifier.

Stock Num	Type	PRICE EACH
D15070	A	\$ 7.65
D15071	B	8.41
D15072	C	10.75

Additional speaker cable for any speaker 2c per foot.

## Microphone Stands

**TYPE A Banquet Stand.** Has heavy cast metal base, stem is of highly polished chrome. Overall height less Microphone 10". Supplied as standard equipment on all 15 watt Sound Systems.

**TYPE B Standard Floor Stand.** Consists of 2 piece standard, adjustable from 10" to 68" and 9" dia. base with spun brass canopy. Entire Unit is finished in highly polished triple plated chrome. Friction clutch allows instant raising and lowering of microphone and keeps smooth constant pressure which prevents collapsing under the heaviest microphone. Total weight 8 lbs. Supplied as standard equipment on 30, 50 and 100 watt systems except portables.

**TYPE C Portable Floor Stand.** Similar in mechanical construction and appearance when set up to Type B. Designed for use with portable systems. Easily and quickly detachable into 4 pieces (9" base and 3-17" sections). Each section is inside threaded to form a smooth surfaced rigid stem. Total weight 8 lbs. Standard equipment on 30, 50 and 100 watt portable systems.



# Here's A Complete 7 Watt

## PORTABLE SYSTEM

D15135—Complete.  
Ready to Operate.

YOUR PRICE

**\$21<sup>50</sup>**

### Amplifier Features

- 1—3 Stages—4 Tubes.
- 2—High Gain for Crystal microphone and Phonograph.
- 3—Microphone and Phonograph Volume Control.
- 4—Continuously Variable Tone Control.
- 5—Simple Plug-in Connections.
- 6—Sturdy Portable Carrying Case.

### Ready to Operate

Covers An Indoor Crowd of Up to 500 People or An Outdoor Area of Up to 3000 Square Feet

Ideal for use in the smaller installations such as Store Advertising, Electric Guitars, Class Rooms, Club rooms, Bally-boo, Window Display Demonstrations, etc. Can also be used with a record player to provide recorded musical entertainment. Has separate input connections for microphone and phonograph. Special switching arrangement allows use of either at one time. Installation is easy, takes but a few minutes. Anyone can do it. Nothing to hook-up, all connections are polarized plug-ins, just plug into A.C. socket. Extremely simple operation. **System includes: 7 Watt Amplifier, Set of 4 Sylvania Tubes** consisting of 1—6SJ7, 1—6SF5, 1—6L6 and 1—80. High Quality Crystal Microphone with 25 ft. of shielded cable. Mike desk stand, 8" PM Dynamic Speaker with 25-ft. cable and plug, all housed in an attractive blue fabricoid covered portable carrying case. Size 11" x 12" x 7 1/4". For 105-120 volt, 50-60 cycle A.C. operation.

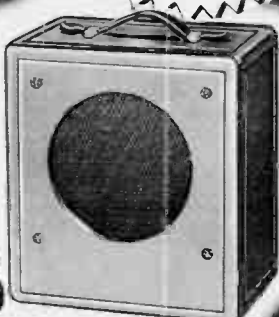

D15135—7 Watt P. A. System as described, complete with High Grade Crystal Microphone and Stand, 25 ft. of Shielded Microphone Cable and Plug, 4 Sylvania Tubes, Speaker and carrying case, ready to operate.

List Price, \$45.00.

YOUR PRICE, ONLY

**\$21<sup>50</sup>**

### Prices 7 Watt Amplifier

D15029—7 Watt 3 Stage High Gain Amplifier for crystal microphone or phonograph. Factory Wired less tubes. For 105-120 Volts 50-60 cycle AC operation. List Price, \$17.50.

**\$8<sup>95</sup>**

D15030 — Amplifier, with Sylvania tubes.

List Price, \$21.10.

**\$10<sup>95</sup>**

YOUR PRICE

# Electric Musical Instrument Amplifiers

## For Use with Wind or String Instruments

Everything you need to adapt any musical instrument for electrical sound amplification is included in the two systems listed. Simply take any guitar, violin, mandolin, ukelele, banjo, accordion, saxophone, clarinet, etc. Tape or clamp on the special pickup and you are all set to swing into this new musical technique. Installation does not harm or alter the instrument in any way. May be used to create special effects in conjunction with orchestras or for solo work to build up volume coverage. Sufficient connecting cable is supplied so that speaker need not be located at musician's feet but can be placed anywhere within a radius of 35 feet. Two systems are available: The 7 watt system fully described above is suitable for use in small orchestras or for solo work to audiences of up to 1000 people. The 15 watt system (fully described on page 102-103) may be used for small or large audiences and has sufficient available volume to handle any normal requirements. Any high impedance microphone can also be used in addition to the instrument pick-up on the 15 Watt System.

### Price

#### 7 Watt System

Includes Amperite Kontak musical instrument pickup with 15 feet of connecting cable and plug, Pickup Volume Control, Amplifier, Complete set of Sylvania tubes, and 8" P3F speaker with 25-ft. cable, all housed in a compact attractive blue fabricoid covered carrying case, size 11" x 7 1/4" x 12". For 105-120 volt, 50-60 cycle A.C. operation.

D15043—As above with hand operated Volume Control. List, \$64.00.

**\$29<sup>95</sup>**

D15044—As above with foot operated Volume Control. List Price, \$67.50.

**\$31<sup>95</sup>**

YOUR PRICE

### Price

#### 15 Watt System

Includes Amperite Kontak musical instrument pickup with 15 ft. of connecting cable and plug, Pickup Volume Control, Amplifier, Complete set of Sylvania tubes and 12" P3F speaker with 25-ft. cable, all housed in a compact, attractive blue, fabricoid covered carrying case, size 18 x 18 x 9 1/4". For 105-120 volt, 50-60 cycle A.C. operation.

D15045—As above with hand operated volume control. List, \$82.50.

**\$39<sup>90</sup>**

D15046—As above with foot operated volume control. List Price, \$87.50.

**\$41<sup>40</sup>**

YOUR PRICE

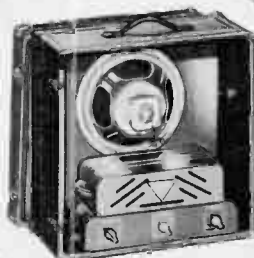

### Completely Portable

The entire outfit comes complete in a compact, light weight, carrying case. Easily carried anywhere. Professional in appearance. Cases are sturdily constructed and attractively finished in rich leatherette with convenient leather handle on top. Amplifier may be removed or left in case as desired. System is convenient to handle and is easily carried.

### Easy to Install

The tiny inconspicuous pickup unit fits under the strings of the instrument or on bell of wind instruments. May be quickly and easily attached or detached. Does not mar instrument. A small piece of adhesive tape or special clamp (see below) holds pick-up securely in place. No wiring to be done. No technical skill required for installation.

# Electric Musical Instrument Accessories



### Amperite Kontak Mikes

A magnetic induction type pickup very rugged in construction. Faithfully reproduces the vibration of any instrument.

D10053—Model SKH less volume control. Use with foot operated volume control.

YOUR PRICE **\$7<sup>06</sup>**

D10085—Model KKH with built-in control allowing regulation of volume by hand on the instrument.

List, \$17.95. YOUR PRICE **\$10<sup>58</sup>**

### Instrument Clamps

D10086—For use in attaching either type Kontak mike to string instruments.

D10087—For attaching to wind instruments.

YOUR PRICE, **\$5<sup>96</sup>**

### Foot Operated Volume Controls

Leaves hands completely free to play instrument. Volume is increased or decreased by movement of foot.

D10064—A mperite Model K.F. Volume regulated by moving foot up and down.

List, \$12.00. YOUR PRICE **\$7<sup>06</sup>**

D10065—Radnek Model 10. Volume regulated by moving foot from side to side.

List, \$12.00. YOUR PRICE **\$5<sup>30</sup>**

# Radolek 15 Watt Deluxe

## Compare These Features!

Entirely self-contained. Remarkably fine tone response essentially flat from 50 to 10,000 cycles. Inverse feedback provides clean reproduction at maximum output. Continuously variable tone control quickly accentuates bass or treble as required. Polarized connecting plugs and sockets eliminating all possibility of a wrong connection.

## Attractive Modern Appearance

Radolek Amplifiers bring you styling and deluxe professional appearance that will make a favorable impression in any installation. The base is finished in baked orange crackle enamel. The Streamlined Protective Shield is finished in baked grey crackle enamel, attractively trimmed with chrome bands and handles. Control indicator plates are etched black with frosted silver numbers. Knobs are red painter type.



For Use on 105-120 Volts  
50-50 Cycle AC

## Full 15 Watts — Powerful — Compact — High Gain Push-Pull For Crystal, Velocity or Dynamic Microphone and Phonograph

### Many Applications!

The ideal amplifier for low-priced installations. These applications represent just a small percentage of the numerous opportunities offered for installation of this compact, high quality public address unit—Call Systems, Store Advertising, Inter-Communicating Systems, Small Auditoriums, Telephone Boosters, Restaurants, Cafes and Lodges. The low hum, triple filtered circuit makes it especially commendable for use in Banquet Parlors, Classrooms and Clubs. The compact size and rugged construction of this amplifier make it well adapted for many portable applications.

Perfect coverage for indoor audiences up to 5000 people, and outdoor areas 3000 to 10,000 square feet!

### Quality Equal to Larger Systems

Designed by the same engineers and built of the same high quality parts as the larger, more expensive Radolek Amplifiers. Each system is subject to careful test and guaranteed to provide satisfactory performance.

### Phonograph Input

Plug-In Phonograph Connections with individual volume control. Any type of high impedance crystal or magnetic pick-up may be used. Phono top described below may also be used. Perfect reproduction of records is assured. Separate phono volume control on front panel permits phonograph music to be blended with speech input to any degree of ratio desired.

### Uses Push-Pull 6L6 Power Tubes

A pair of 6L6's are capable of delivering up to 50 watts of output power. The Radolek 15 Watt High Gain Amplifier uses these highly efficient tubes in the output stage, operating them at an ultra conservative point so that a full-distortion free 15 watts is obtained (considered on a commercial basis). In addition to the exceptionally clean output that results you can count on an extraordinary long life from the tubes.

### Simplified Mixer and Fader

Complete Input Control System including separate Volume Control for Phonograph and Microphone is built right into the Amplifier. The inputs are so interconnected that complete mixing or fading between them can be accomplished easily and efficiently. Enables a voice announcement to be superimposed on a musical background from Phonograph, etc. Genuine Electronic Mixing system allows volume adjustment of either input without affecting the volume level of the other. "Cross talk" is absolutely eliminated.

### Tone Control

Radolek's newly developed "feedback" tone control circuit provides a tonal adjustment of output heretofore unobtainable in any amplifier of this size. Delivers a full distortion-free 15 watts of power regardless of tone control setting. Bass register is brought out without distortion of high frequencies, as is common to most amplifiers.

### 4 Stage—High Gain

Most amplifiers of similar rating provide only 3 stages of audio. Radolek gives you 4 high gain stages which provide ample amplification for using low output microphones, even where exceptionally long cables are necessary.

### Phonograph Attachment

Consists of constant speed phono motor with 9" turntable and high grade crystal pickup mounted on amplifier protective shield. May be substituted in place of regular shield. Amplifier has plug-in connection jacks mounted so that all connections are enclosed inside of shield. May be purchased with amplifier or added to amplifier at a later date.

D15093—Phono attachment unit as described less amplifier. List. \$15.25  
YOUR PRICE ..... \$745

### Biggest Sound Value!

Here feedback gives you a Class "A" push-pull output Filtered Watt, Four Stage Six Tube amplifying circuit most likely to actually sound like lower power amplifiers using single pentode tube output stage with genuine Class "A" push pull output for high fidelity, distortion free reproduction of music. Combination input high gain for crystal, ribbon, velocity or dynamic microphones. Separate input for crystal or magnetic phono pickup. COMPARE—no other 15 watt amplifier represents a value that holds steady in the field of Public Address equipment.

### Amplifier Specifications

1. 15 Watts Push-Pull Class "A" output.
2. 4 Stage High-Gain Input with Six new multi-union tubes, 1-6ST7, 1-6SC7, 1-6AN7, 2-6L6, 1-5V4G.
3. Extremely Low Hum Level. Only .1 or 1%.
4. Only .002 volts input Signal required to obtain maximum output.
5. 130 Db. gain for microphones. 3 Db. gain for phono.
6. Resistance coupled right to final output assuring flat response. Plus or Minus 2 Db. 50-10,000 cycles.
7. Output Impedances, 4, 8, 16, and 300 ohms from built-in output transformer. Two speaker sockets.
8. Polarized Plug-In Input and Output connections.
9. Mixer and Fader is electronic type built into amplifier.
10. Two Volume Controls, one for microphone, one for phonograph.
11. Master Tone Control and on-off switch.
12. Universal Input for Velocity, Crystal or Dynamic Microphone and Phonograph.
13. Inverse Feedback insures greater output without distortion and improved tone quality in peaks.
14. Easily replaced front panel.
15. Protective Shield shows when amplifier is "on."
16. Overall height including protective shield, 6". Base size, 2 1/2" wide, 1 1/2" long, 1 1/2" high.
17. Net Weight, 7 lbs. Shipping Wt., 11 lbs.

### Prices 15 Watt Deluxe Amplifier

D15085—Radolek 4-Stage, 15-Watt, High-Gain Deluxe Two Channel Input Amplifier. Factory wired and Laboratory Certified, Supplied without tubes but with protective shield.  
List Price, \$22.50

YOUR PRICE ..... **\$16.45**

D15086—Complete Amplifier with Set of Six Matched Sylvania Tubes consisting of 1-6ST7, 1-6SC7, 1-6AN7, 2-6L6's, 1-5V4G with protective shield. List Price, \$41.15  
YOUR PRICE ..... **\$20.59**





# Public Address Systems

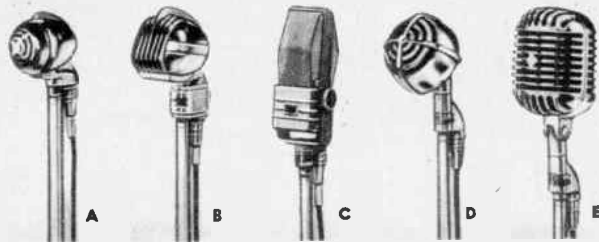

## Choice of Microphones

You may choose any of the microphones illustrated when ordering the Sound Systems described on this page. If you choose: Type A Bullet Crystal No extra charge, Type B Bullet Dynamic or Type C Velocity add \$3.50 to your order, Type D Shure Uniplex add \$8.00, Type E Shure Unidyne add \$13.50. If no choice is specified Type A will be supplied. See page 100 for a complete description of these microphones.

## Fast—Easy Set Up and Operation

Radolek Amplifiers and Sound Systems are easy to install and use and are reliable in operation. No technical knowledge or experience is required to obtain best results as everything possible has been done to simplify the system's operation. Systems come to you complete—ready to set up in a few minutes. Speakers and microphones are supplied with cables connected to polarized plugs. Just "plug-in" the easily identified connections and you're all set to go. Each system is carefully assembled and wired. A thorough test of the completed system is made before shipment, assuring you of trouble free operation when you receive it. Complete instructions included with each system.

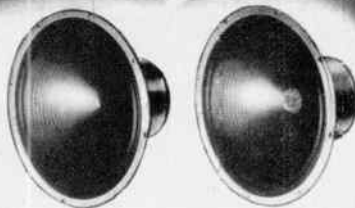

## Speakers

The speakers supplied with the systems listed below are the latest type heavy duty 12" Permanent Magnet Dynamic Speakers with 26 oz. magnets. Speakers do not require external field excitation and use only two wires for connection to amplifier. Each speaker is equipped with a parallel wired outlet socket into which an additional speaker or speaker combination may be plugged making it unnecessary to run each speaker cable back to amplifier. Saves many feet of cable.



## Microphone Stand

The mike stand regularly supplied with systems listed below is a 10" high desk type having a heavy cast metal base. Base is black crackle finish, stem of highly polished chrome. Floor stand may be substituted on any of the systems at an additional cost of \$2.80. Demountable floor stand suitable for use with portable systems may be substituted at an additional cost of \$4.06. See Page 100 for complete description.



## 15 Watt Public Address System for Permanent Installations

### Economy Model

An ideal system for small installations such as Clubrooms, Restaurants, Store Demonstration systems, Taverns, etc. Complete system includes: 15 watt high gain push-pull amplifier with protective installation shield, set of six matched Sylvania tubes, choice of microphone as explained above with 25 ft. cable and plug, microphone desk stand, one 12" heavy duty PM dynamic speaker with 25 ft. of cable and plug, and one blue fabrikoid covered wall baffle. All parts are completely wired ready to install. For 105-120 Volt 50-60 cycle AC operation.

Service! Use this system as a demonstrator in selling P.A. Its high standard of performance makes it possible to give your customer a real idea of what he may expect from the system he buys.

### System Prices

C15098—Economy 15 Watt System. Complete with all equipment, ready to operate as described at left. List Price, \$60.00.

**YOUR PRICE ..... \$31<sup>95</sup>**

D15090—Economy 15 Watt System. As above except less microphone and stand. List Price, \$45.00.

**YOUR PRICE ..... \$24<sup>95</sup>**

D15091—DeLuxe 15 Watt System. Complete with all equipment, less Amplifier Shield, ready to operate as described at right. List Price, \$78.00.

**YOUR PRICE ..... \$39<sup>50</sup>**

### DeLuxe Model

A highly practical Public Address System that will fulfill the requirements of many installations. Suitable for use as Office Call Systems, in Small Auditoriums, Small Ballrooms, Carnival Concessions, Night Clubs, etc. Complete system includes: 15 watt high gain push-pull amplifier, set of six matched Sylvania tubes, choice of microphone as explained above with 25 ft. of cable and plug, microphone-desk stand, two heavy duty 12" PM dynamic speakers each with 25 ft. of cable and plug and two wall mounting blue fabrikoid covered baffles. All units are completely wired and system is ready to operate. Each system is subject to careful test before shipment. For 105-120 Volt 50-60 cycle AC.

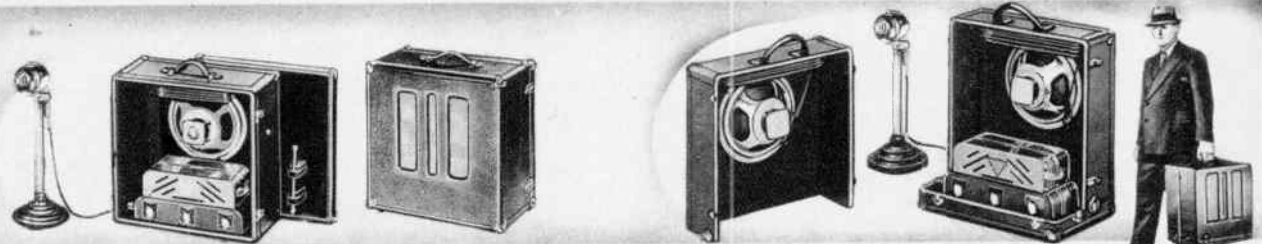

## 15 Watt Public Address Systems for Portable Use

### Economy Model

System consists of 15 Watt High-Gain Push-Pull Amplifier, set of six matched Sylvania tubes, heavy duty 12" PM speaker, choice of microphone and desk stand housed in one sturdy, convenient leatherette covered carrying case, size 17 x 17 x 9 inches. Mike and speaker each have 25 ft. of connecting cable and plug. Meets the need for a compact and inexpensive Sound Distribution System. Each System is subject to careful test before shipment and guaranteed to provide satisfactory performance when used under the conditions for which intended.

### System Prices

D15083—Economy 15 Watt Portable System complete with all equipment, including protective amplifier shield, ready to operate as described at left. For 105-120 Volt 50-60 cycle AC. List Price, \$70.00.

**YOUR PRICE ..... \$36<sup>95</sup>**

D15092—DeLuxe 15 Watt Portable System complete with all equipment, including protective amplifier shield as described at right. For 105-120 Volt 50-60 cycle AC. List, \$90.00.

**YOUR PRICE ..... \$46<sup>95</sup>**

### DeLuxe Model

Designed for compactness, yet case is large and heavy enough to allow proper baffling for speakers and provide excellent reproduction of either voice or music. Includes 15 watt high-gain push-pull amplifier, set of 6 Sylvania Tubes, 2 heavy duty 12" PM speakers, each with 25 ft. of cable and plug, choice of microphone with 25 ft. of cable and plug, microphone stand housed in one unit. All parts are mounted to provide proper weight distribution. 3 Piece case is covered with durable blue leatherette size, 14x18x10". Net weight 28 lbs.

# Radolek 30 Watt DeLuxe



## Attractive Modern Appearance

Radolek Amplifiers bring you styling and DeLuxe professional appearance that will make a favorable impression in any installation. The base is finished in baked maroon crackle enamel. The Streamlined Protective Shield is finished in baked grey crackle enamel, attractively trimmed with chrome bands and handles. Control indicator plates are etched black with frosted silver numbers. Knobs are red pointer type.



Operates on 105-120 Volts 50-60 Cycle AC

## Three Channel Input For Two Microphones and Phonograph

Covers Indoor Audiences of up to 8,000 People or an Outdoor Area of up to 30,000 Square Feet

## Fast—Convenient—Easy Installation

### Biggest Value—Widest Use

Here is the most amplifier for your money in the entire PA field. Alert modern engineering leadership and volume production have produced this super value. Finest quality in every detail. Widest usefulness. Tremendous power. Use this amplifier for your rental jobs as well as for permanent installations. It can be tuned down to handle the small installation and has sufficient reserve power to handle any but the largest setups. Feel confident to sell and install this High Quality Amplifier under toughest competitive conditions.

### Simplified Mixer and Fader

Complete Input System including separate Volume Controls for Phonograph and Microphones is built right into the Amplifier. The inputs are so interconnected that complete mixing or fading between them can be accomplished easily and efficiently. Enables a voice announcement to be superimposed on a musical background from Phonograph, etc. The volume on the microphone can be individually adjusted so that the different sections of an orchestra can be toned down or brought out as desired. One microphone can be used to carry the orchestra as soft-background music; the other microphone for a singer, etc.

### Dual Rectifiers

A new feature providing greater operating efficiency, longer life and cleaner power output. Dual Rectifiers—one for plate and grid bias voltages—one for screen voltages. Voltages remain constant in spite of varying power output levels providing a truer "Class A" output than can otherwise be obtained. These new rectifiers are also of the slow heating type allowing the filament of the other tubes to heat up before plate voltage is applied—this prevents high initial voltage surges giving condensers less abuse and longer life.

### Price

#### 30 Watt DeLuxe Amplifier

For 105-120 Volts, 50-60 Cycle A.C.

D15019—Radolek 4-Stage, 30 Watt, High-Gain DeLuxe Three Channel Input Amplifier. Factory wired and Laboratory Certified. Supplied with protective shield but without tubes.

List Price \$50.00.

YOUR PRICE

**\$24<sup>45</sup>**

D15021—Complete Amplifier with Set of Eight Matched Sylvania Tubes consisting of 2-6SF5's, 1-6SC7, 1-6N7, 2-6L6's, 1-5V4C, and 1-6X5.

List Price \$60.00.

YOUR PRICE

**\$29<sup>89</sup>**

#### Bass and Treble Tone Controls

Either low or high frequencies may be accentuated, both highs and lows may be accentuated at once, or a flat uniform response can be obtained. Innumerable variations are possible so that any tonal requirement may be fulfilled. This feature is particularly valuable for installations which must fit every type of public speaker, singer, orchestra and hall. Accentuating the highs makes a speaker's voice far easier to understand. Accentuating bass response will make a high pitched voice sound more pleasing to the ear, will bring out the low notes so desirable in reproducing organ music, and will often assist in eliminating acoustical feedback. True wide range response is now possible as never before.

#### Phonograph Attachment

Consists of constant speed phono motor with 9" turntable and high grade crystal pickup mounted on amplifier protective shield. May be substituted in place of regular shield. Amplifier has plug in connection jacks mounted so that all connections are enclosed inside of shield. May be purchased with amplifier or added to amplifier at a later date.

D15013—Phono attachment unit as described less amplifier.

List. \$15.00.

YOUR PRICE

**\$7<sup>45</sup>**

### Amplifier Specifications

- 30 Watts "Laboratory Certified" Push-Pull 6L6 "Beam Power" Output.
- Four stages, eight tubes: 2-6SF5's, 1-6SC7, 1-6N7, 2-6L6's, 1-5V4C, 1-6X5.
- 133 Db. usable gain for all stages of microphones.
- Frequency characteristic curve flat within 2 Db. from 50 to 9000 cycles.
- Three channel input—Two Microphone and one Phono.
- Polarized Plug-in connections for three speakers, two mikes and phonograph.
- Complete built-in genuine electronic 2 channel Mixing and Fading System.
- Separate volume control for each of three channels.
- Provisions for connection of remote control.
- Dual tone controls. Treble and bass boost circuit.
- Inverse Feedback. New balanced feedback development assures freedom from distortion peaks.
- Output Impedances: 2, 4, 8, 166, 250, and 500 ohms. Impedance selector for convenient speaker adaptability.
- Extraordinary low hum level—only .1 of 1 per cent.
- Power consumption 150 Watts.
- Power supply, 105-120 volts, 50-60 cycle AC.
- Fully protected with easily accessible quickly renewable fuse.
- Pilot light shows when On or Off.
- Separate On-Off switch.
- Dimensions, with shield: 7½" high, 6½" wide, 16½" long.
- Net weight, 13 lbs. Packed, 20 lbs.
- Bottom protecting plate.
- Finished in baked-on red crackle enamel.
- Protective steel shield with chromium bands standard equipment.

### Remote Control Unit

D15136—Optional Equipment. Permits control of volume for two microphones at a remote point. Amplifier is already arranged to use remote control, no wiring or changes necessary. Complete with 50 ft. of cable and plug.

YOUR PRICE

**\$5<sup>50</sup>**





# Public Address Systems

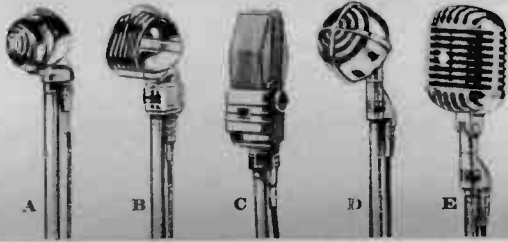

## Choice of Microphones

You may choose any of the microphones illustrated when ordering the Sound Systems described on this page. If you choose: Type A Bullet Crystal No extra charge, Type B Bullet Dynamic or Type C Velocity add \$3.50 to your order, Type D Shure Uniplug add \$8.00, Type E Shure Unidyne add \$13.50. If no choice is specified Type A will be supplied. See page 104 for a complete description of these microphones.

## Complete Ready to Operate

Radolek Amplifiers and Systems are quickly and easily installed and are reliable in operation. You need not have sound or engineering ability or other technical knowledge to obtain best results. No complicated wiring! Just "plug-in" the easily identified connections and you're all set to go. Speakers and microphones are supplied with cables connected to polarized plugs making it impossible to plug into the wrong place. Radolek engineers check each system after it is wired and assembled and before it is shipped assuring correct and trouble-free operation when the system reaches you.

All PA Systems on this page operate from 105-120 Volts 50-60 cycles AC.

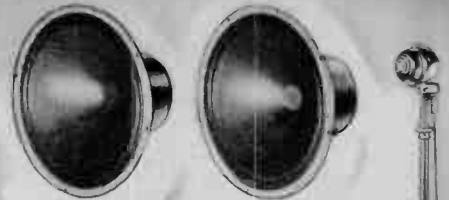

## Finest Quality Speakers

The speakers supplied with the systems listed below are the latest type heavy duty 12" permanent Magnet Dynamic Speakers with 31 oz. magnet. The two speakers will handle the full output of the amplifier without distortion. They do not require external field excitation and use only two wires for connection to amplifier. Each speaker is equipped with a parallel wired outlet socket into which an additional speaker or speaker combination may be plugged making it unnecessary to run each speaker cable back to amplifier.

## Microphone Stand

Full 68" tall, highly polished chrome plated stand with weighted base. Friction clutch allows instant raising and lowering of microphone. Weight of mike will not cause slipping. Will not tip easily.

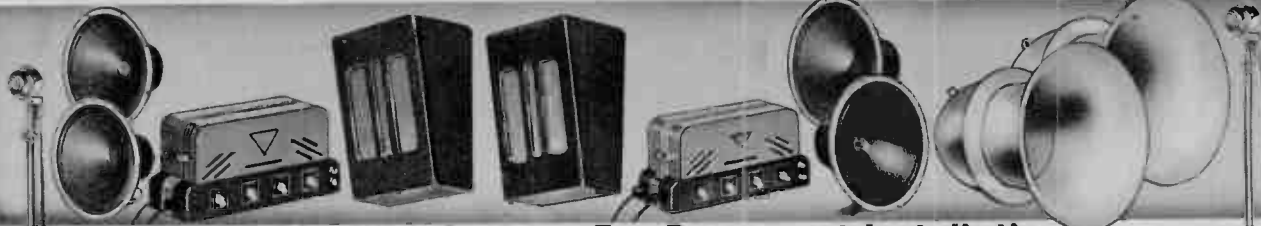

## 30 Watt PA Systems For Permanent Installations

### For Indoor Installations

Includes all equipment required to install a High Fidelity Public Address System for indoor locations. Equipment supplied: 30 watt DeLuxe Amplifier with protective shield fully described on opposite page. Set of Eight matched Sylvania Tubes, Choice of Microphones with 25 ft. of connecting cable and plug as explained above. Heavily weighted all chrome plated Microphone Floor Stand, Two heavy duty 12" PM Dynamic Speakers each with 25 ft. of connecting cable and plug and Two Wall Baffles, covered with attractive blue fabricoid.

D15014—Complete 30 watt DeLuxe Indoor PA System as described above.

List Price, \$110.00.  
YOUR PRICE

**\$53<sup>50</sup>**

D15015—Above PA System complete with record player mounted into amplifier cover as illustrated on opposite page. List Price, \$125.00.  
YOUR PRICE **\$59<sup>95</sup>**

### For Outdoor Installations

Includes all equipment required to install a High Fidelity Public Address System for outdoor locations. Equipment supplied: 30 watt DeLuxe Amplifier with protective shield. Set of Eight matched Sylvania Tubes. Choice of Microphones with 25 ft. of connecting cable and plug as explained above. Heavily weighted all chrome plated Microphone Floor Stand. Two heavy duty 12" PM Dynamic Speakers each with 25 ft. of connecting cable and plug, and Two spun aluminum horns with water-proof protecting covers.

C15016—Complete 30 watt DeLuxe Outdoor PA System as described above. List Price, \$125.00.  
YOUR PRICE **\$59<sup>95</sup>**

D15017—Above PA System complete with record player mounted into amplifier cover as illustrated on opposite page. List Price, \$140.00  
YOUR PRICE **\$66<sup>50</sup>**

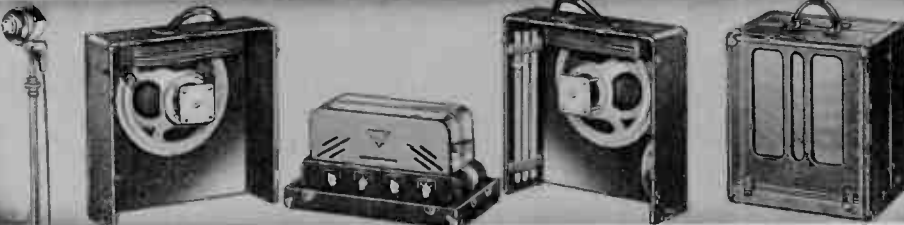

## 30 Watt DeLuxe Portable PA System

### Superb Performance

Designed for compactness, yet case is large and heavy enough to allow proper baffling for speakers and provide excellent reproduction of either voice or music. The complete system including amplifier tubes, speakers, microphone, microphone stand and all necessary cables is housed in one unit readily transported by one person. All parts are mounted to provide proper weight distribution and balance when carrying. Case size, 20 1/2" high x 12 3/4" deep x 18 3/4" wide. Net weight 60 lbs. Sufficient room is provided in case to allow substitution of phono top on amplifier instead of plain top if desired.

### Portable System

### Equipment

Quickly and easily set up—reliable in operation—no sound or engineering ability or other technical knowledge is necessary to obtain best results. The complete system includes: 30 Watt Triple Input Amplifier with protective shield described on opposite page. Matched set of 8 Sylvania tubes. Choice of one microphone as indicated above, with 25 ft. of cable and plug. Demountable 68" floor stand that fits into carrying case. Two heavy duty 12" PM speakers, each with 25 ft. of cable and plug. Complete equipment is housed in 3 section carrying case.

The Complete Public Address System is contained in a 3 piece portable blue fabricoid covered case and is readily transported by one person.



### Prices

D15023—30 watt DeLuxe Portable System complete ready for operation as described. List Price, \$135.00.  
YOUR PRICE **\$65<sup>75</sup>**

D15024—30 watt DeLuxe Portable PA System complete ready for operation as described except includes record player mounted into Amplifier cover as illustrated on opposite page.  
List Price, \$150.00  
YOUR PRICE **\$72<sup>50</sup>**

# Radolek 50 Watt Deluxe

## 6 Inputs—4 Microphone 2 Phono

### Modern Appearance

Radolek Amplifiers bring you styling and deluxe professional appearance that will make a favorable impression in any installation. The base is finished in baked maroon crackle enamel. The Streamlined Protective Shield is finished in baked grey crackle enamel, attractively trimmed with chrome bands and handles. Control indicator plates are etched black with frosted silver numbers.

### Has Automatic Volume Control

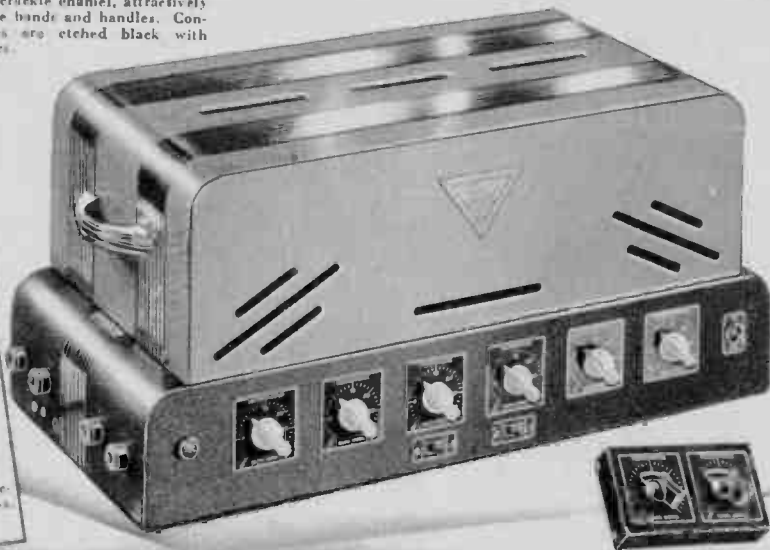

### Remote Control

**Optional Equipment.** For use with above Amplifier. Permits control of volume for two microphones at any remote point up to 1000 ft. from amplifier. Control cables plug into amplifier. Amplifier is already arranged to use remote control, no wiring or changes necessary. **D15136 — Radolek Remote Control Unit.** Complete with 50 ft. of cable and necessary plugs.  
**YOUR PRICE** ..... **\$550**

**For Use on 105-120 Volts 50-60 Cycle AC**

## For Crystal, Dynamic or Velocity Microphones

A SUPER POWER Amplifier engineered for the sound specialist who demands the best quality reproduction combined with convenience in operation and attractive appearance. Every detail of design has been carefully worked out. 50 Watt "Beam Power" Laboratory Certified output. Tremendous in power set compact in size and conveniently flexible in operation. A perfectly balanced combination especially suited for the most exacting installations. Remarkably easy to connect and operate. Arranged to eliminate all possibilities of costly mistakes in set-up. Anyone without technical experience or training can handle every function of operation with perfect satisfaction.

### Perfected Dual-Action Tone Control

Either low or high frequencies can be accentuated as desired. This feature is particularly valuable for installations which must fit every type of speaker, singer, orchestra, and hall. Accentuating the highs makes speakers' voices far easier to understand. Accentuating bass response will make a high pitched voice sound more pleasing to the ear, will bring out the low notes so desirable in reproducing organ music, and will often assist in eliminating acoustical feedback.

### Speaker Matching Switch for Speakers

Eliminates complicated wiring. At many speakers as desired can be used by just "plugging-in" to polarized sockets. A special impedance-changing switch provides instant changeover and correct adaptability to various types and quantity of speakers. Switch may be locked in position.

### Phono Attachment

Consists of constant speed phono motor with 9" turntable and high grade crystal pickup mounted on amplifier protective shield. May be substituted in place of regular shield. Amplifier has plug in connection jack mounted so that all connections are enclosed inside of shield. May be purchased with amplifier or added to amplifier at a later date.

**D15011—Phono attachment unit** as described less amplifier.

List, \$23.00. **YOUR PRICE** ..... **\$1075**

### Prices 50 Watt DeLuxe Amplifier

For Use on 105-120 Volts, 50-60 Cycle AC

**D15130—Radolek 4-Stage, 50 watt, High-Gain DeLuxe Six Channel Input Amplifier.** Factory wired and Laboratory Certified. Supplied with protective shield but without tubes.

List Price, \$100.00. **YOUR PRICE** ..... **\$4950**

**D15131—Complete Amplifier with Set of Fourteen Matched Sylvania Tubes** consisting of 4-6SF5's, 3-6N7's, 1-6HG5, 4-6L6's and 2-5Z3's.

List Price, \$118.34. **YOUR PRICE** ..... **\$5867**

### Super-Power Features

- 50 Undistorted Watts to speaker voice coils. Completely free from drawing grid current on peaks within normal power.
- Six Input Channels with plug-in connections. Four high gain 130 db. for all commercial microphones and two for phono input 85 db. Each channel independently controlled.
- Automatic Volume Control keeps output at practically constant level regardless of talker's position with relation to mikes.
- Remote Volume Control. May be connected to regulate volume of two microphones from remote point.
- Fourteen Multi-function Tubes. 4 Stages: 4-6SF5's, 3-6N7's, 1-6HG5, 4-6L6's, and 2-5Z3's.
- High Fidelity Tone with frequency characteristics flat within 2 db. from 40 to 9000 cycles.
- Tonal Color Control. Accentuates bass or treble as may be preferred.
- Complete Mixing and Fading System. Perfect control over each input providing any combination of tone and volume.
- Plug-in polarized receptacles for four speakers.
- Automatic Speaker Matching. A convenient impedance changing switch permits use of various types and number of speakers. A single setting of this control assures a perfect impedance match with practically any selection of speakers.
- Output Impedance tapped at 1/2, 2/3, 4, 8, 125, 100, 250 and 500 ohms.
- Only .003 Volts Input to obtain full output. Permits microphone cable lengths up to 300 ft.
- Exceptionally Low Hum Level, only .1 of 1% of total output.
- Low Power Consumption, 180 Watts. Power supply required 105-120 volts, 50-60 cycles AC. Safety Fused.
- Strong Steel Chassis in lustrous red crackle finish. Dimensions, 19 1/2" long, 1 1/2" wide, 9" high including shield.
- Net Weight 20 lbs. Shipping weight 35 lbs.



Handless Input Connections for 4 Microphones 2 Phono pickups.



Without AVC — Volume level always too low or too high. Seldom just right.



With AVC — Constant Volume Level regardless of talker's position.

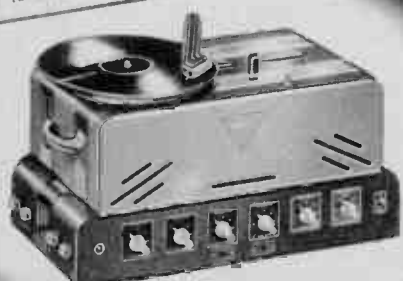



# Public Address Systems

**READY TO SET UP AND OPERATE IN JUST A FEW MINUTES:** Radolek Amplifiers and Systems are easy to install and operate and are reliable in operation. You need not have sound or engineering ability or other technical knowledge to obtain best results. By following a few simple instructions anyone can quickly set up and take down this equipment without error. No complicated wiring! Just "plug-in" the easily identified connections and you're all set to go. Speakers and microphones are supplied with cables connected to polarized plugs making it impossible to plug into the wrong place. Complete installation and operating instructions included. For 105-120 Volts 50-60 cycle AC.

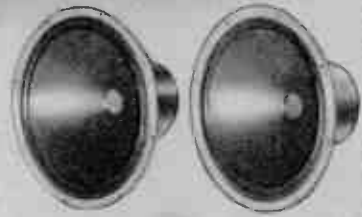

Each speaker is equipped with a parallel wired outlet socket into which an additional speaker or speaker combination may be plugged making it unnecessary to run each speaker cable back to amplifier.

## Finest Quality Speakers

The speakers supplied are the latest type heavy duty 12" Permanent Magnet Dynamic Speakers with 11 oz. magnets. Do not require external field excitation and use only two connection wires. Four speakers will handle the full output of the amplifier with perfect clarity.

## Choice of Microphones

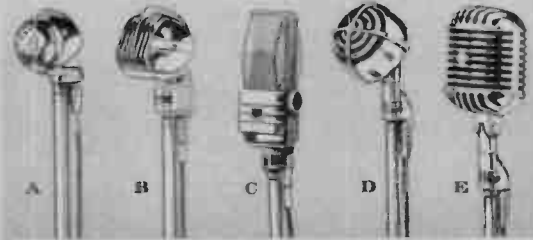

You may choose any of the microphones illustrated when ordering the System on this page. If you choose: Type A Bullet Crystal No extra charge, Type B Ballet Dynamic or Type C Velocity add \$3.50 to your order, Type D Shure Uniplex add \$8.00, Type E Shure Dynamic add \$13.50. If no choice is specified Type A will be supplied. See page 108 for complete description.

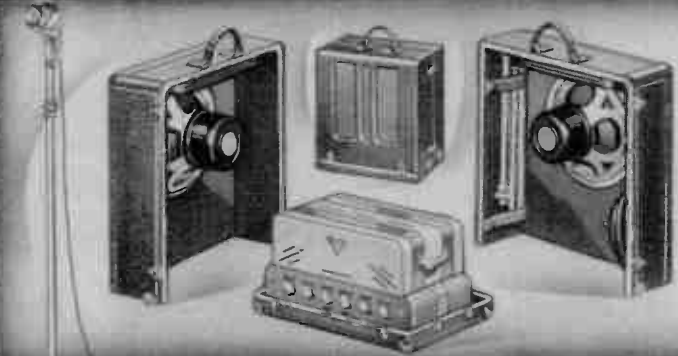

## Complete 50 Watt Portable System

Designed for competition, yet case is large and heavy enough to allow proper baffling for speakers and provide excellent reproduction of either voice or music. The complete system includes: **50 watt Six Input Amplifier** with protective shield described on opposite page. Matched set of

14 Sylvania tubes. Choice of one microphone as indicated above, with 25 ft. of cable and plug. Demountable 68" floor stand that fits into carrying case. Two 12 inch PM Speakers, each with 25 ft. of heavy duty cable and plug. Complete equipment is housed in 3 section carrying case. Case size, 24" high x 14" deep x 20" wide. Net weight 13 lbs.

D15009—50 watt DeLuxe Portable System complete ready for operation as described. List Price, \$210.00.  
**YOUR PRICE**

**\$96<sup>50</sup>**

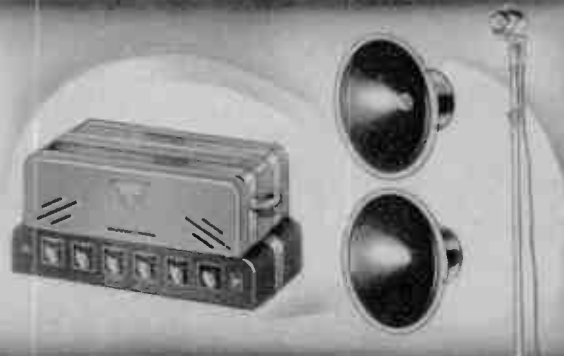

## 50 Watt Basic PA System

Designed for the Public Address Specialist who wishes to use his own special baffles or build the speakers into a wall using the wall as a baffle. Equipment includes: **50 watt DeLuxe Amplifier** with protective shield, set of 14 matched Sylvania tubes, choice of one microphone as explained above with 25 ft. of cable and plug, 68" all chrome plated floor stand, and two heavy duty 12" PM Dynamic Speakers each with 25 ft. of connecting cable and plug.

D15012—50 watt Basic PA System as described completely wired, ready to operate.  
List Price, \$165.00.  
**YOUR PRICE**

**\$83<sup>50</sup>**



## 50 Watt Public Address Systems for Permanent Installations

### For Indoor Installations

Includes all equipment required to install a High Fidelity Public Address System for indoor locations. Equipment supplied: **50 watt DeLuxe Amplifier** with protective shield, 14 matched Sylvania tubes, choice of one microphone with 25 ft. of cable and plug, 68" all chrome plated microphone floor stand, four heavy duty 12" PM Dynamic Speakers each with 25 ft. of connecting cable and plug and four wall baffles, covered with blue fabricoid.

D15005—Complete 50 watt DeLuxe Indoor PA System as described above. List, \$225.00.  
**YOUR PRICE**

**\$105<sup>00</sup>**

### For Outdoor Installations

Includes all equipment required to install a High Fidelity Public Address System for outdoor locations. Will give sufficient sound coverage to handle 90% of your requirements. Equipment supplied: **50 watt DeLuxe Amplifier** with protective shield, 14 matched Sylvania tubes, choice of one microphone as explained above with 25 ft. of cable and plug, chrome plated microphone floor stand, four heavy duty 12" PM Dynamic Speakers each with 25 ft. of connecting cable and plug, and four spun aluminum horns with waterproof protecting covers.

D15007—Complete 50 watt DeLuxe Outdoor PA System as described above.  
List Price, \$219.00.  
**YOUR PRICE**

**\$119<sup>00</sup>**

# Radolek 100 Watt Deluxe

## Six Input Channels

Uses High Impedance Crystal, Velocity or Dynamic Microphones: perfect operation with any type. Has six inputs for Four Microphones and Two Phonos. Special switching arrangement with four gain controls allows use of any four inputs at one time. Ideal for multi-microphone requirements. Permits placing of mikes in important spots for close-range pick-up and announcements during athletic events, political rallies, etc. Give the team line-up from one end of the stadium and pick up a band from the other side, etc. Also ideal for featuring solo sections in large orchestras.

## Monitor Speaker

Built-in speaker provides program monitoring. Indicates exactly what is being reproduced through other speakers in the system. Facilitates mixing of microphones and phono-graph. Has individual volume control.

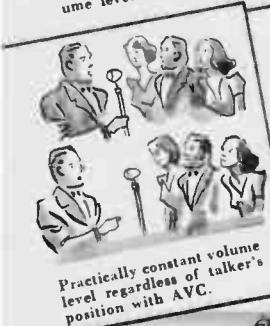

# for Mammoth Stadium Type Installations

## Enormous Sound Coverage

Brilliant and reliable in performance under the most exacting conditions. This amplifier is the result of years of research and tests by Radolek sound engineers to supply a truly high power amplifier which will fill with ease all the requirements of the largest Public Address installations. Install this amplifier with confidence of full, satisfactory coverage for Giant Political Rallies, Large Athletic Stadiums, Huge Auditoriums, Outdoor Band Concerts, Chime Amplification in church steeples, large Circuses and Rodeos, Armories, Sports Arenas and any others that require coverage over an exceptionally large area or great number of people. Will supply adequate sound coverage over outdoor areas of from 100,000 to 300,000 square feet or audiences of up to 100,000 people. The amount of coverage obtainable is dependent entirely upon the type of installations. For example, when used in such installations as chimes amplification in church steeples, it is not unusual for chimes to be heard for several miles under normal conditions.

## Uses Six 6L6's

6-6L6's in the output with 3 separate rectifiers provide an exceptionally clean and powerful output without overworking the power stage. Separate filament and plate transformer provide required voltages without overloading. Oversize output transformer handles full power without distortion.

## Remote Control Unit

Permits control of volume for two microphones at any remote point up to 1000 ft. from amplifier. Plug-in connections. Amplifier is already arranged to use remote control; no wiring or changes necessary.

D15136—Remote Control Unit with 50 ft. cable and plug. **\$550**  
YOUR PRICE .....

## Phonograph Attachment

Consists of constant speed phono motor with 9" turntable and high grade crystal pickup mounted on amplifier cover. May be substituted in place of regular cover of amplifier at any time. Amplifier has plug-in connection jacks mounted so that all connections are enclosed inside of shield.

D15093—Phono attachment unit as described less amplifier.  
List, \$25.00.

YOUR PRICE ..... **\$1195**

## Amplifier Specifications

- 100 Watts normal output to speaker coils. Complete freedom from drawing grid current on peaks within normal power. Plug-in receptacle connections for six speakers. (6 plugs included.)
- Six Input Channels with Plug-In connections. Each independently controlled. Four high gain (130 D.B. for any commercial microphone) and two for phono input (85 D.B.). (5 plugs included.)
- Eighteen Tubes Used—Four 6NF5's, two 6NT's, 2-6J5's, one 6H6, six 6L6's in parallel push-pull; triple rectifiers, one type 5Z3 for plates, one type 5Z3 for screen and one type 5Z3 for grid bias.
- "Hi-Fidelity" Tone—Practically flat from 40 to 10,000 cycles with tone compensator at "normal."
- Two "Tone Color" Controls, Treble (Highs) and Bass (Lows) controlled independently by means of a separate tube circuit. Either Treble or Bass can be actually BUILT-UP without interfering with balance of tone scale.
- Volume Controls for each microphone and phono input.
- Automatic Volume Control keeps output at practically constant level regardless of talker's position with relation to microphone. Control on panel varies effectiveness.
- Complete Mixing and Fading System—Perfect control over each input. Inputs can be delicately blended together in any combination desired.
- Automatic Speaker Matching. Use any number of speakers having 500 ohm impedance transformer. The setting of a single control matches the group accurately to the output of the amplifier.
- Impedance Changing Switch. Permits use of various type speakers and connection to different ohmage output circuits. Output impedances tapped at 84, 100, 125, 16Ω, 250, and 500 ohms.
- Only .003 volts input signal required to obtain maximum output. Permits long microphone leads.
- Extraordinary low hum level—1 of 1% of output. For practical purposes there is no hum.
- Low Power Consumption—225 watts.
- For 105-120 Volts, 50-80 cycle AC operation.
- Quickly Renewable Fuse in power supply.
- Strong Steel Cabinet in baked dark maroon crackle finish. Protecting bottom plate with rubber feet. Removable top plate affords access to tubes and protection from accident or tampering. Well ventilated. Cabinet size: 22" long, 13" wide, 11" high. Net weight 65 pounds, shipping weight 90 pounds.

## 100 Watt Amplifier Price

D15120—100 Watt Deluxe Amplifier completely mounted in attractive steel cabinet. No tubes, no microphone, no speaker, no phonograph included.

List Price, \$145.00.  
YOUR PRICE ..... **\$6950**

D15121—Set of Eighteen Matched Sylvania Tubes for use with above amplifier, including; 4-6NF5's, 2-6NT's, 2-6J5's, 1-6H6, 6-6L6's, 3-5Z3's.

List Price, \$21.50.  
YOUR PRICE ..... **\$1075**





# Public Address Systems

## Easy to Install

**READY TO SET UP AND OPERATE IN JUST A FEW MINUTES:** The 100 watt Radolek Sound Systems listed on this page are easy to install and operate and are reliable in operation. You need not have sound or engineering ability or other technical knowledge to obtain best results. By following a few simple instructions anyone can quickly set up and take down this equipment without error. No complicated wiring! Just "plug-in" the easily identified connections and you're all set to go. Speakers and microphones are supplied with cables connected to polarized plugs making it impossible to plug into the wrong place. All components are matched, wired and tested as a complete system ready for operation before shipping.

These Giant Sound Systems will produce 100 watts of undistorted perfect "High-Fidelity" toned output continuously day in and day out. While the systems have been built primarily for high power installations, they can be adapted equally well to lower powered jobs where superlative tone quality is desired. Tremendous, continuous output without a shade of distortion is made possible by the use of conservatively rated components with wide safety factors.

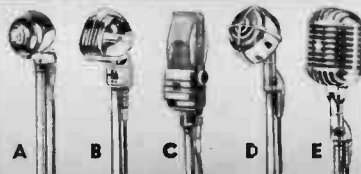

## Choice of Microphones

You may choose any of the microphones illustrated when ordering the Sound Systems described on this page. If you choose: Type A Bullet Crystal **No extra charge**, Type B Bullet Dynamic or Type C Velocity add \$3.50 to your order, Type D Shure Uniplex add \$8.00, Type E Shure Unidyne add \$13.50. If no choice is specified **Type A will be supplied.** See page 100 for a complete description of these microphones.

## For Mobile Use

Any of the systems listed below may be adapted for mobile installations in passenger car or truck by using the gasoline operated AC power supply Num. C16899 priced at \$57.88. Fully described on page 78.



## Finest Quality Speakers

The speakers supplied with these systems are heavy duty 12" PM Dynamic with 31 oz. magnet. Do not require external field excitation and use only 2 connection wires. Each speaker has a parallel wired outlet socket into which additional speakers may be plugged making it unnecessary to run each speaker cable back to amplifier.

## Microphone Stand

68" tall, highly polished chrome with weighted base. Stand supplied with portable system has three piece standard to allow dismantling and fitting into portable Amplifier case shown below.



## 100 Watt Public Address Systems for Permanent Installation

### For Giant Outdoor Installations

This system has been designed to meet the needs of the very large installations in Athletic Stadiums, Huge Political Rallies, etc. Also well adapted to chime amplification systems for churches and cemeteries. System includes: 100 watt amplifier, set of 18 matched Sylvania tubes, choice of one microphone with 25 feet of cable and plug as indicated above, Microphone Floor Stand, Six heavy duty 8" PM driver speakers designed to handle full output of amplifier when used with the six spun steel trumpets furnished. Speakers each have 50 ft. of cable and plug. Six weatherproof baffle covers are supplied to protect speaker cones when installed outdoors permanently. For 105-120 volt 50-60 cycle AC.

**D15032—100 Watt P.A. System for outdoor installation.** Complete as described above, less remote control. **\$259<sup>50</sup>**  
 Last. \$525.00.  
**YOUR PRICE** .....

### For Giant Indoor Installations

Use this system for indoor installations requiring a tremendous amount of sound coverage as in Indoor Sports Arenas, Large Armories, etc. System includes: 100 Watt Amplifier, Set of 18 matched Sylvania tubes, Choice of one microphone with 25 feet of cable and plug as indicated above, Microphone floor stand, Six heavy duty 12" PM dynamic speakers each with 50 ft. of cable and plug, and Six wall mounting blue fabricoid covered baffles. System is completely wired and tested before shipping.

**D15033—100 Watt P.A. System for indoor installation.** Complete as described above, less remote control. **\$153<sup>50</sup>**  
 List Price, \$300.00.  
**YOUR PRICE** .....



## 100 Watt Portable Public Address System

### For Wide Sound Coverage

For extra large installations where it is convenient to use a portable system and where the 30 or 50 watt systems listed on previous pages are not quite adequate. Complete System is housed in three carrying cases. One case houses amplifier and has space for storing microphone, microphone stand and microphone cable. Two split speaker carrying cases house and provide baffling for the speakers and also have brackets for storing speaker cable.

For 105-120 Volt 50-60 Cycle AC Operation

### Equipment Included

Complete system includes: 100 Watt Amplifier mounted in 3 section Amplifier Carrying Case, set of 18 matched Sylvania tubes, choice of microphone with 25 feet of cable and plug as explained above, demountable microphone floor stand that fits into Amplifier carrying case, Four heavy duty 12" PM dynamic speakers each with 50 ft. of cable and plug, Two Split Speaker Carrying Cases which house and provide baffling for the speakers.

### System Prices

**D15034—100 Watt Portable P.A. System** all wired and ready to operate. Complete as described. **\$149<sup>50</sup>**  
 List Price, \$290.00.  
**YOUR PRICE** .....

### Extra Speakers

**D15036—Split speaker carrying case** housing two 12" PM dynamic speakers each with 50 ft. of cable and connecting plug. For use with above system when additional speakers are required. **\$24<sup>40</sup>**  
 List Price, \$50.00.  
**YOUR PRICE** .....

# 30 Watt Mobile Amplifier and Sound Systems

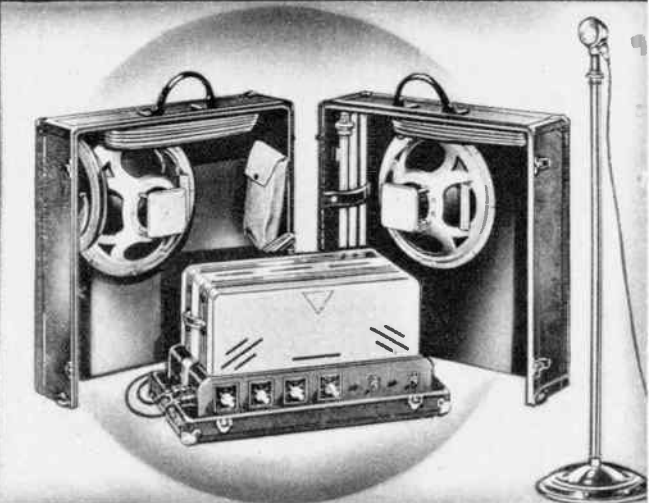

**Operates From 6 Volt Battery or 110 Volt AC Line**

- Extra Power Output—50% more than usual on mobile systems.
- One complete unit—no external power pack or current supply needed.
- Phonograph record player—optional—can be added later if preferred.
- Controls conveniently accessible. Easily handled even in heavy traffic.
- P.M. type speakers draw no field current, provide highest efficiency and greatest power with least battery drain. Can be used any place.

## Choice of Microphones

You may choose any of the microphones illustrated when ordering the Sound Systems described on this page. If you choose: Type A Bullet Crystal No extra charge, Type B Bullet Dynamic or Type C Velocity add \$3.50 to your order, Type D Shure Uniplex or Type E

Shure Uniduc add \$13.50, Type G Shure Crystal Hand Mike with "press to talk" switch add \$3.50. If no choice is specified Type A will be supplied. See page 100 for a complete description of these microphones.

D9971—Type H Shoulder Microphone Carrier for any of above microphones. Less Mike.

**YOUR PRICE \$145**

## No External Power Pack Required

Your Power Source troubles are over with this New Radolek General Purpose Public Address System. Operate it indoors from the 110 Volt AC Power line or set it up in a truck or passenger car with 6 volt storage battery. When your sound car is used in picnic groves or other locations where you stay in one spot use 110 V. AC power if available or if not, a 6 volt storage battery will do. Changeover instantly—no complicated connections, just plug into power line or clip onto battery, throw the power switch, and you're ready to go. Both 6 V. and 110 V. power packs are built into the amplifier. No external equipment used. Delivers tremendous volume with rich clear tone. Covers an audience of 8,000 people indoors. Under favorable conditions can be heard up to 1/2 mile away, outdoors.

## Easy To Install

READY TO SET UP AND OPERATE IN JUST A FEW MINUTES: The Radolek 30 Watt Mobile System is easy to install and operate. You don't have to be an engineer. The most inexperienced novice can quickly set up and take down this equipment without error. No Wiring! Just plug-in. A few simple connections and you're all set to go. Plug-in connectors come already wired and are polarized making it impossible to plug into the wrong socket. Complete installation and operating instructions included.

## Amplifier Only

D15025—30 Watt Mobile Amplifier only with protective cover less phonograph and tubes. List Price, \$100.00.

**YOUR PRICE \$49<sup>50</sup>**

D15026—30 Watt Mobile Amplifier with protective cover and set of 10 Matched Sylvania Tubes. Less phonograph.

List Price, \$111.68. **YOUR PRICE \$55<sup>34</sup>**

## 30 Watt Portable System

D15050—30 Watt Mobile Type Portable System less record player. Ready to operate. Includes: 30 Watt Triple Input Amplifier, 10 Matched Sylvania Tubes. Choice of microphone with 25 foot cable and plug as outlined above-left. Demountable 68" floor stand that fits into carrying case. 2 Heavy duty 12 inch PM speakers, each with 25' feet of cable and plug. Complete equipment housed in 3 section carrying case. Easy and quick to set up. Reliable in performance. Size of carrying case: 21 1/2" x 23 1/2" x 12 1/2".

List, \$210.00. **YOUR PRICE \$98<sup>50</sup>**

## Mobile System

### For Truck Installations

D15027—Complete Mobile System including: 30 Watt Amplifier with protective cover less phonograph; Two 12 inch finest quality 31 oz. magnet, P.M. Dynamic speakers with 50 foot cables and polarized plugs; Two Aluminum baffle horns, with choice of microphones listed above, left; with 25 feet of cable and polarized plug and set of 10 matched Sylvania Tubes. No mike stand or holder supplied.

List Price, \$190.00. **YOUR PRICE \$91<sup>50</sup>**

## Phono Attachment

Either system illustrated above may be purchased with phonograph attachment already installed or, phonograph attachment may be added at a later date without any additional wiring being necessary. Includes high-grade phono motor with 9" turn-table and Astatic crystal pickup.

D15028—List Price, \$23.00. **YOUR PRICE \$9<sup>30</sup>**

## Most Versatile Amplifier

Big money will be made this year renting and selling public address systems for gatherings of every kind. In the entire P. A. field, the Radolek 30 watt Mobile amplifier gives you most for your money. Adequately covers indoor gatherings from a hundred or less up to large crowds of 8,000 and outdoor events of every type from a single tennis court match or small swimming tank meet up to athletic events on large fields 30,000 square feet in size.

Maximum usefulness is obtainable as a result of the combination 6 volt battery and 110 V. AC line operation provided in this amplifier. Dances — Dramatics — Concerts — Call Systems — Clubs — Schools — Churches — Auditoriums — Parks — Playgrounds — Garages — Parking Lots — Theatres and hundreds of places you can think of Right Now are good prospects for P.A. equipment. Prepare now to Cash in on the many P.A. installation possibilities in your locality—Feel confident to sell and install this amplifier under the toughest competitive conditions.

## Amplifier Specifications

1. Dual Purpose Amplifier—For operation on 6 volt storage Battery or 105-120 volt, 50-60 cycle AC line. No external power pack.
2. 30 Watts "Laboratory Certified" Output—Powerful new High-Gain "Inverse Feedback" circuit. Newest engineering. You can use every bit of the distortion-free power developed by this amplifier. Uses high impedance microphones such as Velocity, Crystal, Dynamic, etc.
3. Uses Ten Tubes—2-6BF5's, 2-6BC7's, 1-8J5, 2-6L6G's, 3-6X5G's.
4. Three Channel Input—Two for microphones one for phonograph.
5. High Fidelity Output—Full rated output from battery or power line.
6. Built-in Mixing System—Each input independently controlled for volume and mixing.
7. Hi-Low Tone Control—Complete control of tone, either highs or lows may be emphasized or normal tone brought out with great purity.
8. Electrically operated Record Player—(optional equipment). Smooth running, self-starting, reliable motor. Fine quality crystal pick-up gives life-like reproduction.
9. Speakers—Provision is made for operation with either one or two P.M. dynamic speakers. Connections made with polarized plugs. No chance for wrong connections.
10. New Streamlined Design—All-steel case. Finished in two-tone wrinkle enamel. Lower section is in maroon. Top shell is grey wrinkle, trimmed with chromium. Carrying handles permit easy transportation. Extra strong. Ample ventilation. Size: 9" high, 18" wide, 9 1/2" deep.



# Outstanding Radio Set Values

## Radolek 11 Tube Superheterodyne

6 Push Button Tuning—Built-in Aerial—Tuning Eye  
3 Bands Tune 540 to 18,000 KC—12" Dynamic Speaker

Every possible refinement and engineering improvement necessary to provide the highest quality of radio reception and reproduction has been included in this Deluxe 11 Tube Super. Standard broadcasts come in with amazing clarity and fidelity. 6 button Synchronomatic tuning brings in favorite stations instantly, tuned exactly right. Short-wave bands provide reception for two-way airline broadcasts, for amateur operators all over the continent, and for foreign short-wave announcements of momentous events overseas. This is a radio for pleasure, for entertainment and for adventure, designed to give listeners the greatest possible enjoyment.

### Exquisite Console Cabinet

As good to look at as it is to listen to. The cabinet has all the beauty of the conventional combined with the best of modern art, designed to appeal to the most discriminating taste. Walnut and other fine American woods are trimmed with Brazilian Rosewood finished grille and butterfly figured finished band. The entire cabinet is hand rubbed and polished to a rich, gleaming lustre. A very effective console.

### Consider These Features!

In every respect the receiving unit matches the superb quality and fine craftsmanship of the cabinet. No quality feature has been omitted. 11 tube superheterodyne circuit includes Tuning Eye for accurate dial settings. Automatic push button tuning is combined with improved one-piece variable condenser and tuner. Built-in antenna eliminates aerial and ground connections. 12" electro-dynamic speaker provides balanced reproduction of all programs. Tuning range includes 540 to 1800 Kc., 1750 to 6000 Kc., and 5500 to 18,000 Kc. Slide-rule dial. Size of console, 42"x28"x15". Power output approximately 6 watts. Tubes: 1-8C, 1-6K7G, 3-7E, 2-6AC5G, 1-6K8G, 1-6K7G, 1-6Q7G, -6U5.

For 110-120 Volt AC operation.

D17586—11 tube Deluxe superhet. 5 gang, 3 band. List Price, \$89.50.

YOUR PRICE, Each \$47.50  
In lots of 3 Each.....

**\$45<sup>95</sup>**



## 6 Tube 2 Band AC-DC Superhet

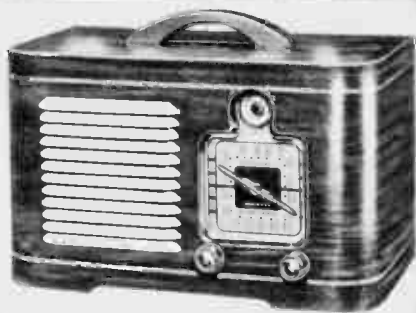

Telebeam Eye  
•  
Tunes  
2½ Bands  
•  
Automatic Volume Control

An outstanding value in a powerful table model receiver. 6 Tube superheterodyne brings in all stations clearly under any conditions. Covers 2½ bands including standard broadcasts, police calls, aviation, amateur and megacycle foreign. Beam power output, coupled with 3" electro-dynamic speaker for clear, full tone at all times. Automatic Volume Control cuts down fading, increases listening enjoyment. Tuning is fast and easy with Telebeam Tuning Eye. Tuning range, 540 to 1720 Kc. and 2300 to 6250 Kc. Finely balanced chassis is designed throughout with all latest engineering improvements to assure the most satisfactory reception and reproduction. Cabinet of selected and matched Walnut trimmed with artistic contrasting inlays and hand polished to a rich glossy finish. Atached aerial and ground. Size 12"x8½"x6". For AC-DC operation. Tubes used: 1-6Q7G, 1-25L6G, 1-25Z5, 1-6A7, 1-6D6, 1-6U5.

D17587 6 tube Telebeam Eye Superheterodyne. Complete with tubes. List, \$29.50.  
YOUR PRICE, Each \$14.25  
In Lots of 3, Each .....

**\$13<sup>45</sup>**

## Melody Cruiser 5 Tube Super

Sails and Rigging Act As Antenna  
D18505 — Melody Cruiser, complete with tubes.

List, \$27.50.  
YOUR PRICE, Each \$16.17  
In lots of 6  
or more,  
Each .....

**\$14<sup>45</sup>**



Ship tradition. Designed to please all lovers of fine nautical craftsmanship. Metal sails and rigging act as antenna, completely eliminating need for any aerial and ground connections. Radio matches ship model in quality. Has powerful permanent magnet speaker for full-tone reproduction of all programs. Nautical style illuminated dial. 5 tube superhet guarantees perfect reception under any conditions. Tunes standard broadcasts from 550 to 1700 Kc. Size, 21½" long, 5" wide, 18" high. Tubes: 1-12A8GT, 1-12K7GT, 1-12Q7GT, 501-6GT, 3525GT. For 105-120 volt AC-DC.

## 5 Tube AC-DC Superhets



Has 6 button synchronomatic tuning. Splendid tone quality. Electro-dynamic speaker. Tunes 2½ bands, 540 to 1720 Kc. and 2300 to 6250 Kc. Includes standard broadcasts, police, aviation, amateur and foreign. Built-in antenna eliminates aerial or ground. Automatic Volume Control cuts down fading. Built for record playing attachment. Polished Walnut wood cabinet has convenient carrying handle. Size, 11½"x14"x6½". For 110V. A.C.-D.C. operation. Tubes used 1-35L6GT, 1-12Q7GT, 1-12A8GT, 1-375GT, 1-12K7GT.

D17588—With tubes. List, \$19.95.  
YOUR PRICE \$12.95 **\$11<sup>95</sup>**  
lots of 3, Each .....

### Synchronomatic Push Button Tuning



Has beautiful Walnut wood cabinet with contrasting bands of V-matched mahogany overlay, polished to a high finish. 6-button synchronomatic tuning. Tunes 2½ bands, 540 to 1720 and 2300 to 6250 Kc., covering standard broadcasts, police, aviation, amateur and Mc foreign. Automatic Volume Control minimizes fading. Electro-dynamic speaker insures finest tone quality. Built-in Antenna. Designed for record playing attachment. Size, 11½"x14"x6". AC-DC. Tubes 1-35L6GT, 1-12Q7GT, 1-12A8GT, 1-375GT, 1-12K7GT.

D17589—Complete with tubes. List Price, \$24.50.  
YOUR PRICE \$14.45 **\$13<sup>95</sup>**  
Lots of 3, Each .....

### Built-In Aerial and Ground



6 Button synchronomatic tuning brings in favorite stations instantly. Electro-dynamic speaker provides rich, natural tone. Tuning range, 540 to 1720 Kc. and 2300 to 6250 Kc. Picks up standard broadcasts, police calls, aviation, amateur and Mc foreign. Built-in Antenna replaces aerial and ground. Automatic Volume Control minimizes fading. Built or record playing attachment. Beautifully finished Walnut wood cabinet has carrying handle. Size overall, 11½"x14"x6". Operates on AC or DC. Tubes: 1-35L6GT, 1-12Q7GT, 1-12A8GT, 1-375GT, 1-12K7GT.

D17590—Complete with tubes. List Price, \$22.50.  
YOUR PRICE, Each..... **\$13.95**  
In lots of 3, Each .....

**Sensational  
VALUE**

# Radolek 7 Tube 2 Band AC Superhet

**Table Model  
RADIO**



*A fine Quality  
Radio  
That is Sure  
to please*

- Two Band Tuning covers 535 to 1600 Kc and 5750 to 18,300 Kc. • Large Edge lighted Slide Rule Dial.
- Built-In Aerial. • Tone Response Control. • Automatic Volume Control. • Phono Connection.
- Push Pull Audio Beam Power Output. • 6" Electro Dynamic Speaker. • Walnut Veneer Cabinet.

**One of the Year's Sensational Values**—More radio for your dollar than we have ever before been able to offer. Unbelievably low in price yet contains DeLux features usually found only in sets selling at a much higher price. Faithful tone, highly visible easy tuning, phonograph connections, attractive styling, and many other sales building factors.

**Foreign and Short Wave Reception**—Get the latest world news first hand, sometimes even before it appears in the papers or is read over the air by local news commentators. Hear all sides of current international problems now broadcast in English from leading foreign short wave radio stations. Listen to the music of many lands. Hear ships at sea conversing with stations on shore, planes in flight receiving instructions and latest flying weather reports from their traffic control bases on the ground; radio amateurs conversing with one another; police calls, and many other broadcasts.

**New Edge-Lighted Slide Rule Dial**—Attractive, highly visible edge-lighted slide rule dial with vernier drive allows accurate tuning of all stations. Large 4 color direct reading tuning scales for quick finding and logging of stations. Relieves all eye strain and eliminates tensed or cramped tuning position necessary with other types of dials. Scales are direct reading over entire two band tuning range of from 535 to 1600 Kc (broadcast and upper police) and 5750 to 18,300 Kc (U.S. and foreign short wave stations).

**Incorporates Latest Features.** Automatic volume control circuit minimizes and in many cases entirely eliminates fading. Continuously variable tone control allows tone range adjustment of voice or music.

**Built-in Loop Antenna** allows perfect reception without the need for unsightly external aerial and ground wires. Permits operation of the set any place in the room, on the porch or outdoors—in fact any where a 110 volt 60 cycle AC outlet is convenient—Simply plug in and play.

**Push-Pull Audio Output** brings you finer, more realistic reproduction with a new richness and tonal perfection. Beam power output with heavy duty 6" electro-dynamic speaker handles full power without effort, reproducing each program with true lifelike quality and adequate volume. Tubes used: 1-6SA7, 1-6SK7, 1-6SQ7, 1-6SF5, 2-6K6G and 1-5Y3C.

**Richly Styled Table Model Cabinet** finished in selected Walnut veneers with mahogany and maple inlay trim. Decorative speaker baffle bars are finished in matched grain walnut. Knobs are molded bakelite mahogany finish. The entire cabinet is rubbed to a lustrous polish. Size: 20 1/2 x 10 1/2 x 10 1/2" deep. Ship. wt. 14 1/2 lbs.

**D17652**—Seven tube 2 Band AC Super, complete with tubes. For 110-120 volt 50-60 cycle AC operation.

List Price, \$29.95.

**YOUR PRICE, Each.....\$19.50** **\$18<sup>33</sup>**

In Lots of 3 or More, Each .....

## 7 Tube 2-Band-Super Chassis and Speaker

**Makes Ideal Replacement Receiver**

**For Installation in Any Cabinet**

For the person who has a radio cabinet which is valued quite highly yet would like also to have the advantages of up-to-date radio reception, this 7 tube AC Super chassis with a 10" dynamic speaker makes an excellent 1941 replacement unit. This is the same receiver chassis as used in the Radolek 7 tube AC Super described above.

### Has All Latest Features

All the latest 1941 features have been incorporated: built-in aerial, automatic volume control, tone control, 2 band tuning covering 535 to 1600 Kc (Broadcast and upper police bands) and 5.75 to 18.3 Mc (Short wave and foreign bands), latest slide rule tuning dial etc.

### Latest Superheterodyne Circuit

Has maximum sensitivity and selectivity for bringing in hard-to-get distant stations. Push-pull audio and beam power output furnish true lifelike tone and plenty of volume. Connections are provided for phonograph record player, television sound or F.M radio tuning adapter. Tubes used: 1-6SA7, 1-6SK7, 1-6SQ7, 1-6SF5, 2-6K6G and 1-5Y3C. Size, 12" wide, 8 1/2" deep and 7 1/4" high.

**D17653**—7 Tube 2 Band AC Super Chassis complete with 10" electro-dynamic speaker, slide rule dial and tubes. For 110 volt 60 cycle AC operation.

**YOUR PRICE, Ea \$16.95**

In Lots of 3  
Or More, Each

**\$16<sup>25</sup>**





# 7 Tube Super Combination Radio Recorder and Phono



Automatic Phonograph  
with Record Changer

SW and Broadcast  
Console Radio

Home Recorder  
and PA System

## 4 INSTRUMENTS IN 1

**Complete Home Entertainment Within the Reach of Everyone.** Never before in the history of radio has so little money been able to bring you so much real enjoyment, such **Big Value** as is contained in this modern 4-Way combination radio set, phonograph, recorder and public address system. The entire assembly has been housed in a very attractive Walnut or Mahogany **Authentic 18th Century Hepplwhite, Highboy Cabinet**—a magnificent instrument that will gratify the most discriminating buyer.

**Make Your Own Records at Home**—it's so simple, anyone can do it—with perfect results. Latest high fidelity crystal microphone with desk stand and 10 ft. of cable comes already attached to recorder amplifier, ready for instant use. The entire family and all your friends will enjoy having records made of their voices or musical accomplishments. In addition, recordings can also be made directly from the radio—important events, famous people, concert orchestras, dance music etc. With the microphone your own voice may be added to any radio program thus enabling you for instance to sing with the world's greatest orchestras or to add your own impromptu remarks or announcements. Excellent recordings may be made using acetate or composition discs up to 10" dia.

**Public Address System for Speeches and Concerts.** The same microphone used for recording, can also be used for talking or playing music through the loud speaker thus utilizing the speaker and amplifier as a public address system. This is especially useful when making speeches or giving concerts before medium sized crowds.

**Latest 7 Tube 2 Band AC Superhet Receiver** with broadcast and shortwave band tuning, brings you Foreign as well as U.S. stations. Has many newest features:—edge-lighted slide rule dial, variable tone control, automatic volume control, push-pull output, 10" electro dynamic speaker and others. For more detailed information see opposite page. Overall cabinet size: 29 3/4"x35x17 1/2" deep. Ship. wt. 110 lbs.



## Available With or Without Recorder In Either Mahogany or Walnut Cabinet

### With Recorder

D17611—In Walnut Cabinet.  
D17612—In Mahogany Cabinet.  
7 Tube 2 Band AC Super Combination Radio Recorder and Record Player, complete with tubes, crystal microphone, 1 cutting needle, 3 play-back needles and 2 blank 6" acetate discs. For 110 Volt 60 Cycle AC operation. List, \$139.50.

**YOUR PRICE, Either Type**

Each, **\$82.50**

In Lots of

3 or More, Each **\$78.50**

### Without Recorder

D17613—In Walnut Cabinet.  
D17614—In Mahogany Cabinet.  
7 Tube 2 Band AC Super Radio-Phonograph Combination complete with automatic record changer and tubes but less record. Automatically plays 8 1/2" or 7 1/2" records. For 110 Volt 60 Cycle AC operation. List, \$99.50.

**YOUR PRICE, Either Type**

Each, **\$59.95**

In Lots of

3 or More, Each **\$56.95**



### Automatic Record Changer

Automatically plays and changes fourteen 10" or ten 12" records except non-recording models which take up to eight 10" or seven 12" records. Both types manually play all acetate and commercial records up to 12" dia. Records can be rejected at will. Pickup used in each is latest high fidelity crystal type with true-tracking light needle weight arm.

## 7 Tube 2 Band AC-Super Console

**A splendid value in a console** that is very attractively priced yet incorporates many Deluxe features ordinarily found only in higher priced sets. Clear high fidelity tone, high visibility tuning, (530 to 1600 Kc for U.S. and Canadian regular broadcast stations and 5750 to 18,300 for U.S. and foreign short wave programs) connections for external phonograph attachment, television sound or FM tuner and many others that delight the eye and ear winning immediate sales appeal.

**The short wave band** will give the listener a never ending series of interesting broadcasts both domestic and foreign. Get the latest world news, enjoy foreign entertainment programs, hear ships at sea, aeroplanes in flight and hundreds of thrilling broadcasts to be found on the short wave band 5,750 to 18,300 Kc.

**Many Big Features**—New edge-lighted vernier drive slide rule dial, in four harmonious colors, provides a quick and accurate means of tuning all stations both local or distant. Individual direct calibrated scales for each band relieves all eye strain and eliminates tensed tuning position often necessary with other types of dials. Tone control is continuously variable

allowing wide range adjustment of tonal color to suit the individual taste. Automatic volume control maintains constant volume level on local stations and minimize, or in many cases eliminates fading of distant reception.

**Built-in antenna** allows perfect reception without the need for external aerial and ground connections. Push-pull output circuit delivers full power to heavy duty 10" electro dynamic speaker which reproduces voice and music with rich harmonious tonal quality. Attractively styled console cabinet is finished in selected Walnut veneers and other contrasting woods. Recessed sloping tuning panel is set apart by curved pilasters and harmonious speaker grille bars backed by neatly designed grille cloth. Tubes used: 1-6SA7, 1-6SK7, 1-6SQ7, 1-5SF5, 2-6K6C's, 1-5Y1G. Size: 24 3/4" x37 3/4" x12" deep. Ship. wt. 47 lbs.

D17659—Radolek 7 Tube AC Super complete with tubes and input connections for television sound, F-M tuner and phonograph. List Price, \$49.95.

**YOUR PRICE,**

Each, **\$29.95**

In Lots of

3 or More, Each

**\$27.50**

Push Button  
TUNING

# Radolek 8 Tube 3 Band AC Super

Push-Pull  
OUTPUT



● Push Pull Audio. ● Beam Power Output. ● Automatic Volume Control. ● Tune Control. ● Built-In Aerial. ● 3 Band Tuning 145 to 1600 Kc., 2.2-7.5 Mc., 7.5 to 24 Mc. ● Large Slide-Rule Dial. ● Edge-Lighted Tuning Scale.

**8 Tube 3 Band AC Super**—Unparalleled value in an automatic push button receiver. Incorporates many worth while features generally found only in larger more expensive radio sets. Everyone will enjoy the fine tone and excellent performance of this superb receiver with its ample 7 watts output and attractive up to the minute cabinet styling that blends with all kinds of furnishing and decorative schemes.

**Three Tuning Bands.** Foreign and Short Wave Reception—Get foreign news and foreign entertainment first hand on the two Short Wave bands 2.2 to 7.5 and 7.5 to 24 Mc. These bands bring in all the important foreign and domestic short wave stations. Everything of interest, foreign music, foreign news, ships at sea, seaplanes in flight and many more interesting entertaining and educational broadcasts are yours at the twist of a dial. Standard broadcast and upper public bands from 145 to 1600 Kc. bring in regular broadcast reception from American and Canadian stations. Extreme sensitivity and exacting selectivity brings in distant stations with ease.

**Illuminated Slide Rule Dial**—Large, easy tuning slide rule dial with vernier drive is clearly calibrated with separate easy-to-read calibrations for each band. Fully illuminated four color scales with knife edge indicator, make tuning a pleasure. You know exactly band and frequency tuning.

**Automatic Push-Button Tuning**—A row of piano key push-buttons conveniently located beneath the tuning dial, allow the selection of any 5 stations for automatic finger tip tuning. Stations so chosen can be set up to faintly and just as quickly and easily changed, singly or in groups, when desired. Control knob is provided for Manual tuning of any station.

## 5 Tube-Super Phono-Radio Combination

Gives you double the value for your money—a phonograph of the very finest quality that plays both 10" and 12" records and a 5 tube AC superheterodyne radio set.

The record player section consists of a 10" turntable, rim driven at 78 R.P.M. by a self-starting, constant speed AC motor. The phono pickup is the latest true-tracking crystal type that gives clear true-tone reproduction of all commercial and acetate type phonograph records up to 15" in diameter.

The radio set is a 5 tube AC superheterodyne. Heavy duty dynamic speaker delivers rich tone quality. A built-in antenna eliminates the need for unsightly external aerial and ground wires. Has tune control. Automatic volume control minimizes fading. Large airplane type dial is calibrated in meters (200 to 500) and kilocycles (1500 to 550).

The whole assembly is attractively housed in a two-tone walnut veneer cabinet that has instant eye appeal. A hinged cover gives access to the phonograph compartment.

● Automatic Push-Button Tuning. ● 5" Electro Dynamic Speaker. ● Selected Walnut Veneer Cabinet. ● Record Player Connection. ● Connection for Television. ● Connection for I-M Tuner.

**Every Useful Feature**—Built-in loop antenna allows perfect reception without the need for unsightly external aerial and ground wires heretofore necessary. Continuously variable tone control gives opportunity for adjustment of tone color for music or voice, to suit the individual taste. Automatic volume control circuit minimizes and in many cases entirely eliminates fading. Push-pull audio system feeding 7 Watts to heavy duty 6" electro-dynamic speaker gives thrilling life-like quality reproduction with plenty of volume. Connections are provided also for external phonograph, television sound, or I-M tuning adapter.

**Attractive Styling**—Richly styled table model cabinet finished in selected walnut veneers with mahogany and maple inlay trim. Decorative speaker grille bars are finished in matched grain walnut. Neatly designed grille cloth is securely anchored in place. Kels are milled bakelite, mahogany finish. The entire cabinet is rubbed to a lustreous polish. Tubes used: 1-8SJ7, 1-5A7, 1-6SK7, 1-6SQ7, 1-6VF5, 2-6XG6 and 1-1Y3G. Size: 20 1/2" x 10 1/2" x 10 1/2" deep. Ship. Wt. 30 lbs.

D17650—Radolek 8 Tube 3 Band AC Super complete with tubes. For 110 V. 60 Cye. AC operation.

List Price, \$39.95.

**YOUR PRICE, Each \$27.95**

In Lots of 3 or More, Each

**\$26.45**

### Two Instruments for

### The Price of One

D17651—Table Model Phono Radio Combination complete with tubes. For 110 V. 60 Cye. AC operation. Size 13" x 13" x 13" deep. List Price, \$29.95.

**YOUR PRICE**

Eq. .... **\$21.45**

In Lots of 3 or More, Each

**\$20.65**





# 8 Tube Super • Combination PHONO-RADIO

## SUPERLATIVE FEATURES

- Authentic Hepplewhite Cabinet available in Mahogany or Walnut.
- Push Button Tuning 3 Band Radio.
- Automatic Record Changer.
- Built-In Loop Antenna

An exceptionally efficient 3 band push button tuning 8 tube superheterodyne radio set and automatic record changer are incorporated in this fine authentic Hepplewhite cabinet. Split lids provide quick access to both the radio and record changer and may remain closed while either is playing. The simulated cabinet doors lined with attractively patterned grille cloth serve as the speaker baffle. Cabinet woods of matched buel and straight grains, available in either Mahogany or Walnut. Size 29 1/4" wide, 35" high and 17 1/2" deep. **Radio Set Features** 3 Band tuning covering 535 to 1600 and 2200 to 24000 Kc. for foreign and American broadcasts. Push button tuning is provided for any 6 broadcast stations in the 535 to 1600 Kc. band. 10" Electro-dynamic speaker. Tone Control. Giant edge-lighted slide rule dial with "neon effect" pointer. Built-in loop antenna. See listing below of chassis and speaker for a more complete description. **Automatic Record Changer** plays and changes up to 8 records, either 10" or 12" automatically. Rejects records automatically by merely pressing button. Crystal pickup provides fine reproduction. Playing records increase the usefulness of the radio and always provides entertaining music when it is not available on the radio.



**Prices**  
**D17654** — Walnut Cabinet.  
**D17655** — Mahogany Cabinet.  
 Complete with tubes but less recordings and phono needles. For 105-120 volt, 60 cycle AC operation. List, \$119.50.  
**YOUR PRICE,**  
 Each ..... **\$72.50**  
 In Lots of 3, Each  
**\$68<sup>50</sup>**

## 8 Tube AC-Super Chassis and Speaker

### 3 Band Tuning • Slide Rule Dial

An Up-to-Date Replacement for Obsolete Receivers—Large, highly visible slide rule type, vernier drive, four color edge-lighted tuning dial has separate scales for each of the 3 bands. Two short wave bands 2.2 to 7.6 Mc and 7.5 to 21 Mc bring in foreign programs. Standard broadcast band covers 535 to 1600 Kc. Extreme sensitivity and exacting selectivity enable you to bring in distant stations easily.

Many latest features have been incorporated. Built-in antenna, eliminates the need for unsightly external aerial and ground connections. Continuously variable tone control allows desired adjustment of tone color. Automatic volume control minimizes fading. Push pull output feeds 7 Watts to 10" electro dynamic speaker giving clear lifelike reproduction. Connections are provided for external phonograph, television sound or F-M tuning adapter. Tubes used: 1-6SJ7, 1-6SA7, 1-6SK7, 1-6SQ7, 1-6SF5, 2-6K6G and 1-5Y3G. Size: 7 1/2 x 11 x 8 3/4" high.

### Prices

**D17656** — Radolek Tube 3 Band AC Super, complete with tubes. For 110 V. 60 Cyc. operation. List Price, \$35.00.  
**PRICE,**  
**EACH \$21.50**  
 In Lots of 3,  
 Each  
**\$20<sup>45</sup>**

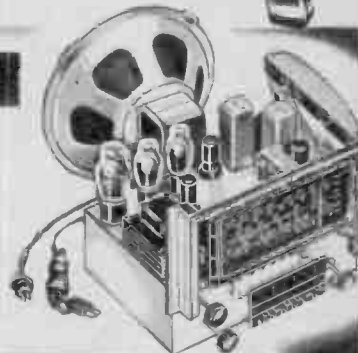

## DeLuxe 8 Tube Super Console

### Outstanding In Performance

Fidelity of tone, high power output and attractive cabinet are readily apparent in this fine 8 tube AC Super. Strikes a new high in DeLuxe Value at moderate cost. A set that will add prestige to any home.

**Three Tuning Bands** covering 2.2 to 7.6 and 7.5 to 21 Mc — Short Waves bring you foreign news and entertainment, ships at sea, airplanes in flight and hundreds of other interesting and educational programs. **535 to 1600 Kc.** covers the entire U.S. and Canadian standard broadcast range. Extreme selectivity and exacting sensitivity enable you to bring in many distant stations.

**Large Slide-Rule Dial** with vernier drive in direct reading in Kc or Mc for all bands. Edge-lighted four color tuning scales are easy to read and decorative in appearance.

**Six Piano-Key Push Buttons** are provided for automatic tuning of six pre-selected stations. This selection can be set or changed whenever desired, quickly and without tools.

**Built-in Loop Antenna** makes unnecessary the use of outside aerial and ground connections for perfect radio reception. Automatic volume control minimizes and often eliminates, fading.

**Push-Pull 7 Watt Output**, 10" electro dynamic speaker and tone control give clear true life reproduction of voice and music with ample volume. Tubes used: 1-6SJ7, 1-6SA7, 1-6SK7, 1-6SQ7, 1-6SF5, 2-6K6G's, 1-5Y3G. Input connections for television sound, F-M tuner and phonograph.

**Modern Cabinet**, finished in selected walnut veneers and other contrasting woods, is richly styled. Recessed sloping tuning panel is set apart by curved pilasters and harmonious speaker grille bars backed by neatly designed grille cloth. A luxurious piece of furniture—will grace the finest home. Size 26 1/4 x 38 x 11 1/2" deep. Ship. wt. 60 lbs

**D17649** — 8 Tube 3 Band AC Super Console complete with tubes. For 110 volt 60 cycle AC operation. List, \$49.95.

**YOUR PRICE \$43.95**  
 Lots  
 of 3,  
 Each ..... **\$41<sup>75</sup>**

For Appearance

# The New ARVIN

## Arvin Model 302 Phono-Radio Combination

Plays Records Up To 12" in Size

Smartest, best-performing low-priced combination on the market. Provides "The music you want—when you want it"—plays records of favorite orchestras, singers and instrumentalists plus powerful high-quality radio reception. All this in one compact, beautifully-designed unit. Completely housed in a smartly-styled, richly finished unbreakable streamlined cabinet that comes in either Deep Brown or Ivory finish. The latest 4-tube radio receiver brings in broadcasts 540 to 1600 K.C. with excellent tone quality and surprisingly great volume. Attractively embossed tuning dial is calibrated in kilocycles and covers the entire broadcast band. Volume control for both radio and phonograph. Switches provided for On-Off and for changing from radio to phonograph. Full-sized permanent magnet type speaker delivers round, rich tone from either radio or records. Audio system is designed to give high output and clarity of reproduction. Constant speed self-starting 78 R.P.M. phonograph motor. Latest type crystal pickup. Rest for pickup arm and well for phonograph needles included. Attached aerial. Tubes: 12SK7, 12SQ7, 50L6GT, 35Z5GT. Size: 10½" x 13½" x 6¼". Operates on 110 volt 60 cycle AC.

D17622—Model 302. Deep Brown Finish with Ivory Trim. With tubes. List Price, \$14.95. **YOUR PRICE, Each \$11.71**  
In Lots of 3, **\$10.98** Each.....

D17623—Model 302A. Ivory Finish with Chrome Trim. With tubes. List Price, \$16.95. **YOUR PRICE, Each \$11.86**  
In Lots of 3, **\$11.07** Each.....

D17624—Carrying case for above models. Includes space for records. List Price, \$2.95. **YOUR PRICE, Each \$2.17**



By concentrating a tremendous factory output on a few popular, fast selling models Arvin engineers and Arvin production experts are able to offer you highest quality radio receivers at prices which enable you to meet all competition on equal or better terms. Up to date engineering coupled with use of only highest quality components and exceptionally rugged construction are your guarantee of the maximum in trouble free performance and enjoyment from Arvin Radios.

## Arvin 3 Tube Tiny Giant

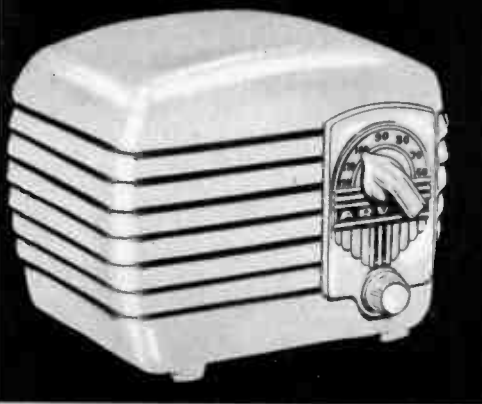

Small enough to tuck away in an overnight bag. Looks and performs like a much higher-priced set. A real companion for travelers or those who want a small, high-quality portable receiver. Handsome enough to be at home in any surroundings, powerful enough for all occasions, light enough to take anywhere. Sturdy construction. Unbreakable one-piece cabinet with bronze embossed dial. Covers entire broadcast band and upper police bands from 540 to 1750 kc. Power output 2 watts to 4" electrodynamic speaker. 20 ft. attached aerial. Underwriters' Approved. Tubes used: 25B8GT, 50L6GT, 35Z5GT. Size: 6½" x 5½" x 3¾". For 105-120 volts AC or DC.

D17625—Model 402. Walnut Finish. With Tubes.

←List, 6.95.  
**YOUR PRICE, Each, \$5.49**  
Lots of 3, **\$5.18**  
Each.....

D17626 — Model 402A. Ivory Finish. With Tubes.

←List, \$7.95.  
**YOUR PRICE, Each, \$5.58**  
Lots of 3, **\$5.28**  
Each.....

←D17627—Suede Carrying case with Zipper Fastener.

List, \$1.00.  
**YOUR PRICE..... 68¢**

D17628—Model 822. 5-Tube Battery or 110V. AC-DC Portable. Complete with Batteries.

List, \$29.95.  
**YOUR PRICE, \$19.66**  
Lots of 3, **\$19.08**  
Each.....

The best buy in portables. Operates on self-contained batteries outdoors and on 110-volt AC or DC indoors. Enclosed drop away front case protects dial while carrying. Strong, light plywood construction. Attractively finished in buffalo-grain leatherette on the outside, with sloping control panel and inside of lid covered with ivory rawhide luggage material. Lid may be removed. Batteries last 250 to 300 operating

## Arvin Battery—AC-DC Portable



hours. Built-in loop antenna. No aerial or ground needed for ordinary use, but may easily be attached for long-distance reception. Quadruple tuned I.F. amplifier gives knife-edge selectivity. Band coverage, 540 to 1600 kc. Cord tucks away in compartment when not in use. Tubes: 1A7GT, 1H5GT, 1N5GT, 3Q5GT, 35Z5GT. Compact size: 12" x 11" x 7¼". Batteries easily replaced.

## Powerful Arvin 6 Tube AC-DC Superhet

Has Built-in Loop Antenna

D17629—Model 732. Rubbed Walnut wood cabinet. With tubes. List Price, Each, \$24.95.

**YOUR PRICE, Each, \$16.30**  
In Lots of 3, **\$15.88**

Housed in a handsome rubbed Walnut wood cabinet, this expensive-looking receiver will harmonize with practically any furnishings. Extremely selective as well as powerful. Separates close-together stations with knife-edge accuracy. Has big, easy-to-read airplane type dial. Tone control is continuously variable throughout entire range. Broadcast band coverage, 540 to 1600 kc. Improved circuit AC-DC superhet chassis has 6 tubes, two of which are dual-purpose tubes. Powerful "Large Area" permanent magnet dynamic speaker gives exceptionally fine reproduction over a wide tone range. Phantom Scope Antenna built inside case is a specially designed and integral part of the famous Arvin Phantom Antenna system. This built-in antenna gives outstanding pick-up and almost unlimited range of reception. Radio plays anywhere it is plugged in without bothersome aerial or ground connections. Tubes: 1-12SA7, 2-12SK7, 1-12SQ7, 1-35L6GT, 1-35Z5GT. Size: 14½" x 8½" x 8¼". For 105-120 Volts AC or DC.

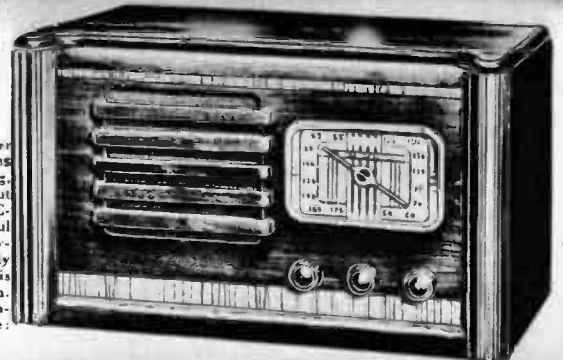





NEW 1941

# ARVIN CAR RADIOS

## Arvin Model 510 Compact

← Small • Low Priced • Powerful • Excellent Tone



The easiest of all auto radios to install. —Just one unit that bolts under the dash at right or left of steering column—within easy reach of driver or passenger. **Powerful 5 Tube Superhet circuit** featuring famous Arvin Phantom filter provides plenty of volume even at high car speeds and in noisy traffic. Easily read illuminated thumb-wheel, fast tuning dial covers entire broadcast band.

A flip of the thumb turns dial from one end to the other. 5" Electro-dynamic speaker gives fine rich tone quality. Full automatic volume control minimizes undesirable fading. **Full power output with low battery drain.** Tubes: 6A8CT, 6K7GT, 6X5GT, 6K6GT. Housed in attractive crackle finish all-metal case. Size  $3\frac{1}{2} \times 5\frac{1}{2} \times 11\frac{1}{2}$ " long. Wt. 17½ lbs.

D17580—Model 510 Arvin Auto Compact. Complete with five tubes.  
List Price, \$14.95.  
**YOUR PRICE, Each.....**

**\$10<sup>99</sup>**

### ARVIN MODEL 610

D17581—Arvin Model 610 complete with five tubes. Similar to model 510 except has 4 push buttons on front of panel for automatic tuning of any 4 pre-selected favorite stations. All other stations may be tuned on illuminated thumb-wheel dial.

List Price, \$17.95.

**YOUR PRICE, Each.....**

**\$12<sup>31</sup>**

### ARVIN MODEL 710

A Single Unit 5 Tube Superhet Auto Radio for quick—easy Custom installation in any car. Arvin's famous Phantom Filter circuit provides power, selectivity and sensitivity to match the performance of sets selling at considerably higher prices. Automatic volume control minimizes fading. Deep-throated 8 in. electro-dynamic speaker has wide tonal range. **Economical on battery.** Tubes: 6A8, 6K7, 6Q7G, 6K6G and 6X5G. Completely housed in attractive taupe finished metal case. Entire unit mounts securely to dash by one heavy stud bolt. Size  $8\frac{1}{2}$ " square by  $7\frac{3}{4}$ " deep. Wt. 19 lbs.

D17582—Arvin Model 710 with Universal Under-Dash Tuning Unit to Fit All Cars. Complete with five Tubes. List Price, \$24.95.

**YOUR PRICE, Each.....**

**\$17<sup>12</sup>**

D17583—Arvin Model 710 equipped with Tuning Unit for Custom Installation on instrument panel of most cars. Specify make, year and model of car so we can ship proper panel to match. Complete with five tubes.

List Price, \$28.00.

**YOUR PRICE, Each.....**

**\$18<sup>99</sup>**

### ARVIN MODEL 810

This Single Unit 6 Tube Superhet Auto Radio set packs an extra wallop that insures efficient, satisfactory performance at all points on the dial and under most adverse conditions. Beam power output, clean cut selectivity and finest tone quality are features that make this Arvin "tops" in car radio value. Deep-throated 8" electro-dynamic speaker has unusually wide tonal range. Continuously variable tone control. Automatic volume control minimizes undesirable fading. Has power output of 5 watts yet requires only 7.2 amps. battery drain at full volume. **Phantom filter boosts signal and allows clearer reception.** Tubes: 2-6SK7, 1-6A8, 1-6SQ7, 1-6V6G, and 1-6X5G. Complete unit housed in attractive crackle finished metal case. Entire unit mounts securely to dash by one heavy stud bolt. Size:  $8\frac{1}{2}$ " square by  $7\frac{3}{4}$ " deep. Wt. 20 lbs.

D17584—Arvin Model 810 with Universal Under-Dash Tuning Unit to fit All Cars. Complete with six tubes. List Price, \$46.10.

**YOUR PRICE, Each.....**

**\$27<sup>50</sup>**

D17585—Arvin Model 810 equipped with Tuning Unit for Custom Installation on instrument panel of most cars. Specify make, year and model of car so we can ship proper panel to match. Complete with six tubes.

List Price, \$49.95.

**YOUR PRICE, Each.....**

**\$29<sup>37</sup>**

### ARVIN CAR RADIO FEATURES

These Fine Sets Are Super-heterodynes of Latest Design Assuring Maximum Performance and Sensitivity Under All Operating Conditions.

Full Tone Electro-Dynamic Speaker Gives Excellent Reproduction Quality

Full Automatic Volume Control Minimizes Undesirable Fading

Arvin Phantom Filter Boosts Signal Strength giving clear reception

Arvin Car Radios Are Easy on the Battery

Low In Price High In Quality Big Values



## Custom Fit and Universal Tuning Units



#### Custom Fit Remote Tuning Panels

Tailored installation of Arvin Models 710 and 810 are easy with the use of these Custom Fit Panel kits, a few of which are pictured above. Each panel is especially designed to exactly fit the instrument panel of a given automobile. There is a custom fit panel available for every popular make of car built, from 1935 to date.

#### Quick—Easy Installation

Flexible remote tuning shafts are cut to proper length and equipped with all necessary fittings. Sets mount with a single stud bolt. Everything possible has been done to speed up installation in your car before the set is shipped to you. All necessary parts and full installation instructions are included with each set.

#### Arvin Universal Tuner

A universal remote tuning control to fit Arvin Models 710 and 810 for those who do not wish a custom installation or for cars on which there are no custom plates available. Control mounts on under edge of cowl or instrument panel at right or left of steering wheel—within easy reach of driver or passenger or both. Fits all cars.



# PHILCO 1941 Auto Radios

The finest auto radio receivers Philco has ever built. New features never before offered at these low prices.

## Efficient 6 and 7 Tube Superhets

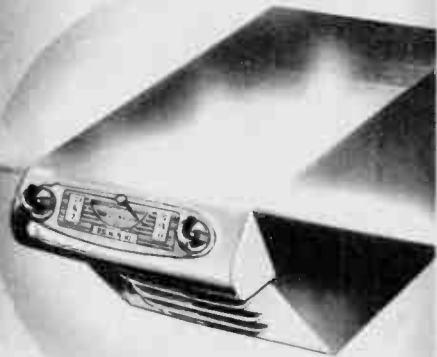

### Philco Model AR-1

D17532—With Six Tubes. List, \$19.95.  
**YOUR PRICE, Each, \$13.95 \$13<sup>50</sup>**  
 In Lots of 3, Each....

Housed in a compact, rugged steel case in wrinkled enamel finish. This new single-unit Philco fits snugly and easily under the instrument panel of any car. Out of the way, yet easy to reach, this 6-Tube Superhet features full sensitivity, tuned antenna circuit, built-in interference filtering, automatic volume control and electro-dynamic speaker. Illuminated dial makes tuning quick, easy and accurate. Easily transferred from one car to another. For better performance than can be expected in this price class.

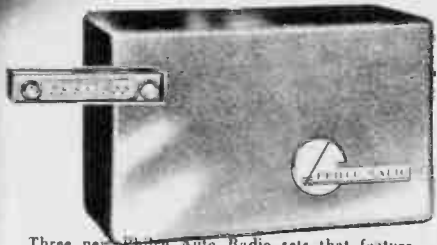

### Philco Model AR-4

D17575 As described above complete with six tubes. List, \$34.95.

**PRICE, Each, \$22.65 \$21<sup>95</sup>**  
 In Lots of 3, Each....

### Philco Model AR-5

D17576—Same as Model AR-4 except includes 5 station automatic tuning. Two dual-purpose knobs control on-off switch, volume, tone, manual tuning and 5-station push-button tuning. Complete with six tubes. List Price, \$44.95

**PRICE, Each, \$28.75 \$27<sup>95</sup>**  
 In Lots of 3, Each....

### Philco Model AR-9

With Short Wave Tuning

D17577—Same as AR-4 except has 3 band tuning. Standard Broadcast 1500 to 550 Kc. and 2 American and Foreign Short Wave Bands 5.9 to 1E Mc. and 11.7 to 11.9 Mc. Also includes especially matched Cowell mounting Auto Aerial. (Will not get police calls.) Complete with six tubes. List, \$52.45.

**PRICE, Each, \$33.43 \$32<sup>63</sup>**  
 In Lots of 3, Each....

### Philco Model AR-3

D17534—With Six Tubes. List, \$39.95.

**PRICE, Each, \$24.50 \$23<sup>75</sup>**  
 In Lots of 3, Each....

Under dash mounting compact, chassis with automatic tuning panel. One push button selects any 5 stations, with separate dial for station identification. All stations, however, can be tuned manually. 6 Tube, Superhet circuit features, Self Contained Noise Filter, Electro-Dynamic Speaker, Automatic Volume Control, Tone Control, Bass Compensation and Full Wave Vibrator. Two illuminated dials, one for push-button and one for manual tuning. Fits any car: Choice of 3 Speakers, 1 for cars with built-in speaker grille, 2 for under-dash mounting, and 3 for instrument panel mounting. Specify which, when ordering.

### Philco Model AR-6

D17535—Complete with six tubes and hand somely designed under-dash panel control. List, \$29.95.

**PRICE, Each, \$21.25 \$20<sup>50</sup>**  
 In Lots of 3, Each....

Constructed to give full, rich, life-like tone and powerful performance with long useful life and trouble-free service. 6 Tube Superhet features electro-dynamic speaker, automatic volume control, bass compensation, full wave vibrator and illuminated tuning dial.

### Philco Model AR-7

D17536—With Six Tubes. List, \$49.95.

**PRICE, Each, \$31.75 \$30<sup>95</sup>**  
 In Lots of 3, Each....

Individual Pushbutton Automatic Tuning of any 5 favorite stations. Also regular dial tuning of all stations. Speaker and 6 Tube Superhet chassis are complete in one case. Delivers full rich tone, and power. Capable of reliable performance over great distance, and under all conditions. Has reception control, large electro-dynamic speaker, automatic volume control, bass compensation and full wave vibrator. Comes complete with handsome under-dash control with illuminated dial.

### Philco Model AR-8

D17540—With Seven Tubes. List, \$69.95.

**PRICE, Each, \$41.75 \$40<sup>25</sup>**  
 In Lots of 3, Each....

Designed to give glorious rich, deep, lifelike tone and to bring in stations from great distances. The utmost in performance and quality. 7 Tube powerful Superhet has among its many features: Separate full size electro-dynamic speaker. Push-button operated reception control which permits automatic tone adjustment for voice or music also minimize interference resulting from car lines, Power cables, static, etc. Electric push-button tuning of any 5 favorite stations and manual tuning for all stations. Automatic volume control and bass compensation, easy reading, full vision dial and full wave vibrator. Comes complete with under-dash control unit with illuminated dial.

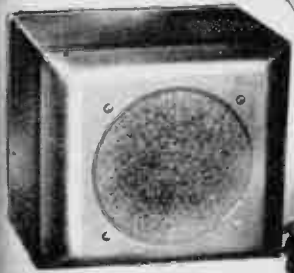
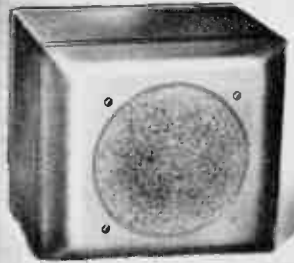
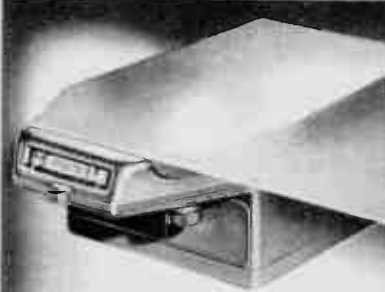

## Crowe-Philco Auto Panel Kits

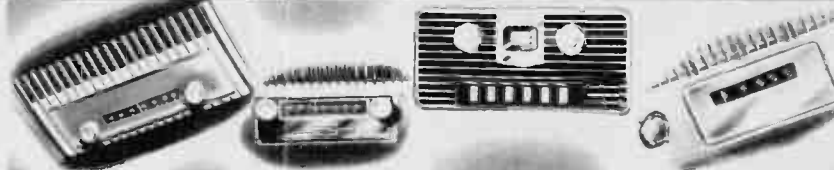

Provide for custom fitting of Philco Auto Radios to any car. Fittings harmonize with car panel in design and color. Each kit is supplied complete, ready for installation. When ordering give Philco set model number also make, model and year of car.  
 D14050 Type C for Philco AR-4, AR-5 and AR-9 in 1940 cars. List, Ea. \$2.00. **\$1<sup>18</sup>**  
**YOUR PRICE, Ea. ....**

D14051—Type B for Philco AR-7 and AR-8 in 1939 and 1940 cars. List, Ea. \$3.00. **\$1<sup>76</sup>**  
**YOUR PRICE, Ea. ....**

D14052—Type A for Philco AR-6 in all cars and AR-7 and AR-8 in 1938 and older cars. List, Ea. \$3.00. **\$1<sup>76</sup>**  
**YOUR PRICE, Ea. ....**

# FLUORESCENT LIGHTING

**Increased Brilliance • Low Operating Cost • Cool Light**

The Fluorescent Units listed here will meet the needs for practically all types of installations in stores, factories, offices, etc. They provide better light than ever before available at savings of 50% and more in operating cost. The prices quoted here assure you of the best values for your money. Guaranteed lasting satisfactory service. Fixtures shown are particularly desirable for the radio shop and store. The pleasing attractive lighting effects will improve your working conditions and build your prestige with your customers.

Each unit comes completely assembled and wired, with all auxiliaries, ready for use. Easy to install, any radio serviceman can quickly make a proper installation. Fluorescent lamps are not included at prices quoted for fixtures. The lamps must be purchased separately. Lamps are available in seven brilliant colors—Daylight, White, Blue, Green, Pink, Red and Gold. Daylight lamps are used in most installations. However, lamps of different colors are interchangeable thus insuring that you can meet any lighting requirement.

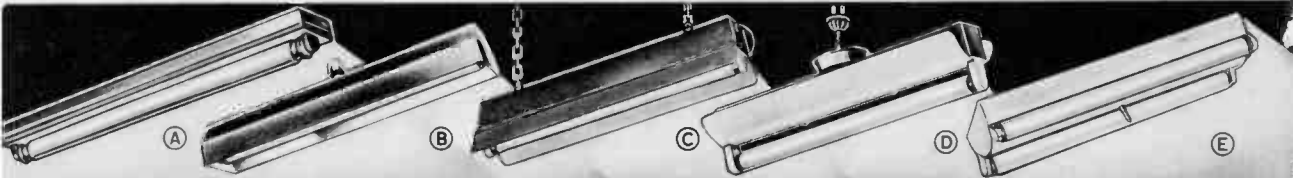

### Universal Mounting

**A** Wider distribution of light for concealed or exposed illumination. Metal case and flat reflector in satin aluminum finish. Convenient screw mounting holes in top and sides and 1/2" pipe knockouts (3 in the top and 1 on each end)—allow fixture to be mounted in any convenient manner—either singly or ganged. Completely wired with auxiliary and separately replaceable starter switch. No lamp included. 2 1/2" wide, 1 3/8" deep.

Stock Number	Watts	Lgth.	Price Each
D16800	15	19"	\$3.38
D16801	20	25"	3.57
D16802	30	37"	5.52
D16803	40	49"	6.35

### Plug-in Fixture

**B** Simply screw this one-piece unit into any light socket. Comes completely assembled and wired including auxiliary and separately replaceable starter switch.—ready for use. Aluminized concave reflector. Metal case in rich brown wrinkle finish. No lamps included.

#### One Light Fixture

Stock Num.	Wts.	WxHxDl.	Price Each
D16804	15	4 1/2 x 3 x 18"	\$2.79
D16805	20	5 1/4 x 3 1/4 x 24	4.65

#### Two Light Fixture

Stock Number	Watts	Lgth.	Price Each
D16806	2-15	5 1/2 x 4 1/4 x 18	4.59

† Also has loops for chain hanging.

### Industrial Fixtures

**C** For Ceiling or Chain Suspension

**C** Two Lamp. Highly efficient daylight shadowless, glareless illumination for stores, shops, factories, etc. Power factor corrected to meet public-utilities requirements. Use standard fluorescent lamps. Fixture of 20 gauge steel. Outside finished in dark crackle enamel. Inside of reflector coated with easy to clean baked on white plastic. No lamps nor chain for hanging included. For 105-120 volts A.C.

Stock Number	Watts	Lgth.	Price Each
D16781	2-20	24 1/2"	\$ 9.95
D16782	2-40	18 1/2"	12.95

### Mounts in Shade Holder

**D** Extra fine quality fixtures, with convex baked-on white enamel reflector. Provides wider distribution of shadowless, glareless light. Brown wrinkle finish metal case fitted with 4" adapter and connecting cord with plug. Simply remove shade of any fixture and replace with this unit. Has knockouts in ends for ganging. Wired complete with auxiliary—ready for use. Separately replaceable starter switches. No lamp included. 3" wide, 3 3/4" deep.

Stock Number	Watts	Lgth.	Price Each
D16811	1-15	18"	\$4.27
D16812	1-20	24"	4.87

**Two Light**

Stock Number	Watts	Lgth.	Price Each
D16828	2-20	24"	5.85

### Ceiling Mount

**E** Two Light Fixture

**E** Gives widespread shadowless, glareless light for general illuminating purposes. Convex reflecting surfaces finished in baked-on white enamel. Sockets of white bakelite. Entire fixture completely wired with auxiliaries, ready for use. Mounts on any flat surface. Has knockout in each end for ganging. Starter switches separately replaceable. No lamps included. 6 1/4" wide, 3 1/4" deep.

Stock Number	Watts	Lgth.	Price Each
D16813	2-15	18"	\$5.75
D16814	2-20	24"	5.85

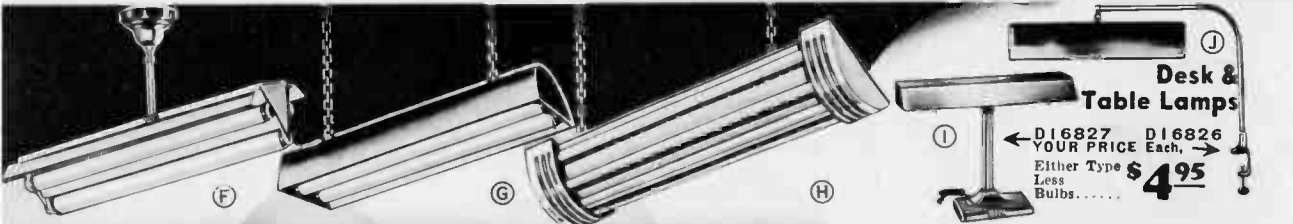

### Pendant Fixture

**F** Three-light fixtures for even spread of light over large areas. Reflecting surfaces, baked-on white enamel finish. 18" stem and canopy of brushed chrome finish. Adjustable ball and socket joint. Completely wired including auxiliaries. Starter switches separately replaceable. No bulbs included. 5 1/2" deep, 14 1/2" wide.

Stock Number	Watts	Lgth.	Price Each
D16817	3-15	18"	\$11.76
D16818	3-20	24"	12.94

As above except has dual stem and canopy.

D16820	3-40	48"	\$20.58
--------	------	-----	---------

### Concentrated Light

**G** Directional illumination fixtures with aluminized concave reflector. Concentrates light over a restricted area. Dark wrinkle-finished metal case has loops for chain hanging and knockouts for pipe suspension. Comes completely assembled and wired including auxiliaries. 8 ft. approved cord and plug and pull-chain on-off switch. Starter switches separately removable. No lamps nor pendant chains included. 9" wide, 4 3/4" deep.

Stock Number	Watts	Lgth.	Price Each
D16783	1-15	18"	\$ 2.91
D16784	1-20	24"	4.09
D16821	2-20	24"	7.61
D16822	2-40	48"	13.49
D16823	4-20	48"	11.73

### Wide Light Coverage

**H** Two and four-light fixtures with aluminum finished convex reflecting surface for spreading of light over wide areas for general illuminating purposes. Aluminum finished metal case is equipped with loops for chain hanging and knockout for pipe suspension. Can also be mounted flat on ceiling. Fixture completely wired ready for use including necessary auxiliaries. 8 ft. cord and plug and pull-chain on-off switch. Four-light unit has attractive satin finished punched aluminum decorative end pieces. No lamps nor pendant chains included.

Stock Num.	Wts.	WxHxDl.	Price Each
D16824	2-40	9" x 30" x 48"	\$13.77
D16825	4-40	12 1/4" x 30" x 48"	21.88

### Mounts in Shade Holder

**I** Shadowless, non-glare fluorescent daylight. Invaluable for working, reading and matching colors. Ideal for service shops, stores, offices, banks, hotels, libraries, factories, etc. Quality constructed throughout. Stands 14 1/2" high. Metal shade 18" long. Heavy cast base. En-

**J** Clamp-On Lamp. Securely fastens to desk, bench, table, etc., not exceeding 2" in thickness. Provides excellent illumination for any type of work. Arm allows reflector to be positioned over any portion of desk or to be swung clear. Shade can be adjusted to any convenient working angle.

### Desk & Table Lamps

**D16827** **D16826**  
YOUR PRICE Each, \$4.95  
Either Type Less Bulbs.....

### Pedestal Desk Lamp

**I** Pedestal Lamp — cool, shadowless, non-glare fluorescent daylight. Invaluable for working, reading and matching colors. Ideal for service shops, stores, offices, banks, hotels, libraries, factories, etc. Quality constructed throughout. Stands 14 1/2" high. Metal shade 18" long. Heavy cast base. En-

tire lamp durably and smoothly finished in lacquered English bronze. Reflector has white baked-on enamel finish. Completely wired, ready for use including auxiliary and 7 ft. Underwriters approved rubber cord and plug. On-off switch in base. Felt pad prevents scratching desk or table.

### Clamp-On Table Lamp

**J** Clamp-On Lamp. Securely fastens to desk, bench, table, etc., not exceeding 2" in thickness. Provides excellent illumination for any type of work. Arm allows reflector to be positioned over any portion of desk or to be swung clear. Shade can be adjusted to any convenient working angle.

### Chain Hanger Unit

**D16797** Hanger — Consists of 3" canopy with loop to which is attached two 3 ft. fixture chains. Connecting wire and 2 loops for attaching reflector also included. Length adjustable to 40" maximum. Finished in bronze. **YOUR PRICE Each..... 79¢**

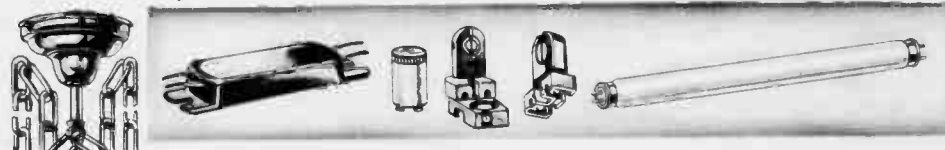

### Ballasts and Auxiliaries

One unit necessary for each fluorescent lamp. High power factor units have a correction of 90% as now required by utility regulation in many states. Other units have normal power factor correction of 50 to 60%. † Have built-in thermal switch. ‡ Switchless type requires separate starter switch, and switch holding socket. All for 105-125 volt, 60 cycle operation.

Watts	High P.F.		Normal Power Factor	
	†Less Switch	‡With Switch	†Less Switch	‡With Switch
	Stock Num.	Your Price	Stock Num.	Your Price
15	D14356	\$1.95	D14354	\$1.15
20	D14351	1.95	D14355	1.15
30	D14352	2.65	D14356	2.42
40	D14353	2.98	D14357	2.87
			D14358	50.52
			D14359	.52
			D14360	1.80
			D14361	1.98

### Starter Switches

For use with switchless auxiliaries and combination sockets listed below.

D14362	—FS2 15-20 Watt	
D14363	—FS4 30-40 Watt	

YOUR PRICE, **37¢**  
Either Type 10 for \$3.55

### Bakelite Sockets

Fit all fluorescent bulbs. Positive contacts. No Switch Socket.

D14364	—Black	17¢
D14365	—White	19¢

With Starter Switch Socket. No Switch Included.

D14366	—Black	28¢
D14367	—White	30¢

### Mazda Fluorescent Lamps

**True Daylight Type**

For use in any make of Fluorescent lighting fixtures or with accessories shown at left. Also available, on special order, in brilliant-white, blue, green, pink, gold or red. No sacrifice in light output because of color coatings which themselves emit light.

Stock Num.	Lamp Watts	Bulb Type	Size Dxl.	List Price Each	\$4.25 Or Less	24 Lots, Each
D14259	15	T8	1x18"	\$0.95	\$0.78	\$0.74
D14263	20	T12	1 1/2 x 24"	1.25	1.03	.98
D14265	30	T8	1x36"	1.25	1.03	.98
D14273	40	T12	1 1/2 x 48"	1.90	1.58	1.49

All units on this page are for use on 105-125 volt, 50-60 cycle current. Units for DC or 220 volt operation can be had on special order at extra cost.

The fixtures selected will meet all average lighting requirements. Additional types are available if needed. Consult us on your Fluorescent lighting problems—we will assist you in selecting the proper, most economical equipment.



# Novelties and Necessities

## Knapp Natural-Angle Shaver

**Speedster Model**  
**D18501—List Price, \$5.00. YOUR PRICE, \$3.25**

The comfort and convenience of dry shaving at a price every man can afford. Two in one shearing head fits every face and makes every face feel fit. Has two sizes of slots to fit both coarse and fine beards. Self-honing—always stays keen and sharp. Famous Knapp Natural-Angle Head means easier, smoother shaves right from the start. No experimenting or painful breaking-in period. Nothing new to learn. Super speed motor moves cutting edges so fast they can't jerk, pull or skip over whiskers. Motor makes 7200 strokes per minute. No oiling needed. Shaver has maroon plastic case with chrome trim. Packed in leather pouch. Detachable cord. 110-120 volt AC only.



### DeLuxe Model

**D18500—List Price, \$10.00. YOUR PRICE, Each, \$6.50**

Simplest, most convenient electric shaver ever made. Shaves quicker and closer without danger of skin burn. No lather, no new awkward shaving positions to learn, no difficulty with any type of beard. Exclusive Knapp Natural-Angle feature allows shaver to be held just like blade razor. Unique two-in-one shearing head equipped with No. 9 cutters for fine beards and No. 11 cutters for coarse beards. Does a perfect job on any face. Powerful universal triple-pole motor receives 3 separate power impulses per revolution, and has speed of 7200 revolutions per minute. Shaver has black plastic case trimmed with chromium. Shaped to fit the hand. Packed in sturdy steel case covered with Fabrikoid. Detachable cord. Underwriters' Listed. 110 volts AC-DC.



## The Yankee Clipper

Brings back the exciting romance of the days when the Yankee Clippers were supreme on the Seven Seas. Ideal for den, study, dining room or bedroom. Men like its nautical atmosphere, women appreciate its attractive appearance. The hull is shaped of selected solid wood in hand rubbed Walnut or Swedish Modern finish. Sails, masts, flags, bowsprit and miniature fittings are highly chrome plated. 4" dia. Clock framed in ship's wheel has accurate self-starting Sessions electric movement. 16 1/2" high, 18 1/2" long, 110 v. 60 cy. AC. **D18507—Swedish Modern Finish. D18506—Walnut Finish. List, \$12.95. YOUR PRICE, Each, \$7.60**

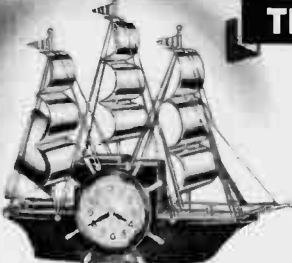

## The Airliner Electric Clock

A true replica of a modern airliner. The perfect ornamental clock for den, living room or office. Gleaming chrome propeller and wings, giant tires, Walnut finish cabin. Sessions self-starting electric clock movement. 21" wide, 10" high. 105-120 Volt. 60 cy. AC.

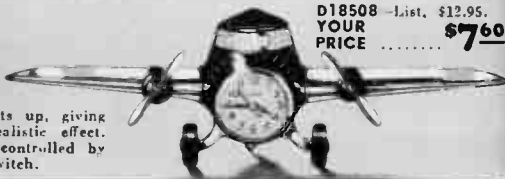

**D18508—List, \$12.95. YOUR PRICE, \$7.60**

Cabin lights up, giving unusual realistic effect. Lights controlled by separate switch.

## Pennwood Numechrom Electric Clocks—"Time at a Glance"

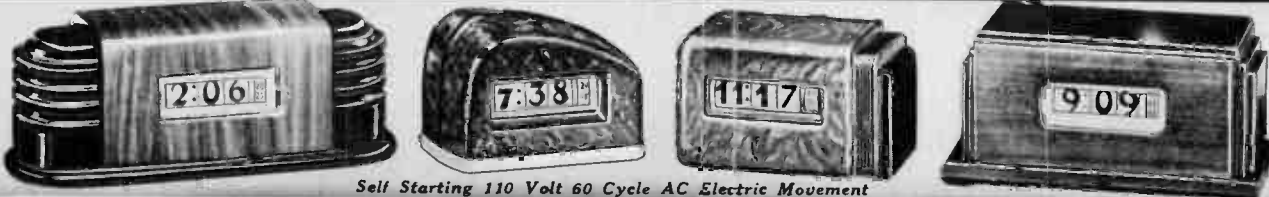

Sell Starting 110 Volt 60 Cycle AC Electric Movement

### The Zephyr

Classic beauty translated into a brilliantly modern design makes the Pennwood "Zephyr" a timepiece of unusual distinction. Styled to harmonize with the finest of interior decorating. Equally appropriate for drawing room, library or an executive's desk. Rich Walnut wood case, hand rubbed to a lustrous finish. Large, easy-to-read numerals give "Time at a Glance" correct to minute and second. No old-fashioned dial, no need to search for hour, minute and second hands. 10 1/2" long, 4" high and 1" deep. **D18535—List Price, \$8.95. YOUR PRICE, \$5.40**

### The Petite

Startlingly new and different modern design. Streamlined, irregular shape suggests the furniture of the future. Pennwood "Time at a Glance" feature. 5 styles of plastic finishes with bases trimmed in gold. Size: 5 1/2" long, 3 1/2" high, 3 1/2" deep. **D18536—Walnut bakelite. D18537—Black bakelite. List Price, \$2.95. YOUR PRICE, Each, \$2.23**  
**D18538—Ivory plaskon. D18539—Pastel Peach plaskon. D18540—Pastel Blue plaskon. List Price, \$3.95. YOUR PRICE, Each, \$2.85**

### The Moderne

Another Pennwood version of up-to-date clock style. Double-purpose design—can be used as book end on table top or desk. Simple combination of straight lines and rounded corners fits in any modern room. Accurate "Time at a Glance" with easily legible black-on-white numerals. Book end and base of clock are dark red. Body available in 3 plastic finishes. Metal trim in polished Gold finish. Size, 5 1/2" long, 3 1/2" high, 3 1/2" deep. **D18541—Mottled Walnut Tenite. D18542—Ivory Tenite. D18543—Hunter's Green Tenite. List Price, \$4.95. YOUR PRICE, Each, \$3.35**

### The Arcturus

Designed for discriminating people who want a modern timepiece that has dignity and elegance. Compact enough for a desk top or shelf, yet its ample lines and rich wood case give the impression of massiveness. "Time at a Glance" numerals give correct hour, minute and second instantly. Suitable for a busy executive's desk or for any well-furnished home. Reliable self-starting Pennwood electric movement. Handsome Walnut wood case with the rich sheen that only hand rubbing can give. Size overall: 7 1/2" long, 4" high, 4" deep. An unusual gift. **D18544—List, \$7.95. YOUR PRICE, \$4.75**

## Sparklet Syphons and Aerator

Sparklets provide a never-falling supply of sparkling club soda for highballs and other tall drinks—charged water for a home soda fountain that makes delicious sodas—a kitchen helper that beats eggs and whips cream. Just put plain water in a Sparklet, insert charging bulb, and you have a quart of charged water. Sparklets are foolproof and safe to operate—easy to use, easy to clean—a dependable, economical accessory for the modern home.



### C Sparklet Aerator

A new kind of household accessory. Can be used either as a syphon for making club soda or as an aerator to whip cream, beat eggs, mix waffles and do a number of other kitchen chores. Full quart capacity. Has large, convenient mouth and simple method of charging. When used as aerator for whipping or mixing contents can be discharged without removing head because of absence of syphon tube. Body is stainless steel with 3 bulbs included. List, \$5.95. **D18579—Red Head. D18580—Black Head. YOUR PRICE, Each, \$4.25**

### A Standard Model

Finished in highly polished heavy chromium plate. Full quart capacity. Has wide mouth for ice cubes, easy cleaning and use of whipping bulbs. Charges through bottom. Lined with pure tin. Complete with 3" bulbs. List, \$5.00. **D18575—Red Head. D18576—Black Head. YOUR PRICE, Each, \$3.57**

### B DeLuxe Model

Same as above except stainless steel body and more streamlined head. Complete with 3 bulbs. List, \$5.95. **D18577—Red Head. D18578—Black Head. YOUR PRICE, Each, \$4.25**

**Sparklet Red Band Bulbs** Turns ordinary water into fresh, fizzy sparkling club soda. Each bulb makes a quart of soda. Can be used with new or old model Sparklet Syphons, or with other makes of syphons. **D18581—10 in box. List Price, 75c. YOUR PRICE, \$4.95**  
**D18582—25 in box. List Price, \$1.75. YOUR PRICE, \$12.25**



**Spark-Whip Blue Band Bulbs** Open up a whole new field of taste thrills and cooking convenience. Whip cream, milk and eggs instantly and effortlessly. For use with Sparklet Syphons or Aerator. **D18583—5 in box. List Price, 70c. YOUR PRICE, \$1.95**

## Eskimo Electric Ventilator

Regardless of outside wind or weather, this ventilator will draw out foul air, smoke and odors at the rate of 400 cu. ft. per minute. Easily installed in new or old buildings. Twin centrifugal fan wheels on each end of motor shaft operate without noise or vibration. Housing finished in ivory enamel with chrome-plated end grills. Quiet running 110-120 volt AC motor has 10 ft. Underwriters' cord and plug.

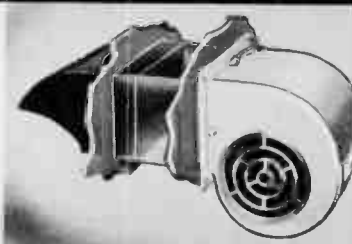

**D18350—For wall mtg. has telescoping steel duct to fit walls 6 to 10" thick, cast iron outside mtg. frame steel hood and automatic shutters. List, Each, \$25.00. YOUR PRICE, \$14.95**

**D18351—For mounting on side wall or ceiling, discharging directly into duct, flue or chimney. List Price, \$23.00. YOUR PRICE, \$13.80**



# Finest Automatic Irons



**Samson Dial-A-Heat Automatic Iron**

D18284—List, \$4.95. **\$3.48**  
YOUR PRICE.....

We believe this to be the finest ironing value on the market. Includes every desirable ironing feature, is of highest quality construction yet low in price. Can be set to correct heat for any fabric. Simply turn dial to heat desired—automatic control holds temperature indefinitely. Thin sole plate brings ironing surface only  $\frac{1}{8}$ " from nickel chrome element, heating quickly and evenly. Tapered and beveled to simplify ironing around buttons, ruffles and pleats. Tearproof heel. Heat dissipating fins make the one-piece bakelite handle always cool and easy to hold. Handle serves as convenient rest. Built-in cord set, 1000 Watts, 110-120 Volt AC operation. Weight,  $\frac{1}{2}$  lbs. Underwriters' Listed.

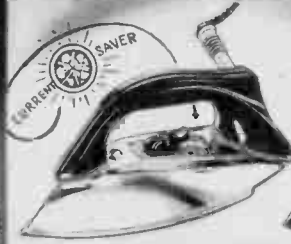

**Samson "Magic Eye" Automatic Iron**

Light flashes on when iron is plugged in, goes out when correct ironing temperature is reached. Shows when current goes on and off while ironing. Finger-ly control dial automatically selects proper temperature for every fabric. Ironing surface is  $\frac{3}{8}$ " from heating element—heats quickly and stays hot. Beveled tapered toe. Air cooled bakelite handle in grained walnut finish. Convenient heel rest. Nickel chrome element embedded in solid steel rock. Approved 7 ft. built-in cord with wire guard, 1000 Watts. For 110-120 volt AC operation. Underwriters' Listed. D18287—List, \$8.95. **\$5.98**  
YOUR PRICE.....



**White Cross Automatic Iron**

Modernistic design. Adjustable to operate at any temperature to suit the fabric to be ironed. Thermostat maintains uniform temperature. Air fins keep handle cool at all times. Beveled edge sole plate. Attached 6' cord set eliminates cord troubles. For 110-120 volt AC current. D18288—1000 Watt, 4 lb. Iron. List Price, \$7.50. **\$4.65**  
PRICE, Each, \$4.95. In Lots of 3, Each. **\$3.72**  
NON-AUTOMATIC D18290—575 Watt, 6 lb. Iron. With heat indicator and on-off switch in handle. Does not have thermostat control. For AC or DC operation. List Price, \$5.95. **\$3.95**  
PRICE, Each, \$3.95. In Lots of 3, Each.....

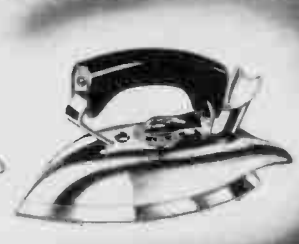

**Lady Dover Automatic Iron**

Adjustable to a wide range of ironing temperatures. Genuine bi-metal thermostat turns current off as soon as the proper intervals automatically maintaining the proper ironing temperature for the particular material being ironed. Never too hot, never too cold. New "quick heat" all around beveled thin sole plate brings working heat within  $\frac{1}{8}$ " inch of extra large ironing surface.  $\frac{1}{2}$  lbs 1000 Watts. Smartly streamlined. Complete with cord and plug set. For 105-120 volt AC operation. Fatigue proof handle, tapered toe. D18291—List, \$3.98. **\$2.65**  
YOUR PRICE.....

## Victor Mono-matic Ironer

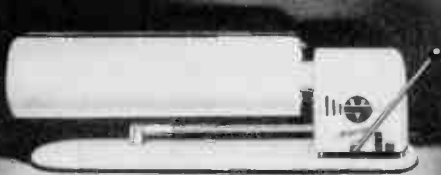

D18293—List, \$29.95. **\$19.95**  
YOUR PRICE.....

A portable "mangle" that is capable of ironing a full family wash, including pleated garments. Also presses trousers, ties, etc. "Lag" roll action delays start of motor after shoe clamps material to roll allowing time for adjusting and guiding work properly. Single lever "Mono-matic" control may be converted instantly from hand to knee operation. Adequate roll capacity irons large pieces quickly and easily. Roll revolves  $5\frac{1}{2}$  times per minute. Light weight, easily portable. May be used anywhere in house, and kept on shelf when not in use. Weighs only 33 lbs. Roll 20" long,  $5\frac{1}{2}$ " in diameter. Powered by induction motor with self-lubricating bronze bearings. Furnished with 11 ft. rubber-covered Underwriters' cord with unbreakable rubber plug. Guaranteed for one year. Size, 29" long, 9" wide,  $8\frac{1}{2}$ " high. 850 Watts. For 110-120 volt AC operation.

## Proctor Automatic Iron



With "Never Lift" Feature

D18367—List, \$12.50. **\$7.97**  
YOUR PRICE.....

"You never have to lift it." Pressure on release in handle lifts iron on its own stand. Pressure on heel of handle closes stand. Stand will not catch fabrics when closed. Temperature is thermostatically controlled and may be set to the requirements of any material. 1000 Watt Heating Unit sealed against air and moisture—no burn-outs. Air-cooled bakelite handle with convenient thumb rest. Finished in black, red and chromium. Has 8 ft. cord set built-in. Guaranteed 3 years. Wt. 4 lbs. For 110-125 Volt AC operation.

## Steam-O-Matic Iron



Operates With or Without Water

An improved steaming iron that quickly presses cellulose, rayons, silks, woolsens and other fabrics without scorching or burning. Eliminates use of damp cloths and sprinkling. Leaves no shine. Can also be operated without water for ironing linens, broadoths, etc. Fully automatic. Indicator heat control is adjustable for every fabric. Holds 1 pint of water for approximately 1 hour's use. 1000 Watt nichrome heating element. Non-detachable cord set. Special aluminum alloy construction. Rust and corrosion proof. Weight 4 $\frac{1}{2}$  lbs. For 105-120 AC operation. D18531—Model B200. List Price, \$12.95. **\$8.45**  
YOUR PRICE, Each..... D18533—Model D550. Non-Automatic Iron. As above less thermostat. Cannot be used without water. For 105-120 volt AC or DC use. List, \$8.95. **\$5.70**  
YOUR PRICE, Each.....

## Electric Heater

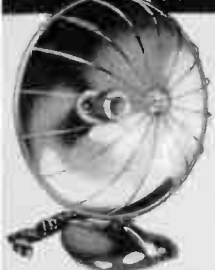

Quality general purpose electric heater for the home, garage workshop, etc. 12 inch chrome plated bowl reflects every bit of the heat developed by the coil nichrome wire heating element. Streamlined base with hang-up slot in rear, tilts to any angle. Rich brown finish. 15" High, 600 Watts. For 105-120 volt AC or DC operation. Approved cord and plug included. List, \$3.15.

With 12" Reflector **\$1.98**  
YOUR PRICE, Each.....

With 10" Reflector **\$1.29**  
Same as above except has 10" reflector. List, \$2.00. YOUR PRICE, Each.....

## Electric Stove

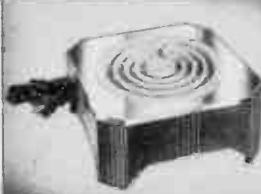

Convenient single burner electric stove. Useful in places where gas and other heating means are not available. Constructed of heavy gauge steel with nickel plated top and black enamel base. Size,  $8\frac{3}{4}$ " sq x  $3\frac{3}{4}$ " high. Heating element  $5\frac{3}{8}$ " dia., 550 watts. For 110 volt. AC or DC operation. Complete with attached cord and plug. D18298—List, \$1.40. **97c**  
YOUR PRICE, Each.....

## Superior Electric Stoves

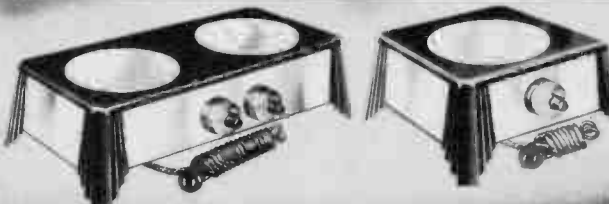

A really heavy duty stove with two completely protected 825 watt Nichrome Elements. The enclosure of elements guarantees longer life. Has two 3-heat switches, each with off-low-medium and high positions. Made of heavy gauge steel with modernistic steel legs. Finished in durable baked enamel with nicked sides. Has 6 ft. cord set attached. Top size  $8\frac{1}{2}$ " x  $17\frac{1}{2}$ ". Weight 12 lbs. Single burner model has one 825 watt element and one 3 heat switch. Top size  $8\frac{1}{2}$ " x  $18\frac{1}{2}$ ". Weight 6 lbs. For operation on 110-125 Volt AC-DC current. Underwriters' Approved.

D18299—Two Burner Stove. List Price, \$6.75. **\$4.48**  
YOUR PRICE.....

D18248—Single Burner Stove. List Price, \$3.50. **\$2.55**  
YOUR PRICE.....



# NEWEST ELECTRIC SEWING MACHINES



For  
105-120 Volt  
AC or DC

D18487—  
With Rev-  
Sew Rotary Head.  
List, \$147.50.  
**YOUR PRICE \$81<sup>65</sup>**

D18490—With  
regular Rotary head.  
List, \$135.00.  
**YOUR PRICE \$76<sup>65</sup>**

## Knee Hole Desk Model

**Rotary Type Head**  
Incorporates the full rotary type head described below in a beautiful knee hole desk, cabinet. Constructed of attractively figured American walnut throughout, beautifully hand polished to a high lustre. Four extra large and roomy drawers, equipped with modern and attractive pulls. Drawers equipped with desk and sewing accessories such as ironing board, spool holder, pin cushion, etc. Provides ample room for sewing needs. Designed to serve as a useful and attractive desk when not in use for sewing. The high grade rotary sewing head is smoother and faster than other types. Speed is regulated by a conveniently located knee control. Comes equipped with full set of accessories.

## Swedish Modern Console

**Rotary Type Head**  
This up-to-the-minute modern cabinet is curdily built throughout. Has arm that supports lid when cabinet is open. Top, lid and front panel are of specially selected 5-ply walnut. Front panel is of beautiful figured walnut veneer. Rigidity of cabinet is increased by stretcher set 2/3 of the way back. Will not interfere with feet. Has swing-out drawer with extra capacity for sewing accessories. Size 24x17x30". Incorporates the full rotary type sewing head and accessories described below.

D18488—With Rev-Sew Rotary Head.  
List, \$102.00.  
**YOUR PRICE \$62<sup>00</sup>**



For  
105-120 Volt  
AC or DC

D18491—With regular Rotary Head.  
List, \$96.50.  
**YOUR PRICE \$57<sup>50</sup>**

## Modern Walnut Console

**With Rotary Type Head**  
D18492—With regular Rotary Head. List, \$95.00  
**YOUR PRICE \$54<sup>50</sup>**  
D18489—With Rev-Sew Rotary Head. List, \$107.50.  
**YOUR PRICE \$58<sup>75</sup>**

Modern walnut console, conservative in design and yet its lines are of the attractive popular style that are featured in Home Furnishings year after year. Lid and top are of striped walnut. Has attractively reeded legs. A double stretcher, needed to match the legs lends rigidity and strength to the cabinet. Motor speed may be controlled by either knee or foot control speed device. Comes equipped with full set of accessories.

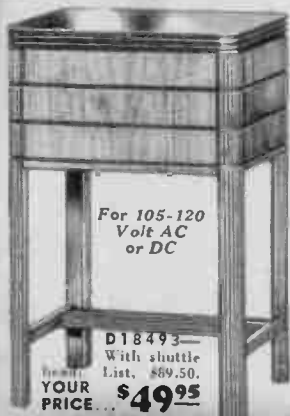

For 105-120  
Volt AC  
or DC

D18493—  
With shuttle  
head.  
List, \$89.50.  
**YOUR PRICE \$49<sup>95</sup>**

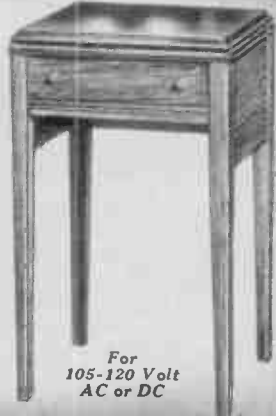

For  
105-120 Volt  
AC or DC

## Popular Walnut Console

**With Shuttle Type Head**  
D18494 List, \$19.50.  
**YOUR PRICE \$35<sup>90</sup>**  
An attractive sturdy and reliable sewing machine cabinet substantially constructed of 5 ply walnut veneer and walnut finished hardwoods highly polished. Modern in design with tapered legs. Medium in size, large enough for all sewing requirements. Sewing head motor regularly furnished for use with any 105-120 volt current. A handy piece of furniture will serve as a general utility stand or convenient table when in closed position. Will give many years of satisfactory and faithful service. Measures when closed, 16 1/2 x 19 x 30". Comes equipped with full set of accessories.

## Special Home Portable

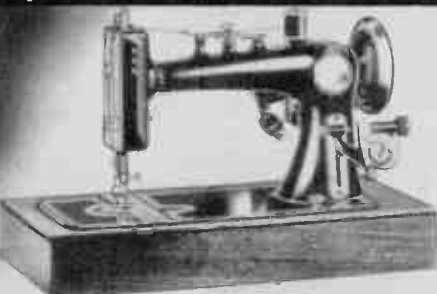

D18495—  
List, \$39.50.  
For 110 volt AC or DC.  
**YOUR PRICE \$24<sup>75</sup>**

A real portable electric sewing machine with shuttle type head, weighs only 25 lbs. Easily carried from place to place. Base is richly finished in walnut color. All bright parts are chrome plated and polished. Sewing head is popular 3/4" size. Has a high arm and allows ample room for handling bulky or heavy material. Speed is regulated by a foot controlled rheostat. Furnished with rubberized cover for dust protection and complete set of accessories.



**The Junior Seamstress**  
D18496—List, \$5.00.  
**YOUR PRICE \$3<sup>48</sup>**

Not only a toy, but a small size practical little machine that will gladden the heart of the young miss. Sews a straight seam the same as mother's regular size machine. An ideal gift item for the little housekeeper providing a means for doing simple sewing jobs. Excellent for training the growing girl in household duties. Hand powered.

## "RevSew" Portable Model "H"

### Mechanical Features Of the Sewing Machines on This Page Rotary Sewing Head

Machines with Rotary Head feature over the shuttle type, finer stitch, quieter smoother operation, faster action and automatic thread tension, an exclusive patent feature that adjusts itself to any thickness of thread. Automatic bobbin rewind release operates without attention when the bobbin is full. Air cooled breeze bearing motor is an integral part of the head—now an attachment. Equipped with a built-in sewing light, number stitch regulator (6 to 32 per inch), wide cloth feed, ribbed pressure foot, self setting needle and self threading shuttle. For 105-120 V. AC-DC.

**Rev-Sew Rotary Sewing Head**  
Machines with Rev-Sew rotary head incorporate every feature above outlined and in addition are designed to sew either forward or backward making a neat double lock stitch. The reversing feature is particularly desirable for fastening of seams, mending, quilting. May also be used for embroidery.

### Shuttle Type Sewing Head

Machines with shuttle head have automatic bobbin rewind release, operate without attention when bobbin is full. Air cooled breeze bearing motor is an integral part of the head—now an attachment. Equipped with built-in sewing light, number stitch regulator (6 to 32 per inch), wide cloth feed, ribbed pressure foot, self setting needle and self threading shuttle. For 105-120 Volt AC or DC.

**DEALERS!** These sewing machines offer you many real sales opportunities. Practically every home is a prospect. You can earn many extra dollars with this line. The quality is guaranteed the best. Sure to please the most exacting seamstress in the shop or home. Long satisfactory trouble free service is assured. Retail prices given are very attractive. Descriptive circulars will be sent on request.



D18497—  
List, 49.50.  
**YOUR PRICE \$34<sup>60</sup>**

A Streamline styled shuttle type portable with concealed electric sewing lamp and automatic bobbin rewind release. Controlled forward and backward feed mechanism. Very easy to thread. All bright metal parts are chrome plated. Speed is regulated by foot control pedal. Supplied with a walnut base and sturdy leatherette case that holds all parts conveniently. Comes furnished with a complete set of accessories. Net weight 48 lbs. For 105-120 volt AC or DC.

# Sessions Electric Clocks

Self-Starting—Synchronous Movements  
For 105-120 Volt, 60 Cycle A.C. Operation



**The Hawthorne**

With 5 Tone Westminster Chime

D18305—List, \$33.50. **YOUR PRICE, \$20.10**

Has full 5 tone Westminster ¼ hr. chimes. Self starting electric movement. Highly polished case of matched walnut veneer with 6" silvered dial and raised numerals. Size 16½" x 9½". Creates a cheerful atmosphere.



**The Shelley**

With Two Tone Chime

D18306—List, \$14.50. **YOUR PRICE, \$8.70**

Has 2 tone ¼ hour chime. Strikes one chime on the half hour and both chimes on the hour. Self starting electric movement. Beautiful inlaid Mahogany veneer case, 21x9½" high. 6" Silvered metal dial with raised numerals. Attractive Old English styling. A time piece that will harmonize with most home furnishings. Suited for any mantel or radio or the library.

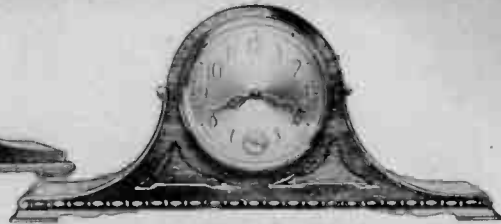

**The Buckingham**

With 5 Tone Westminster Chime

D18307—List, \$26.00. **YOUR PRICE, \$15.60**

Self starting electric movement with full 5 tone Westminster ¼ hr. chime. Chimes every quarter of an hour with a charming and easy-on-the-ear musical phrase. Has 6" silvered metal dial with raised numerals. Case is 21x9½" high. Made of genuine walnut with burl overlays. A time piece that will complement any interior.

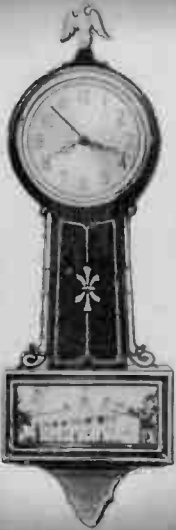

**The Somerset**

D18308—List, \$13.00. **YOUR PRICE, \$7.80**

Banjo style wall clock with whitewood case finished in rich mahogany color. Self-starting electric movement. Has 6" silvered metal dial with raised numerals. Size, 8½" x 26" high.

**The Moline**

D18304—List, \$8.80. **YOUR PRICE, \$5.28**

Similar to above except smaller in size. Size 7" x 22" high.

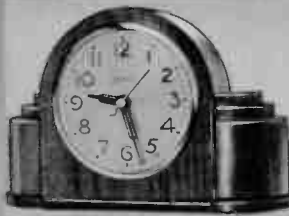

**The Mode**

Luminous Hands and Numerals

D18315—With Alarm. List, \$7.00. **YOUR PRICE, \$4.20**

Hands and Nums. Not Luminous

D18313—Without Alarm. **\$3.00**

D18314—With Alarm. **3.60**

Self starting electric movement in genuine walnut case with black base. Has 4" metal dial with raised numerals. Size, 8½" x 5¼" high. On the alarm models the gently urgent tone of the alarm does not jar the nerves. The luminous hands and numerals are easily readable in the dark. Ideal for the modern home or office.



**The Ship**

Raised Numeral Metal Dial

D18303—List, \$6.55. **\$3.93**

**YOUR PRICE, \$3.93**

An unusual and ornamental clock and panel with bright metal against a beautiful walnut veneer background. Figure shows silhouette of ship under full sail. Useful as well as decorative for office, mantel, study or library. Self-starting electric time movement provides utmost in convenience and accuracy. Size of walnut veneered panel, 10" x 6½". 3½" raised numeral metal dial.



**The Clarion**

With Alarm

Luminous Hands and Numerals

D18294—Ivory Finish. List, \$4.50. **2.70**

D18295—Walnut Finish. List, \$4.25. **2.55**

Hands and Nums. Not Luminous

D18296—Ivory Finish. List, \$3.50. **2.10**

D18297—Walnut Finish. List, \$3.25. **1.95**

Modern design plastic case in Ivory or walnut finish. Dial is 3¾" in diameter and has large, easily-read embossed raised numerals. Bell alarm makes this a general utility clock. Self-starting electric time movement guarantees dependable accuracy. Size 4¾" x 5¼".

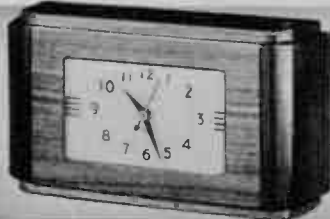

**The Commander**

Luminous Hands and Numerals

D18232—With Alarm. List, \$6.00. **\$3.60**

**YOUR PRICE, \$3.60**

Hands and Numerals Not Luminous

D18233—Without Alarm. List, \$4.00. **\$2.40**

**YOUR PRICE, \$2.40**

D18234—With Alarm. List, \$5.00. **\$3.00**

**YOUR PRICE, \$3.00**

Modern styled genuine walnut case. Ideal for use on radio cabinet, or on a mantel clock. Oblong metal dial has two-tone, easily read numerals. Self-starting electric time movement. Dial is 4¾" x 3", size of case overall is 7¾" x 4".

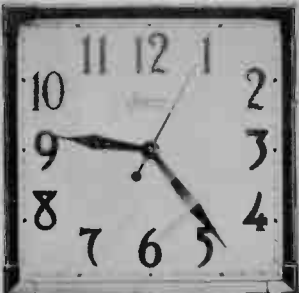

**The Commercial**

D18319—List, \$6.25. **YOUR PRICE, \$3.75**

An excellent clock for stores, offices, and schools. Has self starting electric movement mounted in attractive 14½" square metal case. Silver lithographed metal dial with black and gilt lacquered numerals. Has black metal hands.

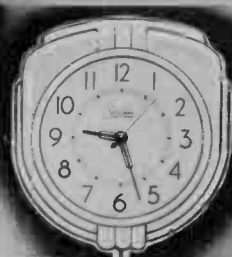

**The Plastique**

D18320—Ivory D18322—Red

D18321—Green D18323—White

List, \$3.00. **YOUR PRICE, Each, \$1.80**

A kitchen wall clock of attractive modern design. Has self starting electric movement in plastic moulded case. Size 7x½" high with 5" dial. Black metal hands.



**The Teapot**

D18324—Ivory D18326—White

D18325—Red D18327—Green

List, \$3.50. **YOUR PRICE, Each, \$2.22**

An attractive kitchen wall clock. Has self starting electric movement in metal tea pot case. Metal dial has raised numerals. Size, 8½" x 7" high. Black metal hands.

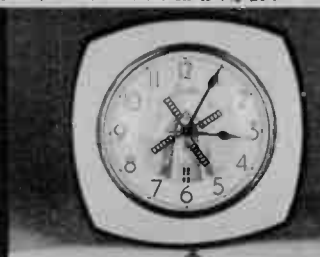

**The Moving Windmill**

D18235—Red Trim. D18236—Blue Trim. List, \$3.90. **\$2.34**

**YOUR PRICE, Each, \$2.34**

Dial is ornamented with an old-fashioned windmill that has moving sails. White case has beveled edge in contrasting colors, red or blue. Size, 7" x 7". Dial is 5" high.



# HAMMOND ELECTRIC CLOCKS

Attractive, dependable, high quality electric clocks. Made by a manufacturer with international reputation for quality engineering. Over 5 million Hammond Clocks are now in use. Silent operation and long life are assured by this modern, slow-speed synchron-

ous motor movement. Day after day, year after year, these clocks will remain accurate to the exact second. Due to extremely low current consumption, these clocks must be restarted manually when stopped. For 105-120 volt, 60 cycle AC operation.



**The Courtier**  
With Alarm

D18202—List, \$4.95. **\$2.91**  
YOUR PRICE.....

Easel type highly figured Butt Walnut panel case with light wood inlays. 3½" White silver plated dial with brushed silver plated ring. Black numerals and hands. Size, 5⅞" high, 4⅞" wide.

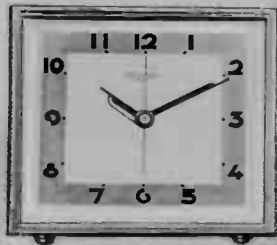

**The Edgemont**  
With Alarm

D18223—List, \$3.95. **\$2.32**  
YOUR PRICE.....

For desk or dressing table. Easel type metal case, brightly chrome finished. 4x4½" two tone satin silver dial with black numerals and hands. Beveled edge crystal. Case size, 4⅝" high, 5¼" wide.



**The Modern Firefly**  
Illuminated Dial-Alarm

List Price, \$4.95. **\$2.91**  
YOUR PRICE, Each.....

D18207—Black and Chrome. D18208—Ivory and Gold. Molded plastic case in either Ivory or Black. 3" Translucent dial is illuminated by tiny bulb. Tells time in the dark with no glare. Size, 5½" high x 4½" wide x 2⅞" deep.

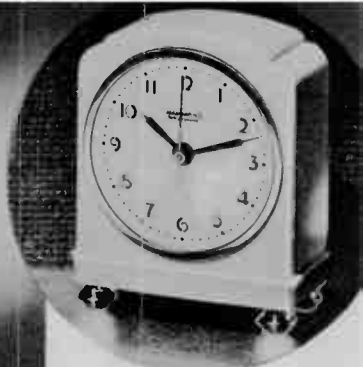

**The Cathay**  
With Alarm

D18209—List, \$3.25. **\$1.91**  
YOUR PRICE.....

A petite Alarm Clock in molded Ivory plastic case. 3½" Metal dial scale finished in Ivory with numerals and hands in black. Bezel and feet are bright gold finish. Size, 3⅞" x 4⅞" x 1⅞". Even though this model is the lowest in price, it contains the same high-grade construction of other models shown on this page.

Dealers! At these new low prices Clocks provide the ideal answer to the gift problem. Buy Now! Our stocks are complete.



**The Mentor**  
With Alarm

D18214—List, \$5.95. **\$3.50**  
YOUR PRICE.....

Mahogany finish case. Face: four-piece matched genuine sapeli. Black moulded plastic feet. Dial: 3½", silver plated brass satin finished ring on matte finished background. Gold color metal bezel. Black hands, gold colored second hand. Size: 4⅞" high, 6¼" wide, 2¼" deep.

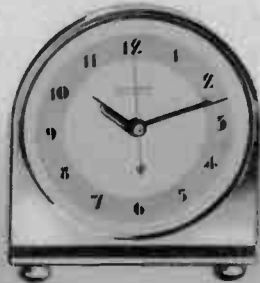

**The Grenadier**  
With Alarm

D18211—List, \$3.95. **\$2.32**  
YOUR PRICE.....

For desk or dressing table. Easel type sparkling chrome plated case with black strip across base. 4¼" Metal dial face has two-tone, silver plated satin finish. Black numerals and hands. Gold colored second hand indicates when clock is in operation. Size 5¼" x 4¾".



**The Tripoli Alarm**  
With Automatic Calendar

D18212—List, \$9.95. **\$5.85**  
YOUR PRICE.....

Striped Mahogany veneer case. Fine hurl finished face with light strip inlays. 3½" Two-tone silver finished dial. Black numerals and hands. Calendar automatically shows day and date. Gold colored second hand indicates when clock is in operation. Size, 5¼" x 6¼" x 3" deep.

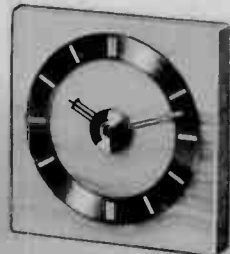

**The Regent**  
With Alarm

D18222—List, \$9.75. **\$5.73**  
YOUR PRICE.....

For Living Room, Library or Den. Easel type case of lustrous genuine Onyx. Hand spun gold plated 4¾" dial with white hour markings. Gold plated hands. Revolving second disc with arrow indicates when clock is in operation. Size: 5½" square.

## Popular Modern Kitchen Clocks

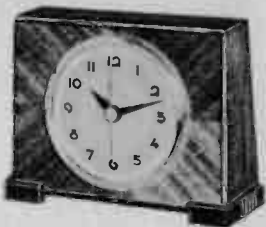

**The Luna**  
With Alarm

D18213—List, \$7.95. **\$4.67**  
YOUR PRICE.....

Solid mahogany case. Amboyne hurl finish face with inlay design border. Translucent plastic dial, 3½", illuminated without glare by tiny bulb. Gold color metal bezel. Black hands with gold color second hand. Size: 5⅞" H., 5¼" W., 2⅞" D.

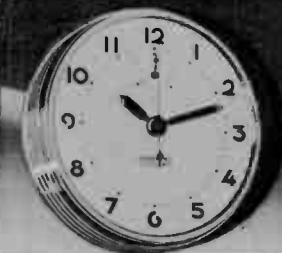

**The Hampton**

D18215—List, \$4.95. **\$2.91**  
YOUR PRICE.....

For the modern kitchen or small office. Bright chrome plated, fluted metal case. 6½" Dial in white. Black numerals and hands. Has special fourth hand—the 3 Minute Meter useful for timing purposes. Sweeping second hand indicates clock operation. Size, 2⅞" x 7⅞" diameter.

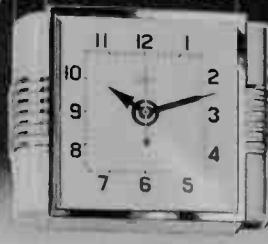

**The Stewardess**

List Price, \$4.50. **\$2.65**  
YOUR PRICE, Each.....

D18216—Ivory. D18301—White. D18217—Black. D18302—Green. D18300—Red. For Kitchen, bath or office. Chrome plated, fluted side hands and bezel. Hangs on wall or stands on own base. 5⅞" x 4⅞" Dial in white with black numerals and hands. Size, 5¼" x 6¼".



**The Parkway**

List Price, \$3.00. **\$1.76**  
YOUR PRICE, Each.....

D18203—Ivory. D18204—Green. D18221—Red. For Kitchen or Bathroom. 6½" dia. metal case in Ivory, Green or Red finish with chrome plate bezel. 4¾" white metal dial with black numerals and hands. Second hand.

# Toasters and Coffee Makers

## Samson Automatic 2-Slice Pop-Up Toaster

The year's best buy in Automatic Toasters

D18269—List, \$9.95.  
YOUR PRICE,  
Each

**\$6.67**

Toasts one or two slices of bread on both sides at the same time, automatically shuts off current and pops toast out when done to just the right color and crispness. Utmost simplicity of operation. Just drop in bread, set for kind of toast desired, press down lever and the toaster takes care of everything else. Tray at bottom catches all crumbs and is easily removed for cleaning. The graceful lines of the lustrous chrome body are enhanced by a richly embossed design. Base and handles of grained walnut bakelite add the proper touch of contrasting color. Equipped with detachable 7" 3" cord for easy access to any outlet. Underwriters' Listed. Operates on 110-120 volts AC only. 800 Watts.



## Toastswell Deluxe

Tray Set and Toaster

D18277—List, \$18.45.  
YOUR PRICE, **\$11.95**

Each... Two-slice fully automatic pop-up Toastswell Toaster as described above, on an extra large Satin Finish genuine Walnut warp and stain-proof Tray. Two crystal glass relish dishes, four crystal glass serving plates and cutting board with permanently attached knife are also included. Designed for impromptu gatherings and informal entertaining. A complete snack-tray to serve unexpected guests and casual visitors. Tray is 15 1/2"x25".

## Toastswell Super-Silent Fully Automatic Toaster

With Split-Second Time Control  
D18276—List, \$11.95.  
YOUR PRICE, Each, **\$7.94**

This new two-slice toaster features a clock mechanism that is absolutely silent, completely eliminating the annoying ticking found in ordinary clock-controlled toasters. Automatic split-second time control regulates toasting time with amazing accuracy. Toasting time is lengthened when toaster is cold and shortened when it heats up, making every piece of toast identical in color and crispness with the others. Selective pop-out feature automatically pops out bread when toasted or keeps it warm in toasting oven until served. Chromium body rests on bakelite base and has bakelite handles and trimmings. All construction is extra heavy. Has nichrome 725 Watt elements. Size, 7x6 1/2"x11 1/2". 110-125 volts AC-DC. Supplied with cord set.



## Automatic Electric Toasters

### A—Toastswell Automatic

D18374—List, \$9.95.  
YOUR PRICE, **\$6.88**

Toasts two slices of bread on both sides at the same time to any desired shade. When toast is finished, the toaster returns to low heat and the selective pop-out feature raises toast to any desired height, or leaves the toast in toasting ovens to stay hot until ready to serve. "Time Master" automatically lengthens toasting period when toaster is cold. Modernistic lines, triple chrome plated, bakelite handles. Nichrome element with Lava insulation. Size 7 1/2"x6 1/2"x8 1/2". 600 Watts, 105-120 volt AC-DC. Includes cord and plug.

### B—Proctor

Automatic Toaster  
D18375—List, \$9.95.  
YOUR PRICE, **\$6.68**

Toasts two slices of bread on both sides at the same time. When toast is complete a bell rings and the current turns off. Feather touch button raises toast for easy removal. Thermostat control permits choice of 8 shades of toast from light to dark. Beautiful modern design with chrome finish. Bakelite knobs and base. Size 7 1/2"x6 1/2"x10". 1100 Watts, 105-120 Volt AC. Includes cord and plug.

### C—Proctor Toaster

With Automatic Timer  
D18378—List, \$3.95  
YOUR PRICE, **\$2.76**

Automatically turns off current and rings bell when toast is finished. Can be set for light, medium or crisp toast. Toast is turned over automatically as door is opened. Smartly finished in chromium with ebony trim. Cord set included. For 105-120 volt, AC or DC.

### D—Quality Toaster

D18379—List, \$1.85.  
YOUR PRICE, Each, **98¢**

High value, excellent quality. Toasts two slices at a time on one side. Toast is turned when door is lowered. Nickel plated doors and baked enamel sides. Bakelite handles. Has 400 watt nichrome element. For 110 volt AC-DC current. Underwriters' Approved. Without cord.

### E & F—Superior Toasters

Chromium finished toaster in modern design with well rounded corners. Has 4 walnut wood handles. Toasts bread or buns to a golden brown. Opening door turns toast automatically. Nichrome element wound on mica. Underwriters' Approved. For 110-125 volt AC-DC. Furnished with 8 ft. cord set.

D18377—E—2 slice 300 watts, **\$2.28**  
List, \$3.50. YOUR PRICE  
D18376—F—4 slice 650 watts, **\$2.98**  
List, \$4.50. YOUR PRICE



## White Cross Coffee-Vacs

Approved by  
Good Housekeeping

Heat resisting glass top and bottom have platinum banding decorations. Modernistic double duty bakelite cover also serves as stand for the upper container. Tray style electric stove is chromium finished with walnut handles and rubberoid feet well insulated. Nichrome element is high quality refractory grid type. Makes delicious coffee the scientifically correct vacuum way. New, improved, triple-speed filter prevents clogging and eliminates muddy, bitter coffee; speeds up drip process cannot slip from position. Easy grip, heat proof bakelite handle makes pouring easy. Furnished with 6 foot cord set. For 105-125 volt AC-DC current.



D18230—6 Cup Gas Model. List, \$2.45.  
PRICE, Each, **\$1.56**  
In Lots of 3, **\$1.44**  
Each

D18228—6 Cup Electric Model. List, \$4.25.  
PRICE, Each, **\$2.84**  
In Lots of 3, **\$2.63**  
Each

D18229—8 Cup Electric Model. List, \$4.75.  
PRICE, Each, **\$3.24**  
In Lots of 3, **\$2.95**  
Each

## Cory Coffee Brewers

With Two-Heat Electric Stove

Fast efficient filtering unit extracts only delicious essential coffee flavor without the objectionable bitter taste that percolating and boiling draws out. Features: Hinged deaerator cover; Chrome plated two heat electrical stove—high for brewing—low for keeping coffee at proper drinking temperature; Bakelite combination funnel holder and cover and bakelite handles; Heat-proof glass-ware with bakelite handles. Made by the makers of Pyrex in the new wide-mouth style for easier cleaning. Includes 6 foot cord set and Bakelite Coffee Measure. 4-6 Cup sizes furnished with Cory glass rod filter. 2-12 Cup sizes furnished with both glass and "Fast Flo" Filter. For 105-120 volt, AC or DC. Underwriters' Approved.



Black Stock Num.	List Price	Your Price Each	3, Ea.	Cup Size
D18380	\$4.95	\$3.38	\$3.15	4-6
D18381	\$5.95	4 10	3.78	7-8
D18382	\$6.95	4 40	4.48	10-12

Ivory Stock Num.	List Price	Your Price Each	3, Ea.
D18383	\$5.45	\$3.70	\$3.48
D18384	6.45	4.45	4.25
D18385	7.45	4.98	4.78

**Gas Models**  
Same as electric model except that no electric heating unit is included. Supplied with black trimmings only.

Stock Num.	List Price	Your Price Each	3, Ea.
D18386	4 6	\$2.45	\$1.68
D18387	7 8	3.45	2.35
D18388	10-12	4.45	2.98

D18231 Glass Filter  
Each **33¢**



# Egg Cookers--Waffle Irons

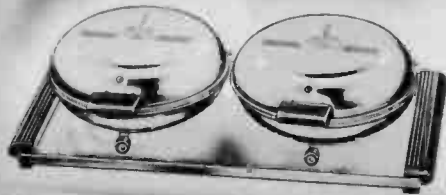

## Samson Automatic Twin Waffle

Bakes two full-size waffles at one time just the way you want them—light, medium or dark. Signal light on each unit glows when grids are ready for batter and again when waffles are done. Fast heating nickel chrome elements bake waffles thoroughly and quickly. Either or both units may be used as desired. Current shuts off automatically when waffles are done.  $\frac{3}{4}$ " cast aluminum greaseless grids. Finished in lustrous chrome with Genuine Walnut handles. Size: 10 $\frac{1}{2}$ " x 8 $\frac{1}{2}$ " x 4 $\frac{1}{2}$ ". Underwriters' Listed. Twin cord set. 110-120 volts A.C. 1250 Watts total.  
**D18264** List, \$11.95. **\$789**  
**YOUR PRICE, Each**.....  
**D18265** Same as above with heat indicator but less automatic current cut-off and heat control. List, \$8.95. **\$595**  
**YOUR PRICE**.....



## Toastswell Automatic Waffle

Many new exclusive features make this Toastswell Waffle one of the finest available. This completely automatic waffle iron does everything but make the batter. Has a special thermostat control that enables anyone to make perfect waffles, without any previous experience, light or dark as desired. Pilot light shining through a ruby jewel shows when to pour in batter and when waffle is completed. When signal light goes out the thermostat automatically shuts off the current, indicating that the baker is ready for more batter or that a waffle is ready to be served. 4" heavy cast aluminum grids with extra outer ring to prevent overflow. Smart new styling with its massive square base, streamlined dome and modern etched design. Made of heavy gauge steel, chrome plated. Has black bakelite handles and feet. Size 11 $\frac{1}{2}$ " x 5 $\frac{1}{2}$ " x 10 $\frac{1}{2}$ ". 660 Watt nichrome element. For 110-120 volt AC. Complete with detachable cord set.

**D18266**—List, \$9.95. **\$680**  
**YOUR PRICE**.....



## White Cross Twin Waffle

Beautiful new White Cross twin waffle iron that bakes two full size waffles quickly and evenly throughout. Each grid has heat indicator that tells when to start baking and when waffle is ready to serve. The styling of this attractive home appliance is as modern as tomorrow and as easy to look at as the crisp waffles it makes are delicious to eat. The new square shape is very much in demand because it matches the modern home or adds a smart touch of modernity to more conservative furnishings. Cast aluminum no-stick grids are 5"x5 $\frac{1}{2}$ " and require no preparatory treatment or breaking in. Special White Cross over type nichrome heating elements distributes heat evenly to both top and bottom grids for uniform baking at all times. Full expansion hinges with concealed connecting nickel wires hold waffles firmly and evenly without crushing. Finished in bright durable chrome with walnut colored lifting and side handles. Comes complete with Underwriters' Approved detachable cord set. 660 Watts

**D18267**—List, \$8.95. **\$595**  
**YOUR PRICE, Each**.....



## White Cross Automatic Waffle

Fully automatic in operation. Signals when grids are ready for batter, signals and turns off current when waffle is baked perfectly. Lever adjustment for light, medium or dark waffles.  $\frac{3}{4}$ " cast aluminum no-stick grids have recess to catch overflow of batter. Full expansion hinge with concealed nickel lead wires. Has beautiful flowing curved lines and handsome engraved decorations on base and cover. Fancy Walnut colored handles. Bright chrome finish. 660 Watt Nichrome element. For use with 110-120 Volt AC current. With detachable cord set.

**D18268**—List, \$9.95. **\$595**  
**YOUR PRICE, Each**.....

## Handyhot Deluxe Automatic Twin Waffle

A De Luxe appliance in every respect, reflecting the modern trend of rich simplicity with full function. Fully automatic, bakes two 6" waffles at one time—or one grid can be used independently of the other if desired. Setting provided for light, medium or dark waffles. Has crystal light indicator which announces when greaseless grids are ready for batter and when waffle is baked, ready to serve. Expansion hinges assure evenly baked waffles. Lustrous non-tarnish chrome finish with natural Walnut wood handles and side rails. 800 Watts. Operates on 110-120 volt AC current only. Underwriters' Listed. With twin plug cord set.

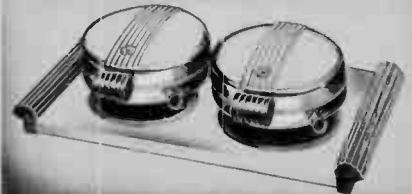

**D18255**—List, \$9.95. **\$660**  
**YOUR PRICE, Each**.....

**D18256**—Same as above except does not have automatic feature. Heat indicator tells when to start baking and when waffle is ready to serve. List Price, \$6.65. **\$445**  
**YOUR PRICE**.....

## DeLuxe Egg Set



Boils, poaches, scrambles or steam-fries eggs automatically. Only a few teaspoons of water necessary to put cooker in operation. Includes: Ivory porcelain Egg Cooker with chrome dome, 4 Double Ivory porcelain Egg Cups, Chrome finished metal Serving Tray, Boiling Tray, Ivory porcelain Poaching Dish and cord set. Underwriters' approved. For 105-120 volt, AC operation.

**D18240**—List, \$6.95. **\$469**  
**YOUR PRICE, Each**.....

**D18241**—DeLuxe Egg Cooker only. Less tray and cups. List Price, \$3.95. **\$265**  
**YOUR PRICE, Each**.....

**D18242**—Standard Egg Set includes Egg Cooker, 4 single egg cups, and serving tray finished in baked Ivory enamel, does not include poaching dish. List, \$3.95. **\$265**  
**YOUR PRICE, Each**.....

**D18243**—Standard Egg Cooker only. List Price, \$1.95. **\$135**  
**YOUR PRICE, Each**.....

## Red Seal Automatic Waffle Iron

Operates with watchlike precision—requires no supervision—each operation is automatic. The heat indicator tells when the grids are at proper temperature for pouring batter. Thermostat adjusts length of baking time automatically to suit consistency of various batters. When waffles are baked, signal light goes out and current turns off. "Mirror finish"  $\frac{3}{4}$ " die cast stick-proof grids with overdrip groove. Finished in durable chromium with embossed cover design. Bakelite handles. Complete with cord set. Underwriters' approved. For 105-120 volts, AC operation.  
**D18252**—Red Seal Fully Automatic Waffle Iron. List, \$5.95. **\$395**  
**YOUR PRICE**.....

## Superior Automatic Waffle

Bakes large 7 $\frac{1}{2}$ " waffle on cast aluminum grids with overflow ring. Heated by fast acting 660 watt nichrome element. Signal light indicator tells when to start baking and when waffle is ready to serve. When waffle is baked signal light goes out and current turns off. Attractively chrome plated and embossed, mounted on tray base with attractive wood handles. For 110-120 volt AC. Comes furnished with 6 ft. approved cord and plug set. Underwriters' Approved.  
**D18368**—List, \$5.60. **\$368**  
**YOUR PRICE**.....  
**D18373**—Same as above with heat indicator but without automatic turn-off feature. List, \$4.75. **\$285**  
**YOUR PRICE**.....

## Quality Waffle Iron

This full size Waffle iron is finished in gleaming chromium plate, black bakelite side and front handles. High quality  $\frac{3}{4}$ " dia. grids are made of special processed alloy, chrome plated. Batter will not stick to grids. Heat indicator tells when hot enough for batter and when waffles are finished. Long life nichrome heating elements in both top and bottom plates. Turns out golden brown waffles every time. Cord set not included. For 105-120 volts, AC or DC operation. 660 Watts.  
**D18249**—List, \$3.15. **\$175**  
**YOUR PRICE, Each, \$1.88.**  
 In Lots of 3, Each.....

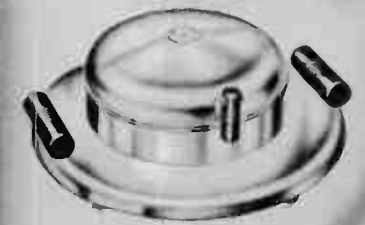

# Appliances for Better Living

## Lady Dover DeLuxe 10-Speed Mixer With Juicer

D18257—List, \$19.95.  
YOUR PRICE..... **\$12.95**

This handsome, powerful mixer is an asset to any kitchen—a fast, efficient servant that takes care of all the mixing, beating, stirring and whipping quickly and easily. 10 full-power speeds instantly available at all times—the right speed for every job. Speed control is conveniently built in to back of motor housing. Powered by rugged universal motor. Will not slow down when beating heavy batter, nor speed up when liquids are added. Mixer tilts back to drain beaters or remove bowl, and detaches easily for mixing or mashing over stove. Juicer attaches directly through handle without use of tools. It is not necessary to remove beaters in order to use the juicer.



## Electric Handmixer

D18279—List, \$5.95.  
YOUR PRICE..... **\$4.15**

Light weight utility mixer, designed especially to handle light beating, mixing, stirring and whipping. Improved twin beaters provide perfect aeration. Can be used in any bowl or pan anywhere in the kitchen without releasing levers, catches or thumb screws. Switch conveniently located on motor for finger-tip control. Twin beaters are instantly detached for cleaning. Attractive design, beautifully finished in white baked enamel with black easy-grip handle. Easily portable. Complete with 40 ounce white translucent glass bowl. Has attached cord. Underwriters' Listed



For 110-120 Volt AC Use

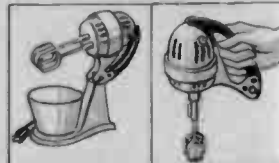

## Lady Dover 3-Speed Mixer

D18258—List, \$14.95.  
YOUR PRICE..... **\$9.45**

Sturdily-built mixer with powerful 3-speed motor. Speed adjustment conveniently located at rear of motor. Finished in white kitchen enamel with comfortable plastic handle. Two efficient beaters easily removable for cleaning. Motor tilts back, and slips easily from base for portable use. Bowl revolves as it mixes. Juicer attachment fits easily into handle without removing Beaters. Complete with juicer, two white glass mixing bowls and heavy duty Underwriters' Approved cord. 105-120 Volts AC or DC. Underwriters' Listed.

## Electric Mixer



Whips cream, beats eggs and mixes salad dressings, kinas, drinks, etc. May be used in cup, bowl or glass. High speed, quiet induction motor. 54 oz. clear glass bowl is graduated in pints, cups and ounces. Motor finished in white, has button type On-Off switch, with nickel plated handle. 8 foot cord and plug attached. For 110-120 volts 50-60 cycle AC operation.

D18338—YOUR PRICE, Each... **\$1.75**

D18259—Similar to above but has smaller motor.  
YOUR PRICE, Each... **95¢**

## Baby Bottle Warmer

Convenient sized electric baby bottle warmer. Heats any standard sized baby bottle to feeding temperature, then shuts off the current automatically. Very speedy in operation. Smooth finished porcelain. Finished with approved rubber covered cord set. For 110-125 Volt AC.

D18392—Pink, Each  
D18394—Blue, Each  
D18393—Ivory, } **69¢**



## Motodent Electric Tooth Brush

A revolutionary device for cleaning the teeth, plates or dentures and for massaging the gums. Attractive Ivory plastic case, fits the hand snugly. Brush oscillates 7200 times per minute or 38 times faster than hand brushing. A whole family can use one Motodent since each member can have a separate brush arm identified by colored dots. Will not injure the enamel or irritate gums. Completely sealed against moisture. Guaranteed for one year. Underwriters' Approved. Furnished with 7 ft. cord and plug.

D18347—List, \$8.75.  
YOUR PRICE..... **\$5.84**

For 110-125 volt AC.  
D18389—A—Brush  
D18390—B—Brush  
D18391—C—Brush  
D18349—D—Brush  
Each..... **35¢**  
D18348—E—Extra Arm and Brush 'D'..... **98¢**



## Eskimo Whiz-Mix Liquefier

### Eskimo Whiz-Mix Liquefier

NEW! DIFFERENT! More than a mixer! It whips, chops, and liquidizes. Apples, oranges, carrots, nut meats converted into a smooth liquid that flows like water! Pineapple made without a freezer! Tomato juice made from whole, ripe tomatoes. Housed in the Chromium plated pressed steel base. Is the extra powerful, high speed motor that drives the whirling stainless steel blades in the upper glass bowl at a speed of 12,000 R.P.M. It is ruggedly built, with bronze bearings, forced ventilation and conveniently located 2-speed switch. Operates on AC or DC 110 V. Overall size, 12" high. Base dia., 7". Capacity of bowl, 1 qt. Ship. Wt., 8 lbs.  
D18278—List, \$15.00.  
YOUR PRICE..... **\$9.45**

### Nite Beam-Bed Lamp

All the convenience of reading in bed without disturbing any one else's sleep. Made of two piece reflector with magnifying lens. Lens holder and reflector attached to body of lamp by bayonet lock, easy to replace bulb. Turn knob socket, special adjustable joint. Sure lock, felt lined clamp, will not mar furniture. Choice of Ivory or bronze finish. Furnished with approved cord and plug, set.  
D18395—Bronze, D18396—Ivory.  
List, \$1.75.  
YOUR PRICE, Each..... **\$1.05**

### New Haven Time Switch

And Self Starting Electric Clock Designed for automatic control of radio sets and electric appliances. At any predetermined time, can be set to turn "on" and "off" for any period of time not over 5 hours nor less than 10 minutes. Convenient appliance outlet at rear. Visual signal indicates any current interruption. Dark walnut bakelite case. Size, 4 1/2" x 4 1/2". For 90-120 volt, 60 cycle AC.  
D18329—List, \$8.75.  
YOUR PRICE..... **\$5.44**



## Westminster Door Chimes

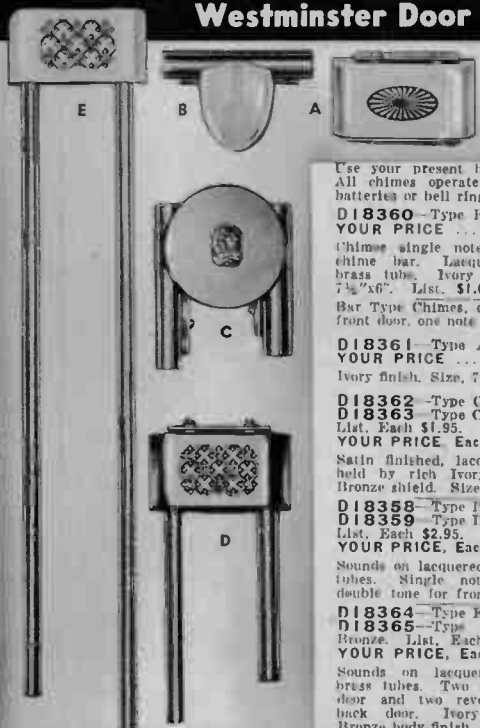

Take the place of harsh, disturbing conventional door bells.

Use your present bell wiring system. All chimes operate from 6 Volt dry batteries or bell ringing transformers.

D18360—Type B.  
YOUR PRICE..... **68¢**

Chimes single note on gold finished chrome bar. Lacquered satin finish brass tubes. Ivory finish body, size, 7 1/2" x 6". List, \$1.00.

Bar Type Chimes, chime two notes for front door, one note for back door.

D18361—Type A.  
YOUR PRICE..... **85¢**

Ivory finish. Size, 7" x 4 1/2". List, \$1.29.

D18362—Type C. Ivory finish.

D18363—Type C. Bronze finish.  
List, Each \$1.95.  
YOUR PRICE, Each..... **\$1.28**

Satin finished, lacquered brass tubes, held by rich Ivory or Old English Bronze shield. Size, 7" x 8".

D18358—Type D. Ivory Finish.

D18359—Type D. Bronze Finish.  
List, Each \$2.95.  
YOUR PRICE, Each..... **\$1.98**

Sounds on lacquered satin finished brass tubes. Single note for back door, double tone for front. Size, 7 1/2" x 4 1/2".

D18364—Type E. Ivory Finish.

D18365—Type E. Old English Bronze. List, Each \$3.95.  
YOUR PRICE, Each..... **\$2.68**

Sounds on lacquered satin finished brass tubes. Two notes for the front door and two reverse tones for the back door. Ivory or Old English Bronze body finish. Size, 7" x 3 3/8".



# Appliance Super Values

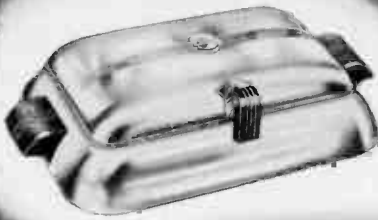

## Superior Sandwich Toaster

With Heat Indicator

Toasts, grills, broils or fries right at the table. Extra large grids with smooth dull aluminum finish have overflow spouts. Handy cup catches excess grease. Accurate heat indicator shows when proper temperature for cooking has been reached. Chromium finish with natural walnut handles. Quick action, steel enclosed, 660 watt Nichrome Elements. For 110-125 Volt, AC-DC. Furnished with 6 foot cord and plug set. Underwriters' Approved.

**D18332**—List, \$5.25. **YOUR PRICE**..... **\$3.38**

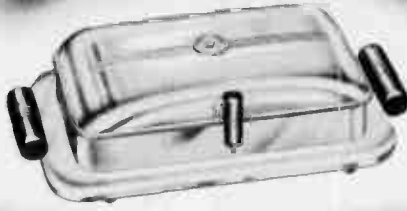

## Superior Sandwich Toaster

With Heat Indicator

Extra value with many quality features. Quickly toasts, broils or fries right at the table. An extra convenience, making snacks or lunches a pleasure to prepare. Accurate heat indicator shows proper heats for heat results. Has extra large sized grids with smooth dull aluminum finish. Speedy steel enclosed 660 watt nichrome elements. Chromium finished with strong wood handles. Each grill has overflow about catching excess grease in handy drip cup. Underwriters' Approved. For 110-125 Volt AC-DC. Furnished with 8 foot cord and plug.

**D18334**—List, \$3.65. **YOUR PRICE**..... **\$2.29**



## Samson Deluxe Electric Heating Pad

**D18335**—Set of removable cast aluminum waffle grids for use with either of above Superior toasters. List, \$1.75. **YOUR PRICE**..... **\$1.18**



**D18336**—Complete with set of cast aluminum waffle grids. List, \$6.95. **YOUR PRICE**..... **\$4.69**

Grills and fries—toasts sandwiches or bakes double size waffles. Heat indicator shows when proper temperature has been reached for cooking. Both grids have "no-drip" drain. Special cup catches excess grease. Self-adjusting hinges allow for expansion. Fast heating 660 watt nichrome element. Finished in gleaming chromium with walnut handles. For 110-125 V. A. or D.C. 6 ft. cord set. Underwriters' Approved.

## Samson Deluxe Electric Heating Pads

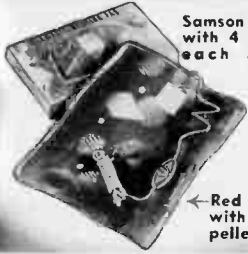

Samson 3 Fixed Heats with 4 thermostats on each heat. Water, stain and perspiration resistant covers.

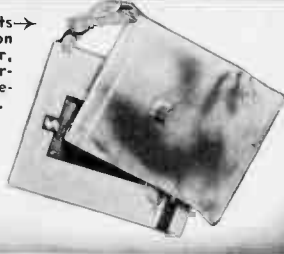

Red Seal 3 Heat with water repellent cover.

Deluxe heating pads incorporate every feature for safety, convenience, and comfort. 3 fixed heats. Low 125°. Medium 150°. High 175°. 4 thermostats keep heat absolutely constant at selected temperature. Desired heat is selected on new type strain relief rotary switch. Fabric of covers treated by new process making them impervious to moisture, stain, and perspiration. Pads can be used with perfect safety for wet applications and compresses. Size 12"x13". Underwriters Approved wetproof. 55 Watts, 115 Volts AC or DC. 8 ft. cord and plug.

**D18262**—Genuine Wetproof Blue Fleeceette Cover. List, \$3.95. **YOUR PRICE**..... **\$2.89**

**D18263**—As described above but not wetproof. Permanent cover, tan flannel, extra green angorine cover furnished is water repellent. List, \$2.95. **YOUR PRICE**..... **\$2.18**

**D18261**—Red Seal 3 heat pad similar to above but with 2 thermostats only and not wetproof, but water repellent. List, \$1.95. **YOUR PRICE**..... **\$1.19**

## Handi-Hot Electric Washer



**D18397**—List, \$14.95. **YOUR PRICE**..... **\$9.98**



Washes up to two pounds (dry) clothes, with same action as a full size washing machine, insuring absolutely clean clothes in a minimum of time. Compact and portable can be used anywhere, in park, on table, stool or chair. Separates into three units that anyone can easily handle. Ideal for mother with baby clothes to wash daily, for the small apartment where space is at a premium, for college girls, tourists, in fact anyone who is interested in cutting laundry bills. Direct motor drive guarantees maximum power to impeller—no pulleys or belts. Gears, sealed tightly in lifetime lubricated case. Positively no oil leakage and no further lubrication necessary. Operates on 110-125 volt, 50-60 cycle current. Exceptionally quiet in operation. Underwriters' Approved. Furnished with approved cord and plug set.

**D18398**—Sturdily constructed, hand wringer for above washer. Has tension adjustment and full 7/4" soft rubber rollers. White enamel finish. **YOUR PRICE**..... **\$3.95**



## Broil King Electric Table Broiler



**D18275**—List, \$13.90. **YOUR PRICE**..... **\$8.85**

Broils, toasts, bakes and reheats delicious dishes right at the table. Has cooking area of 125 square inches—enough for eight good-sized chops, a 4 1/2 lb. steak, two broiling chickens (2-3 lbs. each), or 6 slices of toast. Intense direct heat quickly sears outside of food, sealing in all the natural juices and retaining full vitamin content. Has non-chip porcelain enameled drip pan and bright wire grill adjustable to two heights. Automatic heat indicator and positive high-low heat regulation eliminate all guesswork. High chromium content heating element is encased in a black-glazed chip-proof refractory plate. Element is easily removed for cleaning it and the broiler. Broiler is quickly cleaned by wiping with dish cloth soaked in hot soap suds. Two-piece hinged construction with triple-plated chromium surface. Handsome bakelite trim. Handles and legs are heat-proof. Equipped with detachable cord set and two-heat plug. Rated at 1000 Watts high heat and 450 Watts low heat. 110-125 Volts AC-DC operation. Underwriters' Approved.



encased in a black-glazed chip-proof refractory plate. Element is easily removed for cleaning it and the broiler. Broiler is quickly cleaned by wiping with dish cloth soaked in hot soap suds. Two-piece hinged construction with triple-plated chromium surface. Handsome bakelite trim. Handles and legs are heat-proof. Equipped with detachable cord set and two-heat plug. Rated at 1000 Watts high heat and 450 Watts low heat. 110-125 Volts AC-DC operation. Underwriters' Approved.

## Hollywood Electric Table Broiler

**D18273**—Standard Size 13 1/2 x 9 1/2" 1150 Watt Element. List, \$7.95. **YOUR PRICE**..... **\$5.20**

**D18274**—Family Size 19 x 11" 1450 Watt Element. List, \$11.95. **YOUR PRICE**..... **\$7.95**

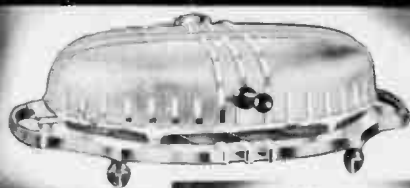

A cast aluminum electric table broiler made to last a lifetime. Cooks steaks and chops—rare, medium and well done in from 8 to 15 minutes. Serve piping hot right from the sizzle platter to the plate, right at the table. The heavy cast aluminum top eliminates heat loss and lowers current consumption. Economical for all meats, fish, toasted sandwiches, etc. First aid for the clever hostess—always ready for unexpected guests. Just bring out the Hollywood Broiler and have a tasty meal ready in 15 minutes. Aids attraction to the table. Easy to operate. Results are always good because heat is controlled. No burning—no smoking. Broiling rack furnished for the steaks and chops. Other meats broil right on cast aluminum steak platter. All juices collect in three grooves with gray veal at one end. Has air-cooled bakelite feet and handles. For 110-125 volt AC-DC. Furnished with cord and plug set.

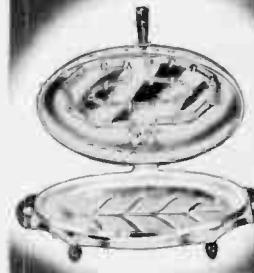

Simple in construction, sturdy, removable nichrome element in the broiler top.

# EVERHOT De Luxe Electric Roaster

Cooks a Full Meal at One Time for the Whole Family

## Features

- Turn-a-Knob Cover Lifter • 18 quart. (22 lb. Turkey) Capacity
- Adjustable Automatic Temperature Control 150° to 550° • Heating Element Surrounds Cooking Well • Hi-reflector Rust-proof Hinged Cover • Utensil Elevating Rack • 6 Piece Utensil Set • Built-in Timer on Floor Cabinet.

**D18515—A—Everhot DeLuxe Electric Roaster.** Equipped with large inset pan, rack, drip pan, 6 piece White Vitreous enameled utensil set, escape back and cord set. List Price, \$24.95. **\$16<sup>21</sup>**  
YOUR PRICE

Cooking the easiest way by under, top, and bottom and radiant heat. With the new Everhot electric roaster you can cook a full meal at one time. Turn-a-Knob Cover Lifter and Utensil Elevating Rack. Hi-reflector Rust-proof Hinged Cover. Utensil Elevating Rack. 6 Piece Utensil Set. Built-in Timer on Floor Cabinet. Adjustable Automatic Temperature Control from 150° to 550° to suit the requirements of practically any type of cooking. See set temperature to heat controller at any desired level. Signal light shows when heat is on. Heavy insulation keeps heat in, prevents scorching, heat is concentrated. Hi-reflector heating element surrounds cooking well and distributes radiant heat. Turn-a-Knob Cover Lifter. Heat reflecting rust-proof cover opens and closes with a slight turn of the knob with bakelite knob on front of cover. Support to remove food without touching cover—no danger of burns or scalds. Cover has automatic vent-fanator 18 quart capacity, large enough to hold a 22 lb. turkey. Accessories included. Removable inner roasting pan, drip pan, adjustable enamel sliding baking and broiling rack, 6 piece white vitreous enameled utensil set including egg separator, meat fork, meat rapier, meat slicer, 48 quart covered vegetable bin, and two covered vegetable bins with a total capacity of 96 quarts. All accessories polished and easily removed for cleaning. Details of roaster is finished in scratch bakelite with chrome trim and chrome feet. Oven and cover with air circulation controlled. Air cooled bakelite handles. Overall outside dimensions, 21" x 12 1/2" x 12 1/2". Underwriters Approved, 1320 Watts. For 105-125 volt AC operation.

## Accessories

**D18590—B—Streamlined Cabinet** with built-in timer clock. "Timer Clock" sets roaster into operation at any desired time and turns it off after selected time interval. Cabinet has inside shelves for all accessories including broiler and griddle. White vitreous enamel finish to match roaster. Size 30" high 24" wide 18" deep. List \$11.95. **\$7<sup>76</sup>**  
YOUR PRICE

**D—Dish Fixture** holds roaster, broiler, egg separator in cabinet for utensils and other appliances.

**D18591—C—Broiler Attachment.** Fits on roaster body in place of cover. Scientifically designed to concentrate heat rays on every inch of broiling surface. 1500 Watt element is easily removed for cleaning. List, \$3.48. **\$2<sup>24</sup>**  
YOUR PRICE

**D18592—D—Griddle Attachment** for use with broiler. Broiler reverses and fits under griddle for frying. List, \$1.50. **98¢**  
YOUR PRICE

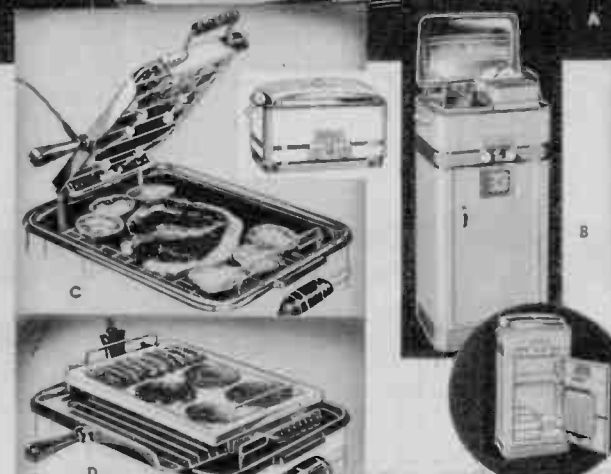

## EVERHOT Electric Rangette

A compact, complete, fully portable cooking unit that is just the thing for the small apartment, housekeeping home or as an auxiliary to the regular kitchen stove. Performs practically every cooking function. Broils, bakes, toasts, fries and roasts. Occupies less than 2 1/2 square feet of space, and may be used with perfect safety on the dining room table. Patented rotating W-heat attachment for a wide range of broil and roast. The use of higher heat in both broiling and roasting. Round burner for quick frying, cooking coffee, etc. Square burner has large removable aluminum griddle which can also be used as a frying pan on the round burner. Griddle reflects heat downward during broiling. Broiler-type broiler toasts two slices of bread in five minutes, broils 1 lb. steak in seven minutes. Has two-position electric rack. Finishes in white enamel with porcelain enamel top. List, \$19.95. **\$12<sup>96</sup>**  
YOUR PRICE



**Oven for Electric Rangette**  
Rearfully finished over the rear square burner of Rangette. Has ample capacity. Equipped with aluminum heating pan and two shelves. Has heat reflector in top. Finishes in white with bakelite handles and chrome trim. List, \$7.00. **\$4<sup>55</sup>**  
YOUR PRICE

## Everhot Electric Table Grill

### HOTEL-QUALITY BROILING AND FRYING AT LOW COST . . .

An attractive portable table top grill that combines the principal features of the electric stove and electric broiler. Broils, Toasts, Stews or Fries quickly and efficiently. Easily changed for different cooking operations. A complete breakfast or supper can be prepared right at the table so that the hostess can be with her guests and at the same time prepare a tasty, appetizing meal. Quick-sear broiler seals flavor in. Holds a good sized steak or two halves of a spring chicken. Broiler rack is adjustable in height for either thick or thin steaks and chops. Toasts six slices of bread in five minutes from a cold start. Removable broiling pan can be used on top of grill for stewing and quick heating of soups, meats and left-overs. Thick aluminum combination top and griddle flows better frying with less grease. Griddle has enamel grease collector and is removable for easy cleaning. Acts as heat reflector during broiling. Makes perfect pan-cakes, bacon and eggs, etc. Size of griddle, 12 1/2" x 12 1/2". Grill has beautiful chrome body with walnut handles and feet. Will not mar table-top. Two heats obtained by plugging into different terminals. Hinged element has bakelite safety lifting handle. Complete with dark blue removable burner cord. 1500 Watts. For 105-125 volt AC operation. List, \$9.95. **\$6<sup>47</sup>**  
YOUR PRICE





# MAKE EXTRA PROFITS

# ON THESE AUTOMOTIVE ITEMS EVERYONE NEEDS

## DeLuxe Hot Water Heater For All Cars

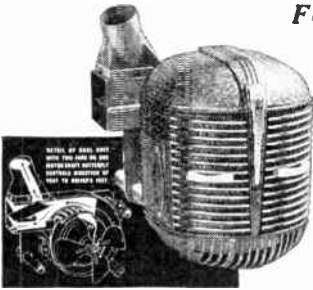

**C18353—Single Blower Unit.** Illustrated but without individual (rear) defroster blower fan. Has outlet on side for attaching windshield defroster unit. List, \$16.95. **YOUR PRICE, \$8.15**

**C18352 — With Dual Blower Unit.** Separate fan drives warm air through the defroster outlets and also directs air to the driver's feet. Defroster attachments are not included. List Price, \$19.95. **YOUR PRICE, \$9.52**

Fits any make or model car or truck and floods warm air into all parts of the car. A powerful 6 volt silent running electric motor drives the fan, forcing air under high pressure through the 48 tube 3", 4 row tubular core heating unit. Motor has self-aligning, oil-less bearings. Illuminated glassless thermostat switch controls the speed of the motor to regulate the amount of heat. Entire heater is sturdily constructed and attractively designed. Finished in reddish-brown crackle enamel. Two adjustable deflectors at front point the heat in any direction. Opening at lower front directs heat to floor. Supplied with all necessary fittings, hose and mounting hardware for quick installation.

## Custom Defroster Attachment

We can supply a windshield defroster attachment for either of the above heaters to exactly fit the vents provided in most late model cars (1937, '38, '39 and '40) having entire installation concealed behind dash board. Older type car, not having vents use a universal model with rubber suction cups for exposed attachment to windshield.

**C18366—Specify Car Make, Year and Model.** **YOUR PRICE, Each, \$1.96**

## Trail Blazer Musical Auto Horn

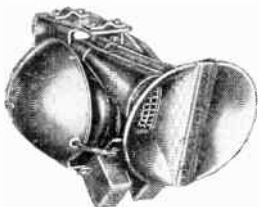

**D18600—Complete with wiring dual relay assembly, mounting bracket and steering column mounting control switch.** For 6 volt DC use. List Price, \$10.95. **YOUR PRICE, \$4.85**

Compact, powerful electric twin horn that sounds one, two or three clear, commanding tones. Wired with built-in dual relay. Easily and quickly installed anywhere, and is particularly adapted to cars having limited underhood space. Control bar is easily clamped to the steering column so that horn button is accessible to driver. Can be installed for either right or left hand operation, on cars having shift lever on steering column, control bar can be put on the left. Control bar is finished in durable metal-lacquer with attractive plastic finger-tip knob. Horn is finished in durable metal-lacquer. Grilles are rust proofed and plated. Size of horn, 7 1/2" x 7 1/2" x 11".

while his hands are still on the wheel. Can be installed for either right or left hand operation, on cars having shift lever on steering column, control bar can be put on the left. Control bar is finished in durable metal-lacquer with attractive plastic finger-tip knob. Horn is finished in durable metal-lacquer. Grilles are rust proofed and plated. Size of horn, 7 1/2" x 7 1/2" x 11".

## Trail Blazer Twin Blast Horn

**D18601—Same** as above but delivers a single, powerful but pleasing tone blast signal. Has single relay unit instead of dual-relay. Switch included. List Price, \$9.50. **YOUR PRICE, \$3.87**

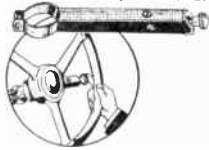

## Bumper-Grille Guard

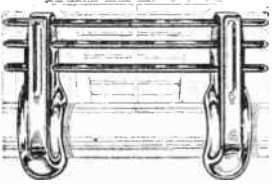

**Sturdy Triple Channel Construction**

**D18602—List Price, \$4.25. YOUR PRICE, \$2.25 \$2.06**

In Lots of 3 or More, Each...

Sturdily constructed and attractively finished in durable, long lasting chrome. Designed to give protection to radiator grille and to improve appearance of the car. Fits majority of cars having the conventional slightly curved type bumpers. Concealed welded "T" bolts. Adjustable width. Width of bars, 28". Overall height, 20". Easy to install.

## Sta-Clear Window Films



**Prevent Fogging and Frosting**

**D18603—List Price, \$1.00. YOUR PRICE, \$54c**

In 12 Lots or More, Each 49c

Thin perfectly transparent sheets that are applied directly to inside of automobile windshield, side and rear windows to prevent fogging and frosting caused by moisture condensation. Films guarantee safer driving and clear visibility in cold, snowy or rainy weather. Can be used in all seasons and all climates. Does not injure glass and can be easily removed with warm water. Practically invisible because they are thin and fit snugly against glass without any intervening indication. All necessary materials and equipment are included in the package. Each package contains two 8"x18" heavy films for windshields, two 7"x9" films for rear windows, two 7"x9" amber films for front door windows, two 7"x9" amber films for rear window, card of special Adhesive, wiper blade, sponge and complete instruction sheet.

## Sealed Beam Auxiliary Lights Driving—Passing—Fog Lights

**With Genuine Mazda Units**

**D18604—Driving Lamp.** For use on right side of car directing light over entire roadway. Equipped with Mazda #4010 unit and switch.

**D18605—Passing Lamp.** For use on left side of car directing light to the right and over road shoulder. Equipped with Mazda #4011 unit and switch.

**D18606—Fog Light, crystal lens.** Equipped with Mazda #4012 unit and switch. List Price, \$5.00. **YOUR PRICE, Either Type, \$2.65**

**D18607—Fog Light, amber lens.** Equipped with Mazda #4012A unit and switch. List Price, \$5.50. **YOUR PRICE, Each Lamp, \$2.91**

The single filament Mazda Sealed Beam units used in these lights are completely self-contained with lens, reflector and bulb built in a one piece hermetically sealed unit. Reflector never becomes tarnished or lens clouded. Gives over 50% more light than older styles and at the same time reduces glare almost entirely, relieving nerve and eye strain. 6 1/2" Diameter all-brass chrome plated shell. Malleable brackets with universal adjustment and theft-proof nuts. Lamps may be tilted in almost any position. Fits bumper brackets of any car. For 6 to 8 volt use.

**8" DeLuxe Sealed-Two-Beam Driving and Fog Light**

**D18608—Combination Two Beam Driving and Fog Light.** Equipped with Mazda #4030 Sealed Beam two-flament lighting unit. Can be used as fog light because it throws light down under fog. 8" Diameter all-brass chrome plated decorated shell with adjustable bracket. Switch included. List Price, \$7.95. **YOUR PRICE, Each Lamp, \$4.20**

**D18609—Supplied in pairs.** List, \$15.00. **YOUR PRICE, Per Pair, \$7.94**

## Sealed Beam Headlight Converters for Cars Prior to 1940—Mazda Units Included

Replace old-style dirt catching, tarnishable lights used on cars prior to the 1940 models, with these 50% more efficient Sealed Beam unit converters. Simple to install. No soldering necessary. Supplied in pairs complete with two Mazda Sealed Beam units.

Stock Num.	List Price	Your Price Per Pair
D18610	\$6.95	\$3.67
D18611	7.50	3.97
D18612	7.50	3.97
D18613	8.95	4.73
D18614	7.25	3.85



Make of Car	Year	Stock Numbers				
		1935	1936	1937	1938	1939
Buick, Chevrolet		18610	18610	18613	18613	18610
Cadillac, LaSalle, Oldsmobile		18610	18610	18613	18610	18610
Chrysler, DeSoto, Dodge		18612	18611	18612	None	None
Ford		18614	18614	18614	Write for Prices	Write for Prices
Hudson, Terraplane, Studebaker		None	18611	18611	18611	None
Lafayette, Nash		None	18611	18611	None	None
Packard 120-6, Pontiac		18610	18610	18610	18610	18610
Packard 8		18610	18610	18610	18610	18613
Plymouth		18612	18611	18611	18612	None

## Special Parking Lights For Above



**D18618—YOUR PRICE Per Pair, \$3.6c**

To be used only when parking lights are a part of the headlamps. Easily attached to the Sealed Beam unit. Bulb included. List Price, \$1.00.

## Unity Spotlights



**For Safety In High Speed Night Driving**

**D18345—6" Model with 160.000 CP beam.** List, \$12.50. **YOUR PRICE, \$8.57**

**D18346—6 1/2" Model with 170.000 CP beam.** List, \$15.00. **YOUR PRICE, \$10.29**

A quality automotive spotlight that provides a concentrated, non-glare, long distance light beam that will penetrate beyond the range of head lights. Fingertip pressure instantly directs this 1/4 mile beam in any direction. Beam is so powerful that it cuts through opposing glare to prevent blinding and shows up every road hazard. All parts are chrome finished. Furnished with bulb, wiring material and installation instructions. Specify car make, year and model when ordering.

## Mazda Sealed Beam Units

Consists of filament, reflector and lens constructed in a permanent, hermetically sealed one-piece unit. Gives more light and always remains bright. Type #1030 (7" dia. 2 filament) used for replacement in new type automotive headlights, others are 5 1/2" dia. with one filament and used in auxiliary lighting equipment. For 6 to 8 volt use. Crystal lens. \*Has amber lens.

Stock Num.	Mazda Num.	Use	List Price	Price Ea.	1-8-4-Up
D14290	4030	Drive	\$1.10	76c	71c
D14291	4040	Drive	1.10	76c	71c
D14292	40M1	Pass	1.10	76c	71c
D14293	40M2	Fog	1.10	76c	71c
D14294	4012A	Pog*	1.35	93c	88c

## Red Seal Auto Fan



**D18201—6" 6 Volt DC Fan.** **YOUR PRICE, \$2.08**

3 for \$5.97

Powerful rubber-bladed fan for use in any automobile. Serves as air circulator on hot days and as windshield defroster in winter. Sturdy, quiet motor with walnut bakelite shell. Two speed switch. Adjustable bracket for mounting on steering column or header board. Complete with cord and connectors.

# NOMA XMAS TREE LIGHTS

## Noma DeLuxe Multiple Wired Sets For Indoor Use



No More Hunting Burned Out Bulbs  
7 Light Set

D14604—Seven Light Multiple Wired Set complete with 7 Mazda type C 7½ lamps in assorted colors. List, \$1.20.

YOUR PRICE, Each, **82c**  
In Lots of 12, Each, ..... **78c**

15 Light Set

D14605—Fifteen Light Multiple Wired Set complete with 15 Mazda type C 7½ lamps in assorted colors. List, \$2.60.

YOUR PRICE, Each, **\$1.78** **\$1.69**  
In Lots of 12, Each, .....

20 Light Set

D14606—Twenty Light Multiple Wired Set complete with 20 Mazda type C 7½ lamps in assorted colors. List, \$3.45.

YOUR PRICE, Each, **\$2.35** **\$2.24**  
In Lots of 12, Each, .....

25 Light Set

D14607—Twenty-five Light Multiple Wired Set complete with 25 Mazda type C 7½ lamps in assorted colors. List, \$4.20.

YOUR PRICE, Each, **\$2.88** **\$2.74**  
In Lots of 12, Each, .....

The DeLuxe set for indoor decorating. Each lamp burns independently—no more hunting for burned out lamps. Has the patent BERRY BEADS that hold the lamp in any position. Furnished with washers to keep lamps tight in sockets and to prevent possible short circuits. ADD-ON extension connection for plugging in additional sets on same outlet.

### 8 Light Loop-Type Outfit



For Indoor Use

D14600—Complete with 8 Mazda type C-6 cone shaped lamps in assorted colors. List, 75c.  
YOUR PRICE, Each, **52c**  
In Lots of 12, Each, ..... **49c**

An excellent, popular priced, Noma loop-type, Christmas tree light set for general indoor use as display lighting or for Christmas tree decoration. This set has the patented, adjustable BERRY BEADS that permit easy attachment to any part of the tree. The plug furnished, permits additional sets to be plugged into the same outlet. Comes attractively packed in a colorful merchandising carton. These outfits are fully approved, by the Underwriters Laboratories, for complete safety.

### 8 Light Glolite Outfit

Series wired. Uses 15 volt Mazda type C6 lamps. Furnished with Add-On plug. Complete with lamps. D14601—List, 75c.

YOUR PRICE, Each, **45c** **42c**  
In Lots of 12, Each, .....

### 7 Lt. Red-Cap Multiple Wired Sets



For Outdoor Use

D14608—List, \$1.65.  
YOUR PRICE, Each, with 7 Mazda type D-9½ lamps in assorted colors, **\$1.13**  
In Lots of 12, Each, ..... **\$1.08**

The ideal Noma outdoor set. Thoroughly weather-proofed. Ideal for all types of decorating where maximum brilliance is required. Spring base socket for positive connection. 13½ feet of multiple wired cord. Has ADD-ON extension connection.

### 8 Light Festoon Type Outfit For Indoor Use



Type Outfit For Indoor Use

D14602—List, 90c.  
YOUR PRICE, Each, with 8 Mazda type C-6 cone shaped lamps in assorted colors, **63c** **59c**  
In Lots of 12, Each, .....

Noma festoon type outfit arranged in a single line allowing greatest flexibility in Christmas decoration. ADD-ON connection provided with each set permits the use of additional outfits or other illuminated decorations which can be plugged in on the same outlet. Has patented BERRY BEADS for convenient attachment to the Christmas tree branches. Each outfit comes packed in a colorful, convenient self-merchandising carton. Fully approved by the Underwriters Laboratories for complete safety in use.

### DeLuxe Festoon Outfit



D14603—List, \$1.00.  
YOUR PRICE, Each, **70c** **66c**  
In Lots of 12, Each, .....

Same as 8 Light Festoon Outfit above except ADD-ON extension connection at both ends to produce long continuous string of lights.

### Noma Multiple Wired OUTDOOR Sets

Noma sets for use on larger trees or where more extensive lighting is required. Same features as Red-Cap multiple wired outfits to the left except larger in size. Uses Mazda 120 Volt C-9½ lamps.

Stock Num.	Num. of Lamps	List Each	YOUR PRICE	
			Each	10 Lots, Each
C14609	15	\$3.40	\$2.33	\$2.22
C14610	20	4.60	3.16	3.01
C14611	25	5.50	3.77	3.60

### 7 Light Outdoor Outfit

D14612—List, Each, \$1.65.  
YOUR PRICE, Each, **\$1.05** **97c**  
In Lots of 12, Each, .....

"Glolite" set uses 7 MAZDA 120 volt type C-9½ lamps in assorted colors. Has the ADD-ON connection. Multiple wired and fully weatherproofed.

## Genuine Mazda Christmas Tree Lights Type C6

15 Volt—Miniature Base  
The standard 15 volt lamp used universally on 8 light series type strings. Size ¾" D.-2" H.

Stock Num.	Color	List Each	Your Price	
C14613	Red	5c	10 for	36c
C14614	Blue	5c		
C14615	Green	5c		
C14616	White	5c	100 for	1,000
C14617	Orange	5c		
C14618	Asstd.	5c	3.43	\$1.85



### Type C-7½

120 Volt—Candelabra Base —7 Watt

For use with multiple sets where each lamp burns independently. For indoor use only. Outside colored. Size 1" D.-2" H.

Stock Num.	Color	List Each	Your Price	
C14619	Red	7½c	10 for	52c
C14620	Blue	7½c		
C14621	Green	7½c		
C14622	White	7½c	25 for	100
C14623	Orange	7½c		
C14624	Asstd.	7½c	\$1.28	\$4.90



### Type C-9½

120 Volt—Intermediate Base—10 Watt

For outdoor use. Colored on the inside of glass to prevent color from scratching or fading. Size 1½" D.-3¾" H.

Stock Num.	Color	List Each	Your Price	
C14625	Red	10c	10 for	75c
C14626	Blue	10c		
C14627	Green	10c		
C14628	White	10c	25 for	100
C14629	Orange	10c		
C14630	Asstd.	10c	\$1.86	\$4.30



## New Noma Tree Holder

All Metal Type

Keeps Tree Straight

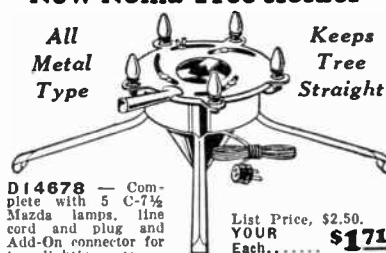

D14678—Complete with 5 C-7½ Mazda lamps. Line cord and plug and Add-On connector for tree lighting sets. List Price, \$2.50.  
YOUR PRICE, Each, ..... **\$1.71**

New self centering feature automatically makes tree stand straight. Simply place the trunk of the tree in the self centering water well, push the handle and watch the three holding prongs bite their way into the trunk which is now straight and securely held in place. Tighten the locking thumbnut and the job is done. 7 Mazda lamps of assorted colors in the tree-holder base furnish a real decorative touch. Attractively finished in red, green and silver.

## Jolly-Lite Tree Base

With 8 Mazda Lamps



D14679—Complete with 8 Mazda Lamps in assorted colors, line cord and plug and Add-On connector for tree sets. List Price, \$3.50.  
YOUR PRICE, Each, ..... **\$2.45**

A sturdy, attractive Noma tree base, illuminated with 8 colored Mazda lamps. Well holds 2 quarts of water, keeps tree fresh and fragrant. Pin in base keeps tree from shifting. Three screws keep tree firm and straight. Attractively decorated with red legs and ivory base with Xmas design.



# Newest Christmas Decorations

## Electric Wreaths Red Silk Chenille

D14632—10" Diameter.  
List, Each, 50c. **32c**  
**YOUR PRICE, 29c**  
In Lots of 12, Each,.....

Beautiful red silk chenille wreaths decorated with holly leaves and poinsettia flowers. Burns one 120 volt MAZDA type C-7½ lamp, set in an ivory candle. Furnished with ample cord and ADD-ON plug. Underwriters' Approved. Packed in individual carton.

D14633—Same as above except 12" in diameter. List Each, 60c.  
**YOUR PRICE, Each, 38c**  
In Lots of 12, Each,..... **35c**

D14634—Same as above except 12" in diameter and furnished with two candles and lamps. List, Each, 80c.  
**YOUR PRICE, Each, 51c**  
In Lots of 12, Each,..... **47c**



## Electric Cross

Red Silk Chenille  
D14535—  
List Each, \$1.60.

**YOUR PRICE, \$1.02**  
In 24 lots, Each

**94c**

A red silk chenille electric cross, 11" high by 8" wide. Fitted with 11 MAZDA T-4 red lamps. Underwriters' approved cord has ADD-ON connector.

D14636—Same as above except white silk chenille with blue lamps.

**YOUR PRICE, Each, \$1.02**  
In lots of 24, ea., **94c**

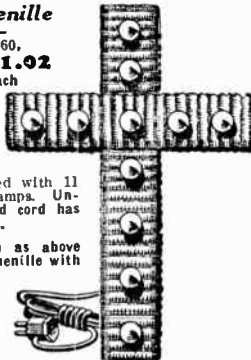

## GloLite Xmas Trees

Colorful Lustrous Rayon

Packed One to a Carton

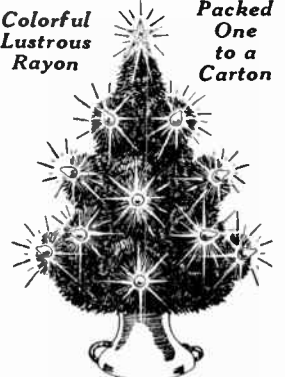

GloLite Christmas trees in green or white lustrous rayon. One bulb "lights" 17 miniature lamps on the 12" size and 21 lamps on the 15" size. Individually packed.

Stock Num.	Size & Color	List Each	Your Price	12	Each
D14653	12" G.	\$1.50	\$0.96	\$0.88	
D14654	12" W.	1.50	0.96	0.88	
D14655	14" G.	2.00	1.27	1.17	
D14656	14" W.	2.00	1.27	1.17	

## Holly Wreath

D14670—12" Dia. With single candle, Mazda lamp and cord.  
List, 95c  
**Your Price, Each, 65c**  
In 12 Lots, Each

**61c**



Noma Illuminated Holly Wreath of closely gathered, green holly leaves, with mistletoe berries interspersed for contrast. Very effective window, mirror and room decoration. Complete with Mazda C-7½ 120 V. AC-DC Lamp and cord with Add-On Connector.

D14671—15" Diameter with single candle, List, \$1.25.  
**YOUR PRICE, Each, 86c**  
Each, In Lots of 12,..... **81c**

D14672—20" Diameter with 3 candles, and C-7½ 120 Volt AC-DC Mazda Lamps. Each lamp burns independently. List, \$2.50.

**YOUR PRICE, Each, \$1.71**  
Each, In Lots of 12,..... **\$1.64**

## Neon Effect Star For Top of Tree

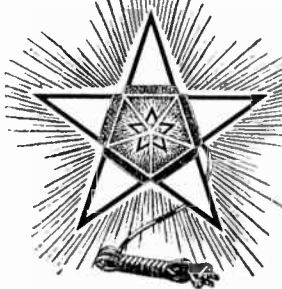

D14637—List, \$1.00.  
**YOUR PRICE, Each, 69c**  
In Lots of 12, Each,..... **66c**  
A 5 pointed star cleverly made of sheet metal with 5 glass tips, measuring 9" across. A beautiful decoration for the top of the Christmas tree or for hanging in the window or on the door. Fitted with one MAZDA 120 volt type C-7½ lamp. When the star is illuminated, the light on the 5 glass tips produces a warm red glow giving the effect of neon lighting at all edges of the glass. Furnished complete with lamp, cord and plug, packed in individual cartons.

## "Merry Xmas Star" For the Top of Tree



D14638—List, \$1.00.  
**YOUR PRICE, Each, 69c**  
In Lots of 25, Each,..... **66c**  
This beautiful 8 light, metal constructed, star of Bethlehem. Gracefully designed with 5 bakelite sockets and a special stem to facilitate its use as a top-of-the-tree decoration. Five MAZDA type C-6 15 Volt lamps illuminate the star tips. A concealed lamp illuminates the words "Merry Christmas" in the body of the star. Furnished with cord and miniature attachment plug for connecting to any 8 light, series wired, tree-lighting set. Come individually packed.

## Noma Trees With Individual Branches and Lights

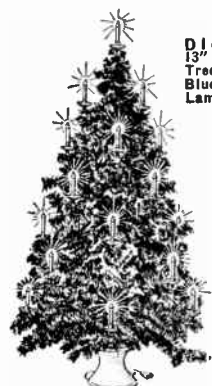

D14648—13" White Tree with 10 Blue Mazda Lamps.

**YOUR PRICE, Each**

**\$1.96**

Just plug in. All the effectiveness of real trees but none of the inconvenience. Economical—Durably constructed—Will last for years. Comes complete with T-4 Mazda lamps, extension cord and add-on connector.

Stock Num.	Size & Color	Num. Lts.	List Price	Your Price
D14647	13" Green	10*	\$3.00	\$1.96
D14648	22" Green	20*	6.50	4.26
D14650	22" White	20†	6.50	4.26
D14651	31" Green	32†	12.00	7.84
D14652	31" White	32†	12.00	7.84

\*Ast. Colors †All Blue

## Illuminated Candeliers

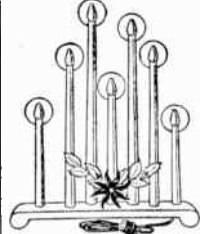

D14673—New Noma Artistic Candeliers with 7 lighted tapered candles equipped with C-7½ 120 V. AC-DC Mazda lamps and new device which produces a halo glow-effect. Sturdy base of new design. Silver holly spray across the candles. Can be used on windows, mantelpiece, buffet, over fireplace, on piano or radio, etc. Complete with cord and Add-On-Connector plug. List, \$3.50.  
**YOUR PRICE, Each, \$2.45**  
Each, In Lots of 6,..... **\$2.30**

## Illuminated Xmas Bells

Rich luminous effect of lights shining through a cluster of cellophane bells with cellophane bow and silver berries. Packed in individual display boxes. Complete with C-7½ 120 V. AC-DC Mazda bulbs and cord with Add-On-Connector plug.  
D14674—12" Cluster of two 5" Bells. List, \$2.50.  
**YOUR PRICE, Each, \$1.28**  
Each, in Lots of 12,..... **\$1.23**  
D14675—14" Cluster of 5" Bells. List, \$4.00.  
**YOUR PRICE, Each, \$2.06**  
Each, in Lots of 6,..... **\$1.96**  
D14676—Large 4" Bell with red foil ribbon. List, \$1.33. **YOUR PRICE, Each, 69c**  
Each, in Lots of 12,..... **66c**



## Christmas Candle



New Noma 10" Illuminated antique ivory drip Christmas candle, trimmed with Poinsettia and silver leaves with princess pine spray. Comes with Halo Glow Device and C-7½ 120 Volt AC-DC Mazda lamp. Nickel silver finish base. A very effective decoration for use on windows, mantelpiece, buffet, over fireplace, on radio, etc.

D14677—10" Illuminated Christmas Candle complete with C-7½ Mazda Lamp, cord and Add-On Connector plug. List, 92c.  
**YOUR PRICE, Each, 63c**  
Each, in Lots of 24,..... **60c**

## Kristel-Krome

Aluminum Foil Ornaments

Will Not Tarnish or Break



D14680—Assortment of 26 Gleaming Kristel-Krome ornaments—enough to decorate a whole tree. Stars, Cones, Balls and Bells are made of brilliantly shining aluminum foil in many colors. Unbreakable and tarnish-proof. Kristel-Krome ornaments may be kept and added to from year to year. Come packed in attractive display carton. List Price, \$1.00.  
**YOUR PRICE, 58c**  
Per Assortment of 26 Ornaments

## Electric Altar

Lighted Cross Lighted Candles and Picture

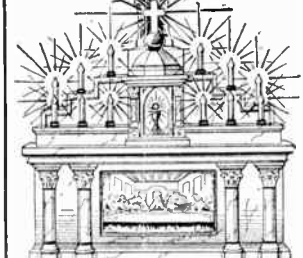

By means of GloLite's patented construction, one bulb lights up the cross, 12 candles and the painting of the "Last Supper" on the face of the altar. A generous sized display 12" across, 5" deep and 15" high, this altar makes a wonderful decoration for the Christmas season. There are three statutory motifs available. \*Mother of Grace, †Sacred Heart of Jesus and †Sacred Heart of Mary.

Stock Num.	Motif	List Price	Your Price	Lots of 6
D14663	*			
D14664	†	\$5.75	\$3.62	\$3.38
D14665	†		Each	Each



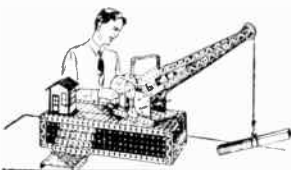

Built With No. 6 1/2 or Over

# FAMOUS GILBERT ERECTOR

REG. U.S. PAT. OFF.

Re-designed—Modernized—Electrified  
The World's Greatest Construction Toy

More new things to build than ever before. Erector sets are fast selling because they are the only construction sets that use the square girders that simulate real construction work. They are easy to assemble and any young boy can easily duplicate the many interesting items shown in the "How-to-Make-'Em Book" which is included with each set. These sets help make the boy constructive minded and help him to gain much valuable knowledge in engineering. Packed in attractively colored boxes which also serve as display cases.

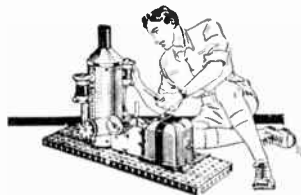

Built With No. 7 1/2 or Over

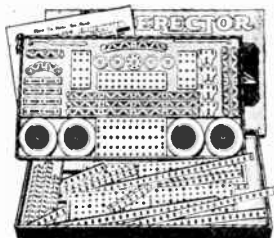

**Model 3 1/2  
Erector**  
D18551—  
List Price, \$3.50.  
**YOUR PRICE**  
**\$2.29**

The Intermediate Set. A very fine inexpensive set with a great variety of building possibilities. Will build derricks, walking beam engine, lift bridge, snow remover, trucks, wagons, etc. Includes many new big base plates, a number of various sized angle, curved and straight girders, 4 large and 4 small wheels, shafts and assembling hardware and tools. How-to-Make-'Em Book is also supplied which shows many interesting items that may be duplicated with this set. Packed in attractively colored box, size 18x10x1 1/4".

**Model 6 1/2  
Erector**  
D18553—  
List Price, \$7.95.  
**YOUR PRICE**  
**\$5.19**



The First Set With Electric Motor that operates on 110 volts 60 cycle AC. Builds airplane ride, windmill pump, airplane hoover, pile driver, etc. Also includes 4 miniature tender's house, various sized curved, straight and angle girders, large and small base plates, 4 large and many small wheels, shafts, assembling tools, hardware and How-to-Make-'Em Book. Packed in metal cabinet, size 16 1/2 x 8 1/2 x 2 1/4".

**Model 8 1/2 Erector**  
With Whistle  
Builds Ferris Wheel  
Magnetic Crane  
D18555 — List Price, \$12.95.  
**YOUR PRICE..... \$8.47**

Builds a great number of electrical operated devices which may easily be duplicated from the How-to-Make-'Em Book. This set features whistle, lights, 110 volt 60 cycle AC reversing electric engine and lifting magnet which is used for constructing magnetic cranes, derricks, etc.



Model 8 1/2 Also Includes an increased number of various sized, curved, straight and angle girders, base plates, end plates, shafts and 4 large truck wheels, many small wheels and gears, steam boiler, miniature tender's house, turret discs, assembling hardware, tools, etc. Packed in sturdy metal cabinet, size 20 1/4 x 12 1/4 x 2 3/8".

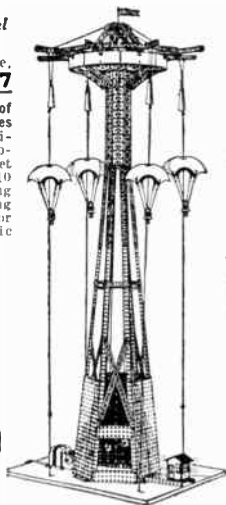
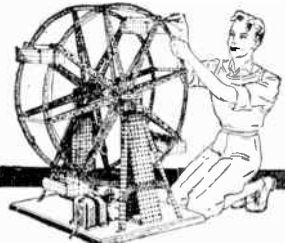

**Model 9 1/2 Erector**  
With Whistle and  
Parts to Build  
Parachute Jump

Also Builds  
Automobiles, Trucks,  
Giant Power Plants,  
Derricks, Etc.

D18556—  
List Price, \$18.95  
**YOUR PRICE..... \$12.39**

The Automobile Set. The greatest of all Erector sets. The most complete electric set on the market. Will build a great number of large motor operated devices such as mammoth walking beam engine, elevator, trucks, etc. Includes 110 volt, 60 cycle AC electric engine with reversible gears, electric lifting magnet, auto chassis parts, steam boiler, whistle, giant fly wheel, electric lights, miniature tender's house and a great number of various sized straight, curved, angle, channel and lattice girders, various sized base plates, end plates and shafts, 4 large truck wheels, many small wheels and gears, turret plates, and a large supply of assembling hardware with tools. How-to-Make-'Em Book offers many construction suggestions that are easily duplicated. Packed in colorful, sturdy metal cabinet with hinged cover, size 22 1/2 x 13 1/4 x 2 3/8".

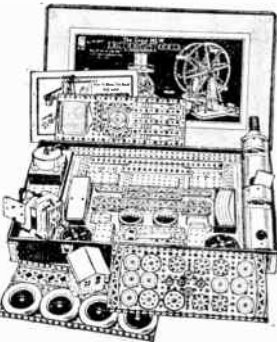

No. 5

## Gilbert Carpenter Tool Chests

No. 10

All real, quality tools—practical for play or actual carpentry use about the home. Each kit contains all necessary tools to do a good job of carpentry. A sensible gift for the constructive minded lad. Packed in strong steel cabinets. Inexpensive and useful.

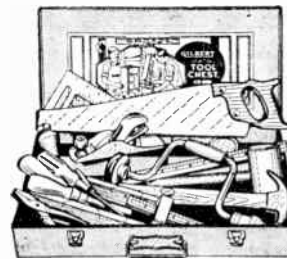

**Model 5**  
D18557—List, \$5.00.  
**YOUR PRICE..... \$3.26**

An inexpensive outfit containing 15 pieces of better grade tools for the young carpenter. Includes 16" crosscut saw, 7" die cast plane, brace with two jaw screw chuck and many other popular tools. Assembled in blue metal case with brass carrying handle. Size 18x10 1/4 x 2 3/8" Wt. 9 1/2 lbs.

**Model 10**  
D18558—List, \$10.00.  
**YOUR PRICE..... \$6.54**

The deluxe chest, containing 30 pieces. Includes 16" crosscut and rip saw, scroll saw, chisels, level, 8 1/2" plane, soldering iron, brace with wood auger bits, and many other popular tools. Packed in blue metal case with brass carrying handle and reinforced corners. Size 22x13 1/2 x 3". Wt. 19 lbs.

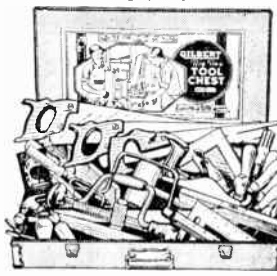



# GILBERT SCIENTIFIC TOYS

## New Gilbert Chemistry Sets

Newly designed in Gilbert's chemical laboratory in collaboration with one of America's outstanding chemical research laboratories under the direction of Treat B. Johnson, Yale University, Ph. D., Ph. D., a recognized authority on chemistry. These sets are up-

to-date with new chemicals, equipment and apparatus. Experiments as never previously offered in toy sets can be performed. Packed in useful sturdy wood cabinet with hinged doors. Chemicals are conveniently located.

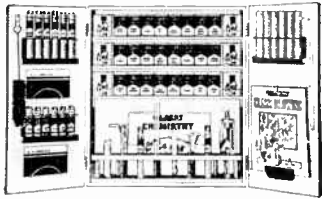

### Above—No. 6 Senior Chemistry Laboratory

D18559—List Price, \$5.00. **\$3.26**  
YOUR PRICE

Imagine making colored fire! Testing foods for their elements! Making sparklers, soda water! Tanning leather! More than 400 exciting chemical feats can be easily performed with this combination chemistry and glass blowing outfit. Contains 63 pieces of chemicals and apparatus including chemistry and glass blowing manual. Packed in two door blue finished wooden laboratory cabinet with five feet of metal shelf room and test tube racks. Size 26 x 14½ x 2½".

### Below—No. 15 Master Scientists Chemistry Laboratory

D18560—List Price, \$15.00. **\$9.80**  
YOUR PRICE

This unrivaled Chemistry Laboratory is the finest set for the student or young scientist. Performs over 800 experiments. Many of these experiments were never before offered in experimental chemistry and include dry-ice experiments, artificial refrigeration, ethyl gas, lacquers, paints, testing of foods, electro-chemistry, electro plating, electrotyping, etching, electrolysis, etc. Includes new chemicals, apparatus and equipment with four big manuals giving experiments in chemistry, glass blowing, mineralogy and chemical magic. Also includes scales, beaker, flask, alcohol lamp, gas generator, thermometer. Packed in blue finished wooden laboratory cabinet with over nine feet of shelf space and test tube racks. Size 51½ x 14½ x 2½" overall.

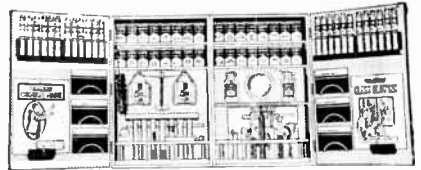

### Above—No. 10 Inventor's Chemistry Laboratory

D18561—List Price, \$10.00. **\$6.54**  
YOUR PRICE

Contains rows and rows of chemicals. With this laboratory outfit you can delve into the wizardry of chemical magic and perform many astonishing experiments. Contains 100 pieces of chemicals and apparatus, including scales and three big books describing over 600 experiments in chemistry, glass blowing and chemical magic. Packed in large blue finished wooden laboratory cabinet with double hinged doors and 7½ feet of shelf space and test tube racks. Articles are conveniently located so that they can be kept in neat order at all times. Size 39 x 11½ x 2½" overall.

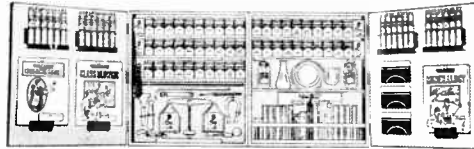

## Gilbert Polarizing Microscopes

Open the Door to a New Wonderland of Nature's Hidden Colors

The invisible becomes visible! Startling colors, otherwise invisible, blaze forth under polarized light in gorgeous effects. Stems of plants, fish scales, crystals, wing cases of beetles, sections of minerals, human hair, natural fibers—all are found to have beautiful natural colors. The colors have always been there, but ordinary microscopes do not reveal them—only through a Polarizing Microscope can they be seen. The intermingled play of vivid colors and delicate tints—the rich color patterns produced in plant stems—

are beyond description. They must be seen to be appreciated. The polarizing microscope is one of the most fascinating of optical instruments. It does all that an ordinary microscope does and in addition makes possible the detection of properties and characteristics that could not be done otherwise. Gilbert polarizing microscopes are equipped with a polarizer which fits underneath the stage and an analyzer that is placed over the eyepiece, when these two items are removed it becomes an ordinary microscope.

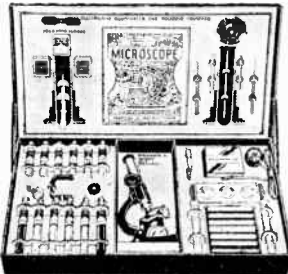

### No. 5 Microscope Set

D18562—List Price, \$5.00. **\$3.26**  
YOUR PRICE

Contains 38 pieces of apparatus, chemicals, and equipment including microscope, 110 volt sub-stage light, slides, specimens, stains, dissecting kit, large dissecting piece with magnifying lens and an illustrated manual showing how to do 213 experiments. Microscope has high magnifying power of 50, 90 and 210 diameters with rack and pinion focusing. Housed in colorful cardboard box, size 18x10x2½".

### No. 10 Microscope Set

D18563—List, \$10.00. **\$6.54**  
YOUR PRICE

A deluxe outfit in wooden cabinet that is really adaptable for advanced work. Contains a professional type microscope equipped with three different objective lenses mounted in turret giving from 95 to 400 power magnification. Microscope has rack and pinion focusing and is equipped with a polarizing device and sub-stage light. Also includes an unusually complete illustrated manual of things to do, 4 piece magnifying unit, dissecting needles, 9 vials of chemicals and stains, prepared slide and extra glass slides, bench microtome, alcohol lamp, adequate supply of specimens, labels, and cover glasses. Cabinet size 14½ x 26 x 3 7/8".

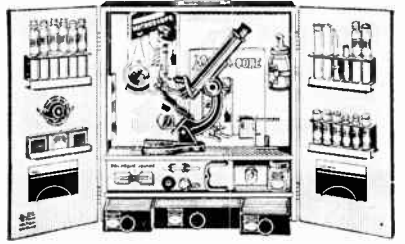

## Bat-R-Up Baseball Game

With All the Thrills of a Big League Game Real Bat and Ball Action—Skill Excitement

D18564—No. 100. Size 15x17" with 12" bat. List, \$1.00. **69¢**  
YOUR PRICE

D18565—No. 200. Size 18x18" with 15" bat. List, \$2.00. **\$1.39**  
YOUR PRICE

A strikingly colored and realistically designed baseball game which will provide many hours of exciting entertainment for the entire family. Two or more persons can play at one time. Radically new, the playing surface is laid out just like a regulation baseball diamond with attractively lithographed stationary metal players taking position of men on the field and formed to catch balls hit directly at them for put-outs and double plays. Provides all the thrilling plays of a regular baseball game.

### No Dials to Spin

No dials to spin to get base hits, double plays or putouts. The player uses a real wooden bat to strike a rubber ball mounted on a pivoting device which in turn drives a small rubber ball out into the playing field. A revolving ball carrier enables the player to place the ball in such position so as to skillfully direct his hit between the players and into the holes drilled along the outer edge to indicate various hits and strikes. 3 Metal discs are supplied to serve as men on base. Dials are for score keeping of runs, balls, strikes and outs. The diamond is made of an attractively colored 3 plywood panel with guard rail to prevent the ball from leaving it and getting lost. Complete with playing instructions and score card pad for keeping track of runs and innings. Four rubber feet on board prevent marring table surface.

## Carron Electric Toy Phonograph

With Acoustic Pickup and Electric Motor

An electric motor phonograph that plays up to 12" records. Just the thing for the children's room or small apartments. Completely self-contained. Has a constant speed, noiseless synchronous motor for 110 volt, 60 cycle AC operation, eliminating the tedious "winding-up." The acoustical pickup reproduces with good tone and volume. Attractive walnut veneer cabinet with contrasting trim. Size 12½ x 9 3/4". Ship. wt. 5¼ lbs.



D15355—Model 504T. List Price, \$6.95. **\$4.38**  
YOUR PRICE

## Telephone Set

C9963—Set of Two Phones and 70 ft. Single Conductor Wire for covering a distance up to 35 ft. Less batteries. **\$2.65**  
YOUR PRICE

Realistic, cradle type metal telephone set. Ideal for all inter-communication purposes. Suitable for useful applications as well as for entertainment use. Has clear natural tone. Requires two 1½ volt dry cells at each phone to cover distance up to 750 ft. 4 Dry cells at each phone for distances up to 3000 ft. Only two wires required between phones. Has push button with buzzer at each phone for signaling persons to answer phone.



# GILBERT AMERICAN FLYER "O" GAUGE TRAINS

The World's Most Complete Line of Scale Model Trains and Equipment

## NEW 3/16" SCALE FOR "O" GAUGE TRACK

American Flyer 3/16" Scale Model Trains combine the size advantages of smaller track gauge trains with the mechanical advantages of "O" gauge train sets. Correctly proportioned and constructed for true railroad realism. Permit extensive track layouts in small space.

Automatic remote control allows operation of locomotive in either direction. Momentary interruption of current throws a relay which reverses direction of train.



**Automatic Car Couplers.** All American Flyer Trains are equipped with modernized automatic couplers. Cars are brought closer together and coupling or uncoupling is simple and positive in action.

**Remote and Manual Control Car Uncoupling.** Uncoupling mechanism is built into track section. Uncouples cars as fast as they pass by. Operates only with the new style automatic car couplers, with which all American Flyer Trains are now equipped.



The Following Trains are "O" Gauge With Remote Control, Automatic Coupling and Lever Operated Uncoupling.



### 2 Car—Steam Type Pioneer Passenger Train

38" Long—19 Pcs.—140" Track

D18150—Model 4001. Supplied less transformer. List Price, \$5.50. **\$3.59**  
YOUR PRICE.....

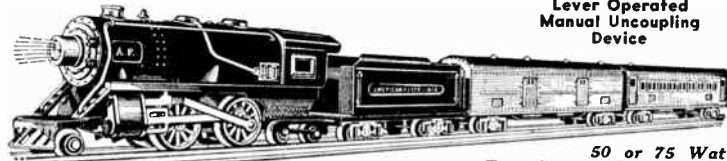

50 or 75 Watt Transformer Recommended

A realistic passenger train that incorporates many of the features which were formerly included only on much higher priced systems. Consists of: **LOCOMOTIVE** and **TENDER**—15 1/2" long overall, pressed steel with nickel appointments. Locomotive—10 wheel remote control, 2-4-4 type with spur gear drive, electric headlight, four drive wheels, eccentric arm double action piston rods, two wheel pony and four wheel booster trucks. Tender—Bunker type with imitation coal and 8 wheels on double trucks. 2 **CARS**—Pressed steel, each 10 1/2" long having 8 wheels on double trucks with nickel journal boxes. Includes Baggage car with

sliding doors and one Coach. **COUPLING**—Automatic on every car and rear of tender, couples anywhere and brings cars closer together. Uncouples by lever operated manual control. **FINISH**—Locomotive and tender in realistic locomotive black with nickel trim. Cars are bright red enamel with silver and nickel trim. **TRACK**—3 rail "O" Gauge type; includes 12-10" curve sections, 1 straight track section, 1 straight track with built-in lever uncoupling device and 1 track connection terminal. Forms an oval with 140" track length.

### 3 Car—Steam Type Pioneer Freight Train

39" Long—20 Pcs.—140" Track

D18151—Model 4002. Supplied less transformer. List Price, \$5.95. **\$3.89**  
YOUR PRICE.....

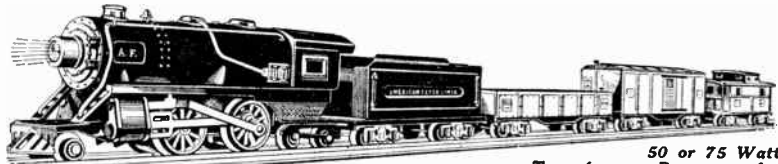

50 or 75 Watt Transformer Recommended

A companion unit to the above passenger train, this freight outfit consists of: **LOCOMOTIVE** and **TENDER**—15 1/2" long overall, pressed steel with nickel appointments. Locomotive—10 wheel remote control, 2-4-4 type with spur gear drive, electric headlight and four drive wheels with eccentric arm double action piston rods, two wheel pony and four wheel booster trucks. Tender—Bunker type with imitation coal and 8 wheels on double trucks. 3 **CARS**—Includes 7 1/2" Gondola with brake wheel, 7 1/2" Box Car with sliding doors, brake wheel and ladders, 6 1/2" Caboose with cupola, end rails and ladders. Cars have 8 wheels on double

trucks with nickel journal boxes. **COUPLING**—Automatic on every car and rear of tender, couples anywhere and brings cars closer together. Uncouples by lever operated manual control. **FINISH**—Locomotive and tender in realistic locomotive black with nickel trim. Cars are vividly colored in baked on enamel with nickel track section, 1 straight track with built-in lever uncoupling device and 1 track connection terminal. Forms an oval with 140" track length.

### 2 Car—Worm Drive 20th Century Streamline Passenger

39 1/2" Long—19 Pcs.—140" Track

D18152—Model 4003. Supplied less transformer. List Price, \$7.50. **\$4.90**  
YOUR PRICE.....

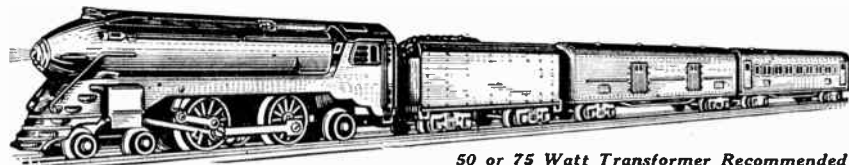

50 or 75 Watt Transformer Recommended

A replica of the famous record breaking New York to Chicago train. Set consists of: **LOCOMOTIVE** and **TENDER**—17" long overall. Locomotive—die cast, 10 wheel, remote control, 4-4-2 type with worm drive for more power and quieter operation, four drive wheels with eccentric arm double action piston rods and four wheel pony and two wheel booster trucks. Tender—Pressed steel having 8 wheels on double trucks with nickel journal boxes. 2 **CARS**—Each 10 1/2" long having 8 wheels on double trucks with nickel journal boxes. Includes Baggage car with sliding doors, and one Coach. **COUPLING**—Automatic on every car and rear of

tender, couples anywhere and brings cars closer together. Uncouples by lever operated manual control. **FINISH**—Locomotive and tender, gun metalcast electrically baked. Cars are in electrically baked green enamel with silver and nickel trim. **TRACK**—3 rail "O" Gauge type. Includes 12-10" curved track sections, 1 straight track section, 1 straight track with built-in lever operated car uncoupling device and one electric track connection terminal. Forms an oval with 140" track length.

### 3 Car—Worm Drive 20th Century Streamliner Freight

40 1/2" Long—20 Pcs.—140" Track

D18126 — Model 4004. Supplied less transformer. List Price, \$7.95. **\$5.19**  
YOUR PRICE.....

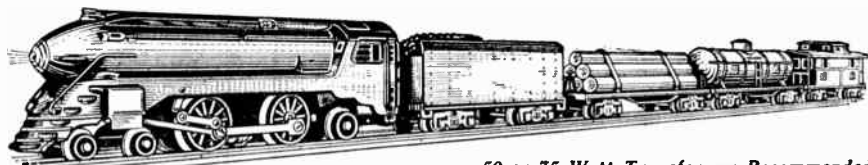

50 or 75 Watt Transformer Recommended

A matching companion to above train set. Set consists of: **LOCOMOTIVE** and **TENDER**—17" long overall. Locomotive—die cast, 10 wheels, remote control, 4-4-2 type with worm drive for more power and quieter operation and four drive wheels with eccentric arm double action piston rods, four wheel pony and two wheel booster trucks. Tender—Pressed steel having 8 wheels on double trucks with nickel journal boxes. 3 **CARS**—Include 7 1/2" Log Car with six realistic logs and brake wheel, 7 1/2" Tank Car with ladders, hand rails and brake wheel and 6 1/2" Caboose with cupola, end rails and ladders. Cars have 8 wheels on double trucks

with nickel journal boxes. **COUPLING**—Automatic on every car and rear of tender, couples anywhere and brings cars closer together. Uncouples by manual control. **FINISH**—Locomotive and tender in gun metalcast. Cars are vividly colored in baked on enamel with nickel trim. **TRACK**—3 rail "O" Gauge type. Includes 12-10" curve track sections, 1 straight track section and 1 straight track with built-in lever operated uncoupling device and one electric track connection terminal. Forms an oval with 140" track length.



# GILBERT AMERICAN FLYER TRAINS

**NEW WORM DRIVE LOCOMOTIVES**—the first time such an exclusive feature has been incorporated in a low price train  
**NEW 3/16" SCALE FOR "O" GAUGE TRACK**

The Following Trains Operate in Either Forward or Reverse Direction by Remote Control and Have Automatically Coupling Cars with Electrically Operated Remote Control Car Uncoupling Device Built-into Track Section.

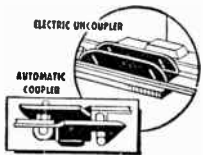

## 2 Car—Worm Drive Pathfinder Passenger Train

Steam Type

38 1/2" Long—19 Pc.—140" Track  
**D18106**—Model 4005. Supplied less transformer.  
 List Price, \$9.50.  
**YOUR PRICE.....\$6.21**

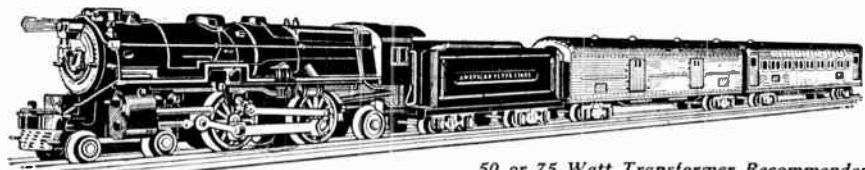

50 or 75 Watt Transformer Recommended

Features automatic electric uncoupling as well as automatic coupling. Special section of track has a built-in trip that disengages car couplers when trip is raised. Trip is electrically remote controlled. Complete train set consists of: **LOCOMOTIVE** and **TENDER**—16" long overall. Locomotive—die cast, 10 wheel, remote control, 4-1-2 type with worm drive for greater power and quieter operation. Also features lucite electric headlight, four drive wheels with eccentric arm double action piston rods, four wheel pony and two wheel booster trucks. Tender—pressed steel, bunker type with imitation coal, hand rails and 8 wheels on double trucks with nickel journal boxes. **2 CARS**—Each 10 1/4" long, have 8 wheels on

double trucks with nickel journal boxes, including one Baggage car with sliding doors and one Coach. **COUPLING**—Automatic on every car and rear of tender. Couples anywhere. Cars closer together. **FINISH**—Locomotive and tender in locomotive black with nickel trim. Cars finished in bright red enamel with silver and nickel trim. **TRACK**—3 rail "O" gauge type. Includes 12-10" curve track sections, 1 straight track section, 1 straight track section with built-in remote electrically controlled uncoupling device and 1 track connection terminal. Forms an oval with 140" track length.

## 3 Car—Worm Drive Pathfinder Freight Train

Steam Type

39 1/2" Long—20 Pc.—140" Track  
**D18107**—Model 4006. Supplied less transformer.  
 List Price, \$9.95.  
**YOUR PRICE.....\$6.51**

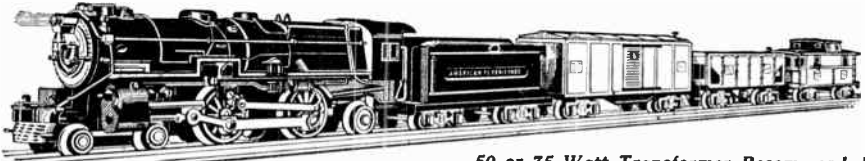

50 or 75 Watt Transformer Recommended

A matching companion to above passenger train. Special section of track has a built-in trip that disengages car couplers by electric remote control. Complete train set consists of: **LOCOMOTIVE** and **TENDER**—16" long overall. Locomotive—die cast, 10 wheel, remote control, 4-4-2 type with worm drive for greater power and quieter operation. Also features lucite electric headlight, four drive wheels, eccentric arm double action piston rods, four wheel pony and two wheel booster trucks. Tender—pressed steel, bunker type with imitation coal, hand rails and 8 wheels on double trucks with nickel journal boxes. **3 CARS**—Includes 7 1/2" Box Car with sliding doors, ladders and brake wheel, 6 1/2" Coal Hopper Car with

ladders, brake wheel and manual control lever for dumping. 6 1/2" Caboose with journal boxes. **COUPLING**—Automatic on every car and rear of tender. Couples anywhere. **FINISH**—Locomotive and tender in locomotive black with nickel trim. Cars are vividly colored in baked enamel. **TRACK**—3 rail "O" gauge type. Includes 12-10" curve track sections, 1 straight track section, 1 straight track section with built-in remote electrically controlled uncoupling device and 1 track terminal. Forms an oval with 140" track length.

## 4 Car—Worm Drive Royal Blue Freight

140" Track

48" Long—21 Pc.  
**D18108**—Model 4008. Less transformer.  
 List Price, \$12.95.  
**YOUR PRICE.....\$8.47**

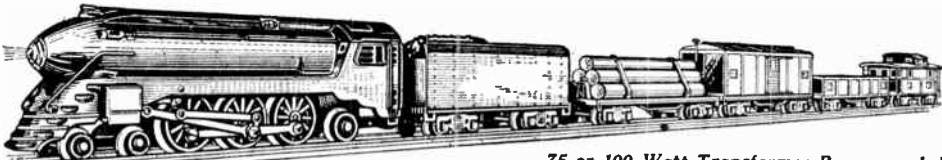

75 or 100 Watt Transformer Recommended

Modern streamlined Royal Blue Freight train. Set consists of: **LOCOMOTIVE** and **TENDER**—17" long overall. Locomotive—die cast, 12 wheels, remote control, 4-6-2 type with worm drive for power and quiet operation. Also features lucite electric headlight, six drive wheels, eccentric arm triple action piston rods, four wheel pony and two wheel hooster trucks. Tender—pressed steel streamline type having 8 wheels on double trucks with nickel journal boxes. **4 CARS**—having 8 wheels on double trucks with nickel journal boxes. Includes 7 1/2" Log Car, 7 1/2" Box Car with sliding doors, 7 1/2" Gondola and 6 1/2" Caboose with cupola. **COUPLING**—Automatic on every car and rear of tender. Couples anywhere. Cars closer together. Electrical uncoupling. **FINISH**—Locomotive, tender and cars finished in royal blue electrically baked enamel with silver and nickel trim. **TRACK**—3 rail "O" gauge type. Includes 12-10" curve track sections, 1 straight track section, 1 straight track section with built-in remote electrically controlled uncoupling device, and 1 track connection terminal. Forms an oval with 140" track length.

Includes 1 Baggage car with sliding doors and 2 Coaches. **COUPLING**—Automatic on every car and rear of tender. Couples anywhere. Cars closer together. Electrical uncoupling. **FINISH**—Locomotive and tender in realistic locomotive black. Cars in electrically baked green enamel with silver and nickel trim. **TRACK**—3 rail "O" gauge type. Includes 12-10" curve track sections, 1 straight track section, 1 straight track section with built-in remote electrically controlled uncoupling device and track terminal. Forms an oval with 140" running track length.

## 3 Car—Spur Gear Drive Northern Pacific Passenger

Steam Type

50 1/2" Long—20 Pc.—140" Track  
**D18158**—Model 4009. Supplied less transformer.  
 List Price, \$14.95.  
**YOUR PRICE.....\$9.77**



75 or 100 Watt Transformer Recommended

A powerful 6 wheel drive locomotive heads this 3 car train which couples, uncouples, and reverses all by electric remote control. Complete train consists of: **LOCOMOTIVE** and **TENDER**—16 1/2" long overall, die cast. Locomotive—12 wheel remote control, 2-6-4 type with spur gear drive. Features electric headlight, six drive wheels, eccentric arm double action piston rods with cross head and valve stem, two wheel pony and four wheel booster trucks. Tender—Vanderbilt type having hand rails and 8 wheels on double trucks with nickel journal boxes. **3 CARS**—Each 10 1/4" long have 8 wheels on double trucks with nickel journal boxes.

Includes 1 Baggage car with sliding doors and 2 Coaches. **COUPLING**—Automatic on every car and rear of tender. Couples anywhere. Cars closer together. Electrical uncoupling. **FINISH**—Locomotive and tender in realistic locomotive black. Cars are vividly colored in baked enamel with silver and nickel trim. **TRACK**—3 rail "O" gauge type. Includes 12-10" curve track sections, 1 straight track section, 1 straight track section with built-in remote electrically controlled uncoupling device and track terminal. Forms an oval with 140" running track length.

## 4 Car—Spur Gear Drive Northern Pacific Freight

Steam Type

47 1/2" Long—21 Pc.—140" Track  
**D18109**—Model 4010. Supplied less transformer.  
 List Price, \$14.95.  
**YOUR PRICE.....\$9.77**



75 or 100 Watt Transformer Recommended

A matching companion to above passenger train. Complete train consists of: **LOCOMOTIVE** and **TENDER**—16 1/2" long overall, die cast. Locomotive—12 wheel remote control, 2-6-4 type with spur gear drive. Features electric headlight, six drive wheels, eccentric arm double action piston rods with cross head and valve stem, two wheel pony and four wheel booster trucks. Tender—Vanderbilt type having hand rails and 8 wheels on double trucks with nickel journal boxes. **4 CARS**—Includes 7 1/2" Box Car with sliding doors, ladders and brake wheel, 7 1/2" Gondola with brake wheel, 7 1/2" Oil Tank Car with ladders, hand rails and brake

wheel and 6 1/2" Caboose with cupola, end rails and ladders. Cars have 8 wheels on double trucks with nickel journal boxes. **COUPLING**—Automatic on every car and rear of tender. Couples anywhere. **FINISH**—Locomotive and tender, realistic locomotive black. Cars are vividly colored in baked enamel. **TRACK**—3 rail "O" gauge type. Includes 12-10" curve track sections, 1 straight track section, 1 straight track section with built-in remote electrically controlled uncoupling device and track terminal. Forms an oval with 140" running track length.

# GILBERT AMERICAN FLYER "O" GAUGE TRAINS

## 3/16" SCALE MODEL DESIGN

The Following Trains Have Forward and Reverse Remote Control, Automatic Car Coupling and Electrical Uncoupling

### 4 Car—Worm Drive Pennsylvania Freight

Steam Type  
47" Long—23 Pc.  
160" Track  
D18110 — Model 4012. Less transformer. List, \$16.95.  
**YOUR PRICE... \$11.07**



below—WORM DRIVE

Here is a freight train that looks like the real thing, being closely proportioned to  $\frac{3}{16}$ " scale for true-to-life appearance. Consists of: **LOCOMOTIVE and TENDER**—17" long overall, die cast. Locomotive—12 wheel remote control, 4-6-2 type with worm drive for power and quiet operation. Features lucite headlight, jeweled markers, six drive wheels, eccentric arm triple action piston rods, side rods and connecting rods, four wheel pony and two wheel booster trucks. Tender—Bunker type with imitation coal and having 8 wheels on double trucks with nickel journal boxes. **4 CARS**—Includes 6 $\frac{1}{2}$ " Coal Hopper Car with ladders, brake wheel and manual control lever for dumping, 7 $\frac{1}{2}$ " Box Car with sliding doors, ladders and

75 or 100 Watt Transformer Recommended  
brake wheel, 7 $\frac{1}{2}$ " Log Car with six realistic logs and brake wheel and 6 $\frac{1}{2}$ " Illuminated Caboose with cupola, end rails and ladders. **COUPLING**—Automatic on every car and rear of tender. **FINISH**—Locomotive and tender in realistic black. Cars are vividly colored in electrically baked enamel. **TRACK**—3 rail "O" gauge type. Includes 12—10" curve track sections, 3 straight track sections, 1 straight track section with built-in remote controlled uncoupling device, and 1 track connection terminal. Forms an oval with 160" track length.

### $\frac{1}{4}$ " Scale Model 4 Car Switcher Freight Train

Steam Type  
56 $\frac{1}{2}$ " Long—23 Pc.  
160" Track  
D18122 — Model 4014. Less transformer. List, \$17.95.  
**YOUR PRICE... \$11.73**

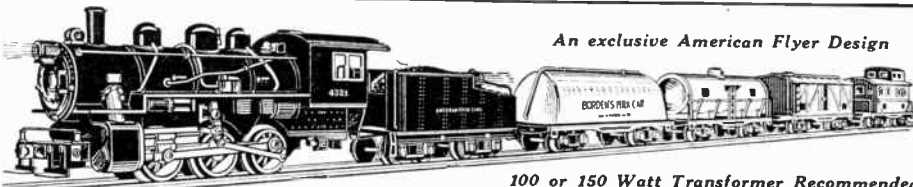

An exclusive American Flyer Design

A powerful 6 wheel drive switcher locomotive heads this train to give your railroad yard a realistic scene. This train is somewhat larger than the other "O" gauge sets, being scaled to  $\frac{1}{4}$ " to the foot. Consists of: **LOCOMOTIVE and TENDER**—15 $\frac{1}{2}$ " long overall, die cast. Locomotive—6 wheels 11-6-0 type with spur gear drive. Features many regulation appointments such as beaming electric headlight, six drive wheels with realistic eccentric side rods, piston rods and link. Has imitation steam and sand domes and whistle. Tender has regulation slope back with bunker and imitation coal, rear headlight, hand rails, and 8 wheels on double trucks with brass journal boxes. **4 CARS**—Each 9 $\frac{1}{2}$ " long with 8 wheels on double trucks with brass journal boxes. Includes Milk car, Oil car with imitation

100 or 150 Watt Transformer Recommended  
filler cap, brass ladders and rails, Box car with sliding doors, brass ladders and brake wheel, and illuminated Caboose with cupola, brass hand rails, end rails and ladders. **COUPLING**—Automatic on every car and rear of tender. **FINISH**—Locomotive and tender in realistic locomotive black. Cars are vividly colored in electrically baked enamel with brass trim. **TRACK**—3 rail "O" gauge type. Includes 12—10" curve track sections, 3 straight track sections, 1 straight track section with built-in remote controlled uncoupling device and 1 track connection terminal. Forms an oval with 160" track length.

### 3-Car—Steam Type N.Y.C. Hudson J-3A Passenger Train

52 $\frac{1}{2}$ " Long—22 Pc.  
160" Track  
D18123 — Model 4015. Less transformer. List, \$19.50.  
**YOUR PRICE... \$12.74**

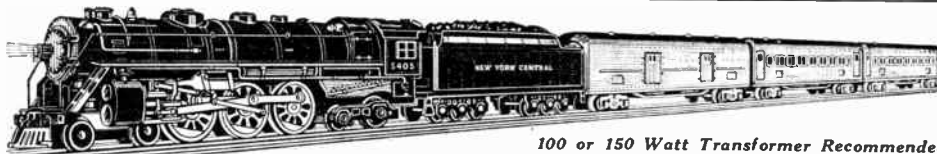

100 or 150 Watt Transformer Recommended

The famous New York Central Passenger Train constructed to Tru-Model  $\frac{3}{8}$ " scale. Embodies many realistic features. Consists of: **LOCOMOTIVE and TENDER**—18 $\frac{1}{2}$ " long overall, die cast. Locomotive—14 wheel remote control, 4-6-4 type with spur gear drive. Features many regulation appointments such as lucite electric headlight, six drive wheels, eccentric arm triple action piston rods, connecting rods, four wheel pony and four wheel booster trucks. Tender—Bunker type with imitation coal and has 12 wheels on double die cast trucks. **3 CARS**—Each 10 $\frac{1}{2}$ " long having 8 wheels on double trucks with nickel journal

boxes. Includes 1 illuminated Baggage Car with sliding doors and 2 illuminated Coaches. **COUPLING**—Automatic on every car and rear of tender. **FINISH**—Locomotive and tender in realistic locomotive black. Cars, electrically baked green enamel with silver and nickel trim. **TRACK**—3 rail "O" gauge type. Includes 12—10" curve track sections, 3 straight track sections, 1 straight track section with built-in remote electrically controlled uncoupling device and 1 track connection terminal. Forms an oval with 160" track length.

### 4-Car—Steam Type N.Y.C. Hudson J-3A Freight Train

48 $\frac{1}{2}$ " Long—23 Pc.  
160" Track  
D18161 — Model 4016. Less transformer. List, \$19.50.  
**YOUR PRICE... \$12.74**

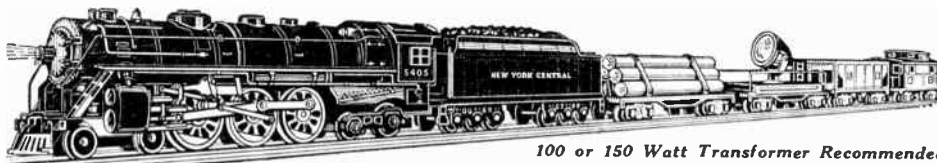

100 or 150 Watt Transformer Recommended

Most accurately detailed freight train, in matching design, to above passenger train. Consists of: **LOCOMOTIVE and TENDER**—18 $\frac{1}{2}$ " long overall, die cast. Locomotive—14 wheel remote control, 4-6-4 type with spur gear drive. Features many regulation appointments such as lucite electric headlight, six drive wheels, eccentric arm triple action piston rods, side rods, connecting rods, four wheel pony and four wheel booster trucks. Tender—Bunker type with imitation coal and has 12 wheels on double die cast trucks. **COUPLING**—Automatic on every car and rear of tender. **FINISH**—Locomotive and tender in realistic locomotive black. **4 CARS**—Include 7 $\frac{1}{2}$ " Log Car with six realistic logs and brake wheel, 7 $\frac{1}{2}$ "

dumping, 7 $\frac{1}{2}$ " Oil Tank Car with ladders, hand rails and brake wheel, 6 $\frac{1}{2}$ " Coal Hopper Car has ladders, brake wheel and manual control lever for dumping, 6 $\frac{1}{2}$ " Illuminated Caboose with cupola, end rails and ladders. **COUPLING**—Automatic on every car and rear of tender. **FINISH**—Locomotive and tender in realistic locomotive black. Cars are vividly colored in electrically baked enamel. **TRACK**—3 rail "O" gauge type. Includes 12—10" curve track sections, 3 straight track sections, 1 straight track section with built-in remote electrically controlled uncoupling device and 1 track connection terminal. Forms an oval with 160" track length.

### 4-Car—Steam Type Union Pacific Freight Train

51 $\frac{1}{2}$ " Long—23 Pc.  
160" Track  
D18124—Model 4018. Less transformer. List, \$24.50.  
**YOUR PRICE... \$16.01**

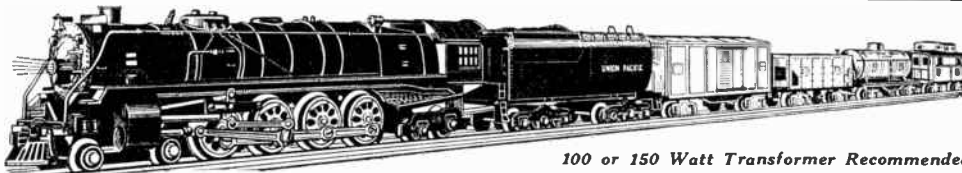

100 or 150 Watt Transformer Recommended

The largest most realistic small train made. Accurate  $\frac{3}{8}$ " scale model design. Includes many realistic appointments. Consists of: **LOCOMOTIVE and TENDER**—21 $\frac{1}{2}$ " long overall, die cast. Locomotive—16 wheel remote control, 4-8-4 type with spur gear drive. Features lucite electric headlight, 8 drive wheels, realistic eccentric arm triple action piston rods, side rods, and connecting rods, four wheel pony and four wheel booster trucks. Tender—Union Pacific type with 12 wheels on double die cast trucks. **4 CARS**—have 8 wheels on double trucks with nickel journal boxes. Includes 7 $\frac{1}{2}$ " Box car with sliding doors, brake wheel and ladders, 6 $\frac{1}{2}$ " Coal Hopper car with ladders, brake wheel and manual control lever for

dumping, 7 $\frac{1}{2}$ " Oil Tank Car with ladders, hand rails and brake wheel, 6 $\frac{1}{2}$ " Illuminated Caboose with cupola, end rails and ladders. **COUPLING**—Automatic on every car and rear of tender. **FINISH**—Locomotive and tender in realistic locomotive black. Cars are vividly colored in electrically baked enamel. **TRACK**—3 rail "O" gauge type. Includes 12—10" curve track sections, 3 straight track sections, 1 straight track section with built-in remote electrically controlled uncoupling device and 1 track connection terminal. Forms an oval with 160" track length.



# GILBERT AMERICAN FLYER "O" GAUGE TRAINS

With ELECTRIC REMOTE DIRECTIONAL CONTROL



The American Flyer has the only remote control system that after a stop instantly starts a train forward without backing up. Directional operation of train is not affected by auto-

matic stopping devices or short circuits. Train always starts forward, reversing of direction is accomplished by independent control included with the following trains.

**3/16" Scale Design with Automatic Coupling and Electrical Uncoupling.**

## 3 Car—Worm Drive Pennsylvania K5 Passenger Train

54 1/2" Long—160" Track  
D18125—Model 4020, Less transformer.  
List, \$27.00.  
**YOUR PRICE... \$17.64**



100 or 150 Watt Transformer Recommended

A popular passenger train constructed to Tru-Model 3/16" scale and incorporating remote directional control feature that always starts the train in forward motion except when reverse button is depressed. Separate reverse remote control box included. Consists of: **LOCOMOTIVE** and **TENDER**—17" long overall, die cast. Locomotive—12 wheel remote directional control, 4-6-2 type with worm drive for power and quiet operation. Features many regulation appointments such as lucite electric headlight with jewel markers, six drive wheels with realistic eccentric arm triple action piston rod, side rods, connecting rods; four wheel pony and two wheel booster trucks. Tender—bunker type with imitation coal. Has 8 wheels on double

trucks. 3 **CARS**—Die cast with 12 wheels on double trucks. Includes 1—12" illuminated Baggage and Mail car and 2—12" illuminated Pullman coaches. **COUPLING**—Automatic on every car and rear of tender. Couples anywhere. Cars closer together. **FINISH**—Locomotive and tender in realistic locomotive black. Cars, electrically baked enamel. **TRACK**—3 rail "O" gauge type. Includes 12—10" curve track sections, 3 straight track sections, 1 straight track section with built-in remote controlled uncoupling device and 1 track connection terminal. Forms an oval with 160" track length.

## 4 Car—Worm Drive N.Y.C. Hudson J-3A Freight Train

49" Long—160" Track  
D18164—Model 4021, Less transformer.  
List, \$27.50.  
**YOUR PRICE... \$17.98**

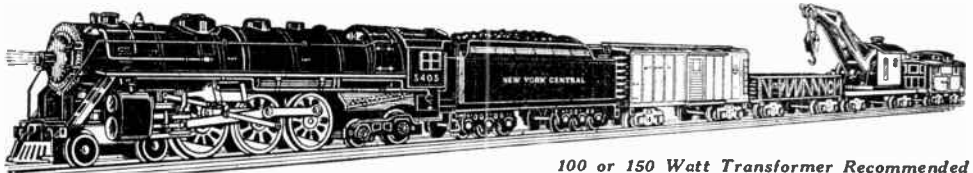

100 or 150 Watt Transformer Recommended

An accurately detailed freight train. Embodies many features to create true railroad realism. Designed and manufactured with utmost precision. Complete freight train consists of: **LOCOMOTIVE** and **TENDER**—18 1/2" long overall, die cast. Locomotive, 14 wheel remote directional control, 4-6-4 type with worm drive for more power and quieter operation. Features lucite electric headlight with jewel markers, six large drive wheels with realistic eccentric arm triple action piston rods, side rods and connecting rods; four wheel pony and four wheel booster trucks. Tender—bunker type with imitation coal. Has 12 wheels on double die cast trucks. **CONTROL BOX**—provides instant remote directional

control of train operation. 4 **CARS**—Die cast type having 8 wheels on double trucks with nickel journal boxes. Includes 7 1/2" Box Car, 7 1/2" Gondola, 7 1/2" Wrecker Car, and 6" illuminated Caboose. **COUPLING**—Automatic on every car and rear of tender. Couples anywhere. **FINISH**—Locomotive and tender in realistic locomotive black. Cars are vividly colored in electrically baked enamel. **TRACK**—3 rail "O" gauge type. Includes 12—10" curve track sections, 3 straight track sections, 1 straight track section with built-in remote controlled uncoupling device and 1 track connection terminal. Forms an oval with 160" track length.

## 4 Car—Worm Drive Union Pacific Freight Train

31" Long—160" Track  
D18162—Model 4023, Less transformer.  
List, \$32.50.  
**YOUR PRICE... \$21.24**

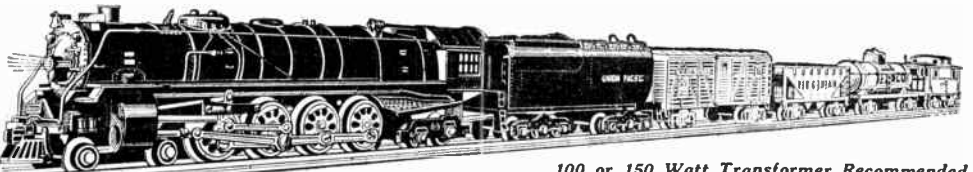

100 or 150 Watt Transformer Recommended

Indoubtedly one of the finest miniature model railroads. The largest, most realistic small train made. An outfit at which every model enthusiast and hobbyist will marvel. Constructed to tru model 3/16" scale design. Complete train consists of: **LOCOMOTIVE** and **TENDER**—21 1/2" long over-all, die cast. Locomotive—16 wheel, remote directional control, 4-8-4 type with worm drive for more power and quieter operation. Features lucite electric headlight with jewel markers, 8 drive wheels with realistic eccentric arm triple action piston rods, side rods and connecting rods; four wheel pony and four wheel booster trucks. Tender—with 12 wheels on double die cast trucks. **CONTROL BOX**—provides instant remote di-

rectional control of train operation. 4 **CARS**—Die cast type having 8 wheels on double trucks with nickel journal boxes. Includes 7 1/2" Cattle Car, 6 1/2" Coal Hopper Car, 7 1/2" Oil Tank Car and 6" illuminated Caboose. **COUPLING**—Automatic on every car and rear of tender. **FINISH**—Locomotive and tender in realistic locomotive black. Cars are vividly colored in baked on enamel. **TRACK**—3 rail "O" gauge type. Includes 12—10" curve track sections, 3 straight track sections, 1 straight track section with built-in remote controlled uncoupling device and 1 track connection terminal. Forms an oval with 160" track length.

## NEW "SAFETY-FIRST" TRANSFORMERS

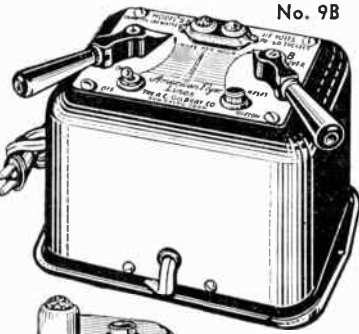

No. 9B

### 15 Volt Maximum Output Guards Against Burning Out Operating Equipment

Provides proper voltage for operating electric trains and other electrical toys. Instrument panel shows "Miles Per Hour." Control handle is replica of control used on regular trains. All models except 5 and 6 have built-in circuit breaker with resetting switch which protects the transformer from burning out. Red jewel light indicates when there is a short circuit. Green jewel pilot light indicates when transformer is in proper operation. All models for 105-120 volt, 50-60 cycle AC operation. Underwriter's approved. See train pages for the transformers recommended for the various trains.

No. 9B Twin transformer makes possible operation of trains on separate track layouts at two different rates of speed.

Stock Num.	Part Num.	Watts	Pilot Lgt.	Short Indicator	Circuit Breaker	List Price	Your Price
D18117	5	50	No	No	No	\$2.50	\$1.64
D18118	6	75	No	No	No	3.50	2.29
D18119	7B	75	No	Yes	Yes	5.00	3.27
D18120	8B	100	Yes	Yes	Yes	6.50	4.28
D18121	9B	150	Yes	Yes	Yes	10.00	6.54

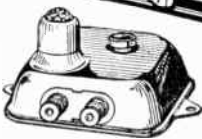

No. 11 Transformer Cutout

### No. 11 Transformer Cut-Out

D18078—Pt. No. 11. Protects transformer when short circuits occur. Has built-in circuit breaker and red jewel light to indicate when there is a short circuit. Recommended for No. 5 and 6 transformers. List Price, \$1.50.  
**YOUR PRICE... 98¢**

No. 5 and 6



No. 8B (7B Similar)

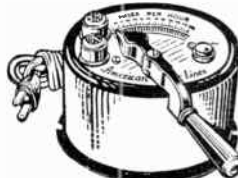

### Station Figure Set

D18097—Pt. 578. Assortment of six hand painted railroad workers with platform truck, 2 milk cans and one barrel. Adds realism to station scenes. List Price, \$2.00.  
**YOUR PRICE, Per Set... \$1.31**

### Genuine Mazda REPLACEMENT BULBS

for Trains and Equipment

Replacement bulbs for all types of electric train systems. Screw base, round clear bulb. .25 Ampere type.

Stock Number	Mazda Number	Volts	Your Price Each	10 for
D10528	1452	8	11¢	66¢
D10529	1453	12	10¢	60¢
D10530	1454	14	11¢	66¢
D10531	1455	18	11¢	66¢

# GILBERT-AMERICAN FLYER "O" GAUGE EQUIPMENT

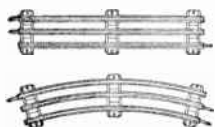

## TRACK SECTIONS

D18131—Pt. 680. 10" Curve Track  
 D18132—Pt. 681. 10" Straight Track  
 D18133—Pt. 621. 5" Straight Track  
 D18134—Pt. 622. 5" Curve Track  
 D18080—Pt. 450. Track Terminal  
 List Price, 20c.  
**YOUR PRICE, Each..... 14¢**

## CROSS OVERS →

D18135—Pt. 602. 90°. List, \$1.25.  
**YOUR PRICE.. 82¢**

### With Electric Remote Control

D18081—Pt. 604. 90° Electric Remote Control Crossover. Permits two train operation on single track layout. Idles one train at crossover while other passes. Includes double button control box. List \$3.00.  
**YOUR PRICE.. \$196**

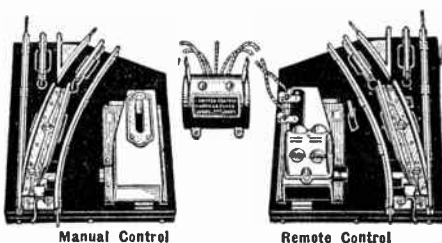

Manual Control

Remote Control

## TRACK SWITCHES

D18136—Pt. 685. Manual Control Switch. Lever operated. List Price, \$3.00.  
**YOUR PRICE, Per Pair..... \$196**

D18137—Pt. 688. Electric Remote Control Switch with two switch control box and signal lights. Permits operation of one train while other is kept standing on siding. List Price, \$7.95.  
**YOUR PRICE, Per Pair..... \$520**

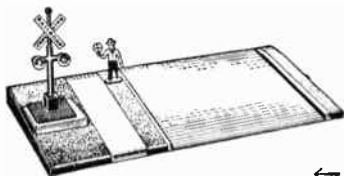

## ← STREET CROSSINGS

D18186—Pt. 584. Bell Danger Signal with watchman. Bell rings and lucite signal light blinks as train passes. Size 10x5 1/4". List, \$4.95.  
**YOUR PRICE, Each ..... \$323**

D18142—Pt. 591. Crossing Gate with watchman's shack. Die cast. Gate raises and lowers and red light shines automatically as train passes. Size 10x5 1/4". List Price, \$3.95.  
**YOUR PRICE, Each ..... \$259**

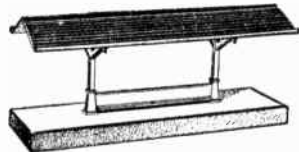
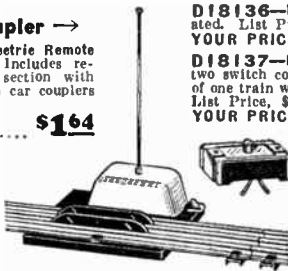

## WAYSIDE STATION ↑

D18187—Pt. 588. Has double seating bench, long roof and two lights. Track terminal included. Size 12x33x5". List Price, \$2.00.  
**YOUR PRICE ..... \$131**

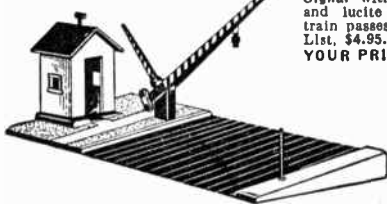

## ELECTROMATIC CRANE →

D18146 — Pt. 583. Automatic Electric Crane. A marvelous device for handling freight. Includes electro magnet for loading steel. Hoist swings it over car and unloads all by electric remote control. Cab and boom turn on swivel. Boom raises and lowers by hand wheel. Size 4x6x11". List, \$6.95.  
**YOUR PRICE ..... \$455**

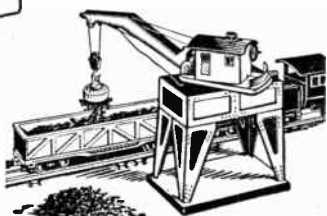

## ← Girder Bridge

D18148 — Pt. 581. Sturdily designed to scale. Black finish. Size 10x4 1/2x1 1/4". List, \$2.00.  
**YOUR PRICE.. \$131**



## TUNNELS ↑

Realistically colored tunnel in two sizes.  
 D18095—Pt. 247. 11" Long. List, \$1.00.  
**YOUR PRICE .... 66¢**  
 D18099 — Pt. 248. 14" Long. List, \$2.00.  
**YOUR PRICE ... \$131**

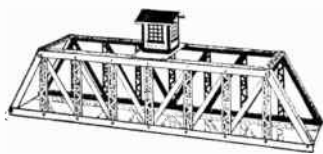

## ← Trestle Bridge

D18091 — Pt. 2. With illuminated tender's house. Track terminal included. Size 25x5 1/2x8 1/2". List, \$2.50.  
**YOUR PRICE.... \$164**



## Improved "O" Gauge Design

Improved flexible track for use with other "O" gauge rigid track equipment and trains. Provides many interesting track layouts, with quick removals and alterations. Can be curved in any direction and stays put in place. Consists of multiple track segments mounted on realistic natural wood ties. Strong enough to carry the weight of a 200 lb. man. 10 Foot length is supplied in two pieces, one 4 ft., other 6 foot long.

Track Terminal provides electrical pick-up from rails for operating other track equipment.

Reversible Switch for either left or right turns. Fits "O" gauge track equipment. Automatically sets itself, permitting trains to run in either direction without wrecks. Has lever for manual operation.



## 7 1/2 Foot All-Metal Viaduct

Streamline design with track underspan. Comes in seven easily and quickly assembled sections. For use with 10 ft. section of Flex-i-Track. Track is not included.

## Prices on Flex-i-Track Equipment

Stock Num.	Item	List Price	PRICE, EACH	
			Single Lots	3 Lots or More
D18076	6 Ft. Flex-i-Track	\$2.25	\$1.47	\$1.32
D18071	10 Ft. Flex-i-Track	3.50	2.28	2.06
D18072	Track Terminal	.25	.17	.15
D18073	Reversible Switch	2.00	1.30	1.18
D18074	Viaduct—Less Track	3.50	2.28	2.06

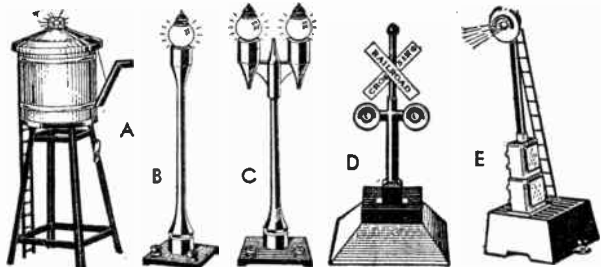

## SIGNAL, LIGHTS and TOWERS

D18188 — A. 9 1/2" Water Tank. Pt. 215. Sturdy structural base with ladder. Adjustable water spout. With aviation light on top. Track terminal included. List Price, \$1.25.  
**YOUR PRICE, Each.. 82¢**

D18189 — B. 6 1/2" Street Light. Pt. 579. With frosted light. Track terminal included. List Price, \$1.25.  
**YOUR PRICE, Each.. 82¢**

D18190 — C. — 6 1/2" Double Street Light. Pt. 583. With 2 frosted lights. Track terminal included. List Price, \$1.95.  
**YOUR PRICE ..... \$127**

D18191 — D. — 4 1/4" Automatic Blinker Signal. Pt. 582. Lucite signals blink as train passes. Track trip included. List Price, \$2.95.  
**YOUR PRICE ..... \$193**

D18192 — E. — 5 1/2" Automatic Block Signal. Pt. 587. Permits one train to follow another without colliding. Holds up second train until first has cleared. Light flashes red and green.

D18193 — F. — 11" Automatic Water Tank. Pt. 596. Remote control raises and lowers spout. Light on top. List, \$3.95.  
**YOUR PRICE, Each ... \$259**



# GILBERT AMERICAN FLYER "O" GAUGE EQUIPMENT

## 3/16" Scale Die Cast Tru-Model Train and Car Kits

American Flyer Train and Car kits are extremely easy to assemble. All machining, drilling and tapping has been done—no soldering is required. They can quickly be put together with ordinary household

tools. The more difficult parts are supplied assembled. Each kit is complete with all parts, instructions, correct colored paints, brush and proper decalcomanias.

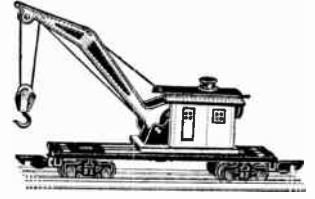
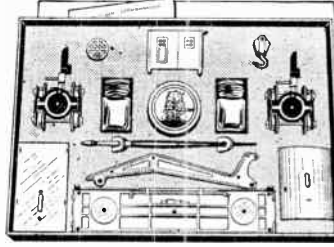
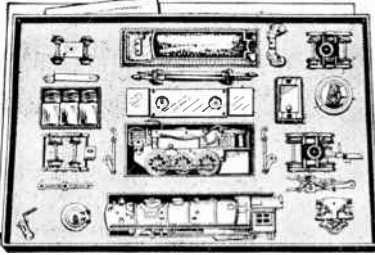

Wrecker Car in Kit

Wrecker Car Assembled

### LOCOMOTIVE and TENDER KITS

For a more complete description see complete train outfits listed on the preceding page.

**D18165**—Model K531. Contains all parts and equipment for building famous 14 wheel 4-6-4 type N.Y.C. Hudson locomotive and 12 wheel tender. Armature, field, gears and drive wheels assembled to engine frame. Ideally directional control unit included. New type positive action coupler on tender. List Price, \$15.00.  
**YOUR PRICE..... \$9.80**

**D18166**—Model 534. Contains all parts and equipment as above for building a 16 wheel 4-8-4 type Union Pacific Locomotive and 12 wheel tender. List Price, \$20.00.  
**YOUR PRICE..... \$13.07**

### INDIVIDUAL DIE CAST TRU-MODEL "O" GAUGE CAR KITS

Stock Number	Part Number	Description	List Price	Your Price
<b>D18167</b>	K508	7 1/2" Box Car Kit	\$2.50	<b>\$1.64</b>
<b>D18170</b>	K508	6 1/2" Hopper Car Kit	2.50	
<b>D18171</b>	K510	7 1/2" Cattle Car Kit	2.50	<b>\$1.96</b>
<b>D18168</b>	K512	7 1/2" Tank Car Kit	2.50	
<b>D18172</b>	K514	7 1/2" Wrecker Car Kit	3.00	
<b>D18169</b>	K516	6 1/2" Caboose Kit	3.00	

### American-Flyer Tru-Model a-Koostikins PASSENGER AND FREIGHT STATION



**D18141**—Pt. 597. Combination station with sound effects. Equipped with an automatic electric audio announcer that produces true-to-life sound effects of hissing steam, chug-o-pistons, train announcing and other sounds. Also automatically stops and starts the trains. Electrically lighted.  
 List Price, \$9.95.  
**YOUR PRICE..... \$6.51**

**D18149**—Pt. 589. Combination Station only with light. Does not include sound effects and train control device. List Price, \$3.95.  
**YOUR PRICE..... \$2.59**



### TOOL SHED

**D18145**—Pt. 595. Realistic tool shed. Equipped with audio announcer producing true-to-life sound effects of real railroad as above and automatically starts and stops trains. Particularly designed to be used with stations not having sound effects.  
 List, \$6.95.  
**YOUR PRICE..... \$4.55**

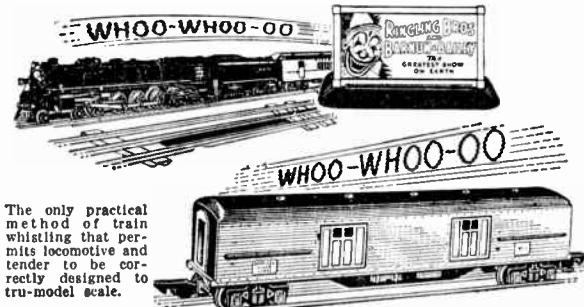

The only practical method of train whistling that permits locomotive and tender to be correctly designed to tru-model scale.

**WHISTLING BILLBOARD**  
**D18079**—Pt. 577—Whistle housed in illuminated billboard. Can be operated at same time as block signal system or automatically thru track strip at any predetermined point and by remote control at any location or time. Size 4 7/8 x 4 1/4".  
 List Price, \$2.50.  
**YOUR PRICE..... \$1.64**

**WHISTLING EXPRESS**  
**D18130**—Pt. 490. Whistle housed in 3/8" scale model pressed steel express car. Permits whistling direct from train. Operates any time, any place by remote control. Blows all code signals. Not for use with trains having separate reversing control.  
 List Price, \$4.95.  
**YOUR PRICE..... \$3.23**

### 3/16" Scale Tru-Model Cars

#### For "O" Gauge Track

#### Pressed Steel Construction With Automatic Couplers

Completely assembled and finished. Correctly designed and proportioned for Tru-Model railroad realism. Can be used with any of the "O" gauge train sets (except Switcher Freight Train) listed on the preceding pages. Cars are vividly colored in electrically baked-on enamel. All cars have 8 wheels with nickel plated boxes on double trucks. Automatic couplers couple cars close together on either straight or curve track. Equipped with all necessary hand rails, ladders and brake wheels.

**D18180**—Pt. 478. 7 1/2" Box Car with sliding doors.

**D18181**—Pt. 486. 6 1/2" Hopper Car with manual control lever operated dumping doors.

**D18182**—Pt. 480. 7 1/2" Oil Tank Car.

**D18183**—Pt. 482. 7 1/2" Log Car with six realistic lgs.  
 List Price, \$2.00.  
**YOUR PRICE, Each... \$1.31**

#### FLOODLIGHT CAR

**D18184**—Pt. 488. 7 1/2" Long. Light turns on swivel base and tilts to any angle. Same 3/8" scale Tru-Model design with automatic couplers as above cars.  
 List Price, \$3.00.  
**YOUR PRICE..... \$1.96**



AUTOMATIC COUPLER POSITIVE IN ACTION

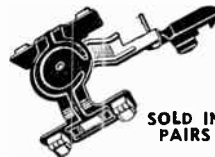

SOLD IN PAIRS

#### New Automatic Couplers

**D18082**—Pt. 676. For use with "O" gauge track equipment. Converts cars with old style couplers to new, positive action type. Coupler is assembled to truck housing. Wheels and axles are not included. Old wheels and axles easily spring into truck housing. Sold in pairs only.  
 List Price, 75c.  
**YOUR PRICE, Per Pair 49c**

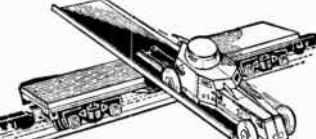
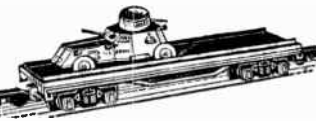
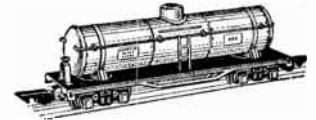
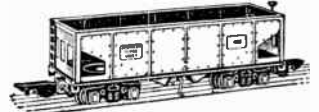
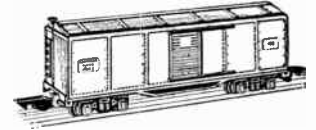

#### AUTOMATIC ARMY CAR

**D18185**—Pt. 472. Automatic Unloading Flat Car with Armored Army Truck. Platform on car swivels and shoots armored army truck down incline by electric push-button remote control. Incorporates same features, design and finish as above cars.  
 List Price, \$3.95.  
**YOUR PRICE..... \$2.59**

# Gilbert-American Flyer Ho Tru-Model Miniature Trains

Many Outstanding features to bring complete TRU-MODEL Realism to Miniature Railroading

Realism is the keynote of these spectacular miniature trains. Built to miniature scale from railroad blueprints—they are real trains in every detail of actual railroad construction. Smaller size permits elaborate track layouts in small space. Die cast locomotive, tender and cars equipped with bakelite wheels and automatic couplers. Realistic HO gauge 2 rail track with solid drawn rails

mounted on roadbed base. Remote Directional Control instantly starts train in forward or reverse direction; separate control box is used for reverse operation. Motor has 20 to 1 gear reduction for greater pulling power. Brass wheels on tender trucks act as current collectors eliminating center rail.

## 3 Car-HO Gauge N.Y.C. Hudson Freight Train

Steam Type  
31" Long—100" Track  
D18100 — Model  
HO-103. Less transformer. 50 or 75 Watt transformer recommended. List, \$19.95.

YOUR PRICE.... **\$13.03**

A realistic miniature train incorporating features mentioned above. Consists of: LOCOMOTIVE and TENDER—14" long overall, die cast. Locomotive—14 wheel, 4-6-4 type with lucite headlight and realistic eccentric arm triple action piston rods, side rods and connecting rods. Tender—bunker type with imitation coal and 12 wheels on double trucks. 3 CARS—die cast with 8 wheels on double trucks. Includes 5 1/2" Lehigh New England Gondola, 5 1/2" Merchants Dispatch and 4 1/2"



3.5 mm. Scale  
With Electrical Remote  
Directional Control and Automatic Coupler

## 3 Car-HO Gauge N.Y.C. Hudson Passenger Train

Steam Type  
42" Long—100" Track  
D18173 — Model  
HO-104. Less transformer. 50 or 75 Watt transformer recommended. List, \$22.95.

YOUR PRICE.... **\$14.99**

A matching companion to above freight train. Consists of: LOCOMOTIVE and TENDER as described above. 3 CARS, each 9" long, die cast with 8 wheels on double trucks. Includes Baggage-Mail car and 2 Passenger Coaches finished in



3.5 mm. Scale  
With Electric Remote  
Directional Control and Automatic Coupling

Caboose. COUPLING—automatic on every car. FINISH—locomotive and tender in realistic locomotive black. Cars are colored in baked enamel. TRACK—2 rail HO Gauge. Includes 12—7 1/2" curved track sections forming a circle with 100" track length. Track connection terminal included. CONTROL BOX provides instant directional control of train operation.

green baked-on enamel. Also includes 12—7 1/2" curved track sections, track terminal and remote directional control box as above.

## HO TRU-MODEL TRAIN AND CAR KITS

American Flyer kits are extremely easy to assemble. All matching, drilling and tapping has been done—no soldering is required. They can be put together

with ordinary household tools. Each kit is complete with all parts, instructions, correct colored paints, brush and proper decalcomanias.

### HO CAR KITS

Easy to Assemble

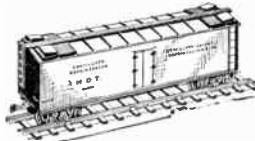

Cars are of die-cast construction exactly similar to those supplied with complete train kits. All necessary parts and paints are supplied.

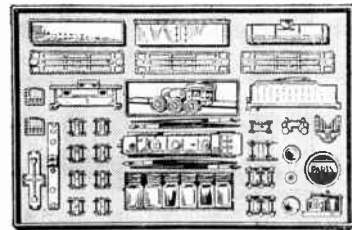

### 4 CAR FREIGHT TRAIN KIT

D18111—Model HO-110K. Complete kit to build a N.Y.C. die cast freight train as described in above complete train set except includes 4 cars: Gondola, Refrigerator, Oil Tank Car and Caboose. Armature field, gears and drive wheels are assembled to engine frame. Less transformer and track sections.

### 3 CAR PASS. TRAIN KIT

D18174—Model HO-111K. Complete kit to build a 3 car N.Y.C. die-cast passenger train as described in above complete train outfit. Less transformer and track sections. List Price, \$14.95. YOUR PRICE, Either Model, Each..... **\$9.77**

Stock Number	Part Number	Description	Your Price
D18103	HO-116K	Sinclair Oil Car	\$0.98
D18175	HO-118K	Gondola—Penn.	.98
D18175	HO-119K	Flat Car	.98
D18105	HO-120K	Caboose	.98
D18176	HO-121K	Baggage & Mail	1.47
D18177	HO-122K	Coach	1.47
D18101	HO-112K	NYC Loco. & Tender	6.54

## HO TRACK EQUIPMENT AND ACCESSORIES



**CROSSOVER**  
D18114 — Pt. HO-262 Track Crossover at 98° angle. Realistic roadbed base. Size: 10x10". List, \$2.00. YOUR PRICE.... **\$1.31**



**TRACK SECTIONS**  
Solid drawn rails mounted on realistic roadbed base.  
D18112—HO-261—8" Straight  
D18113—HO-260—8 1/2" Curved  
D18127—HO-263—4" Straight  
D18128—HO-264—4 1/2" Curved  
List, 40c. YOUR PRICE, Each... **27c**



**TRACK SWITCHES**  
Permits building of many interesting track layouts. Sold only in pairs.  
D18116—Pt. HO-268. Electrically remote controlled switches with signal lights to show direction of rails. Control box included. List Price, \$10.00. YOUR PRICE, Per Pair..... **\$6.54**



**BRIDGE**  
D18179 — Pt. HO-254. Modern girder type Bridge. Authentically designed and built to correct scale dimensions. Finished in red. List Price, \$1.50. YOUR PRICE..... **98c**

**TUNNEL**  
D18178 — Pt. HO-12. Realistic colored tunnel. Constructed in correct HO Tru-Model proportions. 8" long. List, \$1.00. YOUR PRICE..... **65c**



D18115—Pt. HO-265. Manually Operated Switches controlled by hand lever. List Price, \$5.00. YOUR PRICE, Per Pair..... **\$3.27**



**BLOCK SIGNAL**  
D18077—Pt. HO-252. Block Signal mounted on rugged base. Permits one train to follow another on a single track without danger of collision. Equipped with ladder. Lights show Red and Green. Electrically operated. List Price, \$3.95. YOUR PRICE..... **\$2.59**



**SIGNAL TOWER**  
D18076 — Pt. HO-256. Signal Tower with stairs. Top floor has electric light. Brilliantly colored. Die cast. List Price, \$2.95. YOUR PRICE.... **\$1.93**



**PASSENGER AND FREIGHT STATION**  
D18075 — Pt. HO-258. Combination Station. Freight section has raised platform and sliding door. Regulation bay window ticket office. Station mounted on raised platform and illuminated with one light. List Price, \$2.95. YOUR PRICE..... **\$1.93**





# THORDARSON Amateur Transformers

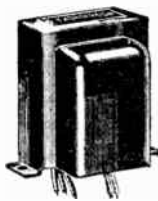

Fig. 2F

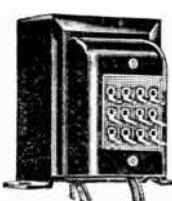

Fig. 4D



Fig. 2D

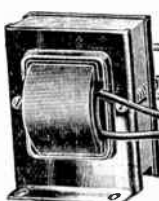

Fig. 3C



Fig. 3H

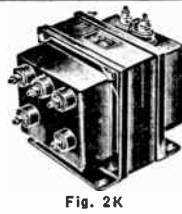

Fig. 2K

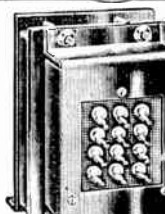

Fig. 2N

## Plate Supply Transformers

DC Voltage ratings are from a two section filter and include voltage drop through rectifier tubes. All have electrostatic shielding between primary and secondary windings. Secondaries are center tapped. Primaries for 105-120 volt, 50-60 cycle AC operation and tapped for voltage variation adjustment.

\*Has 30 Volt Bias Tap. †Designed for double rectifier, will deliver both ratings simultaneously. ‡Has Filament Windings: 5 Volts at 3 Amps., 6.3 Volts at 3 Amps. Ct., 7.5 Volts at 2.5 Amps. Ct.

Mfg. Code	Stock No.	Your Price	Sec. AC Load Volts	DC Volts	DC Ma	Mtg. Fig.	Size—Inches WxDxH
T-19P54	C6830	\$ 3.23	1120	400	150	F	3 1/2 x 3 1/2 x 5
T-19R30*	C6831	4.56	1120	400	150	F	3 1/2 x 4 x 4 1/2
T-19P55*	C6832	3.82	1100/1320	400/500	250	F	3 3/4 x 3 1/2 x 4 1/2
T-19P56	C6833	4.12	1600/1800	600/750	225	F	3 3/4 x 4 x 4 1/2
T-19P57†	C6834	5.00	12150 (10150)	1000 400	125 150	F	3 3/4 x 4 1/2 x 4 1/2
T-19P58†	C6835	8.38	2400 (1800)	1000 750	200 150	F	4 1/2 x 5 1/2 x 6 1/2
T-19P69	C6836	7.64	1900/2300	750/1000	300	F	4 1/2 x 6 1/2 x 6 1/2
T-19P59	C6837	9.40	2500/3120	1000/1250	300	2K	5 1/2 x 7 x 7
T-19P60	C6838	10.88	3420/3750	1250/1500	300	2K	6 1/2 x 4 1/2 x 7
T-19P61	C6839	11.76	3750/4250	1500/1750	300	2K	6 1/2 x 4 1/2 x 7
T-19P62	C6840	13.23	4250/4840	1750/2000	300	2K	6 1/2 x 5 x 7
T-19P63	C6841	13.22	2530/3120	1000/1250	500	2K	6 1/2 x 5 x 7
T-19P64	C6842	16.76	3120/3750	1250/1500	500	2K	6 1/2 x 6 x 7
T-19P65	C6843	17.35	3840/6000	2000/2500	300	2K	6 1/2 x 6 x 7
T-19P66	C6844	20.58	3750/4250	1500/1750	500	2K	6 1/2 x 4 1/2 x 10
T-19P67	C6845	24.99	4250/4840	1750/2000	500	2K	6 1/2 x 4 1/2 x 10
T-19P68	C6846	29.40	4900/6000	2000/2500	500	2K	6 1/2 x 5 1/2 x 10

## Input or Swinging Chokes

Inductance values are measured under full load conditions. Insulation is fully adequate for voltages specified. \*Equipped with only two terminals.

Mfg. Code	Stock No.	Your Price	Ind. Hrys.	DC MA	DC Ohms	Volts Ins.	Mtg. Fig.	Size Inches WxDxH
T-19C39	C6847	\$1.91	5-20	150	215	3000	2F	2 1/2 x 3 x 3 1/2
T-19C35	C6848	2.35	5-20	200	150	3000	2D	3 1/2 x 3 1/2 x 4 1/2
T-19C38	C6849	3.82	5-20	300	105	5000	2D	3 1/2 x 4 x 4 1/2
T-19C37	C6795	5.88	5-20	400	90	5000	2K*	4 1/2 x 5 1/2 x 6 1/2
T-19C38	C6796	8.23	5-20	500	75	5000	2K*	5 1/2 x 6 x 7 1/2

## Smoothing Filter Chokes

Mfg. Code	Stock No.	Your Price	Ind. Hrys.	DC MA	DC Ohms	Volts Ins.	Mtg. Fig.	Size Inches WxDxH
T-19C46	C6799	\$1.91	12	150	215	3000	2F	2 1/2 x 3 x 3 1/2
T-19C42	C6855	2.35	12	200	130	3000	2D	3 1/2 x 3 1/2 x 4 1/2
T-19C43	C6856	3.82	12	300	105	5000	2D	3 1/2 x 4 x 4 1/2
T-19C44	C6857	5.88	12	400	90	5000	2K*	4 1/2 x 5 1/2 x 6 1/2
T-19C45	C6858	8.23	12	500	75	5000	2K*	5 1/2 x 6 x 7 1/2

## Filament Transformers

Excellent voltage regulation. Conservatively rated for continuous operation under full load. For 115 volt, 50-60 cycle AC operation. \*Have tapped primary for 105, 110 and 115 volts.

Mfg. Code	Stock No.	Your Price	Sec. Volts	Sec. Amps.	Volts Ins.	Mtg. Fig.	Size Inches WxDxH
T-60F61	C6860	\$0.88	2.5 Ct.	3.5	1600	A	2 x 1 1/2 x 3 1/2
T-19F88	C6861	1.03	5 Ct.	5.25	1600	A	2 1/2 x 2 1/2 x 3 1/2
T-19F89	C6862	1.32	2.5 Ct.	10	1600	A	2 1/2 x 2 x 3
T-19F90	C6863	1.76	2.5 Ct.	10	7500	3C	2 1/2 x 2 1/2 x 3 1/2
T-64F33*	C6864	2.65	2.5 Ct.	10	7500	2N	3 1/2 x 3 1/2 x 4
T-19F82	C6865	2.94	2.5 Ct.	15	10000	3C	3 3/4 x 2 1/2 x 4
T-63F98	C6866	3.86	5 Ct.	4	1600	3C	2 1/2 x 2 1/2 x 3 1/2
T-19F83	C6867	1.32	5 Ct.	5	1600	3C	2 1/2 x 2 x 3
T-19F84	C6868	1.62	5 Ct.	8	1600	3C	2 1/2 x 2 1/2 x 3 1/2
T-19F85	C6869	1.91	5 Ct.	13	1600	3C	3 3/4 x 2 1/2 x 4
T-19F86	C6870	3.23	5 Ct.	21	1600	3C	3 3/4 x 3 x 5
T-19F91	C6871	1.91	5.25 Ct.	4	1600	3C	2 1/2 x 2 1/2 x 3 1/2
T-19F92	C6872	1.91	5.25 Ct.	10	1600	3C	3 1/2 x 2 1/2 x 4
T-74F23*	C6873	2.94	5.25 Ct.	13	1600	2D	3 1/2 x 3 1/2 x 4
T-74F24*	C6874	4.41	5.25 Ct.	21	1600	2D	3 1/2 x 3 1/2 x 4
T-19F80	C6875	.73	6.3 Ct.	1	1600	A	1 1/2 x 1 1/2 x 3 1/2
T-19F81	C6876	.88	6.3 Ct.	2	1600	A	1 1/2 x 1 1/2 x 3 1/2
T-19F97	C6877	1.03	6.3 Ct.	3	1600	A	2 x 2 1/2 x 3 1/2
T-61F85	C6878	1.18	2.5/5/6.3	2.5	1600	A	2 1/2 x 2 x 2 1/2
T-73F60*	C6879	2.20	6.3 Ct.	5	1600	2D	3 x 2 1/2 x 3 1/2
T-19F98	C6880	1.62	6.3 Ct.	6	1600	3C	2 1/2 x 2 1/2 x 3 1/2
T-19F98	C6881	2.06	6.3 Ct.	10	1600	3C	3 x 2 1/2 x 3 1/2
T-19F93	C6882	1.32	7.5 Ct.	4	1600	3C	3 x 2 1/2 x 3 1/2
T-19F94	C6884	1.76	7.5 Ct.	8	1600	3C	3 x 2 1/2 x 3 1/2
T-62F20	C6885	2.79	7.5 Ct.	8	1600	2D	3 3/4 x 3 1/2 x 4
T-19F95	C6886	1.62	10 Ct.	4	1600	3C	2 1/2 x 2 1/2 x 3 1/2
T-19F96	C6887	2.06	10 Ct.	8	1600	2D	3 1/2 x 3 1/2 x 4
T-64F14*	C6888	3.67	10 Ct.	8	1600	2D	3 1/2 x 3 1/2 x 4
T-19F87	C6889	3.67	10 Ct.	12	1600	3C	3 3/4 x 3 1/2 x 4

## Low Level Matching Transformers

Only the most popular types are listed here. A complete line to fit all applications is available, write us of your needs. Transformers are specially wound to give a very low leakage reactance and provide best frequency response.

### Low Impedance Source (Microphone, Line, Mixer) to Grid

Mfg. Code	Stock No.	Your Price	Ohms Impedance	Pr. Ma. Secondary	O'all Ratio	Mtg. Fig.	Size Inches WxDxH
T-65A73	C6890	\$1.62	200 Ct.	100,000	1:22.2	2F	2 1/2 x 2 1/2 x 3
T-83A78	C6891	1.18	100	400,000 Ct.	1:64	2F	2 x 1 1/2 x 2 1/2
T-55A16	C6892	1.62	200/50	100,000 Ct.	1:22.3	2F	2 x 2 1/2 x 2 1/2
T-61A94	C6893	1.91	500/125	100,000 Ct.	1:14.1	2F	2 1/2 x 2 1/2 x 3

### Tube to Line or Mixer (Low Level)

Primary handles 8 Ma. per side

Mfg. Code	Stock No.	Your Price	Cap. Watts	Max. Primary Ma. Per Side	Ratio of Primary to Secondary
T-14A90	C6894	\$1.47	20000 Ct.	500 Ct.	2F
T-14A91	C6895	1.47	20000 Ct.	200 Ct.	2F

## Multi-Match Driver Transformers

Variable ratios on each transformer permit this series to handle all driver transformer requirements usually encountered in amateur circuits. C.I.T. Transformers are especially recommended for high quality installations. Have Plug-in Jack Terminal Board for quick and accurate matching without soldering. Completely protected against varying climatic conditions.

### "19" Series—Fig. 4D Size: 2 1/2 x 3 1/2 x 1/2"

Mfg. Code	Stock No.	Your Price	Cap. Watts	Max. Primary Ma. Per Side	Ratio of Primary to Secondary
T-19D01	C6896	\$3.53	15	60	1:1/2.2:1/4.1/1.6:1/1.8:1
T-191002	C6897	3.53	15	60	1:1/2.2:1/2.4:1/2.6:1/2.8:2
T-19103	C6898	3.53	15	60	3:1/3.2:1/3.4:1/3.6:1/3.8:1
T-19104	C6899	3.53	15	60	4:1/4.5:1/5:1/5.5:1/6:1
T-19D05	C6605	3.53	15	Primary for 500 ohm line	1:3.15/1/2.75/1/2.5/1/2.25/1/2/1.1.75/1/1.4/1/1.25/1/0.85/1.0.75

### C.H.T. Series—Fig. 3H Size: 4x1/2x4 1/2"

\*P.P. 45's or 2A3's †P.P. Par. 2A3's ‡P.P. 6L6's with 1/2" erse feedback.

Mfg. Code	Stock No.	Your Price	Cap. Watts	Pr. Ma. Per Side	Sec. Series	Ma. Par.	Mtg. Fig.	Size Inches WxDxH
T-15176*	C6618	\$4.85	15	60	1:1/1.2/1.4/1.6/1.8/2.1	60	1:1/1.2/1.4/1.6/1.8/2.1	
T-15177*	C6619	4.85	15	60	2:1/2.2/1/2.4/1/2.6/1/2.8:1	60	3:1/3.2/1/3.4/1/3.6/1/3.8:1	
T-15178*	C6620	4.85	15	60	4:1/4.5/1/5:1/5.5/1/6:1	60	4:1/4.5/1/5:1/5.5/1/6:1	
T-15179*	C6621	4.85	15	60	1:1/1.25/1/1.5/1/1.75/1/2	120	2.25/1/2.5/1/2.75/1/3:1/3.25/1	
T-15180†	C6622	6.76	30	120	1:3.15/1/2.75/1/2.5/1/2.25/1/2	120	1:3.15/1/2.75/1/2.5/1/2.25/1/2	
T-15181†	C6632	6.76	30	120	1:2/1.1.75/1/1.4/1/1.25/1/1.0.85/1.0.75	120	1:2/1.1.75/1/1.4/1/1.25/1/1.0.85/1.0.75	
T-15182‡	C6636	4.85	15	Primary for 500 ohm line	1:3.15/1/2.75/1/2.5/1/2.25/1/2	120	1:3.15/1/2.75/1/2.5/1/2.25/1/2	
T-15D83	C6638	6.76	30	Primary for 500 ohm line	1:2/1.1.75/1/1.4/1/1.25/1/1.0.85/1.0.75	120	1:2/1.1.75/1/1.4/1/1.25/1/1.0.85/1.0.75	
T-15D84†	C6656	6.76	30	80	1:5.1/2.1/2.5/1/3:1/3.5:1	120	1:5.1/2.1/2.5/1/3:1/3.5:1	

## Multi-Match Modulation Transformers

Tapped coils allow perfect matching of any modulator tube to any Class "C" B.F. load. Taps brought out to solder lugs on front of transformer. \*Housed in rectangular metal case with porcelain insulators.

### "19" Series

Mfg. Code	Stock No.	Your Price	Cap. Watts	Pr. Ma. Per Side	Sec. Series	Ma. Par.	Mtg. Fig.	Size Inches WxDxH
T-19M13	C6657	\$2.35	15	50	50	100	2N	2 1/2 x 2 1/2 x 3
T-19M14	C6662	4.12	30	75	75	150	2N	3 1/2 x 3 1/2 x 4
T-19M15	C6663	5.88	40	125	125	250	2N	3 1/2 x 4 x 4 1/2
T-19M16	C6664	8.22	100	175	175	350	2N	4 1/2 x 5 x 6
T-19M17	C6665	14.11	250	225	225	450	2Q*	6 1/2 x 8 1/2 x 7 1/2

### C.H.T. Series

Especially recommended for high quality installations. Completely protected against varying climatic conditions. \*Have plug-in jack terminals for quick and accurate matching of tube loads instead of solder lugs as illustrated.

Mfg. Code	Stock No.	Your Price	Cap. Watts	Pr. Ma. Per Side	Sec. Series	Ma. Par.	Mtg. Fig.	Size Inches WxDxH
T-11M174	C6666	\$5.29	40	100	80	160	3H*	4 x 4 1/2 x 4 1/2
T-11M175	C6667	7.35	75	145	145	290	3H*	5 1/2 x 5 1/2 x 6
T-11M176	C6668	11.35	125	210	160	320	3H*	6 1/2 x 6 1/2 x 6 1/2
T-11M177	C6669	17.64	300	250	250	500	3H*	6 x 7



# Keys·Crystals·Relays FOR THE AMATEUR

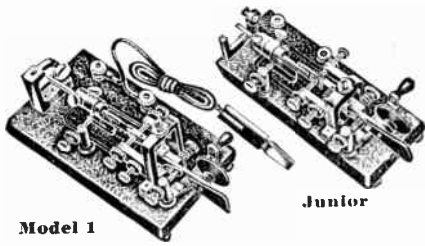

Model 1

## Martin Flash Keys

Semi-automatic transmitting instruments. All models feature perfect control, easy adjustment, now high speeds and durability. Simple to operate. Unconditionally guaranteed. Left hand keys \$2.00 extra.

**Model 1.** For the professional or advanced amateur operator. Reliable single action, easily adjusted for any speed. Heavy coin silver contacts. Closing circuit switch. Split pendulum weight. Base size, 6 $\frac{3}{4}$  x 3 $\frac{1}{2}$  x  $\frac{1}{2}$ ". Weight, 3 $\frac{1}{2}$  lbs. With cord as illustrated.

**D9482—Black crackle finish. \$1029**

**YOUR PRICE..... \$1171**

**D9483—Chrome finish. \$1171**

**YOUR PRICE..... \$1171**

**D9484—Junior Model.** Has all features of professional model but is smaller and lighter in construction. Base size, 6 $\frac{3}{4}$  x 2 $\frac{1}{2}$  x  $\frac{1}{2}$ ". Black crackle finish. Cord not supplied.

**YOUR PRICE..... \$808**

**D9485—Amateur Model.** An outstanding value. Now every amateur can own a Martin Flash Key. Similar in appearance to Junior model. Base size, 6 $\frac{3}{4}$  x 3 $\frac{1}{2}$ ". Black crackle finish. Weight, 2 lbs.

**YOUR PRICE..... \$515**

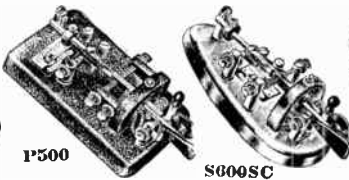

P500

S600SC

## McElroy Speed Keys

Quality semi-automatic transmitting keys. Built by T. R. McElroy, world champion telegrapher. Professional Mac Key, Model 500. Conforms with U.S. Navy specification for "Speed Key." Smooth, easy operation; perfect sending. Moving parts are chrome-plated brass. 8" silver contacts. Patented dot stabilizer. Bakelite insulation. Circuit closing switch. Parkerized base casting and super-structure are black crackle finished. Net weight, 4 $\frac{1}{2}$  lbs. Heavy enough to stay in position. Mac recommends one paddle which is mounted on key. Extra paddle included for those who prefer two.

**D9475—Base size, 3 $\frac{3}{4}$  x 6 $\frac{1}{2}$  x  $\frac{3}{4}$ ". \$750**

**YOUR PRICE..... \$750**

**Super streamspeed, Model S600SC.** The most attractive semi-automatic key made. The streamlined base and all metal parts are finished in polished chrome. Mechanically perfect, the rhythmic dots and dashes are easily received. Feather touch operation permits long periods of sending without fatigue. 8" coin silver contacts. Beryllium copper main and U spring. Coil springs, bearings and pins of finest stainless steel. Truly Mac's masterpiece.

**D9477—Net weight, 4 lbs. \$950**

**YOUR PRICE..... \$950**

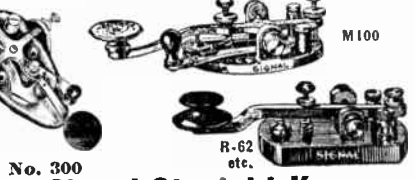

M100

R-62 etc.

No. 300

## Signal Straight Keys

**D9486—Model M100.** Designed for skilled operators. Dual adjustments for tension and lever action. Platinor contacts. Lacquered brass base, nickel plated parts. With circuit switch.

**YOUR PRICE..... \$175**

**D9487—R48.** Less circuit switch. \$165

**YOUR PRICE..... \$165**

## Standard Keys

Heavy rectangular cast base. Stays in place. All parts brass with lacquer finish. Navy type key knob.

**D9488—R62. 3" Contacts. \$206**

**YOUR PRICE..... \$212**

**D9489—R63. 1/2" Contacts. \$212**

**YOUR PRICE..... \$227**

**D9490—R64. 3/8" Contacts. \$227**

**YOUR PRICE..... \$227**

**D9491—Model R50.** Similar to above types. Heavy black crackle finished cast base. Coin silver contacts. Nickel plated parts.

**YOUR PRICE..... \$88c**

## McElroy Straight Keys

**D9478—Streamline DeLux Model 303.** The cast streamlined base and all metal parts are finished in polished chrome. Bronze bearing screws, finely balanced key lever, heavy 8" contacts. Has circuit closing switch.

**YOUR PRICE..... \$285**

**D9479—As above but with black plastic base and less circuit closing switch. \$100**

**YOUR PRICE..... \$100**

## Hi-Power Frequency Control Crystals



Designed to give peak performance in amateur bands, featuring high activity, high efficiency and low drift. Precision ground highest grade, selected quality Brazilian quartz crystal mounted in round bakelite holder, 1 $\frac{1}{2}$  x  $\frac{1}{2}$  x  $\frac{1}{2}$ ". Fits 5 prong socket or Amphenol Crystal socket. Face plate is stamped with exact frequency of crystal. Available in two types: The "Ruby." Temperature coefficient of 4 cycles or less per MC per degree centigrade. Alumilite contact electrodes with extremely hard, polished surface. The "Emerald." Temperature coefficient of 10 cycles or less per MC per degree centigrade. Nickel silver electrodes insure excellent contact.

### The Emerald

Stock Num.	For Band Meters	± KC	Mfg. Type	Your Price
C9435	160	5	LTC2	\$3.35
C9436	160	1	LTC2	4.35
C9437	80	5	LTC2	3.35
C9438	80	1	LTC2	4.35
C9439	40	5	LTC2	3.35
C9440	40	1	LTC2	4.35
C9441	20	15	TH10	5.50
C9442	20	5	TH10	9.50
C9443	10*	30	TH10	5.50
C9444	10*	5	TH10	9.50

### The Ruby

Stock Num.	For Band Meters	± KC	Mfg. Type	Your Price
C9445	160	5	LTC1	\$4.50
C9446	160	1	LTC1	5.50
C9447	80	5	LTC1	4.50
C9448	80	1	LTC1	5.50
C9449	40	5	LTC1	4.50
C9450	40	1	LTC1	5.50
C9451	20	15	TH3	7.25
C9452	20	5	TH3	11.25
C9453	10*	30	TH3	7.25
C9454	10*	5	TH3	11.25

\*Available range 14,400 to 15,000 KC for doubling to 10 meters.

## Allied Transmitter and Industrial Relays

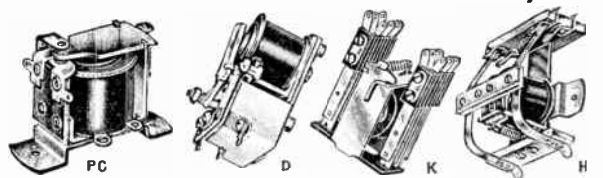

**Type PC.** High quality, compact relays having a multitude of applications. Especially suited for remote control of electrical equipment, amateur uses, etc. Size, 2 $\frac{1}{2}$  x 1 $\frac{1}{2}$  x  $\frac{1}{2}$ " high. Top movement insulated from base. SPDT switch action contacts rated 5 amperes at 125 volts AC.

**C4993—**For use in plate circuits of tubes. 2500 Ohm coil closes contact at 3 Ma., opens at 5 Ma.

**YOUR PRICE..... 97c**

**C4989—**As above but with 5000 Ohm coil.

**YOUR PRICE..... \$211**

**C4990—**With 6 volt DC coil.

**YOUR PRICE..... 92c**

**D4991—**With 6 V. AC coil \$113

**YOUR PRICE..... \$113**

**C4992—**With 110 V. AC coil.

**YOUR PRICE..... \$123**

**Type D.** Contacts rated at 10 amps. 125 volts AC. Vacuum impregnated layer wound coils. D.P.D.T. switch action. For antenna transfer, filament control, dynamotor starting, etc.

**D4950—**With 6 V. AC coil. \$245

**YOUR PRICE..... \$245**

**D4951—**With 110 V. AC coil. \$245

**YOUR PRICE..... \$245**

**Type K.** Contact rating, 1 amp. at 110 volt AC. Phosphor bronze springs.

**D4952—**4-P.D.T. with 110 volt AC coil. \$319

**YOUR PRICE..... \$319**

**D4953—**6-P.D.T. with 110 volt AC coil. \$357

**YOUR PRICE..... \$357**

**Type H.** For switching bands, crystal or tank circuits. Ainsluag insulation. Low-loss type.

**D4954—**With 6 V. DC coil. \$319

**YOUR PRICE..... \$319**

**D4955—**With 6 V. AC coil. \$319

**YOUR PRICE..... \$319**

**D4956—**With 110 V. AC coil. \$319

**YOUR PRICE..... \$319**

**Radolek can supply Relays for any purpose, either Amateur or Industrial. Send us your order. It will be filled at Lowest Prices.**

## Unmounted Crystal



Similar to "Emerald" type. Size, 1" sq. Specify frequency.

Stock Num.	For Band Meters	± KC	Mfg. Type	Your Price
C9500	160	10	AH10	\$2.35
C9502	160	1	AH10	3.25
C9501	80	10	AH10	2.35
C9503	80	1	AH10	3.25

## Crystal Holder



**Type AH**  
**C9504—**  
**PRICE**  
**\$100**

Square molded bakelite plug-in type holder for 160 and 80 meter crystals up to 1" square. Nickel silver electrodes. Fits 5 prong socket.

## McElroy Audio Oscillator



A high quality practice oscillator at an exceptionally low price. Built by T. J. McElroy, world champion telegrapher, the user is assured of perfect clean tone. His provisions for connecting key and headphones. Operated direct from the 110 volt AC or DC line. Requires only one 117LGT tube. Tube socket is located on top of attractive black plastic case. Highly recommended for schools, clubs as well as individual use. Regardless of how much you pay, you cannot get a better oscillator.

**D9480—**Less tube. \$285

**YOUR PRICE..... \$285**

**D1155—**117LGT Sylvania tube for above. \$113

**YOUR PRICE..... \$113**

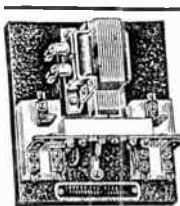

**Gordon Heavy Duty R.F. Relays**  
**D4957—**1 Kw. D.P.D.T. Heavy Duty Relay. \$882

**YOUR PRICE..... \$882**

High power D.P.D.T. relay which will handle one kilowatt easily. Ideal for antenna changeover, multi-band transmitter tank switching, beam antennas and 60 cycle power switching. Insulation is low-loss Ainsluag 196, the finest of all ceramic insulators. Losses are negligible even at 100 Mc. Has husky 3/8" coin silver, self wiping contacts. Switch action has a 4 lb. pull which makes positive contact instantly. All contacts spaced 1/2" apart to eliminate capacity effects and to guard against high potential flash-overs. Actuated by 110 volt, 50-60 cycle solenoid coil. Practiced by 110 volt, 50-60 cycle solenoid coil. Practiced by 110 volt, 50-60 cycle solenoid coil. Practiced by 110 volt, 50-60 cycle solenoid coil.

**Practiced by 110 volt, 50-60 cycle solenoid coil. \$18c**

**Practiced by 110 volt, 50-60 cycle solenoid coil. \$18c**

**Practiced by 110 volt, 50-60 cycle solenoid coil. \$18c**

**Practiced by 110 volt, 50-60 cycle solenoid coil. \$18c**

**Practiced by 110 volt, 50-60 cycle solenoid coil. \$18c**



## Transmitting

## Condensers

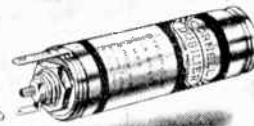
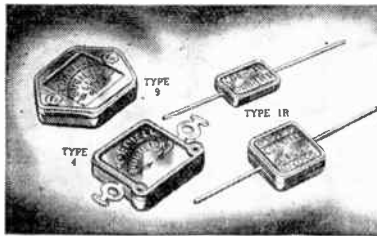

### Types 4 and 9 Mica Condensers

Best grade India mica dielectric and non-magnetic foil provides high breakdown voltage, low power factor and reduces losses. Moulded bakelite case. Accuracy  $\pm 10\%$ . Also available in low loss bakelite and higher tolerances at slightly higher prices.

600 DC Wkg. Volts—1000 Peak  
Type 4 (Lug) Type 9 (Screw)

Stock Num.	Your Price	Cap. Mfd.	Stock Num.	Your Price
C9085	\$0.24	.00005	C9154	\$0.29
C9086	.24	.0001	C9155	.29
C9087	.24	.00025	C9156	.29
C9088	.24	.0005	C9157	.29
C9089	.24	.001	C9158	.29
C9090	.27	.0015	C9159	.31
C9091	.27	.002	C9160	.31
C9092	.34	.003	C9161	.41
C9093	.34	.004	C9162	.41
C9094	.34	.005		
C9095	.41	.006	C9163	.59
C9096	.59	.008	C9164	.71
C9097	.68	.01	C9165	.82
C9098	.79	.015	C9166	.94
C9099	.91	.02	C9167	1.09
C9150	1.12	.025	C9168	1.35
C9151	1.23	.03	C9169	1.47

1200 DC Wkg. Volts—2500 Peak

Stock Num.	Your Price	Cap. Mfd.	Stock Num.	Your Price
C9152	.34	.0001	C9170	.34
C9153	.34	.0002		
C9171	.34	.00025	C9187	.34
C9172	.34	.0005	C9188	.34
C9173	.52	.001	C9189	.52
C9174	.79	.002	C9190	.79
C9175	.91	.004	C9191	.91
C9176	1.03	.005	C9192	1.03
C9177	1.03	.006	C9193	1.03
C9178	1.32	.008	C9194	1.32
C9179	1.65	.01	C9195	1.65

2500 DC Wkg. Volts—5000 Peak

Stock Num.	Your Price	Cap. Mfd.	Stock Num.	Your Price
C9180	.52	.0001	C9196	.52
C9181	.62	.00025	C9197	.62
C9182	.73	.0005	C9198	.73
C9183	.88	.001	C9199	.88
C9184	1.32	.002	C9200	1.32
C9185	1.62	.003	C9201	1.62
C9186	2.06	.005	C9202	2.06

### Type 86 High Voltage Mica Condensers

Particularly suited for high frequency transmitting work. Special mica stack eliminates corona losses. Vacuum impregnation and best grade India ruby mica dielectric. Glazed porcelain case. Size: 2 3/4" high, 2 1/2" deep, 3 1/4" Mtg. Ctrs.

Stock Num.	Cap. Mfd.	DC Wkg. Volts	Your Price
C9203	.0001	12,500	\$2.19
C9204	.0005	12,500	2.50
C9205	.0005	7,000	2.19
C9206	.001	12,500	2.94
C9207	.001	7,000	2.50
C9208	.001	3,500	2.19
C9209	.0015	12,500	3.23
C9210	.002	12,500	3.82
C9211	.002	7,000	3.09
C9212	.002	3,500	2.50
C9213	.005	10,000	5.58
C9214	.01	7,000	5.59
C9215	.01	3,500	4.12
C9216	.02	3,500	5.14
C9217	.02	2,000	6.47

### Type IR Silvered Mica Condensers

Extra heavy silver coating practically eliminates capacity drift. Completely wax impregnated and moulded in low loss red bakelite. 1 1/4" Leads. Size, 3/4" square. Accuracy  $\pm 5\%$ .

Stock Num.	Cap. Mfd.	DC Volts	Peak	Your Price
C9218	.00001	500	1000	\$0.24
C9219	.00005	500	1000	-.24
C9220	.0001	500	1000	-.24
C9221	.00015	500	1000	-.29
C9222	.0002	500	1000	-.29
C9223	.00025	500	1000	-.29
C9224	.0003	500	1000	-.44
C9225	.0005	500	1000	-.44
C9226	.001	500	1000	-.73
C9227	.0015	500	1000	-.88
C9228	.002	500	1000	-.88
C9229	.0025	500	1000	1.18
C9230	.003	300	600	1.32
C9231	.004	300	600	1.38
C9232	.005	300	600	1.47

### High Voltage Dykanol Condensers

#### Dykanol Filled—Dykanol Impregnated—Fire Proof

Filled and impregnated with a dielectric material having characteristics far superior to wax, tar, oil, etc. Extraordinary low power factor and high insulation resistance. Dykanol is non-inflammable, non-oxidizable and has no flash or fire point. Purest aluminum foil and best grade multi-laminated

Kraft tissue are used. Glazed terminal insulators; bakelite insulators used on lower voltage types. Mounted in hermetically sealed aluminum containers insulated from the condenser (except stud mounting type). Conservatively rated; may be safely operated continuously at 10% above rated voltages.

#### Type TJU In Rectangular Metal Container With Mounting Bracket

600 V. DC—440 RMS Rect. AC

Stock Num.	Cap. Mfd.	Size Inches HxWxD	Your Price
C9233	.5	2 1/4 x 1 1/2 x 1 1/4	\$1.62
C9234	1	2 1/2 x 1 1/2 x 1 1/4	2.06
C9235	2	2 3/4 x 1 1/2 x 1 1/4	2.49
C9236	4	3 1/4 x 2 1/2 x 1 1/4	3.23

1000 V. DC—660 RMS Rect. AC

Stock Num.	Cap. Mfd.	Size Inches HxWxD	Your Price
C9239	.5	2 1/4 x 1 1/2 x 1 1/4	1.76
C9240	1	2 1/2 x 1 1/2 x 1 1/4	2.20
C9241	2	2 3/4 x 1 1/2 x 1 1/4	2.94
C9242	4	3 1/4 x 2 1/2 x 1 1/4	3.67

1500 V. DC—1000 RMS Rect. AC

Stock Num.	Cap. Mfd.	Size Inches HxWxD	Your Price
C9244	1	4 x 1 1/2 x 1 1/4	2.64
C9245	2	4 x 1 1/2 x 1 1/4	3.67
C9246	4	4 x 3/4 x 1 1/4	4.98

2000 V. DC—1500 RMS Rect. AC

Stock Num.	Cap. Mfd.	Size Inches HxWxD	Your Price
C9250	1	3 3/4 x 2 1/2 x 1 1/4	3.23
C9251	2	4 x 3 1/4 x 1 1/4	3.82
C9252	4	3 1/4 x 3 1/4 x 2 1/4	5.29

3000 V. DC—2200 RMS Rect. AC

Stock Num.	Cap. Mfd.	Size Inches HxWxD	Your Price
C9253	1	3 1/2 x 3 1/2 x 2 1/4	7.06
C9254	2	4 x 3 x 3 1/2 x 2 1/4	8.82
C9255	4	4 x 3 x 3 1/2 x 2 1/4	12.94

#### Type TLA Stud Mounting Metal Container

Center lug is positive. Can be negative. Insulating washers included. Size, 1 1/2" dia., 2 3/8" to 4 1/2" high. 3/4" Mtg. Stud.

Stock Num.	Cap. Mfd.	DC Volts	RMS	Your Price
C9256	2	600	440	\$1.62
C9257	3	600	440	1.91
C9258	4	600	440	2.20
C9259	1	1000	660	1.47
C9260	2	1000	660	1.91
C9261	.5	1500	1000	1.76
C9262	1	1500	1000	1.91

#### Type TQ In Round Metal Containers

With mounting bracket

Stock Num.	Cap. Mfd.	DC Volts	RMS	Size LxWxD	Your Price
C9263	2	600	440	2 1/4 x 2	\$1.91
C9264	4	600	440	2 3/4 x 2	2.65
C9265	1	1000	660	1 7/8 x 2	1.62
C9266	2	1000	660	2 1/2 x 2	2.20
C9267	4	1000	660	3 1/4 x 2	2.79
C9268	1	1500	1000	2 3/4 x 2	2.06
C9269	2	1500	1000	3 3/8 x 2	2.79
C9270	1	3000	1500	3 1/4 x 2	2.65
C9271	2	2000	1500	4 7/8 x 2	2.94
C9272	4	2000	1500	4 1/4 x 3	4.12
C9273	1	3000	2200	3 1/4 x 3	5.29
C9274	2	3000	2200	5 1/4 x 3	6.47

## Motor Starting Capacitors for Refrigerator Motors

Stock Number	Mfg. Code	Type Case	Cap. Mfd.	Size Inches LxWxD	List Price	Your Price
C9275	JDS-80	A	80	3 1/2 x 3 1/2 x 2	\$3.75	\$2.21
C9276	JDS-100	A	100	3 1/2 x 3 1/2 x 2	4.25	2.50
C9277	JDS-115	A	115	3 1/2 x 3 1/2 x 2	4.65	2.73
C9278	JPW-80	B	80	3 1/2 x 3 1/2 x 2	3.75	2.21
C9279	JPW-100	B	100	3 1/2 x 3 1/2 x 2	4.25	2.50
C9280	JPW-115	B	115	3 1/2 x 3 1/2 x 2	4.65	2.73
C9281	JPW-135	B	135	3 1/2 x 3 1/2 x 2 1/2	5.15	3.03
C9282	JPW-150	B	150	3 1/2 x 3 1/2 x 2 1/2	5.50	3.23
C9283	LMW-80	B	80	4 1/2 x 4 1/2 x 1 1/2	3.75	2.21
C9284	LMW-100	B	100	4 1/2 x 4 1/2 x 1 1/2	4.25	2.50
C9285	LMW-115	B	115	4 1/2 x 4 1/2 x 1 1/2	4.65	2.73
C9286	LMW-135	B	135	4 1/2 x 4 1/2 x 1 1/2	5.15	3.03
C9287	LMW-150	B	150	4 1/2 x 4 1/2 x 2	5.50	3.23
C9288	LMW-200	B	200	4 1/2 x 4 1/2 x 2 1/2	7.00	4.12
C9291	ETN-80	C	75-84	3 1/4 x 1 3/8	2.75	1.62
C9292	ETN-100	C	97-106	3 1/4 x 1 3/8	3.25	1.91
C9293	ETN-115	C	108-120	3 1/4 x 1 3/8	3.50	2.06
C9294	ETN-130	C	124-128	3 1/4 x 1 3/8	3.85	2.26
C9296	ETN-155	C	145-162	4 1/4 x 1 3/8	4.25	2.50
C9297	ETN-155-1	C	145-162	3 1/4 x 1 3/8	4.25	2.50
C9298	ETN-285	C	270-300	4 1/2 x 1 3/8	6.50	3.82
C9299	ETN-285-1	C	270-300	3 1/2 x 1 3/8	6.50	3.82
C9135	ETN-400	C	378-420	4 1/2 x 2	8.50	5.00
C9136	CLB-80	C	80	4 1/2 x 2	3.75	2.21

### Designed for Intermittent Use of 20 3 Second Starts Per Hour

For use on 105-120 volt 50-60 cycle AC only.

Dry Electrolytic condensers designed to exactly replace the original unit used for starting of Refrigerators and other motor driven equipment. The correct replacement condenser for practically any Electric Refrigerator made can be selected by referring to the illustrations at left and the listing given below. A replacement guide is included with each condenser or sent separately on request.

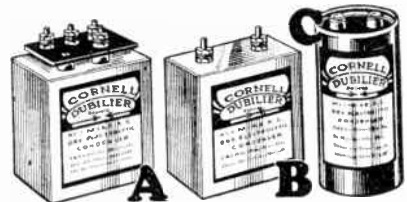

Stock Number	Mfg. Code	Type Case	Cap. Mfd.	Size Inches LxWxD	List Price	Your Price
C9137	CLB-80-1	C	80	4 1/2 x 2 1/2	\$3.75	\$2.21
C9138	CLB-100	C	100	4 1/2 x 2	4.25	2.50
C9139	CLB-100-1	C	100	4 1/2 x 2 1/2	4.25	2.50
C9140	CLB-115-2	C	115	4 1/2 x 2 1/2	4.65	2.73
C9142	CLB-135-7	C	135	4 1/2 x 3	4.65	2.73
C9143	CLB-135	C	135	4 1/2 x 3	5.15	3.03
C9144	CLB-150	C	150	4 1/2 x 3 1/2	5.50	3.23



# TRANSMITTING RECEIVING

# Variable Condensers

## Universal Replacement Variable Condensers

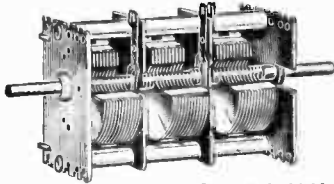

With Shaft Out of Both Ends and With Reversible Trimmers Tuned Radio Frequency type for replacement or new work. Turning shaft out of both ends permits either clockwise or counter clockwise rotation by simply reversing the position of the condenser. Memorable trimmers can be attached to long or short side. Ball bearing races. Frames are steel, aluminum plated. Compact size. End plates 3/8" x 3/8". Length: 2 section 2 1/2", 3 section 3", 3 1/2" diam., 1" long shafts. Capacity of each section is 375 Mmfd. maximum, 15 Mmfd. minimum. **C8954—2 Gang. YOUR PRICE \$1.21** **C8956—3 Gang. YOUR PRICE \$1.81**

## One Gang Condenser

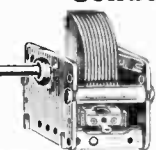

New bar type cadmium plated frame and shields. Universal mounting. End plates 3/8" x 1 1/2" high. Heavy aluminum condenser plates. Low loss bakelite insulation. 1/4" shaft 1 1/2" long. Ball bearing races. Condenser closes to right as illustrated increasing capacity clockwise.

Stock Num.	Min. Mmfd.	Cap. Mmfd.	Plates
C8975	5	140	9
C8973	9	370	19
C8974	10	450	23

**YOUR PRICE. Each..... 72c**

## Midget Condensers

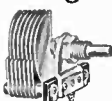

For use in circuits where a small, variable capacity is needed. Fine quality. Excellent design and construction. 1/4" shaft, 3/8" long. Mounts in 3/8" hole, on panel up to 1/2" thick. Overall size opened up, 1 1/4" x 1 1/2".

Stock Num.	Num. Plates	Ca. Max	Mmfd. Min.	Your Price
C8977	3	15	3.5	34c
C8978	5	30	8	37c
C8979	9	60	5.0	43c
C8980	12	80	6.0	46c
C8983	20	140	8.0	57c

## Midget Trimmer



Extremely small: 3/8" x 3/8". Special treated alloy plates. Best mica dielectric. Capacity range 3 to 30 Mmfd.

C8917—Ceramic	8c
Base.....	
C8918—Bakelite	6c
Base.....	

## Panel Bearing Assembly



For mounting Condensers, Volume Controls, etc., away from panel. For 1/4" shafts.

D13570—3" Long.	Net 18c
D13571—4" Long.	Net 24c
D13572—Bearing only.	Net 9c

## AUTOMATIC PUSH-BUTTON TUNERS

Push a button—there's your station—tuned in automatically and perfectly. No knob twisting, twisting or waiting. Station is tuned in immediately as button is depressed. No motor is used. Tuner is not affected by receiver dial setting.

**C10990—6 Push Buttons. List, \$5.50. \$2.35 YOUR PRICE..**



A compact trimmer condenser unit for use with superhet receivers. Simple connections. Supplied complete with escutcheon, call letters, knobs and instructions. **C9680—Special antenna coil for use with above, required on radios having preselector stage using 3 gang condenser. YOUR PRICE. Each..... 55c**

## Cardwell Transmitting Condensers

### Midway Featherweight



For low and medium power transmitters and receivers where light weight and small space are factors. Ideal for portable and aircraft equipment. Panel mounting space only 2 1/2" x 3" condenser open. 3/8" Shaft; aluminum frame; brass bearings. Supplied with aluminum mounting feet. G.E. Mycalex insulation.

### "X" Type



The standard of comparison. Polished aluminum plates, rounded edges. Frames, tie rods, bushings, etc. nickel-plated brass. Steel shaft supports rotor plates. G.E. Mycalex insulation. Panel or chassis mounting.

### "X" Type Singles

Stock Num.	Mfg. Code	Cap. Mmfd.	Air-gap	Your Price
C13500	XT230PS	220	0.70	\$2.70
C13501	XT440PS	440	0.70	4.62
C13502	XP90KS	90	0.84	2.70
C13503	XP165KS	165	0.84	3.90
C13504	XP330KS	330	0.84	6.48
C13505	XP240XS	240	1.00	6.48
C13506	XE120XS	120	1.00	3.60
C13507	XC25XS	25	1.71	2.10
C13508	XC110XS	110	1.71	5.82

### "X" Type Duals

Stock Num.	Mfg. Code	Cap. Mmfd.	Air-gap	Your Price
C13509	XR500PD	500	0.80	\$3.90
C13510	XT80PD	80	0.70	4.62
C13511	XT210FD	210	0.70	5.22
C13512	XP90KD	95	0.84	4.50
C13513	NP325KD	325	0.84	13.20
C13514	NE120XD	120	1.00	6.00
C13515	XE240XD	240	1.00	12.60
C13516	XC50XD	50	1.71	6.42
C13517	XC110XD	110	1.71	10.80

## Disc Type Neutralizers

For low capacity triodes. Finest grade Alsmag insulation, polished aluminum discs. Fine screw thread adjustment in long nickel silver bearing—no wobble. Knurled thumb nut for easy locking. Heavy satin finish aluminum support and base plate.

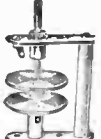

Stock Num.	Mfg. Code	Disc.	Air-gap	Your Price
C13548	ADN	2"	1/2"	\$1.80
C13549	BDN	4"	2"	3.00

## Trim Air Midgets

Single hole mounting insulating insulated midget tuning condensers ideal for portable, general receiving and low power neutralization use. Sturdy construction. Require 1 1/2" x 1 1/2" panel mounting space. 1/4" shaft.



Stock Num.	Mfg. Code	Cap. Mmfd.	Air-gap	Your Price
C13550	ZR15AS	15	0.30	\$0.75
C13551	ZR35AS	35	0.30	.90
C13552	ZR50AS	50	0.30	.96
C13553	ZU75AS	75	0.20	1.02
C13554	ZU100AS	100	0.20	1.05
C13555	ZU140AS*	140	0.20	1.89
C13556	ZT10AS	11	0.70	.87
C13557	ZT15AS	15	0.70	.93
C13558	ZT20AS	30	0.70	1.11

\*Double bearing—2 end plates, shaft not extended at rear.

### Dual Trim Airs

Mounting space 1 1/2" x 1 1/2". Shafts extend at rear for ganging.

Stock Num.	Mfg. Code	Cap. Mmfd.	Air-gap	Your Price
C13559	ER15AD	15	0.30	\$1.56
C13560	ER35AD	35	0.30	1.74
C13561	EU75AD	75	0.20	1.88
C13562	EU100AD	100	0.20	2.04
C13563	EU140AD	140	0.20	3.60
C13564	ET15AD	15	0.70	1.80
C13565	ET30AD	30	0.70	2.16

Radolek can supply any type of Amateur Transmitting condenser that you may require. Send us your order. The merchandise will be shipped promptly at current market price.

### Single Section

Stock Num.	Mfg. Code	Cap. Mmfd.	Air-gap	Your Price
C13518	MR50BS	50	0.30	\$1.68
C13519	MR105BS	105	0.30	1.83
C13520	MR150BS	150	0.30	1.89
C13521	MR260BS	260	0.30	1.98
C13522	MT35CS	35	0.70	2.10
C13523	MT50CS	50	0.70	2.34
C13524	MT100CS	100	0.70	2.94
C13525	MT150CS	150	0.70	3.60

### Dual Section



Capacity given below is per section.

C13526	MR250D	25	0.30	\$2.61
C13527	MR70HD	70	0.30	2.94
C13528	MR150HD	150	0.30	3.18
C13529	NR200HD	200	0.30	3.36
C13530	MT35CD	35	0.70	3.60
C13531	MT50CD	50	0.70	3.81
C13532	MT100CD	100	0.70	4.80

### Air Gap Voltages

0.30"	1000 Volts	1.00"	4250 Volts
0.70"	3000 Volts	1.17"	6000 Volts
0.84"	4200 Volts		

## Ultra High Frequency Transmitting Condensers

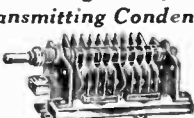

For 5, 10 and 20 meter medium power transmitters and dithering machines. Highly efficient low loss construction. For single hole panel or baseboard mounting. 1/4" shaft.

### U. H. F. Singles

Stock Num.	Mfg. Code	Cap. Mmfd.	Air-gap	Your Price
C13533	NP50DS	50	0.84	\$2.10
C13534	NP75DS	75	0.84	2.46
C13535	NP100DS	100	0.84	2.82
C13536	NP150DS	150	0.84	3.66
C13537	NG31S	35	1.71	3.12

### U. H. F. Duals

Capacity given below is per section.

C13538	NT50GD	50	0.70	\$3.60
C13539	NP35ND	35	0.84	3.60
C13540	NP35DD	35	0.84	3.21
C13541	NP50DD	50	0.84	3.60
C13542	NP75DD	75	0.84	4.32

1/40" plates, buffed and polished. 1/2025" plates, buffed and polished.

## H. F. Neutralizing Condensers

High frequency neutralizers for low capacity tubes. Mycalex insulation. Heavy buffed plates with rounded edges. 180° Rotation.



Stock Num.	Mfg. Code	Cap. Mmfd.	Rotation	Air-gap	Your Price
C13543	NA4NS	4	Adj.	2.16	\$2.16
C13544	NA6NS	6	218	2.16	2.16
C13545	NA10NS	11	218	2.16	2.16
C13546	NA16NS	16	218	3.00	3.00

# REPLACE- MENT

# Coils For Every Service Need

## Meissner Phono Oscillator Coil

With this coil and other components, anyone can construct either a "wireless," or a direct-connected, phonograph oscillator to permit the reproduction of recordings through any radio set without altering the receiver. May be incorporated either in the receiver or with the record player. Tuning knob on top of coil makes it possible to tune the oscillator to any point in the Broadcast band which is clear of interference. Coil is thoroughly impregnated against moisture. Black crackle finished shield can, 1 1/2" sq. x 3 1/2" high. Complete instructions and diagram for building a "Wireless" record player included. **C9788—List, \$2.50. YOUR PRICE \$1.47**



## R. F. Chokes

### Lattice Wound-Mounted

Small, compact, lattice wound coils using silk covered enameled wire. Units are wound to accurate inductance and have high I.F. impedance. Hole in center.



Stock No.	Milli-henries	Stock No.	Milli-henries
K9720	1 1/4	K9725	8
K9721	2 1/4	K9726	16
K9722	4	K9727	16
K9723	5 1/2		
K9724	6		

PRICE, EACH... **15¢**

Stock No.	Milli-henries	PRICE, EACH... <b>27¢</b>
K9728	30 m.h.	

Stock No.	Milli-henries	PRICE, EACH... <b>38¢</b>
K9729	60 m.h.	
K9730	80 m.h.	

## Popular Coil Replacements



Exactly duplicate original coil. Wherever coil is complete with trimmers, shield etc. It is referred to as an assembly; otherwise coil only is furnished. \*A coil repair service listed below.

Receiver Model and Type Coil	Stock No.	Your Price
Apex-Gloritone-7A, 9, 19, 99-IF and Osc. Assem.	D9620	\$1.47
Clarion-100, 220 1F & Osc. Assem. 2nd IF Coil	D9630 D9628	1.47 .59
Crosley-(IF's shown ab 15, 25, 505, 5515 Antenna Type A 1st & 2nd 175 K IF. Pins can 1x1 1/2" Type B Output IF with brass stud and screw Fairbanks Morse-8A-RF	D9586 D9587 D9588 D9589	.59 .59 .59 1.53
Grunow-11G, 1191, 11 BC Antenna Coil BC Det. (Litz Wire Type D) BC Det. (Solid Wire) BC Oscillator 12, 12W, 1291, 1297 BC Antenna BC Det. (Litz Wire Type D)	D9590 D9591 D9592 D9593 D9594 D9595	.59 .59 .59 .59 .59 .59
Motorola-5T-T1, T2, 5Y, 6A, 6T, 9Y, 9R, 9A 2nd IF PHico-38, 38A 1st IF RCA-80, 82, 86, RA E68 1st IF Coil (Pt 8367) 2nd IF Coil (Pt 8365) 3rd IF Coil (Pt 8366)	D9596 D9597 D9659 D9660 D9661	.94 .41 .53 .53 .53
Sentinal-72, 72AE, 73B 801B, 100X-BC Osc. Stewart-Warner R110-BC 1st Det. R193, 1931-9-2nd IF	D9598 D9599 D9580	.59 .59 .59

## Insulex R. F. Choke



High Frequency

A9764—YOUR PRICE **14¢** 10 for \$1.25  
Designed especially for high frequency receivers. Extremely low distributed capacity. For wire lead mounting or may be mounted in grid clips. 2.5 Millihenry inductance. 16 Ohms DC resistance. 150 Ma. current capacity.

## R. F. Choke Coils

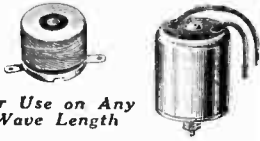

For Use on Any Wave Length

Unshielded coils have solder lugs securely anchored to ceramic form. Shielded coils are completely shielded in aluminum case 1 3/4" diam., 1 1/2" long. Insulated wire leads. Single mount screw projects 3/8".

Unshielded		Shielded	
Stock Number	Milli-henries	Stock Number	Milli-henries
K9731	80	K9738	80
K9732	60	K9739	60
K9733	30	K9740	30

Your Price, Ea. **34¢**      Your Price, Ea. **42¢**

Stock Number	Milli-henries	Stock Number	Milli-henries
K9734	10	K9741	10
K9735	5 1/4	K9742	5 1/4
K9736	3 1/2	K9743	3 1/2
K9737	2 1/2	K9744	2 1/2

Your Price, Ea. **24¢**      Your Price, Ea. **32¢**

## I. F. Transformers

In Metal Shield with Double Tuning Condensers

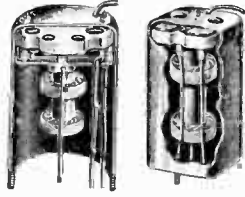

For use as replacements or in new set design. Can be used in any combination required for the I. F. stages. The tuning condensers are of the mica compression type, on Isolantite bases and are adjustable from the top of the shield can. Leads are color coded. Diagram is furnished with each unit. Double Tuned.

I.F. Coils in Round Shield Shield Size, 2 1/2" Dia., 3" High. Spade Bolt Mounting Centers 2 1/2"

Input	Output	Peak K. C.	Frequency Range
K9766	K9767	4f5	442-470
K9768	K9769	1f5	168-180

I.F. Coils in Square Shield Shield Size 1 3/4" Square x 3 1/2" High Spade Bolt Mounting Centers 1 3/4"

Stock No.	Milli-henries	Stock No.	Milli-henries
K9770	465	K9771	465
K9772	175	K9773	175

YOUR PRICE, Either Type, Each... **53¢**

## Meissner Oscillator Coils

Will operate in all types of oscillator circuits. Covers the broadcast band of 150 to 550 meters (540-1780 Kc.) when used with 365 Mmf. tuning condenser. Careful design assures uniform oscillation over entire band. Thoroughly impregnated. Shielded coils are in cans 1 1/2" diameter x 1 1/4" high.



Stock Num.	I.F. Freq.	Use Padder	List Price	Your Price
C9753	175	900 mmf.	95¢	<b>56¢</b>
C9754	436	300 mmf.		Each

Shielded

Stock Num.	I.F. Freq.	Use Padder	List Price	Your Price
C9755	175	400 mmf.	75¢	<b>44¢</b>
C9756	262	488 mmf.		Each
C9757	370	300 mmf.		Each
C9758	456	350 mmf.		Each

Unshielded

## Meissner I.F. Replacement

Used in midget and compact receivers. Has molded plastic trimmer base and supporting dowel. May be used to replace in place, either in-ut or output I.F. transformer. Double tuned for 456 Kc. Size, 1 1/2" x 1 1/4" x 1 1/4" High. **C9785—List, \$1.00. YOUR PRICE... 59¢**



## Carron Wave Traps

Can be attached to any radio and adjusted for maximum efficiency in elimination of cross modulation, code interference, blanketing by powerful nearby stations, broad tuning and many other kinds of interference. Screwdriver adjustment. Coil and trimmer housed in 1 3/4" x 1 1/4" shield can with ear lug mounting. **D9750—Covers 1600 to 1800 Kc. D9751—Covers 1400 to 1600 Kc. D9752—Covers 400 to 500 Kc. List Price, 75¢. YOUR PRICE, Each... 44¢**



## New Triple Tuned I. F. Transformers

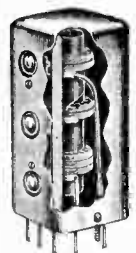

Greater High Fidelity with Increased Selectivity and Sensitivity.

456 Kc. **C9786—Innut. C9787—Output. List Price, \$3.00. YOUR PRICE**

**\$1.32** EACH

Greater High Fidelity reproduction without any sacrifice of sensitivity or selectivity. The selectivity curve has a flat top over practically the entire 10 Kc. range which permits reception over the complete audio range—no cutting of side bands yet positive 10 Kc. separation. One stage of Triple Tuned I.F. gives twice the selectivity of a Double Tuned stage. Triple tie windings are each individually tuned. Adjusting trimmer: are at side of shield can. Frequency range variable from 360 to 480 Kc. Easy to install. Metal shield 2" square by 5" high. Spade bolt mounts. Diagram included.

## Primary Replacement Windings



For Antenna or R.F. Coils

Slip over type high impedance silk covered enamel wire windings. For replacing burned-out antenna and R.F. primaries. Defective primary section is removed from original coil and primary replacement collar slides in place.

Stock Numbers	Ant. Dia.	RF In. Dia.	3.5 Mb. In. Dia.	Price Each
D9666	D9649	1 1/2"	1 1/2"	12¢
D9667	D9670	1 1/2"	1 1/2"	
D9668	D9671	1 1/2"	1 1/2"	
D9669	D9672	1 1/2"	1 1/2"	
D9670	D9673	1 1/2"	1 1/2"	
D9671	D9674	1 1/2"	1 1/2"	
D9672	D9675	1 1/2"	1 1/2"	
D9673	D9676	1 1/2"	1 1/2"	
D9674	D9677	1 1/2"	1 1/2"	
D9675	D9678	1 1/2"	1 1/2"	
D9676	D9679	1 1/2"	1 1/2"	
D9677	D9680	1 1/2"	1 1/2"	

## Dowel Type Windings



Fit inside coil form. Particularly adapted for use where the "slip-over" type cannot be used.

used, 1.7 MH Antenna winding for use with sets having a regular antenna; 2.25 MH for sets with a short "bank" or AC-DC antenna.

Stock Num.	1.7 MH Coll Dia. x Lgth.	Dowel Dia. x Lgth.	2.25 MH Stock Num.
C9600	1 1/2" x 3 1/2"	3/8" x 3/4"	C9603
C9601	1 1/2" x 3 1/2"	3/8" x 3/4"	C9604
C9602	1 1/2" x 3 1/2"	3/8" x 3/4"	C9605

## R.F. Type

**C9606**—1/2" dia. x 1/2" long. 3.5 MH  
**C9607**—5/8" dia. x 3/4" long. 7.5 MH  
**C9608**—3/4" dia. x 1" long. 7.5 MH  
YOUR PRICE, Each... **15¢**  
\*Must be shunted with a 15 or 20 mhf. condenser for best performance.

## Replacement I. F. Windings



Designed particularly for replacement use in small cheap "pocket" sets to help hold down repair costs. Adjustable coupling. Center tap on secondary winding may be disregarded when not needed.

Stock Num.	IF Freq.	T P IF	Your Price
D9681	436	Input	35¢
D9682	436	Output (C.T.)	
D9683	262	Input	
D9684	175	Output	

## Coil Repair and Renewal Service



Antenna, R.F., I.F., and Oscillator Coils Guaranteed Performance

In practically every instance the defective coil will be checked against and rebuilt according to the original manufacturer's specifications. This special engineering service insures receiving an exact duplicate of the original. We guarantee that the remanufactured coil will be returned to you in perfect working condition and with electrical characteristics exactly like the original. Most remanufactured coils will give performance far superior to the original.

### Price List

R. F. Antenna and single section I.F. coils.	<b>KX1959—YOUR PRICE \$1.45</b>
Double Section I.F. Coils	<b>KX1960—YOUR PRICE \$1.75</b>
Combination Oscillator and I.F. Coils (Composite).	<b>KX1961—YOUR PRICE \$1.95</b>

Send Defective Coil And Requested Information. Send original defective coil with following information: Receiver name and model, state bands covered, number and types of tubes used and number of sections in gang condenser. If coil is shielded include shield. If the coil you send is identified as a regularly stocked item we will immediately ship an exact duplicate at the lowest dealer price.



## Meissner Replacement Coils

### Plastic I. F. Transformers

A compact high quality double tuned I. F. of a new type of construction that is not affected by temperature or humidity. Windings are thoroughly impregnated with special low loss compound. Dowel and trimmer bases are of molded plastic. New type "floating" trimmer construction practically eliminates drift. May be peaked at any point within exceptionally wide frequency range. Aluminum can size 1 1/2" square x 2 1/2" high. Mfg. Ctrs. 1 1/2"



Stock Number		In	Out	Inter Stage	Peak Kc.	Freq. Range
C9613	C9617	C9638	175	140	200	
C9614	C9618	C9639	262	200	310	
C9615	C9619	C9640	370	305	480	
C9616	C9637	C9642	456	400	550	

YOUR PRICE, Each ..... **59c**

### Iron Core Ferrocart I.F. Transformer



Provide improved performance. Lateral coil windings on an iron core of microscopically fine particles, individually insulated, have reduced core and winding losses to a minimum. Gain is twice that of the air core types. Selectivity is so improved that receivers having normally poor separation can be converted into receivers having positive 10 kc. separation or better. Only one I.F. in an old receiver need be replaced. In all cases, use of these I.F. transformers as replacement, will give results far superior to those obtained from the original unit. Microphonic noises are eliminated. Gain is doubled. Signal is increased. Complete instructions and recommendations for circuit improvements are included. Complete shielding prevents dust particles, etc. from shorting trimmer condensers. Double tuned mica compensators. Dimensions of shield: 1 1/2" square x 3 1/2" high.

With Mica Tuned Trimmers

Stock Num.	Freq. K. C.	Operating Extremes	Position In Set
K9690	175	127-206	Input
K9691	175	144-320	In-stage
K9692	175	127-206	Output
K9694	456	360-600	Input
K9695	456	360-600	In-stage
K9696	456	360-600	Output
K9697	456	360-600	Output C.T.
C9688	1500	1050-2000	Imp-Intstage
C9689	1500	1050-2000	Output

List Price, \$2.00.  
YOUR PRICE, EACH ... **\$1.18**

We can supply any Meissner product at usual discounts. Send us your order. Shipment will be made promptly.



**New Instruction Manual**  
168 pages of invaluable information and data for Servicemen, Amateurs, Experimenters and Custom Set Builders. Includes technical data — detailed wiring instructions — pictorial diagrams — schematics — alignment data — operating instructions and a host of new and up-

### Compact High Impedance Antenna and R.F. Coils

A new series of compact high impedance Litz wound coils. Covers the broadcast band 190-550 meters when used with a .000365 mfd. (.00035) variable condenser. We recommend that a complete set of coils be replaced in a receiver in order to obtain maximum efficiency. Coils are precision machine wound and use the best of materials. Thoroughly impregnated and impervious to moisture. Will efficiently replace the broadcast coils of practically any receiver. Compact size allows use of these coils in even the smallest set. These coils can be readily substituted for the old Type Enamel Wire Wound Coils and will furnish approximately 20 per cent higher gain and increased selectivity over the broadcast band. Coils are wound on 5/8" dia. forms 1 3/4" long.

**Shielded Type**  
Shield Size 1 1/2" Diameter x 2" High. Spade Bolt Mounting Centers 1 3/4".

C9774—Antenna Coil  
C9775—R. F. Coil  
YOUR PRICE, Each..... **35c**

**Unshielded Type**  
C9778—Antenna Coil  
C9779—R. F. Coil  
YOUR PRICE, Each..... **26c**

### Adjustable Inductance Iron Core Ant. & R.F. Coils

An ideal replacement for coils in practically any broadcast receiver. Eliminates hard-to-get exact duplicates as these coils can be adjusted to accurately track with other coils in receiver. Size, 1 1/2" x 2 1/2". M t g. Ctrs. 1 1/2".

**Shielded**

Stock Number	Type	List Price	Your Price
C9714	Antenna		\$1.18
C1716	Radio Freq.	\$2.00	Each
C9717	Oscillator		Each

**Unshielded**

C9761	Antenna		<b>73c</b>
C9762	Radio Frequency	\$1.25	
C9763	Oscillator		

### Iron Core Ant. & R.F. Coils

New iron core antenna and R.F. coils for use as replacements and for modernization of old radios. The higher gain and increased selectivity of these coils will improve broadcast reception. Iron core and lateral windings on these coils produce a very compact unit. Designed to cover the broadcast band with a .000365 Mfd. (.350 to 370 Mmfd.) condenser. Size 1 1/2" square x 2 1/2" high. M t g. Ctrs. Complete instructions and recommendations for improving old radios are included. High impedance type.

Stock Number	Type	List Price	Your Price
K9710	Antenna		<b>\$1.03</b>
A9715	Inter. R.F.	\$1.75	
K9712	Det. R.F.		

to-the-minute information on radio. Sixteen pages are devoted to a discussion of the principles of Television, modern coil design, how to select proper coils for many purposes, design factors governing their use, how to locate and remedy trouble in them, etc. Contains detailed building and operating instructions, with pictorial and schematic diagrams, for every unit in the entire line of Meissner kits.  
C12541  
YOUR PRICE ..... **49c**

## Carron Replacement Coils

### Standard Antenna and RF Coils

For TRF or Superhet Circuits

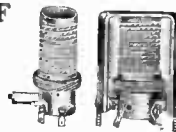

Universal progressively wound Litz wire secondaries provide greater compactness and lower capacity. High impedance primaries result in uniform gain over entire broadcast band. Polystyrene impregnated forms withstand high heat and humidity. Coil form size 7/8" dia., 2 1/4" long. 1750-550 Kc type are for use with 410 Mmfd. tuning condenser; 1550-540 Kc type for 360 Mmfd. condenser.

**Unshielded Coils**

Stock Num.	Type	Tuning Range	List Price	Your Price
D9509	Antenna	1750-550	55c	<b>32c</b>
D9510	RF	1750-550	55c	
D9511	Antenna	1550-540	55c	
D9512	RF	1550-540	55c	Each

**Shielded Coils**  
Shield can size, 1 1/2" dia., 2 1/4" high. With spade bolt mounting.

D9513	Antenna	1750-550	65c	<b>38c</b>
D9514	RF	1750-550	65c	
D9515	Antenna	1550-540	65c	
D9516	RF	1550-540	65c	Each

### Midget Antenna and RF Coils



Best quality. Furnished in broadcast type covering 1550-540 Kc with 360 Mmfd. tuning condenser and also broadcast type with tap to cover police broadcasts. Universal progressive Litz wire wound secondary with high impedance primaries. Polystyrene impregnated 7/8"x1 1/2" coil forms.

**Unshielded Type**

Stock Num.	Coil Type	List Price	Your Price
D9517	Antenna	55c	<b>32c</b>
D9519	RF	55c	

### With Tap for Police Broadcasts

D9520	Antenna	60c	<b>35c</b>
D9521	RF	60c	

### Pee-Wee Coils

D9525—Antenna.  
D9526—RF Coil.  
List Price, 50c.  
YOUR PRICE, Each..... **29c**

Universal progressive secondary windings of Litz wire and high impedance primaries result in exceptionally compact, high gain coils. Wound on 1/2"x1 1/2" polystyrene treated forms. Coils cover 1550-540 Kc with 360 mfd. tuning condenser.

### Oscillator Coils

Wound on ceramic form and fully impregnated. 1750-550 Kc type usually employs a 410 Mmfd. condenser in R<sub>p</sub> stages, 1550-540 Kc type uses 365 Mmfd. condenser in R<sub>p</sub>.

Stock Num.	Freq.	Tuning Range*	List Price	Your Price
D9527	455/6	1550-540	65c	<b>38c</b>
D9528	455/6	1750-550	65c	
D9529	262	1550-540	65c	
D9530	175	1550-540	65c	Each

### Standard IF Transformer

Designed for general replacement and new set construction. Coils are wound on polystyrene impregnated d o w e l s with finest silk insulated wire. Litz wire is used on the 455.6 Kc IF's. All coils feature dehydrated - flash dipped windings, lead spacers to prevent loss of gain and instability. Insulated can liners assure freedom from shorts or leakage. Standard spade bolt mounting. Can size 1 1/2"x1 3/4"x3 1/2".

Stock Num.	IF Freq.	Position In Set
D9531	455/6 Kc.	Input
D9532	455/6	Interstage
D9534	455/6	Output
D9535	455/6	Center Tapped Output
D9537	262 Kc.	Input/Interstage
D9538	262	Output
D9539	175	Input/Interstage
D9546	175	Output

List Price, \$1.25.  
YOUR PRICE, Each..... **73c**

### Special Auto Radio IF Transformers

Similar in appearance to above coils. Polystyrene treated to withstand high temperature conditions usually encountered in auto radio sets. Can size 1 1/2"x1 3/4"x3 1/2".

D9547	455/6	Input
D9548	455/6	Output
D9549	262	Input
D9550	262	Output

List Price, \$1.25.  
YOUR PRICE, Each..... **73c**

### Frequency Modulation IF Transformers

Construct your own FM receiver around these IF coils. Receiver circuit diagram is included with data on winding your own R<sub>p</sub> and oscillator coils. The set transformer operates at 4900 Kc. for minimum image interference. Circuits are resistance loaded so that a better response curve results. This reduces transient effects caused by the rapidly changing frequency and also provides a wide acceptance band at the nose of the curve. Shield can, size 1 1/2"x1 3/4"x3 1/2" high.

Stock Num.	Type	List Price	Your Price
D9551	1st I.F.	\$1.65	<b>97c</b>
D9552	2nd I.F.	1.65	
D9553	3rd I.F.	1.65	
D9554	Discriminator	1.75	\$1.03

### Low Loss Discriminator

Low loss discriminator for use with above IF's. Recommended where high stability of operation over a long period of time is essential. In-termediate air tuned secondary, ceramic form, silver mica coupling condenser and DC return choke. Size 2x3x2 1/2".

D9557—List Price, \$4.00.  
YOUR PRICE ..... **\$235**

### Pre-Selector Coil

**Unshielded Type**  
Improved construction. Meets 80% of pre-selector coil service requirements. Tunes 1750 to 550 Kc with 410 Mfd. tuning condenser. Ceramic form, silver mica coupling condenser and DC return choke. Size 2x3x2 1/2".

D9558—List Price, \$1.00.  
YOUR PRICE ..... **59c**

# CABINETS CHASSIS BASES and PANELS

## Streamlined Amplifier Foundations

Chassis base with shield.

Beautiful foundations for P.A. amplifiers, speech amplifiers and similar apparatus.

Beautiful marine gray wrinkle finish with chrome trim. Chrome plated ventilators in front. Sturdy handles at sides of base. Screened ventilators at top. No bottom plates included.

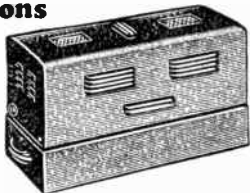

Stock Number	Size Inches W x D x H	Chassis Base	Your Price
D17993	10x5 1/2 x 9	3" High	\$2.65
D17994	12x8 x 9	3" High	3.50
D17995	17x7 x 9	3" High	3.50
D17996	14x10 x 9	3" High	3.82
D17997	17x10 x 9	3" High	4.09

## Standard Foundations

Chassis Base with Shield

Similar to above except does not have chrome trim. Well adapted for permanent installations and for use in carrying cases. Plenty of ventilation. Screened openings in top. Marine gray wrinkle finish. No bottom plates included.



Stock Number	Size Inches W x D x H	Chassis Base	Your Price
D17900	10x5 1/2 x 9	3" High	\$1.50
D17901	12x8 x 9	3" High	2.21
D17902	17x7 x 9	3" High	2.23
D17903	14x10 x 9	3" High	2.50
D17998	17x10 x 9	3" High	2.65

## General Utility Cabinets



Sturdy steel cabinets suitable for input stages, mixers, transformers, amplifiers, monitors, etc. Removable front and back covers held in place by self-tapping screws. Finished in black wrinkle enamel. No chassis base included.

Stock Number	Size Lx D x H	Your Price	Stock Number	Size Lx D x H	Your Price
C17964	4x2x4	\$0.53	C17968	10x 8x 7	\$1.32
C17965	4x3x5	.59	C17969	10x 8x10	1.62
C17966	6x6x6	.68	C17970	12x11x 8	1.76
C17967	9x6x6	1.03			

## Sloping Panel Cabinets

All purpose cabinet with large removable sloping panel. Rear of cabinet has louvred ventilators with opening for cables. Sides have chrome trimmed ventilators. Marine gray wrinkle finish with chrome trim. No chassis base included.

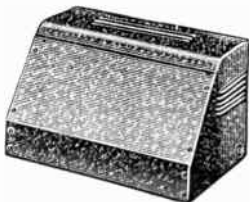

Stock Number	Size L x D x H	Takes Chassis Size	Your Price
D17888	8x8 x 8"	7x7 x 2"	\$2.79
D17889	10x8 x 8"	9x7 x 2"	2.94
D17890	14x8 x 8"	13x7 x 2"	3.23
D17891	18x12x12"	17x10x3"	5.14

## Metal Speaker Cabinets

Sturdy metal cabinet attractively finished in marine gray wrinkle enamel with chrome trim and carrying handle. Modern steel speaker grille. Supplied with well ventilated back covers.



Stock Num.	Size W x H x D	Hole Size	For Spkr.	Your Price
D17850	10x10x6"	4 1/4"	6"	\$3.09
D17852	12x12x7"	6 1/2"	8"	3.82
D17854	4x4x8"	9"	10"	5.00
D17865	16x16x8"	11"	12"	6.47

## Panels for All Radio Purposes

Aluminum Panels. Commercially pure, hard tempered, in natural bright polished finish. Bakelite Panels. Best grade, easily machined without chipping. Polished black finish. Hard Rubber Panels. Can be drilled or cut without chipping. Polished black finish. Masonite Panels are made of tough non-magnetic material. Can be easily cut and drilled with wood working tools. Polished black finish. Will not warp.



Aluminum 1/8" Thick		Hard Rub. 1/4" Thick		Bakelite 1/8" Thick		Masonite 1/4" Thick		
Stock Num.	Your Price	Stock Num.	Your Price	Stock Num.	Your Price	Stock Num.	Your Price	
C11290	\$0.39	C11320	\$0.69	7x10	C11305	\$0.59	C11309	\$0.78
C11291	.49	C11321	.82	7x12	C11306	.75	C11310	.99
C11292	.58	C11322	.98	7x14	C11304	.89	C11311	1.14
C11293	.78	C11323	1.22	7x16	C11308	1.15	C11312	1.39
C11294	.84	C11324	1.58	7x18			C11314	1.84
C11296	1.23	C11327	1.98	7x30			C11299	2.24

**Special Size Panels**  
We can supply panels in any size. Prices: 1/4" Aluminum Panels, 1/4c per square inch. 1/8" Bakelite, 1/2c per square inch. 1/8" Bakelite, 1/4c per square inch. Minimum order 75c.

## Heavy Duty Chassis and Bottom Plates

Steel Black Stock Num.	Chassis Cadmium Stock Num.	Your Price	Size Inches W x L x H	Bottom Plates Black Stock Num.	Cadmium Stock Num.	Your Price
D18400	D18415	\$0.39	4 1/4 x 8 1/2 x 1 1/2	D18430	D18445	\$0.26
D17999	D17879	.40	5 x 9 1/2 x 1 1/2			
D18401	D18416	.45	5 x 9 1/2 x 3	D17880	D17892	.33
D18402	D18417	.40	7 x 7 x 2	D17881	D17893	.38
D17851	D17866	.45	7 x 9 x 2			
D17853	D17868	.50	7 x 11 x 2	D17883	D17895	.41
				D17885	D17897	.41
D17856	D17871	.55	7 x 12 x 3	D17887	D17899	.47
D17858	D17873	.57	7 x 13 x 2	D18432	D18447	.47
D17860	D17875	.70	7 x 17 x 3	D18434	D18449	.47
D17861	D17876	.72	8 x 17 x 2	D18437	D18453	.47
D18405	D18420	.79	8 x 17 x 3	D17882		
D17855	D17870	.66	10 x 11 x 2 1/2			
				D17884	D17896	.47
D17857	D17872	.68	10 x 12 x 3	D17886	D17898	.50
D17859	D17874	.73	10 x 14 x 3	D18434	D18449	.59
D17862	D17877	.80	10 x 17 x 3	D18435	D18450	.59
D17867	D18422	.85	10 x 17 x 4	D18436	D18451	.59
D18408	D18423	.90	10 x 23 x 3	D18438		
D18410	D18425	.95	11 x 17 x 3			
				D18442	D18457	.73
D18413	D18428	1.11	13 x 17 x 2	D18444	D18457	.73
D18414	D18429	1.25	13 x 17 x 4			



One piece chassis and bottom plates made of 18 gauge steel. Suitable for rack or cabinet use. Supplied in cadmium and baked black wrinkle finish. Chassis have 1/2" flange on bottom folded inward, for additional strength and drilled for attaching of bottom plates. Raised bosses on bottom plates.

## Steel Chassis Bases

Bases are made of lead coated, heavy and substantial auto-body steel. Easy to solder. Open on bottom, enclosed top and sides.

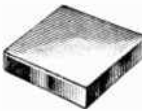

Stock Number	Size L x W x H	Your Price
D15855	9x 7x 2"	\$0.36
D15858	12x10x3"	.51
D15856	13x 7x 2"	.46
D15859	17x10x3"	.61
D15860	23x10x3"	.69

## Hinged Covered Cabinets

For test equipment, oscillators, small transmitters, amplifiers, etc. Made of steel, finished in black crystallized lacquer. Hinged lid. Front, back or bottom can be removed separately. Shipped knocked down. No chassis included.



Stock Number	Size Inches L x W x H	Takes Chassis L x W x H	Your Price
A17917	9 x 5 x 6	8 1/2 x 4 1/2 x 1 1/2"	\$1.45
A17918	10 x 8 x 7	9 x 7 x 2"	1.85
A17919	10 x 8 x 10	9 x 7 x 2"	2.00
A17920	12 x 8 x 7	11 x 7 x 2"	2.43
A17921	12 x 11 x 8	11 x 10 x 2 1/2"	2.43
A17922	14 x 8 x 7	13 x 7 x 2"	2.35
A17923	18 x 12 x 9	17 x 10 x 3"	3.42

## Portable Steel Cabinets

For transceivers, test equipment, etc. Front and back are removable. Leather handle. Black wrinkle finished steel. Fully enclosed.



A17924—Size, 12x7 1/2 x 7 1/2. List, \$2.85. <b>YOUR PRICE ... \$1.53</b>
A17925—Size, 15x7 1/2 x 7 1/2. List, \$3.55. <b>YOUR PRICE ... \$1.88</b>
<b>Chassis for Above</b>
A17926—Size, 7 1/2 x 6 x 2 1/2. List, 50c. <b>YOUR PRICE ... 27c</b>

## Relay Rack Panels



Standard amateur relay rack panels slotted to fit any 19" relay rack having holes at 1 3/4" centers. Available in either black or gray wrinkle finish. Steel panels 1/8" thick. Masonite panels 3/8" thick. All panels 19" wide.

Black Steel Stock Number	Grey Steel Stock Number	Your Price	Size In.	Black Masonite Stock Number	Your Price
C17822	C17834	\$0.42	1 1/2"	C17927	\$0.33
C17823	C17835	.46	3 1/2"	C17928	.41
C17824	C17836	.50	5 1/2"	C17929	.56
C17825	C17837	.55	7"	C17930	.62
C17826	C17838	.59	8 1/2"	C17931	.73
C17827	C17839	.73	10 1/2"	C17932	.85
C17828	C17840	.82	12 1/2"	C17933	.97
C17829	C17841	.95	14"	C17934	1.09
C17830	C17842	1.10	15 1/2"	C17935	1.23
C17831	C17843	1.45	17 1/2"	C17936	1.38
C17832	C17844	1.75	19 1/2"	C17937	1.53
C17833	C17845	2.00	21"	C17938	1.68

## Plain Steel Panels

Black wrinkle finish steel panels for use with metal cabinets and chassis. 3/8" Thick. No. drilled or etched.

Stock Num.	Size	Your Price	Stock Num.	Size	Your Price
C18460	7x10"	\$0.33	C18467	8x16"	\$0.53
C18461	7x12"	.38	C18468	8x18"	.59
C18462	7x14"	.44	C18469	8x21"	.67
C18463	7x18"	.59	C18470	8x24"	.77
C18464	7x21"	.72	C18471	10x14"	.82
C18465	8x12"	.44	C18472	10x18"	.97
C18466	8x14"	.47	C18473	10x24"	1.18

## Chrome Trim Plates

Two-tone satin and polished chrome striped decorative plates for improving the appearance of chassis, cabinets, etc.

Stock Num.	Size W x L	Your Price	Stock Num.	Size W x L	Your Price
D18482	3x10"	38c	D18479	3x23"	88c
D18483	3x12"	44c	D18480	4x14"	71c
D18477	3x14"	53c	D18481	4x17"	88c
D18478	3x17"	65c			

## Rack Screws and Washers

Nickel plated, oval head brass screws and cup washers for rack and panel use. Screw size, 6/32" long. C11876—Per set of 12 screws and 12 washers. **YOUR PRICE ... 10c** Per gross sets (288 Pe.) ... \$1.08





## Bakelite Bar Knobs

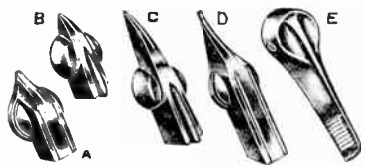

New streamlined design. 2" Bar knobs have slightly shorter tail than the 2 1/4" knobs. \*Made of Plaskon, †Metal Insert and ‡Pointer.

Stock Number	Type	Color	Size	Your Price	Ten For
C11375	A	Black	1 1/4"	4c	35c
C11373	A	Red	1 1/4"	7c	65c
C10952	A	Green*	1 1/4"	8c	75c
C10953	A	Yellow*	1 1/4"	8c	75c
C10955	A	Blue*	1 1/4"	8c	75c
C10950	B	Black	1 1/4"	5c	40c
C10984	B	Black	1 1/4"	6c	55c
C10951	B	Ivory†	1 1/4"	8c	75c
C10956	C	Black	2 1/4"	6c	45c
C10985	C	Walnut	2 1/4"	7c	60c
C11377	D	Black	2 1/4"	6c	45c
C11374	D	Red	2 1/4"	8c	75c
C10900	E	Black	1 1/4"	6c	45c
C10901	E	Black†	1 1/4"	10c	92c
C10902	E	Black	2 1/4"	8c	75c
C10903	E	Black†	2 1/4"	10c	95c

## Walnut Knobs

Finest Quality. Rich Looking

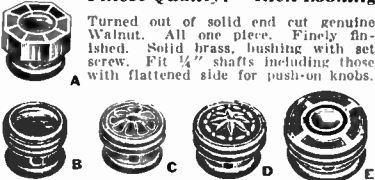

Turned out of solid end cut genuine Walnut. All one piece. Finely finished. Solid brass, bushing with set screw. Fit 1/4" shafts including those with flattened side for push-on knobs.

Stock Number	Type	Size Dia. x Ht.	Your Price
A11393	A	1 1/4" x 3/8"	<b>8c</b> Each
A11392	A	1 1/4" x 3/8"	
A11391	B	1 1/4" x 3/8"	
A11390	B	1 1/4" x 3/8"	
A11395	C	3/4" x 3/8"	<b>Ten for 70c</b> Per Hundred \$6.75
A11394	C	1 1/4" x 3/8"	
A11397	D	1 1/4" x 3/8"	
A11396	D	1 1/4" x 3/8"	
A11389	E	1 1/4" x 3/8"	<b>Knobs may be Assorted</b>
A11388	E	1 1/4" x 3/8"	
A11387	E	1 1/4" x 3/8"	
A11386	E	1 1/4" x 3/8"	

## Bakelite Knobs

Stock Num.	Type	Color	Size In. D x W	Your Price	Ten For
C11382	A	Walnut	1 x 1 1/4"	6c	45c
C11431	B	Black	3/4 x 3/8"	5c	40c
C10960	B	Black	3/4 x 3/8"	5c	40c
C11432	C	Walnut	3/4 x 3/8"	5c	40c
C10961	C	Black	3/4 x 3/8"	5c	40c
C10962	C	Ivory	3/4 x 3/8"	6c	45c
C10963	C	Walnut	1 1/4 x 3/8"	6c	45c
C10965	D	Walnut	1 1/4 x 3/8"	6c	45c
C11385	D	Walnut	1 1/4 x 3/8"	6c	45c

Stock Number	Type	Color	Size In. D x W	Your Price	Ten For
C10974	E	Walnut	1 1/4 x 3/8"	7c	65c
C10975	E	Walnut	1 x 3/8"	8c	75c
C10982	F	Walnut	1 x 3/8"	7c	65c
C10983	F	Black	1 x 3/8"	7c	65c
C11379	G	Walnut	1 1/4 x 3/8"	8c	75c
C11377	H	Black	1 x 3/8"	7c	65c
C11381	H	Black	1 1/4 x 3/8"	9c	85c

All knobs fit 1/4" shaft. Set Screws Included.

## Instrument Dials

With Marker

Chrome-silver finished dial plates with attractive black engraved numerals. Calibrated 0-100. Heavy black bakelite finger grip knob is attached to plate. Vernier marker mounts on panel and accurately indicates dial setting. Knob fits 1/4" shafts. Ideal for test instruments, radios, transmitters, etc.



2 3/4" Dial  
A11061—180 Deg. All 1062—325 Deg. YOUR PRICE, EA. **73c**

4" Dial  
A11063—180 Deg. All 1064—325 Deg. YOUR PRICE, EA. **\$1.03**

## Dial Plates and Flange Knobs

Chrome silver dial plates with accurately engraved black numerals. Calibrated 0-100 over either 180 or 325 degrees. Black bakelite flange type knobs have white indicating line and are knurled for positive grip. Knobs fit 1/4" shaft. Plate remains stationary.

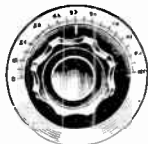

Dial Plates Only	Deg.	Dial Dia.	Your Price	Use Flange Knob	Knob Dia.	Your Price
C11072	180	2 3/4"	27c	Use 1 1/4" bar knob.		
C11073	325	2 3/4"	27c	or knob below.		
C11074	180	3 1/4"	45c	C11080	2 3/8"	28c
C11077	325	3 1/4"	45c	C11080	2 3/8"	28c
C11078	180	4"	54c	C11081	3"	35c
C11079	325	4"	54c	C11081	3"	35c

## Finger Grip Pointer Knobs

Black bakelite knobs for use on instrument, transmitter or receiver panels. Pointer type knobs particularly adapted for use with above dial plates. Fit 1/4" shafts.



With Pointer	Your Price	Fits Plate	Dia.	Less Pointer	Your Price
C11082	23c	2 3/4"	1 1/4"	C11134	16c
C11132	28c	2 3/4"	1 1/2"	C11135	22c
C11133	34c	3 1/4"	2 3/8"	C11138	27c

## Gordon Hand Wheels

With Scale and Pointer

Improves the appearance of any control panel. Black bakelite wheel has white pointer and fits 1/4" shafts. Etched heavy gauge brass dial scale has black anodized background. All scale readings are 0-100 over 180° arc except (\*) which is 270° arc.

Stock Num.	Wheel Dia.	Scale Lgth.	Your Price
D13575	3 1/4"	5 1/2"	\$1.12
D13576	2 1/4"	3 1/2"	.94
D13577	1 3/8"	3 3/4"	.73
D13578	1 3/8"	2 1/4"	.47
D13579	1 3/8"	2 1/4"	.53

Stock Num.	Wheel Dia.	Scale Lgth.	Your Price
D13580	3 1/4" Dia. with Pointer		\$0.82
D13581	3 1/4" Dia. less Pointer		.76
D13582	2 1/4" Dia. with Pointer		.71
D13583	2 1/4" Dia. less Pointer		.64

## Bakelite Vernier Dials

Unexcelled for short wave receivers, test instruments, etc. Made of polished black bakelite. Easy to mount. Smooth operation with no backlash and no gears to strip. Transparent scale type suitable for rear illumination. Universally calibrated 0-100-0 for 180 degree clockwise or counter clockwise rotation. Fit 1/4" shafts.



Stock Number	Size	Dial Scale	Your Price
C10608	3"	Plain	38c
C10668	3"	Transparent	50c
C10629	4"	Plain	45c
C10669	4"	Transparent	62c

## Crowe Etched Name Plates



YOUR PRICE Each... **6c**  
Improves appearance of any control panel. Anodized aluminum finish, silvery white background with black letters. Size 5/8"x1 1/4". Complete with self tapping screws.

Stock Num.	Markings	Stock Num.	Markings
C13360	AC Voltage	C13377	Ground
C13361	Amplifier	C13378	Input
C13362	Antenna	C13379	Key
C13355	Antenna Tuning	C13380	Microphone
C13351	Beam Antenna	C13381	On-Off
C13363	Beat Osc.	C13382	Oscillator
C13352	Bias Voltage	C13383	Output
C13364	Buffer	C13384	Phone-CW
C13365	1st Buffer Grid	C13385	Plate Current
C13366	2nd Buffer Grid	C13387	Power
C13367	3rd Buffer Grid	C13356	Phone-CW
C13368	1st Buffer Plate	C13386	Radio
C13369	2nd Buffer Plate	C13388	Receive
C13370	3rd Buffer Plate	C13389	Record
C13371	Class A Modulator	C13390	Screen Current
C13372	Class B Modulator	C13390	Select
C13353	Compling	C13391	Send
C13354	Crystal	C13392	Speaker
C13373	Crystal Osc. Grid	C13393	Transmitter
C13374	Crystal Osc. Plate	C13394	Tone
C13375	DC Voltage	C13395	Volume
C13376	Filter	C13396	500 O. Input
C13355	Grid Current	C13397	500 O. Output

## 1" Round Name Plates

Has 3/8" hole for jacks or switches. Made of brass with raised nickel plated letters and etched black satin finish background. **9c** Each  
C13357—Marked "Microphone"  
C13358—Marked "Phone"  
C13359—Marked "On-Off"  
Ten for 81c

## Vernier Dial

Attractive vernier dial for test instruments, short-wave radios, etc. 5 to 1 Vernier ratio friction type drive. Transparent marker. Brightly finished brass dial plate has deeply etched black numerals marked 0-100 in 180°. Less knob. C10627—2 3/4" Dia. Dial. YOUR PRICE... **73c**  
C10631—4" Dia. Dial. YOUR PRICE... **\$1.03**



## Indicating Plates

Etched Aluminum

Heavy 24 gauge plates with Black Background — Polished Aluminum Raised Markings. For use with 1/4" pointer knob. All have "off" in lower left hand corner except (\*). YOUR PRICE... Each. **10c**



Stock Num.	Wording at Top of Plate	Wording at Bot. of Plate
D10670	Microphone	Volume Control
D10673	Phono-Radio	Volume Control
D10675	Master Tone Control	Power Switch
D10676	Microphone	Current Control
D10679	Tone Control	Power Switch
D10680	Power	Supply

Stock Num.	Wording at Top of Plate	Wording at Bot. of Plate
D10690	Microphone	Volume Control
D10691	Phonograph	Volume Control
D10692	Tone Control*	Treble
D10693	Tone Control*	Bass
D10694	Tone Control	Power Switch
D10695	Tone Control	
D10696	Expansion	A. V. E.
D10697	Compression	A. V. C.
D10698	Volume Indicator	
D10699	Monitor Volume	

**Switch Plates**  
YOUR PRICE, Any Type Below, Each... **8c**  
Match above indicating plates.  
D10689—PHONO-RADIO for Toggle Switch.  
D10700—ON-OFF for Toggle Switch.  
D10701—MIC-PHONO for Midget Slide Switch.  
D10702—ON-OFF for Midget Slide Switch.

**Planetary Vernier Drive Unit**  
D13585—Dual ratio, 7 to 1 vernier and 1 to 1 direct. Each drive has separate knob. Unit mounts on control shaft behind panel. Drive shaft projects thru panel. **\$1.32**  
YOUR PRICE...  
D10688—Black bakelite knobs for above, per pair. YOUR PRICE... **12c**

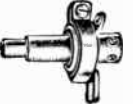

# Hallcrafters RECEIVERS

## The New Model SX-24 Skyrider Defiant

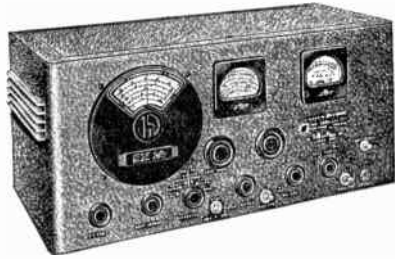

A nine tube communication receiver tuning from 540 Kc. to 43.5 mc. in four bands, (540 to 1738 Kc., 1.7 to 5.1 mc., 5 to 15.7 mc., 15.2 to 43.5 Mc.) that offers the amateur many ingenious features and performance found only in higher priced Hallcrafters receivers. The band spread dial is accurately calibrated directly in frequencies for the amateur bands and indicates the exact frequency of the received signal, performing as a high quality frequency meter. The main tuning dial is also directly calibrated and both are translucent illuminated. The "S" meter is very sensitive and is calibrated in both S units and DB's. Selectivity is variable over a wide range in six steps providing for all practical requirements of phone or C.W. from single signal razor sharpness to broad tuned I.F. A double balance bridge circuit using a 311ley crystal in a new Hallcrafters low capacity holder rejects unwanted signals even when extremely close to the desired frequency.

A new type noise limiter is built in reducing man made interference to a new low level on the ultra high frequency bands. Frequency stability is especially high, variations in line voltages have practically no change in the oscillator frequency. Terminals are also provided on the rear of the chassis for connection to a stand-by relay for break-in operation. 12 Controls on panel as follows: R.F. Gain, Band Switch, Selectivity Switch, Crystal Phasing, Audio Gain, Pitch Control, Main Tuning Control, Bandspread Tuning Control, Tone Control Switch, Automatic Noise Limiter Switch, Send-Receive Switch and BFO Switch. Uses 9 Tubes: 3-6BK7, 1-6K8, 1-6SQ7, 1-6F6G, 1-7E, 1-6H6, and 1-80. Operates on 110-120 volt 50-60 cycle AC current. For battery operation use inverter on page 78. Size of cabinet: 19 1/2" x 9 1/2" x 10 1/2". C18021—Hallcrafters Model SX24 Skyrider Defiant. Complete with tubes and crystal but less speaker. Wt., 56 lbs.

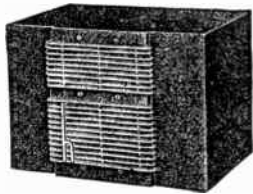

YOUR CASH PRICE..... \$69.50  
Or \$13.90 Down and \$5.33 Monthly for 12 Months.

C18039—Same as above except with 10" PM Dynamic speaker and cabinet as pictured above. Wt., 73 lbs.  
YOUR PRICE..... \$81.50  
Or \$16.30 Down and \$6.25 Monthly for 12 Months.

### Model S-19R Sky Buddy

- 6 Tubes. • 4 Bands with Complete Coverage from 44 Mc. to 545 Kc.
- Phone Jack. • Send-Receive Switch.
- Separate Band Spread Dial. • Beat Frequency Oscillator. • Pitch Control.
- Built-in Speaker.

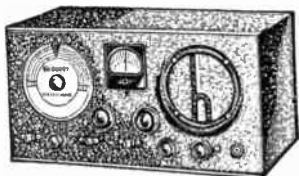

C18010—The Sky Buddy Model S-19R, including built in Speaker and Tubes.  
YOUR CASH PRICE..... \$29.50  
Or \$5.90 down and \$2.26 monthly for 12 months.

The new Hallcrafters Sky Buddy covers everything on the air from 44 Mc. to 545 Kc., including the 10, 20, 40, 80 and 160 meter amateur bands. Has sensitivity and selectivity usually found only on communications receivers selling at many times its modest price. Has AF Gain Control; Band Switch; Combined AVC and Beat Oscillator Switch; Phone Jack, Send-Receive Switch; Pitch Control. The speaker is an integral part of the receiver. Bandspread is better than A.R.R.L. Handbook recommendations for bandspread against scale calibration. Equipped for either Doubt or Marconi Antenna. Tube Complement: 1-6K8G, 1-6K7G, 1-6Q7G, 1-7E, 1-4I and 1-80. For 110-120 volt, 50-60 cycle, AC current only. For battery operation use the inverter listed on the preceding page. Size, 17 1/2" x 8 1/2" x 8 1/2". Ship. wt., 20 lbs.

### Improved S-20R Sky Champion

C18009—Hallcrafters Model S20R Sky Champion, including built in speaker and tubes.  
YOUR CASH PRICE..... \$49.50  
Or \$9.90 down and \$3.79 for 12 months.

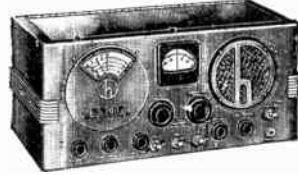

C18041—SM20—"S" Meter in separate meter housing.  
YOUR PRICE..... \$10.00  
Or \$2.00 down and \$1.50 monthly for 6 months.

• 9 Tubes. • 4 Bands Give Complete Coverage of 545 Kc. to 44 Mc. • Separate Bandspread Dial. • Individual Coils for each Band. • Flywheel Tuning. • Band Switch. • Beat Frequency Oscillator. • AVC Switch. • Excellent Sensitivity and Selectivity. • AF Control. • Sensitivity Control. • Noise Limiter.  
A 9-Tube Communications Receiver with Pre-Selection and Built-in Speaker, complete in every respect offering the amateur a quality performance never before available at this price. 4 Bands provide full coverage from 545 Kc to 44 Mc. (approx. 7 meters). Incorporates controls as follows: RF Gain Control, Tone Control, Phone Jack, A.V.C. Switch, Beat Oscillator Switch, Send-Receive Switch, AF Gain Control, Band Switch, BFO Switch and Pitch Control. Sensitivity and selectivity on all bands is extremely good. The separate bandspread on all amateur bands is better than A.R.R.L. Handbook recommendations for bandspread against scale calibrations. Speaker is an integral part of the receiver—nothing else to buy. Tube Complement: 67K7 RF Amp., 6K8, 1st Det. Mixer, HF osc., 6116 Noise Limiter, 6BK7, 1st AF Amp., 6SK7, 2nd AF Amp., 6SQ7 2nd Det., AVC and 1st Audio, 6J5GT Beat Freq. Osc., 6F6G Output and 80 Rectifier. For operation on 110-120 volts, 50-60 cycle, AC current only. Size, 18 1/2" x 9 1/2" x 8 1/2". Wt., 31 lbs.

### Model 5-10 Meter Skyrider

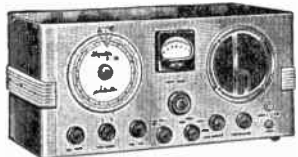

C18011—Skyrider 5-10 (Model S-21), complete with tubes and speaker.  
YOUR CASH PRICE..... \$69.50  
Or \$13.90 down and \$5.33 monthly for 12 months.

C18012—SM18 Carrier Level Meter.  
YOUR CASH PRICE..... \$10.00  
Or \$2.00 down and \$1.50 monthly for 6 months.

This receiver is designed for the amateur who needs and wants the exacting performance required for superior ultra high frequency reception. The Skyrider 5-10 covers the radio spectrum from 68MC to 27Mc in two bands with a degree of sensitivity and selectivity that offers unparalleled reception of the ultra high frequencies. The recently developed RK1852 tube, with a gain increase of 8 to 1, is used as an HF amplifier through which an ultra high frequency sensitivity of better than 1 microvolt is obtained for this receiver. Separate Band Spread Dial. Logging is easy and accurate. Equipped with Inertia Tuning control. 8 Tubes used: 1852, 6L7, 6J5, 6K7, 6P7G, 6F6G, 6H6, 80. Sturdy steel cabinet finished in grey. Size, 18 1/2" x 9 1/2" x 8 1/2". Ship. Wt., 34 lbs. For 110-120 volts, 50-60 cycle operation.

### Model S-22 Skyrider Marine

C18022—Model S22 Skyrider Marine complete with tubes and speaker. For 110 volt, AC-DC operation.  
YOUR CASH PRICE..... \$64.50  
Or \$12.90 down and \$4.94 monthly for 12 months.



- 4 Bands—16.2 to 2150 meters (140 Kc. to 18.5 Mc.). • 8 Tubes. • Automatic Volume Control. • Tone Control.
- Head Phone Jacks. • Beat Frequency Oscillator. • Individual Coils for Each Band. • Sensitivity Control. • "S" Meter Terminals.

An 8 Tube Superheterodyne for commercial frequencies. Band No. 1—2150 to 645 meters (140 to 465 Kc.). Band No. 2—645 to 199 meters (465 to 1510 Kc.). Band No. 3—177 to 53 meters (1.7 to 5.8 Mc.). Band No. 4—54.5 to 16.2 meters (5.8 to 18.5 Mc.). The Main Tuning Dial is directly calibrated and a separate dial is supplied for efficient mechanical Band Spread. Excellent sensitivity and selectivity and improved image rejection at the higher frequencies are attained through the use of 1600 Kc. I.F. transformers. Ideal for marine work. Special emphasis has been placed on its 600 and 700 meter operation. Built-in speaker. R.F. Gain, Band Switch, Tone Control, Pitch Control, Send-Receive Switch, Phone Jack. Each band operated through individual coils. The sturdy metal cabinet is finished in black crystal with chrome trim. Designed for operation on 110 Volt. AC-DC only. For battery operation use inverter on preceding page.

### Model S-27 Communications Receiver

Frequency Modulation and Amplitude Modulation  
D18029 — Model S-27 P.M. and A.M. Receiver, complete with tubes, but less speaker.  
YOUR PRICE..... \$175.00  
Or \$35.00 Down and \$13.42 monthly for 12 months.

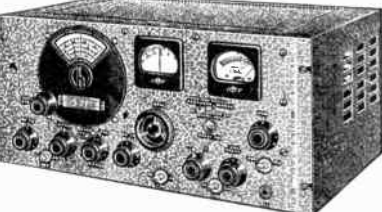

Tunes three bands, 27 to 46 mc., 45 to 84 mc., and 81 to 145 mc., on either Amplitude Modulated or Frequency Modulated Broadcasts. This is a 4 tube communications receiver should not be confused with ordinary home radios for A.M. and F.M. reception. All the refinements that Hallcrafters have incorporated in their famous "Ham" receivers have been built into this new unit; R.F. Gain Control; Antenna Trimmer; I.F. Selectivity Control, Volume, Pitch and Tone Control; S-meter Adjustment; AVC On-Off Switch; Phone Jack; and Send-Receive Switch. Additional features are High gain 1852 tubes in iron core I.F. stages; Accorn tubes in R.F. and converter system; and beam power tubes in the final push-pull stage give a practically flat response over the entire audible range for high fidelity reception. Resistance coupling and degeneration (inverse feedback) are used for minimum distortion. Bass-boost circuit emphasizes low note response. Also has high frequency cut-off circuit for communication reception. Tubes used: 1-95B, 1-495A, 2-1852, 1-1853, 1-6SK7, 1-6SK8, 1-6J5, 1-955, 1-5Z3, 1-1YR-150, 2-6V8. Size, 19" x 13" x 13". Shpg. wt. 75 lbs. For 110-120 volt, 50-60 cycle AC. D18037—10" PM Speaker in Matching Cabinet.....\$12.00

### Model HT-7 Frequency Standard

Complies with F.C.C. regulations for amateur frequency measurements. Ideal for measuring transmitter frequency, checking calibrations and band-setting receivers, locating signals for skeds, setting E.C. oscillator frequencies within very close limits. Consists of a stable crystal oscillator with either 1000 or 100 Kc. output and a 10 Kc. multi-vibrator and harmonic amplifier which produces accurate marker frequencies 10, 100 or 1000 Kc. against any range up to 30,000 Kc. May be set against any broadcast station WWV for extreme accuracy. A tuned circuit increases the strength of the higher harmonics. Complete with tubes and crystal. Size, 5 1/2" x 7 1/2". Wt. 10 lbs. For 110 V. 50-60 cycle operation.  
C18023—Model HT-7. Complete.  
YOUR PRICE..... \$29.50  
Or \$5.90 down and \$2.26 monthly for 12 months.





# Hallcrafters RECEIVERS

## New Super Skyrider Model SX-28



Price Less Speaker

D18030—Skyrider Model SX-28, complete with tubes and crystal but less speaker. **\$159.50**  
YOUR PRICE.....

Or \$31.90 down and \$12.23 monthly for 12 months.

**15 Tubes • Tunes 6 Bands • 2 RF Stages • Piezo Crystal Filter • 6 Step Variable Selectivity • Band Pass Audio Filter • "S" Meter • Automatic Noise Limiter • Improved Signal to Image and Noise Ratio.**

The finest Hallcrafters receiver for short-wave broadcast, standard broadcast and amateur communications. Every worthwhile feature and engineering improvement has been incorporated in this superb instrument. 6 tuning bands provide a most satisfactory L/C ratio: 540 to 1650 KC, 1.5 to 3.2 MC, 3.0 to 6.2 Mc, 5.5 to 12.0 MC, 11.0 to 23 MC, 21 to 43 MC. Maximum sensitivity is obtained from 2 stages of tuned RF. 6 step variable selectivity, from broad high fidelity for music or voice, to extremely sharp crystal filter for CW. Tuning even the weakest signal is a pleasure. Inertia controlled micrometer main dial and calibrated band spread dial permit easy location of stations and proper logging. Wide angle "S" meter is calibrated in "S" and Db. Tone quality exceeds that of the finest home radio. Distortion and interference are held to a minimum by inverse feedback high fidelity push-pull output, automatic noise limiter, band pass audio filter, and switch controlled bass boost.

Controls on the front panel are: Inertia controlled main tuning with micrometer scale calibrated band spread, also inertia controlled; tone and off-on switch; beat frequency oscillator; A.F. gain R.F. gain; 6 position band switch; antenna trimmer; 6 position selectivity control; crystal phasing; adjustable noise limiter send-receive switch; AVC and BFO switch; bass boost switch; and phone jack. Has provision for connecting phono pickup for record reproduction. Receiver is assembled on a sturdy steel chassis, cadmium plated to prevent corrosion. Chassis and front panel can be removed from cabinet and the receiver mounted in any standard relay rack. Panel 1/8" thick. The professional metal cabinet, finished in tool gray wrinkle, is 20 1/2" long, 9 1/2" high and 14 1/2" deep. Tubes used: 4-6SK7, 2-6SA7, 1-6L7, 2-6B8, 1-6H6, 1-6J5, 1-6SC7, 2-6V6GT, 1-5Z3. For 110-120 volt, 50-60 cycle AC current.

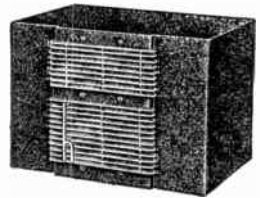

Speaker Prices

D18031 — 10" PM Speaker housed in attractive grey wrinkle finish steel case. An exact match of the SX-28 cabinet. Illustrated above. **YOUR PRICE..... \$12.00**

Or when purchased with SX-28 \$2.40 down and \$1.13 monthly for 12 months.

D18032 — Hallcrafters Jensen bass-reflex enclosure including 12" speaker. (Not illustrated). 30" high, 16" deep, 22 1/2" wide. Receiver may be placed on top of speaker enclosure. **YOUR PRICE..... \$29.50**

Or \$5.90 down and \$2.26 monthly for 12 months.

## New Model SX-25 Super Defiant

- New 12 Tube Circuit • 8 Watt Output • Six Step Selectivity • Automatic Noise Limiter • Two Tuned RF Circuits • Drift Compensation • Tunes 540 KC to 42 MC
- Piezo Crystal Filter • Freq-Meter Tuning.

### Every Desirable Feature

This new Hallcrafters 12 tube communication receiver has won acclaim from amateurs and short-wave listeners all over the United States. Incorporated in the newly developed superb circuit are all the worthwhile features and engineering improvements that you would expect to find only in sets costing much more. Every convenience for easy tuning and enjoyable reception has been included. Illuminated main tuning dial is calibrated directly in frequencies; band spread dial is also calibrated for correct logging of sharp tuning signals; "S" meter is calibrated in both "S" and Db units. Six-step variable selectivity, from broad high fidelity for music and phone to extremely sharp crystal filter for CW. Laboratory checked piezo quartz crystal filter permits critical CW reception even when interference is severe. Sensitivity is raised from 2.8 to 4 times when receiver is tuned to exact frequency of crystal. This means more usable sensitivity; a stage of tuned RF brings in the weakest signals loud and strong.

Tunes the following four bands: 540 KC to 1700 KC, 1.7 MC to 5.1 MC, 5.0 MC to 15.5 MC and 15.1 MC to 42 MC. Drift compensation is incorporated in all bands to keep receiver tuned to desired station. Automatic noise limiter reduces interference as much as 70%, making the Super Defiant extremely sensitive to weak signals. Connections provided for headphones, 500 or 5000 ohm speaker, single or doublet antenna and Send-Receive break-in circuit. Controls on front panel are: Main tuning control calibrated for frequency tuning, calibrated band spread dial, automatic noise limiter switch, BFO pitch control, RF gain, crystal phasing, selectivity switch, audio gain, Hi-Lo tone control. Send-Receive switch and BFO switch. Uses 12 tubes: 2-6SK7, RF amplifiers; 6K8, 1st detector-mixer and H.F. oscillator; 2-6SK7, 2nd and 2nd I.F.; 6SQ7, 2nd detector, AVC and 1st audio; 6SQ7, phase inverter; 2-6F6, push-pull audio; 6H6 noise limiter; 6J5GT, BFO; and 80, rectifier. Usually communication receivers are designed for sensitivity and selectivity only. The Super Defiant also provides distortion-free reception of music and voice.



Receiver is supplied complete with a 10" heavy duty P.M. dynamic speaker. Both speaker and receiver are housed in attractive matched metal cabinets, finished in tool gray wrinkle enamel. Every Ham and SWL will be proud to own this attractive combination of radio perfection. Receiver cabinet size, 19 1/2" long, 11 1/2" deep, and 9 1/2" high. Operates direct from 110 volt, 50-60 cycle AC current connections also provided for operation from vibra-pack or batteries. Consumes 125 watts.

D18033—Model SX-25 Super Defiant, supplied complete with speaker, crystal, matched set of tubes, and operating and alignment instructions. **\$99.50**  
YOUR PRICE.....

Or \$19.90 down and \$7.63 monthly for 12 months.

Take it with you. Use it at home. A truly universal receiver. Operates from 110-125 volt AC or DC or from self-contained batteries. Ideal for the S-W listener or amateur who likes to go places.

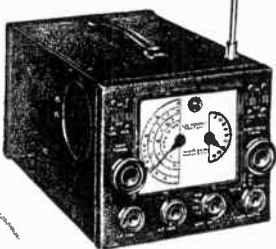

Has all these features: Electrical bandspread, automatic noise limiter, AVC on all bands, sensitivity below 2 microvolts on all bands, permeability tuned RF and IC circuits, and neon bulb to indicate when set is "on". Self-contained collapsible antenna can be extended to nearly 3 feet, also has provisions for attaching doublet or Marconi long antenna. Has phone jack, battery cable with plugs and band switch, AVC off-on switch, BFO off-on switch, BFO on switch, and send-receive standby switch. Tubes used: 1T4, R.F.; 1R5, Mixer; 1P5-GT, 1st IF; 1P5-GT, 2nd IF; 1H5-GT, 2nd det., AVC, 1st audio; 3Q5-GT output; 1G4-GT, BFO; 1G4-GT, noise limiter; 25Z5G rectifier. Receiver is contained in an attractive black crackle finished aluminum cabinet with rounded corners. Net weight, including batteries, is only 18 lbs. Overall height, 7" width, 8 1/2" depth, 13 3/4". Has a convenient carrying handle.

## S-29 Sky Traveler

D18034—Complete S-29 Sky Traveler with tubes and collapsible antenna. **\$59.50**  
YOUR PRICE.....

Or \$11.90 down and \$4.56 monthly for 12 months.

Compact and portable, yet this fine communications receiver has all the features of many larger models. Self contained antenna with high gain coupling circuit provides truly remarkable reception throughout the entire tuning range. Band spreading is electrical. Both RF and IF circuits are permeability tuned. Has one stage of pre-selection on all bands. Automatic noise limiter especially designed for portable radio use. Tunes the following 4 bands: 542 to 1490 KC, 1.43 to 4.35 MC, 4.12 to 11.9 MC and 11.26 to 30.5 MC. Has built-in speaker with provisions for connecting headphones if desired. Uses 9 bantam and miniature 1.4 volt tubes. Operates from self contained batteries or 110-125 volt AC or DC current. Battery life prolonged because of self-contained charging circuit. Features: Automatic noise limiter, RF stage on all bands, sensitivity below 2 microvolts on all bands, permeability tuned RF and IC circuits, and neon bulb to indicate when set is "on". Self-contained collapsible antenna can be extended to nearly 3 feet, also has provisions for attaching doublet or Marconi long antenna. Has phone jack, battery cable with plugs and band switch, AVC off-on switch, BFO off-on switch, BFO on switch, and send-receive standby switch. Tubes used: 1T4, R.F.; 1R5, Mixer; 1P5-GT, 1st IF; 1P5-GT, 2nd IF; 1H5-GT, 2nd det., AVC, 1st audio; 3Q5-GT output; 1G4-GT, BFO; 1G4-GT, noise limiter; 25Z5G rectifier. Receiver is contained in an attractive black crackle finished aluminum cabinet with rounded corners. Net weight, including batteries, is only 18 lbs. Overall height, 7" width, 8 1/2" depth, 13 3/4". Has a convenient carrying handle.

## 12 Watt—HT-11 Marine Radiophone

A complete ship to shore transmitter and receiver. Transmitter operates on three frequencies in the marine 2000 to 3000 kc band. Receiver tunes standard broadcast, 550 to 1700 kc on range #1; and tunes the marine band, 2000 to 3000 kc, on range #2. Receives all standard broadcast stations for entertainment, news, etc., and covers the entire marine band for communications. This is the ideal radiophone for small pleasure craft wanting to cruise in safety. The receiver is manually tuned and has a directly calibrated dial for easy logging of stations. The transmitter is crystal controlled on three frequencies. Comes supplied with a French type handset (combination microphone and headphone) which has a built-in push-to-talk switch. Controls on the front panel are: Transmitter channel switch, receiver band switch, receiver volume control, receiver tuning, transmitter off-on switch, speaker-headphone switch. Tubes used in the transmitter circuit: 6V6, oscillator; 807 power amplifier; and 2-6V6G modulators; in the receiver: 6SK7 RF amp.; 6K8, mixer 6SK7, IF amp.; 6SQ7, 2nd det., AVC, 1st audio; 6K8GT, output; 2-6X5G, rectifier. Entire unit is housed in an attractive sturdy metal cabinet. Rust proofing and corrosion protection used throughout. Dimensions, 14 1/2" x 8 1/2" x 9 3/4".

D18035—HT-11 Radiophone for 110 volt AC current, complete with tubes and handset. **\$149.50**  
YOUR PRICE.....

Or \$29.90 down and \$11.46 monthly for 12 months.

D18036—HT-11 Radiophone For Battery Operation. Equipped with an external power pack, permitting the radiophone to be operated from either a 6 or 12 volt storage battery. Power pack is exceptionally quiet. Price includes complete radiophone, tubes, handset and power pack. **\$159.50**  
YOUR PRICE.....

Or \$31.90 down and \$12.23 monthly for 12 months.

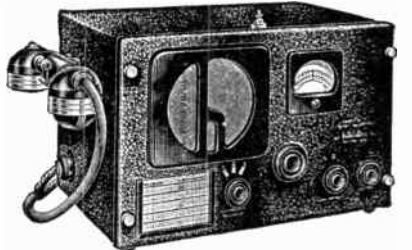



# NEW EQUIPMENT

for the Amateur and Experimenter

AT LOWEST PRICES

## 2 1/2 Meter Transceiver



**D18044** - Abbott Model DK2. Less accessories.

**YOUR PRICE..... \$16.17**

A compact simple to operate portable transceiver that provides an excellent means of communication up to 30 miles distance. Housed in a sturdy steel carrying case that measures only 1 1/2"x9 1/2"x6 1/2" and has room for all necessary batteries. Uses a 4 foot antenna which is supported on set by 2 ceramic insulators. Entire unit with batteries ready to operate weighs less than

25 lbs. Send and receive tuning is by means of a single control. Uses 2 tubes, 1-6J5GT7 and 1-6BE6. Batteries required: 4 #6 Eveready Dry Cells and 3 or 4 #62 Eveready 45 Volt "B" batteries. For use with single button carbon microphone. Tubes, batteries, antenna, microphone and headset are not supplied.

## Browning Frequency Monitor and Deviation Meter

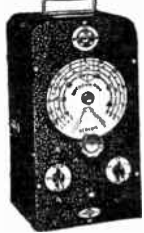

**5 Bands**  
**5 to 160 Meters**  
**D18068**-Model BL-M3 with tubes.  
**YOUR PRICE..... \$39.90**

A heterodyne type frequency meter with built-in mixing circuit to allow checking of transmitter frequency without the use of any auxiliary apparatus. 100-1000 Kc oscillator can be readily checked against WWV. Three additional oscillators cover the six amateur bands 160, 80, 40, 20, 10 and 5 meters. Calibrated 5 1/2" dial permits accurate frequency checking. Electric eye indicator shows zero beat and frequency deviation of carrier. Accuracy greater than 2 parts in 10,000. Self powered 115 volts AC-DC. Cabinet finished in black crackle. Size, 13x7x6".

## Browning Preactor



**Tunes 5 bands**  
**1.6 to 64 MC**

**D18067** - 5DXK Kit (Less 1852 tube).

**YOUR PRICE..... \$13.50**

**D18066** - 5DXP Wired (Less 1852 tube).

**YOUR PRICE..... \$16.50**

efficient general coverage preselector on SV receivers, this unit will serve to convert broadcast receivers for tuning short wave bands. Uses 1-1852 tube. Gain of 1000 or more. 25 to 70 DB added RF gain and image rejection ratios of over 500 may be obtained. Efficient on all bands. Covers 1.6 to 64 MC in 5 bands. 3/4" nickel finished vernier dial. Cabinet size, 7x10x7".

## Band Spread Tuner

Quality built band switching, band spread tuners that can be used as the nucleus of a ham band receiver which can be easily constructed at a cost considerably below that of standard manufactured units. Can also be used as the basis of a regenerative preselector with image rejection ratios of 500 or more.

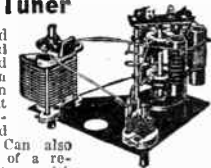

**YOUR PRICE..... \$6.00**

**D17465**-BL-5DX for 5 to 185 Meters. Covers the short wave spectrum in 5 bands with generous overlap. Electrical band spread is possible on any portion of the spectrum. Consists of 5 high Q, cathode tapped coils mounted on band switch; 200 mhf. insolate insulated tank condenser and 25 mmf. insolate insulated band spread condenser all mounted as an integral unit and wired. Trimmers are eliminated providing maximum 1.0 c ratio.

**YOUR PRICE..... \$4.80**

**D17466**-BL-5H For Amateur Bands. Designed exclusively for the Amateur. Covers the 10-20-40-80 and 160 meter bands, with each band spread out over entire tuning range. Consists of 5 high Q, cathode tapped coils rigidly mounted on band switch; 35 mmf. tuning condenser and band setting condenser. Grid leak and condenser also included.

## Meissner Signal-Shifter

**D18065** - Less tubes.  
**Your Price.. \$44.05**

Will allow quick change of frequency over any amateur band from 10 through 160 meters. Has voltage regulation for the oscillator tube, dual rectifier tubes, and key-click filter for pure, chirpless output. Tuning dial has precision vernier scale. Can be link coupled to transmitter for remote control. Equipped with "on," "standby" and "automatic" position switch. Uses 1-6BE6, 1-6AL6, 1-5X4Z, 1-R105, 1-YL1050 tubes. Comes furnished with 80 meter coils. Size, 9x11 1/2x1 1/2" deep. Cabinet finished in black or grey crackle. Operates on 115 volt 50-60 cycles.



**Additional coil sets:**  
**D9663**-10 meter band. **D9662**-20 meter band.  
**D9663**-40 meter band. **D9664**-160 meter band.  
**YOUR PRICE..... \$245**  
**Per Set..... \$245**  
**D1315**-5 SYLVANIA TUBES for above. **\$440**  
**YOUR PRICE..... \$440**

## Browning Converter

**For 5 and 10 Meters**  
**D18043**-Model BL510.  
**Your Price \$24.90**

May be used with any set that can be tuned from 1500 KC to 5 MC. Especially designed for mobile use but operates satisfactorily with any reasonably sensitive receiver. Equipped with band switch and antenna change-over switch. By making minor adjustments to Trimming condensers converter can be made to tune over the entire range from 27 to 64 MC. Features electrical band spread, individual 5 and 10 meter oscillator and antenna circuits, insolate air tuned circuits, and 2 1/2" silvered dial calibrated for 5 and 10 meters with separate 0-4-100 scale. Comes complete with 1-6K5 tube. Obtains power from radio with which used.

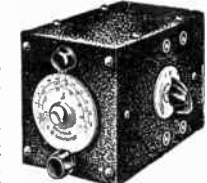

# Transmitting Tubes

R. C. A.					
Type	Stock Num.	Class	Fil. V.	Plate Volts/Dls.	Service Your Price
203A	C453	Tri.	10	1000 100	1.2 \$10.00
800	C462	Tri.	7.5	1250 35	1.2 10.00
801	C463	Tri.	7.5	600 20	1.2 3.45
802	C464	Pent.	6.3	500 10	1.4 3.50
803	C454	Pent.	10	2000 125	1.4 28.50
804	C465	Pent.	7.5	1250 40	1.4 15.00
805	C467	Tri.	10	1500 125	1.3 13.50
806	C467	Tri.	5	3000 150	1.2 22.00
807	C458	Beam	6.3	600 25	1.5 3.50
808	C459	Tri.	7.5	1500 50	1.2 7.75
809	C477	Tri.	6.3	750 25	1.3 2.50
810	C455	Tri.	10	2000 125	1.2 13.50
813	C456	Beam	10	2000 100	1 22.00
814	C468	Beam	10	1250 50	1.5 17.50
833	C469	Tri.	10	3000 300	1.2 83.00
852	C475	Tri.	10	3000 85	1 16.40
866	C495	Rect.	2.5	†See Foot Note	1.50
866A	C474	Rect.	2.5	†See Foot Note	2.50
872	C470	Rect.	5	†See Foot Note	9.00
1623	C471	Tri.	6.3	7500 25	1.2 2.50
954	C486	Pent.	6.3	ULIF Acorn	5.00
955	C487	Tri.	6.3	Type Tubes for	3.00
956	C489	Pent.	6.3	Receiving and	5.00
957	C472	Tri.	1.25	Low Power	3.00
958	C473	Tri.	1.25	Transmitting	3.00
959	C475	Pent.	1.25	Det. Amp.-Acorn	5.00

1-RL Osc., Buffer, Doubler, Amp.  
2-Class "E" Mod. 3-Zero Bias Class "E" Mod.  
4-Supp. Mod. Amp. 5-Class "AB" Mod.  
†Max. Inv. Peak 7,500 V. Peak 1.0 Amps.  
‡Max. Inv. Peak 10,000 V. Peak 1.0 Amps.  
§Max. Inv. Peak 10,000 V. Peak 5 Amps.

**C12464**-RCA Transmitting Tube Manual. 192 Pages. Complete data on all RCA air-cooled transmitting tubes, as well as other helpful information.  
**YOUR PRICE..... \$25¢**

Raytheon					
Type	Stock Num.	Class	Fil. V.	Plate Volts/Dls.	Uses Your Price
RK11	C900	Tri.	6.3	750 25	1 52.50
RK12	C920	Tri.	6.3	750 25	1.3 2.50
RK20A	C901	Pent.	7.5	1250 40	1.4 15.00
RK23	C902	Pent.	2.5	500 10	1.4 4.50
RK25	C903	Pent.	6.3	500 10	1.4 3.95
RK28A	C904	Pent.	10	2000 125	1.4 28.50
RK34	C921	Tri.	6.3	300 10	1.2, 6 3.50
RK37	C905	Tri.	7.5	1500 50	1.2 6.95
RK38	C906	Tri.	5.0	2000 100	1.2 13.50
RK39	C907	Beam	6.3	600 25	1.5 3.50
RK42	D927	Tri.	1.5	180 .7	1 1.10
RK43	C922	D.Tri.	1.5	135 1	1.6 1.50
RK47	C909	Beam	10	1250 150	1.5 17.50
RK48	C910	Beam	10	2000 00	1 27.50
RK49	C911	Beam	6.3	400 21	1 1.25
RK51	C923	Tri.	7.5	1500 60	1 6.95
RK52	C912	Tri.	7.5	1250 62.5	1.3 6.95
RK56	C913	Beam	6.3	300 8	1 3.00
RK60	C914	Tri.	10	1500 125	1.2 13.50
RK59	C924	D.Tri.	6.3	500 15	1.2, 6 4.50
RK60	C925	Rect.	†See Foot Note	†	2.75
RK62	C926	G.Tri.	1.4	45 Gas	Tri. 3.50
RK63	C915	Tri.	5	3000 200	1.2 22.00
RK64	C916	Pent.	6.3	300 6	1 3.50
RK65	D928	Tetr.	5	3000 215	1 34.50
866	C917	Rect.	†See Foot Note	†	1.50
866A	C918	Rect.	†See Foot Note	†	2.50
872A	C919	Rect.	†See Foot Note	†	11.00

\*Max. Inv. Peak 7,500 V. Peak 1 Amp. Output.  
†High Vacuum, 61 Volt drop, 750 V.R.M.S. per Anode. 250 M. A., Output current.  
‡Max. Inv. Peak 10,000 V. Peak 1 Amp Output.  
§Max. Inv. Peak 10,000 V. Peak 5 Amp. Output.

**We Can Supply Other Transmitting Tubes**

## Gammatron Triodes

Gammatron tubes have elements supported directly on short, dew wire leads brought directly to the envelope eliminating all internal insulation. All have plate connection at top envelope. Extremely low interelectrode capacitance. Easy to drive, operate at high efficiency on all bands. Nonex clear glass envelopes and use of Tantalum plates and grids allows safe operation at high element temperature with no danger of breakdown or gas emissions. Types 24, and 54 have standard IX base; 254 and 254C have 50 watt base. \*257 is a new beam power pentode with tantalum construction throughout. Basis is similar to R1A-813.

Type	Stock Num.	Filament V.	Serv. V.	Amps	Max. Plate Volts	Plate Dls.	Uses	Your Price
24	C1840	6	3	3	1500	25	1, 2	\$3.50
54	C1841	5	5	5	2000	50	1, 2	6.75
254	C1842	5	7.5	7.5	3000	100	1, 2	12.50
354C	C1843	5	10	10	4000	150	1, 2	24.50
257*	C1844	5	7.5	7.5	2000	75	1	22.00

## Hytron See Also Page 4

Type	Stock Num.	Serv. Ice	Filament V.	Amps	Plate Volts	Plate Dls.	Uses	Your Price
HY25	C1851	1.2	7.5	2.25	800	25	1, 2	\$3.45
HY40	C1852	1.2	7.5	2.25	1000	40	1, 2	3.50
HY40Z	C1881	1.3	7.5	2.50	1000	40	1, 2	3.50
HY51A	C1853	1.2	7.5	3.50	1000	65	1, 2	4.50
HY51B	C1854	1.2	10	2.25	1000	65	1, 2	4.50
HY51Z	C1882	1.3	7.5	3.50	1000	65	1, 2	4.50
HY60	C1856	1.3	6.3	0.5	425	15	1, 2	2.50
HY61	C1857	1.3	6.3	0.9	600	25	1, 2	3.50
6L6GX	C1850	1.3	6.3	0.9	500	21	1, 2, 5	1.25
866	C1860	Rect.	2.5	7.500	Pk. Inv. V.	1.50		1.50
866 Jr	C1859	Rect.	2.5	1750	Pk. Inv. V.	1.05		1.05
HY61S	C1858	**	6.3	0.15	300	3.5	1, 2	2.00

\*\*Ultra high frequency triodes.



# Stancor Transmitter and Amplifier Kits

## Model 25B

### 25 Watt CW Transmitter Kit



With  
Self Contained  
Antenna Tuning

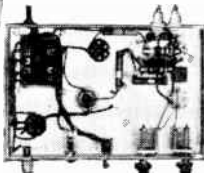

**D18000** — Model 25B Transmitter Kit ready to assemble, less tubes, coils and crystal. **YOUR PRICE \$12.49**

The 25-B meets the requirements for a simple 6L6 transmitter with self-contained antenna tuning. Operates on CW only with 25 watts input from 160 to 10 meters. The rig incorporates only the essentials, leaving off all the trimmings. Simplicity of circuit detail, construction, and operation will satisfy the beginner as well as the seasoned amateur. The 6L6 oscillator circuit is of the regenerative type using R.F. choke in the cathode. For the experimenter provision is made for other types of oscillator circuits such as triplet, etc. Power supply using type 80 tube. Large choke and condenser insure well filtered supply as required by regulations. Bleeder provides safe discharge of condensers and better voltage regulation. No high voltage on top of chassis. Output may be connected to either low impedance or variable impedance matching network. Link coupling, various type feeder lines, or all types of antenna may be connected and easily tuned. Standard coils and crystals are used to cover all bands. Pilot light serves as tuning indicator and fuse. Keys in clean cut manner, suitable for break-in operation. A pilot light located in the center top of the high voltage power transformer winding serves both as a tuning indicator and fuse. All parts mount on a chassis 9 1/2" x 6 1/2" x 2". For operation from 105-120 volts 50-60 cycle AC.

#### Accessories

**D1328**—Kit of 1-6L6 and 1-80 Sylvania tubes for above transmitter. **YOUR PRICE \$110**

Use Coto Pee Wee end link coils described on page 143. Use HiPower Ruby or Emerald Crystals described on page 145

## Model 10P

### 10 Watt Phone and CW Transmitter Kit

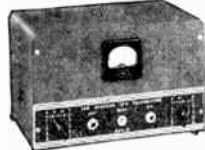

Covering  
5 Band  
Operation



**D18001**—Model 10P Transmitter Kit ready to assemble, less tubes, coils and crystals. **YOUR PRICE \$20.58**

The Stancor 10-P kit fulfills the need for an extremely compact phone-CW transmitter. Although thorough in every detail, its circuit simplicity and utter ease of operation delight both the beginner and seasoned amateur alike. The unique circuit design involves but one inexpensive plug-in coil for each band of operation. Further, only three crystals are used in covering all bands from 20 to 160 meters inclusive. A 6L6 untuned crystal oscillator and a 6L6 amplifier are employed in the radio frequency stages. For radiophone, a 6L6 in Class A serves both as a speech amplifier and plate modulator. The Class C, R.F. amplifier input ratings are 12 watts phone and 20 watts CW. Break-in procedure is accommodated by the simultaneous keying of both oscillator and amplifier. An 80 is used in the inexpensive, but adequate power supply. All types of antennae may be applied to the low impedance output terminals. All of the above mentioned features are self-contained in an attractive 10 1/2" x 6 1/2" x 6 1/2" machine grey, crackle finished cabinet. The appearance is further enhanced by the special front panel escutcheon which has appropriate markings for the controls. Priced surprisingly low, the 10-P is truly a versatile piece of transmitting equipment. For operation from 105-120 volts 50-60 cycle AC.

#### Accessories

**D1329**—Kit of 4 Sylvania tubes for above transmitter—Includes 1-6L6, 2-6L6's, 1-80. **YOUR PRICE \$240**  
**D10124**—Triplet Meter **\$294**

## Model 60P

### 60 Watt Phone and CW Transmitter Kit



Covers  
5 Bands

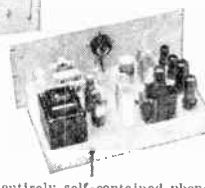

**D18002** — Model 60P Transmitter Kit ready to assemble, less tubes, coils and crystals. **YOUR PRICE \$43.90**

The 60-P presents an entirely self-contained phone-CW transmitter of modern design. Operation may be enjoyed on all amateur bands from 10 to 160 meters inclusive with a rated R.F. amplifier input of 60 watts. The efficient 1K24 tube is employed as a Class C amplifier driven by a 6L6 in a harmonic type of crystal oscillator. Only two plug-in coils are necessary for each band of operation and three crystals suffice for all five bands. For radiophone, the audio channel consists of a 6S17 input stage, a 6N7 voltage amplifier-driver stage, and a pair of 6L6's in Class AB1 as modulators supplying 32 watts of audio. 100% plate modulation of the Class C amplifier is easily attained. The transmitter is powered by a dual rectification and filtration system, which provides the desired DC high voltages with excellent regulation. Other features are oscillator keying, ease of adjustment, and low impedance output termination. The standard dimensions of the 17" x 10" x 3" chassis and the 8 3/4" x 13" panel, allow the 60-P to be housed in a rack type cabinet or to be mounted on a relay rack. Here is a transmitter that offers the amateur a compact, moderately powered, commercial type transmitter with which he can realize excellent results. For operation from 105-120 volts 50-60 cycles AC.

#### Accessories

**D1330**—Kit of 8 Raytheon H.K., and Sylvania tubes for above transmitter. Includes 1-1K21, 3-6L6's, 1-6S17, 1-6N7, 1-5Z3, 1-R1K60. **YOUR PRICE \$1018**  
**D18475**—Bud Cabinet **\$7.35**  
**D10120**—Triplet Meter **\$3.75**

## Model 110CM

### 100 Watt Transmitter Kit

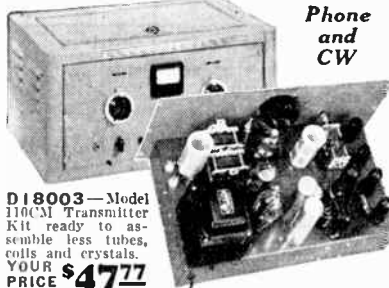

Phone  
and  
CW

**D18003**—Model 110CM Transmitter Kit ready to assemble less tubes, coils and crystals. **YOUR PRICE \$47.77**

The 110-CM transmitter is a high performance, multi-band, phone-CW unit, conservatively rated at 100 watts input, employing cathode modulation. Compact design permits the entire transmitter, modulator and power supply to be mounted on a 17" x 10" x 3" chassis which can be placed in a standard relay rack or cabinet. An RCA 812 is excited by a 6L6 "grid-plate" oscillator and cathode modulated by a pair of 6V6's. A 6S17 followed by a 6T5 provides adequate speech amplification from a crystal microphone. The operating range is from 1.7 to 30 MC. using only two ready-wound plug-in coils for each band. An RK60 and a 5Z3 operate in a dual rectifier system followed by adequate filters to supply all necessary voltages to the various circuits. A low impedance link-coupled output permits the use of any type of antenna. Complete metering of all essential circuits is provided by the switching of a 0-200 D.C. milliammeter mounted on the panel. The Stancor 110-CM is especially applicable to installations requiring radiophone with limited physical space is available. To the "confident brass pounder" it offers an economical and simple way to enjoy radiophone without tying up a large investment in modulating equipment. For operation from 105-120 volts 50-60 cycles AC.

#### Accessories

**D1331**—Kit of Hytron, Raytheon and Sylvania tubes for above transmitter. Includes: 1-HY10, 1-6L6, 1-6S17, 1-6C5, 2-6V6, 1-R1K60, 1-5Z3. **YOUR PRICE \$965**  
**D18474**—Bud Cabinet **\$7.35**  
**D10120**—Triplet Meter **\$3.75**  
**D9559**—Set of Johnson Coils **\$1.92**

## Model 414

### 14 Watt Public Address Amplifier Kit



Class A  
With  
6L6'S

**D18004** — Model 414 P.A. Amplifier Kit ready to assemble, with dust cover but less tubes. **YOUR PRICE \$17.64**

The 414 is an economical and compact A.C. amplifier with 14 watts output. Excellent audio response makes it ideal for small public address systems, window demonstrators, phonograph players, etc. Incorporates two high impedance input circuits as follows: One high gain input for medium output microphones such as crystal, velocity, or dynamic, and one low gain input for phonograph pickup or carbon microphone (must be properly coupled through transformer). A single volume control is used for fading in either input. Includes tone control for attenuating high audio frequencies. Output transformer tapped to provide impedances of 1, 8 and 15 ohms. Tubes used are: 6S17 high gain input, 6C5 voltage amplifier, push pull 6L6's (pentode connected) Class A output, and 80 high voltage rectifier. Entire unit includes punched chassis, panel, and 10 1/2" x 6 1/2" x 6 1/2" cabinet, finished in wrinkle gray. An escutcheon plate clearly marks inputs and controls. A jeweled pilot light is a ready indication that amplifier has been turned on. A dual binding post output strip allows the connection of one or more speakers. The desired output transformer impedance may be permanently connected to the output terminals and the others left unused until the need for their respective impedances arises. An alternative would be to ground the common starting terminal of the transformer and connect the two most desirable taps to the output posts. For operation from 105-120 volts 50-60 cycles AC.

#### Accessories

**D1332**—Kit of five matched Sylvania tubes for above amplifier. **YOUR PRICE \$290**

## Model 430

### 30 Watt Public Address Amplifier Kit

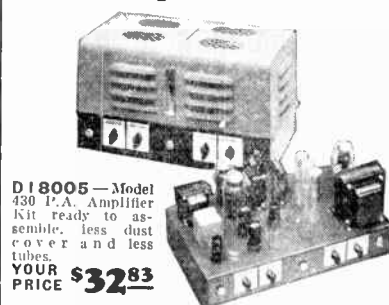

**D18005**—Model 430 P.A. Amplifier Kit ready to assemble, less dust cover and less tubes. **YOUR PRICE \$32.83**

The 430 amplifier for public address system delivers a full 30 watts of unfiltered audio power. Frequency response is uniform from 50 to 15,000 cycles. All inputs are high impedance as follows: two high gain and one low gain inputs. Two volume controls may be used for mixing. Sufficient gain for low output level microphones such as crystal, dynamic, or velocity types. Dual tone control unit allows independent control of either high or low frequencies. Output transformer provides impedances of 4, 8, 15, 250, or 500 ohms. A simple peak limiting circuit can be added, if desired, for use in P.A. as automatic volume control of speech only. The tube complement is as follows: two 6S17 high gain input channels, 6N7 voltage amplifier and electronic mixer, 6V6 (triode connected) driver, push pull 6L6's (pentode connected) Class AB1 output, and 5Z3 high voltage rectifier. Special circuit for increasing bass response. Well filtered power supply insures clear reproduction without disturbing noises. Chassis is of standard size 17" x 10" x 3", and can be fitted with dust cover or mounted on a relay rack mounting. For operation from 105-120 volts 50-60 cycles AC.

#### Accessories

**D1333**—Kit of Seven Matched Sylvania Tubes for above amplifier. **YOUR PRICE \$413**  
**D18476**—Bud Dust cover for above Amplifier. **YOUR PRICE \$3.82**

# PHOTO CELLS--HEADPHONE UNITS

## Worner Burglar Alarm



Photo-Cell System Model 301R-L

Provides Protection for Stores, Homes, Offices, etc. Adaptable for Other Uses.

**D16470—Photo-Cell-Relay Unit and Light Source.** Ready for operation. For use on 115 volt, 60 cycle AC lines. Less batteries. **YOUR PRICE.....\$27.34**

Consists of two units; a source of invisible Infra-red light and a sensitive photo-electric cell. The Infra-red light is focused upon the photo-cell relay unit, either directly or reflected by mirrors. The maximum range of light projection is approximately 75'. Any interruption of this invisible light beam operates a relay that rings a built-in, battery operated bell, external bell or any other warning device of your choosing. Any break of the 115 volt wiring to the unit will sound the alarm also. The alarm will continue to ring until reset by means of a keyless combination locking device on the relay unit. Both units are housed in black wrinkle finished metal cases. Size, Relay Unit, 6 1/2 x 7 x 1 1/2. Light Unit, 7 x 1 x 3 1/2. Uses two 1 1/2 volt external dry cells.

**D16471—External Alarm Signal.** Consists of 5" alarm bell, batteries and 25' cable. Connects to ring simultaneously with bell in relay unit. Black wrinkle finished metal case. Size, 10 x 10 x 4 1/2. **YOUR PRICE.....\$7.64**

**D16472—Mirror with adjustable mounting bracket.** Size, 8 x 1 x 2 1/2. **YOUR PRICE.....\$2.65**

## Eby Experimental Electric Eye Kit



**C13881—Complete Electric Eye Kit.** Easily assembled. **YOUR PRICE \$7.94**

A popular kit for experimental purposes in electronics. Contains all necessary parts for building eight various electric eye circuits. Kit includes: Eby electric eye, Eby Sensitive Relay, amplifier tube, tube and eye sockets, potentiometer, resistors, condensers, terminal strip, all necessary hardware, punched and drilled chassis base and the Electric Eye Booklet. For use on 115 volts, 60 cycles AC.

## Eby Electric Eye



**C13880—YOUR PRICE.....\$2.06**

Compact photo-cell, sensitive to both visible and invisible light. Reacts both to intensity and frequency of incident light rays. Sturdily constructed and housed in shock proof and moisture proof bakelite case. Mounts in standard 4 prong socket. For use with other components in suitable circuits to operate relays in controlling electrical equipment. Size, 1 1/4" dia. x 3/4".

## Eby Electric-Eye Booklet



**C12542—YOUR PRICE.....29¢**

Contains helpful information on the electric eye. Of particular interest to the technician interested in electronics. Describes in detail the principles of photo-cells covering theory and practice. Well illustrated. 30 Suggested circuit diagrams are also given. 32 Pages. Size, 8 1/2 x 11".

## Headphone Adapters



Adapts Any Radio for Headphone Reception.

**D12183—For 4 prong tubes.**  
**D12183—For 6 prong tubes.**  
**D12184—For Octals.** **YOUR PRICE, Each.....88¢**

For adding crystal or magnetic headphones or magnetic speaker to any radio. Does not alter receiver circuit or operation. Wafer adapter slips under power tube and headset or external speaker connects to the combination screw and phone tip jack terminals on the bakelite complete condenser in plate circuit. Two adapters required when used with push-pull tubes.

## Genuine Nathaniel Baldwin Famous Head Phones



**C9405**  
**Your Very Special Price**

**\$4.25**

Manufactured by Nathaniel Baldwin at the special request of RADOLEK. This is without doubt your last chance to obtain a set of these prized head phones. World famous for many years because of their extreme sensitivity and great efficiency. Balanced armature units accurately matched and carefully tested. Used extensively by U. S. Signal Corps, Navy, and by professional operators. Moulded bakelite cases enclose units. While very sensitive they are very rugged and will stand up under hard usage. Complete with adjustable headband and cord. Fitted with MICA diaphragms.

## Brush Crystal Headphones



A piezo electric headphone of exceptionally high quality and excellent frequency response from 100 to 10,000 c.p.s. Impedance 50,000 ohms. For amateur experimental, hard of hearing and Public Address monitoring use. Phones are housed in dark red-brown plastic case. Net wt. 6 oz. Complete with 5' cord and adjustable headband. **C9419—YOUR PRICE..\$5.29**

## Communications Headphones

Especially designed for comfort and dependability. Can be worn for hours at a time without discomfort. Soft rubber gasket on phone insures good ear seal and safety against shock. Yokeless cord design allows greater freedom of movement. Electrical characteristics similar to general purpose type above. Net wt. 6 oz. Complete with 5' cord and adjustable headband. **C9418—YOUR PRICE.....\$7.06**

## Single Phone with Head Band

Electrical characteristics same as above phones. Metal headband with rubber cushion on the side opposite the phone. Complete with 5' cord. Net wt. 3 oz. **C9420—Bakelite case. List, \$5.00**  
**YOUR PRICE.....\$2.94**



**C9417—Aluminum case with soft rubber ring for comfort and good ear seal. Especially suited to hard of hearing applications. List, \$5.25.**  
**YOUR PRICE....\$3.09**

## Lorgnette Headphone

Designed especially for hearing aid application. Dark red-brown molded plastic case. Exceptionally fine response from 100 to 10,000 c.p.s. Handle adjustable from 12" to 17". Complete with 5' cord. **C9423—List, \$6.50.**  
**YOUR PRICE.....\$3.82**

## Brush Hushatone Speaker

An efficient pillow-type speaker. Permits user to enjoy radio programs while in bed, without disturbing or interfering with others in the same room. Easily attached to any radio set. Particularly useful with portable or AC-DC sets. Bakelite body fully enclosed in sponge rubber. May be immersed in liquid for sterilization. Size, 2 1/2 x 2 1/2 x 3/4" thick. Net wt., 7 oz. Includes 7' cord. **C9428—List, Price, \$7.50.**  
**YOUR PRICE.....\$4.41**



## Phone Cushions

**D9406—YOUR PRICE PAIR.....23¢**  
**TEN PAIRS FOR.....\$1.98**

Made of soft sponge rubber. Very light, comfortable. Fits all phones.

## Special Value

### Headphones

**R9430—2000 ohms. 95¢**  
**YOUR PRICE.....**  
**R9431—4000 ohms. \$1.20**  
**YOUR PRICE.....**

An exceptional value. Unusually sensitive and efficient headphones. Noted for fidelity and clarity of tone. Spun and buffed aluminum cases and caps. Single strap adjustable headband. Light in weight and comfortable.



### Single Earphone

With Bakelite Ear Piece and 3' Cord. **Less Headband**

Stock No.	Your Price	Ohms Resist.	Stock No.	Your Price
C9410	59¢	1000	C9412	54¢
C9411	70¢	2000	C9413	65¢

## Carron Headphones

### Model "Super R9"

**R9432—2000 ohms. \$1.35**  
**YOUR PRICE.....**  
**R9433—4000 ohms. \$1.56**  
**YOUR PRICE.....**

Represents the latest in telephone engineering. Large magnets made from nickel-iron-aluminum alloy having high coercive force. Will not loose sensitivity. Mica Diaphragms. Adjustable headband, 5' cord. Bakelite ear-pieces.



## Cannon-Ball Headphones

Thoroughly reliable high quality full size headphones. Responsive to weak signals. Adjustable stainless steel headbands. Complete with cords. Aluminum shells, practically unbreakable bakelite caps. Very light and comfortable to wear.



**R9407—2000 ohms \$1.65**  
**YOUR PRICE.....**  
**R9408—3000 ohms \$1.85**  
**YOUR PRICE.....**

## Individual Volume Control

For either portable or permanent installation of hard of hearing and other headphone installations. Permits each person to adjust volume to their particular requirement. Attractively designed. Brown wrinkle finished metal case. Body size, 2 1/2 x 1 1/2 x 3/4". Tip jack terminals. Supplied with 4 ft. cord. **A9449—YOUR PRICE.....\$1.59**



## Special 4 1/2" Dynamic

**250 Ohm Field, Voice Coil 3/8", 2 Ohms Impedance**  
**K15631—List Price, \$2.50.**

**YOUR PRICE.....\$5.9¢**



Ten for \$5.50  
The Smallest Satisfactory Dynamic Speaker Made. Three Point 2 inch micarta-spider-web voice coil support. Low resistance Hum-Bucking coil. Handles 1 1/2 watt signal with surprising tone quality for such a small reproducer. Extends 2 1/2" back of baffle. Output Transformer not included. Low resistance field coil permits substitution of field in place of first filter choke.

## Amplifier Handbook and P. A. Guide

**D12568—YOUR PRICE.....25¢**

Covers amplifiers and sound system installation. With the information contained in this book every man engaged in radio can have both a theoretical and practical knowledge of the functions and operation of sound systems. Explains all types of microphones, speakers, baffles, etc. Includes mathematical formulas. Many illustrations. Printed on fine paper. 80 Pages. Size 6 1/2 x 9".





Static  
Free

# FREQUENCY MODULATION

Receivers—Adapters—Reproducers—Parts

High  
Fidelity

Static-free radio, for years the dream of engineers and set owners alike, is now a practical reality. At last perfect radio reception, utilizing the entire audible tone range, and covering the complete volume range from dead silence to loudest symphonic fortissimo, is here. F-M reception entirely free from atmospheric, man-made or broadcast station interference, is today available at moderate cost, easily within reach of the large majority of set owners everywhere.

The money making possibilities from the sale of frequency modulation receivers and equipment are BIG. Many localities in the United States are already being served by frequency modulation transmitters, and others are rapidly being added. In addition, wide publicity being given FM reception by national magazines and daily newspapers are creating a keen public interest. Cash in now on the greatest money making opportunity in radio since the "lush 20's."

## Meissner Frequency Modulation Receivers

**Table Model D17545**—Uses same chassis and speaker as console model listed to the right. Housed in gracefully proportioned two toned walnut cabinet. Size 12 $\frac{3}{4}$ x22 $\frac{3}{4}$ x11" deep. Complete with tubes. List, \$99.25. **YOUR PRICE \$58.31**



Of Interest to P.A. Men  
Each of the 3 F-M receiver models described, comes equipped with special shielded cable leading from detector stage for connecting tuner output to any external amplifier and speaker system.

### Complete F-M Receiver Chassis

A high-gain RF stage and mixer-oscillator tube feeds the 4.3 Mc IF signal into a 3 stage IF amplifier and limiter system; a special diode detector arrangement provides a distortion-free audio signal for the two-stage high-fidelity audio amplifier. Has VR150 voltage regulator tube, ceramic sockets and coil forms, and air trimmed discriminator and IF transformer. Large slide-rule type dial with illuminated scale is direct reading 42 to 50 Mc. AVC circuit minimizes or entirely eliminates fading. A 5-step tone control gives full adjustment of high and low frequency response. Maximum undistorted power output, 6 watts. Tubes used; one each, 6SA7, 6H6, 8SC7, 6AD6G, 5U4G, 6C5, 6L6G, VR150 and two each 6SK7, and 1852 (6ACT). Chassis size: 10x12x3". For 110 V. 60 cyc. AC operation. Wt. 16 lbs. less tubes.

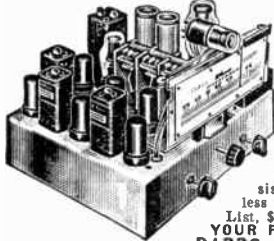

**D17546**—Meissner F-M Receiver Chassis completely wired and factory aligned, less tubes, and speaker. **YOUR PRICE \$40.08**

**D1336**—Set of 12 matched Sylvania tubes for above. **YOUR PRICE \$98.00**

The Newest Development in Radio!

For Perfect  
Radio Reception  
Noiseless  
Static-Free  
High-Fidelity

The new Frequency Modulation system of transmission and reception is now definitely out of the laboratory stage. New type transmitters are being built daily and many more are being planned. If you do not already have an F-M station serving your locality, a check with your local broadcasters should quickly reveal the possibilities of early service of this type in your community.

### Console Model F-M Receiver

The F-M Receiver Chassis described to the left attractively housed in an acoustically correct walnut console cabinet having grain walnut side and top panels with contrasting sliced-burl walnut inclined front panel. A horizontal band of mahogany placed at the upper and lower portions of the cabinet and on either side of the speaker grill, serve to accentuate the attractiveness of this truly fine piece of radio furniture. **D17547**—Meissner Console Type F-M receiver complete with tubes, high fidelity tone chamber and 1M Dynamic Speaker. For 110 V. 60 cyc. AC operation. Size 41x30 $\frac{1}{2}$ x15 $\frac{1}{2}$ " deep. Ship. wt. 105 lbs. **YOUR PRICE \$77.91**



Write us regarding any new developments in frequency modulation. Radolek will always have the latest information ready to pass on to you.

## Browning Tuner and Parts for F-M Reception

**Model BL43A**  
**Transceptor**  
  
Adapts  
Present  
Day Radios  
To F-M  
Operation



**D17571**—Model BL40T 40 to 50 Mc. F-M RF Tuner. Tubes used, 1-6SK7 and 1-6K8. Operates with Model 3000A IF amplifier, listed below. Factory wired and aligned, less tubes and dial. **YOUR PRICE \$11.70**

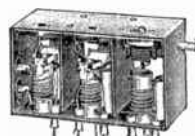

**D17572**—Model BL-3000A 3 MC broad band 2 stage IF amplifier and chassis with mixer, limiter, detector, volume control and AC switch. 10 $\frac{1}{2}$ x9 $\frac{1}{2}$ x2 $\frac{1}{2}$ " Chassis has all holes punched for BL40T RF tuner, power supply and push-pull power amplifier. Tubes used: 1-1852, 1-6SK7, 1-6SJ7, 1-6H6. **YOUR PRICE, \$24.90** less tubes

A complete F-M seven tube tuner for those wanting professional appearance. Easily connected to the Audio Channel of any present-day radio set or, when combined with any good audio amplifier and speaker, a complete F-M receiver can thus be constructed. Contains 1 RF, oscillator and mixer, 2 IF, limiter and detector stages with power supply and volume control built in. Has 6" Slide rule dial calibrated from 40 to 50 Mc. Attractively housed in walnut veneer cabinet, 18x11x24" high. For 115 V. 60 cyc. AC operation.

**D17570**—Browning BL-43A F-M Transceptor complete with power supply, less tubes. List, \$91.75. **YOUR PRICE \$55.05**

**D1337**—Complete Set of 7 matched Sylvania tubes for above. **YOUR PRICE \$44.10**

### Individual FM Parts

**D9745**—3 Mc. IF Transformer. **YOUR PRICE \$1.20**

**D9746**—3 Mc Detection Transformer, air tuned. **YOUR PRICE \$3.75**

**D10634**—Slide-Rule Dial. Has 6" illuminated scale calibrated from 40 to 50 Mc. **YOUR PRICE \$3.15**

**D10639**—Slide-Rule Dial, same as above except has 4" scale. **YOUR PRICE \$2.10**

**D18484**—Punched chassis for RF and IF tuners, audio amplifier and power supply. Size 10 $\frac{1}{2}$ x9 $\frac{1}{2}$ x2 $\frac{1}{2}$ ". **YOUR PRICE \$2.70**

## Utah Baflex Reproducers For F-M Reception

For Best High Fidelity Reproduction from F-M Receivers

For use where best reproduction of complete F-M audio tone range is desired. Incorporates the latest developments and improvements for high fidelity reproduction of music and voice. All back radiation has been eliminated. Base response greatly improved. High frequency response up to 9500 cycles is clear and without cabinet resonance or vibration distortion. Cabinets are sturdy in construction and attractively finished in two tone satin bronze. Comes complete with speaker, but less output transformer.

Stock Num.	Cone Dia.	Magnet Weight	V.C. Imp.	Input Watts Normal	Output Watts Max.	Overall Size	List Price	Your Price
D15663	8"	20 oz.	8	12	15	11 $\frac{1}{4}$ x17 $\frac{3}{4}$ x24"	\$29.50	\$17.34
D15664	8"	31 oz.	8	12	18	11 $\frac{1}{4}$ x17 $\frac{3}{4}$ x24"	33.50	19.70
D15665	12"	46 oz.	8	17	26	12 $\frac{3}{4}$ x22 $\frac{3}{4}$ x31"	44.50	26.16
D15666	12"	7 lbs.	8	22	33	12 $\frac{3}{4}$ x22 $\frac{3}{4}$ x31"	59.50	34.98

See Page 86 for complete listing of output transformers



## I.C.A. "Q" Matching Dipole F-M and Television Antenna



Specifically designed to cover a continuous frequency range of 40 to 90 MC which includes the 42 to 50 MC F.M. Band. May also be used for television. Consists of two 60" adjustable nickel plated admiralty brass sections mounted on a bakelite base with high dielectric insulators. The sections can be adjusted (tuned) to maximum response for a particular F.M. or Television station. Incorporates the "Q" method of coupling between the transmission line and antenna.

**D15959**—F.M. and Television Antenna complete less lead-in cable. List, \$5.50. **YOUR PRICE \$3.23**

**D15960**—F.M. and Television Antenna complete with 60 ft. of transmission lead-in cable. List, \$7.50. **YOUR PRICE \$4.40**

## 3 Section Bi-Telescopic Reflector Type

F-M and  
Television  
Antenna

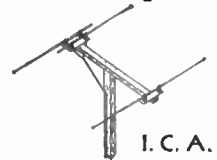

A truly efficient antenna system for best reception of F.M. and Television signals. Made of nickel plated large diameter admiralty tubing, consisting of stationary section with adjustable telescopic ends so arranged as to compensate for space wave frequency reflections. Mounted on low resistance bakelite base with 2 high dielectric insulators. Length, 10 ft. overall.

**D15965**—Antenna and reflector with insulators. List, \$5.00. **YOUR PRICE \$2.94**

Special Transmission Cable for above.  
**D4973**—50 ft. Roll. List, \$2.25. **YOUR PRICE \$1.32**  
**D4974**—100 ft. Roll. List, \$3.75. **YOUR PRICE \$2.20**

# Special MONEY SAVING Values

## Vita-Juicer Juice Extractor

The Newest and Finest Machine for  
Extracting Clear, Pulp-Free Juice  
from Fruits and Vegetables  
Electrically Operated

D18254—For 105-120 volt, 50-60 cycle  
AC operation.  
List Price, \$34.50.  
YOUR PRICE ..... **\$24<sup>15</sup>**

A compact, simply constructed electrically operated device designed to extract the clear, pure un-aerated juice from fruits and vegetables including leafy and tuberous vegetables such as carrots, celery, spinach, etc. Fruits or vegetables are fed thru an opening in the cover and are quickly converted to a fresh clear juice that requires no additional pressing or straining. Quiet in operation. Durable constructed of high grade non-rusting materials. Inside bowl has a baked white enamel finish. Outside is finished in ivory baked crackle enamel for lasting beauty. Size 7 7/8" dia., 9" high. Wt. 12 lbs.



## Sessions "Kloxit" Timer

Helps You to Remember the Things  
You Are Always Forgetting

D18237—Ivory YOUR PRICE ..... **\$1.96**  
D18238—Green EACH .....  
D18239—Black

A dainty accurate timing device that keeps track of the minutes for you and sounds a cheery musical note at any time you want to be reminded of something you have to do within the hour. Invaluable for a great number of uses about the home and for commercial applications. Self winding when setting dial. Dial marked in minutes up to one hour. Metal case, size 4 7/8"x1 1/2"x2".



## Admiral Touch-O-Matic Auto Radio Tuning Unit

Converts any auto radio to push button electric tuning. Touch a button . . . in comes your station. Can be connected to automatically tune five of your most popular stations. "Windows" provide spaces for call letters of stations selected. Manual tuning can be used by pushing a sixth button. Easy to install, the push button unit is housed in a polished bakelite case 5 1/2"x1 1/4"x1 1/8". Mounts on the steering post or under the dash. The control mechanism is housed in a rust proof metal case fitted with holes for attaching to case of auto radio on which it is to be installed. A20047—TOUCH-O-MATIC Tuning unit. Complete with connecting cable, hardware and instructions. List Price, \$8.95.  
YOUR PRICE ..... **\$1.95**

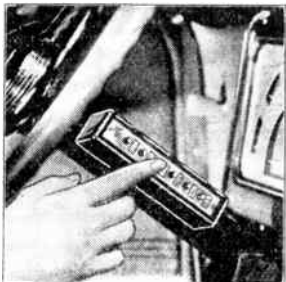

## "Radio Service" Electric Sign

It Tells! It Sells!

R16901—YOUR PRICE ..... **\$1.98**

ADVERTISE! Let these attractive Signs tell the world YOU fix 'em. Your Service calls will increase — your PROFITS will increase — and your shop will be identified as radio headquarters in your locality. Customers won't flock to your shop if it is dark and unattractive. Brighten it up! Install an Electric Sign. Install One of These Signs.

This sign tells every passerby the location of your business. A sales help you need. The greatest sign value of this type ever offered. Sturdily constructed of metal, enameled black with aluminum finished trim. Background on glass is black and the words "Radio Service" are in red "neon-effect." Interior illuminated with single lamp. Economical to operate. Easily read from a great distance. Lamp socket and attaching cord included. No bulb included. Size: 15"x9"x5" deep.

## Pocket Screw Driver Kit

C5787—Set of 3 Screwdrivers in  
Leatherette Pocket Case.  
YOUR SPECIAL PRICE.... **82c**

A necessity for every serviceman. Contains 3 transparent, shock-proof, unbreakable handle type screwdrivers with 1/4" dia., 4" long, 1/4" dia., 8" long and 3/8" dia., 6" long blades. Black leatherette case has compartment for other tools and double snap fastener for carrying in pocket or on belt.  
C5788—Case Only. Less Screwdrivers.  
YOUR PRICE..... **19c**

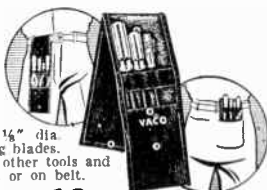

## "Ro-Tray" Cigarette Ash Tray

Turn the Top and See A Cigarette Pop

D31300—Brown  
D31301—Red  
D31302—Lt. Blue  
D31303—Dark Blue  
D31304—Green  
D31305—Ivory

YOUR PRICE,  
Any Type, Each, **.73c**  
In Lots of 12  
or More, Each **67¢**



The modern way to serve cigarettes. Keeps them handy, sanitary and undamaged. Consists of black glass ash tray mounted on aluminum container with provisions for storing up to 20 cigarettes. Small coil spring in each cigarette compartment raises cigarette through hole in the ash tray as it is rotated. Simply reloaded. Available in various colored leatherette bands. Size 4" dia., 3 1/4" high.

## Walsco Staple Driver

Easy to Use  
Saves Time  
Complete with  
230 Staples



D14192—Cadmium Plated. YOUR PRICE ..... **\$2.97**  
D14193—Chrome Plated. YOUR PRICE ..... **\$3.82**

A sturdy light weight staple driver for quickly anchoring wire, insulating material, signs, etc. to any wall or surface. Automatically sets staple to any depth with minimum effort. By striking handle with palm of hand, staple enters ordinary soft surfaces with one stroke, hard surfaces take only a couple of strokes or a mallet or hammer can be used for driving staples into brick, soft concrete, sheet metal etc. Has trigger controlled staple feeding mechanism. Magazine holds 23 staples and can be quickly loaded. High quality steel staples coated with insulating material. Staples come in strips of 23.

D14194—Leather carrying case. D14195—Ivory Finished Staples } YOUR PRICE ..... **24c**  
D14196—Brown Finished Staples } 230 for...  
D14197—Blue Staples } 2300 for. **\$2.00**

## Eveready Streamline Flashlights

With Pre-Focused Bulb

Distinctively styled. Wear resistant chromium finished seamless brass case with rolled on smooth black baked enamel decoration. Features pre-focused lamp, die cast reflector, lamp shock absorber and streamlined lock switch. Batteries replaceable from lens end. No batteries included.



D33—Eveready 2251 Standard 2 Cell. Uses two 950 cells. Size 1 1/4"x5 3/4". List Price, 80c. PRICE, Each, **56c**, Less 2% **55c**  
Six in Display Carton, PRICE, **\$3.29**  
D34—Eveready 2231 Baby 2 Cell. Uses two 935 cells. Size 1 1/8"x5 3/4". List Price, 78c. PRICE, Each, **53c**, Less 2% **52c**  
Six in Display Carton, PRICE, **\$3.12**

## Mazda Flashlight

Bulbs

Guaranteed finest quality.

†Miniature Lens type (not shown).

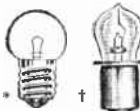

Stock Num.	Max Num.	Volt	Amps.	List Price, Each	Yen for
D10568	222†	2.2	0.25	9¢	53¢
D10466	PR2†	2.4	0.50	13¢	77¢
D10570	14*	2.5	0.30	9¢	53¢
D10467	PR3†	3.6	0.50	13¢	77¢
D10571	13*	3.8	0.30	9¢	53¢
D10468	605*	6.0	0.50	10¢	59¢

## Magazine Subscription Offer



Here is your chance to subscribe to two popular radio magazines at way below the regular year-ly subscription price of \$2.00 each.  
**12 Monthly Issues**

YOUR PRICE ONLY ..... **\$1.25**

DX12400—Radio-Craft. Covers Radio, Television, Facsimile, Electronics and Sound. Over 125 illustrations and diagrams in each issue with service data, kinks, circuits, etc.

DX12401—Radio & Television. Contains latest radio and television news, construction articles, pictorial diagrams, questions and answers, hook-ups for experimenters, kinks, newest radio apparatus, etc.

## Embroidered Silk

Emblems



RADIO REPAIR SERVICE

SERVICE MANAGER

THE RADIO SHOP

D12402—Radio Repair Serv. Each **25¢**  
D12403—Radio Service Manager  
D12404—Service Manager  
D12405—The Radio Shop

Advertise your business in this inexpensive way. Ready for attachment to shirts, coveralls, jackets, caps, etc. Border and lettering embroidered in gold silk on royal blue background. Washable. Size approx. 5 1/2 times above illustrations.

## Bakelite Test Case



K12351—  
With top panel.

YOUR PRICE **59¢**

Polished brown bakelite with beveled bakelite top plate mounting with two insulated screws. Size of case 4 1/2"x2 1/2"x1 1/2". Inside depth 1 3/4". 2 1/2" between inside panel supports. Supplied with six 1/4" holes for small pin jacks, or wires. This is the ideal size small instrument case for small radio apparatus.



# It's Easy to Figure Delivery Charges on Your Order

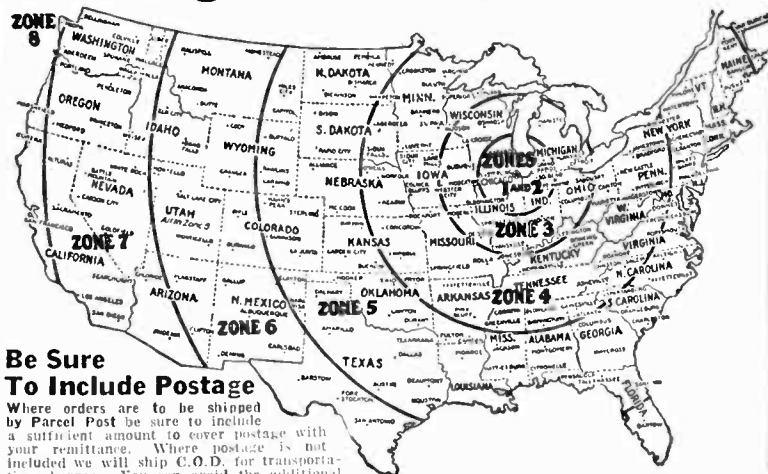

## Be Sure To Include Postage

Where orders are to be shipped by Parcel Post be sure to include a sufficient amount to cover postage with your remittance. Where postage is not included we will ship C.O.D. for transportation charges. You can avoid the additional expense of C.O.D. collections by sending sufficient postage. Any excess amount sent for Parcel Post charges will be promptly credited.

### Table of Approximate Rates Per 100 lbs. for Express and Freight

From Chicago to	Express per 100 Pounds	1st. Class Freight per 100 Lbs.	From Chicago to	Express per 100 Pounds	1st. Class Freight per 100 Lbs.
Alabama	\$3.75	\$2.40	Nebraska	\$3.90	\$2.25
Arizona	7.30	4.12	Nevada	9.10	4.75
Arkansas	3.59	1.60	N. Hampshire	4.00	1.49
California	10.05	4.75	New Jersey	3.75	1.43
Colorado	6.15	3.65	New Mexico	5.60	3.35
Connecticut	3.85	1.49	New York	3.35	1.18
Delaware	3.70	1.42	No. Carolina	3.75	2.50
Florida	5.05	2.20	No. Dakota	4.50	2.60
Georgia	3.50	2.30	Ohio	2.15	.80
Idaho	7.90	4.50	Oklahoma	3.85	2.14
Illinois	1.85	.75	Oregon	9.75	5.10
Indiana	1.65	.70	Pennsylvania	3.75	1.40
Iowa	2.57	.98	Rhode Island	4.00	1.49
Kansas	3.80	2.04	So. Carolina	4.10	2.29
Kentucky	2.20	.98	South Dakota	4.35	2.65
Louisiana	4.20	2.06	Tennessee	3.30	1.75
Maine	4.50	1.49	Texas	7.15	2.37
Maryland	3.45	1.25	Utah	6.90	4.13
Massachusetts	4.00	1.49	Vermont	3.95	1.60
Michigan	3.95	1.09	Virginia	3.60	1.39
Minnesota	3.60	1.49	Washington	9.45	5.10
Mississippi	3.75	1.80	West Virginia	2.95	1.03
Missouri	2.62	1.35	Wisconsin	2.65	.60
Montana	5.35	3.75	Wyoming	5.50	3.50

**NOTE**—To estimate Express charges for shipments under 100 pounds—the minimum charge for a one pound package sent by Express is 36c, ranging up to 42c for highest rate. Beginning with the minimum, charges are increased according to weight of package. For instance the 10 pound rate varies from 44c to \$1.00. The poundage rate varies from about 6% down to about 55% of the hundred pound rate for 50 pounds (from 80c to \$3.62) with the charges for intermediate weights above and below 50 lbs. in approx. proportion.

## How to Order

Send your orders on our convenient Purchase Order form, or in any other manner convenient to you. Be sure to specify Stock Number and Price of each item. Print your Name and Address plainly.

We will ship C.O.D. Most of our customers prefer to send cash with order to avoid extra collection costs. All orders for heavy merchandise to be shipped to distant points should be accompanied by a 25% deposit.

## Your Order Solicited

We solicit orders from those actively and commercially engaged in the radio industry. Manufacturers, Radio Dealers, Radio Servicemen—Industrial and Institutional Laboratories, Public Utilities, Schools, Colleges, Engineers, Experimenters, Radio Amateurs whether registered or not, and those recognized as engaged in developing the Art of Radio. We will also accept orders from the United States Government, Federal Institutions, State, County, Municipal and other governmental bodies and institutions.

## Payment Terms

Our terms are cash with order or C.O.D. Catalog prices are Net—F.O.B. Chicago or factory. All Trade and Cash Discounts have been deducted. While we do not impose minimum order restrictions on our old customers, it will profit you to make up at least \$5.00 orders to avoid additional exchange charges. We will be obliged to pass on to you the exchange charge, made by the Banks, on all personal checks for less than \$5.00. C.O.D. orders from new customers should be accompanied by a 25% deposit.

## Parcel Post Rates

The limit in size is 100 inches in length and girth combined. The postage on any parcel over 84 inches and weighing less than 10 pounds will be chargeable for 10 pounds at the zone rate.

### Table for Packages Weighing 1/2 pound to 20 pounds

Weight Pounds	Zones 1&2		Zone 3	Zone 4	Zone 5	Zone 6	Zone 7	Zone 8
	Up to 150 miles from Chicago	150 to 300 miles from Chicago	300 to 600 miles from Chicago	600 to 1,000 miles from Chicago	1,000 to 1,400 miles from Chicago	1,400 to 1,800 miles from Chicago	Over 1,800 miles from Chicago	
1	\$0.08	\$0.09	\$0.10	\$0.11	\$0.12	\$0.14	\$0.15	
2	.10	.11	.14	.17	.19	.23	.26	
3	.11	.13	.17	.22	.26	.32	.37	
4	.12	.15	.21	.27	.33	.41	.48	
5	.13	.17	.24	.33	.40	.50	.59	
6	.14	.19	.28	.38	.47	.59	.70	
7	.15	.21	.31	.43	.54	.68	.81	
8	.16	.23	.35	.49	.61	.77	.92	
9	.17	.25	.38	.54	.68	.86	1.03	
10	.18	.27	.42	.59	.75	.95	1.14	
11	.19	.29	.45	.64	.82	1.04	1.25	
12	.20	.31	.49	.70	.89	1.13	1.37	
13	.22	.33	.52	.75	.96	1.22	1.47	
14	.23	.35	.56	.80	1.03	1.31	1.58	
15	.24	.37	.59	.86	1.10	1.40	1.69	
16	.25	.39	.63	.91	1.17	1.49	1.80	
17	.26	.41	.66	.96	1.24	1.59	1.91	
18	.27	.43	.70	1.02	1.31	1.67	2.02	
19	.28	.45	.73	1.07	1.38	1.76	2.13	
20	.29	.47	.77	1.12	1.45	1.85	2.24	

For packages over 20 pounds and up to 70 pounds. ADD for each pound:

1 lb	2c	3 1/2c	5c	7c	9c	11c
------	----	--------	----	----	----	-----

**NOTE**—Packages weighing under 1/2 pound allow 1 1/2c per ounce. Packages over 1/2 pound (8 ozs.) and not more than 1 pound take 1 pound rate.

Packages weighing over 1 pound and less than 2 pounds take the 2 pound rate. Always use the next higher pound rate for pounds and fractional pounds. **FOR EXAMPLE:** 1 1/4 pounds requires 2 pound rate, 2 1/4 pounds requires 3 pounds rate.

## Fastest Delivery

We are constantly striving to "cut-time" and to set new speed records on our excellent Shipping Schedule. Most orders are shipped the same day they are received. You cannot afford unreasonable delay. Radolek service means delivery right to your door of the exact merchandise you want, quickly and exactly as ordered.

## Equipped For Service

The most modern stock and shipping equipment—a hustling organization and an experienced and capable management—all combine to give your orders the individual attention that you want.

## Prices Quoted

Prices quoted are for usual commercial quantities. If you can use any items listed in larger quantity, please write for special quotation stating quantity you can use. "List Prices" shown are those suggested by the manufacturers or by us and are intended as a guide to you in setting an average retail or installed price. "Your Price" or "Net Price" is the net price you pay. The cash discount has also been deducted.

## SEND NO MONEY We Will Ship C.O.D.

You need not send a remittance with your order unless you wish to do so. We will ship C.O.D. any merchandise shown in our catalog, but we request that new customers on their first orders, or orders for heavy merchandise to be shipped to distant points be accompanied by a 25% deposit if to be shipped C.O.D. Most of our customers prefer to send cash with order, thereby eliminating delay and unnecessary expense of C.O.D. collection. You may remit by post office or express money-order, bank draft or personal check, as you prefer. If you send currency be sure to register the letter for we cannot be responsible for cash lost in the mails.

## Prices Subject to Market Change

We expect to be able to maintain prices quoted during the life of this catalog. However we reserve the right to revise prices should market conditions compel us to do so. Should any prices advance we will protect you against increased prices for as long as is reasonably possible. We pledge ourselves not to profiteer—we will not raise prices unnecessarily. But where prices are advanced generally on primary markets we may be obliged to make adjustments.

On sales in the State of Illinois we reserve the right to increase our prices, to the extent of any increase in cost of doing business, that may be occasioned by the Illinois State Occupation (Sales) Tax Act.

Likewise on shipments to other states, should taxes of any nature be imposed we reserve the right to add the amount of such taxes to our sale prices.

## SHIPPING ALLOWANCE On Orders of \$25.00 or Over

We will make a transportation allowance of 2% except where merchandise is already quoted prepaid and with the exception of Eveready Batteries.

This allowance can be applied on Parcel Post, Express or Freight Shipments. The allowance can be applied directly on Parcel Post Shipments. On Express and Freight Shipments it is usually necessary for us to make shipment charges collect, so that on Express and Freight Shipments you may make this deduction directly on your order or we will send you a credit for the amount of the allowance.

## Remember

This transportation allowance of 2% applies only on orders for over \$25.00 and is not to be confused with the cash discount allowance of 2% which is already deducted from the Net Prices as quoted in this Profit Guide.

## We Ship Subject to Inspection

We will ship any merchandise ordered, subject to your inspection if shipment is to go forward by express. In this manner, you may see the merchandise at the express office before you accept shipment. If you so prefer, if you desire inspection privileges, be sure to so state plainly on your order.

# This INDEX LOCATES YOUR WANTS QUICKLY

WE WILL SEND YOU A GENEROUS SUPPLY OF ORDER BLANKS ON REQUEST

<b>A</b> A.C. Generator . . . . . 78	Cabinet Repair Kit . . . . . 25	<b>D</b> Dash Mtg. Plates . . . . . 82	Hook-up Wire . . . . . 55	Cable Fittings . . . . . 92
A.K. Power Packs . . . . . 31	Cabinets, Spkr. . . . . 85, 89	<b>DEFENDABLE</b>	Hot-Shot Battery . . . . . 60	Carbon . . . . . 77, 90
Adapters . . . . . 28, 29, 61, 83	<b>Cable</b>	Instruments . . . . . 14	Housing, Speaker 85, 89, 99	Carbon Granules . . . . . 92
Advertising Sign . . . . . 158	Analyzer . . . . . 56	Desk Lamp . . . . . 61	How to Order . . . . . 159	Connectors . . . . . 91
Aerial Accessories . . . . . 52, 53	Auto Radio . . . . . 56, 82, 83	Desk Stands, Microphone . 92	Hydrometer . . . . . 78	Crystal . . . . . 90, 91
Auto Radio . . . . . 79, 83	Dial Cable . . . . . 30, 74	Dials, Tuning 30, 31, 74, 151	Hytron Tubes . . . . . 4, 154	Diaphragms . . . . . 92
Belden . . . . . 52	Dial Drive Rubbers . . . . . 7	Dial Plates . . . . . 30, 74		Dynac . . . . . 69, 74
Eliminators . . . . . 52	Dial Lamps, Sockets . . . . . 26	Dial Lite Coloring . . . . . 25		Plugs . . . . . 28, 29
Endor . . . . . 52, 54	Dial Life Compound . . . . . 25	Dial Non-Slip Compound . . 25		Preamplifiers . . . . . 92
Lead-in (Auto) . . . . . 83	Dial Plates . . . . . 65, 151	Dial Scales, Meter . . . . . 18		Receptacle . . . . . 28, 29
Maet . . . . . 52, 53, 154	Dial Repair Parts . . . . . 30	Dial Seals, Meter . . . . . 18		Ribbon . . . . . 92
Stick Tape . . . . . 54	Door Chimes . . . . . 128	Drills . . . . . 67, 69		Rings . . . . . 36, 92
Vertical Pole . . . . . 53	Drills . . . . . 67, 69	Dry Cells . . . . . 75		Springs . . . . . 92
Window Pole . . . . . 53	Dry Cells Rectifiers . . . . . 51	Dynamic Speakers . . . . . 86 to 88		Stands . . . . . 92
Wire . . . . . 54				Switch . . . . . 29, 92
<b>AEROVOX</b> Condensers 31, 48				Transformers . . . . . 36
Condenser Tester . . . . . 16				Velocity . . . . . 91
Exact Dup. Cond. . . . . 31				Midget Radios
L-C Checker . . . . . 12				2, 111, 116, 117, 163
Air Cell Battery . . . . . 75				Mixture Switches . . . . . 64
Aligning Tools . . . . . 70, 71				Mixers, Electric . . . . . 129
Allied Relays . . . . . 145				Motors, Phono. . . . . 94
Alligator Clips . . . . . 51, 71, 143				
Aluminum Panels . . . . . 150				<b>N</b> Nail Knobs . . . . . 52
Aluminum Rider . . . . . 72				Nail Plates . . . . . 151
Amateur Equip. . . . . 143 to 147, 152 to 155				Needle, Phono . . . . . 94
Amateur Receivers . . . . . 143, 152, 153				Neon Glow Lamps . . . . . 51
American Flyer Trains . . . . . 136 to 142				Neon Short Tester . . . . . 68, 71
Amperite Ballast Tubes . 27				Neutralizing Condensers . 147
Amperite Microphones 90, 101				Neutralizing Tools . . . . . 70
<b>AMPHENOL</b> Products . . . . . 28, 29, 56				Nichrome Wire . . . . . 58
Amplifier Carrying Case . 85				Nightlite, Plug-In . . . . . 68
Amplifier Cabinets . . . . . 99 to 110				Nut, Drivers . . . . . 62
Amplifier Adapters . . . . . 29				
Analyzer Cables . . . . . 56				<b>O</b> Octagon Boxes . . . . . 59
Analyzer Cases . . . . . 18				Ohmmite Resistors . . . . . 40
Analyses, Test . . . . . 7 to 17				Outlet Plugs . . . . . 53
Angle Bracket . . . . . 83				Outlet Receptacles . . . . . 158, 59
Antenna Condensers . . . . . 83				Output Transformers . . . . . 32, 33, 37, 86 to 88
Antenna Equip. See Aerials				Oscillator Coils . . . . . 148, 149
Appliance Cord Sets . . . . . 9				Oscillator, Phonograph . . . 148
Appliance Tester . . . . . 122 to 130				Oscillators, Test . . . . . 11 to 14
Arrestors, Lighting . . . . . 53				Oscillograph . . . . . 11, 13
Auto Trans. . . . . 32, 33, 35, 37				
Auto Bumper Guard . . . . . 131				<b>P</b> Paddling Condensers . . . 147
Auto Fans . . . . . 131				Panel Boring Tools . . . . . 69
Auto Fog Light . . . . . 131				Panel Light . . . . . 26
Auto Heaters . . . . . 131				Panels . . . . . 18, 150
Auto Horn . . . . . 131				Panel, Electric . . . . . 88
Auto Spotlight . . . . . 131				P.M. Speakers . . . . . 86 to 88
<b>Auto Radios</b> . . . . . 118, 119				<b>PHILCO</b> Sets . . . . . 119
Accessories . . . . . 79 to 84				Philo Tubes . . . . . 4
Aerials . . . . . 79, 83				Phones . . . . . 156
Automatic Tuners . . . . . 158				Phone Cords . . . . . 64
Condensers . . . . . 84				Phone Cushions . . . . . 156
Control Cable Fittings . . . . . 82, 83				Phone Packs & Plugs . . . 63
Filter . . . . . 84				Phonograph Adapters . . . 77
Crowe Dash Mtg. Plates 82				Phonograph Cases . . . . . 95
Remote Control Cable . . . 83				Phonograph Motors . . . . . 95
Service Manual . . . . . 19 to 23				Phonograph Needles . . . . . 94
Shielded Lead-in . . . . . 83				Phonograph Oscillator 77, 148
Star Dash Mtg. Plates . . . 82				Phone Postals . . . . . 83
Vibrators . . . . . 80, 81				Phonograph Records . . . . 94
Automatic Cutout . . . . . 30				Phono Recording Blanks . . 96
Automatic Tuners . . . . . 147, 158				Phono Record Changer . . . 94
Auto. Record Changer 95, 97				Phonograph Toy . . . . . 135
				Photo Electric Cells . . . . . 156
				Picket-Select Filter . . . . . 84
				Pigtail Wire . . . . . 54
				Pilot Light, Bulbs . . . . . 26, 74
				Pilot Light, Jewelled . . . . . 26
				Pilot Light Sockets . . . . . 26
				Tip Straps . . . . . 57
				Plugs, Amplifier . . . . . 66, 69
				Plugs, Appliance . . . . . 58
				Plugs, Banana . . . . . 71
				Plugs, Cable . . . . . 28, 29
				Plug Fuses . . . . . 58
				Plug, Microphone . . . . . 28, 78
				Plugs, Phone . . . . . 29, 64
				Plugs, Speaker . . . . . 71
				Plugs, Tip . . . . . 78
				Polish . . . . . 25
				Pocket Tool Case . . . . . 158
				Porcelain Plug Tubes . . . . 32
				Portable Amplifier Cases . . 85
				Portable Instrument Cases 18
				Portable P. A. Amplifier
				101, 103, 105, 107
				Portable Speaker Case . . . . 85
				Power Bldg . . . . . 74
				Potentiometers . . . . . 43
				Power Transformers . . . . . 32 to 37
				Power Transformer . . . . . 35, 78
				Pre-Amplifiers . . . . . 92
				Precision Resistors . . . . . 18, 38
				<b>PRECISION</b> Instruments . 12
				Probe Light . . . . . 68, 71
				Probs, Test . . . . . 70, 71
				Public Address Amplifiers
				99 to 110
				P. A. . . . . 85, 89, 92, 93, 100, 101
				Public Address Kits . . . . . 155
				Punches . . . . . 63, 69
				Push Back Wire . . . . . 55
				Push Buttons . . . . . 58
				Push Button Switches . . . . . 64
				Push Button, Tuners . . . . . 147, 158
				<b>R</b> RCA Aerials . . . . . 52
				RCA Test Inst. . . . . 12
				RCA Tubes . . . . . 6



# This INDEX LOCATES YOUR WANTS QUICKLY

WE WILL SEND YOU A GENEROUS SUPPLY OF ORDER BLANKS ON REQUEST

RCA Victor Pilot Lamp... 74  
 R. F. Coils... 30, 148, 149  
 Racon Units, Baffles... 89  
 Racks... 62, 92, 150  
 Radiat Vibrators... 81  
 Radiators, Vertical... 154  
**Radio Receivers**  
 Auto (Arvin)... 118  
 Auto (Philco)... 119  
 Cabinets... 85  
 Consoles... 111 to 115  
 Kits... 66, 77  
 Midset 2, 111, 116 to 118, 163  
 Radio Tubes... 4, 5, 6  
 Radiok Vol. Controls... 45  
**RAYTHEON Tubes**... 5  
 Razors, Electric... 121  
 Readrite Meters... 17  
 Readrite Test Equip... 7  
 Reamer... 69  
 Receptacles, Microphone... 29  
 Receptacles, Outlet... 58, 59  
 Record Changer... 35, 97  
**Recording Equipment & Access.**... 96 to 98  
 Recording Machine... 97, 98  
 Recording Motors... 94  
 Recording Needles... 96  
 Records, Blank Recording... 96  
 Records, Phono... 92  
 Rectifier, Dry Disk... 18  
 Rectifiers, Meter... 18  
 Rectifier Bulbs... 25  
 Refinishing Kit... 25  
 Refrigeration Manual... 20  
 Relays... 145  
 Relay Rack... 150  
 Remote Control Heads... 32  
 Remote Control Fittings... 33  
 Repair Cement... 25  
**Resistance Indicators**... 38, 39, 40  
**Resistance Tubes**... 27  
 Resistance Wire... 18  
**Resistors—Carbon**... 30, 41  
 Flexible... 38  
 Kits... 35, 39  
 Line Cord... 27  
 Metalized... 38  
 Meter Multiplying... 38  
 Ohmite... 18  
 Precision... 38  
 Spark Plug Sup... 84  
 Variable... 38, 40

Vitreous Enamelled... 40  
 Wire Wound... 38, 40, 41  
 R. F. Coils, Chokes... 30, 148, 149  
 Ride-Chanalyst... 12  
**RIDER Books**... 19, 20  
 Rivets & Rivet Tool... 63  
 Rods, Bakelite... 63  
 Rosin Core Solder... 72  
 Rotary Switches... 17, 64, 65  
 Rubber Cushion... 65  
 Rubber Feet, Grommets... 65  
 Rubber Tape... 58  
**S Sal-Ammoniac Cake**... 72  
 Sandwich Toasters... 129  
 Saws & Blades... 69  
 Scales, Meter Dial... 18  
 Scotch Tape... 58  
 Scratch Filter... 94  
 Scratch Remover... 25  
 Screen Grid Clips... 73  
 Screw Assortment... 62, 63, 74  
 Screw Drivers... 66, 68, 158  
 Screws... 62, 63, 74, 157  
 Selector Switch... 17, 64  
 Service Manuals... 19 to 21  
 Set Analyzers... 7 to 18  
**SEWING MACHINES**... 123  
 Shades, Light... 61  
 Shaft Couplings & Fittings... 74, 83, 151  
 Shielding Coil-Tube... 73  
 Shield Braided Slewing... 59  
 Shielded Wire... 54, 56  
 Shielded Cables... 56  
 Shlms Cone... 25  
 Sign, Electrical... 158  
 Signal Drills... 15  
 Signal Generator... 7 to 16  
**SIMPSON Test Inst.**... 15  
 Socket Adapters... 28, 29  
 Socket Candelabra... 51  
 Sockets Electrical... 58, 59  
 Socket, Lamp... 51, 58, 59  
 Sockets, Microphone... 28, 29  
 Sockets, Pilot Light... 28  
 Sockets... 26, 51, 74  
 Sockets, Tube... 28, 29, 73, 154  
 Socket Wrenches... 66, 68, 70  
**SOLAR Test Instruments**... 16  
 Solder... 40  
 Solder Lugs... 62  
 Solder Paste... 72  
 Soldering Irons... 72

Soldering Iron Tips... 72  
 Spade Lugs... 62  
 Spaghet... 62  
 Spark Plug Suppressors... 84  
 Spartan Condensers... 31  
**Speakers**... 86 to 89, 156  
 Baffles, Cabinets 85, 89, 150  
 Cable... 56  
 Carrying Case... 85  
 Cones... 22, 23  
 Field Coils... 23  
 Horns... 89  
 Public Address... 86 to 89  
 Shims... 25  
 Tester... 13  
 Splintite... 68  
**SPRAGUE Condensers**... 47  
 Spring, Aerial Tightener... 53  
 Springs, Microphone... 92  
**STANCOR Power Packs**... 35, 78  
 Stancor Trans... 33 to 35  
 Standoff Insulators... 56  
 Stands, Microphone... 47  
 Staple Driver... 158  
 Staplers, Staples... 25, 57  
 Star Auto Plates... 82  
 Stools... 67  
 Storage Batteries... 78  
 Suppressors Auto Radio... 84  
**SUPREME Instruments**... 10, 11  
 Swaging Tool... 83  
 Switches... 17, 29, 42 to 45, 58, 59, 64, 65, 82, 92, 128  
**T Taps and Dies**... 69  
 T Taps and Wrench... 69  
 Tap Switch... 29, 64, 65  
 Tape... 58, 145  
 Telegraph Keys... 145  
 Telephone Set... 135  
 Terminals, Battery... 51  
 Terminal Strips... 73  
 Test Adapters... 29  
 Test Clips... 17, 143  
 Test Equipment... 71  
 Test Light, Neon... 71  
 Test Oscillators... 11 to 11  
 Test Prods... 70, 71  
 Test Set Cases... 18, 158  
 Thinwall Conduit... 57  
 Thordarson Trans... 32, 144  
 Time Switch... 128  
 Tip Jacks... 28, 71  
 Tips, Phone... 71

Tips, Soldering Iron... 72  
 Toasters... 126, 129  
 Tube Connector Tester... 16  
 Tube Filterettes... 24  
 Toggle Switches... 58, 59, 65  
 Tone Controls 42 to 45, 64, 82  
 Tools... 66 to 72  
 Tool Boxes... 69  
**Touch-up Kit**... 25  
 Trans, Electric... 142  
 Transformers, Amateur... 144  
 Audio... 32, 33, 35, 37  
 Bell... 58  
 Exact Dup... 30, 34 to 37  
 I. F. ... 30, 148, 149  
 Filament... 37, 144  
 Phone Matching... 37, 66  
 Output... 32 to 37, 86 to 88  
 Power... 32 to 37, 144  
 Train... 139  
 Tubetester... 36  
 Vibrator... 32, 33  
 Transmitters... 152, 153  
 Transmitter Coils... 154  
 Transmitting Cond... 146  
 Transmitting Crystals... 145  
 Transmitting Keys... 145  
 Transmitting Tubes... 143  
 Trimmer Condensers... 147  
**TRIPLETT Instruments**... 8, 9, 17  
 Triplett Meters... 17  
**TRIUMPH Instruments**... 13  
 Tube Data Book... 6  
**Tubes**... 4, 5, 6, 143  
 Gammatron... 143  
 Hytron... 4, 143  
 Raytheon... 5, 143  
 RCA Radiotron... 6, 143  
 Tubes, Adapters... 29  
 Tube Shields... 73  
 Tube Sockets... 28, 29  
 Tube Testers... 7 to 15  
 Tube Tester... 63  
 Tubing, Bakelite... 63  
 Tubing, Flexible Braided... 63  
 Tungar Type Rectifiers... 51  
 Tuners, Push-Button 147, 158  
 Tuning, Condensers... 147  
 Tuning Dials... 30, 31  
 Tuning Eye Assembly... 29  
 Tuning Meters... 17  
 Tuning Wand... 70

**U UTAH Speakers**... 86  
 Utah Vibrators... 81  
**V Variable Condensers**... 147  
 Variable Resistors 38, 40  
 Velocity Microphones... 91  
 Vernier Dial... 74  
 Vibrator Condensers... 48, 50  
 Vibrator Transformer... 32, 33  
 Vibrator Tester... 8  
 Vibrator Guide... 81  
 Vises... 73  
 Vibration... 23  
 Voice Coil Assembly... 33  
 Voltage Dividers... 38, 40  
 Voltage Regulators... 27  
 Voltmeter... 17  
 Volume Controls 41 to 45, 156  
 Vol. Cont. Switches 41 to 45  
**W Waffle Irons**... 127  
 Wall Plates... 29  
 Ward Aerials... 150  
 Washers... 62, 63, 150  
 Washing Machine... 129  
 Watt Meters... 17  
 Weatherproof Cable... 57, 60  
 Weston Instruments... 13  
**Wire**  
 Aerial... 54  
 Bus Bar... 54  
 Bell... 58  
 Ignition... 56  
 Galvanized Guy... 52  
 Lead-In... 54, 55  
 Magnet... 55  
 Manganin (Resistance)... 18  
 Microphone... 56  
 Hook-up... 54, 55  
 Nichrome... 58  
 Shielded... 54, 56  
 Stripper... 54  
 Test Leads... 54  
**WORMER Photoelectric**... 156  
 Wood Screws... 62  
 Wrenches... 66, 68, 69, 70  
**Y YAXLEY Controls**... 42, 43  
 Yaxley Switches... 42, 43, 65  
 Yaxley Dial Plates... 65  
 Yaxley-Encyclopedia... 20, 21, 43

## "HOT" Items to Increase Your Profits

### Economy Portable P. A. System



With Crystal Microphone  
**D15055**—Complete Portable P.A. System. For 110-120 volt, AC or DC operation.  
**\$16.95**  
 YOUR PRICE

An amazingly low priced complete portable P.A. sound system. Includes a 4 tube AC-DC 3 watt amplifier with tubes, speaker, desk stand with removable base, crystal microphone and carrying case. Has a dozen of useful applications. Use it in restaurants, stores, clubs, homes, etc. for demonstration, speech amplification, entertainment, etc. Plays anywhere on AC or DC. Compact and easy to carry. Sets up in a jiffy—as easy to use as a radio. Can be used with any record player having a high impedance pickup. Tubes used, 12J7, 12J5, 50L6, and 35Z5. Has tone control and volume control with on-off switch. Delivers surprisingly high output with good frequency response. Amplifier can be used up to 30 ft. away from the FM speaker which is mounted on the back. Fine durable airplane cloth covered case houses all equipment. Case size 10 1/2 x 10 1/2 x 4 3/4". Net wt. 7 lbs.

### Howard Recording Disc Display

With Disc Assortment  
**D15861**—Total List Value, \$17.50.  
**YOUR PRICE, \$11.25**



Use this attractive display case in your recording studio or store to create greater sales on Howard recording discs. Contains 15-10" discs, 15-8" discs, 20-6 1/2" discs, 6 packages of phonograph needles (packed 25 per package, each needle plays ten records), 6 recording needles retailing at 25c each, an ample supply of consumer sales making literature and display stand. Howard Recording Discs are easy to sell and easy to use. They are flame proof and feature low surface noise, soft metal base and longer life. Packed 5 discs per package. Howard Needles assure finest quality reproduction.

List Price	YOUR PRICE		
	1-9	10-49	50-Up
D9810—6 1/2" Recording Discs, Each...	20c	13 1/2c	12c
D9811—8" Recording Discs, Each...	30c	19 1/2c	18c
D9812—10" Recording Discs, Each...	40c	27c	24c
D9813—Phono Needles, Per Pkg. of 25...	25c	17c	15c
D9814—Recording Needles, Each...	25c	17c	15c

### Magnetic Speakers



Very fine tone qualities. It is a very pressed steel frame, cadmium plated. Heavy magnet with improved balanced armature unit. D.C. resistance 1000 ohms. Will match most output tubes.

Stock Number	Overall Diameter	Overall Depth	YOUR PRICE
D15778	5"	2 1/4"	88c
D15781	6"	2 1/2"	96c
D15782	8"	2 3/4"	\$1.10
D15783	8 1/2"	3 1/4"	1.68

### Tube Sockets



Flush mounting molded bakelite sockets. Metal mounting plates equipped with 3 lugs. Mounts in 1 1/2" holes. Mtg. ctrs. 1 1/2". \*Requires 3/8" hole, 1 1/2" mtg. ctrs.

Stock Number	Number Pins	PRICE EACH	Ten for	100 for
D11993	4	4c	38c	\$3.15
D11994	5			
D11995	6			
D11996	7			
D11997	Octal			
D11998	Octal			

### Fluorescent Lamps

Adjustable to Any Position



Brings daylight fluorescent lighting to your work. Ideal for home, office or shop. Shade is swivel mounted. Separate ratchet type swivel holds extension arm. Telescopic stand for height adjustment. Brown winkle metal with chrome trim (bench type fluorescent lamp uses one T-8 15 watt daylight bulb. For 110-120 volt, 60 cycle AC operation. See also page 120 for other fluorescent fixtures and accessories.

### Bench Type

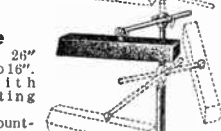

Stand adj. 14 to 26" high. Arm extends to 16".  
**D16778**—With clamp-on mounting bracket.  
**D16779**—With surface mounting flange. Less bulb.  
**PRICE, EACH \$5.80**

### Floor Stand



Stand adjustable from 43 to 63" high. Arm extends to 12". Heavy base. Less bulb.  
**YOUR PRICE \$8.42**

AC - DC  
BATTERY

# PORTABLE RADIOS

## DeLuxe Combination Portable 5 Tube Battery or 110 V. AC-DC

Plays anywhere outdoors—indoors from self-contained batteries or external 110 Volt AC or DC power. Latest superhet circuit. 5 Tubes—all working. 5" P.M. dynamic speaker gives excellent tone and volume. Built-in aerial and full automatic volume control. Full vision, airplane type, illuminated dial, tunes broadcast and upper police bands—538 to 1620 Kc. Very economical on batteries, lasts 150 hours or more. Tubes: 1A7GT, 1N5GT, 1H5GT, 1T5GT and 35Z5GT. Case is attractively covered in durable brown leatherette, size 12 $\frac{1}{2}$ "x9 $\frac{1}{2}$ "x5 $\frac{3}{4}$ " deep. Weight with batteries, 18 lbs.

D17537—With drop hinged protective cover, 5 tubes and batteries. List, \$29.95.

**YOUR PRICE,**  
Each ..... **\$17.25**  
In Lots ..... **\$15.95**  
of 3,  
Each .....

D101—Extra Set of Batteries..... **\$2.25**

D17538—Finished in Gray Airplane Cloth without protective cover but with 5 tubes and batteries. List, \$26.00.

**YOUR PRICE,**  
Each ..... **\$14.95**  
In Lots ..... **\$14.25**  
of 3,  
Each .....

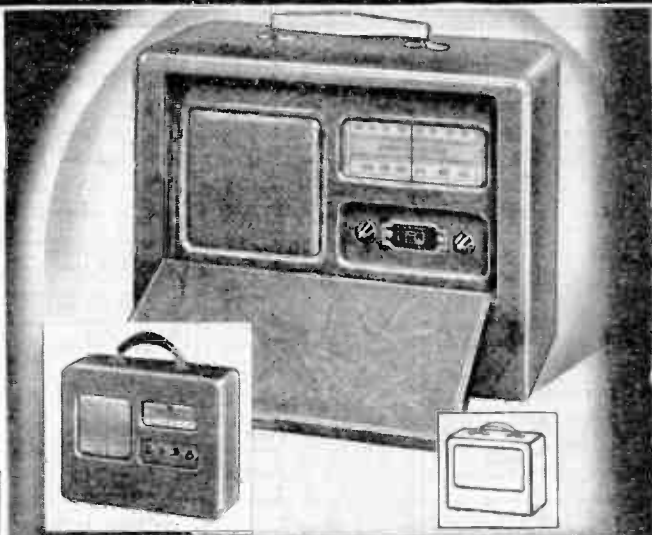

**Your Favorite Programs Wherever You Are**

## 5 Tube 110 V. AC-DC or Battery Super

Carry it with you wherever you go. Tune in political speeches—dance music or favorite programs of every kind—at home, in the car, in the boat, on the beach, in the country—everywhere. Operates from either self contained batteries or 105-120 Volt AC-DC line power. Illuminated airplane type dial covers entire broadcast band 540 to 1550 Kc. Built-in antenna eliminates dangerous, trailing antenna wire. No ground connection required. Automatic volume control minimizes fading. 5" PM. dynamic speaker gives excellent tone quality. Beam power output gives maximum volume at low power cost. **Battery life 150 hours or better.** The neatly styled cabinet, ruggedly built, is covered with durable sun and water proof airplane cloth. Tubes: 1A7GT, 1N5GT, 1H5GT, 1T5GT, 50Y6GT. Size: 9 $\frac{1}{4}$ "x 14 $\frac{1}{2}$ "x5 $\frac{1}{2}$ " deep. Wt. packed, with batteries 18 lbs.

*Most For Your Dollar*

D17539—Radolek DeLuxe Portable. Complete with 5 tubes and batteries. For portable battery or 105-120 volt AC or DC operation. List, \$22.95.

**PRICE, Single Lots**  
Each, **\$14.50**

In Lots ..... **\$13.25**  
of 3, Each

D101—Extra Battery pack for above. **\$22.50**  
Each.....

## 4 Tube Super Battery Portable

Low priced 4 Tube, Battery operated, Portable Superhet . . . the biggest value for your money in this price range. Completely self-contained. Carry it everywhere! Play it anywhere! No house current! No aerial! No ground! Just turn it on and it plays instantly, indoors or outdoors. **Tunes 535 to 1620 Kc.** Airplane dial. Equal in performance to the average 5 Tube AC Radio. Attractively housed in a sturdy airplane luggage type case covered with waterproof fabric. Very compact, only 12" wide x 9 $\frac{1}{4}$ " high x 5 $\frac{1}{4}$ " deep. Weighs only 14 lbs. including batteries. Tubes: 1A7GT, 1H5GT, 1N5GT, 1Q5G. Provides extreme economy in operation with amazing power and marvelous tone at low cost. Battery life is at least 150 operating hours. 5" PM. Speaker. Full AVC. Ship. wt. with batteries, 16 lbs.

*Low Cost*

*Light Weight*

D17679—Radolek 4 Tube 1 $\frac{1}{2}$  Volt Battery Superhe Receiver. Complete with tubes and batteries. List Price, \$18.95.

**PRICE, Single Lots**

Each, **\$11.95**

In Lots ..... **\$11.45**

of 3, Each.....

D132—Extra battery pack for above. Ship. wt. 7 $\frac{1}{2}$  lbs **YOUR PRICE, \$22!**  
Each.....

## 5 Tube 110 V. AC-DC or Battery Super

**5-1 $\frac{1}{2}$ -V. Flashlight Cells Supply Complete "A" and "B" Power**  
Operates also on 105-120 V. AC or DC in home, office, hotel etc., or 6-8 V. storage battery in car or boat. No expensive "B" batteries or "B" battery packs needed. 5 flashlight cells (obtainable everywhere) will give 10 or more hours of service or 10 cells will give 25 hours. The receiver, a powerful highly sensitive 5 tube superheterodyne with 3-gang tuning condenser and big 5 in. PM. Dynamic speaker, has automatic volume control and efficient self-contained antenna allowing exceptionally good reception under all kinds of operating conditions. Attractively housed in durable pig-grained leatherette case with carrying handle and clips for mounting on car window. Large airplane dial covers 540-1750 Kc. Tubes: 1N5, 1A7, 3A8, 1T5, 35Z5. Size 13x 6x5 $\frac{1}{4}$ " high. Shp. Wt. with batteries, 10 $\frac{3}{4}$  lbs.

*Has Greatest Utility Value*

D17508 — Radolek Four Way Portable Receiver Complete with 5 tube, and batteries. List Price, \$29.95.

**Price Single Lots**

Each, **\$19.55**

In Lots ..... **\$18.97**

of 3, Each.

D103—Extra Batteries for above. Set of 5, List Price, 50c

**YOUR PRICE..... 33c**

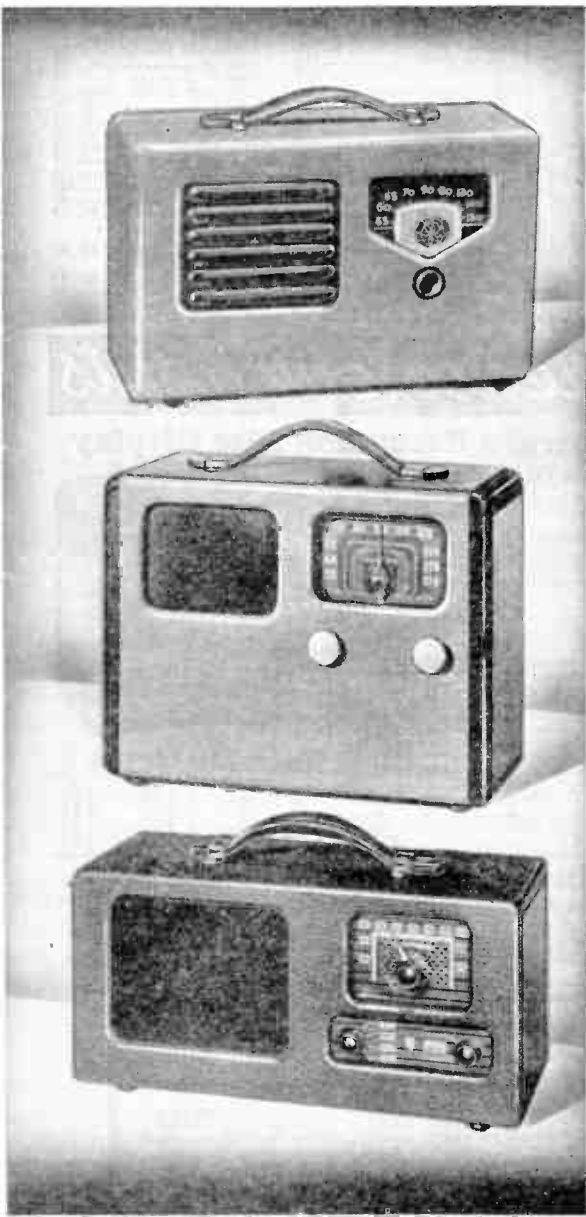



# Meet Competition With These Low Prices



## 6 Tube Superhet

*Walnut Cabinet—Tone Control*

This 6 tube table model attracts the eye with its handsome appearance, and enchants the ear with its full, rich tone. As a piece of furniture it harmonizes with any setting, and adds a sparkling modern touch to any room. Latest 6 tube superhet circuit provides plenty of power to bring in any station with volume to spare. **Tuning range, 540 to 1720 Kc.** Built-in non-directional antenna eliminates aerial and ground connections. Soft, indirect lighting makes the square, airplane type dial easy to read. **Variable tone control** allows delicate shading and faithful reproduction of music and voices. **Full-sized dynamic speaker** assures accurate, full-bodied tone of exceptional quality and clarity. Cabinet is Walnut, hand rubbed to a lustrous finish, with an unusual decorative band of Zebra-wood along the bottom. Loudspeaker louvers are durable and decorative plastic. Size: 9 1/4" x 15 7/8" x 6 1/2". Tubes: 1-12ABGT, 1-12K7GT, 1-12Q7GT, 2-50L6GT, 1-35Z5GT. Operates on 105-120 volt AC-DC.

D17597—Complete with tubes.

List Price, \$22.50.

**YOUR PRICE, Each \$12.45**

In Lots

of 3,

Each .....

**\$11<sup>95</sup>**

## 5 Tube AC-DC Super

## 6 Tube AC-DC Super



### Built-in Aerial —Walnut Case

This attractive 5-tube superhet home portable is small in size but extra big in power, tone quality and all-around value. **Tuning range, 540 to 1720 Kc.** Has built-in antenna—may be plugged in anywhere without need for ground or outside aerial. 5" Dynamic speaker. Operates on 110 Volt AC-DC. Bands of Zebra-wood inlay at top and bottom add a distinctive touch to handsome Walnut finish wood case. The carrying handle on top is of Ivory finish plastic. Louvers of the loudspeaker grille are dark plastic. Size 7"x11"x5 3/4". Tubes used: 12A8GT, 12K7GT, 12Q7GT, 50L6GT, 35Z5GT.

D17598—Complete with tubes.

List Price, \$17.95.

**YOUR PRICE, Each \$11.25**

In Lots of 3, Each .....

**\$10<sup>60</sup>**

### Push Button Tuning — Built-In Aerial

This 6 tube AC-DC Superhet is packed with super-values. Features tone-quality, power, range and appearance. No ground or aerial necessary—just plug in and play. 6 button synchromatic tuning for instant reception of selected stations. 2 1/2" Band tuning range—540 to 1720 Kc and 2300 to 6250 Kc gets standard broadcasts, amateur, police, aviation and 6 megacycle foreign. Automatic Volume Control minimizes fading. Has 5" electro-dynamic speaker. Beautiful Walnut cabinet has convenient handle for carrying. Size, 9"x12 1/4"x6 1/2". Tubes: 1-6K8, 1-6K7GT, 1-6Q7GT, 1-6AE5GT, 1-25AC5GT, 1-25Z8GT.

D17579—Complete with tubes.

List Price, \$29.50.

**YOUR PRICE, Each \$16.95**

In Lots of 3, Each .....

**\$16<sup>25</sup>**

## 4 Tube AC-DC Superheterodyne

**High Performance — Low Price**

Attractively housed in a molded plastic cabinet this new superheterodyne receiver with 4 working tube (no ballast tube) and built-in antenna is an outstanding buy. Covers full broadcast band and upper police bands, 540-1720 Kc. Illuminated aeroplane dial. A.V.C. minimizes fading. Use of new multi-purpose 1.0 Ma. tubes allows maximum set performance at lowest operating cost. Tubes: 12SA7, 12SQ7, 50L6GT and 35Z5GT. 5" Full tone dynamic speaker. Beam power output. For 105-120 volt AC or DC operation. Modern plastic cabinet ornamented with horizontal banding and contrasting vertical speaker louvers. Size 9 1/4"x6 1/2"x6 1/2". Wt. 7 lbs.

D17548—In Walnut finished plastic cabinet.

**YOUR PRICE,**

In Single Lots **\$6.49**

In Lots of 3,

Each .....

**\$5<sup>97</sup>**

D17549—In Ivory finished plastic cabinet.

**YOUR PRICE,**

In Single Lots **\$7.49**

In Lots of 3,

Each .....

**\$6<sup>85</sup>**





