

ELECTRIC INSTRUMENTS

RUSSELL H. ROSS

Principles of Operation



This publication discusses briefly the characteristics of instruments, what makes them operate, and the individual limitations of the various types.

GENERAL  **ELECTRIC**

ELECTRIC INSTRUMENTS

Principles of Operation

THE use of electricity in manufacturing processes has become so general that it is taken for granted by most people. Such an attitude is logical because of the great variety of services that are performed so readily by electricity. Because of the many outstanding advantages of electric power, we sometimes overlook an important question: "Are we using electric energy in the best and most economical way?"

Sight, hearing, taste, touch, and smell will not furnish us directly with a satisfactory answer to this question. To our natural faculties we must

add specialized equipment to find out what is going on in an electric circuit.

Electric instruments are merely tools which enable us, by means of eye and ear, to obtain essential information about electric circuits. Just as with other tools, a study of the construction and application of instruments is desirable. Such a study invariably points the way to lower costs and improved manufacturing methods. To facilitate this understanding, we will discuss briefly here the principles which govern instrument operation.

CONTENTS

	<i>Page</i>
CLASSIFICATION OF INSTRUMENTS.....	4
DIRECT-CURRENT INSTRUMENTS	
PERMANENT-MAGNET MOVING-COIL TYPE.....	4
DAMPING.....	4
AMMETERS AND MILLIVOLTMETERS.....	4
VOLTMETERS.....	5
EFFECT OF D-C INSTRUMENTS ON CIRCUIT.....	5
ALTERNATING-CURRENT INSTRUMENTS	
DYNAMOMETER TYPE.....	7
DAMPING.....	7
VOLTMETERS.....	8
AMMETERS.....	9
WATTMETERS.....	10
COMPENSATED WATTMETERS.....	12
MAGNETIC-VANE TYPE.....	13
DAMPING.....	14
INDUCTION TYPE.....	15
RECTIFIER TYPE.....	16
THERMOCOUPLE TYPE.....	17

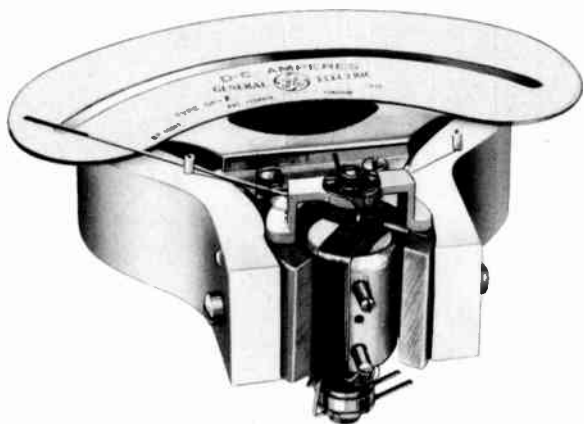

Fig. 1. Essential parts of a permanent-magnet moving-coil instrument

CLASSIFICATION OF INSTRUMENTS

The more common electric instruments can be divided roughly into the following classes.

According to the functions performed:

1. Ammeters
2. Voltmeters
3. Wattmeters

According to the circuit on which they are used:

1. A-c
2. D-c

According to the principle of operation:

1. Permanent-magnet moving coil
2. Dynamometer
3. Magnetic vane
4. Induction

The essential parts of these instruments generally include:

1. Means for providing deflecting torque (obtained by interaction of magnetic fields)
2. A spring or other means to provide a counter-torque
3. A pointer to indicate the resultant position of the instrument moving element

DIRECT-CURRENT INSTRUMENTS

Permanent-magnet Moving-coil Type

The permanent-magnet moving-coil type instrument is used for direct-current measurement. Essential parts of a typical instrument of this type are shown in Fig. 1. Through pole pieces, the permanent magnet supplies a constant magnetic field across the air gap, where a moving coil wound with fine wire is located. The moving coil is provided with hardened-steel pivots which are so fitted into highly polished jewels that the moving coil can rotate with as little friction as possible.

Springs, made of carefully selected phosphor-bronze strip, are used to lead current into and away from the moving system and also to supply restoring torque. The position of the moving coil is indicated by a pointer which moves over a suitably marked scale. The entire moving-coil assembly is made very light in weight to decrease as far as possible the load on the sharp steel pivots. In operation, the current through the moving coil produces a field which interacts with the field of the permanent magnet, and thus supplies deflecting torque.

Damping

Damping is accomplished by winding the moving coil on a light aluminum frame. Eddy currents are set up in the frame because of the motion of the coil in the permanent-magnet field. The field produced by the eddy currents interacts with the permanent-magnet field in such a manner as to oppose the motion of the coil, thus causing it to come to rest quickly.

Ammeters and Millivoltmeters

In general practice, it is not feasible to send more than 0.1 ampere through the moving coil directly; hence, to accommodate larger currents, shunts are provided as shown in Fig. 2. A shunt for instrument service is usually made from material having a very low temperature coefficient of resistance and a low thermal emf to copper. The low temperature coefficient of resistance is necessary to assure that the resistance of the shunt, and therefore the instrument indication will not change when the shunt carries currents which are sufficiently high to cause it to become quite warm. The second requirement, low thermal emf to copper, is important, because, if the shunt terminals become unequally heated, an appreciable voltage may be superimposed on the normal voltage drop of the shunt and thus cause an appreciable error.

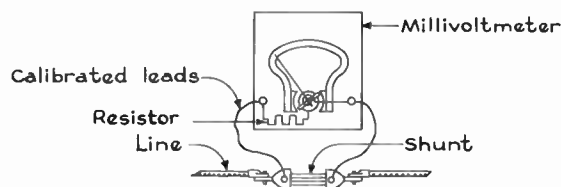

Fig. 2. Millivoltmeter with shunt

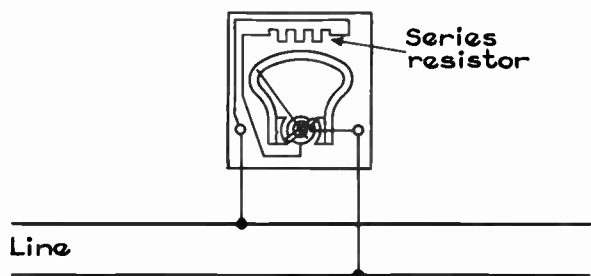

Fig. 3. Voltmeter with internal resistor

D-c millivoltmeters for use with shunts generally require from 10 to 25 milliamperes at from 30 to 200 millivolts for full-scale deflection, depending on the class of instrument. One common type of portable instrument requires 25 milliamperes and 200 millivolts for full-scale deflection. The corresponding switchboard instruments, which need not be held to such close limits of accuracy, require approximately 50 millivolts and 20 milliamperes for full-scale deflection.

It is important to keep in mind that the nominal shunt resistance is the value between the drop terminals; the greater (total) resistance between the current terminals is not ordinarily considered.

It will be noted that the instruments just described are suitable for use only on direct current because the field supplied by the instrument magnet is unidirectional. Impressing 60-cycle current on such an element will result in a torque pulsation which tends to move the instrument pointer upscale, followed 1/120 of a second later by a torque pulsation which tends to drive the pointer an equal distance in the opposite direction. Hence, the pointer merely vibrates a small distance about the scale zero point.

Voltmeters

To make a voltmeter suitable for reading d-c volts, a resistance is inserted in the instrument circuit as shown in Fig. 3. This simply limits the current to such a value that full deflection of the instrument pointer is obtained when the maximum voltage which we desire to read is applied to the instrument. For example, if we had an ammeter rated 10 milliamperes (0.01 ampere) full scale and we wished to make it a voltmeter having a full-scale rating of 150 volts, we should require a total resistance of $\frac{150}{0.01} = 15,000$ ohms.

The milliammeter moving coil itself, of course, has some resistance, about 20 ohms; so we need to add only 14,980 ohms resistance. This resistor is made of very stable material which is not affected by ordinary changes in temperature. The amount of constant resistance added is sufficient to compensate the effect of moving-system resistance which changes with temperature. Hence, the same current will always flow through the element when a given voltage is applied, regardless of the temperature at which the instrument operates. Several different ranges are obtained by using separate tapped resistors known as multipliers, or by tapping off various points on the same resistor.

It is possible to make voltmeters that require a very small amount of current for their operation. A common type of portable instrument, rated at 150 volts, requires about 10 milliamperes for full-scale deflection. It is customary to refer to d-c voltmeters as possessing a certain number of ohms per volt. For example, the 150-volt voltmeter just mentioned, requires 10 milliamperes for full-scale deflection. Hence, its resistance must be 15,000 ohms. Since the resistance is 15,000 ohms and the full-scale volts are 150, the instrument has

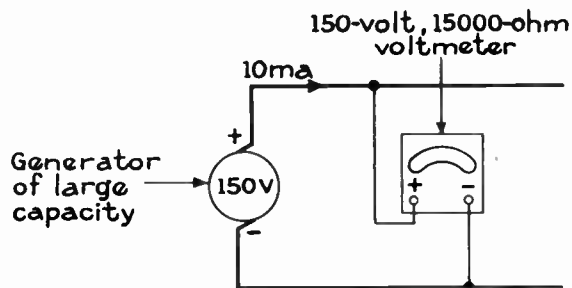

Fig. 4

RUSSELL H. ROSS

$\frac{15,000}{150}$ or 100 ohms per volt. Other portable voltmeters can be made which are considerably more sensitive. Some types on the market possess a resistance as high as 10,000 ohms per volt.

Effect of D-c Instruments on Circuit

At this point, it is well to study the effect on readings which is caused by the current taken by an instrument. For example, if we have a large generator, as shown in Fig. 4, capable of deliver-

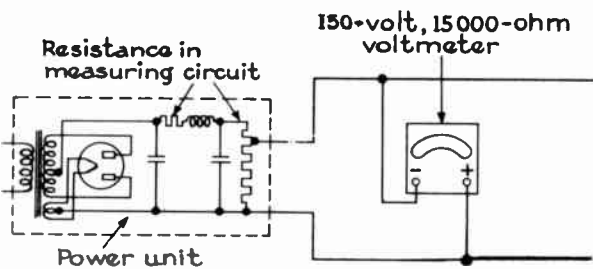

Fig. 5

ing a large amount of power at 150 volts, the voltage drop in the source (due to the 10-milliamper current drain of a 15,000-ohm, 150-volt voltmeter) will be entirely negligible. Hence, such a voltmeter is entirely satisfactory for such measurements.

However, going to the other extreme: if we have a radio power unit, as shown in Fig. 5, which delivers 150 volts, we may find that this power unit has an internal resistance as high as 1000 ohms. If we connect our 150-volt voltmeter to the output of this unit, we shall not read the true value of its open-circuit voltage, since the total resistance through which the current has to flow will be 16,000 ohms applied across 150 volts, and the current will be $\frac{150}{15,000+1000}$ or 9.375 milliamperes,

and our instrument will read $\frac{0.009375}{0.010} \times 150$ or 140.6 volts on scale.

On the other hand, suppose we used a 150-volt voltmeter requiring only 1 milliamper for full-scale deflection. This instrument has a resistance of 1000 ohms per volt, and, when connected to the power unit, the current flowing in the circuit would be $\frac{150}{151,000}$ or 0.993 milliamper. The instrument will then read $\frac{0.000993}{0.001} \times 150 = 149$ volts

on scale. In other words, if we seek to determine the open-circuit voltage of the power unit, and use an ordinary 100-ohms-per-volt instrument for its measure, we shall be in error by 9.4 volts, while the 1000-ohms-per-volt instrument will read the correct value to within 1 volt. The foregoing illustration does not take into account the lowered voltage of the power transformer caused by the load imposed by the voltmeter.

With this in mind, we should consider the effects which occur when ammeters are connected in cir-

cuits. When the circuit is of reasonably high voltage, so that the 50 or 100 or 200 millivolts representing the drop across the ammeter shunt are an inconsequential portion of the total line voltage, introduction of a d-c ammeter will have only a negligible effect. For example, if we wish to measure the current in a 150-volt, 0.3-ohm circuit, as shown in Fig. 6, we might connect a 500-ampere d-c ammeter in the line as shown. Before the ammeter was inserted in the circuit, the line current was $\frac{150}{0.300}$ or 500 amperes. If the 500-ampere shunt was rated 200 millivolts at full load, this would mean that its resistance is $\frac{0.2}{500}$ or 0.0004 ohm (neglecting shunt-terminal resistance). When the shunt is inserted in the circuit, the current which will flow is reduced to $\frac{150}{0.3004}$ or 499.3 amperes. This

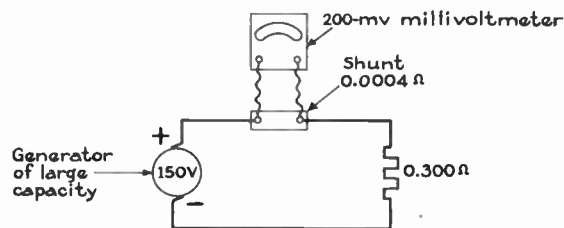

Fig. 6

is sufficiently close to the true value so that the effect of the introduction of the ammeter shunt can be disregarded.

On the other hand, suppose we have a 6-volt source, such as a storage battery furnishing current to a resistance of 0.012 ohm, as shown in Fig. 7. Without any ammeter shunt in circuit, the line

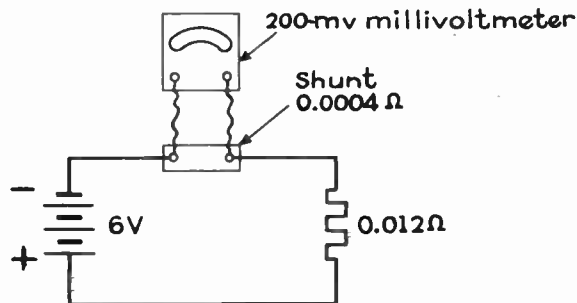

Fig. 7

current is $\frac{6}{0.012} = 500$ amperes. With the ammeter shunt in the circuit, the current is altered to $\frac{6}{0.012+0.0004} = 403.2$ amperes. This value, as indicated by the ammeter, compared with the original value of 500 amperes, is sufficiently in error to warrant consideration. In such cases, the resistance of the leads used to connect the shunt in the circuit must also be considered.

ALTERNATING-CURRENT INSTRUMENTS

Dynamometer Type

The instruments just discussed measure direct-current quantities only, because the field supplied by the permanent magnet is unidirectional. If we should take off the permanent magnet and replace it with a coil of wire suitably arranged with respect to the moving coil, such as shown in Fig. 8, we could connect the fixed and moving coils in series. Then, by sending alternating current through the instrument, we could obtain a deflection which would bear a definite relation to the current being sent through the coil system. This happens, because, when the alternating current reverses, the polarity of the fixed and moving coils reverses at the same instant—and we obtain a pulsating torque which is always in the same direction. This illustrates the dynamometer principle.

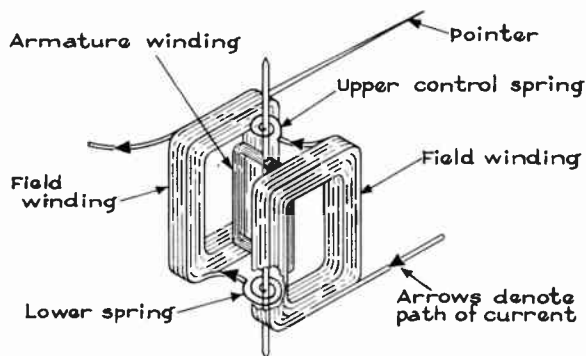

Fig. 8. Elementary diagram of dynamometer-type instrument

In actual practice, the shapes of the moving coils for alternating-current instruments are different from the moving-coil shapes used for direct current. Usually, these coils for a-c instruments are circular, as in Fig. 9, and so proportioned as to afford maximum efficiency. Even with this construction, alternating-current instruments require



Fig. 9. Essential parts of a dynamometer instrument

a larger amount of power for full-scale deflection. The current being measured must not only supply the energy for the moving coil, but must also supply energy for the field winding, which in the case of the permanent-magnet instrument was supplied by the magnet. Another important consideration is to keep any closed loops of wire or masses of metal well away from the fixed and moving coils. Such material would form a path in which current would be induced, and it would cause errors in the instrument indication when the instrument was used on alternating current. These induction troubles do not occur with direct current.

Damping

The instrument shown in Fig. 8 would have very objectionable characteristics, because, when we apply current, the pointer would oscillate back and forth a number of times before coming to rest. In other words, it would not be properly damped.

To obtain damping, two methods are in general use. One involves the use of a thin aluminum or copper vane which swings between the poles of a small permanent magnet. When the moving element deflects, a current is induced in the aluminum vane. The field produced by this current interacts with the field of the permanent magnet and tends to oppose the motion of the moving element, thus causing the system to come to rest quickly. The other method of obtaining damping involves the use of a closed box in which a vane swings in a restricted space. This method of damping is called air damping, while the method which uses the aluminum vane and permanent magnet is known as magnetic damping. Both methods are

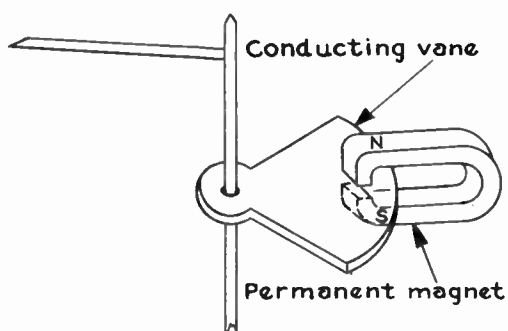

When vane moves, eddy currents are produced in it, tending to oppose motion

Fig. 10. Details of magnetic-damping mechanism

in common use, although it is considerably easier to obtain very high values of damping with the magnetic method. Air damping calls for the use of quite precise construction in respect to clearances and general workmanship.

In Fig. 10 and 11 are shown instrument-damping mechanisms of the magnetic and air types, respectively.

Voltmeters

If we take the dynamometer-type (alternating-current) milliammeter described in a preceding paragraph, and add suitable series resistance constructed of zero-temperature-coefficient material, as shown in Fig. 12, we will have a voltmeter which can be used to measure a-c volts. Alternating-current voltmeters draw considerably more current from the line than d-c voltmeters. In fact it is not unusual to have a high-grade portable a-c voltmeter of 150-volt rating require as much as 75 milliamperes for full-scale deflection. This gives an instrument resistance of approximately 2000 ohms, and a full-scale power consumption of about 11 watts.

Here we come to an interesting point. The series resistor of Fig. 12 contributes nothing to the torque of the instrument, since torque is governed by the product of the ampere-turns of the fixed and moving coils. If we could wind the fixed and moving coils entirely of resistance wire, we could dispense with the fixed resistor normally used. This, however, is not practical, because of the large amount of power which would then have to be dissipated by the coil system. To obviate this difficulty, we

wind the fixed and moving coils with copper wire. Then, to reduce the instrument error caused by change in the resistance of copper when the temperature is varied, we mask or "swamp out" the error by using sufficient series resistance of negligible temperature coefficient. It has been found that a satisfactory relation between copper resistance and swamping resistance exists when the copper resistance amounts to about 10 per cent of the total resistance of the instrument. In other words, in our 150-volt portable instrument previously described, the field and moving coils would have a combined resistance of about 200 ohms, and the series resistance would be approximately 1800 ohms, making a total of 2000 ohms.

If the full-scale voltage rating of the instrument is lowered, the resistance of the instrument, of course, must decrease. Also it is necessary to keep the copper resistance at about the same proportion, namely, 10 per cent. This limits the number of turns which we are able to wind on the fixed and moving coils. Hence, to get the same torque in the instrument, we must use more current, which means that the instrument may draw a very appreciable current from the line. For example, a 15-volt a-c instrument of the higher-grade portable type may draw as much as 250 milliamperes from the line.

To illustrate the effect of increasing the percentage of copper resistance, we could make an instrument which would require less current for full-scale deflection by using smaller-size copper wire on the fixed and moving coils, and by increasing the number of turns. However, the per-

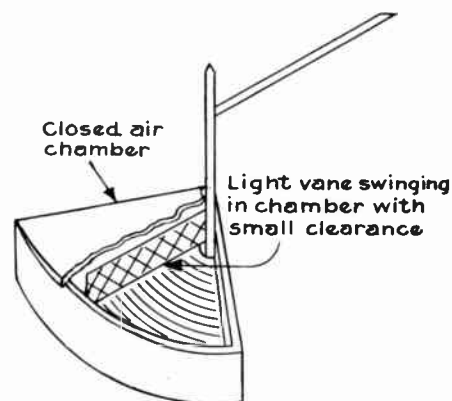

When vane moves, motion tends to be opposed by constriction of air in chamber

Fig. 11. Details of air-damping mechanism

formance of the instrument under various conditions of ambient temperature might be quite poor. Suppose that instead of using 10 per cent or 6 ohms of copper in a 15-volt, 60-ohm instrument, we used 30 ohms copper and 30 ohms zero-temperature-coefficient resistance. Copper changes 0.4 per cent for each degree C change in ambient temperature; thus, if the temperature at which the instrument is used were increased 10 degrees, the resistance of the copper circuit would increase to 31.2 ohms, giving an instrument resistance of 61.2 ohms at this temperature. The instrument would then read $\frac{60}{61.2}$ or only 98 per cent of the correct value when 15 volts were applied.

The foregoing assumption as to instrument indication does not take into account the change in elastic modulus of the instrument spring at this higher temperature. As a matter of fact, in most instruments the elastic properties of phosphor-

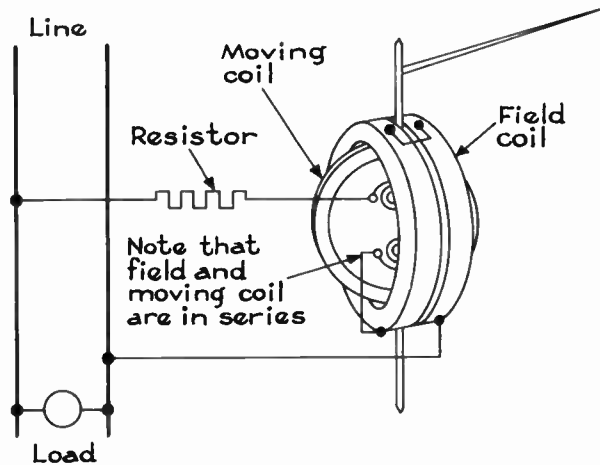

Fig. 12. Schematic view of a dynamometer element arranged to make a voltmeter

bronze spring material change in such a direction as to compensate partly for the error in indication caused by change in the copper resistance of the instrument.

Ammeters

Instead of changing our milliammeter into a voltmeter by providing it with a series resistance, if we equipped it with a shunt, we could use it for measuring values of alternating current greater than 100 milliamperes. We would, however, run into some practical difficulties in applying this scheme if we used a shunt as shown in Fig. 13.

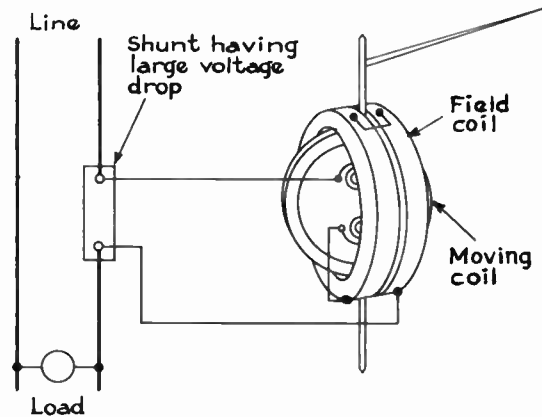

Fig. 13. One way to make a dynamometer ammeter to measure several amperes

The shunt would have to have a very high voltage drop at rated current to divert sufficient current through the ammeter element to obtain full-scale deflection. The milliammeter element would also have to consist principally of copper. As the ambient temperature increases, the amount of current flowing in the instrument element for any given line current would be lower. The inductance of the coils must also be considered. In order to overcome these difficulties, it is customary to send the full line current through the fixed coils of a dynamometer-ammeter, and to allow only the current for the moving element to be taken off the shunt, as shown in Fig. 14. This arrangement permits the use of some series resistance, and materially improves both the temperature coefficient and the time constant of the instrument. For the lower

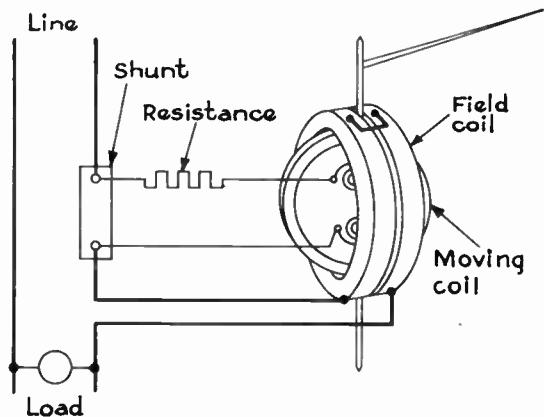

Fig. 14. A better way—the field coil carries all of the line current, and the moving coil carries a definite fraction of it

ratings, the shunt can be located within the instrument case.

Wattmeters

Suppose we took the ammeter arrangement shown in Fig. 14 and connected it in a circuit as shown in Fig. 15, omitting the shunt and adding resistance in series with the moving element, instead. On alternating current, the deflection of the instrument pointer would depend on the product of the instantaneous current flowing in the fixed and moving coils. Since the current in the moving element is proportional to the line voltage, the instrument indication will be proportional to the product of the instantaneous voltage times the instantaneous line current. Or, in other words, the instrument will read watts, and the scale can be so marked. If the maximum and other corresponding values of current and voltage occur at the same instant, as shown in Fig. 16, that is, if the angle between them is zero, the load is said to have a power

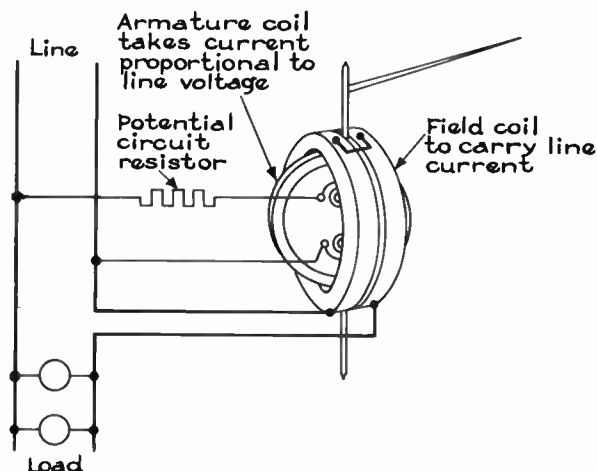

Fig. 15. Schematic view of a dynamometer element arranged to make a wattmeter

factor of unity, since cosine ϕ (ϕ is the angle between current and voltage) is equal to 1. If the current lags 30 degrees behind the voltage, as shown in Fig. 17, the power factor is 0.866 lagging. Note how the instrument which we have shown in Fig. 15 will respond to this condition, remembering that it always reads the quantity proportional to the instantaneous product of the volts and amperes. To take a specific example: we will draw lines corresponding to the voltage and current, values e and i , at a given instant, t , as shown in Fig. 18, and take their product. This product

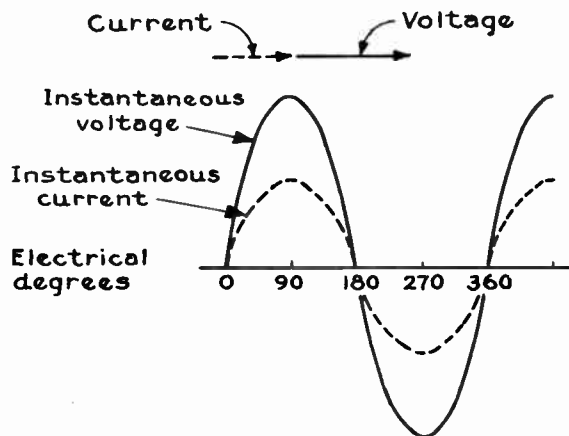

Fig. 16. Current and voltage relations in alternating-current circuit. Power factor equals 1.

($e \times i$ in Fig. 19) will be indicative of the torque on the moving element at that particular instant. Repeating this at suitable intervals, we obtain a torque curve which approximates that shown in Fig. 19. Note that the torque is positive in direction at certain intervals during the cycle, and negative in others. The instrument pointer will, of course, assume a position dependent on the average value of the torque over a period of time, since the instrument element is not fast enough to respond to each impulse of a 60-cycle source. Had a power factor of unity been selected, the torque

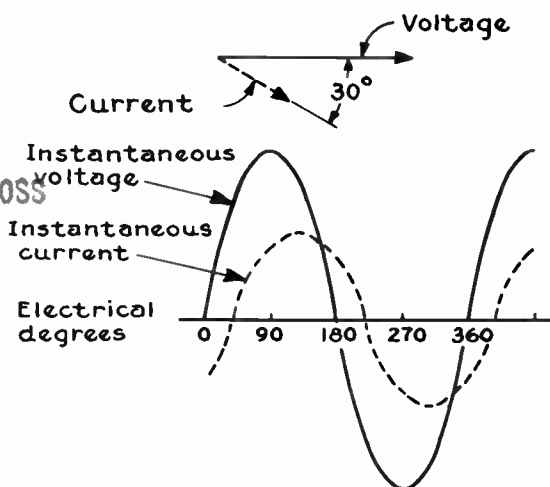
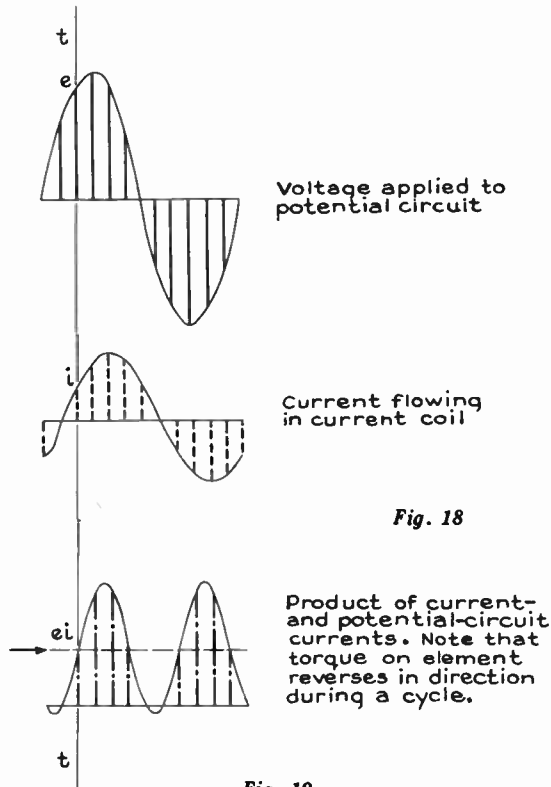

Fig. 17. Current and voltage relations in alternating-current circuit. Power factor equals 0.866, current lagging.



Voltage applied to potential circuit

Current flowing in current coil

Product of current and potential-circuit currents. Note that torque on element reverses in direction during a cycle.

Fig. 18

Fig. 19
Current, voltage, and power relations in a wattmeter

would have been positive in direction at each instant.

While we are pursuing this analysis, let us apply it to the voltmeter which would be connected across the same line—plotting the torque curve over one cycle. Since, in a voltmeter such as is indicated in Fig. 12, the field and moving coils are connected in series, the instantaneous currents in each element are always in phase, regardless of the power factor of the line. To obtain the torque curve, we simply square the ordinates on the current curve. Because of the mass of the moving element, the instrument pointer will again assume an average position with respect to the double-frequency torque pulsations. These conditions and the procedure are indicated in Fig. 20 and 21.

The dynamometer-ammeter element shown in Fig. 14 will also be subjected to the same continuous positive pulsating torque, since the current in the movable coil is always in phase with the line current which flows in the current coil.

In closing this brief discussion on the manner in which these instruments indicate circuit

conditions, the reader should always remember:

The dynamometer-voltmeter indicates *root-mean-square* (rms) voltage.

The dynamometer-ammeter indicates *root-mean-square* (rms) current.

The dynamometer-wattmeter indicates *average* power.

A wattmeter may be connected in circuit as shown in Fig. 22 or as in Fig. 23. Note that in one case the wattmeter potential-circuit loss is being measured; and in the other, the wattmeter current-coil loss. The potential-circuit loss of a typical portable 500-watt wattmeter, 5 amperes, 100 volts, would be in the order of 2 watts at 100 volts; hence, if this instrument were connected as shown in Fig. 22, the watt reading would be 2 watts higher than the true value of watts consumed in the load. The current coil for the wattmeter previously described requires about 2 watts at about 5 amperes. Since the voltage is usually fairly constant, while the current varies, it is much

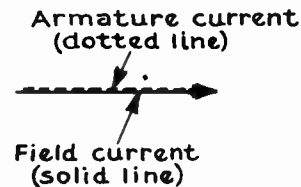

Instantaneous current in field and armature coils of dynamometer voltmeter

Note that armature and field currents are always equal at any time

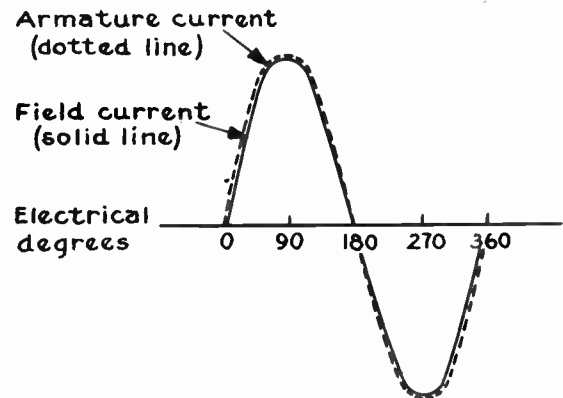
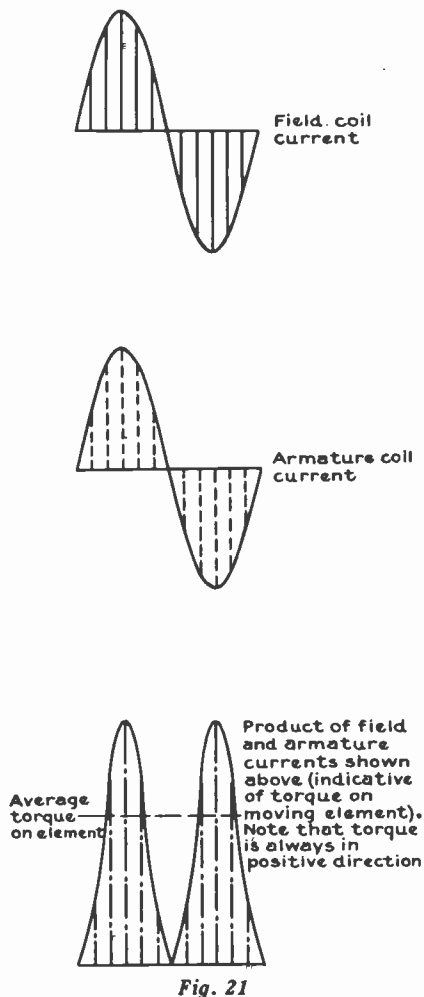

Fig. 20



easier to correct the readings for a constant potential-circuit loss than for a varying current-coil loss. Thus, the connection including the potential-circuit loss is usually preferred.

Compensated Wattmeters

If we made a wattmeter having an auxiliary current winding (each wire of this auxiliary winding lying alongside each wire of the regular current-coil winding, and having the same number of turns as the current-coil winding) but connected it in reverse direction and in series with the potential coil as shown in Fig. 24, we should have what is known as a compensating wattmeter. For an example of its principle of operation, consider the following. Connect this compensating wattmeter as shown in Fig. 25. Now the only current which flows through the current coil is that taken by the potential circuit, and this flows through the com-

pensating winding as well. Since the two windings are opposite in direction, the field of the fixed coils is zero, and no deflection of the wattmeter pointer occurs. When we close the load switch, the instrument will indicate the correct value of watts, since it automatically subtracts the watts required by the potential circuit. It is obvious that compensating wattmeters must be carefully connected in the circuit according to the diagram furnished by the manufacturer.

Compensating wattmeters are often provided with an auxiliary compensating winding known as a voltmeter winding. This consists of an additional winding subtractive as before, so arranged as to be used with a special voltmeter which is located as shown in Fig. 26. When a voltmeter is inserted in the line at the points provided, the voltmeter current flows through its compensating winding and automatically subtracts the watts taken by the voltmeter. The voltmeter used for this class of work is usually especially calibrated for this service, since the compensating winding possesses some resistance. This must be considered when calibrating the voltmeter.

So far in our study of instruments, we have considered only two classes—the permanent-magnet moving coil, and the dynamometer types. In recent years, the improvements in magnetic materials have made modification of the dynamometer type possible, resulting in better characteristics for many classes of work. For example, it has been found possible to add iron to the field struc-

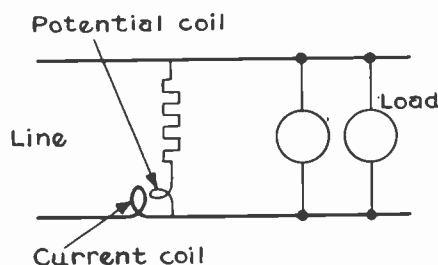

Fig. 22

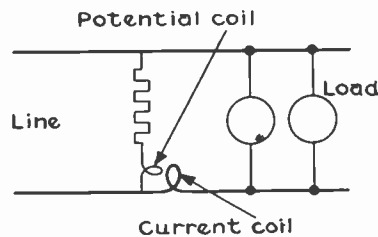

Fig. 23

ture of dynamometer instruments, to change the coil geometry, and to utilize the general construction as shown in Fig. 27. This is called the electrodynamic type, and has found considerable favor in small, compact instruments for general testing where intermediate accuracy is desired. The space necessary for an element having the desired torque is considerably smaller than that required in the dynamometer, and its power consumption for a given torque is also less. A wattmeter of the electrodynamic type, typical of those used for general testing purposes, is shown in Fig. 28.

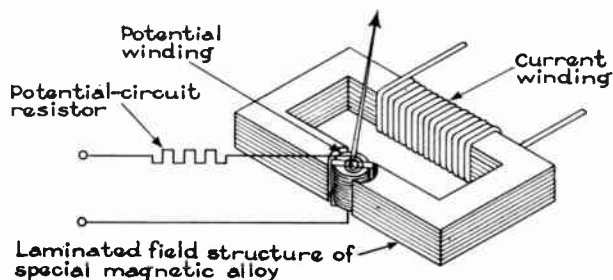

Fig. 27. Schematic construction of electrodynamic wattmeter

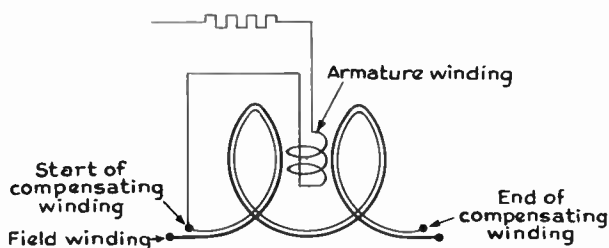

Fig. 24. Schematic arrangement of windings of compensating wattmeter

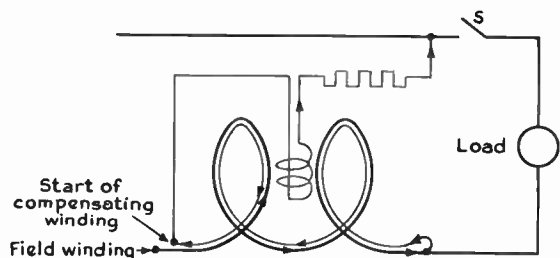

Fig. 25. Illustrating action of compensating wattmeter

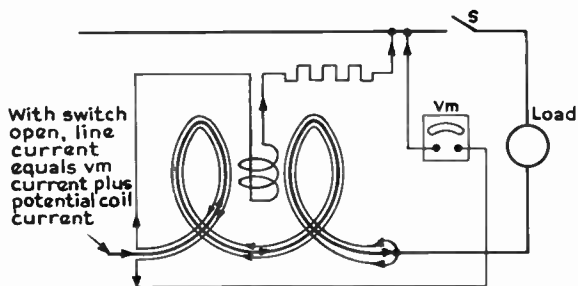

Fig. 26. Illustrating action of compensating wattmeter having voltmeter winding

Magnetic-vane Type

Another type of instrument construction often used for alternating-current ammeters, and to a considerable extent for voltmeters, is the magnetic-vane attraction type. This probably is adaptable to the greatest number of modifications of any of the instrument types. A few of the common ones will be described here. One of the simple ways to make a magnetic-vane attraction instrument is to arrange a construction as shown in Fig. 29. When current is sent through the solenoid, the plunger is drawn into the coil, and a measurable deflection of the instrument pointer is obtained. As a matter of fact, such arrangements are used for



Fig. 28. Type AP-9 electrodynamic wattmeter

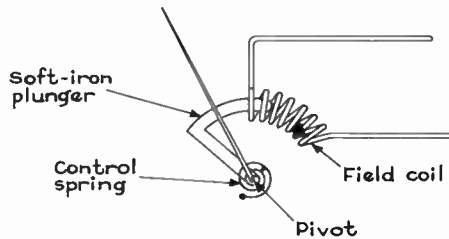

Fig. 29. Schematic diagram of simple magnetic-vane attraction-type instrument

the less-expensive class of instruments. The scale, however, leaves much to be desired from the standpoint of uniformity, the power consumption is high and such an instrument is likely to be very sensitive to slight zero shifts. The worst objection, however, applies to length of scale.

One rather ingenious method of obtaining a reasonably long scale is to use a construction such as shown in Fig. 30. Incidentally, this construction overcomes many of the other shortcomings, and is used in high-grade instruments. If the reader will study this carefully, he will note that both the coil and moving vane are inclined at an angle to each other, and that, theoretically, the instrument pointer could have a movement of almost 180 degrees. See Fig. 31.

Another very important class of magnetic-vane type of instrument is the magnetic-vane repulsion type. A schematic view of this type of construction is shown in Fig. 32. In operation, suppose a direct current is sent through the field coil; the magnetic vane embedded in the side of the coil will have

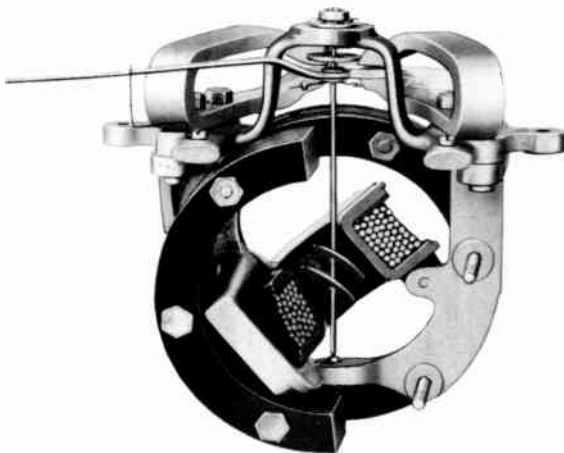

Fig. 30. Essential parts of an inclined-coil attraction-type instrument

definite poles, N-S, induced in it at the points shown. The moving vane will also be magnetized by induction, the polarities being N-S, as shown. It will be noted that the north pole of the moving vane is nearest to the north pole on the piece of magnetic material embedded in the coil, and the south poles are similarly placed. Hence, the vane tends to move away or to be repelled from the stationary magnetic piece. If alternating current is applied to the instrument, the two vanes will simultaneously change polarities as the current varies throughout the cycle; thus, the instrument

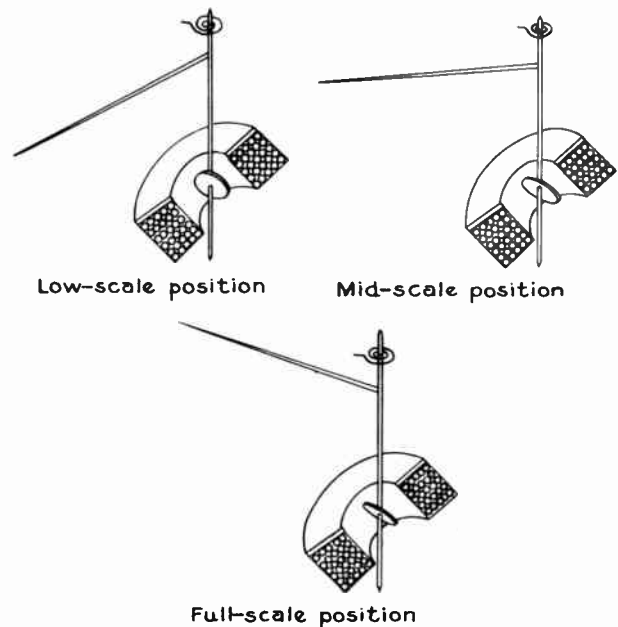

Fig. 31. Inclined-coil attraction-type instrument

also operates on alternating current. In fact, it is in alternating-current measurements that the instrument finds its greatest application.

Damping

To obtain damping on magnetic-vane repulsion instruments, it is nearly always necessary to resort to air damping, since the instrument is appreciably affected by any stray field from the permanent magnet used in connection with magnetic-type damping. The magnetic-vane attraction instrument, previously described, generally employs magnetic damping.

The older type of magnetic-vane instruments was equipped with an especially selected grade of soft iron for the vane. But, when these instruments

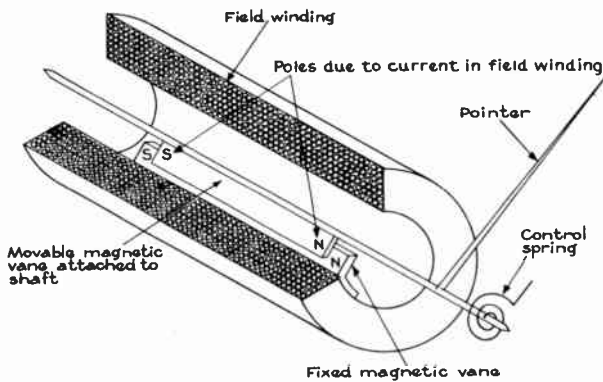

Fig. 32. Elementary diagram—simple magnetic-vane repulsion-type instrument

were used on direct current, variable errors resulted because of a magnetic condition known as hysteresis in the vane. A special nickel-iron alloy, known as Permalloy, which is almost entirely free from this condition, is used in the vanes of modern-type magnetic-vane instruments. For this reason, the modern type of magnetic-vane instrument can be used with very good accuracy on direct current, provided that the average of direct and reverse readings is taken.

In the construction of magnetic-vane instruments, it is general practice to send the entire current through the field coil. The energy consumption varies considerably with the rating of the instrument being used. And while the resistance of most magnetic-vane ammeters may not seriously alter the conditions of an alternating-current circuit, it may cause appreciable disturbance of circuit conditions when instruments of low-current rating are used. For example, a magnetic-vane instrument of the inclined-coil attraction type rated 5 amperes, has a resistance of 0.061 ohm and an inductance of 90 microhenries. At 60 cycles, the reactance of the instrument amounts to 0.034 ohm, resulting in an impedance of 0.07 ohm. For most

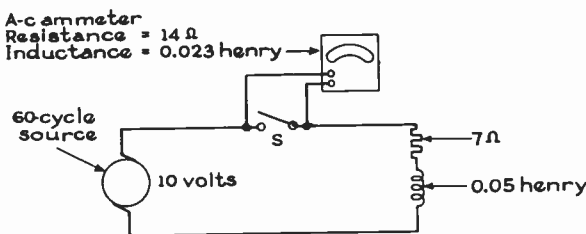
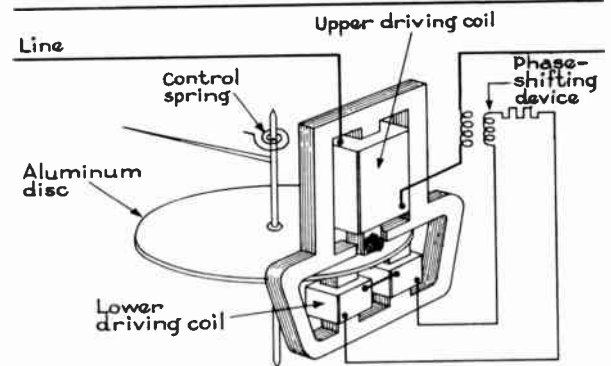

Fig. 33. Measuring circuit in which impedance of alternating-current ammeter is major consideration

applications, the addition of this impedance to a circuit will not seriously affect the indications. However, consider an instrument of the same type rated 0.5 ampere full scale. A typical instrument has a resistance of 14 ohms and an inductance of 0.023 henry. At 60 cycles, the reactance will be 8.67 ohms, and the instrument impedance will be 16.47 ohms. When this instrument is connected in a circuit, shown in Fig. 33, and rated current is sent through it, the drop across the instrument will be large. It will be seen that the normal current which should flow in this circuit is $\frac{E}{R+JX}$, or $\frac{10}{7+J18.85}$ or 0.497 ampere; but when we add our instrument, we change the circuit constants



RUSSELL H. ROSS
Fig. 34. Elementary diagram—simple induction-type instrument

to $\frac{10}{21+J27.52}$, and the ammeter actually reads 0.289 ampere, resulting in a discrepancy of 0.208 ampere or about 40 per cent.

Induction Type

The fourth class of instruments which we are considering briefly is the induction type. This type is not used as widely as are the types previously mentioned. If we take a disk of copper or aluminum and place it in a field structure, as shown in Fig. 34, a current will be induced in the disk. The disk will tend to rotate when alternating currents of the proper phase relation are applied to the two coils. If we so place a spring that it resists the motion in the disk, and if we place a pointer to indicate the resultant position, the value of current will be indicated in the alternating-current line. This instrument, of course, can be used on alternating current only. If direct current were applied, the

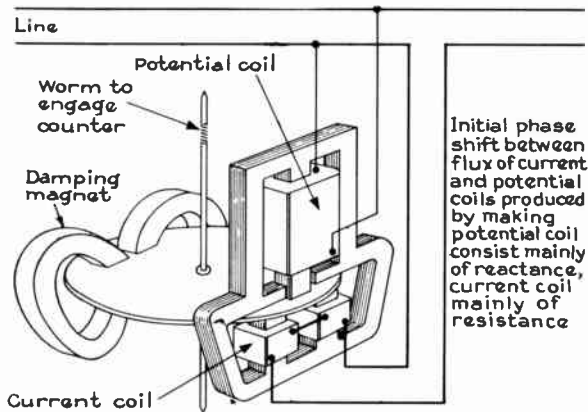

Fig. 35. Elementary diagram—simple induction watt-hour meter

only time at which voltage would be induced in the disk would be just when the circuit was opened or closed. Thus, the disk will tend to move forward and then drop back to its initial position when a steady-state condition is reached. The disk must be made of aluminum, or copper, or of some other material of high electrical conductivity. Since all these materials possess appreciable temperature coefficients of resistance, changes in temperature will affect the readings materially, unless carefully compensated for in other parts of the circuit. This has limited the usefulness of these devices as instruments to a considerable extent.

On the other hand, let us take a structure as shown in Fig. 34, omit the spring and pointer, and place magnets as shown in Fig. 35 at the edge of the disk. When alternating current flows in the field structure, the disk will tend to rotate as before. The disk will cut lines of magnetic flux from the magnets located at its periphery, and the currents induced will tend to reduce the speed of the disk. The effect of temperature on such an arrangement is not nearly so pronounced as in the case of the spring-controlled induction instrument. As the temperature increases, both the induced current actuating the disk and the eddy currents caused by the damping magnets tend to decrease in the same proportion. If we change the connections and add a counter, connected by suitable gearing, to count the total revolutions of the disk of the device shown in Fig. 35, we have the basic elements of the induction watt-hour meter.

Rectifier Type

Some instruments for alternating-current and voltage measurements are of the permanent-magnet

moving-coil type used with auxiliary devices which enable a unidirectional current to be sent through the moving coil. It is only necessary that this unidirectional current bear a definite relation to the alternating-current quantity being measured. The instrument scale can then be marked in terms of the alternating-current value. One easy way to do this is by means of a rectifier. This device allows free flow of current in one direction, but offers a high resistance to the flow of current in the opposite direction.

A rectifier instrument can be equipped with any one of several types of rectifying devices. The one most commonly used is the copper-oxide type, which works on the principle that the electrical resistance of a properly formed layer of copper oxide on a copper surface depends on the polarity of the applied voltage. If we take such a copper-oxide plate, equipped with suitable contacting means, and connect it in the voltmeter circuit, as in Fig. 36a, the current flow through the permanent-magnet moving-coil instrument will be as shown in Fig. 36b. As the applied voltage, V , increases, the unidirectional current through the instrument moving coil will increase. An instrument indication will thus be secured, which bears a relation to the line a-c voltage, and the instrument scale can be marked in terms of a-c volts. This arrangement is called a *half-wave rectifier*.

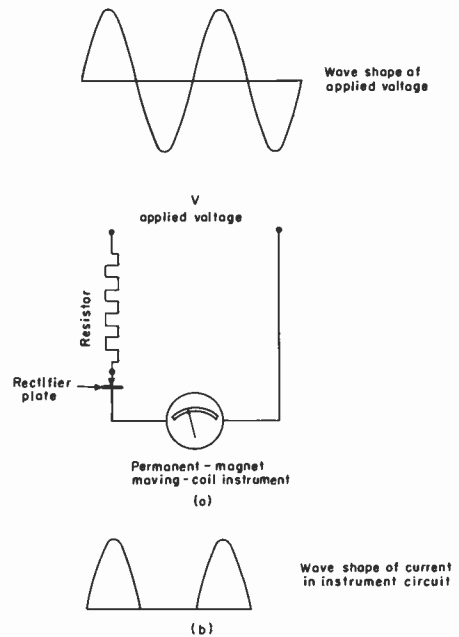

Fig. 36

The half-wave rectifier instrument, which we have just shown, would not be practical for most purposes, because during the negative half cycles during which no current flows, the rectifier must withstand the full line voltage. Copper-oxide plates are not well suited to withstand such inverse voltages, but this difficulty can be remedied by several methods. An easy way is to use four sets of plates connected, as shown in Fig. 37a. This arrangement is often called a *bridge connection*. For convenience, this figure has been drawn twice to show the paths taken by the current during the positive and negative half cycles, respectively. This bridge arrangement rectifies every half-cycle of the a-c wave and is called a *full-wave rectifier*.

Other arrangements are also used involving less than the four copper-oxide plates just mentioned. If such circuits are encountered, the reader can determine their method of operation by making diagrams showing the current flow for each half cycle in the same manner as was done in Fig. 37a and b.

In working with rectifier instruments, we must always bear in mind what the instrument really indicates, regardless of how the scale may be marked. A permanent-magnet moving-coil type instrument indicates average values, and with the rectified sine wave shown in Fig. 37c, the average value is shown by the lower line. On alternating-current circuits, however, the root-mean-square (RMS) value is the quantity generally required. In Fig. 37c, this is shown by the higher line.

For a sine wave, the ratio $\frac{\text{RMS value}}{\text{average value}} = 1.11$ and

the instrument scale is marked directly in terms of the RMS value. For other wave shapes, this ratio is different, and, hence, a rectifier instrument reads RMS quantities correctly only on the wave shape for which it is calibrated. This point must be kept in mind when using rectifier instruments to measure non-sinusoidal quantities, such as the outputs of constant-voltage transformers. Fortunately, the errors resulting from this condition are generally less than 10 per cent of full-scale value.

Some other points to be kept in mind when using rectifier-type instruments are:

- (1) Some aging of the rectifiers occurs in service. For this reason, the stated accuracy of rectifier instruments is often given as ≈ 5 per cent of full scale. Consecutive readings,

however, will often duplicate to within a few tenths of one per cent.

- (2) Exposure of the rectifier instrument to high temperatures, such as 50 C, or to chemical vapors, such as sulphur fumes, may shorten the life of the rectifier.
- (3) The circuit of the instrument itself should never be opened when the rectifier is connected to the line, since this may allow full-line voltage to be impressed on the rectifier plates, and may damage the rectifier.

Despite these considerations, rectifier instru-

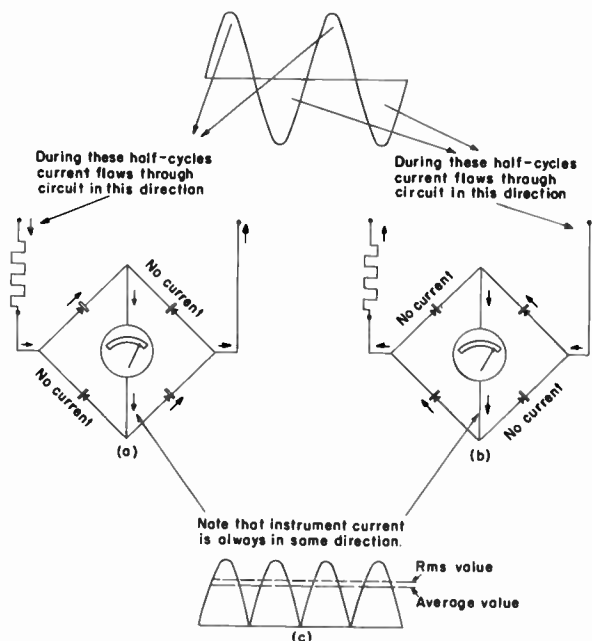

Fig. 37

ments play a very useful part in present-day measurements, because the permanent-magnet moving-coil construction gives higher sensitivity, and a more uniform scale than it is possible to secure with moving-iron or dynamometer types.

Thermocouple Type

Another way in which a permanent-magnet moving-coil type of instrument can be used to measure alternating-current quantities is to use a device known as a thermocouple. A long time ago, it was discovered that if a junction of two wires of unlike materials (such as iron and a copper-nickel alloy) were heated with a gas flame, and the free or "cold ends" were connected to a sensitive d-c millivoltmeter, a deflection of the instrument would

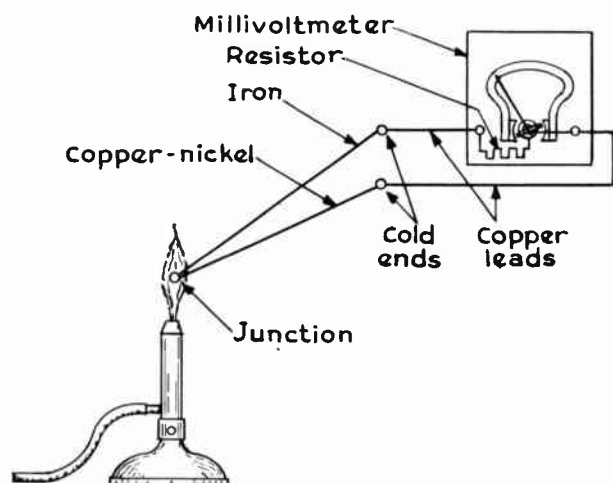

Fig. 38

result. See Fig. 38. The deflection of the instrument will be proportional to the difference between the temperature of the junction which is in the flame, and the temperature of the "cold end," which is the point of connection to the copper leads of the millivoltmeter.

This useful scheme is employed to measure alternating current by simply substituting a resistance wire, or heater, for the gas flame, shown in Fig. 38. See Fig. 39. When an alternating current is sent through this resistance wire which forms the heater, it will elevate the temperature of the junction in the same manner as before. Since the resistance of the heater remains substantially constant, the instrument scale can be marked in terms of the current flowing in the heater circuit. As the temperature attained by the heater is pro-

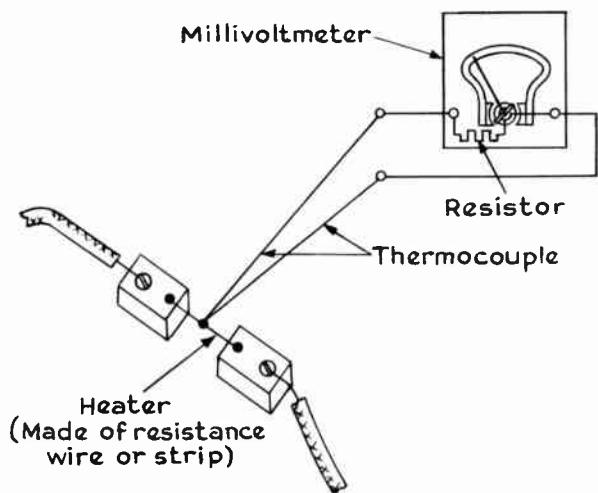

Fig. 39

portional to the square of the current flowing through it, the instrument scale will open up greatly as the current increases. A typical scale is shown in Fig. 41.

The voltage from a thermocouple is proportional to the difference in temperature between the heated junction and the point at which the thermocouple wires are connected to the copper leads of the instrument. Therefore, any change in the temperature of this latter connection point would result in an error in instrument indication. To avoid errors caused by this condition, it is common practice to terminate the heater in rather massive blocks, and then bring the point at which the thermocouple leads join the copper circuit into good thermal contact with these blocks. This is usually done by connecting the leads to a thin copper plate, and separating them from the block by a thin mica strip. This is called cold-junction compensation, and serves to maintain the connection at a fixed relation to the temperature of the heater. See Fig. 40.

The millivoltmeters, used with thermocouples to measure current, must necessarily be more sensitive than those used with shunts, because the emf developed by a thermocouple is quite small. For example, such a thermocouple may have an output voltage of only 15 millivolts, and an internal resistance of 5 ohms. This means that thermocouple instruments should be carefully handled, since the construction is necessarily somewhat delicate.

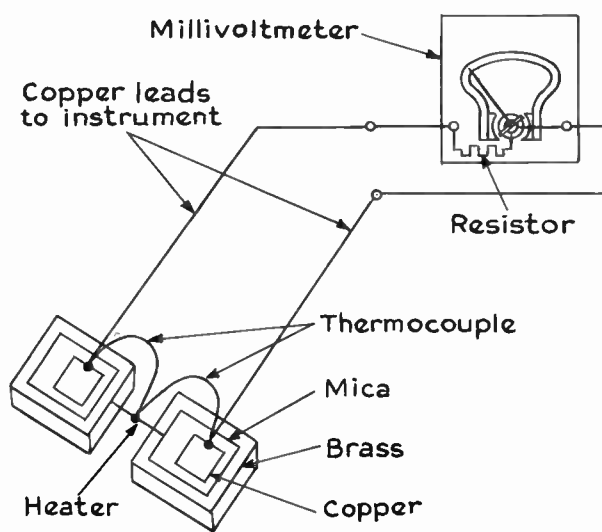

Fig. 40

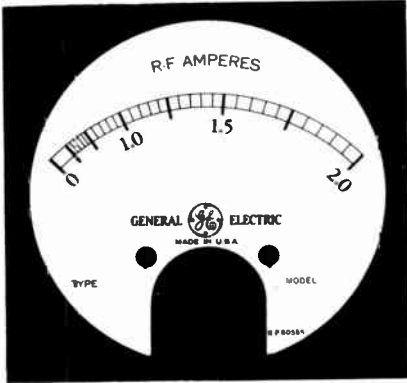

Fig. 41. Typical scale of a standard thermocouple instrument

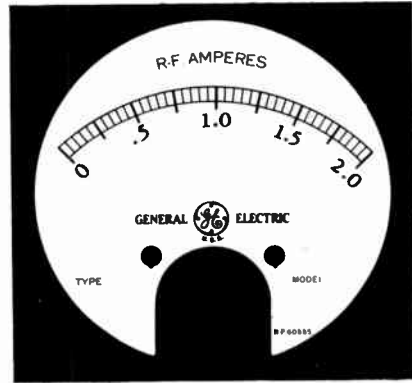

Fig. 43. Typical expanded scale of a thermocouple instrument

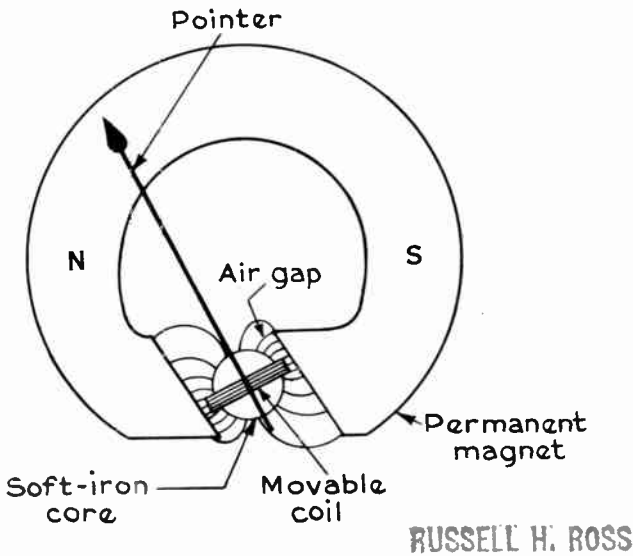

Fig. 42. Pole piece arrangement of a thermocouple instrument

Another fact to keep in mind is that the heater temperature increases as the square of the current. An appreciable overload may raise the temperature of the heater so much that it will quickly burn out.

The thermocouple instrument has an unevenly divided or "square-law" scale, which in some applications is undesirable. While little can be done with the thermocouple itself to overcome this, modifications can be made in the millivoltmeter to give a substantially linear-scale indication. An easy way to do this is to so shape the magnetic pole pieces that the magnetic flux will be less when the coil moves toward the upscale position. A schematic view of such an instrument is shown in Fig. 42, and the resulting scale distribution is shown in Fig. 43. This weakening of the field, which lowers the instrument sensitivity as the coil moves upscale, tends to compensate for the square-law relation.

GENERAL  ELECTRIC
SCHENECTADY, N. Y.