

CONTINENTAL RADIO AND ELECTRIC CORPORATION

6 WARREN STREET
NEW YORK



"THE SYMBOL OF SERVICE"

RADIO EQUIPMENT
HEATING APPLIANCES ELECTRICAL SUPPLIES
EXPERIMENTAL APPARATUS

CONTINENTAL RADIO AND ELECTRIC CORPORATION

6 WARREN STREET

NEW YORK CITY

*Life is Service.
The one who
progresses is the
one who gives his
fellow-beings a
little more—a little
better—SERVICE*

GEORGE E. BURGARD, *President*
JOHN F. GRINAN, *Vice-President*

JOHN DI BLASI, *Secretary*
JOSEPH STANTLEY, *Treasurer*

FOREWORD

In view of the ever increasing number of articles comprising the Radio and Electrical household appliance market, we have listed in this catalogue only a few of the more widely known and commonly used devices.

Our aim is to keep at all times a reasonably complete stock of all articles listed, and thereby put ourselves in a position to make prompt deliveries. Due to our central location, we have the world's electrical market at our doors and can quote prices and delivery on any piece of electrical merchandise.

Our word of honor to you is our guarantee. Let us prove it.

CONTINENTAL RADIO AND
ELECTRIC CORPORATION

PARAGON RA—TEN SHORT WAVE RECEIVER

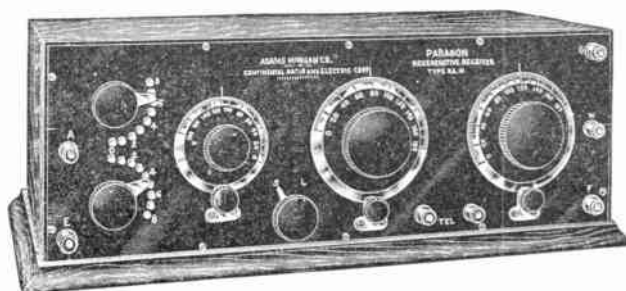

To Radio Men the world over, PARAGON means Radio Receivers which accomplish wonders. This is NOT an idle statement. It is a fact—proven in hundreds of stations by station owners themselves with the now thoroughly famous PARAGON Type RA-6 Amplifying Short Wave Receiver, and the PARAGON Type RA-200 Universal Range Receiver.

Although conceived and designed nearly six years ago, PARAGON receivers have never been equalled in performance. All users of PARAGON know that. Substitutes have been placed on the market in the past, and many will be offered in the future, but the small measure of success with which they have met has been due to the totally unsuccessful efforts of their manufacturers either to produce an exact copy of PARAGON in all its electrical details, or to force the sale by the unlawful use of the name PARAGON itself. They were, and they will continue to be, POOR substitutes.

And now PARAGON makes further phenomenal advances in the PARAGON Type RA-Ten—a new design which is FAR superior to any of its forerunners, and which offers:

24% stronger signals over the entire amateur range and signals of corresponding strength on all wavelengths.

100% greater selectivity possible.

100% greater wavelength range (160 to 1,000 meters).

180 degrees coupling control.

Micrometer Adjustment Control on Coupling, Secondary and Wing Circuits.

Freedom from body capacity effects.

Perfect adaptability to CW reception on Short Waves.

Greatest possible simplicity of operation; rapid manipulation.

The utmost in short wave reception.

Moulded and machine-made parts thruout.

Workmanship, materials and finish of the finest.

A RECEIVER WHICH LACKS NOTHING, and which when connected to

the amateur antenna, audion control panel, or audion control and two-stage amplifier is ready at once for work of the kind which you have never before seen. Carefully written instructions for connection and operation are enclosed with each receiver.

Specifications:

PARAGON Type RA-Ten (Regenerative—Amplifying Ten Hundred Meters).

Wave Length Range, 160 to 1,000 meters.

Primary Control: Units Switch; Multiples Switch. Moulded Knobs.

Coupling Control: Moulded Knob and Dial; 180 Degrees. Micrometer Adjustment knob.

Secondary Control: Moulded Knob and Dial; 180 Degrees. Micrometer adjustment knob.

Wing Ckt. Control: Moulded Knob and Dial; 180 degrees. Micrometer Adjustment Knob.

Wave Change Switch: Moulded Knob; Two positions; Short Range, 160 to 420 meters; Long Range, 400 to 1,000 meters.

Panel: Bakelite Dilecto; Grained Finish; Machine engraved.

Binding Posts: Brass; Satin Nickel Finish.

Case: Heavy Quartered Oak; Weathered, Waterproof finish.

Cat. No. RA-Ten. Price \$170.00

Licensed under Armstrong and Marconi Patents.

NEW TYPE RADION RECEIVING TRANSFORMER

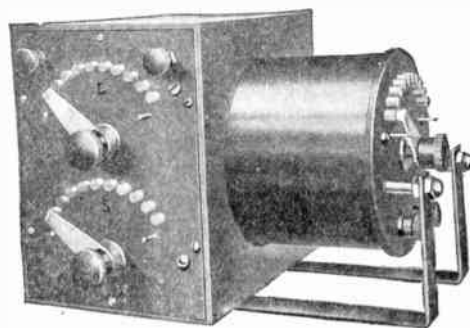

A combination of excellent material, modern design, and unusual value make this receiving transformer a valuable addition to any station or laboratory. The instrument is designed for those who prefer a tuner having conventional cylindrical coils rather than the rotary type. The disadvantage of most couplers of this type is the large table-space necessary to accommodate them. This disadvantage has been eliminated to a large degree in this instrument by the use of banked windings. Both primary and secondary coils are provided with taps, eliminating all sliding contacts. The primary has two 10-point switches, one each for fine and coarse adjustments, while the secondary has one 10-point switch. Bakelite is used throughout for the panels, and the primary is completely enclosed in an oak cabinet. This instrument provides close adjustments with freedom from interference and will respond to wave-lengths up to 3000 meters with an average antenna.

The completed tuner measures 6" deep by 5¼" high by 8" long. Shipping weight 5 lbs.

The value of this instrument should not be judged by its low price. It is one that you will be proud to own and use.

Cat. No. 673—15 Radion Receiving Transformer \$28.00

GREBE SPECIAL RECEIVER

CR-3

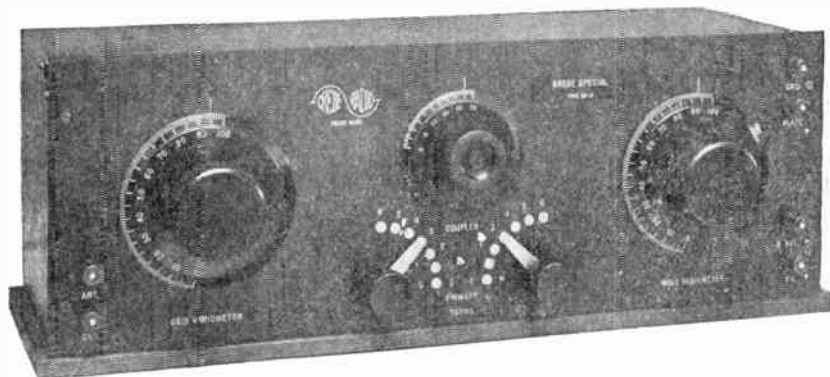

Wave-length range: 150 to 680

MODERN Short Wave Receiver design, having resolved itself into the employment of the Armstrong Regenerative Circuits, it remains for the Radio Engineers to design apparatus in which full advantage is taken of the possibilities of these circuits. Although there are several methods of using regenerative circuits for short wave lengths, there is one which is pre-eminently adapted to the requirements of Relay Communication. This is the tuned grid and plate circuit, employing continuously variable inductances.

The service in which a relay receiver is used and the conditions under which this service must be maintained, demands the fulfillment of the following requirements:

1. Selectivity. 2. Amplification. 3. Flexibility. 4. Rapid adjustment.

In the Type CR-3, maximum selectivity is obtained by the use of a variometer for tuning the grid circuit, thus eliminating shunt and stray capacities. A high degree of amplification is accomplished by tuning the plate circuit with a second variometer. The comparatively small wave-length range (150 to 350) assures great flexibility, inasmuch as the change in wavelength approximates two meters per scale division. Rapid adjustment is made possible by the reduction to a minimum of the tuning elements.

As there are often occasions when it is necessary to tune to wavelengths including 600 meters, provision is made to change the wavelength range from 150-350 to 250-680 meters. This is done by the addition of a very small, low resistance, mica condenser, which is placed in shunt with the secondary circuit. As the capacity of this condenser is very small in comparison with the secondary inductance, the working efficiency of the set on the higher range is unimpaired.

Net weight: 12½ lbs. Shipping weight: 21 lbs.

Wiring diagram, instructions and wavelength curve accompany each receiver.

Supplied without telephones, vacuum tubes or batteries.

Cat. No. 121-18 CR-3 Grebe Special Short Wave Regenerative Receiver. \$130.00

RECEIVING TRANSFORMER No. 344—8

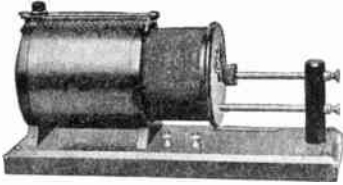

Primary winding, bare copper wire; secondary, silk covered copper tapped to six point switch on coil head. Both tubes hard rubber composition, positively unshrinkable. Base, dark mahogany finish hard-wood. Metal parts nickel plated. Will give excellent selectivity on waves up to 1500 meters with the average antenna. Shipping weight, 6 lbs.
Cat. No. 344—8 Receiving transformer \$18.00

TUNING COIL No. 240—8

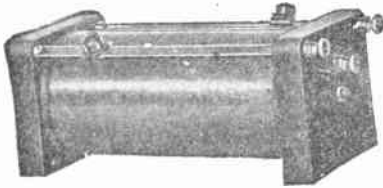

A well constructed two slide tuner at a low price. In every detail of construction and workmanship it stands far above the ordinary low price tuner. May be used with excellent effect as loading inductance in combination with the tuning transformers listed above. Hard rubber composition tube and coil heads. Bare copper wire winding. Nickel plated metal parts. Shipping weight, 3 lbs.

Cat. No. 240—8 Tuning coil \$8.00

LOADING INDUCTANCE No. 510—8

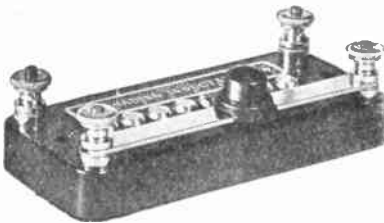

Coils contained in a flat, compact base and tapped to seven active points, each point giving an approximate increase of 400 meters. Moulded hard rubber composition base with nickel plated metal parts. One of the most popular loading inductances ever offered for amateur use. Shipping weight, $\frac{3}{4}$ lb.

Cat. No. 510—8 Loading inductance. \$8.00

FIXED RECEIVING CONDENSER No. 358—8



Regulation "stopping" condenser for use in receiving circuits. Composition base with condenser sealed within. Nickel plated binding posts. Compact, efficient and low priced. Shipping weight, $\frac{1}{4}$ lb.

Cat. No. 358—8 Fixed receiving condenser... \$1.60

DUO-LATERAL WOUND INDUCTANCE COILS



The DUO-LATERAL coil now being offered for the first time, must not be confused with similar appearing coils now on the market. The DUO-LATERAL coil, made in various sizes for general and specific applications, possesses these distinct advantages which make it superior to any other for either amateur, commercial or laboratory work.

1. Lower Natural Period, which enables the user to cover a greater range of wave lengths.

2. Lower High-Frequency Resistance, which means a louder response in the telephones.

3. Very Low Distributed Capacity, which gives a low natural period and makes for sharper tuning.

4. The Exceptionally Low Distributed Capacity is realized by having the turns in the same direction for adjacent layers spaced considerably further apart than in any usual practice.

Cat. No. of Unmounted Coil only, Solid Wire	Working Wave Length Range in Meters with 0.001 M. F. Condenser		Distributed Capacity in Micro-Micro Farads	Average Values of Inductance and High Frequency Resistance at the Following Wave Lengths			Outside Diameter in Inches	Price Unmounted or Coil Only Less Plug
	Minimum	Maximum		Wave Length in Meters	Inductance in Millihenries	Resistance in Ohms		
U S 25	130	250	17	150 300	.045 .045	1.9 1.3	2 1/4	<u>\$1.80</u>
U S 35	180	450	17	200 400	.075 .073	2.6 2.1	2 1/4	<u>2.00</u>
U S 50	250	700	18	300 700	.156 .15	4.2 3.7	2 1/8	<u>2.20</u>
U S 75	400	900	19	400 900	.36 .34	6.3 5.0	2 3/8	<u>2.40</u>
U S 100	500	1400	19	500 1400	.66 .57	27.2 21.3	2 1/2	<u>2.60</u>
U S 150	600	2000	20	700 2000	1.40 1.35	38.0 34.0	2 5/8	<u>2.80</u>
U S 200	1000	2500	20	1000 2500	2.50 2.30	48.0 41.0	2 1/2	<u>3.00</u>
U S 250	1200	3500	20	1400 3500	4.20 4.00	63.0 51.0	2 1/8	<u>3.20</u>
U S 300	1500	4500	21	1500 4500	6.25 6.10	68.0 52.4	3	<u>3.60</u>
U S 400	2000	5000	22	2000 5500	10.62 10.2	73.0 58.7	3 1/4	<u>4.00</u>
U S 500	3000	6000	23	3000 6000	17.6 17.3	75.0 55.0	3 1/2	<u>4.40</u>
U S 600	4000	10000	23	4000 10000	25.0 22.0	90.0 40.0	3 1/8	<u>5.00</u>
U S 750	5000	12000	23	5000 12000	38.0 35.3	97.0 64.0	3 1/8	<u>5.40</u>
U S 1000	8000	15000	24	8000 15000	72.8 68.3	104.0 80.0	3 3/4	<u>5.80</u>
U S 1250	10000	20000	24	10000 20000	116.6 112.3	125.0 95.0	4 1/8	<u>7.00</u>
U S 1500	15000	25000	25	15000 24000	171.5 162.2	140.0 110.0	4 7/8	<u>8.00</u>

DE FOREST ULTRA HONEYCOMB COILS WITH DUO-LATERAL WINDING



These coils are similar to those listed on page 7 and employ the now famous Duo Lateral winding. A De Forest plug is mounted on one end and they can be used with the regular De Forest coil mountings.

MOUNTED DUO LATERAL COILS

CUT NO.	PRICE
DL 25	\$3.30
35	3.40
50	3.50
75	3.70
100	3.80
150	4.20
200	4.60
250	4.90
300	5.20
400	5.50
500	5.60
600	6.10
750	6.60
1000	7.10
1250	7.70
1500	8.20

For data on these coils see page 7.

TYPE LC-100—7, 101—7 AND 201—7 INDUCTANCE COIL MOUNTINGS

The mounting consists of three plug receptacles fastened to a bakelite framework mounted on a pedestal which is in turn fastened to a base. The receptacles are designed to hold our DL Honeycomb Inductance Coils. The center receptacle is fixed and the two outside receptacles move on bearings and are geared to small pinions so that small variations of coupling between the coils can be easily obtained by turning the bakelite knobs. The knobs are so located as to be readily accessible without bringing the hand close enough to the coils to produce objectional capacity effects.

The terminals of the receptacles are connected by heavy Litz to six hard rubber covered binding posts at the back of the base so that one, two or three of the coils may be used as desired. By means of the interchangeability feature in this plug type of coil mounting, inductances of any size may be used, and when connected with variometers or variable condensers, a tapless, and therefore a most efficient tuner, capable of working equally well over all ranges of wave lengths, is provided.

This coil mounting holds two primaries and a secondary for use on balance circuits. It may, of course, be used in any other way the operator sees fit as independent connections are provided for each of the coils.

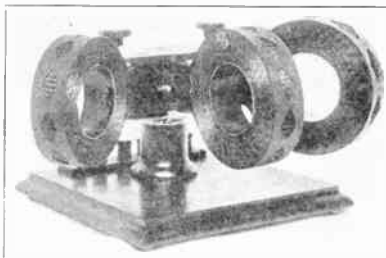

We also furnish the type LC-101—7 coil mounting with a U. S. 100—7 Primary Condenser Switch mounted on its base. The switch is connected in the primary circuit, and an extra pair of binding posts is provided on the rear for connecting to the primary tuning condenser. This is the ideal coil mounting for use with vernier type condensers. It and two variable condensers constitute an experimental tuner for placing on the operating table where it is readily accessible for changing connections.

The metal parts of the mountings are of brass nickel plated. The pedestal and base are of oak, finished in "Early English," so that the whole provides a decidedly attractive piece of apparatus.

Cat. No. LC-100—7	Inductance Coil Mounting without base or pedestal.	
	Shipping weight, 3 lbs. Price.....	\$20.00
Cat. No. LC-101—7	Inductance Coil Mounting on Oak Base as shown.	
	Shipping weight, 4 lbs. Price.....	26.00
Cat. No. LC-201—7	Combination Triple Adjustable Coil Mounting and Primary Condenser Switch Mounted on Oak Base.	
	Shipping weight, 4 lbs. Price.....	30.00

The mountings are always furnished without coils.

CONNECTICUT VARIABLE CONDENSER

This new product of the Connecticut Research Laboratories is a distinct improvement over the conventional instrument which is known as the rotary condenser, an instrument which is still in common use, although it differs in no way from the type originally employed when resonance circuits were first used.

The outstanding features of the new Connecticut Variable Condenser are its compactness, which makes it a far more convenient instrument; its stability, which permits of securing adjustments, once obtained, from purely mechanical fluctuations; and its simplicity of design. Every essential requirement of a Variable Condenser has been fully met, and met in the least complex possible way. The result demonstrates the familiar saying that the "simplest way is the best way." For this new condenser is not merely more convenient and more stable; but it is far more sensitive, capable of much finer adjustments, permits a stronger signal and establishes readings at both ends of the scale.



Cat. No. 41C Price \$10.00

MURDOCK VARIABLE CONDENSER No. 3660—8

The requirements of those who desire to mount their condensers on panels or in cabinets is met by the use of the style shown here. The condenser unit is precisely the same as our No. 366—8 with a top plate so made that the attachment to a panel is very simple. The accompanying drawing shows dimensions and spacing of holes to be drilled in panel. For best looking results the supporting screw holes should be drilled and countersunk for flat head screws. The condenser may be used in any position, as the specially designed friction device permits its continued use regardless of plate position. Capacity the same as No. 366—8. Over all size $3\frac{1}{2}$ " diameter by $3\frac{3}{4}$ " high. This particular style is supplied less knob, pointer and scale. The shaft for knob mounting is $\frac{1}{4}$ " diameter. For those who desire complete instruments, attention is directed to our No. 3662—8 and No. 3663—8. Shipping weight $2\frac{1}{4}$ lbs.

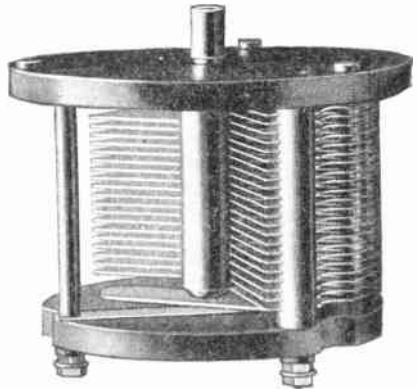

Cat. No. 3660—8 Panel Type Variable VCondenser 43-plate .001 mfd. Price each \$8.00

VARIABLE AIR CONDENSER

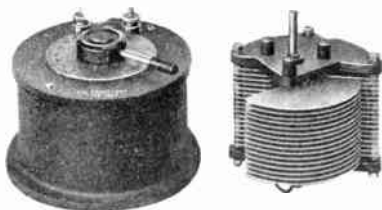

182—16

The design of this condenser makes it particularly adapted for use in radio oscillating circuits. The plates are cut so as to obtain a nearly uniform wavelength variation throughout the entire range of the condenser. This is particularly valuable in circuits such as those used with vacuum tubes, where the ratio of inductance to capacitance is large. The capacitance at the zero end of the scale is very low, being less than 30 micro-microfarads. The plates are heavier than those of the usual variable condenser of this size, and the end supports are arranged to reduce the usual dielectric losses. The rotary plates are mounted on a steel shaft which runs in two cone brass bearings, which permit of adjustment to any desired degree of turning resistance, and of taking up perfectly any wear which may occur in them after years of service. Electric connection to the rotary plates is accomplished by a special flexible lead, thereby preventing any possibility of varying resistance which might result were the bearings used for this purpose.

The case is of spun metal with our permanent black crystalline finish. The panel is of Bakelite with engraved lettering filled with white.

A small extension handle is provided for accurate adjustment.

This condenser is made in two sizes, of approximately 700 and 1000 micro-microfarads maximum capacitance respectively. The smaller condenser is $5\frac{1}{2}$ inches diameter x $4\frac{1}{8}$ inches high and weighs two pounds, while the larger is $5\frac{1}{2}$ inches diameter x $5\frac{1}{8}$ inches high and weighs two and one-half pounds.

Cat. No. 182A—16	Condenser, Max. Cap. 700 M.M.F.	\$24.00
Cat. No. 182B—16	Same as above, calibrated at 10 points	27.00
Cat. No. 182C—16	(182A—16 Unmounted) Without case, top, or binding posts, but with scale and handle.....	17.50
Cat. No. 182E—16	Condenser, Max. Cap. 1000 M.M.F.	27.00
Cat. No. 182F—16	Same as above, calibrated at 10 points.....	30.00
Cat. No. 182G—16	(182E—16 Unmounted) Without case, top, or binding posts, but with scale and handle.....	19.40

“CHELSEA” VARIABLE CONDENSERS



This condenser is suitable for laboratory, commercial or amateur work. Its low price should not be accepted as indication of a low grade article. The top and bottom of the condenser are made of moulded Bakelite, the side of a transparent composition allowing the action of the condenser to be plainly seen at all times.

Special features are: friction control of movable plates, steel shaft rotating in bronze bearings, large scale readings in hundredths, high electrical efficiency, capacity and expert mechanical construction throughout.

The condenser is furnished in two sizes, the larger having a capacity of .0012 Mfd., the smaller a capacity of .00068 Mfd.

- | | | |
|---------------|---|---------|
| Cat. No. 1—40 | “Chelsea” Variable Condenser, Capacity .0012 Mfd.,
37 Plates. Shipping Weight, 4 lbs. | \$10.00 |
| Cat. No. 2—40 | “Chelsea” Variable Condenser, Capacity .00068 Mfd., 19
Plates
Shipping Weight, 3 lbs. | 9.00 |

SEIBT PRECISION CONDENSERS

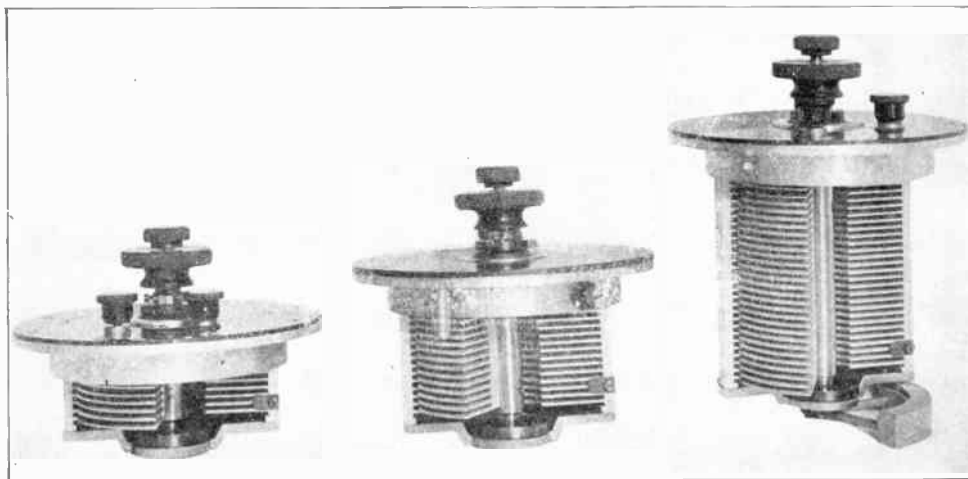

Genuine Seibt Condensers need no introduction to those engaged in radio previous to the war.

They are used by all the European Governments and many commercial companies and they are considered unequalled by radio engineers the world over.

Seibt Precision Variable Air Condensers are constructed entirely different from other condensers inasmuch as both the movable and fixed sets of plates are made each in a single piece. The chief advantages of this condenser are as follows: Absolute rigidity of plates, extraordinary compactness, large minimum to maximum capacity ratio, high insulation resistance and low effective resistance.

Genuine Seibt Variable Air Condensers are now obtainable in the following capacities:

Cat. No. S500—45	Capacity 0.0005 mfd.	500 cms.....	\$44.00
Cat. No. S1000—45	0.0012 mfd.	1000 cms.....	59.00
Cat. No. S2000—45	0.0022 mfd.	2000 cms.....	75.00
Cat. No. S4000—45	0.0044 mfd.	4000 cms.....	120.00

**CAT. NO. CV-500-7
VARIABLE AIR CONDENSER**

This is a new and improved design in variable air condensers.

The 13 aluminum stationary plates are held together by two brass end plates through which rods are passed. The spacers are of aluminum. On the shaft are mounted 12 aluminum rotary plates separated by extra large spacers to prevent change in location and, as an additional precaution, are held together in one corner by a sustaining rod similar to those for the stationary plates. The large shaft is pig-tailed to the end washer, preventing any variation in resistance due to improper contact, and is insulated from the end plates by hard rubber bushings held in place rigidly by threaded washers. Constant tension is maintained by a spring washer, and is adjustable through the bearing in the bottom end. All nuts are soldered.

The capacity is .0005 mfd. This condenser has great mechanical strength due to its rugged construction, and is not to be compared to the cheap stamped or cast condenser usually offered to experimenters and amateurs.

The design embodies a wider air gap than is usual in a condenser of a similar capacity, thus assuring further robustness and eliminating short circuits between plates under the very hardest usage. Overall dimensions 4 $\frac{5}{8}$ " high, 3 $\frac{1}{4}$ " wide, 3 $\frac{3}{8}$ " long.

Cat. No. CV-500—7 Shipping Weight 2 lbs. Net Weight 1 lb. Price, including knob, scale and pointer, ready to mount on your panel \$12.50

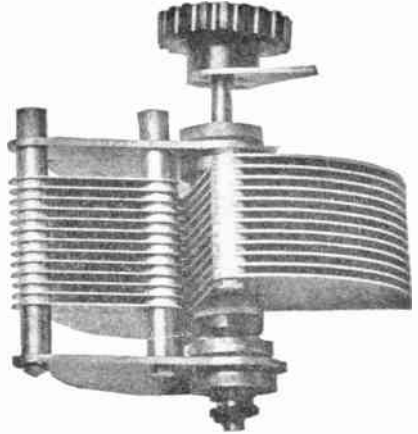

TYPES 43 AND 17 ROTARY VARIABLE CONDENSERS

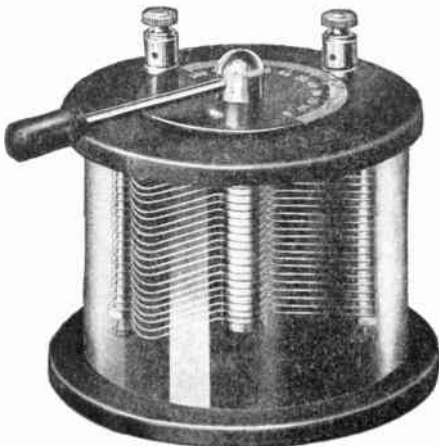

These Condensers are made in two sizes having 43 and 17 plates, respectively accurately punched with hardened dies.

The capacity of the 43-Plate Condenser is approximately .0008 M. F. and of the 17-Plate Condenser approximately .0003 M. F. The shaft carrying the rotary plates is of the finest tool steel made, and runs in a long, accurately machined brass bearing insuring long life and permanency of adjustment. All plates, both rotary and stationary, are spaced with separators machined to an accuracy of one-half of one thousandths of an inch. The entire Condenser is enclosed in a cylinder of the clearest and toughest flint glass with a pressed metal base and a top of special moulded insulating material which will not lose its high polish or its

soft black color. The knob is made of the same material as the top. Readings are

indicated on a black rotary dial with extension handle and sunken silver numerals and scale.

The glass case renders the mechanism of the Condenser visible at all times and the fine workmanship thus exposed to view lends an exceedingly attractive appearance to the instrument.

Cat. No. 735—15	43-Plate Condenser, $4\frac{1}{4}$ inches across base, total height $3\frac{3}{8}$ inches, shipping weight 2 pounds.....	\$13.00
Cat. No. 735—15	43-Plate Condenser without glass case or base.....	11.50
Cat. No. 774—15	17-Plate Condenser, $4\frac{1}{4}$ inches across base, total height $2\frac{5}{8}$ inches, shipping weight 2 pounds.....	11.00
Cat. No. 775—15	17-Plate Condenser without glass case or base.....	10.00

TYPE 800-15 BALANCED TYPE CONDENSER

The purchaser of a variable air capacity will find in this type quality considerably above that usually incorporated in condensers of small size. The plates are quite heavy, .022 thick aluminum, and the assembly is made with two substantial cast aluminum end plates with top and bottom bearings set in hard rubber inserts, the whole giving great ruggedness and freedom from short circuits, loss of adjustment, and change of capacity. Current is conducted from the rotary plates by a coiled flexible conductor and not through the bearings of the instrument, assuring a path of low and constant resistance even when immersed in oil.

The design is such as to make the instrument readily mounted on the back of panels, in which case only three holes must be drilled in the panel. It is balanced by arranging each half of the rotary plates on opposite sides of revolving shaft and placing the stationary plates to correspond, permitting its use in any position or at any angle without counterweights or other similar expedients.



Cat. No. 800—15	Balanced Variable Air Condenser, including scale and handle, without case, 14 rotary, 16 stationary plates. Maximum capacity .0006 M.F., minimum capacity .00005 M.F. approximately, radius of plates $1\frac{1}{2}$ inches, weight, 7 ounces, shipping weight 1 pound..	\$15.00
Cat. No. 800A—15	Same as 800, but maximum capacity, .001 M.F.....	19.00
Cat. No. 800B—15	Same as 800, but maximum capacity, .0015 M.F.....	23.50
Cat. No. 800C—15	Any of these balanced condenser will be furnished mounted in a heavy brass oil tight case with Bakelite top and binding posts, as illustrated, at an additional cost of.....	8.00
Cat. No. 800G—15	Moulded bakelite knob and dial.....	2.60

VARIABLE CONDENSERS

No. 366—8



A variable capacity used extensively in radio receiving sets. Its wide sale has proved the appreciation of amateurs, for at the price, there is no similar instrument at all comparable in construction or in appearance. Polished composition case. 43 plates, semi-circular type. Maximum capacity approximately .001 mfd. Plates and separators cast as units. Fitted with 180 degree scale, turning knob and pointer. Size, 4 inches high, 4 1/4 inches, diameter. Shipping weight 2 1/4 lbs.

Cat. No. 366—8 Variable condenser complete \$9.50

No. 366—8, UNMOUNTED

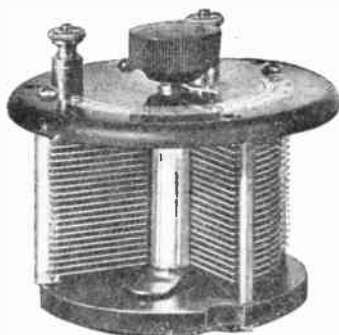

The capacity unit of the No. 366 condenser described above. Includes complete plate sets, movable and stationary, with composition top, scale, pointer, knob, and bottom plate support, completely assembled. A complete working unit which may be mounted on a panel or in any suitable case. We do not supply this interior in separate parts. Shipping weight 2 1/4 lbs.

Cat. No. 366—8, Unmounted Condenser . . \$3.50

No. 367—8

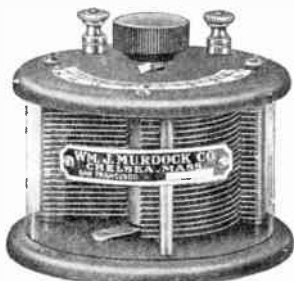

This variable capacity differs from our No. 366 described above, only in that the casing is transparent, affording opportunity to observe movements of the interior if desired. It is offered to meet the needs of those whose personal preferences call for a condenser of this special construction. Shipping weight 2 lbs.

Cat. No. 367—8 Variable condenser complete \$9.50

No. 358—8



A smaller capacity embodying all the constructional features of our No. 366. Has 23 plates and a maximum capacity of approximately .0005 mfd. Casing the same as that of No. 367 described above. This capacity has proved satisfactory with valve circuits for undamped wave receivers. Interior only is furnished if desired. Shipping weight 1 1/2 lbs.

Cat. No. 368—8 Variable condenser complete \$7.50
 Cat. No. 358—8 Int. Interior only..... 6.50

VARIABLE CONDENSER No. 3662—8

The same unit as the No. 3660—8 supplied with specially designed knob, rotatable dial and extension handle. The fittings in this instance are especially desirable, as they are well made and very attractive in appearance. Size over all $3\frac{1}{2}$ " diameter by 4" high. Shipping weight $2\frac{1}{2}$ lbs.

Cat. No. 3662—8 Panel-type 43 plate .001 mfd. with special knob, extension handle, and dial in unit form.

Price each\$10.00

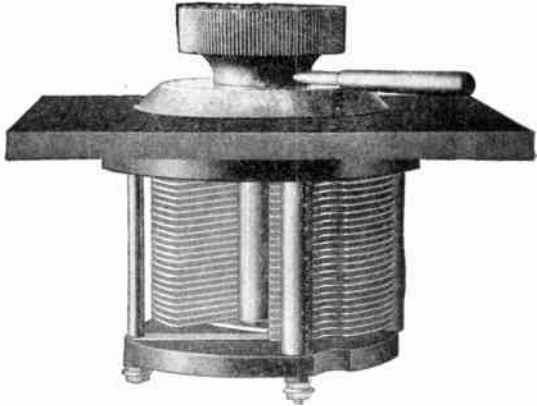
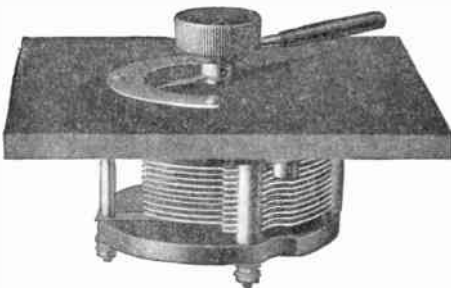
**VARIABLE CONDENSER No. 3681—8**

Our No. 3681—8 Condenser may be had with our standard condenser knob and 180 degree scale as illustrated. Capacity the same as No. 3680—8. Over all size $3\frac{1}{2}$ " diameter by 3" high. Shipping weight $1\frac{1}{2}$ lbs.

Cat. No. 3681—8 Panel-type 23 plate .0005 mfd. with standard knob, scale and extension handle (no panel supplied).

Price each \$7.00

NEW UNIVERSAL TYPE FERRON DETECTOR

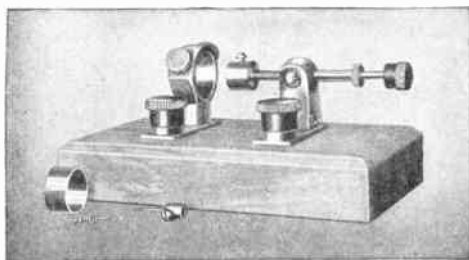

Even a casual glance at the illustration will reveal its convenience, its beauty, and the universal nature of its uses. The large standard has an opening $\frac{3}{4}$ inch in diameter, provided with two knurled set screws for holding any substance desired. The brass cup fits into this, and crystals may be mounted in fusible metal in this cup. All parts of the material in the cup or standard may be reached by the contact

point which is held by a ball and socket joint, providing a neat and convenient means of adjustment. Suitable pressure is given by a fine coiled spring, the tension of which may be varied by sliding the sleeve in and out of the ball.

The movable contact is shown in the illustration fitted with a cup in which any desired substance may be held by means of the set screw. This may be unscrewed, however, and either the needle point or cat whisker point substituted.

The instrument is mounted on a base of engraved bakelite 3 inches by $5\frac{1}{2}$ inches, giving great stability and freedom from vibration. All metal parts are brass, nickel plated, and rubber composition covered binding posts and adjusting knob are fitted.

Cat. No. 675—15	Universal Detector, less crystal.....	\$10.00
Cat. No. 676—15	Additional Cups to fit each holder.....	.40
Cat. No. 678—15	Detector Stand complete with Crystal.....	12.50

AMRAD DETECTOR STANDS

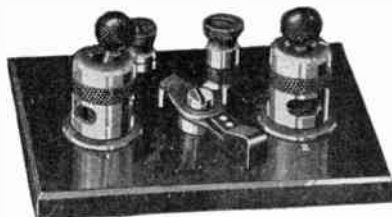

Several noteworthy features not found in other types make Amrad Detector Stands greatly superior in efficiency and ease of operation. An enclosing case carrying a feeler regulated by ball and socket adjustment completely shields the crystal from dust. The tension of the feeler or whisker is instantly adjustable by rotating the enclosing case in a clockwise or counter-clockwise direction. Every point of crystal surface may be reached by an easy finger tip motion of the adjustment knob. The crystal cup, gripped by friction contact in a brass receptacle, is readily removable. The rectifying crystal, which is not furnished with the instrument, is to be selected by the operator and packed into the crystal cup by means of tin foil, Woods' Metal or other alloy fusible at low temperature.

Amrad Detector Stands have been tested and approved by the Navy Department. Our design makes the most delicate adjustment remarkably proof against shock and vibration by reason of the short radius and negligible inertia of the spiral whisker. Two types of Amrad Detector Stands are now available, the duplex with selector switch and the single model without switch. Both are mounted on moulded Electrose bases.

Cat. No. D1—24	Amrad Single Detector	\$8.00
Cat. No. D2—24	Amrad Duplex	14.00

RADIOTRON VACUUM TUBES



Our new detector and amplifier tube is the latest product of the Research Laboratories of the General Electric Co. It has been specially designed to meet the requirements of the amateur and experimental field, hence, the production of a tube which would prove a sensitive detector and a superior amplifier, and which could be operated off a single $22\frac{1}{2}$ volt plate battery.

Radiotron U. V. 200 is the best radio detector and audio frequency amplifier yet produced. It is particularly adapted to standard regenerative circuits, in which it functions with greater sensitiveness and stability than any other tube.

Best detector action is provided by a grid condenser of 0.00025 mfd and our standard grid leak of $\frac{1}{2}$ megohm resistance. The plate voltage must be closely adjustable from 18 to $22\frac{1}{2}$ volts. The requisite variation of the plate voltage may be obtained in three ways: (1) by use of our "B" battery potentiometer; (2) by our variable "B" battery or by a special "A" or filament battery potentiometer of 200 ohms which we will have out very soon. In the case of the last mentioned method the negative terminal of the "B" battery (which is tapped from the 12th cell) connects to the variable contact on the "A" battery potentiometer. When used as an audio frequency amplifier, Radiotron U. V. 200 can be worked from any of our "B" batteries without provision for variation of the plate voltage.

Radiotron U. V. 201 is also a newly designed detector and amplifier of Pliotron type, which was developed by the General Electric Co. experts, who have tested this tube, pronounce it to be the most efficient and stable amplifier available to date. The normal plate voltage is 40 (2 of our "B" batteries), but plate voltages up to 100 volts may be used with increasing amplification.

All Radiotrons are manufactured in accordance with rigid specifications, assuring a uniform product. They are made to fit standard four prong sockets.

U. V. 200 Radiotron vacuum tube.....	\$10.00
U. V. 201 Radiotron vacuum tube.....	13.00

AUDION PANELS



Series P-402—7, P-500—7

These are very efficient and handsome audion control panels. They are within the price limit of every amateur. These control panels do not give one the cheap and thrown-together effect of those usually offered, because they are built with the same grade of workmanship and materials employed in our more expensive apparatus.

GENERAL SPECIFICATIONS, ALL MODELS: Beautifully engraved and grained genuine bakelite panels; 4 prong heavy nickeled tube receptacles; smooth running, positive acting, adjustable rheostats; impregnated efficient mica stopping condensers; adjustable or fixed grid leaks with polished nickel covers; bakelite covered binding posts with new slotted positive connecting feature; positive segmentally connected nickel plated switches; 40 volt "B" battery of two 20 volt type units cast en bloc with operating life of 6 to 12 months—a remarkable advance in "B" batteries. "Early English" finish; perfect workmanship and expensive design throughout.

- Cat. No. P-402—7 Audion Panel. Shipping Weight, 13 lbs. Larger panel with 40-volt "B" battery in cabinet $7\frac{1}{2}$ " x $7\frac{1}{8}$ " \$42.00
- Cat. No. P-500—7 Audion-Ultraudion Panel. Shipping Weight, 13 lbs. Type P402—7, panel with two switches for audion-ultraudion connection and either 20 or 40-volt "B" battery in cabinet $7\frac{1}{2}$ " x $7\frac{1}{8}$ " 48.00

RADIO-CRAFT DETECTOR UNIT



This detector unit indicates the high standard that Radio-Craft has set for its products. Small and compact, this instrument is remarkably efficient and exceptionally beautiful.

The panel with all its mountings can very easily be snapped out of the cabinet and replaced, permitting immediate inspection or replacement of the vacuum tube. This design is exclusive with Radio-Craft products.

Cabinet: Quartered oak cabinet, weathered oak finish.

Panel: Bakelite-Dilecto, grade XX, $4\frac{1}{2}$ " x 7" x $\frac{1}{8}$ " thick, hand rubbed finish.

Rheostat: Radio-Craft standard back mounted, smooth and critical adjustment, resistance of 6 ohms.

Vacuum Tube Receptacle. Is designed to take the standard four prong receiving base made of seamless brass tubing fastened to a bakelite shelf and has heavy phosphor bronze contacts to assure perfect electrical connection.

Binding Posts: Radio-Craft standard, finished in white nickel.

Grid Condenser: Made of the finest India mica and copper foil, fastened to back of panel.

Shipping weight $3\frac{1}{2}$ lbs.

Cat. No. A1-10 Price \$30.00

VACUUM-TUBE UNIT

TYPE RORA

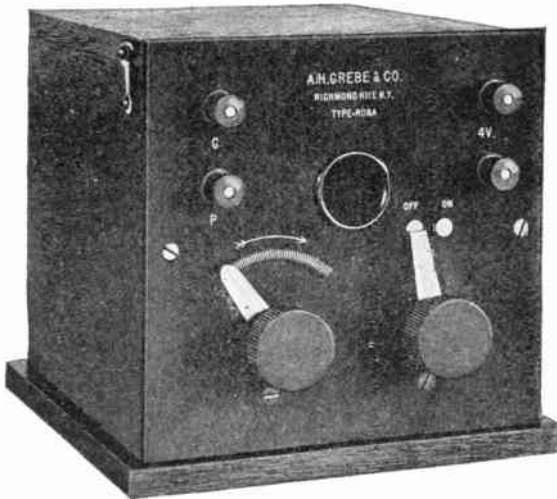

The Type RORA vacuum-tube unit is simplicity itself, yet it incorporates all the features that make for efficiency, durability, and convenience. The panel of this unit is provided with an aperture which assists in the ventilation of the interior, and also provides a ready means of ascertaining the brilliancy of the filament. The wiring of this unit follows the usual practice of rigid bus wiring, which insures permanent connections and precludes the possibility of short circuits between wires. The entire assembly is mounted on the front panel, which practice permits of the ready removal and inspection of the apparatus. The cabinet is supplied with a hinged top for the inspection and replacement of the vacuum tube.

Panel Size, $5\frac{1}{2}$ x $5\frac{1}{2}$ inches. Net Weight, 5 pounds. Shipping Weight, 9 pounds.

Wiring diagram and instructions accompany each unit.

Cat. No. 311—18 RORA Vacuum Tube, unit without Tube and Batteries. \$22.00

VACUUM-TUBE UNIT

TYPE RORH

There are four sets of binding posts on the outside of the panel. Two of these are always used for connecting the filament battery and the telephones. Thus the variable external connections are limited to two sets of binding posts, and these are so located as to permit the shortest possible leads to the receiving apparatus. A two-point switch with "on" and "off" positions and a standard Grebe resistor unit control the filament circuit, and the brilliancy of the filament may be observed through the aperture in the panel.

Inside the cabinet, space has been provided for two 20-volt Standard plate batteries which are connected to binding posts located on the back of the panel.

A grid condenser similar to Grebe Type ROCB is also mounted on the back of the panel, and the leakage element of this condenser may be easily removed for adjustment.

The hinged cover of the cabinet permits easy replacement of both vacuum tube and batteries, or adjustment of the leakage element of the grid condenser.

Panel size, $5\frac{1}{2} \times 5\frac{3}{4}$ inches. Net Weight, $6\frac{1}{2}$ lbs. Shipping Weight, 10 pounds.

Wiring diagram showing the most approved modern circuits and instructions accompany each unit.

Cat. No. 117—18 RORH Vacuum Tube Unit without Tube but with B
Batteries \$34.00

ACME DETECTOR AND AMPLIFIER

The Detector contains a tube socket, condenser, grid leak and filament rheostat all mounted on an engraved bakelite panel with binding posts marked so that external connections may easily be made. An attractive oak box incloses the condenser, grid leak, rheostat and connections, leaving the nickel plated portion of the tube socket, nickel plated binding posts and engraved panel exposed. The rheostat handle projects on the front of the box and is supplied with a pointer under which is a nickel plated dial divided into degrees.

The Amplifier contains a tube socket, Acme A-2 Amplifying Transformer and filament rheostat all mounted on an engraved bakelite panel with binding posts marked Input, Output, A and B batteries. The same style and size of mounting is used as with the Detector, and both instruments are ready for use by inserting a tube and connecting the necessary external apparatus.



Y-1—19 Detector (without tube) \$20.00
Y-2—19 Amplifier (without tube) 26.00

SINGLE-STAGE AUDIO-FREQUENCY AMPLIFIER
TYPE RORE

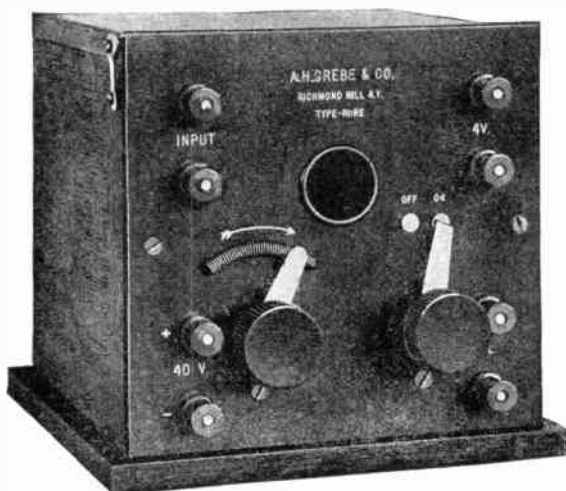

In general appearance, the Type RORE, instrument is very similar to the vacuum tube unit, Type RORH. Its electrical construction is such as to insure the maximum amplification for a single-stage equipment. The amplifying transformer is designed for the maximum amplifying ratio with the correct impedance values for modern vacuum tubes. The closed core design permits of extreme compactness, together with high efficiency. The windings are well protected and insulated. The wiring is of the bus-wiring type, producing a rigid and easily accessible assembly.

Panel Size, 5¾ x 5½ inches. Net weight, 3 pounds. Shipping Weight, 6 pounds.

Wiring diagram and instructions accompany each amplifier.

Cat. No. 115—18 RORE Single Stage Audio-frequency Amplifier..... \$46.00

VACUUM-TUBE DETECTOR AND SINGLE-STAGE
AUDIO-FREQUENCY AMPLIFIER

TYPES RORG and RORL

The input terminals are located in a manner which permits direct wiring to the receiving apparatus and the circuit arrangements within the cabinet allow the use of a great variety of external circuits.

The Type RORL includes the automatic filament control system, which is fully described in other bulletins.

Every detail of construction and assembly has been carefully planned and carried out in these units and they are an example of fine design and workmanship.

Panel size: 6 x 7½ ins. Net Weight, 6 lbs. Shipping Weight, 12 lbs.

Wiring diagram and instructions accompany each instrument. Supplied less vacuum tubes and batteries.

Cat. No. 123—18 RORG Detector and Single-stage audio-frequency amplifier \$86.00

Cat. No. 124—18 RORL. Same as RORG, but including automatic filament control system 94.00

PARAGON V. T. CONTROL



The "Paragon" V. T. Control, embodies a new idea in design that may be classed revolutionary. It makes the cumbersome and expensive cabinet type of control, obsolete and is entirely replacing that type of apparatus.

It is so much more efficient mechanically and electrically and so much more compact and neater in appearance than other types of control panel, that there is no comparison.

It may be used with any tuner or receiver as a detector or oscillator, or together with a suitable transformer, as an amplifier which can be used in connection with a crystal detector or another vacuum tube.

The Paragon V. T. Control consists of a socket, mica grid condenser, grid leak, the famous Paragon Rheostat and nine nickeled brass binding posts, moulded into a panel unit of black condensite.

Overall dimensions 5 x 3 $\frac{1}{8}$ x 1 $\frac{3}{4}$ ". Shipping Weight, one pound.

Cat. No. 70—17 Paragon V. T. Control..... \$12.00

DETECTOR AND AMPLIFIER CONTROL PANELS



Beauty and convenience have been incorporated in the design of these panels. The panels are $5\frac{1}{4}$ " high x $4\frac{1}{2}$ " wide and are made of the finest grained bakelite. The Rheostats used are very smooth running and allow one turn to be cut in or out at a time. Binding posts are hard rubber covered. Detector panel has a detachable plug which takes your regular phone tips, while the Amplifier panel is provided with two binding posts for the phones. Thus making it very easy to connect these two together as detector and amplifier.

Cat. No. ZRD—15	Detector Panel.	Shipping weight 2 lbs.....	\$24.00
Cat. No. ZRA—15	Amplifier Panel.	Shipping weight 3 lbs.....	36.00

RADIO-CRAFT TWO-STAGE AMPLIFIER



Radio-Craft has solved the problem of amplification completely in designing its two-stage amplifier. Indistinct and inaudible signals are rendered perfect by the use of this instrument.

Scientific designing and painstaking construction have obviated interfering noises so often developed in amplifiers. Immediate accessibility is afforded by the exclusive Radio-Craft panel design.

Cabinet: Quartered Oak, weathered oak finish.

Panel: Bakelite-Dilecto, grade XX, $5\frac{5}{8}$ " x 8" x $\frac{3}{16}$ " thick, hand rubbed finish.

Rheostats: Radio-Craft standard back mounted, smooth and critical adjustment, resistance of 6 ohms provided with off position for filament control.

Tube Receptacles: Are designed to take the standard four prong receiving base, made of seamless brass tubing fastened to a bakelite shelf and have heavy phosphor bronze contacts to assure perfect electrical connection.

Amplifying Transformers: Closed core type correctly designed for the standard V. T. tubes, mounted with brass angles on a bakelite panel.

Telephone Jacks and Plug: Standard Federal type; three employed for detector, first and second stage.

Wiring: Rigid hard drawn copper wire covered with varnished tubing.

Binding Posts: Radio-Craft standard, finished in white nickel.

Shipping weight $5\frac{1}{2}$ lbs.

Cat. No. A2—10 Price \$100.00

"SACO" AMPLIFIERS

The "SACO" two-stage audio frequency amplifier has been designed primarily for intensifying feeble electric currents as found in radio and line receiving work.

The amplifier embodies several important features. First, it is adaptable for line and radio telephone circuits. This is due to the accurate design of the input and second stage transformers, which prevent to a great extent, wave distortion of the impressed speech wave. This is of extreme importance if the amplifier is to be used in amplifying line or radio telephonic currents.

The telephone receiver can be connected to either detector, first or second stages of the amplifier by throwing in the receiver circuit into the proper jack with a plug, which is connected to the receiver cord. This permits the operator to select the proper stage in the quickest possible manner.

Squealing, howling or whistling as obtained with other makes of two-stage amplifiers has been entirely eliminated in the "SACO" amplifier. The elimination of these undesired effects, is principally due to the careful design of the transformers, which have a very low influx leakage coefficient, thereby preventing coupling due to these stray fields between circuits to oscillate at audio frequencies.

The two-stage amplifier is inestimable in conjunction with underground and loop antennae reception, especially when working on short wavelengths.

Due to the fact that coupling between circuits has been reduced to a minimum, it makes it possible to use this amplifier in intensifying signals at short wavelengths.

The filament current may be supplied from your detector "A" battery; one set of "B" batteries is only necessary for the two amplifier tubes.

The specifications for the "SACO" type A-2 two-stage audio frequency amplifier are as follows:

PANEL: "Bakelite Dilecto" $\frac{1}{4}$ inch thick, and hand grained. Engraving on the panel is of the standard pantograph type. Letters filled with Dixon white engravers' filler. This filler is set in and will stay in permanently without cracking or falling out from the letters. The view holes are screened with fine brass nickel plated screening. The holes are used to note the brilliancy of the tubes.

TRANSFORMERS: Core type, ratio of transformation 1:3.75. Primary resistance 2,360 ohms, secondary resistance 9,500 ohms. Transformer impedance measured at 800 cycles is the same as the internal impedance of the standard market vacuum tubes. Laminations are very thin and are properly insulated from each other, giving a low percentage of core loss.

TUBE, SOCKETS: Heavy brass tube, hole machine bored to give sliding fit for standard four-prong tube. Bakelite base and four-spring connectors. The sockets are mounted vertically.

RHEOSTATS: Two fibre machine slotted flat forms, wound with special resistance wire, to give maximum resistance with minimum space. Resistance of each rheostat 3.1 ohms. Spring movable contact used to obtain variation of resistance. Spring moved by a knob in front of panel.

BIASING RESISTANCES: Two fibre machine slotted flat forms, wound with special resistance wire.

WIRING: The various apparatus are wired with No. 14 bare hard drawn copper wire, insulated with varnished sleeving, all connections being soldered.

CABINET: Quartered oak, mission finished. A hinged cover is provided on top in order to permit the insertion or removal of the vacuum tubes from their respective sockets.

METAL PARTS: All metal parts are made of brass and are nickel plated and polished.

WORKMANSHIP: The very best workmanship has been applied in the manufacture of this and all of our other standard apparatus.

DIMENSIONS: $11\frac{1}{4} \times 5\frac{3}{4} \times 6\frac{1}{2}$. Approximate shipping weight, 10 lbs.

Wiring diagram and instructions accompany each amplifier.

Cat. No. A2-43 Two-Stage Audio Frequency Amplifier..... \$100.00

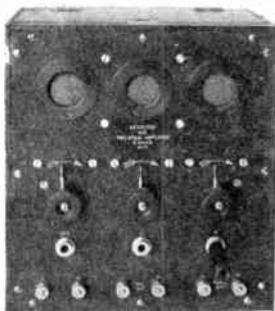

"SACO" DETECTOR AND TWO-STAGE AMPLIFIER

The latest developments and design of vacuum tubes for the detection of radio frequency currents and the amplification of audio frequency currents have been embodied in this latest A3 "Saco" Detector and Amplifier.

The telephone receiver can be connected to either detector, first or second stages of the amplifier by plugging the receiver circuit into the proper jack. This permits the operator to select the proper stage in the quickest possible manner.

Squealing, howling or whistling has been entirely eliminated in this amplifier. The elimination of these undesired effects is principally due to the careful design of the transformers, which have a very low flux leakage coefficient, thereby preventing coupling due to these stray fields between circuits to oscillate at audio frequencies.

The filament current for the three tubes is supplied from one battery. Separate binding posts are provided for the detector plate battery.

PANEL: "Bakelite Dilecto" $\frac{1}{4}$ inch thick, and hand grained. Engraving on the panel is of the standard pantograph type. Letters filled with Dixon white engravers' filler. This filler is set in and will stay in permanently without cracking or falling out from the letters. The view holes are screened with fine brass nickel plated screening. The holes are used to note the brilliancy of the tubes.

TRANSFORMERS: Core type, ratio of transformation 1:3.75. Primary resistance 2,360 ohms, secondary resistance 9,500 ohms. Transformer impedance measured at 800 cycles is the same as the internal impedance of the standard market vacuum tubes. Laminations are very thin and are properly insulated from each other, giving a low percentage of core loss.

TUBE, SOCKETS: Heavy brass tube, hole machine bored to give sliding fit for standard four-prong tube. Bakelite base and four-spring connectors. The sockets are mounted vertically.

RHEOSTATS: Two fibre machine slotted flat forms, wound with special resistance wire, to give maximum resistance with minimum space. Resistance of each rheostat 3.1 ohms. Spring movable contact used to obtain variation of resistance. Spring moved by a knob in front of panel.

BIASING RESISTANCES: Two fibre machine slotted flat forms, wound with special resistance wire.

WIRING: The various apparatus are wired with No. 14 bare hard drawn copper wire insulated with varnished sleeving, all connections being soldered.

CABINET: Quartered oak, mission finished. A hinged cover is provided on top in order to permit the insertion or removal of the vacuum tubes from their respective sockets.

METAL PARTS: All metal parts are made of brass and are nickel plated and polished.

WORKMANSHIP: The very best workmanship has been applied in the manufacture of this and all of our other standard apparatus.

DIMENSIONS: $11\frac{1}{4} \times 5\frac{3}{4} \times 6\frac{1}{2}$. Approximate shipping weight, 14 lbs.

Wiring diagram and instructions accompany each amplifier.

Cat. No. A3-43 Detector and Two-Stage Audio Frequency Amplifier.. \$150.00

RADIO-CRAFT DETECTOR AND TWO-STAGE AMPLIFIER

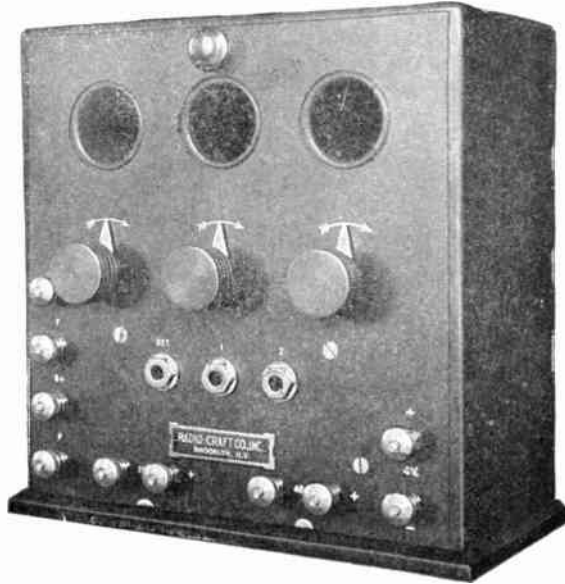

Efficiency to the nth degree is obtained with this piece of apparatus. A combination of the detector unit and the two-stage amplifier—it performs the work of both perfectly. Realizing the convenience of such an instrument, Radio-Craft taxed its ingenuity to the utmost and the result is perfect utility coupled with compactness and beauty. The Radio-Craft panel design is followed, allowing immediate inspection by simply snapping out the panel.

Cabinet: Quartered Oak, weathered oak finish.

Panel: Bakelite-dilecto, grade XX, $7\frac{7}{8}'' \times 8'' \times 1\frac{1}{8}''$ thick, hand rubbed finish.

Rheostats: Radio-Craft standard back mounted, smooth and critical adjustment, resistance of 6 ohms provided with off position for filament control.

Vacuum Tube Receptacles: Are designed to take the standard four prong receiving base, made of seamless brass tubing, fastened to a bakelite shelf, and have heavy phosphor bronze contacts to assure perfect electrical connection.

Amplifying Transformers: Closed core type correctly designed for the standard V. T. tubes, mounted with brass angles on a bakelite panel.

Telephone Jacks and Plug: Standard Federal type; three employed for detector, first and second stage.

Wiring: Rigid hard drawn copper wire covered with varnished tubing.

Binding Posts: Radio-Craft standard, finished in white nickel.

Grid Condenser: Made of finest India mica and copper foil.

Shipping weight $6\frac{1}{2}$ lbs.

Cat. No. A3—10 Price \$140.00

VACUUM-TUBE DETECTOR AND TWO-STAGE AUDIO-FREQUENCY AMPLIFIER

TYPES RORD and RORF



Here is a compact piece of apparatus which combines a vacuum-tube detector with a two-stage audio frequency amplifier. The necessary fittings and controls for the detector tube unit are made an integral part of the assembly, thus making for compactness and efficiency in receiving sets.

Convenience is the keynote of this Type RORD set. The telephone jack and plug system of control is employed to good advantage in the controlling of both the filament and telephone circuits. Too much cannot be said of this feature, since it affords automatic control of the vacuum-tube equipment, thereby affecting an economy in the life of the tubes and the batteries as well as providing instant control of the apparatus. Thus with the plug in the first jack, the detector only is placed in operation; in the second jack the detector is maintained and its output transferred from the telephones to the primary of the first-stage amplifying transformer, the output of which is received in the telephones; in the third jack the previous circuits are maintained, and the second-stage of amplification is obtained.

Panel Size, $6\frac{1}{2} \times 10\frac{1}{2}$ inches. Net Weight, 7 pounds. Shipping Weight, 14 lbs.

Wiring diagram and instructions accompany each amplifier.

Cat. No. 110—18 RORD Detector and Two Stage Audio-Frequency Amplifier	\$140.00
Cat. No. 116—18 RORF Same as RORD, but without automatic filament control	130.00

FEDERAL AUDIO FREQUENCY TRANSFORMERS

These transformers are of the shell core type with a 1 to 3 ratio of turns. The D. C. resistance of the primary is approximately 2200 ohms and of the secondary approximately 9150. The impedance at 500 cycles is the same as that of the internal impedance of the Standard V. T. This, as explained above, provides the maximum efficiency of operation, and may be obtained with other makes of tubes having the same internal impedance. The flux leakage in the Federal transformer is very low and as a consequence the tendency to oscillate at audio frequencies, due to stray fields between circuits in a cascade amplifier, is reduced to a minimum.

The complete transformer is 2 1/4" high, 1 1/4" wide and about 1 1/4" deep. It is provided with mounting lugs so that it can be placed in any position, screws and nuts for mounting are furnished with the No. 225-W Type Audio Frequency Transformers. It is also equipped with both thumb screws and solder clips for convenience of temporary or permanent mounting. In other words, it has dimensions and flexibility particularly suitable for the amateur's cabinet.

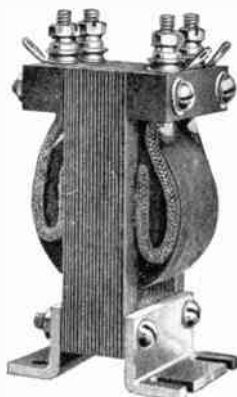

No. 226W—20 Transformer	Price Mounted	\$16.00
No. 226W—20 Transformer	Price Unmounted	15.00

ACME AMPLIFYING TRANSFORMERS

ACME AUDIO FREQUENCY TRANSFORMERS of the A-2 type are designed to be used most successfully with those tubes having a plate to filament impedance of from 20,000 to 30,000 ohms and a grid to filament impedance of 300,000 ohms, as these impedances are most common among tubes on the market. Such impedances of plate and grid circuits call for a ratio of primary and secondary turns of 1 to 4 which is used in the Acme A-2 type. Excellent material and good workmanship are used and a rigid inspection maintained to insure a uniform well made product.

After hooking up an amplifying transformer it is well to try the secondary terminals connected to the grid and filament first one way then the other and note the difference. It is usually found that the best results are obtained with the outside secondary terminal connected to the grid and the inside to the filament.

It is also well to keep the grid at a negative potential in order to prevent grid currents as current flow greatly changes the effective impedance of any transformer.

The complete Acme A-2 type of amplifying transformer is mounted as shown in the cut on aluminum supports with engraved bakelite panel, nickel-plated fittings and binding posts. Two other styles are supplied, one having aluminum supports and terminals on a bakelite strip and the other type consisting of coil and core assembled.

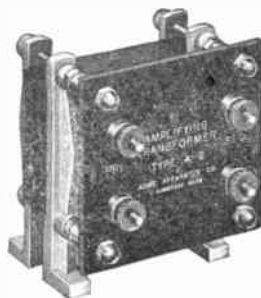

Type A-2—19 Completely mounted with engraved panel	\$14.00
Type A-2—19 Assembled with supports and binding posts	10.00
Type A-2—19 Core and coil assembled	9.00

AMPLIFYING TELEPHONES

These receivers will positively give from two to three times the intensity with nearly all signals, several customers writing us that when used with a crystal detector, results are almost, if not quite, equal to the addition of an Amplifier. The diaphragm is not acted upon directly by a varying magnetic force, but is made of mica and receives its impulses from a thin iron armature to which it is connected by a link.

Some of the prominent advantages of this instrument may be briefly mentioned: It has a long permanent magnet, being more than a complete circle since the ends overlap. The magnetic circuit has comparatively little reluctance, having a double path between the pole pieces. The air spaces are thin and the flux from the permanent magnet does not have to pass lengthwise through the armature. These

features of the magnetic circuit favor a strong flux and permanency of magnetization.

The loss of power by hysteresis and eddy currents is reduced to a minimum and the effect of the winding upon the armature is utilized at both ends and on both sides at each end. The diaphragm being of thin mica is very light and sensitive and the total weight of all moving parts is only a fraction of the weight of the common steel diaphragm. The headband is very simple and its construction will be easily understood from the illustration. It fits snugly and comfortably and will not pull the hair.



Cat. No. 8426—1	C	Amplifying Phones	\$33.00
Cat. No. 8426—1	D	Amplifying Phones	35.00
Cat. No. 8426—1	E	Amplifying Phones	40.00
Cat. No. 8426—1	F	Amplifying Phones	42.00

NO. 55 SPECIAL RECEIVERS



Complete double sets made in resistance of 2000 and 3000 ohms; bipolar receivers; cases, special process hard rubber composition; patented solid construction; magnets, best quality steel in amount sufficient to provide dense and permanent magnetization; spool windings, enamel coated copper wire; diaphragm, thin flexible, non-rusting, and perfectly seated; cord, five foot, mercerized, best quality; headband, nicked German silver, split and adjustable; weight complete double set, 14 ounces; shipping weight double sets, 1¼ pounds, single set, 1 pound receiver only ½ pound.

Cat. No. 55—8	Complete Double Set, 2000 ohms	\$9.00
Cat. No. 55—8	Complete Double Set, 3000 ohms	11.00

TRANSATLANTIC RECEIVERS



New Model Transatlantic

These Receivers are very sensitive, with particular attention given to the quality of the tone produced. They have metal cases with hard rubber ear caps designed to fit the ear with comfort. The magnets are wound with silk insulated wire .002 inch in diameter to a resistance of 2800 ohms to the set. The receivers are suspended from the hard rubber covered split headband by ball and socket joints, and are fitted with a six-foot green silk cord.

Cat. No. 213—1 Transatlantic Model. \$20.00

SUPERIOR RECEIVERS

These Receivers have aluminum cases, hard rubber ear caps, and thin diaphragms, and are wound with No. 40 enameled copper wire to a resistance of 1000 ohms to each receiver, or 2000 ohms per set. They are extremely efficient for a low-priced instrument and will give excellent service.

Cat. No. 214—1 2000 ohm Superior Set, as illustrated. \$14.00



Superior Model

NAVY TYPE TELEPHONES

Brandes Navy Type Telephones need no introduction to the wireless fraternity, as they have been favorably known for a number of years as a sensitive and reliable receiver of good construction and light weight. Each receiver weighs only three ounces and is built like a watch. They are wound to 3200 ohms resistance, have polished aluminum cases, shallow hard rubber ear caps double hard rubber covered headband with swiveled joints, six-foot best silk cord and thin diaphragms (.004 inch).

Cat. No. 212—1 Brandes New Navy Type Head Set... \$28.00

Six-foot Green Cord Double 2.00

Receiver Cap for any of the above Receivers50



BROWN'S RADIO PHONES

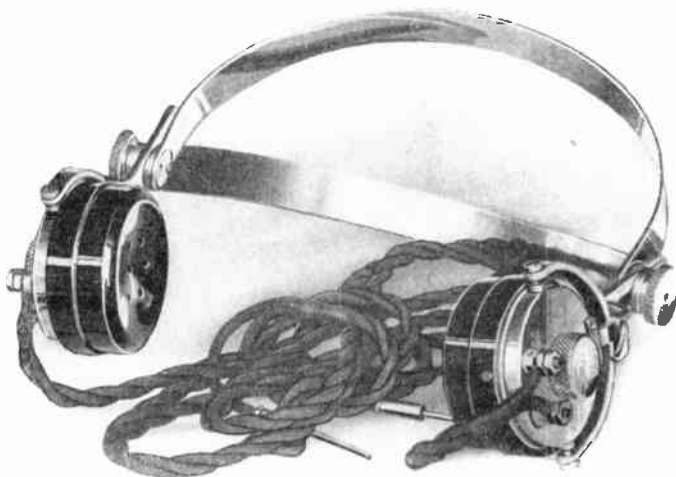

The electrical construction of the Brown Telephone is quite different from any other made. The magnet coils are wound on the pole pieces of a permanent magnet, as usual, but the ordinary diaphragm is replaced by an iron reed tuned to a suitable note, to which an aluminum diaphragm is screwed. This diaphragm is spun into a special fitment. The whole is covered by an ebonite cap. All steel parts are protected against rust. The receivers are mounted on light aluminum head bands, making a very comfortable headset of only 10 oz. weight.

Wireless signals are received not only with increased efficiency, but with a remarkable degree of sharpness. The fact that there is no tendency for signals to run together is a feature of much importance. For loud signals these receivers are equally advantageous and tests have shown remarkable audibilities. These phones were used by the British Admiralty, War Office and Air Force, and by the Germans on submarines—a surprise compliment to the British. Type "A" is recommended for wireless reception, or any work where it is necessary to hear weak signals, as it has the highest efficiency for this particular class of work.

These receivers can be supplied from 120 to 24,000 ohms the pair. Shipping weight, 12 lbs.

Cat. No. 44A	4000 ohms	\$40.00
Cat. No. 44B	8000 ohms	44.00

MAGNAVOX LOUD SPEAKER

Magnavox Radio Telemegafone R1-14

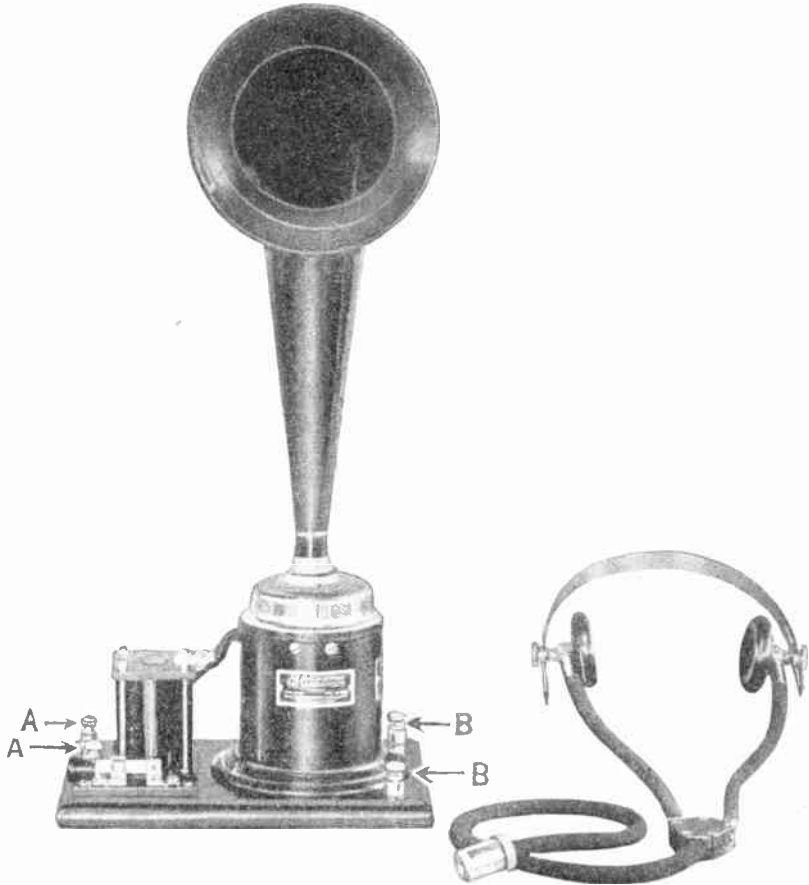

The Type R1-41 Radio Telemegafone set consists of:

1 type LS-2 Telemegafone.

1 metal horn, 17 inches long with mouth 6 inches in diameter.

1 listening tube head-set.

1 special step-down induction coil and battery switch, mounted on base with Telemegafone.

A 6-volt storage battery is required to furnish current to energize the electro-magnet of the Telemegafone. The leads from the battery are connected to terminals marked B-B, which in turn are connected to the field coil of the Telemegafone.

The apparatus illustrated reproduces and amplifies the sound of signals, either telegraphic or telephonic. The Magnavox electro-dynamic receiver, which promises to revolutionize the art of telephony, is used in this equipment. The apparatus itself is not an amplifier in the true sense, inasmuch as it contains no elements which locally will increase the incoming current. The outfit, however, does transform the variable electric currents into sound vibrations in a most efficient manner.

Cat. No. R1-41 Magnavox Radio Telemegafone..... \$180.00

SPECIAL LITERATURE SENT ON REQUEST

CLAPP-EASTHAM TYPE "B. Q." WAVEMETER



Type B. Q. Wavemeter is an accurate instrument of simple and rugged construction and compact size, for portable use, if desired.

The instrument comprises an oak box with Bakelite panel on which are mounted one of our balanced type condensers, buzzers, detector, switch for connecting in either buzzer or detector, and four pair of binding posts (for connecting inductance coil, meter (hot wire or thermo couple) telephones, and buzzer battery (single dry cell) respectively).

A small compartment in the box holds the two inductance windings with their metal strips for attaching to binding posts.

The oak box measures $5\frac{3}{4}$ inches by $8\frac{1}{4}$ inches by $6\frac{1}{2}$ inches high and the instrument weighs complete 5 pounds.

When the buzzer is operated by means of the switch, the meter emits oscillation of known wave length depending upon the setting of the condenser and the coil used as indicated on the chart furnished with each instrument. A capacity curve of the condenser also accompanies each instrument.

It thus provides a source of test signals of any wave length desired, from which other circuits may be calibrated or measured.

When used with the detector and telephone, the instrument may be used to measure signals from any outside source.

The instrument is calibrated from oscillating vacuum tubes with circuits calibrated by the Bureau of Standards. Its range is 150 to 2000 meters.
 Cat. No. 7042—15 Type B. Q. Wavemeter..... \$55.00

Shipping Weight, 8 lbs.

**GENERAL RADIO DIRECT READING WAVE METER
TYPE 174-16**

For many purposes a wave-meter is desirable which will embody the direct reading, accuracy and utter simplicity—but which will also permit of a greater range of wave-lengths than can be obtained with one coil and condenser. No. 174-16 Direct Reading Wave-Meter has been designed to meet these requirements. It contains three coils mounted together and calibrated directly in wave-lengths. A simple switch sets the wave-meter to any of these scales. A sensitive hot-wire galvanometer and crystal detector is supplied. In addition, a High Frequency Buzzer is mounted directly beneath the panel for generating damped oscillations, and a battery compartment, accessible without disturbing the panel, is provided. This wave-meter is therefore adaptable to producing oscillations of known frequency, and to measuring wave-lengths of transmitters or receivers. It is simple to operate and is calibrated by means of oscillating vacuum tubes to better than one per cent. Its range is 130 to 3000 meters.



Cat. No. 174-16 Direct Reading Wave-Meter \$136.00
Shipping weight 10 lbs.

ELECTRODYNE RECTIFIER

This tube is designed to operate on voltages up to 500 and to carry and rectify currents up to 30 milliamperes. In nearly every case, two tubes are used, to rectify both sides of the A. C. wave. In this event, the two tubes will continuously carry 60 milliamperes, sufficient for most purposes. Generally a transformer is employed to transform 110 current to 500 or 750 volts or less. Such a transformer has another secondary of 24 volts, 3½ amperes carrying capacity, for lighting the filaments of the two rectifier tubes in series. We have listed a transformer above which we can supply with either 500 or 750 volt secondary. Total capacity is 150 watts; 84 watts are required for lighting the filaments.

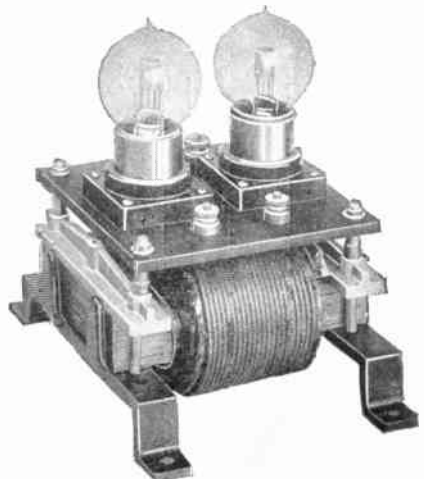

Cat. No. 25RT. Electrodyne Rectifier complete \$70.00
Cat. No. 25VT. Vacuum Tube only 14.00

HYTONE TRANSMITTING SETS

The advantages of the Quenched Spark Transmitter are so well known as to hardly require mention even to the novice. Unfortunately, however, sets of the type used by the United States Navy and others are beyond the reach of the average user, as they require a special 500 cycle motor generator set for their operation, and previous to the introduction of our Hytone Rotary Quenched Spark Transmitter no one had been able to combine the advantages of the quenched spark in a transmitter operating on 60 cycle 110 volt current such as is commonly available for lighting and power purposes. This apparatus has been greatly improved, since it was first introduced by us, and we believe it stands alone in efficiency of operation, and reliability, among 60 cycle transmitters, being surpassed only by the best transmitters operating on 500 cycle generators.

The efficiency is from 50 to 70 per cent when used with an antenna having a radiation resistance of 10 ohms.

The tone or pitch is a clear whistle, almost duplicating the tone produced by a 500 cycle generator.

The set is practically noiseless in operation, the spark is entirely enclosed and invisible. There is an entire absence of loud reports and blinding flashes common to all open spark gaps.

Reliability is inherent in these equipments, rendering electrical breakdown unknown, due to the extremely low potentials employed.

The adjustment of the apparatus is very simple, requiring only the tuning of the helix and the setting of the spark gap, which, when once in adjustment, does not require further attention.

This set conforms to all requirements of the Federal Law as regards a pure wave and damping, and when used with a suitable antenna may be adjusted to 200 meters.

The set consists of Transformer, Rotary Quenched Spark Gap, Motor, Condenser, Helix, Key, Hot Wire Meter and Protective Device.

We can offer this set with the utmost confidence to those who can appreciate high quality, and by reason of its efficiency it will accomplish greater distances than sets of higher power rating and of greater first cost.

Cat. No. 740—15	½ K. W. Hytone Set complete as above, shipping weight 300 pounds	\$500.00
Cat. No. 740A—15	½ K. W. Hytone Gap, Motor and Transformer only, to be used with Condenser and Helix supplied by customer, and without mounting, shipping weight 150 pounds	250.00
Cat. No. 771—15	1 K. W. Hytone Transmitter consisting of same instruments as the ½ K. W. Set.....	1,000.00
Cat. No. 772—15	1 K. W. Hytone Gap, Motor and Transformer only, shipping weight 200 pounds	500.00

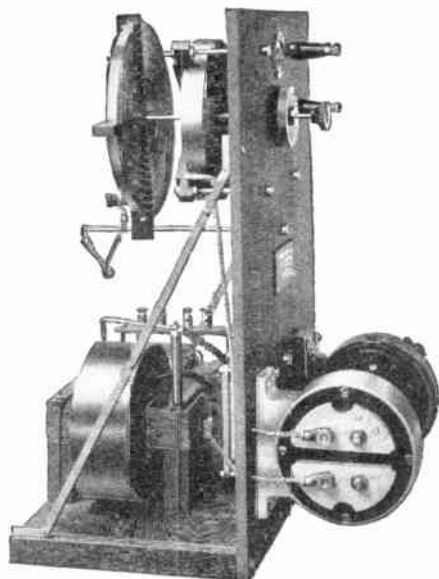

IMPROVED ANTENNA SWITCH

These Antenna Switches have proven very popular among those who take pride in the high quality of their apparatus. The three-pole Switch and hard rubber standard are mounted on an engraved bakelite base six inches by eight inches by ½ inch thick, and terminals are sufficiently separated to provide protection to sets up to 1 K.W. When thrown to the upper or receiving position, the switch disconnects the antenna from the helix, connecting it to the receiving set and opening the power circuit so that damage to the receiving instruments through accidental pressure of the transmitting key is impossible.

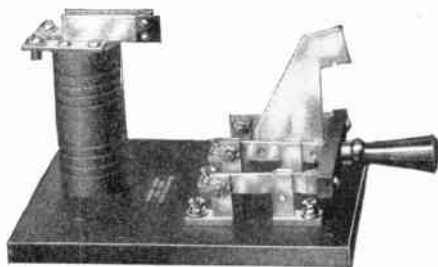

When in the down or sending position the antenna is disconnected from the receiving set and connected to the transmitter, the current supply is closed to the transmitter, the receiving set is short-circuited and grounded for protection and the right-hand switch blade closes the circuit to the motor of a rotary spark gap or closes any other circuit desired. This Switch represents a value to which the illustration cannot do justice. Shipping weight 12 pounds.

Cat. No. 658—15 Improved Antenna Switch \$25.00

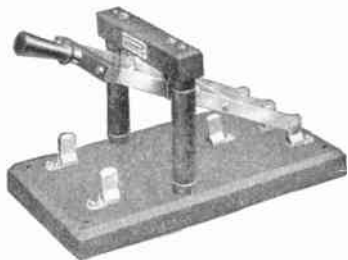

ANTENNA SWITCH NO. 463

A large, sturdy, well built "change over" switch, suitable for use on sets up to 1 K.W. Base, mahogany finish; pillar support, moulded composition, insuring good insulation; copper blades. Fitted with third blade to disconnect receiver when transmitting. Shipping weight 2½ lbs.

Cat. No. 463—8 Antenna switch \$9.00

LIGHTNING SWITCH

In many localities the Fire Underwriters require a 600 vclt 100 ampere S. P. D. T. switch for grounding the aerial when not in use, for protection against lightning.

A ground wire of copper not smaller than No. 4 is also required to run to a ground outside of the building. Lightning switch is mounted on a special waterproof base which is an excellent insulator.

Cat. No. 384—1 Lightning switch 600 V. 100 Amp. \$11.00
 No. 4 Ground wire for sameper foot .30

TYPE 652—15 RADIOCOUPLER

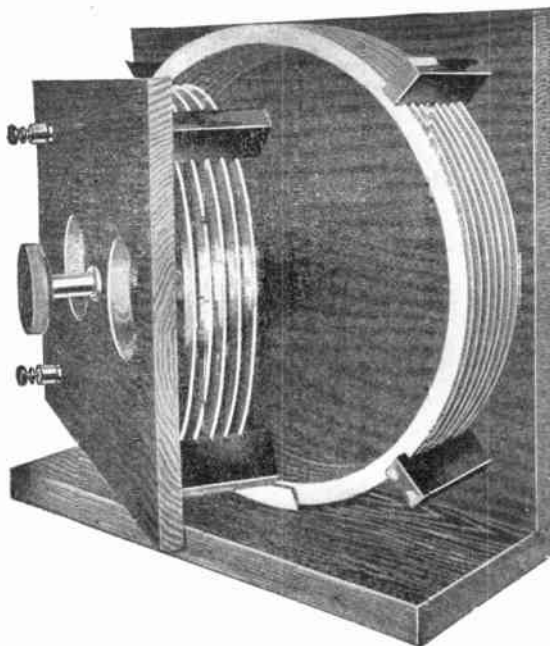

The 652—15 Radiocoupler is a type commonly met with in commercial practice and offers all the advantages of the more expensive types at a minimum cost. The oak framework, finished dull black, carries slotted bakelite arms which support the primary and secondary windings. Primary consists of five turns edgewise copper strip, $7\frac{1}{2}$ inches inside diameter.

The primary is continuously adjustable by means of a rotating handle, as shown in the illustration, while helix clips of our standard type are fitted to the secondary. The instrument is $13\frac{1}{2}$ inches long, 12 inches high and $4\frac{1}{2}$ inches deep, fully closed. Net weight 10 lbs. Shipping weight 25 lbs.

Cat. No. Z652—15 Radiocoupler	\$40.00
Cat. No. Z651A—15 Helix Clip	1.00

OSCILLATION TRANSFORMER No. 424—8

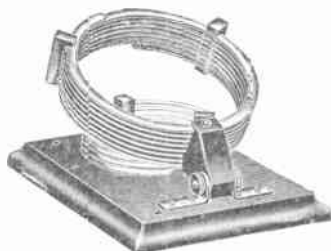

For best sending practice, it has become necessary to use a transmitting transformer of this type in order to secure the sharp wave required by regulations. This is one of our best values. Hinged type, flat copper ribbon wound, supplied with four connection clips. Shipping weight 8 lbs.

Cat. No. 424—8 Oscillation Transformer for Sending. Price each.....	\$10 00
---	---------

DUBILIER MICA CONDENSERS FOR TRANSMITTING

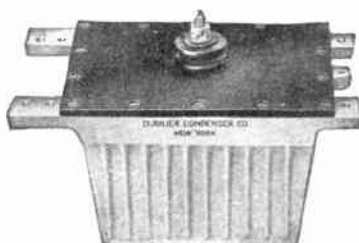

Dubilier Condensers have long been noted for their extreme reliability, high efficiency, ruggedness and compactness. The United States Government used thousands of these condensers during the War. They are furnished in a variety of sizes and shapes, the more common of which are listed below. The illustration above shows the general appearance of the condenser, Bakelite top, aluminium container, etc. The Type T-150 is furnished in a small wooden box, wax impregnated. Only the best grades of Mica and Foil are used in the construction of these condensers. The amateur transmitting on a 200-meter wave will find the condenser having a capacity of 0.007 to give the best efficiency.

Type No.	Power	Max. Volts	Capacity	Price
D 100—23	¼ K.W.	10,000	.007 Mfd.	\$38.00
D 101—23	½ K.W.	14,000	.007 "	60.00
D 102—23	1 K.W.	21,000	.007 "	90.00
D 103—23	1 K.W.	25,000	.007 "	100.00
D 110—23	¼ K.W.	10,000	.01 "	42.00
D 111—23	½ K.W.	14,000	.01 "	70.00
D 112—23	1 K.W.	21,000	.01 "	100.00
D 113—23	1 K.W.	25,000	.01 "	110.00

Special Mica Condensers tested at 1000 volts for use in the construction of amplifiers, and receiving equipment.

D 170—23	Winged type condenser five capacities from .00005 to .00025 mfd.	\$3.00
D 180—23	Fixed Mica Condenser capacity 0.00025 mfd.	2.00
D 181—23	Fixed Mica Condenser capacity 0.0005 mfd.	2.00
D 182—23	Fixed Mica Condenser capacity 0.001 mfd.	2.00
D 183—23	Fixed Mica Condenser capacity 0.005 mfd.	2.00
D 184—23	Fixed Mica Condenser capacity 0.0025 mfd.	2.00

Prices on Other Sizes and Capacities on Application

AMRAD QUENCHED SPARK GAPS

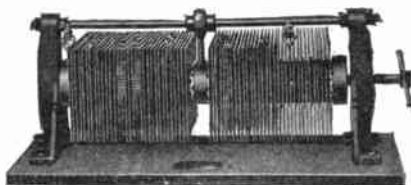

½ K. W. Gap—G-2

Operating Advantages: Wherever noise is objectionable, as in the case of stations located in apartments or those operating late at night, the Amrad Quenched Gap fills a long-felt need. Its operation is practically beyond detection at a distance of eight or ten feet.

From the standpoint of reliability, its use minimizes the liability of condensers to puncture and as there are no motor windings subject to sudden burn-out from kick-back effects, a station equipped with the Amrad Quenched Gap may be depended upon for continuous operation under all conditions.

The comparatively great distances that may be covered with a minimum consumption of energy result in reduced current bills. Elimination of the necessity of waiting for gap motors to come up to speed and slow down, not only affects a further economy, but increases the speed at which messages may be exchanged.

Operating advantages are not confined alone to the transmitting station. Operators of receiving stations using regenerative circuits will find that the spark note of a quenched gap set operating on 60 cycles a.c. may be amplified to greater intensity before distortion becomes noticeable than is possible with a 500 cycle or rotary gap note.

Design: The Amrad Quenched Gap is adapted from a gap carefully designed by us for commercial use. No effort has been spared to make it maintain our commercial reputation both in workmanship and performance.

It is the only quenched gap correctly designed for efficient operation on short wavelengths with transformers supplied by 60-cycle current. Especial attention is directed to the fact that the shorter waves require smaller condensers and consequently higher transformer potentials in order to radiate maximum energy. These high potentials demand the use of a sufficient number of sparking chambers to prevent arcing and insure proper quenching. Our three types of gap contain 7, 16 and 32 sparking chambers respectively, sufficient in each case to maintain maximum efficiency.

Wide heat distribution gained by the use of a large number of gap plates assures long life to both sparking surfaces and gaskets. The gap plates are made square in shape in order to increase the amount of surface radiation and stimulate the flow of natural convection currents.

Construction: The Amrad Quenched Gap consists of an assembly of gap plates, gaskets and spacing rings rigidly held by a powerful screw compression in a rugged frame. All insulating supports are of Bakelite.

The gap plates are die stamped from surface hardened electrolytic copper and individually tested to meet a high standard of accuracy. The superior quality of copper employed accounts for the performance of the Amrad Gap comparing satisfactorily with the costly silver surfaced quenched gaps used in commercial service. The gaskets, constructed from .040 inch fish paper and treated with oil and bees wax compound are superior to mica gaskets. Gap plates are transparent lacquered and the finish of the instrument is an attractive flat black. All parts used in the three types are identical in design.

A complete price list of renewal parts, specific operating directions and extra gaskets accompany each gap.

Cat. No. G1—24	Quenched Spark Gap for 1 K.W.	\$83.00
Cat. No. G2—24	Quenched Spark Gap for ½ K.W.	49.00
Cat. No. G3—24	Quenched Spark Gap for ¼ K.W.	32.00

BEEKO SPARK GAP

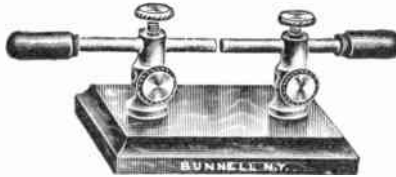

A good substantial zinc spark gap for use with spark coils up to 2 inches. Mounted on a porcelain base with nickel plated brass supports.

Cat. No. 7750—11 Postage weight, 1 lb. Price each..... \$2.80
 Cat. No. 8946—11 Renewal Electrodes. Price pair..... 1.00

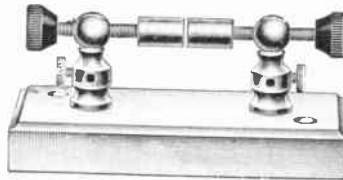

Suitable for stations up to 1/4 K. W. Has adjustable electrodes made of high grade zinc and is mounted on a glazed porcelain base. The large rubber knobs permit gap to be adjusted while in operation.

Cat. No. 421—1 Standard Spark Gap. Price..... \$5.40

TRANSMITTING CONDENSER No. 483—8

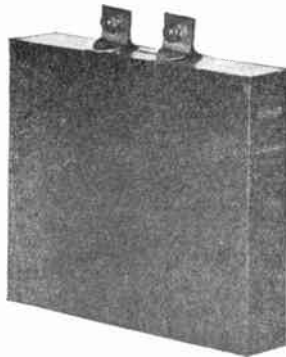

No. 483—8

The Murdock Moulded transmitting condenser is distinctively superior to the average experimental condenser. It is built in solid sections, so constructed that brushing is eliminated, and in operation it is characterized by its extremely low internal losses, lower than those of any similar condenser. It is strong, convenient, and efficient. Investigation of its merits will prove its special value in amateur installations especially with sets of the lower powers using rotary or quenched gaps. Capacity per section, .0017 mfd. Shipping weight per section 3 lbs.

Cat. No. 483—8 Moulded condenser per section. Price each..... \$5.50

TRANSMITTING CONDENSER No. 488—8

Similar in construction to our No. 483 but built of selected materials in sections of .002 mfd., capacity. Designed and constructed for those who desire the best. Shipping weight per section 3 lbs.

Cat. No. 488—8 Moulded condenser per section. Price each..... \$10.00

SPECIAL ACME TRANSFORMERS

ACME 250, 500 AND 1000

The Acme 250, 500 and 1000 watt transformers are so designed that the same operating characteristics as the F and H types are obtained without the use of choke coils. The saving effected by this design together with a different mounting, which is as serviceable if not as attractive, is reflected in the price. These transformers are also of the non-resonant type and draw their full rated power when operating with a rotary spark gap of 700 to 800 sparks per second and .007 MF condenser, and show under these conditions an efficiency of 82 per cent or better at full load with a power factor of .90 or better. As with the F and H types the best of materials are used in construction and each unit tested under actual working conditions. The fully mounted type has secondary terminals with safety gap finished castings, primary binding posts on engraved bakelite terminal board. These transformers are also supplied without castings, terminal board and primary binding posts.

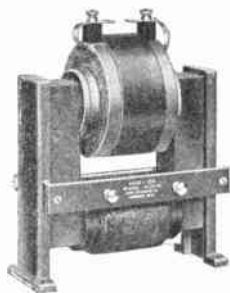

The 500 and 1000 types are provided with means of reducing the power input to one-half value.

110 VOLT 60 CYCLE

Type	Low Power	Full Power Fully Mounted	Voltage	Price
250—19 Transformer		250 watts	9,000	32.00
500—19 Transformer	250 watts	500 watts	11,000	44.00
1000—19 Transformer	500 watts	1000 watts	15,000	66.00
	Without Casting, Terminal Board and Binding Posts			
250—19 Transformer				\$25.00
500—19 Transformer				35.00
1000—19 Transformer				55.00

ACME RADIO TRANSFORMER

The Acme Radio Transformers have been designed to operate Amateur Radio Stations at commercial frequencies, with the highest efficiency and within the limits of decrement and wave-length allowed by law. With the Acme Close-coupled, non-resonant Transformer, designed solely for rotary gap work, the secondary voltage is the same, irrespective of the value of the condenser used and will draw full rated power on a condenser small enough for 200 meter work. The power factor of these transformers is exceptionally high, running from .70 for the one K. W. to .85 for the one-fourth K. W. size. This is an important point, as the transformer of low power factor must be comparatively inefficient, due to the larger losses from the heavy current flowing in the windings. When such a transformer is used on an ordinary house circuit, a large current drawn causes considerable drop of the Line Voltage, which further reduces the available power, besides causing the lights on this circuit to "duck," to the inconvenience of the neighbors as well as the operator. The high efficiency of the Acme Transformer, 80-90 per cent. coupled with the fact that they draw full rated power, means more radiated energy than has ever before been attained by transformers of similar rating.



To prevent blowing of fuses from accidental short circuit of the secondary, and to reduce the short circuit currents during the spark interval, a small external reactance is in the primary circuit at all times. An additional reactance with extra binding posts is provided for use when low power is desired for short distance work.

A safety gap of fixed length is set across the secondary terminals to safeguard the windings from burn-out due to high potential surges. An open style of mounting is used with aluminum castings in the small size, and iron castings with black crystalline lacquer finish in the larger sizes. Binding posts of brass, nicked. Bakelite panel, engraved.

Each transformer is tested under working conditions and a test tag attached shows the actual performance. The power listed below is average values with a condenser of .007 Mfd. and a rotary gap with a spark discharge of 750 per second.

Type	Low Power	Full Power	Shipping Wt.	Table Space	Price
Fl-19	150 watts	500 watts	35 lbs.	5" x 7"	\$60.00
Hl-19	250 watts	1000 watts	60 lbs.	6" x 8"	90.00

These prices are for 100-volt, 60-cycle current. Transformers for 220 volts cost \$2.00 extra. Prices for other voltages and frequencies given upon application.

NEW SERIES HIGH TENSION MAGNETIC LEAKAGE, CLOSED CORE TRANSFORMERS

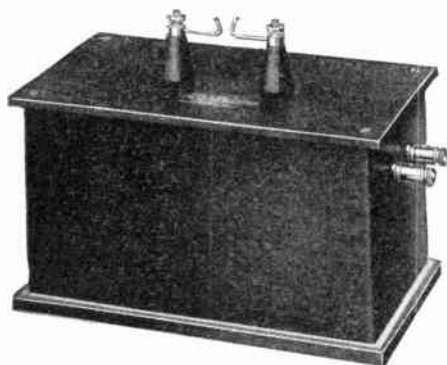

Magnetic Leakage, Closed Core, Resonance Transformers are peculiarly adapted to all purposes where it is desired to charge a condenser in an oscillating circuit, such as operating Tesla and X-Ray coils, spectrum analysis apparatus and particularly in radio telegraph apparatus.

These Transformers are self-controlling, require no rheostat or impedance coil, may be connected directly to 110 volts, 50 cycles A. C. (other frequencies and voltages supplied to order), and unless otherwise specified with order, operate to best advantages on a condenser of .01 M.F. capacity permitting minimum wave length of 200 meters, as required for amateur radio transmitters.

They are now mounted on a slate base with a rubber finished steel case and engraved bakelite top, which carries high potential terminals in the form of hard rubber pillars surmounted by a "Horn" type safety gap. They are also supplied unmounted.

Catalog Number	Power Rating	Maximum Secondary Volts	Required Condenser	Price	Shipping Weight
638—15	¼ K.W.	20,000	.01 M.F.	\$47.00	40 lbs.
639—15	½ K.W.	29,000	.01 M.F.	56.00	80 lbs.
750—15	1 K.W.	40,000	.01 M.F.	80.00	100 lbs.

UNMOUNTED

640—15	¼ K.W.	20,000	.01 M.F.	36.00	30 lbs.
641—15	½ K.W.	29,000	.01 M.F.	44.00	60 lbs.
751—15	1 K.W.	40,000	.01 M.F.	68.00	80 lbs.

C. W. POWER TRANSFORMERS

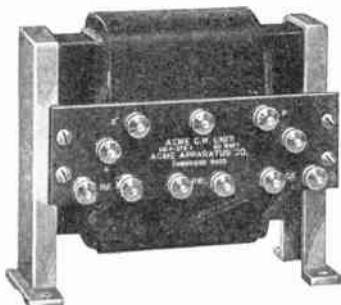

The development of the vacuum tube as an amplifier and rectifier has made it possible for anyone having an antenna to transmit signals and the human voice by means of continuous waves of radio frequencies. Formerly the only source of energy used was a high voltage direct current generator or battery, but by employing rectifying vacuum tubes, chokes, condensers and a properly designed transformer, it is now possible to use the ordinary lighting circuit alternating current supply, thus affecting a considerable saving in the cost of high voltage direct current supply.

C. W. Transmission has many advantages over that of spark discharges, as with C. W. the supply of energy to the antenna is continuous, undamped and of one sharp frequency, while with spark discharges it is intermittent, damped and of more than one frequency. Continuous undamped waves have for a given amount of energy output only a small amount per oscillation at a definite wave length, as contrasted with the spark system, which has a large amount of energy in a small interval of time, after which a period of idleness exists when no energy is being radiated. To handle large amounts of energy in a small interval of time requires large voltages, producing strains on the antenna, leakage and brush discharges. The great advantage of C. W. transmission lies in the receiving end, which, being tuned to one frequency receives all the available energy, as it exists at one frequency only, and being a persistent oscillator is more easily affected by a continuous supply.

The solution of the problem of interference in amateur radio lies in the use of C. W. transmission, as it is possible for stations in one neighborhood to communicate simultaneously at frequencies which differ by only a few per cent. With spark systems it is necessary to work at widely different wave lengths for success and even then there is in all probability a longer wave length with sufficient energy to be heard at some distance, all of which energy is lost to the station with which communication has been established.

With these advantages, coupled with the small losses in vacuum tubes compared with spark gaps, it is possible to communicate over greater distances with C. W. transmission than with spark systems, even with less primary energy.

The ACME C. W. POWER TRANSFORMERS are designed to operate from 110 volts 60 cycles source on the primary, and have two secondary windings of 550 volts each for the 200 watt size and 325 volts for the 50 watt size, and two tertiary windings of 12 volts each, one for rectifying tube filament heating and the other for power tube filament heating. The secondary windings are connected in series with a terminal at the junction so that two rectifying tubes may be used simultaneously, thereby utilizing both halves of the alternating current and voltage waves. By putting a condenser of from 2 MF to 6 MF across the direct current terminals, and choke coils in series with the direct current leads, it is possible to

obtain practically an unfluctuating uniform direct current and voltage for supplying the plate currents of the transmitting power tubes. The tertiary windings are supplied for lighting the filaments, eliminating the use of batteries. This latter winding is tapped in the center and forms one terminal of the direct current supply. By tapping the winding in the center in this manner the direct current flowing in the tube is forced to divide on reaching the filament, preventing excessive current in one side of the filament, which would greatly shorten its life, and in the case of the oscillating tubes prevents the grid from becoming alternately positive and negative. Fluctuation in the voltage may also be reduced by adjusting the rectifying tube filament rheostats.

These C. W. Power Transformers are supplied in two sizes, 200 watt and 50 watt and also mounted and unmounted. The mounted type contains castings, engraved panel and nickel-plated binding posts not supplied with the unmounted type.

Cat. No. 200 CWM—19	C. W. Power Transformers, 200 watts, Mounted	\$40.00
Cat. No. 200 CWU—19	C. W. Power Transformers, 200 watts, Unmounted	32.00
Cat. No. 50 CWM—19	C. W. Power Transformers, 50 watts, Mounted	30.00
Cat. No. 50 CWU—19	C. W. Power Transformers, 50 watts, Unmounted	24.00

200 watts, 110 volts, 60 cycles, 550 volts, 350 milamps, 12 volts for filaments.
50 watts, 110 volts, 60 cycles, 325 volts, 150 milamps, 12 volts for filaments.

Key to Terminal Board:

Terminals marked	P	to plate of rectifying tubes
Terminal marked	—	negative D. C. terminal
Terminal marked	+	positive D. C. terminal
Terminals marked	RF	rectifying tube filaments
Terminals marked	OF	oscillating tube filaments
Terminals marked	Pri	110 volt 60 cycle
Terminal unmarked		center tap for oscillating tube filaments

Larger capacity. Prices on application.

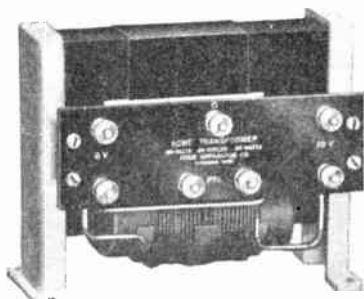

ACME FILAMENT HEATING TRANSFORMERS

When using vacuum tubes for the transmission of radio telegraphy and telephony it is not essential to have the filaments heated by battery current, as it is when using tubes for receiving, as the use of low commercial frequencies at the transmitting station does not greatly affect the reception of signals at the receiving station. The ACME APPARATUS COMPANY has developed a filament transformer to operate on 110 volts, 60 cycles, and to deliver two secondary voltages in order to care for tubes requiring different voltages for proper operation. A center tap is provided on the secondary or filament winding in order to connect the grid circuit to a point whose potential does not alternately change from plus to minus. These transformers are supplied both mounted and unmounted, the former having

supports, bakelite panel, nickel-plated fittings and binding posts. These transformers will supply rated load continuously without undue heating.

Cat. No. 50 FTM—19	Filament Transformers, fully mounted, 50 watt..	\$24.00
Cat. No. 50 FTU—19	Filament Transformers, core and coils assembled, 50 watt	18.00
Cat. No. 150 FTM—19	Filament Transformers, fully mounted, 150 watt	32.00
Cat. No. 150 FTU—19	Filament Transformers, core and coils assembled, 150 watt	26.00

Filament Transformers, larger capacity. Prices on application.

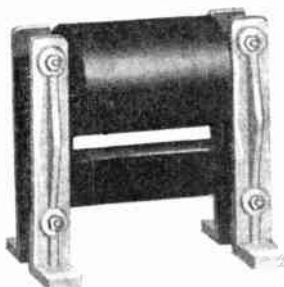

ACME CHOKE COILS

1½ HENRIES

In order to smooth out the pulsations in the direct current supply to keep the direct current constant when modulating, and to prevent the high frequency from getting into the power transformer, it is essential that a choke coil be inserted in the direct current leads.

The ACME APPARATUS COMPANY has developed choke coils which successfully fulfill these conditions, and which are supplied core and coil assembled with supports.

Cat. No. 500 CCS—19	Single-Coil Choke Coil, 500 MA Capacity.....	\$12.00
Cat. No. 150 CCS—19	Single Coil Choke Coil, 150 MA Capacity.....	8.00
Cat. No. 500 CCD—19	Double Coil Choke Coil, 500 MA Capacity.....	16.00
Cat. No. 150 CCD—19	Double Coil Choke Coil, 150 MA Capacity.....	12.00

MICROPHONE TRANSMITTER

This instrument is the result of many years of careful experiments and is considered by experts to be mechanically and electrically correct. They are fitted with the well-known Skinderviken button and are without doubt the finest and best adapted to Radio Telephone work. Every transmitter goes through a series of rigid tests before shipment. Its resistance is very low as compared with the ordinary telephone transmitter, thus insuring very satisfactory results.

THIS TRANSMITTER IS SPECIALLY ADAPTED FOR AMATEUR RADIO PHONES.

Cat. No. 48T	Price	\$5.00
--------------	-------------	--------

ACME MODULATION TRANSFORMERS, TYPE A-3—19 MODULATION TRANSFORMER SAME SIZE AND MOUNTING

The microphone or transmitter used in C. W. radio telephony is connected as a rule to the oscillating system through a modulation transformer, which allows the C. W. to be properly varied at the voice frequencies.

The ACME APPARATUS COMPANY has developed a suitable modulation transformer for this purpose, whose primary and secondary impedances are of the proper values to give most satisfactory results. Care should be observed not to overload the transformer, which under proper working conditions will not distort the speech.

These transformers are the same size as the transformer shown in the accompanying cut, and are supplied in three styles. The mounted and semi-mounted type are recommended for use, as the mechanical construction allows an air gap in the iron circuit, thereby preventing distortion of speech. Where the load is light the unmounted type is perfectly satisfactory.

For those desiring a modulation transformer with variable primary and secondary turns or suitable for larger power the ACME APPARATUS COMPANY is prepared to supply them on order, either according to specifications, or with several random ratios found to cover the limits used in practice.

Cat. No. A3M—19	TYPE A-3 Completely Mounted, with engraved panel	\$14.00
Cat. No. A3SM—19	TYPE A-3 Assembled with supports	10.00
Cat. No. A3U—19	TYPE A-3 Core and Coil Assembled	9.00

WIRELESS SPARK COILS

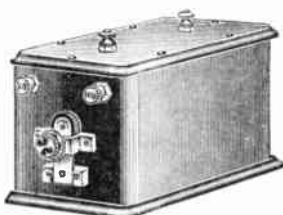

These Coils are designed especially for wireless and experimental purposes. Enclosed in polished oak case with vibrator on the end. Every detail of construction is arranged for durability and efficiency. The spark obtained is powerful and energetic, and is well adapted to operate all high frequency apparatus. We believe that these coils are the most efficient wireless coils on the market. The current consumption of the 1-inch Coil is about $1\frac{1}{4}$ amperes, as compared to from 3 to 6 amperes in other similar coils.

Nos. 459—1 to 464—1 have Condenser in case.

Cat. No. 459—1	Spark Coils, $\frac{1}{4}$ inch	\$7.00
Cat. No. 460—1	Spark Coil, $\frac{1}{2}$ inch	11.00
Cat. No. 461—1	Spark Coil, $\frac{3}{4}$ inch	15.00
Cat. No. 462—1	Spark Coil, 1 inch	16.40
Cat. No. 463—1	Spark Coil, $1\frac{1}{2}$ inch	22.00
Cat. No. 464—1	Spark Coil, 2 inch	30.00
Cat. No. 496—1	Spark Coil, 4 inch	104.40

Price on 495—1 and 496—1 includes 439—1 primary Condenser.

BOSTON KEY

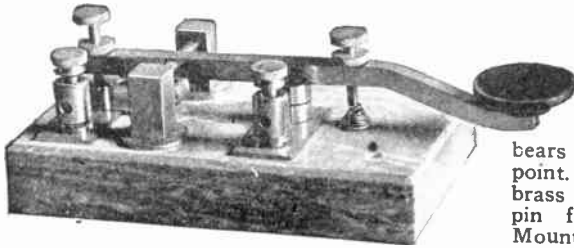

The Boston Key is manufactured with contact points and conductors adapted to sets of all powers, is beautifully finished and bears the stamp of quality at every point. All metal parts are of solid brass nickel plated, except the steel pin forming the center bearing. Mounting is on an engraved bakelite base, 3 1/2 inches by 6 inches, com-

prising a high degree of insulation, solid stability and pleasing appearance. The action of the lever is resilient, preventing fatigue, and the contacts are much larger than required by the amount of current to be carried. The current is not conducted through the bearings but is carried by heavy conductors direct to the binding posts. This key is constructed for heavy current service and has been purchased from us by commercial operating companies and the United States and other governments. This key will give the service demanded of a well made and attractive instrument. Shipping weight 4 pounds.

Cat. No. 643—15 Boston Key for use on current up to 10 amperes..... \$15.00

STANDARD WIRELESS KEY

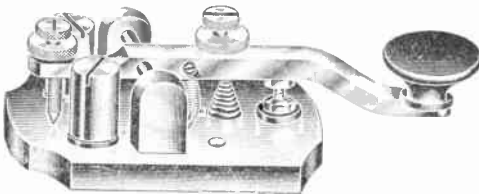

A sturdy heavy key for carrying heavy currents.

All brass construction, with easily removable contacts. Beautifully finished in gold lacquer.

Cat. No. 7933—11	With No. 6 Contacts (Postage Weight, 1 lb.).....	\$8.00
Cat. No. 7940—11	With 1/4 in. Contacts (Postage Weight, 1 lb.).....	14.00
Cat. No. 7941—11	With 3/8 in. Contacts (Postage Weight, 1 lb.).....	16.00

HAND RADIO KEY FOR USE UP TO 1 K. W.



Cat. No. 80—1

The lever is of phosphor bronze accurately balanced. Bronze will not corrode or deteriorate with age.

The base is the Western Union type, and is made of heavy cast brass, well lacquered.

The binding posts have a combination top screw that can be tightened or loosened with the fingers as well as with a screwdriver.

The contacts are made of sterling silver $\frac{1}{4}$ inch in diameter. They are interchangeable and can be readily adjusted. The lower contact can be removed without disturbing the insulation and fitting holding it so that it is not necessary to disconnect the key from its base mounting. This is the only key made with this essential feature. Disturbing the insulation which is the weakest point in a key is serious for many reasons. A special phosphor bronze current carrying spring is fastened on the base and lever so that the current is carried by this spring and not by the trunnion screws.

Cat. No. 80—1	Mesco Hand Radio Key	\$8.00
Cat. No. 88—1	Extra Sterling Silver Contacts, per set of 2	1.00

MASCOT SPARK COILS

This Coil is made to meet the demand of a high grade spark coil. It is the standard coil for small portable wireless sets. Mounted in a nicely finished oak case. Vibrator is made so that it produces a high clear and distinct spark.

Cat. No. 495—1	Spark Coil, 3 inch	63.00
Cat. No. 7758	$\frac{1}{4}$ inch	\$9.00
Cat. No. 7759	$\frac{1}{2}$ inch	11.00
Cat. No. 7760	$\frac{3}{4}$ inch	15.00
Cat. No. 7761	1 inch	16.40
Cat. No. 7762	$1\frac{1}{2}$ inch	22.00
Cat. No. 7763	2 inch	30.00
Cat. No. 7764	3 inch	56.00
Cat. No. 7765	4 inch	80.00

STANDARD PROTECTIVE DEVICE

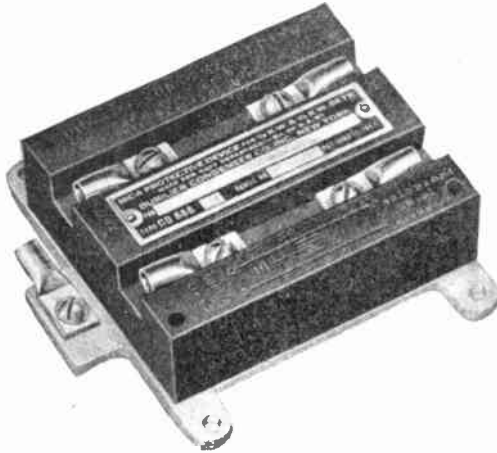

The protection of instruments and small motors and generators up to 1 kw. can be accomplished by the device shown in the above illustration. Bus-bars and lugs are standard 25 ampere type and are so molded in the insulated container as to be slightly below the surface, affording protection from pieces of metal.

A wiring diagram showing methods of connection is impressed in the container.

The capacity of each unit is .02 mfd.

Cat. No. CD-888—23	Tested voltage 3,000	\$12.00
Cat. No. AM-888—23	Tested voltage 2,000	8.00

CONDENSERS SUITABLE FOR RADIO TELEPHONE SETS
 BULB GENERATORS AND SMALL SPARK COIL SETS
 VACUUM TUBE RADIO PHONE CONDENSERS

Dubilier condenser designed for protection purposes on the Standard Radio Telephone Airplane Sets. It is adaptable to all undamped bulb sets for protecting the D. C. generators and eliminating the hum. Capacity .25 mfd., tested voltage 1800 D. C.

Cat. No. D-160—23	Dubilier Condenser	\$14.00
-------------------	--------------------------	---------

ELECTROSE INSULATORS

These insulators are genuine "Electrose" manufactured and are now standard with all Radio Companies and the United States Army and Navy.

LEAD IN INSULATORS



Cat. No. 6222-50

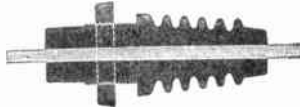

Cat. No. 6858-50



Cat. No. 6815-50



Cat. No. 6266-50

		List Price
Cat. No. 6222-50	Lead in insulator	\$10.00
Cat. No. 6858-50	Lead in insulator	9.20
Cat. No. 6815-50	Lead in insulator	5.00
Cat. No. 6266-50	Lead in insulator	3.40

AERIAL INSULATORS



Cat. No. 4507-50



Cat. No. 4502-50



Cat. No. 4500-50

Cat. No. 4500-50	Ball insulator	\$1.00
Cat. No. 4502-50	Five inch insulator	1.20
Cat. No. 4507-50	Ten inch insulator	2.00

ANTENNA WIRE

No. 14 B. & S. Aluminum, about 240 ft., per lb., price per lb.....	\$1.60
No. 14 B. & S. Hard drawn copper about 85 ft., per lb., price per lb.....	2.00
7/22 Hard drawn copper wire. Price per 100 feet.....	4.00
7/20 Phosphor bronze, Antenna wire. Price per 100 feet.....	6.00
Navy Antenna wire consists of 16 No. 30 wires braided, per 100 feet.....	3.50
7/18 Galvanized Iron Guy Wire, per 100 feet.....	2.00

MAGNET WIRE

LIST PRICES PER LB. ON STANDARD SIZE SPOOLS

Size	Single White Cotton	Double White Cotton	Single White Silk	Double White Silk	Plain Enam- eled
No. 4	\$1.24	\$1.28			
No. 5	1.26	1.32			
No. 6	1.28	1.36			
No. 7	1.30	1.42			
No. 8	1.32	1.52			
No. 9	1.34	1.56			
No. 10	1.38	1.62			
No. 11	1.42	1.70			
No. 12	1.48	1.80			
No. 13	1.56	1.90			
No. 14	1.64	1.98			
No. 15	1.72	2.08			\$1.52
No. 16	1.78	2.20			1.54
No. 17	1.88	2.38			1.60
No. 18	1.92	2.56			1.64
No. 19	2.08	2.76			1.68
No. 20	2.28	3.08	\$3.84	\$5.68	1.72
No. 21	2.44	3.40	4.08	6.20	1.76
No. 22	2.92	3.72	4.68	6.96	1.84
No. 23	2.96	4.12	5.20	7.64	1.92
No. 24	3.32	4.60	5.76	8.60	1.96
No. 25	3.80	5.08	6.32	9.64	2.12
No. 26	4.30	5.90	6.72	10.68	2.30
No. 27	4.74	6.50	7.40	11.96	2.42
No. 28	5.10	7.30	8.32	13.08	2.54
No. 29	5.58	7.98	9.20	15.00	2.70
No. 30	6.10	8.70	10.60	17.20	2.86
No. 31	7.10	10.10	12.00	19.20	3.10
No. 32	7.90	11.50	13.40	22.20	3.22
No. 33	8.80	13.00	15.00	25.80	3.48
No. 34	10.00	14.40	17.00	30.68	3.68
No. 35	11.40	15.80	19.20	35.00	3.92
No. 36	13.40	18.20	23.00	39.84	4.28
No. 37	15.40	20.60	26.60	44.36	4.84
No. 38	17.80	23.00	30.00	50.28	6.00
No. 39	20.20	26.40	34.20	60.00	7.60
No. 40	22.60	30.60	40.00	69.00	9.80

HIGH VOLTAGE DIRECT CURRENT MOTOR GENERATOR

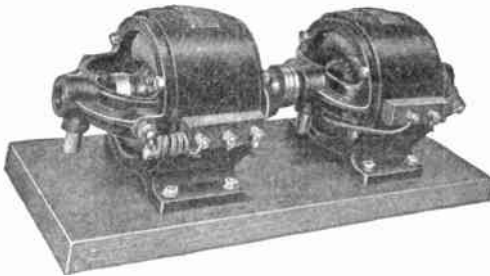

This Motor Generator Set is ideal for use with 500 volt Vacuum Tubes and for many special and experimental purposes requiring not over 0.3 ampere at high voltage. It is rated at 100 watts output, but it is so liberally designed that 100% overload will be carried for short periods. Voltage variations with changes of load are slight, since the generator is flat compound wound.

The machine runs at the standard speed of 1750 r.p.m., and, being provided with $\frac{3}{8}$ " shafts and extra size bronze bearings having wick feed lubrication, will give long and good service. It is mounted on a base 20" x 8" and stands $8\frac{1}{4}$ " high. The output potential may be varied from 240 to 500 volts. Our type TXZ-100-A Regulator is recommended for this purpose.

PRICES AND SHIPPING WEIGHTS

Motor Generator, Type TXW-100-A for AC Drive.....	\$198.00
Motor Generator, Type TXW-100-B for DC Drive.....	220.00
500 Volt Generator, without base or coupling, Type TXW-101-A.....	136.00
Generator Field Regulator, Type TXZ-100-A	40.00

Shipping weight of Motor Generator, 80 lbs. Size boxes, 12 x 12 x 24 inches.

WESTON METERS



D. C. Meter

The Weston line of meters is well known. On account of the large number of different types it is not feasible to give a complete list but we suggest the Model 301—17 instrument as covering a wide variety of uses. Special prices will be quoted upon application on instruments of ranges not included in the table. The standard case-finish is either a dull black japan or full nickel plate. Prices upon any Weston instrument will be quoted upon request.

AMMETERS

Zero-Left	Zero-Left	Zero-Center	Zero-Center
0-1	0-10	1-0-1	30-0-30
0-1.5	0-12	1.5-0-1.5	50-0-50
0-2	0-15	2-0-2	
0-2.5	0-20	3-0-3	
0-3	0-25	5-0-5	
0-4	0-30	10-0-10	
0-5	0-50	15-0-15	Zero $\frac{1}{4}$ Scale
0-8		20-0-20	10-0-30
Model 301—17	Price of each		\$17.00

VOLTMETERS

Zero-Left	Zero-Left	Zero-Left	Zero-Center
0-1	0-5	0-20	3-0-3
0-1.5	0-8	0-25	
0-2	0-10	0-30	
0-2.5	0-12	0-40	
0-3	0-15	0-50	
0-4			
Model 301—17	Price of each		\$17.00

MILLIAMMETERS

Zero-Left	Zero-Left	Zero-Center
0-100	0-400	100-0-100
0-150	0-500	150-0-150
0-200	0-800	300-0-300
0-300		500-0-500
Shipping Weight, 4 lbs.		
Model 425—1	Thermo Meters	
0-1 to 0-5		\$36.50
0-6 to 0-20		44.00

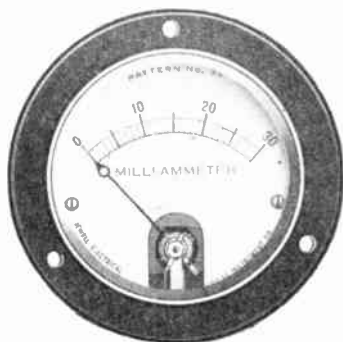

This instrument is the smallest made for panel mounting, and it will be found to be one of the most reliable miniature instruments for direct current work on the market. The diameter of the front of the instrument is $2\frac{1}{2}$ inches and over the flange is $3\frac{1}{4}$ inches.

The small size of these meters make them particularly adaptable to small D. C. switch boards, detector panels, and small C. W. and phone sets.

Made in Milliammeters, Ammeters and Voltmeters in the following ranges.

Cat. No. 33—49

Milli Ammeters	Price	Ammeters	Price	Voltmeters	Price
0— 15 Mil. Amps.	\$13.00	0— 3 Amperes	\$13.00	0— 10 Volts	\$13.00
0— 50 Mil. Amps.	13.00	0— 5 Amperes	13.00	0— 30 Volts	13.00
0— 100 Mil. Amps.	13.00	0—10 Amperes	13.00	0— 50 Volts	13.00
0— 300 Mil. Amps.	13.00	0—15 Amperes	13.00	0— 80 Volts	13.00
0— 500 Mil. Amps.	13.00	0—20 Amperes	13.00	0—100 Volts	13.00
0—1000 Mil. Amps.	13.00	0—25 Amperes	13.00	0—500 Volts	25.00
		0—30 Amperes	13.00		

When ordering please specify range.

RADIO FREQUENCY AMMETER

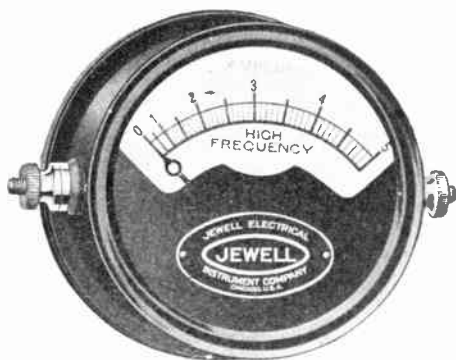

Our type 25 High Frequency Ammeter will be found to be particularly adaptable to medium and small size wireless telegraph and telephone transmitting panels. Much experimental work was done by engineers on high frequency ammeters of various types and the Thermo Couple principle was finally decided upon as being the best adapted to the measurement of high frequency current. The ordinary hot wire or expansion type has a number of undesirable features, such as zero shift, variation of readings with room temperature, variation in reading depending upon the length of time that the current is flowing, and it is delicate. The Thermo Couple type, on the other hand, with its standard direct current D'Arsonval type of movement, is well damped, is rugged in construction, and the readings are absolutely reliable, regardless of external conditions.

This instrument embodies a small Thermo Couple, which is heated by the high frequency current, and the voltage generated by the heating of this Thermo Couple is measured by one of our standard direct current movements. This instrument will be found to be well damped, accurate, and will stand up under the hardest service. It might be noted that instruments of the Thermo Couple type are used by the United States Government on the wireless apparatus of both the Army and Navy, and that the gradual trend seems to be to eliminate the expansion type of instrument as far as possible on this apparatus.

This instrument is also useful for any high frequency work, such as may be encountered in apparatus for the medical profession, testing of alternating current with badly distorted wave form, and general experimental work. The instrument has a nominal diameter of $4\frac{1}{2}$ inches.

	Range	Price
Cat. No. 25A—49	0-1 Amperes	\$36.00
Cat. No. 25B—49	0-3 Amperes	36.00
Cat. No. 25C—49	0-5 Amperes	36.00
Cat. No. 25D—49	0-10 Amperes	36.00

GENERAL RADIO RHEOSTAT

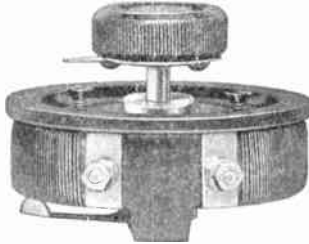

Cat. No. 214—16

The above illustration shows the back of panel type; when mounted only the knob and pointer projecting through the panel. Portable type of rheostat can also be supplied. The resistance of this instrument is about 7 ohms and it has a current-carrying capacity of 1.5 amperes. Ruggedness of construction and smoothness of operation make this rheostat especially adapted to laboratory and radio use. It was particularly designed for use in regulating the filament current in vacuum tube circuits. Other resistances up to 400 ohms can be supplied at a slightly increased cost.

Dimensions, 3 in. d. x 2¼ in. Weight, 7 oz.

Cat. No. 214A—16	Panel	\$5.00
Cat. No. 214B—16	Portable	5.00

PARAGON RHEOSTAT



Designed for either panel or front of board. Has a resistance of 6 ohms, and a current capacity of about 1.1 amps. The base is of moulded condensite and the resistance unit is specially set in a grooved recess. This is without doubt the best and smoothest operating rheostat ever offered to the Radio amateur.

Cat. No. 25—17	Paragon Rheostat	\$3.50
----------------	------------------------	--------

MINIATURE BATTERY RHEOSTAT



Suitable for regulating the voltage of battery circuits in connection with miniature lamps, small motors, etc.

The change in resistance is gradual as the lever passes over the coiled resistance wire, from 0 to 10 ohms. When resting on "off" the circuit is open. In any other position the circuit is closed.

Binding posts and lever nickel plated. Porcelain base. Diameter, $3\frac{7}{8}$ inches.

Experimenters, physicians, surgeons, workers in laboratories, etc., will find this a very useful and efficient miniature rheostat.

Cat. No. 2110—1	10 Ohm Miniature Battery Rheostat.....	\$2.80
Cat. No. 2111—1	4 Ohm Miniature Battery Rheostat.....	2.80

GRAPHITE POTENTIOMETER

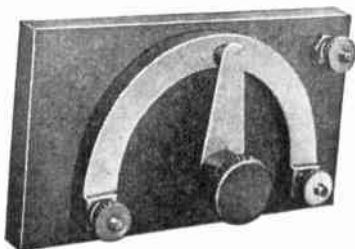

This Graphite Potentiometer, for battery use only, has a maximum resistance of 5000 ohms ensuring long life to any battery connected across its terminals. The sliding contact is of carbon, giving a good contact with the least possible wear to the resistance sector.

Cat. No. 743—15	Graphite Potentiometer	\$5.00
Cat. No. 743A—15	Resistance Sector only, 5000 ohms.....	3.00
Cat. No. 743B—15	Resistance Sector with switch, no base or binding posts	5.00

BURGESS "B" BATTERIES

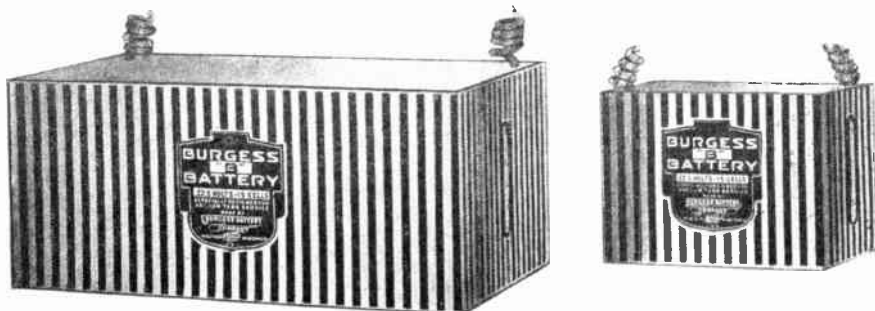

These batteries are an assembly of fifteen individual cells and are designed for use on the "B" or plate circuit in detector or amplifying bulbs, requiring a plate voltage of 22.5 volts or multiples thereof. The batteries must not be confused with batteries consisting of an assembly of flash light cells soldered together in series and sealed in a cardboard case. Burgess "B" batteries are made from special formulae, producing batteries with an exceptionally long life whether in use or when idle. The chemicals are compounded to minimize polarization and depolarization voltage fluctuation, the cause of the troublesome "noises" or "clicks" in the phones.

After manufacture, each cell of a Burgess "B" battery is allowed to stand several days, after which it is tested, and selected for assembly into the complete unit. Each cell is further wrapped in a waterproof and insulating paper, and the wrapped cells are separated from each other by heavy paraffined board. As the insulation completely covers the bottom of the can, moisture on the battery bottom will not give a leakage path between cells for noisy stray currents.

Connections between the cells are short, copper wires carefully soldered, and they are tested before the battery is sealed. The cells are connected together in series in such a manner as to give a minimum voltage between adjacent cells.

A specially prepared wax, free from conductive impurities, is used for sealing the battery, and this wax reaches down between the cells, binding them together into a solid compact block.

The container is a heavy, waterproof box, which keeps the moisture away from the cells. All batteries are carefully sized, and will fit interchangeably into boxes or compartments designed for them.

The leads are cotton covered, rubber insulated, stranded copper wires—red indicating the positive terminal and black the negative.

Tests made on these batteries, alternating them from a warm, moist atmosphere to a dry, cold atmosphere, and at a reduced pressure, show there is practically no change in their characteristics. Batteries have been frozen solid at a temperature of 40° below zero and no appreciable reduction in capacity found after they were thawed.

The number 2156—53 will give an approximate service at 3.0 milamperes of 1,200 hours; guaranteed not to depreciate more than 30 per cent in twelve months. Recommended for use on detectors, amplifiers and for small power bulbs for transmitting purposes where the current is not excessive.

The 4156—53 battery will give an approximate service of 100 hours when discharged at 3.0 milamperes.

Cat. No. 2156—53 "B" Battery 22.5 volts size 3" x 4" x 6 $\frac{5}{8}$ ". Weight, 5 lbs. \$7.0
 Cat. No. 4156—53 "B" Battery 22.5 volts size 2 $\frac{1}{2}$ " x 2" x 3 $\frac{3}{8}$ ". Weight, 1 lb. 4.50

LIGHTING AND IGNITION BATTERIES



MARKO Storage Battery				Overall Dimensions			Gross Weight Pounds	Price
Cat. No.	Type	Volt	Ampere Hour Capacity	Long	Wide	High		
4 VOLT								
10000	4T2	4	20-40	3½	7	8⅞	12	\$21.50
10601	4T4	4	40-60	4½	7	8⅞	17	
10002	4T6	4	60-80	6⅞	7	8⅞	24	
6 VOLT								
10003	6T2	6	20-40	5¼	7¼	8	18	32.50
10004	6T4	6	40-60	6½	7¼	8	27	40.00
10005	6T6	6	60-80	9¼	7¼	8½	37	52.50
10006	6T8	6	80-100	11	7¼	8½	47	65.00
10007	6T10	6	100-120	13¼	7¼	8½	59	72.50
10008	6T12	6	120-150	16	7¼	8½	70	80.00
8 VOLT								
10009	8T2	8	20-40	6½	7	8⅞	23	41.50
10010	8T4	8	40-60	8½	7	8⅞	34	56.50
10011	8T6	8	60-80	11¾	7¼	8⅞	48	72.50
10012	8T8	8	80-100	14¼	7⅞	8⅞	60	87.50
10013	8T10	8	100-120	17⅞	7⅞	8⅞	78	97.50
10014	8T12	8	120-150	20¾	7⅞	8⅞	94	107.50
10 VOLT								
10015	10T2	10	20-40	7⅞	7	8⅞	29	54.00
10016	10T4	10	40-60	10⅞	7	8⅞	42	69.00
10017	10T6	10	60-80	14⅞	7¼	8⅞	58	90.00
10018	10T8	10	80-100	17½	7⅞	8⅞	77	110.00
10019	10T10	10	100-120	21⅞	7⅞	8⅞	95	122.50
10020	10T12	10	120-150	25	7⅞	8⅞	114	135.00
12 VOLT								
10021	12T2	12	20-40	9¼	7	8⅞	35	65.00
10022	12T4	12	40-60	12½	7¼	8⅞	51	80.00
10023	12T6	12	60-80	17	6¾	8⅞	70	105.00
10024	12T8	12	80-100	21⅞	7⅞	8⅞	90	130.00
10025	12T10	12	100-120	26⅞	7⅞	8⅞	115	145.00
10026	12T12	12	120-150	31	7⅞	8⅞	136	160.00
SPECIAL FOR FORD CARS								
11000	6F4	6	60	6¾	7	7	20	38.00
11001	6F6	6	80	9¼	7	7	25	48.00
FOR MOTOR CYCLES								
12000	6FP1½	6	15	4¼	3¼	8¼	11	32.00
12001	6R1½	6	15	3⅞	3⅞	7¼	10	32.00
FOR SMALL LIGHTING PLANTS								
6121	32S7	32	30	16½	7⅞	9	200	230.00
6122	32S9	32	45	20	7⅞	9	220	254.50
6123	32S11	32	65	23½	7⅞	9	245	280.00

Other Sizes of Lighting and Starting Batteries on Request

SMALL BATTERY CHARGING RECTIFIERS TUNGAR RECTIFIERS



In the Tungar rectifier bulb there is an inert gas, at low pressure, which is ionized by the electrons emitted from the incandescent filament. This ionized gas acts as the principal current carrier, with the result that the bulb operates with a low voltage drop (of 5-10 volts) and is capable of passing a current of several amperes, the current limit depending on the design and size of the tube.

There is a simple half-wave bulb in which the cathode (upper electrode) consists of a filament of small tungsten wire coiled into a closely wound spiral, and a graphite anode (lower electrode) of relatively large cross section. All but the smallest bulbs are constructed of high heat-resisting glass. Soft or lead glass is used in the smallest bulbs.

The bulb rectifies, because on the half cycle when the tungsten filament is negative the emitted electrons from the incandescent filament are being pulled toward the anode by the voltage across the tube, colliding with the gas molecules and ionizing them; that is, making them conductive in the direction of anode to cathode; while on the other half of the cycle, when the filament is positive, any electrons that are emitted are driven back to the filament, so that the gas in the bulb is non-conductive during that half cycle.

The Tungar rectifier possesses the following advantages over other devices heretofore used for similar purposes:

It is self-starting; simply turn on the alternating current supply.

It requires no auxiliary starting device: resistance, switches, etc.

It requires no reactance to keep it going, reducing first cost.

Bulbs give a more uniform life.

Cost of bulbs is lower, reducing maintenance cost.

Bulbs smaller for same capacity; easier to install.

Efficiency averages as good as any and better than some.

No moving parts, oil or grease; absolutely clean.

More simple to operate than any; skilled attendance unnecessary.

Impossibility of current reversal from batteries.

Light weight; smaller sets may be hung on a nail on the wall.

No floor or bench space; entirely out of the way.

Tungar rectifiers, particularly the half-wave types, give a very pulsating current, which is entirely satisfactory for charging storage batteries.

	Current Output	Voltage	Net Wgt.	Shipping Wgt.	Price
Cat. No. 195529	2 Amp.	7.5 Volts	8	12	\$36.00
Cat. No. 219865	3 Amp.	1.5 V.	15	24	56.00
	6 Amp.	7.5 V.			
Cat. No. 195528	Renewal tubes for 195529 Rectifier				8.00
Cat. No. 189049	Renewal tubes for 219865 Rectifier				16.00

AUTOMATIC TELEGRAPH TEACHERS

THE No. 2-38 OMNIGRAPH

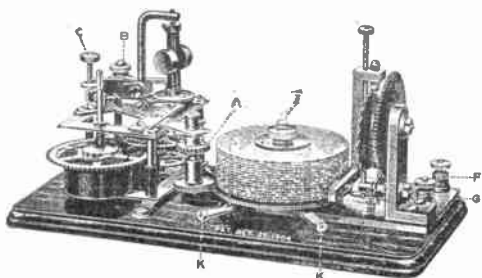

Sends messages at any speed between 5 and 100 words per minute. Morse or Continental Code.

Furnished with 15 Dials, adjusted so you can change from one dial to another or from one word to another automatically.

Operated by a spring motor that will run 1,200 words on one winding. Can be connected to any Key and Sounder or Wireless Buzzer.

connected to any Key and Sounder or Wireless Buzzer.

Cat. No. 2-38 Omnigraph	\$56.00
Cat. No. 2-38 Extra Set 15 Dials, Morse or Continental.....	7.50

OMNIGRAPH No. 2-38 JUNIOR

Has the same essential features of the No. 2, but is only equipped with 5 Dials, which can be furnished in Commercial Morse or Continental.

Cat. No. 2-38 Jr. Omnigraph...	\$40.00
--------------------------------	---------

Cat. No. 2-38 Jr. Extra Set of Dials. (Special Kind.)....	2.50
---	------

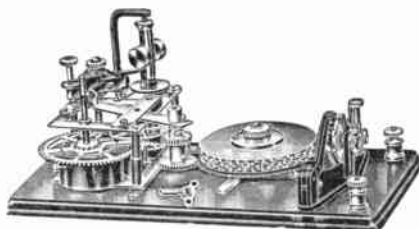

OMNIGRAPH No. 5-38

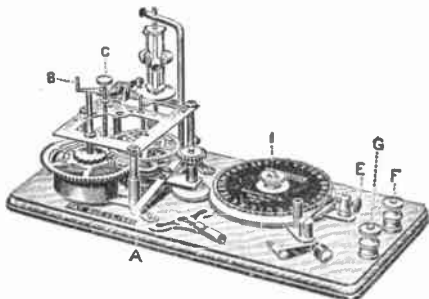

While this instrument has the same motor as the other models it is not elaborate only 2 dials being furnished with this set. Can be used in connection with Key and Sounder or Buzzer Practice Set.

Cat. No. 5-38 Omnigraph...	\$24.00
----------------------------	---------

The Omnigraph is used for instruction purposes by several departments of the U. S. Government and by the leading Universities, College and Telegraph Schools throughout the country.

leading Universities, College and Telegraph Schools throughout the country.

RELIABLE TELEGRAPH KEY

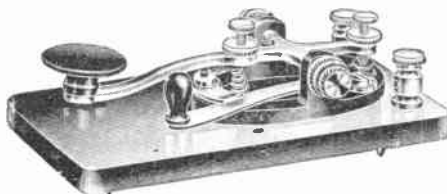

Cat. No. 101—1

RELIABLE TELEGRAPH SOUNDER

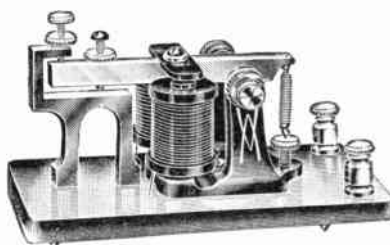

Cat. No. 143—1

The above illustration of the Reliable Telegraph Key and Sounder shows our "Eureka" type of Telegraph Instruments mounted on separate bases.

Under some conditions this arrangement of Key and Sounder is preferable to the single base, because of limited space or a desire to place the sounder where it would be inconvenient for operating the key.

The description of the Eureka Telegraph Instrument on another page will give full details of the construction of both the Key and Sounder.

Two extra binding posts are mounted on the Reliable Key base for convenience in making electrical connections.

Every instrument is guaranteed.

Cat. No. 101—1	Reliable Telegraph Key	\$4.00
Cat. No. 143—1	Reliable Telegraph Sounder, 4 Ohms.....	6.60
Cat. No. 144—1	Reliable Telegraph Sounder, 20 Ohms.....	7.20

WIRELESS PRACTICE SET
FOR LEARNING THE MORSE AND CONTINENTAL CODES

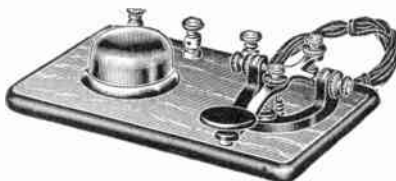

Cat. No. 342—1

The main object of this Practice Set is to enable the beginner to learn the Morse and Continental Codes, which are easily mastered as the buzzer reproduces the sound of the signals of the most modern wireless stations perfectly.

It comprises a regular telegraph key, without circuit breaker, a special high pitch buzzer, one cell Red Seal Dry Battery, and four feet of green silk covered flexible cord.

The key and buzzer are mounted on a highly finished wood base; three nickel plated binding posts are also mounted on the base and so connected that the set may be used for individual code practice or for operation of a two party line, an excellent method of quickly learning the code. After the beginner has mastered the code, the set may be used in his wireless outfit for setting the detector in adjustment, and also the key may be used to control the spark coil.

Recommended for schools, as it gives excellent service for class instruction in code work. Full directions with each set.

Cat. No. 342—1 Wireless Practice Set, with Red Seal Dry Battery and Cord. \$9.00

Cat. No. 344—1 Wireless Practice Set only, no battery or Cord..... 8.00

LEARNERS' EUREKA TELEGRAPH SET

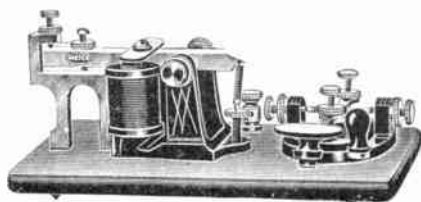

Cat. No. 178—1

The Eureka Telegraph Instrument is a first-class, standard size telegraph set. All of the working parts—which includes sounder lever, sounder yoke or anvil, adjusting screws, etc.—are finely finished composition metal, such as is used in all high-grade instruments. The sounder base is japanned and striped with gilt.

Key knob and circuit closer knob are of polished hard rubber composition. The wood base is of high mahogany finish. The key is our well-known steel lever pattern, and sounder gives a loud, clear, distinct sound.

We claim this the best low priced telegraph set ever made. It is one of our specialties and made in large quantities.

One Red Seal Dry Battery will operate this instrument nicely, but we recommend it only for use on a single instrument, and the key must be left open when not being used.

A copy of "Philosophy and Practice of Morse Telegraphy" is furnished gratis with each instrument.

Cat. No. 178—1 Learners' Eureka Telegraph St. 4 Ohms..... \$8.40
 Cat. No. 179—1 Learners' Eureka Telegraph Set, 20 Ohms..... 9.00



No. 210—15



No. 213A—15



No. 43A—15



No. 66—15

Cat. No. 41—15	Nickel plated acorn nut, threaded 8-32.....	\$.12
Cat. No. 42—15	Nickel plated acorn nut, threaded 10-32.....	.12
Cat. No. 43A—15	Composition handle, ½ inch high, 1 inch diameter, brass insert with set screw ¼ inch hole.....	.80
Cat. No. 210—15	Composition handle, 1 3/8 inches diameter, 3/4 inch high, 1/8 inch hole.....	.60
Cat. No. 211—15	Same as No. 210 2 1/4 inches diameter, 1 inch high.....	.80
Cat. No. 212—15	Knurled knob, 1 15/64 inch diameter, 1 1/8 inch high, 6/32 thread.....	.10
Cat. No. 213A—15	Knurled knob, 1 1/8 inches diameter, 1 1/8 inch high, 10/32 thread.....	.14
Cat. No. 66—15	Nickel plated switch stop, threaded 8/32.....	.20

MESCO RADIO BUZZER

This buzzer maintains a constant note and is recommended as an exciter for checking wave-meters where pure note and ample energy are required.

It consists of practically a closed circuit field of low reluctance, having a steel armature to which is riveted a strap supporting a movable contact. The armature tension is adjustable by means of a screw with a milled head large enough to be easily and permanently adjusted with the fingers. The stationary contact is adjusted by means of a similar screw. The magnet coils are connected in series with a total D. C. resistance of 4 ohms. Shunted across these coils is a resistance having a D. C. value of 3 ohms. This shunt eliminates all sparking such as occurs at the break on ordinary radio buzzers and the energy saved thereby is transferred into any oscillating circuit connected to it, the result being that this buzzer as constructed radiates five times more energy than any other existing type. All connecting wires liable to be broken are eliminated. Contacts are of genuine platinum, which is essential in order to maintain a constant note. The parts are mounted on a Condensite base to insure constancy in operation.

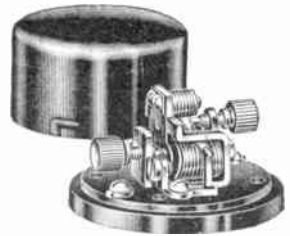

Diameter 2 in., height 1¼ in. The cap is attached to the base by a bayonet joint.

Cat. No. 55—1 Mesco Radio Buzzer \$5.00

CENTURY HIGH FREQUENCY BUZZERS

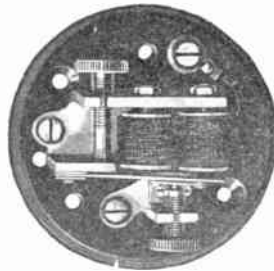

It is safe to say that no other Frequency Buzzer is so extensively used by the Allied Governments as is the famous Century H. F. Buzzer.

Nor is any other buzzer so extensively used by amateurs and experimenters throughout the United States as is the "Century" 168.

The reason is obvious, it has no superior on the market.

It is very carefully made of the best material obtainable. Maintains its note and is satisfactory in every way.

Nothing but pure platinum points are used as contacts.

Cat. No. 8499—1 \$5.00

CAM SWITCHES OR ANTI-CAPACITY KEYS

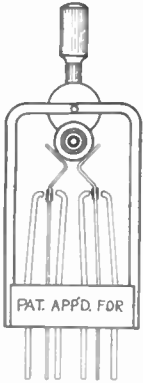

Experimenters can find no more satisfactory switch than the Anti-Capacity and is very highly recommended.

Cat. No. 1424W—20	D.P.D.T.	12 spring	\$5.60
Cat. No. 1426W—20	D.P.S.T.	4 spring	5.10
Cat. No. 1427W—20	P.P.S.T.	4 spring	5.30

NOTE.—The contacts on the No. 1424—20W and 1427—20W are “normally open,” while on the No. 1426—20W they are “normally closed.”

Cat. No. 1424—20W

TELEPHONE JACKS AND PLUGS

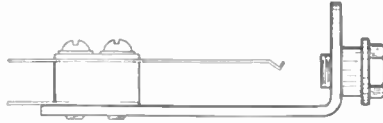

Cat. No. 1421W—20

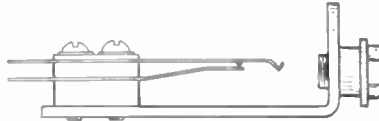

Cat. No. 1422W—20



Cat. No. 1423W—20

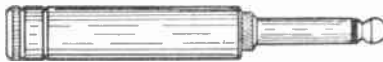

Cat. No. 1428W—20

Cat. No. 1421W—20	Open Circuit Jack	\$1.40
Cat. No. 1422W—20	Closed Circuit Jack	1.70
Cat. No. 1423W—20	Two Circuit Jack	2.00
Cat. No. 1428W—20	Plug	4.00
Cat. No. 1428W—20	Silver Plated	5.00

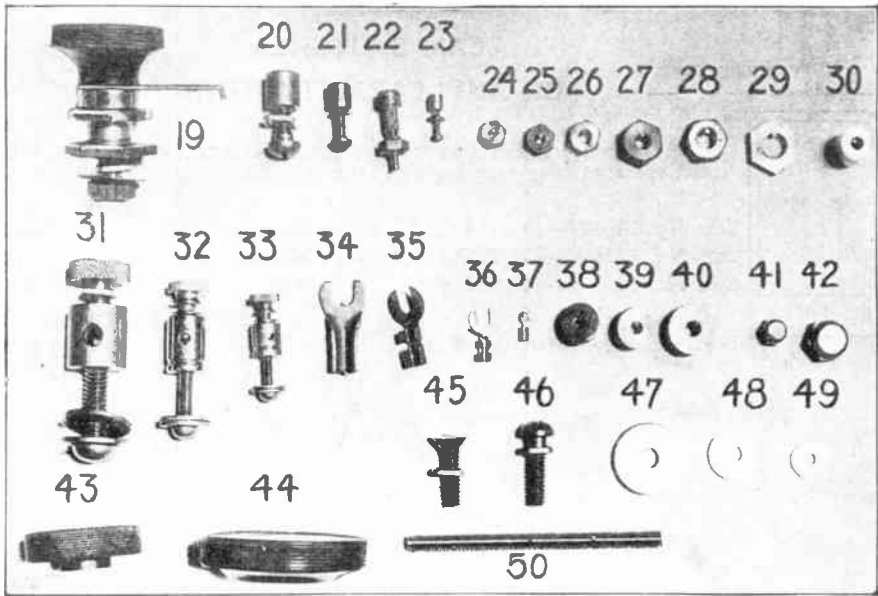

- Cat. No. 19—15 Three-blade instrument switch, edgewise contact type, hard rubber handle, 1¼ inches diameter, ¾ inch high, distance center of handle to end of switch blade, 1¾ inches. Price each..... \$2.00
 - Cat. No. 19A—15 Similar to No. 19, but smaller. Single blade, edgewise contact, composition handle, 1¼ inch diameter. Price each..... .70
 - Cat. No. 20—15 Nickel plated switch point, ⅝ inch diameter, ⅝ inch high with brass screw. Price each..... .24
 - Cat. No. 21—15 Nickel plated switch points, ⅝ inch diameter, ⅝ inch high, with brass screw. Price each..... .14
 - Cat. No. 22—15 Plain brass switch point, ¼ inch diameter on face ⅝ inch high, knurled shank ⅝ inch, threaded shank ⅝ inch. Plain shank ⅝ inch, overall length, 1 inch with nut. Price each..... .20
 - Cat. No. 23—15 Nickel plated switch point, ⅝ inch diameter, ⅝ inch high with nickel plated iron screw. Price each..... .08
 - Cat. No. 31—15 Heavy brass binding post for use up to 60 amperes. Price each..... .80
 - Cat. No. 32—15 Nickel plated standard Clapp-Eastham binding post, will take wire under head or wire or cord tip in hole. Very convenient. Price each..... .40
 - Cat. No. 33—15 Same as No. 32 but smaller. Price each..... .30
 - Cat. No. 36—15 Small spade tip for wire No. 16 B & S or smaller. Price per dozen..... .30
 - Cat. No. 37—15 Small cord tip for fine wires. Price per dozen..... .24
 - Cat. No. 213A—15 Rubber composition covered binding post, 1¼ inch diameter, 10-32 thread. Price each..... .70
 - Cat. No. 38—15 Knurled nut, nickel plated, threaded 6-32. Price each... .12
 - Cat. No. 39—15 Knurled nut, nickel plated, threaded 8-32. Price each... .14
 - Cat. No. 40—15 Knurled nut, nickel plated, threaded 10-32. Price each... .16
- Numbers 24 to 30, 34 and 35, 41 to 50. Prices on application.

BINDING POSTS
CUTS FULL SIZE



No. 4819-1



No. 4820-1



No. 4821-1



No. 4822-1



No. 4823-1



No. 4824-1



No. 4825-1



No. 4826-1



No. 4827-1



No. 4828-1



No. 4829-1



No. 4830-1



No. 4831-1

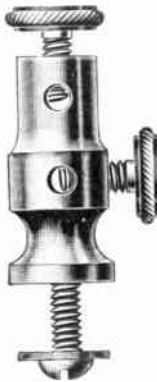

No. 4834-1



No. 4833-1



No. 4835-1



No. 4832-1

Cat. No.

4819-1	Binding Post, Nickel Plated	\$.34
4820-1	Binding Post, Nickel Plated	.48
4821-1	Binding Post, Nickel Plated	.44
4822-1	Binding Post, Nickel Plated	.34
4823-1	Binding Post, Nickel Plated	.52
4824-1	Binding Post, Nickel Plated	.34
4825-1	Binding Post, Nickel Plated	.30
4826-1	Binding Post, Nickel Plated	.26
4827-1	Binding Post, Nickel Plated	.26
4828-1	Binding Post, Nickel Plated	.26
4829-1	Binding Post, Nickel Plated	.22
4830-1	Binding Post, Nickel Plated	.34
4831-1	Binding Post, Nickel Plated	.70
4832-1	Binding Post, Nickel Plated	.18
4833-1	Binding Post, Nickel Plated	.18
4834-1	Binding Post, Nickel Plated	.60
4835-1	Binding Post, Nickel Plated	.60

Unless otherwise ordered, Nickel Plated Binding Posts will be furnished. Plain Brass Finish can be supplied at same price as above. Any other finish special prices.

WIRELESS PARTS

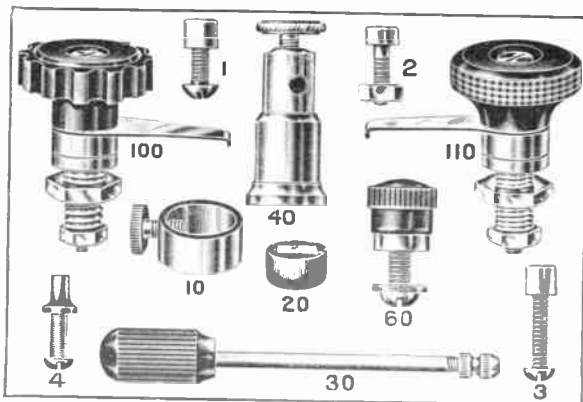

Cat. No.		Price
1-52	Creco $\frac{1}{4}$ " x $\frac{1}{4}$ " nickeled brass contact point	\$.08
2-52	Creco $\frac{1}{8}$ " x $\frac{1}{4}$ " nickeled brass contact point	.08
3-52	Creco $\frac{3}{16}$ " x $\frac{1}{4}$ " nickeled brass contact point	.08
4-52	Creco switch stops (nickeled)	.20
10-52	Creco crystal cup	.50
20-52	Creco tested galena crystal	1.00
30-52	Creco detector rod with holder	1.00
40-52	Nickel plated double Binding Post	.60
60-52	Hard Rubber Binding Post	.24
100-52	Creco switch lever with DeForest Knob	1.30
110-52	Creco switch lever complete	1.30



Grid Leak



DeForest Socket



Radio Corporation Socket

Cat. No.		Price
R100-7	DeForest Socket	\$3.00
GL100-51	Radio Corporation Grid Leak	2.50
M300-51	Radio Corporation Socket	3.00

FAHNESTOCK CONNECTORS

CAT. No. 4—39 FULL SIZE

CAT. No. 3C—39 FULL SIZE

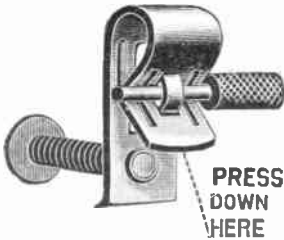

CAT. No. 9C—39 FULL SIZE

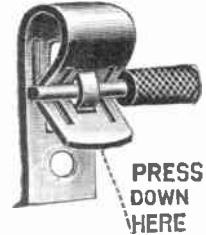
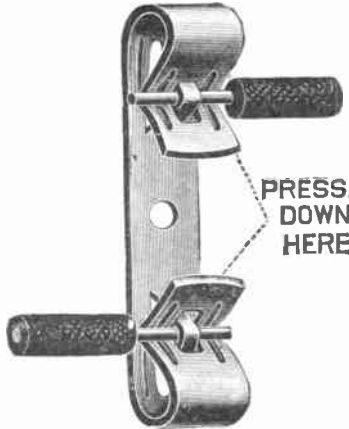

Will take No. 12 B. & S. wire.

Length over all $\frac{7}{8}$ inch
 Width $\frac{3}{8}$ inch
 Screw hole for No. 6 screw.

Cat. No. 3C—39

	Brass	Bronze
Each	\$.10	\$.12
Per Doz.	1.00	1.20
Per 100	4.30	5.00

Will take No. 10 B. & S. wire.

Length over all 1 inch
 Width $\frac{3}{8}$ inch
 Screw hole threaded for 8-32 screw.

Cat. No. 4—39

	Brass	Bronze
Each	\$.10	\$.12
Per Doz.	1.20	1.40
Per 100	4.60	5.30

Price does not include screw shown.

Prices on any length screw for same given on request.

Will take No. 10 B. & S. wire.

Length over all $1\frac{3}{4}$ inches
 Width $\frac{3}{8}$ inch
 Screw hole for No. 8 screw.

Cat. No. 9C—39

	Brass	Bronze
Each	\$.16	\$.20
Per Doz.	1.50	1.70
Per 100	7.00	8.00

Will take No. 16 B. & S. wire.

Has projecting lug to which can be soldered a wire.

Length over all not including soldering lug $\frac{1}{2}$ inch
 Width $\frac{3}{2}$ inch
 Screw hole for No. 4 screw.

Made only in bronze metal
 Cat. No. 15—39

	Bronze	Nickel Bronze
Each	\$.06	\$.06
Per Doz.50	.60
Per 100	3.00	3.20

SIMPLEX ELECTRIC SOLDERING IRONS



These irons are portable and for lamp socket use.

The heating element is constructed with nickel chromium resistance wire and mica insulation, and located to conduct the heat quickly to the tip and insulated to prevent the handle from heating.

The tip is removable.

Each iron is provided with a cord and lamp socket plug.

All tips excepting No. 238 are made of forged copper.

When ordering specify voltage.

Cat. No. 238—5	Telephone Iron. Rod tip. $\frac{5}{16}$ " dia. 12 oz. 75 watts....	\$20.00
Cat. No. 239—5	Same as Cat. No. 238—5, except fitted with forged copper tip, $\frac{7}{8}$ " dia. Four flat sides tapered to $\frac{1}{8}$ " at point. Overall length 12". 14 oz. 75 watts.....	20.00
Cat. No. 240—5	Useful for fixture wires and home use where more heat is required than telephone sizes. This is a popular size. Dia. of tip 1". Overall length 12". 17 oz. 100 watts	20.00
Cat. No. 241—5	For light manufacturing and repair work. Dia. of tip $1\frac{1}{4}$ ". Overall length 15". 26 oz. 200 watts.....	26.50
Cat. No. 242—5	General bench work, tinware, and used largely by munition factories. Dia. of tip $1\frac{1}{2}$ ". Overall length $15\frac{1}{2}$ " 34 oz. 275 watts	47.00
Cat. No. 243—5	Automobile repairing, heavy tinware and sheet metal work when used intermittently. This size is also used for branding purposes. Dia. of tip $1\frac{3}{4}$ ". Overall length $15\frac{1}{2}$ ". 50 oz. 350 watts.....	52.50

"AMERICAN BEAUTY" ELECTRIC IRON

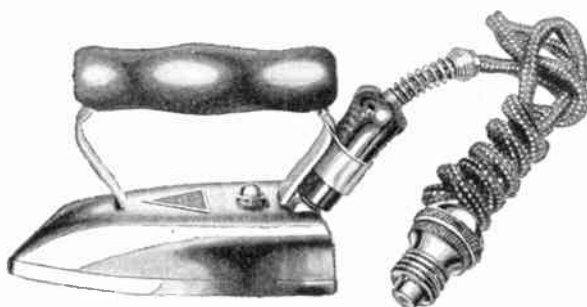

An electric flat iron should be considered primarily as a working tool. Any tool is of value only if it does the work for which it is intended either easier, quicker or better than the article it replaces. In other words the intending purchaser of an electric flat iron should consider, not so much the iron itself, as the work it will do and its serviceability.

The question of the first cost of an electric flat iron is of minor importance. The real point at issue is what will the iron do and will it stand up and give satisfactory service over a long period of years. Most people realize that the best is the cheapest in the long run and are willing to purchase the best when convinced that the article which is presented for their consideration has that Superiority.

Anyone can make claims, but the best proof of the worth of an article is shown in its record. Time alone can tell the story. The fact that the "American Beauty" electric iron is the result of nearly 25 years' experience in making electric heating devices and that it is selling in constantly increasing quantities is the best proof we can offer to substantiate our claims that it is "the best iron made."

The "Little Beauty" weighs three pounds. Both irons are identically the same in construction. Both have standard "American Beauty" encased element. The only difference between the two is the size and weight.

The 6½B—6 is the exact size, weight and shape for general all around household and laundry use. The 3B—6 is intended only for pressing lighter articles and for traveler's use. Other sizes for heavier work will be found listed and described elsewhere in this catalog.

Cat. No.	Code Word	Net Wt.	Size	Approx. Ship. Wt.	Ship. Wt. Case of 6 Watts	Price
6½B-6	Beater	6½ lbs.	6½" x 8¾"	8¼ lbs.	53 lbs.	525
3B -6	Buck	3 lbs.	6¾" x 8¾"	5 lbs.	31½ lbs.	20 00

WESTERN ELECTRIC No. 1 ELECTRIC IRON

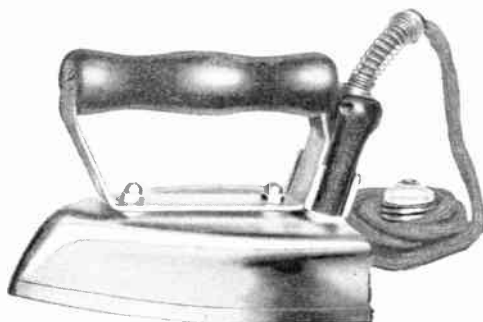

This iron is second only in quality and merit to the American Beauty electric iron. It embodies a number of the characteristics of that iron and is first class in every respect. It sells at a slightly lower price and for the person who does not wish to pay more than is asked for an ordinary electric iron it will be found very desirable.

The bottom plate is machine milled and polished, thus insuring a perfectly flat and true ironing surface. The heating element is easily removable and is so arranged as to apply the heat directly to, and evenly distribute it over the entire bottom plate. The contact pins are non-corroding, round and removable and can be easily replaced if necessary without taking the iron apart. The wooden handle is shaped to fit the hand comfortably, is always cool and is securely fastened to the steel handle supports, thus preventing it from becoming loose. It has a durable, always-cool-enough-to-handle, easily removable, composition switch-plug similar to the one used on the American Beauty electric iron, thus enabling perfect heat regulation. It has a plug guard which holds the switch-plug firmly in place when on the iron and many other exclusive features not found in other electric flat irons that sell at about the same price.

Its shape, size, weight and general design make it adaptable for all around household requirements. It is handsomely finished in polished nickel.

Cat. No.	Code Word	Net Weight	Size	Approx. Shipping Weight	Watts	Price
No. 1-6	Bunt	6½ lbs.	6½" x 3¾"	Single 8¼ lbs. Case of 6, 53 lbs.	525	17.00

"AMERICAN BEAUTY" 9B—6 ELECTRIC PRESSING IRON



In addition to our complete line of electric pressing irons for commercial work, we also carry this 9B—6 iron. It is of the same general design and type of construction as other "American Beauty" electric irons and will be found of great advantage in the home as an auxiliary to our regular household iron.

For pressing clothing of all kinds, also sheets and table linen, or for the person who prefers to iron very damp or fast, and for use in laundries and cleaning and dyeing establishments it will be found ideal.

It weighs a little more and gives off a greater heat than our regular household and laundry size iron. Each iron is packed in separate box.

Cat. No	Code Word	Net Wgt.	Size Bottom	Approx. Shlp. Wgt.	Watts	Finish	Price
9B-6	Ball	9 lbs.	7 $\frac{3}{16}$ " x 4 $\frac{1}{4}$ "	11 $\frac{1}{4}$	675	Polished Nickel	23.00

“AMERICAN BEAUTY” ELECTRIC GRILL

(THREE HEATS)

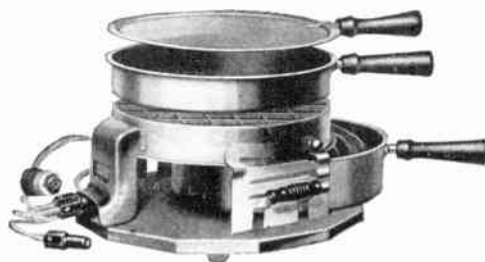

With this handsome electric grill a complete meal can be prepared right at the table.

It boils, broils, toasts, fries or in fact performs any cooking operation in the most satisfactory manner. Two cooking operations at the cost of one.

It is made of sheet steel beautifully finished in polished nickel. Has re-inforced composition heat insulating legs that prevent marring or scratching the surface upon which it may be placed. It has ebony finished wood handles on two sides. Is equipped with a three-heat, easily-removable, practically-indestructible, open-coil heating element.

It will be supplied complete with utensils or the grill alone can be purchased. No. 3375—6 is the grill complete with utensils. No. 3375-SO—6 is the grill only.

Food cooked electrically tastes better than when prepared in any other way because there is no flame, no odor, no combustion, no gases to mingle with and spoil its flavor. There is also less shrinkage.

Cat. No.	Code Word	Diameter of Top	Net Weight	Approx. Ship. Wt. Case of Six	Heats	Watts	Price
3375-6	Gledun	7¼ inches	5 ½ lbs.	49 lbs.	3	660	35.00
3375-6-SO	Glodure	7½ inches	3 lbs.	34 lbs.	3	660	29.00

GRILLS

Nickel Plated Frame, Black Base. Ebonized Handles. 3 Cooking Pans, $\frac{1}{4}$ in., $1\frac{1}{4}$ in., 2 in. deep. Complete with 6 ft. Heater Cord and Lamp Socket Plug.



4 HEAT ROUND GRILL

Cat. No. E1984—2 \$30.00
 4 Heats
 175, 300, 350, 650 Watts
 Weight packed $6\frac{1}{4}$ lbs.



4 HEAT RECTANGULAR GRILL

Cat. No. E1982—2 \$25.00
 4 Heats
 175, 300, 350, 650 Watts
 Weight packed $5\frac{1}{4}$ lbs.

WAFFLE IRON

Makes delicious waffles at the table in less than 2 minutes after the Aluminum grids have been pre-heated for 5 minutes. No smoke—no odor.



Cat. No. E930—2 Watts 600
 Nickel Plated \$40.00
 Size of waffle $3\frac{1}{2}$ x 7 in.
 Weight packed 7 lbs.

Complete with 6 ft. Mercerized Cord and Lamp Socket Plug.

All above packed one in a carton

RITE-HEAT GLOWER STOVE



An ideal small toaster stove upon which light cooking operations of all kinds may be done.

Makes toast perfectly—two slices at a time, or may be used for making toast beneath the heating coils and at the same time something may be cooked on the top.

A great convenience in the home or fine for traveler's use.

It is light, strong and durable and occupies but little space.

It is constructed throughout of sheet steel and is beautifully finished in polished nickel.

Cat. No.	Code Word	Net Wt.	Size	Approx. Ship. Wt.	Watts	Price
3350 G-6	Tabloid	4 $\frac{3}{4}$ lbs.	Top 5" Square Height 3 ins.	Single, 2 lbs. Case of 12, 23 $\frac{1}{2}$ lbs.	500	17.00

"AMERICAN BEAUTY" UPRIGHT ELECTRIC TOASTER

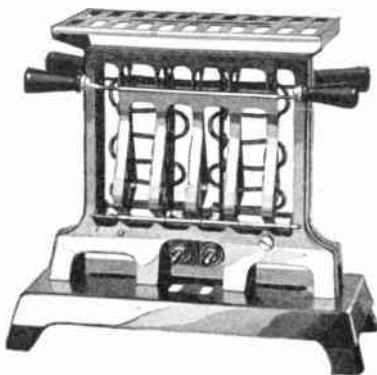

Electric heat is ideal for making toast. No disagreeable odors or gases of any kind to permeate the toast and affect its flavor, just a clean, intense heat is thrown against the bread, toasting it quickly, easily and in the most appetizing manner. When a person once has tasted the delicious toast that can be made with this "American Beauty" electric toaster he will care for no other kind.

With it, fresh, crisp toast can be quickly made—about a slice a minute (at a cost of about one cent per dozen slices), right on the dining table, if desired, and buttered and served while piping hot. Always just enough toast to satisfy everyone. No need of making too much or too little.

This toaster is made entirely of sheet steel, finished in highly polished nickel and has a double base equipped with heat-insulating legs which prevent marring or scratching the surface upon which it stands. It is light, compact, unbreakable and easily cleaned. With ordinary care it should last a life time.

The open, red hot, glowing coils produce an effect that must be seen to be appreciated. The illustrations give only a faint suggestion of the unusual attractiveness of this handsome, efficient device.

Cat. No.	Code Word	Net Wt.	Approx. Ship. Wt.	Shipping Wt.	Watts	Price
5825 G-6	Taste	1 lb 15 ozs.	3 lbs. 15 oz.	Case of 24, 60 lbs.	440	19 00

TOASTERS

Patented three-piece element allows bread to be held very close to the unit making Universal Toasters the most economical. Golden brown, crisp toast—a slice a minute—served piping hot for about one-tenth of a cent a slice. Their attractive design and finish add distinction to any table service.

Nickel or Silver Plated Finish. Cool Fiber Handles and Feet. Complete with 6 ft. Mercerized Cord and Lamp Socket Plug.



Standard Model

Pressed steel throughout. Nickel plated. Bread Holder with strong spring keeps bread firmly in place insuring evenly toasted bread. Very practical.

Cat. No. E946—2	Watts 340
Nickel Plated	\$16.00
Silver Plated	19.00
Height over all	6¾ in.
Weight packed	2½ lbs.



Fancy Design

For those who wish a more elaborate design. Construction same as above except this type has ebonwood feet. Toast kept warm on flat top rack.

Cat. No. E944—2	Watts 340
Nickel Plated	\$17.00
Silver Plated	22.00
Height over all	6¾ in.
Weight packed	2½ lbs.

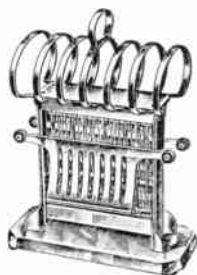

Bread Rack Model

Construction same as E945, except for the handy bread rack and handle. A popular design increasing in favor.

Cat. No. E945—2	Watts 340
Nickel Plated	\$18.00
Silver Plated	18.00
Height over all	10 in.
Weight packed	2¾ lbs.

Packed one in a carton.

SIMPLEX ELECTRIC HOUSEHOLD DEVICES
TOASTERS

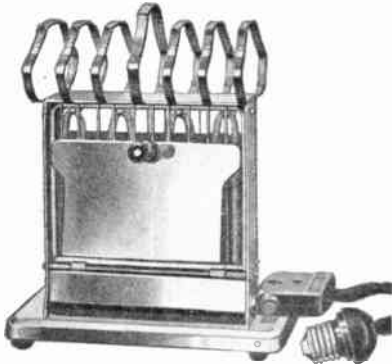

Cat. No. 211-5

Same as Cat. No. 215-5 style except that has a flat top. Complete with quick detachable connector, cord and plug.

Cat. No. 212-5 475 watts..... \$15.00

FOR STANDARD VOLTAGES
 UP TO 125

All brass-nickel plated-double frame. Solid removable doors. Disappearing toast rack. Highest quality of workmanship and material throughout.

Complete with quick detachable connector, silk cord and plug.

Cat. No. 211-5 475 watts..... \$19.00

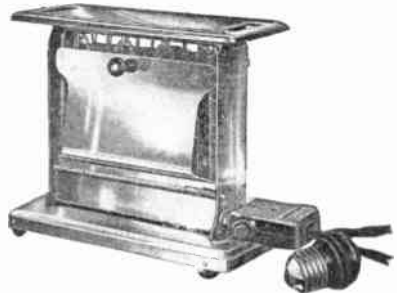

Cat. No. 212-5

Combination handle and toast rack. Heavily nickel plated. Complete with quick detachable connector, cord and plug.

Cat. No. 215-5 475 watts..... \$16.00



Cat. No. 215-5

SIMPLEX ELECTRIC IRONS

ENCLOSED COIL UNIT
 FOR STANDARD VOLTAGE
 UP TO 120

Cat No.	Lbs.	Watts	Size Face	Style
1915-5	6	570	7¼x4"	Household

Enamel Units Price \$16.00



Cat. No. 1915-5

"AMERICAN BEAUTY" ELECTRIC COFFEE PERCOLATORS



Cat. Nos. 2427—6, 2429—6



Cat. No. 2417—6

The delicious coffee and the ease with which it can be prepared in one of these "American Beauty" electric coffee percolators makes their use particularly desirable.

All that is necessary is to put water in the percolator, ground coffee in the receptacle provided for the purpose, attach to any lamp socket, turn on the current and in a few minutes the coffee is ready for use. The merry bubbling of the percolating coffee and the handsome appearance of the percolator adds much to the enjoyment of one's meals.

Cat. No.	Code Word	Capacity	Net Weight	Approx. Ship. Wgt.	Watts	Price
2417-6	Perrico	7 cups	3 lbs. 5 oz.	5½ lbs.	420	43.00
2427-6	Perry	7 cups	3 lbs. 5 oz.	10 lbs.	420	52.00
2429-6	Porhite	9 cups	4 lbs. 2 oz.	10½ lbs.	420	57.00

"AMERICAN BEAUTY" ELECTRIC COFFEE PERCOLATORS



Cat. No. 2326—6



Cat. No. 2316—6

They are made of heavy copper and beautifully finished in polished nickel, are lined with pure tin, have aluminum fittings, a safety fuse plug which prevents burning out the heating element and are supplied complete with a six foot gray silk cord, detachable plugs and attachment plug.

These percolators are of the latest and most pleasing designs and there is a style to suit every taste.

Cat. No.	Code Word	Capacity	Net Weight	Approx. Ship. Wgt.	Watts	Price
2316-6	Persic	6 cups	2 lbs. 14 oz.	5 lbs.	420	35.00
2326-6	Persienne	6 cups	3 lbs. 5 oz.	5 lbs.	420	40.00

NICKEL PLATED, COPPER OR SILVER PLATED

Seamless Spun Copper Bodies, Highly Polished, Nickel or Silver Plated Finish. Ebonized Wood Handles. Heat Proof Glass Tops. Inside Coated with Pure Tin, Silver Finished. Aluminum Interior Fittings. Complete with 6 ft. Mercerized Cord and Lamp Socket Plug.

Complete with No. 4400—2 Tray and No. 4400—2 Sugar Bowl and Cream Pitcher.

LOVING CUP PATTERN

Cat. No. E9166—2

Capacity 6 Cups

Nickel Plated	\$57.00
Copper	60.00
Silver Plated	65.00
Height over all	15½ in.
Weight packed	10 lbs.

Cat. No. E9169—2

Capacity	9 cups
Nickel Plated	\$52.00
Copper	65.00
Silver Plated	70.00
Height over all	17½ in.
Weight packed	11 lbs.

420 Watts



Equipped with patented
Universal Safety
Fuse Plug

Each set packed one in a wooden case

NICKEL PLATED, COPPER OR SILVER PLATED

Seamless Spun Copper Bodies, Highly Polished, Nickel or Silver Plated Finish. Ebonized Wood Handles. Heat Proof Glass Tops. Inside Coated with Pure Tin, Silver Finished. Aluminum Interior Fittings. Complete with 6 ft. Mercerized Cord and Lamp Socket Plug.

Cat. No. E9166044—2

Capacity	6 cups
Nickel Plated	\$104.50
Copper	111.50
Silver Plated	124.00
Weight packed	22 lbs.

Cat. No. E9169044—2

Capacity	9 cups
Nickel Plated	\$109.50
Copper	116.50
Silver Plated	129.00
Weight packed	24 lbs.

420 Watts



NICKEL PLATED

Heavy Spun Copper Bodies, Nickel Plated Finish. Inside Coated with Pure Tin, Silver Finished. Nickel Silver Tea Ball. Ebonized Handles and Knobs. Complete with 6 ft. Mercerized Cord and Lamp Socket Plug.



Equipped with patented Universal Safety Fuse Plug

COLONIAL PATTERN

Cat. No. E9346—2

Capacity	6 cups
Nickel Plated	\$42.00
Height over all	11¾ in.
Weight packed	9 lbs.
420 Watts	

Samovars packed one in a wooden box

Cat. No. E9144—2

Capacity	4 cups
Nickel Plated	\$44.00
Height over all	10¾ in.
Weight packed	8 lbs.

Cat. No. E9146—2

Capacity	6 cups
Nickel Plated	\$47.00
Silver Plated	55.00
Height over all	13½ in.
Weight packed	9¼ lbs.

Cat. No. E9149—2

Capacity	9 cups
Nickel Plated	\$52.00
Silver Plated	60.00
Height over all	15 in.
Weight packed	10¼ lbs.
420 Watts	

Packed one in a wooden box



Equipped with patented Universal Safety Fuse Plug

NICKEL OR SILVER PLATED

Heavy Gauge Copper Bodies, Nickel or Silver Plated Finish. Ebonized Handles and Feet. Heat Proof Glass Tops. Inside Coated with Pure Tin, Silver Finished. Aluminum Interior Fittings. Complete with 6 ft. Mercerized Cord and Lamp Socket Plug.

COLONIAL PATTERN

Cat. No. E9644—2

Capacity	4 cups
Nickel Plated	\$37.00
Height over all	7 in.
Weight packed	4 lbs.

Cat. No. E9646—2

Capacity	6 cups
Nickel Plated	\$42.00
Silver Plated	49.00
Height over all	9½ in.
Weight packed	5 lbs.

Cat. No. E9649—2

Capacity	9 cups
Nickel Plated	\$47.00
Silver Plated	54.00
Height over all	11 in.
Weight packed	6 lbs.
420 Watts	



Equipped with patented Universal Safety Fuse Plug

"AMERICAN BEAUTY" ELECTRIC CHAFING DISH



Cat. No. 2433—6



Cat. No. 2333—6

In addition to the ease and convenience with which one of these electric chafing dishes may be used, they are really less expensive to operate than the old-fashioned chafing dishes heated with an alcohol flame, in fact the amount of current which they consume is so small as to be hardly noticeable.

All dirt, fire, odor and danger is completely done away with. They are always ready to use by merely turning on the current.

These "American Beauty" electric chafing dishes are of the handsomest, most up-to-date designs. They are made of heavy spun copper beautifully finished in polished nickel, are double tin lined, are equipped with safety fuse plugs which prevent burning out the heating element, have ebony finished wood handles and with ordinary care will last for many years.

They are arranged for two heats—high and low—and are furnished complete with a six foot twin conductor, gray silk cord, detachable plugs and attachment plug.

Cat. N	Code Word	Capacity	Net Weight	Approx. Ship. Wt.	Heats	Watts	Price
2334-6 2433-6	Perpend	3 pints	4 lbs. 2 oz.	10 lbs. 5 oz.	2	420	\$45.00
	Persalt	3 pints	4 lbs. 2 oz.	10 lbs. 5 oz.	2	420	\$53.00

“AMERICAN BEAUTY” ELECTRIC DISC STOVE
HOUSEHOLD TYPE

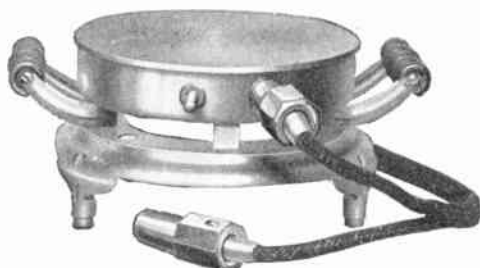

The Disc Stoves listed below have solid steel top plates that will attain a maximum temperature of about 600 degrees F.

The heating units are attached to and in perfect contact with the under side of these plates, and are at the same time readily removable.

These stoves are intended to heat small quantities of water or for cooking or boiling in the home or apartment. They are also extensively used in laboratories and other places where a safe, clean heat is necessary.

They are completely finished in polished nickel, furnished with handles as shown, and made for one heat only, and may be compared to the lid or burner of a kitchen range. Practically any operation that may be done on a range lid or burner can be done on one of these stoves.

The heating elements in these stoves are of the “American Beauty” sheathed type having contact pins which are attached to and are a part of the heating element. The elements are, of course, easily removable and interchangeable.

The legs are heat insulated thus permitting the stove to be used anywhere without danger of marring or scorching the surface upon which it stands.

Cat No.	Code Word	Dia. of Top	Dia. Over All	Ht. Over All	Net Wt.	Apx. Shp. Wt.	Watts.	Price
3210-6	Dike	4¼ in.	6¼ x 4¾ in.	2½ in.	2 lbs.	2½ lbs.	450	\$17.00
3221-6	Diil	5¼ in.	7¼ x 5¾ in.	2¾ in.	2¾ lbs.	3¼ lbs.	500	19.00
3231-6	Dim	6¾ in.	8¼ x 6¾ in.	2¾ in.	3½ lbs.	4½ lbs.	600	22.00

SIMPLEX ELECTRIC DISC STOVES

ENCLOSED COIL TYPE

FOR STANDARD VOLTAGE UP TO 120

This disc stove is remarkable for endurance under severe conditions. The enclosed coil heating unit is identical with the unit used in our domestic and heavy duty ranges and it may be run red hot without damage.



Cat. No. 734—5

Cat. No. 734—5 Single Disc Stove. 8 inches Diameter. 3-Heat. Maximum Watts 1200. Serviceable, nickel-whitened finish. Furnished with cord. No plug \$36.00

SIMPLEX ELECTRIC RADIATORS



Cat. No 99—5

RADIANT TYPES

For standard voltages up to 230—One heat. Newest, handsomest, hottest.

18½" high, reflector 14" in diameter.

Shipping weight, 11½ lbs., 600 watts.

Cat. No. 99—5..... \$25.00

For 100 to 125 volts—One heat

This model differs from the No. 99 in that it does not concentrate its heat to so great an extent but projects it over a greater area. Nevertheless, it is an effective and desirable heater and is exceptionally efficient because the mirror back reflects the greatest possible amount of heat.

The protecting screen is hinged, making it easy to keep clean.

12" high, 6½" wide, 16½" long.

Casing, black finish.

Cord and lamp socket plug.

Shipping weight, 7 lbs. 600 watts.

Cat. No. 100—5..... \$18.00

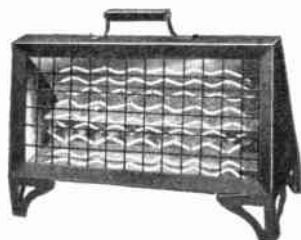

Cat. No. 100—5

HEATING PADS

Buff Color, Soft and Flexible. A sleeping porch necessity.



Cat. No. E19940—2 3 Heat..... \$27.00
 Size of pad12 x 15 in.
 Weight packed2 lbs.
 With 10 ft. Heater Cord and Lamp Socket Plug



Cat. No. E1994—2 1 Heat..... \$21.00
 Size of pad8½ x 11½ in.
 Weight packed1¾ lbs.
 With 8 ft. Heater Cord and Lamp Socket Plug

CURLING IRON AND COMB

Supplies the correct heat without scorching the hair, for only one-fifth of a cent an hour. Hair Dryer made of aluminum, dries the hair quickly after the shampoo or bath. Nickel Plated. 25 watts.

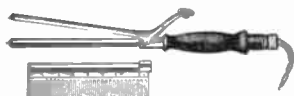

Cat. No. E9901—2 \$14.50
 *Cat. No. E99011—2 16.00
 Diameter of Iron $\frac{1}{8}$ in.
 Length10 $\frac{3}{8}$ in.
 Cat. No. E9902—2 \$14.50
 *Cat. No. E99021—2 16.00
 Diameter of Iron $\frac{1}{8}$ in.
 Length10 $\frac{1}{2}$ in.

*With Hair Dryer

Above Numbers Complete with 6 ft. Mercerized Cord and Lamp Socket Plug.
 Above packed one in a carton

EMERALITE JUNIOR ADJUSTABLE LAMP



This practical little lamp will clamp, stand or hang any place, and will be found exceedingly useful in any home. It is very desirable as a study or reading lamp for children; for the boudoir, or for use on side shelf of grand piano, dressing table or nursery. The shade can be tilted and locked in any position and, no matter how adjusted, the eyes are always protected from the direct glare of lamp. Any standard electric lamp can be used. Base is heavily weighted and felted, and contains an efficient clamp. Total height of lamp 12 inches; glass shade (6 inches diameter) is mounted on substantial holder attached to socket.

EMERALITE 37 JUNIOR—Adjustable Lamp

	Satin Brass	Statuary Bronze
Prices. Complete with Emeraldite glass shade, pull socket, six feet cord and plug. Each	\$10.00	\$11.00
Complete with buff-yellow glass shade, plain or decorated. Each	11.00	12.00
Complete with crystallized Emeraldite glass shade, verde-green or white enamel finish. Each		12.00

Please specify finish and shade.

We carry in stock a complete line of Emeraldite portable lamps, and descriptive booklet will be mailed on request.

WESTERN ELECTRIC SEWING MACHINE

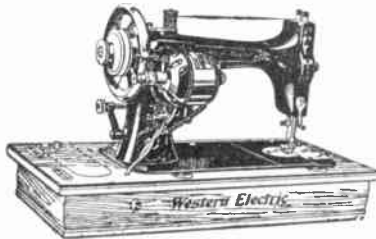

The Western Electric sewing machine is a combination of the standard Western Electric sewing machine motor and a high grade sewing machine of national repute, the combination resulting in a compact, self contained and easily portable electrically operated sewing machine.

The Motor. The electric motor is of the universal type, which can be operated on direct or alternating current circuits. The speed of the motor is controlled by a foot rheostat, and the sewing speed can be varied from slow to fast through several intermediate speeds by a slight pressure of the operators foot.

Cat. No. 1—6 Sewing Machine with a vibrating shuttle. Net weight
32 lbs. Shipping weight 30 lbs. List Price..... \$120.00

No. 12—6 VACUUM CLEANSER

With Motor Driven Brush

The Western Electric Vacuum Sweeper, Sweeps, Loosens and Sucks up the Dirt.

One of the most important features about this sweeper is its application of the worm gear, which immediately makes its construction radically different than any other sweeper with the motor driven brush, the strongest vacuum of any sweeper of its kind. With this sweeper the brush is so adjusted that at all times it just touches the top of the fabric. The nozzle is so built that it rests directly on the surface to be cleaned, and the cleaning current of air is applied directly to that surface. The brush shaft is nicked so that it is smooth and threads will not stick. This machine is lighter than any other motor driven brush type sweeper. In addition to its lightness and added convenience is the form of a lifting device. This is so that the sweeper can be run over fabrics of all different thicknesses, over thresholds, etc., without it having to be lifted. There is an accessibility to the working parts of this motor that no other sweeper has. This motor is balanced, for one end drives the fan and the other end turns the worm, which drives the belt which in turn drives the brush. The fan is substantially constructed. Before attached to the sweeper it is tested to make sure that it is perfectly balanced. The motor is air cooled. The cool air having been drawn from the air perforations in the back of the motor, through the motor cooling it and emptying it through air tubes into the bag crating. The machine, tools, handle and all go out in three boxes.

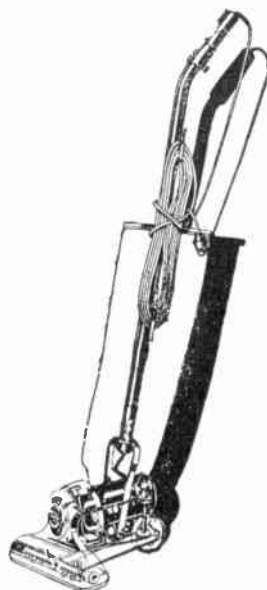

	Weight	Fan Rev.	Brush Rev.	List Price
Less Attachments	13 lbs.			\$115.00
Attachments only	9 lbs.	8300	1100	21.00

WESTERN ELECTRIC WASHING MACHINE With Wringer

All moving parts of the Western Electric washer are enclosed. This machine can be operated with perfect safety by any woman or child. It is the safest washer made and the safest washer made is the safest washer to sell. It is the only machine that has three free sides around which the operator can work without obstruction.

It occupies less floor space than any other machine of equal capacity.

Has patented safety release on wringer which prevents tearing of clothes due to clogged wringer.

There are no bolts or chains to slip or break—no complicated machinery to get out of order. The automatic reverse is accomplished by means of an absolutely new mechanical movement, having by far fewer parts than any other reversing cylinder machine on the market.

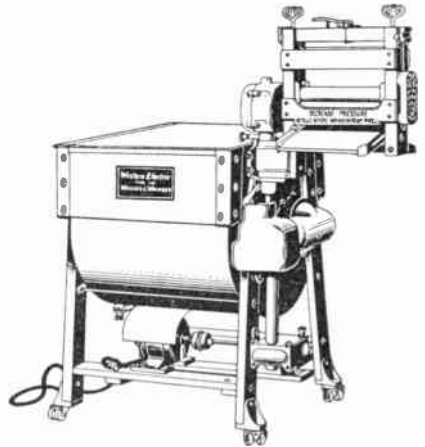

SIMPLE: The machine is composed of but 35 parts against more than one hundred in the next simplest machine. Operated by only two levers—one for washing and one for wringing.

OPERATION: Machine operates on the reversing cylinder principle, which is conceded by experts to be the only correct method for washing clothes clean, and without injury. The wringer has two rolls, reversible, and the rolls are made of the best Para rubber. This machine will do the washing of a family of four in one hour at only two cents for electricity.

SANITARY TUB is completely lined with metal, leaving no crevices or corners for the collection or absorption of impurities. Easily emptied by means of a faucet in the bottom of the machine.

FEATURES: Only two operating levers, no gears inside to tear or spot clothes, reversing cylinder insures through washing metal top, no warping, metal lining throughout, rust-proof swivel castors easily moved, all parts enclosed, no danger to operator or children, motor covered, splash-proof, all gears at one end and protected shaft drive, no troublesome belts or chains, safety release on wringer rolls.

Type	Material of Body	Capacity Sheets	Wringer	Shipping Wt.	List Price
A—6	Steel	6	Stationary	250 lbs.	\$300.00
AS—6	Steel	6	Swinging	250 lbs.	280.00
AC—6	Copper	6	Stationary	250 lbs.	350.00
ACS—6	Copper	6	Swinging	250 lbs.	330.00

Please specify voltage and type of current when ordering.

APPENDIX

PRACTICAL EQUATIONS FOR RADIO TELEGRAPHY

1 For Condensers in Parallel.

$$C = C_1 + C_2 + C_3 \text{ (etc.)}$$

where C = Resultant Capacity

$C_1, C_2, C_3,$ = Capacity of individual condenser units.

2 For Condensers in Series.

$$C = \frac{1}{\frac{1}{C_1} + \frac{1}{C_2} + \frac{1}{C_3}}$$

where C_1, C_2, C_3 = Capacity of individual condenser units.

3 For Time Period of an Oscillation Circuit.

$$T = \frac{1}{N}$$

where T = Time in fractions of a second

N = Frequency of vibration

$$\text{Also } T = \sqrt{\frac{LC}{5033000}}$$

where L = Inductance in centimeters

C = Capacity in Microfarads

4 For Wave Length of an Oscillation Circuit.

$$\lambda^* = 59.6 \sqrt{LC}$$

where λ = Wave length in meters

L = Inductance in centimeters

C = Capacity in microfarads

*This formula is only true for a closed oscillation circuit,

For a plain aerial circuit $\lambda = 38 \sqrt{LC}$

5 For Capacitance of an Aerial.

$$C = \frac{\lambda_1^2 - \lambda_2^2}{\lambda_2^2} \times C_1$$

Where C = Capacity of the aerial in mfd's.

λ_1^2 = Square of the natural wave length of the aerial

λ_2^2 = Square of the wave length of the aerial with C_1 in series

C_1 = Condenser of known capacity connected in series with the aerial

APPENDIX

6 For the Inductance of an Aerial.

$$L = \frac{\lambda_1^2}{\lambda_2^2 - \lambda_1^2} \times l$$

Where L = Inductance of aerial system in centimeters

λ_1^2 = Natural wave length of aerial squared

λ_2^2 = Wave length of aerial with (l) in series, squared.

l = Inductance coil of known value

7 Capacity of a Flat Plate Condenser.

$$C = \frac{KA 2248}{T \times 10^{10}}$$

C = Capacity in microforads

A = Area of dielectric in use in square inches

T = Thickness of dielectric in inches

K = Dielectric constant of insulating medium (generally varies from 6 to 9).

8 For Radiation Resistance of a Flat Top Aerial.

$$R = K \frac{h^2}{\lambda^2}$$

K = A constant, 1600

λ = Wave length of aerial in meters

h = Height of aerial in meters

9 Watts Radiated from a Flat Top Aerial.

$$W = \frac{h^2}{\lambda^2} I^2 \times 1578$$

Where h² = Height of aerial in meters

λ = Wave length of aerial in meters

I² = The square of the hot wire ammeter reading in amperes at the base of the aerial.

10 Ohms Law for Direct Current.

$$I = \frac{E}{R}$$

Where I = Current in amperes

E = Electromotive force in volts

R = Resistance in ohms

Similarly $R = \frac{E}{I}$ and $E = I \times R$

APPENDIX

11 *Watts in a D. C. Circuit.*

$$W = I \times E$$

Where W = Watts

I = Current in amperes

E = Electromotive force in volts

Also $W = I^2 R$

Where R = resistance in ohms

$$\text{Again } I = \sqrt{\frac{W}{R}}$$

12 *Ohms Law for Alternating Current.*

$$I = \frac{E}{Z}$$

I = Current in Amperes.

E = Electromotive force in Volts.

Z = Impedance in Ohms.

$$\text{Also } Z = \frac{E}{I} \text{ and } E = I \times Z.$$

13 *For Impedance.*

$$Z = \sqrt{R^2 + (2\pi FL)^2}$$

where Z = Impedance in ohms

R = Resistance in ohms.

$2\pi FL$ = Reactance of circuit in ohms.

14 *For Reactance.*

$$X = 2\pi FL$$

where X = Reactance of Circuit in ohms.

F = Frequency of circuit in cycles per second.

L = Inductance in henries.

$$\text{or } X = \sqrt{Z^2 - R^2}$$

15 *Inductance of a Circuit by Voltmeter and Ammeter Method.*

$$L = \frac{\sqrt{E^2 - I^2 R^2}}{I^2 (2\pi N^2)}$$

where L = Inductance in henries

E = Potential applied

I^2 = Square of Current flowing

R^2 = Square of Resistance of coil or circuit in ohms.

N = Frequency in cycles per second.

INTERNATIONAL MORSE CODE AND CONVENTIONAL SIGNALS

TO BE USED FOR ALL GENERAL PUBLIC SERVICE RADIO COMMUNICATION

1. A dash is equal to three dots.
2. The space between parts of the same letter is equal to one dot.

3. The space between two letters is equal to three dots.
4. The space between two words is equal to five dots.

A	• —
B	— • • •
C	— • • — •
D	— • • •
E	•
F	• • — •
G	— • • •
H	• • • •
I	• •
J	• — • — • —
K	— • • —
L	• — • •
M	— —
N	— •
O	— — —
P	• — • • •
Q	— • — • —
R	• — • •
S	• • • •
T	—
U	• • • —
V	• • • • —
W	— • — —
X	— • • • —
Y	• — • — —
Z	— • — • •
<hr/>	
Ä (German)	• — • • —
Á or Å (Spanish-Scandinavian)	• • — • —
CH (German-Spanish)	— — — —
É (French)	• • — • • •
Ñ (Spanish)	— • • • — —
Ö (German)	— • — • •
Ü (German)	• • — • —
<hr/>	
1	• — • — —
2	• • — • — —
3	• • • — —
4	• • • • —
5	• • • • •
6	— • • • •
7	• — • • • •
8	— • — • • •
9	— • — • — •
0	— • — • — —

Period	• • • • •
Semicolon	— • — • — •
Comma	• — • • • —
Colon	— • — — • • •
Interrogation	• • — — • •
Exclamation point	— • — • • — —
Apostrophe	• — • — — — •
Hyphen	— • • • • —
Bar indicating fraction	— • • • — •
Parenthesis	— • — • — — • —
Inverted commas	• — • • — • •
Underline	• • — — • — —
Double dash	— • • • • —
Distress Call	• • • — — — • • • •
Attention call to precede every transmission	— • — • — •
General inquiry call	— • • • — — — • —
From (de)	— • • • •
Invitation to transmit (go ahead)	— • • —
Warning—high power	— • • • • — —
Question (please repeat after)—interrupting long messages	• • • — — • • •
Wait	• — • • • •
Break (Bk.) (double dash)	— • • • • —
Understand	• • • — •
Error	• • • • • • •
Received (O. K.)	• — • •
Position report (to precede all position messages)	— • — • •
End of each message (cross)	• — • • • •
Transmission finished (end of work) (conclusion of correspondence)	• • • — • • •

INTERNATIONAL RADIOTELEGRAPHIC CONVENTION

LIST OF ABBREVIATIONS TO BE USED IN RADIO COMMUNICATION

ABBREVIATION.	QUESTION.	ANSWER OR NOTICE.
PBB	Do you wish to communicate by means of the International Signal Code?	I wish to communicate by means of the International Signal Code.
QRA	What ship or coast station is that?	This is
QRB	What is your distance?	My distance is
QRC	What is your true bearing?	My true bearing is degrees.
QRD	Where are you bound for?	I am bound for
QRF	Where are you bound from?	I am bound from
QRG	What line do you belong to?	I belong to the Line.
QRH	What is your wave length in meters?	My wave length is meters.
QRJ	How many words have you to send?	I have words to send.
QRK	How do you receive me?	I am receiving well.
QRL	Are you receiving badly? Shall I send 20?	I am receiving badly. Please send 20.
	• • • • • for adjustment?	• • • • • for adjustment.
QRM	Are you being interfered with?	I am being interfered with.
QRN	Are the atmospherics strong?	Atmospherics are very strong.
QRO	Shall I increase power?	Increase power.
QRP	Shall I decrease power?	Decrease power.
QRS	Shall I send faster?	Send faster.
QRT	Shall I send slower?	Send slower.
QRT	Shall I stop sending?	Stop sending.
QRU	Have you anything for me?	I have nothing for you.
QRV	Are you ready?	I am ready. All right now.
QRW	Are you busy?	I am busy (or: I am busy with). Please do not interfere.
QRX	Shall I stand by?	Stand by. I will call you when required.
QRY	When will be my turn?	Your turn will be No.
QRZ	Are my signals weak?	Your signals are weak.
QSA	Are my signals strong?	Your signals are strong.
QSB	Is my tone bad?	The tone is bad.
QSB	Is my spark bad?	The spark is bad.
QSC	Is my spacing bad?	Your spacing is bad.
QSD	What is your time?	My time is
QSF	Is transmission to be in alternate order or in series?	Transmission will be in alternate order.
QSG	Transmission will be in series of 5 messages.
QSE	Transmission will be in series of 10 messages.
QSH	What rate shall I collect for?	Collect
QSK	Is the last radiogram canceled?	The last radiogram is canceled.
QSL	Did you get my receipt?	Please acknowledge.
QSM	What is your true course?	My true course is degrees.
QSN	Are you in communication with land?	I am not in communication with land.
QSO	Are you in communication with any ship or station (or: with)?	I am in communication with (through).
QSP	Shall I inform that you are calling him?	Inform that I am calling him.
QSQ	Is calling me?	You are being called by
QST	Will you forward the radiogram?	I will forward the radiogram.
QST	Have you received the general call?	General call to all stations.
QSU	Please call me when you have finished (or: at o'clock)?	Will call when I have finished.
QSV	Is public correspondence being handled?	Public correspondence is being handled. Please do not interfere.
QSW	Shall I increase my spark frequency?	Increase your spark frequency.
QSX	Shall I decrease my spark frequency?	Decrease your spark frequency.
QSY	Shall I send on a wave length of meters?	Let us change to the wave length of meters.
QSZ	Send each word twice. I have difficulty in receiving you.
QTA	Repeat the last radiogram.

*Public correspondence is any radio work, official or private, handled on commercial wave lengths. When an abbreviation is followed by a mark of interrogation, it refers to the question indicated for that abbreviation.

**THE RELATION OF NATURAL WAVE-LENGTH, FREQUENCY,
AND INDUCTANCE-CAPACITY PRODUCT
IN CONDENSER CIRCUITS**

Meters	n	L x C	Meters	n	L x C	Meters	n	L x C	Meters	n	L x C
100	3,000,000	0.00282	500	600,000	0.0704	700	429,000	0.1379	900	333,000	0.228
110	2,727,000	0.00341	505	594,000	0.0718	705	426,000	0.1399	905	331,000	0.231
120	2,500,000	0.00405	510	588,000	0.0732	710	428,000	0.1419	910	330,000	0.233
130	2,308,000	0.00476	515	583,000	0.0747	715	420,000	0.1439	915	328,000	0.236
140	2,143,000	0.00552	520	577,000	0.0761	720	417,000	0.1459	920	326,000	0.238
150	2,000,000	0.00633	525	572,000	0.0776	725	414,000	0.1479	925	324,000	0.241
160	1,875,000	0.00721	530	566,000	0.0791	730	411,000	0.1500	930	323,000	0.243
170	1,764,000	0.00813	535	561,000	0.0806	735	408,000	0.1521	935	321,000	0.246
180	1,667,000	0.00912	540	556,000	0.0821	740	405,000	0.1541	940	319,000	0.249
190	1,579,000	0.01015	545	551,000	0.0836	745	403,000	0.1562	945	317,000	0.251
200	1,500,000	0.01126	550	546,000	0.0852	750	400,000	0.1583	950	316,000	0.254
210	1,429,000	0.01241	555	541,000	0.0867	755	397,000	0.1604	955	314,000	0.257
220	1,364,000	0.01362	560	536,000	0.0883	760	395,000	0.1626	960	313,000	0.259
230	1,304,000	0.01489	565	531,000	0.0899	765	392,000	0.1647	965	311,000	0.262
240	1,250,000	0.01621	570	527,000	0.0915	770	390,000	0.1669	970	309,000	0.265
250	1,200,000	0.01759	575	522,000	0.0931	775	387,000	0.1690	975	308,000	0.268
260	1,154,000	0.01903	580	517,000	0.0947	780	385,000	0.1712	980	306,000	0.270
270	1,111,000	0.0205	585	513,000	0.0963	785	382,000	0.1734	985	305,000	0.273
280	1,071,000	0.0221	590	509,000	0.0980	790	380,000	0.1756	990	303,000	0.276
290	1,034,000	0.0237	595	504,000	0.0996	795	377,000	0.1779	995	302,000	0.279
300	1,000,000	0.0253	600	500,000	0.1013	800	375,000	0.1801	1000	300,000	0.282
310	968,000	0.0270	605	496,000	0.1030	805	373,000	0.1824	1010	297,100	0.287
320	938,000	0.0288	610	492,000	0.1047	810	370,000	0.1847	1020	294,200	0.293
330	909,000	0.0306	615	488,000	0.1065	815	368,000	0.1870	1030	291,300	0.299
340	883,000	0.0325	620	484,000	0.1082	820	365,000	0.1893	1040	288,500	0.304
350	857,000	0.0345	625	480,000	0.1100	825	364,000	0.1916	1050	285,700	0.310
360	834,000	0.0365	630	476,000	0.1117	830	361,000	0.1939	1060	283,000	0.316
370	811,000	0.0385	635	472,000	0.1135	835	359,000	0.1962	1070	280,400	0.322
380	790,000	0.0406	640	469,000	0.1153	840	357,000	0.1986	1080	277,800	0.328
390	769,000	0.0428	645	465,000	0.1171	845	355,000	0.201	1090	275,200	0.334
400	750,000	0.0450	650	462,000	0.1189	850	353,000	0.203	1100	272,700	0.341
410	732,000	0.0473	655	458,000	0.1208	855	351,000	0.206	1110	270,300	0.347
420	715,000	0.0496	660	455,000	0.1226	860	349,000	0.208	1120	267,900	0.353
430	698,000	0.0520	665	451,000	0.1245	865	347,000	0.211	1130	265,500	0.359
440	682,000	0.0545	670	448,000	0.1264	870	345,000	0.213	1140	263,200	0.366
450	667,000	0.0570	675	444,000	0.1283	875	343,000	0.216	1150	260,900	0.372
460	652,000	0.0596	680	441,000	0.1302	880	341,000	0.218	1160	258,600	0.379
470	639,000	0.0622	685	438,000	0.1321	885	339,000	0.220	1170	256,400	0.385
480	625,000	0.0649	690	435,000	0.1340	890	337,000	0.223	1180	254,200	0.392
490	612,000	0.0676	695	432,000	0.1360	895	335,000	0.225	1190	252,100	0.399

BOOKS ON RADIO ENGINEERING

In the list below will be found latest books upon modern Radio phone circuits, Amplifiers, both Audio and Radio frequency, loops, and the latest in Radio Engineering Theory.

PRACTICAL WIRELESS TELEGRAPHY by Bucher.....	\$4.50
VACUUM TUBES IN WIRELESS TELEGRAPHY by Bucher.....	4.50
THE WIRELESS EXPERIMENTER'S MANUAL by Bucher.....	4.50
HOW TO PASS U. S. GOVERNMENT WIRELESS LICENSE EXAMINATION by Bucher	1.50
HOW TO CONDUCT A RADIO CLUB by Bucher.....	1.50
RADIO TELEPHONY by Goldsmith.....	5.00
SIGNAL CORPS MANUAL by Major J. Andrew White.....	4.50
PRACTICAL AVIATION by Major J. Andrew White.....	4.50
ELEMENTARY PRINCIPLES OF WIRELESS TELEGRAPHY by Bangay	
Part 1	3.50
Part 2	3.50
SPANISH EDITION Bangay's ELEMENTARY PRINCIPLES OF ELECTRICITY AND MAGNETISM complete.....	6.50
THE OSCILLATION VALVE, THE ELEMENTARY PRINCIPLES AND ITS APPLICATION TO WIRELESS TELEGRAPH by Bangay	5.50
THE WIRELESS TELEGRAPHER'S POCKET BOOK OF NOTES FORMULAE AND CALCULATIONS by Fleming.....	6.00
THE PRINCIPLES OF ELECTRIC WAVE TELEGRAPHY by Fleming	28.00
RADIO TELEGRAPHY AND RADIO TELEPHONY by Fleming.....	6.40
THERMIONIC VALVE AND ITS DEVELOPMENT IN RADIO TELEGRAPHY AND TELEPHONY by Fleming.....	10.00
HANDBOOK OF TECHNICAL INSTRUCTION FOR WIRELESS TELEGRAPHERS by Hawkhead and Dowsett.....	5.00
STANDARD TABLES AND EQUATIONS IN RADIO TELEGRAPHY by Hoyle	6.50
CALCULATION AND MEASUREMENT OF INDUCTANCE AND CAPACITY by Nottage	3.00
MAGNETISM AND ELECTRICITY FOR HOME STUDY by Penrose	3.50
POCKET DICTIONARY OF TECHNICAL TERMS USED IN WIRELESS TELEGRAPHY by Ward.....	2.00
THE PROCEEDINGS OF THE INSTITUTE OF RADIO ENGINEERS	18.00
RADIO ENGINEERING PRINCIPLES by Lauer and Brown.....	7.00
ELEMENTS OF RADIO TELEGRAPHY by Stone.....	5.00
A THOUSAND AND ONE FORMULAS by S. Gernsback.....	3.50
ARTS AND SCIENCE SERIES by Cole and Morgan	
No. 3 LESSONS IN WIRELESS TELEGRAPHY.....	.70
No. 4 OPERATION OF WIRELESS TELEGRAPH APPARATUS..	.70
No. 5 WIRELESS CONSTRUCTION AND INSTALLATION FOR BEGINNERS70
No. 6 EXPERIMENTAL WIRELESS CONSTRUCTION.....	.70
No. 7 HOME MADE ELECTRICAL APPARATUS. Vol. 1.....	.70
No. 8 HOME MADE ELECTRICAL APPARATUS. Vol. 2.....	.70
No. 9 HOME MADE ELECTRICAL APPARATUS. Vol. 3.....	.70
No. 10 HOME MADE TOY MOTORS70

INDEX

- A**
- Amplifiers...24, 25, 26, 27, 28, 29, 30, 31
 Amplifying transformers.....32
 Ammeters58, 59, 60
 Antenna Switches40
 Antenna Wire55
 Appendix.....97, 98, 99, 100, 101, 102
 Audion Panels.....20, 21, 22, 23, 25, 26
- B**
- "B" Batteries63
 Binding Posts.....69, 72, 73, 74
 Books103
 Brass Nuts72
 Buzzers70
- C**
- Cam Switches71
 Chafing Dish89
 Choke Coils50
 Condensers (Variable),
 10, 11, 12, 13, 14, 15, 16, 17
 Condensers (Fixed))6, 54
 Connectors (Fahnestock).....75
 Cord Tips72
 Crystal Cups74
 Coil Mountings9
 Coils (Tuning)6
 Coils Duolateral78, 79
 Crystals (Galena)74
 Curling Irons92
- D**
- Detector and Amplifiers.....24
 Detectors (Audion),
 20, 21, 22, 23, 25, 26
 Detectors (Crystal)18
 Detector Rod74
 Duolateral Coils78, 79
- E**
- Electric Grills.....80, 81
 Electric Irons77, 78, 79
 Electric Soldering Irons.....76
 Emeraldite Junior Lamp.....93
- F**
- Fahnestock Connectors.....75
- G**
- Galena Crystal74
 Grebe Special Receiver.....5
 Grid Leak74
 Grills80, 81
 Ground Wire40
- H**
- Heating Pads92
- I**
- Inductance (Loading).....6
 Insulators55
- J**
- Jacks (Telephone).....71
- K**
- Keys (Telegraph).....67
 Knobs69, 72
- L**
- Learners Telegraph Sets.....69
 Lightning Switch40
 Line Protectors54
 Loading Inductance6
 Loud Speaker (Magnavox).....36
- M**
- Magnavox Loud Speaker.....36
 Magnet Wire56
 Milliammeters58, 59
 Motor Generator Set.....57
- O**
- Omnigraph Transmitters.....66
 Oscillation Transformer.....41
- P**
- Paragon RA-Ten Receivers.....3
 Paragon Rheostats61
 Paragon V. T. Control.....25
 Percolators.....85, 86, 87, 88

INDEX

Plugs (Telephone)	71
Potentiometers	62
Protectors (Line)	54

Q

Quenched Spark Gaps.....	43
--------------------------	----

R

Radiators	92
Radio Couplers	41
Radiotron Vacuum Tubes.....	19
Receivers (Telephone).....	33, 34, 35
Receiving Transformers.....	4, 6
Rectifiers	38, 68
Rheostats	61, 62

S

Sewing Machines	94
Spark Coils.....	51, 53
Spark Gaps.....	43, 44
Storage Batteries	64
Switches (Instrument).....	72, 74
Switches (Antenna).....	40
Switch Points.....	69, 72
Switch Stops	69

T

Telegraph Keys	67
Telegraph Sounders	68
Telephone Jacks	71
Telephone Plugs	71
Thermo Ammeters.....	58, 59
Toasters.....	82, 83, 84
Transformers.....	45, 46, 47, 48, 49, 51
Transmitting Condensers	44
Transmitting Sets	39

V

Vacuum Cleaners	95
Vacuum Tubes	19
Vacuum Tube Sockets.....	74
Variable Condensers, 10, 11, 12, 13, 14, 15, 16, 17	
Volt Meters.....	58, 59, 60

W

Waffle Irons	81
Washers	72
Washing Machines	96
Wave Meters	37, 38
Wire (Aerial)	55
Wire (Ground)	40
Wireless Keys.....	52, 53
Wireless Practice Sets.....	68

MEMO.

MEMO.

MEMO.

MEMO.

MEMO.

MEMO.

MEMO.

COLLISON & KLINGMAN, INC
301-303 ADAMS STREET
BROOKLYN, N. Y.

Continental Radio and Electric Corporation

6 Warren Street

New York City

Price List



"The Symbol of Service"

Radio Equipment
Heating Appliances
Electrical Supplies
Experimental Apparatus

Continental Radio and Electric Corporation

6 Warren Street

New York City

All Prices Subject to Change Without Notice

This List is a Supplement to our Catalogue and gives the Net Prices of all Articles Listed Therein

Terms:

All Prices are Net, F. O. B. our Store.
An Advance Payment of One-Third the Total
Amount Must Accompany All C. O. D.
Orders Exceeding Ten Dollars.

Shipments Made the Day Order is Received

List No.	Net Price Each	List No.	Net Price Each	List No.	Net Price Each
Page 3		1250	3.85	Page 16	
RA-Ten	\$85.00	1500	4.10	366-8	\$4.75
Page 4		Page 9		366-8	
673-15	\$14.00	LC100-7	\$10.00	Unmtd.	4.25
Page 5		LC101-7	13.00	367-8	4.75
121-18	CR3	LC201-7	15.00	368-8	3.75
	\$65.00	Page 10		368-In-	
Page 6		41-C	\$6.50	terior	3.25
344-8	\$9.00	3660-8	4.50	Page 17	
240-8	4.00	Page 11		3662-8	\$5.00
510-8	4.00	182A-16	\$12.00	3681-8	3.50
358-8	.81	182B-16	13.50	Page 18	
Page 7		182C-16	8.75	675-15	\$5.00
US25	\$.90	182E-16	13.50	676-15	.20
35	1.00	182F-16	15.00	678-15	6.25
50	1.10	182G-16	9.70	D1-24	2.50
75	1.20	Page 12		D2-24	5.00
100	1.30	1-40	\$5.00	Page 19	
150	1.40	2-40	4.50	UV200	\$5.00
200	1.50	Page 13		UV201	6.50
250	1.60	S-500-45	\$22.00	Page 20	
300	1.80	S-1000-45	29.50	P402-7	\$21.00
400	2.00	S-2000-45	37.50	P500-7	24.00
500	2.20	S-4000-45	60.00	Page 21	
600	2.50	Page 14		A1-10	\$15.00
750	2.70	CV500-17	\$6.25	Page 22	
1000	2.90	735-15 Com-		311-18	
1250	3.50	plete	6.50	RORA	12.50
1500	4.00	735-15		Page 23	
Page 8		Unmtd.	5.75	117-18	
DL25	\$1.65	774-15 Com-		RORH	\$17.00
35	1.70	plete	5.50	Y1-18	10.00
50	1.75	774-15		Y2-19	13.00
75	1.85	Unmtd.	5.00	Page 24	
100	1.90	Page 15		115-18	
150	2.10	800-15	\$7.50	RORE	\$25.00
200	2.30	800A-15	9.50	123-18	
250	2.45	800B-15	11.75	RORG	47.00
300	2.60	800C-15	4.00	124-18	
400	2.75	800G-15	1.30	RORL	51.00
500	2.80				
600	3.05				
750	3.30				
1000	3.55				

List No.	Net Price Each	List No.	Net Price Each	List No.	Net Price Each
Page 25		Page 35		Page 43	
70-17	\$6.00	44A	\$20.00	G1-24	\$41.50
Page 26		44B	22.00	G2-24	29.50
ZRD-15	\$12.00	Page 36		G3-24	12.00
ZRA-15	18.00	R1-41	\$90.00	Page 44	
Page 27		Page 37		7750-11	\$1.40
A2-10	\$50.00	7042-15	\$27.50	8946-11	.50
Page 29		Page 38		421-1	2.70
A3-43	\$75.00	174-16	\$68.00	483-8	3.25
Page 30		25-RT	35.00	488-8	5.00
A3-10	\$70.00	25-VT	7.00	Page 45	
Page 31		Page 39		250-19	\$16.00
110-18		740-15	\$250.00	500-19	22.00
RORD		740A-15	125.00	1000-19	33.00
	\$70.00	771-15	500.00	250-19	
116-18		772-15	250.00	Unmtd	13.00
RORF	65.00	Page 40		500-19	
Page 32		658-15	\$12.50	Unmtd.	18.00
226W-20	\$8.00	463-8	4.50	1000-19	28.00
226W-20		384-1	5.50	Page 46	
Unmtd.	7.50	No. 4 Wire		F1-19	\$30.00
A2-19		Ft.	.15	H1-19	45.00
Mtd.	7.50	Page 41		Page 47	
A2-19 Semi-		Z652-15	\$20.00	638-15	\$23.50
Mtd.	5.00	Z651-15	.50	639-15	28.00
A2-19		424-8	5.00	750-15	40.00
Unmtd.	4.50	Page 42		640-15	18.00
Page 33		D100-23	\$19.00	641-15	22.00
8426C-1	\$16.50	D101-23	30.00	751-15	34.00
8426D-1	17.50	D102-23	45.00	Page 49	
8426E-1	20.00	D103-23	50.00	200CWM-19	
8426F-1	21.00	D110-23	21.00		\$20.00
55-8 200		D111-23	35.00	200CWU-19	
Ohm.	4.50	D112-23	50.00		16.00
55-8 300		D113-23	55.00	50CWM-19	
Ohm.	5.50	D170-23	1.50		15.00
Page 34		D180-23	1.00	50CWU-19	
213-1	\$12.00	D181-23	1.00		12.00
214-1	8.00	D182-23	1.00	Page 50	
212-1	14.00	D183-23	1.00	50FTM-19	
Cord.	1.25	D184-23	1.00		\$12.00
Caps.	.25			50FTU-19	
					9.00

List No.	Net Price Each	List No.	Net Price Each	List No.	Net Price Each
150FTM-19	16.00	Page 55		Page 59	
150FTU-19	13.00	6222-50 ..	\$5.00	33-49	\$6.50
500CCS-19	6.00	6868-60...	4.60	33-49 0-500	
150CCS-19	4.00	6815-50...	2.50	volts ...	15.00
500CCD-19	8.00	6266-50...	1.70	Page 60	
150CCD-19	6.00	4500-50...	.50	25A-49 ..	\$18.00
48T.....	2.50	4502-50...	.60	25B-49..	18.00
Page 51		4507-50...	1.00	25C-49..	18.00
A3M-19 ..	\$7.00	No. 14		25D-49..	18.00
A3SM-19.	5.00	Aluminum		Page 61	
A3U-19...	4.50	Wire.....	.80	214A-16.	\$2.50
459.....	5.00	No. 14 Hard		214B-16...	2.50
460.....	6.00	Drawn		25-17.....	1.75
461.....	8.20	Copper..	1.00	Page 62	
462.....	9.00	7/22 Stranded		2110-1 ...	\$1.40
463.....	12.00	Copper..	2.00	2111-1....	1.40
464.....	16.00	7/20 phosphor		743-15....	3.00
496.....	57.00	bronze...	3.00	743A-15..	1.50
Page 52		Navy An-		743B-15...	2.50
643-15...	\$7.50	tenna wire		Page 63	
7939-11...	4.00	.16/30....	3.00	2156-53...	3.50
7940-11...	7.00	7/18 Gal-		4156-53...	2.25
7941-11...	8.00	vanized		Page 64	
Page 53		wire.....	1.00	Storage bat-	
80-1	\$4.00	Page 56		teries ...	50%
88-1.....	.50	Magnet		Page 65	
495-1....	35.00	wire	50%	195529..	\$18.00
7758.....	4.50	Page 57		299865...	28.00
7759.....	5.50	TXW-100-A		195528...	4.00
7760.....	7.50		\$99.00	189049...	8.00
7761.....	8.20	TXW-100-B		Page 66	
7762.....	11.00		110.00	2-38	\$38.00
7763.....	15.00	TXW-101-A		2-38 dials	3.75
7764.....	28.00		68.00	2-38 Jr..	20.00
7765.....	40.00	TXZ-100-A		2-38 Jr.	
Page 54			20.00	dials...	1.25
CD888-23	\$5.00	Page 58		5-38.....	12.00
AM888-23	4.00	Model		Page 67	
D160-23..	7.00	301-17 ..	\$8.50	101-1	\$2.00
		425-1 0-5		143-1.....	3.30
		amp.	18.25	144-1.....	3.60
		425-1 0-6			
		to 0-20..	22.00		

List No.	Net Price Each	List No.	Net Price Each	List No.	Net Price Each
Page 68		Page 73		Page 76	
342-1	\$4.50	4819	\$.17	238-5	\$10.00
344-1	4.00	3820	.24	239-5	10.00
Page 69		4821	.22	240-5	10.00
178-1	\$4.20	4822	.17	241-5	13.25
179-1	4.50	4823	.26	242-5	23.50
41-15	.06	4824	.17	243-5	26.25
42-15	.06	4825	.15	Page 77	
43A-15	.40	4826	.13	6½B-6	\$10.00
210-15	.30	4827	.13	3B-6	10.00
211-15	.40	4828	.13	Page 78	
212-15	.05	4829	.11	1-6	\$8.50
213A-15	.35	4830	.17	Page 79	
66-15	.10	4831	.35	9B-6	\$11.50
Page 70		4832	.09	Page 80	
55-1	\$2.50	4833	.09	3375-6	\$17.50
8499-1	2.50	4834	.30	3375-6-S0	14.50
Page 71		4835	.30	Page 81	
1424W-20	\$2.80	Page 74		E9184-2	\$15.00
1426W-20	2.55	1-52	\$0.04	E9182-2	12.50
1427W-20	2.65	2-52	.04	E930-2	20.00
1421W-20	.70	3-52	.04	Page 82	
1422W-20	.85	4-52	.10	3350-G-5	\$8.50
1423W-20	1.00	10-52	.25	5825-G-5	9.50
1428W-20	2.00	20-52	.56	Page 83	
1428W-20		30-52	.50	E946-2	\$8.00
silver		40-52	.30	E944-2	8.50
plated	2.50	50-52	.12	E945-2	9.00
Page 72		100-52	.65	Page 84	
19-15	\$1.00	110-52	.65	211-5	\$9.50
19A-15	.35	R-100-7	1.50	212-5	7.50
20-15	.12	GL-100-51	1.25	215-5	8.00
21-15	.07	M-300-51	1.50	1915-5	8.00
22-15	.10	Page 75		Page 85	
23-15	.04	Brass		2417-6	\$21.50
31-15	.40	3C-39	\$0.05	2427-6	26.00
32-15	.20	per doz	.50	2429-6	28.50
33-15	.15	per 100	2.15		
36-15	.15	4-39	.05		
37-15	.12	per doz	.60		
213A-15	.35	per 100	2.30		
38-15	.06	9C-39	.08		
39-15	.07	per doz	.75		
40-15	.08	per 100	3.50		
		15-39	.03		
		per doz	.25		
		per 100	1.50		

List No.	Net Price Each	List No.	Net Price Each	List No.	Net Price Each
Page 86		E9149-2		E1994-2.	10.50
2316-6 ..	\$17.50	Nickle.	26.00	E9901-2..	7.25
2326-6...	20.00	Silver...	30.00	E99011-2..	8.00
Page 87		E9644-2.	18.50	E9902-2..	9.50
E9166-2		E9646-2		E99021-2..	8.00
Nickeled		Nickle..	21.00	Page 93	
	\$28.50	Silver..	24.50	37 Junior	
Copper.	30.00	E9649-2			Satin
Silver..	35.00	Nickle..	23.50	37 Junior	\$5.00
E-9169-2		Silver...	27.00	Satin.....	5.50
Nickle.	\$31.00	Page 89		Page 94	
Copper.	32.00	2333-6 ...	\$22.50	1-6	\$60.00
Silver..	35.00	24433-6..	26.50	Page 95	
E-9166044-2		Page 90		12-6	\$57.50
Nickel	\$52.25	3210-6..	\$8.50	Attachments	
Copper.	55.25	3221-6...	9.50	only....	10.50
Silver..	62.00	3231-6...	11.00	Page 96	
E-9169044-2		Page 91		A-6 ...	\$150.00
Nickle	\$54.75	734-5 ...	\$18.00	AS-6...	140.00
Silver..	58.25	99-5.....	12.50	AC-6...	175.00
Copper.	64.50	100-5....	9.50	ACS-6..	165.00
Page 88		Page 92		Page 103	
E93462 ..	\$21.00	E19940-2		Books ...	50%
E9144-2..	22.00		\$13.50		
E9146-2					
Nickle..	23.50				
Silver..	27.50				



