

THE ~~CROSLEY~~ BROADCASTER

VOLUME 13

DECEMBER 15, 1934

NUMBER 16

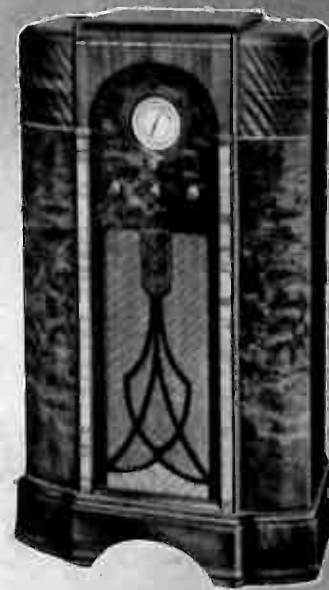

WLW

WISHING YOU
A JOYFUL
~~CROSLEY~~
CHRISTMAS



TALKS TO THE TRADE



P O W E L C R O S L E Y , J R . S A Y S :

MAY this be the merriest Christmas you have ever had—this is our sincerest wish to every Crosley distributor, dealer and salesman.

As the year 1934 draws to a close, let us look back and review a few of the highlights that have made it such a profitable year for every dealer who has ridden along with the Crosley bandwagon.

First of all, the great public acceptance of the name Crosley has been greatly enhanced through the operation of the new 500,000-watt WLW, the world's most powerful broadcasting station.

The amazing line of Crosley electric refrigerators, including the Shelvador, Tri-Shelvador and Chest Shelvador, has proven to be a selling sensation. It is the

fastest growing line of electric refrigerators in America.

In the Crosley Radio line, new heights of value leadership have created vast sales and profits. New beauty and world-wide reception have given Crosley Radios a definite sales leadership that has meant much to every Crosley dealer.

In wishing you a happy and prosperous New Year it is with the thought in mind that we will strive for even greater accomplishments so that every member of the Crosley dealer-family may enjoy greater sales and greater profits than ever before.

As we look forward to 1935, may we feel that our relationship is more closely cemented than ever before and that the New Year will be one of great profit for every Crosley dealer.

NO DEALER CAN AFFORD NOT TO HANDLE CROSLLEY



T H E C R O S L E Y B R O A D C A S T E R

THE CROSLLEY BROADCASTER, EARL DITTMAR, EDITOR. PUBLISHED BY THE CROSLLEY RADIO CORPORATION, CINCINNATI, OHIO. COPYRIGHT 1934. ALL PRICES QUOTED HEREIN ARE EASTERN PRICES. ALL PRICES SUBJECT TO CHANGE WITHOUT NOTICE.

Christmas Sales . . .

It's just a few days until Christmas—but these last few days of the Santa Claus buying season can be great, prosperous days for you. Among the people who are rushing from store to store is a large percentage who are anxious to bring complete, practical joy to the whole family with a Crosley Radio or Shelvador Electric Refrigerator.

When these people see the Crosley models and learn of their sensational value, they will inevitably buy. For where else in all the world is found such high quality at such low prices?

We urge you to continue your aggressive efforts with all the force you command—you will then reap substantial returns in the way of Christmas sales and profits until the last minute your doors are open Christmas Eve.

Start The New Year Right . . .

In a little over two weeks, the great Christmas hustle and bustle will be over—this tremendous yearly buying season will be at an end. But your selling efforts need not lag if you take advantage of every opportunity to continually tell the people of your community that you are the Crosley dealer.

One opportunity that confronts you is to take advantage of the after-Christmas money. As you know, many people present their loved ones with gifts of money at Christmas time. The object, of course, being that these fortunate ones who receive money can purchase gifts of their own choosing. This money is generally spent right after Christmas and it is up to you to see that you get your share of it.

Certainly nothing will bring greater joy nor more complete satisfaction than a Crosley Radio. The range of models is sufficient to satisfy every requirement, taste and pocketbook. Keep on telling everyone that you

sell Crosley Radios and you will start the New Year with a continued season of sales and profits.

Better Housing Act Means Better Sales . . .

In the last issue of the *Crosley Broadcaster*, every Crosley dealer was told how the Federal Housing Act can be applied to the sale of permanently installed Crosley Shelvador Electric Refrigerators. That home owners who are taking advantage of this plan may borrow money to cover their purchase and repay it monthly over a three year period, with no down payment.

To help you urge these home owners to patronize you in buying a Crosley Shelvador, a two-column newspaper ad mat has been prepared. It is complete with copy and carries an illustration of the Shelvador Model EA-35. As an attention-getter, the headline reads, "Uncle Sam Says Enjoy Better Living And The Crosley Shelvador Brings A New Deal To Every Home." Get this mat from your Crosley distributor now and insert it in your local newspaper.

New Radio Catalog Boon To Salesmen . . .

Every Crosley dealer has recently received a highly attractive 16-page catalog that illustrates and describes the complete line of new Crosley Radios. This catalog is of exceptional value to every radio salesman. Being of a size that fits his pocket, it is kept conveniently handy for ready reference whether the salesman is in the store or calling at a prospect's home.

With this catalog, the salesman is prepared to quickly answer any question concerning the complete Crosley Radio line and for this reason it is proving practically indispensable. Every Crosley Radio salesman should have a copy. Ask your Crosley distributor to supply you.

Circular Radio Log . . .

A novel and interesting radio log of the principal short-wave broadcast stations of the world has just been issued for use by Crosley dealers. The kilocycles, call letters and locations of stations are shown on a circular dial. A movable arm that can be placed over any of these stations shows the hours and days each particular station broadcasts.

To give one of these to every owner of a Crosley American-Foreign or All-Wave Radio should be greatly appreciated by the recipient and should create extra good will for the giver. Perhaps this log may be the means for you to cultivate Crosley owners to help you with names of friends who might be radio prospects. A supply can be obtained from your Crosley distributor.

American-Foreign Battery Models Offer Wide Opportunities . . .

Now, with the new Crosley American-Foreign Battery Eight and Battery Eight Lowboy, a whole world of entertainment is brought to the farm home. The world's best entertainment, educational programs and world news is brought right to the farmer with the new Crosley sets.

With the greatly improved conditions for the farmer, there is bound to be more money available to buy the things he wants. And what will bring him and his family greater satisfaction than a new Crosley Battery Radio? Moreover, with a Crosley, a farmer gets up-to-the-minute market quotations and weather reports that will make it a practical, dividend-paying investment for him. He can know when is the best time to plant crops or to harvest them; and when to most advantageously sell grain, stock, poultry and produce.

Every Crosley dealer is urged to take advantage of the opportunities existing in the farm market.

CROSLY JUNIOR SALESMAN CONTEST IS GOING OVER BIG

From practically every section of the country come reports of intense enthusiasm for the Crosley Junior Salesman Contest. As you know, the contest plan is to enlist boys and girls, eighteen years of age or less, to go out and sell Crosley Radios for you as Crosley Junior Salesmen. Ten Crosley Junior Motor Racers, which are real gasoline-operated cars that can go as fast as twenty miles an hour, are to be awarded to the ten boys or girls having the highest number of contest sales points. (One point is credited to the contestant for each dollar of sales, based on Eastern prices). In addition, the Crosley dealer is paying 5% cash commission for every Crosley radio sold by a Junior Salesman.

A few of the interesting reports from various localities follow:

H. A. McRae and Company, distributor at Troy, N. Y., reports that one dealer sold five Crosley Radios in one week through the activity of Crosley Junior Salesmen.

"This contest immediately appealed to us as one of the best promotional schemes we have ever seen," writes W. M. Baldwin, of Rogers and Baldwin Hardware Company, Springfield, Missouri.

And here is what Henry G. Roth, of Ott-Heiskell Company, Wheeling, W. Va., says, "If each dealer would get ten boys and girls out talking Crosley in his neighborhood, just think of the advertising he would get out of it even though they didn't immediately sell a single radio."

Reports from the field also indicate that dealers are promoting this contest through displaying the contest broadside, through broadcasts over local stations, through the use of newspaper ads, handbills and in

Beautiful Crosley Window Display . . .

Wurlitzer of Cleveland, Ohio, recently arranged this highly attractive window display to tell all passers-by that "The World is at your finger-tips with a Crosley." The effectively executed background, the flags of all nations and the various placards very impressively told the story of receiving distant, foreign stations.

other effective ways. For example, a dealer in Saginaw, Michigan, ran a small ad in a newspaper next to the comics at a cost of less than four dollars. Twenty-two boys responded the next day before ten a. m. and fifty percent of these went out immediately to work. So for less than four dollars, this dealer is getting some marvelous good will built up in his neighborhood besides making what sales the boys will bring in.

The Ontario Electric Corporation of Buffalo, N. Y., has had 100,000 handbills printed and is distributing them to the boys and girls of this territory as they pass out of the schools.

Wurlitzers of Detroit is taking advantage of their junior music classes by enrolling junior salesmen from the some 1200 youngsters who take music lessons there.

The Markle Transfer Company, with stores at Wheeler and Glasgow, Montana, is concentrating so intensely on the contest that they have assigned salesmen as contest managers at each of the stores. They say, "We expect to sell at least 30 radios and 60 would not be out of the question from now until Christmas."

And so it goes throughout the country. This is truly one of the greatest sales promotion opportunities any dealer has ever had. Remember the contest closes at 5:00



The Crosley Broadcaster

P. M., December 24, 1934. Keep right on pushing the contest and helping the contestants every minute between now and then. You will undoubtedly be amply rewarded in extra sales and profits.

School Superintendent Praises Crosley Radio . . .

J. V. Kneece, Superintendent of the Fort Lawn Public Schools, Fort Lawn, South Carolina, has written the following words of praise about his Crosley Radio:

"Six years ago this December, I purchased a Crosley from one of your dealers and all during these six years, it has not given me a minute's trouble. It has never been in the repair shop and I have not even bought a new tube. There is hardly a day that passes unless I tune in on many different stations and it is always ready to respond. When I purchased this radio, I had three other makes in my house on trial, but after a good test, decided to purchase the one I now have and I have many, many times thanked myself for deciding on a Crosley.

"I have forgotten the model that I have, but it is a cabinet model with two doors. It has given me 100% satisfaction for these six years and is performing today just as it did the day I bought it.

"Sometimes I think that I would like an All-Wave set, but if I decide to trade this one, it will be for another CROSLY."

Excellent Promotion Given Crosley American-Foreign Sets In WLW Rebroadcasts Of Foreign Programs . . .

One of the greatest merchandising helps ever given Crosley dealers for the promotion of Crosley American-Foreign and All-Wave Radio sales is the rebroadcast of foreign programs over WLW. At various intervals, whenever reception conditions justify it, foreign programs are being picked up on a Crosley model at the Crosley proving station and actually rebroadcast.

In the announcements in connection with these rebroadcasts, the listeners are told just what Crosley model is being used and that if they are using this model they can secure the broadcast by tuning to the position given them.

An example of how much favorable comment these rebroadcasts have created is shown in the following letter from Alvin B. York of Fort Wayne, Indiana:

"I have a Crosley Sixty-One American-Foreign Radio. This morning at 8:20 (CST) I was listening to your program and when you rebroadcast from DJB, Zeesen, Germany, I turned my dial to 15200 kilocycles and there it was direct from Germany just as plain as when rebroadcast over your station. I am very well pleased with my radio. And to think that one can get such a radio as good as mine for only \$39.95!"

WLW carries in addition to these actual rebroadcasts, two special programs each week. These reproduce musical numbers that have been actually heard at a previous time by a listener using a Crosley model. These programs are broadcast from 6:00 to 6:30 every Tuesday evening and 10:30 to 11:00 every Friday evening (EST). They are very excellent and are proving quite effective.

This splendid promotion in behalf of Crosley Radios for foreign reception should be utilized to the advantage of every Crosley Dealer. Tune in to these programs yourself; then tell everyone in your community to do likewise—this should stimulate increased sales and profits.

New Dealer In Peoria . . .

The Cohen Furniture Co., Peoria, Ill., has been appointed a Crosley dealer, according to Advance Appliance Co.



SMART CROSLY DISPLAY BY ROCHESTER'S LARGEST MUSIC HOUSE

Here is an exceptionally smart window display of the new 1935 Crosley Radios recently featured by Western New York State's largest and most outstanding music establishment, the Levis Music Store, located at 412 East Main St., Rochester, N. Y.

This new, beautiful and modernistic music house which was opened early last May, is the culmination of 31 years of progressive expansion which have raised the Levis Music Store from small beginnings to a place of honor in the first rank of music stores in the United States. It is the second Levis Music Store in the City of Rochester and both establishments rank high in the sale of Crosley radios and refrigerators.

Inset shows Mr. William H. Levis who has managed the Levis Music Store for the past 23 years. He is a real Crosley booster and Crosley business go-getter.

Erskine-Healy, Inc., are distributors for Crosley radios and refrigerators in the Rochester territory.

Proves Real Companion . . .

Harold Formolo, of Powers, Michigan, who is in a sanatorium, says that his Crosley radio is his real companion, providing 99 per cent of his entertainment. Here is what he writes:

"When I buy anything I always

comment on it. If it's good I say so. If it isn't, I say so too. So I owe the Crosley Radio a word or two. I have a Crosley Fiver that I've had for about nine months. Believe me I'd never trade it for a lot of other table model radios I've heard and played. My radio is a wonder for getting daylight reception any time of the year. It outplays other sets with more tubes.

"Some time I'm going to get a new radio, if I'm able to financially; and it's got to be another Crosley or it's no sale.

"If I were to advise people who are in the market for a radio, I'd say, 'see and hear a Crosley before you buy'. I wouldn't be afraid to bet my last nickel that the Crosley would need no salesman. It would sell itself."

Frankelite Company Announces New Crosley Dealers . . .

E. J. Rueth, manager radio sales, Frankelite Company, Crosley distributors, Cleveland, Ohio, announces the appointment of the following dealers for Crosley radios: The Rudolph Wurlitzer Co., 110 E. Federal St., Youngstown, Ohio; The Rudolph Wurlitzer Co., 1015 Euclid Ave., Cleveland, Ohio; and the Colonial Furniture Co., 2193 Ontario Ave., Cleveland.



Exceptionally Beautiful Display . . .

This display of Crosley Radios, recently arranged by J. L. Brandeis and Sons of Omaha, Nebraska, made a timely tie-up with the harvest season. The copy theme on the card read "as each year yields its gold-

en harvest so the new Crosley Radio garners for you the wonders of the broadcasting world."

"The Crosley Fiver is worth twice its price"—C. Smith, Louisville, Ky.

WLW Announcer Makes Sale For Dealer . . .

W. J. Barth Company of Fort Wayne, Indiana fully knows and appreciates the value of WLW advertising, if one is to judge from this letter recently received from him:

"We believe we owe a commission to one of your announcers for selling a 6l A. F. Crosley radio for us. It happened this way: Just as we plugged in the set, and not noticing that the dial was set on WLW, we heard the end of a musical selection and then your announcer started his talk on the very set we were showing. Our salesman just stood beside your set without saying a word and at the end of the talk our customer remarked that if the set was as good as the description and talk just given, he would give us an order for it, with the result that the set was delivered to him. This happened yesterday afternoon.

"With this kind of cooperation, Crosley is certainly giving the dealers real up-to-the-minute advertising for the timing was perfect and certainly went over."

Powerful WLW Broadcasts Feature Crosley Products

500,000-watt WLW—the world's most powerful broadcasting station—is carrying these programs, devoted to Crosley radios and refrigerators, into the homes of America to keep the nation ever-conscious of Crosley products and to win prospects and sales for Crosley dealers.

WLW Crosley Programs For Weeks of December 17 and December 24, 1934 (Tune in to 700 Kc.—Eastern Standard Time Listed)

| MONDAY | TUESDAY | WEDNESDAY | THURSDAY | FRIDAY | SATURDAY |
|---|--|--|--|--|--|
| A. M. 6:30—Top o' the Morning with McCormick Fiddlers (Crosley Battery Radios). 7:30—Bob Albright and The Texans (Crosley Radios). 9:45—Music by Divano (Crosley Radios). Noon—Salt and Peanuts (Crosley Radios). P. M. 4:15—John Barker and Orchestra (Crosley Radios). 4:45—Crosley Business News (Crosley Radios for office use). 5:00—Ethel Ponce, blues singer (Crosley Radios). 11:05—Crosley Roamies Concert Orchestra. | A. M. 6:30—Top o' the Morning with McCormick Fiddlers (Crosley Battery Radios). 7:30—Bob Albright and The Texans (Crosley Radios). 11:15—Yucatan Trio—Mexican music (Crosley Radios). P. M. 3:45—Bond of Friendship—Walter Furniss—songs (Crosley Radios). 4:15—Mary Alcott and Orchestra—(Crosley Radios). 4:45—Crosley Business News (Crosley Radios for office use). 6:00—Around the World (Crosley A. F. Radios). 8:30—Crosley Polles — orchestra — vocalists — dramatic skit — (Crosley Radios). | A. M. 6:30—Top o' the Morning with McCormick Fiddlers (Crosley Battery Radios). 7:30—Salt and Peanuts (Crosley Radios). 11:15—John Barker (Crosley Radios). P. M. 4:45—Crosley Business News (Crosley Radios for office use). 5:00—Ponce Sisters, harmony duo (Crosley Radios). 6:00—Bailey Axton, Mary Woods and orchestra (Crosley Tubes). THURSDAY A. M. 6:30—Top o' the Morning with McCormick Fiddlers (Crosley Battery Radios). 7:30—Salt and Peanuts (Crosley Radios). 9:45—The Jacksons, comedy (Crosley Radios). P. M. 4:15—Jeanine Macy and Orchestra (Crosley Radios). 4:45—Crosley Business News (Crosley Radios for office use). 11:05—Zero Hour (Crosley Refrigerators). FRIDAY A. M. 6:30—Top o' the Morning with McCormick Fiddlers (Crosley Battery Radios). 7:30—The Texans, harmony trio (Crosley Radios). | A. M. 6:30—Top o' the Morning with McCormick Fiddlers (Crosley Battery Radios). 7:30—The Texans, harmony trio (Crosley Radios). 9:45—Antoinette West, soprano (Crosley Radios). 10:30—Sandra Roberts, blues singer (Crosley Radios). 11:15—Bailey Axton, tenor (Crosley Radios). P. M. 1:30—Crosley Business News (Crosley Radios for office use). 7:00—R. F. D. Hour—Boss Johnston, McCormick Fiddlers, Larry Greuter, accordionist (Crosley Battery Radios). | A. M. 6:30—Top o' the Morning with McCormick Fiddlers (Crosley Battery Radios). 7:30—The Texans, harmony trio (Crosley Radios). 9:45—Antoinette West, soprano (Crosley Radios). 10:30—Sandra Roberts, blues singer (Crosley Radios). 11:15—Bailey Axton, tenor (Crosley Radios). P. M. 1:30—Crosley Business News (Crosley Radios for office use). 7:00—R. F. D. Hour—Boss Johnston, McCormick Fiddlers, Larry Greuter, accordionist (Crosley Battery Radios). | A. M. 6:30—Top o' the Morning with McCormick Fiddlers (Crosley Battery Radios). 7:30—The Texans, harmony trio (Crosley Radios). 9:45—Antoinette West, soprano (Crosley Radios). 10:30—Sandra Roberts, blues singer (Crosley Radios). 11:15—Bailey Axton, tenor (Crosley Radios). P. M. 1:30—Crosley Business News (Crosley Radios for office use). 7:00—R. F. D. Hour—Boss Johnston, McCormick Fiddlers, Larry Greuter, accordionist (Crosley Battery Radios). |

THE GREATEST SALES HELP YOU HAVE EVER HAD!

In addition to these programs, many spot announcements boosting Crosley products are broadcast each day.

CROSLEY PRESENTS NEW BEAUTY AND WORLD-WIDE RECEPTION IN THE NEW 1935

CROSLEY RADIOS

● THE NEW 1935 Crosley Radios presented on this and the two following pages, have reached a new pinnacle in beauty and smartness. New, rare, and costly woods, modern and pleasing design, have set a pace for the entire radio world to follow. Likewise, these Crosley models include the latest improvements and features in radio—each giving outstanding performance for its price class. The sensational values maintain Crosley's world leadership in offering "the most for the radio dollar". Several models have the Dual Range feature — providing police, amateur and aviation in addition to standard broadcasts. The new American-Foreign and All-Wave Receivers bring a new thrill to all those interested in distant, foreign reception.

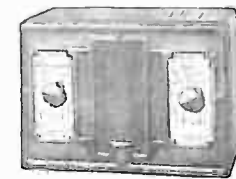

\$19.99

Complete With Tubes and Fabric Carrying Case

Dimensions:
6 $\frac{3}{4}$ " high,
9 $\frac{5}{8}$ " wide,
4 $\frac{1}{2}$ " deep.

FORTY-ONE

**4 TUBES . AC DC
SUPERHETERODYNE**

● OPERATES on any 110 volt circuit. Has two Double Purpose Tubes, Full Floating Moving Coil Electro-Dynamic Speaker, Pilot Light, Attached Antenna. No ground required.

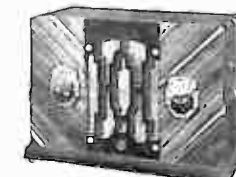

\$22.50

Complete With Tubes

Dimensions:
8" high, 11" wide,
4 $\frac{7}{8}$ " deep.

FORTY-ONE DELUXE

**4 TUBES . AC DC
SUPERHETERODYNE**

● OPERATES on any 110 volt circuit. Has two Double Purpose Tubes, Full Floating Moving Coil Electro-Dynamic Speaker, Pilot Light, Attached Antenna. No ground required.

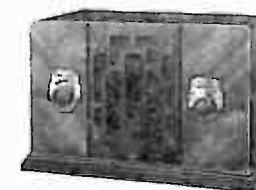

\$29.95

Complete With Tubes

Dimensions:
7 $\frac{7}{8}$ " high,
11 $\frac{3}{4}$ " wide,
6" deep.

FIFTY-TWO

**5 TUBES . AC DC
SUPERHETERODYNE**

● OPERATES on any 110 volt circuit. Has Two Double Purpose

Tubes, Three Gang Tuning Condenser, Automatic Volume Control, Attached Antenna, Pilot Light, Full Floating Moving Coil Electro-Dynamic Speaker. Requires no ground.

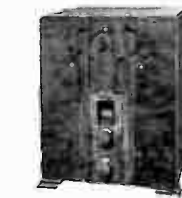

\$19.99

Complete With Tubes

Dimensions:
11 $\frac{5}{8}$ " high,
10" wide,
7 $\frac{3}{4}$ " deep.

FIVER

**5 TUBES
SUPERHETERODYNE**

● RECEIVES all standard broadcasts and some police calls. One Double Purpose Tube—Illuminated Dial—Combined Volume Control and On-Off Switch. Full Floating Moving Coil Electro-Dynamic Speaker.

WESTERN PRICES SLIGHTLY HIGHER

December 15, 1934

The Crosley Broadcaster

DUAL FIVER DELUXE

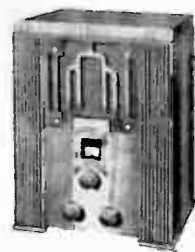

\$29.95

Complete With Tubes
Dimensions: 13 1/8" high, 10" wide, 8 1/2" deep.

5 TUBES . DUAL RANGE SUPERHETERODYNE

● STANDARD broadcasts—550 to 1650 Kc. and police, amateur, aviation broadcasts—1650 to 5000 Kc. Employs Two Double Purpose Tubes, Automatic Volume Control, Three Gang Tuning Condenser, Full Floating Moving Coil Electro-Dynamic Speaker.

FIFTY-FOUR RB LOWBOY



\$39.95

Complete With Tubes
Dimensions: 36" high, 21 5/8" wide, 11 1/16" deep.

DUAL FIVER DELUXE A

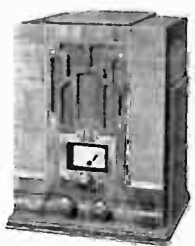

\$35.00

Complete With Tubes
Dimensions: 13 1/2" high, 10 1/2" wide, 8 3/8" deep.

5 TUBES . DUAL RANGE SUPERHETERODYNE

● STANDARD broadcasts—550 to 1650 Kc. and police, amateur, aviation broadcasts—1650 to 5000 Kc. Employs Two Double Purpose Tubes, Automatic Volume Control, Illuminated Airplane Type Dial, Three Gang Tuning Condenser, Full Floating Moving Coil Electro-Dynamic Speaker.

DUAL FIVER DELUXE A LOWBOY



\$47.50

Complete With Tubes
Dimensions: 36" high, 23 3/8" wide, 12 3/16" deep.

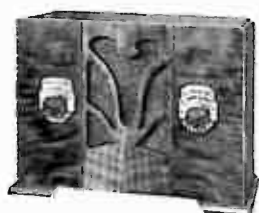

\$19.99

Complete Less Batteries
Dimensions: 8" high, 10 1/2" wide, 5" deep.

BATTERY FORTY 4 TUBES . Superheterodyne BATTERY RECEIVER

● SUPERHETERODYNE chassis. Designed for use with the 2-volt air

cell "A" battery or regular 6-volt battery connected for 2 volts. Low battery drain. Two Double Purpose Tubes increase the efficiency to that of an ordinary six tube set. Pentode Output. Permanent Magnet Speaker.

BATTERY FIVER

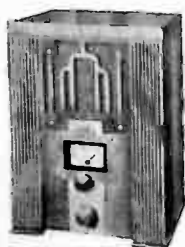

\$29.95

Complete Less Batteries
Dimensions: 13 1/8" high, 10" wide, 8 1/2" deep.

5 TUBES . Superheterodyne BATTERY RECEIVER

● GENUINE superheterodyne chassis. Designed for use with 2 volt air-cell "A" battery. Has Pentode Output, Airplane Type Dial, Permanent Magnet Speaker.

BATTERY FIVER LOWBOY

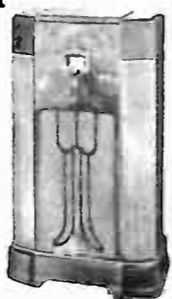

\$49.95

Complete Less Batteries
Dimensions: 36" high, 22 1/4" wide, 11 3/4" deep.

BATTERY EIGHT A. F.



\$59.95

Complete Less Batteries
Dimensions: 18 5/8" high, 16 1/4" wide, 10 1/4" deep.

8 TUBES . American-Foreign BATTERY RECEIVER

● SUPERHETERODYNE. Standard broadcasts—550 to 1700 Kc. and Foreign broadcast—5,800 to 15,300 Kc.—Airplane Type Dial—Automatic Volume Control—Continuous Tone and Static Control—Permanent Magnet Speaker.

BATTERY EIGHT A. F. LOWBOY

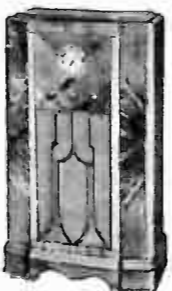

\$74.50

Complete Less Batteries
Dimensions: 37" high, 23" wide, 11 3/4" deep.

WESTERN PRICES SLIGHTLY HIGHER

The Crosley Broadcaster

SIXTY-ONE A. F.

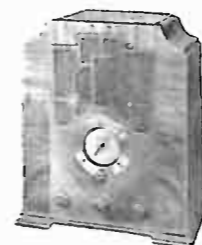

\$39.95

Complete With Tubes
Dimensions: 16 1/8" high, 13 7/8" wide, 8 5/16" deep.

6 TUBES . American-Foreign SUPERHETERODYNE

● AMERICAN broadcasts—550 to 1700 Kc. and Foreign broadcasts 5,800 to 15,300 Kc.—Illuminated Airplane Type Dial—Automatic Volume Control—Three Gang Tuning Condenser—Full Floating Moving Coil Electro-Dynamic Speaker.

SIXTY-FOUR MD LOWBOY

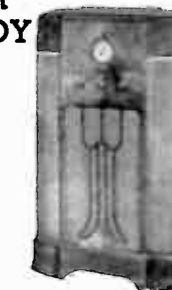

\$54.50

Complete With Tubes
Dimensions: 36" high, 22 1/4" wide, 11 3/4" deep.

614EH THREE BAND ALL-WAVE



\$49.95

Complete With Tubes
Dimensions: 16 1/8" high, 13 7/8" wide, 8 5/16" deep.

6 TUBES . Three Band All-Wave Superheterodyne

● AMERICAN broadcasts — (540-1650 Kc.)—Police, amateur, aviation broadcasts (1650-5000 Kc.)—Foreign broadcasts (5800-15,350 Kc.)—Illuminated Airplane Type Dial—Automatic Volume Control—Three Gang Tuning Condenser—Full Floating Moving Coil Electro-Dynamic Speaker.

614PG THREE BAND ALL-WAVE LOWBOY



\$65.00

Complete With Tubes
Dimensions: 36 1/2" high, 22 3/8" wide, 12 1/16" deep.

SEVENTY-TWO A. F.



\$59.95

Complete With Tubes
Dimensions: 18 5/8" high, 16 1/4" wide, 10 1/4" deep.

7 TUBES . American-Foreign SUPERHETERODYNE

● AMERICAN broadcasts—550 to 1700 Kc. and Foreign broadcasts—5,800 to 15,300 Kc.—Dual Ratio Tuning Control—New Illuminated Airplane Type Dial—Automatic Volume Control—Continuous Tone Control—Full Floating Moving Coil Electro-Dynamic Speaker.

SEVENTY-TWO A. F. LOWBOY



\$79.50

Complete With Tubes
Dimensions: 38" high, 23" wide, 11 1/4" deep.

714GA THREE BAND ALL-WAVE



\$65.00

Complete With Tubes
Dimensions: 18 5/8" high, 16 1/4" wide, 10 1/4" deep.

7 TUBES . Three Band All-Wave Superheterodyne

● AMERICAN broadcasts (540-1700 Kc.)—Police, amateur, aviation broadcasts (1700-5000 Kc.)—Foreign broadcasts (5800-15,350 Kc.)—Dual Ratio Tuning Control—Illuminated Airplane Type Dial—Automatic Volume Control—Continuous Tone Control—Full Floating Moving Coil Electro-Dynamic Speaker.

714NA THREE BAND ALL-WAVE LOWBOY



\$85.00

Complete With Tubes
Dimensions: 38" high, 23" wide, 11 1/4" deep.

814FA ALL-WAVE



\$79.50

Complete With Tubes
Dimensions: 18 5/8" high, 16" wide, 10 5/16" deep.

8 TUBES . ALL-WAVE SUPERHETERODYNE

● ALL WAVE—540 to 24,000 Kc.—Dual Ratio Tuning Control—New Illuminated Airplane Type Dial—Automatic Volume Control—Continuous Tone Control—Push-Pull Output—Full Floating Moving Coil Electro-Dynamic Speaker.

814QB ALL-WAVE LOWBOY



\$99.50

Complete With Tubes
Dimensions: 38 1/2" high, 24 1/8" wide, 12" deep.

WESTERN PRICES SLIGHTLY HIGHER

December 15, 1934



(U. S. Patent Re-issue No. 19,008)

Crosley Electric Refrigerators

Offer Exceptional Sales Opportunities During The Christmas Season



(U. S. Patent Re-issue No. 19,008)



MODEL EA-35

This beautiful Crosley Shelvador Electric Refrigerator has 3.5 cubic ft. NET capacity; 7.5 square ft. of shelf space (N. E. M. A. rating); 2 ice trays each with a capacity of 21 cubes, 42 in all. Dimensions: 48 11/16" high, 23 3/4" wide, 24 7/16" deep.

\$99.50

This model also available with Porcelain Exterior. (PEA-35)\$119.50



MODEL EA-43

The Model EA-43 Crosley Shelvador Electric Refrigerator has 4.3 cubic ft. NET capacity; 9.15 square ft. shelf space (N. E. M. A. rating); 2 standard ice trays and one double depth tray. Dimensions: 54 11/16" high, 23 3/4" wide, 24 7/16" deep.

\$117.00

This model also available with Porcelain Exterior. (PEA-43)\$139.50

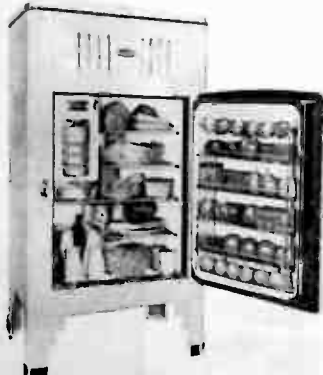

MODEL EA-55

This Shelvador model has 5.5 cubic ft. NET capacity; 11.6 square ft. of shelf space (N. E. M. A. rating); 3 standard ice trays and one double depth tray. Dimensions: 55 3/4" high, 29" wide, 25 13/16" deep.

\$145.00

This model also available with Porcelain Exterior. (PEA-55)\$170.00

A Few Outstanding Features Of Crosley Electric Refrigerators

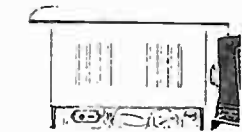

Ventilated Front

No matter where the refrigerator may be placed, proper circulation of air around the refrigerator unit is maintained by means of the special Crosley Ventilated Front. This is a feature of the new Crosley Electric Refrigerators.

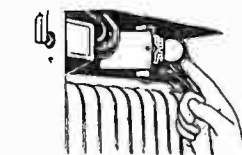

Automatic Interior Light

Crosley electric refrigerators are fitted with an electric light which automatically illuminates the interior whenever the door is opened. The light bulb is of a standard base so that it can be easily replaced.

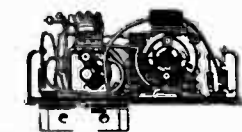

Self-Contained Removable Unit

Inasmuch as the motor, compressor, and condenser are mounted on a metal base, the Crosley unit is completely self-contained and can be removed by merely lifting it out of the top of the cabinet.



ALL PRICES INCLUDE DELIVERY INSTALLATION ONE YEAR'S FREE SERVICE

MODEL EA-20



(Approved by T. V. A.)

Ideal for houses, apartments, cottages, or as an extra refrigerator. Two standard ice trays. Porcelain interior and top; white laquer exterior with black trimmings. Dimensions: 36" high, 23 3/4" wide, 20 3/4" deep.

\$72.50

The sensational Shelvador feature (shelves in the door for butter, bacon, eggs, and other small food articles) is taking the new Crosley Electric Refrigerators to new sales heights this year. The Streamline Beauty of every model wins immediate admiration and proves a lasting satisfaction as it adds charm to America's kitchens. The new Ventilated Front provides maximum refrigeration unit efficiency even when the refrigerator is placed close to the wall or in a small alcove.

Western Prices Slightly Higher

more advantages, stream-line beauty, long, trouble-free service—and they are priced within reach of the masses.

Moreover, the amazing Chest Shelvador is a smashing leader—priced so low that it is within reach of every home that hitherto could not afford electric refrigeration.

Every Crosley dealer is urged to take full advantage of the profit opportunity existing in the sale of Crosley refrigerators during the Christmas season. Display them, advertise them, push them—and you should reap a profitable Christmas.



Exclusive Features Of Crosley Tri-Shelvador



Shelvatray

(Patents Pending)
A handy place to set things and a tray for carrying them. Saves time and effort. Only available in the Crosley Tri-Shelvador.

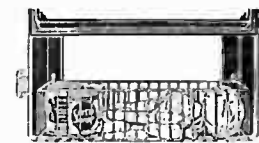

Shelvabasket

(Patents Pending)
Just the place for greens—carrots, beets, cabbages, canned goods and the like. Just open the door and there they are!

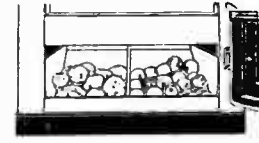

Storabin

(Patents Pending)
Here is the place for potatoes, onions, other bulk items and reserve bottle goods. Neither Shelvabasket nor Storabin is refrigerated.

Incorporating the greatest features ever presented, The Crosley Tri-Shelvador is regarded by Housewives everywhere as the real standard of modern refrigeration efficiency. In addition to the many superb features of the Shelvador series, the Tri-Shelvador includes the sensational Shelvatray, Shelvabasket and Storabin—all exclusive features. It also has a self-closing door on the freezing unit.

Western Prices Slightly Higher



MODEL E-43

A beautiful Tri-Shelvador, 4.3 cubic ft. NET capacity; 9.15 square ft. shelf space (N. E. M. A. rating). Two ice trays and one double depth tray. Dimensions: 56 9/16" high, 23 3/4" wide, 24 7/16" deep.

\$135.00

Also available with Porcelain Exterior. (PE-43)\$160.00



MODEL E-55

5.5 cubic ft. NET capacity; 11.6 square ft. of shelf space (N. E. M. A. rating); three ice trays and one double depth tray. Dimensions: 57 3/4" high, 29" wide, 25 13/16" deep.

\$157.50

This model also available with Porcelain Exterior. (PE-55)\$185.00



MODEL E-70

7 cubic ft. NET capacity; 14.9 square ft. shelf space (N. E. M. A. rating). Dimensions: 58 3/4" high, 32 3/4" wide, 26 3/4" deep.

\$185.00

Also available with Porcelain Exterior. (PE-70)\$215.00



New Radio Dealer Sells 100 First Month

With only one month's experience in the radio business, Carl Noltze, president of the Noltze Motor Company in Sioux City, Iowa, has sold over 100 Crosley radios.

Believing that the secret of selling is to display the sets the people want to buy and to display plenty of them, Mr. Noltze has lived up to his belief in every possible way. An example of the way he displays radios in his sales room is shown in the ac-

companying picture. The Noltze Motor Company sells Auburn cars and between the various automobiles on display anyone cannot help but see a Crosley radio any place he looks.

Mr. Noltze has an effective campaign of newspaper advertising scheduled from now until Christmas. He also makes personal talks on the local radio station each evening which are of extreme interest and are put on in such a manner as to create a waiting audience each evening.

The Crosley distributor that serves this dealer—the Power City Radio Company of Sioux Falls, S. D.—is confident that the Noltze Motor Company is going ahead with excellent strides in handling the Crosley line. Our best wishes go with them.

Food At Fingertips . . .

Roy L. Copeland, of Lone Wolf, Oklahoma, writes: "We purchased a Shelvador after comparing it with several other makes. The extra storage space, the operating cost and the purchase price are what sold us. We are very highly pleased."



Herbert Frank, in charge of May-Stern and Company's refrigeration department is

seen explaining the features of the Crosley Tri-Shelvador to an interested prospect.

SHELVADORS HELP GIVE MAY-STERN BIGGEST REFRIGERATION YEAR . . .

Cincinnati Furniture Store Does Outstanding Business On Crosleys . . .

May-Stern & Company, are rounding out the most successful year they have had in the six years they have been in electric refrigeration. This is the third year they have handled the Crosley line. Emerging from the peak of the refrigeration season, they have entered into the Christmas season with an aggressive sales and advertising campaign to maintain the lead they have held throughout the year.

How did they do it in a city of abundant competition? We asked Martin Mandelker, general manager, and Herbert Frank, in charge of the refrigerator department, to tell us. The answer is simple enough. You have a good plan, an aggressive advertising policy, and use sound merchandising methods throughout—plus a financing plan of your own—and there you have it, a record-breaking year for sales of electric

refrigerators.

"To begin with," said Mr. Mandelker, "in every one of our newspaper advertisements, we emphasized the excellent Crosley Shelvador features. There is no doubt in my mind that our success in selling Crosley refrigerators was due primarily to these novel and practical features. Regardless of what the merchandise is, and no matter in what department in our store it is handled, any particular item that has new features will appeal to the consumer. The features embodied in the Shelvador were the keynote of the stress used by our sales force in selling Crosley refrigerators."

"We have been consistent users of large newspaper space to advertise the special features of Shelvadors. In view of this, together with the schooling of our sales force by the Crosley organization, there certainly is no secret as to the reason for the success of our merchandising program. A most gratifying point in connection with our success in selling Cros-

ley refrigerators is that with the tremendous quantity of units sold by this store during the past season, we had very few service calls. This proves to me that the mechanics of Crosley refrigerators have been brought as close to perfection as is humanly possible.

"Our sales have naturally dropped off a bit in the past sixty days; but there is no doubt in my mind that there will be great possibilities during the month of December for the sale of refrigerators and we are conducting a Christmas promotion in this department which we feel certain will bring us the desired results.

Consistent Advertisers

"In addition to our heavy newspaper advertising, we have at least twelve mailings a year—not less than one each month. We use the Crosley inserts in the mailings. Our mailing lists are made up of the customers of our store—what we call our Honor Roll Customers, those who have accounts with us and have paid them as agreed. We circularize them and also the good open accounts. We believe in cultivating the customers we already have. These mailings always include literature regarding refrigerators in addition to the other kinds of merchandise featured in each particular mailing."

Describing their refrigeration sales plan, Mr. Frank said: "Our merchandising plan is primarily blasting advertising. We are heavy users of newspaper space and two-fisted honest advertising. As Mr. Mandelker has stated, we also use direct mail advertising regularly throughout the year."

"What methods do you use, Mr. Frank, for displaying electric refrigerators in your store?"

"All last summer we had an entire half of the first floor devoted to refrigerators," he stated. "Giving the refrigerator department that much space is partially responsible for the good business we have had. With the radio season at hand part of the space on the first floor is now being used for displays of radios as well.

Displays Throughout Store

"In my opinion, display space is a prime factor in selling refrigerators. We used an entire double window for refrigeration display all summer and tied this up by spotting refrigerators throughout the store. This spotting we have continued. (Continued on Page 15)

JUST OFF THE PRESS

1935 LOG BOOK

Complete - Accurate - Official

★ The new 1935 RADIO LOG with your own advertisement on the front cover and a full page Crosley advertisement on the back cover will prove a very effective method of increasing your sales. Prices on quantities are so low that you can well afford to distribute them free to your customers, or, if you prefer, they will meet with a ready sale in your establishment. To insure prompt delivery,

PLACE YOUR ORDER IMMEDIATELY.

| | | |
|---------------------------------|----------------|--------------|
| Quantity prices are as follows: | 1000 Log Books |\$20.00 |
| | 500 " " | 12.50 |
| | 250 " " | 7.25 |

Prices quoted F.O.B. Cincinnati. Orders shipped PREPAID when check accompanies order.

PLEASE WRITE YOUR ADVERTISEMENT PLAINLY

RADIO DIAL PUBLISHING CO.
22 East 12th St. Cincinnati, Ohio

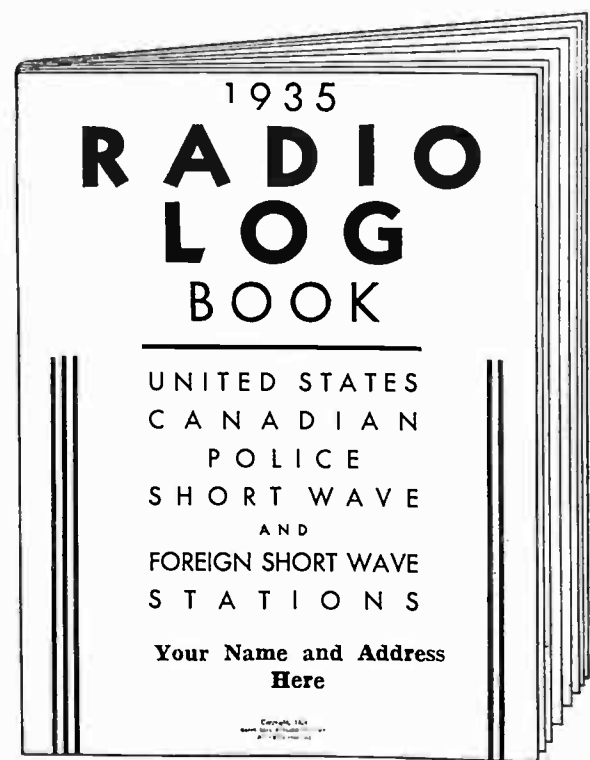



Novel Emphasis On Extra "Usable" Space . . .

The Buffalo General Electric Company of Buffalo, New York, dramatically portrayed the extra "usable"

storage capacity of the Crosley electric refrigerator in this attractive display.



Iowa Store Features Crosley . . .

This photograph shows the store front of M. H. Weiss, Crosley dealer of Anamosa, Iowa. Both Crosley

Radios and Shelvador and Tri-Shelvador Electric Refrigerators are featured.

Ontario Electric Sponsors Crosley Football Team . . .

The Ontario Electric Corporation of Buffalo, New York, being rather consistent users of the sports as an effective sales promotion medium, have sponsored a football team during the season just ended. Called

the Crosley Radio football team, this sponsorship has brought excellent publicity returns.

An action photograph recently appeared in a local newspaper which was an example of the excellent publicity given the Crosley team. Most of the games were played before large crowds.

A. E. Conrad Co. Crosley Dealer At Logansport . . .

The A. E. Conrad Co., 500 North Street, Logansport, has been appointed a dealer for Crosley radios by the Davidson Sales Co., Crosley distributors, South Bend, Ind. The Conrad Company has long been one of the outstanding radio dealers in northern Indiana.

Hieb, Crosley Distributor, Visits Factory . . .

Herb Hieb, president Hieb Distributing Co., Des Moines, Iowa, Crosley distributors, recently spent a few days at the factory and placed a very substantial order for battery sets.

"The battery set business is the best we have had since 1929," he said. "Dealers are clamoring for shipments."

"Business conditions in Iowa are good," he reported. "The dollar volume of radio sales of battery and power sets is well ahead of last year. Although the Crosley Fiver is still the ring favorite, sales of the higher priced models are being noticeably increased. In the upper brackets there has been an average increase of \$15.00 over last year in the list price of radios sold."



"All right, eh?" Boss Johnston, master of ceremonies of the R. F. D. hour over WLW Saturday evenings, confidently inquires as he tunes in the new Crosley Battery Eight American and Foreign receiver.

(Continued from Page 13) even in the cold weather. We have found in many instances that customers purchasing other merchandise have become interested in an electric refrigerator by seeing one in the department they happened to be in.

"Then we back up all this with special solicitations of refrigerators by all the sales people in our store. Regardless of what merchandise is sold in any department, the salesman invariably suggests a refrigerator before writing up that particular deal. This often results in sales that would otherwise be passed up at the time."

"What methods do you use for financing your refrigerator sales? Do you use the meter plan, and if so what has been your experience with it?"

"We do not favor the meter sales plan," said Mr. Frank. "We have tried it. We feel that it is an unnecessary inconvenience to the purchaser, and by handling our own financing, we can arrange terms to the satisfaction of our customers without forcing them to drop a quarter every forty hours in order to have



Novel Display . . .

The Chicago Radio and Music Company of Chicago, Illinois, emphasized the foreign reception of Crosley Radios with this attractive window display. Above the antenna tower, a sign reads, "Crosley WLW Broadcasts to the World." Above the radio, a sign says "Crosley Radios Receive the World." refrigeration. Also, our rates are

lower than those of outside agencies. Some customers believe that the meter is an aid to systematic saving. In this case we offer to supply them with a small savings bank, but have never found this necessary after the customer thought over the weekly or monthly payment plan. Of course, the meter plan did not originate with dealers; it is a plan of the finance companies to make sure of payments."

"What do you think of sending refrigerators on trial? What is the policy of your store in regard to this?"

"We have found that sending refrigerators on trial is absolutely worthless," Mr. Frank stated. "While we have never worked it ourselves, we find through others that it stimulates business for somebody else, and creates a demand among salesmen for high pressure methods that are unethical and cause an unfavorable reaction on the store's good name."

Uses Outside Salesmen

Asked about outside salesmen, Mr. Frank said, "They are an absolute necessity, I believe, under proper circumstances. During the refrigerator season especially they are needed to follow up contacts made at the store and to contact prospects recommended by satisfied users. I personally do not recommend outside salesmen, however, for canvassing and generally bothering the public."

"As to alternate floor selling and outside selling, we feel that a live wire man accustomed to outside selling, is no good on the floor. If he does try floor selling he loses the perspective necessary in a good outside salesman and you lose a good outside man while possibly not creating a good floor salesman. Therefore, we try to differentiate these two branches of our work."

Famous Store New Crosley Dealer . . .

The Famous Store in Wichita Falls announces that it has been appointed dealer in this city for the 1935 Crosley refrigerators and radios. Showings of various models are already on display on the balcony floor of the store, and easily reached from the main floor.

The new department is in charge of Ray Nichols. N. G. Nichols is outside salesman, it was announced by W. E. Smith, manager of the store.



Thousands Daily Pass This Display . . .

Located at 120 W. 42nd Street in New York City, this attractive display of Crosley radios and refrigerators by Wurlitzer was seen by vast hosts of people. Thousands pass by this store every day. This display effectively tells the story of the Sixty-One A. F. being the only nationally advertised six-tube set for American-foreign reception at such a low price.

Davidson Names Crosley Dealer At Valparaiso . . .

J. E. Davidson, president. Davidson Sales Co., Crosley distributors, South Bend, Ind., announces the appointment of J. Lowenstein & Sons' department store, 57 S. Franklin St., Valparaiso, Ind., as dealers for Crosley radios.

Son Succeeds Deceased Father In Store Management . . .

It was rather a stroke of ill-luck that one of the winners in the Crosley National Window Display Contest died before he received notification of the fact that his store had won a prize. This store—C. R. Jones and Company of Spangler, Penn.—lost its active head in C. R. Jones, who died on September 22. However, the store is continuing business under the same name with the son of the former head, Paul R. Jones, as manager.



Tri-Shelvador Passes Through Fire With But Slight Damage . . .

A remarkable indication of the sturdy construction of the Crosley electric refrigerator is evidenced in a letter recently received by the Aitken Radio Corporation, Crosley distributor of Toledo, Ohio. The Floral City Furniture Company of Monroe has written the following:

"We would like to call your attention to an incident which occurred in our City with one of your E-55 Crosley Refrigerators going through a fire and causing such little damage that we think it is remarkable. We sold this refrigerator to Mr. George Saylor of Erie, Michigan, on May 19, 1934.

"About September 10, they called us that this refrigerator had gone through a fire and asked us to inspect the box and advise them whether the box was damaged beyond repair. I was surprised to see that the mechanism and the box itself was in perfect condition except the lacquer finish which was naturally all burned to a crisp for the metal in some parts must have been red hot.

"We brought the box to our store and found all it required to be put in A number one condition was to finish the cabinet, one new rubber lid gasket and one new lead cord. This work was done at our store at a total cost of \$22.50. We returned the box to our customer on September 21, and could not make them be-

To the left is shown a Crosley Tri-Shelvador Electric Refrigerator after it had passed through a damaging fire. The severely burned exterior finish is plainly visible. Below is seen the interior of the same refrigerator, showing how perfectly it was protected—a marvelous evidence of the sturdy construction of Crosley electric refrigerators.



lieve any different but that it was a new box. All the hardware cleaned up as good as new and the mechanism operated just as if it had never gone through the fire.

"This incident is particularly interesting to us because if this door does not warp after going through a fire like this and getting red hot, it will certainly hold up and give exceptional service in ordinary use."

"Crosley Follies" Now Carried On WLW-WOR-WXYZ Hookup . . .

One of the most popular radio programs offered in the interests of Crosley dealers for the publicizing and sales promotion of Crosley receivers is now available to the audience of WOR, Newark, and WXYZ, Detroit, in addition to WLW. The Crosley Follies, a sparkling musical show, recently made its debut over this Newark-Detroit-Cincinnati hookup in a new series of weekly broadcasts. It will continue every Tuesday, 8:30 to 9 P. M., (EST).

For more than four years the Crosley Follies has been a leading production of the Nation's Station.

Powel Crosley, Jr., Reviews 1935 Outlook In Editor And Publisher . . .

In answer to a telegraphic request from Editor & Publisher, the trade paper of editors, Powel Crosley, Jr., president, Crosley Radio Corporation, sent the following statement in regard to 1935 for publication in its special advertising issue:

"I do not like to commit myself to a prophecy; however, an analysis of the outlook for 1935 is in order. I prefer to present my views of the coming year in that light. Among the facts are an increase in farmers' incomes estimated from one to one-and-one-half billion dollars; an increase of approximately 16 per cent in retail sales; and additional millions of persons back at work. These facts should lead to further recovery and help the outlook for 1935.

"The Crosley Radio Corporation has had one of the best years in its history in both refrigeration and radio. Two developments made 1934 one of the record years in radio: short wave receivers and increased farm incomes making possible battery or power radio sets on the farm.

"Our own faith in 1935 is expressed in an addition to the Crosley factory and other changes that will materially increase our production facilities. With these increased facilities, it will be possible to speed production and make quick shipments without having to carry excessive inventories of parts and assembled products."

The initial broadcast over the "Tri-angle network" witnessed the return to the air, after nearly a year's absence, of William C. Stoess and his famed Flying Dutchmen symphonic dance orchestra. For nearly three years this spectacular unit scored with listeners from coast-to-coast over both Blue and Red NBC networks.

Each broadcast features vocal and instrumental specialties through which recent discoveries of WLW talent scouts may be introduced along with return engagements by established artists of the Nation's Station.

It is hoped that this program will be of great interest and profit to every Crosley dealer.

CROSLEY SERVICE SUPPLEMENT

INSTRUCTIONS FOR ORDERING—Give part number, description of part, and serial number of receiver on which part is to be used. If article wanted is not listed separately, then that part of complete assembly containing this article should be ordered. Goods shipped on open account to Crosley Wholesale Distributors only. Cash must accompany Dealer and Consumer orders. Prices are subject to the usual trade discounts, and are subject to change without notice.

PARTS LIST—MODEL 8B3

Figures in first column correspond to figures in diagram on page 18

| Part Number | Description | Price List | Part Number | Description | List Price |
|-------------|-------------|--------------------------------|-------------|------------------------------|-----------------------------|
| 1 | G16—26719 | Ant.-Gnd. Term. | 44 | 21875 | 100,000 Ohms15 |
| 2 | G3 —32000 | L. F. Ant. Trans. | 45 | 21875 | 100,000 Ohms15 |
| 3 | G28—32000 | H. F. Ant. Trans. | 46 | 21876 | 10,000 Ohms15 |
| 4 | G2 —32001 | L. F. R. F. Trans. | 47 | 27121 | 5,000 Ohms15 |
| 5 | G18—32001 | H. F. R. F. Trans. | 48 | 21455 | 300,000 Ohms15 |
| 6 | G2 —32002 | L. F. Osc. Trans. | 49 | 21455 | 300,000 Ohms15 |
| 7 | G21—32002 | H. F. Osc. Trans. | 50 | 26577 | 3 Meg.15 |
| 8 | G1 —32004 | 1st I. F. Trans. | 51 | 21455 | 300,000 Ohms15 |
| 9 | B —34094 | Band Change Switch .. | 52 | 23403 | 150,000 Ohms15 |
| 10 | —42PM | Speaker | 53 | 33490 | 10 Meg.15 |
| 11 | G25—33002 | Variable Cond. | 54 | 21455 | 300,000 Ohms15 |
| 12 | G1 —33008 | {L. F. Ant. Trim. Cond. | 55 | 31094 | 4,500 Ohms15 |
| 13 | G1 —33008 | {H. F. Ant. Trim. Cond. | 56 | 26578 | 5 Meg.15 |
| 14 | G9 —33009 | {L. F. R. F. Trim. Cond. | 57 | 21454 | 1 Meg.15 |
| 15 | G9 —33009 | {H. F. R. F. Trim. Cond. | 48 | 22196 | 20,000 Ohms15 |
| 16 | G18—33009 | {L. F. Osc. Trim. Cond. | 59 | W —34095 | Level Control70 |
| 17 | G18—33009 | {H. F. Osc. Trim. Cond. | 60 | W —33993-A | Tone Control1.35 |
| 18 | G20—33006 | {L. F. Osc. Series T. C. | 61 | G1 —34189 | 1st Audio Trans. 2.50 |
| 19 | G20—33006 | {H. F. Osc. Series T. C. | 62 | G2 —34189 | 2nd Audio Trans. 2.10 |
| 20 | G6 —33006 | {1st I. F. Pri. T. C. | 63 | G2 —34189 | 2nd Audio Trans. 2.10 |
| 21 | G6 —33006 | {1st I. F. Sec. T. C. | 64 | G31—27975 | 34 Socket10 |
| 22 | G21—32004 | {2nd I. F. Trans. | 65 | G84—33070 | 1C6 Socket10 |
| 23 | G21—32004 | {Trimmer Cond. | 66 | G31—27975 | 34 Socket10 |
| 24 | G22—32004 | {3rd I. F. Trans. | 67 | G31—27975 | 34 Socket10 |
| 25 | G22—32004 | {Trimmer Cond. | 68 | G9 —33070 | 30 Socket10 |
| 26 | W —32379 | .02 Mfd. 200 Volt15 | 69 | G9 —27975 | 30 Socket10 |
| 27 | W —32379 | .02 Mfd. 200 Volt15 | 70 | G14—27975 | 31 Socket10 |
| 28 | W —27216 | .05 Mfd. 200 Volt15 | 71 | G44—27975 | 19 Socket10 |
| 29 | G3 —34000 | 2200 Mmfd.50 | 72 | G3 —29237 | Cable & Marker Assm. 1.00 |
| 30 | W —27216 | .05 Mfd. 200 Volt15 | 73 | W —31009-A | Speaker Cable15 |
| 31 | W —28869 | 2.0 Mfd. 200 Volt95 | | 27307 | Spkr. Cone & V. C. As. 3.00 |
| 32 | W —27932 | .0001 Mfd. 200 Volt15 | | 29200 | Spkr. Transformer 1.65 |
| 33 | W —27216 | .05 Mfd. 200 Volt15 | G17—32086 | Dial Assem. 2.00 | |
| 34 | 24814 | 7000 Ohms20 | W —32208 | Dial Hand05 | |
| 35 | W —29910-A | .25 Mfd. 200 Volt20 | | B-76 | Dial Hand Screw05 |
| 36 | G1 —34004 | .00025 Mica15 | W —33528 | Escutcheon & Window .80 | |
| 37 | W —31158 | Dual .006 Mfd. 400 V.25 | W —33984 | Escutcheon Gasket05 | |
| 38 | W —25435 | .003 Mfd. 400 Volt15 | | D-28 | Escutcheon Screws05 |
| 39 | W —24049-B | .1 Mfd. 200 Volt15 | W 33994 | Tuning Knob10 | |
| 40 | W —29910-A | .25 Mfd. 200 Volt20 | W 33995 | Vernier Knob10 | |
| 41 | W —30321-A | 1.0 Mfd. 160 Volt55 | W 31585 | V. C. & T. C. Knob10 | |
| 42 | W —33990 | Dual 8 Mfd. Elect. 1.80 | W 33991 | Band Change Knob10 | |
| 43 | W —27216 | .05 Mfd. 200 Volt15 | G6 —23300 | "A" Batt. Resistor15 | |

Wiring Diagram For Model 8B3

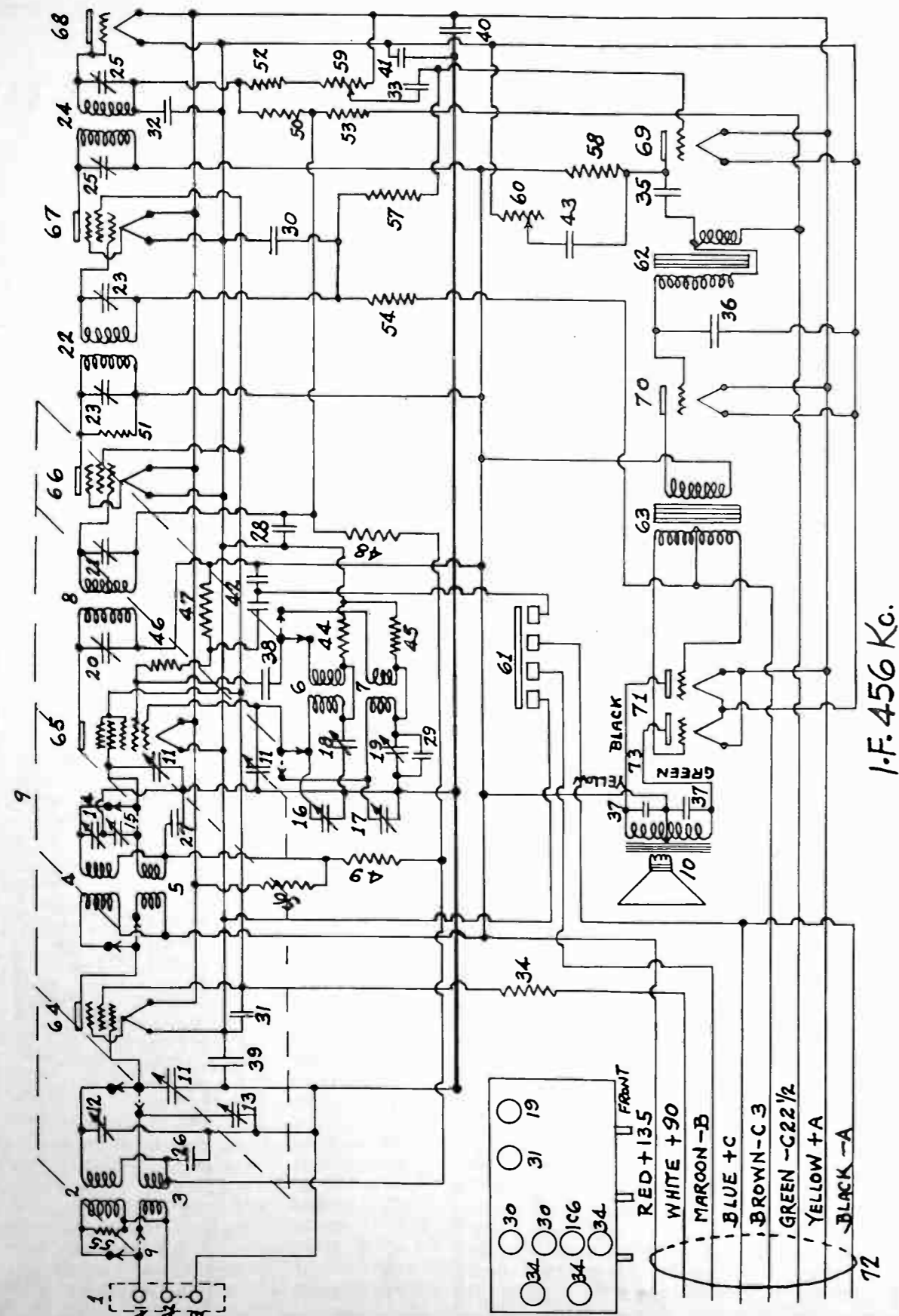

THESE SIX TUBE THREE BAND ALL-WAVE SUPERHETERODYNES

Increase your range of Sales and Profits

STANDARD BROADCASTS



POLICE, AMATEUR, AVIATION

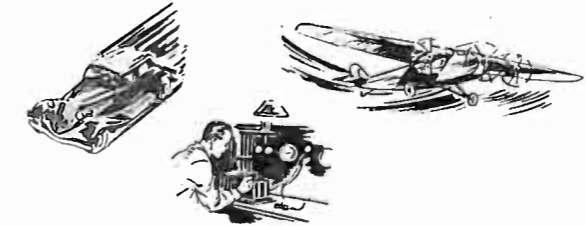

FOREIGN BROADCASTS



THE CROSLY 614EH THREE BAND ALL-WAVE

With this amazing six tube three band all wave radio, your scope of sales and profits is materially increased. In addition to all standard broadcasts it receives foreign, police, amateur, and aviation broadcasts. Exceptionally outstanding quality of tone and performance. Exquisitely designed cabinet.



\$49.95

Complete With Tubes
Western Price Slightly Higher

THE CROSLY 614PG THREE BAND ALL-WAVE (LOWBOY)

A marvelous, all wave receiver for American-Foreign reception and also police, amateur and aviation broadcasts. Choice woods are combined to make this exquisite console cabinet one of the most beautiful of today.



\$65.00

Complete With Tubes
Western Price Slightly Higher

FEATURES—Six-tube Superheterodyne . . . Standard Broadcasts 540-1650 Kc.—Police, Amateur, Aviation Broadcasts 1650-5000 Kc.—Foreign Broadcasts 5800-15,350 Kc. . . Illuminated Airplane Type Dial . . . Automatic Volume Control . . . Continuous Tone Control . . . Two Double Purpose Tubes provide Eight-tube Effectiveness . . . Three Gang Tuning Condenser . . . Full Floating Moving Coil Electro-Dynamic Speaker.

YOU'RE THERE WITH A CROSLY

December 15, 1934

THREE STARS IN A WORLD OF RADIO PROFIT

Glorifying the world's most outstanding radio line are these three brilliant Crosley models. Each is a typical expression of the utmost quality, exquisite beauty, marvelous performance, amazing value that characterize every Crosley Radio—that point the way to a world of radio profit.

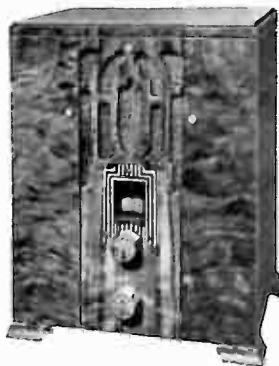

The Crosley Fiver (at the top)—a remarkable five-tube superheterodyne that receives standard broadcasts and some police calls. The world's greatest value—only \$19.99 (Western price slightly higher).

The Crosley Dual Fiver Deluxe (below to the left)—Beyond comparison for its class. Five-tube superheterodyne. Receives police, amateur, aviation, as well as standard broadcasts. Only \$29.95 (Western price slightly higher).

The Crosley Sixty-One A. F. (below to the right)—Bringing the thrill of both American and Foreign broadcasts, here is one of the biggest leaders of today. A six-tube set priced in the range of other five-tube sets for foreign reception. \$39.95 (Western price slightly higher).



WHATEVER HAPPENS YOU'RE THERE WITH A CROSLEY
CROSLEY RADIO